

DECEMBER 4, 1959

# electronics

A MCGRAW-HILL PUBLICATION

VOL. 32, No. 49

PRICE SEVEN DOLLARS FIFTY CENTS



*Special*

**MATERIALS for  
Environmental  
Extremes**

*1523  
Dresson*





# PULSE TRANSFORMERS

## FROM STOCK

**MINIATURE STABLE WOUND CORE**

**HERMETIC MIL-T-27A TYPE TF5SX36ZZ**

UTC miniature, wound core, pulse transformers are precision (individually adjusted under test conditions), high reliability units, hermetically sealed by vacuum molding and suited for service from  $-70^{\circ}\text{C}$ . to  $+130^{\circ}\text{C}$ . Wound core structure provides excellent temperature stability (unlike ferrite). Designs are high inductance type to provide minimum of droop and assure true pulse width, as indicated on chart below. If used for coupling circuit where minimum rise time is important, use next lowest type number. Rise time will be that listed for this lower type number . . . droop will be that listed multiplied by ratio of actual pulse width to value listed for this type number. Blocking oscillator data listed is obtained in standard test circuits shown. Coupling data was obtained with H. P. 212A generator (correlated where necessary) and source/load impedance shown. 1:1:1 ratio.

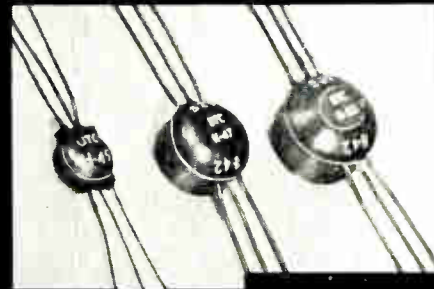

### DEFINITIONS

**Amplitude:** Intersection of leading pulse edge with smooth curve approximating top of pulse.  
**Pulse width:** Microseconds between 50% amplitude points on leading and trailing pulse edges.  
**Rise Time:** Microseconds required to increase from 10% to 90% amplitude.  
**Overshoot:** Percentage by which first excursion of pulse exceeds 100% amplitude.  
**Droop:** Percentage reduction from 100% amplitude a specified time after 100% amplitude point.  
**Backswing:** Negative swing after trailing edge as percentage of 100% amplitude.

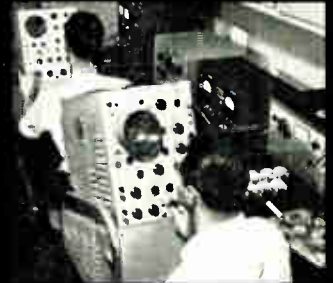

### APPROX. DCR, OHMS | BLOCKING OSCILLATOR PULSE | COUPLING CIRCUIT CHARACTERISTICS

Type No.	1-2	3-4	5-6	Width $\mu\text{Sec.}$	Rise Time	% Over Shoot	Droop %	% Back Swing	P Width $\mu\text{Sec.}$	Volts Out	Rise Time	% Over Shoot	Droop %	% Back Swing	Imp. in. out, ohms
H-45	3	3.5	4	.05	.022	0	20	10	.05	17	.01	20	0	35	250
H-46	5.5	6.5	7	.10	.024	0	25	10	.10	19	.01	30	10	50	250
H-47	3.7	4.0	4	.20	.026	0	25	8	.20	18	.01	30	15	65	500
H-48	5.5	5.8	6	.50	.03	0	20	5	.50	20	.01	30	20	65	500
H-49	8	8.5	9	1	.04	0	20	10	1	24	.02	15	15	65	500
H-50	20	21	22	2	.05	0	20	10	2	27	.05	10	15	35	500
H-51	28	31	33	3	.10	1	20	8	3	26	.07	10	10	35	500
H-52	36	41	44	5	.13	1	25	8	5	23	.15	10	10	45	1000
H-53	37	44	49	7	.28	0	25	8	7	24	.20	10	10	50	1000
H-54	50	58	67	10	.30	0	20	8	10	24	.25	10	10	50	1000
H-55	78	96	112	16	.75	0	20	10	16	23	.40	5	15	20	1000
H-56	93	116	138	20	1.25	0	25	10	20	23	.6	5	10	10	1000
H-57	104	135	165	25	2.0	0	30	10	25	24	1.5	5	10	10	1000
H-60	.124	.14	.05	.05	.016	0	0	30	.05	9.3	.012	0	0	20	50
H-61	.41	.48	.19	.1	.016	0	0	30	.1	8.2	.021	0	0	15	50
H-62	.78	.94	.33	.2	.022	0	0	18	.2	7.4	.034	0	5	12	100
H-63	1.86	2.26	.70	.5	.027	2	10	20	.5	7.5	.045	0	20	25	100
H-64	3.73	4.4	1.33	1	.033	0	12	25	1	7	.078	0	15	23	100
H-65	6.2	7.3	2.22	2	.066	0	15	25	2	6.6	.14	0	10	20	100
H-66	10.2	12	3.6	3	.087	0	18	30	3	6.8	.17	0	10	20	100
H-67	14.5	17.5	5.14	5	.097	0	23	28	5	7.9	.2	0	18	28	200
H-68	42.3	52.1	14.8	10	.14	0	15	28	10	6.5	.4	0	15	30	200

Note: 0 = Negligible

### Vacuum Tube Type Ratio 1:1:1

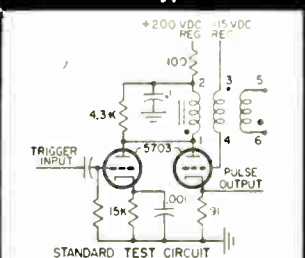

### Transistor Type Ratio 4:4:1

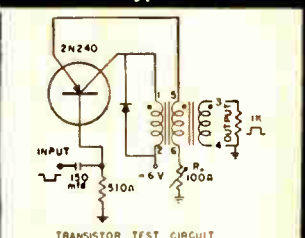

H-45, 46, 60 thru 68 are 3/8 cube, 1 gram

H-47 thru 52, 9/16 cube 4 grams

H-53 thru 57, 5/8 cube 6 grams

## AND SPECIAL UNITS TO YOUR SPECS

While stock items cover low level uses only, most of UTC's production is on

special units to customers' needs, ranging from low levels to 10 megawatts.



Write for Catalog for full details on these and 1000 other stock items

## UNITED TRANSFORMER CORPORATION

150 Varick Street, New York 13, N. Y.

PACIFIC MFG. DIVISION: 4008 W. JEFFERSON BLVD., LOS ANGELES 16, CALIF.  
 EXPORT DIVISION: 13 EAST 40th STREET, NEW YORK 16, N. Y. CABLES: "ARLAB"

A McGRAW-HILL PUBLICATION  
Vol. 32 No. 49

JAMES GIRDWOOD, *Publisher*

W. W. MacDONALD, *Editor*

JOHN M. CARROLL, *Managing Editor*

*Associate Editors:* Frank Leary, Michael F. Tomaino, Howard K. Janis, Sylvester P. Carter, Roland J. Charest, William P. O'Brien, John F. Mason, William E. Bushor, Thomas Emma, Samuel Weber, Sy Vogel, Leslie Solomon, M. M. Perugini, George J. Flynn

*Assistant Editors:* Michael F. Wolff, Nilo Lindgren, Harold M. McKean

*Regional Editors:* Harold C. Hood (Pacific Coast, Los Angeles), Harold Harris (Midwestern, Chicago), Thomas Maguire (New England, Boston)

*Market Research Editor:* Edward DeJongh

*Buyers' Guide Editor:* George Sideris

*Art Director:* Harry Phillips  
*Production Editor:* John C. Wright, Jr.

*Editorial Assistants:* Gloria J. Filippone, Arlene Schilp, Bernice Duffy, Patricia Landers, Carol Weaver, Marian L. Freed, Dolores A. Fornaro, Lorraine Rossi

BRUCE A. WINNER, *Advertising Sales Manager*. R. S. Quint, *Assistant Advertising Sales Manager and Buyers' Guide Manager*. Fred Stewart, *Promotion Manager*. Richard J. Tomlinson, *Production Manager*. George E. Pomeroy, *Classified Manager*. Hugh J. Quinn, *Circulation Manager*

*New York:* Donald H. Miller, Henry M. Shaw, George F. Werner.  
*Boston:* Wm. S. Hodgkinson.  
*Philadelphia:* Warren H. Gardner, William J. Boyle.  
*Chicago:* Harvey W. Wernecke, Martin J. Galloy.  
*Cleveland:* P. T. Fegley, David M. Watson.  
*San Francisco:* T. H. Carmody, R. C. Alcorn.  
*Los Angeles:* Carl W. Dysinger, D. A. McMillan.  
*Denver:* J. Patten.  
*Atlanta:* M. Miller.  
*Dallas:* Gardan L. Janes, Robert T. Wood.  
*London:* E. E. Schirmer, Norman Strick.  
*Frankfurt:* Michael R. Zeynel

## Issue at a Glance

### Business

Germ-Gas Detectors Needed. Exclusive report on chemical warfare.	34
New Bio-Effects of R-F Energy. Studies now seek causes.	38
USSR Improves Computers. What eight U.S. experts found in Russia.	43
What's Next for Transistors. Highlights of Radio Fall Meeting.	46
New Controls for Machines. Emphasis on reliability, upkeep.	51
Gages Guard Great Stone Face. Electronics—and the Old Man.	55
Shoptalk	4
25 Most Active Stocks	21
Electronics Newsletter	11
Market Research	26
Washington Outlook	14
Current Figures	26
Financial Roundup	21
Meetings Ahead	56

### Engineering

B-58 Hustler navigation gear is checked out in Sperry Gyroscope Co. environmental chamber. For what the next generation of planes faces, see p 81. . . . .COVER

Materials for Environmental Extremes. Special report on the materials for high temperature, radiation, corrosion and stress. . . . .By G. Sideris 81

New Developments Revealed at NEC. A look at some National Electronics Conference papers. . . . .By L. Solomon and M. M. Perugini 101

TWT's and Paramps for Low-Noise Reception. These amplifiers will find many new uses. . . . .By D. A. Watkins and G. Wade 106

Synthetic Sapphires for Electronic Components. Compilation of sapphire properties and bonding techniques. . . . .By R. D. Olt 110

Wideband F-M with Variable Capacitance Diodes. Article describes practical vhf and uhf circuits. . . . .By C. Arsem 112

Automatic Measurement of Transistor Beta. System speeds up production testing of transistors. . . . .By E. P. Hojak 114

Radar Jamming Chart. Solves off-target problem. . . . .By R. A. Wall 116

### Departments

Research and Development. Calibrating Microwave Attenuators.	120
Components and Materials. Pyrographite Solves Heat Problems.	124
Production Techniques. Deposition Forms Metals in Plastic.	128
On the Market	132
Plants and People	190
New Books	182
News of Reps	192
Literature of the Week	188
Comment	194

Index to Advertisers. . . . .200

# REGATRAN<sup>®</sup>

## SEMICONDUCTOR

# POWER SUPPLIES...

*Here's reliability . . . Since their introduction, over 24 months ago, not one Regatran has lost a series transistor due to short circuits or overloading.*

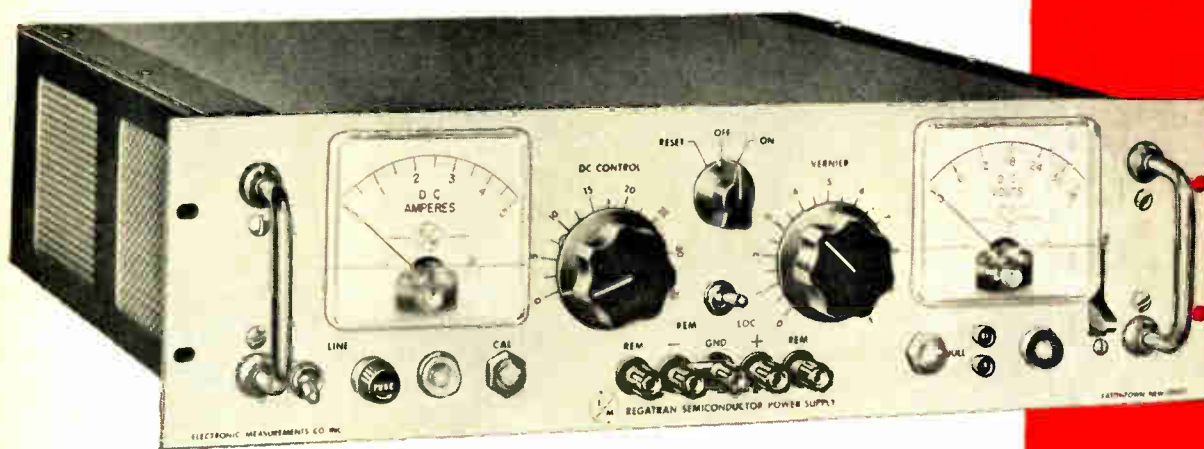

Regatran Semiconductor Power Supplies are available in various ratings up to 0 to 60 V dc and 0 to 30 amperes, depending on model. Write for Bulletin 721.

e/m

ELECTRONIC

MEASUREMENTS

COMPANY OF RED BANK

EATONTOWN · NEW JERSEY

© Regatran is a registered trademark of Electronic Measurements Company of Red Bank.

Patents Pending.

- transistorized
- short circuit proof
- super-regulated
- overload protected
- low output impedance
- lowest ripple
- High-speed regulation
- null balance control

- sensing terminations
- front panel calibration
- any grounding arrangement
- small size, light weight



# SPACE SHRINKERS

**MICROIDS AND MONKEYS** -- Burnell & Co. welcomes the assistance of their simian friends in the task of gathering data vital to space shrinking. By shrinking toroids, filters and related networks for guidance and communication systems, Burnell helps space vehicles carry bigger payloads -- more instrumentation, animals -- eventually man. Typical of our accomplishments is the *MTT MICROID* telemetering band pass filter. Significantly, the combined weight of 23 *MICROIDS* -- plus the monkey -- is less than the single non-miniaturized telemetering band pass filter pictured here. *MICROID* band width is 15% at 3 db -- 60% -- 40% at 40 db. Frequency coverage is from .4 kes to 70 kes.

### Sizes

Channels 1-6	2x27	32x1, 2
Channels 7-10	1-5	16x11/16x11, 16
Channels 11-18	15	16x19/32x1, 2
Alternates A-E	15	16x19 32x1, 2

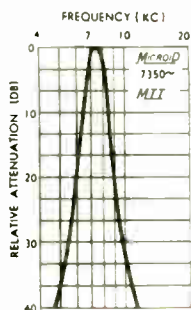

Write for Filter Bulletin MTT 23.

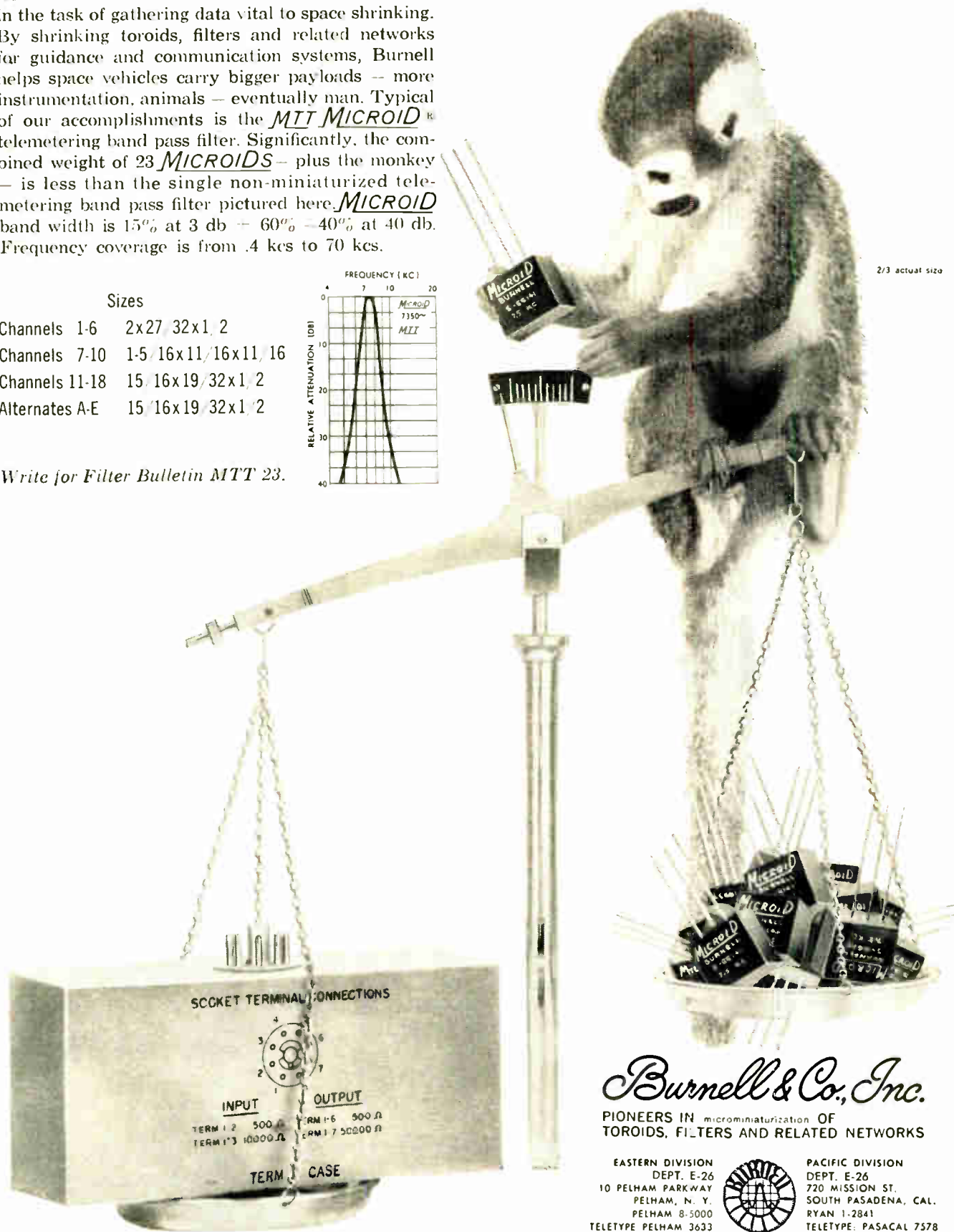

2/3 actual size

*Burnell & Co., Inc.*

PIONEERS IN microminiaturization OF TOROIDS, FILTERS AND RELATED NETWORKS

EASTERN DIVISION  
DEPT. E-26  
10 PELHAM PARKWAY  
PELHAM, N. Y.  
TEL. 8-5000  
TELETYPE PELHAM 3633



PACIFIC DIVISION  
DEPT. E-26  
720 MISSION ST.  
SOUTH PASADENA, CAL.  
RYAN 1-2841  
TELETYPE: PASACAL 7578

# SHOPTALK . . . editorial

## electronics

December 4, 1959 Vol. 32, No. 49

Published weekly, including the ELECTRONICS BUYERS' GUIDE and REFERENCE Issue in mid-June as part of the subscription, by McGraw-Hill Publishing Company, Inc., James H. McGraw (1860-1948) Founder.

Executive, Editorial, Circulation and Advertising Offices: McGraw-Hill Building, 330 W. 42 St., New York 36, N. Y. Longacre 4-3000. Publication Office: 99-129 North Broadway, Albany 1, N. Y.

See panel below for directions regarding subscriptions or change of address. Donald C. McGraw, President; Joseph A. Gerardi, Executive Vice President; L. Keith Goodrich, Vice President and Treasurer; John J. Cooke, Secretary; Nelson L. Bond, President, Publications Division; Shelton Fisher, Senior Vice President; John R. Callahan, Vice President and Editorial Director; Joseph H. Allen, Vice President and Director of Advertising Sales; A. R. Venezian, Vice President and Circulation Coordinator.

Single copies in the United States, U. S. possessions & Canada 75¢; \$1.50 for all other foreign countries. Buyers' Guide in the United States, U. S. possessions & Canada \$3.00; all other foreign \$10.00. Subscription rates—United States and possessions, \$6.00 a year; \$9.00 for two years; \$12.00 for three years. Canada, \$10.00 a year; \$16.00 for two years; \$20.00 for three years. All other countries, \$20.00 a year; \$30.00 for two years; \$40.00 for three years. Second class postage paid at Albany, N. Y. Printed in U.S.A. Copyright 1959 by McGraw-Hill Publishing Co., Inc.—All Rights Reserved. Title registered in U. S. Patent Office. BRANCH OFFICES: 520 North Michigan Avenue, Chicago 11; 68 Post Street, San Francisco 4; McGraw-Hill House, London E. C. 4; 85, Westendstrasse, Frankfurt/Main; National Press Bldg., Washington 4, D. C.; Six Penn Center Plaza, Philadelphia 3; 1111 Henry W. Oliver Bldg., Pittsburgh 22; 55 Public Square, Cleveland 13; 856 Penobscot Bldg., Detroit 26; 3615 Olive St., St. Louis 8; 350 Park Square Bldg., Boston 16; 1301 Rhodes-Haverty Bldg., Atlanta 3; 1125 West Sixth St., Los Angeles 17; 1740 Broadway, Denver 2; 901 Vaughn Bldg., Dallas 1. ELECTRONICS is indexed regularly in The Engineering Index.

Subscription: Address correspondence to: Fulfillment Manager, Electronics, 330 W. 42nd St., New York 36, N. Y. Allow one month for change of address, stating old as well as new address, including postal zone if any. Subscriptions are solicited only from persons engaged in theory, research, design, production, management, maintenance and use of electronics and industrial control components, parts and products. POSITION and COMPANY CONNECTION must be indicated on subscription orders.

Postmaster: please send form 3579 to Electronics, 330 W. 42nd St., New York 36, N. Y.



Member ABP and ABC

**SILENT DEATH.** The U.S. is spending billions for defense against manned bombers, ballistic missiles and submarines but little for defense against chemical and biological warfare.

CW and BW are silent but deadly. They can turn the air we breathe, the food we eat, the water we drink against us. They can be spread by wind, water current or saboteurs. Areas can even be seeded with deadly disease germs that are dormant until irradiated.

Modern chemical agents can't be detected by the keenest nose. Colorless and odorless, they defy detection and can at least destroy judgment when judgment is needed most. The culture, slide and microscope technique doesn't work fast enough in identifying germs. Not when trigger-quick action is required to head off planted epidemics.

There are electronic instruments to detect gas. Some rely on infrared spectroscopy. There are television-like instruments to warn against unusual concentrations of airborne germs.

The Army Chemical Corps has some of this equipment. Civil Defense none. More is needed to insure against attack today. Much more research is needed to develop new instruments for use tomorrow.

*W W Mac Donald*

EDITOR

### Coming In Our December 11 Issue . . .

**MICROMINIATURIZATION.** Some of the most intensive research effort in our industry lies in the field of microminiaturization. Various techniques are being tried in an attempt to cram as many electronic components into a cubic inch as possible.

Some researchers stress the design of integrated circuits (ELECTRONICS, p 35, June 26), while others concentrate on developing micromodules (p 51, May 22).

Next week, R. Langford of Weston Instruments in Newark, N. J., describes the limitations and possible future applications of three approaches to microminiaturization.

From one of these approaches—the concept of the integrated or solid circuit—packing densities of 500 million parts per cubic inch are foreseen.

**NOISE.** Communication system designers are continually seeking out new ways to improve signal to noise ratio. A radio system for high noise paths has been developed at N. V. Philips' Gloeilampenfabrieken in Eindhoven, Netherlands. J. A. Greefkes and F. de Jager claim their new system works at times when noise causes other radio links to fail.

Basic idea of the system is to split voice sounds into frequency and amplitude components, then transmit the two types of information on separate channels and, finally, recombine the separate components into the original sounds.

**MIXER DESIGN.** When two frequencies are heterodyned in a non-linear device, a great number of spurious responses is obtained in addition to the desired sum or difference frequency. R. F. Baum of W. L. Maxson Corp. in New York City presents some nomographs that will help circuit designers find which unwanted harmonics of the two signals will cause interference.



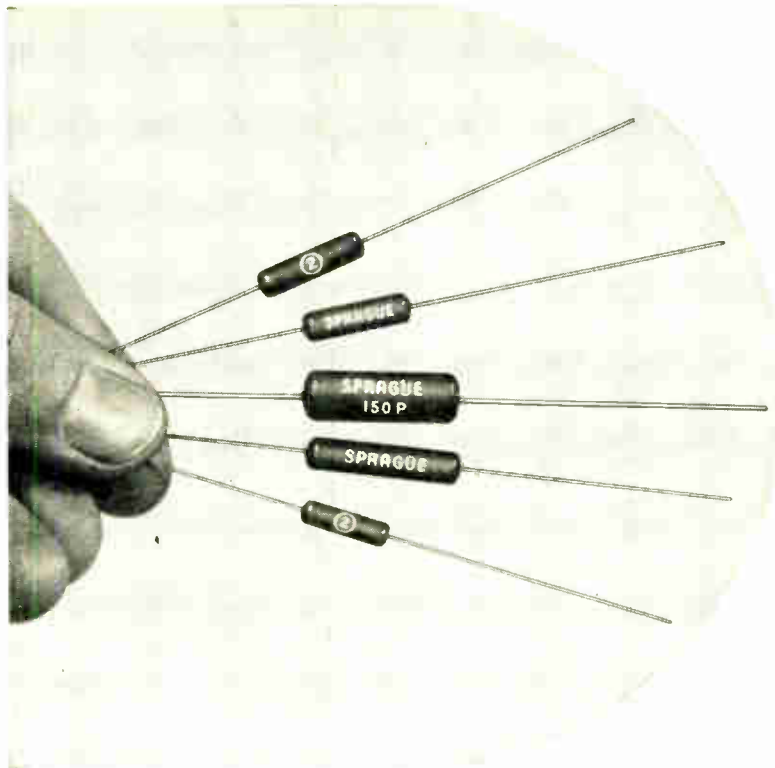

**Miniature**

# **PROKAR® 'D' Molded Capacitors**

**--with improved moisture resistance and  
a new dual dielectric for 125 C operation  
without voltage derating**

Sprague's new and improved PROKAR 'D' Molded Tubular Capacitors meet the need for *ever smaller* molded capacitors capable of withstanding 125 C operation in military, commercial, and industrial electronics.

Key to the new design is an improved processing technique which greatly increases moisture resistance. The new dual dielectric used in Type 150P Capacitors combines the dielectric strength of the highest grade capacitor tissue with the effective moisture resistance of plastic film, giving these miniature units high insulation resistance plus extended life at 125 C. The impregnant used is still the same exclusive high temperature organic material which marked a milestone in molded capacitor development for the original Prokar series.

The improved performance of PROKAR 'D' Capacitors is worth investigating—greater resistance to humidity, high insulation resistance (minimum of 10 megohm-microfarads at 125 C), moderate capacitance change with temperature, longer life, and improved reliability.

*For complete specifications on Type 150P PROKAR 'D' Molded Tubular Capacitors, write for Engineering Bulletin 2300 to Technical Literature Section, Sprague Electric Company, 35 Marshall St., North Adams, Mass.*



SPRAGUE COMPONENTS:

CAPACITORS • RESISTORS • MAGNETIC COMPONENTS • TRANSISTORS • INTERFERENCE FILTERS • PULSE NETWORKS  
HIGH TEMPERATURE MAGNET WIRE • CERAMIC-BASE PRINTED NETWORKS • PACKAGED COMPONENT ASSEMBLIES

# General Plate TRUFLEX Thermostat Metal Assures CONSISTENT SENSITIVITY AND ACCURACY... In SIGNET CONTROLS

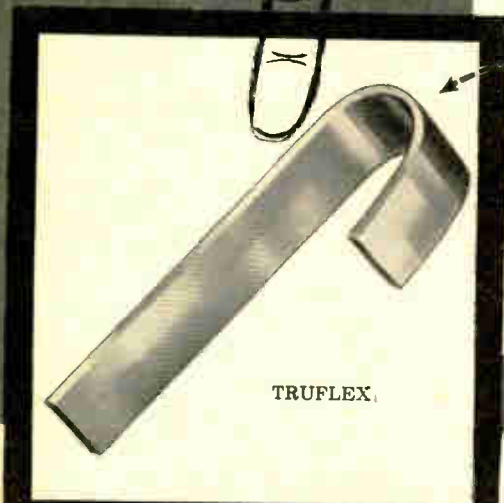
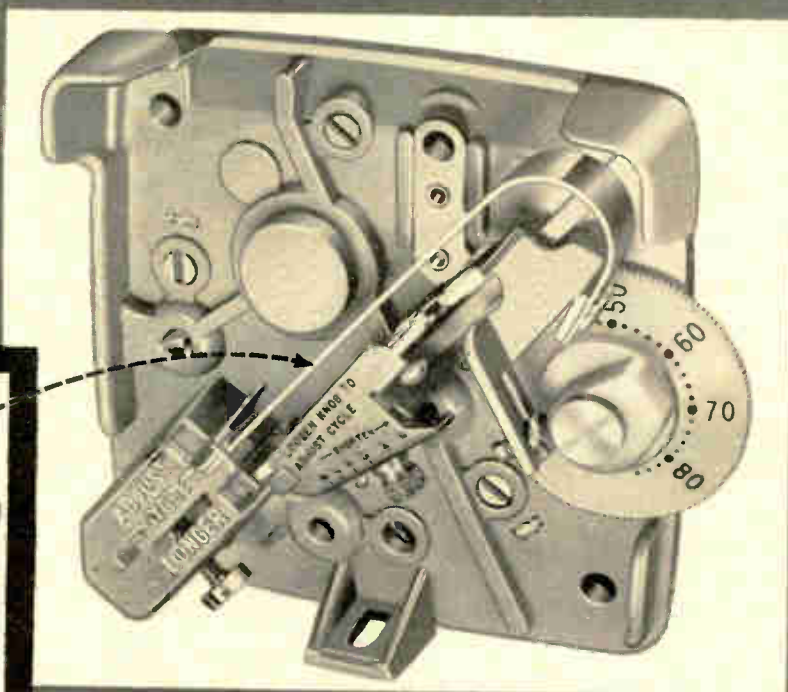

TRUFLEX.



A few typical Truflex fabricated parts

In designing its new attractive thermostat Signet Controls turned to General Plate for Truflex Thermostat Metal. Here's how Mr. W. D. Gibson, Manager of Signet Controls, puts it:

*"The heart of a thermostat is the temperature-responsive element. In designing our new Model T500 we were careful to select a thermostatic material which would be consistently sensitive and accurate. Our previous experience assured us that we would obtain these vital characteristics with Truflex Thermostat material."*

When you buy General Plate Truflex Thermostat Metal you can be sure that the first lot meets specifications 100% and every succeeding lot is a duplicate . . . has identical characteristics to the original . . . whether it be manufactured days, months or years later.

Advanced General Plate production methods insure positive consistency in tolerances, grain structures, expansion, hardness, etc. They assure maximum uniformity of materials which reduces costly rejects and guarantees highest quality performance.

Truflex Thermostat Metals are available as fabricated elements, assemblies and extra long coils or flat strip. Write for information.



## METALS & CONTROLS

1912 FOREST STREET, ATTLEBORO, MASS., U. S. A.

A DIVISION OF TEXAS INSTRUMENTS INCORPORATED

GENERAL PLATE PRODUCTS: Clad Metals • Electrical Contacts • Truflex® Thermostat Metal • Platinum Metals • Reactor Metals • Radio Tube & Transistor Metals

6 CIRCLE 6 ON READER SERVICE CARD



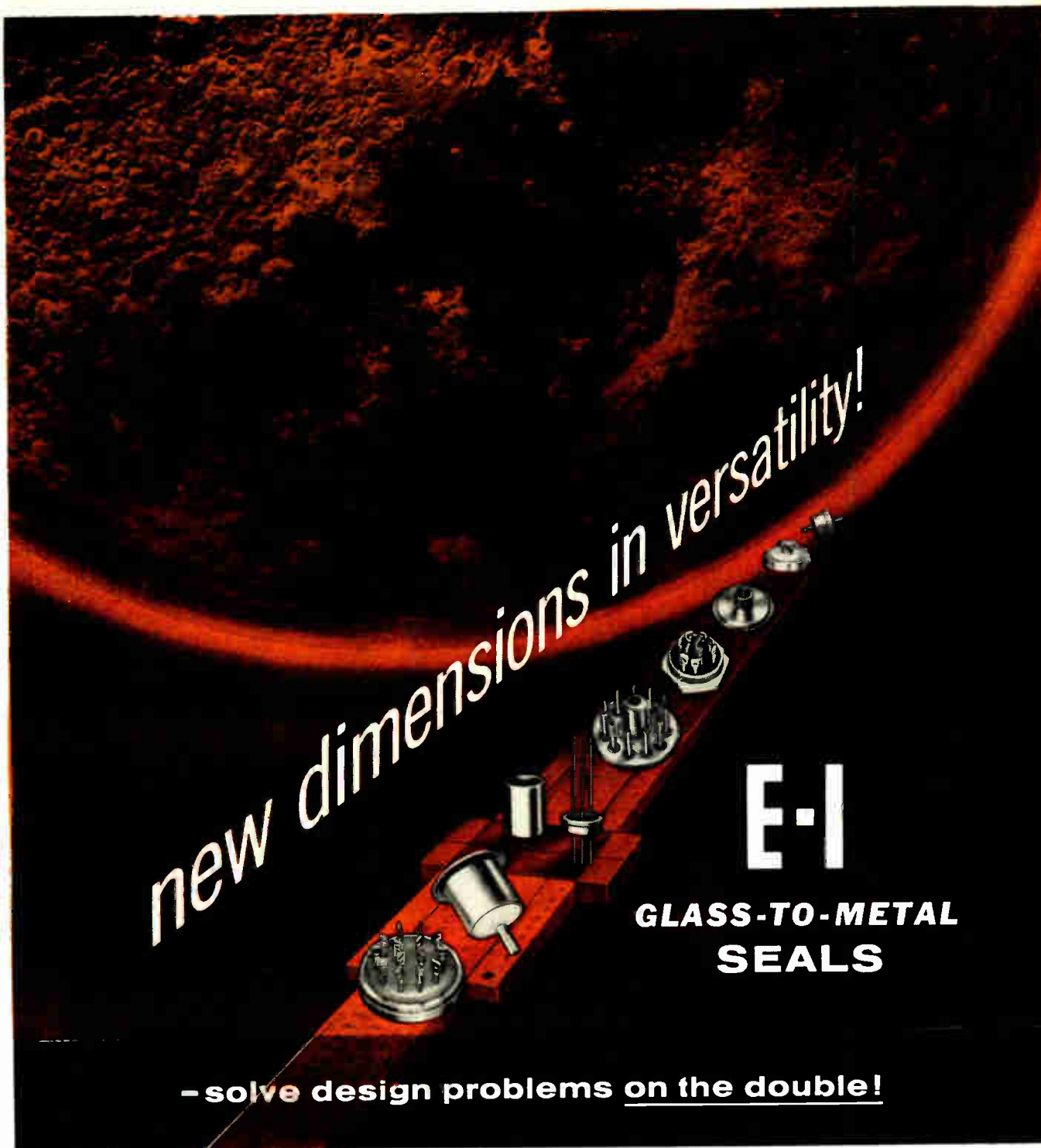

*new dimensions in versatility!*

**E-I**

**GLASS-TO-METAL  
SEALS**

**- solve design problems on the double!**

**COMPRESSION SEALS  
MULTIPLE HEADERS  
SEALED TERMINALS  
CONDENSER END SEALS  
THREADED SEALS  
TRANSISTOR CLOSURES  
MINIATURE CLOSURES  
COLOR CODED TERMINALS  
CUSTOM SEALING**

**THE MOST COMPLETE LINE OF STANDARD TERMINALS-**  
Specifying E-I sealed terminations means you are assured of the widest possible design latitude. E-I offers the engineer/designer the industry's most complete standard line of sealed terminals and miniature components . . . proven reliability in today's most critical applications . . . custom designing for unusual requirements . . . and custom sealing service on components of your manufacture. Call or write for illustrated bulletins and complete information on standard terminals, or send sketches and details for quotations on custom types you require.

Patented in Canada, No. 523,390;  
in United Kingdom, No. 734,583;  
licensed in U. S. under No. 2561520



**ELECTRICAL INDUSTRIES**

*A Division of Philips Electronics  
& Pharmaceutical Industries Corp.* **MURRAY HILL, NEW JERSEY**

# BROAD

*with these convenient, precision*

## NEW AMPLIFIER!

Just clamp on probe and read current instantly!



hp 154A Voltage/Current Dual Channel Amplifier

### SPECIFICATIONS

(When plugged into -hp- 150A/AR Oscilloscope)

#### CURRENT CHANNEL

- Band Pass:** 50 cps to 8 MC.  
**Sensitivity:** 10 calibrated ranges, 1 to 1,000 ma/cm, 1, 2, 5, 10 sequence. Accuracy  $\pm 5\%$ . Vernier between steps (extends 1,000 ma/cm range to at least 2,500 ma/cm).  
**Max ac Current:** 10 amperes rms 20 KC and above. Below 20 KC core saturation reduces current capability proportional to frequency.  
**Max dc Current:** Direct current to  $\frac{1}{2}$  amp has no appreciable effect.  
**Input Impedance:** Approx. 0.01 ohm shunted by 0.8 uh.

#### VOLTAGE CHANNEL

- Band Pass:** dc coupled: dc to 10 MC, 0.035  $\mu$ sec rise time.  
ac coupled: 2 cps to 10 MC, 0.035  $\mu$ sec rise time.  
**Sensitivity:** 9 calibrated ranges, 0.05 to 20 v/cm; 1, 2, 5, 10 sequence. Accuracy  $\pm 5\%$ . Vernier between steps.  
**Input Impedance:** 1 megohm (nominal), 30 uuf shunt.

#### GENERAL

- Vertical Presentation:** (1) Either voltage or current signal continuously or (2) voltage and current signals sampled at 100 KC or on alternate traces.  
**Vertical Position:** Each channel individually adjustable.  
**Price:** \$430.00 (includes current probe).

The new hp 154A's exclusive "clamp-around" probe permits fast, direct measurement of current from 50 cps to 8 MC, 1 ma to 15 amperes (peak-to-peak) *without breaking into the circuit, loading, or voltage drop due to resistor insertion*. Here is a time-saving convenience feature of real significance in the investigation of transistors, logic circuits and other measurements where current information is of prime importance.

In addition, the 154A — actually two instruments in one — makes possible swift, simple and direct comparison between voltage and current waveforms. In this comparison service, one section of the 154A reads current while the other reads voltage in a manner identical with other hp voltage indicating instruments. Comparison is achieved by electronic channel switching — through alternate sweeps or 100 KC chopping. Either of the 154A's dual channels may also be used individually.



now offers better-than-ever service



# EN

## the utility of your 150 A/AR oscilloscopes

### amplifiers and accessories

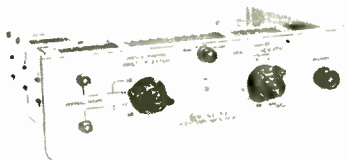
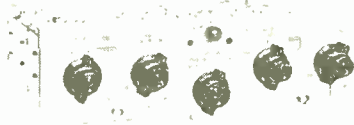

Ⓜ 152B Dual Trace Differential Amplifier. New plug-in amplifier providing differential input and dual traces electronically switched between A and B channels at either 100 KC or on alternate sweeps. Sensitivity range 0.05 v/cm to 50 v/cm, input attenuator with 9 calibrated ranges in 1, 2, 5, 10 sequence and vernier. \$250.00.

Ⓜ 153A Very High Gain Amplifier. New plug-in permitting 150A to be used for many direct measurements from transducer without *preamplification*. Pass band dc to 500 KC, sensitivity 1 mv/cm to 125 v/cm, balanced input on all ranges. 15 calibrated ranges in 1, 2, 5, 10 sequence, 1 mv/cm to 50 v/cm; plus vernier. \$125.00.

Ⓜ 151B High Gain Amplifier. For 150A high gain unit with 5.0 mv/cm sensitivity; frequency response dc to 10 MC. 12 calibrated ranges on 1, 2, 5, 10 sequence, 5 mv/cm to 20 v/cm; accuracy  $\pm$  5%. Vernier adjustment. 1 megohm input impedance with 31 uuf shunt. Pass band rise time 0.035  $\mu$ sec. Has 2 BNC terminals. \$200.00.

Ⓜ 196A Oscilloscope Camera. All new, most useful scope camera ever. Full-size, distortion free pictures; full picture area may be scaled. Simple multiple exposures; with one hand move lens through 11 detented positions. Pictures sharp, clear, compare to CRT resolution. Professional bellows prevents light leaks; easy tab pulling; set f-stop and shutter without removing camera from scope; mount on scope with one hand. Employs Polaroid® Land Camera back, new *flat* Wollensak 3" f/1.9 lens. Wt. 9 lbs. \$425.00.

Ⓜ AC-115A Oscilloscope Testmobile. For 150 series oscilloscopes but fits others. 4" rubber tired wheels, heavy chrome tube construction, tilts 'scope to 30° in 7½° increments, folds for storage, shipping. \$80.00 Ⓜ AC-116A Storage Unit fastens to Ⓜ AC-115A, holds 150A plug-ins or Ⓜ AC-117A Accessory Drawers. Ⓜ AC-116A, \$22.50. Ⓜ AC-117A, \$10.00.

Data subject to change without notice. Prices f.o.b. factory

## HEWLETT-PACKARD COMPANY

1002 Page Mill Road • Palo Alto, California, U.S.A.  
Cable "HEWPACK" • Davenport 5-4451  
Hewlett-Packard S.A., Rue du Vieux Billard No. 1, Geneva, Switzerland  
Cable "HEWPACKSA" • Tel. No. (022) 26.43.36

### NOW! Ⓜ IN EUROPE!



In 1959, Hewlett-Packard S.A. was established in Geneva and a branch opened in Frankfurt am Main offering technical sales and engineering help and information. Previously established relationships with representatives in other parts of Europe of course continue. In addition, there is now an Ⓜ warehouse in Basel stocking instruments and parts, and an Ⓜ factory near Stuttgart producing Ⓜ instruments for customers throughout Europe.

# to our customers in Europe!

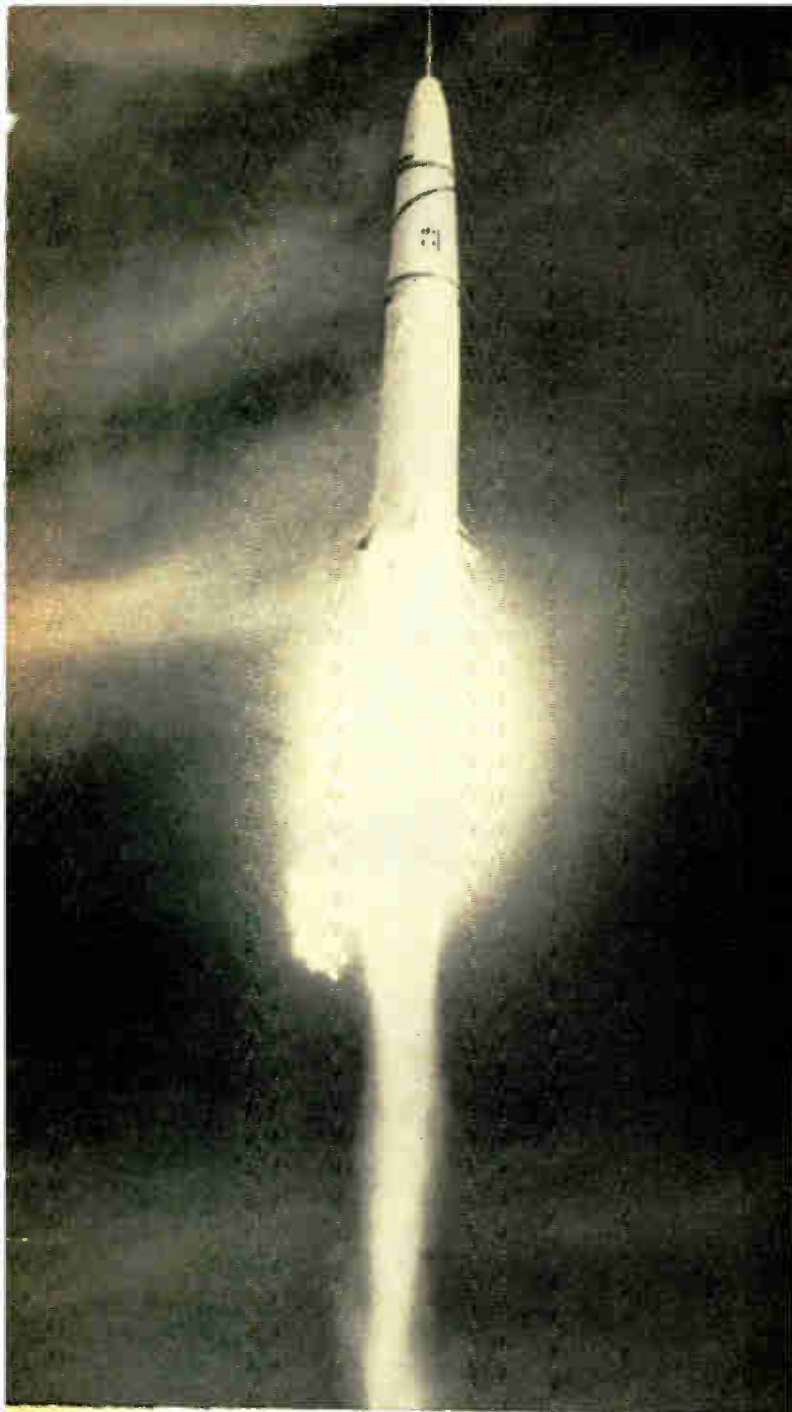

## EIMAC CERAMIC-METAL REFLEX KLYSTRONS FOR SEVERE ENVIRONMENT APPLICATIONS

In modern airborne and missile systems, reflex klystrons must be capable of maintaining exceptional frequency stability under conditions of severe shock, vibration and acceleration. Eimac's new ruggedized X- and K-Band reflex klystrons achieve this stability through an advanced system of stacked-ceramic construction and integral brazed 'dual-cavity' design.

Ceramic construction permits internal electrodes to be supported on rigid concentric cones and allows the entire vacuum assembly to be furnace-brazed into a single rugged structure. The resonant cavity design consists of a fixed-tuned (and hence rugged) inner cavity closely coupled through a ceramic window to a secondary tunable cavity outside the vacuum envelope. The external cavity is tuned by means of a capacitive slug over a minimum range of 700 megacycles per tube.

This advanced design has resulted in a series of four exceptionally stable reflex klystrons covering the 8500 to 11,500 megacycle range at a typical output power level of 75 milliwatts. At vibration levels of 15 to 20G the peak-to-peak deviation of these tubes is less than 50 kilocycles for any vibrating frequency from 20 to 2000 cycles per second, with the force applied in any plane of the tube. The advantage of this low FM noise level in local oscillator service is obvious. Ceramic construction and the superior tube manufacturing techniques it makes possible permit tube or seal temperatures of 250°C without impairment of operation.

For severe environment microwave applications investigate the advantages of Eimac ceramic-metal reflex klystrons.



**EITEL-McCULLOUGH, INC.**  
San Carlos, California





## **ELECTRONICS NEWSLETTER**

**ORBITING COMMERCIAL NAVIGATION SYSTEM** for use by mariners is proposed by Bendix Aviation. A. C. Gilbert, director of the company's Space Long Range Planning division, suggests that a transmitter could be included among the instruments aboard a NASA satellite without impairing the satellite's scientific objectives. Commercial ship owners could then buy receivers at from \$1,000 to \$2,000 each. Apparently the Bendix system would not use the "radiotelescope" principle on which the planned Navy navigation satellite *Transit* is based. To use *Transit*, the satellite's precise position must be known and predictable long in advance at all times. Azimuth and elevation of the radio beam from *Transit* will be measured by surface ships and aircraft as if the man-made satellite were a star; lines of position will be calculated by prepared tables. Though Bendix does not disclose how its system will operate, Gilbert says a stable predictable orbit is not required.

*Pinhead-sized electronic gear for space vehicles was predicted by scientists at last month's American Rocket Society meeting. Gene Strull of Westinghouse's Semiconductor division, Baltimore, described a light telemetry system which, besides power supply and load, consists of a single semiconductor wafer 1/1,000 of a cubic inch.*

**ATLAS ICBM SIGNAL FAILURE** when the vehicle's speed reaches about 6,800 mph, at altitudes under 55 miles, was also reported at the American Rocket Society meeting. Edward Niemann, Jr. of GE's Missile and Space Vehicle department, reported the failure was almost instantaneous, with transmission resuming after several seconds. Max Lowy of Data Control Systems, Inc., Danbury, Conn., said the phenomenon might be a problem in Project Mercury, which is expected to use the Atlas as a booster for a manned space satellite. Data on thrust chamber pressure was among signals that faded.

*Radio-controlled winged booster, half aircraft and half missile, is proposed as a means of recovering costly rocket boosters by Rudi P. Buschmann of Lockheed's Advanced Design division. He said present boosters cost from \$1,000 to \$10,000 per pound of payload, added that a vehicle brought back to earth would almost halve booster costs.*

**NEW OCEANOGRAPHIC VESSEL** for Woods Hole Oceanographic Institution will be provided by a \$3-million National Science Foundation grant. NSF Director Alan T. Waterman called the grant a "first step" in meeting the need for adequate research vessels. (On the need, see **ELECTRONICS**, p 40, Nov. 20). The new ship, a "distinctive" research vessel which evolved from design studies previously supported by NSF, will replace the 28-year-old *R/V Atlantis* of WHOI's fleet. Another sign of new civilian oceanographic effort is NSF's

announcement of the appointment of John Lyman as Associate Program Director (Oceanography) for Earth Sciences. He was formerly director of the division of oceanography of the U. S. Navy Hydrographic Office.

*Analog-to-digital conversion system that will simultaneously sample as many as 15 sonar or other analog inputs at rates up to 17,000 per second is being developed for the U. S. Navy Electronics Laboratory, San Diego, by Packard Bell Electronics.*

**INFORMATION HANDLING** at a 30-million-word-a-second rate is possible with several devices reportedly created at Sperry Gyroscope, Great Neck, N. Y., a Sperry Rand division. The devices were created, says the company, "for the purpose of developing computers and communications systems capable of handling large amounts of information at speeds at least 1,000 times faster than large electronic computers currently in use." One device is a microwave diode which switches 700 million bits of information a second; another is a microwave amplifier tube which performs logic operations at the rate of 1 billion times a second.

**SATELLITE POSSIBILITIES** which the Strategic Air Command feels should be explored include satellites with reconnaissance capability, communications satellites and those with built-in know-how needed to launch, if necessary, a warhead from orbit. Some may be used to intercept others and put them out of operation, or for electronic surveillance of the increasing orbital traffic. "If the occasion demands," says SAC, "satellites will one day be able to jam enemy radars or toss a high-frequency monkey wrench into enemy communications networks." SAC adds that contracts for much of this "hardware" have already been let.

*Bendix is readying production plans for a new general-purpose computer in the medium-to-large range. System will be designated the G-20, is due on the market next year.*

**SEAWARD EXTENSION OF SAGE** will be accomplished under a new contract for Airborne Long Range Input (ALRI), which will amount to about \$35 million in its first stages and has just been awarded to Burroughs by the Air Materiel Command, Dayton, Ohio. Burroughs' system management contract runs for 42 months, with some 50 to 60 percent of the work to be placed with subcontractors.

**CANADIAN MICROWAVE SYSTEM** running 142 miles from Rimouski, Quebec, to New Carlisle, N. B. is expected to be completed in June, 1960. System which is being built by Canadian Pacific Communications, will carry French-language tv, may be expanded later.



**MINOXO  
INDICATOR**

**SUPER-SENSITIVE  
DEOXO INDICATOR**

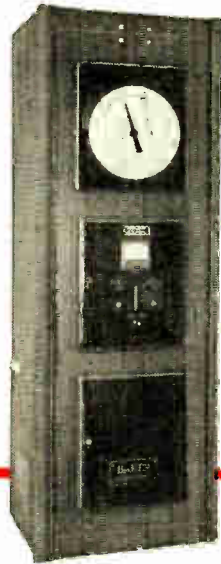

**for detection  
and measurement  
of oxygen or hydrogen  
impurities in other gases**

**MINOXO INDICATOR** . . . measures traces of molecular oxygen in other gases—from 1 to 10 parts per million, and from 1 to 100 PPM. High sensitivity and rapid speed of response enable it to be used for laboratory investigation and production quality control.

**SUPER-SENSITIVE DEOXO INDICATOR** . . . measures oxygen or hydrogen present as impurities in other gases—from 2 to 200 parts per million oxygen and 4 to 400 parts per million hydrogen. Dual range permits measurement up to .25% oxygen or .50% hydrogen. Send for literature.

CHEMICAL DIVISION • 113 ASTOR STREET  
NEWARK, N. J.

CIRCLE 81 READERS SERVICE CARD



**CHEMICAL  
DIVISION**

**WRITE FOR LITERATURE**



**H. A. WILSON  
DIVISION**

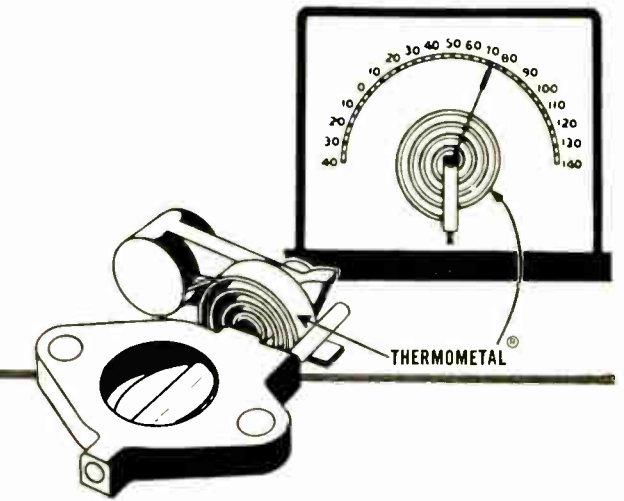

**THERMOMETAL® for  
dependable temperature,  
electrical current and  
voltage control applications**

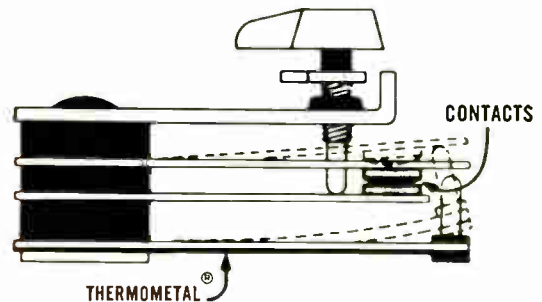

Leading manufacturers depend upon the outstanding performance of Thermometal in electrical appliances, thermal cutouts, heating controls and many other applications involving the indication and accurate control of temperatures, electrical currents, voltages, etc. Thermometal is supplied in strip form, rolled and slit to close tolerances and tempered to specification. Thermometal elements and sub-assemblies are also supplied to specifications, with or without contacts attached. Send for literature.

H. A. WILSON DIVISION • U.S. HIGHWAY 22  
UNION, N. J.

CIRCLE 82 READERS SERVICE CARD

**DOMESTIC DIVISIONS:** AMERICAN PLATINUM & SILVER DIVISION, AMERSIL QUARTZ DIVISION, BAKER CONTACT DIVISION, BAKER DENTAL DIVISION, BAKER SETTING DIVISION, BAKER PLATINUM DIVISION, CHEMICAL DIVISION, EAST NEWARK INDUSTRIAL CENTER, HANOVIA LAMP DIVISION, HANOVIA LIQUID GOLD DIVISION, IRVINGTON-BAKER REFINING DIVISION, D. E. MAKEPEACE DIVISION, NATIONAL ELECTRIC INSTRUMENT DIVISION, RESEARCH AND DEVELOPMENT DIVISION, H. A. WILSON DIVISION. **COMPANIES ABROAD:** ENGELHARD INDUSTRIES OF CANADA, LTD. TORONTO, ENGELHARD INDUSTRIES OF QUEBEC, LTD. MONTREAL, ENGELHARD INDUSTRIES, LTD. LONDON, ENGELHARD INDUSTRIES A. G. ZURICH, ENGELHARD INDUSTRIES PTY., LTD. MELBOURNE, SOCIEDAD SURAMERICANA DE METALES PRECIOSOS S. A. BOGOTA, INDUSTRIE ENGELHARD S. P. A. ROME, ENGELHARD INDUSTRIES OF SOUTHERN AFRICA, LTD. JOHANNESBURG. **ASSOCIATED COMPANIES:** ACME TIMBER INDUSTRIES, LTD., SOUTH AFRICAN FOREST INVESTMENTS LTD., SOUTH AFRICA, AZOPLATE CORPORATION, CHARLES ENGELHARD, INC., NUCLEAR CORP. OF AMERICA, INC., U.S.A.



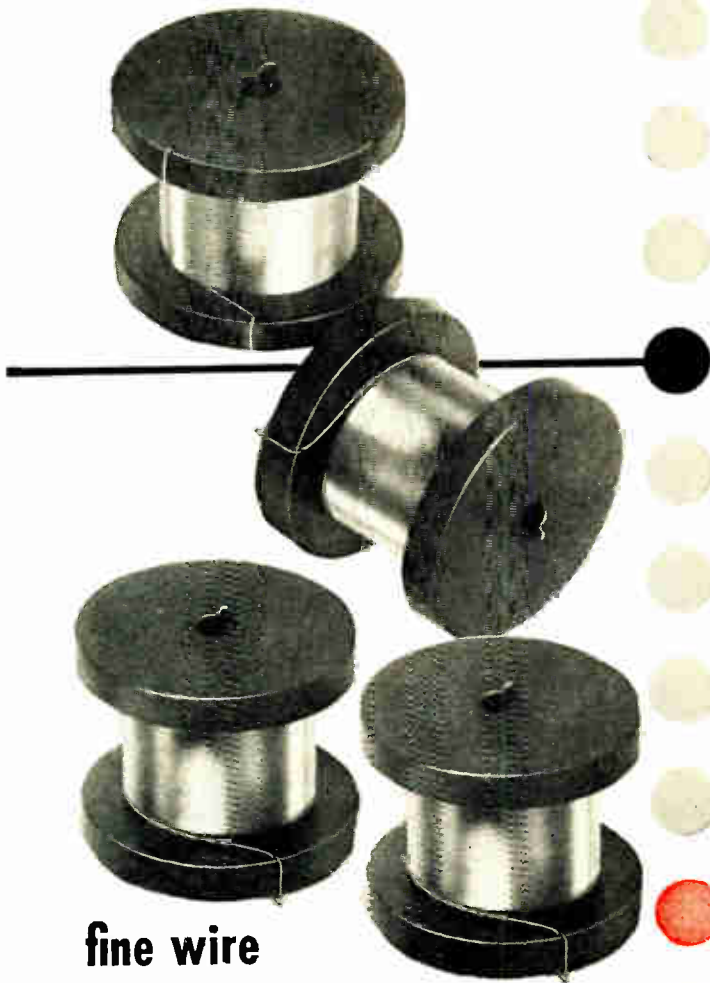

## fine wire for every application

Here, you will find a thoroughly dependable source for fine wire of ductile and non-ductile materials for every application. Special processes have been developed for bare drawing wire as fine as .0004". Where smaller fine wire is required, the Woilaston Process for ductile metals and the Taylor and Extrusion methods for non-ductile materials are employed. All standard fine wire requirements are stocked for prompt delivery. Full facilities are available for the production of fine wires made to your own specifications.

BAKER PLATINUM DIVISION • 113 ASTOR STREET  
NEWARK, N. J.

CIRCLE 83 READERS SERVICE CARD

BAKER  
PLATINUM  
DIVISION

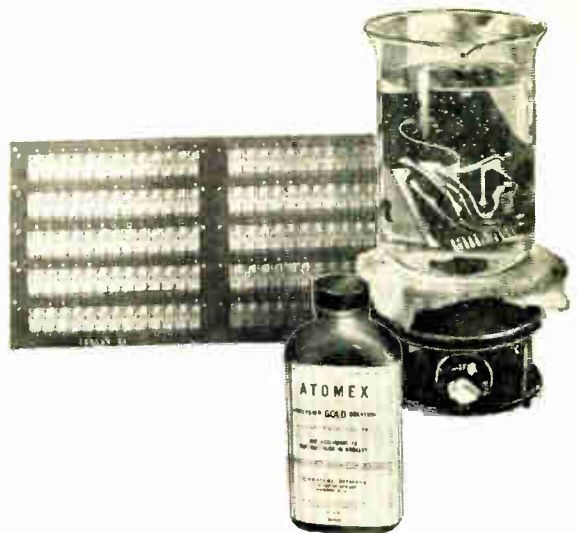

## gold and rhodium plating for corrosion-resistant surfaces

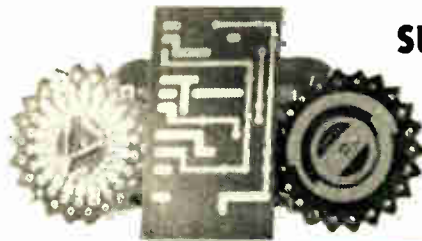

**ATOMEX<sup>®</sup>** is a 24k gold immersion solution that permits the deposition of a thin, dense, uniform layer of 24k gold on printed circuits and metalized plastics by means of a simple bath. The Atomex procedure is more permanent and less expensive than electroplating of comparable thickness. Costly analytical control is unnecessary.

**Rhodium**—a complete line of plating solutions are also available for high-reliability electrical and electronic applications. Rhodium is highly resistant to corrosive atmospheres, oxidation and arc erosion—reduces wear on moving surfaces—assures low noise level for moving contacts, no oxide rectification, low and stable contact resistance. Rhodium plating is indicated when a low-resistance, long-wearing, oxide-free contact is required. Send for literature.

CHEMICAL DIVISION • 113 ASTOR STREET  
NEWARK, N. J.

CIRCLE 84 READERS  
SERVICE CARD

ENGELHARD INDUSTRIES, INC.

EXECUTIVE OFFICES:  
113 ASTOR STREET • NEWARK 2, NEW JERSEY

CHEMICAL  
DIVISION



## COMPLETE LINE + FAST SERVICE = HIPERSIL CORES

Westinghouse stocks all types and sizes of Hipersil cores in three locations to serve you better

**COMPLETE LINE** includes the new EIA, RS-217 standard sizes.

- Type C: 12.4, 2 and 1 mil sizes, in single- and 3-phase, from a fraction of an ounce to 300 pounds.
- Ring Cores: with new polyclad treatment—assure best magnetic performance of any Epoxy resin-coated core ready to receive windings.
- Special Cores: to any specification and shape requirement—rectangular, triangular and others.

**FAST SERVICE** is assured by complete stocks at Greenville, Pa.; Boston, Mass.; and Los Angeles, Calif.

Performance of Hipersil® cores in "iron-core" components is guaranteed to meet or exceed specifications.

For more facts, write for Price List 44-520 and Descriptive Bulletin 44-550 to Westinghouse Electric Corporation, P.O. Box 868, Pittsburgh 30, Pa. J-70920

YOU CAN BE **SURE**... IF IT'S  
**Westinghouse**

WATCH WESTINGHOUSE LUCILLE BALL-DESI APNAZ SHOWS\*  
ON TV, FRIDAYS

# WASHINGTON OUTLOOK

DEFENSE DEPARTMENT continues to enforce its go-slow policy in Army countermissile development. For fiscal 1961, the Army requested \$300-million for continued research and development on the Nike-Zeus anti-ICBM and at least \$700 million to begin production of subsystems and components. The Pentagon approved the R&D request but turned down the production plans.

Defense Department officials say they want to wait until the Zeus can be tested as an entire system—which isn't likely to occur before 1962. They also express doubts about the feasibility of meeting the threat of salvos of ballistic missiles with the Zeus system. Consensus of high Pentagon officials—faced with serious budgetary pressures—seems to be that the \$300 million for continued R&D is a reasonable hedge bet, but that production is unlikely.

Meanwhile, the ballistic-missile early-warning system is proceeding on schedule. If all goes well, ELECTRONICS learns, the three stations of the BMEWS network will be in at least partial operation sometime next year—long before an effective countermissile could possibly be developed to throw up against an attack.

- **Turmoil over government patent policies** is due to be revived. In recent months, industry has plumped for liberalization of the patent policy of National Aeronautics & Space Administration. NASA policy reserves to the government all patent rights on inventions developed under the agency's contracts. This differs from the Pentagon's policy: defense contractors can patent inventions and exploit developments on the commercial market. The only obligation the defense contractor has is to allow the military services royalty-free licenses to produce.

Counter-pressure is developing now from congressional quarters to make the Pentagon follow the same policy as NASA, and restrict commercial exploitation of inventions made under military contract. The pressure comes from the Senate small-business committee, which begins a full-blown investigation into patent policies next Tuesday.

Informed Washington sources told ELECTRONICS that the source of the pressure is the small businessman's complaint: that it's unfair to allow the big firms to commercially exploit developments the government has paid for.

- **Army has invited** some 100 aircraft and electronics companies to a special meeting this week to hear about the Army's long-range interests in aviation. One of the Army's interests: surveillance planes heavily instrumented with electronic detectors. The companies were asked to submit "voluntary" design concepts "on a no-pay basis" to meet the Army's aviation requirements.
- **Toolmakers, squeezed by growing competition** from low-cost foreign manufacturers, have taken a different tack from semiconductor manufacturers in asking help from the Office of Civil & Defense Mobilization.

Machine-tool industry made a formal presentation to OCDM outlining the industry's problems: danger to national security represented by increasing dependence on foreign suppliers, decline of the export market, and related industry conditions. Then they said the government should determine whether or not the machine-tool industry is essential to national defense and devise its own scheme to "preserve" the industry.

Semiconductor manufacturers, working through Electronic Industries Association, asked for import restrictions on the grounds of defense essentiality.



DEVELOPED BY SPERRY SEMICONDUCTOR...

# PERFORMANCE PROVED IN



# UNIVAC LARC

SOLID  
STATE  
COMPUTER

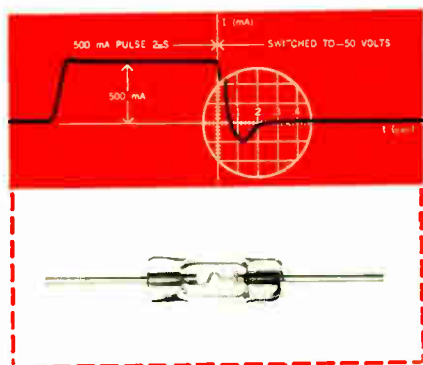

For the most advanced semiconductor devices in your computer applications—

**SPECIFY SPERRY**

# SPERRY

**SPERRY SEMICONDUCTOR DIVISION, SPERRY RAND CORPORATION. SOUTH NORWALK, CONN.**  
Regional Sales Offices: South Norwalk, Conn., New York, N. Y., Chicago, Ill., Los Angeles, Calif.

## HIGH-CURRENT FAST- SWITCHING SILICON DIODES



Ultra-high speed computing, 25 to 200 times faster than other existing comput-

ers, is an accomplished fact in Remington Rand's UNIVAC LARC—the most sophisticated of the new "second-generation" computers. Key to its unparalleled speed and reliability are the thousands of Sperry high-current fast-switching diodes built into its critical memory driving circuits.

Selected from Sperry's unique high-current silicon types, these were the only diodes in the industry able to meet the severe performance requirements of the LARC circuitry. Many Sperry computer diodes, such as the 1N690 and 1N691, are finding wide acceptance by the industry in more than a dozen other high speed computer prototypes.

# *new, low-cost Keithley micro-microammeter*



*MODEL 414 offers high performance  
over 17 ranges for just \$280*

Think of the many ways you could use a truly dependable and economical micro-microammeter:

- testing reverse leakages in diodes and transistors, and grid currents in vacuum tubes. The 414 is ideal for many production tests, requiring only manipulation of a single range switch and very infrequent zero checks.
- monitoring and controlling nuclear reactors. The 414 costs less per channel than more complex systems, offers greater dependability and safety because each channel is independent of the others.
- measuring photocell currents, determining radioactivity in "tagged" biological samples, measuring leakages of insulators, resistors, and capacitors. You can convert the 414 for current integration, use it in a thickness gauge, or as an ionization gauge control.

The 414 is built to the same rigid standards as other, more sensitive Keithley products. It is available with a contact meter for go no-go production tests, alarm and control systems.

## **SPECIFICATIONS**

**17 RANGES** in 1x and 3x steps, from 10 milliamperes to 0.1 milli-microampere full scale.

**ACCURACY** within  $\pm 3\%$  full scale on all ranges down to 10 milli-microamperes, and within 4% on the more sensitive ranges.

**INPUT DROP** of less than five millivolts on all ranges, with full-scale signals.

**RESPONSE TIME** of less than 0.5 second on all ranges for any input capacitance up to 5000 micro-microfarads.

**ZERO DRIFT** of less than 2% of full scale, in any eight-hour period, on any range.

**RECORDER OUTPUT** of 5 volts with a 1-ma capability.

**INPUT CONNECTOR** at front; output connectors at both front and back.

**DIMENSIONS** 19" x 5 1/4" high x 10" deep. Net weight, 16 pounds.

**PRICE** . . . . . \$280.00

SEND TODAY FOR COMPLETE DETAILS



**KEITHLEY INSTRUMENTS, INC.**  
12415 EUCLID AVENUE • CLEVELAND 6, OHIO



## YORK-HOOVER GUARANTEE

The York-Hoover Body Division occupies 350,000 square feet of modern manufacturing facilities. Highly skilled engineers, metal workers, welders and finishers take traditional Pennsylvania Dutch pride in producing this top quality Shelter S-141.

This is your guarantee, backed by 67 years of creative engineering and production "know how."

# YORK-HOOVER

*announces the new  
electronic shelter S-141*



**IN MISSILRY ...**  
as a tracking  
center



**IN COMMUNICATIONS**  
... as a microwave  
center



**IN NAVIGATION**  
... as a GCA and ILS  
center



**IN GENERAL FIELD**  
... as a maintenance  
shop

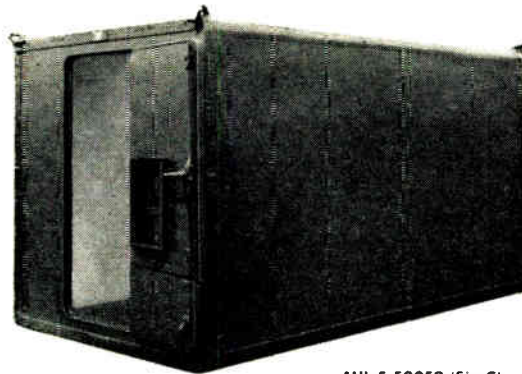

MIL-S-52059 (Sig C)



**IN RAPID AIR  
TRANSIT ...** as a  
shipping container

### PARTIAL LIST OF CUSTOMERS

U. S. Army Signal Corps  
U. S. Marine Corps  
American Electronics  
Laboratories, Inc.  
Motorola, Inc.  
Philco Corporation

York-Hoover Loading Device  
permits simple and reliable  
loading of shelters on  
military type trucks  
in all terrains.

### EXCLUSIVE FEATURES

**ALL WELDED CONSTRUCTION**—Inert arc welded aluminum frame resistance welded to the outer skin results in the most rugged and reliable semi-monocoque construction.

**SQUARE INSIDE CORNERS**—Maximum internal space utilization is achieved; simplified corner installation of ducting, raceways and equipments is permitted.

**LIGHTWEIGHT CONSTRUCTION**—The unique combination of high strength to weight ratio foams results in the lightest weight sandwich panel construction consistent with military specifications.

**REPLACEABLE SKIDS**—Designed to permit easy replacement of skids.

**FLEXIBLE DESIGN WITH MINIMUM COST**—The York-Hoover shelter design lends itself to maximum individual custom requirements, such as, access openings, internal reinforcements, overall dimensions and similar modifications.

**TESTED AND APPROVED**—The York-Hoover S-141 Shelter has been tested and complies with U. S. Army Signal Corps specification.

**YORK-HOOVER**

YORK



**CORPORATION**

PENNA.

*Creative Engineering for Industrial and Military Products Since 1892*

World Radio History

Write for  
Bulletin  
No. 949

# ON THE TARGET!

WITH

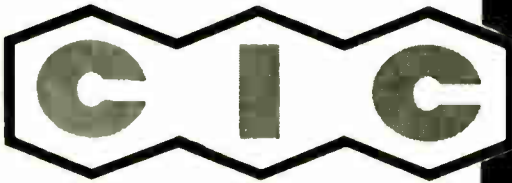

## SINE-COSINE FILM POTS

★ 0.015% ACCURACY!  
★ INFINITE RESOLUTION!

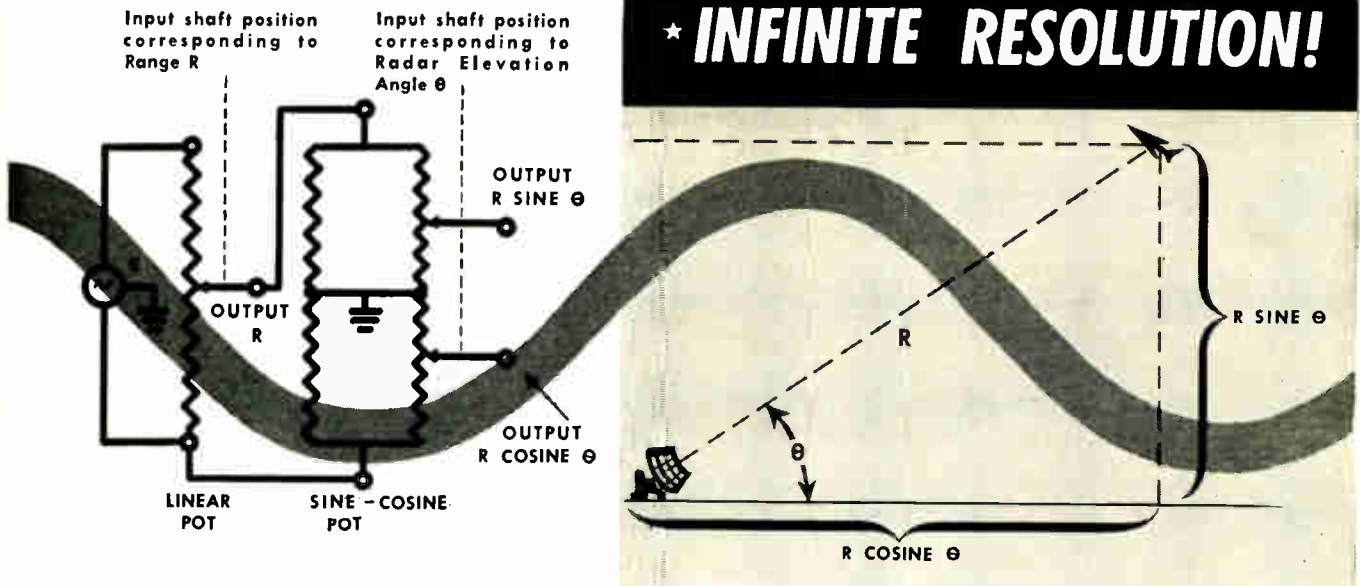

### COMPARE SYSTEMS ERROR YOURSELF!

Typical example of Radar Tracking System Problem:  
To accurately locate target

Range to Target: 50,000 yards  
Radar Elevation Angle: 45°

Error with Wire-Wound Pots

Quadrature due to Inductance of Windings (@ 1000 cps)...	35
Resolution .....	30
Linearity .....	50
	<u>115 yds</u>

Error with C.I.C. Film Pots

Quadrature due to Inductance	0
Resolution .....	0
Linearity .....	8
	<u>8 yds</u>

### YOU DON'T HAVE TO ACCEPT THE ERRORS IN WIRE WOUND POTS!

Engineers recognize the obvious superiority of C.I.C. Film Sine-Cosine Pots; THOUSANDS are currently in use in Hawk, Atlas, Nike and other missile systems, as well as in the APS-81, ASG-15 fire control system and AN/ASB-4 Bombing/Navigation system, all used on the B-52 Bomber, AN/APA-125 Radar Indicator, and many others. You too can have superior systems with C.I.C. Film pots. Send us your specifications today!

### FIRST IN FILM POTS

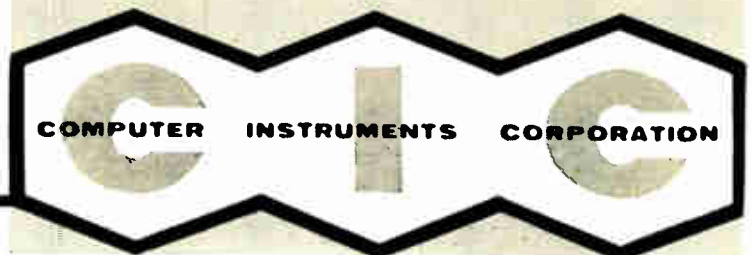





92 Madison Avenue, Hempstead, L. I., N. Y.

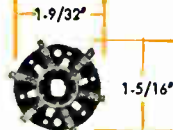

# Widest Option in Low-Power Rotary Switches

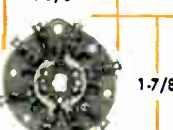
## SECTIONS

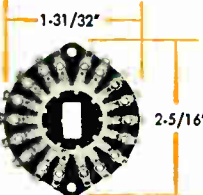
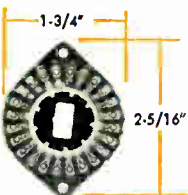
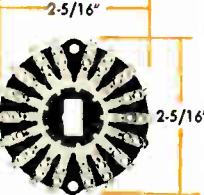
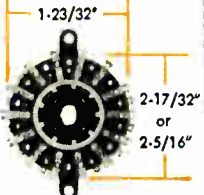
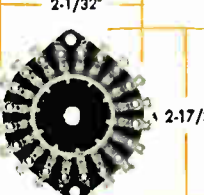
 <p>1-5/16" 1"</p> <p>THROW: 30°, 36°, 45° INSULATION: stator glass silicone; rotor, KEL-F</p>	 <p>1-9/32" 1-5/16"</p> <p>THROW: 30°, 45°, 60°, 90° INSULATION: phenolic, Mycalex, ceramic</p>	 <p>1-13/32" 1-17/32"</p> <p>THROW: 25.7°, 30°, 36°, 45°, 60° INSULATION: phenolic, ceramic</p>	 <p>1-5/8" 1-7/8"</p> <p>THROW: 18°, 20°, 30°, 36°, 45°, 60°, 90° INSULATION: phenolic, Mycalex, ceramic</p>	 <p>1-7/8" 1-7/8"</p> <p>THROW: 30°, 36°, 45°, 60°, 90° INSULATION: phenolic, Mycalex, ceramic</p>
 <p>1-31/32" 2-5/16"</p> <p>THROW: 20°, 40° INSULATION: phenolic</p>	 <p>1-3/4" 2-5/16"</p> <p>THROW: 15°, 30° INSULATION: phenolic</p>	 <p>2-5/16" 2-5/16"</p> <p>THROW: 20°, 40° INSULATION: phenolic, Mycalex</p>	 <p>1-23/32" 2-17/32" or 2-5/16"</p> <p>THROW: 12.85°, 25.7° INSULATION: phenolic</p>	 <p>2-1/32" 2-17/32"</p> <p>THROW: 12.85°, 18°, 25.7°, 36° INSULATION: phenolic</p>

## METAL PARTS AND FINISHES

**STANDARD COMMERCIAL**—Punched steel parts are lead-coated, cold-rolled steel. Parts such as nuts, lockwashers, etc., are cadmium-plated steel. Shafts may be cadmium-plated steel, brass, or aluminum. Brass parts are unplated.

**TROPICAL OR 50-HOUR SALT SPRAY MILITARY SPECIFICATIONS**—All steel and brass parts are cadmium-plated and chromate-dipped. Stainless steel parts are passivated.

**200-HOUR SALT SPRAY MILITARY SPECIFICATIONS**—All brass parts are nickel plated. All stainless steel parts are passivated. Shafts, "C" washers and index springs, balls and plates are stainless steel.

## CONTACTS

**Famous Oak double wiping, high-pressure design. Riveted or eye-leted in place and keyed from turning. Rotors shorting or nonshorting.**



**TYPE 1**—Contacts are spring brass, silver-plated. Rotors are brass, silver-plated. Temperature limit: 100°C constant ambient.

**TYPE 2**—Contacts, spring tempered-silver alloy. Rotors, coin-silver alloy. Temperature limit: 100°C constant ambient.

**TYPE 3**—Contacts and rotor blades made of Oak alloy

**CMS-202.** This is a special alloy for high temperature operation to 150°C.

**GOLD-PLATED CONTACTS**—Type 1 or 2 contacts may be gold-plated .0002" thick. Not to be confused with gold flash. **FOR PRINTED CIRCUITS**—Standard Oak contacts with a lug extending from the terminal end. Lug inserts in board for dip soldering.

## ACCESSORIES



**AC SNAP SWITCHES**—36 models for use on most switch types. All are UL approved.

**POTENTIOMETERS**—Customers' choice. Mounts on rear of Oak switches. Operates by switch shaft or separate concentric shaft.

**ELECTROSTATIC SHIELDS**—Used between sections. Sizes and shapes for all switches.

**BEARING STRAPS**—Added shaft support on long switches. Steel, brass, and phenolic.

**MOUNTING BRACES**—Prevents frame twist on long switches due to torsion.

**SPECIAL SHAFTS**—Hollow, dual-concentric, and triple-concentric for many switches.

# OAK MFG. CO.

1260 Clybourn Ave., Dept. G, Chicago 10, Illinois  
Phone: MOhawk 4-2222

When your design calls for a low-power rotary switch, you want a unit that matches job requirements exactly—not an "almost" fit. But in the process you don't want the switch to involve a lot of extra tooling and delay either. At Oak, the above options, plus numerous other alternatives in construction, are *pretooled* for economy, service, and convenience.

**Specify your low-power switches the easy way—from the most diversified, the most "ready-to-go" line available.**

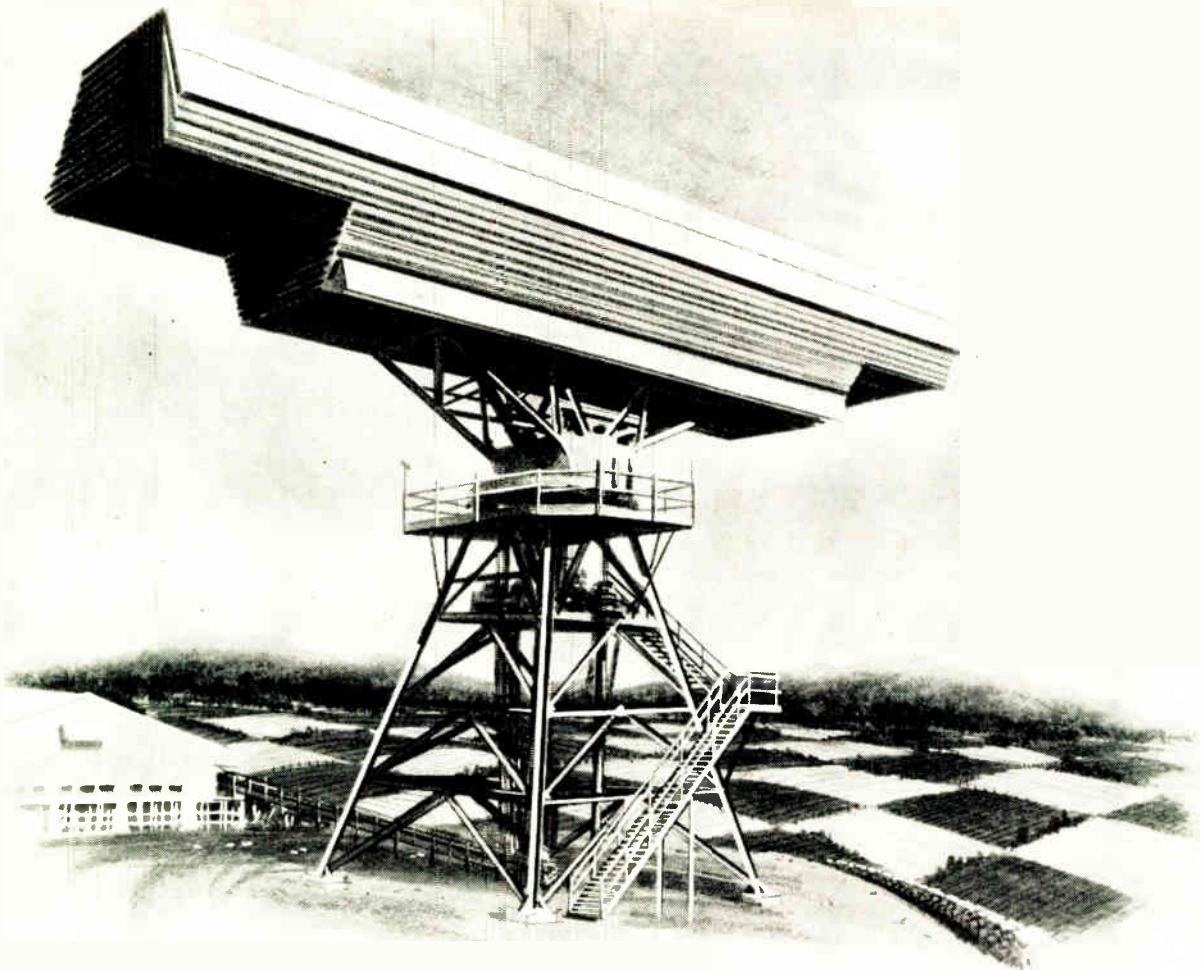

## CHESSMAN . . . 1960

New orders of power through Amplitron transmitter application. New frequency areas. Ferrite mechanisms. Sophistication in receiving and data processing techniques. This is advance technology at Raytheon Heavy Electronics.

Developments in such areas are already incorporated in these Heavy Electronic long range radars, ordnance and communications systems:

- AN/FPS-28 800-ton warning system for SAGE network.
- 96-voice channel pulse-code-modulation equipment.
- Two-gun MEMRAD Bright Display.
- AN/SPG-51 radar for Tartar Missile fire control system.

Each development evolved from imagination . . . technical command . . . experience — the qualities we always seek.

Select positions may be investigated by writing: Mr. Donald H. Sweet, Executive & Engineering Placement, Raytheon, 624W Worcester Road, Framingham, Mass. (suburban Boston).

### HEAVY ELECTRONIC GOVERNMENT EQUIPMENT DIVISION



EXCELLENCE  
IN ELECTRONICS



HEAVY  
ELECTRONIC

AIRBORNE  
ELECTRONIC

SYSTEMS  
MANAGEMENT

SUBMARINE  
SIGNAL

SANTA  
BARBARA



# Earnings Keep Going Up

EARNINGS REPORTS continue to reflect the upward profit trend most electronics companies are enjoying this year. Among these are:

• **Sonotone Corp.**, Elmsford, N. Y.—reports for the nine months ended Sept. 30—the highest sales and earnings for any comparable period in company history. Net sales in this interval amounted to \$18,271,000, an increase of 14 percent over 1958's \$15,980,000. Net earnings for the 1959 period were \$829,201, a 54-percent rise over net earnings of \$539,424 in 1958.

• **Avnet Electronics**, Westbury, L. I., announces sales for its first fiscal quarter ended Sept. 30 were \$2,132,091 and profits were \$255,713. This is equivalent to 34 cents a share. For the same period last year, sales were \$1,345,246, profits \$161,002. Since Avnet was not publicly owned last year, earnings per share are not reflected for 1958.

• **Hallcrafters Co.**, Chicago, ended an eight-month fiscal period this year with sales up 21 percent from the same period in 1958. Net sales for the first eight months of 1959 were \$15,904,952 as against \$13,093,550 in 1958. Earnings this year rose 113 percent from 1958's \$225,152 to \$480,602. W. J. Halligan, Hallcrafters' president, said earnings for the first eight months of 1959 approach total 1958 figures.

• **Astron Corp.**, East Newark, N. J., reports net sales for the nine-month period ended Sept. 30 were \$3,512,292, as compared with \$2,944,750 in the same period in 1958. Earnings were down this year to \$14,108, as compared with \$19,329 in 1958. This is due to capital expenditures made in late 1958 and early this year to expand production and research facilities, says Joseph Frank, Avnet's president.

• **Clevite Corporation**, Cleveland, terms third-quarter results for this year "outstanding". Sales reached \$19,651,000, and net profits

were 73 cents per share. In 1958, comparable figures were \$15,048,000 and 49 cents, respectively. Total sales for the first nine months of 1958 were \$46,922,000, and \$62,448,000 for this year. Nine-month profits for 1959 were \$9,833,000, as against \$3,914,000 for 1958.

• **Litton Industries**, Beverly Hills, Calif., reports first fiscal quarter sales of \$36,400,000, up from \$27,080,000 for the same period in the previous year. The 34-percent increase in sales was matched by a 35-percent increase in earnings. Earnings totals were \$1,537,000 for the new quarter, as compared with \$1,136,000 last year. Earnings per share on the 1,835,000 shares outstanding amounted to 82 cents, as compared with 64 cents a year ago.

## 25 MOST ACTIVE STOCKS

	WEEK ENDING NOVEMBER 20			
	SHARES (IN 100's)	HIGH	LOW	CLOSE
Elec & Mus Ind	5,768	12¼	10¾	11½
Avco Corp	2,956	15¾	13½	14¾
Univ Control	2,782	20¾	17½	20¾
Clarostat Mfg	1,556	15¼	12¼	14¾
Int'l Tel & Tel	1,157	42½	40½	40½
Philco Corp	1,057	28¾	26¾	27½
Siegler Corp	1,016	34¾	29¾	34½
Sperry Rand	900	23¾	22¼	23¼
Lear	839	20¼	18¼	18½
Int'l Resistance	801	19¾	16	19½
Reeves Sndrcft	706	10¼	8¾	10
Varian Assoc	691	48¼	42¾	48¼
Gen Dynamics	689	45¾	43¾	44¾
Gen Instrument	675	31¾	28¾	29¾
Gen Electric	661	84	81¼	83¼
Ampex	638	134¾	113½	134¾
Barnes Eng	632	32¼	27½	32
Sonotone	624	16¾	14¾	15
Beckman Inst	572	67	63	65
Skiatron	572	67½	6	6
Magnavox	567	39½	34½	36½
Raytheon	502	52¾	50¼	51
RCA	498	66½	64¾	66
Burroughs Corp	471	33¾	32¼	33¾
Hoffman Electncs	453	31¾	28½	31¾

The above figures represent sales of electronics stocks on the New York and American Stock Exchanges. Listings are prepared exclusively for ELECTRONICS by Ira Haupt & Co., investment bankers.

## DIVIDEND ANNOUNCEMENTS

	Amount per Share	Date Payable
Amer Bosch Arma	\$.30	Dec. 31
Hoffman Electncs	.15	Dec. 11
Lockheed Aircraft	.30	Dec. 11
Standard Coil Prods	3%	Dec. 31

## MINIATURE TRANSISTOR TRANSFORMERS

from stock

Design and performance meets or exceeds all applicable commercial and government specifications including MIL-T-27A. Available for immediate delivery from franchised stocking distributors.



## DC-DC CONVERTER

All Items Designed for 13.6V. Except 8034 which is for 28V Input.

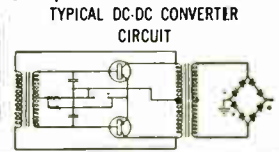

Part Number	Total V.A. Output	D.C. Output		
		F. W. Bridge Volts	Ma.	C.T. Full Wave Volts Ma.
M8034	125	500	250	250 420
M8035	125	500	250	250 420
M8036	40	450	90	225 155
M8037	22.5	250	90	125 155

## MICRO MINIATURE TRANSISTOR



Available in 4 case types  
Hermetic (H) 1 5/16" x 1 1/16", wt. 3/4 oz.  
Open Frame (F) 7/16" x 1 1/32" x 3/4", wt. .4 oz.

Part Number	Application	Pri. Imp.	
		Imp.	Sec. Imp.
MMT 5*	Coll. to Speaker	50,000	6
MMT 7*	Coll. to P.P. Emit.	25,000	1,200 C.T.
MMT 9*	Line to P.P. Emit.	600 C.T.	1,200 C.T.
MMT 10*	Coll. to Emit.	25,000	500
MMT 11*	P.P. Coll. to Emit or Line	4,000 C.T.	600 C.T.
MMT 12*	Coll. to Speaker	2,000	3.4
MMT 16*	Coll. to P.P. Emit.	10,000	1,500 C.T.
MMT 17*	P.P. Coll. to P.P. Emit.	10,000 C.T.	200 C.T.
MMT 18*	P.P. Coll. to P.P. Emit.	25,000 C.T.	1,200 C.T.
MMT 19*	Coll. to P.P. Emit.	2,500	2,500 C.T.

\*Add either -M or -H to part number to designate construction. See catalog for detailed information.

## ULTRA MINIATURE TRANSISTOR



Open-frame (F)\* Wt. .08 oz. size 3/8" x 3/8" x 1/32"  
Molded (M)\* Wt. .14 oz. size 1/2" x 1/2" dia.  
Nylon Bobbin, Nickel-Alloy

Part Number	Application	Primary Impedance		Secondary Impedance
		Imp.	Imp.	Imp.
UM 21*	Output	1,000	1,000	1,000
UM 22*	Output	1,000	1,000	1,000
UM 23*	Driver	20,000	1,200 C.T.	1,200 C.T.
UM 24*	Output	1,000	50	50
UM 25*	Output	400	50	50
UM 26*	Output	400	11	11
UM 27*	Output	400 C.T.	11	11
UM 28*	Choke	10 Hy. (0 dc)	8 Hy (5 ma)	650

\*Add either F or -M to designate construction. See catalog.

Write TODAY for catalog and price list of the complete MICROTRAN line.

**MICROTRAN company, inc.**  
145 E. Main St., Valley Stream, N.Y.

TAP2

TAF

# 18,000-Hour Life

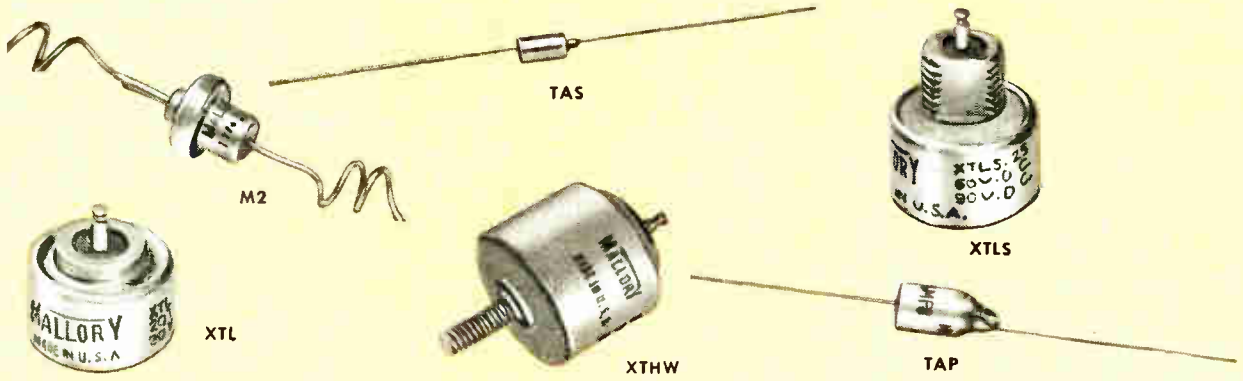

TNT

Type	Description	Capacity Range	W. Volts DC Rating at 85°C	Temperature Range	Case Style	Body Length	Body Diameter
HAT	Pellet Anode—Liquid Electrolyte	1-10 mfd.	16-1V.	-20 to +85 C	Metal Case—Axial Leads—Insulated Case	.210" max.	.075" max.
TAS	Pellet Anode—Solid Electrolyte	.33-330 mfd.	35-6V.	-80 to +85 C	Metal Case—Axial Leads	.250" to .750"	.125" to .341"
TAM	Pellet Anode—Solid Electrolyte	6.8-56 mfd.	25-6V.	-55 to +85 C	Dip Coated Resin—Upright Mounting	.175" thick	.313" square
TAF	Foil Anode—Semi-Liquid Electrolyte	.25-440 mfd.	150-3V.	-55 to +85 C	Metal Case—Axial Leads	.688" to 2.750"	.188" to .375"
STNT	Pellet Anode—Liquid Electrolyte	2-40 mfd.	50-3V.	-55 to +85 C	Metal Case—Axial Leads	.350"	.155"
TNT	Pellet Anode—Liquid Electrolyte	4-80 mfd.	50-3V.	-55 to +85 C	Metal Case—Axial Leads	.500"	.155"
TAP	Pellet Anode—Liquid Electrolyte	2-30 mfd.	90-6V.	-55 to +85 C	Metal Case—Axial Leads	.500"	.238"
TAP2	Pellet Anode—Liquid Electrolyte	11-140 mfd.	90-6V.	-55 to +85 C	Metal Case—Axial Leads	.660"	.238"
M2	Pellet Anode—Liquid Electrolyte	11-140 mfd.	90-6V.	-55 to +150 C	Metal Case—Axial Leads	.500"	.290" (Body) .484" (Flange)
XTK	Pellet Anode—Liquid Electrolyte	2-70 mfd.	340-8V.	-55 to +175 C	Metal Case—Axial Leads or Terminal	.438" to 1.313"	.650"
XTM	Pellet Anode—Liquid Electrolyte	4-140 mfd.	340-8V.	-55 to +175 C	Metal Case—Axial Leads or Terminal	.563" to 1.781"	.650"
XTL	Pellet Anode—Liquid Electrolyte	3.5-120 mfd.	630-18V.	-55 to +200 C	Metal Case—Axial Terminal	.500" to 2.595"	.875"
XTH	Pellet Anode—Liquid Electrolyte	7-240 mfd.	630-18V.	-55 to +200 C	Metal Case—Axial Terminal	.688" to 4.063"	.875"
XTV	Pellet Anode—Liquid Electrolyte	18-1300 mfd.	630-30V.	-55 to +175 C	Metal Case—Axial Terminal	.563" to 2.750"	1.125"
XTO	Pellet Anode—Liquid Electrolyte	7-240 mfd.	630-18V.	-55 to +200 C	Metal Case—Axial Terminal	.563" to 2.750"	1.125"

STNT

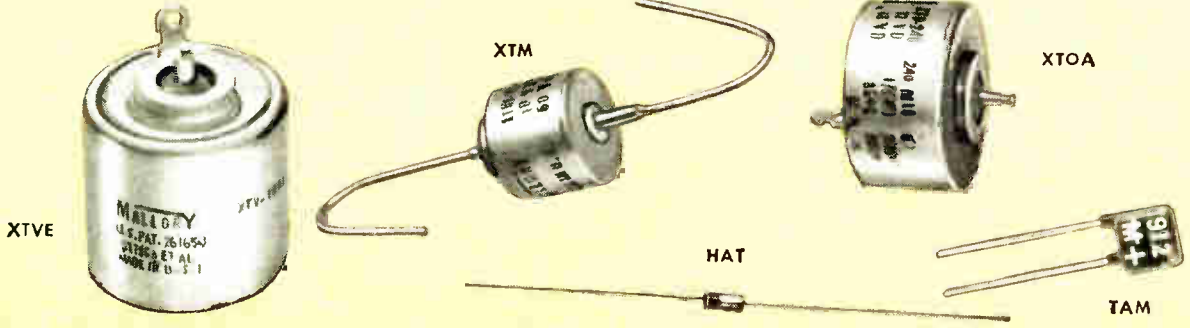



# Tests Prove Reliability

## of Mallory Tantalum Capacitors

The real measure of reliability is the proved ability to "take it." And that's what you get with Mallory tantalum capacitors. Latest proof of Mallory performance is a series of life tests recently completed. Longest of the tests, made on 16 production samples of XTL-125 capacitors, ran for 18,000 hours at 85°C with rated voltage applied to parallel connected capacitors.

Not a single capacitor failed. At the end of the test, capacitance and equivalent series resistance measured essentially the same as the day the test began. DC leakage current decreased from 125 to 25 microamperes.

In the laboratory, Mallory tantalum capacitors are further checked by 100% inspection tests, and

by electrical tests under MIL-C-3965B and 2000-hour life tests at elevated temperatures made on random samples from production lots. In the field, Mallory tantalum capacitors have built a reputation for trouble-free service during the ten years that we have been manufacturing them.

*Pioneer in tantalum technology*, Mallory makes 15 different tantalum types to match your requirements . . . ranging from micro-miniature to high capacity units. Many are available in 200°C ratings, introduced commercially by Mallory a decade ago.

Write for complete data, and for a consultation on your specific circuit requirements.

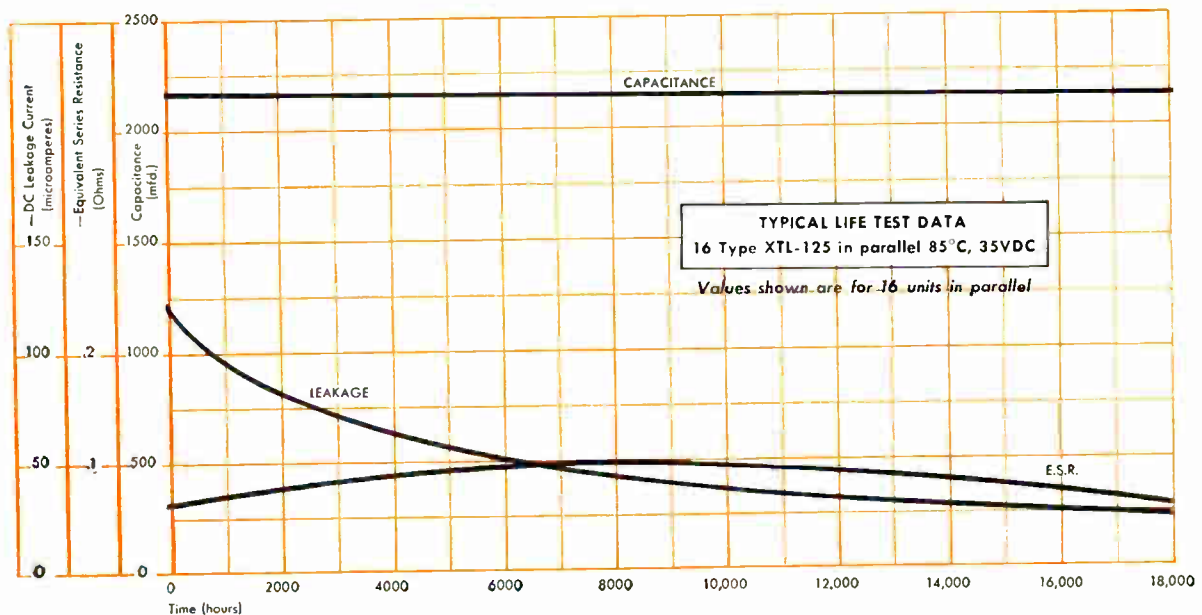

Mallory Capacitor Company  
Indianapolis 6, Indiana  
a division of

Serving industry with these products:

- |  |  |  |
|--|--|--|
| <b>Electrochemical</b><br>Capacitors<br>Batteries<br>Resistors | <b>Electromagnetic</b><br>Vibrators<br>Relays<br>Choppers        | <b>Metallurgical</b><br>Contacts<br>Powder Metallurgy<br>Materials<br>Welding Materials<br>High Density Metals |
| <b>Electromechanical</b><br>Switches<br>Control Devices        | <b>Electronic Assemblies</b><br>Power Supplies<br>Tuning Systems | <b>Semiconductor</b><br>Silicon Rectifiers   |



# Raytheon Voltage Regulating PLATE-FILAMENT

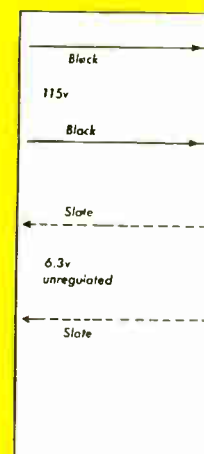
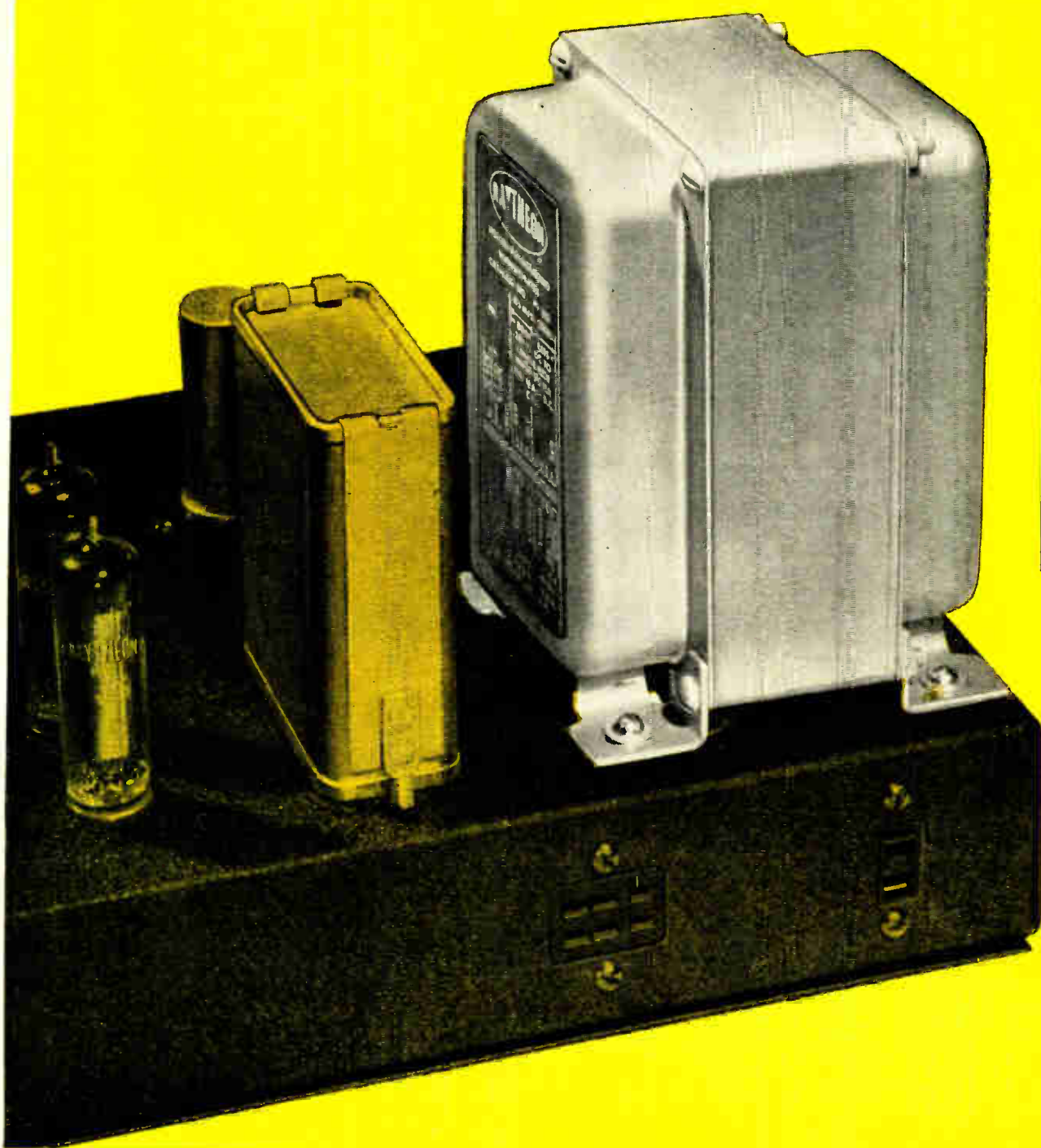



# TRANSFORMERS . . . . .

## Transformers that regulate voltage to within $\pm 3\%$

This versatile Raytheon unit looks like a transformer, but does the combined job of transformer plus voltage regulator.

In a conventional power supply circuit, the voltage regulating transformer maintains a dc output voltage within  $\pm 3\%$  with line variations of  $\pm 15\%$ .

For custom requirements, please write our Applications Engineering Group for an answer to your particular need. Raytheon Company, Manchester, New Hampshire.

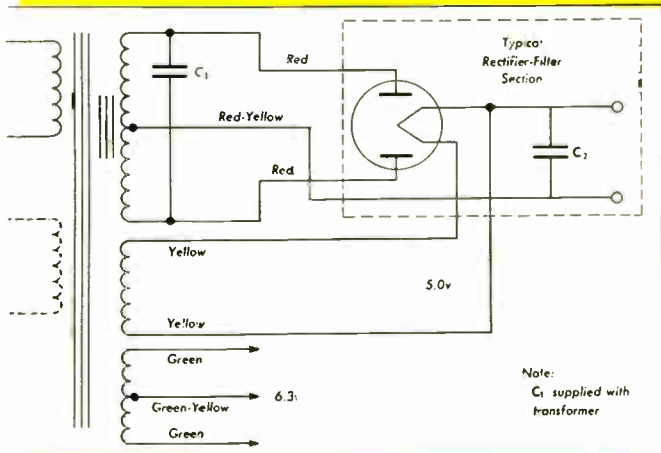

**CIRCUIT DIAGRAM** shows Raytheon Voltage Regulating Transformer in typical full-wave rectifier circuit. Three standard models with ratings up to 380 VDC @ 250 MA are immediately available from stock.

**THIS BOOKLET GIVES YOU COMPLETE SPECIFICATIONS.** For your copy plus a companion data booklet, write Raytheon, Manchester, N. H.

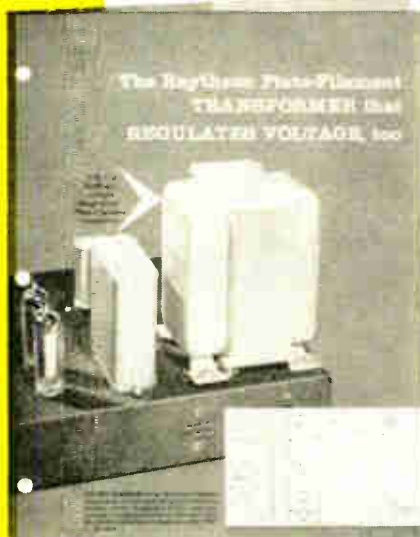

**RAYTHEON COMPANY**  
Industrial Apparatus Division



*Excellence in Electronics*

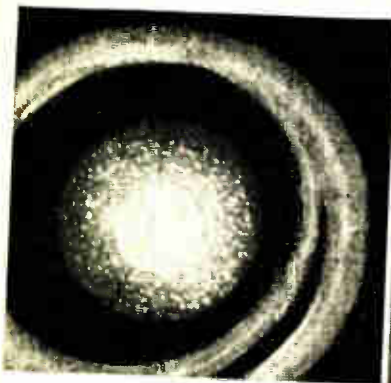

Style your career  
to the space age...

## DOUGLAS AIRCRAFT COMPANY MISSILES AND SPACE SYSTEMS

has immediate openings  
in the following fields—

### Electrical and Electronics:

Control System Analysis & Design  
Antenna & Radome Design  
Radar System Analysis and Design  
Instrumentation  
Equipment Installation  
Test Procedures  
Logic Design  
Power System Design

### Mechanical Engineering —

Analysis and Design of the following:

Servo Units  
Hydraulic Power Systems  
Air Conditioning Systems  
Missile Launcher Systems  
Propulsion Units and Systems  
Auxiliary Power Supplies

### Aeronautical Engineering:

Aerodynamic Design  
Advanced Aerodynamic Study  
Aerodynamic Heating  
Structural Analysis  
Strength Testing  
Dynamic Analysis of Flutter  
and Vibration  
Aeroelasticity  
Design of Complex Structure  
Trajectory Analysis  
Space Mechanics  
Welding  
Metallurgy

### Physics and Mathematics:

Experimental Thermodynamics  
General Advanced Analysis in  
all fields  
Computer Application Analysis  
Computer Programming and  
Analysis  
Mathematical Analysis

For full information  
write to:

Mr. C. C. LaVene

Box F-620

Douglas Aircraft Company, Inc.  
Santa Monica, Calif.

## MARKET RESEARCH

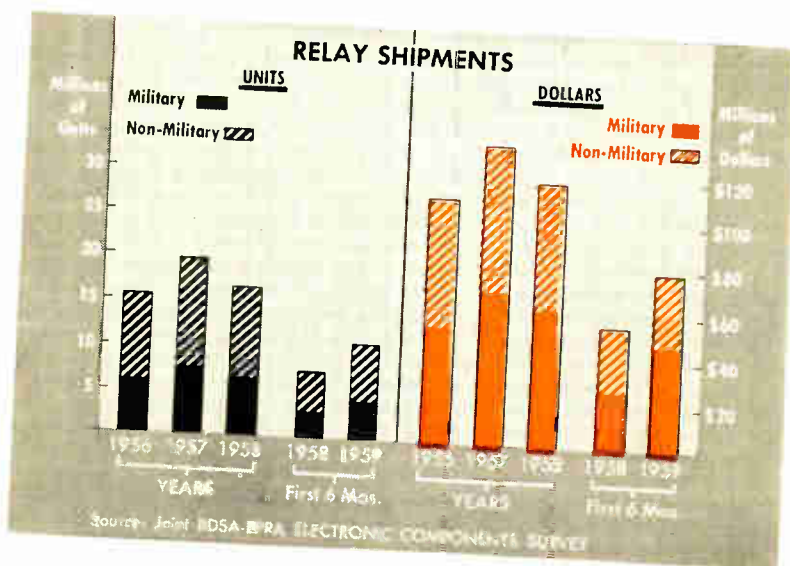

# Relay Market Shows Strength

RELAYS for electronic applications shipped during the first six months of 1959 were way ahead of the first half of 1958, according to the latest joint survey by Electronic Production Resources Agency and Business and Defense Services Administration.

Survey returns are of special significance at this time because they confirm previously reported opinions of manufacturers and others that the market for relays has suffered little from the development of solid-state switches.

Shipments of 11,071,000 relays worth \$79,365,000 were made in the first half of 1959, the survey reports. In the first half of 1958, about 7,621,000 relays worth \$54,384,000 were shipped.

Comparison of the figures shows a first half 1959 gain of about 45 percent in both dollars and units over the 1958 first half.

• One Japanese transistor is imported today for every 3.6 transistors produced in the United States, although imports began only three years ago, reports David R. Hull, president of the Electronic Industries Association.

Within two years, Japanese penetration of the transistor radio market has increased five-fold and now equals 25 percent of domestic output. Hull adds.

Speaking before a conference of

the Joint Electron Devices Engineering Council, he said: "We regard transistor imports as merely the beginning of a general deployment of the Japanese electronics industry on the territory and into the defense potential of the United States."

### LATEST MONTHLY SALES TOTALS

(Add 000)

(Source: EIA)	September 1959	August 1959	Change From One Year Ago
Rec. Tubes, Value	\$34,594	\$29,974	+ 1.9 %
Rec. Tubes, Units	41,989	35,435	+ 4.81 %
Pic. Tubes, Value	18,066	15,494	-13.2 %
Pic. Tubes, Units	914	823	-14.7 %
Transistors, Value	20,851	18,054	+92.8 %
Transistors, Units	8,653	7,130	+70.5 %

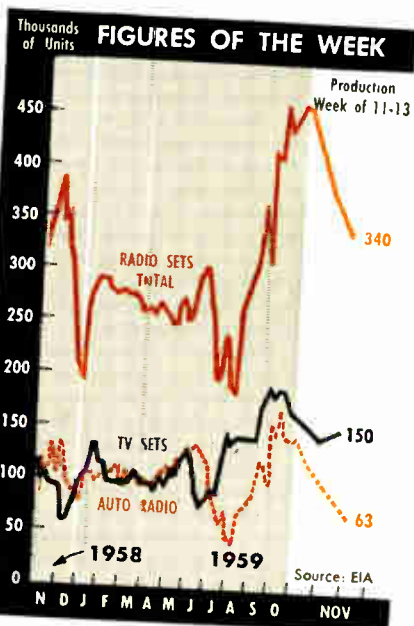

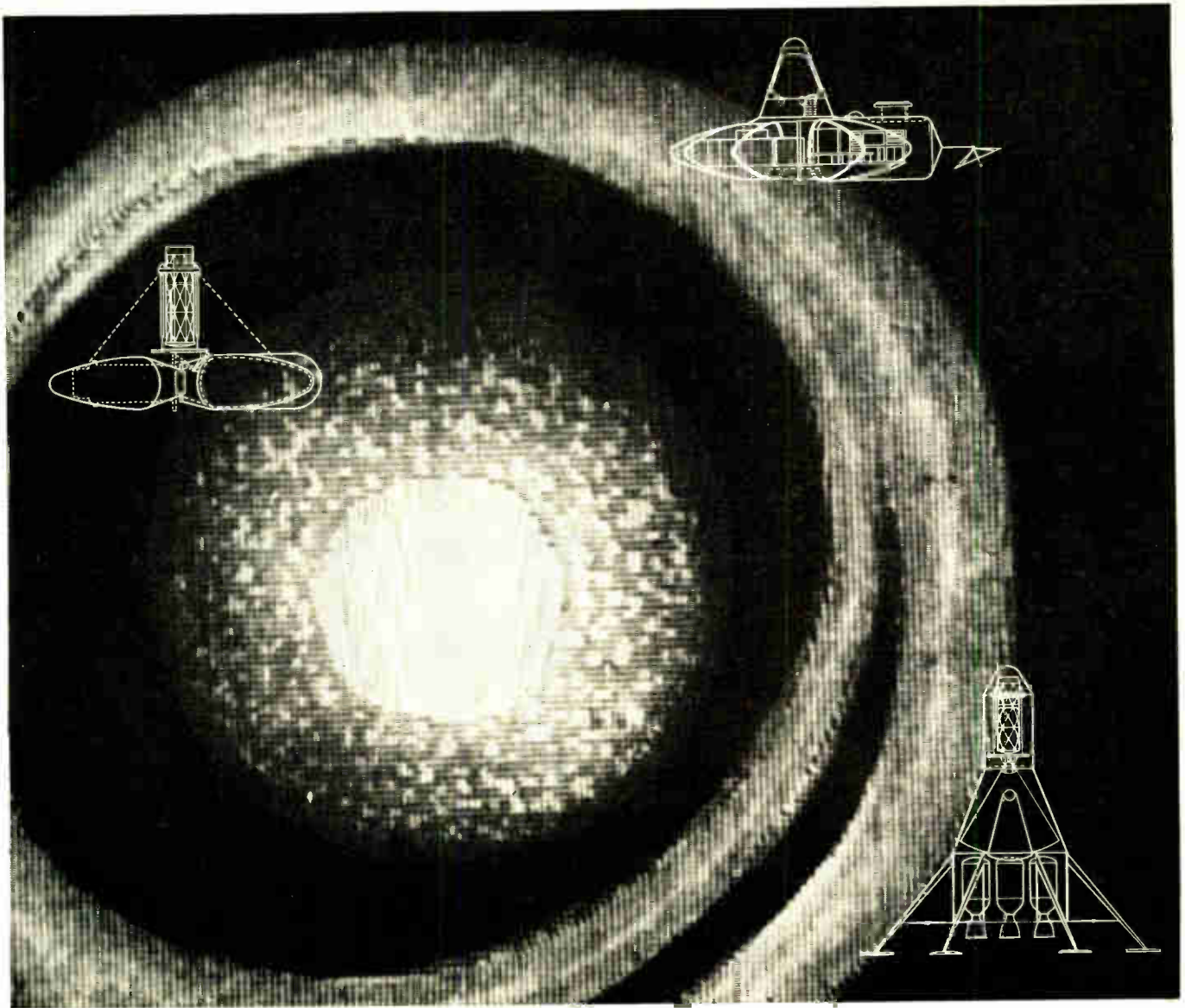

## *New styles for the man-about-space*



Every time a space traveler leaves home (earth), he has to wrap himself in the complete environment necessary to his physiological and psychological well-being. Styling sealed space capsules to suit man's every requirement has been a major project at Douglas for more than ten years. Forty basic human factors areas were explored in these studies. Now Douglas engineers have evolved plans for practical space ships, space stations and moon stations in which men can live and work with security thousands of miles from their home planet. We are seeking qualified engineers and scientists who can aid us in furthering these and other out-of-this-world but very down-to-earth projects. Some of our immediate needs are listed on the facing page.

Dr. Eugene Konecci, Head, Life Sciences Section, reviews a new concept in space cabin design with Arthur E. Raymond, Senior Engineering Vice President of **DOUGLAS**

MISSILE AND SPACE SYSTEMS ■ MILITARY AIRCRAFT ■ DC-8 JETLINERS ■ CARGO TRANSPORTS ■ AIRCOMB ■ GROUND SUPPORT EQUIPMENT



# SIZE 8

## SYNCHROS · SERVO MOTORS · MOTOR TACH GENERATORS

400 Cycle: Many for 125°C operation . . . Higher for special applications

Many Immediately Available From Stock in Small Quantities

### SIZE 8



### SYNCHROS

Highly Stable. Minimum Error  
Variation from -55°C to +125°C

OSTER TYPE	CLASS	INPUT VOLT-AGE	INPUT CUR-RENT AMPS	INPUT WATTS	OUTPUT VOLT-AGE	PHASE SHIFT (° LEAD)	ROTOR RESIST-ANCE (OHM)	STATOR RESIST-ANCE OHMS	Z <sub>10</sub> OHMS	Z <sub>50</sub> OHMS	Z <sub>155</sub> OHMS	NULL VOLT-AGE (MV)	MAX. ERROR FROM E.Z. (MIN.)
4253-01*	LZ-CT	11.8	.087	.21	23.5	9.0	157.0	24.0	212+j722	28+j119	263+j69	30	±7
4269-01*	Diff	11.8	.087	.21	11.8	9.0	35.0	24.0	37+j139	28+j124	47+j13	30	±7
4273-01**	XMTR	26.0	.100	.54	11.8	8.5	34.0	12.0	48+j255	12+j45	82+j31	30	±7
4277-01*	HZ-CT	11.8	.030	.073	22.5	8.5	316.0	67.0	500+j1937	79+j350	594+j182	30	±7
4261-01**	Resolver	26.0	.043	.39	11.8	15.0	162.0	22.0	208+j612	34+j159	243+j77	30	±7

\*Stator as Primary \*\*Rotor as Primary

### SIZE 8



### SERVO MOTORS

OSTER TYPE	RATED VOLTAGES	Z = R + jX	IN. OZ. STALL TORQUE	RPM NO LOAD SPEED	WATTS PER PHASE	GM. CM. ROTOR INERTIA	LENGTH IN. MAX.	WEIGHT OZ.	T/I RATIO RAD/SEC <sup>2</sup>
5004-01	26V 26V	288 = 226 + j 176 294 = 238 + j 174	.15	6200	2.0	.47	0.863	1.2	22,500
5004-02	26V 36V	288 = 226 + j 176 526 = 409 + j 332	.15	6200	2.0	.47	0.863	1.2	22,500
5004-03	26V 40V	288 = 226 + j 176 715 = 582 + j 415	.15	6200	2.0	.47	0.863	1.2	22,500
5004-09	26V 40V	230 = 190 + j 131 519 = 399 + j 332	.20	6200	2.5	.47	0.863	1.2	30,000

### SIZE 8



### MOTOR TACH-GENERATORS

OSTER TYPE	RATED VOLTAGES	Z = R + jX	IN. OZ. STALL TORQUE	RPM NO LOAD SPEED	WATTS PER PHASE	GM. CM. ROTOR INERTIA	LENGTH IN. MAX.	WEIGHT OZ.	T/I RATIO RAD/SEC <sup>2</sup>	GENERATOR VOLTAGE	INPUT WATTS	OUTPUT VOLTS PER 1090/RPM
6204-01	26V 40V	230 = 190 + j 131 519 = 399 + j 332	.20	6000	2.5	.65	1.728	2.5	21,800	26	2.5	.25
6204-03	26V 26V	230 = 190 + j 131 230 = 190 + j 131	.20	6000	2.5	.65	1.728	2.5	21,800	26	2.5	.25

The Size 8 400 Cycle Servo Motor Tach Generators listed above have 150° max. cont. frame temperature, 110 MA input current, ±5° phase shift and Null Voltage (Total R. M. S.) of 15 millivolts.

#### OTHER PRODUCTS INCLUDE:

Resolvers  
Computers  
Indicators  
Servo Mechanisms  
Servo Torque Units  
DC Motors

#### MANUFACTURING CO.

Avionic Division  
Racine, Wisconsin

**EASTERN OFFICE** 310 Northern Blvd. • Great Neck, Long Island, New York  
Phone: HUnter 7-9030 • TWX Great Neck N.Y. 2980

**WESTERN OFFICE** 5333 South Sepulveda Blvd. • Culver City, California  
Phone: EXmont 1-5742 • UPTon 0-1194 • TWX S. Mon. 7971

Engineers For Advanced Projects:

Interesting, varied work on designing transistor circuits and servo mechanisms.

Contact Mr. Robert Burns, Personnel Manager, in confidence.



**Extruded and machined parts . . .  
8 different ALSiMag compositions**



**Pressed ALSiMag ceramics . . .  
9 different compositions**

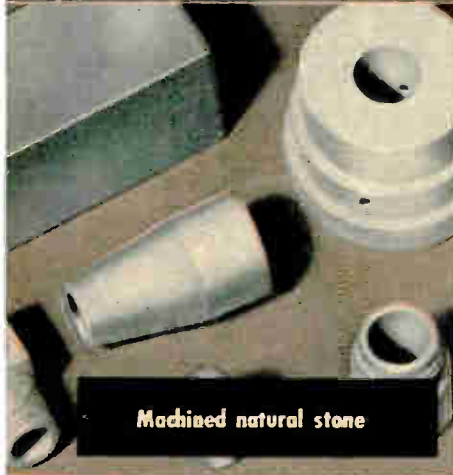

**Machined natural stone**

**ALSiMAG<sup>®</sup>**  
**offers . . .**  
*the widest variety  
of technical ceramics  
from any single source*

Specialized engineering talent in depth • The quantity you need . . . deliveries and quality as agreed • Special speedy service on prototypes • Specialized equipment for smaller quantity production • Unequaled facilities for volume production when you really need volume.

**from one source . . .**

These are typical samples picked up in our Inspection Department over a week end. They illustrate the great variety of technical ceramics constantly flowing through our ultra-modern plants.

Parts are shown approximately 1/2 size.

**Property Chart Sent on Request.**

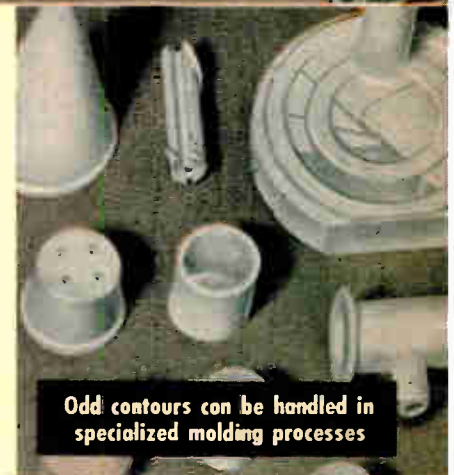

**Odd contours can be handled in specialized molding processes**



**Various methods of molding permit use of the best one**



**ALSiMag metal-ceramic assemblies**



**Casting handles larger shapes, odd contours**



**High temperature hermetic seals**



**Soft solder metalization**

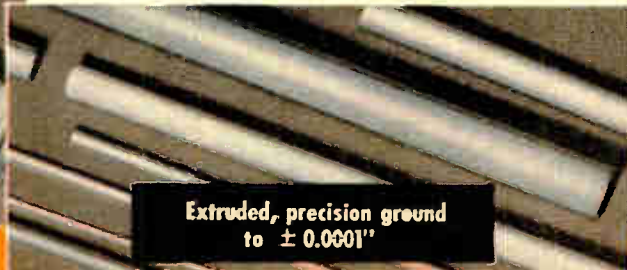

**Extruded, precision ground to ± 0.0001"**



**Precision thin and sub-miniature ceramics**

A Subsidiary of Minnesota Mining and Manufacturing Company

**AMERICAN LAVA CORPORATION**

**CHATTANOOGA 5, TENN.**  
58TH YEAR OF CERAMIC LEADERSHIP

For service, contact American Lava representatives in Offices of Minnesota Mining & Manufacturing Co. in these cities (see your local telephone directory): Boston: Newton Center, Mass. • Chicago: Bedford Park, Ill. • Cleveland, O. • Dallas, Texas • Los Angeles, Cal. New York: Ridgefield, N. J. • Philadelphia, Pa. • St. Louis, Mo. • St. Paul, Minn. • So. San Francisco, Cal. • Seattle, Wash. All other export: Minnesota Mining & Manufacturing Co., International Division, 99 Park Ave., New York, N. Y.



# Plan For Uniform Performance

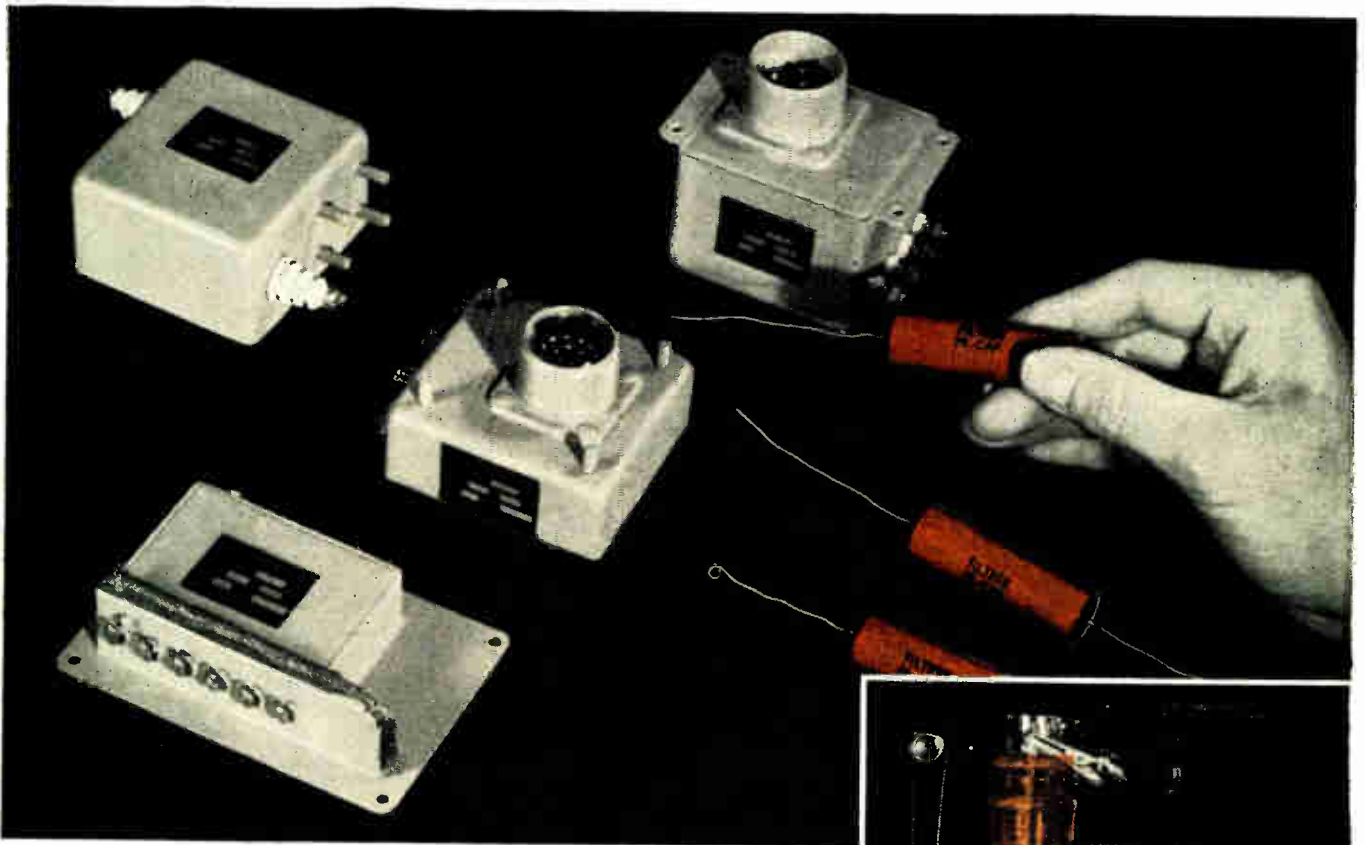

## Low Power Factor and Constant Capacity Assured by Dow Corning Silicone Fluids

Here's an example of value engineering with silicone fluids:

The Filtron Co., Inc., of Flushing, N. Y., manufactures RF interference filters and capacitors for both military and commercial use. To assure an almost constant capacitance vs temperature relationship for their specialty capacitors . . . and the lowest possible power factor for their RF interference filters . . . Filtron engineers impregnate them with Dow Corning silicone fluids.

Silicone fluids are, in themselves, excellent dielectrics. In capacitors and RF filters such as these, silicone fluids boost the performance of the paper dielectric . . . substantially increase permissible operating temperatures, decrease electrical losses. Highly stable to changing environments, silicones show little drift in electrical or physical properties over a broad range of temperature and frequency conditions. They add greatly to reliability . . . often eliminate costly compensating circuits.

*Dielectric-Coolants* . . . Silicone fluids also make highly effective heat transfer media. Because of their relatively constant viscosity, their pumping rate does not vary appreciably at differing temperatures. They're nonoxidizing, nongumming . . . can be sealed in for the life of the equipment. Electric grade fluids may be cycled directly over operating assemblies.

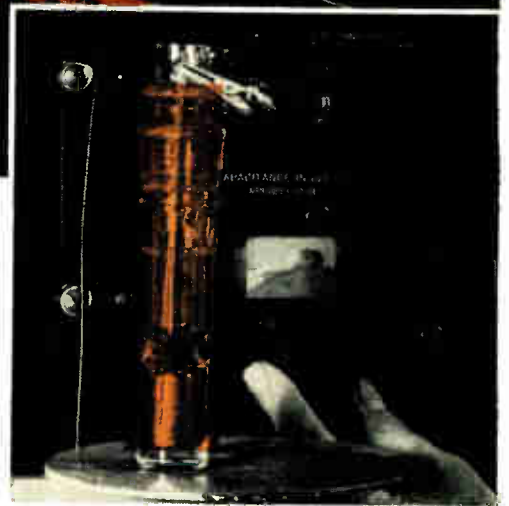

Typical Dielectric Properties of 200 Fluid, 100 CSTK.

Property	Temperature		
	-55 C	23 C	200 C
<b>Dielectric Constant,</b>			
1.0 kcs. . . . .	3.1	2.7	2.3
0.1 mcs. . . . .	3.1	2.7	2.3
<b>Dissipation Factor,</b>			
1.0 kcs. . . . .	0.0005	0.00004	0.001
0.1 mcs. . . . .	0.0002	0.00001	0.0003
Resistivity, ohm-cm . . .	$10 \times 10^{14}$	$2.0 \times 10^{14}$	$1.0 \times 10^{13}$
<b>Electric Strength,</b>			
dc, 20 mil gap			
v/mil . . . . .	700	650	550

Your nearest Dow Corning office is the number one source for information and technical service on silicones.



**Dow Corning**

CIRCLE 104 ON READER SERVICE CARD



# ... engineer for value with silicones

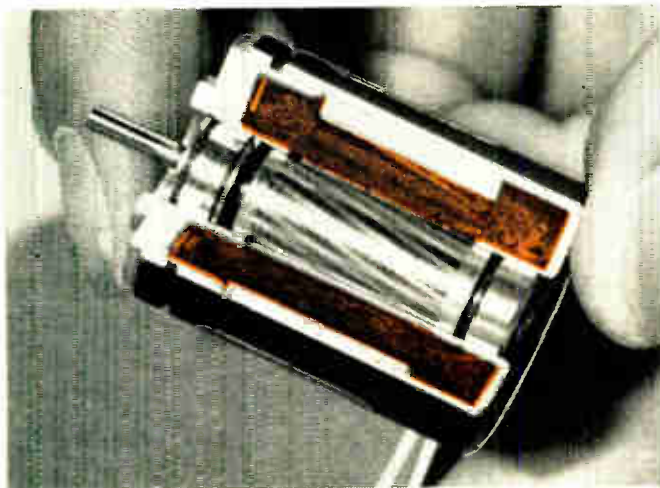

## Solventless Resin Fills A Void

This servo motor, made by G-M Laboratories, Inc., Chicago, must withstand high humidity and high temperatures in operation. On analyzing the requirements of size, weight and reliability, engineers at G-M Laboratories concluded that a silicone insulation system would permit the best design, so they impregnated the stator under vacuum with Dow Corning solventless silicone resin. This moisture-proof, heat-resistant material fills the coil interstices and sets up to a solid, bubble-free mass. It protects against vibration, oxidation, corona and moisture . . . provides good heat transfer.

Investigate Dow Corning solventless silicone resins for use as rigid potting, filling, impregnating or encapsulating materials. They're radiation resistant . . . can be used with inorganic fillers.

CIRCLE 105 ON READER SERVICE CARD

## Soften Shock With Silastic RTV

This transistorized oscillator, produced by Delta-f, Inc., Geneva, Illinois, is designed for use in airborne and transportable communications equipment. To protect against shock, Delta-f engineers use a flowed-on blanket of Silastic<sup>®</sup> RTV. It supplies needed cushioning, and is unaffected by the built-in heating element. Silastic RTV can withstand temperatures up to 260 C. down to -70 on the cold side. In addition, it resists moisture, oxidation, and other adverse conditions.

Silastic RTV is the Dow Corning fluid silicone rubber that vulcanizes at room temperature. Easy to use, it can be applied by dipping, pouring or with a caulking gun. When used as a potting material, it flows into place, filling all voids . . . sets up to form silicone rubber with excellent dielectric properties.

CIRCLE 107 ON READER SERVICE CARD

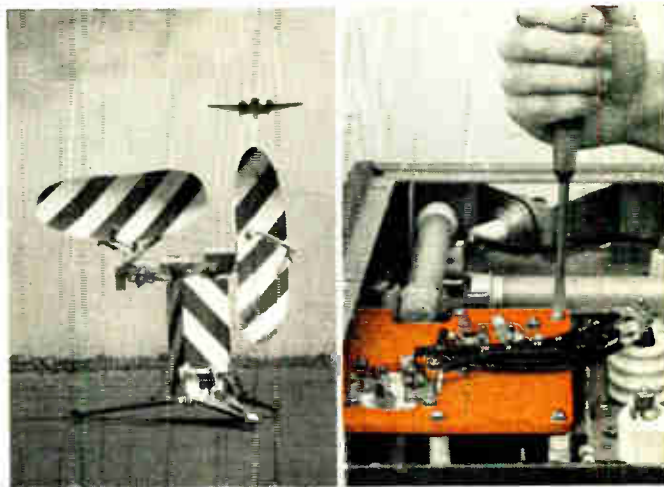

## For Maximum Security: Silicone-Glass

Ground approach radar must provide the ultimate in reliability. That's why Gilfillan Brothers, Inc., of Los Angeles, use silicone-glass laminates in their Quadradar sets which are designed to provide vital flight information that facilitates ground controlled approach and landing of high speed aircraft.

Silicone laminates are specified because they have uniform dielectric properties under climatic and atmospheric conditions. Little affected by moisture, silicone-glass terminal boards prevent recurrent arcing even at high voltage and high humidity . . . provide low loss factor and low attenuation at RF frequencies. In addition, silicone laminates are strong and resist creep under pressure of fasteners; and, when needed, their heat resistance is exceptional . . . up to 250 C continuous for years on end.

CIRCLE 106 ON READER SERVICE CARD



**CORPORATION**

**MIDLAND, MICHIGAN**

branches: ATLANTA BOSTON CHICAGO CLEVELAND DALLAS LOS ANGELES NEW YORK WASHINGTON, D.C.



**GALLAGHER  
COTTON MILLS**

**BEE BEE TOGS, Inc.**



**ELECTRONIC  
COMMUNICATIONS  
Inc.**

**CONTINENTAL OPTICAL COMPANY**

**THE PERISCOPE  
INSTRUMENT CORP.**

**Metal Industries, Inc.**

**Hood**

**THE BABY BUTLER**  
ELEVATORIZED

**CIRCUIT**  
A DIVISION OF INTERNATIONAL PAPER PRODUCTS CO.  
ST. PETERSBURG • FLORIDA



**THE HOUSTON CORPORATION**

**ALLSTATE**  
INSURANCE COMPANY

FLORIDA FISHING TACKLE Mfg. Co. Inc.  
**Barracuda**  
TACKLE

**RADER AND ASSOCIATES**  
ENGINEERS AND ARCHITECTS

**GENERAL NUCLEAR  
ENGINEERING CORPORATION**

**A-M-P**

**"TAPECO"**

**CREST**  
DIVISION OF JACQUES-KREISLER CO.

*Smith and Gillespie*

**SPERRY**

**Roy**  
CORPULIN COATING SYSTEM

*Colonial  
Fashion*

**HARCOCK  
& WILCOX**  
BOILER DIVISION

Here's one of the few areas in America where it is possible to attract personnel in every category without difficulty.

Why?—No executive or employee need be more than 15 minutes away from home and garden, from fresh and salt water, fishing, bathing, boating, water skiing . . . no more than 15 minutes away from schools, churches, shopping centers, recreational and social activities.

All this, plus a favorable business climate and SUN-sational living all year, in this enchanting land of flora and fauna.

*Be in Good  
Company*

Executive decisions, after extensive site location surveys in many areas of the nation, have resulted in major companies locating here. Their managements will gladly give you the result of their findings.

**NOTE:** Persons seeking positions please write Florida State Employment Service, 1004 First Avenue North, St. Petersburg.

Communicate in confidence with:

**GREATER ST. PETERSBURG CHAMBER OF COMMERCE**

Jack Bryan, Industrial Director

Dept. ISA

St. Petersburg, Florida



**VARIAN**

**PRESENTS**

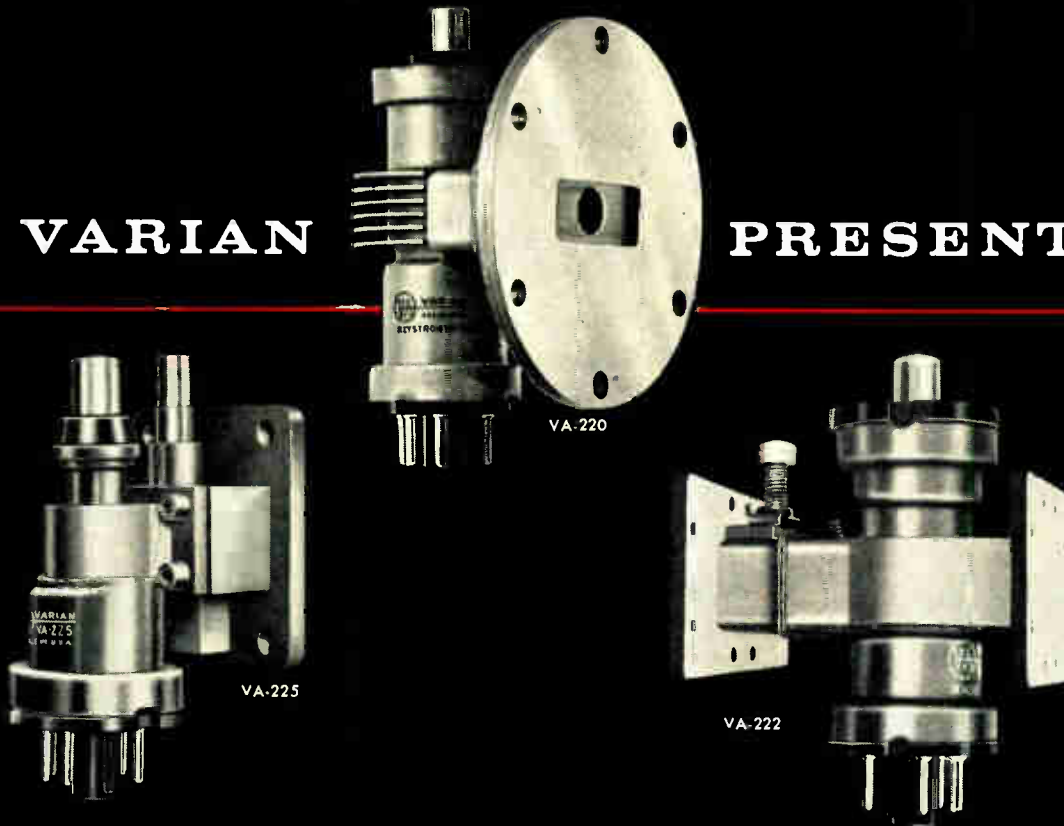

**A COMPLETE COMPLEMENT OF 1 WATT RELAY TUBES**

**...WITH FREQUENCY RANGES COVERING THE COMMON CARRIER, STL, AND GOVERNMENT BANDS**

The well known VA-220 Klystron series, long the accepted standard of the relay industry, is now guaranteed for 5000 hours.

The VA-222 series has all the desirable qualities of the VA-220 series but it is conduction cooled making possible added economies in equipment design...no cooling blower required.

Write for free comprehensive catalog on Varian Microwave tubes, produced by the world's largest manufacturer of Klystrons.

The VA-225A and B are the newest additions to this group of efficient Klystrons. Each provides a 1000 megacycle tuning range within the 7.0 kMc to 8.5 kMc range. The electrical specifications are similar to those of the VA-220.



**VARIAN** ASSOCIATES  
PALO ALTO 1, CALIFORNIA  
Representatives in all principal cities

MECHANICAL TUNING RANGE	
VA-220A and VA-222A	7425-7750 Mc
VA-220B and VA-222B	7125-7425 Mc
VA-220C and VA-222C	6875-7125 Mc
VA-220D and VA-222D	6575-6875 Mc
VA-220E and VA-222E	6125-6425 Mc
VA-220F and VA-222F	5825-6125 Mc
VA-220G and VA-222G	4475-5575 Mc
VA-220I and VA-222I	7750-8100 Mc
VA-225A	7500-8300 Mc
VA-225B	7000-8000 Mc

KLYSTRONS, TRAVELING WAVE TUBES, BACKWARD WAVE OSCILLATORS, HIGH VACUUM PUMPS, LINEAR ACCELERATORS, MICROWAVE SYSTEM COMPONENTS, R.F. SPECTROMETERS, MAGNETS, MAGNETRON TUBES, STABILIZERS, POWER AMPLIFIERS, GRAPHIC RECORDERS, RESEARCH AND DEVELOPMENT SERVICES.



# Germ-Gas Electronic Detectors

Civil Defense has no warning system against attack by chemical or biological agents. Soviets say they will use these in any full-scale war

By JOHN F. MASON, Associate Editor

THE COLD FRONT that brought snows to Montana and chills to most of the eastern U. S. last month could have put millions of Americans to bed with influenza or killed them with psitticosis.

Accomplishing this would have been easy.

One or two aircraft could have seeded with pathogenic organisms the warm air that precedes the cold front. This could have been done far up in the Arctic.

Nerve gas that kills in minutes is not as easy to deliver. The source must be closer to the victims. Nevertheless, it too is a threat.

Soviet leaders have stated publicly that in the next war they will use thermonuclear, chemical and biological weapons. Russian writer Raymond Gorthoff says in his book *Soviet Strategy in the Nuclear Age*: "Such weapons can be released from suboceanic containers in the Pacific to 'ride' the prevailing winds covering the U. S."

The National Security Council has recommended that CBR (Chemical-Biological-Radiological Warfare) be restricted to use only in retaliation. Some groups want this decision reversed and CBR elevated

to membership in the accepted family of combat weapons systems.

## What Chemical Warfare Means

The U. S. and the Soviets both possess psychochemicals that can convert aggressive extroverts into cowering, useless neurotics. Other chemicals might cause defenders of a city to welcome the enemy with ludicrous hospitality or incapacitating fits of giggles.

These chemicals—derivatives of lysergic acid—attack nerve centers.

Both sides have lethal nerve gases—organic phosphorus fluorine compounds—producible in up to 20 combinations. Acting as an anticholinesterase, one nerve gas attacks the nerves around the heart, constricting and stopping it in a matter of four minutes.

Pellets of radioactive material can be released above the clouds to float down to an unsuspecting population below. This approach is unlikely, however, due to cost.

Chemical and biological agents can be delivered in many ways. A low-flying Snark-type missile could dump almost any of the agents over an airfield, town or cornfield ready for harvest.

Saboteurs could do the job with a thermos bottle emptied into a city's water supply, germs dusted into the ventilation system of an office building, or a few trucks armed with gas dispensers surrounding a Strategic Air Command base or a Bomarc air defense site.

Investigations by Army Chemical Corps and by university researchers have established that reproductive rates of microorganisms can be influenced by r-f energy. In the microwave spectrum, this effect can be negative; in the h-f spectrum, it is not only positive but highly frequency-specific. X-band energy, for example, inhibits yeast reproduction, but h-f energy in the 1-to-20-meter band stimulates growth of many microorganisms.

The reaction apparently is not a function of heat, but seems to be due to electrical fields acting on the microorganism.

Researchers have proved that ultrasonic energy also effects reproductive rates of microorganisms. This effect too seems to be frequency specific.

Short-wave r-f and ultrasonic energy also change the reaction times of many enzymes. Uhf energy can denaturate proteins.

## Electronics: Vital for Detection

At present the Chemical Corps has prototypes of warning devices for biological warfare and chemical warfare agents. Civil Defense has no warning devices for either.

The BW warning system consists of three components: an air sampling device developed by the Chemical Corps and the Armour Research Foundation called the aerosoloscope; a particrome analyzer; and an automatic colony counter and microculture counter, developed by

Field tests of chemical, biological and radiological warfare agents require elaborate electronic instrumentation



# Needed

DuMont. The entire complex fills a large room. The Corps would like a transportable trailer system.

The aerosoloscope electronically measures and counts airborne particles—including radioactive fallout—ranging in size from one micron to 64 microns at the rate of 100 per second. Here's how it works:

The dust particles seen in a shaft of light are only reflections of the particles themselves. The reflection caused by the light is detected by a multiplier phototube that determines the size of each particle. Electrical impulses are amplified and transmitted to 12 dials. The first dial records the number of particles one to 1.4 microns in diameter. Each succeeding dial records slightly larger particles.

The next step is to identify whether the particles are dust, pollen or germs. The output of the aerosoloscope is fed into the particle-chrome analyzer. The particles are stained with a blue dye. When viewed under ultraviolet light, BW germs fluoresce blue while dust and pollen fluoresce green. A tv camera using sensitive color filters automatically counts the blue and green particles. A sudden increase in blue particles reveals the presence of a large concentration of germs.

Particles are fed into an automatic colony counter for electronic counting in one second.

The counter uses rectangular plastic strips, each perforated with 994 holes. The strip is photographed and the film examined by a tv scanner which counts the number of holes containing bacteria.

## Probe 10-Micron Area

For long-range detection of chemical agents, the Corps is looking for efficient and sensitive infrared detectors that will operate in the 10-micron area. Eastman Kodak is studying use of zinc gold-doped germanium phototransistors.

Prototype of a 1/2-mi to 5-mi-range infrared device has been developed by the Corps and Farrand Optical Co. for use by troops in the field.

Called LOPAIR (for long-path infrared), the equipment is based on the i-r spectrometer. When a

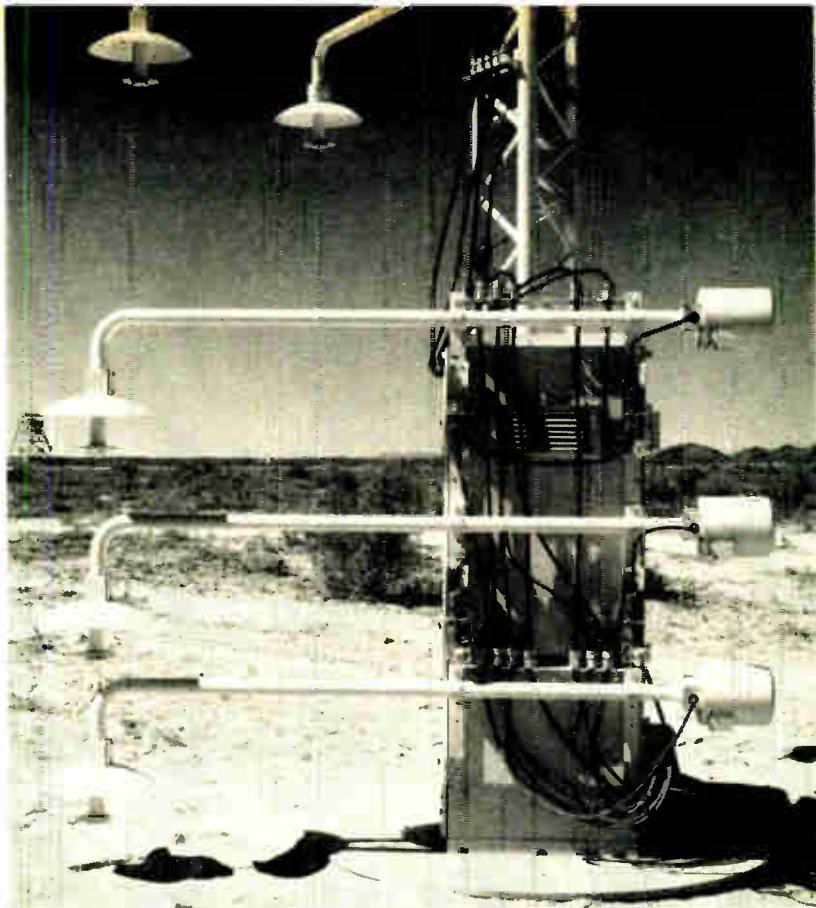

Precise meteorological data is automatically obtained on weather towers at the Chemical Corps Proving Ground and telemetered back to the master control center for analysis

tiny amount of contaminant in the air crosses an i-r beam, a warning light flashes and a horn sounds. Contaminants are detected even if they are colorless and invisible to the naked eye, as nerve gas is.

The system can detect and measure almost any substance by its i-r spectrum. Once the alarm has been set to detect one specific substance, however, it will normally not be set off by other materials present.

The equipment will not sound the alarm if a person, animal or vehicle breaks the i-r beam.

The present system uses mirrors to set up a beam pattern.

The Army would like to circumvent using the mirrors. The setup requires precision and, in a tactical area, might be dangerous. With a more sensitive i-r detector, radiation could be reflected by natural objects, such as large rocks. An even more sensitive detector could receive natural i-f radiation emitted by the rock itself.

## Developing Dosimeter

The Corps is studying radiological warfare, investigating gamma and neutron shielding, and developing a tactical gamma-neutron dosi-

meter for use in field operations.

Research center for both CW and RW is the Chemical Warfare Laboratories, Army Chemical Center, near Edgewood, Md.

Main test work for BW, CW and RW is carried out at the U. S. Army Chemical Corps Proving Ground, Dugway, Utah. The proving ground includes meteorological towers, CW and BW samplers arranged in a grid pattern, telemetry network and central control center.

The weather towers continuously record temperature, barometric pressure, humidity and wind data. This information is telemetered to the control center every hour.

Samplers are glass bottles with small battery-run motors for taking in air and sealing the bottle; they are controlled remotely by radio.

The control center directs all sites by a master radio transmitter. Telemetered data from the weather towers and test sites are automatically translated to punched cards and fed into a computer.

A radioactive test facility is under construction at Dugway which will use a radio-controlled rail system for sending instruments into contaminated areas.



# New Biological Effects of R-F

Research programs demonstrate that all biological effects of r-f are not traceable to heat. Studies aim now at causes

NEW RESEARCH in biological effects of r-f energy is beginning to demonstrate the possibility that living organisms present significant nonthermal reactions to various portions of the radio spectrum.

(Up until the beginning of this year—as *ELECTRONICS* reported in "Researching Microwave Health Hazards," p 49, Feb. 20—the most significant effects reported were thermal in character and thus directly related to average power level. One clearly nonthermal phenomenon was the formation of pearl chains in certain types of cells in suspension, under the influence of high-frequency power at low levels. But other nonthermal effects were extremely hard to trace, and many researchers hesitated to accept early and highly tentative findings.

(Research this year, however, has not only demonstrated nonthermal behavior, but also begun to educe theoretical explanations for it.)

## The Marching Protozoa

Dramatic evidence of electrical influence on living matter has been presented by John H. Heller of the New England Institute for Medical Research. In his work, he has influenced the migratory behavior of unicellular organisms, produced chromosomal aberrations resulting in subsequent mutation, and produced a kind of split personality in large protozoa—amoebae and paramecia—in which their internal structure was oriented one way and their whole-body structure in another. In one repeatable experiment, he used this to sunder an amoeba violently, of course destroying it.

Heller's experiments were performed using a 1-to-100-mc variable-frequency oscillator. Voltage was continuously variable from zero to 20 kv. Pulse techniques were used, with pulses varying in width from 1 to 20 microseconds and rep rates varying from 30 to 10,000 per second.

Energy from the r-f source was coupled to two flat electrodes placed several millimeters apart. Specimens of particulate matter, bacteria or protozoa were placed between two cover slips, sealed with a silicone gasket, and the test chamber laid across the electrodes. Experiments were conducted at low average values of power, insufficient to heat the suspensions. Tests in the frequency range from 5 to 25 mc were most generally effective.

At lower frequencies, Heller reports, motile protozoa migrated parallel with the electrodes; at higher frequencies they switched and marched back and forth between the electrodes. Effective frequencies were quite specific for various organisms, so that at a given frequency, one species may march one way, another across the path of the

first, and a third may be unmoved by the whole proceeding.

## Mutant Garlic

Squashed garlic tips exposed to five minutes of r-f (about 6 mc) began, some 10 hours later, to exhibit aberrations in reproductive behavior, with the peak aberrancy occurring 24 hours later. Many cells could not properly reproduce: in some cases the nucleus divided—or almost divided—but the cell would not; in others the chromosomes scattered instead of remaining in a neat central nucleus; still other cells split but a chromatic bridge remained between nuclei, or the nucleus did not divide equally.

These chromosomal aberrations, Heller reports, appear to be frequency-specific. They also subsequently confirmed themselves as

## Missile Control Center Goes Aloft

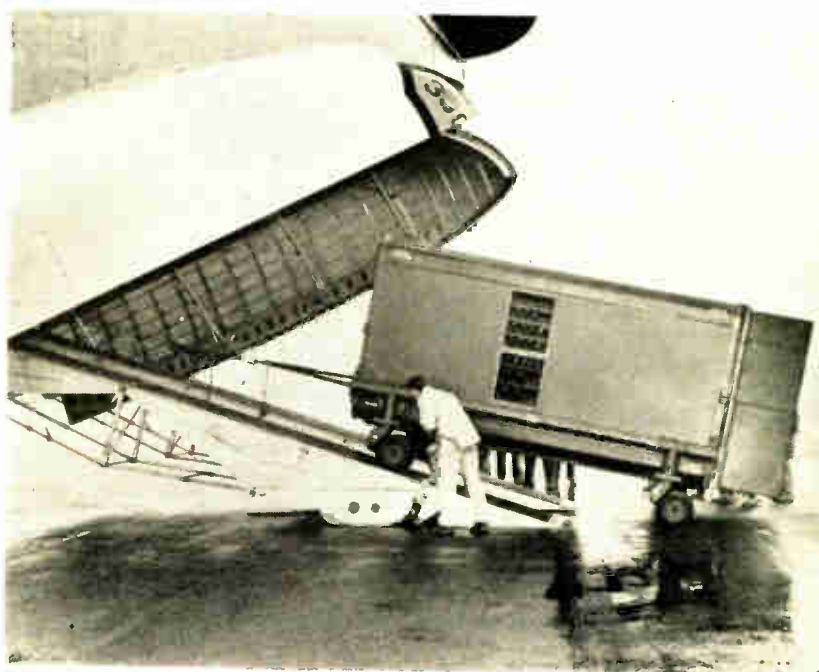

Battery control center for the Hawk missile system, Army's surface-to-air, semiactive radar homing missile, is loaded into a C-124 aircraft. Raytheon is prime contractor for the system; aluminum shelter is manufactured by Craig Systems, Inc.



# Energy

permanent mutations.

H. P. Schwan and D. W. C. Shen of the University of Pennsylvania's Moore School have evolved a theory that may eventually explain the marching protozoa. Certain advanced analytical investigations at the University of California at Berkeley may unriddle the mutation phenomena.

Schwan and Shen, continuing earlier investigations into the behavior of spherical particles in suspension, have applied the Maxwell-Wagner theory of inhomogeneous dielectrics to ellipsoidal particles in suspension. Their work demonstrates the frequency-dependence of the dielectric constant and conductivity of a suspension of membrane-covered ellipsoids. Dielectric constant falls irregularly with increasing frequency, and conductivity rises; the crossover point may be the point in the frequency spectrum at which the particles cease moving parallel to Heller's electrodes and begin moving across them.

Investigations at Berkeley have established that the growth of microorganisms is stimulated by r-f irradiation. Other investigations show that X-band irradiation inhibits the reproductive and survival abilities of yeasts. Statistical evaluation of mutations has not yet been undertaken.

One investigator postulates that deoxyribonucleic acid, the memory constituent of individual cell nuclei, acts as a signal generator; that ribonucleic acid, another component of the nucleus, acts as an amplifier; and that enzymes or proteins act as effectors, obeying signals from the two acids. Signals are coded pulses in various regions of the spectrum, highly redundant to ensure data transfer, and recoupled by feedback loops. Cell membranes act as noise filters.

If this circuit analogy does exist, then r-f energy at frequencies high enough to bypass the cell-membrane capacitance can heterodyne the signals in the cells and affect the transfer of information.

## 7 benefits for you with trio labs' BUILD-IN concept

By designing-in trio miniature panel-mounting instruments into operating and testing equipment, you . . .

- customize both your test set-up and instruments
- save space (average trio model is 4" x 4" x 4")
- save time: at-a-glance sequential or continuous monitoring
- save money: exclude unnecessary instrument functions, ranges
- make monitoring foolproof: read "go no-go" by switching
- improve testing efficiency and system reliability
- increase overall design freedom

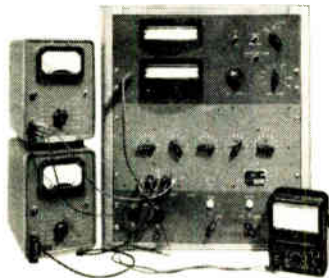

**BEFORE . . .** 3 external instruments were used to measure AC and DC voltages . . . cluttered, tedious, wasteful, subject to error.



**AFTER . . .** 3 trio VTVMs integrally built-in now are always on hand to measure just the parameters you designate.

3 ways you can use Trio Labs' pioneer know-how . . .

1. choose from trio's complete line of "standard" models.
2. select a "special" already produced—and you save the engineering time and money that went into it.
3. consult us for design specific to your own needs.



Write for free "how to" Engineering Guide to Dept. E-12

TRIO LABORATORIES, INC., PLAINVIEW, L. I., NEW YORK

© 1959

## ELECTRONIC-ELECTRICAL CAREER BULLETIN

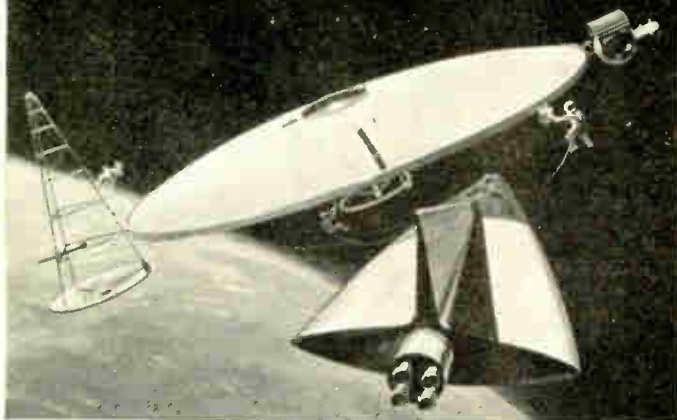

**MARS VEHICLE.** Drawing, based on Boeing study, of space vehicle designed for launching from orbiting platform for reconnaissance flight to Mars and return. Lunar, orbital and interplanetary system studies, and expanding programs such as the advanced Minuteman solid-propellant ICBM, are typical of challenging, long-range assignments Boeing offers electronic-electrical engineers.



**DARK TUNNEL.** View in 100-foot dark tunnel, part of extensive Boeing infrared research and development facilities. Boeing investigations include use of infrared, visible and ultra-violet techniques for use in communication, navigation, detection and guidance at altitudes above tropopause. IR systems, inertial navigation, electrical power systems for satellites, shockwave radiation and refraction and iridome heating are other areas of assignments open at Boeing.



**SEATTLE** area, boating capital of U.S., offers world-famous recreational facilities. Fresh and salt water boating and fishing are only one hour from dramatic snow-capped mountains renowned for six-months-a-year skiing. Mild year-round climate. Excellent schools and universities, cultural activities, modern housing and shopping centers. Wonderful Western living for the whole family!

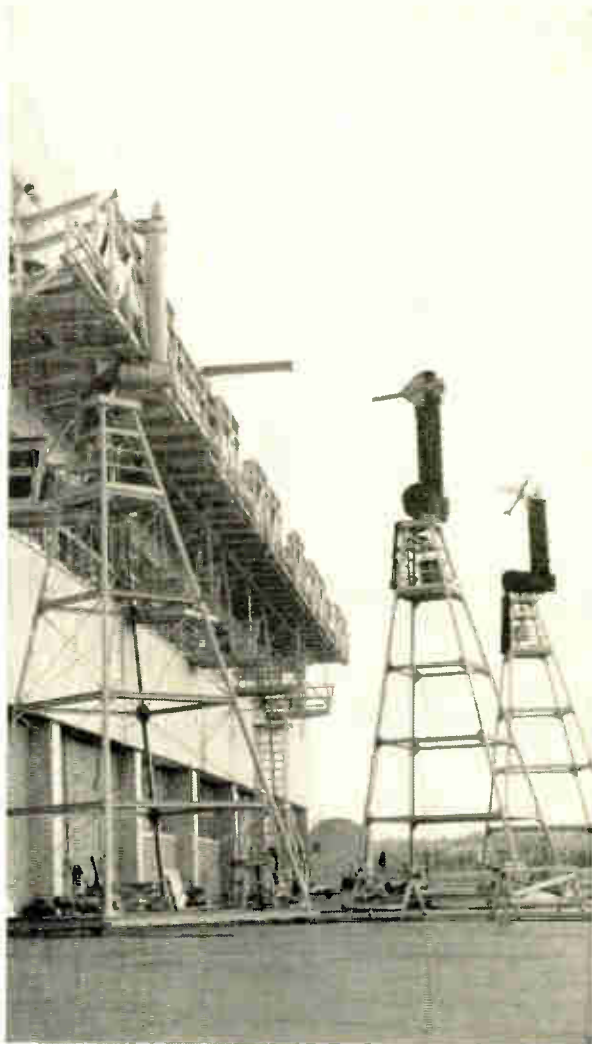

**ANTENNA PATTERN RANGE,** with movable towers capable of handling models up to 1000 pounds. Boeing has openings in ECM antenna development, and in gas, solid and liquid dielectric research, as well as large-aperture antennas for ASMs, orbital vehicles and airborne warning systems. Other openings are available in instrumentation, missile guidance and control.

### ELECTRONIC-ELECTRICAL ENGINEERS

Write today for details of challenging, long-range positions available to you right now at Boeing. You'll find at Boeing a dynamic professional environment that's conducive to rapid advancement and deeply rewarding achievement.



Mr. Stanley M. Little,  
Boeing Airplane Company,  
P.O. Box 3822 - ENF, Seattle 24, Wash.

Send me details of electronic-electrical positions, and the booklet, "Environment for Dynamic Career Growth."

Name..... Degree(s).....

Address .....

City..... State.....

Field of interest.....

**BOEING**

Seattle • Wichita • Cape Canaveral



under  
this  
semiconductor  
symbol...

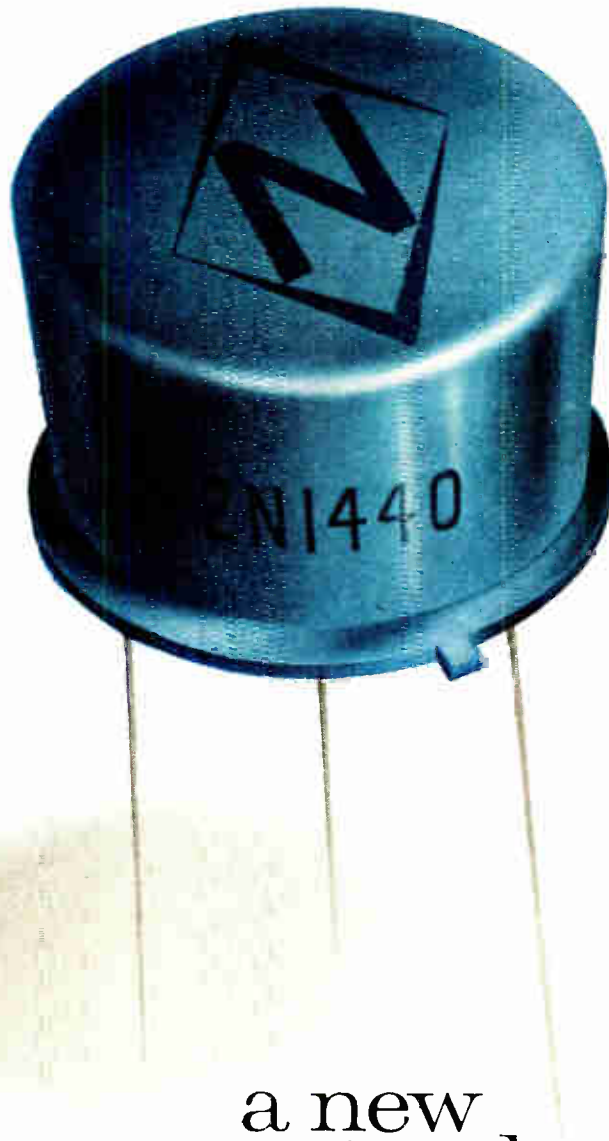

a new  
standard of  
PNP silicon alloy  
transistors

2N1440 series—now available

for further information, write:

 **National**  
SEMICONDUCTOR CORPORATION • DANBURY, CONN.  
West Coast Office: 690 N. Sepulveda Blvd., EL Segundo, Calif.

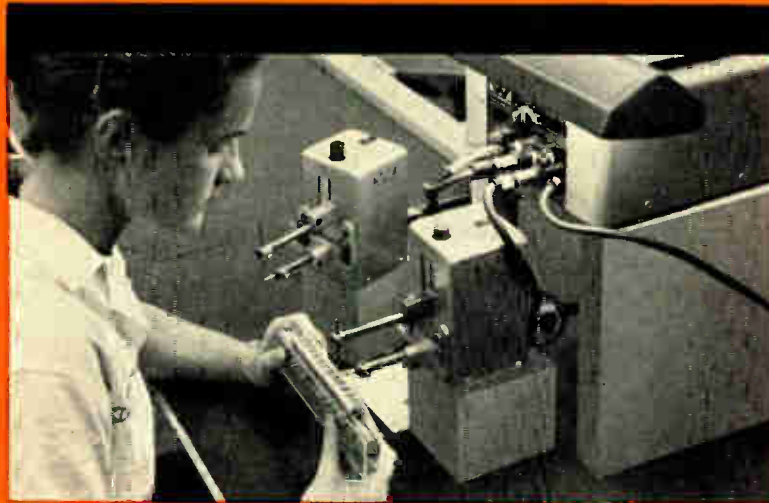

## WELD-PACK REVOLUTIONIZES COMPONENT ASSEMBLY

Cutting size and weight 75% or more the new "Weld-Pack" construction as produced by Sippican Corporation for MIT's Instrumentation Laboratory stacks components in true three-dimensional packaging of almost any shape or module. Packaging densities ranging to 260,000 components per cubic foot are achieved *only* through Weldmatic welding, which cannot damage adjacent components through unwanted heat. "Weld-Pack" eliminates unnecessary weight of phenolics and lack of continuity in printed wiring — gives designers unlimited freedom. For this fresh, new concept in packaging, Sippican Corporation depends on WELDMATIC electronic welders chosen after careful evaluation of *all* stored-energy equipment. Unvarying uniformity of welds; accurate, repeatable pressure — these are some of the WELDMATIC features so important to constructing "logic sticks" and other component packages to new standards of quality.

IMAGINE reliability of only one reject in one million welds . . . no cold joints . . . no flux contamination . . . greater mechanical strength. FIND OUT how Weldmatic welding can help *you* with difficult metal-joining production problems.

*(Above) Sippican assembler uses two Model 1032 Welding Heads and companion Weldmatic Power Supply in performing two separate welding operations on a "Weld-Pack" without changing electrodes or fixtures. (Right) Following wiring diagram on Mylar insulation sheet, operator welds nickel ribbon buss to both tinned copper resistor and dumet semiconductor leads in this computer logic stick.*



## WELDMATIC

370 NORTH HALSTEAD AVENUE, PASADENA, CALIFORNIA

DIVISION OF UNITEK CORPORATION





New Russian computer, BESM-2, performs 8,000 mathematical operations per second while operating at calculating center of Moscow's USSR Academy of Sciences

# USSR Improves Computers

Eight U. S. experts report that Soviet computer technology is moving up apace, still lags Western developments

BOSTON—SOVIET COMPUTER technology is advancing rapidly but appears still to lag the free world. That is the consensus of the members of an eight-man team of American experts who visited the Soviet Union last May. Report on team observations was disclosed here this week by Willis Ware of RAND Corp., speaking at the Eastern Joint Computer Conference.

The eight experts went to Russia as part of an exchange which saw eight Russians visit this country. The trip was sponsored by the Institute of Radio Engineers, Association for Computing Machinery, and the American Institute of Electrical Engineers.

## Members of Team

The team was made up of Morton Astrahan, IBM; S. N. Alexander, Bureau of Standards; Lipman Bers, New York University; Morris Rubinoff, then with Philco, but now with University of Pennsylvania; Harry Goode, then of Bendix, now with University of Michigan; Paul Armer and Willis Ware, both of RAND Corp.; and Harry Huskey, University of California.

Several of the group, reporting their observations earlier to the Office of Naval Research, speculated that the Russians may not have disclosed all of their latest computer

developments and techniques.

Here are some of the team's observations:

Soviets lag in use of high-speed magnetic tape transports for input and output. Several Russian computers use punched movie-type film with eight data storage tracks, which provides 75 words per second. This is faster than punched paper tape, but substantially slower than magnetic tape input-output equipment.

Magnetic drums used as memory devices achieve storage density of about 100 bits per inch. Russians use a one-mil spacing between drum and read-write head. Heads are preheated before rotor is started to maintain a clearance between the drum and head when the drum expands.

Deposited-carbon resistors are used universally. One explanation is that fabrication of deposited-carbon resistors is a more easily mastered art than that of producing cheaper composition resistors.

## Trouble With Transistors

Diffused-base transistors capable of operating at frequencies up to 120 mc were shown to the visitors. Russians, however, appear to be having trouble fabricating transistors with uniform characteristics.

Deposited thin magnetic films are

being actively investigated by the Soviets. Best results have been obtained using an 80/20 permalloy with film thicknesses of about 2,000 angstroms.

A high-speed printer capable of printing 50 lines per second is now under development. The machine is limited to numbers and does not print letters. Machine stores up to 10 lines at a time, prints them simultaneously.

Computer manufacturing techniques appear to be about on par with those in use in this country. No etched circuit boards were seen, but the Russians do make wide use of plug-in circuit modules.

One of the first large Russian digital computers is a machine that originally had an acoustic memory, later was changed to cathode-ray-tube storage and, still more recently, to ferrite-core memory. This computer can perform an average of 8,000 operations per second. An improved version of the earlier model is in the prototype stage.

A small digital computer operating at about 100 operations per second is in widespread use and has been exported in small numbers. More than 150 have been manufactured.

Small desk-size analog computers were much used in laboratories visited by the U. S. team.

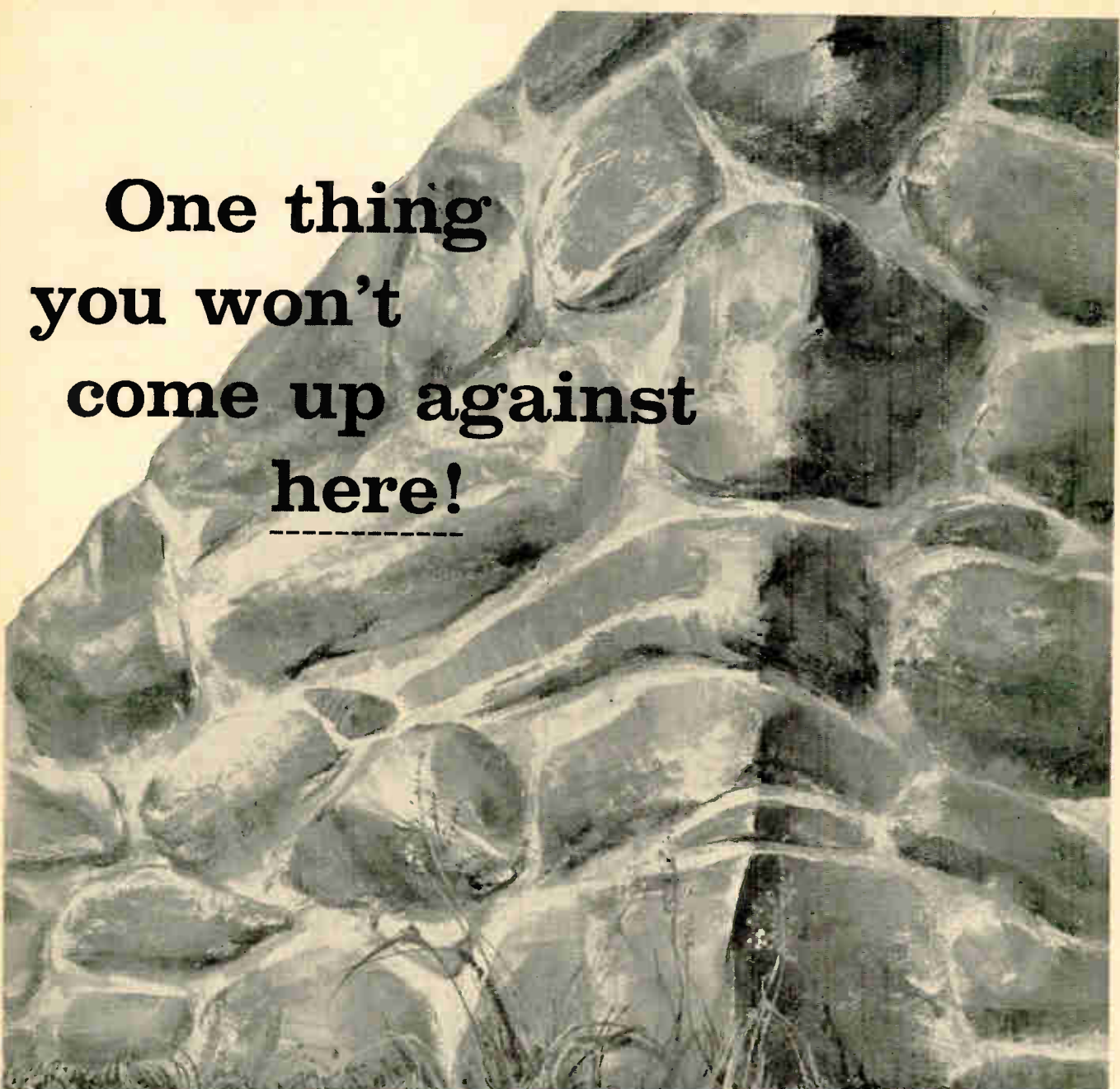

**One thing  
you won't  
come up against  
here!**

---

The engineer working in the Missile Systems Division of Raytheon Company gets *help not hindrance* in improving his professional status. His ability is quickly recognized . . . his achievements rewarded. He *grows* constantly with fast growing RAYTHEON. If you can qualify for one of the following positions, *why hesitate?* Write Mr. Jerry Morris, Professional Employment, Raytheon Company, Missile Systems Division, Bedford, Massachusetts.

**IMMEDIATE OPENINGS FOR:**

**Data Handling Engineers** . . . with experience in high-speed, analog-to-digital conversion techniques, logic design, converter and buffer design. Should have thorough knowledge of tape recorder techniques and digital, servo, and digital-computer design.

**Circuit Design Engineers** . . . with experience in design of high-speed switching circuits, pulse techniques, and computer logic. Should be experienced in one or more of the following areas: navigation, guidance, control circuits, CCM, FM, PCM, PDM, and fusing circuitry.

**Packaging Engineers** . . . with a knowledge of packaging and production techniques in sheet metal and electronic equipment. Will design electronic portions of guided missiles, radars, computers, test equipment. Should have thorough knowledge of circuitry.

**Electromechanical Designers** . . . will design electromechanical equipment and electronic portions of guided missiles, including coordination of effort through the shop. Will work closely with Design Engineers in developing electronic packaging philosophies. Knowledge of electronics, electronic components, and ability to read schematics required. Should have experience in sheet metal equipment design and knowledge of current "state of the art" in electronic equipment.



**MISSILE  
SYSTEMS  
DIVISION**





# New "METALLIZED" MYLAR Subminiatures

## PROBLEM-SOLVING CAPACITORS for High density packaging



**SPACE SAVING.** Significant size reduction over film-foil and paper-foil designs can save vital space. The net volume saved increases with capacity value.

**WEIGHT SAVING.** The quantity of metal required for plates in these metallized Mylar designs is less than 5% of that for an equivalent foil design. Weight saving increases rapidly as capacity value increases.

**"EDGE MOUNTING".** Because its cross-section is rectangular, Type XG63F permits mounting with either the side or edge in contact with the chassis. Type XG63FR is designed for edge mounting only.

**SUPERIOR IR** Insulation resistance of these rugged Mylar dielectric types far exceeds the IR obtainable from paper designs. (See curve below for actual performance.) • DuPont's trademark for polyester film



**X663F**  
AXIAL LEADS



**X663FR**  
RADIAL LEADS

- ① TOUGH MYLAR CASE
- ② EPOXY END SEAL

**INSULATION RESISTANCE.** Greater than 30,000 megohm-microfarads at 25°C, but need not exceed 30,000 megohms

**DISSIPATION FACTOR.** Less than 1% when measured at or referred to 1000 CPS — temperature of 25°C

**VOLTAGE RANGE.** Available in 100, 200, 400 and 600 VDC

**ACCELERATED LIFE TEST.** 250 hours at +100°C and 125% of rated voltage

**CAPACITANCE TOLERANCES.** Standard tolerance ±20%, also available in ±10%, and ±5%

**TEMPERATURE RANGE.** Full rated voltage from -55°C to +100°C, to +125°C with 50% derating

### TYPICAL SIZES-SHOWING THICKNESS • WIDTH • LENGTH

CAP IN MFDS	100 VOLTS			200 VOLTS			CAP IN MFDS	100 VOLTS			200 VOLTS		
	T	W	L	T	W	L		T	W	L	T	W	L
01	156	203	1/4	1.5	1.87	1/4	1.00	451	593	1/4	485	687	1/4
1	250	359	1/4	250	359	1/4	2.00	486	718	1/4	482	734	1/4
33	296	484	1/4	328	500	1/4	3.00	453	765	1/4	546	903	1/4
47	359	546	1/4	343	625	1/4	4.00	500	890	1/4	656	1,015	1/4
68	343	515	1/4	421	750	1/4	5.00	464	843	1/4	621	1,250	1/4

Capacitance Change vs. Temperature

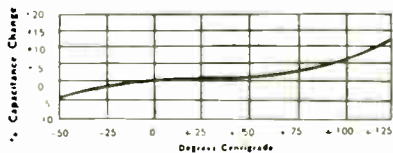

Insulation Resistance vs. Temperature

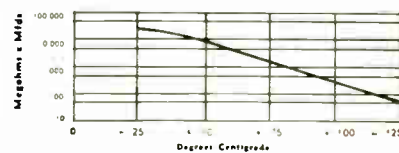

Write for literature on these NEW, "space-saving" types



**GOOD-ALL ELECTRIC MFG. CO. OGALLALA, NEBR.**

A LEADING MANUFACTURER OF TUBULAR, CERAMIC DISC AND ELECTROLYTIC CAPACITORS

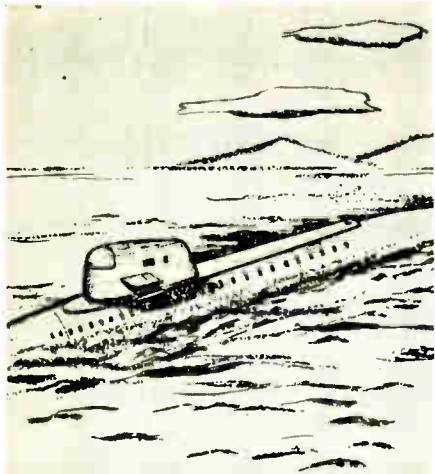

2N416  
2N417  
2N425  
2N426  
2N427  
2N428



Specify with assurance  
when you specify

**INDUSTRO**

alloy junction germanium

**PNP TRANSISTORS**

Absolute reliability has been imperative in the Polaris. The extreme reliability designed into the Polaris Missile Program requires transistors which far exceed the operating and environmental conditions of MIL-T-19500A.

Industro is proud of its contribution to the success of this vital military project.

Whether your transistor requirements are military or commercial you can depend on Industro. We invite your inquiries.

**INDUSTRO**

35-10 36th Avenue • L. I. C. 6, N. Y.

IN CANADA:  
CANADIAN GENERAL ELECTRIC COMPANY LIMITED

# What's Next for

Engineers at Radio Fall Meeting see transistors soon going in tv and f-m receiver front ends

SYRACUSE, N. Y. — Transistors soon in tv and f-m receiver front ends. That was the big news at last month's Radio Fall Meeting here. Interest in semiconductor trends brought more than 350 engineers to the meeting.

The three-day affair was sponsored by the Electronic Industries Association engineering department, with participation by Institute of Radio Engineers professional groups on reliability and quality control, electron devices, and broadcast and television receivers.

A highlight of the program was the transistorized tv tuner session: Victor Mukai, General Instrument Corp., presented design notes on a transistorized vhf tv tuner; Karl Whittig, Standard Coil Products

Co., described transistorized tv and f-m tuners; and H. F. Cooke, Texas Instruments, Inc., discussed developmental work he and colleague R. R. Webster had done with mesa transistors and tv tuners.

## Cite Performance, Cost

Improvement in performance of both microalloy diffused and mesa transistors, and continuing reduction of cost, were cited by panel members as reasons for their use soon in front ends of tv and f-m receivers.

Whittig said Standard Coil was pleased at the high rate of interchangeability it was having with transistors and that the devices had brought tuner costs down. Cooke noted good uniformity in mesa transistor production and predicted

## Busy Communications 'Turrets'



Army Combat Development Experimentation Center, Ft. Ord, Calif., uses high frequency radiotelephones to collect real-time tactical data from experimental areas. Field messages are sent to a retransmission station. From there, 30 channels are combined by multiplex equipment and transmitted by microwave to the control center



# Transistors

a 3-kmc limit for the device because of the small size in which it can be mass-produced. Also anticipated by the panel were 2-transistor f-m tuners.

Statements from the audience indicated the belief that tunnel diodes were still too early in the development stage to be considered in tuner design.

"Tunnel diodes now cost like diamonds—we're trying to get them down to gold," observed one engineer.

At the transistorized tv receiver session R. B. Ashley, GE, described a transistorized linear vertical deflection system; L. J. Mattingly, Motorola, discussed a receiver sound section using transistors; J. G. Humphrey, GE, presented a transistorized i-f amplifier; and C. D. Simmons and C. R. Gray, Lansdale division of Philco, described the video processing circuits of an all-transistor receiver. A. R. Curll, Philco, displayed a working model of a 21-transistor battery-operated receiver.

## Applications, Trends

Transistorized a-m/f-m and auto radios were assigned a special session: H. Van Abbe, AmpereX, described an integrated a-m/f-m portable; R. A. Santilli and H. Thanos, RCA, presented an a-m/f-m receiver using drift transistors; J. Hammerslag, Hughes Products, discussed application of semiconductor capacitors to auto radios; J. Kalman, Hoffman Electronics, described solar power supplies for transistorized radios; and R. A. Santilli and C. F. Wheatly, RCA, discussed use of drift transistors in car radios.

The electron tube meeting featured: new oscillator-mixer circuits for tv and f-m tuners. E. H. Hugenholz, AmpereX; composite base metal for oxide-coated cathodes, W. T. Millis, GE; sarong cathode, D. R. Kerstetter, Sylvania; new 6EV5 vhf tetrode, R. Pear, Westinghouse; and Nuvistor triodes as r-f amplifiers in tv receivers, L. Barr, RCA.

# The smallest, lightest, PRECISION TRIMMING POT on the market!



## FAIRCHILD TYPE 926- $\frac{3}{8}$ " DIAMETER TRIMMER

**Smallest?** ... You can't get one any smaller, not when diameter and length measure only  $\frac{3}{8}$  of an inch.

**Lightest?** ... Although it weighs only 3 grams, this precision micro-miniature trimmer incorporates a machined aluminum case, stainless steel shaft and precious metal wiper and contacts designed for high reliability. It is protected against dust and moisture by an "O" ring shaft seal.

**All this and reliability too** ... The Trim-tite, Jr. meets MIL SPEC 202A for missile and aircraft applications, assuring constant setting over a wide range of severe environmental conditions.

**Standard and high-temperature units** are available in resistance ranges as high as 25K with linearity values as low as 3%. Power ratings at various ambients are shown below.

**A "GIANT-SIZE" VERSION** The Fairchild Trim-tite type 927 — measuring  $\frac{1}{2}$  inch in diameter and length, and weighing 9 grams

— is available in resistance ranges as high as 50K. Resistance values up to 150K can be supplied on special order.

**Standard units** in a wide range of resistance values are available for off-the-shelf delivery.

*For complete specifications and detailed application information regarding your particular requirements, write to Dept. 32E*

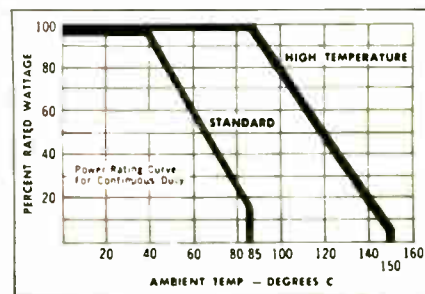

# FAIRCHILD CONTROLS CORPORATION

COMPONENTS DIVISION  
225 Park Avenue, Hicksville, L. I., N. Y. • 6111 E. Washington Blvd., Los Angeles, Cal.  
A Subsidiary of Fairchild Camera and Instrument Corporation

GYROS  
PRESSURE  
TRANSDUCERS  
POTENTIOMETERS  
ACCELEROMETERS

# Need Better Electrical and Thermal Conductivity in a Glass-to-Steel Hermetic Terminal?

For most applications, solid 446 stainless alloy electrodes are best suited to our users needs. They are ideally suited to the perfect mating between our V24M glass and the pin. This fusion of glass and metal together with compression accounts for the rugged leak-proof character of Fusite Terminals under rough production handling and makes for easy solderability.

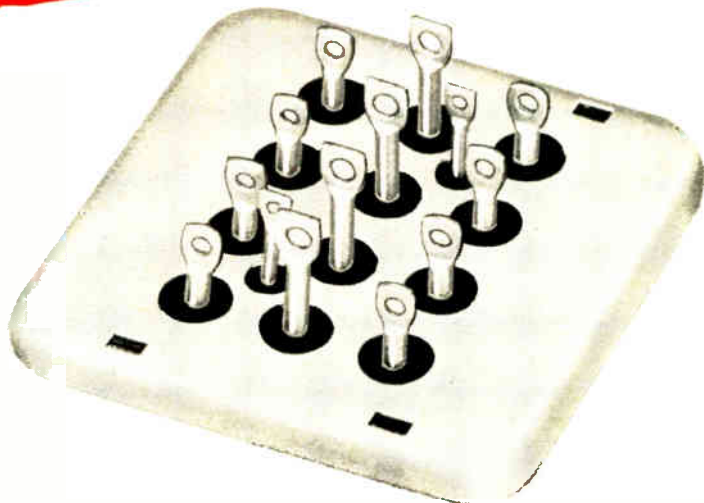

## CONSIDER THE PLUS OF COPPER CORED ELECTRODES

When your application indicates the need for greatly improved electrical or thermal conductivity, you still need not sacrifice these inherent Fusite advantages. At slight additional cost, any of our terminals can be ordered with electrodes that have a copper core of as much as 25% of the total electrode area. Copper cored wire has up to 10 times increased current carrying capacity, yet, you maintain nearly all the advantages of solid 446 stainless.

*Would you like to make tests?*  
Write Department M-6



THE **FUSITE** CORPORATION

6000 FERNVIEW AVE., CINCINNATI 13, OHIO

Woodford Mfg. Co., Versailles, Kentucky.

In Europe: FUSITE N. V. Königsweg 16, Almelo, Holland



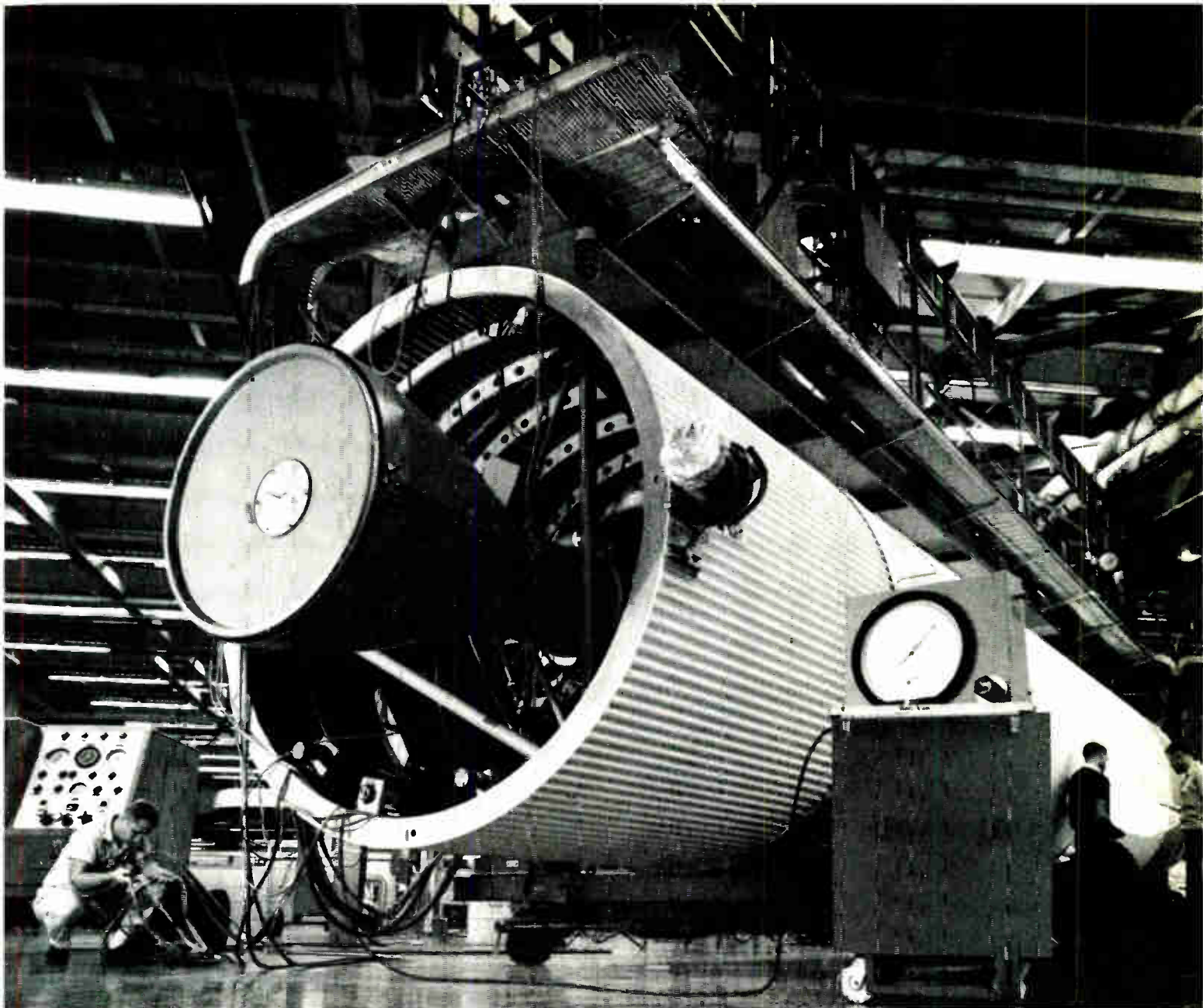

Jupiter IRBM Missile in final test and checkout area where actual flight conditions are simulated, at the Chrysler operated U.S. Army Michigan Ordnance Missile Plant near Detroit.

## IN SOUTHEASTERN MICHIGAN: A SCIENTIFIC CLIMATE FOR THE ELECTRONICS INDUSTRY

An important aspect of Southeastern Michigan's scientific climate is the steady growth of electronics research and production activity. Here electronics firms can benefit because of the area's world-wide reputation for know-how in production technology. Here components for improved missile controls, communications systems, data processing and miniaturization are produced profitably, for economical distribution throughout the United States.

The men that manage and man this new industry have found that Southeastern Michigan is a great place in which to live and work. And it has dozens of modern communities which have provided wisely for future expansion. Many have retained professional city planners to assure optimum land use. We would welcome the opportunity to discuss communities and plant sites with you on a completely confidential basis.



Typical of Southeastern Michigan's electronics activity are: (Left) Burroughs Corporation—assembly of test equipment for check-out of Atlas ICBM guidance system. (Center) Scientist observes formation of a vanadium crystal in Ford Motor Company Scientific Laboratory. (Right) Technician at Performance Measurements Company finishing a digital torque indicator.

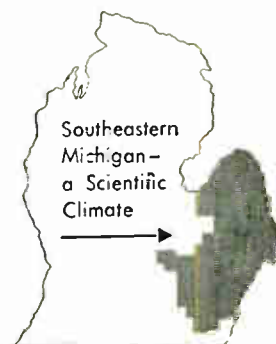

Write Plant Location Service,  
Area Development Division.

**DETROIT EDISON**



# The Silicon Controlled Rectifier

*how will it affect your business?*



General Electric's revolutionary Silicon Controlled Rectifier was introduced just two short years ago. The SCR has already proved it lowers costs, improves performance and solves old problems in radically new ways. It can replace thyratrons, magnetic amplifiers, power tubes and transistors, relays, switches, and many other devices. These are a few of the changes the SCR is now bringing about:

Vastly superior motor control systems for industry. Faster, more precise, smaller, more versatile, non-mechanical.

AC current for vehicles and aircraft. The SCR is the first really practical means of getting high power AC from variable DC. Static inverters with ratings of several kilowatts are possible.

Simple temperature controls accurate to 1/10th degree or better. Practical for all types of industrial furnaces.

Superior DC motor operation from an AC source. Extends the use of DC where desirable. Eliminates motor generator sets or magnetic amplifiers. Replaces mechanical speed and direction changers.

Stage lighting dimmer controls. Small, precise, reduces cost of installation for the entire system.

Current-limiting circuit breaker. Opens in less than twelve micro-seconds, long before a fault current can reach its peak.

More efficient lighting systems. Much more light per bulb through small, efficient SCR frequency converters that result in higher frequency and smaller ballasts.

#### **How will it affect your business?**

You'll be better able to judge after you have read our informative new folder. Write today to General Electric Company, Semiconductor Products Department, Section S25129, Electronics Park, Syracuse, New York.

*Progress Is Our Most Important Product*

**GENERAL  ELECTRIC**

Semiconductor Products Department



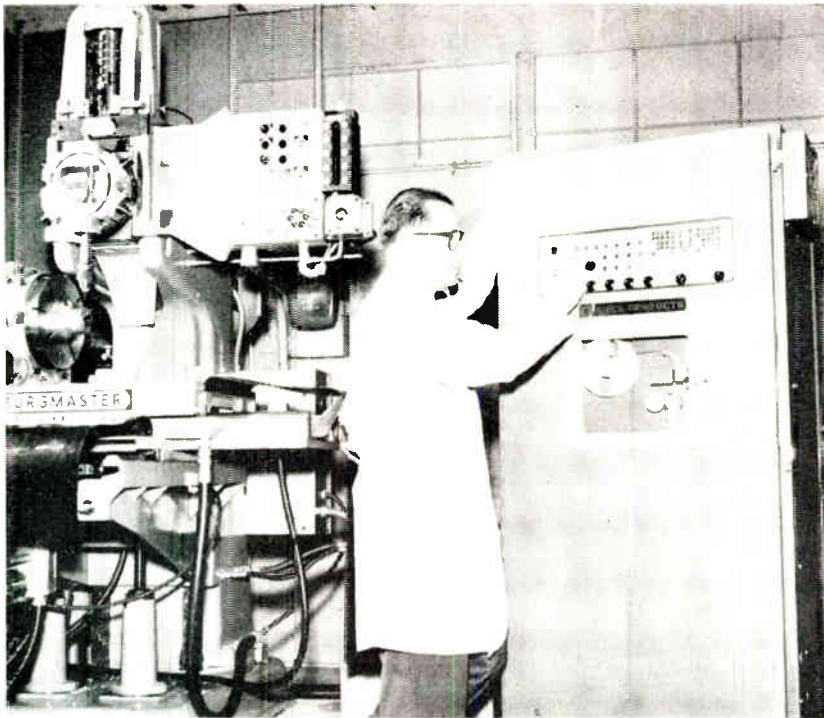

Operator demonstrates ease of starting and stopping Hughes machine control equipment. Discrete positioning is possible at 180 inches per minute

## New Controls for Machines

Transistorized system comes in modular units for easy maintenance, increased reliability

LOS ANGELES—A new numerical control positioning system, recently unveiled here by Hughes Aircraft, features repeatable accuracy to 0.0002 inch and adaptability to drilling, punching, riveting, spot welding, and turning operations.

Completely transistorized, the compact unit can be adapted to any of a number of new machines, or retrofitted to older models. William C. Leone, manager of the company's industrial systems division, reports the system "features highly advanced diode and transistor circuits, designed in modular units for easy maintenance and great reliability."

### High Reading Speed

Standard punched tape, one inch 8-channel, is utilized. Extremely fast reading speed is made possible by electronic photocell positioning transducers. Reportedly, highly accurate positioning is obtainable using positioning speeds of 180

inches per minute.

Low power requirements of the transistorized circuits permit simple power needs—110 volt, single phase. Drive motors plus control equipment require less than 7 amps. The control device does not make use of any closed-loop type of servo, making it adaptable for numerical control of many existing machine tools. The system permits two-axis numerical control.

Control cabinet contains ample space for later additions of third-axis control equipment.

To allow for initial checkout of machining runs, the control can be set to operate manually or semi-automatically, as well as fully automatically.

When the machine tool is performing one operation, the tape unit is reading the next instructions, thus speeding up the process.

A single compact cabinet houses the photocell tape reader, operator control, and electronic circuits.



FIRST IN  
MILLIMICROSECOND  
INSTRUMENTS

700 mc Bandpass  
(0.6 msec Rise Time)  
300 mc Rep. Rate  
with Your Present  
Oscilloscopes



### LUMATRON Model 22ST

Universal Millimicrosecond  
Oscilloscope Sampling Unit.  
Converts your present  
oscilloscope to  
millimicrosecond  
operation.

First with a complete line of  
millimicrosecond instruments,  
including:  
Oscilloscopes, Sampling Units,  
High Impedance Probes,  
Sync Trigger Units,  
Accessories,  
Automatic Test  
Equipment

Lumatron instruments are now in use in  
laboratories and factories throughout the world.  
WRITE FOR SPECIFICATIONS TO DEPT. E-12  
LUMATRON ELECTRONICS, INC.  
63 URBAN AVENUE, WESTBURY, L. I., NEW YORK

## LUMATRON ELECTRONICS

CIRCLE 51 ON READER SERVICE CARD  
CIRCLE 52 ON READER SERVICE CARD →

# TRIPLET

Quality...  
First to last

# COMPLETE PANEL METER

## BAR-RING TYPE MOVEMENTS (Exclusively Triplet)

- Self Shielded
- Not affected by magnetic panels or substantially by stray magnetic fields.
- More Torque
- Lower Terminal Resistance
- Faster Response
- Exceedingly Rugged and Accurate
- All Case Sizes

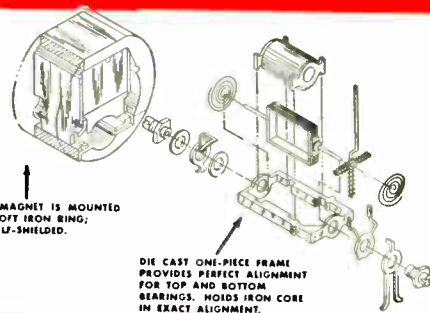

ALMICO MAGNET IS MOUNTED INSIDE SOFT IRON RING; FULLY SHU-SHIELDED.

DIE CAST ONE-PIECE FRAME PROVIDES PERFECT ALIGNMENT FOR TOP AND BOTTOM BEARINGS. HOLDS IRON CORE IN EXACT ALIGNMENT.



Round Flush Mounting (2 1/4")  
Model DC 221-T, AC 221-A, RF 241-T



Rectangular Flush Mounting (2 3/4")  
Model: DC 227-PL, AC 227-PL, RF 247-PL



Round Flush Mounting (2 1/4")  
Model: DC 221-T, AC 221-A, RF 241-T, D.C. 281

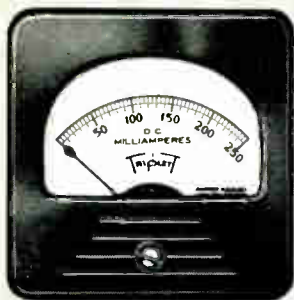

Rectangular Flush Mounting (2 3/4")  
Model DC 227-T, AC 237-S, RF 247-T

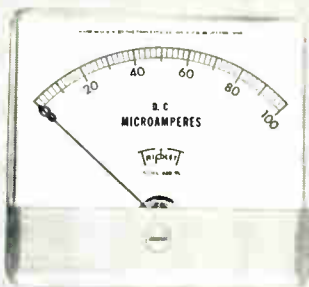

Rectangular Flush Mounting (4 1/4")  
Model: DC 420-PL, AC 430-PL, RF 440-PL

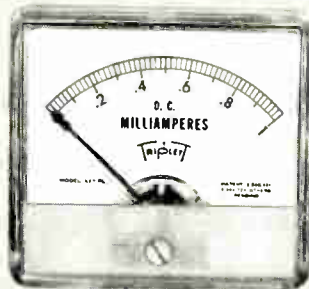

Rectangular Flush Mounting (2 1/4")  
Model: DC 227-PL, AC 237-PL, RF 247-PL

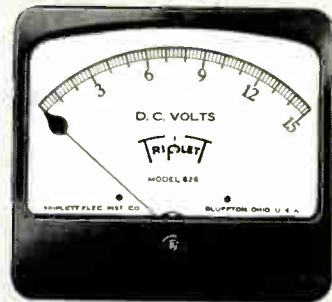

Rectangular Flush Mounting (6")  
Model: DC 626, AC 636, RF 646



Suggested Instruments — 1 1/2", 2 1/4" and 3 1/4"  
In addition to the popular commercial line of panel instruments, Triplet supplies a complete line of ruggedized and tested instruments designed to meet government specification MIL-STD-1032A.

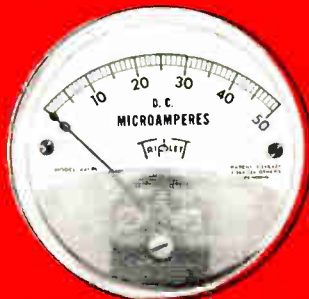

Round Flush Mounting (2 1/4")  
Model: DC 221-PL, AC 221-PL, RF 241-PL

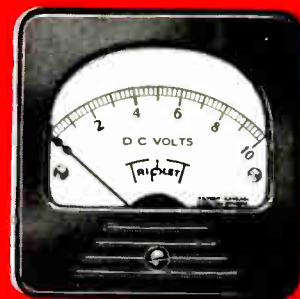

Rectangular Flush Mounting (2 1/2")  
Model: DC 227-A, AC 227-A, RF 247-A, D.C. 287-A

For complete details see your Electronic Parts Distributor, or write



# LINE FULLY MEETS YOUR NEEDS

The name TRIPLETT has been on instruments of our manufacture for more than 55 years, and is regarded as a symbol of customer satisfaction to industrials and distributors in all parts of the world. Our instruments can be built to customer

specifications or provided from our large stocks of standard ranges in hundreds of sizes and types. We also carry in stock many semi-finished movements which can be converted readily to special customer needs.



Rectangular Flush Mounting (4 1/2")  
Model: DC 428, AC 438, PF 448

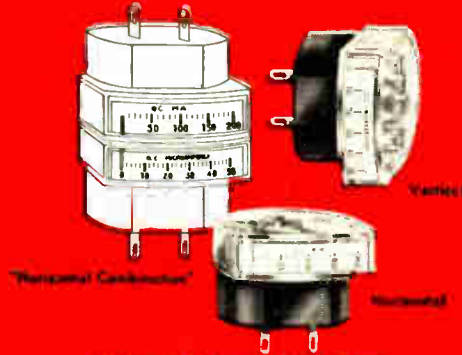

Miniature Edgewise Panel Meters  
—Model 120



Model 357-U Unimeter 3 1/2"  
Assembled

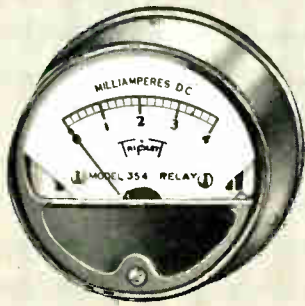

Model 354-Relay



Tilting Case Portable  
Model: 325 (DC), 335 (AC)



Model 420-U Unimeter 4 1/2"  
with mirror scale

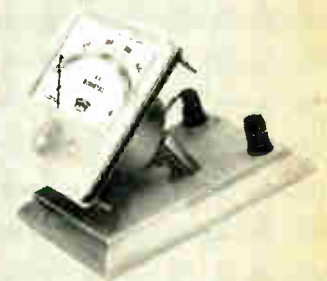

Model 234 Unimeter Stand

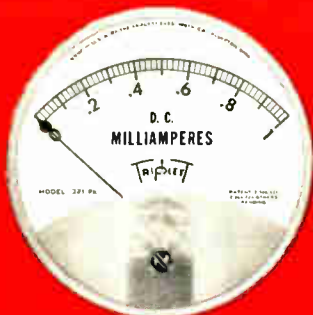

Round Flush Mounting (3 1/4")  
Model: DC 321-P, AC 331-P,  
PF 341-P

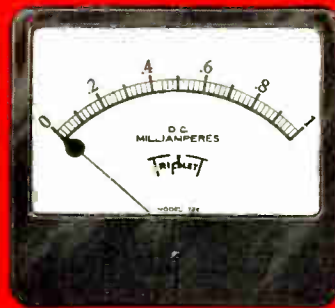

Rectangular Flush Mounting  
(2 1/4")  
Model: DC 718, AC 738, XE 748

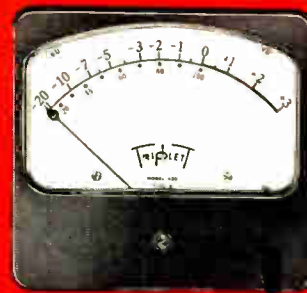

Model 420 VU Meter  
Type A Scale



6" Matted Case 6.7" Scale Portable  
Model: 322 (DC), 323 (AC)

**TRIPLET**  
Quality...  
First to last

TRIPLET ELECTRICAL INSTRUMENT COMPANY  
BLUFFTON, OHIO

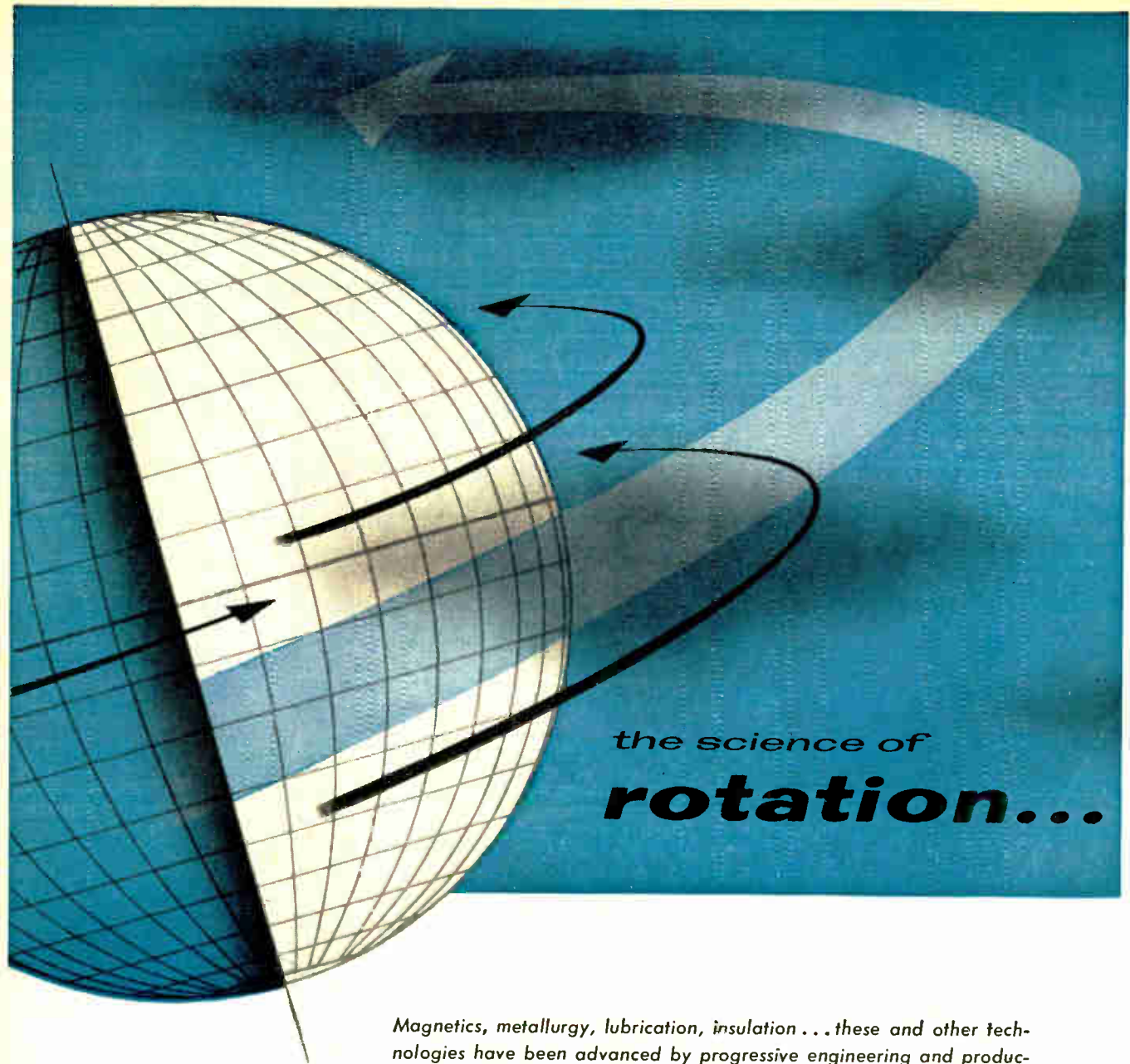

*the science of*  
**rotation...**



**TYPE VIHJ-G8**

Miniature Vane  
 Axial Blower

Maximum air delivery  
 in the smallest package

Combining a unique mechanical and aerodynamic design with EAD's standard, reliable 1" diameter motor has resulted in this extremely compact and efficient fan. In addition to the 2 pole characteristics listed below, EAD can supply 4 and 6 pole designs and models for operation from 1600-cycle and variable frequency power sources. Here is another development in the growing family of EAD V-Line vane axial blowers.

**TYPICAL CHARACTERISTICS**

115 Volt • 400 cycles single or three phase	1.5" total length
19,000 RPM nominal	1.990" housing diameter
65 CFM at 0" SP	Available with:
35 CFM at 2.3" SP	1. Leads
Life in excess of 1000 hours at 125°C.	2. Terminals on mounting flange
	3. Terminals on housing

Write for complete technical data. Dept 397.

Magnetics, metallurgy, lubrication . . . these and other technologies have been advanced by progressive engineering and production personnel at Eastern Air Devices to make a science of "the act of turning." Since 1942, this scientific approach to the improvement and development of precision rotating devices has resulted in higher output efficiencies, reliable operation in higher ambients and superior performance characteristics under the most severe environmental conditions. In addition to continued product improvement, the application of this science has developed a number of firsts, including variable frequency motors, pure sine wave alternators and thermistor compensation of integrating tachometers. Combine this technical ability with high volume production, unsurpassed quality control, parts standardization for lower cost, and you can see why EAD has been specified by leading systems manufacturers for nearly two decades.

**EASTERN AIR DEVICES, INC.**



Subsidiary of Norbute Corporation • Dover, New Hampshire

INDUCTION MOTORS • SERVO MOTORS • HYSTERESIS MOTORS  
 INTEGRATING TACHOMETERS AND MOTOR TACHOMETERS • BLOWERS  
 INERTIALLY DAMPED SERVO MOTORS • TORQUE MOTORS • FANS  
 DAMPING MOTOR TACHOMETERS • GEAR MOTORS • ALTERNATORS

World Radio History



# On the Market . . .

## Cold Cathode Trigger-Timer-Gap Tube

switches 1000 amperes

The KP-130 is a subminiature, cold cathode tube, capable of switching pulse circuits with currents in excess of 1000 amperes.

The KP-130 is one of a family of "Krytrons" announced recently by KIP ELECTRONICS CORPORATION, manufacturer of electron tubes in Stamford, Connecticut.

The KP-130 is a T-3 size (see cut) capable of controlling pulse discharges as high as 1100 amps at 2500 volts. The anode delay time (time from the application of signal until conduction) averages 0.2 microseconds. The variation in delay ("jitter") is barely measurable, averaging less than 0.05 usec.



Actual Size

Hold-off voltage is in the 3000-4000 volt range, with higher voltage models in development.

With its high-voltage, high-current handling capabilities, the KP-130 will replace timer tubes and spark gaps, thereby eliminating circuit components and improving equipment reliability.

A low-level radioactive material is included for light and dark stability, but no external radiation results therefrom.

Tubes are available from stock. For further details, contact KIP ELECTRONICS CORPORATION, Dept. 926, Box 562, Stamford, Connecticut.



Engineers prepare reinforcing rod for strain gage installation atop The Old Man of the Mountains in New Hampshire



# Gages Guard Great Stone Face

### World-famous Old Man of the Mountains is being checked electronically for disintegration signs

THE OLD MAN OF THE MOUNTAINS in Franconia Notch, N. H.—the natural wonder immortalized in Hawthorne's "The Great Stone Face" and viewed by thousands of tourists each year—is being protected from disintegration by electronic monitoring techniques.

The Old Man, official symbol of the State of New Hampshire and proclaimed the most perfect natural stone face in the world, developed a cranial crevice hundreds of years ago, and state engineers estimate the crack has been expanding one inch per century.

#### Install Strain Gages

In addition to covering the top of the crevice and constructing a system of gutters to decrease water seepage, engineers clamped the two sides of the fissure together by steel rods. The rods bridge the gap diagonally and are fastened to each side of the crevice by steel hairpins imbedded 30 inches in the rock face. Large turnbuckles adjust the tension on each rod to eliminate further expansion of the crevice.

It was decided that observations using bonded filament strain gage techniques would provide the most reliable, repeatable and sensitive method of monitoring rod strain

induced by shifting of the overhanging ledge and of determining the load distribution.

#### Engineers Take Readings

Electronics engineers from Yewell Associates of Burlington, Mass., and Baldwin-Lima-Hamilton of Waltham, Mass., several times climbed over the rugged pathways at the top of Cannon Mountain, 1,200 feet above Lake Profile, to prepare the rods, install the etched foil strain gages and take test readings with a battery-powered strain indicator.

A four-arm Wheatstone bridge configuration was installed on each rod, with gages arranged to provide maximum sensitivity to axial rod strain, a cancellation of bending strains and compensation for temperature effects on the strain gages. A jacking jig designed and built by the state engineers was used to jack the strain out of one link of each tie rod. This was done in order to reach a zero stress level as a reference for strain measurement.

Released load readings will be repeated in the spring to observe changes in rod strain resulting from shifting of the rock formation caused by frost, and to adjust the turnbuckles.

# BIRD

## "Thru-line" DIRECT READING Directional RF WATTMETER



### MODEL 43

An insertion type instrument used to measure forward or reflected power in coaxial transmission lines in the frequency range 25 to 1000 mc. Directional selectivity is accomplished by fingertip rotation of element to point arrow in direction of power to be measured. Calibration charts or full scale meter adjustments are not needed for this direct reading instrument.

The lightweight and portable Model 43 may be used on mobile or fixed equipment. It is recommended for accurate measurement of forward or reflected power... transmission line loss... insertion loss of components, such as filters, connectors, switches, relays, etc... antenna matching work... continuous monitoring of transmitter output and... VSWR in complete systems in operation.

## SPECIFICATIONS

Each model 43 Directional Wattmeter is made up of a line section, an indicating meter and plug-in measuring elements all contained in an aluminum case.

**ELEMENTS:** Available in the combinations of power and frequency ranges listed below:

**FREQUENCY RANGE:** 25 to 1000 mc in five ranges: (25-60mc) (50-125mc) (100-250mc) (200-500mc) (400-1000mc)

**POWER RANGE:** 10 to 500 Watts in six ranges: (10W) (25W) (50W) (100W) (250W) (500W)

**ACCURACY:**  $\pm 5\%$  of full scale

**VSWR:** Below 1.05 for complete unit and two connectors.

**QUICK - CHANGE CONNECTORS:** Two TYPE "N" FEMALE connectors which mate with UG/21/B are supplied **UNLESS OTHERWISE SPECIFIED**. Optional: (Male or Female "HN") (Male or Female "C") (Male "N") and (Female UHF: SO-239)

**WEIGHT:** 4 pounds

**DIMENSIONS:** 7" x 4" x 3"

Complete Specifications BULLETIN #436 Sent on Request.

### OTHER BIRD PRODUCTS



"Termaline"  
RF Load  
Resistors



Coaxial  
RF Filters



Coaxial  
RF Switches



"Termaline"  
RF Absorption  
Wattmeters



# BIRD ELECTRONIC CORP.

Churchill 8-1200  
30303 Aurora Road, Solon, Ohio  
Western Representative:  
VAN GROOS COMPANY, Woodland Hills, Calif.

## MEETINGS AHEAD

Dec. 3-4: Vehicular Communications, Annual Meeting, PGVC of IRE, Colonial Inn & Desert Ranch, St. Petersburg, Fla.

Dec. 8-10: Electrical Insulation, Applications, Nat. Conf., AIEE, NEMA, Shoreham Hotel, Cleveland.

Jan. 11-13: Reliability & Quality Control, National Symposium, ASQC, IRE, EIA, AIEE, Statler Hotel, Washington, D. C.

Jan. 31-Feb. 5: Comparison of Control Computers, Winter General Meeting, AIEE, New York City.

Feb. 3-5: Military Electronics, Winter Convention, Biltmore Hotel, Los Angeles.

Feb. 10-12: Solid-State Circuits Conf., AIEE, IRE, Univ. of Penn., Philadelphia.

Feb. 11-13: Electronic Representatives Assoc., Annual Convention, Drake Hotel, Chicago.

Feb. 20-29: Component Parts and Electronic Tubes, International Exhibition, Porte de Versailles, Place Barlard, Paris.

Mar. 21-24: Institute of Radio Engineers, National Conv., Coliseum & Waldorf-Astoria Hotel, N. Y. C.

Apr. 4-7: Nuclear Congress, EJC, PGNS of IRE, New York Coliseum, New York City.

Apr. 11-13: Protective Relay Engineers, Annual, A&M College of Texas, College Station, Texas.

Apr. 11-14: Weather Radar Conference, American Meteorological Society and Stanford Research Institute, San Francisco.

Apr. 18-19: Automatic Techniques, Annual Conf., ASME, IRE, AIEE, Cleveland-Sheraton Hotel, Cleveland.

Apr. 19-21: Active Networks & Feedback Systems, International Symposium, Dept. of Defense Research Agencies, IRE, Engineering Societies Bldg., New York City.

Aug. 23-26: Western Electronics Show and Convention, WESCON, Ambassador Hotel & Memorial Sports Arena, Los Angeles.

There's more news in ON the MARKET, PLANTS and PEOPLE and other departments beginning on p 132.



# THE 'DO' LINE THAT TELLS AGGRESSORS, 'DON'T!'

Because the tropo scatter radio equipment of Radio Engineering Laboratories, Inc., has proved its worth in installations around the world, it is also specified for the U.S. Air Force's DEW-East—the vital DEW Line extension from the present terminal on Baffin Island 1,200 miles east to Iceland. Once again, Western Electric Co., Inc., has chosen REL apparatus for this "can do" communications system to bridge the gap of ice and open water, and overcome the plagues of atmospheric and electromagnetic disturbances.

It's the unequalled reliability of REL equipment which has made it the choice for eight of the nine major networks in operation or on order. In fact, more kilowatt miles of REL tropo apparatus are in use or on order than those of all other companies combined.

The hazards of snow, ice and weather that make construction of DEW-East stations so formidable for the men who build them, call for equipment with the same sturdiness, the background of experience, the same quality of "can do". That's REL. And that's why you'll want REL's help in solving your specialized radio problems.

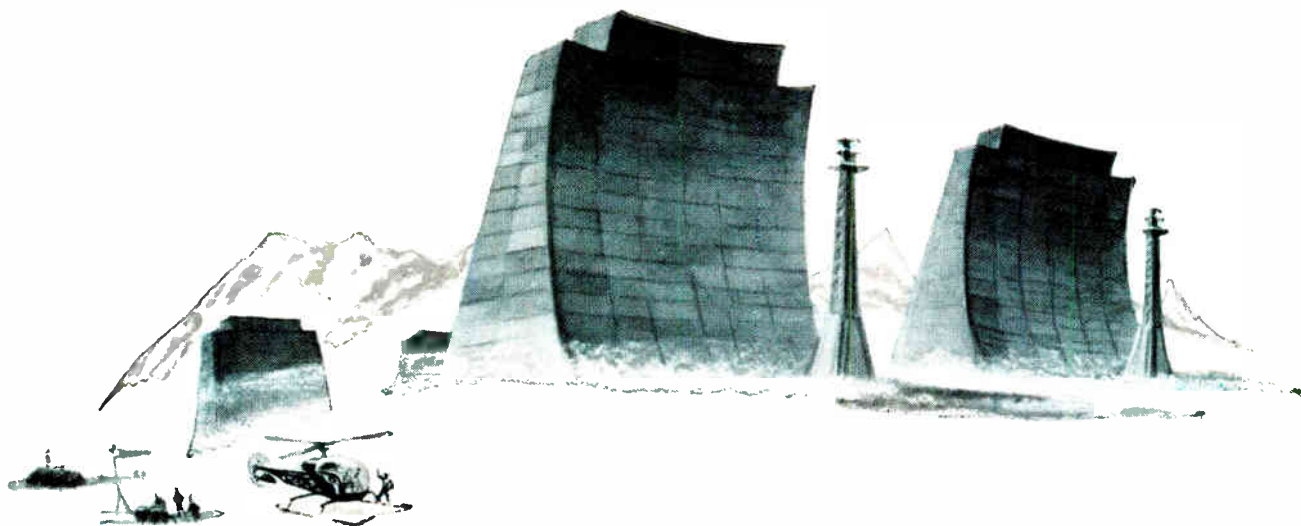

## Radio Engineering Laboratories • Inc

*A subsidiary of Dynamics Corporation of America*

Dept. E • 29-01 Borden Ave • Long Island City 1, NY



*Creative careers at REL await a few exceptional engineers. Address résumés to James W. Kelly, Personnel Director.*

# NOW 9 STANDARD TYPE TIME DELAY TIMERS

**IN AN EXTENDED RANGE OF TIME CYCLES**

1/60th of a second to 24 hours

For bigger savings in OEM design and installation now, choose a standard time delay timer from Industrial Timer's expanding line to satisfy almost *every* mounting requirement... back, side, flush, through-the-panel, totally enclosed or explosion proof. Industrial Timer's bigger-than-ever selection gives you greater design latitude in both function and appearance... eliminates the need for costly custom-made controls in your specifications.

All 9 types have these special features:

1. Actuated by momentary or sustained pulse
2. Automatic reset
3. Heavy duty load switches rated at 10 and 15 amps
4. Easy, positive adjustment of time cycles

By specifying Industrial Timer you are assured of accurate and dependable controls for applications requiring a specific time delay between circuit operations. Full details in Bulletins 300, 800 and 900.

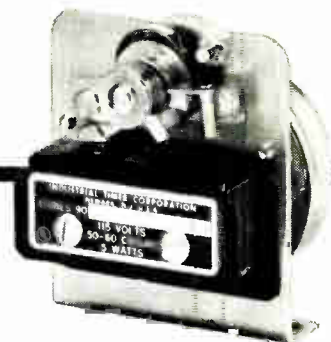

**Series 90**

Back-mounted, for applications where time cycle is infrequently changed or permanently fixed (1/2 sec. to 5 min.)

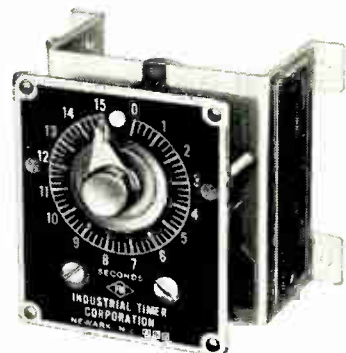

**Series SF**

Back-mounted (1/10 sec. to 5 min.)



**Series TDAB**

Flush-, back-mounted or totally enclosed (1/60 sec. to 3 hrs.)

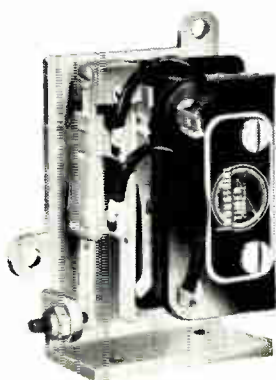

**Series TH**

Back or bottom-mounted. Thermal time delay switch. (15 sec. to 2 min.)

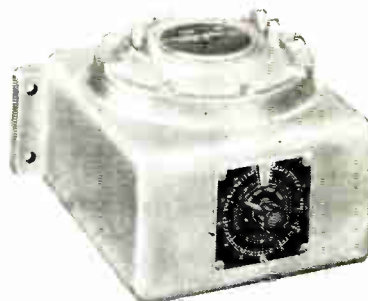

**Series TDXP**

Bottom or back-mounted. Explosion proof. External adjustments (1/60 sec. to 3 hrs.)



*Timers that Control  
the Pulse Beat of Industry*

**INDUSTRIAL TIMER CORPORATION**

1407 McCARTER HIGHWAY, NEWARK 4, N. J.

Industrial Timer's complete line also includes: Interval Timers, Running Time Meters, Cam Timers, Explosion Proof Timers, and Programmers. Our 40-page catalog describing these is available on request.



Quality Features of

# OHMITE®

# VITREOUS ENAMELED RESISTORS

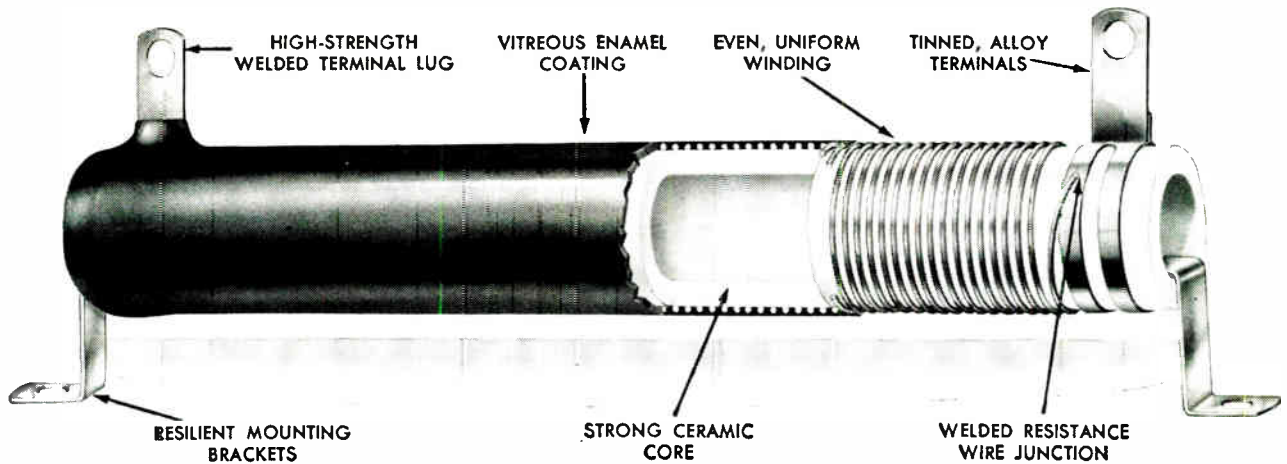

**Balanced Thermal Expansion prevents crazing and moisture entrance**

In Ohmite resistors, spot welding replaces soldering, brazing, and mechanical fastening. Spot welding produces strong connections that are not affected by vibration or high temperatures. Ohmite welded construction also produces an almost flush connection between the resistance wire and terminal. This prevents thin spots or bulges in the vitreous enamel coating which might cause future trouble and failure. Many different types of terminals are available besides the lug illustrated.

## Ohmite can supply all of your resistor needs

some of the many types available

- |   |  |
|---|--|
| Axial Lead  | Live Bracket Mounting Resistors  |
| Brown Devil® Wire Lead                                    | Edison Screw Base Mounting Resistors   |
| Fixed, Lug Type   | Riteohm® Wire-Wound Precision Resistors, Encapsulated; Vitreous Enameled; Molded Jacket; Hermetically Gloss Sealed |
| Dividohm® Adjustable                                      | Riteohm® Metal Film Resistors  |
| Thin Type   | Resistors to meet MIL Specifications   |
| Noninductive  | High-Shock Resistors   |
| Powr-Rib®, High Current, Round or Ribbon Wire, Open Wound |  |
| Corrib®, High Current, Corrugated, Edgewound Ribbon       |  |
| Resistors with Heat Conducting Studs                      |  |
| Ferrule Mounting Resistors                                |  |

The almost endless variety of Ohmite resistors in many sizes and types—in a wide range of wattages and resistances—makes it possible to meet each individual need. Many of these can be supplied from the world's largest factory stock. Whatever your resistor requirements may be, chances are you will find exactly the type you need in industry's most complete line of high-quality resistors.



Be Right with

**Ohmite Manufacturing Company**  
3610 Howard Street  
Skokie, Illinois

- |                       |           |                    |
|-----------------------|-----------|--------------------|
| RHEOSTATS             | RESISTORS | RELAYS             |
| TANTALUM CAPACITORS   |           | TAP SWITCHES       |
| VARIABLE TRANSFORMERS |           | DIODES R.F. CHOKES |

Write on company letterhead for Catalog 58

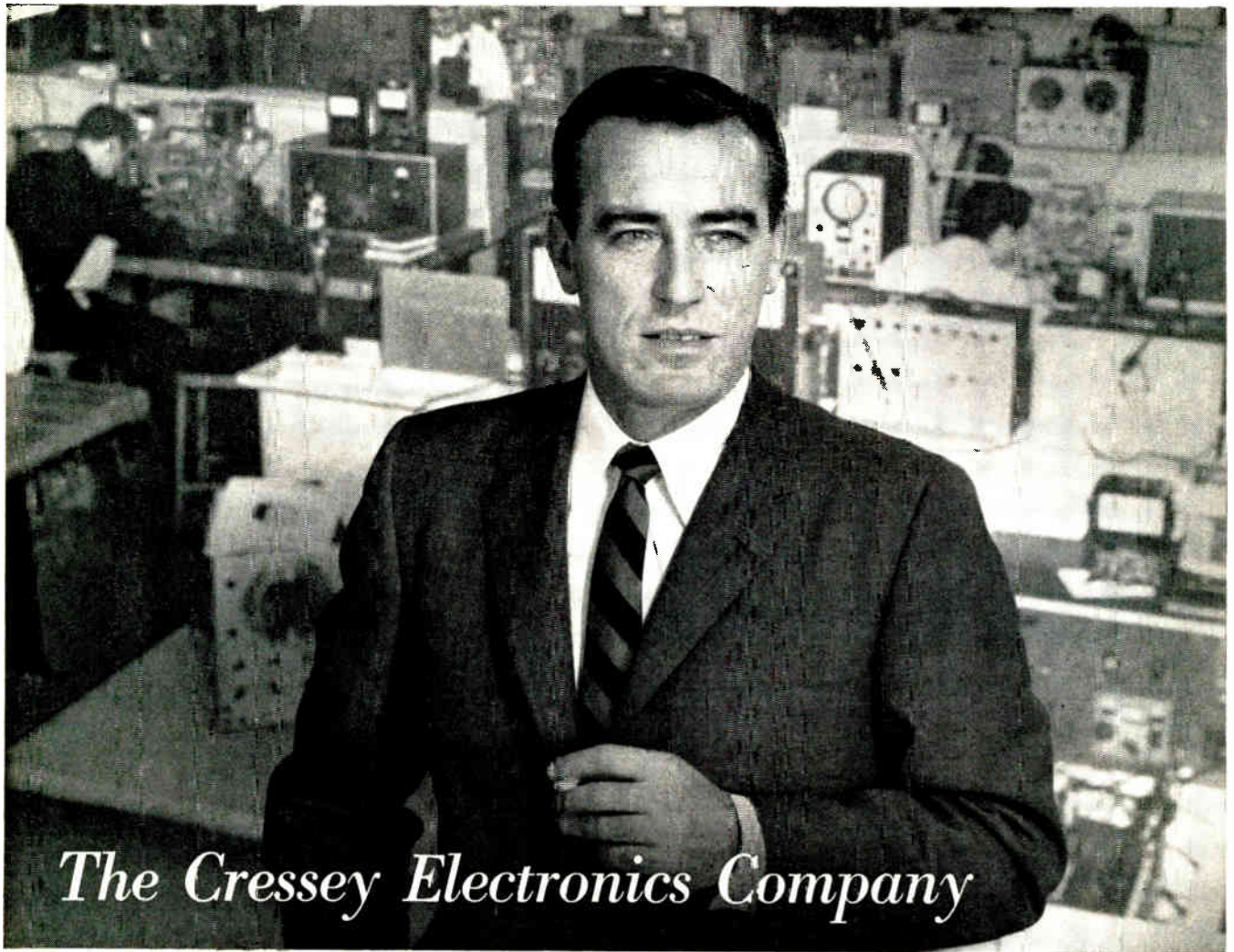

## *The Cressey Electronics Company*

*carries on into the future*

**. . . with the help of the Ætna Life's Business Planning Department**

Stanley B. Cressey owns a small, but thriving electronics business. He built this business to a steady year-round volume and looks to the day his son can take it over.

A representative of Ætna Life's Business Planning Department explained what can happen to such a business when its owner-manager dies. With him goes not only the value of his own experience but also the "good will" he has created — leaving more of a problem than a legacy to the heirs!

So Stan's Ætna Life representative, attorney and accountant, worked out a plan to safeguard his family's interest. It will provide money to get them over the rough spots, to maintain profits and stabilize credit until Stan Jr., can take over.

If you own or operate any kind of business, it will pay you to investigate the vital need for a business continuation plan — and no one is better equipped to serve your interests than the Business Planning Department of your local Ætna Life General Agency.

**ÆTNA LIFE**  
INSURANCE COMPANY



*Affiliates: Ætna Casualty & Surety Co. • Standard Fire Insurance Co. • Hartford, Conn.*





**1003-C VIDEO TRANSMISSION TEST SIGNAL GENERATOR**

Produces multi-frequency burst, stairstep, modulated stairstep, white window, composite sync. Variable duty cycle. Regulated power supply.

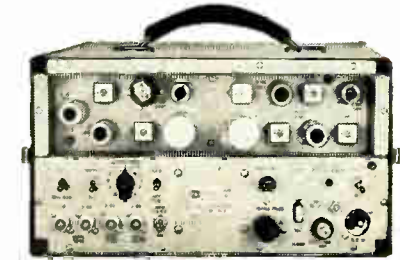

**1004-B VIDEO TRANSMISSION TEST SIGNAL RECEIVER**

Very rapid and accurate measurements of differential phase and differential gain characteristics of video facilities. Responds to standard stairstep test signal modulated with 3.58mc, or any differential phase or gain test signal.

# VIDEO TRANSMISSION TEST EQUIPMENT

In Daily Use by All Major Networks, Stations and Telephone Co. Coaxial Cable, Microwave, and Intercity Facilities.

ALL CARRYING CASE UNITS IMMEDIATELY ADAPTABLE TO STANDARD RACK MOUNTING



**1005-A VIDEO TRANSMISSION TEST SET**

**1005-A1** — Produces composite television waveforms suitable for measuring amplitude vs. frequency, differential gain vs. amplitude, dynamic linearity, differential phase vs. amplitude, high frequency transient response, low frequency transient response, low frequency phase or streaking, smears, mismatches, and other video characteristics.

**1005-A2** — Supplies composite EIA Sync, blanking, horizontal and vertical drive signals and regulated B+ power for itself and 1005-A1. Features magnetic core binary counters.

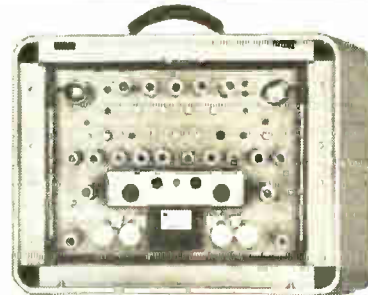

**1008-A VERTICAL INTERVAL KEYS**

Permits test and control signals to be transmitted simultaneously with program material, between frames of TV picture. Any test signal (multiburst, stairstep, color bar, etc.) may be added to the composite program signal. Test signals are always present for checking transmission conditions without impairing picture quality. The home viewer is not aware of their presence.



**1073-CR**

**SINE SQUARED (SIN<sup>2</sup>)— SQUARE WAVE GENERATOR**

Produces new waveform for testing TV or other pulse unit or system for amplitude and phase characteristics. Sin<sup>2</sup>-Square Wave pulse is equivalent to TV camera signal and is more sensitive than a Square Wave in indicating ringing. Video test signal adjustable for 1.0 volts or 1.4 volts peak to peak. Now in use by major TV networks and telephone companies.

AT THE FRONTIERS OF ELECTRONICS  
COLOR TV • INDUSTRIAL INSTRUMENTATION • TELEMTRY



## TELECHROME MANUFACTURING CORP.

28 RANICK DRIVE AMITYVILLE, N.Y. Lincoln 1-3600

Cable Address: COLORTV

TWX: AMITYVILLE NY2314

Midwest Engineering Division—106 W. St. Charles Rd., Lombard, Ill., MAYfair 7-6026

Western Engineering Division—13635 Victory Blvd., Van Nuys, Calif., State 2-7479

Largest selection

# Trimpot®

the original leadscrew-actuated potentiometer

More engineers specify Trimpot because:

### Trimpot line is complete

Bourns offers you the largest selection of leadscrew actuated potentiometers... 20 basic models—4 terminal types—three mounting methods.

### Trimpot is small

Space saving size and rectangular shape permit the installation of 12 to 17 units in one square inch of panel area.

### Trimpot is accurate

Multi-turn screwdriver adjustment provides 9000° of rotation... you can make and repeat the finest adjustments.

### Trimpot is stable

Adjustment shaft is self-locking... settings are virtually immune to severe acceleration, vibration and shock.

### Trimpot is fully tested

All instruments are 100% inspected before shipment to assure you of reliable performance.

### Trimpot is proved

It is used in more military and commercial equipment than any other leadscrew actuated potentiometer.

Only Bourns Trimpot potentiometers give you these outstanding features

**BODY**—High-temperature, thermosetting plastic body is sealed, enabling potentiometer to meet Mil-Specs for humidity, sand, dust, fungus, salt spray, etc.

**COLLECTOR BAR**—Precious metal collector bar provides positive electrical contact, improves potentiometer performance and reliability.

**WIPER CARRIAGE**—Special high-temperature plastic carriage with precious metal contact spring permits exact settings and stability under severe environmental conditions.

**SHAFT HEAD**—Stainless steel with machined slot for screwdriver adjustment. Meets military salt spray requirements.

**O-RING**—Silicon rubber O-ring seals potentiometer against humidity, withstands high temperature.

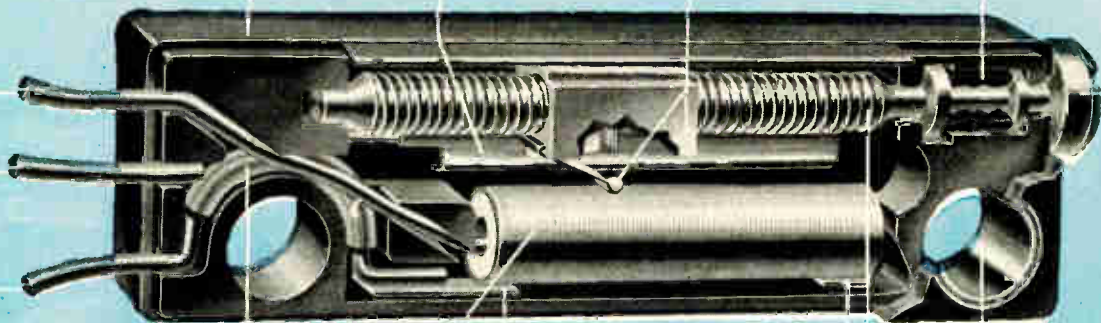

**TUBING INSULATION**—Tubing around terminal eliminates possible short or electrical cross-over.

**SILVERWELD\* TERMINATION**—This exclusive Bourns feature is unequalled in ruggedness. There is a metal-to-metal bond from the terminal to the resistance wire.

**EYELETS**—Stainless steel eyelets are set on 3/4" centers and provide easy mounting with 2-56 screws.

**TERMINALS**—Three terminals are gold-plated copperweld wire or Teflon-insulated leads.

**ELEMENT**—Special ceramic mandrel is precision wound with low temperature coefficient resistance wire.

**LEADSCREW**—Stainless steel leadscrew is corrosion resistant, withstands salt spray.

\*TRADEMARK

This cutaway of Model 220 is typical of the design of all Bourns Trimpot potentiometers though some features may vary from model to model.



# Longest record of reliability



General Purpose Wirewound Trimpot—Model 200. Operates at 105 C / L,S,P terminals / 1/4 watt / 10 ohms to 100K. Available as rheostat, Model 201.



High-Resistance Wirewound Hi-R Trimpot—Model 207. Operates at 175 C / L terminal / 2 watts / 100 ohms to 100K. Available as rheostat, Model 208 Hi-R Trim R<sup>2</sup>.



Dual-Element Wirewound Twinpot—Model 209. Operates at 105 C / L terminal / 1/4 watt / 10 ohms to 20K. Two potentiometer outputs with one adjustment shaft.



General-Purpose Carbon Trimpot—Model 215. Operates at 125 C / L,S,P terminals / 1/4 watt / 20K to 1 Meg. Available as Mil-Spec humidity-proof unit, Model 235 (1K to 10 Meg).



Subminiature Wirewound Trimpot—Model 220. Operates at 175 C / L & W terminals / 1 watt / 100 ohms to 20K. Meets Mil-Specs for humidity.



### Panel-Mount Trimpot

All models are now available with the added convenience of panel mounting. Unique design permits quick factory attachment of rugged panel-mount assembly to standard "on-the-shelf" Trimpot potentiometers. The Panel Mount Trimpot takes as little



High-Temperature, Humidity-Proof Wirewound Trimpot—Model 224. Operates at 175 C / L,S,P terminals / 1 watt / 100 ohms to 100K. Meets Mil-Specs for humidity.



Humidity-Proof Wirewound Trimpot—Model 236. Operates at 135 C / L,S,P terminals / 0.8 watt / 10 ohms to 100K. Meets Mil-Specs for humidity.



High-Temperature Wirewound Trimpot—Model 260. Operates at 175 C / L,S,P terminals / 1 watt / 10 ohms to 100K.



High-Quality Commercial Wirewound Trimit—Models 271, 273, 275. Operates at 85 C / L,S,P terminals / 1/4 watt / 100 ohms to 10K.



High-Quality Commercial Carbon Trimit—Models 272, 274, 276. Operates at 85 C / L,S,P terminals / 0.2 watt / 20K to 1 Meg.



Low Cost Commercial Wirewound E-Z Trim—Model 277. Subminiature—1" x 17/64" x 5/16". Tapered all-purpose lug terminals / 1/2 watt / 100 ohms to 10K. For computers, test equipment, industrial control systems, etc.

as 1/12 sq. inch of panel space, meets Mil-Specs for vibration, shock, salt spray, etc. Recessed head prevents accidental changes of setting. Silicon rubber O-ring and Teflon washer provide moisture barrier.

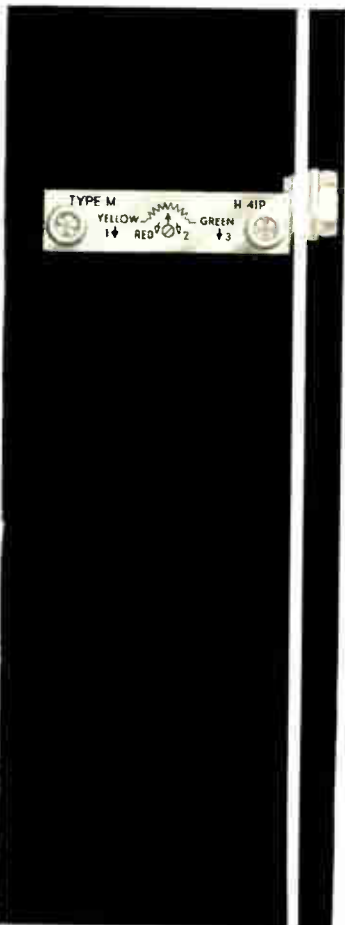

### Key to terminals

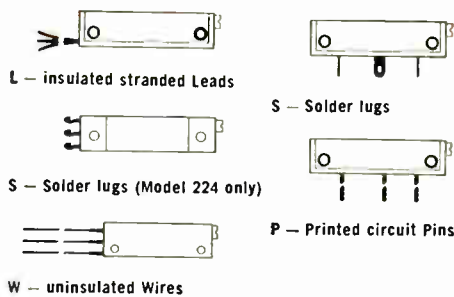

### Standard resistances (ohms)

10	50	200	1K	5K	20K	100K	500K
20	100	500	2K	10K	50K	200K	1Meg

other Resistances Available

Write for detailed specifications and list of stocking distributors.

## BOURNS Inc.

P.O. Box 2112e, Riverside, California  
Plants: Riverside, California  
and Ames, Iowa

In Canada: Douglas Randall (Canada), Ltd., licensee

Exclusive manufacturers of TRIMPOT®, TRIMIT®. Pioneers in potentiometer transducers for position, pressure and acceleration.

*Is inner-space  
your problem?*



## RMC **Subminiature TYPE SM** Discaps

If your designs continually shrink allowable space for components RMC's Type SM DISCAPS are the answer for capacitors. These subminiature DISCAPS can be specified with assurance of the quality, dependability and performance inherent in all DISCAPS.

Type SM meet the specifications of EIA-RS-198 for Z5U capacitors and are available in values of 800, .001, .0015 GMV; .005 + 80% - 20% ± 20%; .01 + 80% - 20% ± 20% and .02 + 80% - 20%. Capacity change between + 10°C and + 65°C is a minimum.

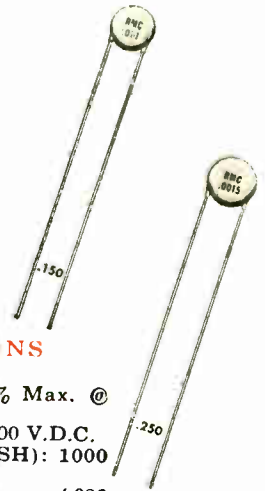

### SPECIFICATIONS

POWER FACTOR: 1.5% Max. @ 1 KC (initial)  
 WORKING VOLTAGE: 500 V.D.C.  
 TEST VOLTAGE (FLASH): 1000 V.D.C.  
 LEADS: No. 22 tinned copper (.026 dia.)  
 INSULATION: Durez phenolic (1/8" max. on leads)—vacuum waxed  
 STAMPING: RMC—Capacity—Z5U  
 INITIAL LEAKAGE RESISTANCE: Guaranteed higher than 7500 megohms  
 AFTER HUMIDITY LEAKAGE RESISTANCE: Guaranteed higher than 1000 megohms

DISCAP  
 CERAMIC  
 CAPACITORS



**RADIO MATERIALS COMPANY**  
 A DIVISION OF F. R. MALLORY & CO., INC.  
 GENERAL OFFICE: 3325 N. California Ave., Chicago 18, Ill.  
 Two RMC Plants Devoted Exclusively to Ceramic Capacitors  
 FACTORIES AT CHICAGO, ILL. AND ATTICA, IND.





AN ACHIEVEMENT  
IN DEFENSE ELECTRONICS

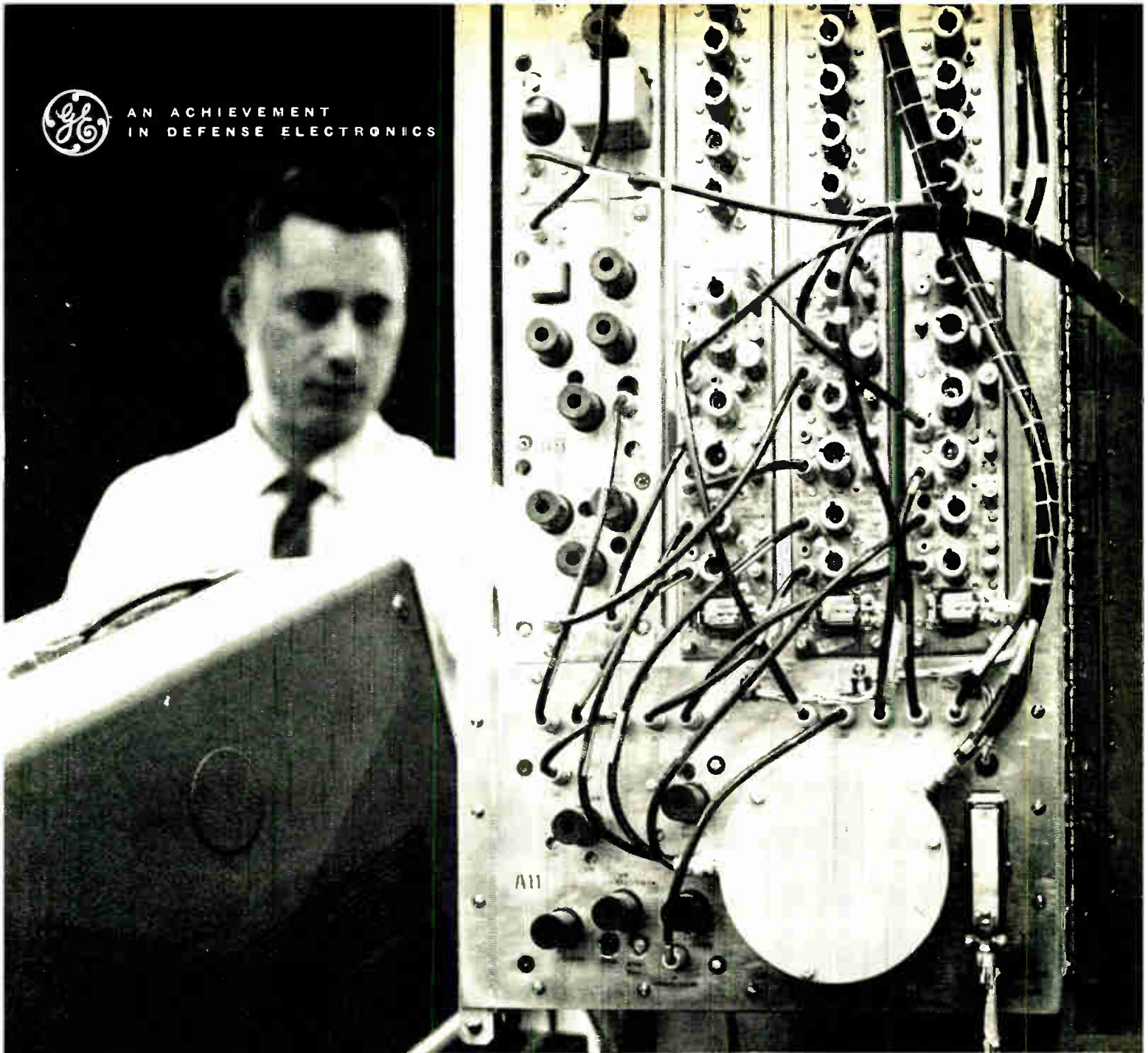

## NEW SONAR SIGNAL PROCESSOR DOES WORK OF 1,000 UNITS

The first sonar signal processors to utilize time compression are being produced by General Electric. These new processors were developed in cooperation with the United States Navy. Extracting only critical bits of transmitted and received signals in series, one unit can perform as many correlating operations on a continuous signal—in the same time—as a parallel processor with thousands of units.

Excellent improvement in signal-to-noise ratio also makes these new processors effective against background levels which have formerly made certain signals undetectable by any other practical means. The new equipment is also designed to handle signals from more than one transducer.

This advance in sonar signal processing is typical of General Electric's many achievements in defense electronics.

227-3

*Progress Is Our Most Important Product*

**GENERAL  ELECTRIC**

DEFENSE ELECTRONICS DIVISION • HEAVY MILITARY ELECTRONICS DEPT. • SYRACUSE, N. Y.

## Designing in miniature? Here's how to save space —

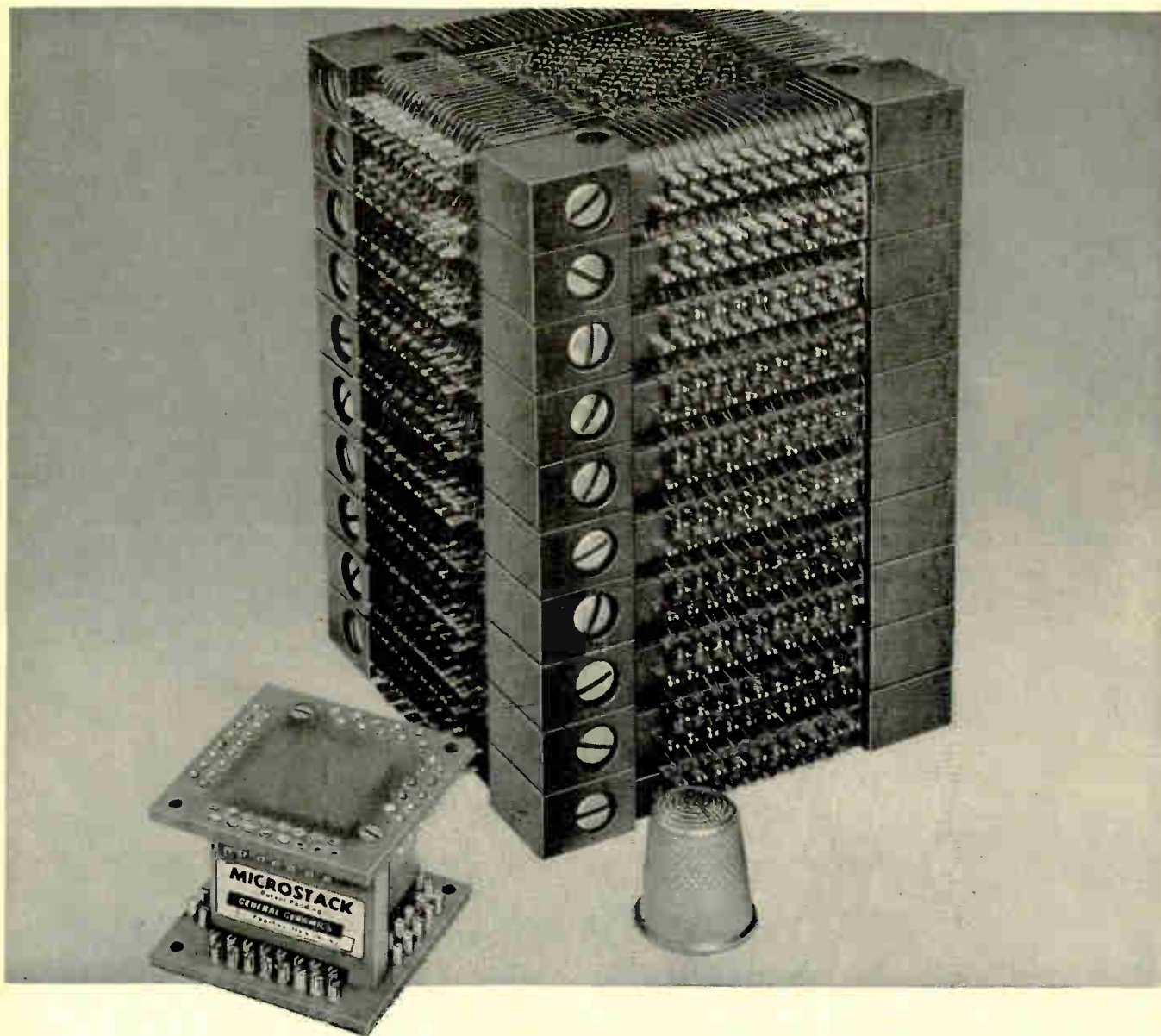

# ...90% of it!

New G-C MICROSTACK\* for coincident current memory systems has a physical volume just 10% that of conventional stack. MICROSTACK shown with 2560 cores measures only 1.125" x 1.4" x 1.4", a reduction in size from 3½" x 3½" x 5".

This miniature stack consists of an array of 16 x 16 x 10. Solder connections are greatly reduced (from 1192 to 104), thereby substantially increasing reliability.

Noise level in the new MICROSTACK is as low as that of conventional types. The new MICROSTACK is available with all standard memory cores. Standard packages are available with coincident current wiring in 10 x 10 x 8, 16 x 16 x 8 and 32 x 32 x 8 arrays.

*For further information, please write on company letterhead—address inquiries to Dept. E.*

\*Trademark

**GENERAL CERAMICS**

ORIGINATOR OF THE SQUARE LOOP FERRITE

**General Ceramics Corporation**  
KEASBEY, NEW JERSEY, U.S.A.



# Complex Ceramic Assembly Problem?

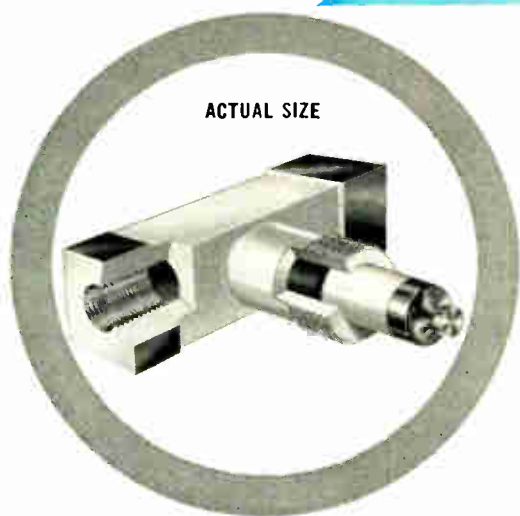
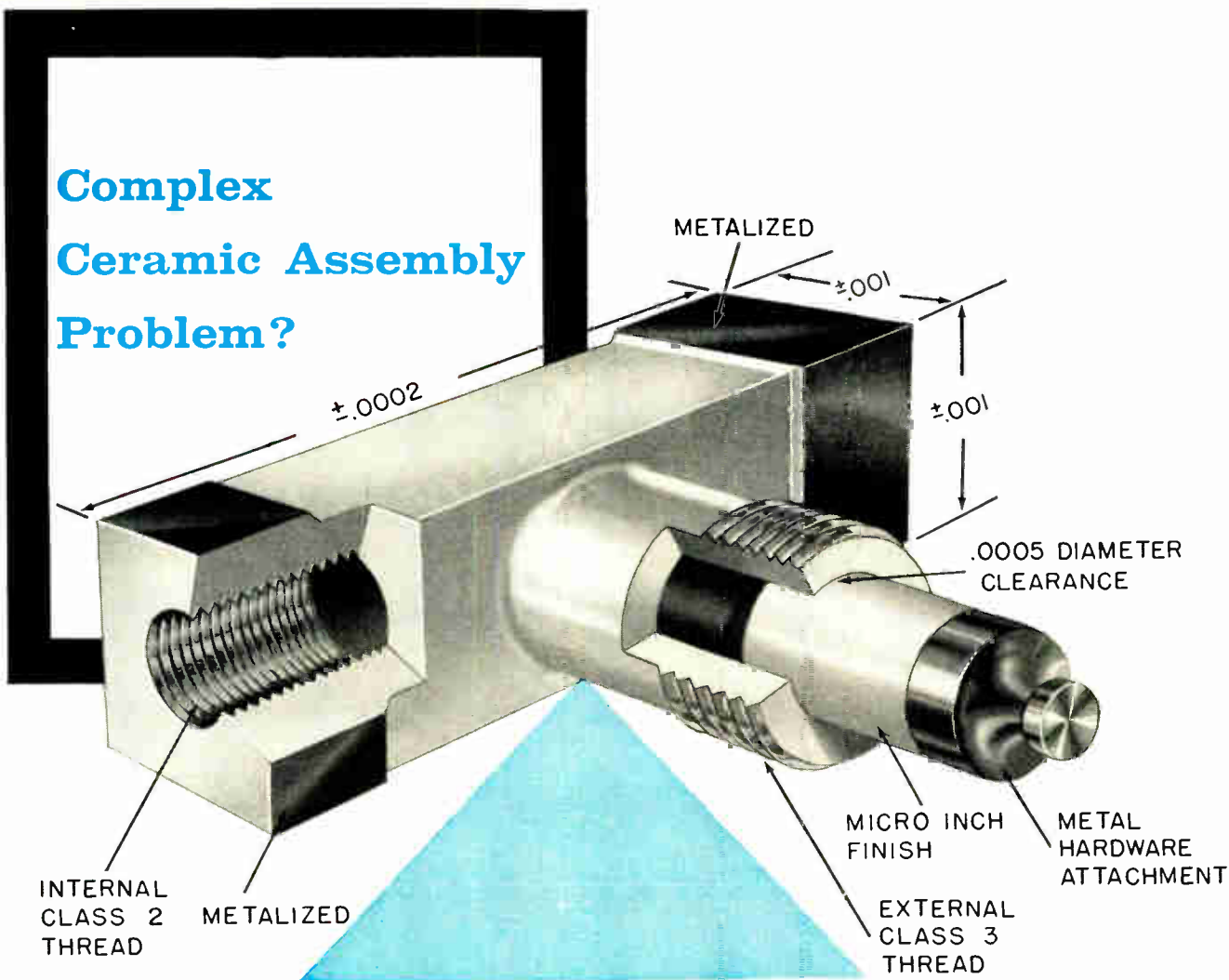

## Centralab solves them daily

The pictured unit shows how CENTRALAB can control the manufacturing of precision ceramic-to-metal assemblies to extremely close tolerances, no matter how complex the shape, how intricate the machining. Let CENTRALAB design and production engineering help you take full advantage of the superior electrical and physical properties of High Alumina and Steatite ceramics.

You can achieve improved performance and eliminate production assembly problems by utilizing CENTRALAB's know-how in the specialized techniques of close tolerance ceramic-to-metal fabrication. CENTRALAB can handle complex, precision assemblies involving machining of ceramics or metals to  $\pm .0002$ ", metalizing of ceramics, cementing, riveting, soldering, plating, and stamping.

For detailed information on how High Alumina and Steatite ceramics can solve your electromechanical problems, write for free copy of CENTRALAB's new Ceramic Design Handbook (Bulletin No. 42-554), or consult Sweet's Product Design File (folio 4a/ce).

# Centralab

X-5970 

A DIVISION OF GLOBE-UNION INC.  
914L E. KEEFE AVE. • MILWAUKEE 1, WISCONSIN  
In Canada: 669 Bayview Ave., Toronto 17, Ontario

VARIABLE RESISTORS • SWITCHES • CERAMIC CAPACITORS • PACKAGED ELECTRONIC CIRCUITS • ENGINEERED CERAMICS  
ELECTRONICS • DECEMBER 4, 1959 CIRCLE 67 ON READER SERVICE CARD 67



... and B.F. Goodrich is selling it... in the form of microwave absorbent. If you're in the business of space, this is the testing material for you. As you know, the specifications and details are complicated. So why not ask for *all* the information? Write for free booklet to The B.F. Goodrich Company, 586 Derby Place, Shelton, Connecticut.

# **B.F. Goodrich** *microwave absorbents*

68    CIRCLE 68 ON READER SERVICE CARD



They got rid of the dobbin...



## We got rid of the bobbin!

Why should precision wire wound resistors continue to be wound on bobbins and encapsulated in epoxy resin . . . when we know the life of the resistor is shortened and its stability lowered by the varying expansion rates of the wire, bobbin, and resin.

Let's face it: Bobbin's ready for the pasture! General Transistor has developed a precision wire wound **bobbinless** resistor that floats in a special viscous fluid. Result: a strain-free resistor with tolerances as low as 0.05% and Temperature Coefficients of Resistance as low as 2PPM/°C.

These facts alone are proof that it's time to learn more about GT Precision Wire Wound Bobbinless Resistors.



Actual size

Get the full details! Write today for brochure GR-30.

**GENERAL TRANSISTOR CORPORATION**

91-27 138th Place • Jamaica 35, New York • Phone: Hickory 1-1000



FOR IMMEDIATE DELIVERY FROM STOCK, CONTACT YOUR NEAREST AUTHORIZED GENERAL TRANSISTOR DISTRIBUTOR OR GENERAL TRANSISTOR DISTRIBUTING CORP., 91-27 138TH PLACE, JAMAICA 35, NEW YORK. FOR EXPORT: GENERAL TRANSISTOR INTERNATIONAL CORP., 91-27 138TH PLACE, JAMAICA 35, NEW YORK. PRECISION MAGNETIC RECORDING HEADS AVAILABLE FROM GENERAL TRANSISTOR WESTERN CORP., 6110 VENICE BLVD., LOS ANGELES, CALIF.

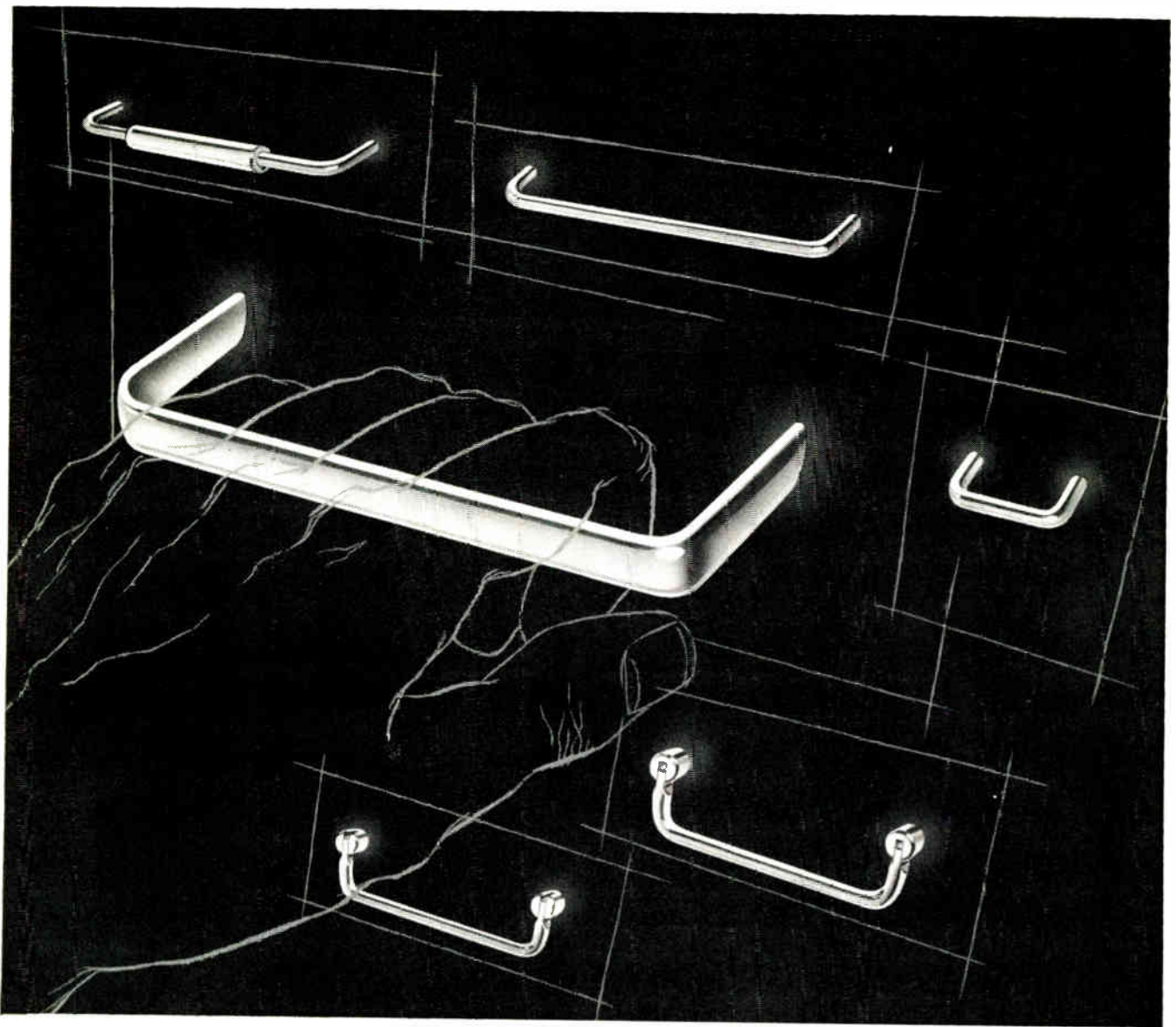

Materials used in the quality-controlled manufacture of CAMBION handles include aluminum, brass and stainless steel. Finishes are of polished nickel, black oxide, and black alumilite. Types available are rigid, adjustable and folding. Folding types are in two different models — designed to fold against the panel in either one or two directions.

## How to handle things better — 28 ways

Made in 28 different standard combinations, CAMBION<sup>®</sup> panel handles are also custom-made to any specifications, in any quantity. All are of quality materials which meet or better government specifications. In addition to a firm grip, all have an attractive appearance. Polishing before plating removes all surface imperfection, and color buffing after plating adds lasting luster.

Expert engineering and manufacturing skill control production of the complete CAMBION line — terminal boards, solder terminals, insulated terminals, coils, coil forms, capacitors, swagers and hardware. In any quantity of CAMBION components you order you get top quality — with every component guaranteed.

Available locally through Authorized CAMBION Distributors. Or write to Cambridge Thermionic Corporation,

437 Concord Avenue, Cambridge 38, Massachusetts. On the West Coast: E. V. Roberts and Associates, Inc., 5069 West Washington Blvd., Los Angeles, California. In Canada: Cambridge Thermionic of Canada, Limited, Montreal, P.Q.

The CAMBION line of panel and chassis hardware is recognized as the best looking, best behaving, most polished family in its field. Besides handles, other popular members are terminal boards, diode clips, battery clips, miniature plugs and jacks. CAMBION custom hardware can be designed and manufactured on request.

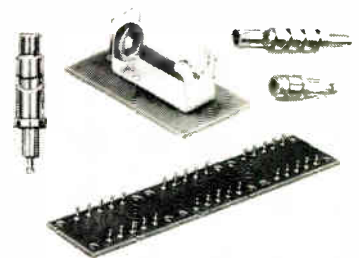

CAMBRIDGE THERMIONIC CORPORATION  
**CAMBION**<sup>®</sup>  
 The guaranteed electronic components







CLARE ANNOUNCES THE

# Type 211 Stepping Switch

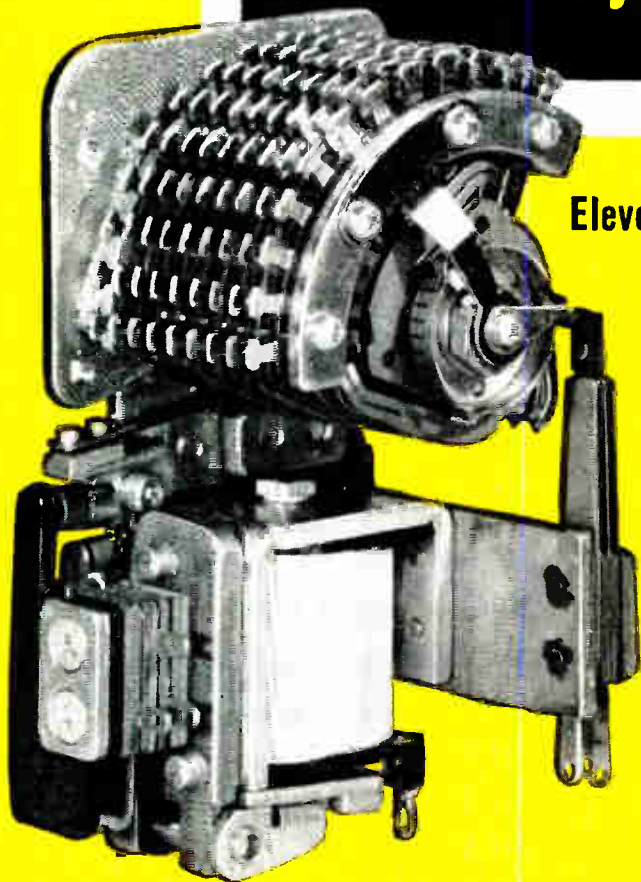

**Eleven-point stepping switch has 12-level capacity, 100,000,000-step\* life**

Many new, improved features give this Clare Type 211 springdriven stepping switch longer service life, greater capacity and a freedom from maintenance hitherto unknown in an 11-point switch. Rugged, compactly built, the 211 is available with a variety of enclosures and mounting assemblies to meet a wide range of design applications.

**\*LONGER LIFE EXPECTANCY**—This new switch has a life expectancy of from 100 million steps at twelve levels to 300 million steps at three levels with proper relubrication and readjustment.

**GREATER STEP CAPACITY**—Up to twelve 11-point levels or four 33-point levels enable it to handle complex switching, counting, totalizing, selecting, and sequence control operations.

**SIMPLIFIED MAINTENANCE**—Fewer moving parts, due to the elimination of pawl bearings, and a more rigid armature arm simplify maintenance and increase service life.

### TYPE 211 SWITCH—ELECTRICAL DATA

**OPERATING SPEEDS**—Self-interrupt speed: 60 SPS at 25°C on nominal voltage. Remote impulse speed: 30 SPS at 25°C on nominal voltage with 66% make impulse.

**OPERATE & RELEASE TIME**—Operate time: 20 ms at 25°C on nominal voltage. Release time: 10 ms at 25°C on nominal voltage.

**OPERATE & RELEASE VOLTAGE**—Maximum pull-in at 25°C is 66% of nominal voltage. Minimum dropout at 25°C is 5% of nominal voltage.

**BREAKDOWN TEST**—1000 v, rms, 60 cps, 1s standard.

**COILS**—Coil resistances for typical voltages are shown below:

Voltage Vdc	1-8 Levels		9-12 Levels	
	Ohms		Ohms	
6	1.5		1.5	
12	6		6	
24	24		20	
48	100		70	
60	150		100	
110	600		400	

### TYPE 211 SWITCH—MECHANICAL DATA

**OVERALL DIMENSIONS**—Length (maximum)—4-5/16 in. Height (1C interrupter, 1C O.N.S.)—2 1/4 in. Width—from 1-5/16 in. for 3 levels to 2-13/16 in. for 12 levels.

**NET WEIGHT**—From one pound for 3 levels to 1 1/2 pounds for 12 levels.

**BANK CONTACT**—Standard is phosphor bronze. Also available are coin silver or gold plated phosphor bronze.

#### MAXIMUM BANK LEVELS & PILEUPS

Type of operation (points)	11	33
Bank levels maximum (electrical)	12	4
Interrupter springs	6	6
Off-normal springs	6	6
Number of ratchet teeth	33	33

**WIPEPS**—Standard wipers are non-bridging phosphor bronze with coin silver and gold plated phosphor bronze available in either non-bridging or bridging models.

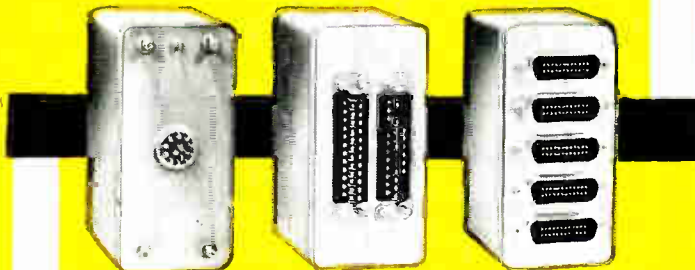

**VARIETY OF ENCLOSURES**—Hermetically sealed enclosures, filled with nitrogen or oil, are available with hook-type solder terminals. Dust cover enclosures are available with miniature or standard Amphenol Blue Ribbon connectors.

Write for bulletin CPC-3 to C. P. Clare & Co., 3101 Pratt Blvd, Chicago 45, Illinois. In Canada: C. P. Clare Canada Ltd., P. O. Box 134, Downsview, Ontario. Cable Address: CLARELAY.

# CLARE RELAYS

*FIRST in the Industrial Field*

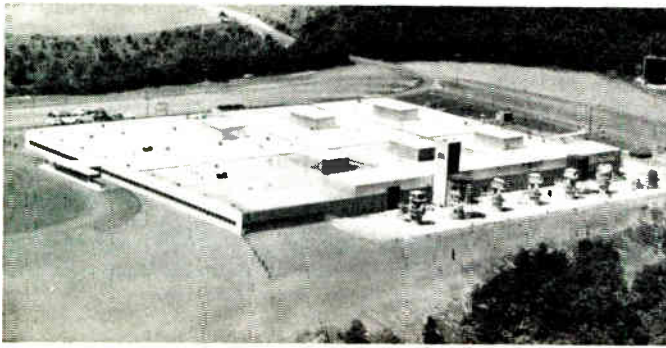

**MODERN PLANT** of Sperry Piedmont Co. at Charlottesville, Virginia, started with 75,000 sq. ft. of floor space in 1956, now covers 175,000 sq. ft. Over 900 people are employed . . . 83-acre tract gives ample expansion room.



**COMPLETE FACILITIES** include dust-free rooms for precision production . . . environmental testing equipment . . . compass-testing devices that simulate ship's pitch, yaw and roll. Plant is fully air-conditioned.



**COMPLEX INSTRUMENTS** for submarines, warships, cargo vessels and small craft are made by skilled Virginians. In conjunction with state government, Sperry sponsored night school programs to advance employees' knowledge in electronics and mathematics.



**UNIVERSITY OF VIRGINIA** at Charlottesville is a source of engineers, and its facilities are available for employees' post-graduate courses or for research projects. Virginia Polytechnic Institute and other excellent colleges and universities also supply Sperry Piedmont with recruits.

**Let These Outstanding Industries Tell You Why They Have Located in VIRGINIA**

- General Electric Company
- ITT Corporation
- The Babcock & Wilcox Company
- Reynolds Metals Company
- The Dow Chemical Company
- Allied Chemical Corporation

## **Sperry Piedmont Finds Academic Atmosphere, Adaptable Labor, and Plenty of Elbow Room in VIRGINIA**

In today's competition for engineering talent, good living conditions are important. And that's one major reason why Sperry Piedmont Company built its plant at Charlottesville, Virginia. Home of the University of Virginia, this historic town provided unsurpassed recreational and cultural background . . . traditionally good living . . . plus the academic atmosphere that's so attractive to technical men and so prevalent in Virginia's numerous university towns.

Other factors influencing Sperry's choice of location were excellent transportation facilities, nearness to Washington, no shortage of housing, good hospitals and medical care, dependable, conscientious manpower.

If you're planning a new plant, let us tell you why so many companies are locating in Virginia. Phone, wire, write, or visit in complete confidence . . .

C. M. Nicholson, Jr., Commissioner  
Division of Industrial Development  
Virginia Dept. of Conservation and Economic Development  
State Office Bldg., Richmond, Va.  
Phone MILton 4-4111 Ext. 2255

*You, too, can find these... and many other great competitive advantages in* **VIRGINIA**

Virginia's a wonderful place to play or work. Send for Free Vacation Guide Book.

←CIRCLE 71 ON READER SERVICE CARD

CIRCLE 72 ON READER SERVICE CARD



**BASIC  
BUILDING  
BLOCKS  
FROM KEARFOTT**



**FLOATED RATE  
INTEGRATING  
GYROS**

Specifically designed for missile applications, these Kearfott miniature gyros operate efficiently at unlimited altitudes. Their outstanding accuracy and performance make them superior to any comparably-sized units on the market. Hermetically sealed within a thermal jacket, these gyros are ruggedly designed and completely adaptable to production methods. Performance characteristics that are even more precise can be provided within the same dimensions.

**TYPICAL CHARACTERISTICS**

Mass Unbalance:

Along Input Axis: 1.0"/hr  
maximum untrimmed

Standard Deviation (short term):

Azimuth Position: 0.05°/hr  
Vertical Position: 0.03°/hr

Drift Rate Due to Anisoelectricity

Steady Acceleration:  
.015°/hr./g<sup>2</sup> maximum

Vibratory Acceleration:

.008°/hr./g<sup>2</sup> maximum

Damping:

Ratio of input angle to  
output angle is 0.2

Characteristic Time:

.0035 seconds or less

Weight: 0.7 lbs.

Warm-Up Time:

10 minutes from -60°F

Life: 1000 hours minimum

*Write for complete data.*

**BASIC  
BUILDING  
BLOCKS  
FROM KEARFOTT**



**20 SECOND  
SYNCHRO**

This synchro, just one of a broad line offered by Kearfott, provides the extreme accuracy required in today's data transmission systems. Kearfott synchro resolvers enable system designers to achieve unusual accuracy without the need for 2-speed servos and elaborate electronics. By proper impedance, matches up to 64 resolver control transformers can also operate from one resolver transmitter.

**TYPICAL**

**CHARACTERISTICS**

	SIZE 25	
	Control	Transmitter
Type Resolver	Transmitter	Transformer
Part Number	Z5161-001	Z5151-003
Excit. Volts (Max.)	115	90
Frequency (cps)	400	400
Primary Imped.	400/80°	8500/80°
Secondary Imped.	260/80°	14000/80°
Transform. Ratio	.7826	1.278
Max. Error fr. E.Z.	20 seconds	20 seconds
Primary	Rotor	Stator

*Write for complete data.*

**BASIC  
BUILDING  
BLOCKS  
FROM KEARFOTT**



**MINIATURE  
VERTICAL  
GYRO**

Provides accurate vertical reference in the form of two 400 cps synchro signals proportional to sine of gimbal's displacement about pitch and roll axes. Gravity-sensitive vertical reference device provides electrical signals directly to torque motors which maintain gyro spin axis perpendicular to earth's surface. Hermetically sealed and impervious to sand, dust, sun, rain, salt, spray, humidity or fungus as specified in MIL-E-5272A.

**TYPICAL  
CHARACTERISTICS**

Free Drift Rate:

Within 0.5° in one minute time.

Shock:

The gyro operates satisfactorily without damage after 60g shock of .015 seconds duration.

Hermetically Sealed:

These instruments are hermetically sealed and are not affected by sand, dust, sunshine, rain, humidity or fungus conditions.

Operating Temperature Range:

Gyros operate in ambient temperatures below -20°C to +100°C. A maximum of 3 minutes of operation at 400°F will not damage these gyros nor impair their accuracy.

Weight:

5.5 lbs. approximately.

*Write for complete data.*

*Time Index Digitalizer*



*Precise Angle Indicator*



*Size 8 Integrating  
Motor Generator*



**Engineers:** Kearfott offers challenging opportunities in advanced component and system development.

**Kearfott**

**A  
GENERAL  
PRECISION  
COMPANY**

**KEARFOTT COMPANY, INC., LITTLE FALLS, N. J.**

A subsidiary of General Precision Equipment Corporation  
Sales and Engineering Offices: 1500 Main Ave., Clifton, N. J.  
Midwest Office: 23 W. Colindar Ave., La Grange, Ill.  
South Central Office: 6211 Denton Drive, Dallas, Texas  
West Coast Office: 251 N. Virredo Avenue, Pasadena, Calif.

# Will tomorrow be a challenge

# ... or a bore?



If you feel that your present job is not fully tapping your potential, here are 4 new career opportunities for Electronics Engineers that have every bit of the challenge you may be looking for . . .

**1** *Site Systems Reliability Engineer:* This position calls for a seasoned engineer capable of integrating and directing on-site reliability assurance activities necessary to secure customer acceptance of the detection system. Unusual combination of technical ability, relations and communications (written and spoken) is

required. Desirable experience includes approximately ten years in design and field installation of transmitters on electronic systems with ability in both electronic and mechanical fields. Ability to motivate technicians for optimum performance is necessary. Salary structure is equal to the challenge.

**2** *Radar Equipment Systems Specialist:* This position calls for a creative engineer capable of conceiving and directing the design of long-range radar systems. Desirable experience includes around ten years in

at least one of the following: radar systems design, antenna systems, R.F. components, radar receiver systems or radar data processing systems. Salary structure is equal to the challenge.

**3** *Advanced Systems Engineer:* This position calls for a creative engineer capable of defining future defense and space detection problems as well as the ability to conceive and establish the feasibility of optimum systems solutions to these problems—making use of the most advanced techniques and understanding. He must recognize the need for and coordinate the development of new techniques and the exploration of

new phenomena in the area of detection systems. Background desired: Bachelor degree plus a combination of advanced training and several years experience in both the theoretical and practical aspects of detection systems engineering. A desire to work in the conceptual phase of system design with the analytical ability required to evaluate and demonstrate the effectiveness of proposed systems.

**4** *Advanced Radar Systems Analysis and Development Engineer:* Engineers are needed who are able to visualize and define future defense and space problems—conceive advanced radar systems to solve them. An advanced degree and/or strong background in system analysis and design is essential. Assignments open

include: analyze and define requirements for advance detection systems and determine broader parameters for such systems, establish their feasibility; analyze long range missile detection systems and specify optimum configuration on the basis of utility, performance, cost and delivery.

228-9

All of these openings are on General Electric missile and satellite detection projects and will be filled with engineers having the capability and desire to make creative contributions.

Write in confidence to T. M. George,  
Supervisor—Personnel Administration

Missile Detection Systems Section  
HEAVY MILITARY ELECTRONICS DEPARTMENT

**GENERAL**  **ELECTRIC**

SYRACUSE, NEW YORK



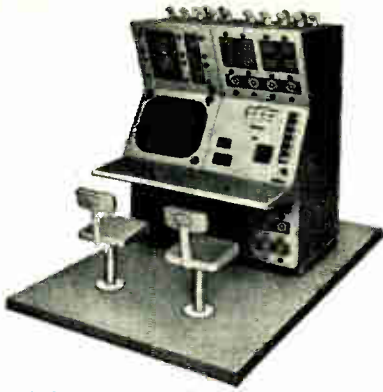

TODAY'S ANTISUBMARINE WEAPONS CONTROL COMPUTER

**THE TIME:** Early 1940. **THE ACHIEVEMENT:** A small, compact ballistic computer for the U.S. Navy. **THE RESULT:** The beginning of Librascope's leadership in the design, development, and production of weapons and navigation control systems and components.

Today, Librascope-designed and manufactured electronic and mechanical equipment for the MK 113, MK 111, MK 110, MK 107, and MK 105 underwater fire control systems include computers, attack directors, torpedo and missile angle solvers, attack plotters, depth plotters, position keepers, target motion analyzers, stabilization computers, roll and pitch computers, and various indicators and control instruments. ■ Librascope's simulation laboratories provide the Navy with a means for testing and analyzing the performance of equipment under "real attack" conditions. In the field, our engineers assist in the maintenance and improvement of Librascope systems.

# SHIPBOARD COMPUTERS

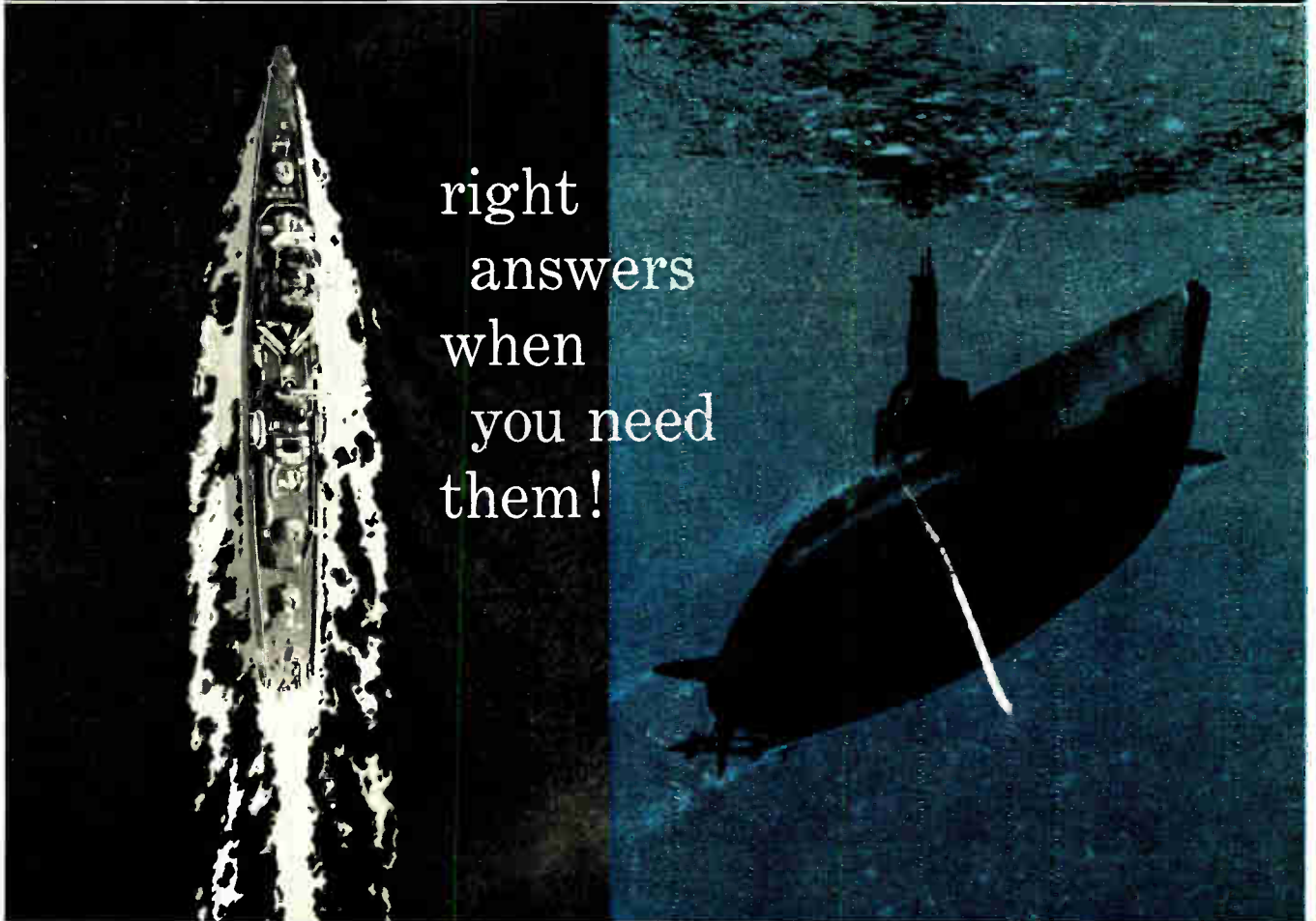

right  
answers  
when  
you need  
them!

COURTESY HOD-TV FILMS' "THE SILENT SERVICE"

For information on career opportunities at Librascope, write Glen Seltzer, Employment Manager.

Librascope's experience creating new concepts in computer — control systems for both military and industrial use can be accurately applied to your specific needs. ■ For detailed information and solutions to your computer problems, write...



LIBRASCOPE, INC. • 808 WESTERN AVENUE • GLENDALE, CALIF. • A Subsidiary of General Precision Equipment Corporation

ELECTRONICS • DECEMBER 4, 1959

CIRCLE 75 ON READER SERVICE CARD 75

# NOW LEASE

*Kleinschmidt teletypewriter equipment  
at substantial savings*



***From standard page printers to electronic switching systems, Kleinschmidt offers industry the most complete quality line — at lower leasing costs***

Kleinschmidt is a basic manufacturer of teletypewriter equipment for private wire systems. Now commercial users can effect significant savings over present common carrier rates by leasing directly from Kleinschmidt. This equipment has been proved superior in quality and reliability with the U.S. Army Signal Corps for over a

decade. Kleinschmidt is the world pioneer in the development and design of teleprinted systems for communication, data processing and production control applications. All Kleinschmidt products have the nationwide service facilities of Smith-Corona Marchant Inc.

**Call or write, now, for complete information.**

# KLEINSCHMIDT



**DIVISION OF SMITH-CORONA MARCHANT INC., DEERFIELD, ILLINOIS**

Pioneer in teleprinted communications systems and equipment since 1911



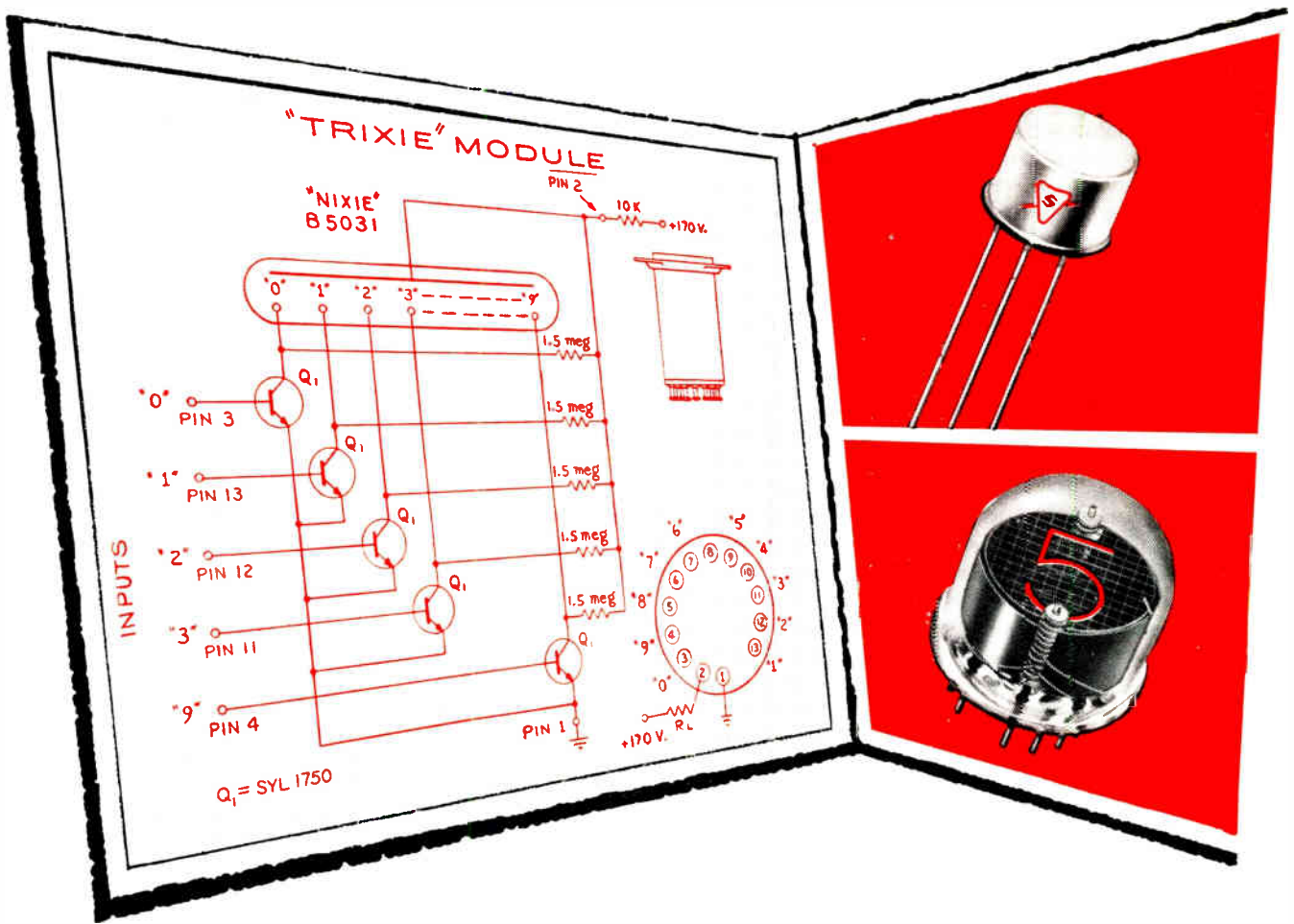

... NEW LOW-COST

## Transistorized Readout

**"Trixie", new computer read-out circuit design, utilizes Sylvania's new NPN transistor, Syl 1750, and the Nixie® indicator tube**

Now, designers can meet direct read-out requirements for computers, instrumentation and data display with new economy and efficiency. Sylvania, pioneer manufacturer of NPN transistors, has developed new parameters in the Syl 1750 to meet the need for a low voltage input driving circuit for the Nixie indicator tube.

"Trixie" (Transistors + Nixie tube)

comprises ten Sylvania NPN medium voltage switching transistors, Syl 1750, in a common emitter configuration. Each transistor drives one of the tube's ten cathodes. The result is the lowest power visual readout available. It can be designed in plug-in module form around a standard Nixie tube socket with terminals provided for electrical connections. A typical module, especially adaptable for direct panel mounting, has an over-all length of two inches and a nominal one-inch diameter.

The new Syl 1750, specially designed for "Trixie," is a 40 v (minimum) NPN germanium alloy junction tran-

sistor. Its low cost is a product of Sylvania's production know-how in NPN transistor manufacture and long experience in NPN design. Syl 1750 meets the reliability and performance criteria of other Sylvania switching transistors and matches their high-quality standards. It is encased in a JEDEC TO-5 package with the Sylvania welded hermetic seal for full protection against humidity and other environmental conditions.

Call your Sylvania representative now for full details of the new low-cost transistorized readout components.

"Trixie" & "Nixie" are trade marks owned by Burroughs Corporation.

 **SYLVANIA**   
Subsidiary of  
**GENERAL TELEPHONE & ELECTRONICS**

Sylvania Semiconductor Division  
100 Sylvan Rd., Woburn, Mass.

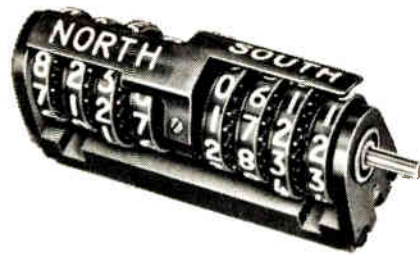
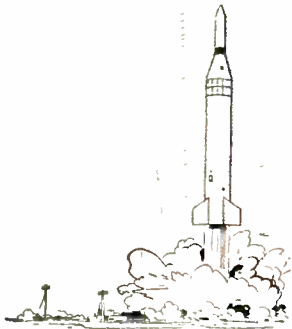

Precision Readout Counters for navigational and control systems include Tandem counters (left), concentric drums, and multi-bank types. "Application Engineered" as complete packages.

# PRECISION readout (DIGITAL IN-LINE) COUNTERS

High Speed Counter works at 1000 rpm with low torque and miniature size. For aircraft fuel-flow meter and similar applications.



*New Concepts in Fast, Accurate Data Presentation*

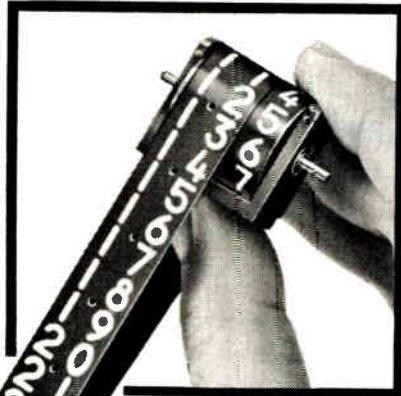

New 360° Tape-Type Bearing Counter recently developed for digital readout of angular relationship. Tape greatly reduces size and weight over conventional devices. "Application Engineered" as required.



Precision Counter has completely internal supporting structure for instrument applications requiring extreme compactness, light weight and ruggedness. Three or five wheels, numerals in enamels or fluorescent points.

Now you can use modern digital readout whenever extreme accuracy and precision indication are required. Veeder-Root Instrument-type Counters have "Application Engineered" tolerances, meet severe environmental specifications, operate accurately at high speeds, and offer wide selections of gearing and package designs.

Here are just a few of the ways Veeder-Root Precision Readout can improve and simplify product operation and performance . . .

- Figures and letters are positive, and easily comprehended
- In-line presentation more *quickly* read
- Replaces micrometer and vernier devices
- Maximum readability in miniature sizes
- Fractions, degrees are positively displayed

Take full advantage of digital readout with Veeder-Root Precision Counters — for military, aircraft, missile and industrial instrumentation. Standard types and special designs for all types of application, and design assistance is available from Veeder-Root Counting Engineers. Write or call.

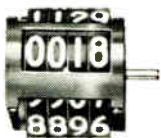

High speed miniature counter suitable for applications requiring small size and weight, low torque and low cost. External pinion, 1/2" wheels, 1/8" characters.

## Veeder-Root

HARTFORD 2, CONNECTICUT

*'The Name that Counts'*



New York • Chicago  
 Los Angeles • San Francisco  
 Seattle • St. Louis  
 Greenville, S. C. • Altoona, Pa.  
 Montreal  
 Offices and Agents in other principal cities



Here are the "basic ingredients" in some of today's most advanced design concepts . . . Norton Ceramic Materials. Exceptionally versatile, these exciting materials are meeting operating requirements of products and processes across industry.

Norton Ceramic Materials offer design engineers a wide range of outstanding physical, chemical, thermal, and electrical properties. What's more, they provide interesting combinations of these properties. For example: CRYSTOLON\* silicon carbide provides high thermal conductivity as well as exceptional thermal strength; ALUNDUM\* aluminum oxide has excellent chemical stability in addition to good abrasion resistance; MAGNORITE\* magnesium oxide offers high purity, thermal and electrical resistance; fused

## Dynamic Ideas in Engineering . . .

*thrive on Norton ceramic materials*

zirconium oxide is today's highest melting point material available in tonnage quantities and it's immune to both reducing and oxidizing atmospheres. And each product has many other invaluable properties.

Think of Norton Ceramic Compositions as essential components in equipment for metal and chemical processing, electrical, electronic, ceramic and nuclear applications . . . as "the answer" to literally hundreds of design problems. They're manufactured to meet highly exacting standards of purity, density, shape, size and wear resistance . . . available in granular and in fabricated form to meet your requirements efficiently and economically. For complete details, write for "Norton REFRACTORY GRAIN". NORTON COMPANY, Refractories Division, 941 New Bond Street, Worcester 6, Mass.

\*Trade-Marks Reg. U. S. Pat. Off. and Foreign Countries

**NORTON**

REFRACTORIES

Engineered...  $R_x$  ...Prescribed

Making better products . . . to make your products better

NORTON PRODUCTS Abrasives • Grinding Wheels • Grinding Machines • Refractories • Electrochemicals — BEHR-MANNING DIVISION Coated Abrasives • Sharpening Stones • Pressure-Sensitive Tapes

# SR-220 New Silicone Varnish cures at low (150°C) temperature

**HEAT RESISTANCE SUPERIOR TO CONVENTIONAL SILICONE VARNISHES**

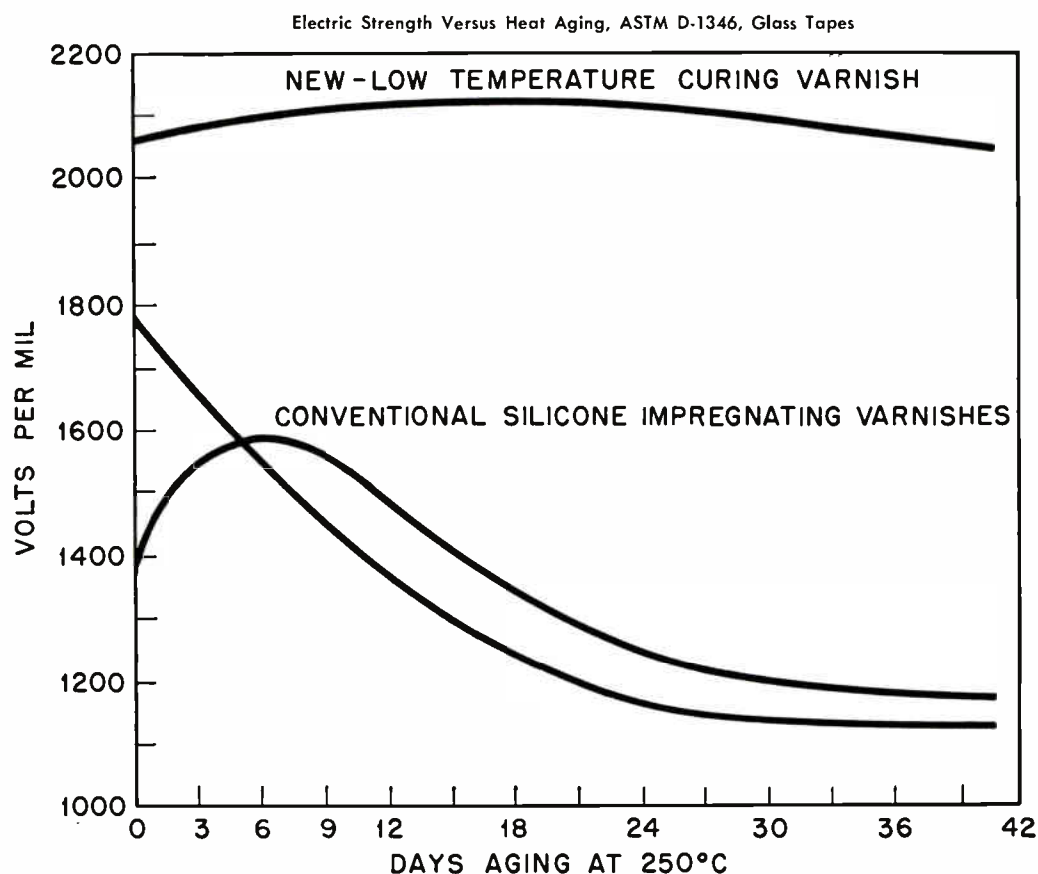

SR-220 is a new silicone impregnating varnish by General Electric that cures in the same ovens used for organic varnishes. The customary advantages of silicone insulation are improved, too. For instance, thermal stability at elevated temperatures is far better than conventional silicone varnishes. Shelf life and tank stability are excellent.

With G-E SR-220 you have a new opportunity to improve the temperature resistance of insulation systems in all temperature classes. Silicone insulation means longer equipment life, high temperature resistance, extra overload capacity and smaller equipment size. With SR-220 you can have these features without investing in high temperature ovens. Call your G-E Silicone Sales Representative for further details, or write Section N1216, Silicone Products Department, General Electric Company, Waterford, N. Y.

**GENERAL  ELECTRIC**

Silicone Products Department



## WHEN FLIGHT VARIABLES WILL MERGE

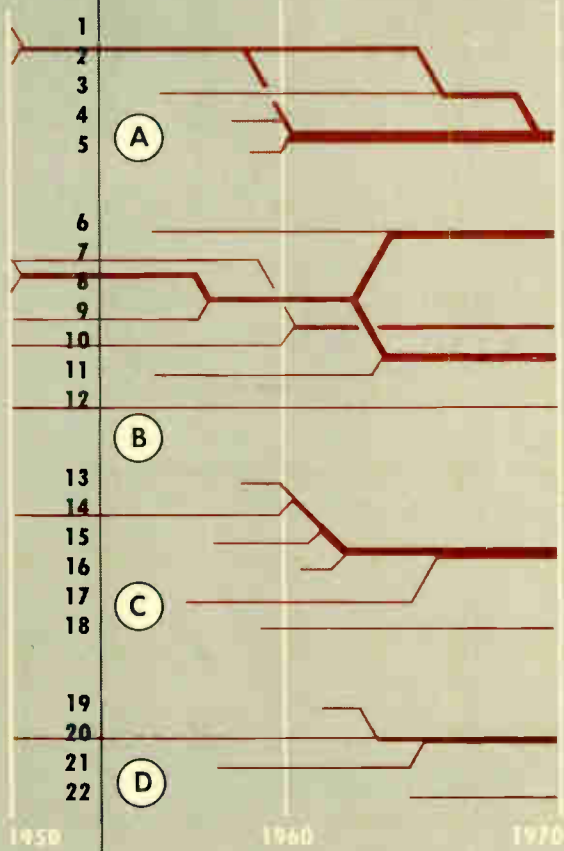

### FLIGHT VARIABLES

#### A—Thermal Environment

- 1 Atmospheric Pressure
- 2 Atmospheric Temperature
- 3 Aerodynamic Heating
- 4 Solar Irradiation
- 5 Vehicle Radiation

#### B—Kinematic Environment

- 6 Acoustic Vibration
- 7 Mechanical Vibration
- 8 Atmospheric Temperature
- 9 Atmospheric Pressure
- 10 Steady-State Acceleration
- 11 Aerodynamic Heating
- 12 Transient Acceleration

#### C—Corrosive Environment

- 13 Ozone
- 14 Atmospheric Pressure
- 15 Solar Radiation
- 16 Ionized and Dissociated Gas
- 17 Aerodynamic Heating
- 18 Meteoritic Dust

#### D—Electromagnetic Environment

- 19 Solar Radiation
- 20 Atmospheric Pressure
- 21 Nuclear Radiation
- 22 Geomagnetic Field

FIG. 1

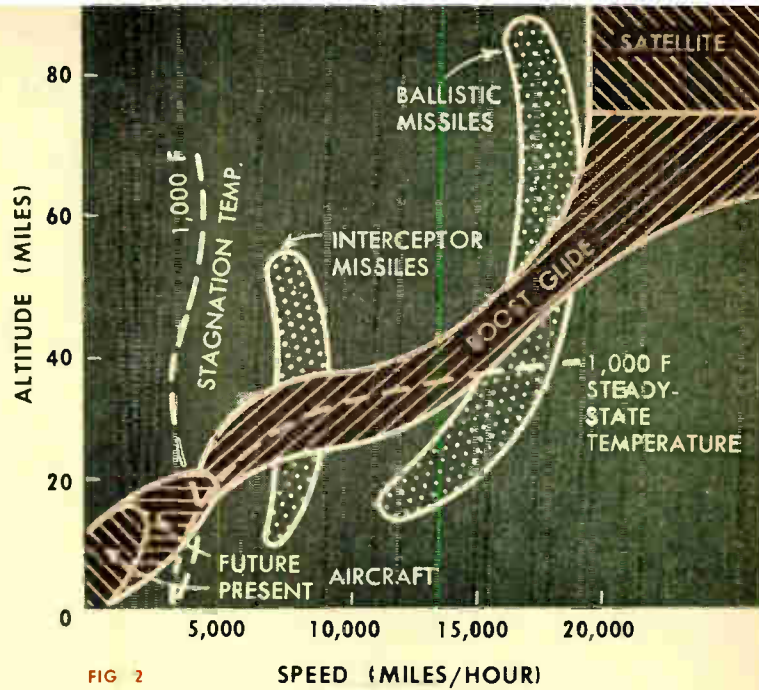

FIG. 2

# MATERIALS for Environmental Extremes

By GEORGE SIDERIS

Buyers' Guide Editor, *ELECTRONICS*

1. *Tomorrow's Environmental Extremes*
2. *Environmental Limits of Materials*
3. *Compatibility of Materials*
4. *Materials Development Needs*

In his talk before the 1959 IRE National Convention, Allan M. Hadley, Deputy Secretary of the Advisory Group on Electronic Parts, ventured that the most pressing problem facing 75 percent of electronic designers was better materials. He said:

"The Jet Age (and the) Nuclear Age . . . both burst upon us almost simultaneously, bringing with them requirements which at first seemed so fantastic as to defy the imagination. Just at the time when operating temperatures of electronic devices had been pushed upward from 65 C to 125 C . . . the Air Force suddenly advanced requirements calling for operation at 350 C and 500 C.

". . . The impossibility of upgrading electronic

parts made from conventional materials . . . was obvious almost at first glance . . . Cooling was a compromise which added to the complexity of the installations as well as to their weight and size . . .

Organic materials—at least as we now know them—have little or no possibility of use above 260 C . . . most magnetic materials undergo drastic changes at less than 500 C . . . the changes in the electrical properties of materials that might operate at 500 C would be intolerable . . . High on the list (of military needs) are materials possessing improved heat resistance, greatly improved dimensional stability over wide temperature ranges, and having uniform electrical properties under all conditions . . ."

# 1. Tomorrow's Environmental Extremes

Use of electronic equipment in high-speed aircraft, space vehicles and nuclear environments is bringing about serious problems of heat, radiation and stress

A MAJOR TASK of electronics materials developers is to cope with environments anticipated for special nuclear weapons, nuclear aircraft and missiles, and high-speed aircraft operating within the atmosphere (Table I).<sup>1</sup>

An estimate of when the environmental hazards will merge is shown in Fig. 1.<sup>2</sup> Conventional defini-

tions of environmental extremes presuppose protection of electronic gear by cooling, heating, and by encasement in sealed housings or behind radiation shielding.

But space and weight considerations oppose use of heavy protective structures in some airborne equipment. Each extra pound of equipment weight in a missile raises its takeoff weight by about 30 pounds. In addition, it is difficult to cool equipment which must also be shock-mounted, or sealed. The objective is equipment which can be thrust almost naked into hostile environments.

**CIVILIAN ELECTRONICS**—Military developments will probably, as in the past, affect civilian electronics. Temperature-stable materials can mean simplified circuits, new industrial markets, greater freedom in miniaturization, packaging and production techniques. Shock, moisture, humidity, corrosion and biological attack are problems common to military and civilian equipment.

**SPACE FLIGHT**—Successful performance of satellites has allayed some of the pre-Sputnik concern about the effects of ozone, low pressure, radiation,

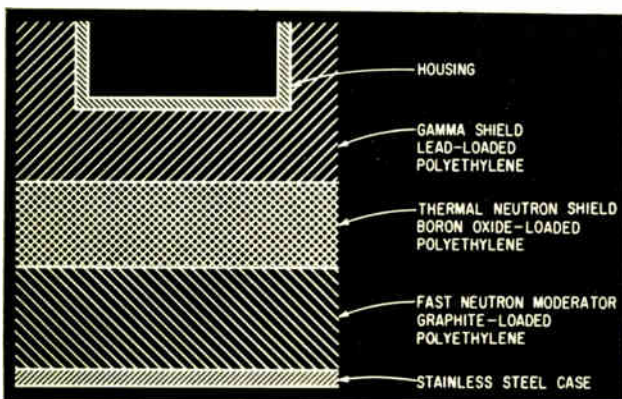

FIG. 3—Shielding which will protect electronic equipment from a near miss by an atom bomb (2 mev gamma energy and 1 mev neutron energy)



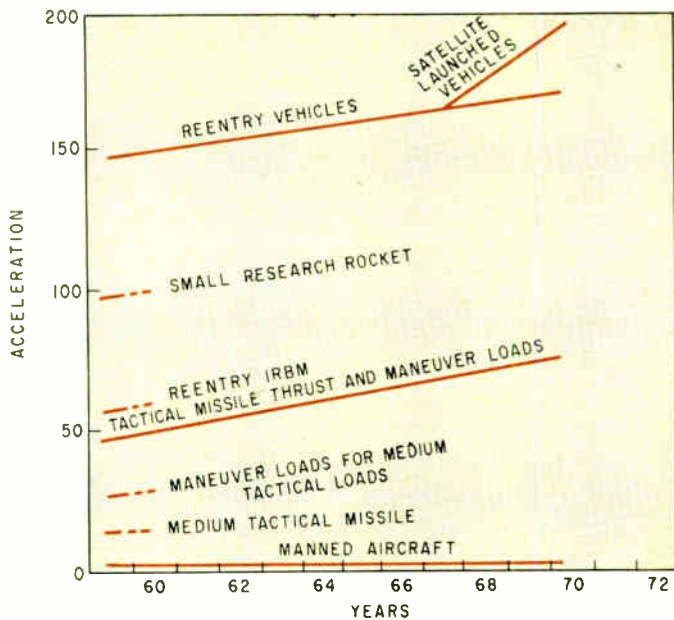

FIG. 4—Anticipated accelerations for aircraft, missiles and spacecraft

temperatures and meteorites in space. Environments inside the satellites have been mild. While the life of components held in the Van Allen radiation belt might be as low as a few days, quick passage through the belt has little effect. Micrometeorite sandblasting—which could destroy heat stabilizing satellite coatings—has apparently been negligible. Meteorite puncture of Explorer III was suspected.

**HEAT AND RADIATION**—High speed flight creates aircraft temperatures to 500 C, higher on exposed surfaces (Fig. 2).<sup>2</sup> Temperatures to 5,000 C are faced for brief periods by radomes under reentry conditions. The military electronic materials goals are 500 C for nuclear weapons, 350 C for high performance aircraft, 200 C with radiation resistance for nuclear-powered aircraft and missiles, and 125 C with pulse radiation resistance for interceptor type aircraft and missiles.

Many conventional materials, particularly those which are inert, will tolerate radiation. There are relatively few materials which tolerate radiation, high temperature and mechanical stress simultaneously. These materials are mainly metals and inorganics. Materials with low neutron capture cross sections are desirable in radioactive environments to prevent buildup of long-lived radioactive isotopes. Many of the popular electronic materials—aluminum, copper, germanium, silicon, silver, magnesium—have short-lived isotopes.

Radiation readily affects most organic materials, semiconductors, oil-impregnated components, boron or lead glass tubes. Inorganic capacitors, metal resistors and some magnetic materials bear up well.

Table I—Military Environment Goals

Characteristic	1957	1959	Equipment <sup>a</sup>
Operating Temp	-65 to 1,000 C	-65 to 500 C	nuclear weapons
Storage Temp	-65 to 71 C	-65 to 85 C	all
Thermal Shock	.....	-65 to 500 C	nuclear weapons
Moisture 100% RH	10 cycles	10 cycles	all
Vibration (cps)	10-3,000	10-3,000	nuclear weapons
	40 g	40 g	
Air-induced Vib (cps)	150-9,600	150-9,600	air, missiles and nuclear weapons
Acceleration	165 db	165 db	all
	50 g	50 g	
	11 msec	11 msec	
Radiation n/cm <sup>2</sup> /sec	10 <sup>15</sup> , 1,000 hr	10 <sup>16</sup> , 1,000 hr	nuclear aircraft,
photons/cm/sec	10 <sup>15</sup> , 1,000 hr	10 <sup>16</sup> , 1,000 hr	nuclear weapons,
n/cm <sup>2</sup> /sec	.....	10 <sup>17</sup> , 80 msec	missiles
gamma r/sec	.....	10 <sup>8</sup> , 80 msec	

(a) Classes of equipment as defined in 1959. The classes of equipment used in the 1957 list of environmental goals have been redefined

An example of the type of shielding needed for radiation-sensitive systems exposed to a near miss by an atomic bomb is shown in Fig. 3.<sup>3</sup>

**MECHANICAL STRESS**—Acceleration is expected to climb, in out-of-atmosphere vehicles, to three or four times the present 50 g (Fig. 4).<sup>2</sup> Peak vibration may go up 50 percent by 1970, in large rocket-powered vehicles. Increasing requirements brought about by air-induced vibration, however, should peak in a few years at about 170 db.

#### DEFINITIONS OF NUCLEAR ENERGY UNITS

**nv**—neutron flux: neutrons times velocity (cm per sec times neutrons per cm<sup>2</sup>)

**nv<sub>t</sub>**—integrated neutron flux: total neutron flux during exposure time

**ev**—electron volt

**Curie**—radioactivity of 1 gram of radium: equal to 37 billion atomic disintegrations in 1 second

**rad**—radiation dose: equal to absorption of 100 ergs of energy by 1 gram of exposed matter

**rem**—biological measure of radiation dose. A rad of alpha rays equals 10 rem; a rad of x-rays, gamma rays or beta rays equals 1 rem

**Roentgen**—irradiation sufficient to produce about 2 billion positive and 2 billion negative ions in 1 cc of dry air at 0 C and 760 mm Hg (83 ergs per gram, or about 7.2X10<sup>7</sup> 2—mev neutrons/cm<sup>2</sup>)

## 2. Environmental Limits of Materials

Research is raising endurance limits of materials like structural metals, conductors and magnetic materials; components such as transducers, semiconductor devices, capacitors, resistors

**STRUCTURAL METALS**—The structural requirements of virtually all electronic equipment can be met on most environmental levels with currently available alloys (Fig. 5).<sup>2</sup> Airframe and chemical process needs have caused development of metals adequate for most electronic needs.

A rule of thumb on heat resistance is to take 40 percent, in degrees Kelvin, of the pure metal's melt-

ing point. The ratio is 60 percent or better for alloys. Under radiation, most metals become harder, stronger and increase in resistivity. With high temperature added, changes tend to anneal out as fast as they occur.

Irradiation tends to make most metals harder but less ductile. Except for titanium, metals which normally yield under tension will generally break under tension above yield stress after irradiation. But irradiation also increases the yield strength of metals by 60 to 450 percent.

Stainless steels are good materials for extreme temperature and radiation. They are widely used to protect transducers in reactors.

**ELECTRICAL INSULATION**—When subjected to radiation, ceramics may discolor, expand and change in thermal conductivity. However, magnesium oxide single crystals and boron carbide tend also to fracture; zirconium oxide changes in crystal structure; silicon carbide, cordierite and zircon tend to lose crystallinity.

Quartz decreases in density and may dissolve into glass. In one series of tests on quartz crystals, 75 percent failed. Remedies (for crystal oscillators)

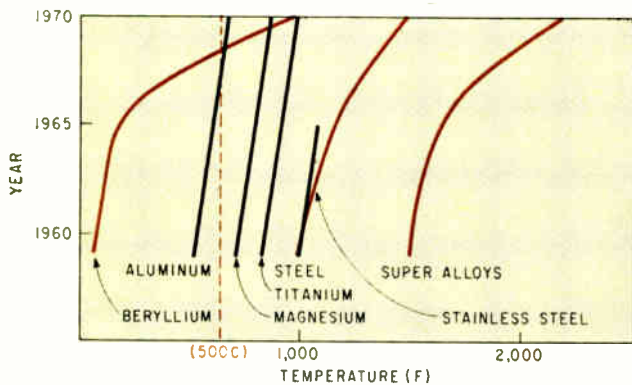

FIG. 5—Temperatures at which alloys retain structural strength

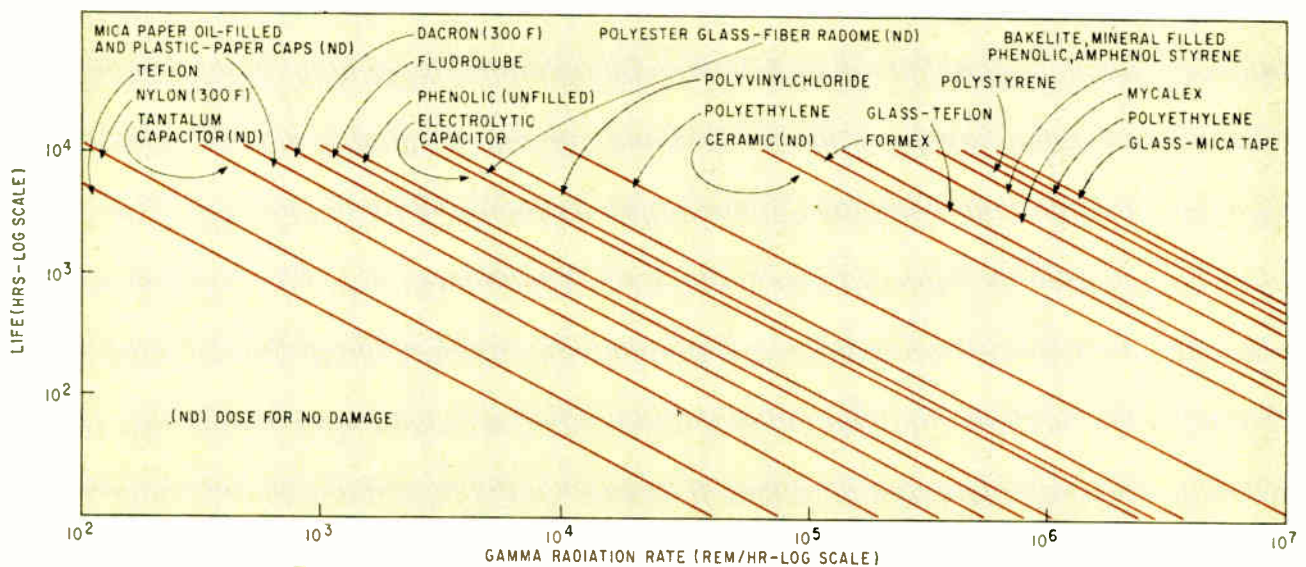

FIG. 6—Approximate life expectancy of some dielectric materials and tantalum, oil-filled and electrolytic capacitors



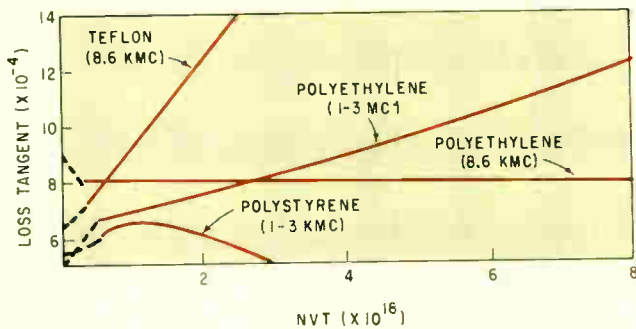

FIG. 7—Loss tangents of some commonly used dielectrics at medium to high frequency, after irradiation

may be found in more inert supporting materials and more selective cuts.

Silica and soda-lime glasses change color. Borosilicates suffer severe surface checking in addition to color change. Lead glasses devitrify to lead and other materials. The above effects were noted after irradiation of about 10<sup>20</sup> nvt and 10<sup>7</sup> r.

Most plastics tend to lose tensile strength and impermeability under irradiation and they are often useless at 10<sup>20</sup> n/cm<sup>2</sup> even at normal temperatures. Halogenated polymers like fluorocarbons can give off corrosive gases. Moderate radiation, however, strengthens such plastics as polyethylene and styrene. Radiation stability can be improved by inorganic fillers, rigid plastics are more resistant than soft materials. Filled epoxies, polyesters and phenolics and silicone resins are radiation-resistant (Figs. 6 and 7).<sup>4,5</sup>

**HIGH-TEMPERATURE INSULATIONS**—Natural and synthetic glass-bonded micas, sapphire and glasses of the fused quartz, fused silica, lime, barium and calcium aluminosilicates, and the glass-ceramics are all servicable at high temperatures.

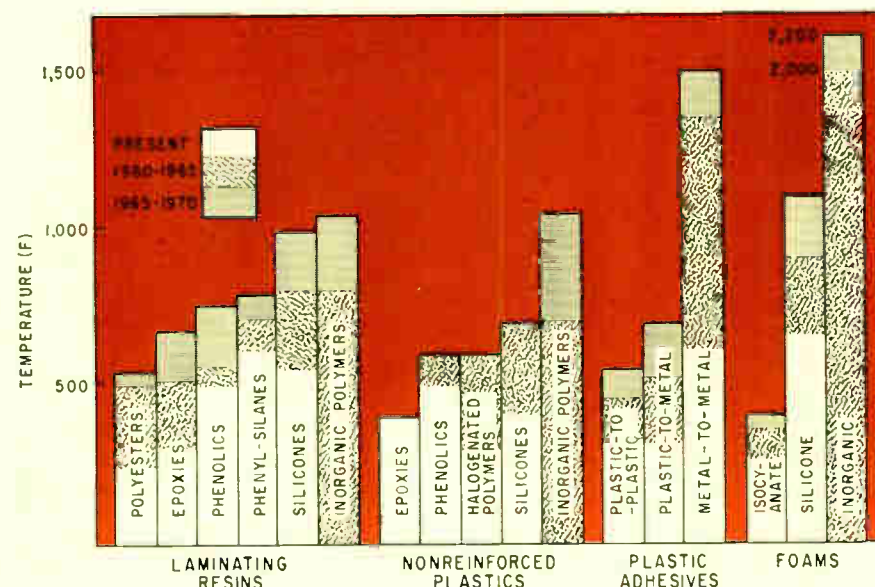

FIG. 8—Approximate temperature limitations of selected plastics (200 hours)

Glasses with resistivities as high as 10<sup>14</sup> ohm-cm at 250 C, 10<sup>10.8</sup> at 350 C and 10<sup>10.4</sup> at 500 C are available.

Some ceramics with service temperatures over 1,000 C are listed in Table II. Beryllia must be used with caution since it is toxic and decomposes when not protected from moisture. Thoria is slightly radioactive. Plastics limits for structural use are given in Fig. 8<sup>2</sup>.

Glass, in various fibrous, matted, woven and pellet forms, mica flakes, synthetic mica and similar materials will upgrade organic materials. Plastics molded with glass fiber fillers provide strong structural parts and permit more or heavier parts to be placed on circuit boards. Teflon and silicones are usable at 400 C and over for short periods. Several inorganic materials absorb moisture unless provided with a glaze or other seal coat.

**PRINTED-CIRCUIT BOARDS**—Ceramic, glass-ceramic and glass-bonded mica are suited to applications at 400 C and up. Miniature printed circuits with moly-manganese wiring fired on alumina are reported to withstand 700 C; platinum wires and silver contacts embedded in Forsterite got an 800 C report. Conductors may also be molded or plated into the substrate to provide a flush surface for contact wiping.

The effect of radiation on the dry flexural strength of glass-reinforced laminates is shown in Fig. 9.<sup>6</sup> Heat resistant laminates were also tested at 260 C after irradiation. Other strength tests results were roughly parallel, except for a non-heat-resistant epoxy which delaminated at about 10<sup>6</sup> r during wet flexure and tensile tests. The dielectric constants of these materials remained essentially constant between exposures of 10<sup>5</sup> to 10<sup>7</sup> r.

Organic laminates for continuous service at 200 C and short term service at 250 C are found in the

Table II—Some Inorganic Insulations Servicable at 1,000 C

- Sapphire Crystal
- Alumina
- Alumina Porcelain
- Alumina Silicate
- Cordierite
- Fired Talc
- Zircon Porcelain
- Steatite
- Forsterite
- Lithia Porcelain
- Beryllia
- Magnesia
- Thoria
- Silica Glass

**Table III—Properties of Bonded Synthetic Fluorophlogopite Mica**

Properties	Binder Material	
	Silica Sol <sup>a</sup>	Glass
Max Fabrication Temp(C)	200	732
Max Service Temp (C)	1,100	500
Volume Resistivity (dry) ohm-cm at 25 C	$4.02 \times 10^{10}$	$2.6 \times 10^{13}$
500 C	$6.68 \times 10^6$	$8.5 \times 10^7$
Dielectric Strength 25C	55 v/mil min	112 v/mil min
Dielectric Constant (dry)		
10 <sup>6</sup> cps at 25 C	3.35	6.47
500 C	5.94	8.02
Loss Tangent (dry)		
10 <sup>6</sup> cps at 25 C	0.0045	0.0056
500 C	0.37	

(a) Eccoceram SM-25

**Table IV—Temperature Limits of Foams**

Material	Max Temp (F)	Material	Max Temp (F)
Silica, Alumina . . .	2,500	Silicone (sponge) . . .	500
Wollastonite . . . . .	1,500	Cellulose . . . . .	350
Ceramic . . . . .	1,200	Polystyrene . . . . .	165
		Cross-linked . . . . .	350
Silicone (filled) . . . . .	800	Polyurethane . . . . .	350
Silicone . . . . .	700	Phenolic . . . . .	300
Epoxy . . . . .	600		

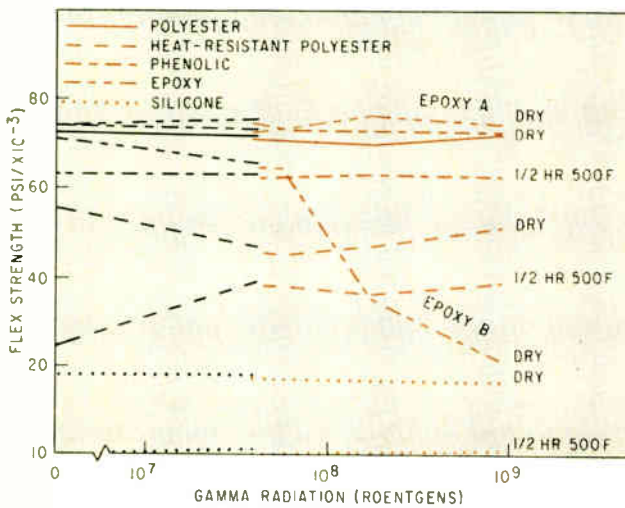

**FIG. 9—Glass-reinforced laminates (1/8-inch thick) retain structural strength under gamma irradiation**

NEMA grades. Felted asbestos-phenolic laminates have a 250 C continuous rating and a 475-500 C short term capability. At low frequencies, heating raises the dielectric constants. At high frequencies, heating has little effect on reinforced polyester, asbestos phenolic or glass-phenolic at a given frequency.

**ENCAPSULANTS AND IMPREGNANTS**—Organic potting compounds are generally not usable beyond 200 to 250 C unless filled. Among the exceptions are silicones, which retain some 80 percent of their original properties at 315 C; butadiene-based resins, 260 C, and epoxies, 315 C. Silicone varnishes containing phenyls are said to be radiation resistant. Under irradiation, a silicone oil may become rubbery; silicone rubber may become brittle. The former provides a potential means of low-temperature cures for oil-impregnated material such as cable insulation.

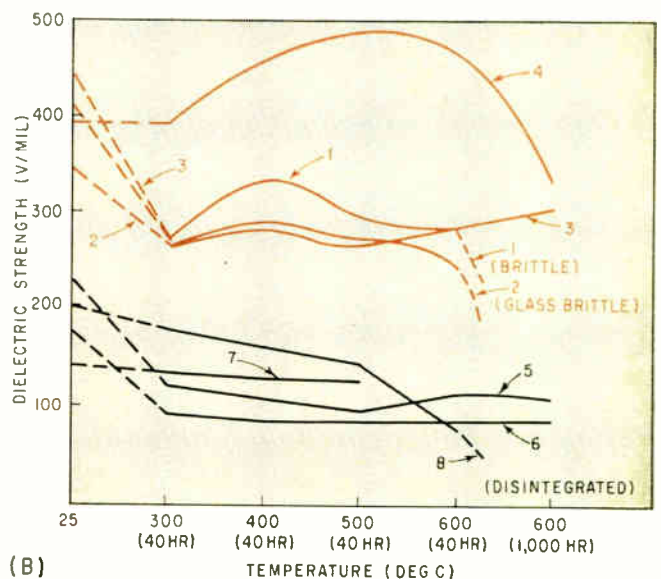
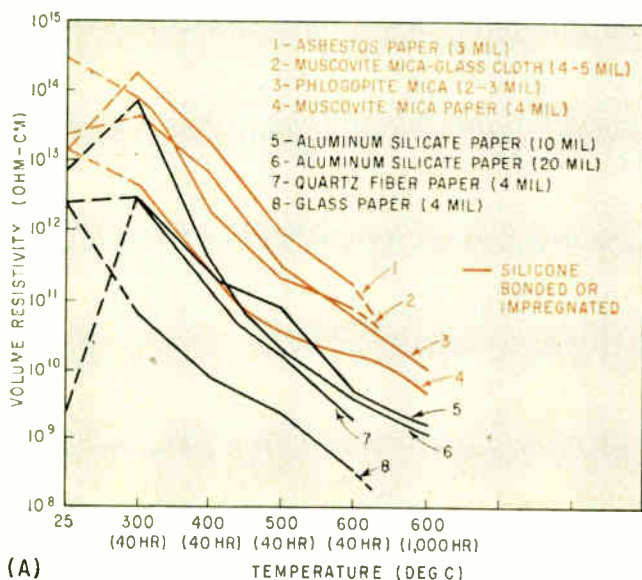

**FIG. 10—Results of an evaluation of sheet insulation for a transformer to operate at 500 C. Silicone-mica was selected**



One of the problems of inorganic potting compounds is that they are applied as a slurry. The liquid, as it evaporates at high temperature, may leave gaps in the insulation or cause corrosion. If the component permits tamping or pouring in powdered oxides or other inert materials, this problem is minimized. Cements such as those based on magnesite, phosphate-bonded zircon and calcium aluminate are satisfactory provided they do not form corrosive chlorides. Low melting glasses may also be used for moderate temperature applications. Properties of two inorganic compounds are given in Table III.<sup>7</sup>

**FOAMS**—Foams (Table IV) are used for radomes, microwave absorbers, encapsulants, protective packaging. The inorganic types are generally tamped in place or cut to size. Teflon is "foamed" by filling it with low temperature materials which are sintered out. Plastics can generally be foamed in place. If internal heat must be dissipated, cool-

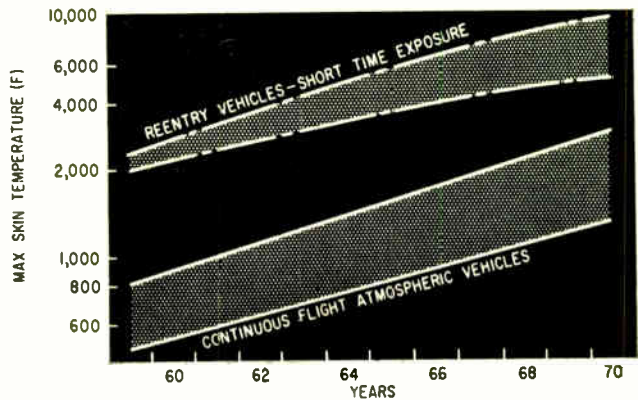

FIG. 11—Anticipated aerodynamic heating temperatures. The atmospheric flight is projected to a speed of Mach 4

ing ducts or metallic paths should be molded into the foam to draw off heat.

Ceramic foams can be made with excellent elec-

Table V—Weight Loss of Some Materials When Exposed to Plasma Arc

Resin and Filler	Loss <sup>a</sup>
<b>High Temp Phenolic</b>	
—chopped Refrasil cloth	2.3
—Orlon fiber	1.3
—chopped Nylon cloth	1.1
—acid leached asbestos	2.1, 2.9
—chopped asbestos fabric	2.1
<b>Phenolic Molding Compound</b>	
—Mil Type MFG	2.1
—high temp	1.7
<b>Phenolic</b>	
—graded magnesium oxide	1.8
—graphite molding compound	1.7
<b>Melamine</b>	
—Fiberglas (NEMA G-5)	3.6, 5.4
—cotton (NEMA MC)	2.6
<b>Silicone</b>	
—Fiberglas (NEMA G-7)	3.3
—chopped glass fiber mold comp.	2.9
<b>Epoxy</b>	
—electrical grade laminate	2.3
epoxy-pyromellitic dianhydride in Fiberglas	3.0
<b>Hard Rubber</b>	
—no carbon	2.8
vulcanized fiber	2.7
copper rod (for comparison)	60

(a) Weight loss in mg/kw-sec: 1/2-inch diameter rods

Table VI—Properties of Radome Materials

Material	Temp (F)	Dielectric Constant @ 8,600 mc	Loss Tangent @ 8,600 mc
Silicone resin-inorganic bead sandwich	room	3.99	0.022
	660	3.33	0.022
	920	3.30	0.024
Phenolic resin-inorganic bead sandwich	room	5.88	0.050
	660	5.75	0.038
	900	5.20	0.033
Inorganic laminates	room	3.30	0.0089
	500	3.47	0.0167
	1,000	3.46	0.0198

Table VII—Ground Radome Coatings

Resin Type	Adhesion to Polyester Laminate	Outdoor Durability
Acrylic	fair	excellent
Alkyd	good	good
Drying oil	fair	fair
Epoxy	excellent	good
Phenolic	good	fair
Vinyl	poor to fair	fair to good
Silicone	fair	good
Chlorosulfonated Polyethylene	poor	good
Polytetrafluoroethylene	poor	(limited data)
Polytrifluoromono-chloroethylene	poor	fair
Polychloroprene	good	good to excellent
Polyurethane	good	good

**Table VIII—Resistivities of Conductors at 500 C**

Material	$\mu\text{ohm-cm}$	Material	$\mu\text{ohm-cm}$
Silver.....	4.1	Magnesium <sup>a</sup> ..	13.8
Copper.....	5.1	Molybdenum..	15.8
—Al clad <sup>a</sup> ...	6.3	Tungsten.....	18.5
—Ni clad 27% <sup>a</sup>	7.9	Platinum.....	29.1
Gold.....	6.6	Palladium.....	31.3
Silver-Mg-Ni..	6.8	Titanium.....	14
Aluminum <sup>a</sup> ...	10	Nickel.....	73.3

(a) Melting points 650–660 C  
 Ratio between room temperature and 500 C resistivities is 2.52 for silver; 2.71, gold; 2.9, copper; 3.82, aluminum, and 10, nickel

**Table IX—Ultra-High Temperature Conductors**

Material	Max Service Resistivity (ohm-cm)		
	Temp (C)	@ 20–25C	High Temp
Zirconium Oxide.....	2,500	a	$1 \times 10^6$ @ 2,000 C
Tin Oxide.....	1,500	$4 \times 10^6$	$6 \times 10^3$ @ 1,200 C
Moly Disilicide	1,500	$25 \times 10^{-6}$	$80 \times 10^{-6}$ @ 1,600 C

(a) Nonconductor at 20 C  
 Silicon carbide and zinc oxide may also be used

trical stability. Wollastonite is heavy, but has a low dielectric constant (1.4 to 1.5 for 40-pound foam at 3 mc) which is reported to be constant from 20 to 800 C.

Unlike solid materials, foams can do double duty as shock absorbers, vibration dampers or thermal shields. Instruments placed in an Atlas missile, for example, were housed in urethane. Entire chassis can be packaged in foam if the tube shields and cooling ducts are molded into the foam.

**TAPES, FILMS, TUBES**—Organic materials are usable to 260 C. Teflon, as a cable wrapping is reported usable for 100 hours at 350 C. Silicone-glass has up to 1,000-hour life at 300 C and short term life at 400 C. Beyond this range it is necessary to use inorganic materials or silicone-impregnated inorganic materials. The performance of some of these materials is shown in Fig. 10.<sup>8</sup>

**GASES AND FLUIDS**—Perfluorocarbon gases are suitable for cooling and insulation at temperatures around 200 to 250 C and are reported to be com-

patible with other electronic materials used at those temperatures. Silicones and silicate-ester-based fluids are also considered 200 C fluids. Fluids are another double-duty material, since their damping action protects against vibration and shock. The new liquid state diodes and switches, for example, are reported to be relatively insensitive to vibration. Inert gases are required at very high temperatures.

**RADOMES**—Radome designers have for several years been living with the thermal problems (Fig. 11)<sup>2</sup> now facing designers of internal aircraft and missile systems. Although most high-temperature radome materials (Table V)<sup>9</sup> are designed for systematic erosion, radome experiences should be instructive to persons developing other structural components.

At temperatures over 125 C, reinforced plastics lose strength more slowly than light metals. On exposure to flowing heat, the outer surface absorbs much of the heat. The surface is then cooled by discarding the hottest material, transpiration of a

**Table X—Radiation Effects on Some Magnetic Core Materials**

Material	% Change in D-C Properties						% Change in A-C Properties							
	$u_0^a$		$H_c$	$B_r$	$B_s$	$B_r/B_s$	Flux Density			$B_r/B_m$		$H_c$		
	$u_m$	$H_p^d$					60~	400~	60~	400~	60~	400~		
3.5 silicon Iron.....	8	-1	5.7	0.8	0	0.8	0.1	1	0.5	7	1.5	1.5	9	7
Orthanol.....	-31	15	-28	-24	-4	-21	0.1	-36	-41	2	-17	-17	44	85
5-79 Mo-Permalloy.....	-9.3 <sup>b</sup>	-93	815	-38	-3.2	-36	0.01	-92	-84	4	-46	-37	1,000	780
2 Vanadium Permendur...	2.7	1.7	-2	-0.6	-0.7	0	1	5	2.5	20	-6	-2.5	5	10
16 Alfenol.....	34	15	-8	7.5	-5	13	0.1	-4	-5	5	-1.5	1	8	4
Nickel Ferrite.....	1.2	1.4	-4.6	-4	-1.7	-2.4	4	-2.5	23	20	-0.5	8	5	3.5
2-81 Mo-Permalloy.....	-6.8	-3.7				0.2	1	-7	-8	20				

Irradiation to  $2.74 \times 10^{18}$  neutrons/cm<sup>2</sup> (a) Permeability at B of 20 gauss (b) Reannealing restored magnetic properties (c) B for H of 30 oersted (d)  $h_p$  is the a-c field intensity in oersted at which corresponding properties were measured;  $u_0$  is initial permeability;  $u_m$ , maximum permeability;  $H_c$ , coercive force;  $B_r$ , residual induction;  $B_s$ , saturation induction, and  $B_r/B_s$ , squareness ratio



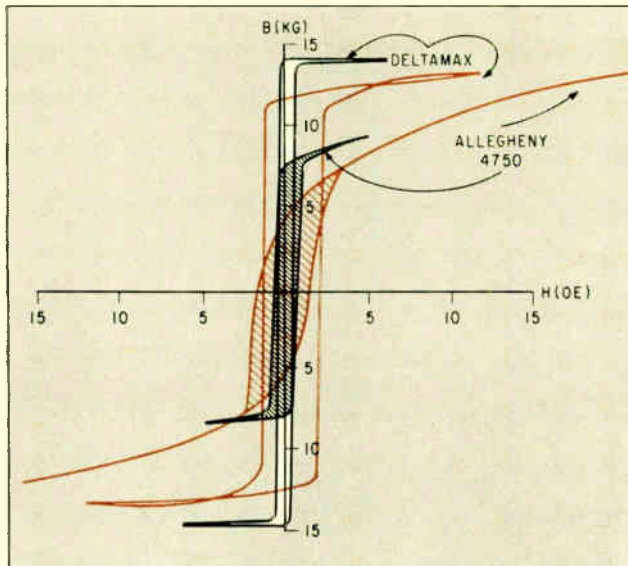

FIG. 12—Effect of irradiation on two 50-50 nickel alloys. Deltamax was irradiated at 115 C and Allegheny 4750 at 190 C

coolant through a porous wall, sublimation and similar methods.

Radome materials are frequently phenolic, silicone or other plastics supported by fibers. The laminates may be used to sandwich inorganic beads (Table VI).<sup>10</sup> Inorganic laminates may be made of fibers in calcium aluminate and phosphate cements, oxysulphate and oxychloride. Unsupported inorganic materials include alumina, glass-ceramics, glass-bonded mica and, for irdomes (infrared): sapphire, high temperature glasses and silica.

For service at moderate temperatures, laminates are made with silicones (500 C), phenolics (400 C), polyester (370 C), triallyl cyuranate, epoxies, phenolic honeycomb (260 C) and isocyanate foams (120 C).

Other cooling methods include heat sinks—beryllium is difficult to work with, but has good heat dissipating properties and has been chosen for Project Mercury—and heat reflective coatings. An investigation is being made of possible coatings which could change color with temperature, to automatically stabilize internal temperatures of satellites and space ships. Rain and snow-erosion-resistant coatings like neoprene are provided radomes intended for service in the atmosphere.

Reinforced plastics are also used in ground radomes. Here, wind, cold, snow and weathering are the environmental extremes. Weather norms generally prevent snow, ice and wind from becoming severe all at once. Weathering is prevented by coating. One firm tested a number of materials (Table VII)<sup>11</sup> and concluded that acrylic emulsions are good for polyester domes. Lithium chloride is reported to be a good anti-icing spray.

**WIRE AND CABLE**—Coaxial cable made with air-spaced Teflon is suitable for 300 C; ceramic fibers, silica, magnesium oxide, ceramic beads, for 500 C

Table XI—Effect of Irradiation on Some High-Permeability Cores

Material	Coercive Force	Initial Permeability
Supermalloy	815%	-93%
4-79 Mo-Permalloy	423%	-89%
Mumetal	158%	-66%
50-50 Nickel-Iron		
—unoriented	99%	-68%
—oriented	-28%	-31%

Table XII—Effect of Temperature on Some Nickel-Iron Alloys

Temp (C)	B <sub>r</sub> (kg)	B <sub>r</sub> /B <sub>s</sub>	Temp (C)	B <sub>r</sub> (kg)	B <sub>r</sub> /B <sub>s</sub>
Hipernik			Hipernik V		
-60	10.5	0.683	-57	14.9	0.98
250	5.4	0.445	250	7	0.554
-60	10.5	0.660	-60	13.5	0.901
Deltamax			Supermalloy		
-60	14.8	0.99	-57	4.6	0.704
250	7.2	0.592	250	3.6	0.531
-60	14.2	0.871	-61	4.6	0.695
Mo-Permalloy			Hymu 80		
-60	3.9	0.57	-57	5.5	0.858
250	3.6	0.531	250	4	0.606
-60	3.9	0.419	-60	5.5	0.816

Table XIII—High-Temperature Effects on Some Magnetic Cores

Material (Balance Fe)	Temp	$\mu_e$ (1,000)	$\mu_m$	B <sub>r</sub> (kg)	B <sub>m</sub> <sup>c</sup> (kg)	B <sub>r</sub> /B <sub>m</sub>	H <sub>c</sub> (oe)
Transformer-A <sup>a</sup> (4.7 Si)	24C	0.79	10.7	9.5	14.9	0.64	0.41
	300C	1.3	11.3	7.8	14.4	0.54	0.32
	500C	0.47	12	6.6	14	0.47	0.27
3 cycles	24-500C	0.85	11.9	9.6	14.8	0.65	0.43
	24C	0.8	10.7	11.3	15.1	0.75	0.48
Audio Transf-B <sup>a</sup> (3.6 Si)	300C	1.3	11.3	9.3	14.6	0.63	0.39
	500C	0.5	12.2	7.7	14.1	0.55	0.28
	24-500C	0.85	11.4	11.2	15	0.75	0.48
L-Silectron <sup>b</sup> (3 Si)	24C	1	28	15.5	18.5	0.84	0.28
	300C	3.6	30	13.5	17.4	0.78	0.2
	500C	0.67	25.2	9.4	15.4	0.61	0.16
3 cycles	24-500C	1.7	18.3	12.5	18.4	0.68	0.3
	24C	1.6	23	14.4	18.5	0.78	0.33
Z-Silectron <sup>b</sup> (3 Si)	300C	1.6	23	12.1	17.5	0.69	0.29
	500C	0.9	23	8.3	15.5	0.53	0.18
	24-500C	1.9	16	11.3	18.5	0.61	0.32

Values of H<sub>c</sub>, B<sub>r</sub>, B<sub>m</sub> and B<sub>r</sub>/B<sub>m</sub> are for H<sub>m</sub> = 30 oersteds (a) Toroidal laminations (b) Spiral tape (c) Maximum induction

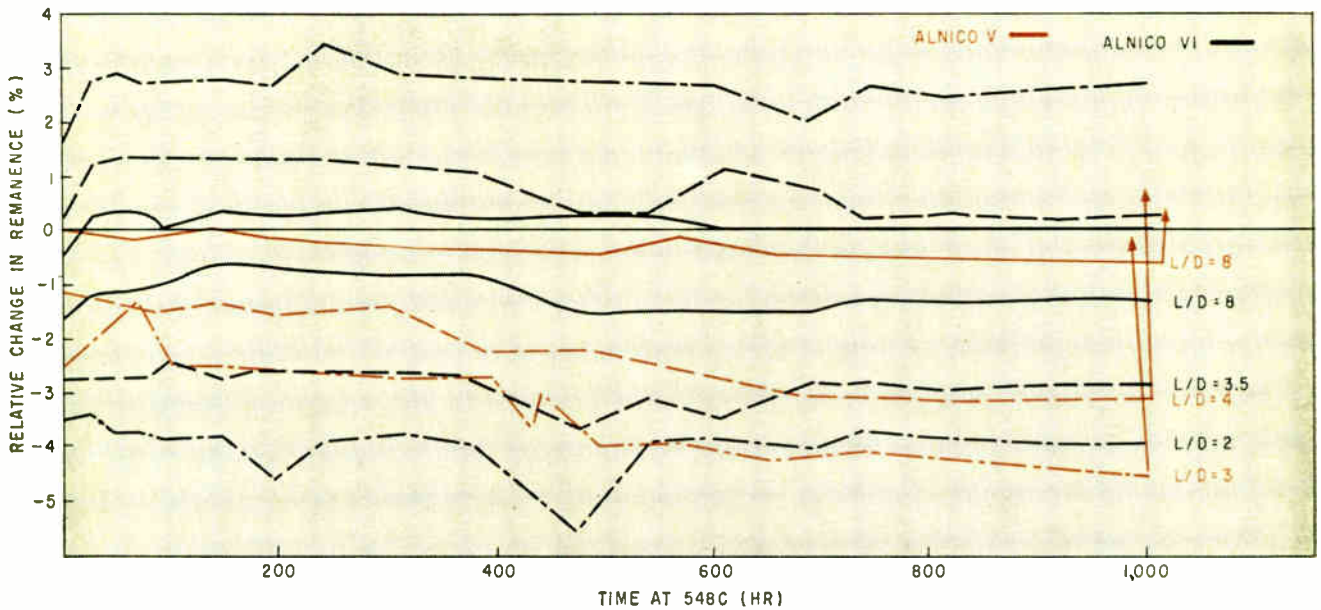

FIG. 13—Temperature effects in Alnicos 5 and 6. Material effects are seen above the zero line. Material and irreversible effects are below the line. The vertical arrows show results of remagnetizing Alnico 5

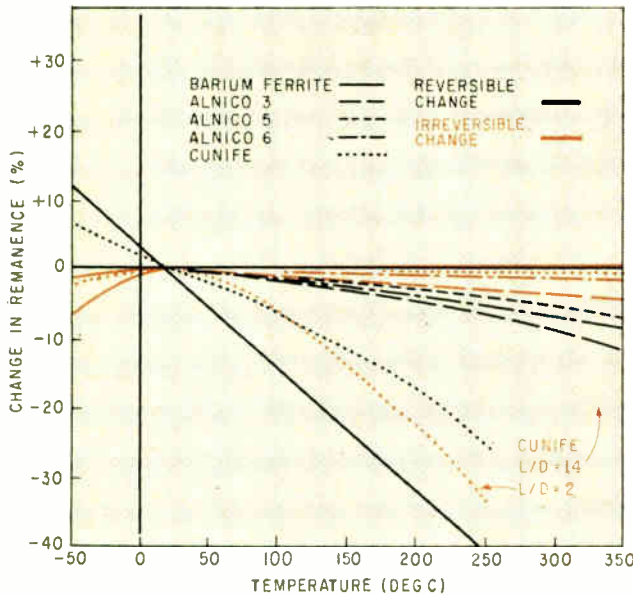

FIG. 14—Effect of temperature on some permanent magnets. Two curves are given for Cunife to show the influence that length-diameter ratios have on temperature stability of permanent magnets

and over. Glass-bonded mica, boron nitride, silica foam, glass-ceramic and polyparaxylene are potential high temperature dielectrics. Capabilities of the metallic conductor and sheathing are the limiting factors.

Asbestos, glass and ceramic fibers, and anodized aluminum oxide provide 500 C wire insulation. When good windability is required, the fibers can be supported by an organic binder which is driven off by high temperature baking. High temperature wires may also be made by plating copper with aluminum and then anodizing the aluminum. The oxide film can be supported with a ceramic-resin mixture. The resin is then baked out. Chemically-

produced fluoride coatings on copper and aluminum are also reported good at 500 C.

**CONDUCTORS**—Providing allowances are made for changes in properties, conductive metals are suitable in radiation environments. Since tinning is ineffective at high temperatures and copper oxidizes at 250 C, copper must be plated or clad to protect the insulation and conductivity. Silver and thick nickel cladding are adequate. Silver is a good 500 C conductor (Table VIII).<sup>12</sup> Suitable wire joints can be made by brazing like metals or welding silver. Terminal connections for 500 C have been made by brazing silver, aluminum or nickel-clad wires to silver, nickel and stainless steel terminals. Some ceramic materials are potentially useful as electrical conductors at ultra-high temperatures. (Table IX).<sup>13</sup>

**CONNECTORS**—Beryllium copper and phosphor bronze contact spring materials are reported to lose tension at high temperatures. Inconel and stainless steel can be used. Noble metal is used in high temperature contacts, or as cladding or plate over nickel over base metal. Noble metal oxides may be good alternatives. Rhenium is recognized as a good tube metal and it is also a potential high temperature contact material. An oxide is formed at about 600 C, but it has low resistance.

**SOLDERS AND BRAZES**—Tin-lead base solders are acceptable for radiation environments providing the temperature is low. Silver solders and brazing materials are required at high temperatures. Alternative fastening methods include welding and cold welding. The integrity of solder joints subjected to vibration and shock is best preserved by cleanliness and stress-free design. For strong joints in aluminum wire, the wire can be dipped in



**Table XIV—Curie Temperatures of Ferroelectric Materials**

Material	T <sub>c</sub> (C)	Material	T <sub>c</sub> (C)
<b>Titanates</b>		<b>Niobates</b>	
Barium.....	120	Potassium....	435
Lead <sup>a</sup> .....	490	Sodium.....	-110
Strontium.....	-269	Cadmium.....	-88
Cadmium.....	-223	Pb <sub>2</sub> Nb <sub>2</sub> O <sub>7</sub> ....	-258
Iron.....	~700		
Nickel.....	~700	Pb(NbO <sub>3</sub> ) <sub>2</sub> ...	570
<b>Tantalates</b>		<b>Stannates</b>	
Sodium.....	475	Lead.....	150
Potassium.....	-260		
Lead.....	260	<b>Zirconates</b>	
Rubidium.....	247	Lead.....	230
<b>Rhenium Trioxide</b>		<b>Gallate</b>	
Tungsten Oxide...	710	Lanthanum..	~475
Moly Oxide.....	>530		

(a) Lead zirconate-titanate is reported elsewhere to have a T<sub>c</sub> of 570 C

**Table XV—Potential High-Temperature Materials**

Material	Melt Pt (C)	Material	Melt Pt (C)
<b>Carbides</b>		<b>Nitrides</b>	
Hafnium.....	4,160	Tantalum.....	3,360
Tantalum.....	4,150	Titanium <sup>b</sup> .....	3,220
Titanium <sup>a</sup> .....	3,140	Boron <sup>a</sup> .....	2,730
Tungsten.....	2,820	<b>Oxides</b>	
Vanadium.....	2,810	Zirconium <sup>a</sup> ....	2,900
Thorium.....	2,770	Hafnium.....	2,812
Silicon <sup>b</sup> .....	2,700	Thorium.....	2,800
Molybdenum...	2,570	Beryllium <sup>a</sup> ....	2,570
Aluminum.....	2,200	Magnesium <sup>a</sup> ...	2,540
Carbon <sup>b,c</sup> .....	3,500	Aluminum <sup>a</sup> ....	2,050

(a) 500 C capacitors in development (b) Used in resistors (c) Deposited

copper chloride. The chemical removes the oxide and deposits a copper coating. Lead-tin solder strength is improved by adding cerium. Soldering to aluminum is improved by using a zinc solder, alloys of zinc, cadmium and silver, or rubbing warm aluminum with gallium.

**MAGNETIC CORE MATERIALS**—Radiation generally produces significant changes in structure-sensitive properties such as coercive force, permeability and remanence. The effects of temperature and radiation on some core materials are shown in Tables X, XI, XII and XIII and Fig. 12.<sup>14, 15, 16, 17, 18</sup> Extreme changes in Supermalloy may

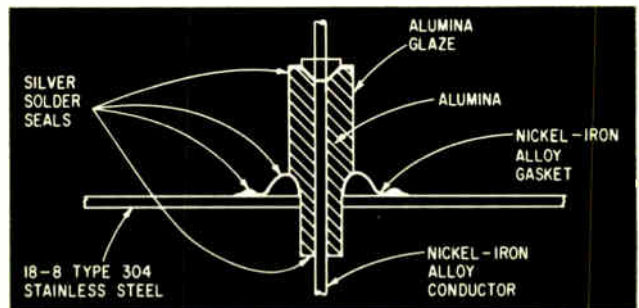

**FIG. 16—Hermetic terminal seal used in 500 C transformer**

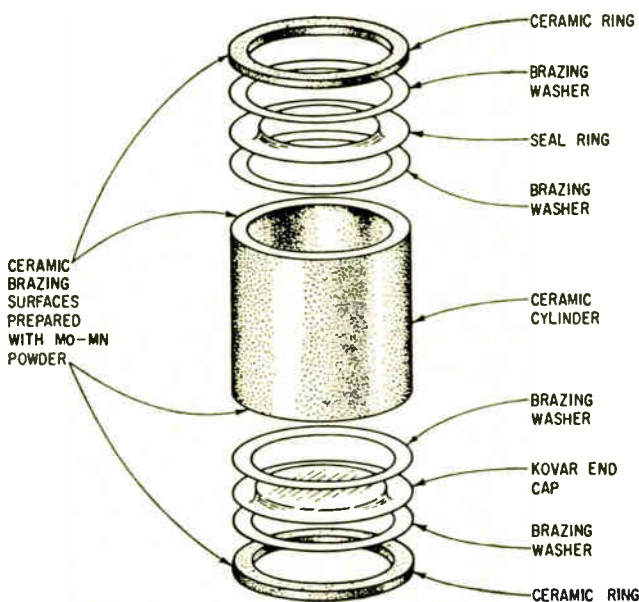

**FIG. 15—Exploded view of a ceramic tube envelope fabricated by the moly-manganese process**

permit its use as a dosimeter. 2 V Permendur contains 49 percent cobalt and becomes highly radioactive. The hysteresis loop of Deltamax changes gradually but squareness ratio is little affected. The loop of 4-79 Permalloy remains square. Carbonyl iron powder cores with glass or plastic binders showed negligible changes in high frequency loss under irradiation. Loss factors at 25 to 50 kc increased over 90 percent in 2-81 Mo Permalloy and Sendust, and 47 percent in nickel ferrite.

**PERMANENT MAGNETS**—High temperatures produce three types of change in permanent magnets: reversible changes which are self-recovering as temperature drops, irreversible changes which are restored by remagnetization and material effects. If remagnetization after high temperature exposure does not restore the original properties, the difference is probably due to changes in the material. Material effects may increase remanence, but irreversible effects always lower remanence. The degree of change is affected by the length-to-diameter ratio, as indicated in Figs. 13<sup>19</sup> and 14.<sup>20</sup> Alnicos V and VI are usable to 550 C. Other high temperature magnets include Remalloy, Indalloy, car-

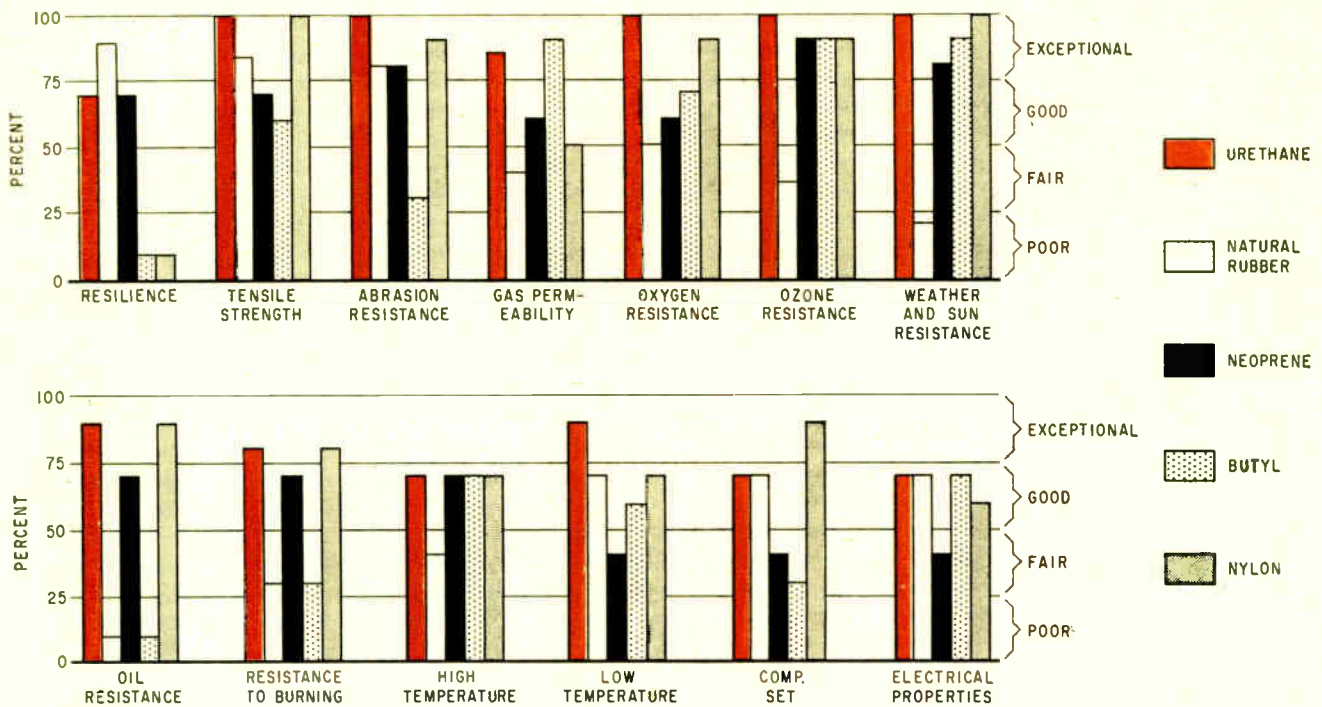

FIG. 17—Properties of some elastomers and nylon under various use conditions

bon or tungsten steel and other Alnicos.

**FERRITES**—Most ferrites are not significantly damaged by irradiation, but a high Curie temperature is desirable to offset gamma radiation heating. If they are used in fairly large magnets, they are susceptible to thermal shock. Expansion coefficients show a sharp peak at or just slightly below their Curie temperature. However, ferrites with Curie temperatures over 500 C, usable around 250 C, are available.

**TRANSDUCER MATERIALS**—Under irradiation, the following effects have been noted in magnetostrictive materials: silicon iron alloys showed no change in anisotropy, but significant changes in saturation magnetostriction; there was no appreciable effect on nickel ferrite. Adding cobalt to nickel ferrites stabilizes temperature drift. Cobalt-substituted nickel-zinc ferrites should be suitable at 250 C. In the metals, nickel is useful over 250 C and 50-50 nickel-iron to 520 C. The temperature resistance of cobalt-irons is still higher, depending on the amount of cobalt contained.

Barium titanate piezoelectric transducers have a low Curie temperature and limited temperature range. Table XIV<sup>21</sup> gives the top Curie temperatures of various materials systems. Among the materials on which details are available are potassium-sodium niobates and lead-titanate-zirconates.

Resistance strain gages made of intermetallic resins processed with rare earths and zirconium tetrachloride are reported to be useful to almost 600 C. The material is used to measure explosive forces and has a high shock rating.

**SEMICONDUCTORS**—Conventional semiconductor devices exposed to radiation are reported to have failure rates up to 50 percent.

Radiation effects are pronounced in crystals functioning by minority carrier action. Tunnel diodes, which depend on majority carrier action showed no effect at fluxes to  $10^{13}$  nvt and are also usable to 315 C. Derating germanium transistor circuits should permit their operation at fluxes of  $10^{16}$  n/cm<sup>2</sup>.

Wide band gap materials which can be operated at high temperatures will likely be radiation-resistant. The heat would cause radiation-produced defects in the crystal structure to be annealed out at or shortly after the time the defects are produced. Gallium arsenide anneals rapidly at about 300 C and 470 C.

Gallium arsenide devices have been operated at 450 C and silicon carbide rectifiers at 650 C. It is hoped that silicon carbide and boron phosphide may provide devices useful to 1,000 C. Low-temperature indium antimonide infrared detectors operating in the photoelectromagnetic (pem) mode are considered radiation-resistant.

Intermetallics are also raising the temperature of solar batteries. Cadmium sulfide has produced electricity to 400 C compared with 260 C for silicon. Higher temperatures mean greater efficiency, according to one report. In space, solar batteries are protected from surface damage by fused silica windows. Solar X-rays have only slight effect and would cause a 25 percent loss in power output over seven years. Thermoelectric elements with a service temperature of 1,500 C are anticipated in the selenides, oxides and sulfides. Indium arsenide phosphide has been found usable at temperatures of 450—800 C.



**CAPACITORS AND RESISTORS**—Inorganic dielectrics have raised capacitors to the 300 C to 500 C range. A stacked mica capacitor in a stainless steel case has been reported at 600 C. High temperature ceramics show promise. These materials are also radiation resistant, but high purity is necessary to avoid semiconductor effects.

Experimental 500 C capacitors have been made of boron nitride, magnesium oxide and aluminum oxides, which yield the desired R-C product of five megohm-microfarads. The oxides withstood nuclear irradiation at 400 C, but boron nitride was converted to boron oxide. Melting points of materials applicable to high temperature resistors or capacitors are given in Table XV.<sup>22</sup>

The ceramics may be applied as slurries on platinum electrodes or chemically formed on metals. Refractory metals can be sputtered on glass or ceramic substrates. Inconel and Hastelloy may also be used as electrodes.

High temperature resistor materials, in addition to carbon and silicon carbide, include antimony alloyed with rhodium or tin, and combinations of noble metals. The metals can be deposited on ceramics or glass, wire-wound or applied as chlorides, nitrides, silicides or oxides. Chrome-silicon films, servicable at 250 C, changed only a few percent on short term exposure at 750 C. Platinum films have a linear temperature coefficient of resistance from 28 to 500 C. Boron carbide thermistor films are stable at 750 C, but crack when cycled between 200 C and 300 C.

**ELECTRON TUBES**—High temperature tubes are needed not only to withstand high ambient temperatures, but also to permit high temperature bakeout and heaterless operation. The hard metal and ceramic structures adopted also make for mechanical ruggedness. A representative construction is shown in Fig. 15.<sup>23</sup> Parts are assembled by metalizing and vacuum brazing. High temperature metallurgical problems were tackled years ago by tube designers and progress has been steady. Stacked construction is also employed for rugged relays.

**SEALS AND ADHESIVES**—High temperature ceramic to metal seals are produced by firing oxides into the ceramic surfaces, then plating and vacuum brazing. Transition materials include copper or nickel plated moly-manganese, copper-titanium, copper-zirconium and nickel-titanium. At temperatures to 500 C, components may be sealed with refractory cements, solder glasses or alloy gaskets (Fig. 16).<sup>24</sup> Lead-copper-titanium and other brazes are satisfactory to about 300 C. Pressurized tubing with soft metal coating provides a reusable 400 C seal. Lower temperature seals include plastic-base adhesives and elastomers. The properties of some elastomers are given in Fig. 17.<sup>25</sup> Phenolic-loaded epoxy can be used to 250 C; epoxy also adheres at cryogenic temperatures.

**Table XVI—Service Temperatures of Some Lubricants**

Lubricant	Temperature (F)
Sodium Greases.....	-45 to 325
Silicone Greases and Oils.....	-100 to 350
High Temperature Oils.....	-40 to 500
Alkyl Silanes.....	to 550
Meta-Polyphenyl Ethers.....	20 to 900
Molybdenum Disulfide—in air....	-100 to 750
—in vacuum	to 2,000
Molybdenum Disulfide-Graphite..	750 F long time 1,200 F short term (24 hr)
Gas.....	over 1,200
Liquid Metals.....	to 1,400

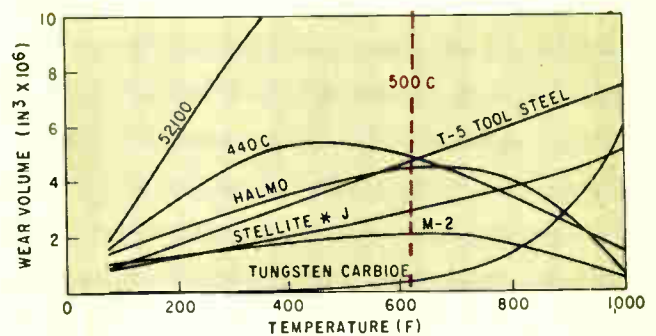

**FIG. 18—Effect of temperature on wear of some materials considered for bearing use**

**BEARINGS AND LUBRICANTS**—Fig. 18 summarizes high-temperature wear of some bearing metals.<sup>26</sup> Iron-base alloys must be protected from oxidation at high temperatures. Austenitic stainless steels, nickel and cobalt alloys and cemented carbides require less protection.

Nominal temperature limits of present and proposed lubricants are given in Table XVI. Organic lubes may break down under irradiation. Molydisulfide is reported to be unaffected by radiation and is used as a lubricant in nuclear power plants. It is inert, can be used as a dry film or added to greases, oils or plastic bushings.

Other materials which show promise at high temperatures include air with additives to prevent corrosion, vapors, alkyl silanes, polyphenyls, organometallics, liquid metals; phosphorous, boron or flourine additives. Lubricating coatings may be formed by chlorides, sulfides or phosphides, or such nonseizing metals as silver, cadmium, indium, tin, antimony, thallium, lead, bismuth and germanium. Meta-polyphenyl ethers, while not suited to low temperatures, are radiation resistant. Gas "bearings" are receiving considerable attention.

# 3. Compatibility of Materials

Here is a system approach to guide you in selection of contacting metals, plating processes, protective coatings and insulating materials

DATA ON THE compatibility of materials at 500 C is limited since relatively few assemblies have been operated at this temperature. Generally, if the material can stand the temperature alone, it can stand it in combination with other materials. Materials which give off corrosive products during a temperature rise are usually degraded themselves.

High temperature materials systems, therefore, are usually inert. When it is necessary to use a material, such as transformer steel, which oxidizes or corrodes at high temperature, it is protected by an inert gas or an inert solid insulation. In some cases, oxides and other films are permissible when these films, such as aluminum oxide, prevent further corrosion.

Of paramount importance is the selection of materials with similar coefficients of expansion. Low expansion materials are desirable and, fortunately, many of the high temperature materials are in this class. Precautions against materials which degrade by decomposing or which change size also apply to assemblies for radiation environments.

**METALS CORROSION**—At all temperatures, corrosion is a major problem associated with commonly-used metals. The main causes and cures for corrosion are given in Table XVII. Table XVIII gives a number of metal combinations to be avoided<sup>27</sup>. Fig. 19 shows the amount of corrosion which other metals produce in aluminum<sup>28</sup>.

Although salt spray is the generally-used metals corrosion test, long-term exposure in an industrial atmosphere is more destructive than salt air (Table XIX).<sup>29</sup> Materials with good corrosion resistance at

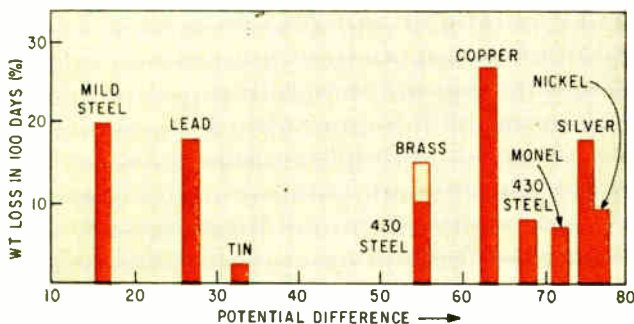

FIG. 19—Corrosion of aluminum alloy (1100) when coupled with other metals

Table XVII—Corrosion Causes and Cures

**Galvanic:** Caused by a difference in potential. Cured by selecting metals with similar potentials, coating the cathodic metal with the anodic metal, breaking the galvanic circuit with an insulating coating or bushing, plating both metals with compatible materials, using a sacrificial anode or a corrosion inhibitor

**Pitting:** Similar to galvanic with variations in the metal causing local differences in potential. Cured by protective coatings or plating

**Stress:** Caused by differences in potential between parts of the crystal lattice. Cured by stress-annealing and stress-free design

**Intergranular:** Caused by grain differences resulting from such joining methods as welding. Cured by using weldable materials or another fastening method

temperatures over 500 C include steel, stainless steels, nickel, Monel, Inconel, Hastelloy and brass (if low strength at 500 C is tolerable).

**PLATINGS AND COATINGS**—The present and anticipated temperature limitations of various finishes are shown in Fig. 20.<sup>2</sup> In addition to standard finishes for light metals the following finishes are reported to be suitable for moderate to high temperature service: magnesium can be plated with aluminum which is then anodized, or plated with copper and tin. Fusing the tin with hot oil pre-

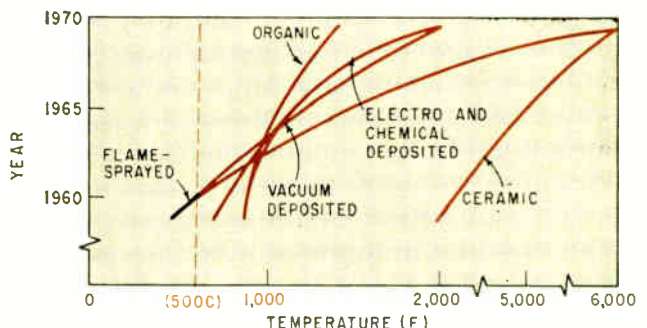

FIG. 20—Temperature limits of protective finishes for metals and anticipated improvements



**Table XVIII—Corrosion of Some Metals**

Metal Considered	Corroded By
1. Noble Metals . . . . .	none
2. Monel, Inconel, Nickel-Moly Alloys	(a) 1, 14, 15
3. Cupronickels, Silver Solder, Aluminum and Tin Bronzes	(a) 2, 11, 12, 14 (b) 1, 11, 14, 15
4. Copper, Brasses, Nickel Silver	(a) 2, 3, 5, 6, 11, 12, 14 (b) 1-3, 5, 6, 11, 12, 14, 15
5. Nickel . . . . .	(a) 2, 11, 12, 14 (b) 1, 11, 12, 14, 15
6. Lead, Tin, Soft Solder	(a) 2-5, 11-14 (b) 2, 3, 4, 7, 9, 11-15
7. Steel . . . . .	(b) 1-6, 11-15 (c) 16
8. Cadmium . . . . .	(a) 7, 16 (b) 1-5, 7, 11-15
9. Zinc . . . . .	(a) 6, 8 (b) 1-5, 7, 11-16
10. Magnesium . . . . .	(a) 8, 9, 16 (b) 4, 6-16 (c) 1, 2, 3, 5
11. Aust 18-8 St St	none
12. 18-2 Cr-Ni St St	(b) 1-4
13. 13 Chrome Stainless	(a) 6 (b) 1-5, 11-15
14. Chromium . . . . .	none
15. Titanium . . . . .	none
16. Aluminum . . . . .	(a) 6, 7, 11-14 (b) 2, 5, 6, 7, 11-15 (c) 1, 3, 4

**Table XIX—Atmospheric Corrosion**

Metal	Industrial % Wt Loss <sup>a</sup>	Atmos- phere Mils/ Year	Salt Air % Wt Loss <sup>b</sup>
Tough Pitch Copper . . . . .	6.1	0.0546	2.4
3 Si, 1 Mn-copper . . . . .	7.4	0.0651	...
Tin Bronze . . . . .	10.6	0.0883	3.2
Aluminum Bronze . . . . .	7.2	0.0644	5.7
Aluminum . . . . .	3.4	0.0289	1.3
Manganese Bronze . . . . .	58.3	0.453	21.9
Brass (15 Zn) . . . . .	8.5	0.0741	2.5
Brass (30 Zn) . . . . .	13.7	0.120	0.9
20 Ni, 5 Zn-copper . . . . .	11.3	0.102	1.0
Cu 32-nickel . . . . .	8.8	0.0756	0.5
Lead . . . . .	1.8	0.0151	...
High Grade Zinc . . . . .	35.3	0.309	8.5
Commercial Tin . . . . .	7.5	0.0659	...
Al-coated Duralumin . . . . .	3.5	0.0293	0.2

(a) Weight loss over approximately 20 years at Altoona, Pa., or New York, N. Y. (b) Approximately 20 years at Key West, Fla., or Sandy Hook, N. J.

(a) Corrosion slightly increased by contact (b) Corrosion significantly increased, especially in salt or polluted air (c) Don't use in presence of moisture

vents deterioration by pitting corrosion.

Whisker formation in waveguide is prevented by gold plating. Silver will also stop whiskers, but may migrate through insulations. Nickel and precious metal platings improve the contact properties of base metals and will stand up in corrosive atmospheres provided platings are carefully chosen and are of optimum thickness.

High temperature insulating coatings are provided copper and aluminum by fluorination. Silicon monoxide is also a good protector. Wear and corrosion resistance is gained by such processes as flame-plating, nitriding, carburizing and chromizing. Flame-sprayed cermets are reported to withstand 500 C temperature. Cermets are formed from mixtures of carbides, borides or silicides with high temperature metals or reducible oxides. Their conductivity is about equal to solder. Alumina can also be flame-sprayed.

Most plastic coatings adhere well to metal and have good weathering properties, salt-spray resistance and electrical properties. Silicone, vinyl, chlorinated rubber, urethane and fluorocarbon coatings have the good heat resistance combined with insulation properties.

Modified epoxy coatings for printed circuits are usable at 350 C for short periods. Flexible formulations are necessary for vibration and shock resistance. Plastic-metal laminates are not suited to high temperature, but the covering has excel-

lent wearability. The metal can be fabricated and welded without damaging the coating.

**PLASTICS**—Within their temperature limitations, the electrical grades of plastics and laminates are not always compatible with other organic materials.

Including modifications of the basic insulating plastics, resins, oils and fillers, there are literally thousands of possible insulating systems. Practical approaches include choosing proven combinations, confining the materials to those with similar bases, or testing new combinations.

Expansion rates and other physical properties of organic insulations can be adjusted with fillers. Fairly wide ranges are possible in epoxies and phenolics. When adjoining materials are stress-sensitive, relief from strains resulting from curing the more rigid encapsulants should be sought. One method is to first coat the part with silica gel or other elastic material.

When the component or system is slated for an industrial application, an insulation with good all-around chemical resistance is desirable. Polyvinyl chloride and its rubber blends, polycarbonate, polyethylene, fluorocarbons, polyester, vinyl, phenolic and some epoxies and alkyds are among the suitable materials. Another routine precaution is to plate all hardware with a corrosion resistant metal.

# 4. Materials Development Needs

What is being done to improve materials for extreme environments? Measures include: seeking high purity in materials, environmental testing of complete systems and uniform standards

FIRST IMPRESSIONS given by the large number of military-sponsored high temperature-nuclear radiation materials studies, contract reports, conference papers and trade publications is that there is an ample choice of materials to satisfy anticipated environmental needs.

The facts are that many of the materials and components are prepared under laboratory conditions. Devices made from the more familiar inorganic dielectrics and tube-type metals are being produced: for example, high temperature tubes, relays, switches, cables, connectors and magnetic metals. Many of the novel materials mentioned in this report are not being produced in sufficient quantities with sufficient purity. This means, for the time being, limited variety in components.

The second major necessity is across-the-board miniaturization. This should work itself out. Some of the production methods associated with refractory materials—sputtering, powder metallurgy, vacuum deposition, chemical conversion, inked and fired circuits—are more suited to miniaturization than conventional production methods.

A third major necessity, perhaps the most im-

portant, is combined environments testing of materials, components and eventually systems. There seems to be little of this in comparison to the standard methods of shuttling materials from one single or double environment to another. A primary problem is the difficulty of doing anything more than radiation testing in a reactor. More convenient types of radiation can be used, but it is difficult to estimate neutron flux resistance on the basis, for example, of gamma radiation resistance.

Superimposed on the combined environment testing needs is the fact that final evaluations of materials cannot be made until the tests also simulate the life of a system through a series of storage and use cycles. This will probably result in a second round of materials research and development programs after the products of the current round are put into use. An ultimate solution may be selecting materials for their known characteristics at specific temperatures above ambient and then holding the system at that temperature. The procedure is followed now, at lower temperatures, for components and circuits which must operate with extreme accuracy.

## REFERENCES

- (1) Advisory Groups on Electronic Parts and Tubes, Environmental Requirements Guide for Electronic Component Parts, OTS, Dept. of Commerce, Wash., 1959.
- (2) 1959 Annual Forecast of Trends and Requirements, Aerospace Industries Association, Los Angeles, 1959.
- (3) J. R. Hendrickson, Sr., Theoretical Considerations in Selecting Shielding Materials for Protection of Electronic Circuits from Nuclear Radiation, *Biennial Elec Mat Symp*, IRE U of P, 1957.
- (4) H. C. Sullivan, et al, Engineering Performance in a Nuclear Environment, *ibid*.
- (5) D. S. Billington and J. H. Crawford, Jr., Effect of Neutron Irradiation on Dielectric Materials, *Sym Conf on Eff of Rad on Die Mat Naval Res Lab*, 1954.
- (6) R. C. Tomashot and D. Harvey, Effects of Nuclear Radiation on the Mechanical Strength of Glass Fiber Reinforced Plastic Laminates, *Proc 12th Ann Mtg*, Reinf Plastics Div., SPI, New York, 1957.
- (7) Data supplied by Emerson and Cuming, Inc., Canton, Mass.
- (8) G. I. Duncan and M. M. Felger, Properties of Electrical Insulation at High Temperature, *Trans AIEE Winter Gen Mtg*, New York, 1958.
- (9) I. J. Grunfest and L. H. Shenker, The Behavior of Reinforced Plastics at Very High Temperatures, *Proc 13th Ann Mtg*, Reinf Plastics Div., SPI, New York, 1958.
- (10) F. Bozzacco and P. Swenson, Radome Materials for Operating Temperatures above 500 F, *ibid*.
- (11) J. R. Lampman and G. F. Damon, Protective Coatings for Electronic Laminates, *Proc 13th Ann Mtg*, Reinf Plastics Div., SPI, New York, 1959.
- (12) M. E. Goldberg, et al, Electronic Component Parts Research for 500 C Operation, WADC T R 57-362, Part I, ASTIA Doc. AD 142350 (See also Part II, WADC 57-362, ASTIA AD 155785).
- (13) Z. A. Post and P. E. Ritt, Conductive Ceramics, *Biennial Electronic Materials Symposium*, IRE, U P, 1957.
- (14) R. S. Sery, et al, Effects of Nuclear Irradiation on Magnetic Materials, *Conf on Magnetism and Mag Mat*, AIEE, 1957; Naval Ordnance Lab Report 4381.
- (15) D. I. Gordon, R. S. Sery, Nuclear Irradiation Effects on Ferromagnetic Core Materials, Resumes Des Communications, *Int Cong Solid State Phys*, Brussels, 1958.
- (16) J. J. Clark and J. F. Fritz, The Effect of Temperature on the Magnetic Properties of Nickel-Iron Alloys, WADC Tech Note 57-434, ASTIA 142267.
- (17) M. Pasnak and R. H. Lundsten, Effects of Extremely High Temperatures on Magnetic Properties of Core Materials, Navord Report 6132, NOL, 1958.
- (18) A. L. Schindler, et al, Effect of Neutron Irradiation on the Magnetic Properties and Degree of Magnetic Metal Alloys, *J Appl Phy, Suppl to Vol. 30, No. 4*, April, 1959, Am Inst of Physics.
- (19) R. K. Tenzer, The Remanence of Alnico V and VI Magnets between Room Temperature and 550 C, WADC T R 59-138.
- (20) R. K. Tenzer, Effects of Temperature Variations on the Remanence of Permanent Magnets, WADC Tech Note 56-276.
- (21) S. F. Pulvari, Ferroelectric Materials Survey with Particular Interest in Their Possible Use at High Temperature, WADC T R 56-467.
- (22) A. J. Zaehring and R. M. Nolan, 1958 Missile Materials Review, *Missiles and Rockets*, p 69, Mar., 1958.
- (23) *Fansteel Metallurgy*, Sept., 1959.
- (24) H. B. Harms and J. C. Fraser, Ultra High Temperature Miniaturized Power Transformers and Inductor Materials, Vol. I, WADC T R 57-492, ASTIA Doc. No. AD 155527.
- (25) R. E. Bolin and R. C. Burck, Properties of Commercial and New Solid Urethane Elastomers, *Sym Sealants and Sealing of Aircraft, Missiles and Elect Comp*, I A S, Los Angeles, 1959.
- (26) K. D. Mackenzie, High Temperature Materials and Lubricants, *Instr Bull Bearing Conf*, New Departure Div. of General Motors, 1958.
- (27) U. R. Evans and V. E. Rance, Corrosion of Dissimilar Metals, *Prod Eng*, p 187, Dec., 1956.
- (28) K. G. Compton and A. Mendizza, Galvanic Couple Corrosion Studies by Means of the Threaded Bolt and Wire Test, *Sym on Atm Corrosion of Non-Ferrous Metals*, ASTM, STP 175, Philadelphia, 1956.
- (29) H. R. Copson, Report of Subcommittee VI, *ibid*.





# PROGRESS IN PLASTICS

## THE TROUBLE WITH PRINTED CIRCUITS— AND HOW CDF WORKS TO SOLVE IT

The honeymoon is long since over; suppliers and manufacturers are engaged now in the humdrum activity of making printed circuits *work*. The industry found in time that there was still a long way to go before the *magic* of printed circuitry was proved incontrovertibly in practice. The truth: Too many mass-produced printed circuits simply were no good. Why?

The trouble was not in the theory. Or in approved manufacturing techniques. It lay—and still lies—in raw materials, primarily in the consistency of quality of base laminates.

We're not here to say that CDF has a totally rosy record in this field. No, we've had our share of failures along with our many triumphs. In fact, our failures during the early years of copper-clad laminates taught us certain important things that our competitors have yet to learn.

But we do emphasize this: We've made—and are still making—great progress at CDF in licking problems that have beset the printed-circuit producer and the printed-circuit user in obtaining top-quality laminates on every order, regardless of grade.

Here, for example, are a few areas where CDF R&D has been particularly active:

**1. Consistent quality.** A major cause for printed-circuit rejects has been delamination and blistering of the base laminates when subjected to high temperatures in processing. New developments in CDF raw-materials control promise a heartening break-through in this respect. Also, CDF technical personnel are engaged in counseling circuit manufacturers in optimum handling and processing techniques.

**2. Foil-bond strength.** Certain metal-clad laminates seem to pass the most rigid laboratory tests, only to fail at the end of manufacture when dipped in solder or when put through long-term operational tests at elevated temperatures. The foil-bonding strength of CDF Di-Clad® laminates, however, is recognized throughout the industry as superior in every grade.

Nevertheless, improvements are being made daily in foil adhesives and bonding methods at CDF, and bond strengths are being increased—not only in number of pounds required for foil separation, but in length of safe solder-immersion and high-temperature operation time.

**3. Range of selection.** CDF has consistently offered the widest range of metal-clad grades—in phenolic and epoxy paper-base, epoxy-glass, and Teflon\*-glass. And CDF Di-Clad Teflon-glass grades remain the only laminates of their kind approved by the military. CDF Technical Bulletin 11,900 gives the latest information on all Di-Clad printed-circuit grades.

\* du Pont's TFE fluorocarbon resin

**4. Flexible grades.** Newly-perfected *flexible* grades of CDF Di-Clad promise

the designer even greater freedom. One of the headaches in the use of printed circuits has been their rigidity. They tend to hamper independent movement and vibration of connected systems. They occasionally dictate inconvenient housing shapes. Flexible printed circuits, however, overcome these objections and provide many additional benefits of their own. Details on how CDF flexible Di-Clad materials can help see you out of a printed-circuit problem can be obtained from your CDF sales engineer. Look up his phone number in the Product Design File (Sweet's), Electronics Buyers' Guide, or your own CDF catalog. Or send us your print or your problem, and we'll return recommendations based on your individual needs.

### NEW CDF LITERATURE

Information on new grades, special applications, and outstanding properties of CDF insulating materials is made available regularly through CDF Technical Bulletins and Folders. The following literature is new. For copies of any bulletins listed, send the coupon below.

- CDF Di-Clad Laminates— Bulletin 11,900
- CDF Skived Tapes of Teflon— Bulletin 97
- CDF Pressure-Sensitive Tapes of Teflon— Bulletin 102
- CDF Grades Meeting NEMA, ASTM, Federal, and Military Specifications— Bulletin 10,100
- CDF Dilecto® Paper-Base Laminates— Bulletin 11,110
- CDF Dilecto Epoxy Laminates— Bulletin 11,200
- CDF Spiral Tubing— Bulletin 14,000

**CONTINENTAL-DIAMOND FIBRE  
NEWARK 16, DELAWARE**

Please send me the following CDF literature:

\_\_\_\_\_

\_\_\_\_\_

\_\_\_\_\_

\_\_\_\_\_

Name \_\_\_\_\_ Title \_\_\_\_\_

Company \_\_\_\_\_

Street Address \_\_\_\_\_

City \_\_\_\_\_ Zone \_\_\_\_\_ State \_\_\_\_\_



**CONTINENTAL-DIAMOND FIBRE**

A SUBSIDIARY OF THE *Buditt* COMPANY • NEWARK 16, DEL.  
In Canada: 46 Hollinger Road, Toronto 16, Ontario

# An Advertising Manager Asks Some Questions About *Fansteel Developments*

... and uncovers additional facts about new developments of interest to engineers concerned with product reliability. Joseph V. Di Masi, Fansteel Advertising Manager, turned reporter and here's what he found out from his company's Rectifier-Capacitor Division.



*Glen Ramsey, Vice President Fansteel Metallurgical Corporation and General Manager of the Rectifier-Capacitor Division*

## What about our new silicon controlled rectifier?

I'll tell you this... it's going to embody a brand new concept in rectifier encapsulation. It will be something different—something better than any controlled rectifier the industry has ever seen. Research and development is completed... laboratory and field testing is over, and we now know that this rectifier will perform even better than expected... and full production will be under way early in 1960.

## What do you feel was the most important Fansteel development in 1959?

The GOLD-CAP Tantalum Capacitor, beyond a doubt! Certified pre-testing of every single GOLD-CAP is a new concept that has set a pattern in the industry and has satisfied the increasing reliability demands of both military and civilian applications. But it's only one step in our program to achieve the ultimate in reliability for all Fansteel products.

## What are the reports from the field on our GOLD-CAP?

All good! I think we've proved that engineers require the kind of reliability we're offering in the GOLD-CAP Capacitor for two good reasons. They want to be *sure* of getting 100 good, reliable capacitors out of every 100 they buy—we furnish complete test results and, doubly important, they urgently need a product like the GOLD-CAP as a basis to achieve the overall reliability they're trying to build into their products.



*Paul Weirich  
Assistant General Manager*



X599



# That Made News In 1959



Howard Brauer  
Manager, Quality Control

Paul Weirich

Glen Ramsey

James H. Hall  
Staff Engineer

## When will our new silicon rectifier plant be in production?

By next month, the new plant will be supplementing our current silicon rectifier output by an additional 60,000 units per day. This will include our complete line of new industrial power rectifiers and the brand new silicon controlled rectifiers. The new facilities will also be used for producing our automotive silicon rectifier which, as you know, was featured in the November 15th issue of *AUTOMOTIVE INDUSTRIES* and the August issue of *INDUSTRIAL LABORATORIES* among other publications.

## Are we expanding to keep up with solid tantalum capacitor demands?

Yes, we have recently completed the second phase of our S-T-A expansion program and the third phase is well under way. We are now able to deliver normal requirements from stock. Our current expansion program anticipates production requirements in 1960 approaching existing wet capacitor production. I might also mention in connection with our S-T-A, that we are actively participating in the micro-modular program.

## What steps were taken to further improve product reliability?

Enlargement, consolidation and, in general, improvement of our quality control program was the latest move—another complete step in our long-range reliability plan. You know, quality control doesn't just *meet* reliability requirements... it *leads*.

We believe that the only purpose of quality control is to assure the reliability that is engineered and designed into the product. Following this belief has always kept us years ahead of industry's reliability needs—and we intend keeping that lead.

FANSTEEL METALLURGICAL CORPORATION  
NORTH CHICAGO, ILLINOIS, U. S. A.



# in SILICON transistors

## ...the "HOT" Line is

# PHILCO



*...for all High Temperature Commercial and Military Applications*

### ... High Speed Switches

Philco's full range of silicon high speed switching transistors, in both PNP and NPN types, provides the designer with a wide choice to meet the requirements of all high temperature applications. They are engineered and specified to permit simple, straightforward design of practical circuits up to 5 mc pulse rates, using saturated configurations and up to 30 mc pulse rates with non-saturating techniques. Packaged in TO-1, TO-5 and TO-9 cases.

**PNP** 2N496  
2N1119  
2N1429

**NPN** 2N1199

### ... High Frequency Amplifiers

Philco amplifying transistors are available in nine types, covering the complete high frequency range. The designer will find both PNP and NPN types that permit the design of communications systems at frequencies up to 60 mc. They have low collector capacitance and are available with restricted beta ranges to simplify design problems. All offer excellent performance at junction temperatures up to  $+140^{\circ}\text{C}$ . Packaged in TO-1, TO-5 and TO-9 cases.

**PNP** 2N495  
2N1118  
2N1428

**NPN** 2N1267 2N1270  
2N1268 2N1271  
2N1269 2N1272

*All types environmentally tested in accordance with MIL-T-19500A . . . and have been thoroughly field-proven in countless critical military and industrial applications. For complete data and application information, write Dept. E-1259*

All Types Immediately Available  
in Production Quantities . . . and  
1-99 from your local Philco In-  
dustrial Semiconductor Distributor

# PHILCO®

LANSDALE DIVISION • LANSDALE, PENNSYLVANIA

World Radio History

CIRCLE 100 ON READER SERVICE CARD





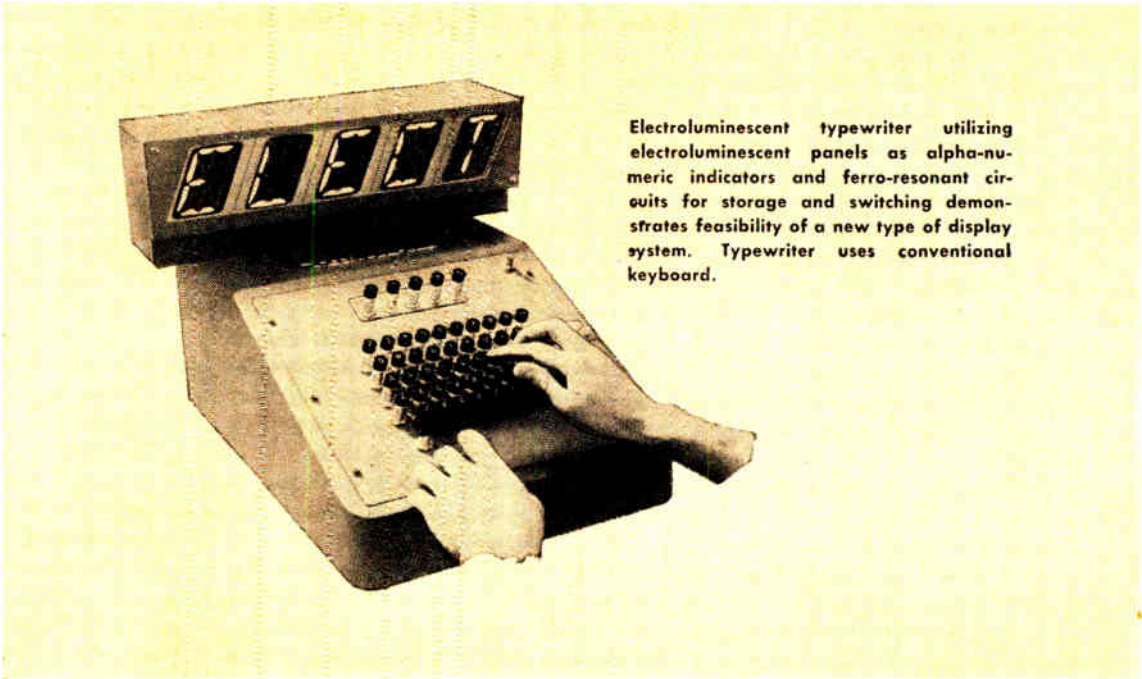

Electroluminescent typewriter utilizing electroluminescent panels as alpha-numeric indicators and ferro-resonant circuits for storage and switching demonstrates feasibility of a new type of display system. Typewriter uses conventional keyboard.

## New Developments Revealed at NEC

Subjects of a selection of papers presented at the 1959 National Electronics Conference show a cross-section of electronic devices ranging from microcircuits to airborne data acquisition systems. Interest in transistorized circuits remains high as manufacturers continue to reduce size and power consumption

By **LESLIE SOLOMON** and **M. M. PERUGINI**, Associate Editors

SEVERAL NEW and interesting circuits were shown at the NEC in October. The emphasis at this conference was on systems rather than components (see *ELECTRONICS*, p 51, Oct. 16).

Among the systems shown were an electroluminescent typewriter, ultrasensitive thermistor bridge, magnetic-amplifier controlled d-c power regulator, electronic switchboard and high-speed encoder. The

state-of-the-art and future developments in microcircuits and airborne data acquisition systems were also discussed.

**MICROCIRCUITS IN THE FUTURE** — Solid-state devices are assuming the configuration of functional electronic blocks.<sup>1</sup> Designers insist that miniaturization must not be achieved at the expense of

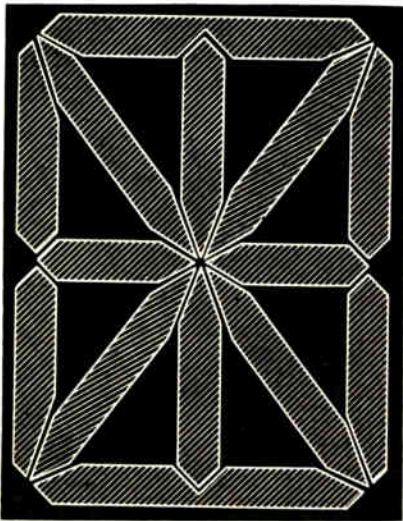

FIG. 1—Exciting combinations of segments can create numbers or letters

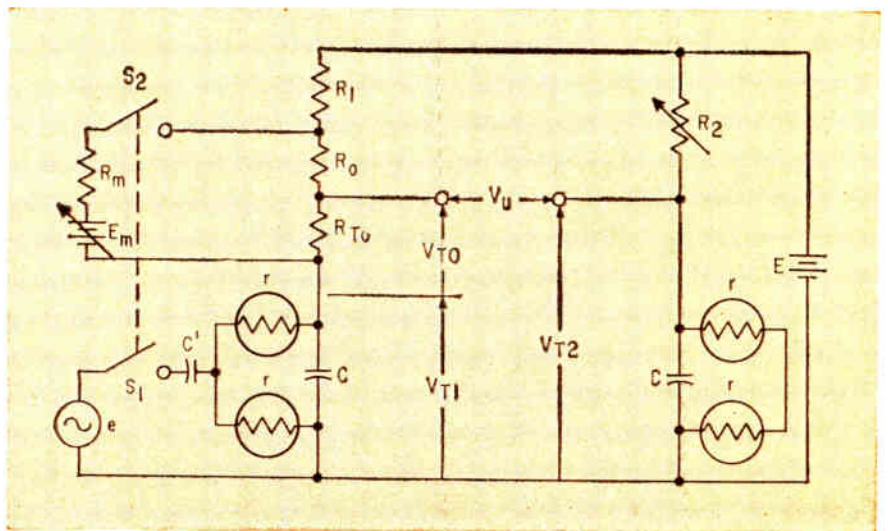

FIG. 2—Sensitive thermistor bridge uses temperature-compensated balanced design. Use of identical thermistor units increases sensitivity

reliability and performance. Towards this goal, several approaches have been tried. Individual components made in a uniform square format with dimensions  $0.3 \times 0.3$  in. will facilitate assembly by automatic machinery and as the art progresses, multiple components and single circuits would be incorporated on each wafer and assembled into the micromodule block. The major problem in this area is the physical size and reliability of the interconnections.

A new interconnection technique called weld-pack (ELECTRONICS, Oct. 9, 1959) joins the components by resistance welding using nickel ribbon as required. A factor of ten increase in packing density is claimed when compared with conventional printed circuit wiring. In the weld-pack development, a computer determines the optimum layout of components and interconnections and prints a physical layout of the equipment.

One approach to placing multiple components on a single substrate is the deposition and insertion of components, devices and connections into a single substrate. One example of this construction uses a steatite ceramic as a base on which resistors and connecting wiring are silk screened. The capacitors are inserted into recesses and diffused germanium transistors and diodes are fabricated and connected to the circuit using photo-lithographic techniques.

Other manufacturers are using the evaporation of resistive materials into a dielectric substrate such as barium titanate, while others are using silk screen techniques on dielectric plates.

Another step to integrated circuits is using the same material to perform more than one component type function. An early English approach was to use an insulating panel grooved for the conductive paths. The grooving may also constitute the inductance and some capacitance. This method did not produce a high degree of miniaturization.

A recent technique produces resistors, capacitors

and interconnections with a single layer of tantalum. In this method a photoengraved undercoat of copper is sputtered with tantalum film to produce the desired pattern. Fine resolution (one mil lines and spacings) have been produced.

One company has produced solid circuits with all components produced within a single crystal of semiconductor material using diffusion techniques with a photolithographic process.

In the field of special-purpose devices, the dual-hook collector transistor, which can perform complex logical operations for full binary addition, has been developed. In this transistor, the *npnp* layer configuration has been utilized to design a stepping transistor element. These devices can be fabricated and interconnected on one piece of silicon to produce counting and decoding circuits. Other devices have been developed using the field effect, impact ionization at low temperatures, evaporated magnetic films and evaporated semiconductors.

**ELECTROLUMINESCENT TYPEWRITER** — The Westinghouse Electric Corporation has developed an electroluminescent typewriter<sup>2</sup> to demonstrate the feasibility of a new type of display system. This system utilizes electroluminescent alpha-numeric indicators and ferro-resonant storage and switching. The electroluminescent typewriter consists of a conventional typewriter keyboard upon which information is entered and then displayed sequentially on five alpha-numeric indicators. After the information has been written, the five characters may be selectively or totally erased. It is possible to write letters, numbers or symbols on any chosen indicator.

Electroluminescence produces light by exciting phosphors with an electric field, produced in conventional cells, by an alternating voltage. The phosphors are embodied in a dielectric medium which is sandwiched between two conducting electrodes and the entire structure is then encapsulated in epoxy



resin for moisture proofing.

By segmenting the panels as shown in Fig. 1, and exciting them in certain sequences, various combinations of numbers, letters or symbols may be produced. The light output cannot fail suddenly as an incandescent lamp often does, but failure is indicated as the segment slowly diminishes in light output. The light output is sufficient for the display to be read at ambient lighting. The color of the light is a function of the phosphor used and the frequency of the excitation voltage.

#### ULTRASENSITIVE THERMISTOR BRIDGE —

Thermistor bridge techniques find wide use in the measurement of low-level r-f power (0-10 mw) from audio through microwave frequencies. The Illinois Institute of Technology has developed an ultrasensitive d-c operated, temperature-compensated balanced thermistor bridge. The bridge is maintained at balance in the presence of r-f power by removing from the thermistor an equal and easily measured amount of d-c power. The r-f and d-c calibrating signals are applied simultaneously in pulses to diminish the effect of d-c drift in the bridge output. The thermistor response to pulsed energy is analyzed on the basis of thermal equilibrium considerations.

The sensitivity of a thermistor bridge is limited by the temperature sensitivity of the thermistors used. Fluctuations and drift in both the ambient temperature and bridge driving voltage cause variations of the thermistor resistance that are reflected in the bridge output voltage. However, if two identical thermistor units biased at the same resistance are employed, one for sensing the r-f signal and the other for compensation, then the undesired output signals are minimized thus increasing the sensitivity of the bridge.

As shown in Fig. 2 the circuit has two pairs of thermistors  $r$  and two capacitors  $C$ . Capacitor  $C$  acts as an r-f short to keep r-f current out of the bridge and the two thermistors in parallel are presented to the r-f generator  $e$  while two series thermistors are presented to the d-c bridge. Capacitor  $C'$  is used as an r-f short to isolate d-c from the r-f system.

Each of the sensing thermistors is biased at a resistance  $r = R_T$  where  $R_T$  is twice the characteristic impedance of the r-f system thus terminating the r-f system in a matched load. The two thermistor mounts are placed alongside each other in a cork-insulated heat-reflecting metal box so as to be exposed to similar thermal environment and also to protect the thermistors from ambient temperature fluctuations.

By using a stable driving voltage source, temperature insensitive resistors and good solder connections, the major source of bridge instability will be minimized.

During operation, the sensing thermistors are biased by a switch which alternately inserts the thermistors and a standard 200-ohm resistor (not shown in Fig. 2). The supply voltage  $E$  is adjusted until the same bridge output is observed regardless

of whether the standard resistor or sensing thermistors are in the bridge. The bridge is then balanced by adjustment of  $R_2$  which is variable but nominally the same value as  $R_1$ .

When an r-f signal  $e$  is applied to the sensing thermistors, the thermistor resistance changes and the bridge output meter will show a deflection. Voltage  $E_m$  is then increased from zero until the output meter returns to its initial position. The effect of increasing  $E_m$  is to reduce the d-c until the removed d-c thermistor power is equal to the applied r-f power, and the series thermistor resistance comes back to its initial value provided  $R_{T1}/R_0 = 2R_T/R_1$ .

**PULSING**—Despite use of compensating thermistors, the bridge output may still drift from balance due to drift during the rebalancing interval and deflections due to  $E_m$  and its associated resistors. When the r-f and d-c signals are alternately applied and removed, the observed pulsations of the output indicator will decrease towards zero as adjustments are made. With this technique, the bridge need not be at perfect null initially since the required rebalance is indicated when the output pulsations cease regardless of the voltage level about which they occur.

**MAGNETIC CONTROLS**—A system using sensitive magnetic amplifiers has been devised to replace voltage-sensitive relays as the basic element in a d-c bus voltage regulator. The use of magnetic amplifiers facilitates changes in bus voltage settings,

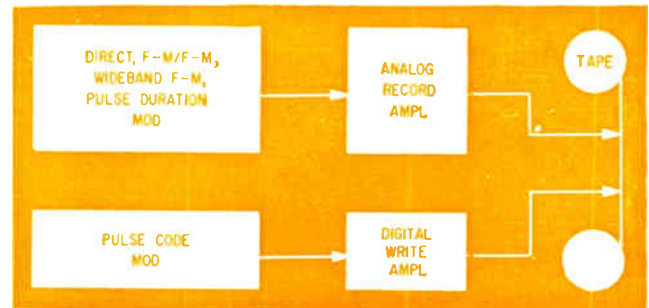

FIG. 3—Combination recording simplifies data editing

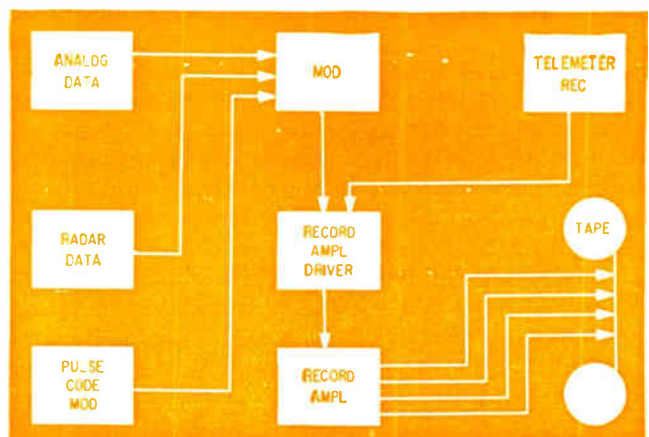

FIG. 4—Wideband recording increases flexibility of data acquisition systems

eliminates the need for recalibration, reduces maintenance and improves the ruggedness of the basic sensing device. Regulation of bus voltages up to 700 v has been successful with this approach. This magnetic regulator scheme is similar to that which uses voltage sensitive relays as the detection element but the use of magnetic amplifiers permits the voltage limits to be set by positioning control panel rheostats.

**AIRBORNE DATA ACQUISITION**—Magnetic recording has become a major tool in airborne data acquisition.<sup>5</sup> Conventional fixed-head recorders can record from d-c to 250 kc while recorders using rotating heads have recorded as high as 7½ mc. In addition, the time relation between events can be preserved precisely on magnetic tape. Recent advances in system components and new techniques have made combinations and wideband recording practical.

**COMBINATION RECORDING** — Improvements in recording heads and tape guidance make it possible to record 32 tracks across an inch of tape. The increase in area utilization is accomplished without

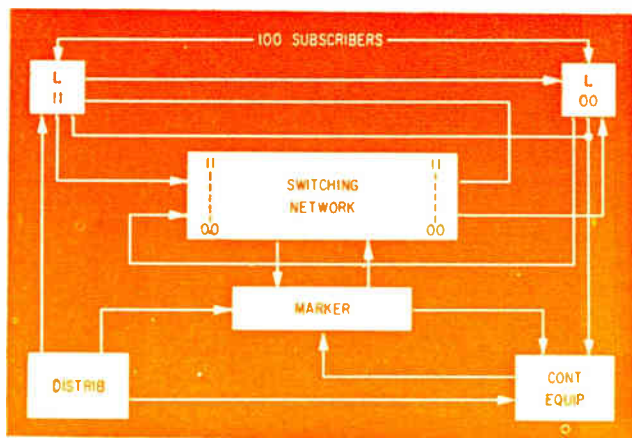

FIG. 5—Electronic switchboard uses marker to find free route between called and calling parties

sacrificing performance while reducing effects of tape skew.

Another practical advantage of better area utilization is that it allows combination recording of analog and digital data, Fig. 3. Sixteen tracks of digital information and seven of analog information can be recorded on 1-in. tape. The technique of recording digital and analog data simultaneously is used to obtain data on aircraft and missile tests.

As combination recording requires only one transport the size, cost and complexity of the acquisition system are reduced considerably. Data editing is simplified because all data for a test are located on one tape in the same time sequence and location.

**WIDEBAND RECORDING**—A significant advance in airborne data acquisition is an instrumentation

wideband recorder now under development. The recorder is based on the rotating magnetic head principles originally used in television recorders. Because of the 4-mc response of this two-track recorder, the data acquisition capabilities of magnetic recording will be increased.

The most promising future for telemetry recording seems to be in the use of wideband and pre-detection recording techniques. This concept, outlined in Fig. 4, uses the wideband recorder's ability to record the i-f output of a telemetry receiver. An increase in signal-to-noise ratio is achieved by compensating for signal fading or excessive noise after the raw data are captured on the tape. Later, the tape can be reproduced and the recorded data discriminated or demodulated in an optimum manner.

Since data recorded prior to demodulation or discrimination may be thought of as intelligence within a bandwidth, the wideband recorder will permit direct recording regardless of the modulation scheme employed. This ability to record any and all types of modulation data becomes important as the bulk of weapons testing shifts from aircraft to missiles to space vehicles.

**ELECTRONIC SWITCHBOARD**—The use of *pnpn* silicon diodes make it possible to eliminate electro-mechanical switching in automatic telephone exchanges.<sup>6</sup> These diodes, which act as nearly ideal switches, are used in the four-stage switching network of the fully electronic private exchange shown in Fig. 5. Centralized control equipment in this experimental 100-line crosspoint switching is time-logic circuits.

**SYSTEM DESCRIPTION** — Each subscriber's line terminates in its corresponding line equipment, *L*, and is transformed from a two-wire line into a single wire connection to both sides of the switching network. Audio-frequency connections between subscribers are made and ended by the switching network under the control of the marker.

The marker, composed of registers and associated logic circuits, receives connect commands from the control equipment. Connect commands are accompanied by the addresses of both calling and called parties. The time required for a connect operation is 32 millisecc; for disconnect, 16 millisecc.

Since all connect and disconnect operations involve the marker, connections are established and terminated on a one-at-a-time basis. This does not introduce appreciable delays. Even if all 100 subscribers finished dialing at the same moment, the marker would accommodate all subscribers within 2.4 sec.

**CONTROL EQUIPMENT**—The control equipment collects, stores and modifies the information used by the marker. It contains a ferrite core memory of 100 words (one per subscriber), a register and logic circuits.

The information in the 100 words, each containing 16 bits, makes it possible for the marker to se-



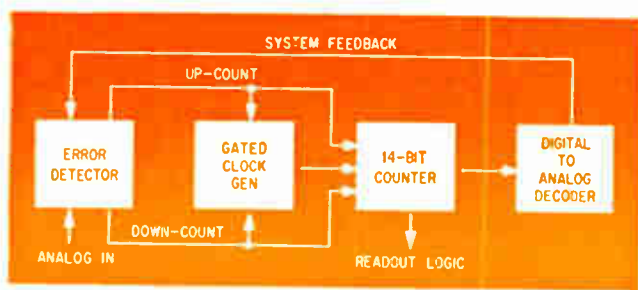

FIG. 6—Simplified diagram illustrates feedback nature of encoder

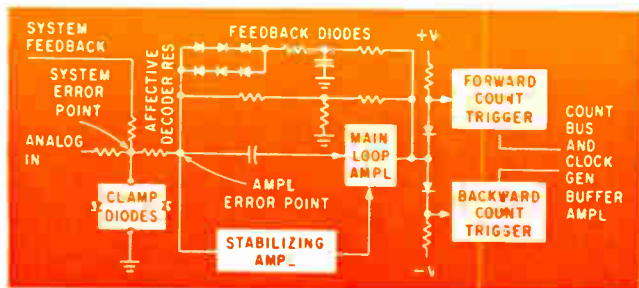

FIG. 7—Noise levels at outputs of error detector are less than 100 mv peak-to-peak

lect a free route between called and calling parties.

Words in the ferrite core memory are modified either by new information generated by the subscriber or by commands from the marker.

To provide a time-sharing control method, the distributor generates 100 sequential timing pulses, each 160 microsec long and recurring every 16 millise. These pulses divide the system time base into 100 time slots of 160 microsec each, each slot being associated with one subscriber.

Since the ferrite memory of the control equipment contains a storage location for every subscriber, a subscriber can start dialing as soon as he lifts the handset. Because of this, no dial tone is needed.

The ringing and ringback signal is transmitted through the crosspoint switching network to both called and calling subscribers. To amplify this signal, each telephone contains a transistor amplifier that is on only when the telephone handset is on the hook. Thus, the ringing signal is amplified in the called party's handset and fed into the receiver capsule to produce an audible tone.

**HIGH-SPEED ENCODER**—A new analog-to-digital encoder provides continuous conversion of analog voltages at a rate of one bit per 4 microsec.<sup>7</sup> This corresponds to an input rate of 2,500 v per sec. Resolution of this transistorized, servo-type encoder is one part in 2,000 and conversion accuracy is  $\pm 0.10$  percent,  $\pm 1$  bit. When used as a static encoder, conversion time is less than 16 millise. This time can be reduced by one or two orders of magnitude with little added complexity and with no loss of accuracy.

Figure 6 is a simplified block diagram of the encoder. An error signal flowing into the error

detector starts conversion. If this signal is greater than the error detector threshold level, the detector energizes the clock generator and the appropriate count bus. Clock pulses are impressed upon the counter and, depending upon the error signal polarity, are either added to or subtracted from the number in the counter.

Since the counter flip-flop drive the decoder switches, the system feedback current is corrected at the rate of one bit per clock pulse. Correction continues until the error current is below the system threshold. When this occurs, the count bus is de-energized and the clock pulses are inhibited; stopping the counter.

The error signal is the difference between the analog input and the decoder feedback currents. The analog input voltage varies from d-c to several kilocycles. This voltage may be applied suddenly, as in a static converter application, causing full-scale step errors. System feedback currents are essentially staircase functions with step frequencies as high as 250 kc and contain switching spikes of random amplitude. These spikes are as high as one-half full scale and may persist for as long as 3 microsec. They are responsible for the major delay in the loop response.

**ERROR DETECTOR**—The error detector, shown functionally in Fig. 7, consists of a wide band, chopper-stabilized, d-c amplifier with complementary Schmitt trigger outputs. The main loop amplifier contains direct coupled circuits, capacitively coupled to the error point. The stabilizing amplifier coupled to the main loop amplifier corrects for drift in the loop.

The overall amplifier loop is closed through a non-linear feedback network designed to reduce the effect of saturation and to permit rapid recovery from system overloads. Separating the amplifier and system error points and clamping the system error point with diodes gives additional overload protection. These circuits enable the amplifier to respond properly to full scale transient errors.

Gain-frequency characteristics of the main loop and stabilizing amplifiers are shaped to provide a closed-loop gain of 52 db, flat from d-c to 1-mc. To prevent loading the amplifier and thereby reducing loop gain, the Schmitt triggers are coupled to the amplifier output by AND gates.

#### REFERENCES

- The following papers were all delivered at the 1959 NEC:
- (1) W. A. Adcock, Texas Instruments Inc., Dallas, Texas, A Survey of the Future of Microcircuitry.
  - (2) T. Hamburger, Westinghouse Electric Corp., Baltimore, Md., Electroluminescent Typewriter.
  - (3) L. J. Greenstein, R. B. Schulz, M. Epstein and D. Fryberger, Armour Research, Illinois Inst. of Technology, Chicago, Illinois, Technical Considerations for an Ultra-Sensitive Bridge to Measure RF Power and Voltage.
  - (4) P. W. Covert, Magnetics Inc., Butler, Pa., and M. Kramer, Aluminum Co. of America, Cleveland, Ohio, Precise Control of High-Voltage D-C Using Magnetic Controls.
  - (5) M. E. Harrison and E. P. Brandeis, Ampex Corp., Redwood City, Calif., Some New Techniques in Airborne Data Acquisition (similar paper presented at 1959 Wescon).
  - (6) J. G. Van Bossse, General Telephone Laboratories, Inc., Northlake, Ill., A Fully Electronic Private Automatic Telephone Switchboard.
  - (7) H. F. Lewis, J. J. Mielke and R. C. Platzek, Autonetics, Div. of North American Aviation, Inc., Downey, Calif., A High Speed, Electronic, Analog-To-Digital Encoder.

# TWT's and Paramaps for

Recently developed techniques indicate that there is no theoretical limit to the noise reduction that can be achieved with traveling-wave tubes. Comparison of twt's and parametric amplifiers leads to some interesting predictions

By D. A. WATKINS and G. WADE, Stanford University, Stanford, California

**D**ETECTION OF extremely weak signals has been of great interest from the inception of radio and microwave engineering. But now, as developments are realized in other fields, the necessity of achieving better sensitivity such as is offered by traveling-wave tubes and parametric amplifiers becomes more apparent.

For example, the job of early warning radars is to detect at distances up to several thousand miles the presence, direction of travel and speed of a ballistic missile. Although these radars are capable of megawatt peaks of transmitted signal, the power in the returning echo may be only a few millimicrowatts. Receivers with low noise characteristics are needed.

## Satellite Repeaters

Artificial earth satellites have opened the way for alternatives to cable transmission and tropospheric scatter for transoceanic communication. It is now possible to put into

orbit a satellite capable of serving as an orbital radio repeater. Such a repeater could be either passive or active.

A simple passive repeater already proposed<sup>1</sup> would consist of a metalized 100-foot diameter plastic sphere (Fig. 1). One such sphere in a polar orbit at a height of 3,000 miles would be visible to both sides of the Atlantic for more than one-fifth of the time. Several such spheres properly spaced could constitute a full-time relay system.

Orbital repeaters of the active type have also been proposed<sup>1</sup> involving fixed satellites (that is, satellites in the equatorial plane with 24 hour orbits) carrying microwave repeater equipment. Orbital heights of about 22,000 miles would be necessary. Because of present limitations on the amounts of power that can be transmitted, receivers in both the passive and active systems would require extremely low noise figures.

Since the discovery a quarter of

a century ago of atmospheric noise coming from outer space, the findings of radio astronomy have played an important part in shaping our concepts of the universe. For example, radio astronomy has been largely responsible for mapping the Milky Way and showing that the solar system is positioned along the inner edge of one spiral arm of a tightly wound spiral galaxy.

Radio observations are being made in a variety of different ways in search for information concerning a variety of phenomena. For example, detection can involve a single radio spectral line or it can involve the total radiation flux from an extremely broadband source. For this latter case, which constitutes the bulk of the work, minimum detectable signal is directly proportional to the noise figure minus one and inversely proportional to the square root of the bandwidth of the receiving equipment. Hence, in this application, both low noise and wide bandwidth are necessary.

## Low Noise Amplifiers

Two types of amplifiers, the traveling-wave tube and the parametric amplifier, are finding wide use where low noise is a requirement.

In comparing these two types of amplifiers it is advisable to exercise some caution. Effective use of any type of amplifier requires not only an understanding of its capabilities in terms of the usually measured characteristics, but also an understanding of its physical operation. For example, because the parametric amplifier is a negative resistance device and because it generates an auxiliary signal (called the idler signal), its noise behavior is markedly different from that of the traveling-wave tube. A simple

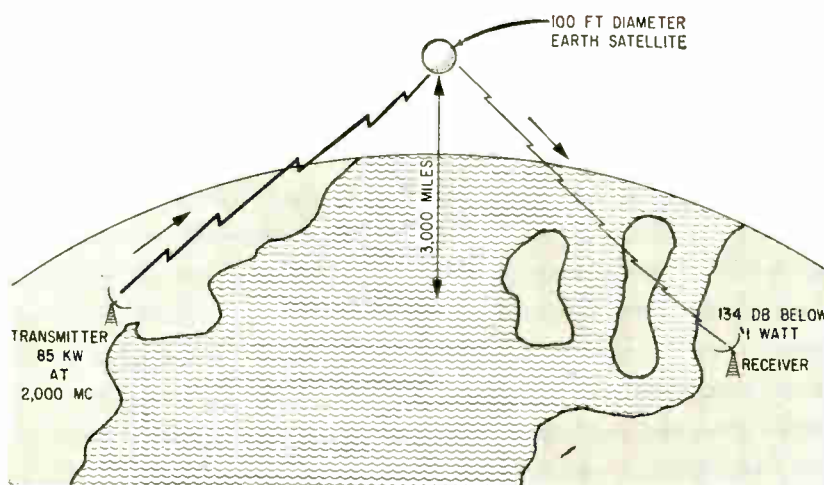

FIG. 1—Large reflecting spheres circling the earth at properly spaced intervals can function as passive links in a transoceanic communication system, provided receiving equipment is sufficiently sensitive



# Low-Noise Reception

examination of measured noise figure data does not tell the whole story, and in fact can be quite misleading.

This discussion is limited to single-channel operation in unrefrigerated parametric amplifiers, where the operation is similar to that of traveling-wave tubes. Parametric amplifiers operating in the degenerate mode are not considered.

## Traveling-Wave Tube

Important new techniques have been discovered recently for reducing noise in traveling-wave tubes. At one time it was widely believed on the basis of theoretical calculations that the minimum possible noise figure for any type of microwave tube was about 6 db. At the present time noise figures lower than 3 db have been measured at S-band on a backward-wave amplifier, a particular form of traveling-wave tube. Present theory indicates that there is no limit to the amount of noise reduction which can be achieved with backward-wave amplifier tubes.

In its simplest form the traveling-wave tube consists of a pencil-shaped electron beam traveling near a slow-wave structure, usually a helix. The beam velocity is nearly equal to the velocity of propagation of an electromagnetic wave on the helix. Amplification comes about through a continuous interaction between the electrons of the beam and the traveling electromagnetic wave on the slow-wave structure.

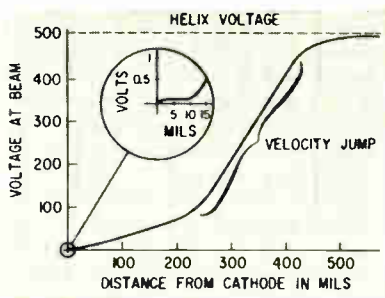

FIG. 2—Typical beam potential profile for new noise reduction technique in twt's shows the extended low velocity region where beam voltage is low

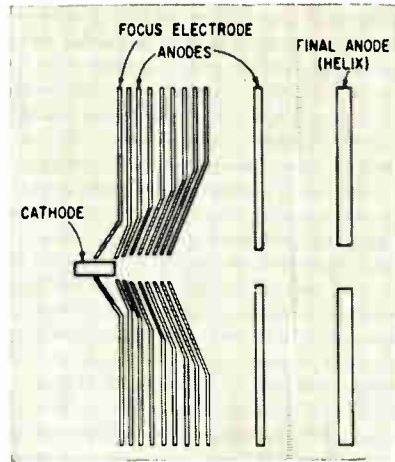

FIG. 3—Stacked array of anodes produces low velocity potential profile for noise reduction

Electrons on the average are slowed down by this interaction. The amount of energy extracted from the beam for amplifying the signal is equal to the difference between the kinetic energy of the electrons at the beginning of the slow-wave structure and that at the end. The interaction with each electron extends over the entire length of the helix and therefore lasts for a relatively long period of time. This fact makes possible high amplification with nonresonant structures of relatively low impedance. As a consequence of the nonresonant structure, it is possible to obtain extremely wide bandwidth in a traveling-wave tube.

## TWT Noise

Main source of noise in a traveling-wave tube is shot noise from the electron beam. Assume that the beam is suddenly accelerated to a velocity as high as or higher than that corresponding to a few volts immediately after the beam emerges from the cathode. Theory shows that under these conditions there is a limit to the amount of shot noise reduction.

No practical noise reduction technique or combination of techniques is capable of reducing the noise figure to below about 6 db if the beam voltage always remains above a few volts. This fact gave rise in the past

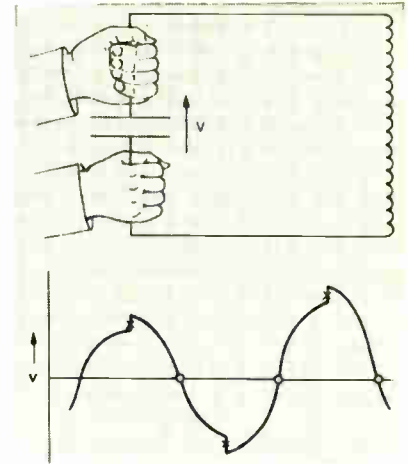

FIG. 4—This simple resonant circuit and pump illustrate the mechanism for energy transfer in parametric excitation

to the erroneous belief that the minimum possible noise figure under any condition was about 6 db.

## TWT Noise Reduction

A new technique for noise reduction, which was discovered by researchers at Stanford University<sup>2</sup> and Hughes Aircraft Company<sup>3</sup>, involves an operation on the beam in the vicinity of the cathode or where the thermal velocity spread is large relative to the average velocity of the electrons. Specifically, the beam is made to flow through an extended low velocity region, shown in Fig. 2, where the beam voltage is below a few tenths of a volt. Under these conditions, effective noise reduction has already produced measured noise figures at S-band of slightly less than 3 db and at X-band of slightly above 4 db.

A practical method of producing a potential profile involving a low velocity region is to use a stacked array of anodes as shown in Fig. 3. The potential of each anode can be adjusted individually in an experimental determination of the optimum profile for producing the lowest noise figure.

This technique is operable both with conventional wide-band traveling-wave tubes and with narrow-band backward-wave amplifiers (voltage tunable over wide frequency ranges). Either of these

types of tube is capable of amplifying a single channel of frequencies with high gain and excellent stability. The noise figures already obtained are low. There is every reason to expect that lower noise figures will be achieved in future tubes.

### Parametric Amplifier

The term parametric excitation has been used for a number of years to refer to a method of exciting and maintaining oscillations in a dynamical system. The system can be either electrical or mechanical. Excitation is brought about by a periodic variation in an energy storage element of the system such as a capacitor, an inductor or a spring constant.

Although the principle involved in this type of oscillator has been known and rather well understood for over a hundred years, it was only recently suggested that this principle could be used in building amplifiers and that it would be particularly valuable at microwave frequencies.

The principle is classical in nature; and this fact suggests the possibility of a number of physical embodiments. Parametric devices have been built involving the use of pendulums, vibrating strings, electron beams, ferrites and semiconductor material, the last three at microwave frequencies. However different in appearance the various devices may be, they all operate by virtue of a periodic variation in an energy storage element.

**Table 1—Possible Typical Characteristics for Future Low-Noise Amplifiers**

Characteristic	TWT	PA	PA (TW)
Approx. noise figure at 3,000 mc (db)	2	2	2
Approx. dynamic range for 1 mc bandwidth (db)	80	100	100
Maximum stable gain	70	25	35
	(short-circuit stable)	(with inductor)	(with circulator)
Life (hr)	10,000	10,000	10,000
Est. overall weight (lb)	10	2	4
Power consumption (w)	1	2	20

At present, development of ferrite amplifiers is much less advanced than that of diode amplifiers. Although ferrite devices may ultimately prove to have certain advantages over diode devices, too little is known about them now to be able to predict their future usefulness. Good low noise operation with excellent gain and stability has been obtained from electron-beam parametric amplifiers. However, to date, all such amplifiers have been built to operate in the degenerate mode. For these reasons, discussion here is confined to parametric amplifiers using semiconductor diodes.

### Parametric Excitation

A semiconductor diode is capable of providing a periodic variation in an energy storage element, the necessary ingredient in parametric excitation. The diode can easily be made to look like a time-varying capacitance.

Consider the mechanism by means of which energy can be transferred into the fields of a resonant tank from a pump which produces the time variation in the capacitance. Figure 4 shows a simple resonant circuit and a pair of hands which pull the condenser plates apart and push them together again. The hands represent the pump.

Assume that before the hands go to work there is already some energy stored in the circuit. At the moment the voltage goes through a positive or a negative maximum, the hands suddenly pull the condenser plates apart. Work is done in separating the charge on the two plates and the energy goes into the electric fields existing across the plates. Capacitance is reduced and, since voltage is inversely proportional to capacitance, the voltage is amplified. Each time the voltage goes through zero the hands suddenly push the plates back together again. When the plates are pushed together there is no charge on the capacitor and no work is required. By repeating the process indefinitely, the voltage across the capacitor is amplified indefinitely. Figure 4 shows the resultant voltage curve. A net flow of energy takes place from the pump into the fields of the resonant tank.

Actual circuits for parametric

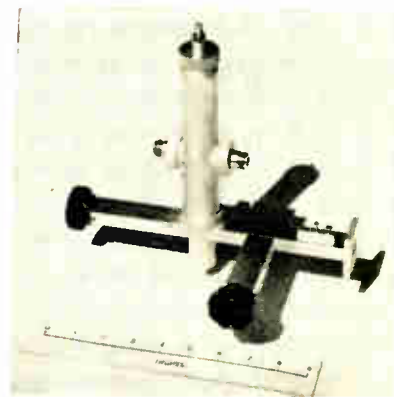

**FIG. 5—In this experimental parametric amplifier, amplification takes place over a single band of frequencies**

amplifiers are, of course, more complicated than this. However, the energy exchange mechanism is basically the same. Whatever it is that brings about a capacitance variation (that is, the pump) does so in such a fashion that on the average the capacitance is reduced when the voltage across the plates is at a positive or negative maximum, and the capacitance is increased when the voltage is zero.

With a semiconductor diode, the pump is simply a source of microwave voltage at the proper frequency. The diode exhibits a capacitance whose value is a function of the voltage across it. By providing a microwave pump voltage across the diode, the diode capacitance can be made to vary at the pump frequency.

### Frequency Relationships

A word of explanation is necessary concerning the frequency relationships among the fundamental signals found in a simple parametric amplifier. From the preceding explanation of energy transfer it is apparent that in a microwave parametric amplifier the energy for producing the amplification is supplied to the amplifier at a microwave frequency rate. The signal to be amplified is at a different microwave frequency. Because of the nature of the parametric principle a beat phenomenon takes place between the pump signal and the amplifying signal. Consequently, a third signal is produced having a frequency equal to the difference between the pump frequency and the amplifying frequency. Since in the conventional



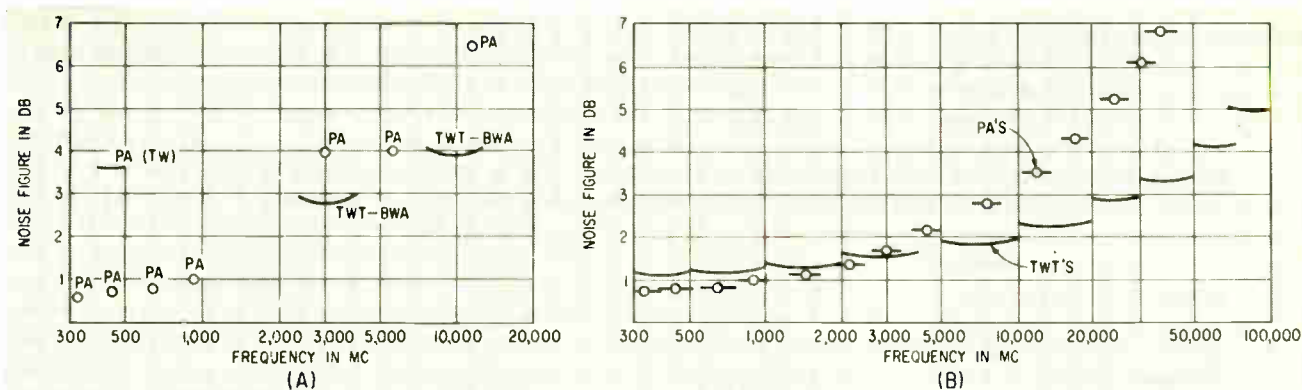

FIG. 6—Present status of measured noise figures (A) and possible future status (B) for parametric amplifiers, PA, and for traveling-wave tubes, TWT. For traveling-wave amplifiers of the backward-wave type, BWA, the bandwidth indicated represents tunable bandwidth. Parametric amplifiers using multiple diodes in traveling-wave circuits are marked PA(TW)

parametric amplifier this signal is a more-or-less useless by-product of the parametric process, the signal is called the idler.

When the pump frequency is double the amplifying frequency, the idler frequency is the same as the amplifying frequency. This mode of operation is referred to as the degenerate mode.

#### Single-Channel Operation

Where it is desirable for the amplification to take place only over a single band of frequencies (that is, in a single channel) the idler frequency band is filtered out at both the amplifier input and output. If this were not done an idler signal would appear at the output with each amplifying signal. Also a spurious signal at the amplifying frequency would be generated and would appear at the output for each input signal at the idler frequency. When the above filters are provided, only amplified versions of input signals at the amplifying frequency appear at the output. This mode of operation is referred to as single-channel operation.

Figure 5 shows an experimental parametric amplifier which operates in the single-channel mode. In this amplifier, the pump signal at 10 kmc is supplied to the waveguide from the right; the input signal at 780 mc is supplied to the coaxial line connection on the right, and the amplified output is taken from the coaxial line connection on the left.

For single-channel operation when the amplifier is at room temperature the minimum theoretical

noise figure is equal to the ratio of pump frequency to idler frequency. By increasing the pump frequency to values very much higher than the amplifying frequency, this ratio, and hence the minimum noise figure, will tend to unity. To make the noise figure as low as possible the pump frequency should be made as high as possible.

#### Comparisons

A plot of noise figure as a function of frequency for various low-noise traveling-wave tubes and single-channel parametric amplifiers is shown in Fig. 6A. Where bandwidth is significant, a line rather than a point is used to designate the noise figure. A smooth line through the parametric-amplifier noise figures would intersect such a line through the traveling-wave-tube noise figures in the S-band region. Below S-band the parametric amplifier noise figures are lower, while above S-band the traveling-wave tube noise figures are lower.

Theoretically there is no limit to the noise reduction which can take place in either device. However, there are inherent practical limitations in each. A consideration of these limitations indicates that the present relative noise figure situation may be more or less permanent.

#### Performance Predictions

Although any prediction of future performance is extremely hazardous in these fast changing fields, a prediction is ventured in Fig. 6B. In addition to low noise figures for both parametric amplifiers and traveling-wave tubes, wide

bandwidths are indicated for the parametric amplifiers. Increasing bandwidth in these amplifiers has already been accomplished by using several diodes in a traveling-wave circuit and by using a single diode along with filter networks.

Traveling-wave tubes should continue to have good characteristics for broadband applications, for high-gain applications and for applications where high stability is needed. Parametric amplifiers should perform well at the lower frequencies where the bandwidth requirements are modest.

Table I presents a prediction of typical characteristics for three types of amplifiers operating at S band. The three types referred to are the traveling-wave tube, the single-diode parametric amplifier and the multiple-diode (traveling-wave) parametric amplifier.

For each type a noise figure of about 2 db has been assumed. The figures used in estimating life, overall weight and power consumption take into account the vacuum tube which is required to provide the pump power for the parametric amplifiers.

Predicted values for maximum stable gain give the twt's a wide edge.

#### REFERENCES

- (1) J. R. Pierce and R. Kompfner, Transoceanic Communication by Means of Satellites, *Proc IRE*, 47, p 372, March 1959.
- (2) A. E. Siegman, D. A. Watkins, and H. C. Hsieh, Density-Function Calculations of Noise Propagation on an Accelerated Multivelocity Electron Beam, *Jour Appl Phys*, 28, No. 10, p 1,138, Oct. 1957.
- (3) M. R. Currie and D. C. Forester, Low-Noise Tunable Preamplifiers for Microwave Receivers, *Proc IRE*, 46, p 570, March 1958.

# Synthetic Sapphires for Electronic Components

Grown single crystals of aluminum oxide retain useful properties at extreme temperatures. Here is how sapphire is built into components

By R. D. OLT, Linde Co., Division of Union Carbide Corp., New York, N. Y.

SYNTHETIC SAPPHIRES, grown from high-purity alumina by the flame fusion process, offer engineering advantages in advanced electronic component design. Some applications are reviewed in Table I. Sapphires are also used as ball, rod and washer insulators, tuning slugs and optical parts in infrared systems.

In addition to the properties listed in Table II, sapphire has zero porosity (no outgassing) and is chemically stable to all common acids and most alkalis. It is optically transparent, with 85 percent transmission at wavelengths from 1,450 angstroms (ultraviolet), through the visible light spectrum, to 5.5 microns in the infrared spectrum.

**BONDING**—Techniques chosen for bonding sapphire to metal, glass or ceramic depend largely on the operating environment (Table III). Materials with

a similar coefficient of expansion are desirable. However, housekeeper techniques, graded seals or compressive joints may be used where expansion is not matched.

Materials with thermal expansion coefficients similar to sapphire include alloys of 42 percent nickel and 48 percent iron (Driver Harris 146, Allegheny Ludlum 4750), nickel-chrome-iron alloys (Allegheny Ludlum Sealmet 4, Carpenter 426), low-alloy titanium, tantalum-molybdenum, high alumina ceramics and Corning 7520 glass. Most epoxy resins, platinum or silver coatings, and copper or nickel vapor depositions will form a mechanical bond with clean sapphire. Certain glasses wet sapphire.

High temperature bonds to metal require that the sapphire first be metallized. High alumina techniques are generally applicable. Either an 80 percent molybdenum—20 percent manganese metallizer, sometimes with CaO and SiO<sub>2</sub> added, or the titanium hydride technique have been used successfully. The metallizer is then nickel or copper plated and the sapphire is brazed to the metal member. Suitable brazes include gold-nickel, copper-silver or other eutectics. A one-step process, using 12 percent titanium-cored copper-silver eutectic solder, has been employed extensively.

## REFERENCES

- (1) J. Cohen, Electrical Properties of Sapphire Single Crystals, Sylvania Report TR 59 (203.1), April, 1959.
- (2) F. Singer and H. Thernauer, *Metallurgia*, 36, p 237, 1947.
- (3) L. Navias, Advances in Ceramics Related to Electronic Tube Development, *J. Amer. Cer. Soc.*, p 334, Aug. 1954.
- (4) A. R. Von Hippel, "Dielectric Materials and Applications," Wiley & Sons, New York, 1951 (with additional data to April, 1958).
- (5) Final Report, *Ad Hoc Comm on Ceramic Receiving Tubes* GFT 219/26, Off Asst Sec of Defense, Adv Group on Electron Tubes, Aug. 11, 1957.
- (6) Lead Telluride, Infrared Detectors, Contract AF 33(600) 25711, Vol. 1, 57 WCLR-1991, p 53, Farnsworth Electronic Co., Feb., 1957.
- (7) D. S. Hughes, W. W. Robertson, Apparatus for Obtaining Optical Adsorption Spectra at Pressures to 6000 Bars, *J. Opt. Soc. of Amer.*, 46, 577, July, 1956.
- (8) H. G. Drickamer, et al, Scintillation Counters for Continuous Analysis Under High Pressure, *Chem. Eng. Prog.*, 49, 9, p 503.
- (9) D. M. Warschauer and W. Paul, Unsupported Area High Pressure Seal, *Rev. Sci. Instr.*, 28, 62, 1957.
- (10) C. S. Peersall and P. K. Zingesser, Metal to Non-Metallic Brazing, Mass. Inst. of Tech. Tech. Report 104, April, 1949.
- (11) F. W. Martin, Glass to Synthetic Sapphire Seals, private communication, Corning Glass Works, Jan. 24, 1958.

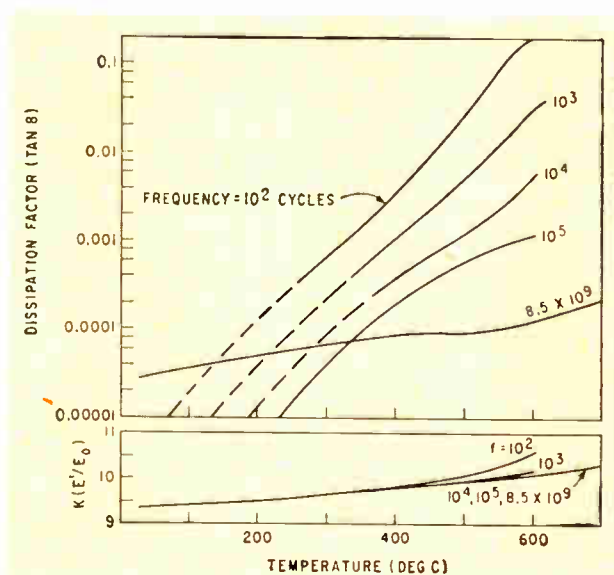

FIG. 1—Dissipation factor (top) and dielectric constant of synthetic sapphire at varying frequencies and temperatures, with electrical field perpendicular to optical axis (after Von Hippel)



**Table I—Electronic Uses of Sapphire**

Application	Comments
Supports in Electron Tubes, TWT Helix Rods	high temperature strength, dielectric uniformity, low camber, small diameter rigidity, low loss
Electron Guns	flame polish for cleaning ease, reduced surface current leakage, high temperature resistivity, low cost
Microwave Output Windows	visible transparency, low adsorption, thin section strength, no glassy binder (punctures), high thermal conductivity
Stacked Ceramic Tubes	improved heat dissipation by radiation and higher thermal conductivity
Arc Lamps	ultraviolet and infrared transmission, surface electrical stability at high temperatures

**Table II—Properties of Synthetic Sapphire**

Property	Temp	Value
Density (gms/cc)	room	3.98
Hardness (Moh)	room	9
Compressive Strength (psi)	room	300,000
Young's Modulus (psi × 10 <sup>6</sup> )	room	50-56
Tensile Strength (psi, design minimum)	20 C	58,000
	500 C	40,000
	1,000 C	52,000
Modulus of Rupture <sup>a</sup> (psi × 10 <sup>3</sup> )	room	65-100
Modulus of Rigidity (psi × 10 <sup>6</sup> )	room	27
Thermal Conductivity (cal/cm, °C, sec)	2.5 K	0.08
	20 K	8
	77 K	3
	0 C	0.11
	100 C	0.06
	400 C	0.03
	1,000 C	0.02
Specific Heat (cal/gm)	20 C	0.18
Heat Capacity (abs joules/deg mole)	20 C	78
	1,000 C	125
Average Coefficients of Thermal Expansion, 60 degrees orientation (cm/cm °C × 10 <sup>-7</sup> )	20-50 C	58
	20-500 C	77
	20-1,000 C	84
	20-1,500 C	90
Volume Resistivity (Ref 1) (order of, in ohm/cm)	500 C	10 <sup>11</sup>
	1,000 C	10 <sup>9</sup>
	1,500 C	10 <sup>8</sup>
	2,000 C	10 <sup>8</sup>
Te Value (deg C)	—	1,222 ± 8
Dielectric Strength (v/cm) 60 cycle (v/mil) (Ref 2)	room	480,000
	room	1,200

	Dielectric Constant	Loss Tan	Loss Factor
10 kmc <sup>b</sup> (Ref 3)	11	0.0002	0.0022
8.5 kmc <sup>c</sup> (Ref 4)	13.5	0.00021	0.0028
8.5 kmc <sup>d</sup> (Ref 4)	10.4	0.00043	0.0045

(a) Maximum bending stress, depending on orientation  
 (b) At 20 C, field 60 degrees to optical axis (c) At 800 C, field parallel to optical axis (d) At 800 C, field perpendicular to optical axis

**Table III—Representative Sapphire Bonding Techniques and Materials**

Operating Conditions	Bonding Techniques and Materials <sup>a</sup>
<b>LOW TEMPERATURES</b>	
To 4 K (-269 C, Liquid Helium), Vacuum	Araldite Type 1 resin (Ciba) bond
77 K (-196 C, Liq N <sub>2</sub> ) to 120 C	Tygoweld 38-C, Activator 41 (U. S. Stoneware) bond
77 K to 400 C, Vacuum	7520 glass (Corning) graded to Kovar <sup>6</sup>
Liquid Oxygen (90 K or -183 C)	bond to 321 or 347 stainless steel by Epon 8 with 6% Activator A (Shell)
<b>ROOM TEMPERATURE</b>	
To 140 C	bond with C-2 epoxy (Armstrong)
To 150 C, Non-vacuum	platinize with Platinum Paste 12 (Hanovia) and soft solder
To 75,000 psi	rubber O-rings <sup>7</sup>
To 150,000 psi	copper washers, or directly supported by lapped steel disk <sup>8</sup>
To 470,000 psi	unsupported Neoprene Teflon washer <sup>9</sup>
<b>HIGH TEMPERATURES</b>	
To 500 C, Vacuum	glass frit. Example: 165 grams of > 325 mesh powders <sup>6</sup> is suspended in collodion, parts are joined and fired in atmosphere of 85N <sub>2</sub> -15H <sub>2</sub> at 1,240 C for 20 minutes
To 600 C, Vacuum	titanium hydride metallizer, copper-silver solder, processed in vacuum at 960 C <sup>10</sup>
To 600 C, Vacuum	12% titanium-cored BT solder (Handy & Harmon), processed in vacuum at 1,000 C
To 700 C, Vacuum	moly-manganese metallizer, copper-plated, electroformed into copper waveguide <sup>6</sup>
To 800 C, Vacuum	Telefunken process; moly-manganese metallizer, nickel plate, Nioro nickel-gold alloy (Western Gold & Platinum) or BT solder, processed in wet H <sub>2</sub> atmosphere furnace at 1,650 C, 30 minutes, 3 steps <sup>5,10</sup>

**SYNTHETIC SAPPHIRE TO GLASS<sup>d</sup> SEALS<sup>11</sup>**

Kovar.....	sapphire to 7520 to 7052
Graded Glass	sapphire to 7520 (direct at 650 C) to 7052-7050-7070-7740
Frit to Graded Glass	sapphire to 7280 (frit at 275 C) to 7800-3320-7740

(a) Superscript numerals indicate references. (b) Mixture of 12.7% weight of LiCO<sub>3</sub>, 8.7% CaCO<sub>3</sub>, 17.6% BaCO<sub>3</sub>, 16.9% Al<sub>2</sub>O<sub>3</sub>, 42.4% SiO<sub>2</sub> and 1.7% Cr<sub>2</sub>O<sub>3</sub>; collodion is 26 grams A-10 acryloid (Rohm & Haas) and 110 grams cellosolve acetate (Eimend and Abend). This frit is used at Stanford University and was developed by Bell Telephone Laboratories. (c) Used by Stanford University Electronics Research Laboratory. (d) Corning codes

# Wideband F-M With

Here are two practical circuits which use voltage-variable capacitances as the means of modulating an oscillator tube

By COLLINS ARSEM, Diamond Ordnance Fuze Laboratories, Washington, D. C.

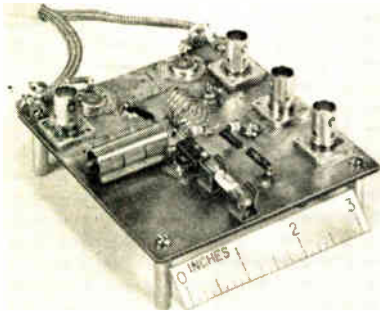

Schematic of this lab model of 100-mc oscillator is shown in Fig. 1

THERE ARE many useful systems for producing frequency modulation of vhf oscillators.<sup>1, 2, 3, 4</sup> The system described here uses variable-capacitance diodes to produce frequency deviations as great as or greater than those obtainable with the other systems, without many of their shortcomings.

If a reverse voltage is applied to a semiconductor junction diode, the two regions adjacent to the junction are swept free of mobile carriers (holes and electrons) and assume opposite net charges due to the immobile impurity ions (donors and acceptors). The device thus forms a charged capacitor. Variation of the applied voltage will change the capacitance in a manner determined by the way in which the impurity-ion concentration changes with distance in the junction region. Capacitance variation is usually a function of the method of fabrication. For example, the capacitance of a fused-junction diode is proportional to  $V^{-1/2}$ , while the capacitance of a grown junction is proportional to  $V^{-1/3}$ .

## 100-mc Oscillator

Choice of the type of variable capacitance diode is largely deter-

mined by oscillator frequency, desired deviation, maximum diode dissipation and the allowable load that can be presented to the oscillator by the modulator circuit. One complication is the fact that many circuit configurations which reduce the loading due to the diodes also tend to reduce the frequency deviation.

The oscillator tube should be chosen to produce an oscillator circuit of low internal impedance. This is especially important at high frequencies since the relatively low equivalent parallel resistance of the diodes might cause excessive loading of a high-impedance oscillator, particularly when the diode network shunts the tank directly.

One of the most satisfactory circuits of those investigated is the Hartley oscillator of Fig. 1 in which the plate current is limited by plate resistor  $R_1$  instead of by grid-leak bias. The tube operates with the grid at essentially zero d-c potential, thus causing the values of transconductance ( $g_m$ ) to be higher and the values of a-c plate resistance ( $r_p$ ) to be lower than their negative-grid-region values. This type of operation thus tends to reduce the internal impedance of the oscillator tube and makes it better suited for this application.

Inductance  $L_1$  is a  $\frac{1}{2}$ -in. diameter air-core coil. The cathode is tapped to the  $4\frac{1}{2}$ -turn coil at  $2\frac{1}{2}$  turns above ground.

The modulator circuit is a practical compromise between high deviation and low internal diode loss. This circuit consists of two similar variable-capacitance diodes ( $D_1, D_2$ ) which are in series with respect to r-f and in parallel with respect to audio modulating signals and d-c bias. The net result is a variable

capacitor having half the capacitance, but the same percent change in capacitance-per-volt as a single diode.

Oscillator frequency, which was about 100 mc. was deviated as much as 28 mc peak-to-peak (p-p) with modulating signals of less than 28 v p-p and negligible modulating power. Diode d-c bias is adjusted so that the peak modulating voltage does not cause diode conduction, and hence severe r-f losses.

Figure 2 shows frequency spectra obtained with a carrier frequency of 100 mc which is modulated by a 100-ke and a 10-ke sine-wave. Only the envelopes of the spectra are actually observable with 10-ke modulation because the minimum resolution of the spectrum analyzer that was used in testing was 25 kc. Individual sidebands are discernible in the spectra for 100-ke modulation and deviations up to 4 mc p-p; but as the deviation is increased, the patterns tend to show only the envelopes of the spectra. Here once again the analyzer's resolution prevented the

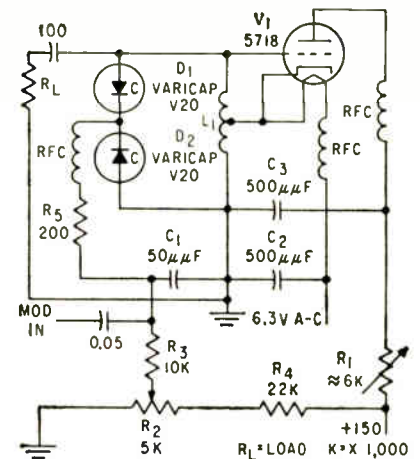

FIG. 1—100-mc lumped-constant oscillator



# Capacitance Diodes

separation of the greatly increased number of sidebands.

Shown in Fig. 3A is a typical output curve of a lumped-constant oscillator similar to that shown in Fig. 1. The curve shows variation in the r-f voltage across the oscillator load for a frequency swing of 20 percent, peak-to-peak. Over all change in voltage is approximately 2.5 db. Figure 3B shows oscillator frequency as a function of diode bias. For all these measurements the d-c plate input power was about  $\frac{1}{2}$  W; the plate voltage and current were approximately 30 v and 17 ma, respectively.

## 400-mc Oscillator

Wide-band frequency modulation of a 400-mc distributed-parameter Colpitts oscillator (Fig. 4) was obtained with a bilateral (symmetrical) transistor in the modulator circuit. Transistor  $Q_1$  is equivalent to two reverse-biased diodes connected in series with respect to r-f and in parallel with respect to modulating signals and d-c bias.

Inductances  $L_1$  and  $L_2$  are sections of transmission line;  $L_1$  is 3 $\frac{1}{2}$ -in. long and  $L_2$  is 2 $\frac{3}{8}$ -in. long. Both inductances are constructed of brass  $\frac{1}{8}$ -in. diameter rod which is centered in a 1-in. cross section channel. Collector and emitter of  $Q_1$  are connected respectively to the rod ( $L_1$ ) and channel wall; collector and emitter connections are approximately 1.8 in. away from the channel-wall connection of  $L_1$ .

Figure 5A shows the spectrum obtained for a frequency deviation of 15 mc peak-to-peak and Fig. 5B shows the nearly flat r-f output voltage obtained over this 15-mc band. The upper line in Fig. 5B is the voltage curve and the lower line is the base-line. Figure 5 was obtained while the oscillator was delivering 685 mw to a 50-ohm load with a plate efficiency of 22 percent.

The above results are typical examples of wide-deviation frequency modulated vhf oscillators. Useful frequency deviations of 10 percent or more are possible with the capacitance diodes mentioned. Opera-

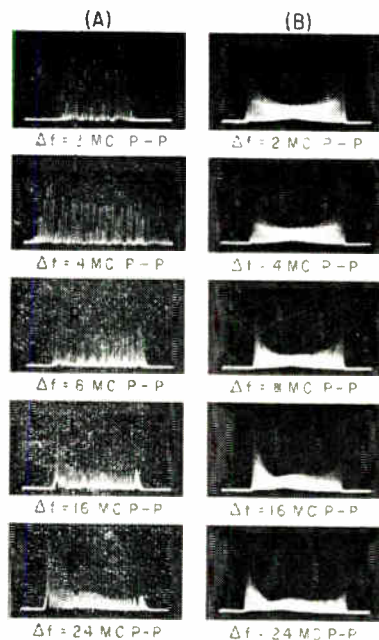

FIG. 2—Sinewave modulation of 100-mc oscillator at 100-kc (A) and 10-kc (B)

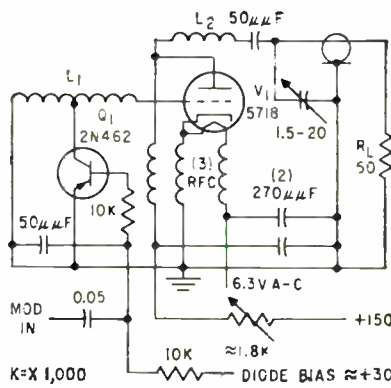

FIG. 4—400-mc oscillator uses a symmetrical transistor

FIG. 5—400-mc-osc. spectrum (A) and output voltage (B) for 15-mc p-p deviation

tion at uhf should be possible if distributed-parameter type circuits are used.

Further increases in bandwidth and reduced a-m will be obtained by using improved variable-capacitance diodes now appearing on the commercial market.

Because of the high input impedance these variable-reactance diode modulators are ideally suited to wide-band high-frequency modulation with complex waveforms and

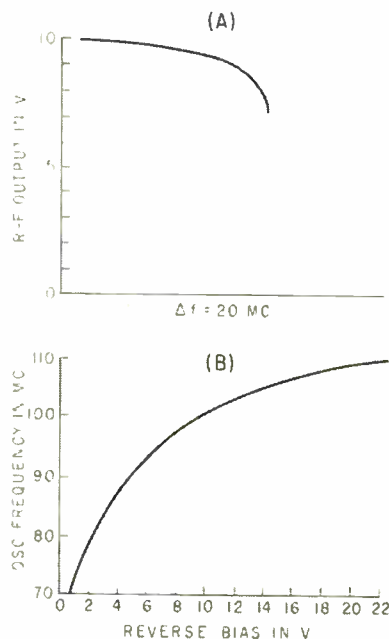
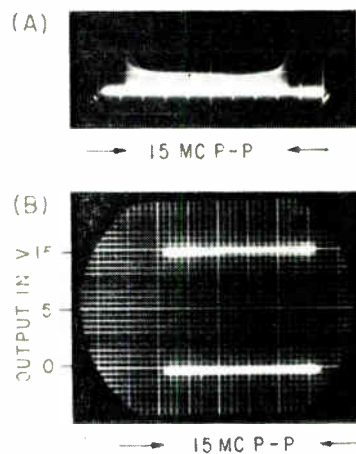

FIG. 3—Output for a 20-mc p-p deviation (A);  $f$  vs bias with  $R_L=2,000$  ohms (B)



little modulation power.

## REFERENCES

- (1) A. Hund, *Reactance Tubes in Frequency Modulation Applications*, *ELECTRONICS*, 15, Oct. 1942.
- (2) M. Epstein and H. H. Weider, *Capacitor-Modulated Wide-Range F-M System*, *ELECTRONICS*, 26, Oct. 1953.
- (3) C. G. Southamer, *Applications of High Frequency Saturable Reactors*, Proc of the National Electronics Conference, 9, Feb. 1954.
- (4) W. A. Edson, "Vacuum Tube Oscillators", 16, John Wiley and Sons, Inc., New York, 1953.
- (5) R. D. Middlebrook, "An Introduction to Junction Transistor Theory", 9, John Wiley and Sons, Inc., New York, 1957.





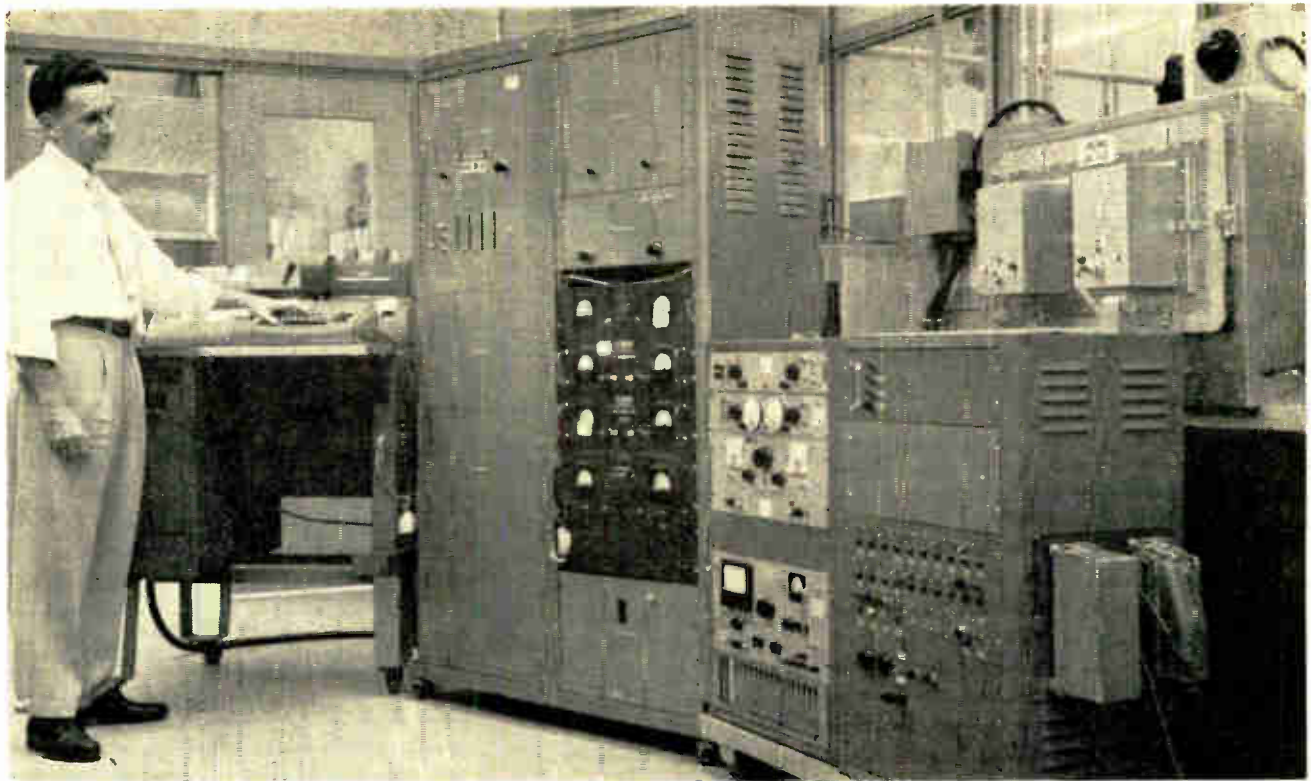

Automatic transistor measuring system has console, digital voltmeter and punch card readout. Beta is just one of the transistor parameters that the system can measure

which is at a +2-volt reference.

Because  $Q_1$  is a *pn*p transistor, base and collector current will flow from these bias conditions and the voltage drop across  $R_2$  will increase. The initial voltage drop across  $R_2$  was small and was caused by the small base current of  $Q_2$ . Since point *B* is now less negative, the base current of  $Q_2$  is reduced. Collector current of  $Q_2$  and thus base current of  $Q_1$  are therefore reduced. Point *A* now becomes more positive again because of the decreasing collector current in the test transistor. As point *A* attempts to go above 2 volts, transistor  $Q_1$  will cut off. The turning-off and turning-on action is filtered by  $R_3$  and  $C_1$ , thereby presenting a smooth d-c bias to the circuit.

The actuation of  $K_1$  removes  $C_2$  and shunts it with a discharge resistor so the circuit will be ready for the next transistor. With the collector current of  $Q_1$  held at the desired value, the base current is measured and beta is determined. Base current is determined from the voltage drop across  $R_2$ .

#### Adjustments

Bias adjustments should be completed with a test transistor in the

circuit because when transistor  $Q_1$  is turned on it will have about 0.1-volt drop between emitter and base. The reference voltage, therefore, will always be about 0.1 volt more than the desired collector voltage. Supply voltage  $V_{cc}$  and the reference voltages may be adjusted while monitoring point *A* for collector voltage and voltage drop across  $R_1$  for collector current.

For testing transistors at a low collector current (about 1 ma), the beta of  $Q_1$  should be at least 60. Base current of  $Q_1$  will then be negligible compared to the collector current of the test transistor.

The discussion has assumed that an *n*pn transistor was being tested, with *pn*p units in the test circuits. For testing *pn*p elements, the test circuits use *n*pn units and all voltage polarities are reversed. In the production model of the tester, these polarity changes are made with a switch.

For minimum noise pick-up at the readout equipment, a shielded cable is used as a return. Because this requirement means that one side of base-current-measuring resistor  $R_2$  must be grounded, all other points in the circuit are left ungrounded. A bus bar wire is used to

connect the points marked common in the drawing.

#### Accuracy and Limitations

With the type transistors shown in Fig. 1,  $h_{fe}$  values from 6.5 to 125 were measured. These values are well within the usual range for most transistors of this type. Collector currents from 1.0 ma to 100 ma were realized without difficulty. Using one-percent precision resistors for  $R_1$  and  $R_2$ , and maintaining one-percent accuracy in the associated readout equipment, over-all system accuracy of the transistor tester is about two percent.

High power transistors can be measured with the same basic technique. Higher power transistors are used for  $Q_2$  and the capacity of the bias and power supply are increased accordingly.

Because of its accuracy and speed of operation in measuring transistor parameters, the automatic beta tester is an improvement over other methods of measuring this parameter. The bias points are automatically established at the same levels each time, thus minimizing error and allowing a greater number of units to be tested in a given period of time.

# Radar Jamming Chart

Improved radar interference nomograph provides solution to off-target jamming problem. Two examples are given

By RICHARD A. WALL, Systems Research Laboratory, Motorola, Inc., Riverside, California

**M**OST EXISTING NOMOGRAPHS are unsuitable for radar interference calculations where the interference comes from a location other than that of the target. A radar jamming nomograph is provided which is applicable whether the interference is located at the target or elsewhere.

In this article the term jamming will be understood to apply to either intentional or unintentional interference.

## Jamming Equation

The nomograph is based on the jamming equation which is obtained by combining the radar and beacon equations.<sup>1</sup> It is expressed as

$$\frac{P_j}{P_r} = \left( \frac{R_j^2}{R_r^3} \right) \left( \frac{G_r^2}{G_{jr} G_{jr}} \right) \left( \frac{\sigma}{4\pi} \right) Q_i$$

The vulnerability factor  $Q_i$  represents the ratio of jamming power to signal power necessary to obscure target signals or cause the radar to malfunction. It is given by

$$Q_i = \left( \frac{B_j}{B_r} \right) \left( \frac{D}{FL} \right) \left( \frac{N_r}{N_j} \right)^{1/2}$$

In actual practice  $Q_i$  is seldom evaluated directly because of the uncertainties associated with the correlation factor and radar integration capabilities. The  $Q_i$  term can be evaluated or estimated for specific conditions but in general it is specified as an arbitrary number of db.

The effect of propagation losses under conditions of inter-

ference is often overlooked. A radar designed to give adequate performance under specified conditions of interference or propagation loss may fail when both occur simultaneously, since the interference suffers a one-way loss while the radar echoes suffer a two-way loss. Interference allowances should always be augmented by propagation allowances rather than letting the larger of the two govern.

The nomograph scales can be multiplied by appropriate factors to get desired values. Multiplying  $R_j$  by ten, for example, increases  $P_j/P_r$  by 20 db, while multiplying  $R_r$  by ten decreases  $P_j/P_r$  by 40 db.

## Examples

A proposed 100-kw radar will be subjected to interference from a fixed transmitter 20 miles away. The jammer has an antenna gain of 10 db toward the radar and puts out an effective power of 3 kw in the radar receiver passband. The radar antenna will have a main beam gain of 40 db with sidelobes 20 db down. If the vulnerability factor is estimated at 15 db, what detection range can be expected against targets with an echoing area of 5 square meters?

The antenna factor is  $2 \times 40 - 40 - 10 = 30$  db for the main lobe, and  $2 \times 40 - 20 - 10 = 50$  db for the sidelobes. Starting with the given values for  $P_j$  and  $P_r$  a straightedge is aligned as

Table I—Symbols

$P_j$	Interfering transmitter power
$P_r$	Radar transmitter power
$R_j$	Distance between jammer and radar
$R_r$	Distance between target and radar
$G_r$	Radar antenna maximum gain
$G_{jr}$	Radar antenna gain in jammer direction
$G_{jr}$	Jammer gain in radar direction
$\sigma$	Effective target echoing area
$B_j$	Jamming signal bandwidth
$B_r$	Radar receiver bandwidth
$D$	Ratio between jammer and radar duty cycles
$F$	Correlation factor between jamming signal and radar receiver acceptance characteristics
$L$	Propagation loss (see text)
$N_r$	Effective number of radar returns integrated per unit sampling time or per azimuth scan
$N_j$	Effective number of jamming pulses integrated (by radar) per unit sampling time or per azimuth scan

shown by the solid lines on the nomograph and the anticipated detection range is found to be 2.8 pointing toward the jammer. Using the alignment illustrated by the dashed lines the range is found to be 9 miles when the main beam is pointing away from the jammer.

The author wishes to acknowledge the assistance of Glenn Garrison in preparing the nomograph.

(Continued on p 118)

## REFERENCES

- (1) L. N. Eidenour, "Radar System Engineering", McGraw-Hill Publishing Co., 1947.



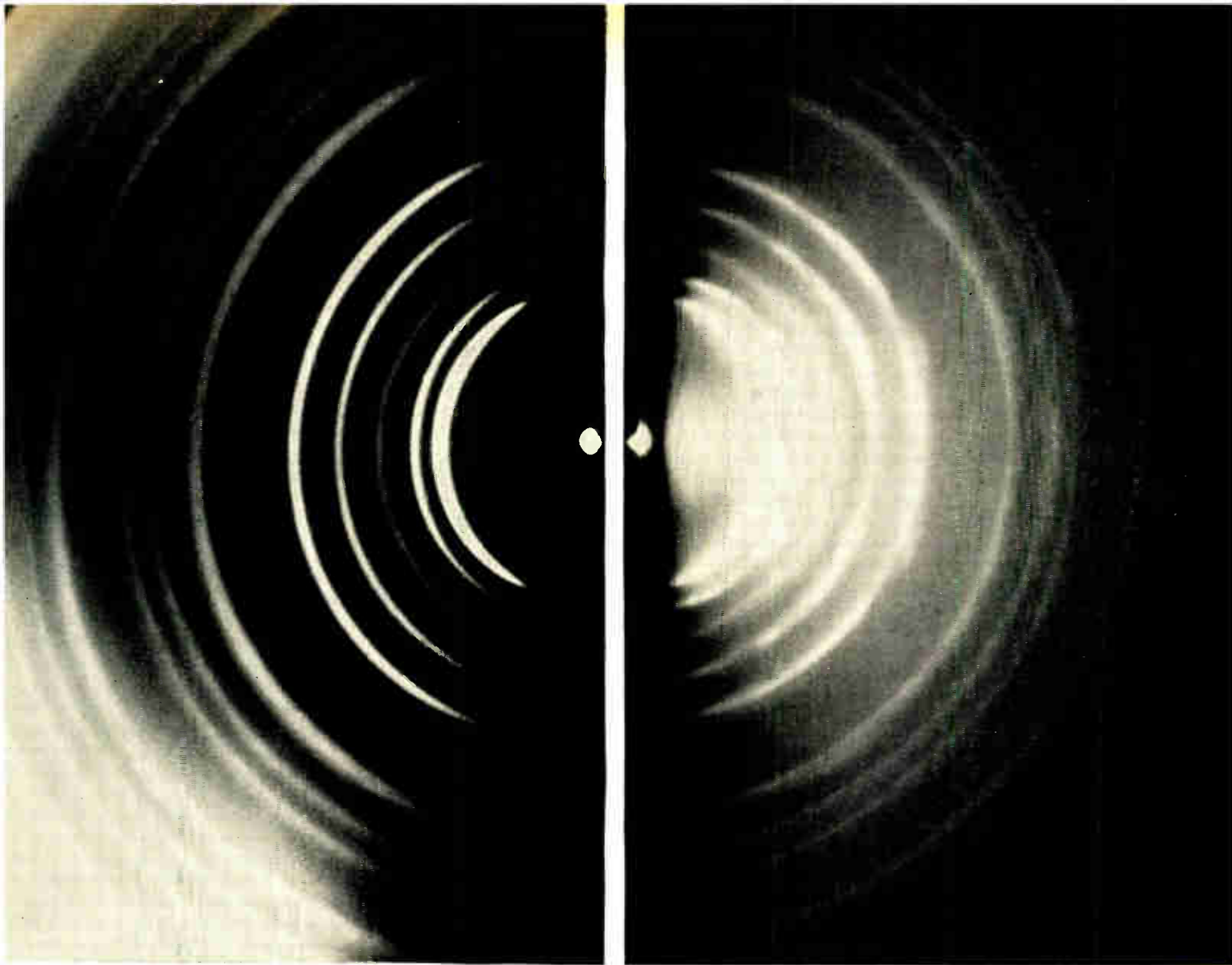

Report from IBM



Yorktown Research Center, New York

## MAGNETIC EXPLORATION ALONG THE CRYSTAL AXIS

How does the orientation of crystallites within a thin metallic film relate to its magnetic properties? This is the question under study by a group of scientists at Zurich, Switzerland—one of the laboratories coordinated from the IBM Yorktown Research Center.

Electron-diffraction permits the investigation of the crystal structure of thin magnetic films prepared by evaporation in vacuum. In particular the orientation of the numerous small crystals in a polycrystalline film can be detected. The uniform distribution of density along the rings in the left-hand picture results from a random distribution of crystal axes, whereas the arcing of the rings at the right indicates a

preferred orientation, known as fiber texture. Alignment of the axes of the individual crystallites contributes to the film's magnetic anisotropy—the variation of magnetic energy with different directions of magnetization.

Techniques for producing predictable anisotropy in thin films and for measuring magneto-crystalline relationships are among the goals of the present work. Thorough understanding of all factors influencing the magnetic anisotropy is mandatory for the development of optimal operation of magnetic thin film logic and memory devices. Mastery of anisotropic films may thus offer a promising route to greater capabilities in tomorrow's computers.

# IBM® RESEARCH

Investigate the many career opportunities available in exciting new fields at IBM.  
International Business Machines Corporation, Dept. 554L1, 590 Madison Avenue, New York 22, New York.

World Radio History

DISTANCE TO JAMMER  
( $R_j$ )

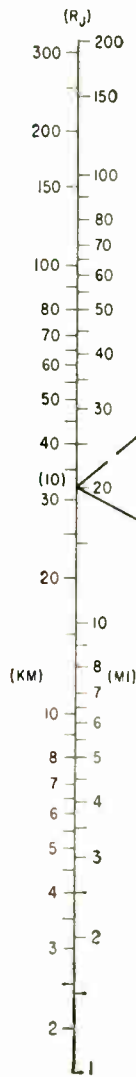

ANTICIPATED  
DETECTION  
RANGE

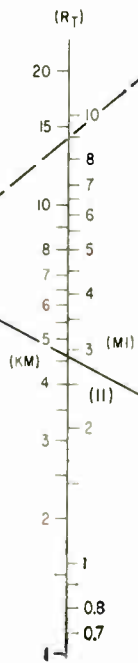

RADAR JAMMING NOMOGRAPH

TARGET  
AREA

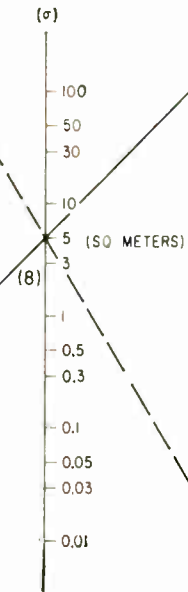

VULNERABILITY  
FACTOR



ANTENNA  
FACTOR

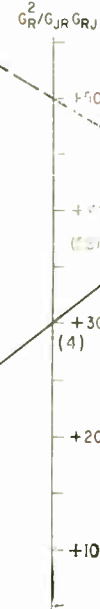

$P_j/P_R$

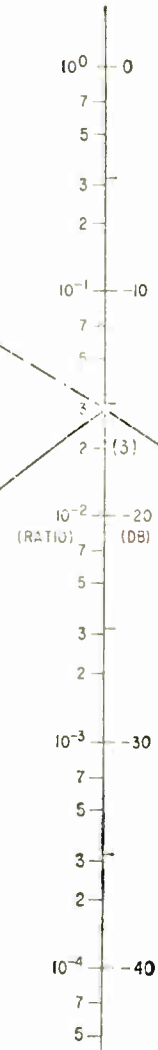

RADAR  
POWER

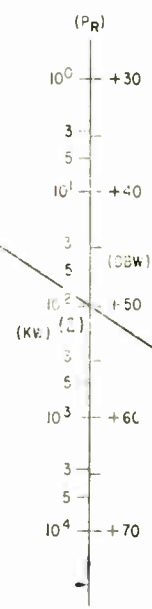

JAMMER  
POWER

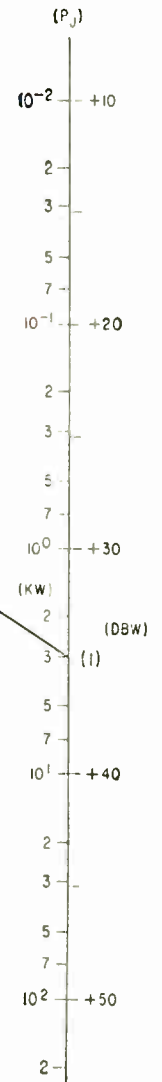



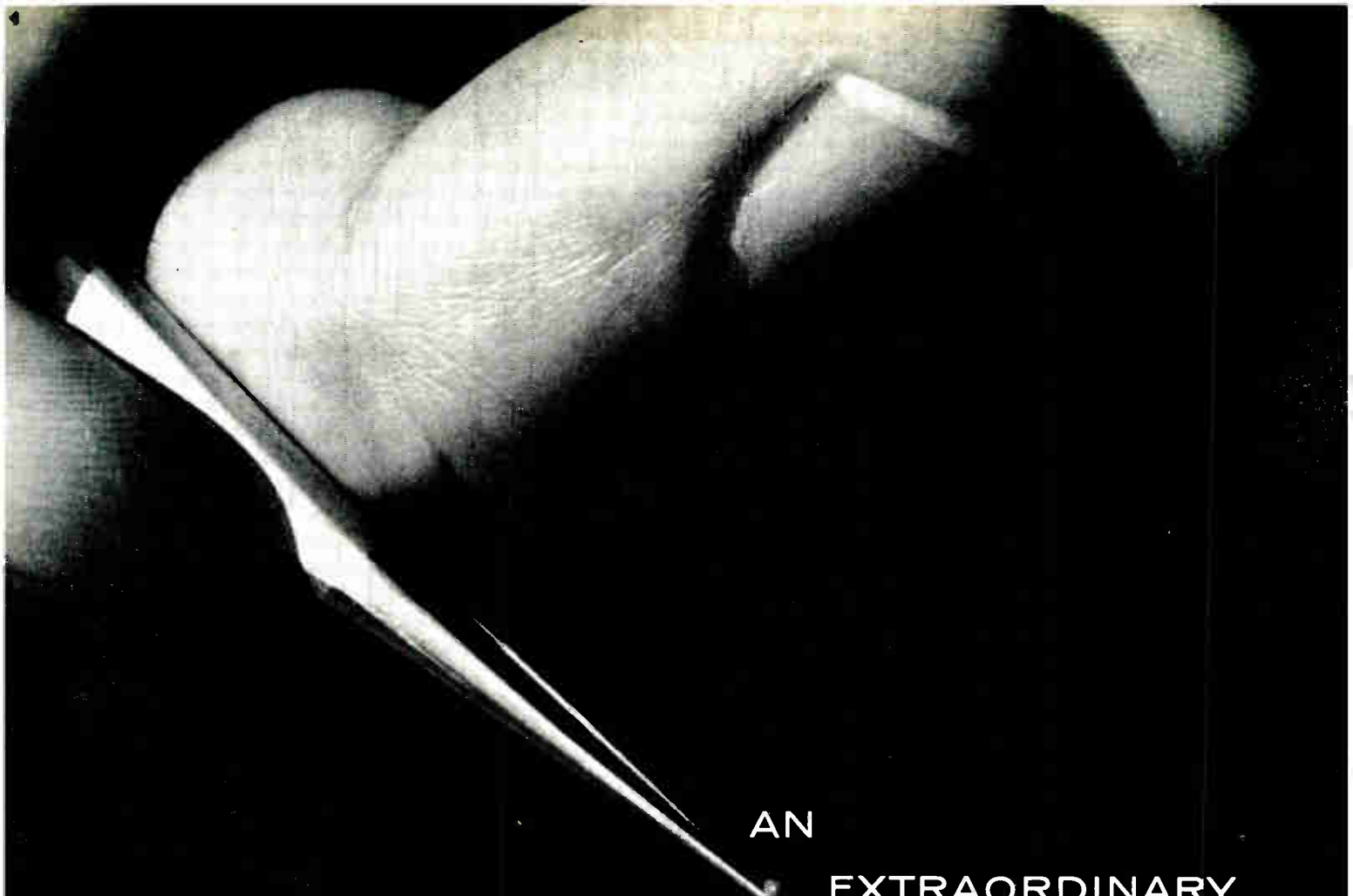

AN  
EXTRAORDINARY  
TRANSISTOR

This tiny silicon chip does something no other transistor can do. It achieves the speed of the fastest germanium plus having the superior temperature characteristics and reliability inherent to silicon. It is the Fairchild 2N706.

This extraordinary transistor was introduced to industry in August of 1959. Within two months, many thousands of units had been shipped and the 2N706 was being designed into highest performance computer circuits. No "blue sky" project, the 2N706 is applicable and extremely advantageous to all types of high speed computer logic.

The 2N706 is also extraordinary as a success story in people—solid-state physicists, physical chemists, metallurgists, electrical engineers, mechanical engineers and industrial engineers. Free flow of ideas and enthusiasm produced an accumulation of advanced semiconductor technologies at an unprecedented rate. From the beginning, only two years ago, the 2N706 was the goal. En route, these technologies resulted in the production of

eight other silicon transistors. These devices have clearly established Fairchild as the leader in advanced semiconductor development.

Step by step, the Fairchild program was planned and held in focus by a top management team of advanced degree scientists. And now, this same program is being zeroed in on new targets, among them Esaki diodes and integrated solid-state circuitry. If yours is a relevant background and you like the way we work, why not drop us a line? We would like to hear from you.



545 WHISMAN ROAD/MOUNTAIN VIEW, CALIFORNIA / YORKSHIRE 8-8161

# Calibrating Microwave Attenuators

LOWER RANGE microwave variable attenuators can be calibrated to accuracies better than 0.0001 db. This accuracy exceeds the precision to which available attenuators can be set and read.

The method was evolved by the National Bureau of Standards in connection with its program to develop microwave standards and precision measurement methods at microwave frequencies.

Calibrated microwave attenuators and directional couplers are used in such instruments as field-strength meters and signal generators and in alignment of radar transmitters and receivers. Attenuators used for power measurements reduce high power outputs by a known amount to a level that can be conveniently measured with milliwatt instruments. Microwave equipment manufacturers need their transfer standards calibrated against a national standard to ensure accuracy of attenuators. The present development provides the required accuracy in the lower ranges.

The improved accuracy was made possible by adapting a very stable power measurement system to attenuation measurements. The resulting calibration system consists of an amplitude-stabilized microwave signal source and a bolometer detector operated in a temperature-stabilized water bath. There are provisions for tuning out reflections at the place where the test attenuator is inserted and for accurately measuring d-c power supplied to the bolometer detector. A second bolometer detector forms part of the amplitude stabilization loop.<sup>1</sup>

As the attenuator dial is moved from zero position, microwave power input to the bolometer mount changes from its initial level,  $P_1$ , to a second level,  $P_2$ . Measured attenuation is  $A = 10 \log_{10} (P_1/P_2)$ .

### Measuring Technique

Microwave power as measured by the bolometer technique is proportional to the amount of d-c power withdrawn to maintain constant bolometer resistance. The constant

of proportionality is the effective efficiency of the bolometer mount. This factor cancels out in the expression for attenuation if it is independent of power level. Previous experiments verify that it is.<sup>2</sup>

The bolometric measurements are made by a self-balancing d-c bridge<sup>3</sup>, a constant-current generator and associated d-c measurement apparatus. This instrumentation provides a direct indication of changes in microwave power input, which makes possible determination of small attenuation values.

### Actual Measurements

Attenuation of a rotary-vane type variable attenuator was measured by this method. To obtain an indication of repeatability of attenuator setting, results of three independent settings were recorded. Although prime interest was in the lower range, the full range of the attenuator was measured.

Two sources of error were considered in estimating error limits in resulting data—mismatch error and the error arising from uncertainty in measuring d-c power differences. Calculations of the limits of mismatch error<sup>4</sup> are based on system reflections corresponding to a vswr less than 1.005 and on changes in attenuator characteristics determined from separate measurements. The error in measuring d-c power differences is estimated to be less than 0.1 percent  $\pm 0.1$  microwatt.

A statistical analysis of the data indicates that accuracy exceeds the precision with which the attenuator can be set and read. This finding suggests that variable microwave attenuators with expanded scales and precise gears are needed if full advantage is to be taken of this calibration accuracy.

### REFERENCES

- (1) G. F. Engen, Amplitude Stabilization of a Microwave Signal Source, *IRE Trans on Micro Theory and Tech.*, MIT-6, April 1958.
- (2) G. F. Engen, Recent Developments in the Field of Microwave Power Measurements at the National Bureau of Standards, *IRE Trans on Inst.*, I-7, p. 304-306, Dec. 1958.
- (3) G. F. Engen, A Self-Balancing D-c Bridge for Accurate Bolometric Power

## Telemetering Power Line Stress

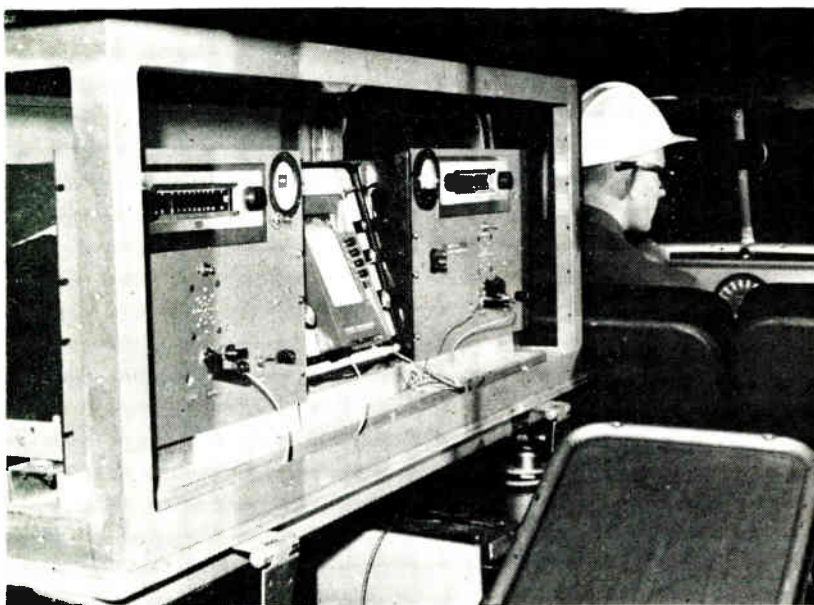

Receivers and recorder mounted in patrol vehicle are part of Preformed Line Products system for measuring stress in power lines carrying high voltages. Battery-powered transmitter and transducer fastened to line under test provide fm/fm signal. With appropriate transducers, system can be used for many other measurements





ELLIOTT CROCKER-WHEELER

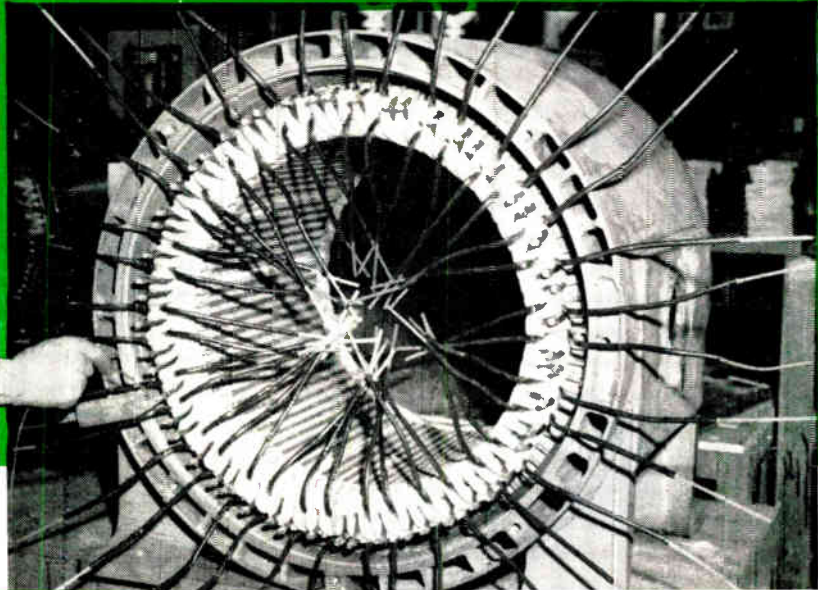

**USES**

*Isolastane is Natvar's new elastomeric isocyanate-type coating for Fiberglas\* braid and tape. Isolastane tubing being installed on coil leads and connectors of a larger AC motor.*

**NATVAR**

**ISOLASTANE® TUBING**

**TO INSULATE AND PROTECT MOTOR LEADS**

The Crocker-Wheeler plant of Elliott Company builds a wide range of electrical motors in sizes up to 500 hp. Natvar Isolastane tubing is widely used on both large and small AC induction motors.

Isolastane tubing is especially suitable for protection of motor coil leads and connectors because of its uniformly high dielectric value, mechanical strength,

and resistance to all oils and solvents commonly used in insulating applications.

When you need flexible insulating materials with good physical and electrical properties and exceptional uniformity, it will pay you to get in touch with your distributor or with us direct.



**Natvar Products**

- Varnished cambric—sheet and tape
- Varnished canvas and duck—sheet and tape
- Varnished silk and special rayon—sheet and tape
- Varnished papers—rope and kraft—sheet and tape
- Varnished, silicone varnished and silicone rubber coated Fiberglas\*—sheet and tape
- Slot cell combinations, Aboglas®
- Isoglas® sheet and tape
- Isolastane® sheet, tape, tubing and sleeving
- Vinyl coated and silicone rubber coated Fiberglas tubing and sleeving
- Extruded vinyl tubing and tape
- Styroflex® flexible polystyrene tape
- Extruded identification markers

\*T.M. (Reg. U.S. Pat. Off.) OCF Corp.  
We will be very happy to supply information on any of our products on request.



*Natvar Isolastane tubing, as applied to these AC field coil leads flexes easily and gives ample electrical and mechanical protection.*

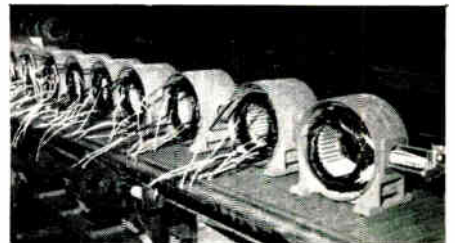

*Isolastane tubing, applied to coil leads of these smaller NEMA frame motors will withstand continuous operating temperatures up to about 155°C (class F) and is extremely tough and resilient and resistant to abrasion.*

**NATVAR CORPORATION**

FORMERLY THE NATIONAL VARNISHED PRODUCTS CORPORATION

TELEPHONE

FULTON 8-8800

CABLE ADDRESS

NATVAR: RAHWAY, N. J.

201 RANDOLPH AVENUE • WOODBRIDGE, NEW JERSEY

# LOW NOISE *miniature* CHOPPERS



ACTUAL SIZE

## BY AIRPAX

Airpax low noise choppers have been developed for use where exceedingly low level signals in low impedance circuits would be lost in the background noise attendant with normal chopper operation. Designed after exhaustive tests for optimum electrostatic and electromagnetic shielding, Series 2300 choppers, using a drive frequency of 400 CPS, have found wide acceptance where the noise level must be kept in the 1 microvolt region.

Illustrated is the type 2300-1, with top solder lug terminals. Also available with plug-in top terminals and external mu-metal shield.

CM33



CAMBRIDGE DIVISION, CAMBRIDGE, MARYLAND

Measurements, *J. Res.*, NBS, 59, p. 101-105, Aug. 1957.  
 (4) R. W. Beatty, Mismatch Errors in the Measurement of Ultrahigh Frequency and Microwave Variable Attenuators, *J. Res.*, NBS, 52, p. 7-9, Jan. 1951.

### MTI Airport Radar Reduces Clutter

HIGH-POWER 50-cm radar has been installed at Wellington Airport, N. Z., which has just been officially opened. The 500-kw system, supplied and installed by Marconi's Wireless Telegraph Co. Ltd., is a dual transmitter-receiver installation. Either unit can be switched to the common antenna.

The system provides both long-range airways cover and short-range airport approach control in a single equipment.

Two-way microwave radio links are provided over which radar signals are passed to displays at the airport and the control center four miles away. The links also provide a path for remote control of the radar antenna. The radio links were chosen over coaxial lines because of the cost factor and because of the risk of cable damage from earthquakes and tremors in the area.

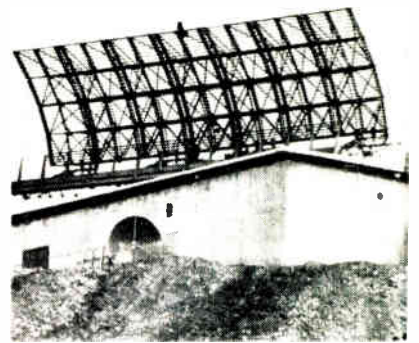

Airport radar antenna in New Zealand has been designed to withstand high winds. Dish antenna shown at base of building is one of two used for microwave link to transmit radar signals to airport and to four-mile distant control center

The 50-cm wavelength was selected because of heavy rainstorms encountered at Wellington. It is claimed that no form of precipitation obscures aircraft from the system. However, storm centers can be seen faintly on the screens, enabling aircraft to be guided through or around them.



The mountainous terrain surrounding the airport would normally cause considerable clutter. The fully coherent moving target indicator radar is said to remove the clutter to provide effective short-range coverage.

The antenna has been designed to rotate at full speed in winds up to 60 knots, at half speed up to 90 knots and to withstand effects of 120-knot wind.

## Data System Records Weather Variables

DIGITAL data system designed by Datex Corp. for Rome Air Development Center is monitoring environmental variables during operational tests of intrusion alarm systems. Digital and analog recordings and direct analog indications of meteorological variables are provided by the system.

As part of the Security Devices Development Program, RADC is checking out commercial anti-intrusion equipment to determine potential Air Force application. The anti-intrusion equipment is primarily concerned with detecting penetration of classified areas.

Since Air Force application will require that the equipment operate in various geographical locations, the equipment must be checked out during typical environmental variations. The new data-recording equipment, essentially a weather-logging system, will record prevalent weather conditions during operational testing of the security equipment.

The system is arranged to receive 60 alarm contacts and will—upon closure of one or more of these contacts—initiate a data-recording cycle. A single data recording cycle will include wind direction, wind velocity, temperature, relative humidity, precipitation, line voltage, time and two decimal digits identifying site. Information from each recording cycle will be recorded on a single card. In addition, the system provides continuous analog indications of the meteorological variables and provides an analog record of wind velocity, wind direction, humidity and temperature.

CIRCLE 123 ON READER SERVICE CARD →



S  
A  
R  
K  
E  
S  
T  
A  
R  
Z  
I  
A  
N

over 95%  
of all  
popular  
rectifier  
tube types  
can be  
replaced with  
Tarzian tube  
replacement  
silicon  
rectifiers

ultimate  
reliability,  
small size—  
with  
excellent  
efficiency—  
are some  
of the  
many  
Tarzian  
plus values

**S-5251**  
1600 PIV - 600 MA DC  
Replacement for types 5AU4, 5AW4, 5AZ4, 5T4, 5U4, 5Y4, 5W4, 5Y3, 5Z4

**S-5207**  
1600 PIV - 396 MA DC  
Replacement for types 6X4, 6063, 6202

**S-5011A**  
1600 PIV - 750 MA DC  
Replacement for types 80, 82, 83, 83V, 5Z3

**S-5017**  
1680 PIV - 750 MA DC  
Replacement for types OZ4, 5X4, 5Y4, 6AX5, 6X5

**S-5018**  
1400 PIV - 750 MA DC  
Replacement for types 5AU4, 5AW4, 5AZ4, 5T4, 5U4, 5Y4, 5W4, 5Y3, 5Z4, 5931, 6087, 6106

**S-5019 or S-5162**  
2800 PIV - 300 MA DC  
Replacement for type 3R4

**S-5033**  
4500 PIV - 250 MA DC  
Replacement for types 6AU4, 6AX4, 6BL4, 6U4, 6W4, 12AX4, 17AX4, 25W4

**S-3343**  
7000 PIV - 300 MA DC  
Replacement for types 816, 836 or 3B28 and 866 at reduced voltage

**S-5130**  
10400 PIV - 300 MA DC  
Replacement for types 866, 866A, 3B28

Write for complete information.

**SARKES TARZIAN INC. • SEMICONDUCTOR DIVISION**  
415 north college • bloomington, indiana • edison 2-1435

In Canada: 700 Weston Rd., Toronto 9, Tel. Roger 2-7535  
Export: Ad Auriemo, Inc., New York City

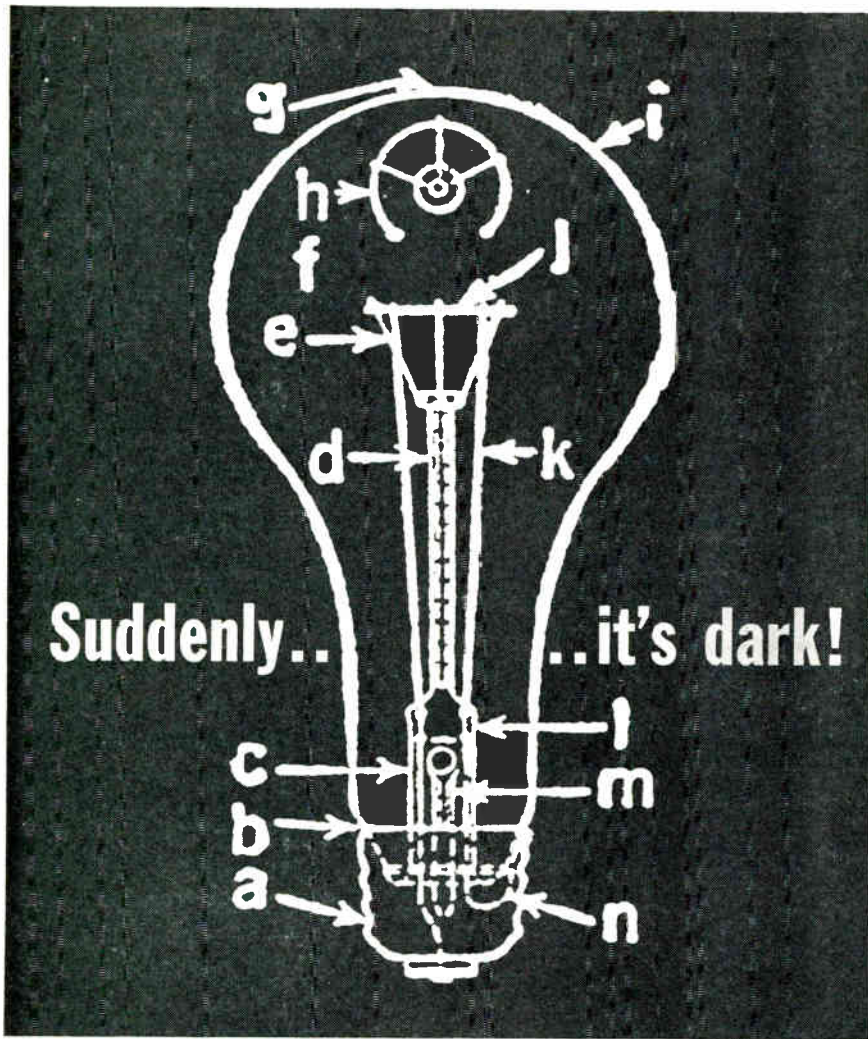

A pretty dark situation, indeed—when a *single* electron tube failure can shut down an equipment or entire production line test facility! Use IERC's new set of a, b, c's to help you get improved electronic equipment reliability. **a.** The practice of replacing tube failures in manner and attitude like that of replacing a light bulb is neither protection nor cure against a continuing high rate of electron tube failures! **b.** Downtime, labor replacement costs often add up to 10 times the tube cost! **c.** You can actually increase tube life up to 12 times by specifying and using IERC Heat-dissipating Electron Tube Shields! The full facts, in the form of **d.** complete product literature, **e.** test reports, **f.** engineering data and **g.** tube shield application guides, especially prepared to help you "see the light," are available on request—write today!

Patents 2807659, 2766020 or Patents Pending.  
Cross-licensed with North American Aviation, Inc.



**International Electronic Research Corporation**  
145 West Magnolia Boulevard  
Burbank, California



Foreign Manufacturers: Europelec, Paris, France. Garrard Mfg. & Eng. Co., Ltd., Swindon, England.

graphite is 2.26 gm per cc. Ordinary commercial graphites run from 1.6 to 1.7; densified graphites range from 1.7 to 2 gm per cc. Pyrographite has been prepared with measured densities as high as 2.22. Density increases with temperature of preparation, due to a higher degree of crystallite orientation at higher temperature.

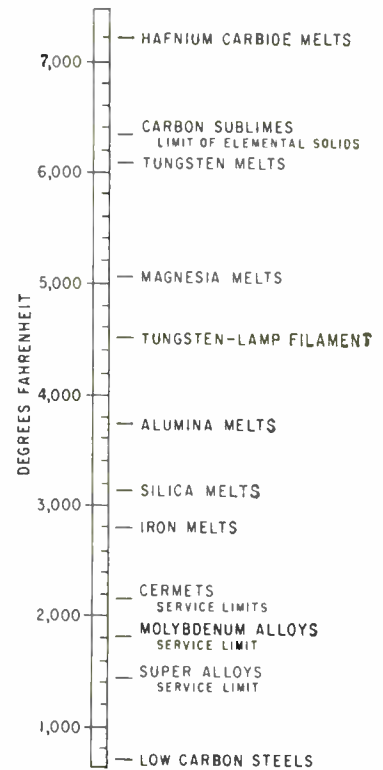

FIG. 2—Temperature limits of materials

Pyrographite has a strength-to-weight ratio along the planes higher than series 310 stainless steel at low temperatures. Above 2,000 C, where normal graphite has one of the highest strength-to-weight ratios known, Pyrographite has a ratio five times as great.

Figure 2 gives the temperature limits of some other materials. Figure 3 is a graph showing thermal conductivity comparisons of Pyrographite. And Fig. 4 compares strength-to-weight ratios.

Various tests in highly erosive atmospheres shows little erosion compared to almost complete breakdown for graphite. This property, like many others can be attributed to the high degree of order in the crystal lattice.

Of particular interest for applications in nuclear reactors is im-



permeability to gases. Using a standards mass spectrometer leak detector, no permeation by helium has been detected. The material exhibits this property after heating to 2,500 C and recooling, even in films as thin as one or two mils.

Although work to date has been concentrated chiefly on developing classified products for military applications, Raytheon expects that their development will be applied to numerous other products, both military and commercial. It is believed that the physical properties of Pyrographite will make it particularly suitable for applications where strength, impermeability and chemical inertness are required at high temperatures.

Further property studies, particularly in the electrical and microwave field may open up many more potential applications. The thermoelectric properties of modified

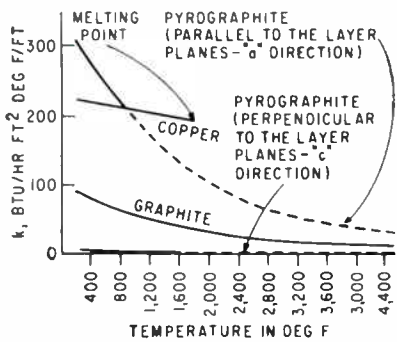

FIG. 3—Thermal conductivity vs temp

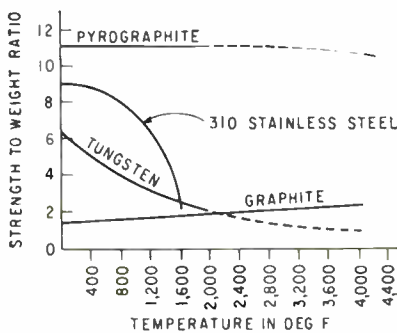

FIG. 4—Strength-to-weight ratio vs temperature

Pyrographites, for example, may make the material ideal for electrical heating and cooling.

Raytheon has recently established a large-scale pilot facility in Lawrence, Mass., for the production of Pyrographite and plans to supply significant quantities of the material in various forms and shapes.

## SENSITIVE RESEARCH:

# AC-DC *Electrostatic* Voltmeters

- Accuracies of .5% and 1% F.S.
- Ranges from 120 V. F.S. to 100,000 V. F.S.
- Input resistances as high as 5 quadrillion ohms!



Model CRV

Model CRV — Crest or Peak Voltmeter for reading true RMS, negative and positive peaks in a self-contained portable unit. Accuracy 1% for basic 0-1 KV, instrument. Supplied with 1% external multipliers for ranges up to 100 KV. For use an AC or pulsed DC with a minimum repetition rate of 20 pps or more. 5.2" hand-drawn mirrored scale. Formica case.

Model ESH — AC/DC high voltage measuring instrument. Responds to true RMS regardless of wave shape. Accuracy 1% F.S. (.5% up to 30 KV, an special order). Single range or multirange combinations from 5 KV. to 100 KV. F.S. Switch controlled from rear. 6" hand-drawn mirrored scale. Transit lock and brackets for panel mounting available. Sturdy aluminum case.



Model ESH



Model ESD

Model ESD — AC/DC portable voltage measuring instrument. Responds to true RMS regardless of wave shape. Accuracy 1% F.S. (.5% on ranges of 500 V. or more on special order). Single range or multirange combinations from 120 V. F.S. to 6 KV. F.S. 5.2" hand-drawn mirrored scale. Formica case. Available as edgewise panel instrument with same performance characteristics.

University Model (not illustrated) — Moderately priced, smaller sized version of Model ESD. Accuracy 1% only. Single range or multirange combinations from 300 V. F.S. to 5 KV. F.S. 4" hand-drawn mirrored scale. Moulded black bakelite case.

Model VPA (not illustrated) — Positive or negative peak voltage adaptor for use with models ESH, ESD and University. Maximum inverse peak rating 30 KV.

Diamond Pivots and shock mounted jewels are included in the models CRV, ESH and ESD. They are many times more shock resistant than conventional pivots and jewels, and their installation assures a friction-free moving element under the severest operating conditions.

All SRIC instruments are calibrated against primary standards that have National Bureau of Standards Certificates of Accuracy and are unconditionally guaranteed.



Symbol of Quality

## SENSITIVE RESEARCH INSTRUMENT CORPORATION

NEW ROCHELLE, N. Y.

ELECTRICAL INSTRUMENTS OF PRECISION SINCE 1927

# Deposition Forms Metals in Plastic

METAL ELECTRODEPOSITION enables the production of integrated metal-plastic components with a minimum of piece-by-piece assembly and promotes miniaturization since the plastic body can be molded and machined to close tolerances as a preliminary step. The process has been used for several years by Electro Tec Corp., S. Hackensack, N. J., to make slip rings for gyros and other precision applications.

Gold and silver rings are deposited to 0.5 inch thick routinely and thicknesses over an inch are feasible. Sizes have ranged from 0.040 inch diameter on 8-ring subminiature assemblies, 0.14 inch diameter on 45-ring assemblies and 53 rings have been deposited on the face of a disk 50 inches in diameter.

A half-section of a typical ring is shown in Fig. 1. The body is molded around the lead wires and machined. Rings are keyed to the body and leads via recesses in the bottom of the ring groove, producing a strong bond.

Metallic surfaces not to be plated are masked. Leads are inserted in Teflon tubing which is sealed. Projecting ends of leads are soldered to twisted pairs of copper wires which form the top frame of the fixture (Fig. 2). Small assemblies are spaced by a serrated plastic plate and are held in position by elastic bands.

Bare copper thief wires form a cage around the slip ring bodies. Initially, the thieves help concentrate plating current around the bodies by adding to plating area. This also makes it easier to calculate plating area, particularly for miniature rings. As the deposition builds up, the thieves protect against possible overloads and

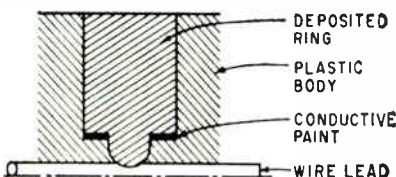
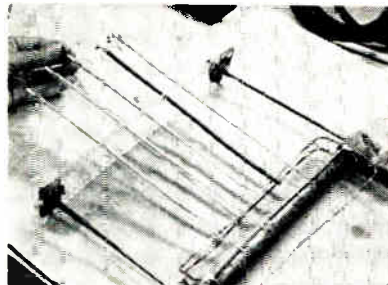

FIG. 1—Cross section of ring, showing method of keying to lead



Machined plastic bodies of large ring assemblies are hung from oscillating rod



Protruding center wire is capped with plastic to prevent plating



Leads are soldered to fixture frame. Note thief wires

soften plating action, aiding slow buildup of stress-free deposit.

Bodies are first cleaned by degreasing and ultrasonic washing.

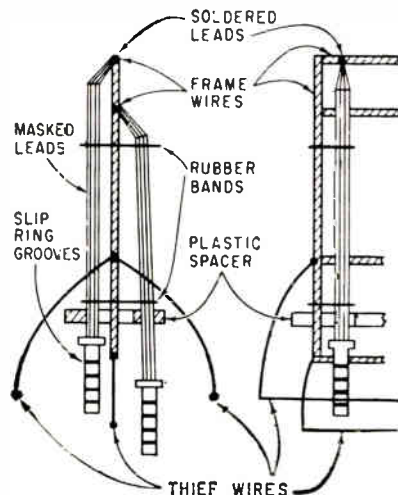

FIG. 2—Fixture used for miniature cylindrical slip rings

They are then dipped in soap solution. Six volts are impressed on the workpieces, making the solution gassify and scrub the metallic surfaces. Acid dips are used to neutralize the soap or activate the surface. Dips are alternated with rinses in cascade water baths.

Oscillating rods agitate workpieces in large tanks. The solution is agitated in smaller tanks by magnetic stirrers, turned by a rotating field in the tank pedestal. Bath makeup is monitored by chemical analysis. Cyanide solutions are generally used. These are prepared in the plant since commercial solutions are not satisfactory for heavy deposition. Current, temperature and agitation rate must also be calculated for specific types of assemblies.

Anode ingots are wrapped in filter paper and hung in nylon cloth bags. Mesh bags would permit undissolved



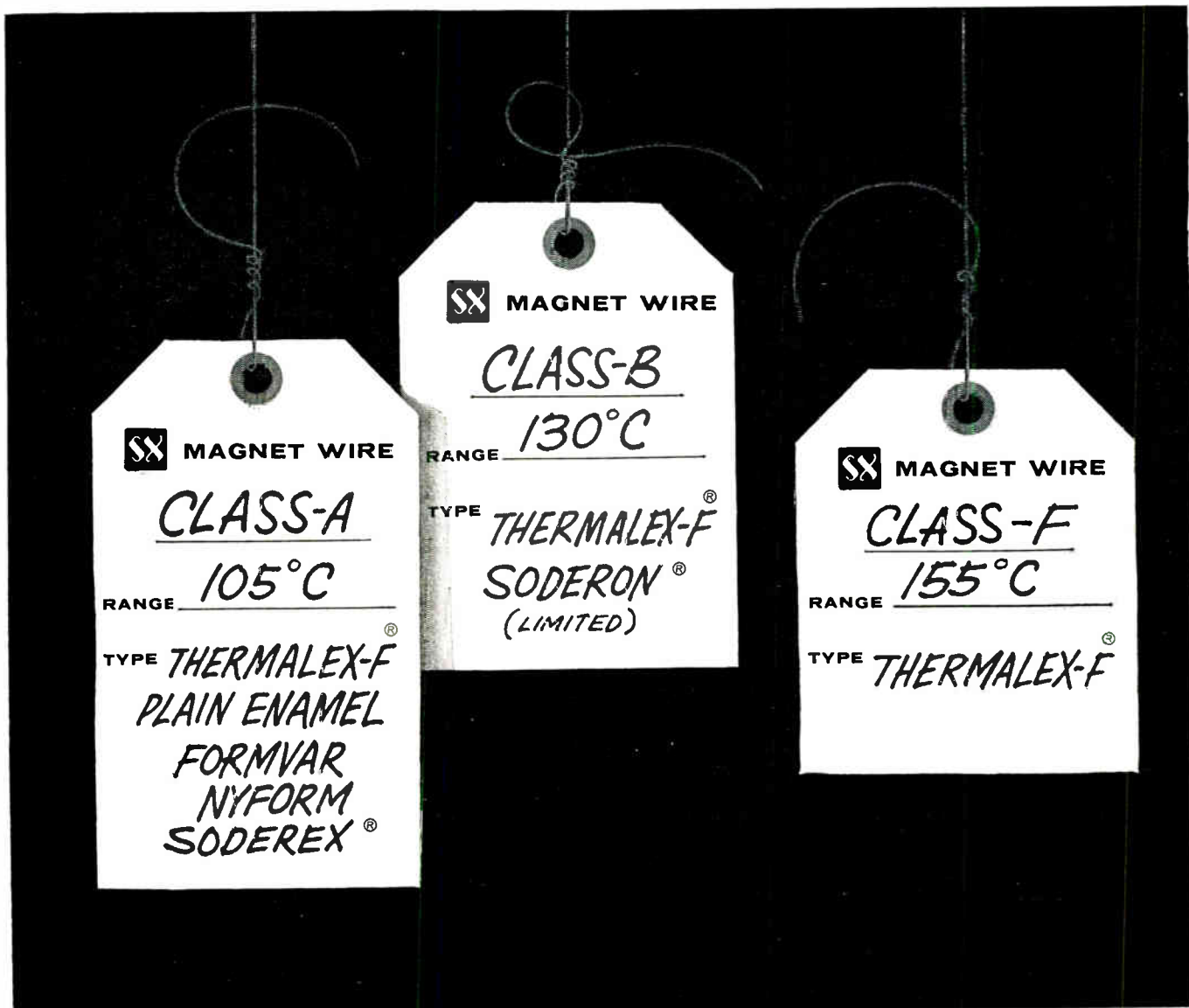

**The right insulation  
for every application  
with Essex Film-Coated Magnet Wire**

*Write for the new data and samples  
available on all-purpose Thermalex-F®*



—THE WIRE DESIGNED WITH THE FUTURE IN MIND.



**MAGNET WIRE DIVISION**

**ESSEX WIRE CORPORATION**

**Fort Wayne, Indiana** Manufacturing Plants: Anaheim, Calif.; Fort Wayne, Ind.; and Hillsdale, Mich.

*National Network of Warehouses and Sales Offices... Call your local "Essex Man."*



## What can you do with a remarkable instrument like this?

We knew we had an outstanding instrument in our product line when this readout device was introduced several years ago. It proved to be ahead of its time during those early days, but now this remarkable precision instrument for displaying data is gaining acceptance in many industries. It's about as big as a candy bar, and it will display, store, or transfer up to 64 different numbers, letters, or symbols without using complicated conversion equipment and "black boxes."

This is an entirely new species of readout device so we had to give it a new name, the Readall® readout instrument.

We developed the Readall instrument for data display in flight control equipment. We knew the Readall instrument was fine but didn't know just *how* valuable it was. But one of our engineers did. He designed a complete new pipeline control system based on the new instrument. The application was a breakthrough in data handling, and the control system is a big success.

Naturally, we put the Readall instrument

on the market so systems engineers could use it to improve their control systems. We announced the Readall instrument as "... an electro-mechanical, D.C. operated, readout device for displaying characters in accordance with a pre-determined binary code ... a compact, self-contained device ... which can be applied to the output of digital computers, teletype receiving equipment, telemetering systems, or wherever data must be displayed."

Other systems have been developed with separate units for data display, decoding, storing, and electrical readout. These separate units cost more and occupy more room. Market response confirms the need for *one, small, inexpensive* unit that does all three jobs. The Readall instrument serves the purpose.

We'd like to discuss possible applications for the Readall instrument with you. If you want information as to possible applications you have in mind for this remarkable instrument, please fill in the coupon.

*®Trademark*

*"Pioneers in Push-Button Science"*

**UNION SWITCH & SIGNAL**  
DIVISION OF WESTINGHOUSE AIR BRAKE COMPANY  
PITTSBURGH 18, PENNSYLVANIA

Union Switch & Signal  
Division of Westinghouse Air Brake Company  
Pittsburgh 18, Pennsylvania

Here is a possible application we have in mind for the Readall instrument:

\_\_\_\_\_

Send more information about the Readall instrument

Name \_\_\_\_\_ Title \_\_\_\_\_

Company \_\_\_\_\_

Address \_\_\_\_\_

City \_\_\_\_\_ Zone \_\_\_\_\_ State \_\_\_\_\_

See us at Eastern Joint Computer Conf. Dec. 1, 2, 3, 1959  
Statler Hilton Hotel, Boston, Mass. Booths #1 and #2.

particles to enter the bath and become inclusions in the deposition. Ingots are pure metal, frequently reprocessed to raise purity. Alloys are not used because, the firm reports, alloying metals cause variations in contact resistance and noise in the signal through the ring.

Pumps which will not contaminate the solution are used to constantly filter the solution. One such pump is the milk type used to pump blood during heart operations. Solution is circulated in plastic tubes which are milked by the pump's metal fingers. The closed system also avoids leakage which is expensive and a health hazard. Five tubes, each circulating 12 to 15 gallons an hour, may be used in each pump.

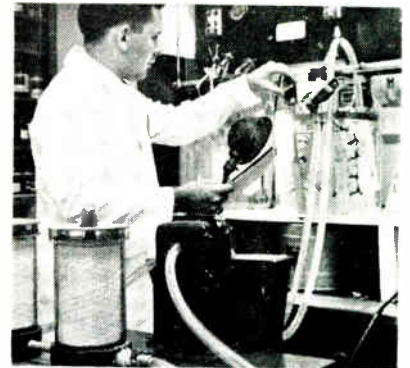

Plastic tubes circulate solution through filter. Black object in center is milk pump

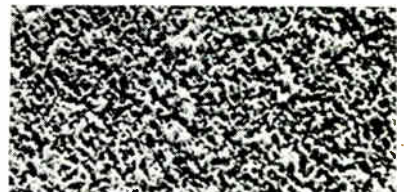

Photo (800 X) of deposited metal surface, etched with chromic acid, shows regularity of structure

Some rings are deposited in ultrasonically-agitated baths. The deposition is reported to be exceptionally pore-free, stress-free and of regular crystalline structure. Deposits of gold an inch thick are readily obtained.

Flow through filters is stepped up in this method of deposition. The ultrasonic energy, while continually driving fresh solution onto the plating surface, is continually cleaning everything in the bath and attacking maskants. The work is agitated by oscillating rods to avoid variations in deposits which could



be caused by standing waves in the solution. Tanks are 40 kc commercial cleaning units fitted with controls, pumps, filters and oscillators.

Rings are deposited with excess diameter and machined and polished back to finished size. If an overplate of gold on silver, or rhodium, is specified, assemblies are recleaned. A typical procedure is electroclean in soap solution, pickle in 10 percent sulfuric acid and electroclean in phosphoric acid (for rhodium) with rinses. The rhodium bath is housed in a constant-temperature cabinet. Fixtures are hand-dipped since flash plates require only a quick dip. An 18-second dip plates 10-millionths of an inch. Plates up to 40 millionths may be applied. (Photos of miniature rings were taken in Blacksburg, Va., plant, and large rings in Ormond Beach, Fla., plant.)

## Guide and Stop End Wire Stripping Hazard

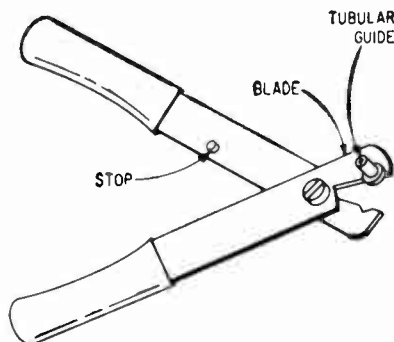

FIG. 1—Positions on guide and stop on stripper

IN STRIPPING insulation from wire wrap and solder connections, any nicking of the metal may cause the wire to break during vibration and excessive handling. A stripper modification (Fig. 1), devised by F. D. Pessia and R. N. Sweetland, of International Business Machines Corp., New York, prevents this.

A wire will be nicked if it is presented to the stripper blades at any angle other than approximately 90 degrees. By welding a tubular guide to a blade of the stripper, this angle is assured. The guide tube is sized to accept the wire size for which the stripper is set. A permanent stop on the other blade limits closure of the stripping blades to an aperture slightly larger than the wire size.

CIRCLE 131 ON READER SERVICE CARD →

AUGUST

27

*EEOCo meets crash schedule  
...delivers electronic timing  
equipment in record time!*

When electronic timing signal equipment was needed for the opening shoot on the Pacific Missile Range, Electronic Engineering Company of California EEOCo delivered three distribution amplifiers and thirty neon driver amplifiers to Vandenberg Air Force Base.

EEOCo was able to meet this crash schedule because of the know-how gained in over nine years of supplying timing instrumentation equipment used on most major missile test ranges in the United States. This experience enables EEOCo design and production engineers to employ R & D production techniques with maximum effectiveness.

Typical of the instrumentation timing signal hardware sold by EEOCo are the airborne time code generators, distribution amplifiers and time code generators described below. For full data on these units, request Data File 101.

AIRBORNE TIME CODE GENERATOR provides a 10-digit time code recycling every 900 seconds. Output is pulse-width modulated for direct recording on oscillographs or as an AM carrier signal for recording on magnetic tape; also produces signals for timing lamps in cameras. Accuracy is one part in  $10^6$  with a stability of one part in  $10^6$  per day. Active elements are semi-conductors or magnetic cores.

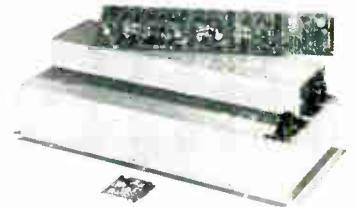

DISTRIBUTION AMPLIFIER (with neon driver in photo). Transistorized time code amplifier for handling up to 12 driver amplifiers for energizing neon timing lamps in instrumentation cameras. Accepts two timing signal inputs either of which can be supplied to any of 12 output circuits each capable of producing input for driver. Driver connects directly into timing signal cable near camera.

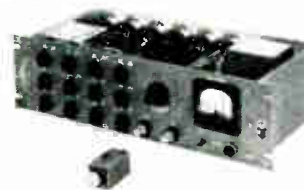

TIME CODE GENERATOR. Stable, crystal controlled unit generates 24-hour time-of-day code in modified binary-coded-decimal form. Each second is identified with 20-bit code. Code continuously displayed on hours, minutes, seconds and may be pre-set to clock time. Code automatically recycles at end of 24-hour interval. Drift is less than one second per week.

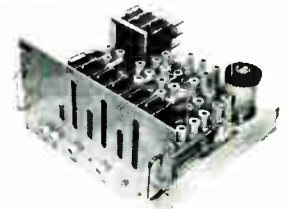

**Electronic Engineering Company of California**

1601 East Chestnut Avenue, Santa Ana, California

Several important career opportunities have just opened up in EEOCo's engineering department. For further information, call or write Merl Perkins.

MISSILE AND AIRCRAFT RANGE INSTRUMENTATION SYSTEMS • DIGITAL DATA PROCESSING SYSTEMS • COMPUTER LANGUAGE TRANSLATORS • SPECIAL ELECTRONIC EQUIPMENT

# On The Market

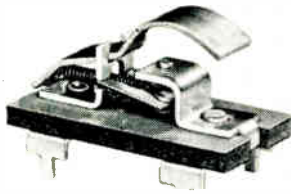

## Snap-Action Switch for p-c use

CHERRY ELECTRICAL PRODUCTS CORP., 1650 Deerfield Road, Highland Park, Ill. Series S30-42B switches feature special terminals for easy p-c insertion, positive over-

travel stop and over 50 actuator variations. Gold flash and other special contact material is available for special l-v applications. Switch measures  $\frac{1}{2}$  in. by  $\frac{1}{2}$  in. by 1 in. It is rated: 10 amperes/125v a-c, 5 amperes/250 v a-c,  $\frac{1}{2}$  h-p/125/250 v a-c.

**CIRCLE 301 ON READER SERVICE CARD**

## Lead Bending Block no plier damage

BY-BUK Co., 4314 W. Pico Blvd., Los Angeles 19, Calif. No. 700 universal component bending block is designed for bending leads to accurately register with their holes in p-c panels. Tool can be quickly adjusted to the body length of any component measuring from 0 to  $1\frac{1}{4}$

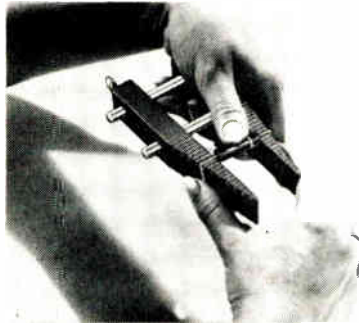

in. long. The leads are bent by finger pressure thus eliminating plier damage, and avoiding replacement of costly component parts. It is possible to bend both leads as close as 0.070 in. to the ends of the component. The bends can be made for panel holes as wide as 3 in. apart and will handle any diameter lead up to 0.045 in.

**CIRCLE 302 ON READER SERVICE CARD**

## Precision Film Pot miniaturized

COMPUTER INSTRUMENTS CORP., 92 Madison Ave., Hempstead, L. I., N. Y. Model 50 is a single turn precision pot which utilizes the Super-Con film resistance element offering virtually infinite resolution. Linear-

ity to 0.2 percent is available with life in excess of 30 million revolutions at 100 rpm. Non-linear outputs, tapped elements and ganged units are also available. Unit will operate over a temperature range of  $-55$  C to  $150$  C and under the most severe environmental conditions.

**CIRCLE 303 ON READER SERVICE CARD**



## P-M Geared Motor meets MIL-I-6181B

ELECTRO PRODUCTS DIVISION, Western Gear Corp., 132 W. Colorado Blvd., Pasadena, Calif. Model P7P-6TFRP, a 28 v d-c permanent mag-

net geared motor, is designed for services as a magnetron tube drive. It develops 16 oz in. of torque at 1,000 rpm and has a thermal protector for overload and stall conditions as well as a radio filter.

**CIRCLE 304 ON READER SERVICE CARD**

## D-C Power Supplies transistorized

DRESSEN-BARNES CORP., 250 N. Vinedo Ave., Pasadena, Calif. Four new fully transistorized d-c power supply modules provide d-c power over ranges including 5 to 32 v and up

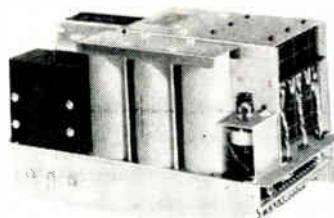

to 6 amperes. By combining the modules in series, the upper voltage range is increased to 64 v. Input is 105-125 v a-c, 60 cps; ripple, less than 2 mv rms. The modules are designed for optional mounting in the 70-101 rack mounting kit.

**CIRCLE 305 ON READER SERVICE CARD**

## Pulse Transformer subminiature

PULSE ENGINEERING, INC., 560 Robert Ave., Santa Clara, Calif. The

Micro-Stat pulse transformer features clamped ferrite core construction. Use of core-gapped construction instead of the conventional toroid and cup core is said to pro-





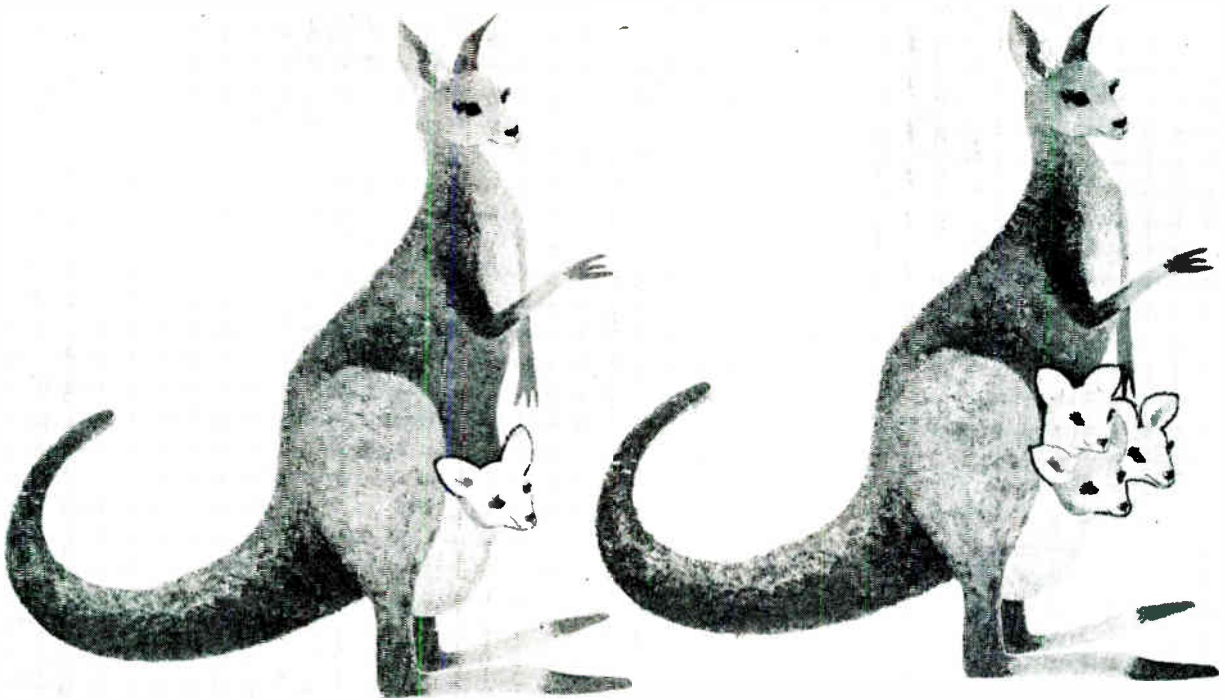

**TRIPLE** THE CAPACITY  
AT NO INCREASE IN SIZE

NEW FROM

**JFD**



actual size



MINIATURE  
TRIMMER  
SEALCAP\*

From JFD, pioneer in precision electronic components, comes the most important new miniature trimmer development in years!

Now you can have *triple* the range previously attainable in a miniature trimmer capacitor—at *no* sacrifice in volume—with new MAX-C Sealcaps.

Imagine the possibilities in your circuitry!

This new series incorporates revolutionary new advances in trimmer production which combines the advantages of a thin dielectric gap with the structural strength and ruggedness of a heavy wall glass tube. The result is a broad capacitance tuning range

at a *300 per cent* saving in volume over other presently available piston trimmer caps.

Also, MAX-C Sealcaps feature a new sealed interior construction that locks out all atmospheric effects, locks in stable performance under critical extremes of altitude, vibration, shock, temperature and other rigorous environmental conditions.

These new trimmers along with the complete JFD line of miniature and subminiature trimmers, and LC tuners offer you new dimensions in design. For complete data, write today for bulletin #221.

MINIATURE PANEL MOUNT MAX-C SEALCAP SERIES

Model	Min.	Max. (Pf)	DISTANCE BEYOND PANEL	MAXIMUM TRIMMER
MC601	1.0	14.0	2/4"	5/16"
MC603	1.0	28.0	1/4"	5/16"
MC604	1.0	42.0	29/32"	5/16"
MC606	1.0	60.0	1 1/32"	5/16"
MC609	1.0	90.0	1 3/4"	5/16"

Also available in printed circuit lug and lead and 4 wire lead type.

Pioneers in electronics since 1929

**JFD ELECTRONICS CORPORATION**

1462 62nd Street, Brooklyn, New York

JFD International, 15 Moore Street, New York, New York

JFD Canada Ltd., 51 McCormack Street, Toronto, Ont., Canada

\*TRADEMARK

**JFD**

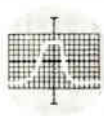

Now in mass production for more than 4 years...

# TI 2N337 SERIES USE-PROVED IN ADVANCED APPLICATIONS

## CIRCUIT DEVELOPMENT ENGINEER

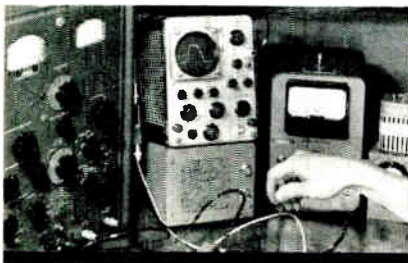
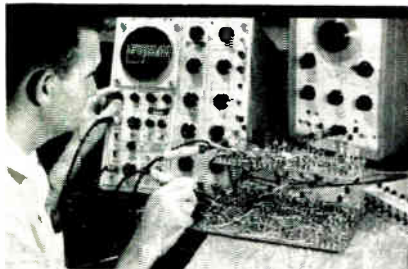

Now get advanced application information and complete reliability and life-test data on TI grown-junction silicon transistors—based on four years' experience.

PARAMETER TEST CONDITIONS AND LIMITS

PARAMETER MEASURED	TEST CONDITIONS	ACCEPTANCE LIMIT	
		MIN	MAX
$I_{CBO}$	$V_{CB} = 20 \text{ vdc}$ $I_E = 0$ $T_A = 25^\circ\text{C}$	—	$2 \mu\text{a}$

PARAMETER TEST CONDITIONS AND LIMITS

PARAMETER MEASURED	TEST CONDITIONS	ACCEPTANCE LIMIT	
		MIN	MAX
$h_{FE}$ pulse	$V_{CE} = 5 \text{ vdc}$ $I_C = 10 \text{ ma}$ $T_A = 25^\circ\text{C}$	45	150

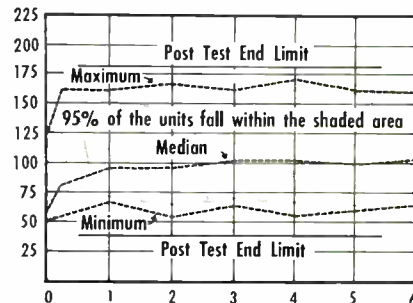
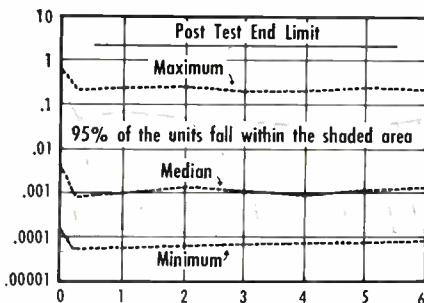

**your future:**  
a challenging opportunity with an industry leader

At Texas Instruments, your future is filled with specific, stimulating growth assignments in evaluating and characterizing transistors and special semiconductor devices. You'll participate in such transistorization projects as:

- AM, FM, and TV receivers
- audio and video, i-f and r-f amplifiers
- hi-fi and electronic organs
- nonlinear and switching circuits
- computer system logic
- servo and power amplifiers

With TI... receive liberal company-paid benefits, including profit sharing (last year 15% of base salary) ... enjoy premium living in a moderate climate with excellent neighborhoods, schools and shopping facilities.

Interviews will be held in your area soon. If you have an Electrical Engineering degree and/or knowledge of transistor circuitry, please send a resume to:

W. T. Hudson, Dept. 200-E-EL  
(for immediate Eastern appointment)

1141 E. Jersey Street, Elizabeth, New Jersey

or  
C. A. Besio, Dept. 200-EL



**TEXAS INSTRUMENTS**  
INCORPORATED  
SEMICONDUCTOR - COMPONENTS DIVISION  
POST OFFICE BOX 312 • DALLAS, TEXAS

$I_{CBO}$  and  $h_{FE}$  characteristics of a sample of 60 TI 2N337 and 2N338 units over a 6-week period. These tests are conducted by TI's independently operated Quality Assurance Branch, and are representative of the complete parameter behavior test information in the Silicon Transistor Reliability Data brochure listed below.

### PUSH-PULL TRANSISTORIZED SERVO AMPLIFIER

Description of a 2-watt transistorized servo amplifier which, using unfiltered rectified a-c for the collector supply, has high collector efficiency.

### HIGH-INPUT-IMPEDANCE AMPLIFIER USING SILICON TRANSISTORS

Amplifier described has input impedance of 8 megohms, voltage gain of 40 db, and output impedance of 600 ohms.

### TRANSISTORIZED VOLTAGE REGULATOR CIRCUIT

Description of a circuit which can regulate the voltage to loads demanding up to 600 ma.

### HIGH-FREQUENCY CHARACTERISTICS OF GROWN-DIFFUSED SILICON TRANSISTORS

Description of characteristics of 2N338 switching and general-purpose unit and 3N34 and 3N35 very-high-frequency tetrodes.



### SILICON TRANSISTOR RELIABILITY DATA

Complete parameter analysis of TI 2N332 through 2N343 — a graphic presentation of parameter behavior with time when one type transistor from a series is subjected to stated tests. The graphs above are representative of this data.



These reports are available by writing on your letterhead to your nearest TI sales office, and are not available through magazine reader service cards.



# HIGH SPEED SWITCHING

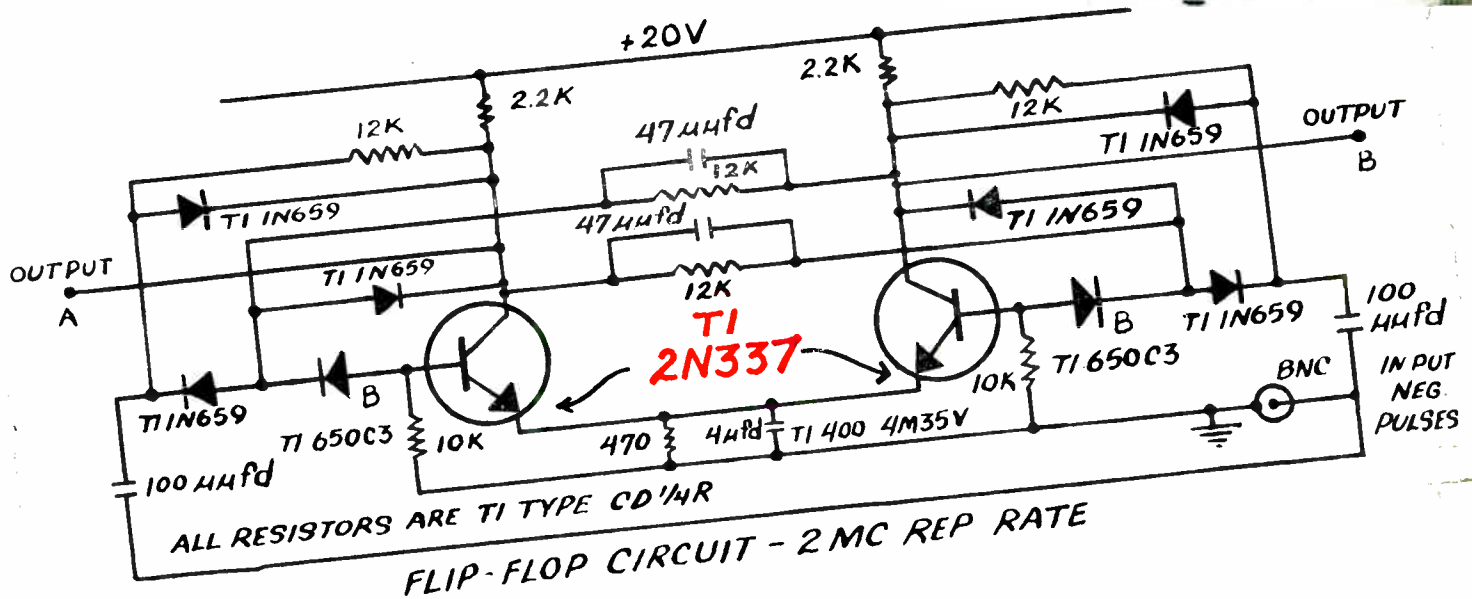
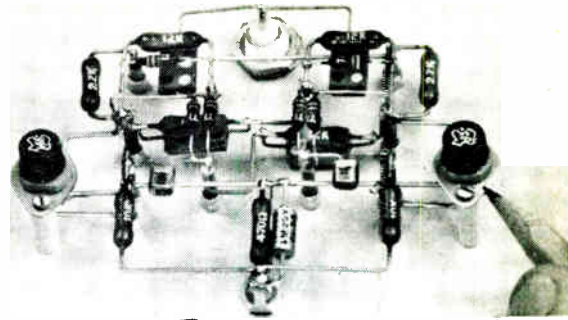

## ... with reliable TI silicon transistors

New improved TI 2N337 and 2N338 specifications provide greater design flexibility for your switching circuits . . . nuclear counters . . . pre-amplifiers . . . RF amplifiers . . . 455 KC IF amplifiers . . . and many other high frequency applications.

You get high gain at low current levels with TI diffused silicon transistors. High alpha cutoff . . . 10 mc min for 2N337, 20 mc min for 2N338 . . . and extremely low collector capacitance assure optimum

performance in your switching and high frequency amplifier applications.

Over four years of mass production and successful use in the most advanced military and industrial applications have proved the value of the TI 2N337 series. Consider TI's guaranteed specs when you select devices for your next transistor circuit. These units are immediately available in production quantities or from large stocks at all authorized TI distributors.

design characteristics at 25° C ambient (except where advanced temperatures are indicated)

	test conditions	2N337			2N338			unit
		min	design center	max	min	design center	max	
$I_{CBO}$	Collector Cutoff Current† at 150°C‡	—	—	1	—	—	1	µA
$BV_{CBO}$	Breakdown Voltage	—	—	100	—	—	100	µA
$BV_{EBO}$	Breakdown Voltage	45	—	—	45	—	—	V
$h_{ib}$	Input Impedance	30	50	80	30	50	80	Ohm
$h_{ob}$	Output Admittance	—	0.2	1	—	0.2	1	µmho
$h_{rb}$	Feedback Voltage Ratio	—	200	2000	—	300	2000	$\times 10^{-6}$
$h_{fb}$	Current Transfer Ratio	0.95	0.985	—	0.975	0.99	—	—
$h_{FE}$	DC Beta	20	35	55	45	80	150	—
$f_{\alpha b}$	Frequency Cutoff	10	20	—	20	30	—	mc
$C_{ob}$	Collector Capacitance*	—	1.2	3	—	1.2	3	µfd
$R_{cs}$	Saturation Resistance†	—	75	150	—	75	150	Ohm
$h_{fe}$	Current Transfer Ratio	14	22	—	20	24	—	db
$t_r$	Rise time§	—	0.05	—	—	0.06	—	µsec
$t_s$	Storage Time	—	0.02	—	—	0.02	—	µsec
$t_f$	Fall time	—	0.08	—	—	0.14	—	µsec

\* Measured at 1 mc

† Common Emitter

‡  $I_B = 1\text{mA}$  for 2N337, 0.5mA for 2N338

§ Includes delay time ( $t_d$ )



WORLD'S LARGEST SEMICONDUCTOR PLANT



**TEXAS INSTRUMENTS**  
INCORPORATED  
SEMICONDUCTOR COMPONENTS DIVISION  
POST OFFICE BOX 312 • 13500 N. CENTRAL EXPRESSWAY  
DALLAS, TEXAS

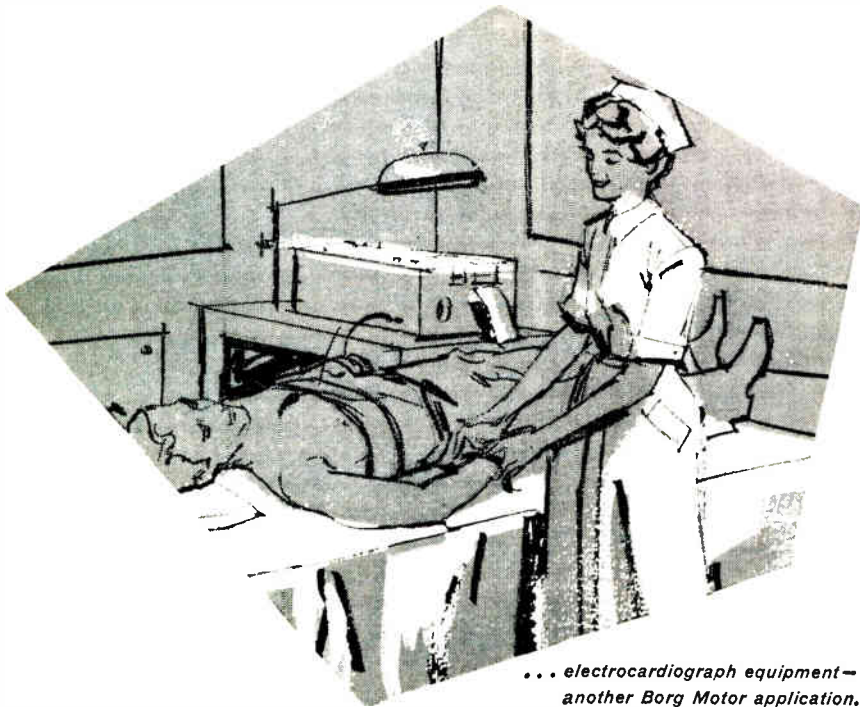

... electrocardiograph equipment—  
another Borg Motor application.

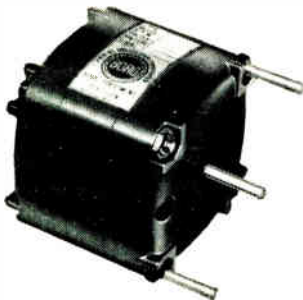

## BORG MOTORS... FOR RELIABLE INSTRUMENT POWER

Borg Motors provide reliable power sources for precision instrument equipment. Permanently sealed bearings and high-quality gearing assure minimum noise and continued high-level performance. Long known as efficient power sources for recorders and timing devices, Borg Motors are reliably serving many manufacturers of medical equipment, industrial television and many other instrument lines. Available from 1/2000 to 1/750 horsepower . . . 2 and 4 pole . . . synchronous and induction . . . with and without gear trains. Gear-train motors have stainless steel output shafts.

Write for complete data.

Ask for Catalog BED-A90



**BORG EQUIPMENT DIVISION**  
AMPHENOL-BORG ELECTRONICS CORPORATION  
JANESVILLE, WISCONSIN

MICROPOTS • MICRODIALS • INSTRUMENT MOTORS • FREQUENCY STANDARDS

CIRCLE 136 ON READER SERVICE CARD

← CIRCLE 135 ON READER SERVICE CARD

vide improved voltage breakdown and insulation resistance. Design also features faster reset and less  $B_r$ , higher power capabilities, lower losses, and increased total flux swing capability. Micro-Stats are available in either epoxy construction or in hermetically-sealed metal casings.

CIRCLE 306 ON READER SERVICE CARD

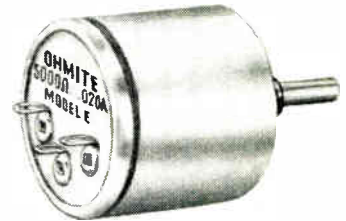

### Miniature Rheostat in enclosed style

OHMITE MFG. Co., 3661 Howard St., Skokie, Ill. Model E miniature rheostat can now be furnished in a lightweight drawn aluminum dust-tight housing. The three rheostat terminals are brought out to corresponding terminals on the back panel. Exclusive of shaft, the entire enclosure measures 1 1/4 in. diameter by 1 1/2 in. long. Units are rated 12 1/2 w at 40 C ambient. Model E is applicable to many military uses (particularly in aircraft), and to industrial applications.

CIRCLE 307 ON READER SERVICE CARD

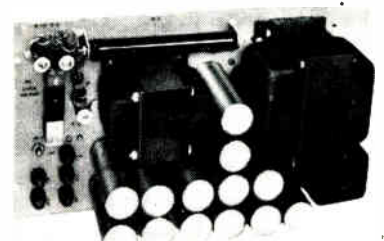

### Power Supply all solid-state

WESTERN DESIGN DIVISION of U. S. Industries, Inc., Santa Barbara, Calif. Model 738-001 is designed to provide an output up to 3 amperes at 130 v d-c for laboratory and instrumentation use. It operates at an efficiency in excess of 80 percent under full load conditions where

DECEMBER 4, 1959 • ELECTRONICS



# lacing tapes ENGINEERED for TEMPERATURE by GUDEBROD

## 375°C GUDE-GLASS

Flat braided of glass fibers, Gude-glass is recommended for use where high temperature is a factor. Available with special finishes for non-slip characteristics, it is non-toxic, resists fungus and is flexible within its complete range: -40°C to 375°C

## 220°C TEMP-LACE

Manufactured of pure TEFLON\*, Temp-Lace is the latest addition to the Gudebrod line. Chemically inert, it is available in natural finish, with a fungistatic rubber coating or with a silicon dispersion finish. In five sizes, it is flexible from -40°C to 220°C.

## 160°C STUR-D-LACE H

Flat braided of DACRON\*\* with non-corrosive rubber finish or wax finish, Stur-D-Lace H meets the most severe requirements for fungus-resistance. It is non-toxic, knots tightly, is unaffected by most chemical solvents. In five sizes, all with high dielectric strength.

## 90°C GUDELACE

The original Gudebrod lacing tape, flat braided of nylon with special wax finish, Gudelace has become the standard where excessive high temperatures are not encountered. In seven sizes, Gudelace also comes in six colors for circuit coding.

Write for new Data Book with complete specifications of All Gudebrod Lacing Tapes.

\*Du Pont's trade mark for its TFP fluorocarbon fiber  
\*\*Du Pont's trade mark for its polyester fiber

# GUDEBROD BROS. SILK CO., INC.

ELECTRONICS DIVISION  
225 West 34th Street, New York 1, N.Y.  
EXECUTIVE OFFICES  
12 South 12th Street, Philadelphia 7, Pa.

CIRCLE 203 ON READER SERVICE CARD  
ELECTRONICS • DECEMBER 4, 1959

the input supply is 125 v a-c. Unit provides regulation to  $\pm 2$  percent at primary power inputs of 105 to 125 v a-c, 50 to 60 cps. Ripple is less than 1 percent rms. For line of load changes of 1.5 amperes, the output voltage transient remains within  $\pm 3$  v of the steady value.

CIRCLE 308 ON READER SERVICE CARD



## Cable Disconnect fits many sizes

AMP INC., Harrisburg, Pa. Coaxicon, the new coaxial and shielded cable disconnect, has been expanded to fit a wider range of cable sizes. The unit now fits all cables up to 1 in. o-d. Interchangeable contacts permit a greater variation of inner conductor diameters in each cable size—either solid or stranded. Application technique requires one crimp for complete assembly.

CIRCLE 309 ON READER SERVICE CARD

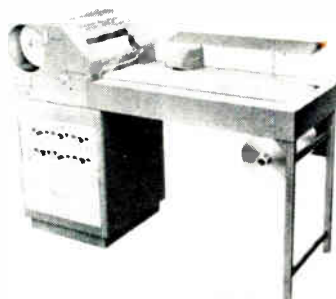

## Recorder six-channel

THE GERBER SCIENTIFIC INSTRUMENT Co., 89 Spruce St., Hartford 1, Conn. Unit illustrated was designed to fill the need for a recorder which would allow the user to obtain a view of the oscillogram and make notes or corrections with the oscillogram in motion. The oscillogram is transported on a belt along the top of the readout table allowing the operator a full and undisturbed view of nearly three

TEXAS INSTRUMENTS  
SEMICONDUCTORS



DELIVERED  
IMMEDIATELY

From  
**Lafayette Radio**



Your Authorized  
TI Distributor

COMPLETE LINE  
AT FACTORY  
PRICES!

For fast, reliable delivery on all TI use-proved, guaranteed semiconductors and components, just call Lafayette Radio and get off-the-shelf delivery.

Free!  
1960 ELECTRONICS  
CATALOG #600

Telephone or write now for your free copy of Lafayette Radio's new industrial electronics catalog . . . over 300 pages describing the industry's latest electronic equipment, including Texas Instruments complete line of semiconductors and components.



**Lafayette Radio**  
Department TI-K

139 W. 2nd Street  
Plainfield, New Jersey  
PL 6-4718

100 6th Ave.  
New York 13, N.Y.  
WO 6-5300

165-08 Liberty Ave.  
Jamaica 33, New York  
AX 1-7000

110 Federal Street  
Boston 10, Mass.  
HU 2-7850

24 Central Ave.  
Newark 2, New Jersey  
MA 2-1661

CIRCLE 137 ON READER SERVICE CARD 137



now available from G-L . . .

## HIGH PERMEABILITY nickel alloy Magnetic Laminations

plus the *QUALITY,*  
*UNIFORMITY* and *SERVICE*  
that have made  
**G-L TAPE WOUND CORES**  
a standard in the industry

High permeability magnetic laminations, made to the most exacting standards in the industry, can now be obtained from G-L.

**Transformer Laminations** have the superior characteristics and uniformity-of-product associated with G-L magnetic tape wound cores. Controlled production techniques, careful selection of material, expert tooling and precision stamping assure you of the highest quality.

**Magnetic Head Laminations** are the result of improvements made by G-L on normal processing techniques to provide laminations with minimum burrs, improved stacking factors, reduced head dimensions.

**Special Shapes** are available from G-L for special applications. Our own tool and die shop is set up to do rapid prototype work.

Your inquiries are invited. Write, wire or call. Send us prints on your current requirements for an immediate quotation. Our illustrated magnetic laminations folder, TB-104, will be mailed upon request.

### **G-L ELECTRONICS**

2921 Admiral Wilson Blvd., Camden 5, N. J.

Phone WOODLAWN 6-2780

Teletype TWX 761, Camden, New Jersey

feet of record. A top-mounted fluorescent lamp evenly illuminates this area. A time stamp is built into the machine which prints the year, month, day, hour, minute, and tenths of a minute directly on the oscillogram at preset intervals for future reference.

**CIRCLE 310 ON READER SERVICE CARD**



### **Controlled Rectifier inverter type**

GENERAL ELECTRIC Co., Liverpool, N. Y. Five new inverter-type controlled rectifiers have a maximum 12- $\mu$ sec turn-off time at their highest rated junction temperature. Turn-off time is defined as the time interval required for the silicon controlled rectifier to regain its forward blocking state after forward current conduction. They are available in piv ratings of 100, 150, 200, 250 and 300 v. Devices are rated for operation, in the junction temperature range from -65 C to +125 C. Prices range from \$38 each for the 100-v unit to \$116 each for the 300-v device in large quantities to original equipment manufacturers.

**CIRCLE 311 ON READER SERVICE CARD**

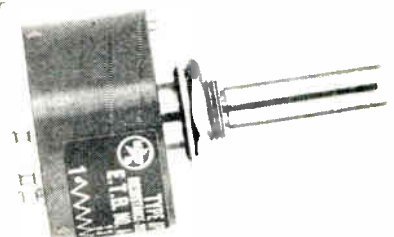

### **Precision Pot infinite resolution**

ACE ELECTRONICS ASSOCIATES, 99 Dover St., Somerville 44, Mass. The Acemho is a conductive plastic precision pot offering long life with low noise. It is environmentally



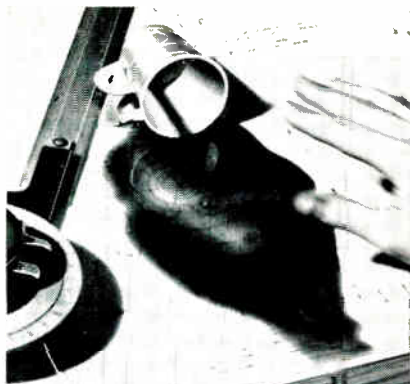

# FUTURA!<sup>®</sup>

## CHART-PAK'S NEW DRAFTING FILM

**Saves Time —  
Saves Money**

Now Chart-Pak brings you "Tomorrow's Drafting Film Today" . . . an amazing new drafting medium on "Cronar"\*

**REDUCED SMUDGING**

**HEAT RESISTANT**

**RESISTS CRACKING**

**HIGH TEAR STRENGTH**

**SUPERIOR TRANSPARENCY**

**MOISTURE PROOF**

**ERASES EASILY**

**VERY FLEXIBLE**

**WON'T YELLOW WITH AGE**

**NO STRETCH OR SHRINK**

**LIES FLAT**

**DOESN'T "DOG-EAR"**

**COSTS NO MORE THAN HIGH-  
GRADE CLOTH OR VELLUM**

Write Today for Full  
Information and Free Sample



**CHART-PAK, INC.**

ORIGINATOR OF THE TAPE METHOD OF DRAFTING

2412 River Road, Leeds, Mass.

\*DuPont Registered Trade Mark

CIRCLE 204 ON READER SERVICE CARD  
ELECTRONICS • DECEMBER 4, 1959

protected against shock, vibration, acceleration, moisture, humidity and other factors. Unit is available in standard sizes and configurations, linear and nonlinear.

CIRCLE 312 ON READER SERVICE CARD

### Control Systems for aircraft

AIRBORNE ACCESSORIES CORP., 1414 Chestnut Ave., Hillside 5, N. J. Packaged modular control systems built or assembled entirely from stock units, assemblies and sub-assemblies are now available to manufacturers in the aircraft, missile, electronic control and related fields. Systems include transducer, preamplifier, power amplifier, linear or rotary actuator plus auxiliary equipment as required—rectifier, inverter, voltage regulator, etc.

CIRCLE 313 ON READER SERVICE CARD



### Power Connectors center screwlock

DEJUR-AMSCO CORP., 45-01 Northern Blvd., Long Island City 1, N. Y., announces series 1900 miniature rectangular power connectors with center screwlock and closed entry contacts. Terminals for solderless wire wrap, solderless taper pin or solder cup are available. The closed entry contacts supplied, provide increased reliability and maintain a low millivolt drop under constant and uniform insertion pressure. In addition to the 152-contact type illustrated, this series can also be supplied with 104, 78 or 34 contacts. Body material is molded from



**DELIVERED  
OFF-THE-SHELF  
From  
MILGRAY**

 Your Authorized  
TI Distributor

All TI semiconductors are in stock, ready to be rushed to you NOW! There is no delay when you order from MILGRAY.

You know you are getting maximum reliability when you specify Texas Instruments semiconductors, USE PROVED by thousands of customers and GUARANTEED for one full year by TI.

AVAILABLE IN  
1-999 QUANTITIES:

Silicon transistors, germanium transistors, silicon diodes and rectifiers and carbon film resistors.

sensor silicon resistors: 1-499

tan-TI-cap tantalum capacitors: 1-99



**MILGRAY  
ELECTRONICS, INC.**

136 Liberty Street  
New York 6, N. Y.  
RE 2-4400 TWX NY 1-4013

CIRCLE 139 ON READER SERVICE CARD 139



He's bragging about  
how the cable works!

## Hickory Brand Coaxial Cable, that is!

- Polyethylene insulation assures maximum operating efficiency

Hickory Brand Coaxial Cables are especially adaptable to applications requiring high, very high and ultra-high frequencies.

The dielectric material of these RG/U Cables is polyethylene . . . shielding braid is single or double copper, single tinned copper or double silver as required.

Quality-engineered Hickory Brand Electronic Wires and Cables are precision-manufactured to meet the most exacting specifications.



Write for complete information on the full line of  
**HICKORY BRAND**  
**Electronic Wires and Cables**

Manufactured by  
SUPERIOR CABLE CORPORATION, Hickory, North Carolina

8605

140 CIRCLE 140 ON READER SERVICE CARD

glass filled Diallyl Phthalate (MIL-M-19833, type GDI-30).

CIRCLE 314 ON READER SERVICE CARD

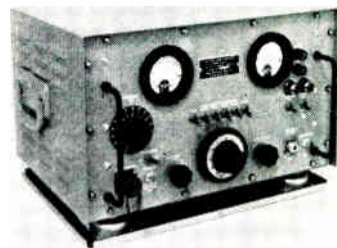

## Signal Generator 400-450 mc

BABCOCK RADIO ENGINEERING, INC., 1640 Monrovia Ave., Costa Mesa, Calif. Primarily developed as a test unit for f-m radio receivers, the BSG-7 may be used wherever frequency modulated r-f carrier signals of precise frequency and amplitude are required. Units are available covering any consecutive 15 frequencies of discrete 1 mc spacing over the range of 400-450 mc with variable carrier deviation from 0 to  $\pm 300$  kc and r-f signal accuracy of 0.01 percent. Internal modulation providing the first six standard a-f channels or external modulation up to 80 kc is included as a design feature.

CIRCLE 315 ON READER SERVICE CARD

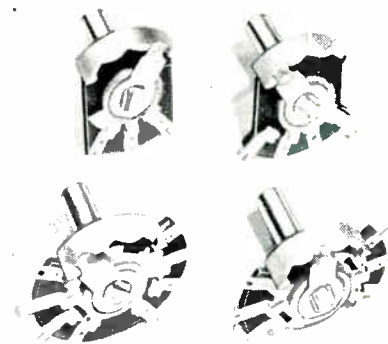

## Tone Switch 2- or 3-position

CENTRALAB, a division of Globe-Union, Inc., 900 E. Keefe Ave., Milwaukee 1, Wisc. Series 200 Ultra-Economy tone switch has the mounting and index frame die cast as a single unit, affording substantial savings in the cost of parts and assembly. Switch has a current rating of 250 ma at 115 v a-c and 1.75

DECEMBER 4, 1959 • ELECTRONICS



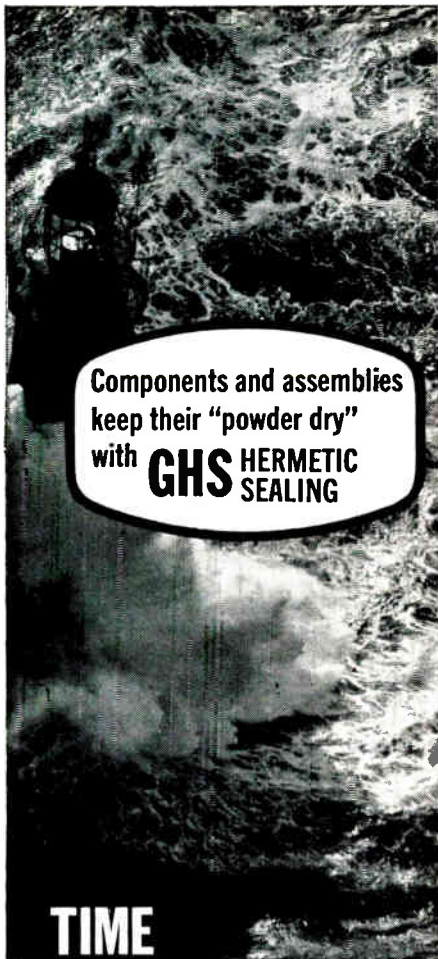

Components and assemblies  
keep their "powder dry"  
with **GHS HERMETIC SEALING**

**TIME**

### Stands Still For Reliability

Next time you plan a product for market or the military — think of this. A GHS hermetically sealed enclosure protects components and assemblies against 7 major causes of product failure for a lifetime of use... in fact, it would take over 30 years for less than a cc of air to penetrate it! Time virtually stands still... and the ravages of moisture, dust, corrosion, fungus, etc., cannot interrupt the fine quality and performance of your products originally designed into them. For complete reliability, we invite you to investigate the GHS system of product improvement with hermetic sealing.

### NON-DESTRUCTIVE TESTING

#### MEGPOT



A highly efficient, portable Megohm-Meter and High Potential Test Set for rapid testing of components and insulation. 10 million megohms, 100, 200 or 500V DC, automatic charge and safety controls. Up to 5000V AC.

WRITE OR CALL TODAY FOR HERMETIC SEALING BROCHURE, AND MEGPOT BULLETIN NO. 158A



#### GENERAL HERMETIC SEALING CORP.

99 E. HAWTHORNE AVE.  
VALLEY STREAM, L.I., N.Y.  
Valley Stream 5-6363

ELECTRONIC SUB-SYSTEMS ■ MEGPOTS ■ GASEALS  
TOGGLE SWITCHES ■ HERMETIC SEALING SERVICES

CIRCLE 205 ON READER SERVICE CARD  
ELECTRONICS • DECEMBER 4, 1959

amperes at 24 v d-c. It can be supplied as a two or three position switch with 3, 4, 6 or 9 contacts clips. Insulation is laminated phenolic type PBE per military spec MIL-P-3115. Voltage breakdown between critical parts is 1,000 v rms.

CIRCLE 316 ON READER SERVICE CARD

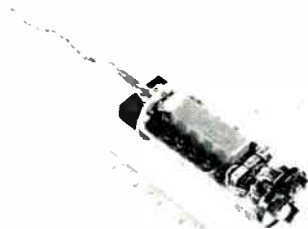

### Receiver marker beacon

TWENTY-FIRST CENTURY ELECTRONICS INC., 6227 Columbus Ave., Riverside, Calif. New transistorized marker beacon receiver can occupy a standard 2 1/2 in. instrument panel hole. The signal frequency is for a standard marker beacon at 75 mc, plus three audio modulation frequencies which illuminate one of the three indicators on the front panel to enable the pilot to accurately position his aircraft for approach or holding. Both visual and aural signals are provided when tuned to a standard marker beacon transmitter. Power consumption is 13.75 v d-c, 0.5 ampere, or 27.5 v d-c at 0.25 ampere. Antenna (input) impedance is 52 ohms. Price is \$295.

CIRCLE 317 ON READER SERVICE CARD

### Spectrum Analyzer real-time

FEDERAL SCIENTIFIC CORP., 615 W. 131st St., New York 27, N. Y., announces a line of real-time Simoramic spectrum analyzers. Unit synthesizes the equivalent of thousands of bandpass filters located side by side in the frequency domain through the use of a single delay line in a well-controlled closed loop. The outputs of the individual synthesized filters are presented sequentially for either human observation or computer consumption. Model 4A Simoramic analyzer



## TEXAS INSTRUMENTS SEMICONDUCTORS

**DELIVERED  
OFF-THE-SHELF**

From  
**NEWARK  
ELECTRIC CO.**

 Your Authorized  
TI Distributor

TI semiconductors are *USE-PROVED* by thousands of customers and *GUARANTEED* for one full year! Now available at Factory Prices in 1-999 quantities:

Silicon transistors, germanium transistors, silicon diodes and rectifiers and carbon film resistors.  
sensing silicon resistors: 1-499  
tan-TI-cap tantalum capacitors: 1-99

**FREE**  
Newark Electric's all-new  
**1960 INDUSTRIAL ELECTRONICS CATALOG #70**

Order your copy now! Over 500 industrial suppliers in one giant 404-page reference! An up-to-the-minute guide to the latest listings of electronic equipment... including Texas Instruments complete line of semiconductors and components.

**NEWARK**  
ELECTRIC COMPANY

Dept. ED-6 • 223 W. Madison Street  
STate 2-2944 • Chicago 6, Illinois

CIRCLE 141 ON READER SERVICE CARD 141

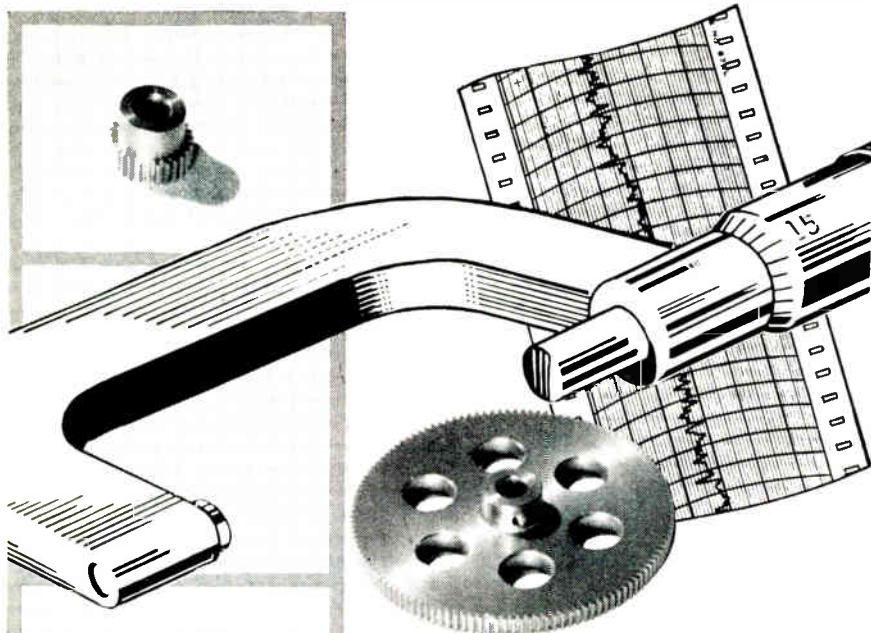

**YOU CAN ALWAYS DEPEND ON**  
*Certified*  
**APPCO PRECISION STOCK GEARS**

Precision gears of all types, pitches and sizes right out of stock. Each certified for accuracy . . . each meets or surpasses A. G. M. A. specifications.

APPCO Certified Precision Stock Gears are offered in 32, 48, 64, 72, 96 and 120 diametral pitches of 14½° and 20° pressure angles. Each gear is completely sealed on a shipping tray with a plastic cover . . . always "factory-fresh," free of dust, corrosion, and scratches.

APPCO Precision Gears are engineered and manufactured to allow for accurate assembly of precision units . . . held to tolerances that assure precise fits to standard instrument bearings, shafting, etc. according to accepted industry practice and A. G. M. A. specifications. For complete technical data and catalog write to Atlas Precision Products Co., Castor and Kensington Aves., Philadelphia 24, Pa.



*Division of*  
**PRUDENTIAL INDUSTRIES INC.**

covers the frequency band 1 cps to 200 cps with approximately 1 cps resolution.

**CIRCLE 318 ON READER SERVICE CARD**

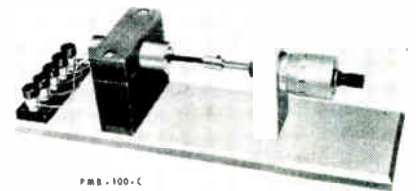

PMB-100-C

**Test Stand for checking lvd't's**

SCHAEVITZ ENGINEERING, Pennsauken, N. J. Model PMB-100-C test stand has been designed for precise measurements of linear variable differential transformer response to linear core motion independently of installation. The lvd't is clamped in the mount, and a nonmagnetic, nonconductive core rod is used to position and support the core as the micrometer is adjusted. The test stand is normally used with a signal generator, amplifier, precision potentiometer, voltmeter and an oscilloscope, to measure and test linearity, phase, input and output volts and operations at various frequencies.

**CIRCLE 319 ON READER SERVICE CARD**

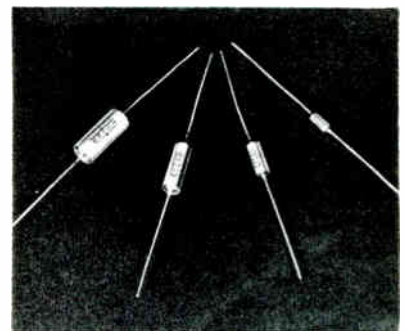

**Capacitors solid tantalum**

ELECTRONIC FABRICATORS, INC., 682 Broadway, New York, N. Y. Line of solid tantalum capacitors offers a capacitance range from 1.0 µf to 330 µf. They provide ±20 percent tolerance of rated value when measured at 25 C and at 120 cps. Dissipation factor is below 6 percent and leakage current measured at rated voltage and 25 C is below 0.03 µa



KEEPS *Total* COST DOWN

IF INSTALLED-COST IS A DESIGN PROBLEM

## Look at the KA general purpose RELAY

What do your relays cost *installed*? Initial cost is never the whole story.

Our KA Relays are engineered for modern production methods. They're available with printed circuit, taper tab, quick-disconnect or hook solder terminals . . . are simple, economical to install. This fact, combined with low original cost, keeps your total cost down.

Another source for savings! All standard KA ac relays bear U/L and Canadian Standard Association seals of approval.

Write or call for more information or see the complete P&B catalog in Sweet's Product Design File.

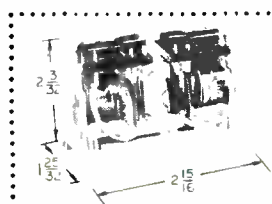

**KB LATCHING RELAY** consists of two KA Relays, forming a mechanical latching relay, featuring a large number of contact arrangements.

### KA ENGINEERING DATA

#### GENERAL:

Insulation Resistance: 100 megohms min.  
Breakdown Voltage: 1500 V. rms between all elements.

Temperature Range:  
-55° C. to +85° C. DC  
-55° C. to +70° C. AC

Weight: 2.0 ozs.  
Pull-In: DC 75% of nominal voltage.  
AC 78% of nominal voltage.

Terminals: Taper tabs.  
Printed circuit.  
Quick-disconnect.  
Pierced solder lugs.

Enclosures: Dust Cover  
(max. 55° C. ambient for AC relays)  
(max. 70° C. ambient for DC relays)

#### CONTACTS:

Arrangements: 3 Form C (3PDT) max.  
Material: Movable— $\frac{1}{8}$ " silver; stationary— $\frac{1}{32}$ " wide silver overlay.

#### COILS:

Load: 5 amps @ 115 V. AC 60 cps res.  
Resistance: 16,500 ohms max.  
Power: 1.2 watts (DC), 2 volt amps (AC)  
Duty: Continuous AC or DC (DC coils will stand 4.5 watts at 25° C.)

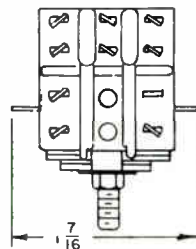
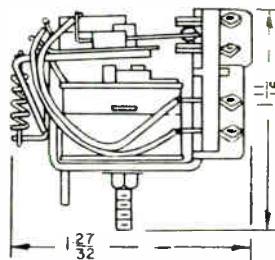

P&B STANDARD RELAYS ARE AVAILABLE AT YOUR LOCAL ELECTRONIC PARTS DISTRIBUTOR



# POTTER & BRUMFIELD

DIVISION OF AMERICAN MACHINE & FOUNDRY COMPANY, PRINCETON, INDIANA

IN CANADA: POTTER & BRUMFIELD CANADA LTD., GUELPH, ONTARIO

# UNPARALLELED CONSTANCY

# with CLIMATE LAB

*Humidity-Temperature Test Apparatus  
with Program Control*

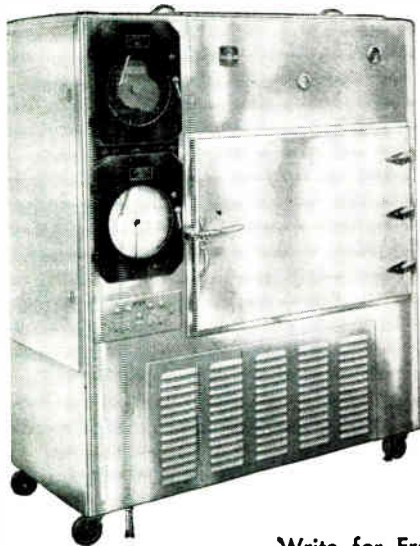

Includes a test chamber, conditioning chamber and program recorder-controller within a single cabinet. Shaped cams are utilized to produce various time-temperature-humidity programs. Test conditions maintained within  $\pm 1\%$  R. H. and  $\pm 1^\circ$  F.

This apparatus has long been used by manufacturers and government inspectors alike to measure the ability of various products to meet JAN and MIL Specifications. The Climate Lab is also used to produce atmospheric conditions for testing electronic components, food and farm products, packaging, mechanical parts, paints, plastics, biological specimens, bacteria, insects, and many other products.

Write for Free Aminco Bulletin 2274-

**AMERICAN INSTRUMENT COMPANY, INC.**  
8030 Georgia Ave., Silver Spring, Md.

**need  
reference  
data?**





Look in the new

# electronics BUYERS' GUIDE



Complete list of government buying agencies, specs and applications in 64 page reference section of the '59-'60 issue.

A **McGRAW-HILL PUBLICATION**

 330 W. 42nd Street   
New York 36, N. Y.

per  $\mu$ f per v—or 2  $\mu$ a—whichever is greater. Operating temperature range is from  $-55^\circ$  C to  $+125^\circ$  C.

**CIRCLE 320 ON READER SERVICE CARD**

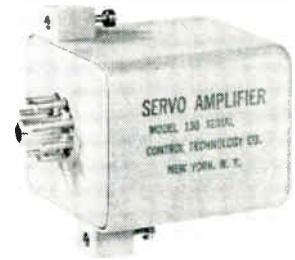

## Servo Amplifier transistorized

CONTROL TECHNOLOGY CO., 1186 Broadway, New York 1, N. Y. Model 130 amplifier will drive either 3.5 w or 6 w servo motors from low level 400 cps signals. Maximum gain is 2,000 and may be adjusted by external resistor. Gain stability is 3 db over temperature range. Input impedance (100 K to 1 megohm) and isolated input make the unit ideal for all computing applications as well as servo designs. Internal limiting prevents overdrive for high input signals. Unit meets MIL-E-5272 environmentals. Company manufactures many variations of this unit and will also design amplifiers for special applications.

**CIRCLE 321 ON READER SERVICE CARD**



## NPN Transistors 25 computer types

CBS ELECTRONICS, 100 Endicott St., Danvers, Mass. A line of *npn* transistors for high-speed switching and h-f amplification comprises 25 computer types suited for logic-circuit, core-driver, and other switching applications. These alloy-junction germanium units feature high current and voltage, flat gain, and low saturation resistance. They use a reliable, welded JETEC TO-9 package. Alpha-cutoff frequencies



# FOUR-WAVEFORM DISPLAYS

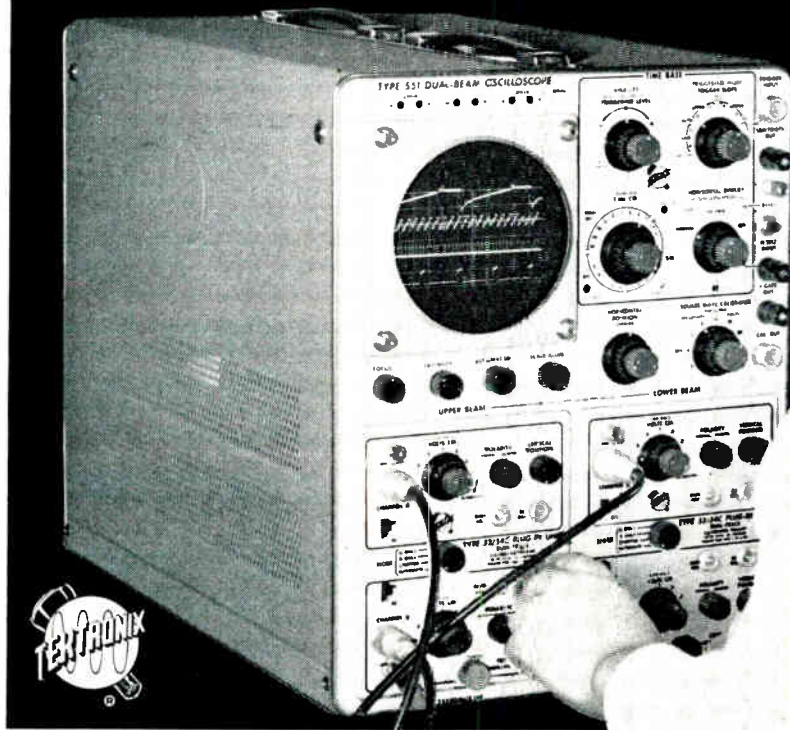

## TWO BEAMS

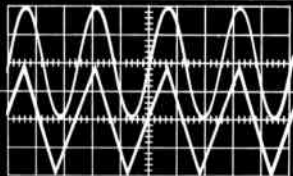

## FOUR TRACES

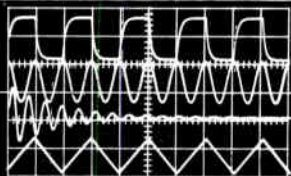

When the job requires it, you can double up and display four different waveforms at once with this dual-beam oscilloscope. Type 53/54C and/or Type C-A Dual-Trace Plug-In Units in both channels make possible the four-trace display.

Less spectacular but more frequent uses of this versatile fast-rise oscilloscope include waveform comparison measurements on a dual-beam display in the dc-to-25 mc range, and all the usual and unusual applications of a high-performance laboratory oscilloscope.

**PRICE**  
without plug-in units.....\$1800  
**Type 500/53A**  
Scope-Mobile.....\$110  
**Type K Fast-Rise**  
Plug-In Preamplifiers, each.....\$135  
**Type C-A Dual-Trace**  
Plug-In Preamplifiers, each.....\$250  
(f.o.b. factory)

**ENGINEERS**—interested in furthering the advancement of the oscilloscope? We have openings for men with creative ability in circuit and instrument design, cathode-ray tube design, and semiconductor research. Please write Richard Ropiequet, V.P., Eng.

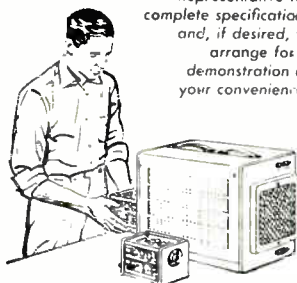

Please call your Tektronix Field Engineer or Representative for complete specifications and, if desired, to arrange for a demonstration at your convenience.

## TYPE 551 DC-to-25 MC

### Special Features

#### WIDE-BAND VERTICAL AMPLIFIERS

Main-unit risetimes—1.2  $\mu$ sec.  
Passbands and risetimes with Type K (53/54K) units—dc-to-25 mc, 0.014  $\mu$ sec.

#### SIGNAL-HANDLING VERSATILITY

All Tektronix A to Z Plug-In Preamplifiers can be used in both channels.

#### 0.2 $\mu$ sec DELAY NETWORKS

#### WIDE SWEEP RANGE

0.02  $\mu$ sec/cm to 12 sec/cm.

#### SINGLE SWEEPS

Lockout-reset circuitry.

#### COMPLETE TRIGGERING

Fully-automatic or amplitude-level selection with preset or manual stability control.

#### 10-kv ACCELERATING POTENTIAL

Brighter display for fast sweeps and low repetition rates.

## Tektronix, Inc.

P. O. Box 831 • Portland 7, Oregon

Phone CYpress 2-2611 • TWX-PD 311 • Cable: TEKTRONIX

**TEKTRONIX FIELD OFFICES:** Albertson, L. I., N.Y. • Albuquerque • Annandale, Va. • Atlanta, Ga. • Buffalo • Cleveland • Dallas • Dayton • Endwell, N.Y. • Houston • Lathrup Village, Mich. • Lexington, Mass. • East Los Angeles • West Los Angeles • Minneapolis • Mission, Kansas • Orlando, Fla. • Palo Alto, Calif. • Park Ridge, Ill. • Philadelphia • San Diego • St. Petersburg, Fla. • Scottsdale, Ariz. • Stamford, Conn. • Syracuse • Towson, Md. • Un an, N.J. • Willowdale, Ont.

**TEKTRONIX ENGINEERING REPRESENTATIVES:** Hawthorne Electronics, Portland, Oregon, Seattle, Wash.; Hytron-C, Measurements, Denver, Colo.; Salt Lake City, Utah.

Tektronix is represented in 20 overseas countries by qualified engineering organizations.

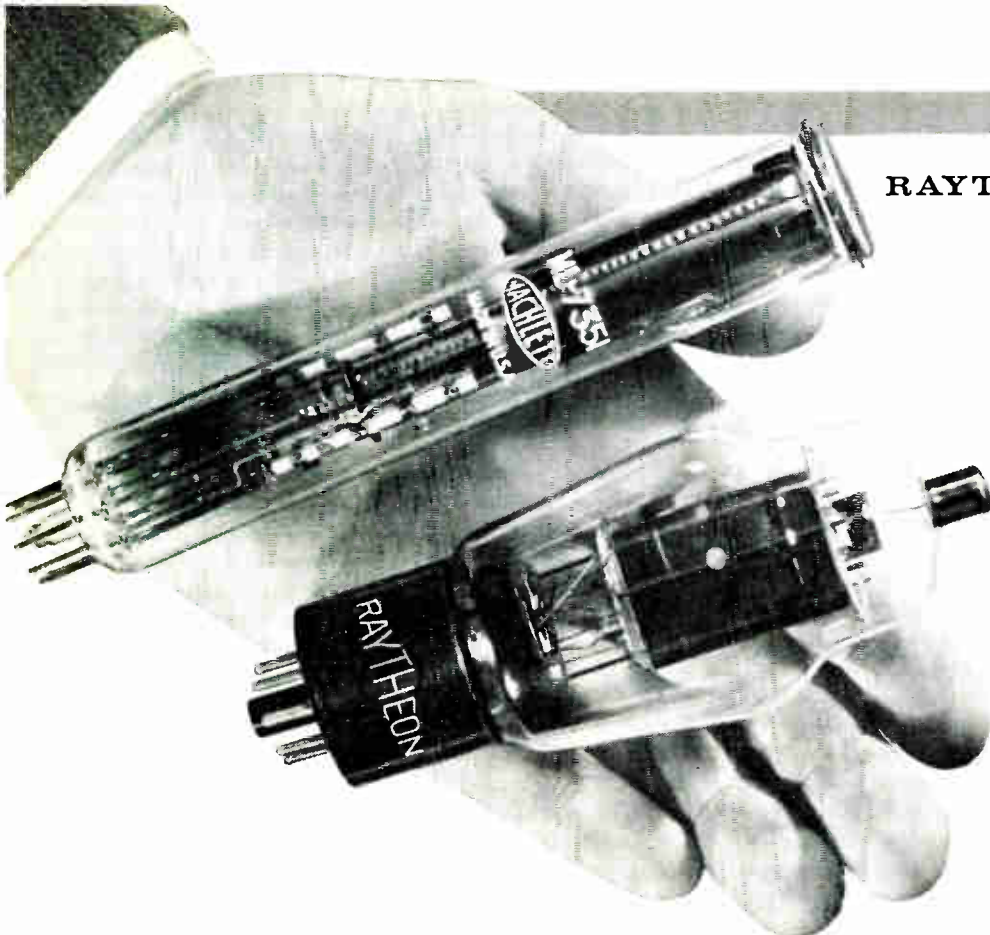

## RAYTHEON DISTRIBUTORS\*

Radio Specialties Company, Inc.  
Alamogordo, New Mexico  
HEmlock 7-0307

Radio Specialties Company, Inc.  
Albuquerque, New Mexico  
AM 8-3901

Wedemeyer Electronic Supply Co.  
Ann Arbor, Michigan  
NOrmandy 2-4457

Electronic Expeditors, Inc.  
Appleton, Wisconsin  
REgent 3-1755

Wholesale Radio Parts Co., Inc.  
Baltimore, Maryland  
MUIberry 5-2134

Forbes Distributing Company  
Birmingham, Alabama

Cramer Electronics, Inc.  
Boston, Massachusetts  
COpley 7-4700

DeMambro Radio Supply Co., Inc.  
Boston, Massachusetts  
AL 4-9000

Lafayette Radio Corp. of Mass.  
Boston, Massachusetts  
HUBbard 2-7850

Marks Parts Company  
Braddock, Pennsylvania  
ELeetric 1-1314

Valley Electronic Supply Co.  
Burbank, California  
VICToria 9-4641

Electrical Supply Corporation  
Cambridge, Massachusetts  
UNiversity 4-6300

Allied Radio Corporation  
Chicago, Illinois  
HAYmarket 1-6800

Newark Electric Company  
Chicago, Illinois  
EState 2-2950

United Radio Inc.  
Cincinnati, Ohio  
CHerry 1-6530

Main Line Cleveland, Inc.  
Cleveland, Ohio  
EXpress 1-1800

Pioneer Electronic Supply Co.  
Cleveland, Ohio  
SUperior 1-9411

Buckeye Electronic  
Distributors, Inc.  
Columbus, Ohio  
CA 8-3265

Graybar Electric Company  
Dallas, Texas  
RIVERSide 2-6451

Srepco, Inc.  
Dayton, Ohio  
BAIdwin 4-3871

**THE FINEST  
ELECTRONIC  
COMPONENTS  
ALWAYS ON HAND...  
CALL YOUR  
RAYTHEON  
DISTRIBUTOR**

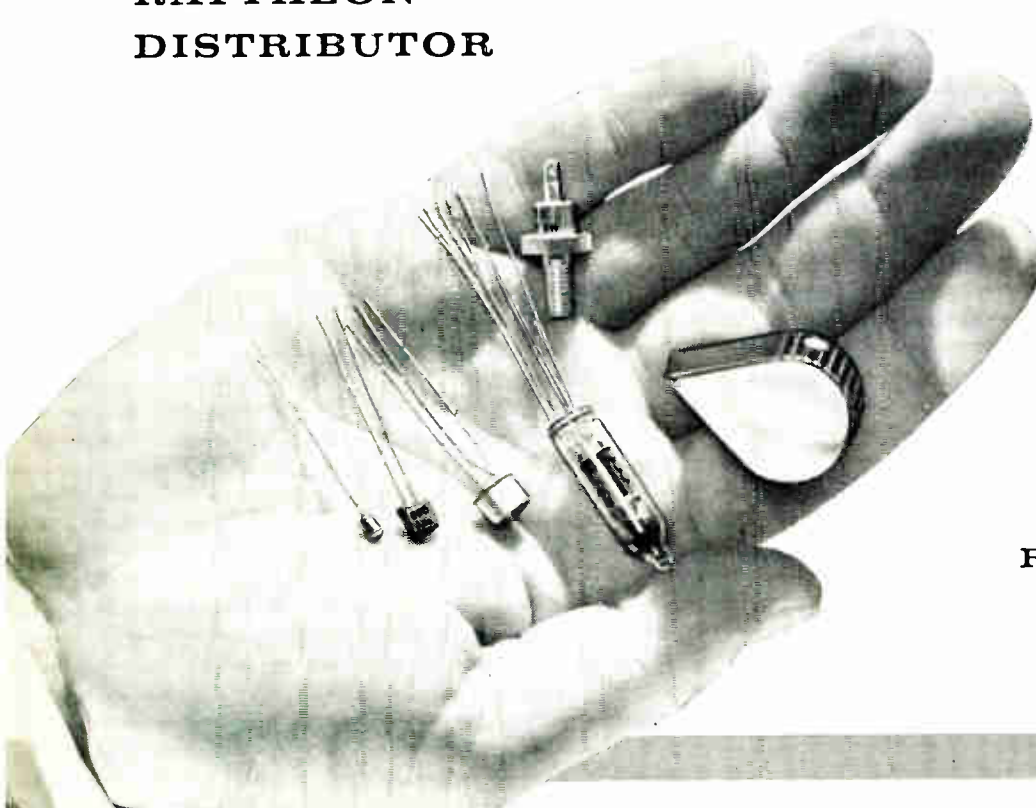

## RAYTHEON COMPANY

RECEIVING AND INDUSTRIAL TUBES  
SEMICONDUCTOR PRODUCTS  
MECHANICAL COMPONENTS

CIRCLE 146 ON READER SERVICE CARD



## SERVING KEY MARKETS INCLUDE...

Ward Terry Company  
Denver, Colorado  
AMherst 6-3181

Ferguson Electronic Supply Co.  
Detroit, Michigan  
WOODward 1-2262

R. V. Weatherford Co.  
Glendale, California  
VICtoria 9-2471

Electronic Expeditors, Inc.  
Green Bay, Wisconsin  
HEmlock 2-4165

Hollywood Radio Supply, Inc.  
Hollywood, California  
HOLlywood 4-8321

Harrison Equipment Company  
Houston, Texas  
CApitol 4-9131

Ellington Radio, Inc.  
Jackson, Mississippi

Burstein-Applebee Company  
Kansas City, Missouri  
BALtimore 1-1155

Bondurant Brothers Company  
Knoxville, Tennessee

Graybar Electric Company, Inc.  
Los Angeles, California  
ANGelus 3-7282

Kierulff Electronics, Inc.  
Los Angeles, California  
RICHmond 8-2444

Twin City Electronics  
Menasha, Wisconsin

East Coast Radio  
& Television Co.  
Miami, Florida  
FRanklin 1-4636

EX-EL Distributors, Inc.  
Milwaukee, Wisconsin

Electronic Expeditors, Inc.  
Milwaukee, Wisconsin  
FLagstone 2-2070

Milwaukee Electronic  
Expeditors, Inc.  
Milwaukee, Wisconsin  
GReenfield 6-4144

Arrow Electronics, Inc.  
Mineola, Long Island, New York  
Pioneer 6-8686

Electronic Expeditors  
of Minnesota, Inc.  
Minneapolis, Minnesota  
FEderal 8-7597

Forbes Electronic Distributors, Inc.  
Mobile, Alabama

H. L. Dalis, Inc.  
New York, New York  
EMpire 1-1100

Milo Electronics Corporation  
New York, New York  
BEekman 3-2980

Priest Electronics  
Norfolk, Virginia  
MA 7-4534

Brill Electronics  
Oakland, California  
TE 2-6100

Elmar Electronics  
Oakland, California  
Higate 4-7011

Electronic Expeditors  
of Oshkosh, Inc.  
Oshkosh, Wisconsin  
BEverly 5-8930

Almo Radio Company  
Philadelphia, Pennsylvania  
WAlnut 2-5918

Radio Electric Service Co.  
Philadelphia, Pennsylvania  
WAlnut 5-5840

Radio Specialties & Appl. Corp.  
Phoenix, Arizona  
AL 8-6121

Lou Johnson Company  
Portland, Oregon  
CApitol 2-9551

The George D. Barbey Co., Inc.  
Reading, Pennsylvania  
FR 6-7451

Meridian Electronics, Inc.  
Richmond, Virginia  
RICHmond 5-2834

Standard Supply Company  
Salt Lake City, Utah  
EL 5-2971

Radio Parts Company  
San Diego, California

Santa Monica Radio Parts Corp.  
Santa Monica, California  
EXbrook 3-8231

Thurow Distributors  
Tampa, Florida  
TAMpa 2-1885

Standard Radio Parts, Inc.  
Tucson, Arizona  
MA 3-4326

S & S Radio Supply  
Tulsa, Oklahoma  
CHerry 2-7174

Electronic Industrial Sales, Inc.  
Washington, D. C.  
HUdson 3-5200

Kenyon Electronic Supply Co.  
Washington, D. C.  
DEcatur 5800

Goddard Distributors, Inc.  
West Palm Beach, Florida  
TEmple 3-5701

*\*Arranged alphabetically by city.*

## DISTRIBUTOR PRODUCTS DIVISION

WESTWOOD MASS.

RAYTHEON/MACHLETT POWER TUBES  
VOLTAGE REGULATORS  
CAPTIVE HARDWARE



range from 1 to 17 mc, and maximum dissipations from 50 to 150 mw.

**CIRCLE 322 ON READER SERVICE CARD**

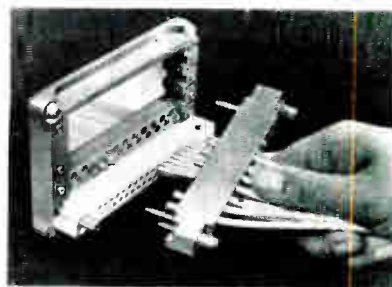

### Versatile Connector for miniature coax

BURNDY CORP., Norwalk, Conn., announces a compression-type Hyfen gang connector for miniature coaxial cable. Connector's pin and socket contacts are crimped to both inner and outer conductors. Connector frames will accommodate three, five or eight inserts, snapped in from either front or back. Inserts for coax cable accommodate up to 21 pins or sockets. A plug or receptacle insert may hold either male or female contacts, or they may be intermixed. Coax cable inserts and standard wire inserts may be mounted in the same frame. Contacts can be crimped to cable ends either after the harness is in place, or on a high-speed production basis, away from the equipment to be wired.

**CIRCLE 323 ON READER SERVICE CARD**

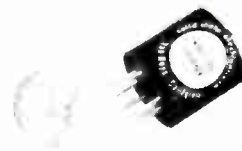

### Plug-In Chopper transistorized

SOLID STATE ELECTRONICS CO., 8158 Orion Ave., Van Nuys, Calif. Model 65 plug-in chopper (or modulator) incorporates a transformer-coupled isolating drive network so that it can, for example, be driven from a 100 cycle power line or from a drive source that is common to the d-c voltage being chopped. Sinusoidal or square wave drive may be utilized over a frequency range extend-

It helps  
to have  
a magnet  
when looking for  
a needle  
in a haystack

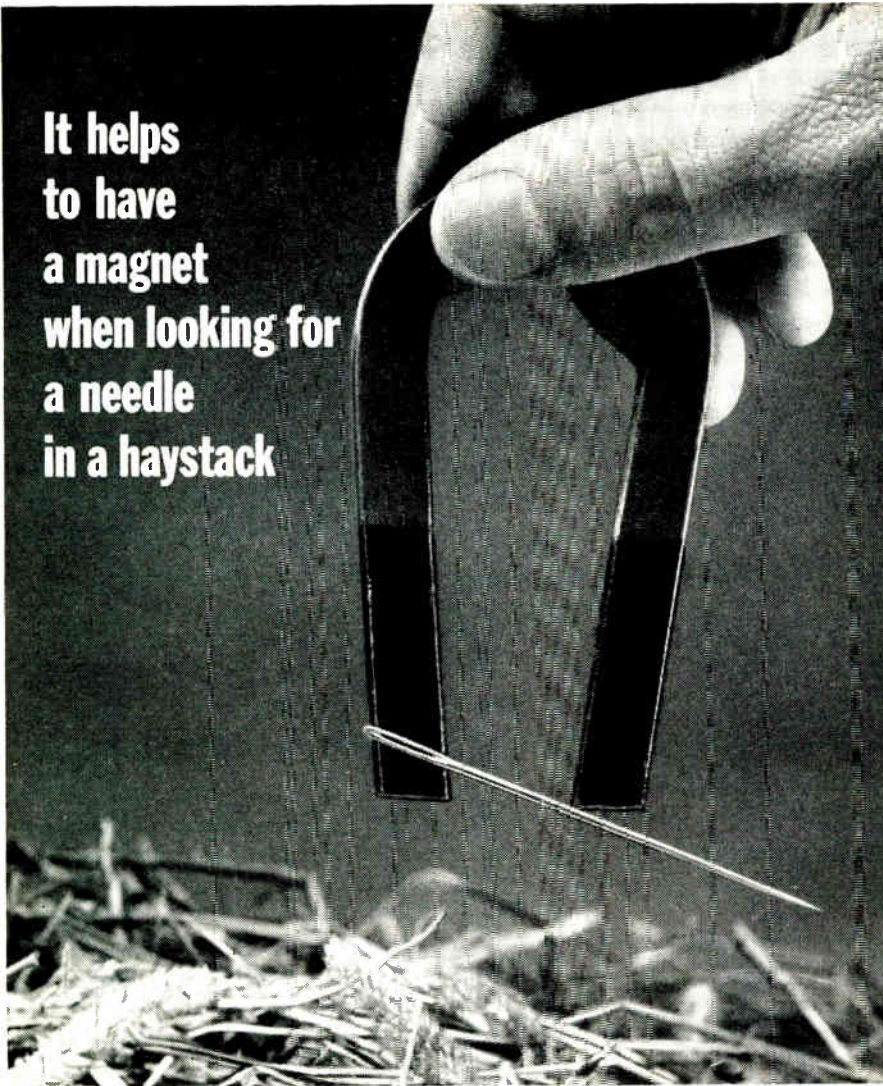

## Let GPU *Site-Service* find the right plant location for you!

GPU *Site-Service* is complete and confidential. As the one central source of plant location information for nearly half of Pennsylvania and New Jersey, it has full details about any of 1279 communities, large and small.

Its files contain more than 600 listings of available sites and buildings, ready to be matched to your requirements.

Contacting GPU *Site-Service* can be your first step toward location in one of the nation's finest industrial areas.

Wire, write or phone today. Your inquiry will receive prompt, confidential attention.

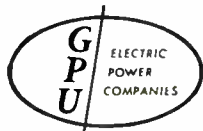

Metropolitan Edison Co.  
Pennsylvania Electric Co.  
New Jersey Power & Light Co.  
Jersey Central Power & Light Co.

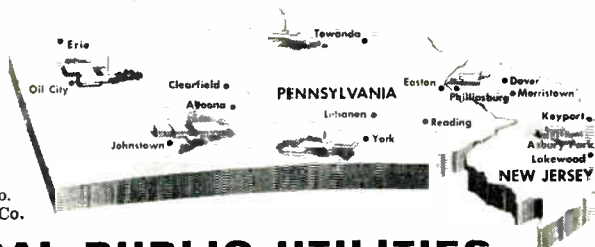

### GENERAL PUBLIC UTILITIES CORPORATION

Att: Wm. J. Jamieson, Area Development Director, Dept. E-9  
67 Broad St., New York 4, N.Y. WHitenal 3-5600

ing from 270 cps to 30 kc. Unit may also be used as a synchronous demodulator to convert an a-c signal to d-c.

CIRCLE 324 ON READER SERVICE CARD

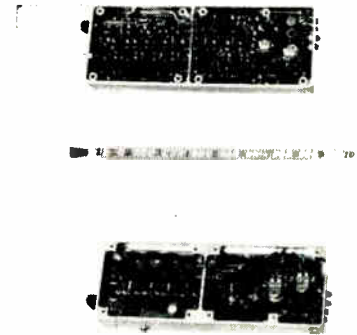

### I-F Amplifiers transistorized

REMANCO, INC., 1630 Euclid, Santa Monica, Calif. A line of i-f amplifiers utilize silicon tetrode transistors. Five models are available at 30 mc and 60 mc frequencies. Special units may be obtained at any center frequency up to 80 mc. Two basic types are available: (1) A hybrid unit incorporating a 7077 ceramic triode front end yielding a noise figure of 3.5 db at 60 mc and 2.0 db at 30 mc. (2) All transistor i-f's with the front end designed for minimum vswr. Units have exceptionally fast recovery time, wide dynamic range, and are quite compact in size. They withstand temperatures up to 85 C.

CIRCLE 325 ON READER SERVICE CARD



### Oscillogram Scanner instant response

THE GERBER SCIENTIFIC INSTRUMENT Co., 89 Spruce St., Hartford 1, Conn. Model S-25 oscillogram scanner permits the user to either independently or simultaneously scan up to four records. Oscillogram rolls up to 3 in. in diameter can be handled directly. Instrument consists of a Formica tabletop, 90 in. by 30 in. with guide rails for



Preformed cold drawn Nichrome Heating Elements being anchored into place indicate tremendous size of Lindberg missile furnace.

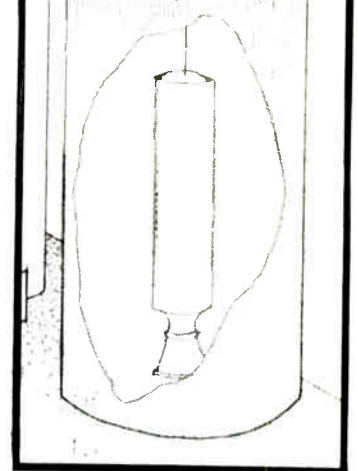
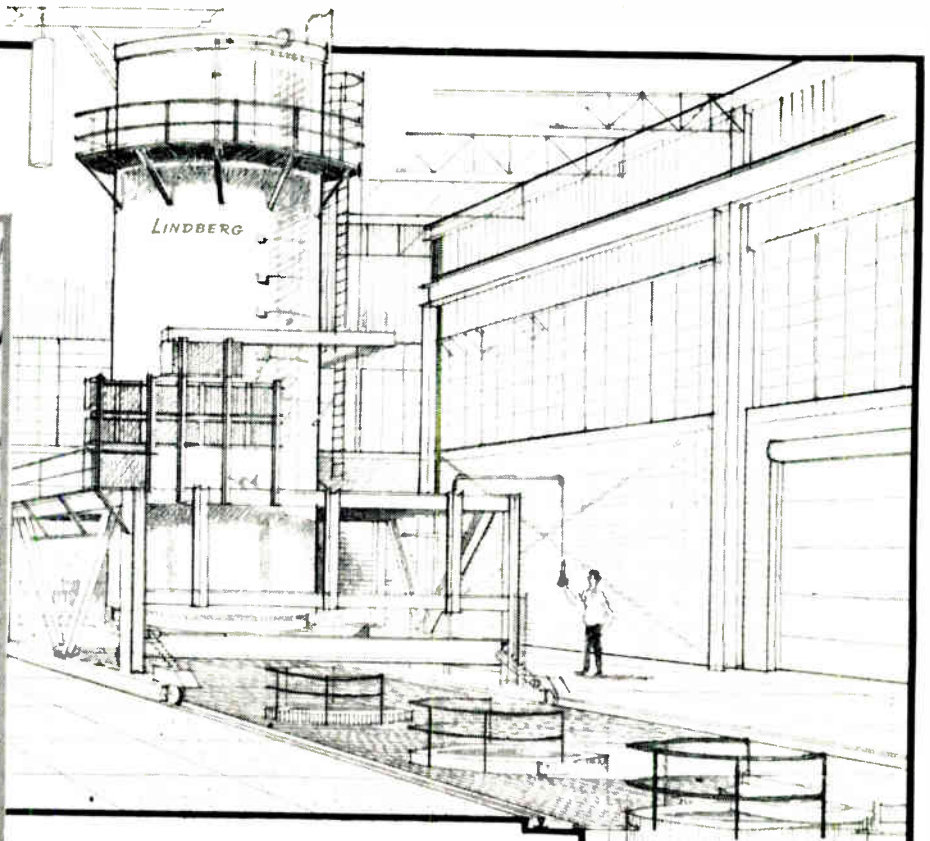
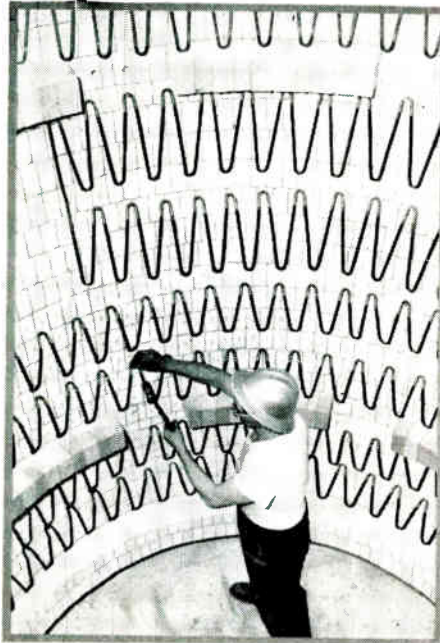

# Nichrome\* ELEMENTS HEAT WORLD'S LARGEST MISSILE FURNACE

2500 feet of extra heavy Nichrome V Wire provides 5-zone heating up to 2050°F

This giant 500 KW gantry type Lindberg\* hardening furnace is the newest and largest ever built to meet the most exacting heat treating requirements of today's, and tomorrow's, missile metals. It accommodates an effective work load nearly 7 ft. in diameter and 24 ft. long.

Now in operation at Lindberg Steel Treating Company's Melrose Park Plant, the controlled atmosphere installation is both bottom loading and bottom quenching. The 19' by 57' pit—28' deep, beneath the towering electrically heated furnace, houses the loading station, 2 quench tanks (atmosphere and salt) and water wash tank. Work loads pass from furnace to quench through an airtight seal, permitting complete control and pre-

cise duplication of atmospheres and treating cycles.

In the hardening furnace there are five control zones which operate between 250°F and 2050°F. Saturable core reactors automatically vary the voltage to the Nichrome\*V heating elements between 2.2 and 220 volts, depending on temperature and load.

The selection of Nichrome V by Lindberg to supply reliable and closely controlled heat and temperature in this furnace is further evidence of the confidence that industrial leaders have in the quality and performance of Driver-Harris high-nickel alloys. Why not benefit from their experience. Tell us about your requirements. \*T.M. Reg. U.S. Pat. Off. †Lindberg Engineering Company

## DRIVER-HARRIS\* COMPANY

HARRISON, NEW JERSEY • BRANCHES: Chicago, Detroit, Cleveland, Louisville

Distributor: ANGUS-CAMPBELL, INC., Los Angeles, San Francisco • In Canada: The B. GREENING WIRE COMPANY, Ltd., Hamilton, Ontario

MAKERS OF THE MOST COMPLETE LINE OF ALLOYS FOR THE ELECTRICAL, ELECTRONIC, AND HEAT-TREATING INDUSTRIES

ELECTRONICS • DECEMBER 4, 1959



CIRCLE 149 ON READER SERVICE CARD

149



# ADVANCED DESIGN COMPONENTS

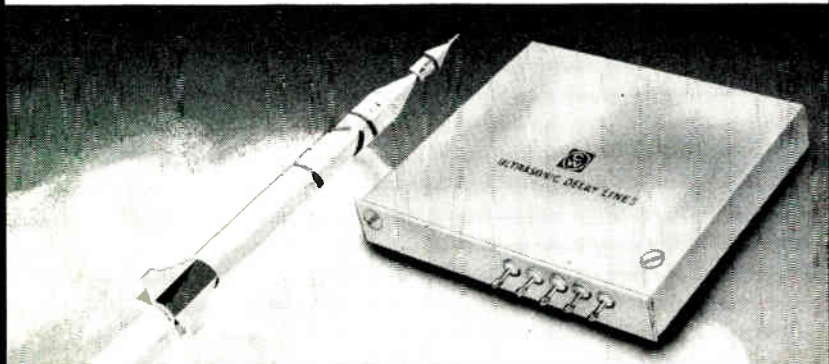

## New ULTRASONIC DELAY LINES

Low cost — Small size

Development engineers can now employ new concepts in existing and proposed applications. These Curtiss-Wright delay lines are extremely small, hermetically sealed and vibration proof. They are ideally suited for use in computers, coders and decoders, telemetering and navigational systems.

### SPECIFICATIONS

Delay range....5 to 6000 microseconds  
Tolerance..... $\pm 0.1$  microsecond  
Signal to noise ratio..Greater than 10:1

Input & output impedance...50-2000 ohms  
Carrier frequency.....100 kc-1 mc  
Delay to pulse rise time....Up to 800:1

### DIGITAL MOTORS

For high reliability applications

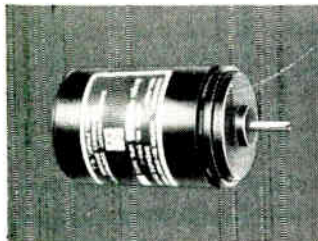

These stepping motors meet the requirements of assured reliability and long life for aircraft, missile and automation systems.

#### FEATURES

Dynamically balanced  
Bi-directional • Positive lock  
Simplicity of design  
High pulsing rate

### TIME DELAY RELAYS

For high vibration applications



"H" Series thermal time delay relays are designed to meet the high shock and vibration conditions of today's military applications.

#### FEATURES

Time delays from 3 to 180 seconds  
Temperature compensated  
Hermetically sealed • Miniature  
Meets rigid environmental specifications

WRITE FOR COMPLETE COMPONENTS CATALOG 159

ELECTRONICS DIVISION

# CURTISS-WRIGHT

CORPORATION • WEST CALDWELL, N. J.

each channel. A control panel permits the user to drive any one or all rolls either separately or jointly in either direction. Speed is adjusted by means of a rheostat. Special reading heads are available for either digital or analog readout to permit the operator to print or punch amplitude as well as time information into cards.

**CIRCLE 326 ON READER SERVICE CARD**

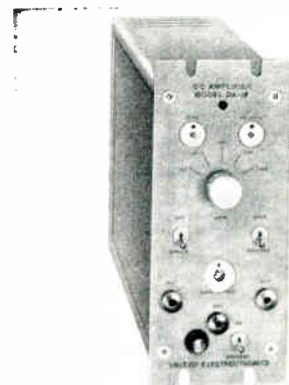

## D-C Amplifier transistorized

UNITED ELECTRODYNAMICS, 200 Alendale Road, Pasadena, Calif., announces a laboratory d-c amplifier with noise of only  $5.0 \mu\text{v}$ , peak to peak, a response time to a step function input of only  $7 \mu\text{sec}$ , an overload recovery time of  $50 \mu\text{sec}$  and a special heat control system which insures exceptionally low drift. Model DA-12 instrumentation amplifier is supplied with both differential input and differential output circuits which also function with either or both input and output single-ended.

**CIRCLE 327 ON READER SERVICE CARD**

## Antenna Tower heavy-duty

ROHN MFG. Co., 116 Limestone, Bellevue, Peoria, Ill., is producing a heavy-duty self-supporting tower to height of 130 ft and suitable for all types of communication needs. It is constructed by using 13 different tower sections of varying size, weight, structural strength and taper. The individual sections can be used in making additional combinations to build self-supporting towers of variable heights and structural capacities so as to fit the



particular need as required by the type antenna being used. Tower fulfills a large range of uses in mounting antennas for microwave, radio communications and tv reception.

**CIRCLE 328 ON READER SERVICE CARD**

### Silicon Diodes fast switching

RHEEM SEMICONDUCTOR CORP., 327 Moffett Blvd., Mountain View, Calif. Designed to meet military specifications, types RD2121-RD-2124 are for very fast computer switching applications. The diodes recover to 200 K ohms in 0.2  $\mu$ sec and have a typical capacitance of 1.5  $\mu$ mf. Units are available now in the standard subminiature glass package.

**CIRCLE 329 ON READER SERVICE CARD**

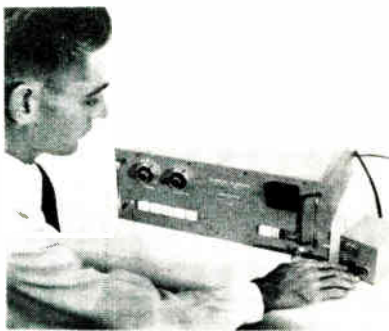

### Telemetry Calibrator transistorized

RAMO-WOOLDRIDGE, a division of Thompson Ramo Wooldridge Inc., P.O. Box 90534 Airport Station, Los Angeles 45, Calif. Model TG-72 transistorized telemetry calibrator features small size and optimum flexibility, and can be used in a variety of applications. It has 18 IRIG channels, which can be scanned  $\pm 7.5$  percent of center frequency. Three and 11 point frequency checks are available per channel on an optional basis, and all frequencies are accurate within 0.01 percent.

**CIRCLE 330 ON READER SERVICE CARD**

### Metal Film Resistor molded unit

ELECTRA MFG. CO., 4051 Broadway, Kansas City, Mo. Molded precision metal film resistor features low con-

With  Tape Recorders you get

# PRECISION + PORTABILITY

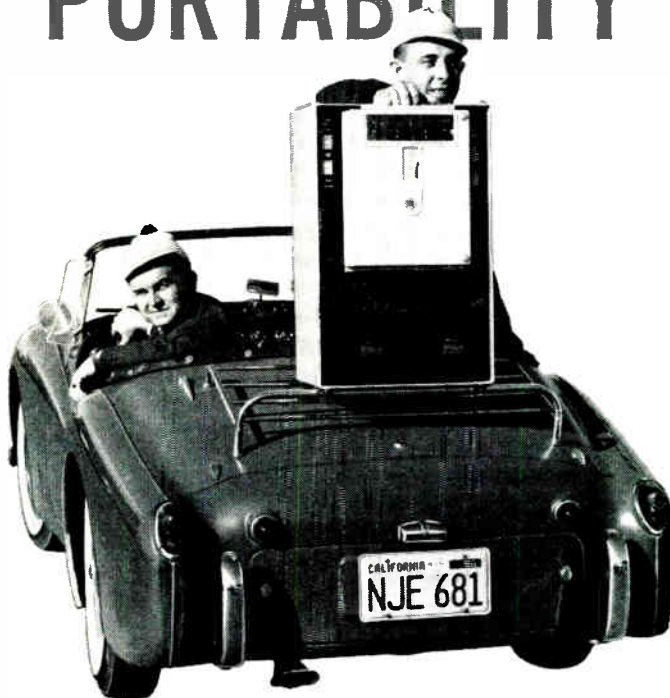

Here's a portable 14-channel magnetic tape recorder/reproducer with performance specs that meet or exceed 1,000-lb. models requiring 1000 watts.

Yet this Precision Instrument Co. recorder (largest of 3 portable models) weighs only 100 lbs. and uses just 275 watts!

There's no mystery about it. By combining transistorized, top-grade electronics and stacked reel tape magazines, **PI** produces recorders 1/10th the size and weight of 19-inch rack installations without sacrificing precision or flexibility.

That's why you'll find **PI** recording *and* reproducing test data in hard-to-reach locations, where space is limited or wherever portability is an advantage. For example, at missile sites, on mountain tops, aboard subs, even in a bathysphere.

In the laboratory, you can move a **PI** recorder from job-to-job, bench-to-bench as easily as any other item of test equipment. **PI** recorders use standard tapes and heads, are completely compatible with other makes of recording apparatus.

**PI's** portability is apparent. Now let us prove performance. Call your **PI** representative for literature and to arrange a *demonstration*, or write us direct. Please address Dept. 1812



*Precision Is Portable*

**PRECISION INSTRUMENT COMPANY**

1011 COMMERCIAL STREET • SAN CARLOS, CALIFORNIA • PHONE: LYTELL 1-4441

# When Top Quality Capacitors Are Required Specify Pyramid Mylar® or Tantalum

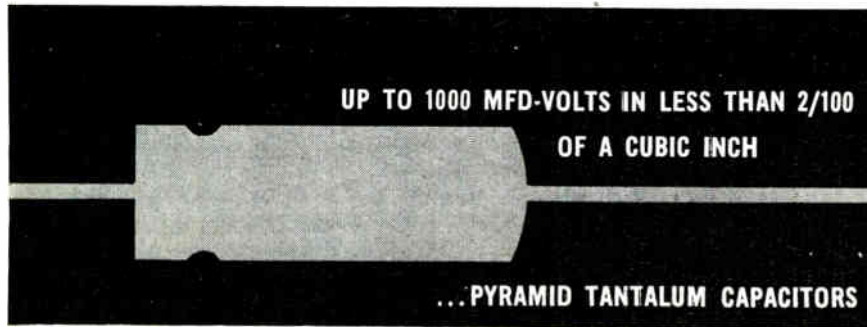

Miniaturized to provide maximum space economy.

New Pyramid Tantalum slug capacitors have cylindrical cases and contain a non-corrosive electrolyte. Due to the special construction of materials used in the manufacture of Pyramid Tantalum slug capacitors, these units are both seep and vibration proof. In addition, this type of capacitor assures long service life and corrosion resistance—made to meet MIL-C-3965 Specifications.

Commercially available immediately, these new Pyramid Tantalum capacitor units have an operating range between  $-55^{\circ}\text{C}$  to  $100^{\circ}\text{C}$  for most units without any de-rating at the higher temperature.

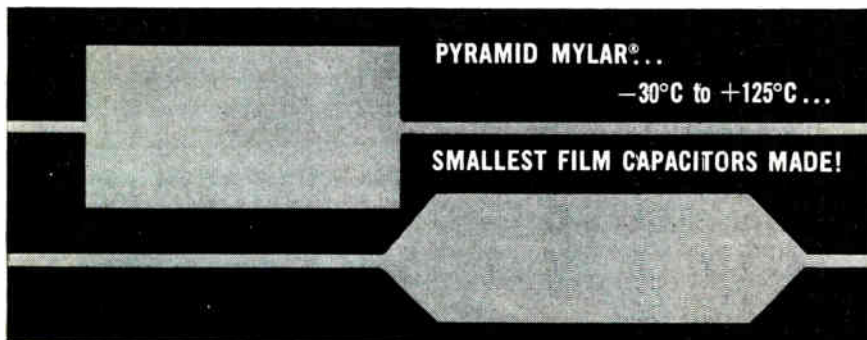

Pyramid new Mylar capacitors have extremely high insulation resistance, high dielectric strength and resistance to moisture penetration.

Commercially available immediately, Pyramid Mylar capacitors have an operating range between  $-30^{\circ}\text{C}$  to  $+125^{\circ}\text{C}$  with voltage de-ratings above  $+85^{\circ}\text{C}$ . Pyramid wrapped Mylar capacitors—Series Nos.: 101, 103, 106 and 107 have the following characteristics:

Construction Styles:	Basic No.	Type Winding	Shape
	101	Inserted Tabs	Flat
	103	Extended Foil	Flat
	106	Inserted Tabs	Round
	107	Extended Foil	Round

**Tolerance:** The standard capacitance tolerance is  $\pm 20\%$ . Closer tolerances can be specified.

**Electrical Characteristics:** Operating range for Mylar capacitors—from  $-55^{\circ}\text{C}$  to  $+85^{\circ}\text{C}$  and to  $+125^{\circ}\text{C}$  with voltage de-rating.

**Dissipation Factor:** The dissipation factor is less than 1% when measured at  $25^{\circ}\text{C}$  and 1000 CPS or referred to 1000 CPS.

Insulation Resistance:	Temperature	IR x mfd	Maximum IR Requirements
	$25^{\circ}\text{C}$	50,000	15,000 megohms
	$85^{\circ}\text{C}$	1,000	6,000 "
	$125^{\circ}\text{C}$	50	300 "

Pyramid Mylar capacitors are subject to the following tests:

**Test Voltage**—Mylar capacitors shall withstand 200% of rated D.C. voltage for 1 minute at  $25^{\circ}\text{C}$ .

**Life Test**—Mylar capacitors shall withstand an accelerated life test of 250 hours with 140% of the voltage rating for the test temperature. 1 failure out of 12 is permitted.

**Humidity Test**—Mylar capacitors shall meet the humidity requirements of MIL-C-91A specifications.

Complete engineering data and prices for Pyramid Mylar and Tantalum Capacitors may be obtained from Pyramid Research and Development Department.

© DU PONT REGISTERED TRADEMARK

CAPACITORS—RECTIFIERS  
FOR ORIGINAL EQUIPMENT—  
FOR REPLACEMENT

# PYRAMID

ELECTRIC CO.  
NORTH BERGEN, N. J.

EXPORT: 458 Broadway, N.Y. 13, N.Y. • CANADA: Wm. Cohen, Ltd.—7000 Park Ave., Montreal

trolled temperature coefficient, low noise level and high stability under severe humidity conditions. According to the manufacturer, it is smaller and lower in cost than a precision wire wound resistor, and features uniformity in size over wide resistance ranges. It is available in five sizes,  $\frac{1}{4}$  through 2 w.

CIRCLE 331 ON READER SERVICE CARD

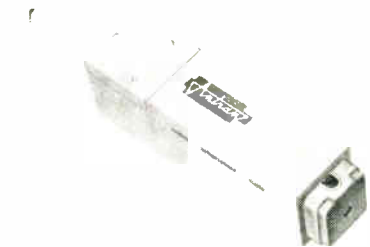

## R-1 Filter for screen rooms

ANTRAN, Greenwood Acres, Annapolis, Md. A filter with the attenuation characteristics necessary for filtering screen room telephone lines with no loss is announced. Unit permits the use of telephones and intercoms in the screen rooms without introducing interference. The 600-ohm impedance matches that of the telephone line. Unit has a telephone connector block for wiring to telephone lines. A balanced filter, it can be employed for any audio purpose. It is rated at 0.5 ampere, 300 v. 0 to 60 cycles. Resistance is 12 ohms.

CIRCLE 332 ON READER SERVICE CARD

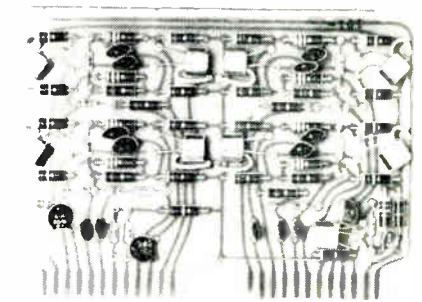

## Digital Module transistorized

COMPUTER CONTROL CO., INC., 983 Concord St., Framingham, Mass. Model BD-101 digital module consists of four transistor flip-flops which may be externally connected as a binary counter, as a binary



# SEVEN TUBES FOR STEREO

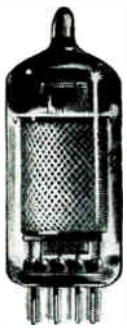

**EF86 6267**

High gain AF input pentode with exceptionally low noise, low hum and low microphony.



**ECC83 12AX7**

Double triode, low hum, low microphony, low noise, high gain tube.



**ECL82 6BM8**

Miniature triode pentode for use as audio amplifier and output tube. Two tubes in ultralinear push-pull can supply up to 7 watts of stereo power per channel.



**EL84 6BQ5**

Miniature 12 watt high slope pentode. A medium power high fidelity tube particularly suitable for compact stereo circuits, up to 17 watts per channel.

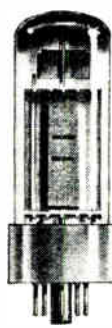

**EL34 6CA7**

Highly sensitive 25 watt pentode. Two tubes in ultralinear push-pull providing up to 34 watts output, particularly suited for compact integrated stereo amplifiers.



**EZ81 6CA4**

Miniature full wave cathode type rectifier with high voltage and good regulation supplying up to 150mA.

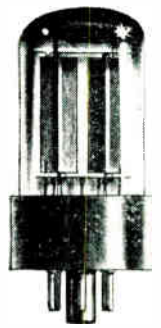

**GZ34 5AR4**

Bantac full wave cathode type rectifier, supplying high voltage with good regulation for currents up to 250mA.

**Mullard**  
ELECTRONIC TUBES  
used throughout the world



"Mullard" is the Trade Mark of Mullard Ltd., and is registered in most of the principal countries of the world.

**Supplies available from:**

**In the U.S.A.**

International Electronics Corporation  
81 Spring Street, New York, 12, N.Y.  
U.S.A. Worth 6-0790.

**In Canada**

Rogers Electronic Tubes & Components  
116 Vanderhoof Avenue, Toronto 17,  
Ontario, Canada. Hudson 5-8621.

**MULLARD OVERSEAS LTD., MULLARD HOUSE,  
TORRINGTON PLACE, LONDON, ENGLAND**

# MARCONI FM SIGNAL GENERATOR

*Covers 10 to 470 mc on fundamentals*



Model 1066A offers a unique combination of features essential to the exacting tasks required of a precision fm generator.

Its wide range is covered with the complete absence of spurious sub-harmonics. Directly calibrated stepped and continuous incremental tuning, supported by exceptional frequency stability, bring new ease and accuracy to bandwidth measurement. Deviation up to  $\pm 100$  kc is produced at either of two modulation frequencies by a ferrite modulator. Other major features are the Marconi-patented contactless range turret, and a piston attenuator giving a high-quality 50-ohm output.

#### MARCONI FM SIGNAL GENERATOR MODEL 1066A

##### Abridged Specifications

FREQUENCY RANGE: 10 to 470 mc in five bands—all on fundamentals. FREQUENCY STABILITY: Better than 0.0025% per 10-minute period after warm-up. INCREMENTAL FREQUENCY CONTROLS: Variable. 0 to  $\pm 20$  and 0 to  $\pm 100$  kc. Stepped,  $\pm 5$ , 10 and 15 kc. MODULATION: 0 to 20 and 0 to 100 kc deviation monitored and continuously variable; amplitude modulation at any depth up to 40% is also obtainable. MODULATION FREQUENCIES: 1 and 5 kc. OUTPUT: 0.1  $\mu$ v to 100 mv across a 50 $\Omega$  termination. OUTPUT ACCURACY: Incremental, 0.2 db; within 2 db overall. LEAKAGE: Negligible; allows full use of 0.1  $\mu$ v output. TUBES: 5Z4G, 6AK6, 6CD6G, 6AK5, 5861, 6C4, 6L6G, 12AT7, 6X2, 5651. Marconi FM Deviation Meters 791D and 934/2 are companion instruments. Send for leaflet B159 for full details.

**MARCONI  
INSTRUMENTS**

*Marconi  
for fm  
test gear*

111 CEDAR LANE · ENGLEWOOD · NEW JERSEY Tel: LOwell 7-0607  
Canada: Canadian Marconi Co. Marconi Building, 2442 Trenton Ave., Montreal 16  
MARCONI INSTRUMENTS LTD · ST. ALBANS · HERTS · ENGLAND

coded decimal counter, or as other multistage counter that requires feedback. Power required is +20 v at 20 ma and -90 v at 1 ma. Maximum input rate is 100 kc.

**CIRCLE 333 ON READER SERVICE CARD**

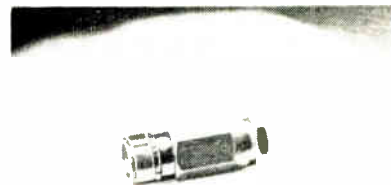

#### Cable Connectors subminiature

SEAELECTRO CORP., 139 Hoyt St., Mamaroneck, N. Y., has developed snap-on versions of its standard 50- and 75-ohm ConheX connectors. A spring ring or band around the slotted coupling sleeve provides the attachment means. These connectors are reduced in length and diameter for greater convenience as well as eye appeal.

**CIRCLE 334 ON READER SERVICE CARD**

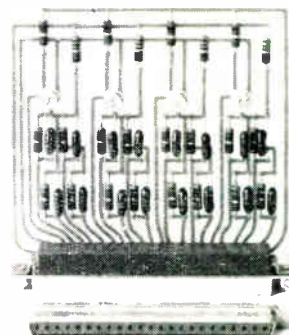

#### Module Blocks transistorized

WANG LABORATORIES, INC., 12 Huron Drive, Natick, Mass. Series 200 Logiblock transistorized module building blocks include "NOR" circuits, flip-flops, one-shot multi-vibrators blocking oscillators, coupling circuits, drivers for indicators or electromechanical devices. Each modular unit can perform many functions by using different connections on the socket. Floating sleeves and pins are used for the plug-in connection to insure very



low contact resistance after repeated insertions. Blocks are rated to operate at 200 kc although some may operate at 400 kc or higher.

**CIRCLE 335 ON READER SERVICE CARD**



### Transformer voltage regulating

RAYTHEON Co., Industrial Apparatus Division, Manchester, N. H. New voltage regulating plate-filament transformer performs the same functions as a conventional transformer while maintaining voltage within  $\pm 3$  percent of rated output with line variations from 100 to 130 v. Regulating voltages for both plates and filaments, the unit prolongs tube life and improves overall reliability and performance of the equipment in which it is installed.

**CIRCLE 336 ON READER SERVICE CARD**

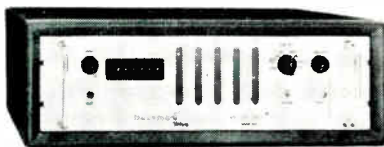

### Solid-State Counter weighs 21 lb

BERKELEY DIVISION, Beckman Instruments, Inc., 2200 Wright Ave., Richmond 3, Calif. Model 5311 is equipped with a highly variable counting interval so that users may obtain indications of flow, pressure and speed in desired units, such as gals/sec, psi or rpm. The counting interval may be varied in 10  $\mu$ sec steps from 10  $\mu$ sec to 1 sec. Frequency counting range is 10 cps to

**ELECTRONICS • DECEMBER 4, 1959**

**FIRST**  
it was  
industrial  
applications...

**THEN**  
exacting  
military  
systems...

**...and NOW**  
it's the  
**TV**  
**MANUFACTURER**  
who sees the solution  
to his problems...



*The frame grid is the closest approach to the ideal "Physicist's grid"—electrical characteristics but no physical dimensions. It results in:*

- higher transconductance per milliamper
- tighter  $G_m$  and plate current tolerance
- low transit time
- low capacitances
- lower microphonics
- rugged construction

...in  
**Amperex**  
**FRAME**  
**GRID**  
**TUBES**

FOR TV TUNERS

6ES8  
4ES8  
6ER5  
2ER5  
6DJ8

FOR MILITARY REQUIREMENTS  
AND  
EXACTING INDUSTRIAL APPLICATIONS:

6688  
6688A (MIL-E-1/1218)  
6922  
6922 (MIL-E-1/1168)  
5847 (MIL-E-1/467)  
5842 (MIL-E-1/468)

AVAILABLE FROM ALL  
AMPEREX FRANCHISED DISTRIBUTORS

#### AMPEREX FRAME GRID

The grid-to-cathode spacing tolerance is determined by the carefully controlled diameter of grid support rods (centerless ground) and by frame crossbraces between these rods. Extremely fine grid wire eliminates the "island effect" usually encountered in conventional tubes with equally close grid-to-cathode spacing. Rigid support of fine wires reduces mechanical resonance and microphonics in the grid

#### CONVENTIONAL GRID

Grid-to-cathode spacing tolerance depends on accuracy of grid dimension, obtained by stretching on a mandrel, and on tolerances of holes in top and bottom mica rod supports. Diameter of grid wire must be large enough to be self-supporting.

*For additional data write to*

Semiconductor and Special Tube Division  
Amperex Electronic Corporation  
230 Duffy Ave.,  
Hicksville, Long Island, N. Y.

in Canada:

Rogers Electronic Tubes & Components,  
116 Vanderhoof Avenue, Toronto 17, Ontario

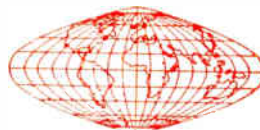

ask **Amperex**

about applications assistance on frame grid tubes for TV and FM tuners, and on reliable premium quality (PQ) tubes for industrial and military applications

**CIRCLE 155 ON READER SERVICE CARD 155**

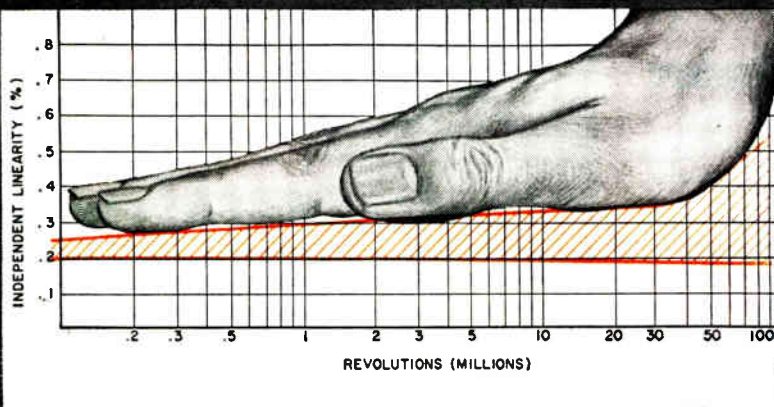

## only Markite Potentiometers...

**Limit Linearity Changes for  
more than 50 Million Cycles**



Where performance is paramount and critical applications demand the ultimate in reliability... Markite Potentiometers are specified.

The results of the quality control test charted above show why... linearity stability for more than 50 million cycles.

At Markite, achieving this high degree of reliability is nothing startling... it's normal... it's inherent... it's a product of Markite's program to surpass minimum requirements.

To complement reliable performance, Markite Conductive Plastic Potentiometers also provide:

- Infinite resolution.
- Independent linearity to 0.05% in 1 $\frac{5}{16}$  in dia. units.
- Operation in ambient temperatures up to 200°C.
- Shock and acceleration resistance in excess of 100g.
- Vibration resistance in excess of 70g.
- Rotational speeds up to 1,000 rpm.
- Operation under all applicable Military Specifications.

Write for Design Data and Catalog for Rotary and Rectilinear Potentiometers

**MARKITE PRODUCTS CORPORATION**  
155 Waverly Place • New York 14, N. Y.

200 kc. Transistorized circuitry offers maximum reliability over the ambient temperature range of - 5 F to + 150 F. The counter also makes highly accurate period measurements by timing the duration of from 1 to 100,000 cps in 10  $\mu$ sec units.

**CIRCLE 337 ON READER SERVICE CARD**

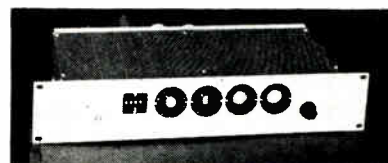

## High-Speed Counter eight-digit

OXFORD ENGINEERING Co., 47A River St., Wellesley Hills 81, Mass. Model 271A is an 8-digit high-speed counter which totalizes impulses up to a maximum rate of 1,200,000 counts per minute. The instrument is completely transistorized and utilizes cold-cathode decade counting tubes, affording low power consumption of less than 10 w. and extreme reliability.

**CIRCLE 338 ON READER SERVICE CARD**

## Filters tungsten carbide

ENGINEERED MATERIALS, P. O. Box 363, Church St. Station, New York 8, N. Y., is offering tungsten carbide filters of 60 percent density. They are said to withstand temperatures well above stainless-steel filters and have very high resistance to corrosion. The low density filters can be made to any desired shape.

**CIRCLE 339 ON READER SERVICE CARD**

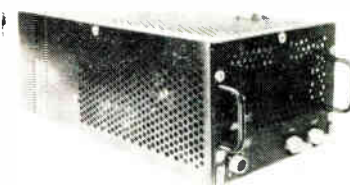

## Cooling Units self-contained

ELECTRO IMPULSE LABORATORY, 208 River St., Red Bank, N. J. These units are used to cool electronic tubes and high power resistors; can



- Reduce costs
- Simplify assembly
- Improve appearance with

# GRC

## DIE CAST ZINC ALLOY & MOLDED NYLON FASTENERS

**DIE CAST ZINC ALLOY**



Wing Nuts



Cap Nuts



Thumb Nuts



Thumb & Wing Screws



MOLDED NYLON Screws



Hex Nuts



Washers



Screw Insulators

- High in quality
- Uniformly accurate
- Low in cost
- Wide range of stock styles, types, sizes and threads

Produced in one high speed automatic operation, GRC's exclusive methods assure uniformity, smooth, rustproof & corrosion resistant surfaces and the lowest possible cost. New kinds of fasteners never before available... modifications in stock fasteners for specialized use... infinite variety in styles, types and sizes, have been made possible by GRC's special automatic die casting and molding machines.

Write, wire, phone RIGHT NOW for prices, your copy of GRC's NEW FASTENER CATALOG



**GRIES**

### WING NUTS



WASHER BASE



CAPPED

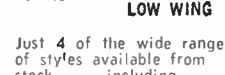

ECONOMY SERIES

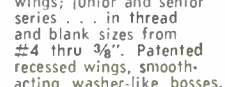

LOW WING

Just 4 of the wide range of styles available from stock... including extra low, high and round wings; junior and senior series... in thread and blank sizes from #4 thru 3/8". Patented recessed wings, smooth-acting washer-like bosses.

**GRIES REPRODUCER CORP.**  
 World's Foremost Producer of Small Die Castings  
 151 Beechwood Ave. • New Rochelle, N. Y.  
 New Rochelle 3-8600

CIRCLE 206 ON READER SERVICE CARD

# FOR MAXIMUM MINIATURIZATION & LOWER COST...

## Versatile Co-Netic and Netic Magnetic Shielding Foils

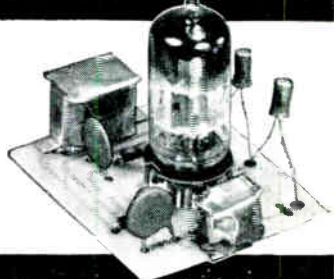

Permits positioning components closely without interference from damaging magnetic fields, making possible compact and less costly systems.



Cuts readily to any shape with ordinary scissors.

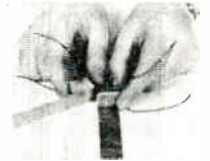

Wraps easily.



Easily fastens to walls for shielding entire rooms.



### How Co-Netic and Netic foils lower your magnetic shielding costs:

- 1) You use less shielding material because (a) foil thickness is only .004" and (b) foils cut easily to exact shape required, minimizing waste.
- 2) Odd shaped and hard-to-get-at components are easily shielded, saving valuable time and eliminating tooling costs and inflexibility of rigid metals.

These foils are non-shock sensitive, non-retentive, require no periodic annealing. They effectively shield electrostatic and magnetic fields over a wide range of intensities. Both foils available from stock in any desired length in various widths.

Co-Netic & Netic foils are successfully solving many types of magnetic shielding problems in numerous critical satellite, missile, magnetic tape and other military, airborne, electronic and laboratory applications. These foils can help you solve your magnetic shielding problems.

**MAGNETIC SHIELD DIVISION PERFECTION MICA CO.**  
 1322 No. Elston Avenue • Chicago 22, Illinois

CIRCLE 157 ON READER SERVICE CARD 157

# specify... G-E 125C TANTALYTIC\* CAPACITORS

for high-temperature miniaturized electronic equipment in high-speed aircraft.

- Designed for operation in ambient temperatures from -55C to +125C at full rated voltage.
- Rated for full 2000-hour life at 125C with not more than 25% loss of initial capacitance.
- Available in plain or etched foil, with both polar and non-polar construction.

SPECIFYING INFORMATION on G-E's complete Tantalytic line is available from your nearest Apparatus Sales Office, or write for GEA-6258B, to General Electric, Section 449-14, Schenectady 5, N.Y.

\*Registered trademark of General Electric Co.



CIRCLE 207 ON READER SERVICE CARD

ELECTRONICS • DECEMBER 4, 1959

first TRUE  
MINIATURE

"E"



## altitude-moisture resistant

AMPHENOL *MINNIE* connectors are the first true miniature "E" types—the only miniatures able to pass the new, exacting altitude-moisture immersion test. In this test mated, wired connectors are immersed in salt water and altitude cycled to 80,000 ft. for one minute, 65,000 ft. for one-half hour and then returned to ground pressure for another half-hour. *MINNIE* insulation resistance after this test is a minimum 1000 megohms.

In aircraft, in missiles and in exacting ground and sea applications AMPHENOL *MINNIE* connectors will provide outstanding service. Any company working with environmentally-resistant connectors is invited to write for complete *MINNIE* information.

*Unitized end grommet, stainless steel bayonet slots and pins, hooded socket contacts are other Minnie E features.*



**AMPHENOL** CONNECTOR DIVISION

Amphenol-Borg Electronics Corporation CHICAGO 50, ILLINOIS

also be used as the heat exchanger for calorimeters. Units include heat exchanger, circulating pump, storage tank, flow and pressure interlocks. Sizes are available between 10 w and 50,000 w. Model shown dissipates 1,500 w. Fluids used are transformer oil OS45 or DC200 fluid.

CIRCLE 340 ON READER SERVICE CARD



## Plug-In Circuits transistorized

VITRO LABORATORIES, 200 Pleasant Valley Way, West Orange, N. J. A series of transistorized, digital, plug-in circuits features complete input and output buffering. Built for rugged applications, the cylindrical modules are designed to minimize system design problems and assure functional reliability. Built-in buffering allows engineers to go directly from logic diagrams to circuitry. Modules for binary and linear counter stages, pulse shapers, pulse generators, multiple coincidence gates, and relay and neon drivers are provided as shelf items. Special circuits are readily available.

CIRCLE 341 ON READER SERVICE CARD



## Calibrator time/frequency

GENERAL RADIO Co., West Concord, Mass. Type 1213-D is a compact, crystal-controlled time/frequency



calibrator, with a short-time stability of 1 part in  $10^7$ , which furnishes standard frequencies from 10 kc to 1,000 mc not only for the calibration of electronic equipment, but also for the measurement of unknown frequencies. The instrument also provides timing markers at decade intervals from 0.1 to 100  $\mu$ sec.

**CIRCLE 342 ON READER SERVICE CARD**

## P-M Oscillator no cooling required

HUGGINS LABORATORIES, 999 East Arques Ave., Sunnyvale, Calif. Model HO22 backward wave oscillator is focused in a periodic permanent magnet structure. This development opens a wide range of new uses for the bwo. With no cooling required, all need for auxiliary power is completely eliminated. A capsule,  $11\frac{1}{2}$  in. by  $2\frac{1}{2}$  in., weighing 3.5 lb, replaces solenoid and power supply weighing approximately 50 lb.

**CIRCLE 343 ON READER SERVICE CARD**



## Bias Regulator dual unit

ARKAY ENGINEERING, INC., 225 Santa Monica Blvd., Santa Monica, Calif. Model RK60 is a transistorized unit with two independent bias-voltage regulators for use in transistor or tube circuit design. Each regulator provides continuously variable 0 to  $-6$  or  $-6$  to  $-30$  v d-c. Each regulated output can be metered with automatic range switching. Maximum input 35 v d-c; minimum input, 5v



## smaller size, longer life and ... it's rechargeable!

Rigid specifications of RCA Victor called for a tiny rechargeable battery to power two of its newest transistor radios. This battery had to be of sufficient reliability to permit advertising a 5-year warranty on performance. After extensive testing, it chose a "VO" sealed nickel cadmium button cell battery which exceeded specifications.



### Makes New Designs Possible

Powering the RCA Victor sets is only one of many new applications for these batteries. Imaginative engineers have already designed them into photoflash power packs, burglar alarms, missiles, aircraft, prosthetic devices — wherever *small size, large capacity, light weight, long life, no maintenance, complete reliability and easy recharging* are desired.



### Most Complete Line Available

"VO" cells are available in capacities of 100, 180, 250, 500 and 1750 mah; have a nominal 1.2 voltage; can be packaged in any combination to meet your voltage specs. Patented sintered plate construction provides exceptional cycling characteristics; highest capacity per unit size. Like more information? Write us for Bulletin No. VO-110.



Actual size  
of 100 mch  
button cell



Available from stock—  
GLENNITE BATTERY DISTRIBUTORS  
92-15 172nd Street, Jamaica, New York

**Gulon Industries, Inc.**

Alkaline Battery Division, Metuchen, New Jersey,

# TWELVE IMPORTANT CONTROLS

Uses include such equipment as aircraft instrument panels, shipboard control centers, ground control equipment in either fixed or mobile installations, industrial process control centers, electronic test instruments and computers. Twelve important controls to meet your design problems provide a new standard in reliability of operation.

**TP SERIES** — Types TP05, TP09, TP11, TP13, TP17 and TP20, in 6 sizes from 1/2" to 2" diameter. Each is a single-turn, high torque, rotary, wire-wound pot, engineered for peak performance under severe environmental conditions. Threaded bushings, precision register, mounting nut, lock washer and locating pin permit exact positioning for precise control. Available with non-linear functions, including complete series of sine-cosine functions. Accurate, dependable, long-life performance.

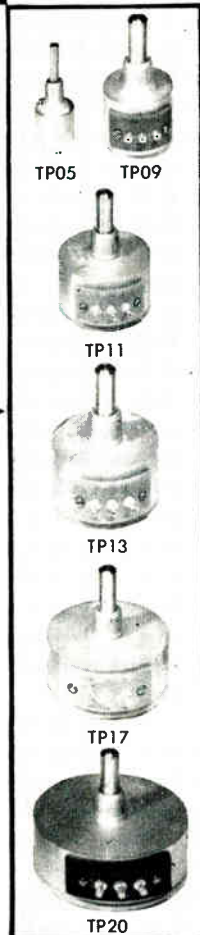

high torque panel control  
**POTENTIOMETERS**

**MTF SERIES** — Types M3TF, M5TF and M10TF. Housed in corrosion resistant box-like enclosures, all have a lead screw shaft arrangement for driving the wiper transversely from end to end of the resistance element. Encapsulated metallic film resistance element provides infinite resolution, 3, 5 or 10 turns (1080°, 1800°, 3600°) of rotation for accurate setting. Threaded bushing, with concentric locking device supplied to provide simple panel mounting knob for precise manual control.

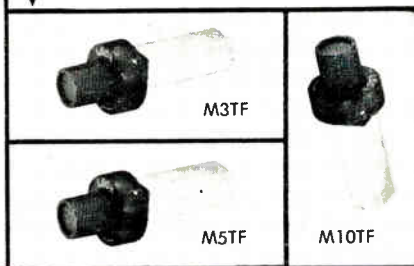

designed for precise setting

**P SERIES** — Types P1 1/4, P1 3/8 and P3 with numerals designating diameters. Especially designed for low cost commercial applications. These rotary type pots feature low inductance and capacitance. Available in linear or non-linear functions, single or ganged assemblies.

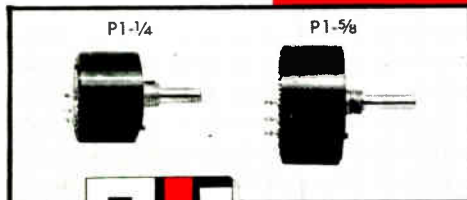

Get this new TIC catalog with complete details on the most complete line of precision potentiometers by calling, writing or wiring.



**TECHNOLOGY INSTRUMENT CORP.**  
569 MAIN STREET, ACTON, MASS.



**Subsidiaries:**  
Technology Instrument Corp. of Calif.  
North Hollywood, California  
Acton Laboratories, Inc., Acton, Mass.  
Tucson Instrument Corp., Tucson, Ariz.  
Serytrol, Inc., Chicago, Ill.  
Altomac Corp., Canton, Mass.

greater than desired output. Load regulation is 0.3 percent zero to full load; 0.1 percent regulation for ±10 percent change of input v d-c.

**CIRCLE 344 ON READER SERVICE CARD**

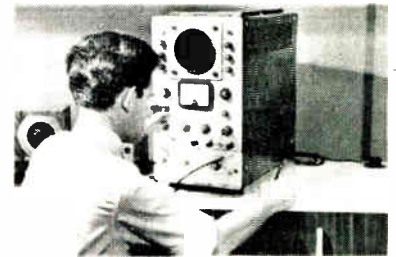

## Oscilloscope general-purpose

E.M.I. ELECTRONICS LTD., Hayes, Middlesex, England. The W.M.8 oscilloscope provides a wide variety of facilities which make it particularly suitable for tv waveform analysis, pulse measurement, computer development and production testing. The amplifier has differential inputs with a common attenuator switch. The fine gain control enables any signal to be displayed at a convenient size on the 5 in. crt. Oscilloscope has a bandwidth of d-c to 15 mc (-3 db); sensitivity is 1 v/cm to 25 v/cm (50 mv/cm to 25 v/cm using amplifier type 8).

**CIRCLE 345 ON READER SERVICE CARD**

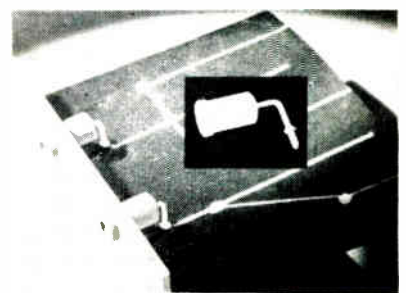

## Simplified Jack for printed wiring

SEAELECTRO CORP., 610 Fayette Ave., Mamaroneck, N. Y. Press-Fit type SKT-100 PC mounts in a metal angle-iron edging for the printed-wiring board, while the rear right-angle lug fits in a hole for the connection. It accepts a 0.080 in. diameter probe up to 0.025 in. long. Beryllium-copper contacts in the Teflon insulator body maintain high



# CIRCUIT DESIGN ENGINEERS NEEDED

IN SOUTHERN CALIFORNIA

**Bendix-Pacific**

the major source for instrumentation systems and components, offers you a unique opportunity to fully use your ability with a rewarding future as a qualified engineer.

Have you had two or more years experience in the design of VHF or UHF transmitters?

... in airborne packaging?

... in transistor circuitry?

If you have, we want to talk to you.

Please send resume to W. C. WALKER  
ENGINEERING EMPLOYMENT MANAGER



11604 SHERMAN WAY  
NORTH HOLLYWOOD, CALIFORNIA

Other High-Level Electronic Engineering Positions Available

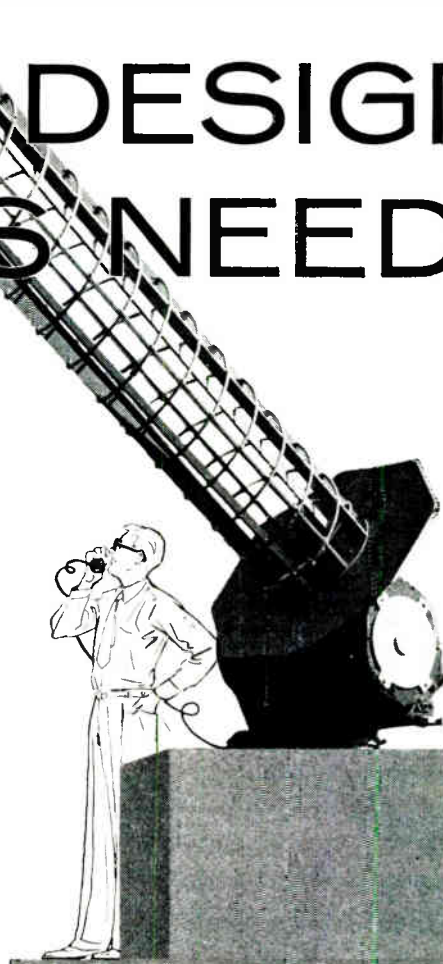

## Meet John Mason

Associate Editor, **electronics**  
MILITARY ELECTRONICS EXPERT

### Resumé:

Mexico City College, Mexico, BA. Air Force officer, navigator with 32 combat missions; Director of Flight Training, Pathfinder Radar School; head of Loran School. News editor, associate editor of aeronautical trade magazine, wrote free lance aviation articles. Recalled to Air Force, 1951, and studied at Georgetown Graduate School. Assigned to Libya, then Munich. Wrote news stories plus daily digest of iron curtain radio news.

### Present Occupation:

As an associate editor of **electronics** John is deeply involved with the technical and business aspects of military electronics (the current \$4.5-billion government market) and draws heavily on his electronics and Air Force background.



### References:

John is typical of the 26-man staff of specialists who edit **electronics** . . . men who produced 2,856 pages of editorial material during 1958. A mature, experienced staff, averaging 36 years of age, these people are dedicated to serving the needs of the reader of **electronics**. If your subscription to **electronics** is expiring, or if you are not a subscriber . . . if you will miss reading some of the exciting articles John Mason is planning for the near future . . . fill in the box on the Reader Service Card. It's easy to use. Postage is free.



**electronics**

A McGraw-Hill Publication • 330 West 42nd Street, New York 36, N.Y.

**marion**  
 advancement  
 in instrument  
 design

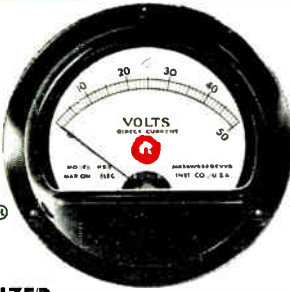

**SEALED  
 RUGGEDIZED  
 PANEL METERS**

The "Original"  
 MIL-M-10304-A  
 Instrument

HERMETICALLY SEALED... GLASS-TO-METAL

MIL 2 1/2" (MR26) and MIL 3 1/2" (MR36) sizes. Also 1 1/2" Ruggedized and 4 1/2" Sealed Models. vo, ma, amp, mv, volt, KV, AC rectifier types for voltage, decibel and VU measurement. Standard ranges. Bulletin on request. Marion Instrument Division, Minneapolis-Honeywell Regulator Company, Manchester, N. H., U. S. A.

Copyright © 1958, Marion

**marion**  
 "WHERE ELECTRONICS MEETS THE EYE"  
**meters**



**CIRCLE 208 ON READER SERVICE CARD**

retention with no signs of fatigue even after many insertions and withdrawals of an oversized probe.

**CIRCLE 346 ON READER SERVICE CARD**

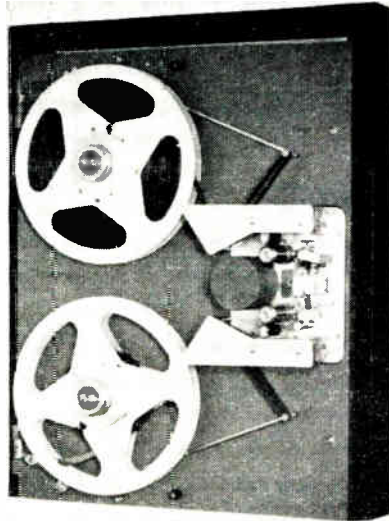

**Digital Transport  
 for low-speed use**

POTTER INSTRUMENT CO., INC., Sunnyside Blvd., Plainview, N. Y. Model 3280 transport serves in a typical application as a coupling device to digital communication circuits or as a recorder of long term data occurring at low rates. Speed range of from 10 ips to 0.1 ips is offered with fast start-stop capability to enable slaved operation for single character transfer. Dual speed combinations are available with standardized ratios. Completely transistorized electronics, end of tape sensors, and adaptability to various reel configurations are some of the featured characteristics.

**CIRCLE 347 ON READER SERVICE CARD**

**Trimmer Pots  
 panel-mount**

ATOHM ELECTRONICS, 7648 San Fernando Road, Sun Valley, Calif., announces a series of panel-mount trimmer potentiometers. The panel-mount, fabricated entirely of stainless steel, is available as an integral part on all trimmer types, or can be furnished as an accessory, complete with mounting hardware. Use of panel-mount trimmers permits greatest ease of circuit calibration without removal of cov-

**MICO** Precision Apparatus

**NEW HEAVY  
 DUTY 2 & 3  
 DIMENSIONAL  
 ENGRAVER**

FOR  
 Engraving  
 Nameplates  
 Fine Routing Work  
 Profiling Small  
 Objects  
 Making Small Dies  
 and Molds



**UHF COAXIAL  
 WAVEMETERS**



2-75  
 Centimeter  
 Range

Send for Illustrated Catalogs  
**MICO INSTRUMENT CO.**

77 Trowbridge St Cambridge 38, Mass.  
**CIRCLE 209 ON READER SERVICE CARD**

**fci**  
 Stabilized  
 Precision  
 Capacitors

TYPE	CAP. RANGE	V.D.C.	T:MP	P.F.	T.C.	I.R. 25°C	MIN. TOL.	SOAK-AGE
A	001-20MF	100-30KV	-55°C +85°C	02% 1KC	-100 PPM/C	10 <sup>6</sup> MEG	0.1	0.01%
B	001-20MF	600-20KV	-55°C +70°C	02% 1KC	+800 PPM	10 <sup>6</sup> MEG	1.0%	3.00%
C	001-20MF	100-30KV	-55°C +200°C	02% 1KC	-50 PPM/C	10 <sup>6</sup> MEG	0.1	0.01%
D	0001-20MF	100-60KV	-5°C +125°C	5% 1KC	+500 PPM	10 <sup>6</sup> MEG	1.0%	0.10%

ALSO MANUFACTURERS OF:  
 LOW CURRENT POWER SUPPLIES  
 2 KVDC-30 KVDC  
 METALLIZED PAPER & MYLAR CAPACITORS

**Film Capacitors, Inc.**  
 3400 PARK AVENUE - NEW YORK 56, N. Y.

send for this  
**FREE**

**EICO Electronics Catalog**

you save 50% on Top-Quality Test Instruments

**Hi-Fi • Ham Gear  
 KITS AND WIRED**  
 for professional and home use

<b>TEST INSTRUMENTS</b> battery eliminators battery testers bridges decade boxes electronic switch flyback tester oscilloscopes probes signal and sweep generators tube testers transistor tester vacuum tube voltmeters volt-ohm-milliammeters	<b>HI-FI</b> stereo and monaural tuners preamplifiers power amplifiers integrated amplifiers speaker systems
<b>HAM GEAR</b> cw transmitter modulator-driver grid dip meter	<b>OVER 1 1/2 MILLION</b> EICO instruments in use throughout the world.

LIFETIME service and calibration guarantee. IN STOCK at your neighborhood EICO dealer. Send now for FREE catalog E-11

**EICO** 33-00 N. Blvd., L. I. C. 1, N. Y.  
 ...praised by the experts as BEST BUYS IN ELECTRONICS  
 © 1958 ELECTRONIC INSTR. CO., INC.

**CIRCLE 210 ON READER SERVICE CARD  
 DECEMBER 4, 1959 • ELECTRONICS**



# 1959 IRE SHOW REGISTRATION:

6

0,

0

5

2

*and we're set to  
handle even more  
of you in 1960  
looking for*

## **NEW IDEAS in RADIO-ELECTRONICS!**

Yes, the IRE NATIONAL CONVENTION and RADIO ENGINEERING SHOW is growing bigger every year, and drawing more people—950 exhibitors representing 80% of the productive capacity of your industry—60,052 registrants last year! Yet, it's one of the most well planned, well executed gatherings you'll ever see!

There's room to move around, room to see all you want to see because the IRE takes over all 4 floors of the giant Coliseum in New York City to show what your huge, fast moving radio-electronics industry is coming up with. First and second floors for components; third for instruments and systems; and fourth for production items. Follow the engineers to the Coliseum for NEW IDEAS IN RADIO-ELECTRONICS, 1960!

**The IRE NATIONAL CONVENTION**  
Waldorf-Astoria Hotel  
**and The RADIO ENGINEERING SHOW**  
Coliseum, New York City

**MARCH 21, 22, 23, 24**

**The Institute of Radio Engineers**  
1 East 79th St., New York 21, N. Y.

**PRODUCTION ITEMS**

**INSTRUMENTS  
& SYSTEMS**

**COMPONENTS**

**COMPONENTS**



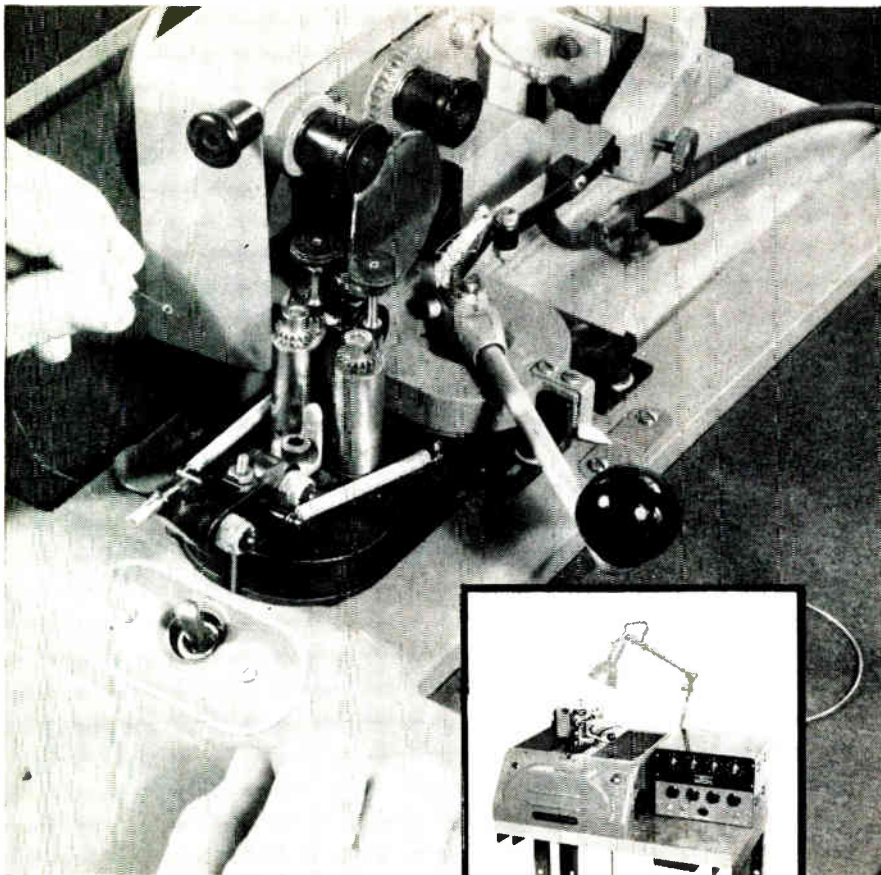

## NEW BOESCH MINITOR

... machine - winds  
1/32" toroids

The coil shown above is a 1/32" residual I.D. toroid being wound by machine on Boesch's new Model MW400 MINITOR. It's the smallest machine-wound coil ever made (only half as large as the smallest previously available), and it can only be wound on MINITOR!

This achievement reflects a completely new, unique method of coil winding perfected by Boesch. The wire is loaded *inside* a hollow, round cross-section shuttle, and the winding is spun out. A single loading of this unique shuttle is usually enough to wind several coils.

MINITOR handles wire sizes from #36 to #50 AWG, and winds up to 500 turns per minute. Maximum finished coil size is 3/4".

Shuttles for MINITOR are loaded by a Boesch PW-100 Loader. This machine can service as many as 20 winding machines, and it can load needles for hand winding as well.

If you now own a Boesch SM series machine, you can convert it to MINITOR operation economically by buying a 400-200 Head, a 400-300 Core Rotating Assembly, and the PW-100 Loader.

WRITE TO US TODAY for complete specifications, delivery schedules and prices on MINITOR.

**B** BOESCH MANUFACTURING  
COMPANY, INCORPORATED  
BOESCH DANBURY, CONNECTICUT

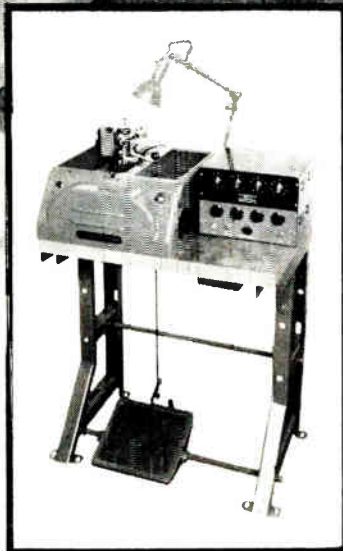

ers or housings, thus saving considerable time, and removing the possibilities of accidental damage to precision components and assemblies.

CIRCLE 348 ON READER SERVICE CARD



### Preamplifier for telemetering

LEL, INC., 380 Oak St., Copiague, L. I., N. Y. Designed to meet severe environmental conditions, the TP-4 telemetering preamplifier is enclosed in a weatherproof housing for antenna tower mounting and is complete with self contained power supply. Each is provided with a sun shield for use in tropical areas. Unit is designed to operate from a 50 ohm source, has 22 db minimum gain, 4 db maximum noise figure, and covers the 215 to 260 mc telemetering band. Individual test data, including a plot of noise figure vs frequency, are supplied.

CIRCLE 349 ON READER SERVICE CARD

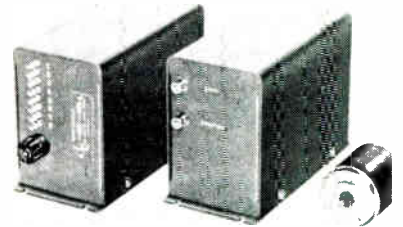

### Servo Amplifier transistorized

INDUSTRIAL CONTROL Co., 805 Albin Ave., Lindenhurst, L. I., N. Y. The 762A is a 60 cps servo amplifier designed to drive a size 18 servo motor from synchro resolver, or a-c pot



first again from Cornell-Dubilier...  
miniaturized filters for

# electronic noise suppression



INSERTION LOSS - DB

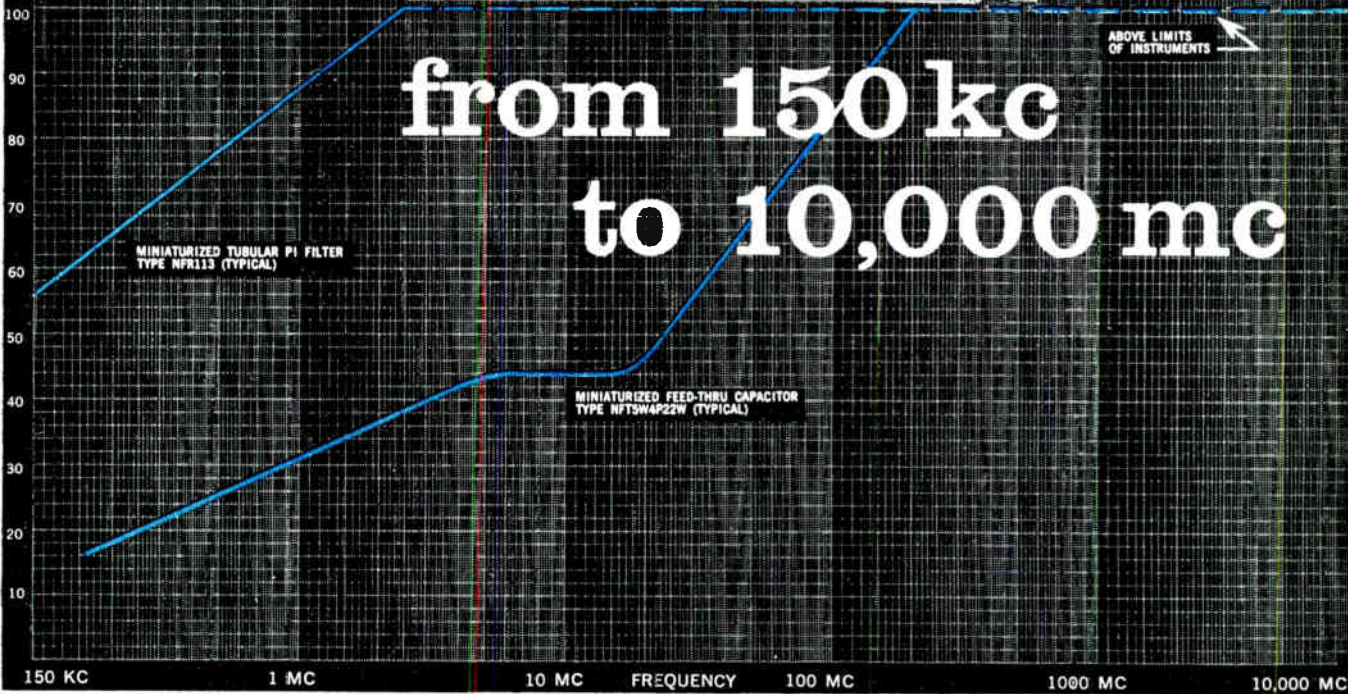

## Another First From The Cornell-Dubilier Filter Laboratories.

Now... MINIATURIZED pi filters and 3-terminal feed-thru capacitors for interference suppression at any frequency from 150 kc to 10,000 mc. No matter how unusual your design requirements, the C-D Filter Laboratories can deliver the precise suppression component you need. Tubular shapes, neck-mounting designs and smallest possible case sizes save space and weight, and provide easy installation. C-D's *miniaturized* tubular pi filters and feed-thru's also provide better insertion loss per unit volume, lighter unit weight and lower unit cost as compared to other types of suppression devices at identical ratings. To obtain complete specifications, write for Engineering Bulletins 171, 172 and 166 to Cornell-Dubilier Electric Corp., South Plainfield, N. J.

### MINIATURIZED SUPPRESSION COMPONENTS

#### Typical Specifications



Tubular Pi Filter TYPE NFR113

Voltage: 125 VAC (60 cycles), 300 VDC  
Current: 0.5 Amperes, Weight: 4.0 oz.  
Dimensions: 1" x 2-11/16"



Feed-Through Capacitor TYPE NFT5W11-22W

Voltage: 125 VAC (60 cycles), 400 VDC  
Current: 25.4 Amperes Capacitance: 0.22 mfd.  
Dimensions: .562" x 1-29/32" Weight: 0.83 oz



Consistently

reliable

# CORNELL-DUBILIER

## CAPACITORS



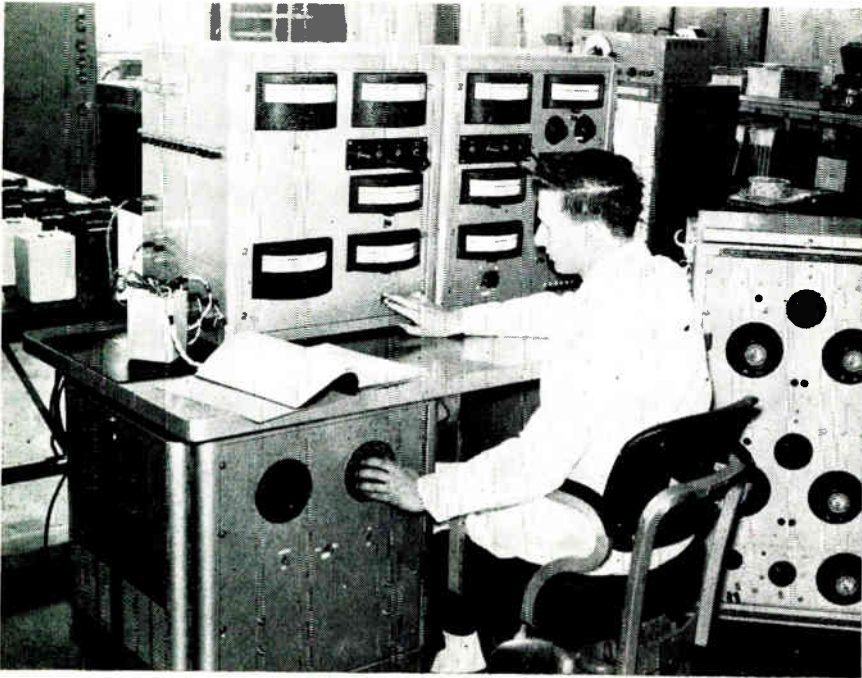

## It costs less to RENT AN ELECTRONICS LABORATORY than to buy one

You can save costly investment in laboratory equipment and staff... and still get top-quality R/D services... by using the complete product testing and evaluation facilities of United States Testing Company. Since 1880 thousands of clients in all industries have used our services to get:

### Improved Product-Design Through Testing

Our test engineers will set up an evaluation program that "locks in" with each step of your product development from design to prototype to finished product.

### An Independent Laboratory

We present a completely objective, unbiased approach to your design evaluation problems. All reports to clients are impartial, factual and confidential.

### Economical Handling of Peak Loads

We are equipped to take over your peak loads *immediately* at a fraction of what it would cost your company to maintain a staff of the necessary calibre.

### Product Qualification

Tests run by United States Testing Company are recognized by military and government procurement agencies in placing a product on the Qualified Product list.

### Facilities and Services

**Electronic Laboratory**—evaluates electronic components and systems in communications and industrial fields; includes automated facilities for low-cost collection of reliability data.

**Environmental Laboratory**—simulates high-low temperatures, humidity, altitude, immersion, salt spray, sand and dust, rain, fungus, vibration, shock, acceleration, etc.

**Materials Testing Laboratory**—conducts tension, compression and transverse tests on metals, ceramics, plastics, rubber and wood materials; spectrographic analysis and X-ray also available.

**Mechanical Laboratory**—evaluates mechanical, electro-mechanical hydraulic and pneumatic devices.

**Chemical Laboratory**—covers all fields including physical and biological chemistry; also infrared spectrophotometry.

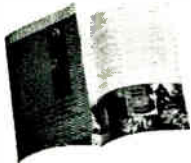

Send for your free copy of bulletin 5801 describing our complete services and facilities.

**United States Testing Co., Inc.**  
1415 Park Avenue, Hoboken, N. J.

Branch Laboratories

BOSTON • BROWNVILLE • DALLAS • DENVER • LOS ANGELES  
MEMPHIS • NEW YORK • PHILADELPHIA • PROVIDENCE • TULSA

The  
World's Most  
Diversified  
Independent  
Laboratory.



data. Twin controls are provided for gain and damping with which the loop performance can be optimized. Full output is obtained for 200 mv rms, into the input impedance of 100 K. The amplifier's carrier phase shift is +90 deg. Damping is adjustable, error-rate. Weight is 3½ lb; dimensions, 6¼ by 2¼ by 4¼ in.

CIRCLE 350 ON READER SERVICE CARD



### Microwave Filter for C-band

AIRTRON, INC., a Division of Litton Industries, Morris Plains, N. J., announces a compact microwave filter which passes a specific frequency band while sharply rejecting other frequencies above the pass band. Designed for C-band operation, the unit consists of a straight section of waveguide with four E-plane cut-off stub arms located along one broad wall of the waveguide. Higher rejection in the stop band is obtained by employing additional stub sections. Characteristics are: insertion loss in the pass band of 0.3 db max.; vswr in the pass band, 1.40 max.; rejection in the stop band, 30 db min.; and power handling capacity, 0.5 megawatt c-w.

CIRCLE 351 ON READER SERVICE CARD

### Servomotors high temperature

KEARFOTT Co., INC., 1500 Main Ave., Clifton, N. J. The R133-003 pinion shaft and R133-004 plain shaft size 11 servomotors are constructed of temperature resistant parts and impregnating materials and operate effectively at temperatures ranging from -54 C to +150 C. Extremely high torque-to-inertia ratios recommend the motors for use in critical applications. In addition, stators are integrally cast in a thermoset-



CAREERS SOAR.....

AT LINK-PALO ALTO

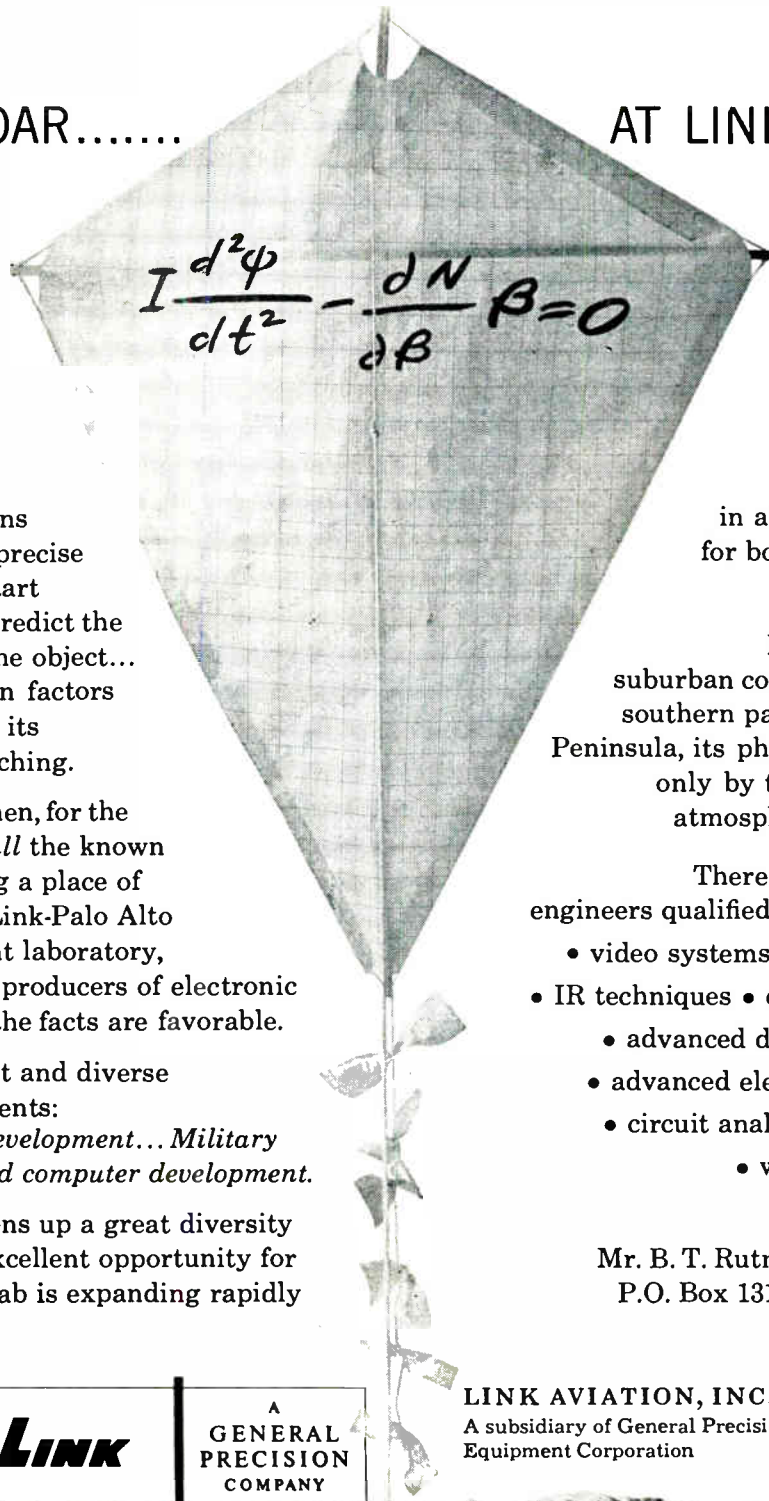

An engineer soon learns that in order to make precise projections, he must start with precise facts. To predict the reactions of an airborne object... even a kite...all known factors must be considered in its construction and launching.

How important it is, then, for the engineer to consider *all* the known factors when choosing a place of employment. At the Link-Palo Alto electronic development laboratory, (pioneers and leading producers of electronic flight simulators) *all* the facts are favorable.

Link has three distinct and diverse development departments:  
*Industrial products development... Military electronics... Advanced computer development.*

This arrangement opens up a great diversity of assignments and excellent opportunity for advancement, as the lab is expanding rapidly

in all areas of development for both our commercial and military customers.

Palo Alto is a charming, suburban community located on the southern part of the San Francisco Peninsula, its physical climate matched only by the benign professional atmosphere at the Laboratory.

There are many openings for engineers qualified in the following fields:

- video systems • electronic packaging
- IR techniques • engineering psychology
- advanced data processing systems
- advanced electro-mechanical design
- circuit analysis • computer design
- weapon system analysis

Move up! Write to Mr. B. T. Rutman, Link Aviation, Inc. P.O. Box 1318, Palo Alto, California



LINK AVIATION, INC.  
A subsidiary of General Precision Equipment Corporation





Photographed at G.E.'s Receiving Tube Plant, Owensboro, Ky.

## Lint-free Uniforms

You can reduce lint . . . improve product quality standards in precision work . . . by using uniforms of 100% filament DACRON\* polyester fiber. The smooth surface of DACRON yarns will not generate or pick up lint. These new uniforms are extra-durable, too . . . mean savings on replacement costs. And they keep their neat appearance with easiest possible maintenance.

**For advice tailored** to your own lint-control program write: Industrial Uniform Consulting Service, E. I. du Pont de Nemours & Co. (Inc.), Textile Fibers Department, 31G6 (E), Centre Road Building, Wilmington 98, Delaware.



BETTER THINGS FOR BETTER LIVING...THROUGH CHEMISTRY

\*Du Pont's registered trademark for its polyester fiber. Du Pont makes fibers, not fabric or uniforms shown. Enjoy THE DU PONT SHOW WITH JUNE ALLYSON, Monday Nights—10:30 P.M.—CBS-TV

168 CIRCLE 168 ON READER SERVICE CARD

ting resin to provide greater efficiency by permitting straight-through bores and minimum air gaps.

CIRCLE 352 ON READER SERVICE CARD

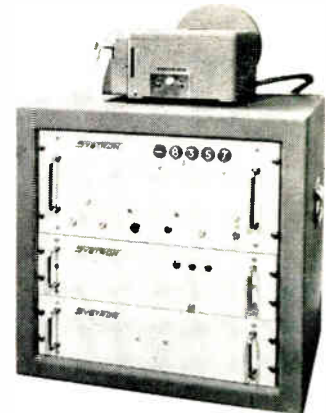

### Data Processor high-speed

SYSTRON CORP., 950 Galindo St., Concord, Calif., announces a single channel analog to digital conversion system providing a punch paper tape processed in binary coded decimal form for use with most special-purpose digital computers. The 161 system measures d-c voltages from  $3 \mu\text{v}$  to 1,000 v with an accuracy of  $\pm 0.05$  percent and at a recording speed of 10 per sec.

CIRCLE 353 ON READER SERVICE CARD

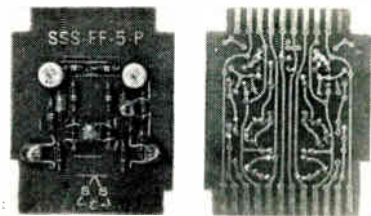

### Plug-In Modules control and logic

SOLID STATE SYSTEMS, INC., 5716 Camille Ave., Culver City, Calif. A line of transistorized plug-in modules includes flip-flops, gates, triggers, diode AND and OR logic units, power switching amplifiers and other modules for complete implementation of static control or computer systems with capabilities of accepting pulse repetition rates of 100,000 pps. Modules are  $2\frac{1}{2}$  in. wide by  $2\frac{3}{8}$  in. high by  $\frac{1}{8}$  in. thick and fit a standard 12-terminal p-c

DECEMBER 4, 1959 • ELECTRONICS



connector. All p-c conductors are hard gold alloy plated, minimizing contact resistance of tabs and improving solderability of the assembly.

CIRCLE 354 ON READER SERVICE CARD



### Potentiometers trimming type

HELIPOT DIVISION of Beckman Instruments, Inc., 2500 Fullerton Road, Fullerton, Calif. Helitrim trimming potentiometers use ceramic-metal resistance elements. Characteristics include: infinite resolution; 1.5 w power rating at 125 C ambient, derating to zero at 200 C;  $\pm 100$  ppm/deg C tempo above 500 ohms; 100 to 50,000 ohms resistance range; 2 ohms maximum end resistance and zero backlash. Environmental requirements of MIL-S-202, NAS-710 and MIL-R-19A as applicable are met or exceeded.

CIRCLE 355 ON READER SERVICE CARD

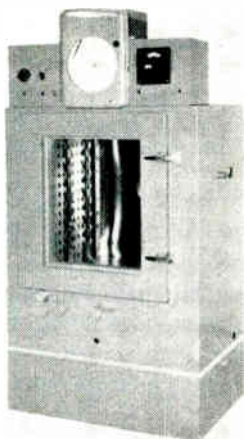

### Test Chamber hot-cold

ELECTRIC HOTPACK CO., INC., Cottman & Melrose Sts., Philadelphia 35, Pa. Designed for thermal shock and other controlled temperature testing and conditioning processes involving electronic components and parts, these chambers have tempera-

ELECTRONICS • DECEMBER 4, 1959

This ruggedized, shock and vibration-proof

preset counter is transistorized to

provide low power input and

insure trouble-free operation for

long periods... sealed against

splash, dust, and oil mist... module

plug-ins for easy servicing and quick

modification... small (3½" x 9½" x 13")

and light (10 pounds)...

for counting, batching, mixing,

sorting, winding, packaging and other

machine and process control... write for data sheet on...

**ERIE INSTRU/MATION 300T PRESET COUNTER.**



**ERIE PACIFIC** - DIVISION OF  
**ERIE RESISTOR CORPORATION**  
 12932 S. Weber Way, Hawthorne, Calif.

CIRCLE 169 ON READER SERVICE CARD

169

# CHICAGO

*ultra* *miniature*

## TRANSISTOR TRANSFORMERS

**Stocked for immediate delivery from your electronic parts distributor**

**Encapsulated — designed and built in accordance with MIL-T-27A**

Here are 27 hermetically sealed units designed especially for use in transistor circuits. Remarkably efficient for their size, these transformers have excellent frequency response with low harmonic distortion.

Leads are embedded in plastic to withstand a 12 pound pull and are individually spaced for printed circuit board insertion. The Chicago UME Series transformers measure .312" x .400" x .420" and weigh approximately 1/10 ounce. Detailed specifications and performance curves are given in Chicago Bulletin CT-46. Write for your free copy.

CHICAGO Part No.	Application	Pri. Impedance In Ohms	Sec. Impedance in Ohms
UME-12	output	500/600	50/60
UME-13	output	1000/1200	50/60
UME-14	output	600	3.2
UME-15	output	1200	3.2
UME-16	output	10,000	3.2
UME-18	choke	3 hy @ 2 Macd	—
UME-19	output or driver	10,000 CT/12,500 CT	500 CT/600 CT
UME-20	driver	10,000/12,500	1200 CT/1500 CT
UME-21	driver	10,000/12,500	2000 CT/2500 CT
UME-22	single or PP output	150 CT/200 CT	12/16
UME-23	single or PP output	300 CT/400 CT	12/16
UME-24	single or PP output	600 CT/800 CT	12/16
UME-25	single or PP output	800 CT/1070 CT	12/16
UME-26	single or PP output	1000 CT/1330 CT	12/16
UME-27	single or PP output	1500 CT/2000 CT	12/16
UME-28	single or PP output	7500 CT/10,000 CT	12/16
UME-29	output	300 CT	600
UME-30	output	500 CT	600
UME-31	output	900 CT	600
UME-32	output	1500 CT	600
UME-33	interstage	20,000 CT/30,000 CT	800 CT/1200 CT
UME-34	input	200,000 CT	1000 CT
UME-35	interstage	10,000 CT/12,000 CT	1500 CT/1800 CT
UME-36	choke	6 hy @ 2 Macd	—
UME-37	choke	1 hy @ 2 Macd	—
UME-38	choke	12 hy @ 0 dc	—
UME-39	choke	20 hy @ 0 dc	—

ture ranges from -65 F to 540 F. Maximum temperature uniformity and CO<sub>2</sub> dispersal is achieved by a built-in air circulation system. Controls include separate thermostats for operation above and below ambient temperatures.

**CIRCLE 356 ON READER SERVICE CARD**

### Power Supply high-temperature

ARNOUX CORP., 11924 W. Washington Blvd., Los Angeles 66, Calif. A line of precision regulated power supplies operate at such temperature extremes as +120 C and -55 C. Each is silicon transistor regulated with silicon rectifiers, tantalum capacitors and a Zener diode reference. Other characteristics include low ripple and low output impedance.

**CIRCLE 357 ON READER SERVICE CARD**



### Indicator Lamps microminiature

THE MENINGER CO., P. O. Box 243, West Caldwell, N. J. Models M-1 and M-2 incandescent lamps are designed for use in microminiature modules. They operate in the range of 1-1½ v and draw 25-35 ma. They measure 0.050 in. o-d, about 0.090 in. in length. The filament is wound from 0.0005 and 0.00025 in. tungsten wire over a 0.0015 mandrel. Bulbs feature long life and ruggedness.

**CIRCLE 358 ON READER SERVICE CARD**

### Tape Unwinder weighs 1½ lb

WESTERN APPARATUS Co., 2001 Greenleaf St., Evanston, Ill. Model TU-1 portable unit can be set on any flat surface of proper dimensions. Wound tape can be removed



Since 1955, Chicago Standard Transformer Corporation has been operating continuously under RIQAP, the U.S. Army Signal Corps' Reduced Inspection Quality Assurance Plan. When you specify Chicago Standard transformers, delivery time is reduced and incoming inspection is at a minimum. You are assured of the highest quality units for military application.

**CHICAGO STANDARD TRANSFORMER CORPORATION**  
3502 WEST ADDISON STREET CHICAGO 18, ILLINOIS

170 **CIRCLE 170 ON READER SERVICE CARD**

DECEMBER 4, 1959 • ELECTRONICS



from the company's TW tape winder and placed over the core of the unwinder reel for feeding from the center of the roll into a transmitter. Unit is 5 in. high, 12½ in. wide, 12 in. reel.

**CIRCLE 359 ON READER SERVICE CARD**



### H-V Supply regulated unit

COMPONENTS CORP., Denville, N. J. Model 61-R transistorized supply operates from 6 v d-c. Its high voltage output can be externally set from 900 to 1,200 v. A special Zener bridge is used for reference to regulate the output by means of a closed loop servo system. Units can be operated over a wide temperature range (up to 85 C). Price is \$200.

**CIRCLE 360 ON READER SERVICE CARD**



### Screening Table produces p-c boards

WYRKO PROJECTS, INC., 60 Main St., Binghamton, N. Y. Notably useful in the production screening of precision miniaturized boards and components, this screen printer will duplicate any number of identical circuit patterns from an original set up. Production fidelity of the circuit boards will not vary more than

**ELECTRONICS • DECEMBER 4, 1959**

# four-count 'em-four

Helipot builds four distinct lines of precision components. And each offers **the most** in design, production, delivery and value.

## Beckman Rotating Components

Unique size 8's . . . plus 11's, 15's and 18's . . . in servomotors, rate generators, inertia and velocity damps, gearheads and black box assemblies. Acceleration and response? Like heaven on earth!



## Beckman Expanded Scale Meters

AC/DC Voltmeters with ±0.1% accuracy, ultrasresolution, true rms indication. 126 standard and ∞ spec models. And there's more to meet your eye: expanded scale freq meters, linear scale ammeters, complete monitoring packages.



## Beckman Standard Breadboard Parts

24-hour delivery . . . 1,139 items . . . myriads of precision gears, grid plates, hangers, shaft hardware, limit stops, dials, differentials, magnetic clutches, ball-and-disc integrators . . . **but everything**

## Helipot Precision Potentiometers

When it comes to pots, we **do** make the most! A full single-turn family: 15 series in 1/2" to 3" dia. A complete multi-turn line: 19 series in 7/8" to 3-5/16" dia. All metal or economy . . . linear and non-linear . . . spec pots, trimming pots, delay lines, turns-counting dials. This **must** be the place!



For a real cool list of catalogs, data sheets and tech papers . . . ask for Literature Selector **A491**

Beckman / **Helipot**

Helipot Division of Beckman Instruments, Inc.  
Fullerton, California  
Engineering representatives in 29 cities .

60001 © 1959 B. I. C.

**CIRCLE 171 ON READER SERVICE CARD 171**

# FREE ANALYSIS OF YOUR DIFFICULT MACHINING PROBLEMS

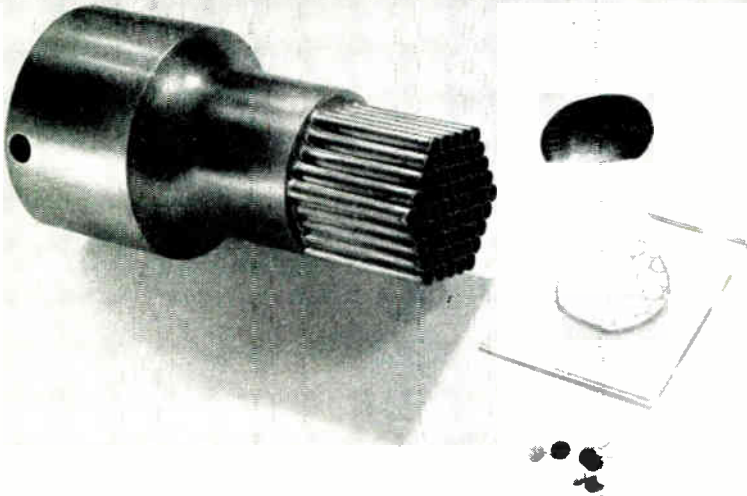

## Cuts Round Semiconductor Chips, Increases Yield 13%

**PROBLEM:** Cut round semiconductor chips from silicon and germanium wafers. Advantage of round chips is that for a given area they fit into smaller packages than rectangular chips. Also, round chips offer no orientation problem in packaging, thus lend themselves readily to automatic assembly.

**SOLUTION:** A Raytheon Impact Grinding Analyst recommended using ganged steel tubes brazed together as the cutting tool with a 700 watt Raytheon Impact Grinder.

**RESULT:** Round chips successfully mass-produced, yield per wafer of semiconductor material increased 13%.

**HOW YOU CAN BENEFIT:** Whatever your difficult cutting, slicing, drilling or shaping problem—in hard or brittle material your Raytheon Impact Grinding Analyst can help you solve it. For full details, fill out the enclosed coupon and send it in. No cost or obligation.



*Excellence in Electronics*

**MAIL THIS  
COUPON  
FOR FREE  
ANALYSIS**  
—without  
cost or  
obligation.

TO: RAYTHEON COMPANY  
INDUSTRIAL APPARATUS DIVISION  
PRODUCTION APPARATUS DEPT. GE12  
MANCHESTER, NEW HAMPSHIRE

- Please send me literature on Raytheon Impact Grinders.  
 Please have a Raytheon Impact Grinding Analyst contact me.

My problem is: (describe metals or non-metals involved, tolerances, etc.)

NAME \_\_\_\_\_

COMPANY \_\_\_\_\_

ADDRESS \_\_\_\_\_

CITY \_\_\_\_\_ STATE \_\_\_\_\_

0.005 in. in two dimensions. Machine offers a chase frame adjustable in 0.5 in. increments up to 24 in. by 36 in., and capable of accommodating circuit boards as large as 29½ in. by 17½ in. by ¾ in. thick.

**CIRCLE 361 ON READER SERVICE CARD**

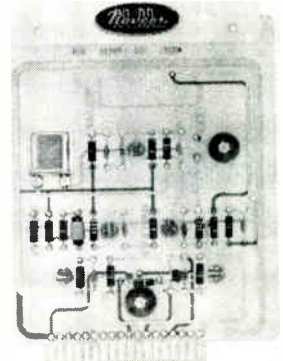

## Pulse Generator all-transistor

NAVIGATION COMPUTER CORP., 1621 Snyder Ave., Philadelphia 45, Pa. Model 300X pulse generator provides accurately timed clock pulses at crystal controlled frequencies. A standardized 2.5 v pulse of both polarities is generated by a crystal controlled oscillator. The output stage is transformer-coupled and has a constant voltage characteristic which maintains an undeteriorated pulse when loaded between 0 and 100 ma output current. It is accurate to 0.01 percent of crystal frequency and will operate from 0 to 135 F.

**CIRCLE 362 ON READER SERVICE CARD**



## Telemetering System silicon solid state

SOLID STATE ELECTRONICS Co., 8158 Orion Ave., Van Nuys, Calif. Model T-108 is a high temperature, ruggedized tone generating system capable of operation within associated f-m/f-m telemetering systems. Unit is designed to indicate the precise



# BEEDE-E-25

## EDGEWISE METER

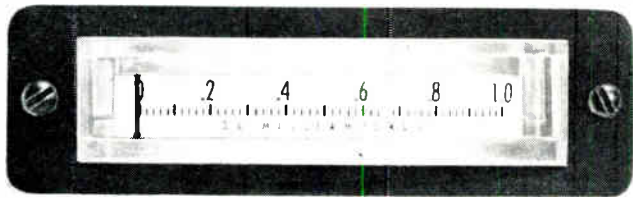

ACTUAL SIZE

... can be used in either Horizontal or Vertical position — may be paired for comparative reading.

Conserves Space where panel area is limited

Contains the Magcentric Self Shielding Movement

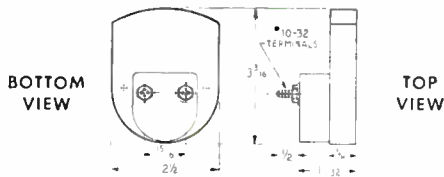

**BEEDE** ELECTRICAL INSTRUMENT CO., INC.  
PENACOOK, N. H.



CIRCLE 211 ON READER SERVICE CARD

**CO-AX**

# 4 mm f/ft

**★ ULTRA LOW capacitance & attenuation**

WE ARE SPECIALLY ORGANIZED TO HANDLE DIRECT ORDERS OR ENQUIRIES FROM OVERSEAS  
**SPOT DELIVERIES FOR U.S. BILLED IN DOLLARS—SETTLEMENT BY YOUR CHECK CABLE OR AIRMAIL TODAY**

TYPE	μF/ft	IMPED.Ω	O.D.
C 1	7.3	150	.36
C 11	6.3	173	.36
C 2	6.3	171	.44
C 22	5.5	184	.44
C 3	5.4	197	.64
C 33	4.8	220	.64
C 4	4.6	229	1.03
C 44	4.1	252	1.03

**NEW 'MX and SM' SUBMINIATURE CONNECTORS**  
Constant 50Ω-63Ω-70Ω impedances

TRANSRADIO LTD, 138A Cromwell Rd. London SW7 ENGLAND  
CABLES: TRANSRAD, LONDON

VITREOSIL® FUSED QUARTZ

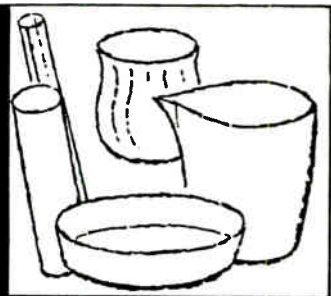

**OFFERS THE FINEST PROPERTY VALUES FOR FINER PRODUCTS**

- Absolute Chemical Purity
- Extreme Heat Resistance
- Thermal Shock Resistance
- Chemical Inertness
- Outstanding Electrical Properties
- Full Range Radiant Energy Transmission

In laboratories and other applications where critical requirements must be met, there is no room for second best. Vitreosil possesses properties of greatest value for: ultra-violet applications, metallurgical investigations, chemical research, photochemistry, spectroscopy, and many uses in physical, optical and electrical research as well as product operations.

Vitreosil is available in an unusually wide variety of types and sizes—Or, we'll be happy to fabricate to your specifications. Write us about your requirements today. For your convenience, use the coupon below. See our ad in Chemical Engineering Catalog.



**THERMAL AMERICAN FUSED QUARTZ CO., INC.**  
18-20 Salem Street,  
Dover, New Jersey

Please send technical data on

Company \_\_\_\_\_  
Name \_\_\_\_\_  
Street \_\_\_\_\_  
City \_\_\_\_\_ Zone \_\_\_\_\_ State \_\_\_\_\_

CIRCLE 173 ON READER SERVICE CARD

*Professional Opportunities Are Available For*

## **Electrical Engineers**

*with interest and experience  
in the following fields:*

- Design and Development of:  
Industrial Electronics and Power  
Controls and Instrumentation  
Electronics
- Operation & Maintenance of  
Nuclear Devices

*For information please write to:*

*Personnel Manager*

**Brookhaven  
National  
Laboratory**

**UPTON, LONG ISLAND, N. Y.**



occurrence and sequence of remote functions through environmental extremes. Standard unit contains 11 sine wave oscillators. Each oscillator output is controlled by means of a remote 28 v d-c supply through a gated switch. The opening of any or all gates allows the respective oscillator outputs to appear on the common bus of the summing amplifier where they are mixed. The mixed composite signal is amplified and may then be fed to a transmission line or to a voltage-controlled subcarrier oscillator for conversion to f-m within a specified IRIG band.

**CIRCLE 363 ON READER SERVICE CARD**



### **Frequency Standard transistorized**

NATIONAL CO., INC., Malden, Mass. Model NC-1200 frequency standard uses a transistorized crystal oscillator identical with the one used in the most advanced models of the Atomichron. It provides outputs of 0.1, 1.0 and 5.0 mc, all stable to one part in 10<sup>8</sup> parts per day. All three outputs may be used simultaneously and each is capable of developing an output voltage of 200 mv across a 50 ohm load. Oscillator meets MIL-E 16400 shock and vibration specifications.

**CIRCLE 364 ON READER SERVICE CARD**

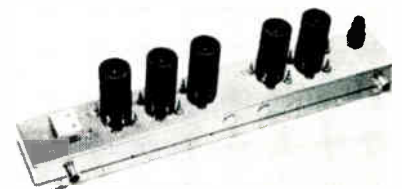

### **I-F Amplifier extended range**

LEL, INC., 380 Oak St., Copiague, N. Y. The I.F. 39 has a gain of 120 db, 3 mc bandwidth, 200 mc center frequency, detector output, and provision for gain control. A matched input noise figure of 6.5 db is stand-

## **environmental TESTING problems?**

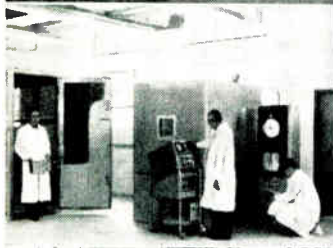
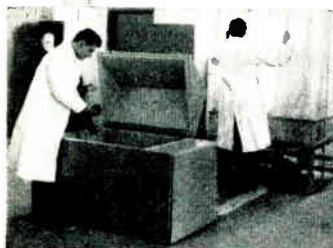

**SINUSOIDAL and RANDOM VIBRATION**  
(5 TO 5000 CPS — 120°F TO + 600°F  
200,000 FEET ALTITUDE)  
(WITH AUTOMATIC CONTROLLING, PROGRAMMING  
AND RECORDING)

**HIGH INTENSITY ACOUSTIC NOISE**  
(WITH DIRECT RECORDING)

**HIGH-LOW 1200°F TO — 120°F TEMPERATURES**  
(AT ALTITUDES TO 200,000 FEET)

**MISSILE SHOCK ACCELERATION TESTING**  
(SAWTOOTH — SINEWAVE — SQUAREWAVE)

**SALT SPRAY FUNGUS EXPLOSION**

**SAND & DUST HUMIDITY RAIN SUNSHINE**

**ROTARY ACCELERATION SHIELDED ROOM**

**FACILITIES QUALIFIED PERSONNEL**

**ITEMLAB INC.** 18 Beechwood Ave.  
Port Washington, N.Y.



ard; lower noise figure input circuitry can be supplied if required.

**CIRCLE 365 ON READER SERVICE CARD**

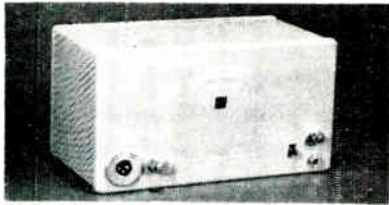

### Limiter-Expander compact unit

ELECTRONIC SYSTEMS ENGINEERING Co., 903 Cravens Bldg., Oklahoma City, Oklahoma. Model L.E-20 Lim-pander features a plug-in input transformer and an adjustable power output control, in addition to such operational characteristics as a 50  $\mu$ sec limiter attack and 25 milli-sec limiter release. Major design objectives were a small and compact unit that can be easily adapted to fit into any existing audio system, and provide the advantages of "voice intelligibility improvement" plus "background noise suppression". Unit produces 25 db of "soft sound" amplification, that penetrates dead spots, and overcomes room noises; combined with 50 db of automatic audio power control.

**CIRCLE 366 ON READER SERVICE CARD**



### Power Transformers for control uses

MICROTRAN Co., INC., 145 E. Mineola Ave., Valley Stream, N. Y., announces miniature epoxy molded control transformers. They are available on special order in va ranges up to 25 va and frequencies from 50 through 2,600 cycles. Nickel plated brass screw stud terminals are furnished. Strap, insert

# Measures

# 1 mv to 1000 v

# from

# 15 cps to 6 mc

Features Accuracy 3% to 3mc., 5% above - Input Impedance 7.5 mmfds shunted by 11 megohms

## BALLANTINE WIDE-BAND SENSITIVE VOLTMETER

Model 314  
Price: \$285

gives  
you  
these  
advantages:

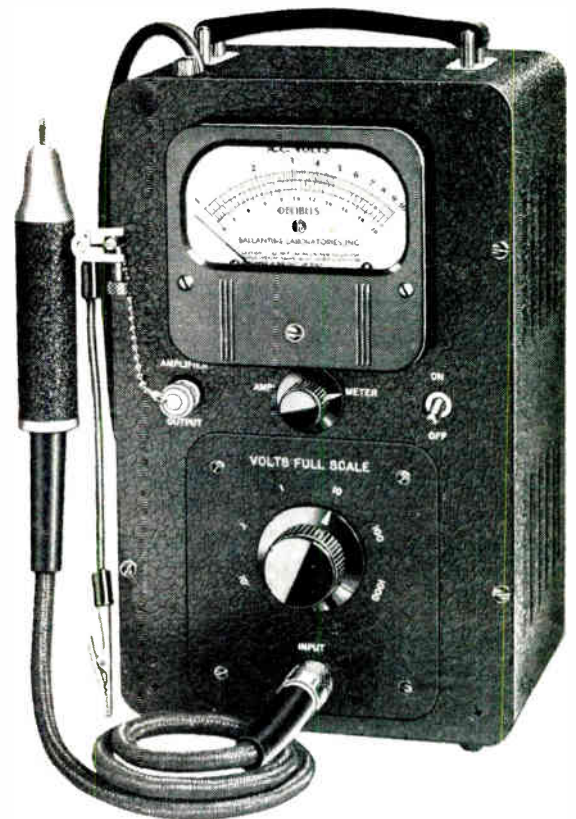

- Same accuracy and precision at ALL points on a logarithmic voltage scale and a uniform DB scale.
- Only ONE voltage scale to read with decade range switching.
- Probe with self-holding connector tip enables measurements to be made directly at any point of circuit.
- High input impedance insures minimum loading of circuit.
- Stabilized by generous use of negative feedback.
- Can be used as 60 DB video pre-amplifier.

**Write for catalog for complete information**

*Manufacturers of precision Electronic Voltmeters, Voltage Calibrators, Capacitance Meters, DC-AC Inverters, Decade Amplifiers, and Accessories.*



**BALLANTINE LABORATORIES, INC.** BOONTON NEW JERSEY



**Test:**  
*in progress*

**Readout:**  
*instantaneous*

Immediately evaluate your test results, using new, extra-thin Kodak Linagraph Direct Print Paper in suitable moving-mirror galvanometer oscillographs.

No wet processing! Records can be read as they're being made. And you get sharp, legible traces to 30,000 i.p.s.

New Kodak Linagraph Direct Print Paper on extra-thin base provides extra footage for longer runs. Sizes on request. For complete details, write to:

**EASTMAN KODAK COMPANY**  
Photo Recording Methods Division  
Rochester 4, N. Y.

*Now available on extra-thin base*

CIRCLE 213 ON READER SERVICE CARD

*new* **GEN-PRO**®

**SOLID-BLOCK TERMINAL BOARDS**

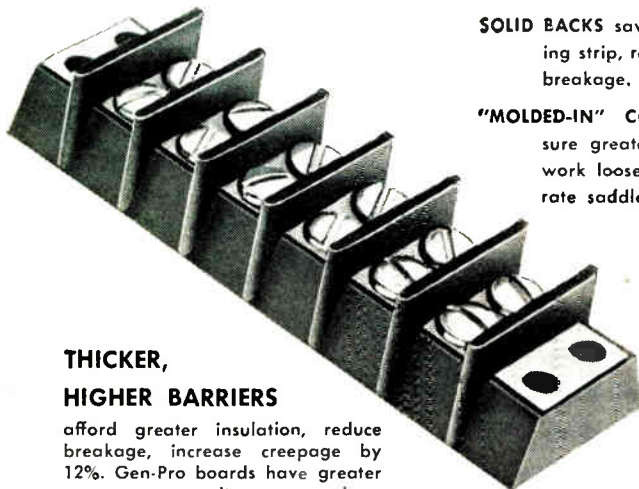

**SOLID BACKS** save cost of insulating strip, resist moisture and breakage.

**"MOLDED-IN" CONDUCTORS** assure greater capacity, can't work loose; eliminate separate saddle plates.

**THICKER, HIGHER BARRIERS**

afford greater insulation, reduce breakage, increase creepage by 12%. Gen-Pro boards have greater amperage capacity, are mechanically and electrically interchangeable with other boards. Also available with molding compound PER MIL-14E. Competitively priced. Immediate delivery.

Series 440  
Illustrated

**WRITE TODAY** for bulletin illustrating types in stock with specifications and list of lugs available.

**GENERAL PRODUCTS CORPORATION**  
Over 25 Years of Quality Molding  
UNION SPRINGS, NEW YORK TWX No. 169

176 CIRCLE 176 ON READER SERVICE CARD

or stud mounting is available. These units can be supplied to meet MIL-T-27 grades 2 and 5.

CIRCLE 367 ON READER SERVICE CARD

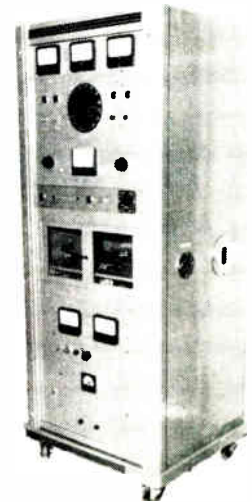

**R-F Signal Sources**  
varied applications

BURMAC ELECTRONICS CO., INC., Rockville Centre, N. Y. Model 700 is now available to the radar and microwave industry. Series is available for c-w pulse or dual modes of operation. Unit incorporates optimum wave shape and circuit parameters to insure proper operation of the r-f generator tube and is available from uhf through and including the K band, microwave frequency spectrum. Antenna measurements, component testing and auxiliary transmitter functions are typical applications.

CIRCLE 368 ON READER SERVICE CARD



**Ultrasonic Cleaner**  
high-power

NATIONAL ULTRASONIC CORP., 111 Montgomery Ave., Irvington, N. J. Model 240 is designed for use where high energy density ultrasonic cleaning is required. It features a 5-gallon heavy-gage polished stainless steel tank 12 in. long, 12 in.

DECEMBER 4, 1959 • ELECTRONICS



Announcing . . .

LABORATORY STANDARD  
**R. F. VOLTMETERS**



- Flat response to 100 megacycles/sec.
- Ideal for checking V T V M's
- Calibrate on D.C. or 60 cycles/sec.
- Can be certified by Bureau of Standards
- Separate thermocouple units available in ranges 1 volt, 3 volts and 10 volts
- Also units for 30 volts and 100 volts with less frequency range

Write for Bulletin 800.

**Rawson**  
ELECTRICAL INSTRUMENT CO.  
*fine instruments since 1918*  
111 Potter Street • Cambridge, Mass.

CIRCLE 235 ON READER SERVICE CARD

**How To Get Things Done  
Better And Faster**

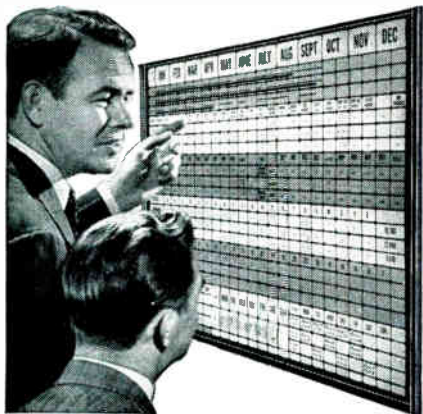

**BOARDMASTER VISUAL CONTROL**

- ☆ Gives Graphic Picture—Saves Time, Saves Money, Prevents Errors
- ☆ Simple to operate—Type or Write on Cards, Snap in Grooves
- ☆ Ideal for Production, Traffic, Inventory, Scheduling, Sales, Etc.
- ☆ Made of Metal Compact and Attractive. Over 400,000 in Use

Full price **\$49.50** with cards

**FREE** 24-PAGE BOOKLET NO. C-20  
Without Obligation

Write for Your Copy Today  
**GRAPHIC SYSTEMS**

55 West 42nd Street • New York 36, N. Y.

CIRCLE 236 ON READER SERVICE CARD  
ELECTRONICS • DECEMBER 4, 1959

Complete **LACING CORD** line

designed by

**Electronic  
Specialists**

for

**ELECTRONICS**

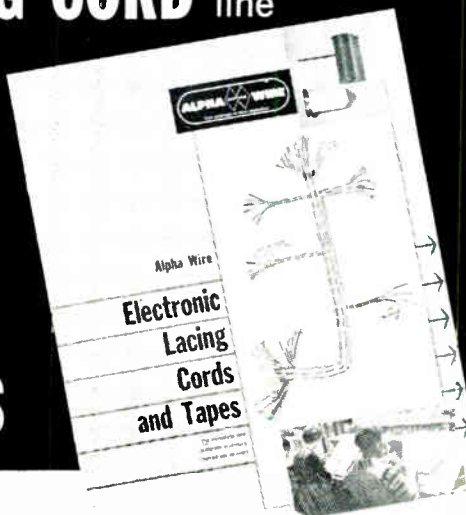

Who knows better about lacing cord than the leader who has been designing and manufacturing electronic wire and custom cables for 38 years?

- round cords and flat-braided tapes
- nylon, dacron and teflon-fiberglass
- finishes: micro-crystalline wax, synthetic rubber-like resin, teflon resin, synthetic rubber
- meets industrial specifications and MIL-T-713A
- each spool individually packaged in boxes

Available for immediate delivery from your local Alpha Wire electronic parts distributor. Write for free Catalog I-59.



ALPHA WIRE CORPORATION • 200 Varick Street, New York 14, N. Y.  
CIRCLE 214 ON READER SERVICE CARD

- automatically normalizes current in DC teleprinter signal loops
- eliminates metering and manual adjustments
- effects savings in maintenance costs
- may be used on polar or neutral DC circuits
- requires no supplemental power supply

**TRANSISTORIZED LOOP CURRENT CONTROL**

Type 238: Model 1, for 60 ma DC loops;  
Model 2, for 20 ma DC loops

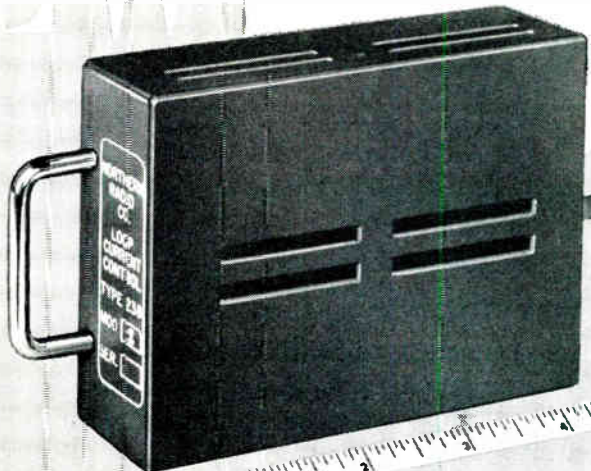

Pace-Setters in Quality Communication Equipment

**NORTHERN RADIO COMPANY, inc.**

147 WEST 22nd ST., NEW YORK 11, NEW YORK

In Canada: Northern Radio Mfg. Co., Ltd., 1950 Bank St., Billings Bridge, Ottawa, Ontario.

CIRCLE 177 ON READER SERVICE CARD

177

# PRECISION DEFLECTION WITH COSSOR YOKES

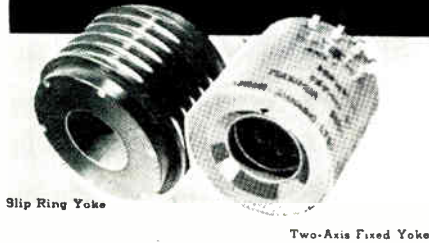

Slip Ring Yoke

Two-Axis Fixed Yoke

## Component Development Engineering at its BEST!

- ADVANCED ELECTRICAL DESIGN
- PRECISION MECHANICAL DESIGN
- ACCURATE PRODUCTION METHODS

Custom Built to the most Exacting Specifications by Cossor Engineers

In Mumetal Cores for Optimum Geometry  
In Ferrite Cores for Speed and Sensitivity  
In Non-magnetic Cores for Perfection of Response

Any of Cossor's Three Core Types can be made in single or double axis with single or push-pull windings, and encapsulated for fixed or slip ring (rotating) use

Normal characteristics of yokes for 1 1/2 in neck tubes are

Positional accuracy - the spot position will conform to the yoke current coordinates within 0.25% of tube diameter. For deflection angles less than 2.25 better accuracy can easily be achieved

Memory - 0.5% max without over swing  
0.1% or less with controlled overswing

Complete encapsulation in epoxy (stycast) or silicone resins is standard for all Cossor deflection yokes, and is done with special moulding tools ensuring accurate alignment of the yoke axis. When slip rings are added, solid silver rings are mounted in encapsulating resin. The finished slip ring yoke is precision turned to centre bore, and can include bearing mounting surfaces with dimensional tolerances approaching those associated with high quality metal parts.

Settling Time (Micro sec.) =  $120 \sqrt{\text{Inductance in Henries}}$

Sensitivity degrees/milliampere =  $0.095 \sqrt{\frac{\text{Inductance} \cdot \text{millihenries}}{\text{Accelerator Voltage} \cdot \text{kV}}}$

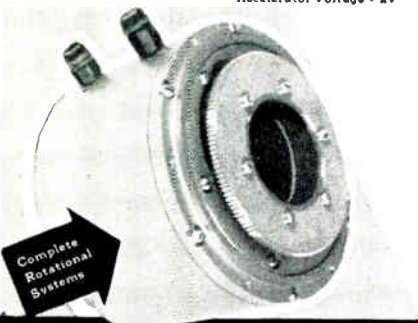

Complete Rotational Systems

COMPONENTS DIVISION.

## E.M.I. COSSOR Electronics Limited

WOODSIDE, DARTMOUTH, N. S.  
2005 Mackay St., Montreal, Que.  
3077 Bathurst St., Toronto, Ont.  
Corporation House, 160 Laurier West, Ottawa, Ont.

deep and 9 in. wide; 44 1/2 percent of the tank bottom being covered with driving elements. Actual radiating surface is 48 sq in. The 115-v a-c single phase 60-cycle generator delivers an average power output of 250 w and produces peaks of 1,000 w. Features include 0-60 minute timer, one tube oscillator, and provision for remote control of equipment. Price is \$990.

CIRCLE 369 ON READER SERVICE CARD

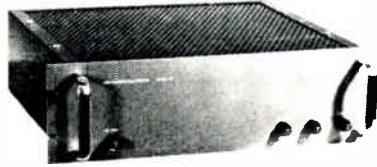

## Power Supply multi output

MID-EASTERN ELECTRONICS, INC., 32 Commerce St., Springfield, N. J. Model 157 transistorized power supply provides three simultaneous outputs, all regulated within 0.25 percent for line and load changes. Input power is 115 v, 400 cps, 3-phase. Output ratings are 22 1/2 v d-c at 1 ampere; -12 v d-c at 1 ampere; and -6 v d-c at 0.5 ampere all slightly adjustable. Ripple is 0.01 percent; recovery, less than 50 μsec; and overshoot will not exceed 1.0 percent of voltage setting.

CIRCLE 370 ON READER SERVICE CARD



## Frequency Generator hermetically sealed

VARO MFG. Co., INC., 2201 Walnut St., Garland, Texas. Model 6261 incorporates a bimetallic tuning fork to provide precision frequency. Oscillator circuit uses silicon transistors, precision wire wound resist-

LIGHTWEIGHT AND INEXPENSIVE

# BENCH SHEAR

WEIGHT WITH 30" HANDLE 18 LBS.



## CAPACITY

MILD STEEL  
FLATS—10 GA.      BARS—3/16" x 2"  
ROUNDS—7/16"      ANGLE IRON—1/8"

WHITNEY-JENSEN

No. 39

BENCH SHEAR

WHITNEY METAL TOOL CO.  
722 Forbes St., Rockford, Ill., Since 1910

CIRCLE 215 ON READER SERVICE CARD



## ELECTRICAL COIL WINDINGS

- Encapsulated
- Bobbin
- Paper Interleave
- Cotton Interweave
- Form Wound
- High Temperature

Send us your coil specifications for quotation.

TRANSFORMERS MADE TO ORDER

THE DANO ELECTRIC COMPANY

MAIN STREET • WINSTED, CONN.

CIRCLE 216 ON READER SERVICE CARD  
DECEMBER 4, 1959 • ELECTRONICS



ors and metallized mylar capacitors to achieve reliable operation to 125C. The generator has an output of 2.5 v with frequencies from 300 to 4,000 cps at accuracies of 0.1 percent to 0.01 percent.

**CIRCLE 371 ON READER SERVICE CARD**



### D-C/D-C Converter transistorized

STANDARD ELECTRONICS CO., 1611 W. 63rd St., Chicago 21, Ill. The 200 series d-c to d-c converters are available custom-designed to O.E.M. specifications. They can be designed to handle power ratings up to 500 w. Conversion efficiencies are offered up to 85 percent with operating temperature range up to 80 C. Regulation is available up to 1 percent. All units meet Military requirements for radio interference.

**CIRCLE 372 ON READER SERVICE CARD**

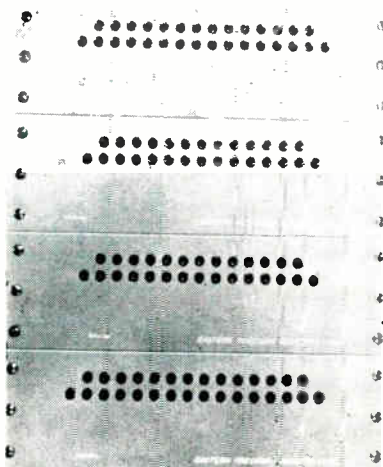

### Delay Lines 100 millisecc

EASTERN PRECISION RESISTOR CORP., 675 Barbey St., Brooklyn 7, N. Y. Series DL-1000-10,000/25T constant delay lines feature extremely

one  
product  
ties  
all  
these  
together...

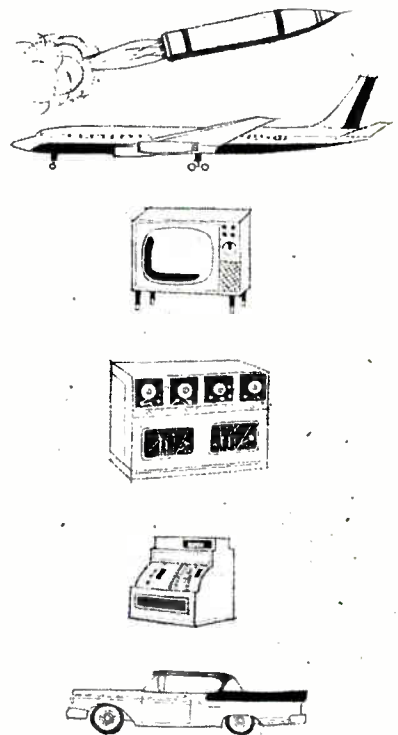

## BERYLLIUM COPPER ELECTRICAL CONNECTORS

Where performance is mandatory... where failure must not occur... "Berylco" beryllium copper provides the vital link between electrical components in aircraft/communication/business machines. Excellent fatigue life, combined with the high spring and electrical properties of beryllium copper, insure positive (corrosion-free) contact with the *minimum of surface contact resistance*.

Do you have such a problem? Write us today for descriptive literature and engineering data. Qualified technical assistance is always as close as your phone.



## THE BERYLLIUM CORPORATION

P. O. Box 1462, Reading, Pennsylvania

# Using Thermistors

Edited by  
FENWAL ELECTRONICS, INC.

**STABLE THERMISTORS PERMIT  
HIGH CONTROL ACCURACY  
WITH SIMPLE CIRCUITRY**

Circuit shown for the Fenwal Electronics' Model 150 Temperature Controller is typical. It has a sensitivity of  $0.001^{\circ}\text{C}$  throughout its working range!

New, extremely stable, probes permit full exploitation of thermistors' inherently high sensitivity to temperature change.

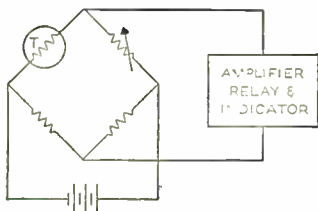
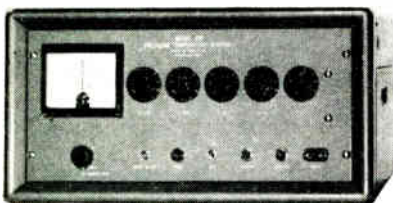

Fenwal Model 150 Thermistor Controller

Operating characteristics of the new probes are precisely predictable and repeatable over the entire control range. Furthermore, the large change in resistivity of a probe in response to a small temperature change greatly simplifies circuit design. (Resistance can change as much as 4000 ohms — or more — for a change of only  $1^{\circ}$  in temperature.) In most cases, a standard resistance bridge circuit is ample for measurement of signal output.

For full details on thermistors, send for Catalog EMC-2. Further details on Model 150 also available on request. Write FENWAL ELECTRONICS, Inc., 211 Mellen Street, Framingham, Mass. And simplify your circuit design problems with a G200 Experimental Kit of thermistors. Available from Fenwal Distributors or the Framingham plant.



Making Precision Thermistors  
to Make Your Design Ideas Come True

180 CIRCLE 180 ON READER SERVICE CARD

long delay and low attenuation, together with excellent phase linearity. It has 100 external taps, permitting 1-millisecond increments to be selected. The line consists of four identical 0 to 25 millisecond tapped delay lines in cascade. Each of these separate delay lines contains 25 sections of m-derived LC networks utilizing high-Q toroidal inductances and ultrastable capacitors. An 18-page technical brochure and catalog is available.

CIRCLE 373 ON READER SERVICE CARD

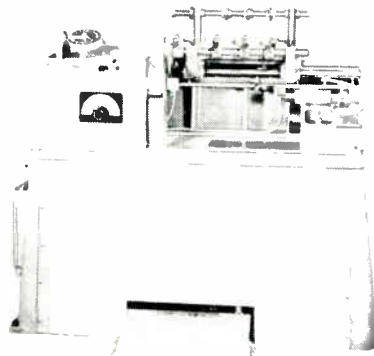

## Coil Winder multiple unit

GEO. STEVENS MFG. CO., INC., Pulaski Rd. at Peterson, Chicago 46, Ill. Model 500-AM multiple transformer/bobbin winder eliminates gear changes and permits virtually instant change-over from one wire gage to another. Complete transformers may be wound without removing mandrels from machine. Dial is calibrated in wire sizes from 10 to 31 Awg, permitting instant selection of correct winding pitch. Maximum coil o-d is 16 in. Winding speeds are up to 380 rpm.

CIRCLE 374 ON READER SERVICE CARD

## Relay Miss Tester electronic gate

SHASTA ELECTRONIC CO., P.O. Box 316, Palo Alto, Calif. Machine will cycle relays for testing under dry circuit conditions. The relay contacts are tested dynamically at open circuit voltages as low as 1 mv with closed circuit currents as low as  $1\mu\text{a}$ . An electronic gate is provided to eliminate erroneous miss indications.

CIRCLE 375 ON READER SERVICE CARD



**Need product  
info?**

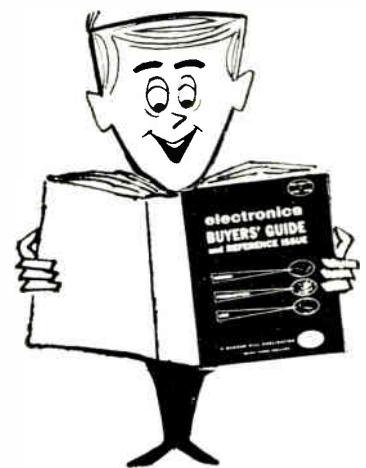

**Look in the  
new**

**electronics  
BUYERS' GUIDE  
and Reference Issue**

Over 699 regular advertisers, have catalog information in the '59-'60 issue, 42% more than in any other electronic directory.

A MCGRAW-HILL PUBLICATION

330 W. 42nd Street  
New York 36, N. Y.





# Accurate Q Measurements

## 1 KC to 260 MC

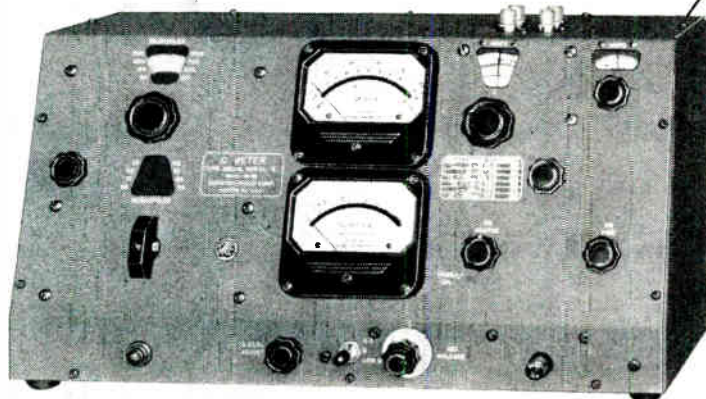

PRODUCTS OF 25 YEARS  
SPECIALIZED EXPERIENCE  
IN Q METER DESIGN!

Model 260-A Q Meter

Model 190-A Q Meter

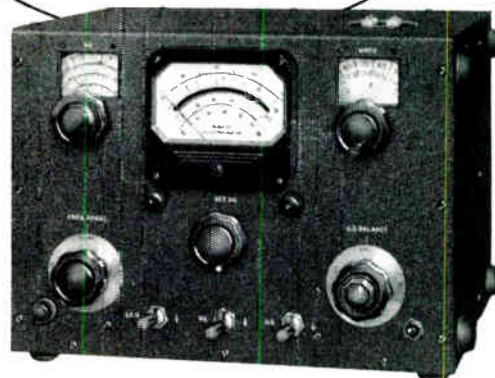

### These BRC instruments

incorporate many exclusive design features resulting in improved accuracy and reliability—

BRC Q Meters are versatile, general-purpose instruments with a broad field of application in the laboratory and on the production line. They are designed to measure coils, capacitors, resistors, transformers, dielectrics, networks and filters through either series or parallel connection to a calibrated resonant tank circuit.

#### To Users of Earlier Models of BRC Q Meters!

While older models of the world-famous BRC Q Meters are still performing satisfactorily after many years of continuous service, users of these instruments are invited to investigate the greatly improved accuracy and convenience of the Types 190-A and 260-A.

- Low Q scales permit direct measurement down to a Q of 5 (190-A) or 10 (260-A)
- Extremely wide direct reading Q range: 5-1200 (190-A), 10-625 (260-A)
- $\Delta$  Q Scales permit accurate measurement of capacitors, dielectrics, and resistors
- Mirror meter scales eliminate parallax
- Electronically regulated power supplies provide maximum stability
- Extremely low injection impedance provides maximum Q accuracy

### Specifications

	TYPE 190-A	TYPE 260-A
<b>Freq. Range:</b>	20 Mc. to 260 Mc.	50 Kc.* to 50 Mc.
<b>Q Range:</b>		
Total Range:	5 to 1200	10 to 625
Low Range:	10 to 100	10 to 60
$\Delta$ Q Range:	0 to 100	0 to 50
<b>Q Accuracy:</b>	$\pm 7\%$ * 20 Mc. to 100 Mc. $\pm 15\%$ * 100 Mc. to 260 Mc. *for circuit Q of 400 read directly on indicating meter.	$\pm 5\%$ * 50 Kc. to 30 Mc. $\pm 10\%$ * 30 Mc. to 50 Mc. *for circuit Q of 250 read directly on indicating meter.
<b>Capacitor Range:</b>	7.5 to 100 $\mu$ f	30 to 460 $\mu$ f
<b>Capacitor Accuracy:</b>	$\pm 0.2\mu$ f, 7.5-20 $\mu$ f $\pm 0.3\mu$ f, 20-50 $\mu$ f $\pm 0.5\mu$ f, 50-100 $\mu$ f	$\pm 1\%$ or 1 $\mu$ f, whichever is greater.
<b>Price:</b>	\$875.00 F.O.B. Boonton, N. J.	\$850.00 F.O.B. Boonton, N. J.

\*1 Kc. to 50 Kc. with external oscillator.

25<sup>th</sup>  
ANNIVERSARY



**Boonton Radio Corporation**  
BOONTON, NEW JERSEY

Precision Electronic Instruments since 1934

# Cushions Insulates & Deadens Sound.

Utilized by  
Manufacturers and Users

of Electronic Equipment, Systems, Component Parts, Accessories, in all fields — Military (including missiles program) — Industrial — Entertainment — Home.



## FOAMSTIK<sup>TM</sup> TAPE

SELF-ADHERING  
PLASTIC FOAM MATERIAL

Solves production problems.  
Improves product performance.

TESAMOLL Foam Stik tape is a highly flexible, resilient, extremely light weight plastic foam material. Backed by an aggressive, quick-sticking adhesive. Protected by a poly vinyl chloride liner which can easily be peeled off as Tesamoll Foam Stik Tape is applied.

Adheres instantly and firmly on contact by gentle finger pressure to metal, wood, glass, plastic, etc. (some textiles). No moistening, no mess. No waste of time or material. Cuts with snip of scissors.



### IN CONVENIENT ROLLS

Thickness: 1/8", 1/4", 1/2"  
Widths: 1/4" to 18 1/2"  
Other sizes on request.  
Standard colors: White, Grey, Black.

Characteristics: Uniform texture. Chemical stability. Excellent compressibility. Low compression set. High thermal insulating efficiency. High co-efficient of friction. Electrostatically negative. Neutral pH factor. Odorless. Weight 1/3 that of foam rubber. Unaffected by water, grease, lubricants, most chemicals. Does not rot. Proof against fungus, mildew, insects.

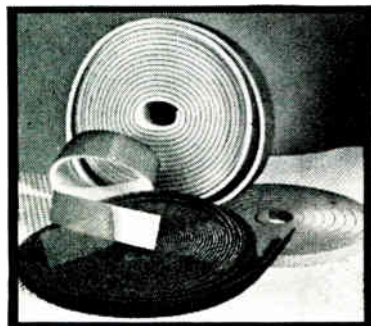

### Complimentary Booklet

Gives complete technical data; present applications in electronics, engineering, chemistry, aviation; present uses in commercial products.



UNITED MINERAL & CHEMICAL CORP. Dept. E-912  
16 Hudson Street, New York 13, N. Y.

Send me BOOKLET, FREE SAMPLES, and full information on TESAMOLL FOAMSTICK Tape.

Name ..... Title.....  
Address.....  
Firm.....  
City ..... Zone ..... State.....

U. S. Agents  
UNITED MINERAL & CHEMICAL CORP.  
16 Hudson Street, N.Y. 13, Tel: BEekman 3-8870

## NEW BOOKS

### Electronic Measuring Instruments

By E. H. W. BANNER.

The MacMillan Company, New York, 496 p, \$7.95.

THIS book is almost exclusively devoted to instruments that are manufactured in Britain. Much of the writing deals with devices that are unfamiliar to the average electronics engineer. Here many of the technical terms are undefined, and the reader, especially the American reader, will have to fashion their definitions from the text.

In describing a particular device, the author discusses the main features, sometimes including specialized construction and manufacturing techniques. Simple design equations, where applicable, are also used. Most of the devices are illustrated by a photograph and/or schematic. The bibliography is brief but sufficient.

Prices are not given. Inclusion of this vital information would have made the book even more useful without increasing its size. Also, the 4 1/2 page index is inadequate for a book of this type.

Every designer and consumer of electronic measuring equipment will find that this book is a rich source of ideas. Transistors are only mentioned in four places in the book, but this partly results from the time lapse between manuscript and publication.

SID DEUTSCH, Associate Professor of Electrical Engineering, Polytechnic Institute of Brooklyn, N. Y.

### Magnetic Amplifier Engineering

By GEORGE M. ATTURA.

McGraw-Hill Book Co., Inc., New York, 1959, 229 p, \$7.50.

THIS book presents a clear and cohesive treatment of the theory and design of magnetic amplifiers. Covered in individual chapters are saturable reactors, the reactor-rectifier amplifier and reset control. Attura's diagrams are especially good. Many books on magnetic amplifiers have



# Cut Holes In Less Than 90 Seconds!



## CHASSIS PUNCHES

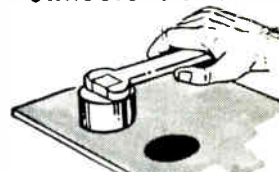

Make any size hole you want for sockets, plugs, meters, others... do it faster with less effort with famous Walsco L.T.\* Chassis Punches. Easy to use... last a lifetime. Send postcard for free literature.

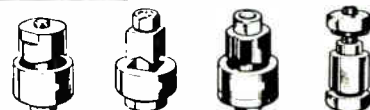

(\*L.T. is Walsco's exclusive "Low-Torque" design)

## WALSCO ELECTRONICS MFG. CO.

Division of Textron Inc.

Western Plant: Los Angeles 18, California  
Main Plant: ROCKFORD, ILLINOIS, U.S.A.

CIRCLE 218 ON READER SERVICE CARD

## MEET TOM EMMA

Associate Editor, electronics  
FINANCE EXPERT



Thomas Emma, BA, Columbia, is a U.S. Naval Reserve officer who was formerly a technical writer with IT&T. Tom prepares "Financial Roundup"—a regular weekly business feature. In the coming months Tom will be concerned with radio communications, but he will be specifically involved with spectrum usage problems. To keep abreast of finance in electronics, turn to Tom's weekly coverage of latest developments. To subscribe or renew your subscription, fill in box on Reader Service Card. Easy to use. Postage free.



A McGraw-Hill Publication  
West 42nd Street, New York 36, N. Y.



needlessly complicated diagrams by a physical representation of the cores and windings. On the other hand, Attura uses the functional approach. In most cases, the circuit diagrams are accompanied with magnetization curves that present a step-by-step picture of magnetizing force versus magnetization. There are also voltage waveforms showing the voltage across reactor and load.

In the circuit schematics, communications symbols are used instead of the power type symbols often used in magnetic amplifier texts.

The book also covers magnetic amplifier components such as cores and rectifiers. A thorough treatment of magnetic theory is given which furnishes a solid basis for designing magnetic amplifiers.

There are examples of design of cascaded magnetic amplifiers and of hybrid amplifiers that use electron tubes and/or transistors as well as magnetic amplifiers. These hybrid circuits are becoming increasingly important in equipment such as servos.

The book can be recommended to all practicing engineers and students as a means for removing the magnetic-amplifier blind spot that plagues so many in the electronics industry.—J.M.C.

## Solid State Magnetic and Dielectric Devices

By H. W. KATZ.

*John Wiley and Sons, Inc., New York, 1959, 542 p, \$13.50.*

IN ADDITION to the transistor, a wide variety of solid state devices are currently being developed and are assuming considerable importance in engineering. The purpose of this book is to fulfill the need for a comprehensive treatment of the theory and applications of such devices exclusive of the transistor. The fourteen contributing authors have covered a very large field and the editor, H. W. Katz, has succeeded in integrating the material into a consistent development.

In the first four chapters, the basic theory of electrostatic and magnetostatic fields and of the electric and magnetic properties of

At Los Alamos the application of creative imagination is stimulated by the inspiring geography and culture of the old Southwest.

For employment information write:  
Personnel Director  
Department 59-203

los alamos  
scientific laboratory  
OF THE UNIVERSITY OF CALIFORNIA  
LOS ALAMOS, NEW MEXICO



Original Painting by Louise Ganthers, Taos, N. M.

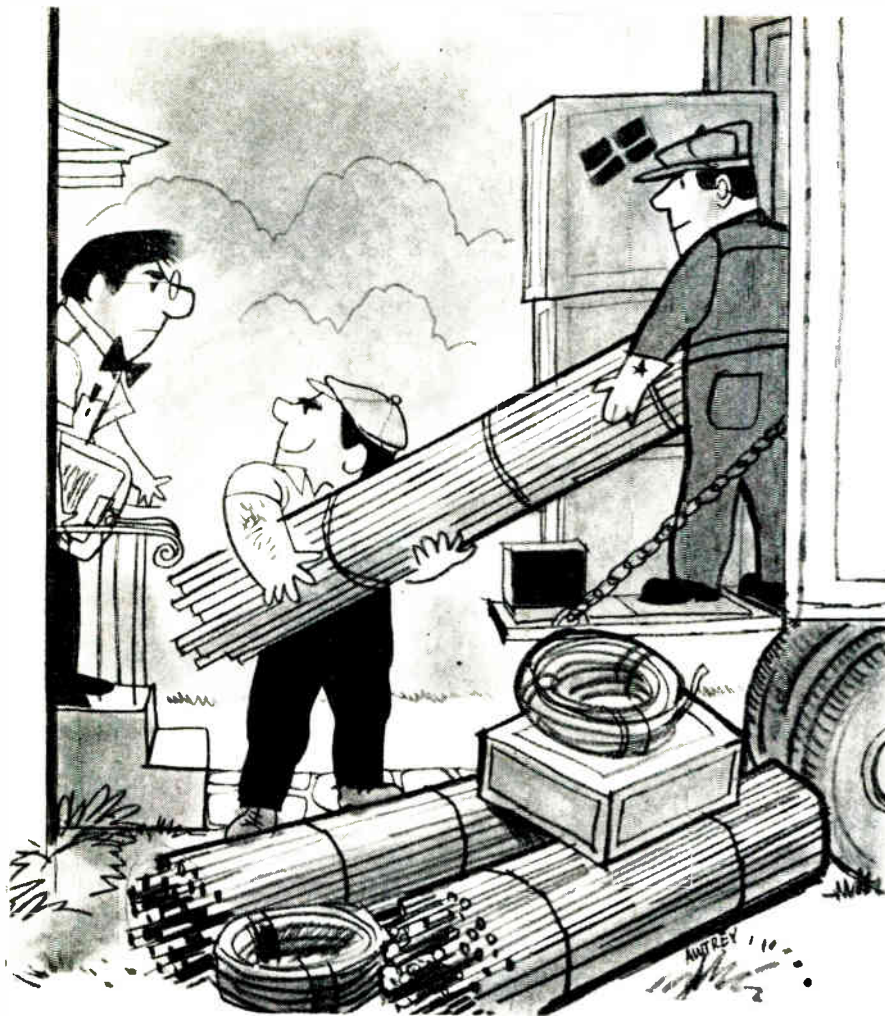

## plan ahead!

To be really sure of getting your pot deliveries on time, you could assemble your own! But just when you're counting on sub-contractors to deliver the necessary parts — you *might* find they're tied-up on someone *else's* job! So if you *must* be sure, lay in a good supply of raw materials in quantity lots — metals, glass, wire, plastics, bearings — the works!

But before you load up the living-room with bar stock, check with Ace. You'll find, to your relief, that Ace abundantly warehouses all their own raw materials — just for the express purpose of being able to *make* everything they need — when it's needed, for controlled delivery! So if *delivery* of precision pots is a prime consideration, talk to the company that does its *own* sub-assembly manufacture — see your Acerep!

From raw materials to completed pot — within the plant — our servo-mount A.I.A. size  $\frac{7}{8}$ " ACEPOT®. As with all the others, from  $\frac{1}{2}$ " to 6".



**ACE** ELECTRONICS ASSOCIATES, INC.  
99 Dover Street, Somerville 44, Mass.  
SOMerset 6-5130 TMX SMVL 181 West. Union WUX

Acepot® Acetrim® Acoset® Aceohm® \*Reg. Appl. for

solid state materials is developed. The succeeding seven chapters discuss the practical applications of these theories. For instance, microwave ferrite devices, magnetic and dielectric amplifiers, solid state memory devices, the principles of magnetic recording, and the techniques of magnetic and dielectric measurements are all discussed.

ARMEN H. ZEMANIAN, *College of Engineering, New York University, N. Y.*

## THUMBNAIL REVIEWS

**Principles of Electronics.** By M. R. Gavin and J. E. Houldin, D. Van Nostrand Co., Inc., Princeton, N. J., 1959, 347 p. \$5.75. This is an introductory text suitable for an undergraduate course in physics or electronics. Emphasis is on basic principles of tubes, transistors and other electron devices, rather than on specific applications in systems. Final section contains about 250 problems with answers arranged to correspond with chapter topics.

**Mathematics Dictionary.** Edited by G. James and R. C. James, D. Van Nostrand Co., Inc., 1959, 546 p., \$15.00. This revised and enlarged second edition contains more than 7,000 mathematical terms, concepts and relationships. Additions include basic terms in modern algebra, number theory, topology, vector spaces, game theory, linear and dynamic programming, numerical analysis and computing machines. A multilingual index lists English equivalents of French, German, Russian and Spanish terms.

**Materials for Rockets and Missiles.** By R. G. Frank and W. F. Zimmerman, The Macmillan Co., New York, 1959, 124 p., \$4.50. This is a materials handbook which also includes tables, graphs and photomicrographs rounding up compositions and mechanical characteristics of modern alloys, cermets and ceramics used as structural and mechanical parts in high temperature applications. Text discusses use and fabrication of materials. No data is given on electrical properties.

**Principles of Transistors Circuit.** By S. W. Amos, John F. Rider Pub., Inc., New York, 1959, 176 p., \$3.90. This book begins with introductory chapters on the physical processes occurring in transistors and then goes on to emphasize applications. Most of the book is devoted to determination of input resistance, stage gain, optimum load, power output, coupling capacitor values and transformer winding inductances in various types of circuits.



# Get out your pencil and help yourself to electronics READER SERVICE it's free—it's easy—it's for your convenience

Use these handy READER SERVICE CARDS for more information on: ADVERTISEMENTS—NEW PRODUCTS—LITERATURE OF THE WEEK

1—Circle the number on the postpaid card below that corresponds to the number at the bottom of Advertisement, New Product item, or Literature of the Week selection.

2—INQUIRIES FROM FOREIGN COUNTRIES that are not mailed at least

10 days prior to the expiration date shown on the card must be mailed directly to the advertiser.

3—Please print carefully, as it is impossible to process cards that are not readable.

**A**  
**FOR SPECIFIC ITEMS IN MULTI-PRODUCT ADVERTISEMENTS**  
For more information on specific items in multi-product advertisements, print carefully on the Reader Service Card below in Box "A" the circle number of the advertisement and the specific product(s) on which you desire more information.

**HOW TO SUBSCRIBE—HOW TO RENEW YOUR SUBSCRIPTION—TO electronics—**  
If you are not a subscriber, or if your subscription is about to expire, to receive electronics regularly, fill in the section "FOR SUBSCRIPTIONS" on a card below. Send no money, electronics will bill you at the address indicated on the Reader Service Card.

Correct amount of POSTAGE must be affixed for all FOREIGN MAILINGS

**DEC. 4 • 59**  
CARD EXPIRES FEB. 4 • 60  
For Foreign Mailings JAN. 25 • 60

## electronics • READER SERVICE CARD • Please Print Carefully

Your Name \_\_\_\_\_ Position \_\_\_\_\_  
Company \_\_\_\_\_  
Address \_\_\_\_\_

**CIRCLE THESE NUMBERS WHEN INTERESTED IN ALL ITEMS SHOWN IN ANY ADVERTISEMENT**

1	2	3	4	5	6	7	8	9	10	11	12	13	14	15	16	17	18	19	20	21	22	23	24	25
26	27	28	29	30	31	32	33	34	35	36	37	38	39	40	41	42	43	44	45	46	47	48	49	50
51	52	53	54	55	56	57	58	59	60	61	62	63	64	65	66	67	68	69	70	71	72	73	74	75
76	77	78	79	80	81	82	83	84	85	86	87	88	89	90	91	92	93	94	95	96	97	98	99	100
101	102	103	104	105	106	107	108	109	110	111	112	113	114	115	116	117	118	119	120	121	122	123	124	125
126	127	128	129	130	131	132	133	134	135	136	137	138	139	140	141	142	143	144	145	146	147	148	149	150
151	152	153	154	155	156	157	158	159	160	161	162	163	164	165	166	167	168	169	170	171	172	173	174	175
176	177	178	179	180	181	182	183	184	185	186	187	188	189	190	191	192	193	194	195	196	197	198	199	200
201	202	203	204	205	206	207	208	209	210	211	212	213	214	215	216	217	218	219	220	221	222	223	224	225
226	227	228	229	230	231	232	233	234	235	236	237	238	239	240	241	242	243	244	245	246	247	248	249	250
251	252	253	254	255	256	257	258	259	260	261	262	263	264	265	266	267	268	269	270	271	272	273	274	275
276	277	278	279	280	281	282	283	284	285	286	287	288	289	290	291	292	293	294	295	296	297	298	299	300
301	302	303	304	305	306	307	308	309	310	311	312	313	314	315	316	317	318	319	320	321	322	323	324	325
326	327	328	329	330	331	332	333	334	335	336	337	338	339	340	341	342	343	344	345	346	347	348	349	350
351	352	353	354	355	356	357	358	359	360	361	362	363	364	365	366	367	368	369	370	371	372	373	374	375
376	377	378	379	380	381	382	383	384	385	386	387	388	389	390	391	392	393	394	395	396	397	398	399	400
401	402	403	404	405	406	407	408	409	410	411	412	413	414	415	416	417	418	419	420	421	422	423	424	425
426	427	428	429	430	431	432	433	434	435	436	437	438	439	440	441	442	443	444	445	446	447	448	449	450
451	452	453	454	455	456	457	458	459																

460	470
461	471
462	472
463	473
464	474
465	475
466	476
467	477
468	478
469	479

**FOR SUBSCRIPTIONS:**  
(CHECK ONE BOX)  
 NEW  RENEWAL  
(CHECK ONE BOX BELOW)  
DOMESTIC  3 yrs. — \$12.00  
 1 yr. — \$ 6.00  
CANADA  1 yr. — \$10.00  
FOREIGN  1 yr. — \$20.00  
Product(s) manufactured: \_\_\_\_\_  
or Service(s) Performed: \_\_\_\_\_

**DEC. 4 • 59**  
CARD EXPIRES FEB. 4 • 60  
For Foreign Mailings JAN. 25 • 60

## electronics • READER SERVICE CARD • Please Print Carefully

Your Name \_\_\_\_\_ Position \_\_\_\_\_  
Company \_\_\_\_\_  
Address \_\_\_\_\_

**CIRCLE THESE NUMBERS WHEN INTERESTED IN ALL ITEMS SHOWN IN ANY ADVERTISEMENT**

1	2	3	4	5	6	7	8	9	10	11	12	13	14	15	16	17	18	19	20	21	22	23	24	25
26	27	28	29	30	31	32	33	34	35	36	37	38	39	40	41	42	43	44	45	46	47	48	49	50
51	52	53	54	55	56	57	58	59	60	61	62	63	64	65	66	67	68	69	70	71	72	73	74	75
76	77	78	79	80	81	82	83	84	85	86	87	88	89	90	91	92	93	94	95	96	97	98	99	100
101	102	103	104	105	106	107	108	109	110	111	112	113	114	115	116	117	118	119	120	121	122	123	124	125
126	127	128	129	130	131	132	133	134	135	136	137	138	139	140	141	142	143	144	145	146	147	148	149	150
151	152	153	154	155	156	157	158	159	160	161	162	163	164	165	166	167	168	169	170	171	172	173	174	175
176	177	178	179	180	181	182	183	184	185	186	187	188	189	190	191	192	193	194	195	196	197	198	199	200
201	202	203	204	205	206	207	208	209	210	211	212	213	214	215	216	217	218	219	220	221	222	223	224	225
226	227	228	229	230	231	232	233	234	235	236	237	238	239	240	241	242	243	244	245	246	247	248	249	250
251	252	253	254	255	256	257	258	259	260	261	262	263	264	265	266	267	268	269	270	271	272	273	274	275
276	277	278	279	280	281	282	283	284	285	286	287	288	289	290	291	292	293	294	295	296	297	298	299	300
301	302	303	304	305	306	307	308	309	310	311	312	313	314	315	316	317	318	319	320	321	322	323	324	325
326	327	328	329	330	331	332	333	334	335	336	337	338	339	340	341	342	343	344	345	346	347	348	349	350
351	352	353	354	355	356	357	358	359	360	361	362	363	364	365	366	367	368	369	370	371	372	373	374	375
376	377	378	379	380	381	382	383	384	385	386	387	388	389	390	391	392	393	394	395	396	397	398	399	400
401	402	403	404	405	406	407	408	409	410	411	412	413	414	415	416	417	418	419	420	421	422	423	424	425
426	427	428	429	430	431	432	433	434	435	436	437	438	439	440	441	442	443	444	445	446	447	448	449	450
451	452	453	454	455	456	457	458	459																

460	470
461	471
462	472
463	473
464	474
465	475
466	476
467	477
468	478
469	479

**FOR SUBSCRIPTIONS:**  
(CHECK ONE BOX)  
 NEW  RENEWAL  
(CHECK ONE BOX BELOW)  
DOMESTIC  3 yrs. — \$12.00  
 1 yr. — \$ 6.00  
CANADA  1 yr. — \$10.00  
FOREIGN  1 yr. — \$20.00  
Product(s) manufactured: \_\_\_\_\_  
or Service(s) Performed: \_\_\_\_\_

# NO PIGEONHOLES

In some industries a man is boxed off by his title. In most fields, for example, a management man won't talk the same language as a design engineer.

The Electronics man, however, is not easily pigeonholed. Whatever his title, whatever his department, this engineering oriented man

influences the buying and specifying of electronic equipment.

*electronics* is edited to reach the important areas of the electronics industry... the men who, regardless of title, influence the purchase of products, materials and service. This is why it pays to advertise in *electronics* and *electronics* BUYERS' GUIDE.

The Electronics man "buys" what he reads in

## electronics

A McGraw-Hill Publication

330 West 42nd Street, New York 36, N. Y.



**BUSINESS REPLY MAIL**

NO POSTAGE STAMP NECESSARY IF MAILED IN THE UNITED STATES

6¢ Postage Will Be Paid By  
**ELECTRONICS**

Reader Service Dept.  
330 West 42nd Street  
New York 36, N. Y.

FIRST CLASS  
PERMIT NO. 64  
(SEC. 34.9 P.L.&R.)  
NEW YORK, N. Y.



**BUSINESS REPLY MAIL**

NO POSTAGE STAMP NECESSARY IF MAILED IN THE UNITED STATES

6¢ Postage Will Be Paid By  
**ELECTRONICS**

Reader Service Dept.  
330 West 42nd Street  
New York 36, N. Y.

FIRST CLASS  
PERMIT NO. 64  
(SEC. 34.9 P.L.&R.)  
NEW YORK, N. Y.





**The Physics of Electricity and Magnetism.** By W. T. Scott, John Wiley and Sons, Inc., New York, 1959, 635 p. This is a textbook for juniors, seniors and first year graduate students which provides an explanation of the basic theory of electricity and magnetism in a rigorous manner from the viewpoint of a physicist.

**An Approach to Electrical Science.** By H. G. Booker, McGraw-Hill Book Co., Inc., New York, 1959, 826 p, \$9.50. Treats basic electromagnetic theory, electron devices, circuits and components from physical science viewpoint. Designed as a sophomore engineering text, it crosses lines of physics, mathematics and electrical engineering.

**Modern Trends in Documentation.** By Dr. Martha Boaz, Pergamon Press, Ltd., New York, 1959, 103 p, \$5.00. Proceedings of symposium held at University of Southern California in April 1958 including eight papers on information retrieval, two papers on machine translation of foreign languages, and 15 pages of panel discussion of the papers. Applications of computers and smaller machines to the problems of librarians are stressed.

**Theory of Functionals and of Integral and Integro-differential Equations.** By V. Volterra, Dover Publications, New York, 1959, 226 p, \$1.75. This is a reprint of Volterra's classical work which was first published about thirty years ago. It is mainly of interest to the student or scientist possessing a firm foundation in mathematics.

**The Radio Amateur's Handbook.** American Radio Relay League, Inc., West Hartford, Conn., 1959, 746 p. \$3.50. This latest version of an old favorite has been brought up to date in all sections, with a complete revision of the vacuum-tube characteristics section.

**Programming for Digital Computers.** By Joachim Jeanel, McGraw-Hill Book Co., Inc., New York, 1959, 517 p, \$12.00. Methodical approach to programming problems for stored-program computers. Presumes no previous experience. Covers both scientific and data-processing applications.

**Proceedings of the Fourth National Conference on Tube Techniques.** Sponsored by Advisory Group on Electron Tubes, New York University Press, New York, 1959, 270 p, \$7.50. Pattern of previous conferences is followed giving a wide-angle view of recent developments in tube design, tube component and material analyses, and production and test techniques. Emission and cathodes receive special attention.

# from Magnet Charger

## HEADQUARTERS

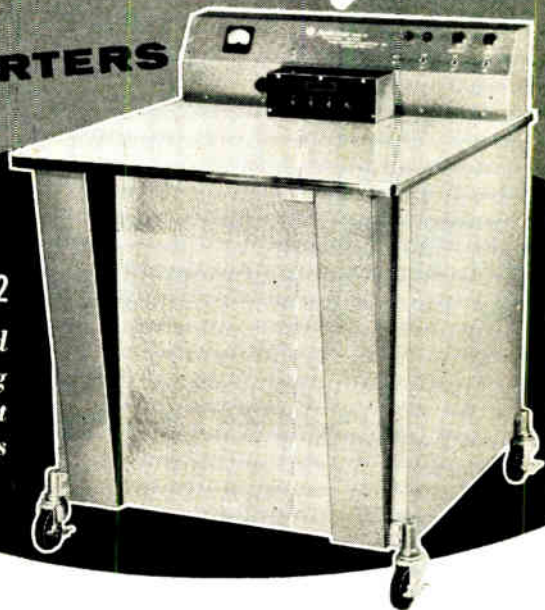

**MODEL 942**

*Recommended  
by Leading  
Magnet  
Makers*

**3  
VERSATILE  
MODELS**

For saturating Alnico magnets weighing up to 34 lbs. and high flux ceramic magnets of any shape or pole configuration. Operates on condenser discharge principle from regular 115-volt, 60-cycle line.

Charging outputs from 100,000 to 200,000 ampere-turns through plug-in transformers, up to 3600 watt-seconds using wire-wound fixtures. Adapters for multi-pole rotors, rod, bar, ring and various other shapes available. Designed for continuous production use with low power consumption. Price of basic unit is less than \$2100.



**MODEL 1500**

A medium power Magnet Charger capable of developing peak magnetizing force of 40,000 ampere-turns. Designed for production, research and instrument repair work. The Model 1500 easily saturates the new high coercive materials such as Cobalt Platinum and Barium Ferrite. Portable table model operates on 115-volt, 60-cycle line; size 11" wide x 15" high x 20" deep; weight 125 lbs. Price \$945.

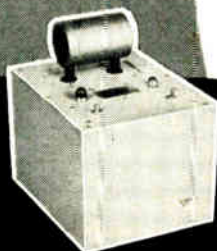

**MODEL 1221**

A low cost, condenser discharge unit employing novel, plug-in wire-wound type charging fixtures, the Model 1221 is designed for the user of small magnets. Its 10,000 ampere-turn output will saturate about 2" of Alnico V. Charging cycle rate is approximately 3 seconds, continuous duty, operates from 115-volt line. Price \$180.

*Performance of all models is rigidly guaranteed. Prices are net f.o.b. Boonton, N.J. and subject to change without notice.*



**13 years' magnet charging experience is yours for the asking—send for illustrated data sheets.**



**Radio Frequency  
LABORATORIES, INC.**  
Boonton, New Jersey, U. S. A.

*Here's one that doesn't have  
to be "Mothered"*

You get continuous,  
trouble-free service  
from this rugged,  
reliable, direct-writing

**RECORDING**

**D. C. MICROAMMETER by Esterline Angus**

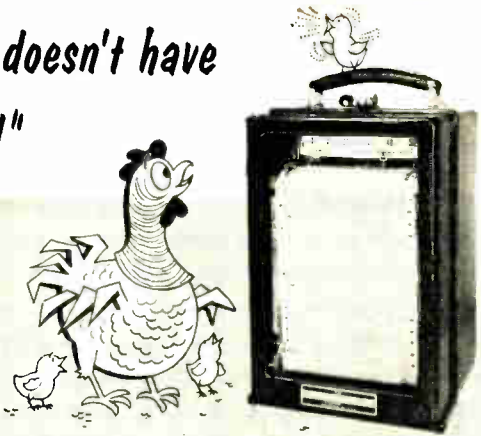

Built to "take it," this new D.C. Microammeter combines famous E/A excellence of design and ruggedness of construction with the extra-sensitivity of 0-50 microamperes at 200 ohms input resistance.

The simplicity of its direct-writing movement eliminates the complexity associated with servo or linkage driven writing systems.

It's a time-saver, too, with no unnecessary adjustments—such as con-

tinually setting zero. You put this D.C. Microammeter into operation merely by connecting the input leads.

Here's the recording instrument of a thousand and one uses. Send for Catalog Section No. 41 and see how it can help you.

**The Esterline-Angus Company**

*No. 1 in fine Graphic Instruments for  
more than 50 years.*

DEPT. E, P. O. BOX 596, INDIANAPOLIS 6, IND.

CIRCLE 220 ON READER SERVICE CARD

**PLATING** of electronic components



**Diodes... Transistors... Rectifiers... Capacitors**

Our Electronic Plating Thickness Tester measures plating within most rigid specifications. This includes precious metal plating for bomb heads, printed circuits, precision instrument parts, hermetic seals, fuses, relays, rotor arms, slip rings, locking clips, contact points, terminals, transistors, diodes, rectifiers and capacitors.

In addition to a constant thickness check of all specification plating, the technicians of our Research and Development Unit maintain a continuous check on the purity of solutions.

30,000 Sq. Ft. devoted to Electronic Plating and Research. Send for our electronic plating brochure... or have our representative call.

GOLD • SILVER • RHODIUM • PLATINUM • PALLADIUM • NICKEL  
Specialists in Metal Plating since 1936.

**SPECTRONIC PLATING CO., INC.**

*A Division of Spectranome Plating Co., Inc.*

330 W. 13th STREET • NEW YORK 14, N.Y. • AL 5-8677

188 CIRCLE 188 ON READER SERVICE CARD

**Literature of**

**MEASUREMENT INSTRUMENTATION.** Telemetering Corp., P. O. Box 645, Mesa, Arizona. A booklet outlines research, development and production facilities of this new company specializing in electronic measurement instrumentation.

CIRCLE 380 ON READER SERVICE CARD

**METALS FOR SEMICONDUCTORS.** Sigmund Cohn Corp., 121 S. Columbus Ave., Mt. Vernon, N. Y., has prepared a brochure entitled "Metals and Alloys for use in Conjunction with Semiconductor Products."

CIRCLE 381 ON READER SERVICE CARD

**COMMERCIAL CAPACITORS.** The Astron Sales Corp., East Newark, N. J. A 6-page illustrated brochure contains listings of complete lines of capacitors for commercial use.

CIRCLE 382 ON READER SERVICE CARD

**MICROWAVE TERMINATIONS.** Radar Design Corp., Pickard Drive, Syracuse 11, N. Y. An 8-page brochure describing a wide range of low- and high-power coaxial and waveguide terminations give complete specifications and applications.

CIRCLE 383 ON READER SERVICE CARD

**FACILITIES BROCHURE.** Instrument Systems Corp., 129-07 18th Ave., College Point 56, N. Y. A new brochure outlines the company's knowledge, experience and management, and shows its facilities in the fields of electronics, precision mechanisms, and instrumentation.

CIRCLE 384 ON READER SERVICE CARD

**SILICONE RUBBER.** General Electric Co., Waterford, N. Y. Bulletin CDS-179 features silicone rubber for lead wire insulation. It also offers a comparison between silicone rubber, polyvinyl chloride, neoprene and natural rubber, as insulating materials.

CIRCLE 385 ON READER SERVICE CARD

**INSULATING MATERIALS.** Columbia Technical Corp., 61-02 Thirty-First Ave., Woodside 77, N. Y., has available a handy-to-use data sheet on the complete line of HumiSeal synthetic resin coatings

DECEMBER 4, 1959 • ELECTRONICS



# the Week

for insulation and protection of electronic components and assemblies against corrosion, moisture and similar environmental stresses.

**CIRCLE 386 ON READER SERVICE CARD**

**FERRITES.** Kearfott Co., Inc., 1500 Main Ave., Clifton, N. J. A 19-page booklet contains information on ferrites for missile and advanced electronics applications.

**CIRCLE 387 ON READER SERVICE CARD**

**CONTROLS AND CONTROL SYSTEMS.** Whittaker Controls, Division of Telecomputing Corp., 915 N. Citrus Ave., Los Angeles, Calif. A 16-page general capabilities and background brochure, containing over 25 photographs, graphically discusses the organization's active technical diversity.

**CIRCLE 388 ON READER SERVICE CARD**

**THERMAL MAGNETIC CIRCUIT.** E-T-A Products Co., 6284 N. Cicero Ave., Chicago 46, Ill. A specification sheet contains detailed information on low-cost circuit breakers featuring model variations with and without auxiliary or alarm circuits.

**CIRCLE 389 ON READER SERVICE CARD**

**MOLDING COMPOUNDS.** Durez Plastics Division of Hooker Chemical Corp., North Tonawanda, N. Y. A 16-page reference booklet lists the physical properties of 33 phenolic and 3 diallyl phthalate molding compounds.

**CIRCLE 390 ON READER SERVICE CARD**

**PULSE TRANSFORMERS.** Technitrol Engineering Co., 1952 E. Allegheny Ave., Philadelphia 34, Pa., has published three new technical brochures to help circuit design engineers accurately specify the design of low power pulse transformers.

**CIRCLE 391 ON READER SERVICE CARD**

**TAPE WOUND CORES.** G-L Electronics, 2921 Admiral Wilson Blvd., Camden 5, N. J. Precision-made tape wound cores can now be obtained in two new core materials to precise limits, and these materials and limits are described in the 8-page bulletin TB-105.

**CIRCLE 392 ON READER SERVICE CARD**

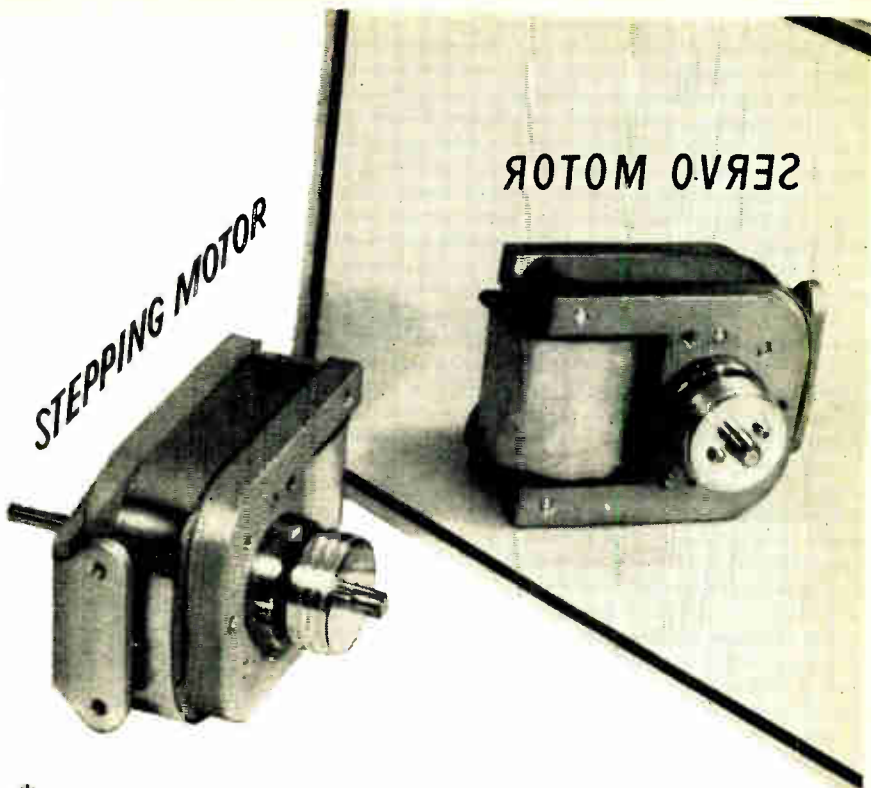

This stepping motor, when suitably pulsed, has a torque output of 1 inch-ounce, in steps that are never more, never less than 18°. Each one is produced by a half cycle or a current reversal. Consequently it is very useful for converting electrical numbers to mechanical numbers, and has been sold for this purpose for some time (the Sigma "Cyclonome"®).

In the trick mirror is a servo motor which stops on command with perfect obedience, because it stops every little while anyway, delivering torque in 18° quanta. The 20-tooth ratchet sensation is produced by a fiercely discontinuous permanent magnet field, which develops going and stopping torques of 1 inch-ounce.

So, here is a positioning servo motor which is synchronous and has a mechanical time constant of  $\frac{1}{4}$  cycle. Effective ratio of torque to inertia, with regard to coasting, is *infinite* — as long as these parameters are respected:  $\text{inertia (gram-cm}^2\text{)} \times (\text{steps/sec.})^2 \leq 180,000$ , and  $\text{steps/second} \leq 300$ , assuming direct drive to mechanical load. (Otherwise, you have a synchronous motor of unspecified nature.)

Since any reduction ratio is squareable (we wish it were cubable) a ratio of 10:1 permits an inertia of 200 gram-cm<sup>2</sup> to be driven at three-hundred 18° steps per second. Useful torque is then 700 gram-cm. Think of it — 6 inch-pounds per second, for only 10 or 15 watts. While there is a relation between power and speed, there is *no relation between torque and speed*. Torque is proportional to input current (up to saturation), speed to input frequency.

If you will write on your letterhead, you will receive an engineering bulletin describing the simple Cyclonome discussed above, as well as the reversible model.



**SIGMA INSTRUMENTS, INC.**

62 Pearl Street, So. Braintree 85, Massachusetts

An Affiliate of The Fisher-Pierce Co. (since 1939)



## Dynamic Gear in New Home

DYNAMIC GEAR CO., designer and manufacturer of miniaturized precision gears, differentials and allied components for application in the electro-mechanical field, recently moved into a new and larger plant in Amityville, N. Y.

William A. Wiegand, president of the 11-year-old firm, says the new plant's total area covers 20,250 sq ft, of which 15,000 sq ft is utilized for increased production facilities. A portion of this area includes the quality control section and a temperature, humidity-controlled precision assembly room. In this room, precision components such as gear trains and servo-mechanisms are assembled under critical conditions. Also a part of the new plant operation is an extended engineering service. DG engineers can take a client's spec sheet and work it into a complete set of finalized drawings or, if desired, do the final assembly of the component, the company says.

Dynamic Gear Co. was founded in 1948 by Wiegand in a Brooklyn barn that rented for \$25 a week. The new Amityville plant was constructed at a cost of more than \$250,000.

The miniature, precision gears—both stock and custom—are known as Dynaco gears and are used in the guidance systems of the Thor, Atlas and Titan missiles, says the firm. More recently, the company adds, these gears were utilized in the inertial navigational system of the Navy's new nuclear-powered submarines capable of firing the Polaris missile.



## Name Kenny V-P At Super-Temp

AMERICAN SUPER - TEMPERATURE WIRES, INC., has appointed James Kenny as vice president in charge of engineering. He had previously

been chief engineer and has been with the Winooski, Vt., company since 1956.

In his new capacity Kenny will have administrative and technical supervision of engineering activities at the company's three plants. He will also be available for consultation on development and production problems relating to new wire and cable designs.

## Georgia Company Plans Expansion

SCIENTIFIC-ATLANTA, INC., manufacturer of microwave instrumentation, has completed the purchase of 64 acres of land just outside Norcross, Ga. The tract will be used for expansion of the company's manufacturing facilities.

In making the announcement,

Glen P. Robinson, Jr., president, pointed out that the company had grown from 41 employees in the summer of 1957 to 125 at the present time.



## Elect Day REL Director

JAMES R. DAY, close collaborator of the late Major E. H. Armstrong in the development of wide-band frequency modulation, and himself the inventor of many important devices in this field, has been elected a director of Radio Engineering Laboratories, Inc., Long Island City, N. Y., communications subsidiary of Dynamics Corp. of America.

A vice president of REL since 1949, Day joined the company in 1945. REL produces tropospheric scatter communications equipment and also ssb radio equipment and tv-radio transmitting equipment.

## Organize New Microwave Corp.

THE PRESIDENT of Norfolk Precision Machine Corp., J. L. Travers, announces the formation of a new division, Precision Microwave Corp., in Millis, Mass., to design, manufacture and test microwave systems and components.

Precision Microwave division is headed by Eugene G. Slotta, who was for the past 7 years with Raytheon Co., Waltham, Mass. There he served as microwave methods engineer, founder and general foreman of Government Equipment di-



A Miniature  
Switch

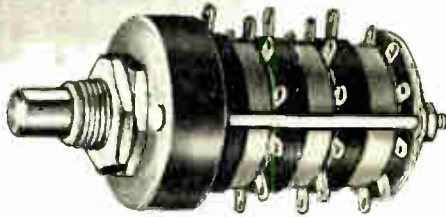

## ...with Positive Detent Action

Grayhill  
Series  
24

This fully enclosed one inch diameter miniature tap switch, designed for high reliability in military and commercial applications, provides accurate indexing by precision detent mechanism.

One to 10 decks, 2 to 10 shorting or non-shorting positions per deck. 36° indexing. Break 1 amp. 115 V. AC, or carry 5 amps. Has passed many military environmental tests including explosion test per MIL-E-5272A Procedure 1.

Write for Complete Specifications



Phone: Fleetwood 4-1040  
523 Hillgrove Ave., LaGrange, Ill.

"PIONEERS IN MINIATURIZATION"  
CIRCLE 221 ON READER SERVICE CARD

# VALUABLE 64 PAGE REFERENCE SECTION

in electronics BUYERS' GUIDE

Prepared especially by the 25-man editorial staff of *electronics*, this 64-page section is designed to assist the buyer by providing him with market data, electronics applications, market distribution, market reports and books, industry organizations and services.

electronics BUYERS' GUIDE  
and Reference Issue

A McGraw-Hill Publication  
330 West 42nd Street  
New York 36, New York



# BOWMAR

PRECISION SERVO  
GEARHEADS  
AND SPEED REDUCERS

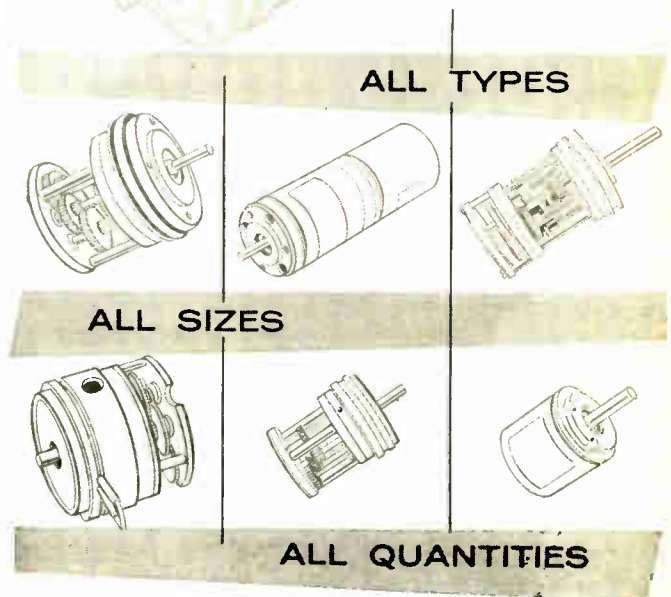

Bowmar designs and manufactures all types of precision geared components, assemblies and packages for all types of precision control systems. Dozens of semi-standard speed reducer and gearhead sizes are offered in most ratios; but these types may be altered, or entirely new types can be developed to fit new requirements. Typical of many Bowmar designs currently being manufactured —



TWO SPEED GEARHEAD X-709. Unit shown has speed reductions of 2400:1 and 24000:1 for fast approach and slow zeroing. Unit is electrically actuated and is completely self contained. Typical of many Bowmar designs currently being manufactured.



PRECISION SERVO MOTOR GEARHEAD 750-GH (with housing). Standard ratios to 2000:1; Starting torque: .005 in.-oz.; Load torque: 5 in.-oz.; Backlash: 30 min. max.; Diameter: .750 in. Typical of many Bowmar designs currently being manufactured.



PRECISION MINIATURE SPEED REDUCER 1062. Standard ratios to 4000:1. Starting torque: .005 in.-oz.; Load torque: 25 in.-oz.; Backlash: 45 min. max.; Diameter: 1.062 in. Typical of many Bowmar designs currently being manufactured.



CONCENTRIC SHAFT SPEED REDUCER X-530. Single ended unit has optional internal slip clutch set to customer requirements. Most ratios available. Starting torque: .01 in.-oz.; Backlash: 30 min. max.; Diameter: 1.062 in. Typical of many Bowmar designs currently being manufactured.



SEND NOW FOR DATA PACKAGE NO. 1158  
INSTRUMENT CORPORATION  
8000 Bluffton Road • Fort Wayne, Indiana

REPRESENTATIVES IN PRINCIPAL U. S. AND CANADIAN CITIES

# PERFORMANCE BEYOND THE STATE OF THE ART!

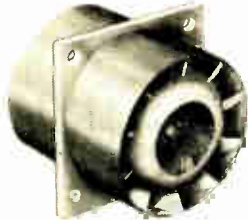

With  
Dean & Bensons

# POW AIR

Series HP & HF  
Standard 2" Blower  
*Performance Rated!*

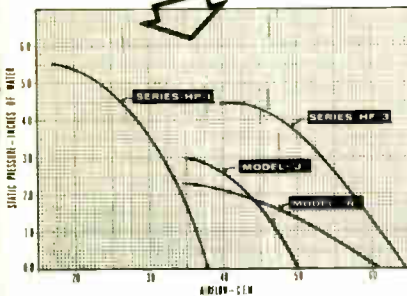

- Greater operating efficiency resulting in increased performance.
- Up to 200% greater performance for new design approaches.
- Slip out AC or DC Motor allows for easy and inexpensive maintenance without replacing entire unit.
- 400 Cycle or 28 V. DC units available without design change.

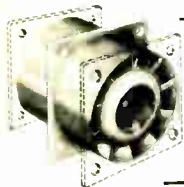

Flange location  
anywhere at  
no additional  
cost.

**DEAN & BENSON**  
RESEARCH  
Division of Benson Manufacturing Co.  
Kansas City 1, Mo.

vision microwave shop, and general shop superintendent of Waltham's Plant No. 1, respectively.

David A. Fulton, engaged in microwave engineering, production sales and consulting work for 7 years, has been appointed chief engineer of the new firm.



## Name Benjamin Sales Manager

CHRISTIE ELECTRIC CORP., Los Angeles, Calif., has appointed Fred Benjamin sales manager of the firm's Industrial Division. He will devote his activities to the company's complete and diversified line of d-c power supplies and industrial battery charging equipment.

Prior to joining the Christie organization, Benjamin held positions as director of research and development at American Electronics and a director of sales and engineering at Magnetic Systems.

## News of Reps

McCarthy Associates Inc., electronics manufacturers reps, Pasadena, Calif., has promoted Ron Klaas to the newly created position of business manager and treasurer.

Appointment of five additional sales rep firms by Electronics International Co., Burbank, Calif., is announced. Reps are: Allan Crawford Associates of Willodale, Ontario, covering all Canadian provinces, except British Columbia; E. G. Holmes & Associates of Atlanta, Ga., and Orlando, Fla.,



## FOREMOST

in

## SONAR

**EDO CORPORATION**  
College Point, L.I., N.Y.  
Since 1926

CIRCLE 223 ON READER SERVICE CARD

No quicker, more accurate way to get information on **PRODUCTS** and **SERVICES** than . . . .

**electronics  
BUYERS'  
GUIDE**

keep it  
at your  
fingertips!



**electronics  
BUYERS' GUIDE**

A McGRAW-HILL PUBLICATION  
330 WEST 42nd ST. NEW YORK 36, N. Y.



for Alabama, Georgia, North Carolina, South Carolina and Florida; N. R. Schultz Co. of Seattle, Wash., for Oregon, Washington and Idaho; Technical Instruments, Inc., of Reading, Mass., and Bridgeport, Conn., for Connecticut, Rhode Island, Massachusetts, Maine; and Instruments For Measurements of Sunnydale, Calif., covering California.

Kiva Sales Co. of Phoenix, Arizona, has been appointed by Mid-Eastern Electronics, Inc., for the entire state. Kiva will handle Mid-Eastern's line of power supplies, ultra high resistance measuring instruments and special test equipment.

Six new reps throughout the U. S. have been appointed by Babcock Relays, Inc., Costa Mesa, Calif. Firm manufactures miniaturized precision relays for use in both airborne and ground commercial and military applications.

The newly appointed reps include Stan Colthier Co. of Minneapolis, Minn.; Jas. J. Backer Co. of Seattle, Wash.; G&H Sales Co. of Cincinnati, Ohio; Kay Sales Co. of Kansas City, Mo.; Packard Associates, Dallas, Texas; and Reed-Tollefson Corp. of Rochester, N. Y.

Pyramid Electric Co., Darlington, S. C., announces appointment of Ken Steinke Sales of Milwaukee, Wis., as rep for its line of capacitors and silicon rectifiers in the state of Wisconsin.

Alfred Electronics, Inc., Palo Alto, Calif., manufacturer of broad band microwave instruments and power supplies, names George Gostenhofer & Associates, Inc., of Waltham, Mass., as engineering sales rep in the New England area.

Industrial X-Ray Engineers of Seattle, Wash., has been appointed to represent Sperry Products Co. in the Pacific Northwest, to include Oregon, Washington, Idaho and western Montana. Company will handle sales and service of the full Sperry ultrasonic line—instruments, accessories and automated testing systems.



the  
**3**<sup>rd</sup>

## international exhibition of electronic components

IN PARIS  
FROM FEBRUARY  
19th TO 23rd  
1960

The greatest world gathering  
in the field of electronics.

Recognized Travel Agency :  
Cook's International Sleeping-Car Agency

FÉDÉRATION NATIONALE  
DES INDUSTRIES ÉLECTRONIQUES FRANÇAISES

(F.N.I.E.) 23, rue de Lübeck - PARIS 16<sup>e</sup> - Tél. : PAS. 01-16

CIRCLE 225 ON READER SERVICE CARD

## NEW SYNCHRONOUS TIMERS

- 1-minute timer adjustable in 1 second intervals—0 to 60 seconds. 3-minute timer adjustable in 3 second intervals—0 to 180 seconds. 5-minute timer adjustable in 5 second intervals—0 to 300 seconds
- No guesswork . . . exact time interval set by positioning bronze pointer
- Sweep-second pointer provides visual count-down during timing operation
- Automatic reset returns pointer to start position after each cycle
- Models interchangeable without disturbing mounting base or wiring
- Rugged timing mechanism guarantees accurate, trouble-free performance



Write today for  
Bulletin EN38-W218  
Cutler-Hammer Inc.  
Milwaukee 1 Wis



# CUTLER-HAMMER

Cutler-Hammer Inc., Milwaukee, Wis. • Division: Airborne Instruments Laboratory. • Subsidiary: Cutler-Hammer International, C. A.  
Associates: Canadian Cutler-Hammer, Ltd.; Cutler-Hammer Mexicana, S. A.; Intercontinental Electronics Corporation.

**Free** send for the  
most widely used  
**ELECTRONIC SUPPLY GUIDE**

## ALLIED'S 1960 CATALOG

**BUY AT FACTORY PRICES**  
WORLD'S LARGEST STOCKS AT YOUR COMMAND

specialists in the complete supply of:

- Semi-Conductors
- Special-Purpose Tubes
- Controls, Resistors
- Connectors
- Test Equipment & Meters
- Switches & Timers
- Relays
- Knight-Kit® Instruments
- Knight® P.A. Equipmt.
- Transformers
- Electronic Parts for Every Industrial Need

**ONE ORDER TO ALLIED FILLS THE WHOLE BILL:** Your ALLIED Catalog is the best single source for electronic supply. It puts the world's largest stocks at your command—there's no need to deal with hundreds of separate factories—*one order to us fills the whole bill.* You get same-day shipment (fastest service in electronic supply) and you buy at factory prices. Send today for your FREE 1960 ALLIED Catalog—your one-source electronic supply guide.

your dependable  
direct factory source  
for everything in  
electronic supply

### ALLIED RADIO

100 N. Western Ave., Dept. 11-M9  
Chicago 80, Ill.



CIRCLE 226 ON READER SERVICE CARD

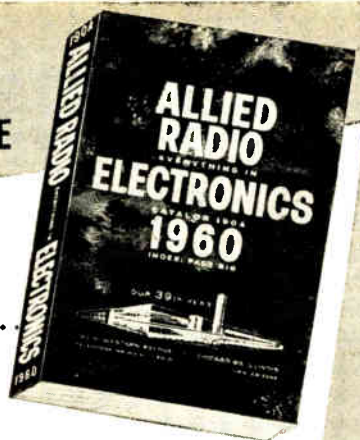

## Comment

### Help Wanted

I have a problem. I have been receiving your magazine for four months now and feel that among your contributors may be one with the answer.

I have an old reed pump organ handsomely carved in a black ebony-type finish. It is my desire to build an electronic organ with two-manual full bass, or the bass of a Hammond or other make with two or three octaves in the bass section. I also am desirous of building this organ with transistors instead of vacuum tubes because of space limitations.

So far I cannot find circuits drawn or pictured with layouts of what I need. I figure I will need tone generators or oscillators, power supplies, audio (high-fidelity if possible), and manuals. Is there a book or books which would enable me to pick up the basic circuits involved, or am I reaching for the moon?

I would buy an electronic organ but at \$1,800 or so I figure I'd better do it myself. With the circuits, I could build it as I could afford the parts . . .

VICTOR A. FRAPPIER

ALEXANDRIA, VA.

It may seem an easy way to fob off responsibility, but we recommend that reader Frappier peruse our annual indexes, which appear in the last issue for each year.

We picked up our own 1958 index just now and found listed an article "Electronic Organ Uses Neon Tone Generators," p 36, Aug. 29 '58. This article, we recall, describes a basic circuit which provides the 12 notes of the diatonic scale, plus the necessary dividers for subharmonics at octave intervals, and tone-coloring circuitry. The organ resulting was a two-manual 25-stop instrument with a 13-key pedal clavier (full pedal keyboards of 2½ octaves are rarely found on home organs).

Another article on tone generators appeared in our Jan. '51 issue. And we have carried many articles on regulated power supplies of all types, and on high-fidelity audio reproduction systems.

By the way, the Hammond organ produces its tones electrically, not

High Quality.....

Easy to Handle.....

Attractive Price.....



Catalogue on Request

#### SLIDUP VARIABLE AUTOTRANSFORMER

The SLIDUP is a manual voltage control that finds application in the electronic devices wherever a. c. voltage must be adjusted smoothly and continuously. Many kinds of SLIDUP are available upon request.

Enquires for other Japanese electronic components are also solicited

### TOYO TRADING CO., LTD.

P. O. BOX NO. 999 CENTRAL TOKYO, JAPAN.  
1-CHOME, HONGOKU-CHO, NIHONBASHI, CHUO-KU,  
TOKYO. CABLE ADDRESS "SHININGEAST" TOKYO

CIRCLE 227 ON READER SERVICE CARD

## MEET ED DeJONGH

Associate Editor, electronics  
MARKET RESEARCH EXPERT



A graduate of Oberlin, BA, and Harvard Business School, MBA, Ed DeJongh is the researcher and analyst who is responsible for "Market Research", "Figures of the Week", sales estimates, sales forecasts, marketing news, and developments in marketing. Ed is constantly preparing for a year-end statistical issue and forecast for the following year. If you're not a subscriber, if your subscription is expiring, if you need market data in your work, fill in box on Reader Service Card. Easy to use. Postage free.



A McGraw-Hill Publication  
330 West 42nd Street, New York 36, N. Y.



**IN LESS THAN  
4 SECONDS**

FROM THIS

TO THIS

OR THIS

**WITH THE REVOLUTIONARY  
PRODUCTION AID TOOL!**

**"PIG-TAILOR"®**

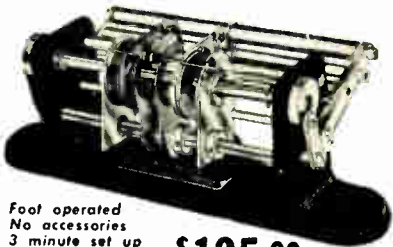

Foot operated  
No accessories  
3 minute set up

**\$125.00**

**'PIG-TAILORING'**

a revolutionary new mechanical process for higher production at lower costs. Fastest PREPARATION and ASSEMBLY of Resistors, Capacitors, Diodes and all other axial lead components for TERMINAL BOARDS, PRINTED CIRCUITS and MINIATURIZED ASSEMBLIES.

PIG-TAILORING eliminates: • Diagonal cutters • Long nose pliers • Operator judgment • 90% operator training time • Broken components • Broken leads • Short circuits from clippings • 65% chassis handling • Excessive lead tautness • Haphazard assembly methods.

PIG-TAILORING provides: • Uniform component position • Uniform marking exposure • Miniaturization spacing control • "S" leads for terminals • "U" leads for printed circuits • Individual cut and bend lengths • Better time/rate analysis • Closer cost control • Invaluable labor saving • Immediate cost recovery.

**Pays for itself in 2 weeks**

**"SPIN-PIN"®**

Close-up views of "SPIN-PIN" illustrate fast assembly of tailored-lead wire to terminal.

- No Training
- No Pliers
- No Clippings
- Uniform Crimps
- 22 Sizes

**PAYS FOR ITSELF  
THE FIRST DAY!**

**\$500**  
EACH

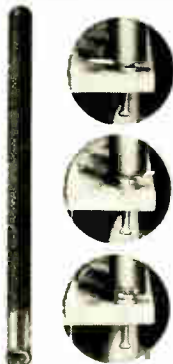

Write for illustrated book to Dept. E-12



**BRUNO-NEW YORK INDUSTRIES CORP.**  
DESIGNERS & MANUFACTURERS OF ELECTRONIC EQUIPMENT  
460 WEST 34th STREET • NEW YORK 1, N. Y.

CIRCLE 229 ON READER SERVICE CARD

electronically. It might not be wise to try to mix the breeds.

#### Credit Where Due

With reference to our article "Function Generation With Operational Amplifiers" (p 66, Nov. 6), you are to be congratulated for your speedy handling of the editing and production.

The first of the precision limiter circuits shown (our Fig. 1B) was originally published by C. D. Morrill and R. V. Baum (in "Diode Limiters Simulate Mechanical Phenomena," *ELECTRONICS*, p 122, Nov. '52). Due to the omission of a reference mark included in our original manuscript, Messrs. Morrill and Baum were not given proper credit for this remarkable circuit, although the reference to their paper was correctly included at the end of the article.

I should appreciate your printing this, because I feel strongly about giving credit where it is due.

GRANINO A. KORN

UNIVERSITY OF ARIZONA  
TUCSON, ARIZ.

So do we.

#### Grammatical Errors?

Mr. Upson is to be commended for his letter (Comment, p 139, Nov. 13), in which he points out frequent grammatical errors found in technical journals.

Whether Mr. Upson knows it or not, however, his letter illustrates another rather common error in the use of the term *whether or not*.

MARTIN BREMMER

N. A. PHILIPS CO.  
IRVINGTON-ON-HUDSON, N. Y.

"Whether reader Bremmer knows it or knows it not" yields, by ellipsis, "whether he knows it or not," and that, by transposition, "whether or not he knows it." (The direct construction was the one reader Upson used.) The alternative "whether or no" is not so easily accounted for, since "no" is not ordinarily an adverb—as "not" is. In England, "whether or not" is used less frequently than "whether or no," but either form is acceptable and "whether or not" is standard American.

**HERE'S A MANUAL FOR  
QUALIFIED PERSONS**

**INTERESTED IN  
Reliable  
Printed  
Circuits...**



Where performance is critical and failure unforgivable, there is only one way to make printed circuits. It is with quality control in depth, as developed by the Bureau Of

Engraving, Inc., and as described in our new U.S. Air Force Approved QUALITY CONTROL MANUAL FOR PRINTED CIRCUIT BOARDS AND BOARD ASSEMBLIES.

For instance, it is not enough that every circuit be gaged to a very close tolerance. Consideration must also be given to the fact that the gage itself wears in use. Under GAGE CONTROL our manual states, "The Gage Control procedure insures that all gages, measuring and test equipment being used are within the tolerances required to maintain manufacturing specifications . . . gage is to be inspected according to the wear policy and frequency as specified on the gage control card."

Procedures, functions, definitions and maintenance of materials specifications are discussed in detail. Our QUALITY CONTROL MANUAL meets MIL-STD-105A and MIL-Q-5923C standards.

If you are a qualified person (engaged in the development or manufacture of products requiring printed circuits), write for our manual on your company letterhead. Copies will be sent out free as long as our limited supply lasts.

WRITE TO:

Member of the  
Institute of Printed Circuits



**BUREAU OF ENGRAVING, Inc.**

Industrial Division

504 S. 4th St., Minneapolis 15, Minn.  
Telephone FEderal 9-8721

CIRCLE 195 ON READER SERVICE CARD

195

ENGINEERS—Electrical, Mechanical, Industrial

# WESTERN ELECTRIC

## Is Augmenting Its Professional Staff

Western Electric has openings for men of superior professional ability. Present areas of activity that afford opportunity to utilize your full technological skills are:

- NIKE ZEUS ANTI-MISSILE MISSILE SYSTEM ■ MISSILE GUIDANCE SYSTEMS ■ ASSOCIATED GROUND CONTROL RADAR SYSTEMS ■ FIRE CONTROL RADAR ■ UNDERWATER DEFENSE SYSTEMS ■ DIGITAL COMPUTERS ■ WAVEGUIDES AND GYROS ■ HIGH PRECISION ELECTRONIC COMPONENTS AND SOLID STATE DEVICES

You are invited to discuss with us how your previous training and experience can fit you for an important career position in one of these engineering areas:

- Development
- Project
- Test Planning
- Test Set Design
- Pilot Line Manufacture
- Tool Design
- Product Design
- Standards
- Technical Publications
- Field Engineering

*Also Openings For:*

- Technical Writers
- Engineering Associates

Positions are available at these Western Electric Locations: Winston-Salem, Greensboro and Burlington, North Carolina  
Laureldale, Pennsylvania and Whippany, New Jersey

*For a personal interview in your area or at one of the above locations, address your resume to: Mr. T. R. Lannon  
Engineering Employment Manager, Dept. 924G.*



Lexington Road, Winston-Salem, North Carolina

### ELECTRICAL ENGINEER

Graduate Electrical Engineer. Some practical experience with emphasis on theory for R & D in a company manufacturing electrical equipment in the low voltage field. Excellent future in a non-defense industry. All benefits plus profit-sharing. Send complete resume to Personnel Director.

TELECONTROL DIVISION  
**HANCOCK INDUSTRIES**  
JACKSON, MICHIGAN

### ELECTRONICS—FRANCE

Aggressive well established—since 1932—sales—engineering organization. Best connections to govt. & industry. Well liked French-American management. Will cooperate with U. S. mtrs. wishing to enter EUROPEAN COMMON MARKET. Write

RA-3092, Electronics  
Class. Adv. Div., P.O. Box 12, N.Y. 36, N.Y.

*"Put Yourself in the  
Other Fellow's Place"*

## TO EMPLOYERS TO EMPLOYEES

Letters written offering Employment or applying for same are written with the hope of satisfying a current need. An answer, regardless of whether it is favorable or not, is usually expected.

**MR. EMPLOYER**, won't you remove the mystery about the status of an employee's application by acknowledging all applicants and not just the promising candidates.

**MR. EMPLOYEE** you, too, can help by acknowledging applications and job offers. This would encourage more companies to answer position wanted ads in this section.

We make this suggestion in a spirit of helpful cooperation between employers and employees.

This section will be the more useful to all as a result of this consideration.

Classified Advertising Division

**McGRAW-HILL PUBLISHING CO., INC.**  
330 West 42nd St., New York 36, N. Y.



# ELECTRICAL ENGINEERS

Challenging positions open for high caliber Electrical Engineers with some experience to work in interesting research and development programs in instrumentation and circuitry.

We offer you an opportunity to do non-routine research and use your initiative and creative ability.

Excellent employee benefits, including liberal vacation policy and tuition-free graduate study. Please send resume to:

E. P. Bloch  
**ARMOUR RESEARCH FOUNDATION**  
 of Illinois Institute of Technology  
 10 West 35th Street  
 Chicago 16, Illinois

## —ENGINEERS— LENKURT

has opportunities FOR YOU in the following fields:

- COMMUNICATIONS
- DEVELOPMENT
- SALES
- ASST. ELECTRICAL ENGINEERING WRITERS

Live and work on the Beautiful San Francisco Peninsula.

Please call—collect—LYtel 1-8461

or send resume to:

E. Jack Shannahan, Employment Manager

**LENKURT ELECTRIC CO., Inc.**  
 1105 County Road San Carlos, California

## DISENCHANTED ENGINEERS

If your present employer has failed to utilize your full potential, why not permit us to explore the parameters for your personal qualifications with the many dynamic young companies in aviation, electronics, missiles and rockets. We now have in excess of 1,000 openings in the \$8,000 to \$10,000 bracket, all of which are fee paid. Why wait? Send resume in duplicate at once indicating geographical preferences and salary requirements.

FIDELITY PERSONNEL  
 1530 Chestnut Street, Philadelphia 2, Pa.  
 Established 1943

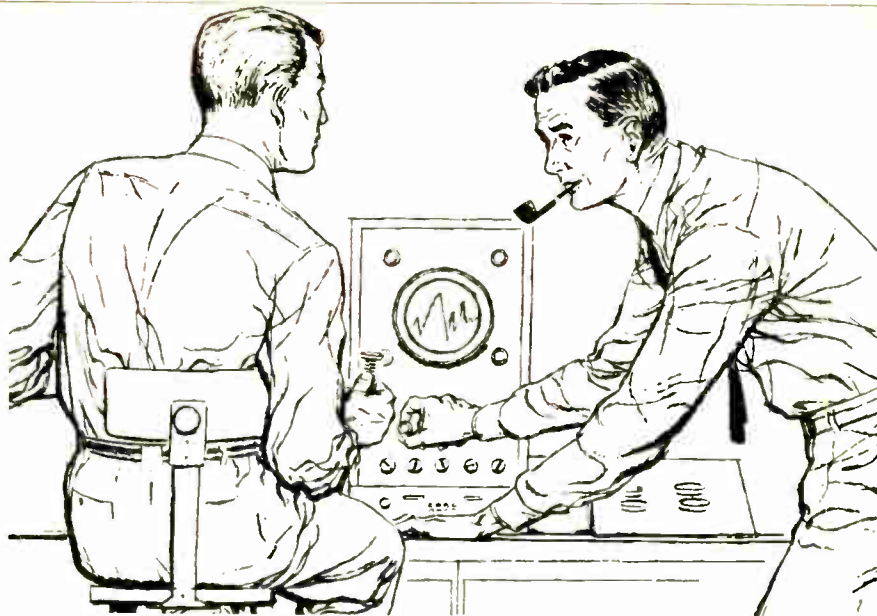

# REWARDING!

A feeling of accomplishment, comfortable salary, security, fine home, prestige in the community. Yes, these are the marks of a successful Motorola engineer in Chicagoland. But, what exactly makes a career at Motorola so rewarding—beyond the ordinary realm of material benefits?

Foremost is opportunity. For here a man is encouraged to use all of his creative talents to their fullest. He works on projects that spark vision, that inspire imagination. He works with men who recognize and respect his abilities . . . a calibre of men that he cannot help but admire.

Yes, a career at Motorola is deeply rewarding. You owe it to yourself to discover *exactly* how much. Simply clip the coupon below.

- Radar transmitters and receivers
- Radar circuit design
- Electronic countermeasure systems
- Military communications equipment design
- Pulse circuit design
- IF strip design
- Device using klystron, traveling wave tube and backward wave oscillator
- Display and storage devices
- 2-WAY RADIO COMMUNICATIONS
- VHF & UHF receiver
- Transmitter design and development
- Power supply
- Systems engineering
- Antenna design
- Selective signaling
- Transistor applications
- Crystal engineering
- Sales engineering
- Design of VHF & UHF FM communications in portable or subminiature development
- Microwave field engineers
- Transistor switching circuit design
- Logic circuit design
- T.V. circuit design engineering
- Home radio design
- New product design
- Auto radio design
- Mechanical engineering
- Semi-conductor device development
- Semi-conductor application work

Also splendid opportunities in

Phoenix Ariz., and Riverside, Calif.



# MOTOROLA Inc.

Mr. L. B. Wrenn, Engineering Personnel Mgr., Dept. D  
 4501 Augusta Blvd., Chicago 51, Illinois

Without obligation, send copy of  
 "Selecting an Engineering Career with a Future"

NAME \_\_\_\_\_

ADDRESS \_\_\_\_\_

CITY \_\_\_\_\_

ZONE \_\_\_\_\_ STATE \_\_\_\_\_

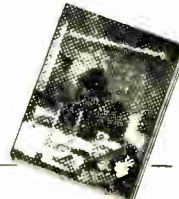

# New Multi-Million Dollar Engineering Research and Manufacturing Facility

for **NORDEN**

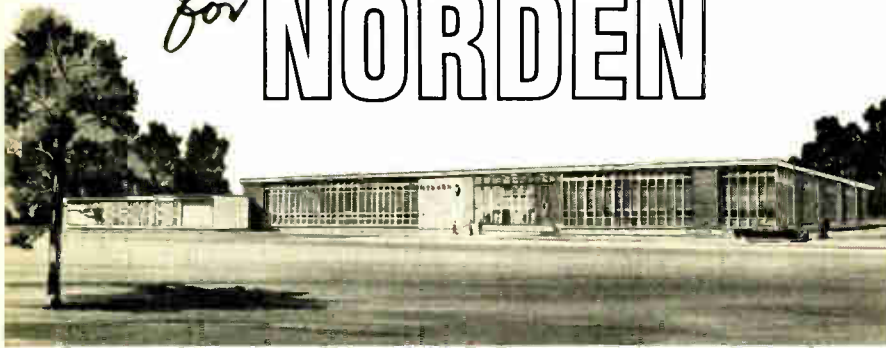

## Now Under Construction in NORWALK, CONNECTICUT

Next fall the Norden Division of United Aircraft Corporation will consolidate in its new 350,000 sq. ft. Norwalk home the operations it is now carrying on in plants and laboratories in White Plains, New York and Stamford and Milford, Connecticut. The Keta Department, however, a prominent leader in the field of rotating components, will continue operations at its modern facilities in Commack, Long Island.

### An Unmatched Combination of Professional and Living Advantages

The ultra-modern new building on a spacious 80-acre site will contain the most up-to-date laboratory equipment. Norden's expanding programs offer a wide choice of assignments in advanced electronics areas. Typical projects include: AN/ASB-7 BOMB-NAV SYSTEM • 3-DIMENSIONAL TERRAIN PRESENTATION FOR LOW-FLYING AIRCRAFT • METEOROLOGICAL RADAR • AUTOMATIC TRACKING TV THEODOLITES • INERTIAL NAVIGATION SYSTEMS • SPACE INSTRUMENTATION SYSTEMS.

On the personal side are such advantages as living in picturesque New England, where both traditional and modern homes are available, though only 41 miles from New York City. And Norwalk may be said to have "more than its share" of cultural activities, boasting the largest community art center in the East and its own symphony orchestra. Outdoor recreation also abounds, with golf courses, beaches on Long Island Sound and excellent boat basins.

### Openings now at all levels in two locations—

White Plains, New York and Stamford, Connecticut

Fire Control Systems  
Radar Systems  
Communications Equipment  
Infrared Equipment  
Data Processing Equipment  
Television Systems

Inertial Guidance Systems  
Navigational Systems  
& Components  
Microwave Equipment  
Aircraft Instrumentation  
Anti-Submarine Warfare

Send resume to:

Technical Employment Manager



## **NORDEN LABORATORIES**

NORDEN DIVISION OF UNITED AIRCRAFT CORPORATION  
121 Westmoreland Avenue—White Plains, New York

## FOR ADDITIONAL INFORMATION

About Classified Advertising,

Contact

*The McGraw-Hill  
Office Nearest You.*

ATLANTA, 3  
1301 Rhodes-Haverty Bldg.  
JACKSON 3-6951  
M. MILLER

BOSTON, 16  
350 Park Square  
HUBBARD 2-7160  
M. J. HOSMER

CHICAGO, 11  
520 No. Michigan Ave.  
MOHAWK 4-5800  
W. HIGGINS—E. S. MOORE

CLEVELAND, 13  
1164 Illuminating Bldg.  
SUPERIOR 1-7000  
W. B. SULLIVAN—T. H. HUNTER

DALLAS, 2  
1712 Commerce St.,  
Vaughn Bldg.  
RIVERSIDE 7-5117  
GORDON JONES—F. E. HOLLAND

DETROIT, 26  
856 Penobscot Bldg.  
WOODWARD 2-1793  
J. R. PIERCE

LOS ANGELES, 17  
1125 W. 6 St.  
HUNTLEY 2-5450  
R. YOCOM

NEW YORK, 36  
500 Fifth Ave.  
OXFORD 5-5959  
H. T. BUCHANAN—R. P. LAWLESS  
T. W. BENDER

PHILADELPHIA, 3  
Six Penn Center Plaza  
LOCUST 8-4330  
H. W. BOZARTH

ST. LOUIS, 8  
3615 Olive St.  
JEFFERSON 5-4867

SAN FRANCISCO, 4  
68 Post St.  
DOUGLAS 2-4600  
S. HUBBARD



# ELECTRONIC ENGINEERS

- Career Opportunities
- Challenging Assignments
- Top Earnings

Leading, independent research organization has positions available for men with BS and MS degrees in Electronic Engineering. Men with experience in the development of vacuum tubes, transistor or relay circuits, or recent outstanding college graduates will qualify. Interesting, unusual work in data transmission and retrieval and digital computing.

- Non-military work
- Individual effort recognized
- Good job security
- Ideal working conditions
- Excellent employee benefit program
- Long-established firm

Comfortable living in Suburban areas only minutes away.

## FORWARD YOUR RESUME IN CONFIDENCE

P-3093 Electronics, 520 N. Michigan Ave., Chicago 11, Ill.



### all-level Electronic SCIENTISTS, ENGINEERS, EXECUTIVES EMPLOYER & EMPLOYEE

VISIT OUR BOOTH 42, 1959 EXPOSITION OF SCIENCE AND INDUSTRY,  
AAAS MEETING, CHICAGO, ILL., DEC. 26-31.

Employees seeking relocation, employers seeking personnel use our personalized service—confidential handling. Fees no problem. Salaries \$6000—\$60,000. Resumes or job specifications welcomed now. Write Dr. A. H. Hammond, 1029 Vermont Ave., N. W., Wash. 5, D. C. Phone ME 8-2567.

NATIONAL SCIENTIFIC PERSONNEL BUREAU, INC.

## CONTACTS

### "HOW TO MAKE MONEY IN Mobile Radio Maintenance"

AUTHORITATIVE GUIDEBOOK  
ABOUT THE BOOM IN TWO-WAY MOBILE RADIO.  
GIVES FACTS, FIGURES, PAY RATES,  
WRITE TODAY!

FREE



LAMPKIN LABORATORIES, INC. Instruments Div. BRADENTON, FLA.

CIRCLE 463 ON READER SERVICE CARD

## GLASS BEADS

Solid • Close Tolerances • 1.5 to 10 mm.

FS-3098, Electronics

Class. Adv. Div., P.O. Box 13, N.Y. 36, N.Y.

CIRCLE 464 ON READER SERVICE CARD

## PROFESSIONAL SERVICES

ALBERT PREISMAN

Consulting Engineer

Television, Pulse Techniques, Video

Amplifiers, Patent technical consultation.

616 St. Andrews Lane, Silver Spring, Maryland

YARDNEY ELECTRIC CORP.

"Pioneers in Compact Power"

Electro-Chemical Generators of Energy

"from milliwatts to megawatts"

10-50 Leonard Street  
New York 13, N. Y.

Worth 6-3100  
\* T.M.

## SEARCHLIGHT SECTION

(Classified Advertising)

BUSINESS OPPORTUNITIES  
EQUIPMENT - USED or RESALE

### DISPLAYED RATE

The advertising rate is \$4.00 per inch for all advertising appearing on other than a contact basis. Contract rates quoted on request. An ADVERTISING INCH is measured 1/8 inch vertically on one column, 3 columns—20 inches—to a page. EQUIPMENT WANTED or FOR SALE ADVERTISEMENTS acceptable only in Displayed Style.

### UNDISPLAYED RATE

\$2.40 a line, minimum 3 lines. To figure advance payment count 5 average words as a line. BOX NUMBERS count as one line additional in undisplayed ads.

### BUSINESS OPPORTUNITY

Capital available for well managed companies in electronics, chemical or related fields in need of funds for growth. Must have established record of at least 2-3 years with interesting future prospects. BO-3127, Electronics, Class. Adv. Div., P. O. Box 12, N. Y. 36, N. Y.

## GENERATORS

High frequency, 400 cycles, also available in variable voltage and variable frequency at any voltage and phase desired. Driven by constant speed motors or variable speed motors, A.C. or D.C. Control panels also available. Large stock on hand. Write for catalogue and prices.

Reliable Electric Motor Repair Co.  
19 California Avenue, Paterson, N. J.

CIRCLE 460 ON READER SERVICE CARD

## GLASS TUBING

PYREX - NONEX - URANIUM

BULB & CYLINDERS

WRITE FOR FREE MONTHLY LIST

HOUE SUPPLY COMPANY

PHONE COLFAX 4-1286

P.O. Box 206 Keyport, N. J.

CIRCLE 461 ON READER SERVICE CARD

## LOOKING FOR USED/SURPLUS ELECTRONIC EQUIPMENT/COMPONENTS?

For an up-to-date listing of such equipment see Searchlight Section of Nov. 13th

## STRETCH YOUR BUDGET WITH PRE-SELECTED SURPLUS!

MEASUREMENTS CORP. MODEL 79-B PULSE GENERATOR. 60-100,000 cy. New, Original pack. FOB Harrisburg, Pa. Only \$99.50

400 CY. + .001% LAB STANDARD REFERENCE POWER SUPPLY. Model 400-A. New. Fork controlled (Amet. Time Prod.) Osc. main control, 6V6GT output, VR-150 reg. pwr. supply, 5U4, also gives handy bench B-plus, filtered, 300 V. no load, controlled by 1500 ohm variable in series with 500 ohm effective fixed int. res. Up to 120 MA. Also 6.3 VAC 4 A. Input: 50 60 cy. or 95/117 130 190/210/234/260 V. With schematic. FOB Los Angeles, Cal. \$97.50

.02% LAB STANDARD REFERENCE SOURCE 1,000, 500, 250, 125, & 62 1/2 CY. Modular sub-chassis with Amer. Time, Prod. NO. 2003 Fork and 4 Walkert plug-in binary flip-flop countdowns. New. Requires external 250-300 VDC, 35 ma, & 6.3 VAC, 2.1 A, both handy at front panel of mod. 400-A described above. With tubes, and schematic, tested. FOB Los Angeles, Calif. \$79.50

HEWLETT-PACKARD MODEL 200-C AUDIO OSCILLATOR. 20-200,000 cy. Certified. FOB Los Angeles \$99.50

HEWLETT-PACKARD MODEL 205AG AUDIO MICROVOLTER. 20-200,000 cy. Output calibrated in dbm. Certified. FOB Los Angeles \$249.50

LX-( ) MICROVOLTER. Same as Gen. Radio Mod. 804-B except in aluminum case, loss leakage, 7-5—330 Mc. Certified. FOB Los Angeles, Cal. \$179.50

LAF-2 MICROVOLTER. 90-60 MC ± 1%. Output calib. 1 mv-1 V. Internal pulse mod. or ext. pulse or sine mod. Input 105 125 V., 50/60 cy. Certified with calibration charts and reprints of needed parts of tech manual. FOB Los Angeles, Cal. \$89.50

LAE-2. Same as above, except 520-1300 MC. New, complete. FOB, Charleston, S. C. Only \$119.50

MEASUREMENTS CORP. MODEL 84 MICROVOLTER. 300-1,000 MC. ± 2%. Certified condition. FOB Los Angeles, Cal. \$149.50

MINIATURE OIL-SEALED BENCH POWER SUPPLY. 0-32,000 VDC. Test insulation. Cond. Prod. Co. PS-30-1360. Only 7 x 7 x 8" plus terminals and anti-corona balls. 1 MA DC with 1% ripple. Input 60 cy., 118 V. to fl. pri. and 0-118 V to plate pri. FOB Los Angeles, Cal. \$69.50

BALLANTINE 220-A DECADE AMPLIFIER. Steps up 10-150,000 cy. by 10X or 100X rms voltage, ± 2%. Use for meter step-up. New. FOB Los Angeles, Cal. Only \$49.50

PHOTRON F2 2-PEN PORTABLE RECORDER. Electric writing. Two Photron model G1 galvanometers, ea. 1500 ohms, 1.3 mm/colt. flat to 100 cy. when used with amplifier. Synch motor chart speeds 5, 25, 125 mm/sec. Certified. FOB Los Angeles \$249.50

BRUSH 6-PEN INK RECORDER. Model RL-206, equiv. to current catalogue RD-2661-00. Certified. FOB Los Angeles, Cal. \$995.00

TS-34/AP COMBINATION TEST OSCILLOSCOPE /SYNCHROSCOPE. Ready to plug in and use. With reprints of most important pages of the Tech Manual. FOB Los Angeles \$49.50

TS-34A/AP. Improved version of above, more versatility in the synchroscope function. Certified. FOB Los Angeles \$69.50

DUMONT #241 5" TEST SCOPE. Certified Less front cover & coax probe which everyone throws away. With instruction book reprint. FOB Los Angeles \$79.50

GROUND-TO-AIR COMMUNICATIONS, 225-390 MC. AMR Receiver-transmitter, #2, AS, 10 V. to antenna, 10-channel crystal control. Autotune selection. Works on 12, 24, 110, 230 VDC and 115 or 230 V. 60 cy., 1 ph. With all tubes, crystal oven, plugs and antenna. Apparently exc. used, cond. With partial handbook reprint. FOB Hartford, Conn. \$99.50

CONSTANT LINE VOLTAGE, NO HARMONIC DISTORTION. 1 kva automatic or manual Superior No. S620 Special. Bridge sensing servo-system turns. Powerstat. Input 60-130 V., 1 ph., 60 cy., adjusts to mill at 100-120 V. Metered. FOB El Paso, Tex. \$125.00

SOLA 3080B CONSTANT-VOLTAGE TRANSFORMER. 500 VA, 1 ph., 60 cy., 95-125 V. to isolated 115 V. ± 1%. Certified. FOB Los Angeles \$49.50

SOLA 30710 CONSTANT-VOLTAGE TRANSFORMER. 2 kva. Tapped for 50 or 60 cy., 1 ph. and for 95-125 or 190-250 V pri. Isolated secondary 115 V. ± 1%. New. FOB Harrisburg, Pa. \$147.50

GE CONSTANT-VOLTAGE TRANSFORMER. 2.3 kva, 57-63 cy., 1 ph, 100-135 V in., to link-switch selected 112/115/117 V. ± 2%. New. FOB Seattle, Wash. \$79.50

California buyers add 4% sales tax

## R. E. GOODHEART CO.

Electronic Design . . . Development

Manufacturing . . . Sales

P. O. BOX 1220-B

BEVERLY HILLS, CALIFORNIA

CIRCLE 462 ON READER SERVICE CARD

# NEED SPECIAL BLOWERS?

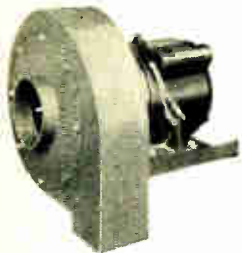

ELECTRONIC COOLING



HEAVY MACHINERY COOLING



INSULATED FOR TEMPERATURES



NO-CORROSION  
ALUMINUM CONSTRUCTION

**PEERLESS  
ELECTRIC  
SUPPLIES  
BOTH  
BLOWERS  
AND MOTORS  
AS A  
COMPLETE  
UNIT!**

- Meet government specifications!
- Air requirements up to 8" static pressure!
- Special finishes, fungus-treated, insulated, etc.!
- High and low temperature requirements!
- Special units for space conditions!

*Contact us today! We're interested in your inquiry!*

**PEERLESS  
ELECTRIC  
DIVISION**

**PORTER**

**H. K. PORTER  
COMPANY, INC.**

W. MARKET ST. • WARREN, OHIO

PORTER SERVES INDUSTRY: with 14 Divisions including: Thermoid, Delta-Star Electric, National Electric, Peerless Electric, Riverside-Alloy Metal, Refractories, Connors Steel, Vulcan-Kidd Steel, Forge and Fittings, Disston, Leschen Wire Rope, Mouldings, H. K. Porter Company de Mexico, S.A., and H. K. Porter Company (Canada) Ltd.

Member of the Air Moving and Conditioning Association, Inc. (AMCA)

Also Manufacturing The Massachusetts Line®

## INDEX TO ADVERTISERS

- Ace Electronics Associates, Inc. .... 184
- Actua Life Insurance Co. .... 60
- Airpix Electronics Inc. .... 122
- Alpha Wire Corp. .... 177
- Allied Radio .... 194
- American Instrument Co. .... 144
- American Lava Corp. .... 29
- Ampere Electronic Corp. .... 155
- Amphenol-Borg Electronics Corp. .... 158
- Atlas Precision Products Co. .... 142
- Eastman Kodak Co. .... 176
- Edo Corporation .... 192
- Eitel-McCullough, Inc. .... 10
- Electrical Industries .... 7
- Electronic Engineering Co. of California .... 131
- Electronics Instrument Co., Inc. (EICO) .... 162
- Electronic Measurements Co. .... 2
- Engelhard Industries, Inc. .... 12, 13
- Erie Resistor Corp. .... 169
- Essex Wire Corp., Magnet Wire Div. .... 129
- Esterline-Angus Co. .... 188
- Baker & Adamson, Div. of Allied Chemical .... 36
- Ballantine Laboratories, Inc. .... 175
- Beede Electrical Instrument Co., Inc. .... 173
- Bendix-Pacific .... 161
- Beryllium Corporation, The .... 179
- Bird Electronic Corp. .... 56
- Boeing Airplane Co. .... 40
- Boesch Mfg. Co., Inc. .... 164
- Boonton Radio Corp. .... 181
- Borg Equipment Div., Amphenol-Borg Electronics Corp. .... 136
- Bouras, Inc. .... 62, 63
- Bowmar Instrument Corp. .... 191
- Brookhaven National Laboratory .... 174
- Bruno-New York .... 195
- Bureau of Engraving .... 195
- Burnell & Co., Inc. .... 3
- Cambridge Thermionic Corp. .... 70
- Centralab, A Div. of Globe-Union, Inc. .... 67
- Chart-Pak, Inc. .... 139
- Chicago Standard Transformer Corp. .... 170
- Clare and Co., C. P. .... 71
- Computer Instruments Corp. .... 18
- Continental-Diamond Fibre, A Subsidiary of the Budd Co. .... 97
- Cornell-Dubilier Electric Corp. .... 165
- Cossor (Canada) Ltd. .... 178
- Curtiss-Wright Corp. .... 150
- Cutler-Hammer, Inc. .... 193
- G-L Electronics .... 138
- General Ceramics Corp. .... 66
- General Electric Company Apparatus Dept. .... 157
- Heavy Military Electronics Dept. .... 65, 74
- Semiconductor Dept. .... 50
- Silicone Prod. Dept. .... 80
- General Hermetic Sealing Corp. .... 141
- General Products Corp. .... 176
- General Public Utilities .... 148
- General Transistor Corp. .... 69
- Good-All Electric Mfg. Co. .... 45
- Goodrich Co., B. F. The .... 68
- Graphic Systems .... 177
- Grayhill Inc. .... 191
- Gries Reproducer Corp. .... 157
- Gudebrod Bros. Co., The .... 137
- Gulton Industries, Inc. .... 159
- Dano Electric Corp., The .... 178
- Daven Co., The .... 3rd Cover
- Dean & Benson Research .... 192
- Detroit Edison .... 49
- Dilectrix Corp. .... 201
- Douglas Aircraft Co., Inc. .... 26, 27
- Dow Corning Corporation .... 30, 31
- Driver-Harris Co. .... 149
- Du Pont Co., Textile Fibers Dept. .... 168
- Fairchild Controls Corp. .... 47
- Fairchild Semiconductor Corp. .... 119
- Fansteel Metallurgical Corp. .... 98, 99
- Federation Nationale .... 193
- Fenwal Electronics, Inc. .... 180
- Film Capacitors, Inc. .... 162
- Freed Transformer Co., Inc. .... 202
- Fusite Corp., The .... 48
- Helipot Division of Beckman Instruments, Inc. .... 171
- Hewlett-Packard Co. .... 8, 9
- See advertisement in the June, 1959 Mid-Month ELECTRONICS BUYERS GUIDE for complete line of products or services.
- Eastern Air Devices, Inc. .... 54



# Panoramic's unique RESPONSE TRACING SYSTEM

## 0.5-2,250 cps

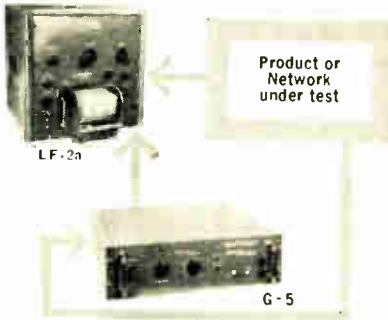

### for

- Analyzing frequency response characteristics of
  - servo amplifiers • filters
  - acoustic reproducers
  - transformers
  - hearing aids • shaker tables
- Locating resonant frequencies in mechanical structures

Serving as a frequency sweep source and synchronous selective indicator, the G-5 and LF-2a system shows a single line response to fundamental frequency only, discriminates against noise and hum, has virtually unlimited dynamic range. Sweep widths of 2-500 cps may be centered at any point in the range from 0.5-2000 cps. Scan rate of 10 sec., 2 mins. or 16 mins.

Write, wire, phone TODAY for more information or help on your specific problem



Send for our new CATALOG DIGEST and ask to be put on the mailing list for The PANORAMIC ANALYZER, featuring application data.



PANORAMIC RADIO PRODUCTS, Inc.  
530 So. Fulton Ave., Mount Vernon, N. Y.  
Phone: OWens 9-4600

Cables: Panoramic, Mount Vernon, N. Y. Site  
CIRCLE 228 ON READER SERVICE CARD  
ELECTRONICS • DECEMBER 4, 1959

- Industrial Timer Corp. .... 58
- Indusro Transistor Corp. .... 46
- Institute of Radio Engineers, The... 163
- International Business Machines Corp. 117
- International Electronic Research Corp. .... 126
- Itemlab, Inc. .... 154

- JFD Electronics Corp. .... 133

- Kearfott Co., Inc. .... 73
- Keithley Instruments, Inc. .... 46
- Kip Electronics Corp. .... 55
- Kleinschmidt, Div. of Smith-Corona Marchant, Inc. .... 76

- Lafayette Radio .... 137
- Lampkin Laboratories, Inc. .... 199
- Librascope, Inc. .... 75
- Link Aviation Inc. .... 167
- Los Alamos Scientific Laboratories... 183
- Lunatron Electronics, Inc. .... 51

- Mallory and Co., P. R. .... 22, 23
- Marconi Instruments .... 154
- Marion Instrument Division, Minneapolis-Honeywell Regulator Co. .... 162
- Markite Products Corp. .... 156
- McDonnell Aircraft .... 125
- Metals and Controls, A Div. of Texas Instruments Incorporated .... 6
- Mico Instrument Co. .... 162
- Microtran Co., Inc. .... 21
- Milgray Electronics, Inc. .... 139
- Mullard Ltd. .... 153

- National Semiconductor Corp. .... 41
- Natvar Corp. .... 121
- Newark Electric Co. .... 141
- Northern Radio Co., Inc. .... 177
- Norton Company .... 79

- Oak Mfg. Co. .... 19
- Ohmite Manufacturing Co. .... 59
- Oster Mfg. Co., John .... 28

• See advertisement in the June, 1959 Mid-Month ELECTRONICS BUYERS GUIDE for complete line of products or services.

## the MIRACLE of

# METALLIZING

## on THIN CAST

# Teflon<sup>\*</sup> FILM



TYPE CM . . .

metallized on  
one or both surfaces—  
with or without  
insulated margin

- ✓ Top adaptability for subminiature applications requiring minimal dimensions
- ✓ Unsurpassed electrical characteristics at high temperatures
- ✓ Optimum reliability through "self-healing" properties

Type CM Metallized Teflon is the latest achievement in our accelerated R&D program. For your specific Teflon requirements — ask about Dilectrix' exclusive and patented family of products, and Custom Applications Department.

WRITE DEPT. RD-2  
for further details and  
full catalog.



# DILECTRIX CORPORATION

Allen B'ld. & Grand Ave.  
Farmingdale, L. I., N. Y.

PIONEERS IN THE DEVELOPMENT  
OF CAST TEFLON FILM

CIRCLE 201 ON READER SERVICE CARD 201

Give your products  
**MORE RELIABILITY and  
 BETTER PERFORMANCE with**  
**FREED**  
**QUALITY**



**Ruggedized,  
 MIL STANDARD  
 POWER & FILAMENT TRANSFORMERS**  
 Primary 105/115/125 V 50-60~

Cat. No.	Appl.	MIL Std.	MIL Type
MGP 1	Plate & Fil.	90026	TF4RX03HA001
MGP 2	Plate & Fil.	90027	TF4RX03JB002
MGP 3	Plate & Fil.	90028	TF4RX03KB006
MGP 4	Plate & Fil.	90029	TF4RX03LB003
MGP 5	Plate & Fil.	90030	TF4RX03MB004
MGP 6	Plate	90031	TF4RX02KB001
MGP 7	Plate	90032	TF4RX02LB002
MGP 8	Plate	90036	TF4RX02NB003
MGF 1	Filament	90016	TF4RX01EB002
MGF 2	Filament	90017	TF4RX01GB003
MGF 3	Filament	90018	TF4RX01FB004
MGF 4	Filament	90019	TF4RX01HB005
MGF 5	Filament	90020	TF4RX01FB006
MGF 6	Filament	90021	TF4RX01GB007
MGF 7	Filament	90022	TF4RX01JB008
MGF 8	Filament	90023	TF4RX01KB009
MGF 9	Filament	90024	TF4RX01JB012
MGF 10	Filament	90025	TF4RX01KB013



**Ruggedized,  
 MIL STANDARD  
 AUDIO TRANSFORMERS**

Cat. No.	Imped. level-ohms	Appl.	MIL Std.	MIL Type
MGA 1	Pri. 10,000 C.T. Sec. 90,000 Split & C.T.	Interstage	90000	TF4RX15AJ001
MGA 2	Pri. 600 Split Sec. 4, 8, 16	Matching	90001	TF4RX16AJ002
MGA 3	Pri. 600 Split Sec. 135,000 C.T.	Input	90002	TF4RX10AJ001
MGA 4	Pri. 600 Split Sec. 600 Split	Matching	90003	TF4RX16AJ001
MGA 5	Pri. 7,600 Tap @ 4,800 Sec. 600 Split	Output	90004	TF4RX13AJ001
MGA 6	Pri. 7,600 Tap @ 4,800 Sec. 4, 8, 16	Output	90005	TF4RX13AJ002
MGA 7	Pri. 15,000 C.T. Sec. 600 Split	Output	90006	TF4RX13AJ003
MGA 8	Pri. 24,000 C.T. Sec. 600 Split	Output	90007	TF4RX13AJ004
MGA 9	Pri. 60,000 C.T. Sec. 600 Split	Output	90008	TF4RX13AJ005

MIL Transformers are available from stock.

Write for further information on these units or special designs.

Send for NEW 48 page transformer catalog. Also ask for complete laboratory test instrument catalog.

**FREED TRANSFORMER CO., INC.**  
 1722 Weirfield St., Brooklyn (Ridgewood) 27, N. Y.

- Panoramic Radio Products, Inc. .... 201
- Perfection Mica Co. .... 157
- Philco Corp., Lausdale Div. .... 100
- Potter & Brumfield .... 143
- Porter Co., Inc., H. K. .... 200
- Precision Instrument Co. .... 151
- Pyramid Electric Co. .... 152

- Westinghouse Electric Corp. .... 14
- Whitney Metal Tool Co. .... 128

- York-Hoover Corp. .... 17

- Radio Corp. of America .... 37, 4th Cover
- Radio Engineering Laboratories, Inc. .... 57
- Radio Frequency Laboratories, Inc. .... 187
- Radio Materials Co. .... 64
- Rawson Electrical Instrument Co. .... 177
- Raytheon Co. .... 20, 24, 25  
41, 146, 147, 172

PROFESSIONAL SERVICES ..... 199

- Sarkes Tarzian, Inc. .... 123
- Sensitive Research Instrument Corp. .... 127
- Sigma Instruments, Inc. .... 189
- Spectronic Plating Co., Inc. .... 188
- Sperry Semiconductor Division of Sperry Rand Corp. .... 15
- Sprague Electric Co. .... 5
- St. Petersburg Chamber of Commerce. .... 32
- Superior Cable Corp. .... 140
- Sylvania Electric Products, Inc. .... 77

CLASSIFIED ADVERTISING  
 F. J. Eberle, Business Mgr.

EMPLOYMENT OPPORTUNITIES 196-199

EQUIPMENT  
 (Used or Surplus New)  
 For Sale ..... 199

ADVERTISERS INDEX

- Technology Instrument Corp. .... 160
- Tektronix, Inc. .... 145
- Telechrome Manufacturing Corp. .... 61
- Texas Instruments Incorporated .... 134, 135
- Thermal American Fused Quartz Co., Inc. .... 173
- Toyo Trading Co. Ltd. .... 194
- Transradio Ltd. .... 173
- Trio Laboratories, Inc. .... 39
- Triplett Electrical Instrument Co. .... 52, 53
- Union Switch & Signal, Div. of Westinghouse Air Brake Co. .... 130
- United Mineral & Chemical Corp. .... 182
- United States Testing Co., Inc. .... 166
- United Transformer Corp. .... 2nd Cover

- Armour Research Foundation of Illinois, Institute of Technology .... 197
- Fidelity Personnel ..... 197
- Goodheart Co., R. E. .... 197
- Hancock Industries ..... 196
- Houde Supply Company ..... 199
- Lenkurt Electric Co., Inc. .... 197
- Motorola, Inc. .... 197
- National Scientific Personnel Bureau, Inc. .... 199
- Norden Laboratories Norden Div., of United Aircraft Corp. .... 198
- Reliable Electric Motor Repair Co. .... 199
- Western Electric ..... 196

- Varian Associates ..... 33
- Veeder-Root ..... 78
- Virginia Dept. of Conservation and Economic Development ..... 72

● See advertisement in the June, 1959 Mid-Month ELECTRONICS BUYERS GUIDE for complete line of products or services.

This index is published as a service. Every care is taken to make it accurate, but ELECTRONICS assumes no responsibilities for errors or omissions.

- Walsco Electronics Mfg. Co. .... 182
- Weldmatic, Div. of Unitek Corp. .... 42



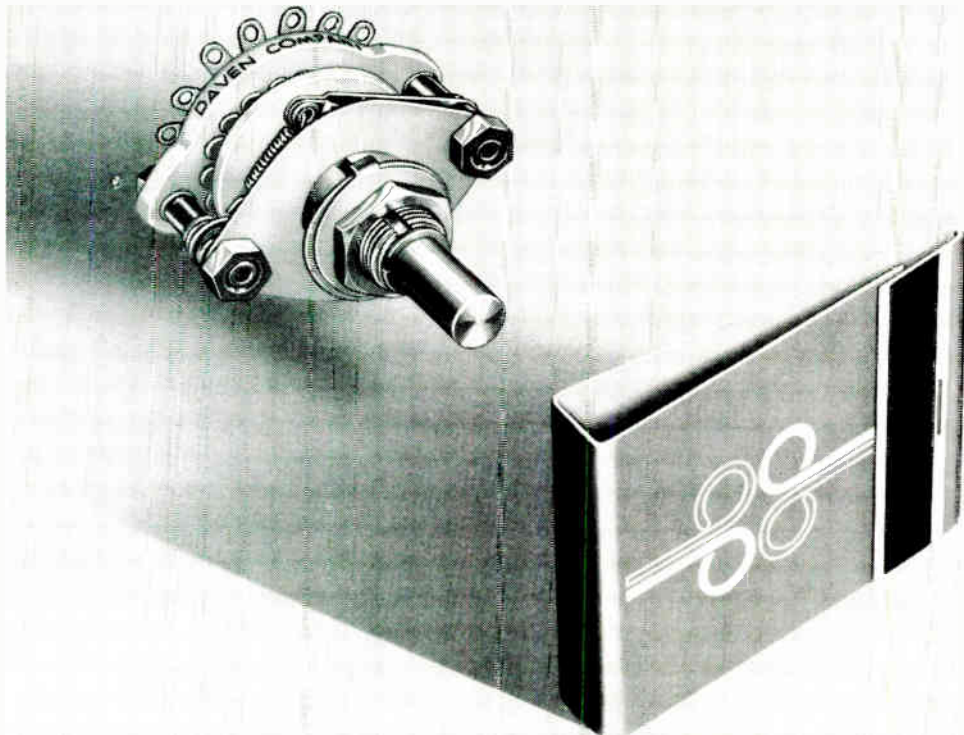

**DID YOU SAY**

**small?**

Occupying less than  $1\frac{1}{2}$  square inches of panel space, this Miniature Ceramic Switch nevertheless contains as many as **18 positions on a single wafer**. And it's rugged! Solid silver alloy contacts, rotors, and slip rings provide low and uniform contact resistance. Ceramic parts are silicone impregnated to function under extreme humidity. Sturdy solder terminals are supplied for wiring. This miniature switch meets and exceeds the electrical and environmental requirements of Mil-Spec S-3786. Flashover voltage at 60 cycles is 1000 volts peak . . . current carrying capacity is 2 amperes. For guided missiles, airborne radar equipment, portable and mobile ground equipment . . . for any application that requires an extremely small and rugged switch, specify Daven's Series M Miniature Ceramic Switches. These units can be "ganged" with up to 8 decks with slight mechanical modifications. 2 or 3 poles per deck may also be obtained as standard. Prototypes can be delivered within 2 weeks.

Write for complete information.

THE **DAVEN** CO.

526 West Mt. Pleasant Ave.  
Route 10, Livingston, N. J.

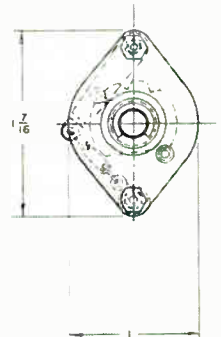
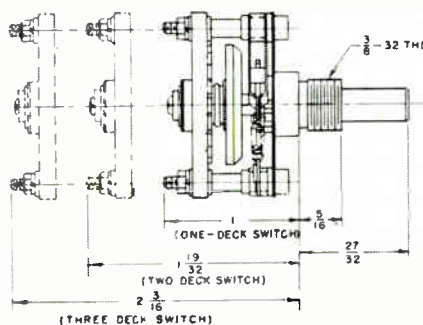

TODAY, MORE THAN EVER, THE DAVEN  STANDS FOR DEPENDABILITY!

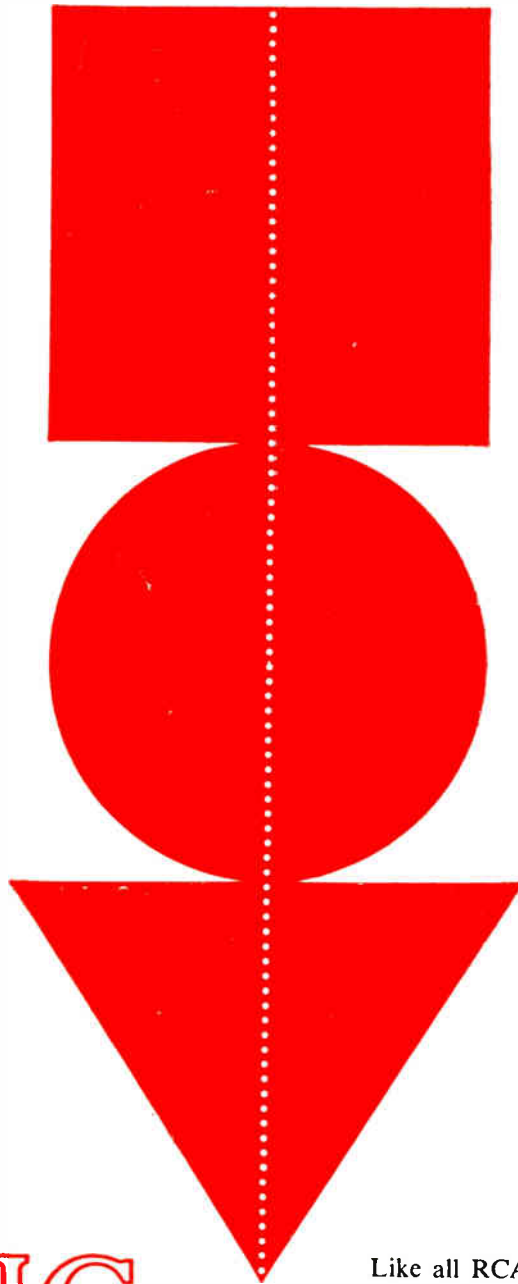

# BASIC TO GOOD DESIGN

*Certain fundamentals such as history of proven field performance, proven reliability, and availability are basic to good design.*

## RCA-12DT8

*Take for example RCA-12DT8, the designer-preferred twin triode for rf amplifier and combined oscillator-mixer service in 5-tube FM and low-cost AM-FM receivers.*



Like all RCA Preferred Tube Types, RCA-12DT8 offers outstanding uniformity of electrical characteristics, top performance, and excellent availability. Volume production and a program of continuous evaluation also bring new improvements to this type. For instance, frequency stability has been improved and microphonics reduced by the use of a new and more rigid grid wire. And the possibility of heater-to-cathode shorts and heater burnouts has been minimized due to an improved heater wire.

So call your RCA Field Representative and ask him for complete information on the Preferred-Type Tube that's basic to good design—RCA-12DT8. Ask him too about RCA-6DT8.

**EAST:**  
744 Broad Street  
Newark 2, N.J.  
Humboldt 5-3900

**MIDWEST:**  
Suite 1154  
Merchandise Mart Plaza  
Chicago 54, Ill.  
Whitehall 4-2900

**WEST:**  
6355 East Washington Blvd.  
Los Angeles 22, Calif.  
Raymond 3-8361

ANOTHER WAY RCA SERVES YOU THROUGH ELECTRONICS



**RADIO CORPORATION OF AMERICA**  
Electron Tube Division  
Harrison, N. J.