

OCTOBER 23, 1959

# electronics

A MCGRAW-HILL PUBLICATION

VOL. 32, No. 43

PRICE SEVENTY-FIVE CENTS

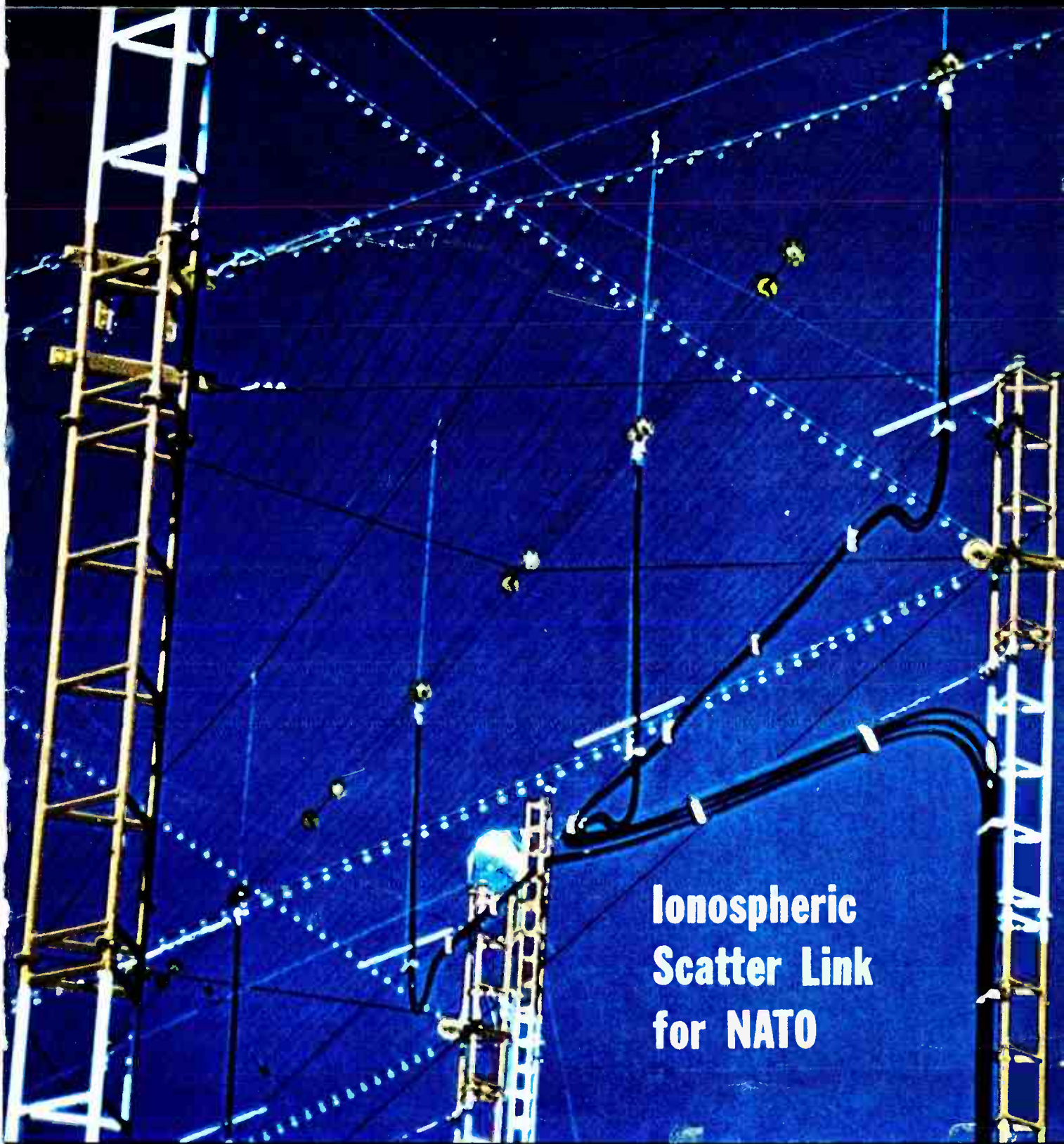

**Ionospheric  
Scatter Link  
for NATO**

*Special* **MODERN COMMUNICATION METHODS**

World Radio History

# Creative Microwave Technology

Published by MICROWAVE AND POWER TUBE DIVISION, RAYTHEON COMPANY, WALTHAM 54, MASS., Vol. 1, No. 8

## NEW RAYTHEON HEATERLESS AMPLITRONS EXCEED 1,000 HOURS AT RATED POWER OUTPUT

Two new 3-megawatt, S-band Amplitrons have demonstrated an operating life of more than 1,000 hours at rated power output. The QK-622 covers the 2,900 to 3,100 Mc band; the QK-783, the 2,700 to 2,900 Mc band. Both tubes supply full power with low phase pushing characteristics over their entire operating bands at efficiencies greater than 70%--making them unquestionably the most highly efficient microwave tubes thus far developed.

Tubes may be operated at reduced peak power levels to serve as driver stages. High efficiencies are retained at peak power of 600 Kw and gain of 10 db.

Exceptionally long tube life is made possible by the fact that no cathode warmup is required. Starting takes place whenever RF input is present prior to application of modulating pulse. Heater supplies may be omitted entirely from the equipment.

Applications include power-amplifier stages for long-range radars. The tube has been used successfully as an RF power source for linear accelerators.

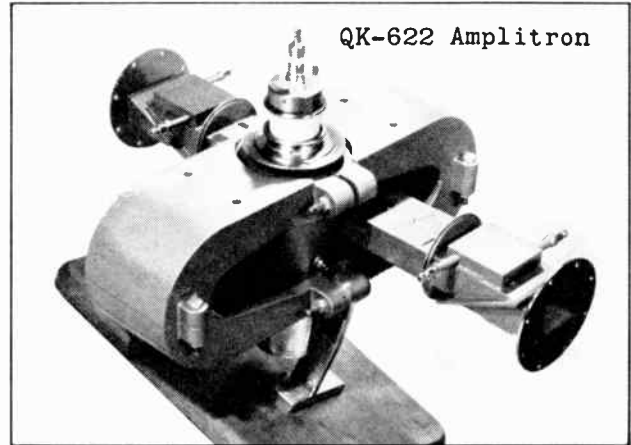

QK-622 Amplitron

### Typical Operating Characteristics (QK622 and QK783 Amplitrons)

Peak Power Output (min.).....	3 Mw
Average Power Output.....	15 Kw
Pulse Duration .....	10 $\mu$ sec
Band Width .....	200 Mc
Duty Cycle .....	.005
Pulse Voltage .....	50-55 Kv
Peak Anode Current .....	65 amps
Efficiency.....	70%
RF Input .....	475 Kw
Weight (with permanent magnet) .....	125 lbs.

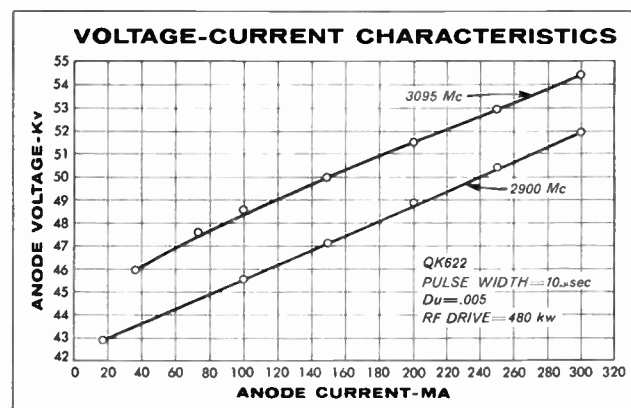
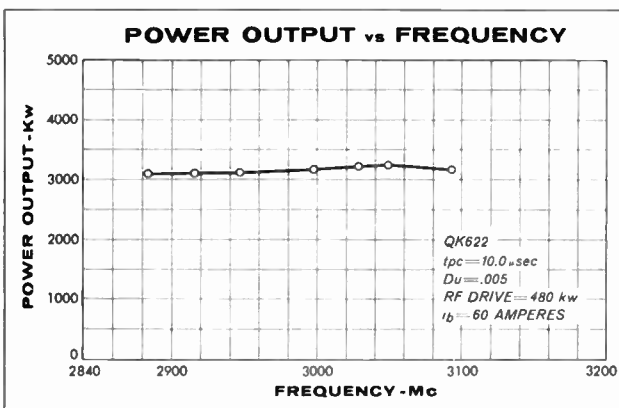

*Excellence in Electronics*



You can obtain detailed application information and special development services by contacting: Microwave and Power Tube Division, Raytheon Company, Waltham 54, Massachusetts

**A LEADER IN CREATIVE MICROWAVE TECHNOLOGY**



A McGRAW-HILL PUBLICATION  
Vol. 32 No. 43

JAMES GIRDWOOD, *Publisher*

W. W. MacDONALD, *Editor*

JOHN M. CARROLL, *Managing Editor*

*Associate Editors:* Frank Leary, Michael F. Tomaino, Howard K. Janis, Sylvester P. Carter, Roland J. Charest, William P. O'Brien, George Sideris, John F. Mason, William E. Bushor, Thomas Emma, Samuel Weber, Sy Vogel, Leslie Solomon, M. M. Perugini, George J. Flynn.

*Pacific Coast Editor (Los Angeles)* Harold C. Hood; *Midwestern Editor (Chicago)* Harold Harris; *New England Editor (Boston)* Thomas McGuire.

*Art Director,* Harry Phillips, Roy Thompson.

*Production Editor,* John C. Wright, Jr., Bernice Duffy.

*Market Research,* Edward DeJongh.

*Editorial Assistants,* Gloria J. Filippone, Arlene Schilp, Patricia Landers, Carol Weaver.

BRUCE A. WINNER, *Advertising Sales Manager.* R. S. Quint, *Assistant Advertising Sales Manager and Buyers' Guide Manager.* Fred Stewart, *Promotion Manager.* Richard J. Tomlinson, *Production Manager.* George E. Pomeroy, *Classified Manager.* Hugh J. Quinn, *Circulation Manager.*

*New York:* Donald H. Miller, Henry M. Shaw, William J. Boyle. *Boston:* Wm. S. Hodgkinson. *Philadelphia:* Warren H. Gardner. *Chicago:* Harvey W. Wernecke, Martin J. Gallay. *Cleveland:* P. T. Fegley. *San Francisco:* T. H. Carmody, R. C. Alcorn. *Los Angeles:* Carl W. Dysinger, D. A. McMillan. *Denver:* J. Patten. *Atlanta:* M. Miller. *Dallas:* Gordon L. Jones, Robert T. Wood. *London:* E. E. Schrimmer. *Frankfurt:* Michael R. Zeynel.

## Issue at a Glance

### Business

Did Lunik Drop Moon Package? An analysis of first Russian data	42B
Noises From Outer Space. More radar and radio telescopes. Why?	46
Inside the Defense Market. Our share will top \$6 billion.....	51
Police Using More Electronics. This sales area shows promise....	62
Calls for More Research \$. Study criticizes U.S. money limits....	67
Shoptalk .....	4
25 Most Active Stocks.....	25
Electronics Newsletter .....	11
Market Research .....	28
Washington Outlook .....	14
Current Figures .....	28
Financial Roundup .....	25
Meetings Ahead .....	70

### Engineering

Corner reflector at Izmir, Turkey, designed by Page Communications Engineers, Inc., is part of NATO ionoscatter network. See p 93 .....COVER

Modern Communications Methods. A special report on how modern techniques are overcoming the problems of high traffic density and limited spectrum space.....By S. Weber 93

Electronic Surveying. Modified radar and computers aid mapping  
By A. S. Rosenthal 113

Character Displays Using Analog Techniques. System forms characters from overlapping dots on conventional oscilloscope.  
By S. C. Chao 116

Soft Solder Conductivity. Here's a tabulation of the electrical conductivity of 21 solders.....By A. B. Kaufman 119

Unconventional Technique for Measuring VSWR. Instrument uses simple R-C coupler for antenna measurements....By J. Hanson 120

Equations for Designing Transistor Power Supplies. How they are obtained and how they are used.....By T. Hamm, Jr. 122

Recording Attenuation of Waveguide Components. Attenuation vs frequency can be photographed.....By G. Edelcreek 126

### Departments

Research and Development. Chart Gives Thermal Changes..... 128

Components and Materials. New Film Deposits Improve Resistors 132

Production Techniques. "Mother" Boards Take Small Modules.... 136

On the Market.....140

Plants and People.....184

Literature of the Week.....178

News of Reps.....187

New Books .....

Comment .....

Thumbnail Reviews .....

Index to Advertisers.....196

ELECTRONICS PROGRESS  
THROUGH CHEMISTRY  
AND METALLURGY

**NEW**  
**Sylvania PS-7**  
Potassium Silicate  
contains **35%** solids

**A long step ahead in  
picture tube silicates**

Now, Sylvania introduces another first... PS-7 Potassium Silicate with 35% solids content to supplement PS-6, a 29.5% solids solution—long recognized as the industry standard.

This new form of silicate obviously contains less water... affording customer savings in both transportation and storage. Actually, due to PS-7's lower price, on a usable materials basis, additional savings will be realized. By adding varying amounts of water, both PS-7 and PS-6 can be diluted to the required concentration.

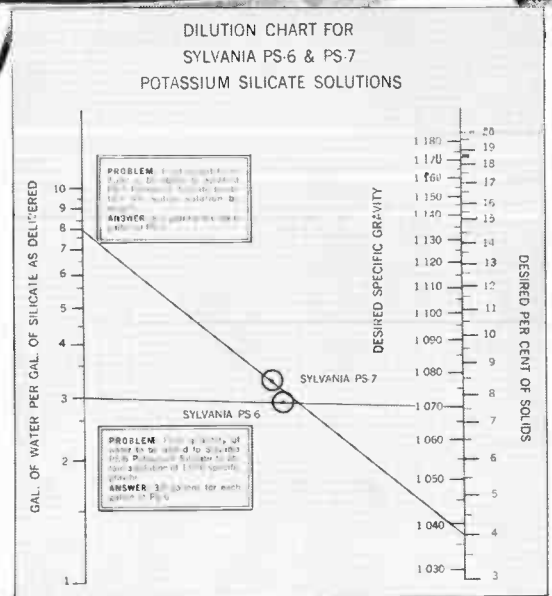

Whichever concentration you select, you will be getting the highest purity silicates obtainable today. Sylvania specifications exceed the industry acceptance figures by a considerable margin. Your Sylvania representative will be glad to furnish samples of these fine products for your evaluation, or write for new technical bulletin.

**SYLVANIA**   
Subsidiary of  
**GENERAL TELEPHONE & ELECTRONICS**

SYLVANIA ELECTRIC PRODUCTS INC.  
Chemical & Metallurgical Division  
Towanda, Penna.



# LAMBDA'S ALL-TRANSISTOR LINE

*Delivered now • Guaranteed for five years*

## FOUR NEW POWER SUPPLIES



## 1-AMP and 2-AMP • CONVECTION COOLED

*No internal blowers • No moving parts*

**0-32 VDC**

**0-1 AMP**

**0-2 AMP**

Model LT 1095	<b>\$285</b>
Model LT 1095M (metered)	<b>\$315</b>
Model LT 2095	<b>\$365</b>
Model LT 2095M (metered)	<b>\$395</b>

- Ambient 50° C at full rating.
- High efficiency radiator heat sinks.
- Silicon rectifier.
- 50-400 cycles input.
- Special, high-purity foil, long-life electrolytics.

- Compact. Only 3½" panel height.
- Short-circuit proof,
- Protected by magnetic circuit breakers.
- Hermetically-sealed transformer. Designed to MIL-T27A.

- All transistor. No tubes.
- Fast transient response.
- Excess ambient thermal protection.
- Excellent regulation. Low output impedance, Low ripple.
- Remote sensing and DC vernier.

### CONDENSED DATA

Voltage Bands ... 0-8, 8-16, 16-24, 24-32 VDC  
Line Regulation ... Better than 0.15 per cent or 20 millivolts (whichever is greater). For input variations from 105-125 VAC.  
Load Regulation ... Better than 0.15 per cent or 20 millivolts (whichever is greater). For load variations from 0 to full load.  
AC Input ..... 105-125 VAC, 50-400 CPS

Electrical Overload Protection ... Magnetic circuit breaker, front panel mounted. Unit cannot be injured by short circuit or overload.

Thermal Overload Protection ... Thermostat, manual reset, rear of chassis. Thermal overload indicator light, front panel.

Size ..... 3½" H x 19" W x 14⅜" D.



*New!*

**1959 CATALOG  
NOW AVAILABLE**

New 36-page edition contains information and specifications on Lambda's full line of transistor-regulated and tube-regulated power supplies.



**LAMBDA ELECTRONICS CORP.**

11-11 131 Street, College Point 56, N.Y.

Send for your copy.

World Radio History

CIRCLE 3 ON READER SERVICE CARD

## electronics

October 23, 1959 Vol. 32, No. 43

Published weekly, including the ELECTRONICS BUYERS' GUIDE and REFERENCE Issue in mid-June as part of the subscription, by McGraw-Hill Publishing Company, Inc., James H. McGraw (1860-1948) Founder.

**Executive, Editorial, Circulation and Advertising Offices:** McGraw-Hill Building, 330 W. 42 St., New York 36, N. Y. Longacre 4-3000. **Publication Office:** 99-129 North Broadway, Albany 1, N. Y.

See panel below for directions regarding subscriptions or change of address. Donald C. McGraw, President; Joseph A. Gerardi, Executive Vice President; L. Keith Goodrich, Vice President and Treasurer; John J. Cooke, Secretary; Nelson L. Bond, President, Publications Division; Shelton Fisher, Senior Vice President; John R. Callahan, Vice President and Editorial Director; Joseph H. Allen, Vice President and Director of Advertising Sales; A. R. Venezian, Vice President and Circulation Coordinator.

Single copies in the United States, U. S. possessions & Canada 75¢; \$1.50 for all other foreign countries. Buyers' Guide in the United States, U. S. possessions & Canada \$3.00; all other foreign \$10.00. Subscription rates—United States and possessions, \$6.00 a year; \$9.00 for two years; \$12.00 for three years. Canada, \$10.00 a year; \$16.00 for two years; \$20.00 for three years. All other countries, \$20.00 a year; \$30.00 for two years; \$40.00 for three years. Second class postage paid at Albany, N. Y. Printed in U.S.A. Copyright 1959 by McGraw-Hill Publishing Co., Inc.—All Rights Reserved. Title registered in U. S. Patent Office. **BRANCH OFFICES:** 520 North Michigan Avenue, Chicago 11; 68 Post Street, San Francisco 4; McGraw-Hill House, London E. C. 4; 85, Westendstrasse, Frankfurt/Main; National Press Bldg., Washington 4, D. C.; Six Penn Center Plaza, Philadelphia 3; 1111 Henry W. Oliver Bldg., Pittsburgh 22; 55 Public Square, Cleveland 13; 856 Penobscot Bldg., Detroit 26; 3615 Olive St., St. Louis 8; 350 Park Square Bldg., Boston 16; 1301 Rhodes-Haverty Bldg., Atlanta 3; 1125 West Sixth St., Los Angeles 17; 1740 Broadway, Denver 2; 901 Vaughn Bldg., Dallas 1. ELECTRONICS is indexed regularly in The Engineering Index.

**Subscription:** Address correspondence to: Fulfillment Manager, Electronics, 330 W. 42nd St., New York 36, N. Y. Allow one month for change of address, stating old as well as new address, including postal zone if any. Subscriptions are solicited only from persons engaged in theory, research, design, production, management, maintenance and use of electronics and industrial control components, parts and products. **POSITION and COMPANY CONNECTION** must be indicated on subscription orders.

Postmaster: please send form 3579 to Electronics, 330 W. 42nd St., New York 36, N. Y.



Member ABP and ABC

**DID USSR DROP MOON PACKAGE?** We guessed the Oct. 4 Soviet lunar shot quickly reported by the newspapers might contain a "hidden" story as we followed McGraw-Hill cables from London and Moscow.

Associate Editor Janis, who has been on top of Soviet electronics for three years, suspected the Russians might have dropped a "moon package;" their scientists predicted such a feat several times in the last year. Associate Editor Solomon independently plotted Soviet data, along with information from the big Jodrell Bank (England) radiotelescope.

Off to Bureau Chief Gibson in Moscow went a series of questions. We didn't get all the answers but we learned a lot. In London, correspondent Tunstall kept an open line to Jodrell Bank for the latest word on lunik's signals.

What happened on 39.986 mc as lunik neared the moon, and why? For some well-informed conclusions see the story on p 42B.

**INSIDE THE DEFENSE MARKET.** Determination of the dollar-and-cents product composition of the big defense market has represented a major statistical problem of our industry for years.

Estimates of electronics procurement by Defense Dept. budget categories have been available. But few of our firms manufacture according to D.O.D. budget categories. Their records are grouped by specific products.

To help penetrate the military market data barrier ELECTRONICS asked Arthur D. Little, Inc. of Cambridge, Mass. to make a detailed study. Into the story also went planning and guidance by our marketing specialist, Ed De Jongh. The story begins on p 51.

**EYES ON THE SKY.** Radio and radar telescopes are springing up all over the U. S. Strong military interest involves more than basic research. Navy admits 90 percent of the work of its 600-ft dish, to be built at Sugar Grove, W. Va., will be military. Electronic countermeasures and counter-countermeasures will play big roles. For a rundown on big dishes, holes in the ground and the miles of perpendicular line tuning in on outer space, see Associate Editor Mason's article on p 46.

### Coming In Our October 30 Issue . . .

**WESCON HIGHLIGHTS.** Each year increasing size of the Western Electronics Show and Convention points up the growth of the west coast as an electronics center. Factors responsible for this expansion were analyzed in an ELECTRONICS report by Pacific Coast Editor Hood (p 103, August 7, 1959).

Next week, ELECTRONICS rounds out its Wescon coverage with highlights of the 42 technical sessions. To bring you this survey, Associate Editor Weber teamed up with Hood to attend sessions, buttonhole engineers and visit plants where some of the developments were taking place. As a result, you'll read about a new directive long-range sonar transducer, the latest developments in tunnel diodes, the Biax high-speed ferrite memory and logic element, a digital telemetry system for space probes and a maser preamplifier for X-band radar.

**DESIGNING AGAINST HUMIDITY.** Hot, humid environment is very destructive to electronic equipment.

A. P. Harris and E. W. Parrot of the Canadian Department of National Defence provide a comprehensive study of water in its various states that will help you understand the effects of humidity on electronic components.



# SPRAGUE® RELIABILITY in these two dependable wirewound resistors

MINIATURE  
**Blue Jacket®**  
VITREOUS-ENAMEL POWER RESISTORS

Sprague's new improved construction gives even greater reliability and higher wattage ratings to famous Blue Jacket miniature axial lead resistors.

A look at the small *actual sizes* illustrated, emphasizes how ideal they are for use in miniature

NEW SMALLER SIZE

## KOOLOHM®

INSULATED-SHELL POWER RESISTORS

New Koolohm construction features include welded leads and winding terminations—Ceron ceramic-

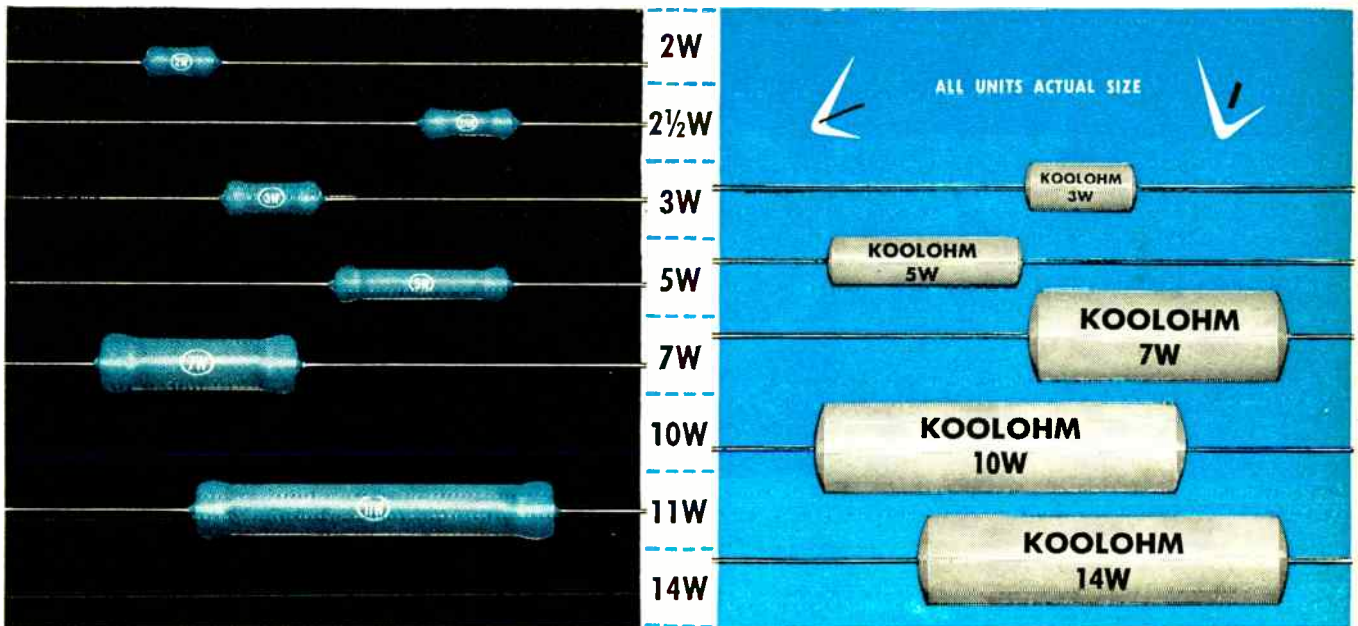

electronic equipment with either conventional wiring or printed wiring boards.

Get complete data on these dependable minified resistors, write for Engineering Bulletin 7410.

**TAB-TYPE BLUE JACKETS:** For industrial applications, a wide selection of wattage ratings from 5 to 218 watts are available in Sprague's famous Tab-Type Blue Jacket close-tolerance, power-type wirewound resistors. Ideal for use in radio transmitters, electronic and industrial equipment, etc. For complete data, send for Engineering Bulletin 7400A.

insulated resistance wire, wound on special ceramic core—multi-layer non-inductive windings or high resistance value conventional windings—sealed, insulated, non-porous ceramic outer shells—aged-on-load to stabilize resistance value.

*You can depend upon them to carry maximum rated load for any given physical size.*

Send for Engineering Bulletin 7300 for complete technical data.

### SPRAGUE ELECTRIC COMPANY

35 MARSHALL STREET • NORTH ADAMS, MASS.



SPRAGUE COMPONENTS: RESISTORS • CAPACITORS • MAGNETIC COMPONENTS • TRANSISTORS  
INTERFERENCE FILTERS • PULSE NETWORKS • HIGH TEMPERATURE MAGNET WIRE • PRINTED CIRCUITS



## THE HUMAN FACTOR in today's technology

Scientists have long been preoccupied with the technological problems of Man and the Machine. The increasingly complex nature of advanced systems has created an urgent need to enhance man's contribution to effective systems performance. The complicated nature of this relationship requires the skills of psychologists, social scientists, mathematicians, and engineers.

At Ramo-Wooldridge, human engineering, personnel selection, individual and system training, display design, and communications are successfully integrated into systems design and development by the technique of large-scale simulation.

Simulated inputs enable scientists to observe a system as it operates in a controlled environment and make possible the collection of data on performance, training, human engineering, maintenance, and logistics and support. Scientists and engineers use this data to assure the design, production, and delivery of a unified system capable of high performance and reliability.

Expanding programs at Ramo-Wooldridge in the broad areas of electronic systems technology, computers, and data processing have created outstanding opportunities for scientists and engineers. *For further information concerning these opportunities write to Mr. D. L. Pyke.*



**RAMO-WOOLDRIDGE**

P. O. BOX 90534, AIRPORT STATION • LOS ANGELES 45, CALIFORNIA  
a division of *Thompson Ramo Wooldridge Inc.*





# DESIGN BREAKTHROUGHS

in fastener engineering

One of the earliest and most basic breakthroughs in fastener design was the common clothes pin. And, although DOT is not a manufacturer of clothes pins, many a DOT industrial fastener has had an equally revolutionary effect on modern fastening technique. Hundreds of different DOT fasteners have created relatively minor revolutions in specific industries.

A DOT fastener may save a few man-minutes of labor. It may save material. Or it may improve product performance and hence saleability. But multiply each small improvement by the number of units in a true mass-production operation and the savings really pile up to impressive proportions.

Rather than spend your own design staff's time on fastening problems, it might pay you well to call in DOT. You'll have at your service a design and production organization with large-scale facilities for genuine mass-production of special-purpose fasteners and self-fastening devices of all kinds.

Supplementing the Carr Fastener Company are a number of other plants which form the United-Carr Fastener group. They are located in the principal production centers of the United States, Canada, England and Australia. Your nearest United-Carr field office (see below) is no further away than a telephone call from your desk.



## CARR FASTENER COMPANY

Division of United-Carr Fastener Corporation • Cambridge 42, Massachusetts

Offices In:

Atlanta, Boston, Chicago, Cleveland, Dallas, Detroit, Los Angeles, New York, Philadelphia, Syracuse

World Radio History

CIRCLE 8 ON READER SERVICE CARD →

# •• WHAT IS HAPPENING IN

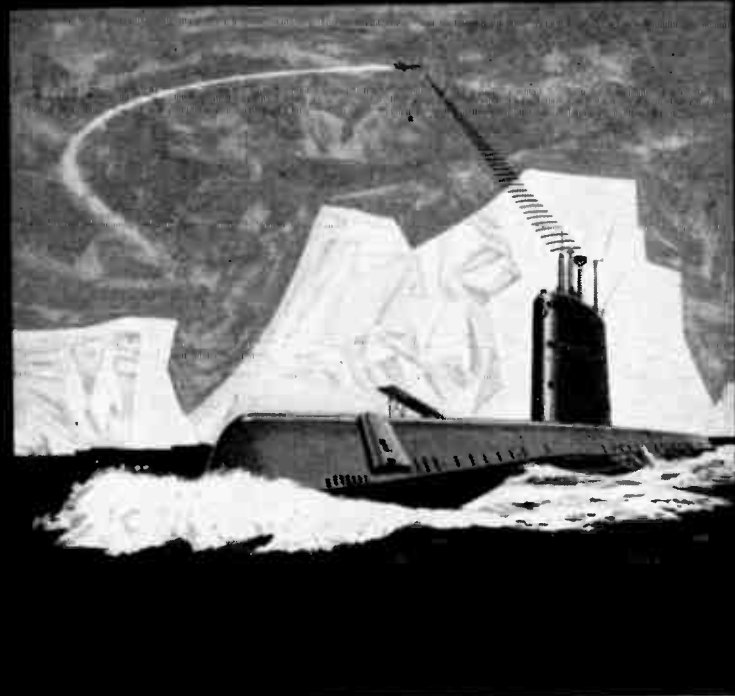

## AIRBORNE ELECTRONICS

... includes specialists in the development of systems and equipment for aircraft, missiles and spacecraft. Their capabilities include extensive experience in miniaturization techniques, weight and power conservation, systems design and transistorization.

- Transistorized Search, Bombing, and Terrain Clearance Radar
- All Weather Radar Toss Bombing
- Radar Augmenter Beacons

## SHIPBOARD ELECTRONICS

... comprises three design groups; Radar, Guidance, and Ordnance Equipment. Their personnel are specialists in the development of systems designed to withstand extremes in environment encountered in submarines and surface vessels.

- Electronic Simulators
- Radar Course Directing Centrals
- High Power Lightweight Air Search Radars

Outstanding engineers and scientists are invited to inquire into opportunities on Stavid's advanced systems engineering teams. World Radio History  
Write Dept. 124



# ELECTRONICS AT STAVID ?

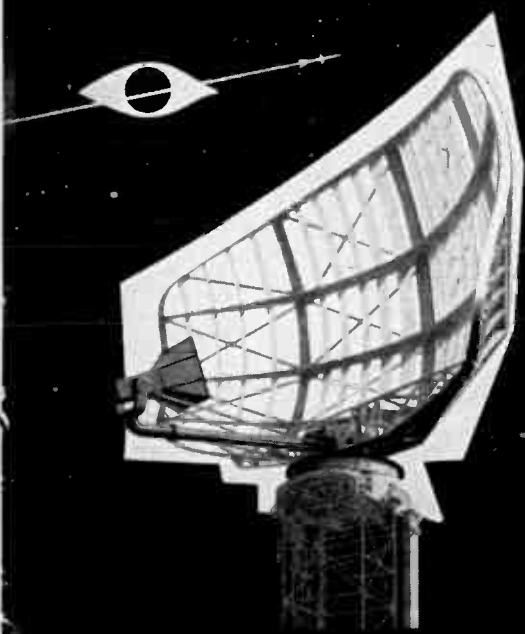

## **These current projects demonstrate Stavid's engineering versatility and diversification.**

- The first lightweight shipboard air search radar capable of distinguishing aircraft in formation several hundred miles away.
- An airborne search, bomb/nav and terrain avoidance radar weighing less than 235 pounds.
- A sferics system that tracks severe weather disturbances over a 2000 mile radius.
- A twelve-pound radar transponder for tracking research vehicles 200 miles above the earth.
- High-power air search radars are being reduced from 6000 pounds to less than half.
- Missile control systems have been shrunk 70% in volume, 60% in weight, and designed for mechanized assembly.
- A missile launching silo was completely instrumented in two months.
- Anti-jamming techniques are being perfected for advanced radars.
- Simulators to train submarine-based missile crews in guidance techniques are being produced in quantity.

## **GROUND-BASED ELECTRONICS**

*...represents three major capabilities; antenna development, electromagnetic detection systems, and passive detection of long-range missiles and submarines.*

- Sferics Locating System
- Broadband High Frequency, High Power Worldwide Communications Antenna
- Missile Beacon Telemetry Systems

**WATCH STAVID FOR THE  
LATEST DEVELOPMENTS IN**

*Imaginative Electronics...*

**STAVID Engineering, Inc.** Plainfield, New Jersey

A SUBSIDIARY OF LOCKHEED AIRCRAFT CORPORATION



## NATO SELECTS EIMAC KLYSTRONS TO POWER EUROPE'S LARGEST TROPO-SCATTER NETWORK

One and ten kilowatt amplifiers in NATO's continent-spanning tropo-scatter system will be Eimac Amplifier Klystrons. Since Eimac Klystrons first made large-scale tropospheric communications possible in 1954, they've become famous for reliability in all major tropo-scatter networks: Pole Vault, Dew Line, Texas Towers, White Alice, Florida-Cuba TV. Individual Eimac Klystrons have logged more than 35,000 hours continuous air time in tropo-scatter service.

Exclusive design features make Eimac Klystrons outstanding for tropo-scatter. Extra-wide frequency tuning is achieved with one set of tuning cavities. Inductive tuning achieves uniform bandwidth plus greater broadbanding by external cavity loading. Eimac's external cavity design lowers original cost, and replacement cost is lower since tuning circuitry is purchased just once.

One wide range load coupler covers the entire frequency range. Eimac's

series connected body magnets permit use of one power supply, one control for body magnets.

Eimac Klystrons will be used in NATO installations. Proved Eimac reliability will aid in safeguarding the security of all free European nations.

**EITEL-McCULLOUGH, INC.**



San Carlos • California



## **ELECTRONICS NEWSLETTER**

**IF LUNIK DID NOT DROP A PACKAGE** on the moon (see p 42), there is reason to believe that the Soviets will make such an attempt soon. A Tass dispatch in Russian on Oct. 4, the day of the launching, declared: "The program for research into cosmic space that has been outlined by Soviet scientists is being carried out so precipitously that there is no doubt that in the very near future constant radio communications will be established between the earth and the moon." Prof. Aleksandr Mikhaylov, director of the Pulkovo observatory, thinks an automatically operating moon station will open great prospects for astronomical research and for physical experiments. "Astrophysics," he declares, "will soon receive far more material than it has ever received in the many decades of its existence." Back in March, two months after the firing of Lunik I, Prof. G. V. Petrovich suggested an instrument drop on the moon but declared that it was "first necessary to solve the problem of the safe descent of instrument containers to the moon's surface."

*Third stage "cosmic rocket" described after Lunik I is the key to present Soviet space efforts. It is controlled by an automatic system which, say the Soviets, "stabilizes the attitude of the rocket in a specified trajectory and ensures the calculated velocity at the end of the engine's operation."*

**RED CHINESE COMMENT** on the latest Soviet lunar probe included a statement two days after the launching by Chao Chiu-chang, director of the institute of geophysics of the Chinese Academy of Sciences, that tv equipment aboard the "interplanetary station" was used to photograph the far side of the moon. The Soviets had not confirmed the existence of such tv gear during the week following launching. There seem to be three possible explanations for the absence of Soviet confirmation: (1) The experiment didn't work properly; (2) The announcement is being held up for the best propaganda moment; (3) The Soviets did not brief their Red Chinese friends correctly.

**NUMERICAL CONTROL FIELD** is "blossoming." That's the report from L. T. Rader, general manager of GE's Specialty Control department, Waynesboro, Va. He expects that within three to five years half of all machine tools sold will be automatically controlled, cites recent jumps in orders received by his own department. In 1958, says Rader, volume of orders jumped sixfold over the previous year and, in 1959, orders are running  $3\frac{1}{2}$  times the 1958 volume. Occasion for his remarks was the unveiling of a 100-ton turret punch press by GE and Wiedemann Machine Co. The machine costs \$200,000, of which \$50,000 represents cost of controls.

**CREWLESS AUTOMATIC TRAIN OPERATION** is being considered by the New York City Transit

Authority for the Times Square-Grand Central crosstown subway shuttle. Though reportedly only in "the talking stage," engineers of Union Switch & Signal Co. are working out an experimental system. Starting would be initiated by an automatic programmer. Automatic gear would control acceleration, normal running speed and decrease in speed to permit train to stop at destination.

*Thermoelectric air conditioning for a Navy garment is being developed by Westinghouse scientists. Unit will consist of a cooling and heating unit, a light-weight battery power supply and a blower system. It will maintain temperature in the suit at comfortable levels when worn in outside temperatures ranging from 40 below zero to 135 F.*

**JAPANESE MISSILE MANUFACTURE** has been launched by Mitsui, one of the combines that provided armaments during World War II. Six Mitsui companies, including at least one electronics giant, have banded together as the Missiles and Space Techniques Research and Development Group. Plans include production of the Hawk ground-to-air missile for the Japanese Self-Defense Agency and weather rockets for the U.S. market. Other big Japanese names such as Mitsubishi, Fuji Precision and Kawasaki Aircraft have already announced similar plans to do missile work. Mitsui, with business ties to such U.S. firms as Raytheon, GE and Aerojet General, hopes to provide defense materiel to countries in Southeast Asia receiving American aid.

**TELEVISED MOON VIEW** as seen through a 36-inch reflecting telescope is possible with closed-circuit gear recently installed at the observatory of Case Institute of Technology. A 4-lb transistorized camera is held to the eyepiece of the telescope by detachable brackets. Images are magnified 1,500 times on a 21-in screen, with some details reportedly better than those seen in normal viewing. Three receivers are located in the auditorium of the observatory. Second camera transmits movements and operation of the telescope to a monitor for audience demonstration.

*The 183.6 mc frequency used by the Soviets' orbiting space station was the same used on the lunik that impacted the moon for both its lunar altimeter and data transmission.*

**MOON ROCKET CONTROL** requires precision 10 times greater than that needed to send up an earth satellite, and the precision required for the Soviet "interplanetary station" is even greater. So says Lu Yuan-chiu, research fellow of the Red Chinese Academy of Science's institute of automation and telomechanics. He concludes that in the last two years Soviet precision in rocket control has improved by at least 10 times.



# NEW: "Solid-State" Fluid

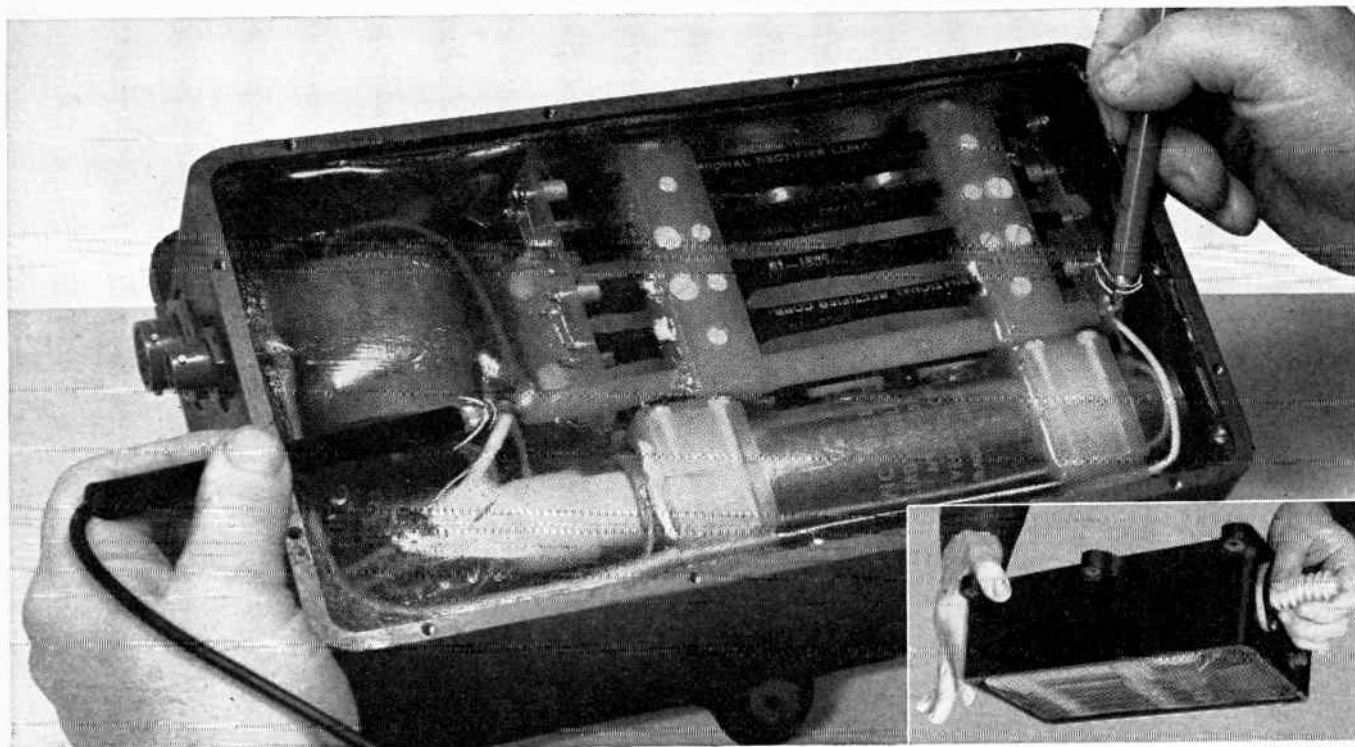

PHOTO COURTESY CBS LABORATORIES

## Now: Potted Protection Plus Visual & Instrument Checking

The newest development in potting and encapsulating materials is Dow Corning Dielectric Gel. Supplied as a crystal clear fluid plus catalyst, it pours easily into assemblies and sub-assemblies, fills every void, sets up to a firm, pliable, transparent gel. The gelled mass exerts virtually no stress on components; has excellent adhesion; will not displace if vibrated or inverted. Potted components and connections are visible, probes can be inserted through it for instrument checking. When probes are removed, the gel heals itself, leaving no voids.

Here's how Dielectric Gel aids miniaturization: When designing the high voltage power supply for their new Photoscan airborne reconnaissance system, CBS Laboratories Division of Columbia Broadcasting System Inc., had to meet stringent reliability requirements despite elevated temperatures, high vibration levels, severe size and weight limitations. Their new design and miniaturization techniques were made possible by Dielectric Gel.

Requiring only 0.09 cubic feet complete, with components spaced less than 1/4" apart without danger of arcing, the new power supply provides output voltages that can be regulated from 1,000 to 25,000 volts. Current capacity at 25 kv is well over 100 microamperes. This power supply is an integral part of Photoscan, a universal visual intelligence-gathering, processing and transmitting system which can readily be installed in virtually any missile or air-borne vehicle. The units are small, light in weight, simple to install and service.

### PROPERTIES OF CURED DIELECTRIC GEL

Color	Water	White
Specific Gravity at 25 C		0.970
Coefficient of Thermal Conductivity:		
(cal per cm °C sec)	150 C	0.00070
	200 C	0.00078
Electric Strength*, volts per mil		800
Dielectric Constant†	23 C	150 C
100 cps - 0.1 Mcs	3.0	2.6
Dissipation Factor†		
100 cps	0.0005	0.002
1.0 kc	0.0005	0.0005
0.1 Mcs	0.0001	0.0001
Volume Resistivity†, ohm-cm	$1 \times 10^{15}$	$1 \times 10^{14}$

\* 60 cycles, rapid rise, 0.020 inch-spacing of 0.5 inch-diameter spherical electrodes.

† Using 54 mmfd fixed air capacitor, Cardwell type, ER-50-FS as electrodes, ASTM D150-54T and D1169-52T.

Dielectric Gel, plus CBS Laboratories packaging techniques simplify volume production problems . . . assure high voltage power supplies that are compact, reliable and easy to service.

Write for more information on Dow Corning Dielectric Gel, the new potting material that permits visual and instrument checking of potted electronic circuitry and simplifies production problems.

CIRCLE 100 ON READER SERVICE CARD

Your nearest Dow Corning office is the number one source for information and technical service on silicones.



# Dow Corning

# ...other silicones aid miniaturization

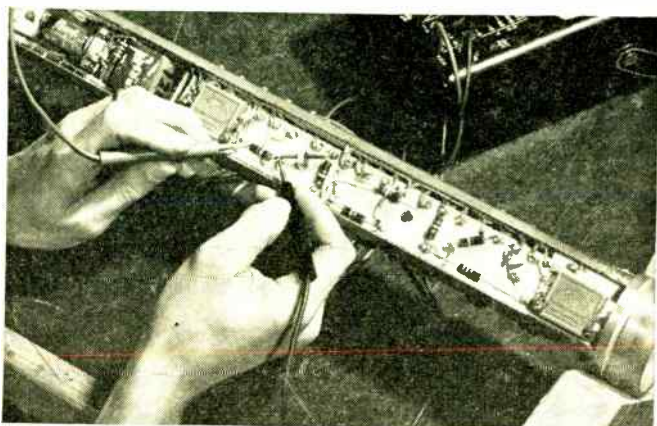

## Light Silicone-Glass Parts Resist Heat

Where space is small, silicone-glass laminates make ideal parts. Reasons: they resist heat and humidity; are easy to fabricate into miniature components; resist creep and delamination. Silicone-glass laminates are light weight, strong, have good dimensional stability, withstand operating temperatures to 250 C, have low loss factor; permit adjacent soldering and have high resistance to moisture, ozone, arcing and corona.

In the geophysical well-logging instrument shown, Schlumberger Well Surveying Corporation specified terminal boards of silicone-glass laminate. The silicone laminate proved more reliable under operating conditions and easier to fabricate than other materials.

CIRCLE 101 ON READER SERVICE CARD

## Silastic Assures Reliability Of Miniature Tube

Here's a good example of how miniaturization is aided by Silastic®, the Dow Corning silicone rubber.

A single tube from the line of Beam Switching Tubes developed by the Electronic Tube Division of Burroughs Corporation can replace as many as 90 transistors, diodes and resistors in electronic distributing, switching, and counting circuits. But proper operation and continued reliability depend upon the relationship of crossed magnetic and electrical fields . . . determined by the relative position of the glass envelope and the magnet which surrounds it. This positioning is very critical.

A cushion of Silastic assures proper alignment, bonds the glass envelope and magnet, provides greater shock resistance than any other material tested . . . contributes to the ease with which the tube meets military shock, vibration and other environmental requirements. Easily applied by simple injection techniques, Silastic is also used between magnet and tube shield.

CIRCLE 102 ON READER SERVICE CARD

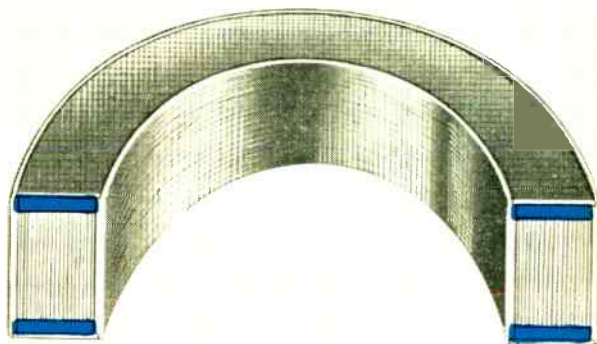

## Silicone Compounds Cushion Small Cores

Tape wound toroidal cores, in both miniature and large sizes, are cushioned with silicone compounds between core and outer box by Magnetics Inc. Through the damping effects of the grease-like Dow Corning compounds, their phenolic-boxed cores are protected against vibration, shock effects and strain due to temperature change. They're "performance-guaranteed" up to 177°C.

Dow Corning silicone compounds were selected because they're inert, have high heat resistance and are easily applied. The compounds are nongumming, nonmelting, maintain a stable viscosity from -75 to 200 C. They have excellent dielectric, damping and heat-dissipation qualities, and are superior barriers to moisture. Other firms use silicone compounds for heat-sinks, sealants and similar applications, both mechanical and electrical.

CIRCLE 103 ON READER SERVICE CARD

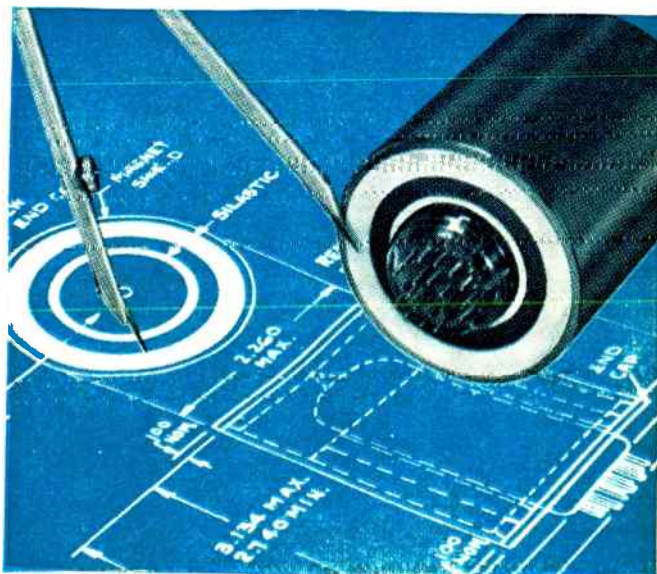

**CORPORATION** MIDLAND, MICHIGAN

branches: ATLANTA BOSTON CHICAGO CLEVELAND DALLAS LOS ANGELES NEW YORK WASHINGTON, D.C.



# WEINSCHEL

## FIXED COAXIAL ATTENUATORS

1 to 12.4 KMC

50 Ohms 1 to 20 db

Connectors: Type N, C, BNC, TNC or SC. Each type with male/female, double male or double female connectors. Made with Weinschel Film Resistors for maximum stability.

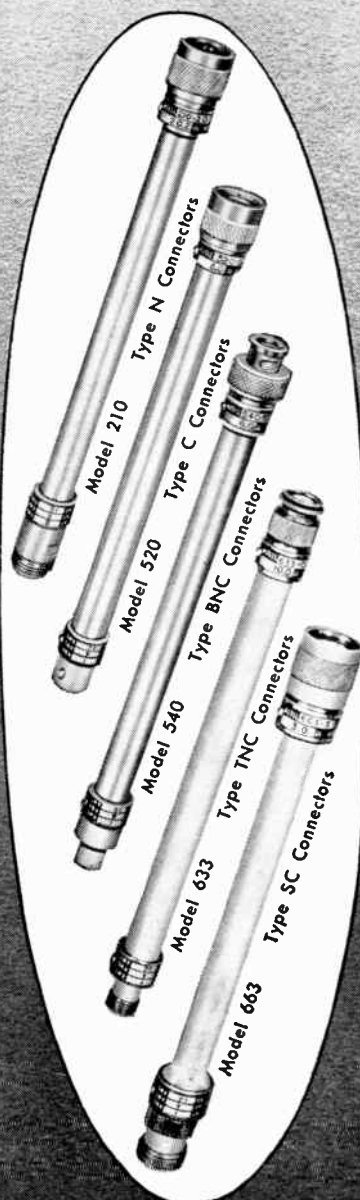

Write for complete catalog, specifying frequency range of interest.

**Weinschel Engineering**  
KENSINGTON, MARYLAND

# WASHINGTON OUTLOOK

WASHINGTON—PLEA FOR IMPORT RESTRICTIONS ON TRANSISTORS and other semiconductors faces tough sledding. Electronic Industries Association had petitioned the Office of Civil and Defense Mobilization based on the claim of defense essentiality. This asserts that increasing imports of transistors and related products threaten to impair national security.

OCDM's study of EIA's plea will stress the adequacy of domestic productivity capacity—how U.S. capacity stacks up against military needs and whether imports could idle or halt expansion of U. S. facilities.

**A recent Pentagon report to OCDM bears on the adequacy of electronic component manufacturing capacity. The Defense Dept.'s Electronic Production Resources Agency told OCDM about two months ago that there is adequate U. S. capacity for production of transistors and other semiconductors to meet both current and long-range mobilization requirements.**

According to one Washington insider, EPRA's study relating transistor requirements to capacity was made in response to a National Security Council directive. About two years ago, a charge was reportedly made before NSC that construction of the DEW line was being delayed by a shortage of electronic components.

EPRA's study shows no inadequacy in any capacity to manufacture electronic components. A high-level OCDM official tells ELECTRONICS that the study may have significant impact on EIA's petition.

- Reorganization of the Air Research and Development Command will be reflected in future relations with Air Force contractors. A Pentagon official calls the ARDC administrative streamlining an attempt to pull back management responsibilities from contractors as much as possible to build up Air Force in-house capabilities.

**A new Command and Control Development Division will be set up at Hanscom Field, Bedford, Mass., to direct all Air Force contracting for communications and electronic control systems. Air Force Cambridge Research Center will serve as nucleus for the new division.**

Air Force officials say the reorganization will bolster the authorities of ARDC field offices and will benefit contractors with quicker decisions and faster action on proposals and complaints.

Under the new ARDC setup, the prime contractor will still integrate a large electronic system. But an ARDC regional agency, such as Rome, N. Y., will have overall responsibility on specs, subcontractors and requirements, turning over the project to the prime for integration only when the other phases have been completed.

- Full-scale missile manpower survey has just been issued by the Labor Dept.'s Bureau of Employment Security. But the report leaves much to be desired.

**The survey reports the missile business as of October 1958, and covers only 320 plants of major prime and subcontractors. It reports total missile employment of 319,300, breaking down the work force by the government's Standard Industrial Code. Since the code has no formal designation for the electronics industry, the survey's scope is considerably limited.**

The report was made in connection with a Walsh-Healey minimum wage determination, crux of which was to measure missile manpower on an airframe versus electronics basis. The survey shows 39.3 percent of the missile work force in aircraft plants, 21.1 percent in ordnance and accessories, 19.9 percent in electrical machinery, 6.4 percent in scientific, control and related instruments. But electronic plants are buried in these and other categories, so it's impossible to measure missile employment in detail.



# CLEVITE

## SILICON JUNCTION DIODES



ACTUAL SIZE

*250 MIF Package . . .  
Fast Switching and JAN Types  
Featuring . . .*

● **MECHANICAL RELIABILITY** — Rugged, hermetically sealed, subminiature packages. Designed to meet both military and commercial requirements.

● **ELECTRICAL SUPERIORITY** — Excellent high temperature operation . . . thermally stable . . . high forward conductance . . . efficient rectification.

● **JAN TYPES** — IN457, IN458 and IN459 conform to JAN Specifications

*For details, write for Bulletin B217A-1 B217A-2*

### TECHNICAL DATA

Type	Max. DC Inver. Oper. Voltage	Forward Current @ Specified Voltage	Max. Inverse Current		
			@ 25°C	@ 150°C	Test Volts
IN457	60 V	20 ma @ 1.0 V	0.025 $\mu$ a	5.0 $\mu$ a	60 V
IN458	125 V	7 ma @ 1.0 V	0.025 $\mu$ a	5.0 $\mu$ a	125 V
IN459	175 V	3 ma @ 1.0 V	0.025 $\mu$ a	5.0 $\mu$ a	175 V
1N662	90 V	10 ma @ 1.0 V	20 $\mu$ a	100 $\mu$ a (@ 100° C)	50 V
1N663	90 V	100 ma @ 1.0 V	5.0 $\mu$ a	50 $\mu$ a (@ 100° C)	75 V
1N778	100 V	10 ma @ 1.0 V	0.5 $\mu$ a	30 $\mu$ a (@ 125° C)	100 V
1N779	175 V	10 ma @ 1.0 V	0.5 $\mu$ a	30 $\mu$ a (@ 125° C)	175 V

#### OTHER CLEVITE DIVISIONS:

Cleveland Graphite Bronze • Brush Instruments  
Clevite Electronic Components • Clevite Harris Products  
Clevite Ltd. • Clevite Ordnance • Texas Division  
Clevite Research Center • Intermetall G.m.b.H.

**CLEVITE**  
**TRANSISTOR PRODUCTS**  
241 CRESCENT ST., WALTHAM 54, MASS.  
TWinbrook 4-9330



World Radio History



# Only GENERAL CERAMICS offers a complete line of HIGH FREQUENCY FERRITE CORES

Make G-C your single source for a complete line of H-F ferrites ranging in frequency from 300 kc to 220 mc.

Ferramic® Q-1, Q-2 and Q-3 materials, developed and introduced by G-C, feature exceptionally low losses, temperature stability and high permeability. Whether your ferrite requirement is for the commercial entertainment industry, military, ground or air borne communication equipment or industrial electronic applications, G-C will meet your needs with the broadest line of high frequency ferrite materials and in the shapes you require.

This curve demonstrates the exceptional qualities of G.C.'s "Q" family of materials — high permeability and low loss.

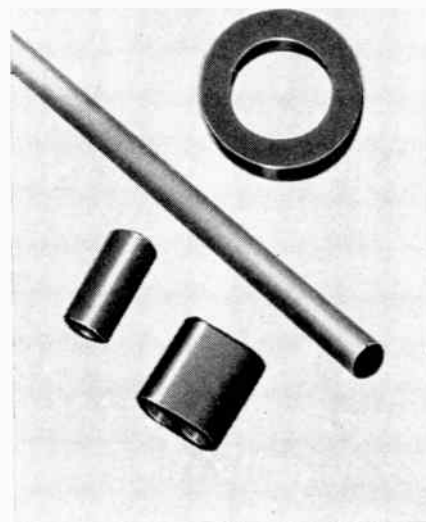
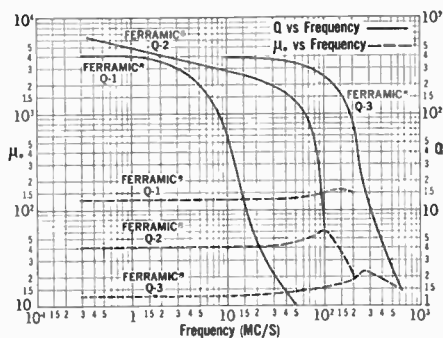

## Q-1 Material

Ideally suited for IF transformers at 455 kc and antenna cores from 500 kc to 1700 kc.

**Magnetic properties include:** Initial permeability at 1 mc/sec. — 125; Maximum permeability — 400; Saturation flux density — 3300 gauss; residual mag. — 1800 gauss; coercive force — 2.1 oersted; temperature coefficient of initial permeability — .10%/°C max; Curie point — 350°C; vol. resistivity — high; loss factor at 1 mcs/sec. — .000020; loss factor at 5 mcs/sec. — .000050.

Standard Ferramic parts in various sizes and shapes offer a dependable, quick solution to design problems. Custom parts can be produced to your specifications. Contact General Ceramics' engineering advisory service. Our staff is ready to discuss your problems and make recommendations.

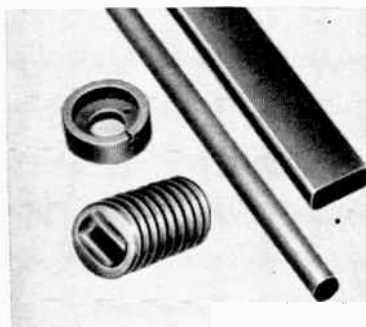

## Q-2 Material

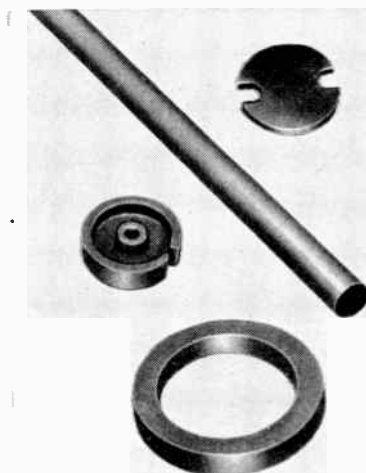

This material produces excellent results in TV receiver IF applications at 45 mc; and FM radio applications at 10.7 mc.

**Magnetic properties include:** Initial permeability at 1 mc/sec. — 40; Maximum permeability — 115; Saturation flux density — 2400 gauss; residual mag. — 750 gauss; coercive force — 4.7 oersted; temperature coefficient of initial permeability — 0.10%/°C max; Curie point — 450°C; vol. resistivity — high loss factor at 10.0 mc/sec. — 0.000085; loss factor at 50.0 mc/sec. — 0.000017.

## Q-3 Material

The exceptionally high Q, excellent temperature stability and high permeability of Q-3 ideally suits it for applications in the 88 mc–108mc FM band and television RF frequencies from 50 mc–216 mc.

**Preliminary specifications include:** Initial permeability  $\mu_0$  — 14; Maximum permeability  $\mu_{max}$  — 42; Saturation flux density  $B_s$  — 2600 gauss; Residual magnetism  $B_r$  — 1470 gauss; Coercive Force — 21 oersted; Q at 100 mc — 250; Q at 150 mc — 150; Q at 200 mc — 70; Resistivity high; Curie point 330°C; Temperature coefficient of  $\mu_0$  — .09%/°C max.

### A New 16-page FERRITE PARTS CATALOG



Is available to engineers by request on company letterhead. It contains complete engineering data on stock parts and materials. When requesting your copy, please address Dept. E.

**General Ceramics Corporation**

KEASBEY, NEW JERSEY (Near Perth Amboy) — Telephone: VALley 6-5100

World Radio History

**GENERAL CERAMICS**

Industrial Ceramics for Industrial Progress... Since 1906

# COUNTERS COUNTERS

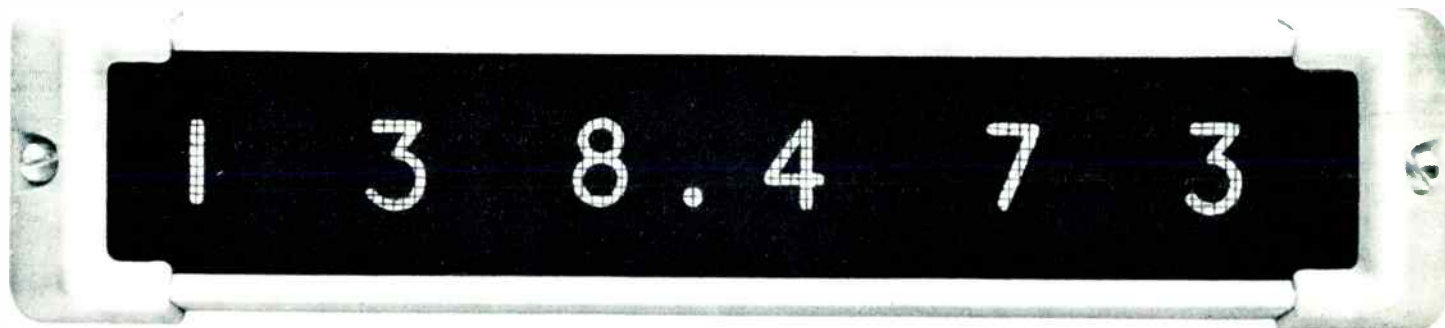

Multi-purpose  
Special-purpose  
Frequency, speed and time  
Computing digital  
Dual preset  
Telemetry  
Industrial  
Nuclear scalars



plus a broad array of highly convenient, time saving accessories

Digital Recorders  
Digital Clocks  
Digital Comparators  
Digital Indicators  
Computer Couplers  
Voltage-to-Frequency Converters  
Counter Scanners  
Card Punch Couplers  
Tape Punch Sets



*See next pages for the world's most complete array of precision counters and accessories, available now through your Hewlett-Packard/Dymec representatives!*



# Never before such a complete



## NEW



## 524C PRECISION ELECTRONIC COUNTER

Bright, big-number readout • New stability — 3 parts in  $10^7$  short-term • Direct, instantaneous, automatic readings • Covers frequencies 10 cps to 220 MC\* • Measures time interval 1  $\mu$ sec to 100 days • Measures period 0 cps to 10 KC • Resolution 0.1 microseconds • No calculation or complex setup • Easily used by non-technical personnel • High sensitivity, impedance, reliability

\*With proper plug-ins.

New big-number readout, and new crystal oscillator stability of 5 parts in  $10^7$  per week—these are significant advances incorporated into new *hp* 524C Electronic Counter.

The new *hp* 524C permits you to buy only the basic counting facilities you need now—later on add inexpensive plug-ins to triple and quadruple the usefulness of your counter.

The basic *hp* 524C reads frequency 10 cps to 10.1 MC over 5 selected periods. Display time is variable, counts are automatically reset, action is repetitive, readings are direct without calculation or interpolation; an automatic illuminated decimal point is included.

The instrument is of highest quality throughout and employs a military design approach. *hp* 524C, less plug-ins, \$2,300.00 (cabinet); \$2,275.00 (rack mount).

### 5 PLUG-IN UNITS INCREASE FLEXIBILITY, USEFULNESS FOR MANY MEASUREMENTS



*hp* 525A FREQUENCY CONVERTER  
Extends 524's direct reading range to cover 10 cps to 100 MC with no loss in accuracy. Provides additional amplification to increase video sensitivity to 0.1 v through 524's basic 10 cps to 10.1 MC range. \$250.00.



*hp* 525B FREQUENCY CONVERTER  
Converts *hp* 524 for direct readings 100 to 220 MC in decade steps. Maintains same high accuracy throughout range; provides high sensitivity for low level work. \$250.00.



*hp* 526A VIDEO AMPLIFIER  
Increases 524 sensitivity to 10 mv for low-power frequency measurement 10 cps to 10.1 MC. Accuracy same as counter; minimum input 10 millivolts rms. \$175.00.



*hp* 526B TIME INTERVAL UNIT  
Permits 524 to measure interval 1.0  $\mu$ sec to 100 days with accuracy of 0.1  $\mu$ sec stability. Reads in sec, msec or  $\mu$ sec. Triggering from separate "stop" or "start" on pos. or neg. going waves. Trigger adjustable — 192 to  $\pm$  192 volts. \$175.00.



*hp* 526C PERIOD MULTIPLIER  
Permits 524 to measure period over 100, 1,000 or 10,000 cycles of unknown, thus providing greater accuracy for frequency readings. Front panel switch selects desired multiple. \$225.00.

### *hp* 524D FREQUENCY COUNTER



For users who prefer vertical neon readout at slightly lower cost, *hp* also offers the precision Model 524D Electronic Counter. *hp* 524D is electrically similar to *hp* 524C described above, and accepts all 525/526 series plug-ins. Model 524D, \$2,150.00.

# Call your



World Radio History



# rep now



# Use these versatile Dymec "building-block" counters and accessories for DIGITAL DATA SYSTEMS

These Dymec instruments make possible, at uniquely low cost, assembly of a custom digital system specifically suited to your needs.

The Dymec instruments shown on these pages are specialized. Yet they are compatible, requiring a minimum of adaption to combine them into a fully integrated system. Many can be used directly with *hp* counters and printers, card punches, tape perforators, and standard input-output equipment of other manufacturers. Dymec instruments are quantity-produced for obvious cost savings to you; yet are of finest quality, meeting the most exacting laboratory standards.

Many different systems can be assembled from these and other standard Dymec instruments. Dymec offers the equipments separately, as sub-systems, or as completely engineered, ready-to-use systems. Contact your nearby *hp*-dymec representative for detailed information on selecting and adapting these instruments for your specific data-handling problem.

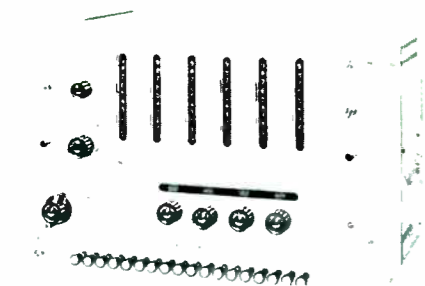
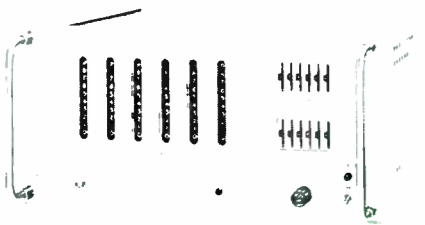
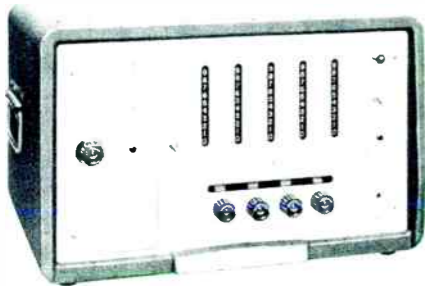

## DY-2210 VOLTAGE-TO-FREQUENCY CONVERTER AND INTEGRATOR

Provides precision dc voltage measurements and integration with electronic counters. Inherent noise-smoothing characteristics. Multiple input ranges, either polarity. Input 0 to 1 v produces 0 to 10,000 cps output. \$650.00. AC and remote models available.

## DY-2500 COMPUTING DIGITAL INDICATOR

RPM, flow, pressure, speed, frequency—all may be read easily in direct numeric form with the DY-2500 and appropriate transducers. Features include: 5-digit readout, 4 or 5 preset decades, gate time adjustable from 0.0001 to 9.9999 seconds in 0.1 msec steps (other ranges available), frequency range 1 cps to 120 KC (220 KC optional), crystal accuracy, recorder and b-c-d output, built-in self-check. Price: \$1330.00 to \$1425.00. Also DY-2500N with "nixie" in-line readout. Price \$1525.00 to \$1600.00 (Both models available in cabinet or rack mount.)

## DY-2507 DUAL PRESET COUNTER

Precise control and monitoring of machine processes, automatic limit control and warning, sorting, packaging, automatic coil winding, equipment programming, go/no-go testing—these are typical production and research assignments in which the DY-2507 provides an output when either of two preset values is reached, or exceeded. Output is continuous or pulsed; reset is manual or automatic. Presetting is on front panel, or remote. Available with 3 to 6 decades. Price: \$700.00 to \$895.00 (rack mount only).

## DY-2503A / B FM / FM TELEMETERING COUNTERS

Simplify telemetering operations! This original Dymec contribution in specialized electronic counters provides normalized indications of FM subcarrier signal period. Six-place indication displays ratio between input signal period and channel mid-band period. 18 channels selected by pushbuttons; equal resolution on all subcarrier bands, 1 part in 100,000 or 1 part in 10,000 with 1.0 or 0.1 second sampling time (front panel control). Digital recorder output. Model DY-2503B is similar to the DY-2503A but includes a function selector and multiplier controls. Price: DY-2503A (cabinet mount) \$1650.00, (rack mount) \$1630.00. DY-2503B (rack mount only) \$1800.00.

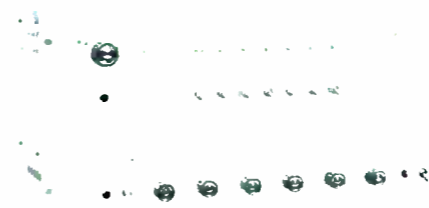

**DY-2513 COUNTER SCANNER.** Gathers multiple electronic counter data for printing on a single digital recorder. Simplifies simultaneous data measurements. For all Dymec or *hp* counters. \$1,750.00.



**DY-2538 PROGRAMMED DIGITAL COMPARATOR.** Unique, error-free comparison circuit, no drift or calibration; visual and electrical output; use with Go/No Go systems. Preset high and low tolerance limits selected electrically. \$950.00. Also manual-selection models.

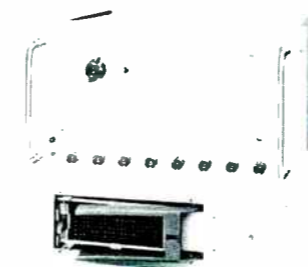

**DY-2512 CARD PUNCH COUPLER** permits direct entry of counter information onto punched cards, eliminating manual key punch. Operates unattended. Readily connects Dymec or *hp* counters to IBM 523 Summary Card Punch. \$1,890.00.



**DY-2530 BINARY/DECIMAL REGISTER.** Universal output coupler connecting electronic counters to digital displays, comparators, printers, computers. Stores parallel binary-coded-decimal information in multi-contact relays. 10 models, dual or single output, 3 to 7 registers. \$565.00 to \$1,230.00.



**DY-2540 SCANNER/COUPLER** transfers electronic counter data to serial entry machines such as tape perforators, electric typewriters, serial entry card punches. Multiple inputs, multiple outputs. \$890.00.



**DY-2542 TAPE PUNCH SETS** record data from electronic counters on punched tape. High speed—recording rate 60 characters/second. Standard model: 5-level output code, 11 character format. Available with internal tape punch (\$4,480.00) or for use with external punch (\$3,240.00).

Call your *hp* / Dymec rep now for application information and tech data sheets on any of the *hp* and Dymec equipment shown on these pages

*Data subject to change without notice. Prices f.o.b. factory.*

## HEWLETT-PACKARD COMPANY

1275A Page Mill Road, Palo Alto, California  
Cable "HEWPACK" DAvenport 5-4451

## DYMEC

A division of Hewlett-Packard Co.  
1395A Page Mill Road, Palo Alto, California  
DAvenport 6-1755

Field representatives in principal cities throughout the Free World  
Hewlett-Packard S.A., Rue du Vieux Billard No. 1, Geneva, Switzerland  
Cable "HEWPACKSA" Tel. No. (022) 26.43.36

5490

### NOW! *hp* IN EUROPE

In May 1959, Hewlett-Packard S.A. was established in Geneva (a branch has since opened in Frankfurt am Main) offering technical sales and engineering help and information. Previously established relationships with representatives in other

parts of Europe, of course, continue. In addition, there is a new *hp* warehouse in Basel stocking instruments and parts, and an *hp* factory near Stuttgart will soon be producing *hp* instruments for customers throughout Europe.



**NEW**



**hp 523CR ELECTRONIC COUNTER**

Significantly improved 0.1 v sensitivity • Superior trigger level circuitry • Direct frequency, period or time interval readings • High quality, versatility at moderate cost • Basic accuracy  $\pm 1$  count — stability (2 ppm week) • Pulse output for Z-axis scope modulation.

New hp 523CR is a revolutionary, all-purpose counter measuring frequency 10 cps to 1.2 MC, time interval 1  $\mu$ sec to 27.8 hours and period 0.00001 cps to 100 KC. Stability is 2/1,000,000 per week; readout is direct, in-line with bright, clear numerals visible under any lighting conditions. Results are displayed in seconds, milliseconds, microseconds or KC with automatic decimal. Display time is variable 0.1 sec to 10 seconds, or "Infinite." Accuracy is  $\pm 1$  count — crystal stability, 5 gate times. Usable with 100 KC primary standard. High quality, completely self-contained. Pulse output provided for modulating oscilloscope Z-axis. hp 523CR (rack mount only), \$1,485.00.

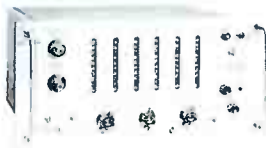

**hp 523DR ELECTRONIC COUNTER**

At slightly lower cost, hp also offers the precision hp 523DR Electronic Counter. Model 523DR is electrically identical to Model 523CR, except that readout is by six columnar neon indicators instead of in-line digital display. hp 523DR (rack mount only), \$1,285.00.



**hp 522B ELECTRONIC COUNTER**

One of the most versatile, low-cost precision electronic counters ever offered. The popular hp 522B is used for such varied measurements as production quantities, nuclear radiation, power line frequencies, rps and rpm, very low frequencies, weight, pressure, temperature, acceleration, etc. Frequency range 10 cps to 120 KC, time interval 10  $\mu$ sec to 10 seconds. Reads direct in cps, KC, seconds, and milliseconds. Count automatically reset, action repetitive, useable in remote operation. Time base stability 1/100,000 per week. Easily used by untrained personnel. \$915.00 (cabinet) \$900.00 (rack mount).



**hp 521 SERIES INDUSTRIAL COUNTERS**

Low cost, simple operation, almost limitless uses characterize hp 521 Industrial Counters. hp 521A measures frequency, random events per unit of time; with transducers also measures rps, speed, rpm, weight, pressure, temperature, acceleration, etc. hp 521A reads direct in cps, display is variable 0.1 to 15 seconds or "hold." Frequency range is 1 cps to 120 KC, accuracy  $\pm 1$  count  $\pm$  accuracy of power line frequency (usually  $\pm 0.1\%$ ); input min. 0.2 v rms; input attenuator adjusts sensitivity 0.2 to 100 v rms,

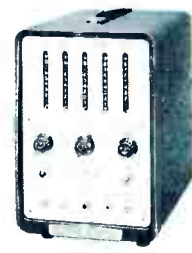

input impedance 1 megohm with 50  $\mu$ pf shunt, gate time 0.1 and 1 sec, also Manual Gate. hp 521C same as 521A except has greater accuracy, crystal controlled time base and 5-place (instead of 4-place) registration with count capacity of 99,999. hp 521D same as 521A except has in-line readout in bright, large numerals. hp 521E similar to 521C but has 5-place, in-line readout. hp 521G similar to 521A but measures to 1.2 MC (5 places). hp 521A, \$475.00. hp 521C, \$650.00. hp 521D, \$675.00. hp 521E, \$875.00. hp 521G, price on request.



**hp 560A, 561B DIGITAL RECORDER AND CLOCK**

Continuous digital records from hp Dymec counters, digital voltmeters, other digital equipment. Direct reading. Accuracy identical to driving instrument. Records 11-digit lines at rates up to 5 per second. Secondary or coding data may be entered simultaneously.

hp 560A Digital Recorder provides a permanent printed record of all types of test data. In addition, a unique analog output makes possible graphic recording of very small data variations.

The analog output is a voltage or curve proportional to the number represented by any three consecutive digits of recorded data. This digitally-derived analog output provides zero-suppression which is virtually error-free. An inherent range-shifting feature keeps the record on scale. Expanded scale records with extreme resolution can thus be made using conventional potentiometer or galvanometer recorders.

Model 560A is normally furnished with 6 plug-in comparators for 6-digit presentation; additional comparators may be plugged in at any time.

hp 561B Digital Recorder requires 10-line coded decimal entry with separate connection for each position of each print wheel so that the instrument may be operated from the hp 405AR Digital Voltmeter. \* Frequency Counters or relays, stepping switches and beam switching tubes.

hp 571B and 570A Digital Clocks (shown installed) mount in the left-hand side of hp 561B and 560A respectively, and add time-of-day information to other recorded data. These clocks can also control rate at which measurements are made. In line, 6-place numeric readout; maximum 23 hours, 59 minutes, 59 seconds. Internal or external time base. Prices on request.



**hp 540A/B TRANSFER OSCILLATOR**

Just two hp instruments—Model 540B Transfer Oscillator and a 524 series electronic counter, (with plug-ins) are all the equipment you need to measure unknown frequencies up to 12.4 KMC swiftly and accurately.

This simple, two instrument setup is particularly useful for quick CW and AM frequency measurement, FM center frequency and deviation checks, and frequency of high-noise signals. Frequencies of pulsed signals can be measured using an external oscilloscope. Overall accuracy is better than 10 times that of the best microwave wave-meters; and on clean CW signals, is about 1/10,000,000.

**BRIEF SPECIFICATIONS, hp 540B**

Oscillator Frequency Range: 100 to 220 MC.  
 Harmonic Frequency Range: Up to 12.4 KMC  
 Stability: Better than 0.002%/minute  
 Output: 2 volts into 50 ohms  
 Amplifier Gain: 40 db max, 1 v output  
 Oscilloscope: 100 cps to 200 KC; vert. sens. 5 mv rms/inch  
 Price: \$750.00  
 Model 540A, similar to 540B, but requires an external mixer above 5 KMC. \$615.00.

**BRIEF SPECIFICATIONS**

Accuracy: Identical to counter used  
 Printing Rate: 5 lines/sec maximum  
 Digit Capacity: Up to 11 per line  
 Driving Source: 560A—Parallel entry staircase voltages  
 561B—Ten-line decimal code  
 Analog Output (560A): Proportional to any 3 consecutive digits; max. amplitude 1 ma or 100 mv  
 Print Command Signal: 10  $\mu$ sec minimum, pos. or neg., 15 v pulse  
 Price: hp 560A \$1,265.00 (with six comparators).  
 hp 561B \$1,065.00 (11 columns).

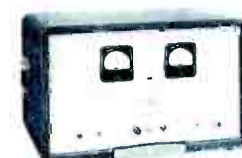

**hp 520A NUCLEAR SCALER**

Makes possible quantitative measurements of extremely fast random or continuous occurrences; simplifies measurement of "fast" pulses or nuclear parameters. Count capacity 100 in 2 decades; may be connected to 100,000 pps counter. Positive pulses only, min. amplitude 5 v, max. 30 v. \$615.00 (cabinet), \$600.00 (rack mount).



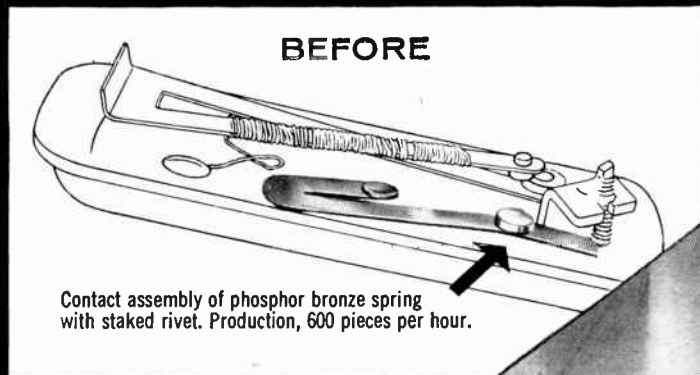

Contact assembly of phosphor bronze spring with staked rivet. Production, 600 pieces per hour.

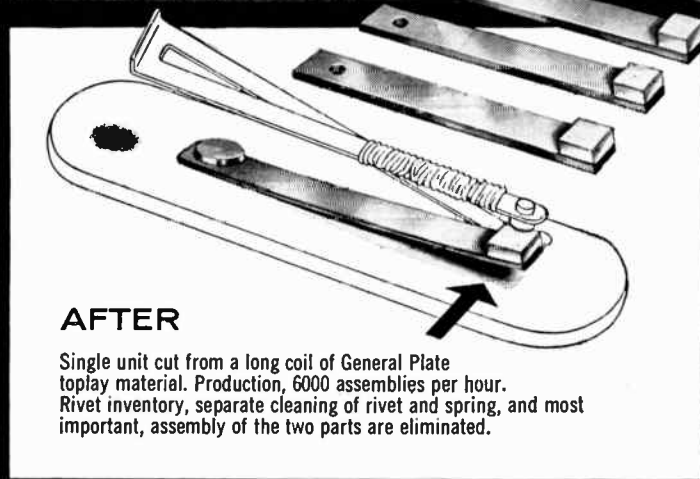

**AFTER**

Single unit cut from a long coil of General Plate toplay material. Production, 6000 assemblies per hour. Rivet inventory, separate cleaning of rivet and spring, and most important, assembly of the two parts are eliminated.

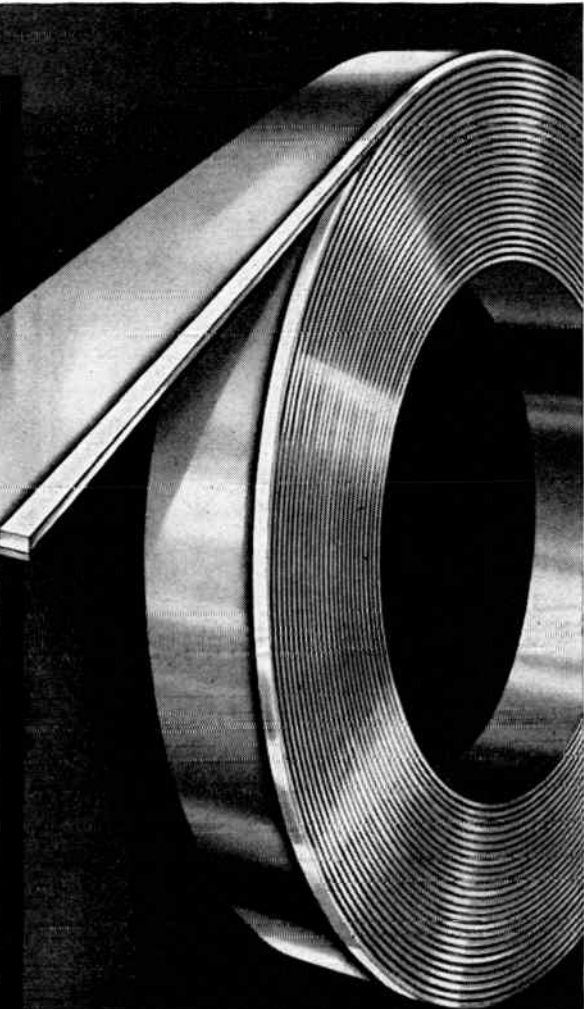

## GENERAL PLATE TOPLAY MATERIAL ENABLES KING-SEELEY CORPORATION TO Increase Contact Assembly Production 900%

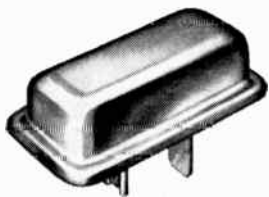

Recently King-Seeley Corporation, long a leading manufacturer of instrument panel gauges and other automotive equipment, redesigned the contact assembly in the constant voltage "CV" voltage regulator, a component of their constant voltage gauge systems. The old design called for blanking of a phosphor bronze spring, cleaning and finally staking of a General Plate rivet. By changing to General Plate toplay contact material the operation called for simply cutting off and cleaning. Expensive assembly operations were eliminated. The result . . . an increase in production of contact assemblies by 900%.

General Plate clad contact materials make it possible to manufacture complete contact assemblies to close tolerances by single blanking and forming operations. Compare this to other methods whereby the contacts and supporting members are fabricated separately and then assembled.

Let us make an electrical contact cost analysis on products you want to automate. Find out how General Plate clad electrical contact materials can be put to work for you. Write *now*.

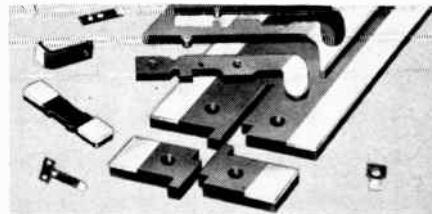

General Plate Clad Contact Materials . . . Single and double inlay, overlay and toplay provide better electrical performance, longer operating life and lower fabrication costs.

### METALS & CONTROLS

1310 FOREST STREET ATTLEBORO MASS., U.S.A.

A DIVISION OF TEXAS INSTRUMENTS INCORPORATED

General Plate Products: Clad Metals • Electrical Contacts • Truflex® Thermostat Metal • Platinum Metals • Reactor Metals • Radio Tube & Transistor Metals

## *Biggest thirst in the universe*

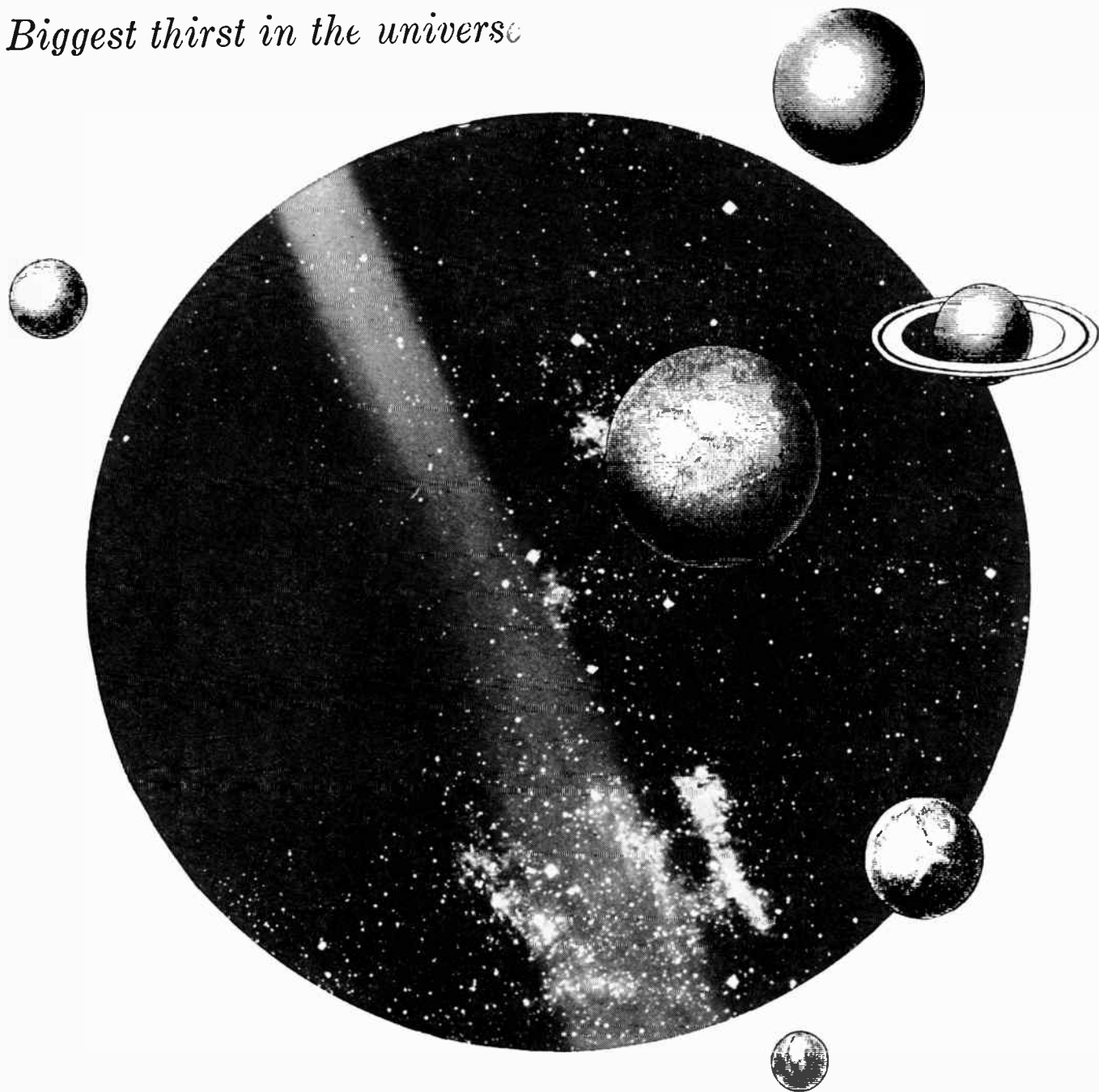

Each 6,000,000 pound thrust rocket ship now being planned for manned interplanetary exploration will gulp as much propellant as the entire capacity of a 170 passenger DC-8 Jetliner in less than 4 seconds! It will consume 1,140 tons in the rocket's approximately 2 minutes of burning time. Required to carry this vast quantity of propellant will be tanks tall as 8 story buildings, strong enough to withstand tremendous G forces, yet of minimum weight. Douglas is especially qualified to build giant-sized space ships of this type because of familiarity with every structural and environmental problem involved. This has been gained through 18 years of experience in producing missile and space systems. We are seeking qualified engineers and scientists to aid us in these and other projects. Some of our immediate needs are listed on the facing page.

Dr. Henry Ponsford, Chief, Structures Section, discusses valve and fuel flow requirements for space vehicles with **DOUGLAS**  
Donald W. Douglas, Jr., President of

MISSILE SYSTEMS ■ SPACE SYSTEMS ■ MILITARY AIRCRAFT ■ JETLINERS ■ CARGO TRANSPORTS ■ AIRCOMB ■ GROUND HANDLING EQUIPMENT

[World Radio History](#)



# Fiscal Reports Show Gains

SEMICONDUCTOR MANUFACTURERS are scoring new highs in financial activity this Fall. Among reports from manufacturers are:

• "Our transistor sales are up 472 percent for the first quarter of the present fiscal year over the corresponding quarter last year," announces C. A. Tepper, president of **Industro Transistor**, Long Island City, N. Y.

The company estimates that if sales and earnings continue at the present level, Industro will net about 50 cents a share after taxes for the current fiscal year.

Plans now in effect at Industro call for doubling the present *pnp* transistor production line by the beginning of next month. These added facilities are expected to yield a volume of three to five million dollars annually.

In addition, the company is installing a silicon transistor line expected to be in full production by the end of this year. Discussions are in progress regarding listing Industro on the American Stock Exchange in the near future.

• Increase of 24 percent for fiscal year 1959 over 1958 is reported by **International Rectifier Corp.**, El Segundo, Calif. Company sales for the year ended June 30, 1959 were \$10,870,038 as compared to \$8,766,173 last year. Net earnings after taxes this year rose to \$877,371, equivalent to 81 cents a share on 1,080,000 shares of common stock outstanding.

This compares with a net income of \$735,783 or 68 cents a share for fiscal 1958. Current assets of IRC are \$4,425,075, current liabilities \$1,200,108, giving a net working capital of \$3,224,967. A five-percent stock dividend will be paid next Monday, Oct. 26, to stockholders of record on Oct. 15.

• **Universal Controls** discloses the founding of a new subcompany, **C. P. Clare Transistor Corp.**, Glen Head, L. I. This new development was disclosed originally last

May at a closed meeting of stockholders, and announced publicly this Fall with the news that ground will be broken for a new plant this month. C. P. Clare Transistor is presently manufacturing a quality line of *pnp* germanium transistors for specialized applications.

Although the new organization has not yet made any noticeable change in the Universal Controls financial situation, UC reports that the first six months of the current fiscal year show a volume equivalent to 86 percent of the total recorded for the previous fiscal year. Sales of the new transistors are expected to substantially boost last year's volume of \$29,076,000.

## 25 MOST ACTIVE STOCKS

	WEEK ENDING OCTOBER 9			
	SHARES (IN 100's)	HIGH	LOW	CLOSE
Lear Inc	898	16¼	13¾	16¼
Int'l Tel & Tel	881	37	33½	37
Raytheon	782	50¾	44¾	49¾
Univ Control	773	18	16	17¼
Sperry Rand	626	22¾	21¾	22
Avco Corp	586	13¾	12½	13¾
Gen Elec	532	79¼	77¼	77½
RCA	500	60½	56¾	59¾
Gen Dynamic	478	47¾	44¾	46
Burroughs	378	30¾	29½	29¾
Texas Inst	368	143¼	131½	142½
Siegler Corp	359	30¾	28¾	30
Philco Corp	349	25¾	23¾	25¼
Westinghouse	347	94¾	91¾	94¼
Zenith Radio	269	103½	94½	102½
Standard Coil	252	16¾	15½	16¾
Cons Electrodynamic	239	35¾	31¾	33¾
Litton Ind	226	121¾	108	120¼
Gen Instr	223	25¾	22½	24¾
Beckman Instr	199	57¾	52½	57½
Emerson Rad & Phone	195	16½	14½	16
El-Tronics	192	1½	1¼	1¾
DuMont Labs	190	8½	7¾	8
Admiral Corp	180	20¾	18¾	20
Int'l Bus Mach	171	421	410	411½

The above figures represent sales of electronics stocks on the New York and American Stock Exchanges. Listings are prepared exclusively for **ELECTRONICS** by Ira Haupt & Co. investment bankers.

NEW PUBLIC ISSUES	No. of Shares	Issue Price
Acme Missiles	150,000	6
Camloc Fastener	150,500	9
Hikock Elec Inst	90,000	*
*to be announced		

NEW ISSUES PLANNED	No. of Shares	Issue Date
Electro-Sonic Labs	100,000	Oct 26
Shell Electronics	170,000	Oct 27
Electronics Funding	75,000	Oct 30

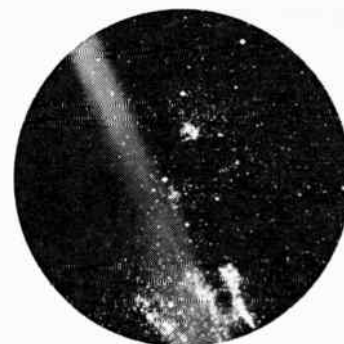

If your thirst for advancement is unslaked...

## DOUGLAS AIRCRAFT COMPANY MISSILES AND SPACE SYSTEMS

has immediate openings in the following fields—

### Electrical and Electronics:

- Control System Analysis & Design
- Antenna & Radome Design
- Radar System Analysis and Design
- Instrumentation
- Equipment Installation
- Test Procedures
- Logic Design
- Power System Design

### Mechanical Engineering —

Analysis and Design of the following:

- Servo Units
- Hydraulic Power Systems
- Air Conditioning Systems
- Missile Launcher Systems
- Propulsion Units and Systems
- Auxiliary Power Supplies

### Aeronautical Engineering:

- Aerodynamic Design
- Advanced Aerodynamic Study
- Aerodynamic Heating
- Structural Analysis
- Strength Testing
- Dynamic Analysis of Flutter and Vibration
- Aeroelasticity
- Design of Complex Structure
- Trajectory Analysis
- Space Mechanics
- Welding
- Metallurgy

### Physics and Mathematics:

- Experimental Thermodynamics
- General Advanced Analysis in all fields
- Computer Application Analysis
- Computer Programming and Analysis
- Mathematical Analysis

For full information write to:

**Mr. C. C. LaVene**

**Box F-620**

**Douglas Aircraft Company, Inc.**  
**Santa Monica, Calif.**

**THE PRACTICAL LOW COST ANSWER TO MULTI-CHANNEL OSCILLOGRAPHIC RECORDING PROBLEMS ... SANBORN INTRODUCES THE FIRST OF THE 950 SERIES ... THE 950-1500 SYSTEM ... FOR FLOATING OR GROUNDED INPUTS FROM 10  $\mu$ V TO 0.1 VOLT PER DIVISION ... ALL-TRANSISTORIZED ELECTRONICS MOUNTED BEHIND A SINGLE 7" HIGH PANEL ... FLUSH-FRONT RECORDER WITH 9 ELECTRICALLY-CONTROLLED CHART SPEEDS ... IMPROVED, RUGGED GALVANOMETERS ... CLEAR, INKLESS TRACES ... RECTANGULAR COORDINATE RECORDINGS ... ALL IN A SYSTEM DESIGNED SPECIFICALLY TO PROVIDE GREATER ECONOMY AND ACCURACY WHEN SYSTEM FLEXIBILITY IS NOT REQUIRED.**



Additional features of the 950-1500 include: common power supply, built-in MOPA, front and rear inputs, easily serviced plug-in circuit cards, adaptability for use with other readout devices. When many channels are constantly in use for floating or grounded high gain inputs the simplified 950-1500 design assures dependable operation, yet at much lower "per channel" cost.

*Complete details are available from Sanborn Sales-Engineering Representatives located in principal cities throughout the U.S., Canada and foreign countries.*

#### SPECIFICATIONS

INPUT	100,000 ohms, all ranges, floating and guarded.
OUTPUT	400 ma. full scale, 15 ohms nominal load, ungrounded
LINEARITY	$\approx 0.4\%$
SENSITIVITY	10, 20, 50, 100, 200, 500, 1000 and 2000 uv per chart div
COMMON MODE REJECTION	100 db, min. dc
FREQUENCY RESPONSE	0-100 cps within 3 db or 10 div peak to peak. 0-50 cps within 3 db or 50 div peak to peak.
NOISE	$\frac{1}{4}$ div peak to peak maximum.

(All data subject to change without notice)

NEREM '59 Comm. Armory, Boston, November 17, 18, 19.

**SANBORN  COMPANY**

INDUSTRIAL DIVISION 175 Wyman Street, Waltham 54, Massachusetts

World Radio History



Every feature you've ever wanted, now yours with this

# NEW MOSELEY X-Y RECORDER

- New, integral AC/DC input
- No extra AC converter to buy
- Built-in X-axis time base
- Operates direct from transducer
- Accuracy, resolution  $\pm 0.25\%$
- Local or remote operation

and look at the broader utility you get with these precision Moseley accessories



NEW MODEL 20

Model 2D is a significantly advanced X-Y Recorder offering virtually every useful Recorder capability, plus a new control panel arrangement insuring maximum operating convenience. Brief specifications are: Input range 7.5 mv to 150 v on X-axis; 5 mv to 100 v on Y-axis. X-axis time base, 5 steps, 7.5 to 750 secs. Input resistance 200,000 ohms/v, accuracy and resolution  $\pm .2\%$ , zero offset, pen speed 20 in/sec each axis, vacuum paper hold-down.

Call your Moseley AUTOGRAF Recorder representative today or write direct for detailed data on Model 2D and accessories.

Data subject to change without notice.

Pioneer and leader in X-Y and Strip-Chart Recorders

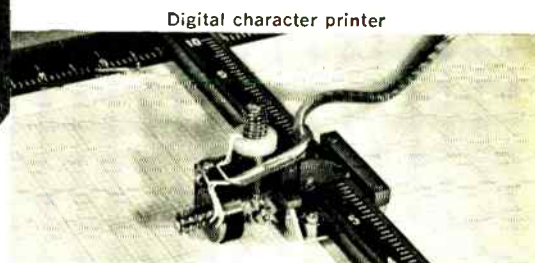

Digital character printer

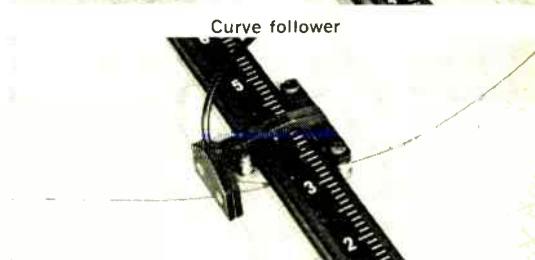

Curve follower

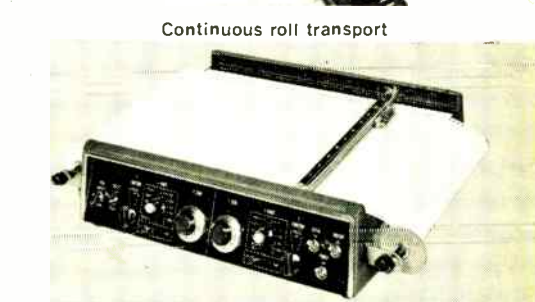

Continuous roll transport

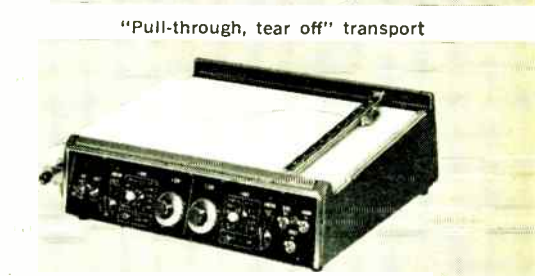

"Pull-through, tear off" transport



**F. L. MOSELEY COMPANY**  
 Dept. A10, 409 N. Fair Oaks Ave., Pasadena, California  
 MUrray 1-0208 TWX PASA CAL 7687  
 Field representatives in all principal areas

5631

# CerMac

## SPECIALTY SEALS

precision-made to  
your specifications



### High-temperature specialty seals vacuum-tight, shock- and vibration-proof

A competent, dependable source for custom seals is CerMac (Ceramic-Metal Assemblies Corporation). Here experienced and skilled personnel employ modern precision manufacturing facilities to produce hermetic seals and other metallized ceramic assemblies of highest quality with prompt deliveries. Send drawings for quotations.

Representatives in principal cities

**CERAMIC-METAL  
ASSEMBLIES CORP.**

P. O. Box E-328 Latrobe, Pennsylvania

Phone: Latrobe, Keystone 9-1757

## MARKET RESEARCH

# Infrared's Future Promising

FAST-GROWING MARKETS which offer the possibility of sales multiplying several times within a few years are the life-blood of the electronics industry.

In the past these fast-growth markets have made it possible for the electronics industry to continually renew its growth. The markets have also been the means whereby many small companies have become big ones.

### Sales to Soar

Consequently, many members of our industry are strongly interested in the market for infrared gear. Currently it is one of the most rapidly-growing markets in the industry. Sales are expected to multiply almost four times in the next four years.

The 1959 market is roughly estimated at \$110 million, including \$100 million worth of military business, say manufacturers and other industry experts. By 1963 the market for infrared systems and devices is expected to increase to \$425 million. The military will take \$400 million worth and the remainder will be accounted for by civilian applications.

The infrared market has been boiling ever since the outstanding success of the infrared-guided Sidewinder missile under actual combat.

The Sidewinder is the largest present application for infrared equipment. However, today's Sidewinder system is restricted to detecting the high temperatures found in a jet exhaust. The missile is confined to attacks on the rear portion of enemy aircraft.

A program is now underway to alter the detection system so that it will be possible for the Sidewinder to use the lower skin temperature of the aircraft as a source of energy. If the program is successful the Sidewinder will be capable of attack from any direction.

The Falcon air-to-air missile is the second largest military user of an infrared detection and guidance system.

In project Midas (Missile Iner-

tial Defense Alarm System) infrared will be used to detect the launching of ICBM's. Infrared energy is drastically attenuated by rain, fog, and clouds. However, these phenomena are not normally present at higher altitudes. Consequently, infrared can operate reliably as a missile detection medium at such altitudes. Limited tests conducted thus far indicate airborne infrared may be able to outperform radar in detecting ICBM launchings.

Infrared is also being actively developed as a means of battlefield surveillance. Drones can be employed to map a battlefield area by using infrared to detect and locate sources of heat such as tanks, trucks and guns.

High research and development costs have thus far prevented widespread civilian use of infrared systems. Some present civilian applications include railroad hot box detectors, process analyzers, boiler flame-failure detectors and laboratory analytical instruments.

The Federal Aviation Agency is reported seriously considering the use of infrared as a means of avoiding aircraft collisions.

The recent Argus project has confirmed that certain high-altitude magnetic effects will disrupt microwave communications and that infrared will not be affected. Consequently, there has been a great deal of interest in the possibility of using infrared as a communications medium for satellites. In this case, a heat source would be modulated for communications.

## FIGURES OF THE WEEK

### LATEST WEEKLY PRODUCTION FIGURES

(Source: EIA)	Oct. 2, 1959	Sept. 4, 1959	Change From One Year Ago
Television sets	192,383	141,550	+58.3%
Radio sets, total	467,129	369,035	+50.9%
Auto sets	183,656	125,087	+77.8%

### LATEST MONTHLY SALES TOTALS

(Add 000)	August 1959	July 1959	Change From One Year Ago
Rec. Tubes, value	\$29,974	\$29,786	+17.8%
Rec. Tubes, units	35,435	36,394	+16.3%
Pic. Tubes, value	\$15,494	\$14,684	+9.2%
Pic. Tubes, units	832	750	+15.4%



# how to get ultra- uniformity

## in a Silicon PNP fused alloy transistor

Through precise manufacturing techniques, Hughes PNP fused-junction silicon transistors give you uniformity of parameters by type. Result: Circuit interchangeability no longer is a problem.

Designed for switching and amplifying applications at low and medium current levels, these Hughes transistors offer you a number of advantages:

- useful Beta over a wide range of collector currents
- high punch-thru voltage ( $BV_{CEO}$  in excess of 100 volts in types 2N1244 and 2N1234)
- low collector cutoff current

These devices, now available in production quantities, are housed in TO-5 (single ended) and coaxial packages (double ended). Engineered for reliability, they meet MIL-T-19500A specifications.

Your inquiry regarding these transistors will be given prompt attention. Just write Marketing Department, HUGHES SEMICONDUCTOR DIVISION, NEWPORT BEACH, CALIFORNIA... or contact the Hughes Semiconductor Sales Office or distributor nearest you.

Coaxial Package Type:	2N1238	2N1239	2N1240	2N1241	2N1242	2N1243	2N1244
TO-5 Package Type:	2N1228	2N1229	2N1230	2N1231	2N1232	2N1233	2N1234
Breakdown Voltage @ $-100\mu A: C_{EO}, C_{BO}, E_{BO}$	-15V	-15V	-35V	-35V	-65V	-65V	-110V
$h_{FE}$ (Typical)	22	40	14	25	14	25	14
Typical Collector Cutoff Current	$-0.01\mu A_{dc}$	$-0.01\mu A_{dc}$	$-0.01\mu A_{dc}$	$-0.01\mu A_{dc}$	$-0.01\mu A_{dc}$	$-0.01\mu A_{dc}$	$-0.01\mu A_{dc}$
$V_{CE}$ (max.) ( $I_C = -10mA_{dc}, I_B = -2mA_{dc}$ )	-0.2Vdc		-0.2Vdc		-0.2Vdc		-0.2Vdc
$V_{CE}$ (max.) ( $I_C = -20mA_{dc}, I_B = -2mA_{dc}$ )			-0.4Vdc		-0.4Vdc		-0.4Vdc
Coaxial Package: Power dissipation	1 watt in free air (derate 1.4 mw/°C) 5 watts with heat sink (derate 37 mw/°C)				Collector current limited by power dissipation. Operating and storage temperature range $-65^\circ C$ to $+160^\circ C$		
TO-5 Package: Power dissipation	400 mw (derate 3.0 mw/°C)						

SEMICONDUCTOR DIVISION

**HUGHES PRODUCTS**

© 1959, HUGHES AIRCRAFT COMPANY

Creating a new world  
with ELECTRONICS

SEMICONDUCTOR DEVICES • STORAGE TUBES AND DEVICES • MICROWAVE TUBES • VACUUM TUBES — COMPONENTS • CRYSTAL FILTERS • MEMO-SCOPE® OSCILLOSCOPES • INDUSTRIAL CONTROL SYSTEMS

# TOUGH ENOUGH FOR AIRBORNE RADAR

## Hughes microwave tubes

Rugged, compact, light in weight... all Hughes Microwave Tubes have withstood the most severe requirements of airborne radar systems and therefore can be applied in the most taxing of environmental problems.



### KU BAND BACKWARD WAVE OSCILLATOR

The Hughes Type LOU-2 is a precision built oscillator which tunes over the frequency range of 12.4 to 18.0 kmc. Typical power output over band is 10 to 60 milliwatts. The tube is housed in a self-contained permanent magnetic focusing package so that a separate power supply for a focusing electromagnet is not required.



### S-BAND TRAVELING WAVE AMPLIFIER

Periodically focused, the type MAS-1A has a peak power output of one kilowatt over a band of 2-4 kmc at duties up to 0.005. The tube has a gain of 30 to 33 db, giving an excess of one kilowatt over most of the band. When two tubes are operated in cascade, the one kilowatt output can be obtained with a drive on only one milliwatt.



### S-BAND BACKWARD WAVE AMPLIFIER

The Hughes type PAS-2 is a narrow-band, voltage-tuned amplifier that is designed for use as an r-f preamplifier stage in contemporary radar communications and other microwave receivers. Features: frequency range 2.4-3.5 kmc, insertion noise figures on order of 4½ db, tube noise figures of less than 5 db, voltage-tuned, crystal protection, spurious input signal elimination, cold isolation greater than 80 db and image rejection.

*For additional information please write: HUGHES PRODUCTS, Electron Tube Division, International Airport Station, Los Angeles 45, California.*

*For export information, write: HUGHES INTERNATIONAL, Culver City, California.*

Creating a new world with ELECTRONICS

**HUGHES PRODUCTS**

© 1959, HUGHES AIRCRAFT COMPANY



# CLEAN ELECTRONIC PARTS CLEANER ULTRASONICALLY!

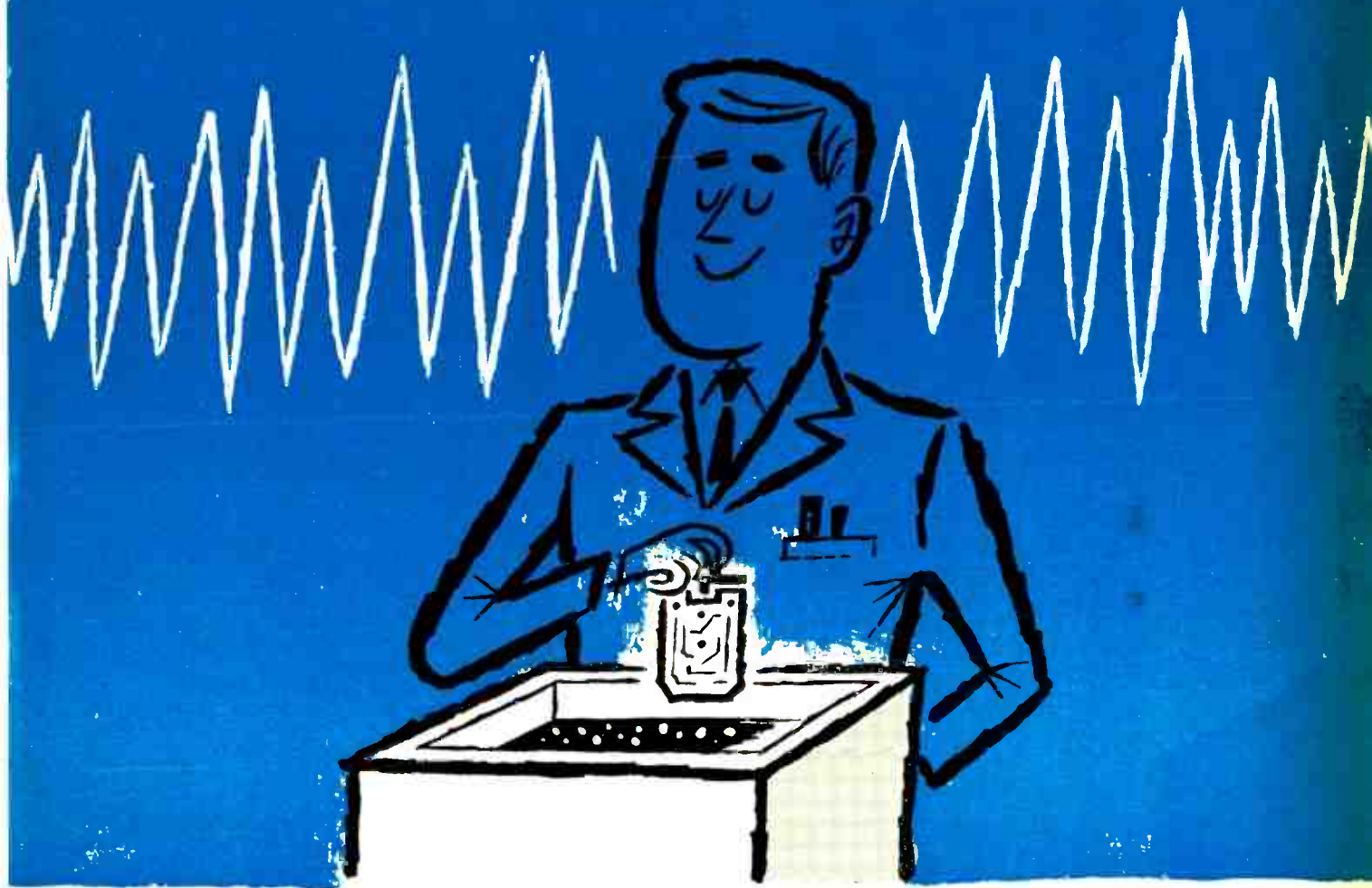

Save labor, save time—*blast* away dirt and dust by the remarkable ultrasonic method that Acoustica has developed to a fine point of efficiency. The hard-to-get-at parts in the most intricate electronic instruments are cleaned as easily as the most exposed parts. The powerful “cavitation” action of an Acoustica ultrasonic tank radiates to the innermost places, removes the most stubborn dirt or dust. Transistors, potentiometers, vacuum tubes, and scores of other products are thoroughly cleaned and decontaminated this modern, efficient way. Many leaders in the electronic industry have changed to Acoustica ultrasonic cleaning!

Acoustica is the recognized leader in quality ultrasonic cleaning equipment, the sole producer of the *Multipower* transducer. An Acoustica *certified* ultrasonic application is your assurance of maximum cleaning efficiency!

Acoustica Associates, Inc., Fairchild Court, Plainview, N. Y., 10402 Aviation Blvd., Los Angeles, Calif.

  
THE GREATEST NAME IN ULTRASONICS



Could this be a picture of you tomorrow? In the fall of 1958, it was Jack Carroll, principal speaker at the opening of Electronic Associates' modern new plant in Long Branch, N. J.

Jack Carroll (*right*) discusses the new equipment he has just seen during a visit with Henri Busignies, President of ITT Laboratories (*center*) and Anthony Pregliese, ITT Public Relations.



# YOU . . .

## *An Editor of a Top Engineering Publication?*

**JACK CARROLL, MANAGING EDITOR OF *ELECTRONICS MAGAZINE*,  
ROSE TO A TOP POST IN LESS THAN TEN YEARS**

### *Are Jack Carroll's shoes your size?*

"If it's scope you want, try keeping on top of everything that's hot in electronics," says John M. Carroll, *ELECTRONICS*' Managing Editor at McGraw-Hill Publishing Company.

A Lehigh B.S. graduate in 1950, Jack has become an industry authority in less than 10 years. "Knowing that the industry itself is looking to your magazine for the word on things is the most stimulating part about it. It's your job to get the thinking of the men behind everything that's new in the field. You work with the top of the profession. What engineer can resist that?"

### *Wrote in College*

In his senior year at Lehigh, Jack got his first real taste of writing as editor of the college newspaper. He joined McGraw-Hill as editorial assistant on *ELECTRONICS* in 1950, took a 17-month "leave" in Korea, then became assistant editor in 1952 and associate editor in '54.

"By then I'd got my M.A. in physics at Hofstra on the McGraw-Hill Tuition Refund Plan, where the company pays half the cost. And since I was promoted to managing editor in 1957, I've been working after hours on my doctorate in engineering science at N.Y.U. This is an engineer's outfit. You grow right along with your industry at McGraw-Hill," says Jack.

"The engineer who chooses a McGraw-Hill career need have no fear of winding up in a corner on one part of one project. You work with the new . . . the experimental . . . the significant. Sitting down with the leaders of your field is part of the job. Your assignment? Interpreting today's advanced thinking for the rest of your field."

### *McGraw-Hill Tuition Refund Plan*

All of our editors have the opportunity to continue their education in their chosen fields under the McGraw-Hill Tuition Refund Plan. Physics, economics, aerodynamics, and business management are typical of the courses they may choose.

### *You May Be The Right Man*

How about writing experience? It helps, but if you like to write—and engineering is your profession—that's the main thing.

Would you like to learn what opportunities McGraw-Hill offers in your field? Write for "Careers in Publishing At McGraw-Hill." Tell us about your background, college record, outside activities and why you seek a career in engineering journalism.

Write to: The Editorial Director, McGraw-Hill Publishing Co., Inc., 330 West 42nd Street, New York 36, New York.



McGraw-Hill Publishing Company, Inc., 330 West 42nd Street, New York 36, N.Y.



## **PAGE COMMUNICATIONS, LEADERS IN WORLD-WIDE TELECOMMUNICATIONS, USES "MOON MESSAGE" TECHNIQUES TO LINK THE FREE WORLD**

Employing advanced techniques similar to those used to reflect the first complete message off the moon, Page Communications Engineers leads in planning and setting up world-wide telecommunications networks. Recently Page linked the NATO Nations. Over the Atlantic and the Pacific, Page engineered the first transoceanic scatter-propagation networks for clear, long-distance transmission. Page works with all the U. S. Armed Forces, serves on the DEW Line and the Pacific Missile Range.

On the African continent, Page combines troposcatter, telephone, teletype and data communications to link Morocco, Spain, and the United Kingdom. In a joint venture, Page is building a national telecommunications and broadcast system for the Kingdom of Libya. Page,

through its affiliate, Edison-Page, is active in Italy. As today's leader in the field, Page Communications continually brings its intercontinental experience to advancing the ever-expanding arts of radio, television, navigational aids, telemetry and wave propagation.

*Challenging opportunities are available  
for qualified engineers.*



**PAGE COMMUNICATIONS  
ENGINEERS**

710 Fourteenth Street, N.W., Washington 5, D. C.  
A Subsidiary of **NORTHROP CORPORATION**

San Francisco · Manila, P. I. · Guam · Honolulu · Tripoli  
Madrid · Edison-Page, S.p.A., Rome, Italy



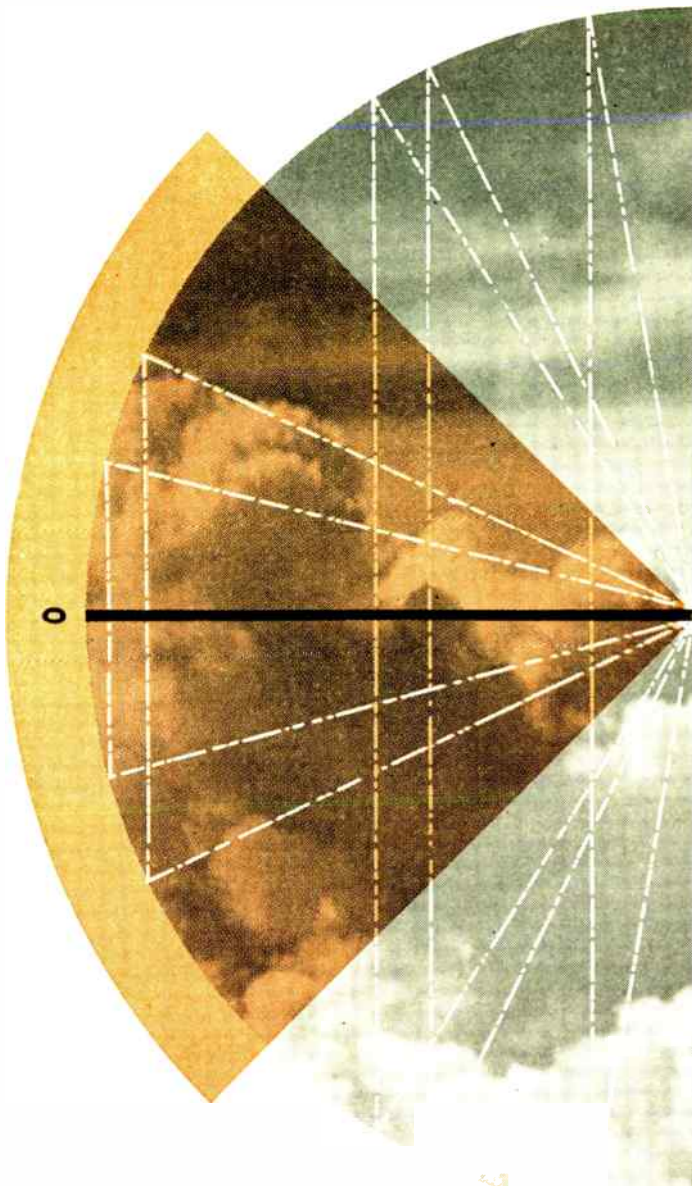

AN AIRBORNE

## THREE PHASE STATIC INVERTER

THAT CAN OPERATE  
INTO VARIABLE  
POWER FACTOR LOADS

Reliability and versatility in a size and weight never before obtainable make Temco Electronic's three phase static inverter extremely able to meet today's critical design needs. This advanced inverter allows unbalanced or variable power factor loading to be introduced while maintaining a symmetrically regulated three phase output. Regulation is achieved through a unique magnetic control circuit. Frequency control is maintained by a solid state oscillator. The inverter will operate dependably under extreme environmental conditions of temperature, vibration and shock.

Unusual capabilities in the application of circuitry and packaging give Temco unequalled ability to design and fabricate inverters to meet special requirements. Contact Temco for additional information.

**TEMCO**

**ELECTRONICS**

A Division of TEMCO AIRCRAFT CORPORATION • P. O. BOX 6191 • DALLAS 22, TEXAS

Many excellent engineering and scientific positions are now open in this and other Temco programs. We invite your inquiry.

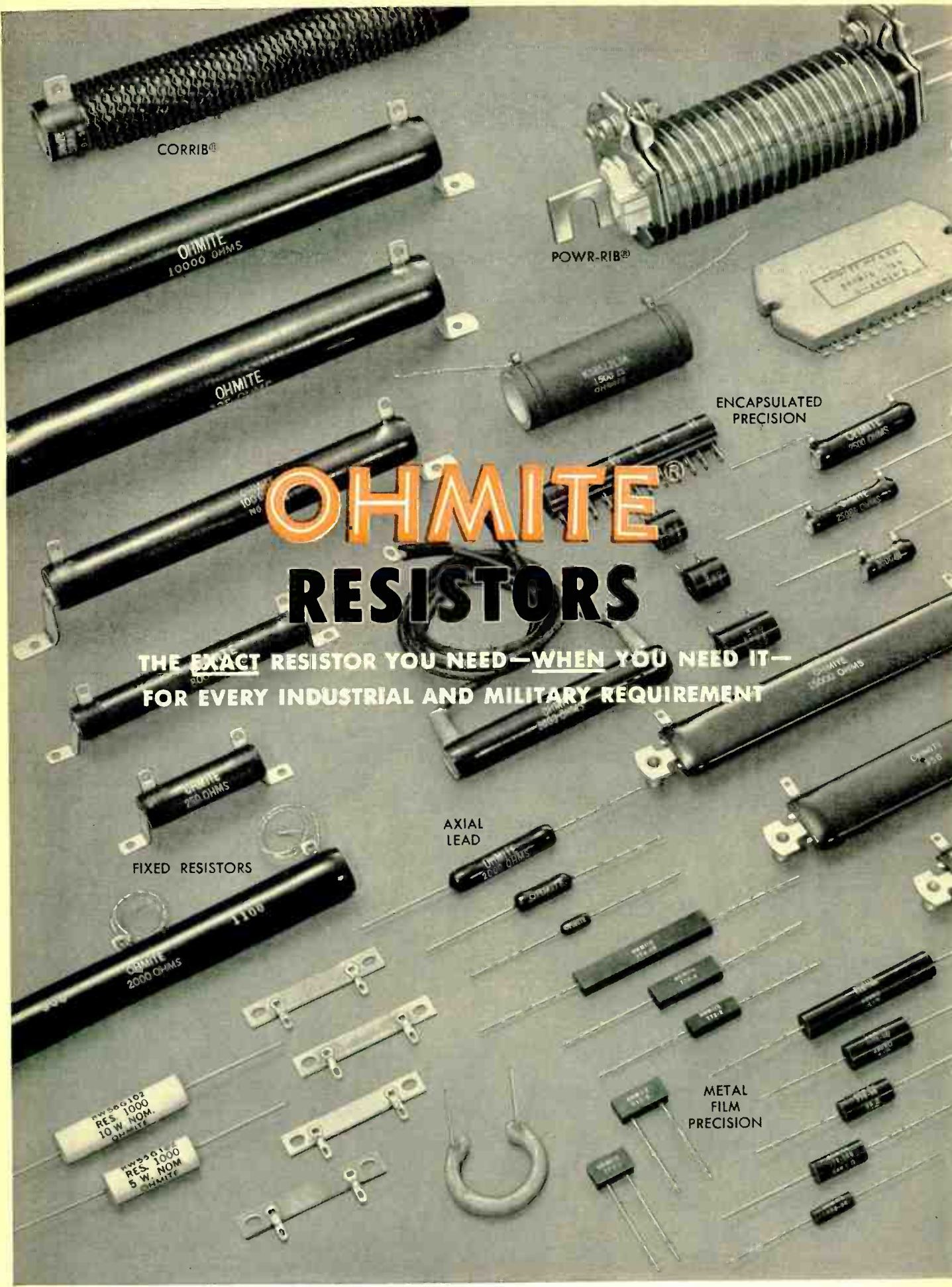

CORRIB®

OHMITE  
10000 OHMS

OHMITE

POWR-RIB®

ENCAPSULATED  
PRECISION

# OHMITE RESISTORS

THE EXACT RESISTOR YOU NEED — WHEN YOU NEED IT —  
FOR EVERY INDUSTRIAL AND MILITARY REQUIREMENT

FIXED RESISTORS

AXIAL  
LEAD

METAL  
FILM  
PRECISION

RW560102  
RES 1000  
10 W. NOM.  
OHMITE

RW5501  
RES 1000  
5 W. NOM.  
OHMITE



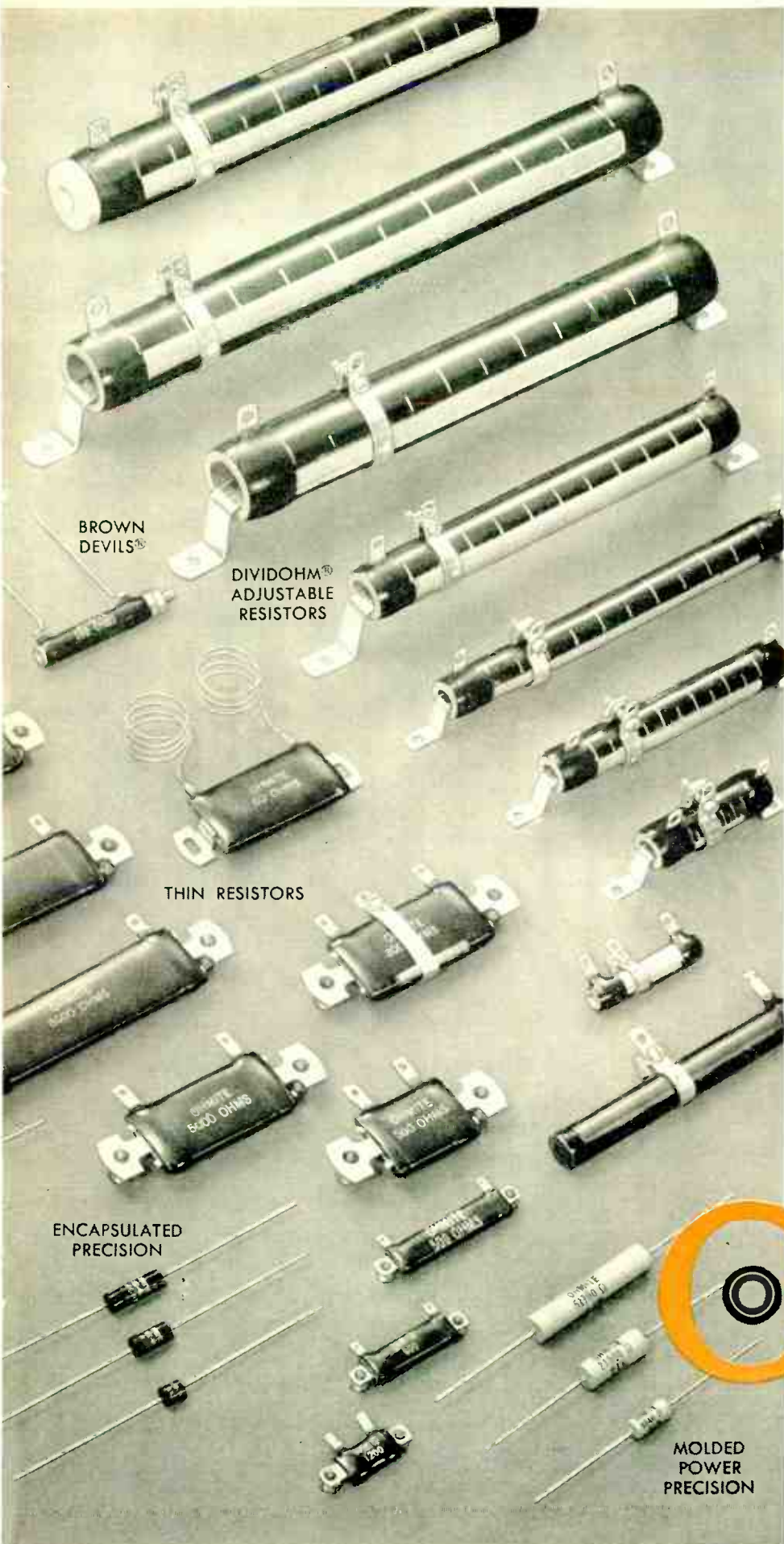

BROWN DEVILS<sup>®</sup>

DIVIDOHM<sup>®</sup> ADJUSTABLE RESISTORS

THIN RESISTORS

ENCAPSULATED PRECISION

MOLDED POWER PRECISION

Fixed . . . adjustable . . . tapped . . . noninductive . . . precision metal film and encapsulated wire-wound . . . thin type . . . high-current—practically anything you need, whether it be for commercial or military equipment, you can find in the Ohmite line. It's the most comprehensive, most complete selection available to resistor users.

**W**ORLD'S LARGEST STOCK FOR IMMEDIATE DELIVERY—You don't have to assume that the resistor you need is special. Chances are Ohmite's huge stock of several million resistors in more than 2000 sizes and types contains a unit that fits your requirements. Many types of Ohmite resistors are also available from stock, locally, through hundreds of Electronic Parts Distributors located across the Nation.

If, however, you do need special resistors, Ohmite can make them promptly to your exact needs—including a *complete line of units that meet military specification MIL-R-26.*

**Y**OUR CUSTOMERS KNOW THE VALUE OF OHMITE QUALITY—When a purchaser sees Ohmite resistors in a piece of equipment, he knows that equipment is designed and built for dependability. He knows about the quality features found in Ohmite resistors—features such as balanced thermal expansion of all parts in vitreous-enameled power resistors, plus all-welded construction. He knows there are no thin spots in the coating, no cracks or crazing to let moisture in. He also knows of the exhaustive tests behind Ohmite units which are coated with silicone-ceramic, epoxy resin, and other materials.

**O**HMITE ENGINEERING ASSISTANCE ASSURES THE RIGHT UNIT—Selecting the right resistor for the job is sometimes a tough proposition. Why not call on Ohmite application engineers to help out. Take advantage of their specialized skills and background. You'll get the exact resistor you need and in a lot less time. Contact them today.

*Write on Company Letterhead for Catalog and Engineering Manual 58*



**Quality Components**

**OHMITE MANUFACTURING COMPANY**  
3610 Howard Street, Skokie, Illinois

- BILESTATS RESISTORS RELAYS
- TAP SWITCHES E.F. CHOSES
- VARIABLE TRANSFORMERS
- TANTALUM CAPACITORS
- GERMANIUM DIODES

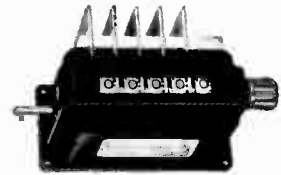

**by the  
numbers!**

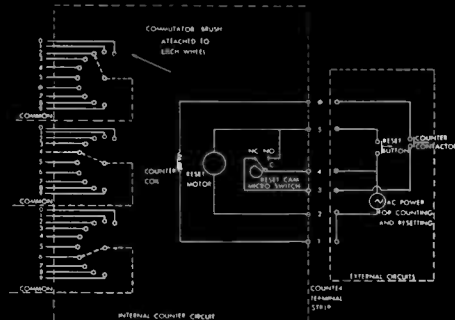
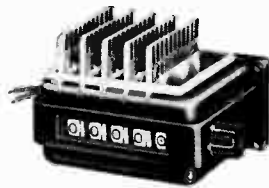

**How these counters work:** Data Readout Counters are actuated mechanically by rotation of a shaft or electrically by making and breaking a circuit. Each wheel has a printed circuit, with a contact for each digit. Remote Data Readout Counters are available with manual or electrical reset, and for base or panel mounting. Standard Models are available from stock.

## Remote Readout Counters Simplify Automatic Data Processing

Now . . . Veeder-Root Remote Data Readout Counters can provide a low-cost method of collecting and feeding important information . . . by transmitting counter readings electrically.

Counter readings can be fed directly onto a punched card or tape, and into adding machines or any other data handling devices. The counter can actuate alarms or control machines to predetermined settings. And they can be arranged for automatic reset and recycling. External circuits can be designed to transmit totals in binary code, international code or in digital form.

Remote Data Readout gives you many unusual opportunities to put *Control* to work. Automatic processing

of machine production, and shaft rotation, remote digital readout, centralized control, simplified automation, and printing and computing applications are just some of the intriguing possibilities available with remote data readout.

Send for **Veeder-Root Technical Information** . . . Complete specifications on Remote Data Readout Counters will be sent at once; and application assistance is available if desired.

**Veeder-Root inc.**

HARTFORD 2, CONNECTICUT

*"The Name that Counts"*

Hartford, Conn. • Greenville, S. C. • Altoona, Pa. • Chicago  
New York • Los Angeles • San Francisco • Seattle • St. Louis • Montreal  
Offices and Agents in Principal Cities

VR9-57



# Electron Tube News

## —from SYLVANIA

New designs to meet new demands — everywhere in electronics

### LOW HEATER POWER CATHODE-RAY TUBES...



Low Heater Power CRT's use 1.5 v supply compared to 6.3 v for ordinary tubes

**New 1.5 volt, 140 ma heater for CRT's under development at Sylvania will add new portability to oscilloscopes, radar and TV**

Another revolutionary advance in cathode-ray tube design is now in final stages of experimental development at Sylvania's Industrial & Military Cathode-Ray Tube Department—Low heater power CRT's. The new 1.5 volt, 140 ma heater design requires less than 1/16 the power of ordinary CRT's—or less than ¼ watt compared to 4 watts. This not only means highly significant reductions in power supply requirements with the 210 mw heater but significant reductions in cool-

ing requirements. As a result, new design approaches will be opened for portable oscilloscopes, portable radar, portable transistorized TV, missiles and any other application where minimum power supply weight and size are important considerations.

Your Sylvania equipment sales representative will be glad to discuss specific applications and sample availability with you.

### CLOVERLEAF CATHODE ASSEMBLY DESIGN...

**"Cloverleaf" ceramic cathode assembly design, now available in all new Sylvania picture tubes, assures faster warm-up time throughout tube life**

Already proved in hundreds of thousands of picture tubes is the Sylvania Cloverleaf cathode assembly. Its unique ceramic Cloverleaf configuration greatly reduces heat conduction losses and nearly doubles TV warm-up

speed by reducing cathode-ceramic disc contact area. This not only increases assembly ruggedness but contributes to the overall efficiency of the tube.

Sylvania Cloverleaf is now available in all new TV picture tubes ranging from 110° 300 ma types to 72° 600 ma types as well as some industrial and military cathode-ray tubes. Contact your Sylvania representative for the full story on Sylvania Cloverleaf.

### INDUSTRIAL & MILITARY CATHODE-RAY TUBES...

Today, Sylvania's Industrial and Military Cathode-Ray Tube department is producing over 150 tube types to meet the specialized needs of the growing industrial and military market. Here are the latest additions to this expanding line:

**Type 4MP—series**—This four-inch square face CRT is designed for use in oscilloscopes and other display devices where space considerations are important. It fea-

tures electrostatic focus and deflection as well as post deflection acceleration. Its deflection plate leads are sealed through the neck . . . a design which assures low capacity and inductance.

**Type 5BCP—series**—This five-inch round oscilloscope tube is designed with a 7/8-inch neck diameter that can more effectively utilize low deflection power. It features magnetic focus and deflection.

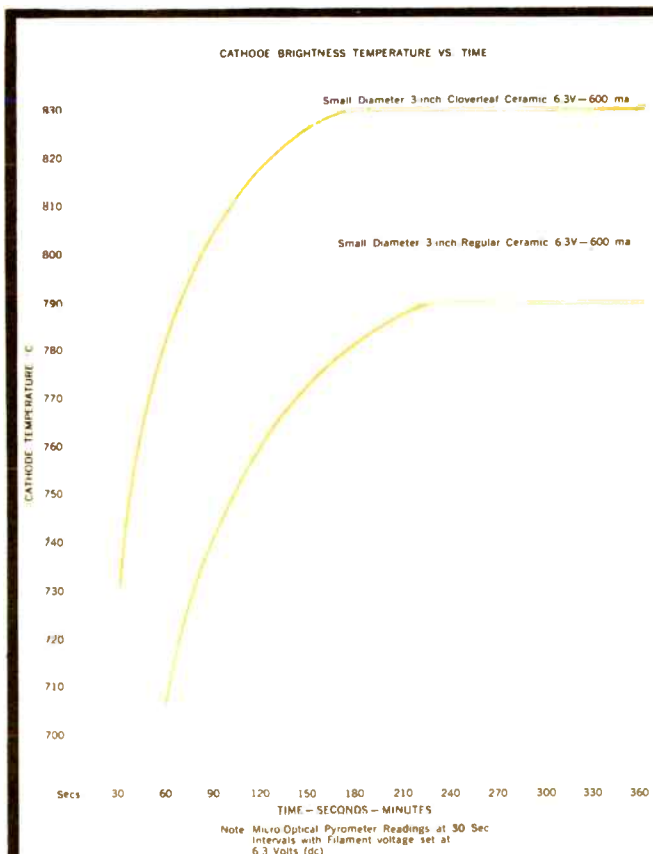

Faster picture tube warm-up time of the Sylvania Cloverleaf Cathode assembly shows up in this comparison of it with a conventional cathode assembly

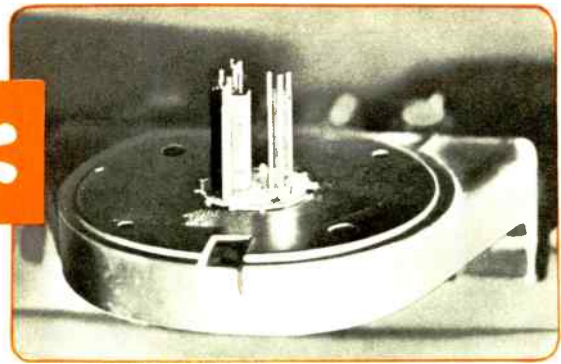

**THIS IS AUTO-MOUNT...**

## **HEART OF SYLVANIA AUTOMATION**

Now in operation in Sylvania tube plants throughout the U.S. is this intricate maze of engineering ingenuity called Auto-Mount. Designed and developed by Sylvania engineers, it automatically assembles delicate tube elements with a precision and efficiency unattainable by human hands. It represents one of the greatest single contributions to uniformity in mass-produced electron tubes ever developed.

Auto-Mount first prepunches each mica spacer with specially designed dies that achieve greater precision and exactness than heretofore possible. At the same time, it automatically checks mica thickness and rejects those not meeting its tight tolerances. This new degree of mica control not only means greater spacing precision of tube elements but tighter fit in the mica spacer. The result is less micro, reduced noise, better heat dissipation and greater overall tube efficiency.

Next, Auto-Mount delicately feeds famous Sylvania cathodes to each moving jig assembly and precisely inserts them into proper position. Then, as the assembly moves through each station, grids, plates, and finally the top mica are automatically inserted and assembled. It performs tab bending operations with exact uniformity, resulting in a tighter mount and reduced micro. Each mount undergoes multiple visual and microscopic inspections to assure quality. Any mount that does not meet Auto-Mount's stringent standards is automatically rejected.

Not only does Auto-Mount contribute to better tube performance by eliminating human errors, damage and inaccuracies, but because it requires elements of closer dimension tolerances than hand mounting, the mount it produces is inherently more uniform and rugged. This means less micro, better cutoff, less heater-cathode leakage and more uniform characteristics from tube to tube.

The end result is a new degree of performance perfection from Sylvania receiving tubes unmatched by any other mass-produced electron tube. Contact your Sylvania representative today for complete information on Sylvania Auto-Mount receiving tubes.

 **SYLVANIA**   
Subsidiary of  
**GENERAL TELEPHONE & ELECTRONICS**



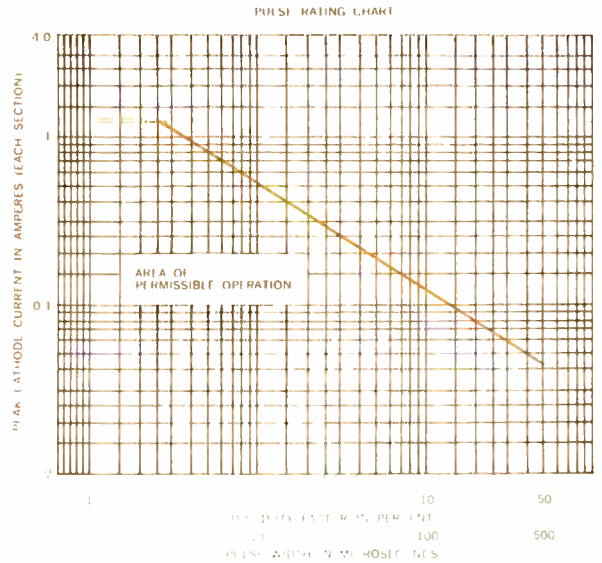
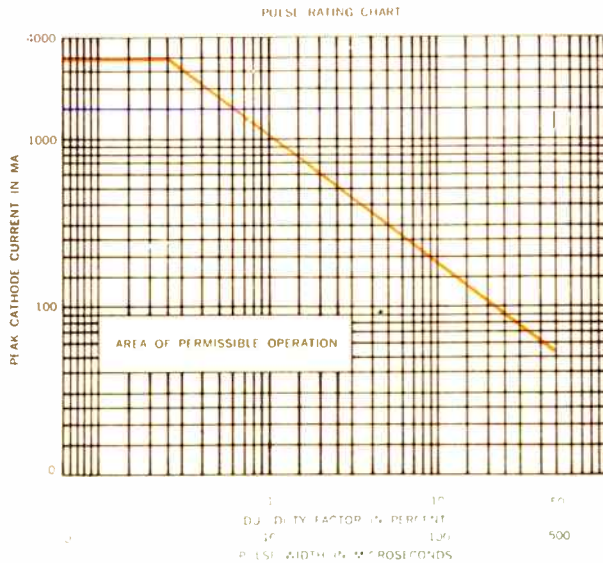

Pulse Rating Charts, exclusive with new Sylvania Pulse Types, show the high current capabilities of the new tubes

## PULSE TUBES...

Sylvania develops industry's first sub-miniature Pulse Tubes specifically designed for pulse amplifier and BTO circuits

Now the design engineer can select sub-miniature tube types specifically designed for pulse applications. Sylvania is developing a line of pulse types rated to deliver high pulse current with reliability, compactness and accuracy. No longer is it necessary to use tubes designed for other purposes that are not rated to consistently meet pulse requirements. With the new Sylvania types, higher pulse current is assured and each is supplied with a pulse rating chart. This not only makes the design problem much simpler but means better end equipment performance.

Two new pulse types GB-7327 and GB-7550 are already in full production at Sylvania with more on the way:

**TYPE GB-7327**—This new subminiature (T-3 bulb) medium mu double triode is specifically designed and processed for pulse applications.



It features low vibrational noise and excellent performance under rugged environmental conditions. It is a direct replacement for types 6111 and 6021 and with some modification can replace any double triode. The tube, as its GB prefix indicates, is specifically designed to meet commercial and industrial application requirements. In addition, it is the first tube made by Sylvania that employs both the AQL and new Sylvania ADL quality systems. This means extra assurance that every Sylvania pulse tube will meet customer specifications effectively.

**TYPE GB-7550**—This is Sylvania's newest pulse type, a subminiature (T-3 bulb) double triode with a higher cathode pulse current. It can easily replace types 6111 and 6021. With varying degrees of modi-

fication, it can be used in place of any double triode. It features a larger cathode for additional current capabilities and new grid radiators for more effective dissipation. It too is a Sylvania GB type made to meet the specific requirements of industrial and commercial applications. It also incorporates both the AQL and new Sylvania ADL quality standards.

Both new Sylvania pulse types, GB-7327 and GB-7550, may be used in pulse amplifier or BTO circuits. This opens applica-

tions in areas such as: Aerial Navigation Equipment (Pulse radar and missiles) Sylvania is continuing to develop additional pulse tube types to meet increasing industry demand for accurate, dependable high-current pulses. Check with your Sylvania representative or contact the factory directly for latest information on Sylvania GB Pulse Tubes.



### New Sylvania Pulse Types GB-7327 and GB-7550

#### Characteristics

##### DIRECT INTERELECTRODE CAPACITANCES (Unshielded)

Grid to Plate  
Input: g to (h+k)  
Output: p to (h+k)  
Section No. 1  
Section No. 2

Grid to Grid  
Plate to Plate  
RATINGS (Absolute Maximum Values)  
Heater Voltage 3  
DC Plate Voltage  
Instantaneous Forward Plate Voltage  
Plate Dissipation (Each Plate)  
Grid Dissipation (Each Plate)

##### CHARACTERISTICS RANGES (Each Section)

Pulse Cathode Current:  
Ef=6.3 V; Eb=300 Vdc; Ec=-25 Vdc;  
egk=+50 v at tp=10 usec; prr=1000 pps;  
tr=0.8 usec Max.; tf=1.0 usec Max.

#### GB-7327

1.5 uuf  
1.9 uuf  
  
0.28 uuf  
0.32 uuf  
0.011 uuf Max.  
0.50 uuf Max.

6.3 ± 5% V  
300 Vdc  
400 V  
0.95 W  
0.2 W

700 mA Min.

#### GB-7550

4.0 uuf  
4.0 uuf  
  
0.24 uuf  
0.28 uuf  
0.16 uuf Max.  
1.2 uuf Max.

6.3 ± 5% V  
300 Vdc  
400 V  
2.0 W  
3.6 W (Both Plates)  
0.4 W (Each Grid)

1400 ma Min.  
Ef=6.3 V; Eb=300 Vdc;  
Ec= -30 Vdc; Instantaneous  
Voltage Between Grid and  
Cathode (Smoothed Peak)=  
+40 v at tp=10 usec;  
prr=0.8 usec Max.;  
tf=1.0 usec Max.

Postage  
Will be Paid  
by  
Addressee

No  
Postage Stamp  
Necessary  
If Mailed in the  
United States

## BUSINESS REPLY CARD

First Class Permit No. 2833 Sec. 34.9 P.L.&R., Buffalo 9, N.Y.

SYLVANIA ELECTRIC PRODUCTS INC.

1100 Main St.

Buffalo 9, N. Y.

World Radio History

# STRAP-FRAME CONSTRUCTION...

Sylvania introduces the strap-frame grid design in a new tetrode type 6ER5, designed as a VHF amplifier for TV tuners

Complementing the Framelok Grid design for power applications is the Sylvania strap-frame grid development for high frequency tuner type applications. First Sylvania tube incorporating strap-frame grid construction in a T-3 envelope is type 6ER5. It is a semi-remote cutoff tetrode designed as a VHF amplifier for TV tuners. It features high transconductance, high input impedance, low intermodulation distortion and dual cathode pins. Grid No. 2 functions as a shield to reduce grid to plate capacitance.

The strap frame, as its name implies, gives new extra support to grid side rods. Not only

does this make a more rugged, accurately aligned grid possible, but since the grid laterals themselves do not support the rods, finer grid wire with greater TPI (turns per inch) can be used. The end result is higher gm, better dissipation and overall more efficient performance.

### RATINGS (Design Center Values)

Supply Voltage	550 Volts
Plate Voltage	250 Volts Max.
Grid No. 2 Voltage	100 Volts
Plate Dissipation	2.2 Watts Max.
Grid No. 2 Dissipation	0.5 Watts
Cathode Current	20 Ma Max.
Negative Grid Voltage	50 Volts Max.
Grid Circuit Resistance	
Cathode Bias	1.0 Megohm Max.



Sylvania's new Strap-Frame high frequency tuner type, 6ER5. Strap-Frame grid construction permits use of finer grid wire for more TPI

## VIDEO...

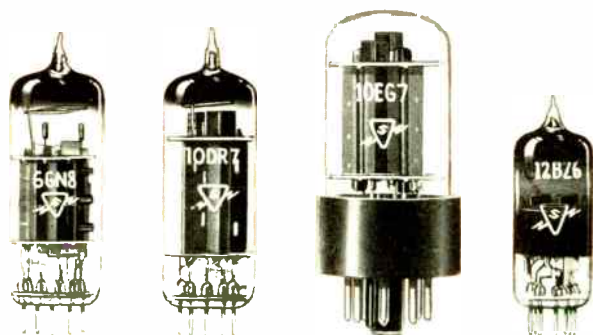

Subsidiary of  
**GENERAL TELEPHONE & ELECTRONICS**

SYLVANIA ELECTRIC PRODUCTS INC.  
1740 Broadway, New York 19, N. Y.  
In Canada: Sylvania Electric (Canada) Ltd.  
P. O. Box 1190, Station "O," Montreal 9

Please send additional information on the items checked below:

- Industrial & Military Cathode Ray Tubes
- Type 4MP—series
  - Type 5BCP—series
- New Sylvania Pulse Tubes:
- Type 7327
  - Type 7550
- New Strap-frame Grid Tube
- Type 6ER5
- New entertainment receiving tubes
- Type 6GN8
  - Type 10DR7
  - Type 10EG7
  - Special tube designs for particular applications
  - Type 8GN8
  - Type 12BZ6

Name \_\_\_\_\_  
Address \_\_\_\_\_  
Company \_\_\_\_\_  
Code 4Q59

### Five new types from Sylvania for TV service

**TYPES 6GN8 AND 8GN8**—Both of these new types incorporate a high mu triode and a sharp cutoff pentode in one T 6½ envelope. The triode section is designed for voltage amplifier or sync separator service. The pentode section, designed for video amplifier service, features a controlled knee characteristic.

**TYPE 10DR7**—Double triode in a T 6½ envelope with a high mu section for vertical deflection oscillator use, and a low mu section for use as a vertical deflection amplifier.

**TYPE 10EG7**—T9 double triode for series string TV with a medium mu section designed for vertical deflection oscillator use and a low mu section for vertical deflection amplifier use.

**TYPE 12BZ6**—T 5½ semi-remote cutoff pentode for use as an automatic gain controlled amplifier.



Use this handy business reply card to request additional information on these important new Sylvania developments



**NEW**

**4 MILLIMICROSECOND  
SILICON MESA DIODE**

**PUTS YOUR  
COMPUTER CIRCUITS  
A YEAR AHEAD!**



**UNIFORMLY FAST  $t_{rr} = 4 \mu s$  MAXIMUM ALL TYPES**

A newly developed silicon mesa diode gives millimicrosecond recovery time (*in normal, forward switching*) with high breakdown voltage. These characteristics can be the solution to many of last year's, this year's, — and next year's computer circuit problems.

The six diodes in the table below are in current production and available. Contact our sales department for immediate quotations.

TYPE	Peak Reverse Voltage		Capacitance (@ —6 Volts)	Forward Voltage Drop @ 25°C and 10 mA
	@ 25°C & 1.0 $\mu A$	@ 100°C & 10 $\mu A$		
4226	20 Volts	20 Volts	1.0 $\mu f$	1.1 Volts
4223	30 Volts	30 Volts	1.0 $\mu f$	1.0 Volt
4222	40 Volts	40 Volts	1.0 $\mu f$	1.0 Volt
4227	20 Volts	20 Volts	2.5 $\mu f$	1.0 Volt
4228	30 Volts	30 Volts	2.5 $\mu f$	1.0 Volt
4229	40 Volts	40 Volts	2.5 $\mu f$	1.0 Volt



**MICROWAVE ASSOCIATES, INC.**  
BURLINGTON, MASSACHUSETTS • BRowing 2-3000

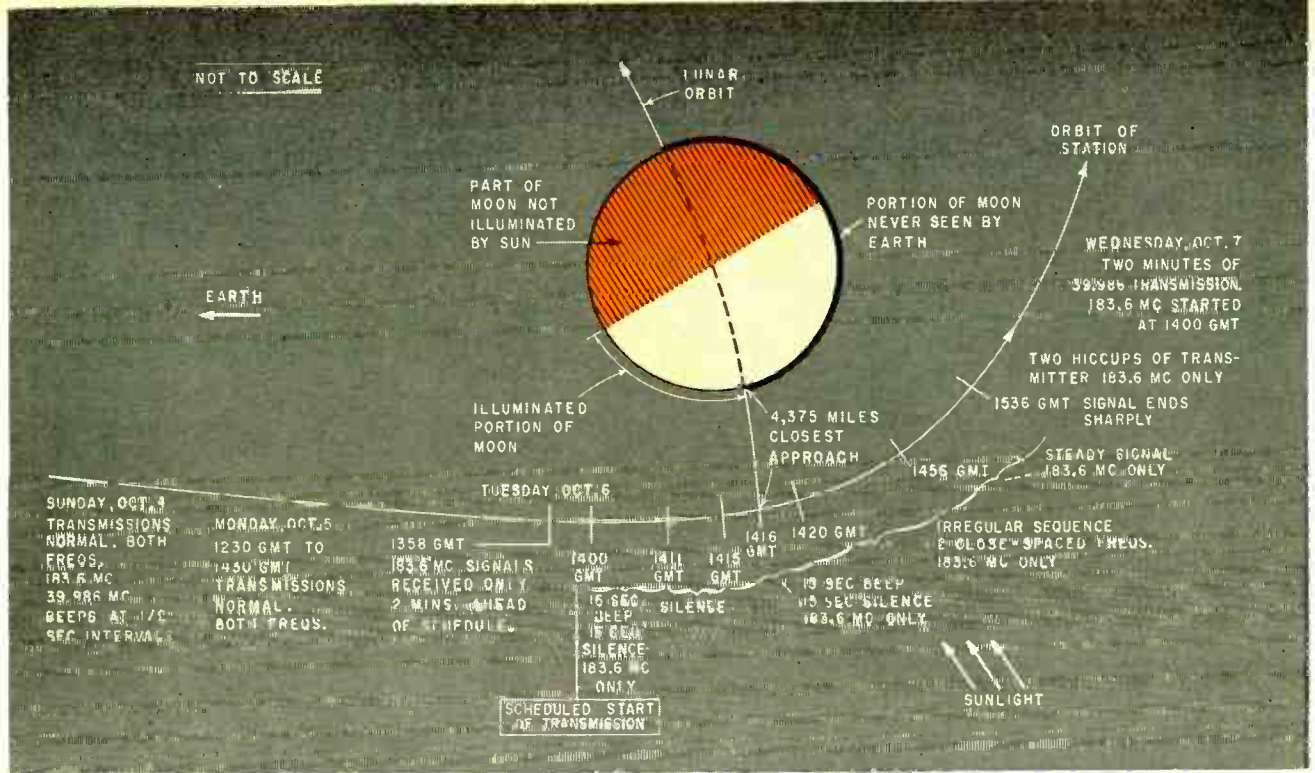

# Did Lunik Drop Moon Package?

Early lunik data suggests possibility of an instrument drop on moon, with orbiting "interplanetary station" acting as a relay to earth

MOON STATION fired into orbit around the moon and earth by the Soviets Oct. 4 appears to be one step in a Russian effort that points towards exploring the planets.

That the moon satellite could be an orbiting station that relays data to earth from an instrument pack dropped on the far side of the moon was a possibility raised by study of information available as ELECTRONICS went to press.

## Soviets Holding Facts?

A whole week after launching, information from Moscow was much more general and incomplete than after previous space feats. But information from McGraw-Hill's Moscow and London bureaus, plus previous technical articles and statements by Soviet scientists suggests a "kicker" to the latest lunar shot.

Conceivably, the Soviets were holding back release of detailed information about the orbiting of the moon pending scientific verification of the complete space experiment.

This would involve study of data already telemetered, or might even require a second pass around the far side of the moon. The latter would mean a 54-day wait until Nov. 28.

Instruments on the "cosmic rocket" were listed as "scientific and radiotechnical equipment."

An instrument package called an "automatic interplanetary station" weighs 612 lb. After the specially designed third stage scientific rocket escaped the earth's atmosphere in a lunar trajectory, the "interplanetary station" was disengaged. The whole rocket weighed 3,416.6 lb and carried 344 lb of its own measuring instruments and power sources.

"We hope," said Soviet scientist A. Shternfeld, "that in time it will be possible to regulate its orbit so that the station periodically will arrive over the unseen side of the moon."

Orbiting station is being interrogated from an undisclosed coordinating-computer center in the USSR and was expected to trans-

mit information in two to four hour sessions over two frequencies—183.6 and 39.986 mc.

## 'Functioning Normally'

The station's orbit is controlled simultaneously on one of the two frequencies used for transmitting information from the station (believed to be 183.6 mc). Equipment on the station is powered by solar and chemical batteries.

Preliminary analysis of data indicated that temperature inside the station was being maintained at 25 to 30 C. and pressure about 1,000 millimeters. Instruments and batteries were said to be "functioning normally."

However, early Soviet data raised some big question:

What happened to the 344 lb of instruments and power supply the Soviets said were carried by the third-stage rocket in addition to the 612-lb orbiting station?

If there were only two transmitting frequencies used and they both emanate from the orbiting station,



why would the third stage carry an instrument and power pack?

Prof. G. V. Petrovich, writing of Soviet space plans in a technical journal last March, said moon study would be expanded by "depositing on its surface scientific equipment with telemetric and television apparatus, and radio stations for communication with the earth and transmission of scientific observations."

### Behavior of Signals

Jodrell Bank Observatory tracked the Soviet space signals for four days with space and time coordinates cabled by the Soviets. For two days transmissions on both 183.6 and 39.986 mc were normal. On the third day, when the rocket was nearest the moon, strange things began to happen:

No transmission was received on 39.986. Strong signals on 183.6 were received two minutes ahead of schedule and were characterized by a sequence not previously used by the Russians, consisting of 15-second signals spaced 15 seconds apart on the carrier wave. After 20 minutes the transmission changed to irregular sequences on two very closely spaced frequencies, lasting about 36 minutes. Then a steady signal resumed and lasted about 40 minutes until transmission ended. Two "hiccups" were heard later.

A four-minute silence earlier led scientists to speculate that a partial eclipse may have occurred.

On the fourth day Jodrell Bank picked up 183.6 normally but received 39.986 for only two minutes, one hour after transmission on the first frequency began. By the fifth day, Jodrell Bank scientists were unable to offer ELECTRONICS any useful interpretation of the character of transmissions on either frequency, and reported they were no longer tracking the signals.

### Package Dropped?

From the information plotted in the drawing it is apparent that the signals behaved erratically as their source approached the moon on the third day. The orbiting satellite had already separated from the third-stage rocket, which followed it, according to the Soviets. It is therefore conceivable that the erratic signals emanated when a moon package was being dropped.

# AIRPAX

## MAGNETIC AMPLIFIERS

60 CPS

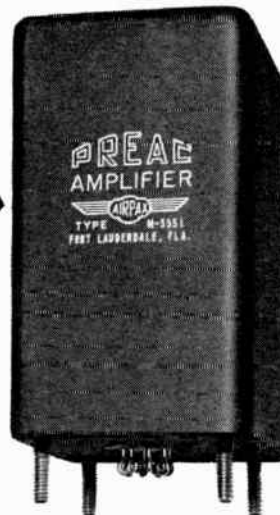

PREAC®

Fifty db power gain and full linear output with but milli-microwatt input power are inherent characteristics of the PREAC magnetic amplifier. Thermocouples, strain gauges, pressure transducers or high impedance sources may supply the input signal. Null drifts are as low as 1.0 micro-microwatt. Other applications include null and error detection, integration and summing, and use in sensitive micro-voltmeter and micro-ammeter circuits.

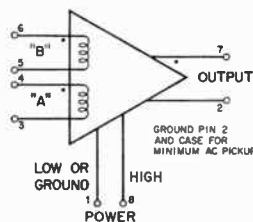

ELECTRICAL CONNECTIONS

TRANSFER CHARACTERISTICS

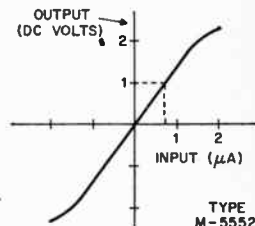

### SPECIFICATIONS FOR 60 CPS PREAC AMPLIFIERS

TYPE	DC Microamperes Input for 1 DC Volt Output, 5K Load		Control Winding Resistance—Ohms		Bandwidth—CPS, with Tabulated Input Loop Resistance	
	Winding A	Winding B	Winding B	Winding A	Winding A	Winding B
M-5549	4.8	7.4	188	65	0.26 CPS/0.1K	0.6 CPS/0.1K
M-5550	1.2	7.4	188	980	0.32 CPS/2K	0.6 CPS/0.1K
M-5551	2.4	2.4	490	490	0.5 CPS/1K	0.5 CPS/1K
M-5552	0.7	7.4	310	2600	0.13 CPS/3K	0.6 CPS/0.1K

AIRPAX also produces a complete line of 400 CPS PREAC magnetic amplifiers.



SM33

SEMINOLE DIVISION

FORT LAUDERDALE, FLA

# DIFFUSED SILICON TRANSISTORS

## A report on mesa transistors at Fairchild

**What** do they mean to the circuit designer working on next year's transistorized equipment? The superior speed-power combination attainable with this new type of transistor has caused virtually every semiconductor manufacturer to give them top R & D priority. Meanwhile Fairchild has been producing diffused silicon transistors in quantity for over a year and can answer the important questions.

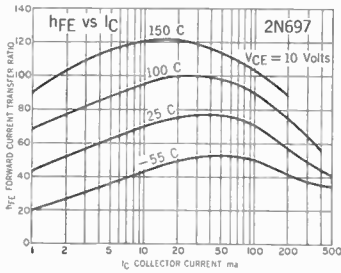

**Are they replacing existing types?** Some customers have replaced four to five types with one Fairchild type. This is readily possible because the diffused silicon transistor retains its high performance characteristics over a wide spread of collector current and operating frequency. Graph shows, for example, the range of useful current gain in the Fairchild 2N697. A few such diffused silicon devices could cover the entire range served by present transistors, and complementary NPN and PNP devices are feasible.

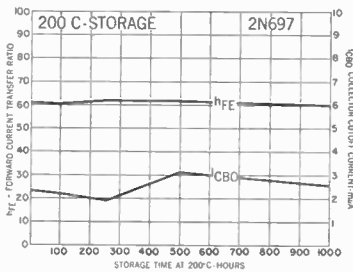

**Are they reliable?** Reliability is one of their top advantages. A 60-hour pre-aging of all units at 300° C accomplishes a stabilization equal to thousands of operating hours at 200° C. At the 200° C temperature, parameters are relatively unaffected by extended storage as shown on the graph. Also, mesa construction eliminates suspended masses, hence Fairchild units have survived mechanical shocks as high as 20,000 g. Customers' tests have consistently proven these transistors more reliable than any other type.

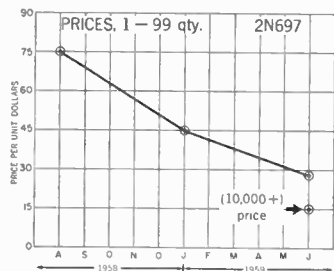

**Are they economically practical?** Prices were reduced by over 60% in just nine months after they were first introduced, making them competitive with lower performance units of other types. But most important for the future: the diffusion process is inherently controllable, hence well suited to automated production. The result: far better and more versatile devices at a price equal to or lower than prices on today's predominant types of transistors.

**Are they being accepted by users?** In less than one year after announcing the diffused silicon mesa transistor, Fairchild opened a new manufacturing plant approximately six times larger than the company's original facility. This was in response to demand. And already additional expansion is being planned.

*May we keep you up to date on further developments? Write Dept. A-10-23*

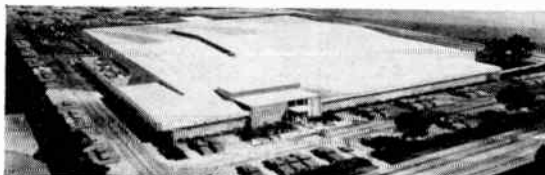

545 WHISMAN ROAD • MOUNTAIN VIEW, CALIFORNIA • YORKSHIRE 8-8161



**NEW**  
**DEVICE TO SOLVE**  
**ULTRA-CRITICAL**  
**CONTROL-BY-LIGHT**  
**APPLICATIONS**

**FOR MAXIMUM**  
**LIGHT SENSITIVITY**  
**IN A**  
**MINIMUM SIZE**

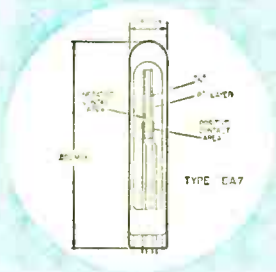

Hoffman's newly developed line of especially designed "silicon" photo-voltaic units provide maximum light sensitivity in a minimum size. Provided in a large variety of shapes, segmentations, configurations and encapsulations, the "Detector Cell Capsules" provide greatest possible design flexibility.

Wide number of ideal applications for these units include: computers (punched card and tape read-outs), detector instrumentation, programming controls, infrared sensors, counting devices, remote switching systems, and automatic "triggering" equipment.

This sub-miniature, hermetically sealed device has a storage temperature range of from  $-65^{\circ}\text{C}$  to  $+175^{\circ}\text{C}$ ; response time of 20 microseconds; illumination level required 1250 ft. candles (tungsten light @  $2800^{\circ}\text{K}$ ); peak spectral response of 8500 angstroms.

For design consultation and information, contact your nearest Hoffman semiconductor representative.

One of the series of new "dedication" products being manufactured in Hoffman's new El Monte, California plant.



**CORPORATION**  
**SEMICONDUCTOR DIVISION**  
 Plants in El Monte, California and Evanston, Ill.

# COMPUTER TAPE?

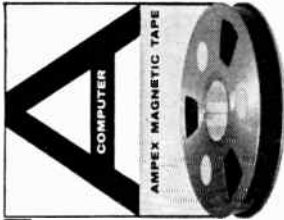

*AMPEX C-1...no other tape that lasts as long performs so well*

## Noises From Outer

What are we hearing through the electromagnetic window to the cosmos? Here's the story

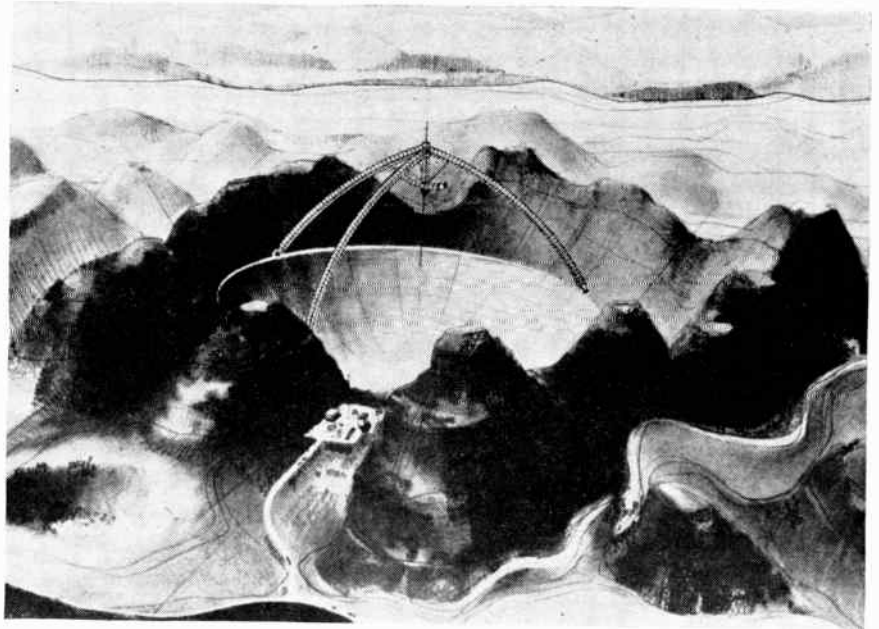

USAF's 1,000-ft antenna in Puerto Rico will bring in stronger, more distant noises

THE DEFENSE DEPARTMENT'S increasing interest in electromagnetic noises from outer space brings up a thought-provoking question: Why?

Radio and radar telescopes are springing up in increasing numbers and multiplying in size. Most of these installations are being paid for by Defense.

What are these devices listening to and what are they sending out?

Logically, due to the capabilities of such equipment, electronic counter—and counter-counter—measures play a part in the program. Just how much is a tight military secret.

### **What's Possible**

Several possibilities are common sense:

Sensitive ears can pick up much intelligence from enemy missile experiments, satellites and outer space probes. In relation to anti-missile defense, strong transmitters might distinguish between enemy warheads and decoys. Radar telescopes can detect silent celestial wanderers from pulses bounced off their ionized trails. A strong beam might jam instructions to vehicles as well

as provide them with capricious commands.

A reconnaissance satellite could be made to dump its findings over our territory before it got home, waste its batteries in the wrong place, and in other ways render it useless to an aggressor. Orbiting satellites—guidable by retrorockets triggered off by radio command—could be sent off in the wrong direction or brought down for first hand investigation.

Much of the work the military and universities are doing is basic research. Radio frequency charts of the celestial vault are being compiled in many countries. A number of U. S. companies are working on radiometric sextants for ship and submarine navigation. Studies are being made on the behavior of electromagnetic transmission in space, through the ionosphere, and in the polar regions.

Other communication techniques involve using as passive relay stations, orbiting 100-ft inflatable balloons such as NASA's Project Echo, meteoritic swarms, and the moon. Ways are being sought to predict electromagnetic storms, and



# Space

how to prevent natural "jamming" of weapon systems by cosmic noise.

## Facing Problems

Many problems face the design engineers in creating devices to accomplish these objectives. Making maneuverable a vertical dish the height of two football fields is one of them. Another headache is maintaining the figure of the surface of a big dish at its various positions. Deflection of one portion of the surface throws the frequency out of phase. This is particularly important for the high frequencies that will be used in space communication.

Considerable thought is going into possible use of a spherical mirror in place of a paraboloid. The latter has just one axis of symmetry whereas a sphere has an infinite number. Disadvantage to a sphere is that it doesn't automatically bring all radiation in phase to a single point. This spherical aberration could be overcome if the antenna designers could come up with a feed or combination of feed and electromagnetic lens that would compensate for spherical aberration. With this accomplished, the sky could be scanned by simply moving the feed.

Part of the stated mission of the latest and biggest window to the cosmos—the 1,000-ft radar telescope Cornell University will build for USAF in Puerto Rico—is for detection of enemy ballistic missiles and satellites. The system will also cooperate with missile launchings from Cape Canaveral, Fla.

Capable of picking up an object one cubic yard in size at a distance of 20,000 mi. or mapping areas of the sun and moon, the saucer-shaped antenna will be made of aluminum mesh. It will rest in a scooped-out crater in the ground. Pulsed radio beams will be transmitted directly overhead. Operating wavelengths, though planned for about 66 cm may get down to 21 cm.

Use of the telescope will be to study ionization effects of ballistic nose cones passing through the upper atmosphere, to measure elec-

# NEW HIGH CURRENT Miniaturized TRANSPAC®



**NEW  
SOLID  
STATE  
SHORT-  
CIRCUIT  
AND  
TRANSIENT  
PROOF  
POWER  
PACKS**

Featuring ERA's  
New "Thermo-guide"®  
principle  
for minimum heat rise,  
size and weight.

## FEATURES:

- New High Current Solid-State Designs
- Battery Voltage Outputs
- Advanced Thermal Design
- Low Ripple Content
- Short-Circuit Proof . . . Automatic Recovery
- Thermal Transistor Stud Temperature Monitor and Automatic Cut-Off
- All Components Accessible
- Minimum Size and Weight
- Moderately Priced

©Reg. U.S. Pat. Off.

©Patent applied for

## SAVE SPACE, WEIGHT and WIRING

ERA's new high current transistorized Transpacs are miniaturized self-contained AC operated units which provide regulated DC outputs at all standard battery voltages. These units may be used to replace battery sources for laboratory and test purposes or wired into equipment to supply a rugged reliable source of DC power for miniature or standard size electronic devices.

## SPECIFICATIONS

Input 105-125 VAC, 60-400cps. Line or load regulation better than 0.05% or 5 millivolts. Ripple less than 1 millivolt. Models listed are specified for operating temperatures up to 55°C. but may be derated for extended temperatures. Extremely high temperature and military designs also available on order. Units include provision for 5% minimum voltage adjustment.

Model No.	Output Volts	Current Amps.	Case Size (WxDxH — inches)	Net Price*
TR6R	6	0-2	4 1/4 x 4 x 5 1/8	\$160.
TR12R	12	0-2	4 3/4 x 4 x 5 1/8	160.
TR18R	18	0-2	5 x 4 1/4 x 6 3/8	160.
TR24R	24	0-2	5 x 4 1/4 x 6 3/8	160.
TR32R	32	0-2	5 x 4 1/4 x 6 3/8	160.
TR6-32R	6-32**	0-2	5 x 4 1/4 x 6 3/8	185.

\* Prices FOB Cedar Grove, subject to change without notice

\*\* Selectable voltages at 6, 12, 18, 24 or 32 VDC

In addition to models listed, units can be supplied to meet special military or commercial requirements. Write for quotations on special types.

For further details send for catalogue #118.

# ELECTRONIC RESEARCH ASSOCIATES, INC.

67 Factory Pl., Cedar Grove, N. J.      Center 9-3000      TWX NJ1144

SUBSIDIARIES

Era Electric Corporation • Nutley, N. J.      Era Pacific Inc. • Santa Monica, Cal.

# Listening in on Outer Space . . .

tron densities and temperatures in space, and for radar mapping of the moon and planets.

The project is scheduled for completion in 1962 and will cost \$4.5 million.

Largest rotatable telescope will be the Naval Research Laboratory's (NRL) 600-ft paraboloid at Sugar Grove, W. Va. Costing \$79 million, the 20,000-ton facility is also scheduled for completion in 1962. Navy admits that 90 percent of the work planned for this big dish will be military, not basic research. It will transmit and receive.

## First Full Study

The 85-ft steerable parabolic radio telescope at the University of Michigan, dedicated earlier this month, is also sponsored by the Naval Research Lab. Contracts to date have amounted to about \$600,000 with the university.

Incorporated in the large dish is a newly developed broad band traveling-wave radiometer with a proven performance ten times better than in other similar receivers, ONR says.

Another feature of the new telescope is a ruby maser radiometer developed by the University of Michigan, which will increase the normal range about three times.

## Using New Maser

The California Institute of Technology is operating two 90-ft steerable parabolic antennas under an ONR contract.

A non-steerable radio telescope is now under construction by the University of Illinois near Danville, Ill. under ONR contract.

Navy has a stationary bowl telescope 263-ft long and 220-ft wide for moon-relay communications at Stump Neck, Md.

Navy will unveil next month a new moon-relay setup. It will consist of a transmitter site at Annapolis, Md., a receiver at Cheltenham, Md., a transmitter at Opana, Hawaii, and a receiver at Wahiawa, Hawaii. Each site has an 84-ft steerable dish.

Also under construction is an 85-ft dish to be operated by the University of California. Located

in northern Calif., this radio telescope has a parabolic reflector equipped with appropriate feed horns to enable operation over frequencies including the 1,420 mc hydrogen-line frequency. It will be used to study hydrogen and other gas concentrations around galactic and extra-galactic stars, to understand the role of these gases in the birth and evolution of the stars.

Army Signal Corps isn't active now in radio telescope. All its gear is being used to watch satellites and other space probes.

Besides USAF's Puerto Rican project, there are a number of big USAF radar telescope projects going on. Work is under way on a 142-ft parabolic radar screen at Stanford University. A similar

tenna at Ohio State University. A 1,000-ft telescope of similar design is planned in Nancay, France.

The Foundation has sponsored two dishes (24-ft and 60-ft) at Harvard, an 85-ft telescope at Green Bank, W. Va.

## Spaced Array Telescope

National Bureau of Standards does considerable radio astronomy work at Boulder, Colo. Equipment consists of three converted German Wurzburg radars, 26-ft dishes; a pair of 40-ft and a pair of 60-ft steerable parabolic arrays.

Carnegie Institute of Washington, D. C. has three telescopes with 28-ft, 60-ft and 85-ft dishes.

A spaced array telescope is scheduled for completion in December

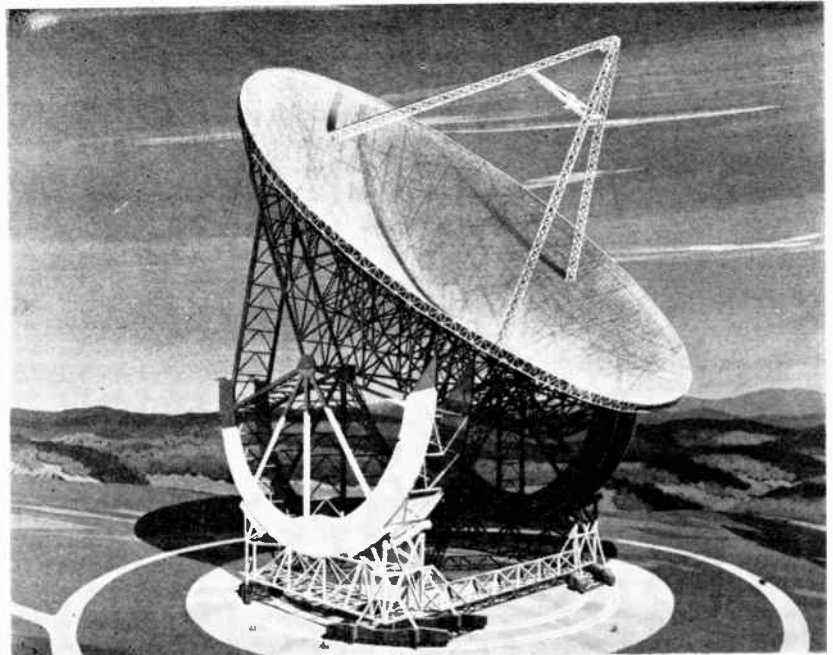

Navy's 600-ft dish going up in Sugar Grove, W. Va., will be world's biggest

USAF project is planned to go up in Scotland. Rome Air Development Center has two 28-ft parabolic dishes operating on frequencies of 233 mc and 456 mc at the University of Alaska. Object is to study effects of the aurora and ionosphere on electromagnetic transmission. Rome is also working with an endfire traveling wave antenna array used as interferometers operating on 53 mc and 200 mc at Cornell University.

The National Science Foundation is partially financing a fixed parabolic reflector with a tiltable an-

by the Convair Scientific Research Laboratory.

The telescope is about 800 ft wide in the north-south direction, and each of the eight rows is 1,443 ft apart. A two-mile-long transmission line bisects the grid.

Air Force Cambridge Research Center sponsors 84-ft telescopes at Hamilton and Westford, Mass., and Prince Albert, Canada. USAF funds are helping support the 250-ft dish at Jodrell Banks, England. USAF is also working on minimum power needs for space vehicles.



When requirements are rugged:

only Weston

# RUGGEDIZED

Instruments  
are so  
consistently

**RELIABLE**

Sure, lots of instruments are offered for use under rough conditions. But how many make the grade? How many can you count on to give consistently dependable service over the years? And how many manufacturers provide a line of such instruments broad enough to satisfy a wide range of applications?

**ONLY WESTON!** Yes, not only does the Weston Ruggedized Line conform to the broadest range of MIL specs . . . it *delivers* the stability, accuracy and near-invulnerability that the most finicky user requires.

#### LOOK AT THESE NEW FEATURES!

Sturdy new plastic windows and advanced case design permit the use of *practical* zero correctors in all models. And the well-known Weston Ruggedized Instruments have now been expanded to include 250° scale instruments, with improved accuracy and legibility. Together with Weston exclusive up-front scales, this insures the utmost in readability. These features, and those listed at the right, are the reasons for the high recognition Weston Ruggedized Instruments have earned.

For full information, contact your local Weston sales office . . . or write to Daystrom-Weston Sales Division, Newark 12, N. J. In Canada: Daystrom Ltd., 840 Caledonia Rd., Toronto 19, Ont. Export: Daystrom Int'l., 100 Empire St., Newark 12, N. J.

# WESTON

*Instruments*



WORLD LEADER IN MEASUREMENT AND CONTROL

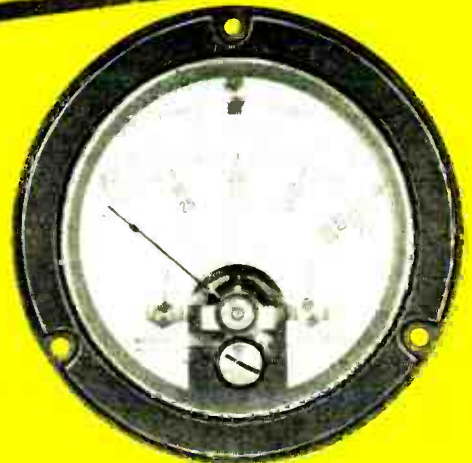
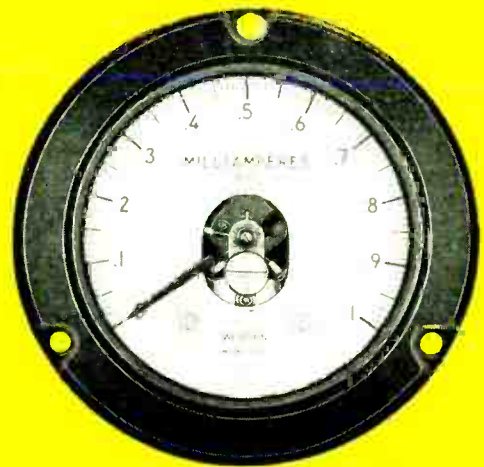

**ALL Weston ruggedized instruments offer ALL these advantages:**

- Dependable service, even under extremes of shock, vibration, temperature, humidity and general abuse.
- Highest ratio of scale area to casing size.
- Mechanisms feature spring-backed jewel construction. Internal shock mounting plates are integrally molded and bonded to cases in specially compounded rubber.
- Rigid steel housings provide excellent shielding against external magnetic fields. Instruments may be mounted interchangeably on magnetic or non-magnetic panels.
- In the 250°-scale Model 1539, accuracy is available to within  $\pm 1\%$  of full scale range.
- New cases with sturdy plastic windows permit use of practical zero correctors.

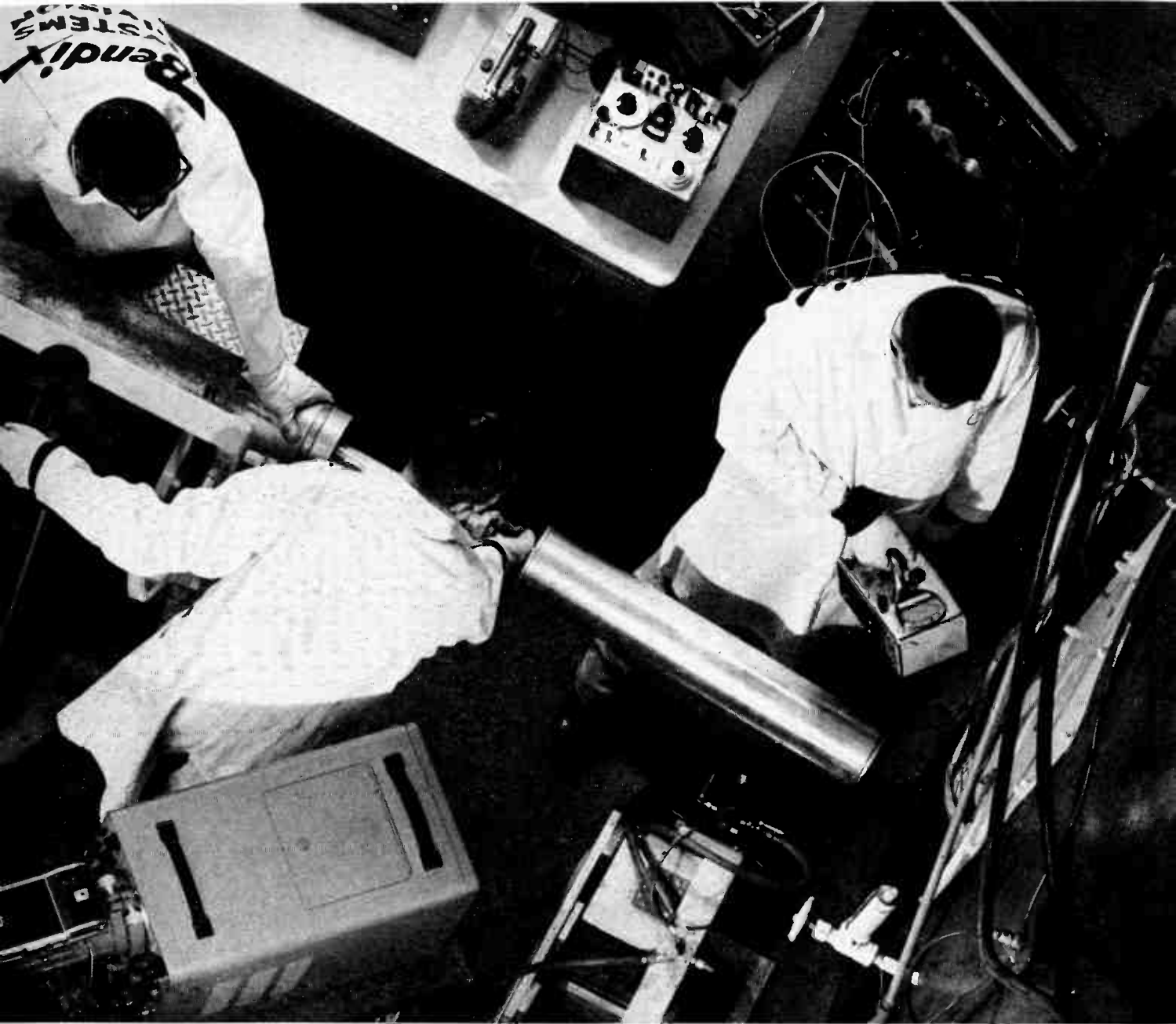

Bendix engineers use the University's Ford Nuclear Reactor to test radiation resistance of airborne communications equipment.

## IN SOUTHEASTERN MICHIGAN: A SCIENTIFIC CLIMATE FOR THE ELECTRONICS INDUSTRY

The Bendix Systems Division in Ann Arbor is typical of the firms in this area which use the extensive facilities of The University of Michigan to further research and development projects. This is but one example of how one of several nationally known schools in the area helps to create the scientific climate so vital to the electronics industry.

A climate which stimulates and aids the search for knowledge,

important as it is, is not all you'll find in Southeastern Michigan. A great place in which to live and work, the area also has many communities which have planned conscientiously and carefully for their prosperous growth—and yours. These communities are confident when they extend an invitation to industry-on-the-move because area planning has been done under the guidance of skilled professionals. We would welcome the opportunity to discuss this subject with you further.

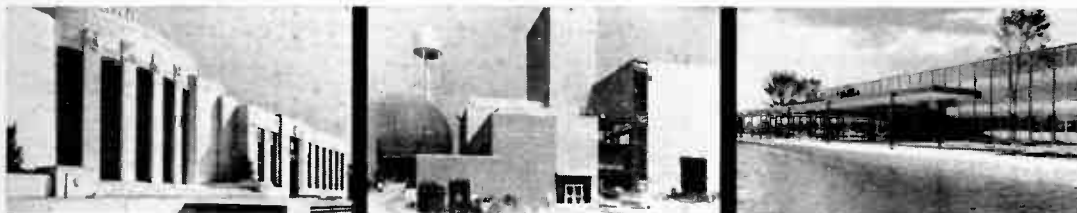

EZRA STOLLER

Southeastern Michigan's scientific climate is illustrated by (left) headquarters for the Engineering Society of Detroit and for the forty-nine engineering groups which are affil-

iated with it, (center) The Enrico Fermi Atomic Power Plant near Monroe, (right) Research Building at the General Motors Technical Center at Warren, Michigan.

Write to Plant Location Service,  
Area Development Division

**DETROIT EDISON**







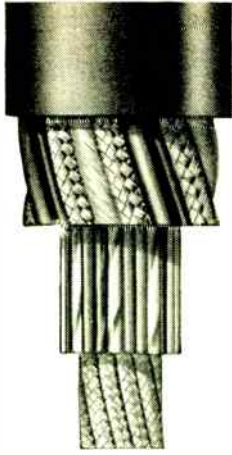

## ROYAL MULTI- CONDUCTOR CABLES

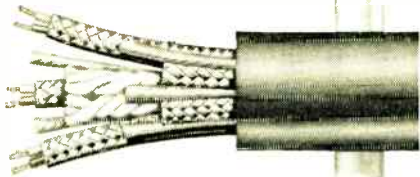

With capability and capacity in both engineering and production, Royal's skills and manufacturing resources are at your service for multi-conductor cables for special applications. Simple or complex constructions, Royal handles them all with precision, for dependable performance.



Send us your specifications, or ask to have a representative call.

**ROYAL ELECTRIC CORPORATION**  
301 Saratoga Avenue  
PAWTUCKET • RHODE ISLAND

**ROYAL**  
ELECTRIC  
...an associate of **ITT**

(Continued from p 51)

1958. A six-percent gain in fiscal 1960 will bring the production procurement total to \$4.300 billion.

This category includes products in quantity or final production. Larger companies in the industry have been getting the bulk of this type of business.

Higher volume estimates for the fiscal 1958-1960 periods are largely due to increased spending for missiles and air defense systems.

Remaining three major expenditure groups are of special significance to smaller electronics companies which are less handicapped by size in competing for these contracts.

Development and Test, which provides for the procurement of equipment prior to quantity production, is estimated at \$330 million in fiscal 1959. The 27-percent increase over fiscal 1958 volume is largely due to the considerable amount of checkout and test work involved in the missile development program.

Air Force has been responsible for about 60 to 75 percent of D&T expenditures between fiscal 1958 and fiscal 1960.

### Development and Test Expenditures

(Millions of Dollars)

Fiscal Years:	1958	1959	1960
Army	\$27	\$42	\$65
Navy	33	85	95
Air Force	200	203	200
<b>Total</b>	<b>260</b>	<b>330</b>	<b>360</b>

Few areas of the electronics industry are growing at a faster rate than R&D which climbed to an estimated half billion dollars in fiscal 1959, a one-third increase over fiscal 1958 volume of \$375 million.

The fiscal 1960 volume is due for an additional 11-percent gain. Changing character of military warfare, with emphasis on new equipment such as countermeasures, space satellites and integrated communications systems, is supplying the power for higher R&D expenditures.

R&D ability of a high order has become so important in military electronics production that DOD

considers this ability as a basic admission ticket to most of the newer and fast-growing military products and systems.

Operations and Maintenance comprises expenditures for spare parts, overhaul and modification of gear.

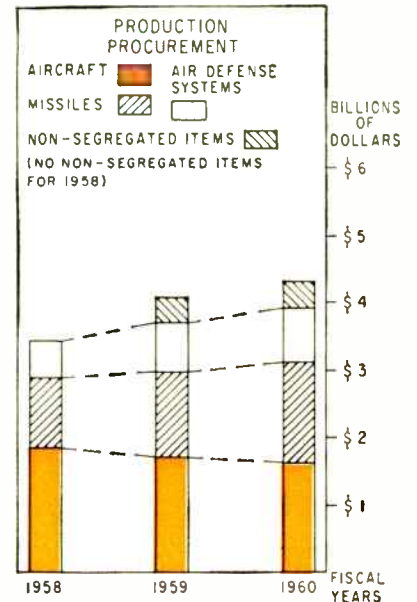

Increased spending in Production Procurement, Development & Test and R&D categories will boost military electronics expenditures to \$6.1 billion

### Operation and Maintenance Expenditures

(Millions of Dollars)

Fiscal Years:	1958	1959	1960
Army	\$100	\$100	\$110
Navy	100	100	100
Air Force	600	600	650
<b>Total</b>	<b>800</b>	<b>800</b>	<b>860</b>

Though aircraft electronics expenditures are declining, several types of aircraft electronic equipment are doing well.

For instance, navigation equipment expenditures increased 20 percent in fiscal 1959, rising to \$300 million. Production orders for Doppler radar and the increasing complexity of navigation equipment needed for fast flight speeds contributed much of the increase. The higher fiscal 1959 volume is expected to be maintained.

### Another Jump Coming

Aircraft computer expenditures are estimated at \$175 million for fiscal 1959, a 17-percent increase over fiscal 1958. In fiscal 1960 sales



# Can Sell . . .

will enjoy an additional increase—this time by 14 percent.

The sizeable Other Aircraft Electronics expenditure is sharply decreasing. It includes servos, hydraulic valves, flow regulators and other gear that control airplanes.

Missile expenditures will soon rival aircraft electronics as the leading electronic production procurement group. Percentage of total procurement expenditures is expected to rise from 31 percent in fiscal 1958 to 35 percent in fiscal 1960. The report estimates that missile electronics currently accounts for over half of a missile's total cost.

Missile airframe electronics volume is estimated at \$620 million, a big 35-percent jump over fiscal 1958, and an expected 28-percent increase in fiscal 1960 will bring missiles up to \$800 million. Main cause: quantity missile production.

Included in the missile airframe figures are electronic guidance, computers, servo systems and missile airframe controls. Guidance expenditures, up 38 percent in fiscal 1959, are due for a nine-percent rise in fiscal 1960.

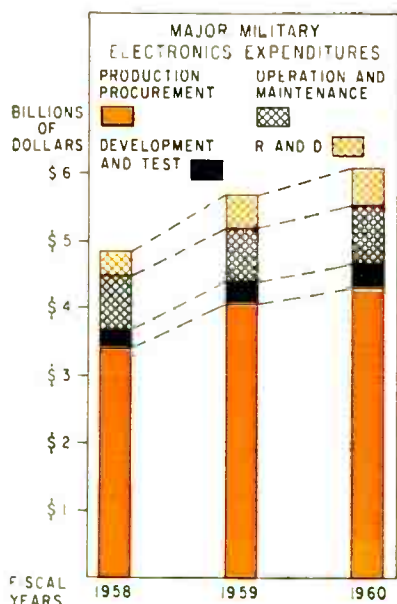

Missile and air defense system purchases more than make up for drop in aircraft electronics

Missile ground control spending is expected to increase more moderately than spending for missile airframe equipment.

# PHALO® engineered...

458-B

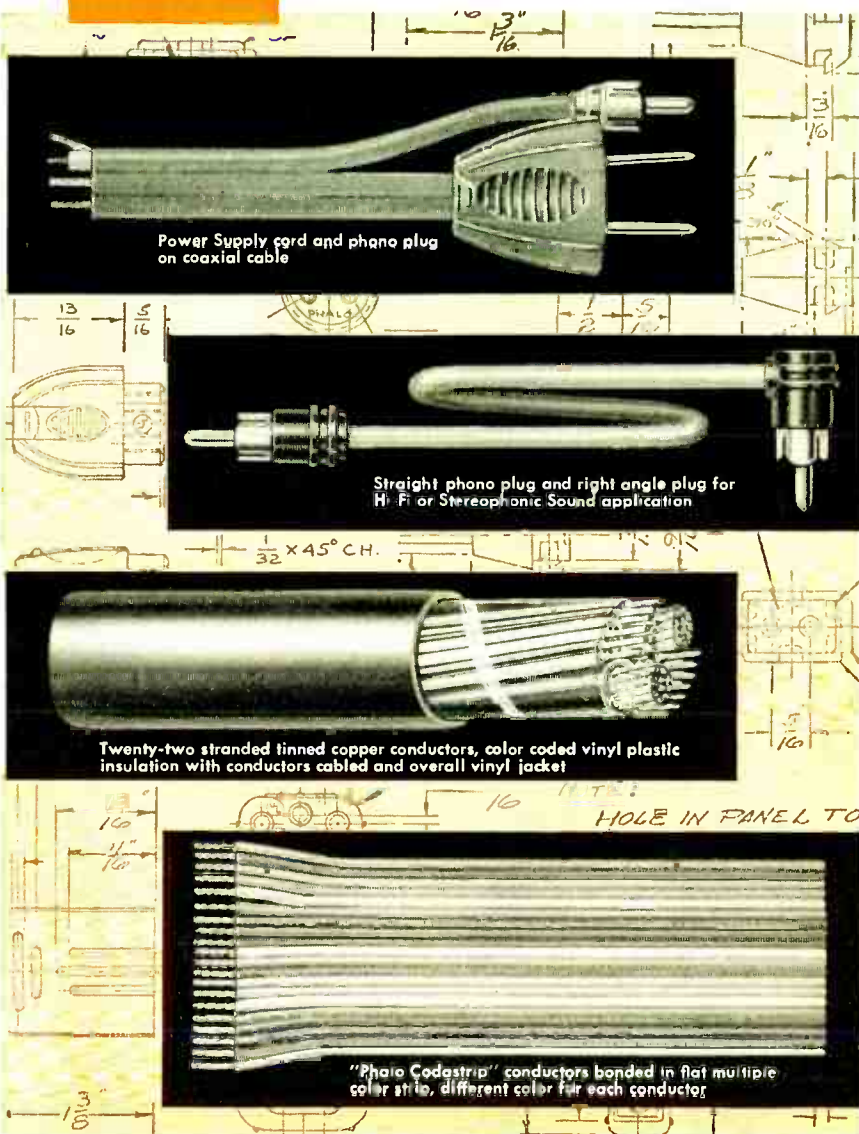

## to fill the needs you specify...

Recognized engineering diversity . . . new, greatly enlarged capacity . . . new, maximum efficiency of production. Very simply, that is Phalo 1959.

Producing For All Industry From The Most Modern Plant In The Wire and Cable Industry!

*Complete Product Data and Sales Service Information On Request*

**PHALO ENGINEERED PRODUCTS: INSULATED WIRE AND CABLE, CORD AND CORD SET ASSEMBLIES, CUSTOM PLUGS, TUBING, WIRING HARNESSSES, ETC.**

# PHALO

530 BOSTON TURNPIKE  
**PLASTICS CORPORATION**  
SHREWSBURY, MASSACHUSETTS

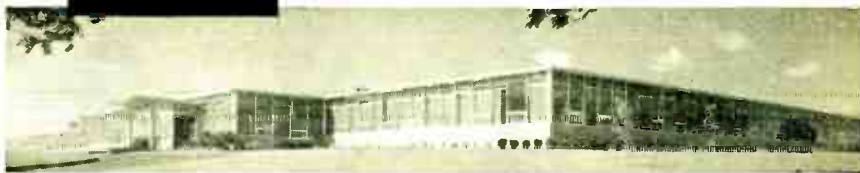

*Representatives in Leading Cities Throughout The U. S. A.*

# NOW from INDIANA STEEL

## NEW HIGH ENERGY ALNICO V-7 PERMANENT MAGNETS ACHIEVE TYPICAL ENERGY VALUES OF 7 MILLION FOR THE FIRST TIME!

For the design engineer with a special application problem

Hyflux Alnico V-7 is a new high energy material now available for special applications requiring either greater energy per unit weight or volume, or equal energy from a lighter or smaller magnet.

Compared with the previous energy leader — Alnico V, new Hyflux Alnico V-7 represents a significant advance in the energy level of permanent magnets. To show this, a portion of the Demagnetization and Energy Product Curve has been enlarged and depicted here.

The curve for Hyflux Alnico V-7 shows a typical energy value of 7.00

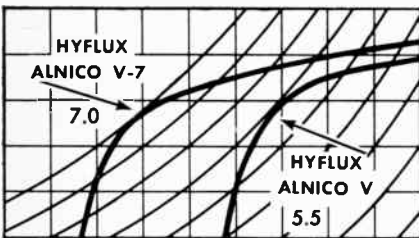

million. By comparison, Alnico V has a typical value of only 5.50 million.

The reason for this remarkable performance lies in the very high degree of crystal magnet orientation found in the material. As a result, Hyflux Alnico V-7 produces more

magnetic energy per unit volume or weight than any other permanent magnet material presently available.

Other characteristics of Hyflux Alnico V-7 are equally impressive. For example, residual induction ( $B_r$ ) is 12,750 gauss, and the coercive force ( $H_c$ ) is 765 oersteds. For Alnico V the  $B_r$  is only 12,500 gauss and the  $H_c$  600 oersteds. Improvements such as these point the way to important design breakthroughs in many fields.

### When To Use Hyflux Alnico V-7

A premium material, Hyflux Alnico V-7 is particularly suited for use in space age or other critical equipment requiring a greater level of energy, or where smaller size and weight without loss of energy is needed.

- 1. Military Electronics.** Use Hyflux Alnico V-7 for light-weight ground and airborne generators and alternators (in a full range of frequencies).
- 2. Testing Equipment.** Use Hyflux Alnico V-7 in meters, recording instruments, oscillographs, magnetometers and galvanometers.
- 3. Miniature and Sub-miniature Components.** Use Hyflux Alnico V-7 for missile-borne guidance and recording equipment.

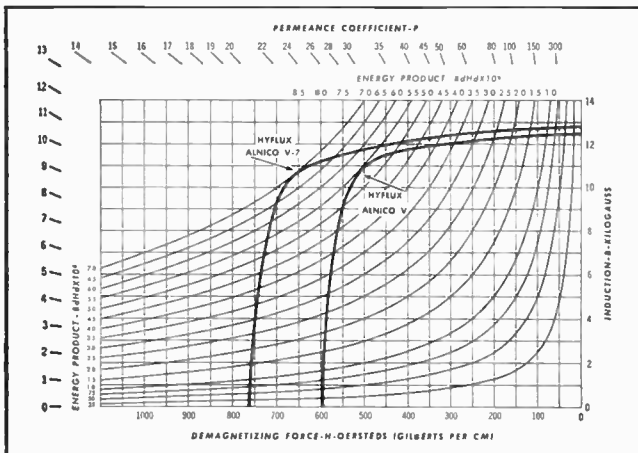

DEMAGNETIZATION AND ENERGY PRODUCT CURVE

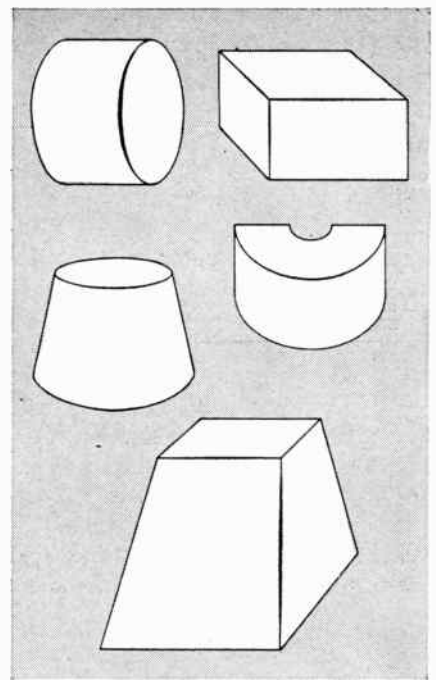

### Designing With Hyflux Alnico V-7

The nature of the material is such that orientation (and magnetization) must be straight, eliminating the familiar horseshoe shape. Cylinders, rectangles and other prismatic shapes, however, are possible, as are certain conic or pyramidal frustums. Pole faces may be ground quite easily. Side surfaces may also be ground, but somewhat slower than normal.

### TYPICAL CHARACTERISTICS OF HYFLUX ALNICO V-7

(in comparison with Alnico V)

PROPERTIES	Hyflux Alnico V-7	Alnico V
Residual Induction (minimum) $B_r$ , Gauss	12,750	12,500
Coercive Force (minimum) $H_c$ , Oersteds	765	600
Peak Energy Product $B_r H_d \max \times 10^6$	7.00	5.50
Peak Magnetizing Force Oersteds	3,000	3,000
Weight (lb per cu in)	0.265	0.265
Mechanical Properties	Hard-Brittle	Hard-Brittle

For more information on new Hyflux Alnico V-7 and its role in the design future of your firm, write Dept. A-10

THE INDIANA STEEL PRODUCTS COMPANY

Valparaiso, Indiana

WORLD'S LARGEST MANUFACTURER OF PERMANENT MAGNETS

In Canada: The Indiana Steel Products Company of Canada Limited, Kitchener, Ont.

INDIANA  
PERMANENT  
MAGNETS



# SEVEN TUBES FOR STEREO



**EF86 6Z6**

High gain AF input pentode with exceptionally low noise, low hum and low microphony.



**ECC83 12AX7**

Double triode, low hum, low microphony, low noise, high gain tube.

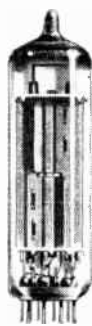

**ECL82 6BM8**

Miniature triode pentode for use as audio amplifier and output tube. Two tubes in ultralinear push-pull can supply up to 7 watts of stereo power per channel.



**EL84 6BQ5**

Miniature 12 watt high slope pentode. A medium power high fidelity tube particularly suitable for compact stereo circuits, up to 17 watts per channel.

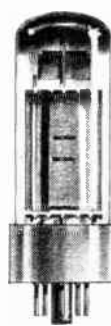

**EL34 6CA7**

Highly sensitive 25 watt pentode. Two tubes in ultralinear push-pull providing up to 34 watts output, particularly suited for compact integrated stereo amplifiers.



**EZ81 6CA4**

Miniature full wave cathode type rectifier with high voltage and with good regulation supplying up to 150mA.

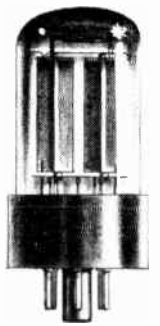

**GZ34 5AR4**

Bantall full wave cathode type rectifier, supplying high voltage with good regulation for currents up to 250mA.

**Mullard**  
ELECTRONIC TUBES  
used throughout the world



"Mullard" is the Trade Mark of Mullard Ltd., and is registered in most of the principal countries of the world.

Supplies available from:  
In the U.S.A.

International Electronics Corporation  
81 Spring Street, New York, 12, N.Y.  
U.S.A. Worth 6-0790.

In Canada

Rogers Electronic Tubes & Components  
116 Vanderhoof Avenue, Toronto 17,  
Ontario, Canada. Hudson 5-8621.

**MULLARD OVERSEAS LTD., MULLARD HOUSE,  
TORRINGTON PLACE, LONDON, ENGLAND**



ATLAS utilizes a radio-command guidance system provided by the Defense Systems Department. Depicted here is the dramatic blastoff of the ATLAS which — under radio-command guidance — produced a successful earthly orbit as part of project SCORE.





# GENERAL ELECTRIC'S DEFENSE ELECTRONICS DIVISION

## Organized for a Full Range of Systems Requirements

### DEFENSE SYSTEMS DEPARTMENT

The Defense Systems Department, Syracuse, N. Y. — newest of the Division's five functionally organized departments — is the focal point of those integrating capabilities so vital to major prime and support systems for national defense. Made up of the Company's top systems management and technical talents, DSD is G.E.'s single point of authority and responsibility for major, long-range defense programs.

### ORDNANCE DEPARTMENT

#### POLARIS

... whose inertial guidance and fire control equipments will be provided by the Ordnance Department, Pittsfield, Mass. — center of the Division's capabilities in precision electro-mechanical elements of sea and land-based weapons systems. In addition to POLARIS equipments, the Department produces radar antennas, directors, launching and handling equipment and underwater ordnance.



### LIGHT MILITARY ELECTRONICS DEPARTMENT

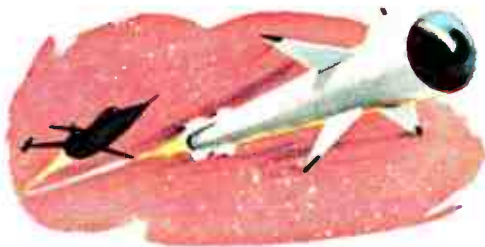

#### SIDEWINDER

... the deadly air to air missile whose infrared guidance and control units are provided by the Light Military Electronics Department, Utica, N. Y., is representative of its capabilities for military electronic subsystems and equipments contained in, or launched from, air vehicles. Its additional contributions range from electronics countermeasures to integrated avionic systems.

### HEAVY MILITARY ELECTRONICS DEPARTMENT

#### DATA PROCESSING AND DISPLAY EQUIPMENT

... for air space management is being developed and produced by the Heavy Military Electronics Department, Syracuse, N. Y. — center of the Division's capabilities for the design, production and installation of land-based and sea-borne detection, guidance and control equipment. Major contributions of this Department range from long-range sonar to the largest known radar systems.



### MISSILE AND SPACE VEHICLE DEPARTMENT



#### RE-ENTRY/RECOVERY VEHICLES

... such as the ATLAS experimental nosecone — largest re-entry vehicle ever recovered from space — are designed and built by the Missile and Space Vehicle Department, Philadelphia, Penna. Experienced in space technology, MSVD developed operational ATLAS and THOR re-entry vehicles. Other responsibilities range from certain missile arming and fuzing projects to the re-entry/recovery vehicle of the DISCOVERER satellite.

226-3

DEFENSE ELECTRONICS DIVISION

# GENERAL ELECTRIC

World Radio History

SYRACUSE, NEW YORK

Copies of this illustration, in full color and suitable for framing, may be obtained by writing the Defense Systems Department, P. O. Box 457, Syracuse, N. Y.

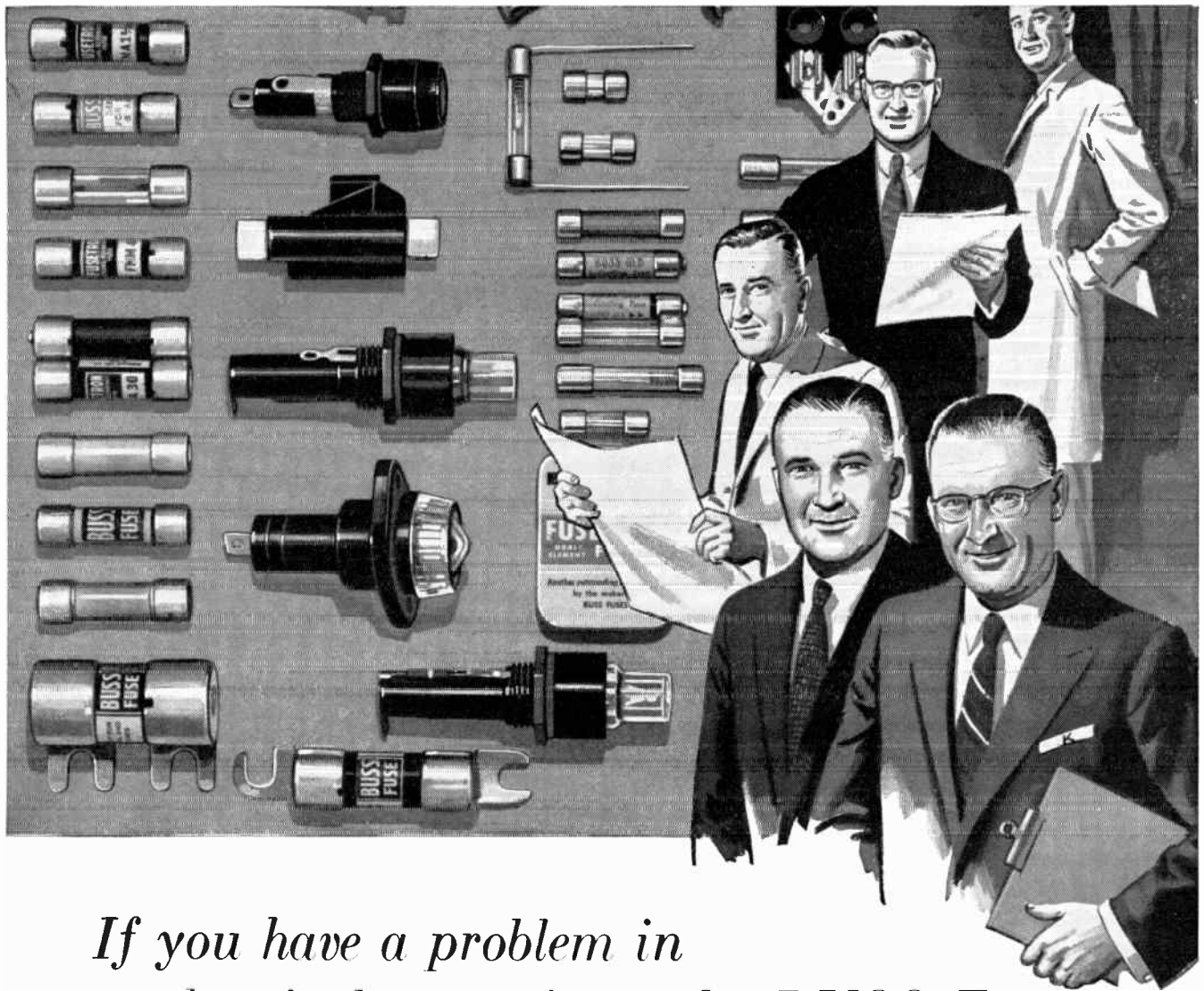

## *If you have a problem in electrical protection — let BUSS Fuse Engineers Help You Solve It.*

If you have an electrical protection problem, the BUSS fuse research laboratory, and its staff of engineers are *at your service*. Our engineers will work with yours to help you find a solution — and so save you engineering time.

It is quite possible a fuse already stocked by local wholesalers will be your answer, so that the right fuse is readily available if your equipment needs service.

The complete BUSS and FUSETRON fuse line includes:

Single-element fuses for circuits where quick-blowing is needed, such as for instrument protection.

Single-element fuses for normal circuit protection.

Dual-element, slow-blowing fuses for circuits where harmless current surges occur.

Indicating fuses where signal must be given when fuses open — or to activate an alarm.

BUSS and FUSETRON fuses range in size from 1/500 amperes up — and there's a companion BUSS line of fuse clips, blocks and holders.

### **Dependability Always**

Every BUSS or FUSETRON fuse is tested in a sensitive electronic device

that automatically rejects any fuse not correctly calibrated, properly constructed and right in all physical dimensions.

For a catalog on BUSS and FUSETRON small dimension fuses and fuseholders, — write for bulletin SFB. If you need special fuses or fuseholders, submit description or sketch, showing type of fuse to be used, number of circuits, type of terminal, etc.

BUSSMANN MFG. DIVISION,  
McGraw-Edison Co.  
University at Jefferson, St. Louis 7, Mo.

1259

**BUSS fuses are made to protect - not to blow, needlessly.**

*BUSS makes a complete line of fuses for home, farm, commercial, electronic, electrical, automotive and industrial use.*





**covering the**  
**IR spectrum**  
**from the near to the far**

**Infrared at ITT includes complete detection systems as well as basic components**

INFRARED is today, as it has been for a number of years, one of the "hottest" activities at ITT.

ITT Laboratories is equipped to design and develop new ideas in generation, transmission, detection, and utilization of infrared radiation.

ITT has made many important contributions in IR techniques—not only from one end of the spectrum to the other, but from simple devices for viewing objects in the dark to air-to-air search-track and tracking of satellites in orbit.

ITT's advanced position in the IR systems field is founded on its broad experience in basic IR components, such as lead telluride, doped germanium, and indium antimonide detectors; black-body radiation sources; image converter, photo-multiplier, and Iatron® direct-view storage tubes for display of IR information.

For increased detector efficiency, ITT has developed a full line of coolers, including cryostats for gaseous nitrogen, recirculating liquid nitrogen coolers, and liquid nitrogen dispensers that will cool cells for many hours—even after more than a day in storage. ITT also supplies component and system test equipment.

Whether infrared requirements are commercial or reach into the most sophisticated areas of military electronics, ITT's complete research and manufacturing facilities can meet the need.

For information on "active" or "passive" infrared systems, write ITT, 67 Broad Street, New York 4, N. Y.

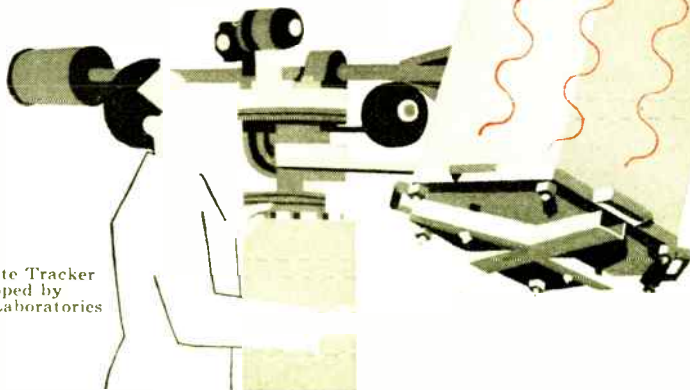

Satellite Tracker developed by ITT Laboratories

**Among the infrared research activities at ITT Laboratories**

- PRE-LAUNCH GUIDANCE
- SURVEILLANCE
- RECONNAISSANCE
- AIR-TO-AIR SEARCH
- AIR-TO-AIR SEARCH-TRACK
- JET AIRCRAFT DETECTION
- SATELLITE TRACKING
- AIRBORNE MAPPING
- FIRE CONTROL
- TEMPERATURE CONTROL
- MEDICAL ELECTRONICS
- COMMUNICATION SYSTEMS
- CRYOGENICS
- IR MASERS



... the largest American-owned world-wide electronic and telecommunication enterprise, with 101 research and manufacturing units, 14 operating companies and 130,000 employees.

**INTERNATIONAL TELEPHONE AND TELEGRAPH CORPORATION 67 Broad Street, New York 4, N.Y.**

ITT COMPONENTS DIVISION • ITT FEDERAL DIVISION • ITT INDUSTRIAL PRODUCTS DIVISION • ITT LABORATORIES • INTELEX SYSTEMS INCORPORATED  
 AIRMATIC SYSTEMS CORPORATION • KELLOGG SWITCHBOARD AND SUPPLY COMPANY • ROYAL ELECTRIC CORPORATION • AMERICAN CABLE & RADIO CORPORATION • FEDERAL ELECTRIC CORPORATION • ITT COMMUNICATION SYSTEMS, INC. • INTERNATIONAL ELECTRIC CORPORATION • INTERNATIONAL STANDARD ELECTRIC CORPORATION • LABORATORIES AND MANUFACTURING PLANTS IN 20 FREE-WORLD COUNTRIES

World Radio History

**ADAPTABLE  
FOR ALL  
APPLICATIONS**

*Hoyt* Panel Meters



NEW! Matching AC and DC Meters in striking configuration of gleaming, transparent polystyrene modernize all panels. Interchangeable with 3 1/2" diameter meters, ruggedly built, 2% accuracy, full-width scales in all popular ranges. HOYT No. 1035 DC and No. 1036 AC.

Be sure of the highest accuracy, dependability, and readability — plus economy — with HOYT precision electrical instruments. Moving coil, rectifier, and repulsion types available in a wide variety of sizes, ranges, cases, and colors—many with parallax-free, mirror scales . . . the complete line of matched AC and DC Panel Meters for original equipment or replacement use. Also, custom-designed to your most exacting specifications.

Write for fully illustrated literature containing descriptions, engineering data, and low prices.



Write to Export Manager regarding world-wide availability for Electronic, Industrial, and Automotive applications.



**ELECTRICAL  
INSTRUMENTS**

**BURTON-ROGERS COMPANY**  
Sales Division  
42 Carleton St., Cambridge 42, Mass., U.S.A.

# Police Using More



Helicopter-mounted audio gear aids police

## New ways of detecting and preventing crimes electronically spur growth of new devices

ELECTRONIC CONTRIBUTIONS to police work promise to grow as crime prevention authorities become increasingly aware of what our industry can do for them.

At the 66th annual convention of the International Association of Police Chiefs in New York recently, a number of exhibits showed how the electronics engineer is helping.

Infrared detection equipment, having become a member in good standing of the Army, Navy and Air Force, has now joined the police force as well.

One device, introduced less than a year ago, is an ir detector combined with a telescope designed for police surveillance work. It can be operated from batteries, from an auto cigarette lighter socket, or from standard house current.

Q.O.S. Corp., developer of the detector, says it can spot a moving figure at 500 ft in complete darkness, and make positive identification possible at over 100 ft. The device contains a transistorized power supply, sells for \$850.

Specialized oscillograph equipment is gaining increased acceptance among police organizations in the lie detection field. Detectives and engineers both are finding a challenge in this gear.

Lie detectors operate on the theory that body characteristics, such as temperature, skin tension, pulse rate and other variables, change under the stimulus of interrogation. The rate of change, how-

ever, is so slight that electronic amplification is usually the only way to detect and record it.

Although no development that will produce the "complete" lie detector is seen in the immediate future, training experts agree the growing interest of the electronics researcher is producing significant advances in lie detection.

Facsimile transmitters in network operation represent another growth area for police electronics. A system, developed by Fairchild Camera & Instrument Co. only last month, features automatic enlarg-



IR scope sees in darkness

ing of copy at the reception point. In the transmissions of fingerprints and identification photographs, enlargement is particularly valuable.

The system gives an enlargement ratio of 1 to 1.8 at the rate of 1.8 in. per minute. It scans at 180 lines per in. and delivers hard copy with-



# Electronics

out chemicals in daylight.

Specialized audio equipment, such as helicopter-borne public address gear, and directional sirens, attracted the attention of many officials.

In police radar, promising developments in timing equipment were shown. Size reductions and greater sophistication have resulted in equipment that can be mounted on an auto spotlight bracket and read from a meter the size of a vtvm.

## 80,000-volt X-rays Detected

PROJECT SUNFLARE II, recently completed by the Naval Research Laboratory, has revealed x-rays with energies as high as 80,000 volts above the absorbing atmosphere of the earth.

Findings indicate that temperatures in the solar atmosphere may be as high as 100 million C.

The project, supported by a \$250,000 National Science Foundation grant, was a sequel to two previous NRL flare studies—Project Roc-koon, begun in 1956, and its continuation in 1957 for the International Geophysical Year, Sunflare I.

### Launched During Flares

NRL used 12 Nike-Asp rockets with 55-lb instrument payloads; eight were completely successful, rising to 130-to-150-mi altitudes and yielding some eight minutes of telemetered data on the best flights. Three were launched during flares, five during quiet solar periods.

The sustained emissions detected by the rockets were not revealed by x-ray measurement gear aboard Sputnik III. The U. S. National Academy of Science says the Soviet satellite was not equipped with gear sensitive enough.

One conclusion to be drawn from the NRL experiments: Even the quiet sun emits a broad spectrum of x-rays extending to very high energies, but with very low flux. Excitation during a flare merely enhances x-ray emission over the whole spectral range.

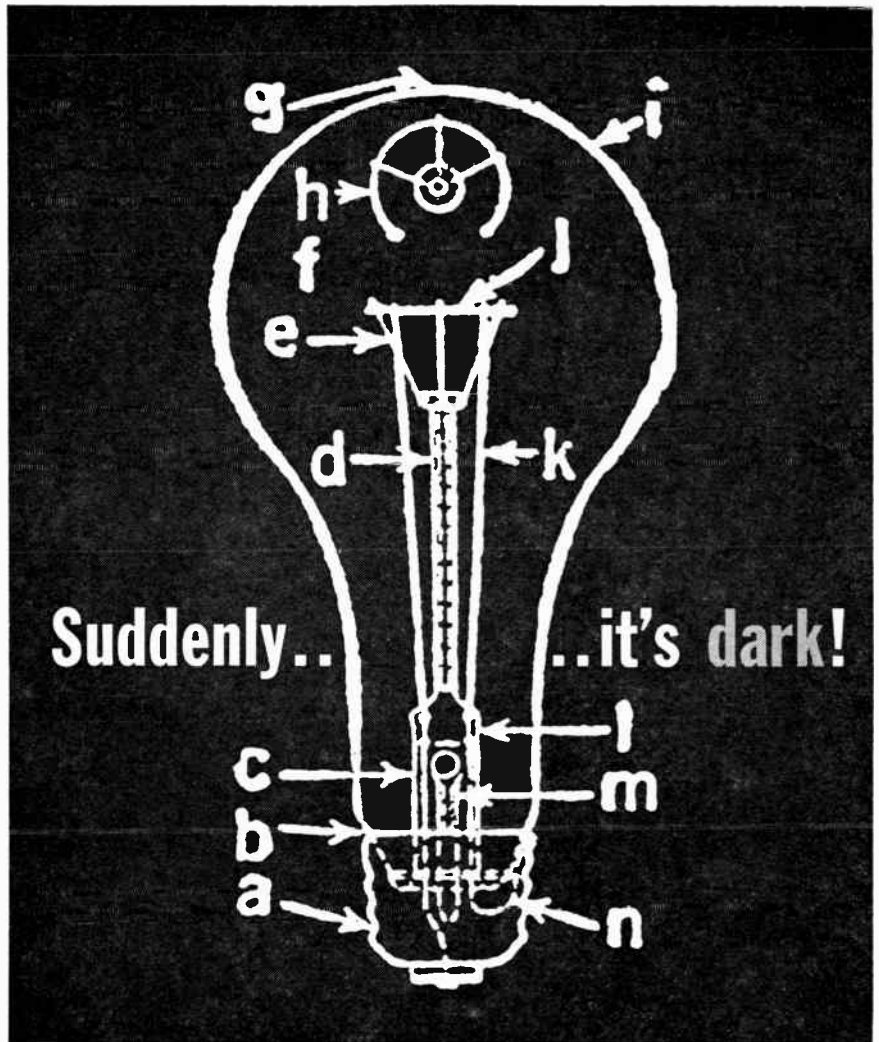

A pretty dark situation, indeed—when a *single* electron tube failure can shut down an equipment or entire production line test facility! Use IERC's new set of a, b, c's to help you get improved electronic equipment reliability. **a.** The practice of replacing tube failures in manner and attitude like that of replacing a light bulb is neither protection nor cure against a continuing high rate of electron tube failures! **b.** Downtime, labor replacement costs often add up to 10 times the tube cost! **c.** You can actually increase tube life up to 12 times by specifying and using IERC Heat-dissipating Electron Tube Shields! The full facts, in the form of **d.** complete product literature, **e.** test reports, **f.** engineering data and **g.** tube shield application guides, especially prepared to help you "see the light," are available on request—write today!

Patents 2807659, 2766020 or Patents Pending.  
Cross-licensed with North American Aviation, Inc.



International Electronic Research Corporation

145 West Magnolia Boulevard  
Burbank, California



Foreign Manufacturers: Europelec, Paris, France. Garrard Mfg. & Eng. Co., Ltd., Swindon, England.

# Sound..

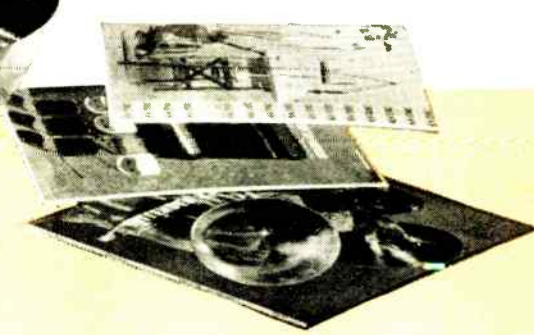

## NEW MATCHED DUAL CONTROLS FOR STEREO

—another Mallory "First". Single-knob control of two amplifiers, with perfect tracking across the normal listening range, can be obtained with this Mallory tandem dual control. The elements are prematched for perfect balance, and electrically aligned front to back to coincide accurately at all points of the curve. Tapers match within  $\pm 5\%$  tolerance. Like all Mallory carbon controls, these dual controls offer long life, low noise, excellent stability and high wattage . . . without premium cost.

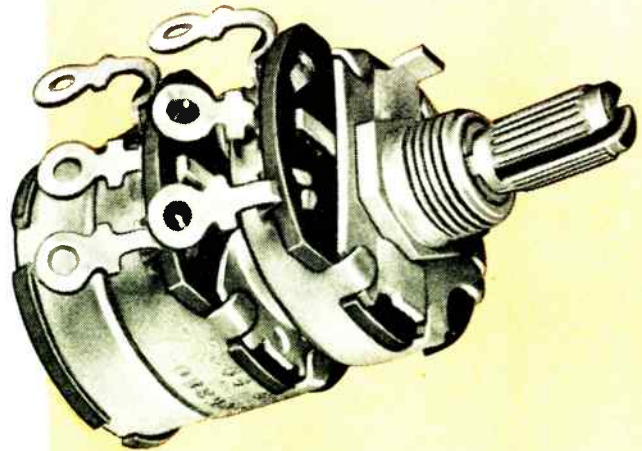



# ..True to Life

Mallory precision-made controls put extra performance in your stereo sound systems

New Mallory controls for stereo raise even further the high standard of precision set by Mallory controls for monaural hi-fi. They can help you provide the fine sound reproduction quality demanded by an increasingly discriminating public.

Several of these controls, like the one shown below, are completely new developments for stereo and hi-fi. Others have been extensively applied in commercial sound systems and in laboratory-grade equipment. All have

been built into them the long engineering experience and skilled craftsmanship characteristic of Mallory components.

In addition to individual controls, Mallory designs complete "control packages" based on the unique concept of db or voltage tracking, and which provide far closer matching and tracking than can be obtained with usual 20% tolerance controls. For a consultation with a Mallory control specialist, or for engineering data, just write or call us.

Mallory Controls Company  
Frankfort, Indiana  
*a division of*

P.R. MALLORY & CO. Inc.  
**MALLORY**

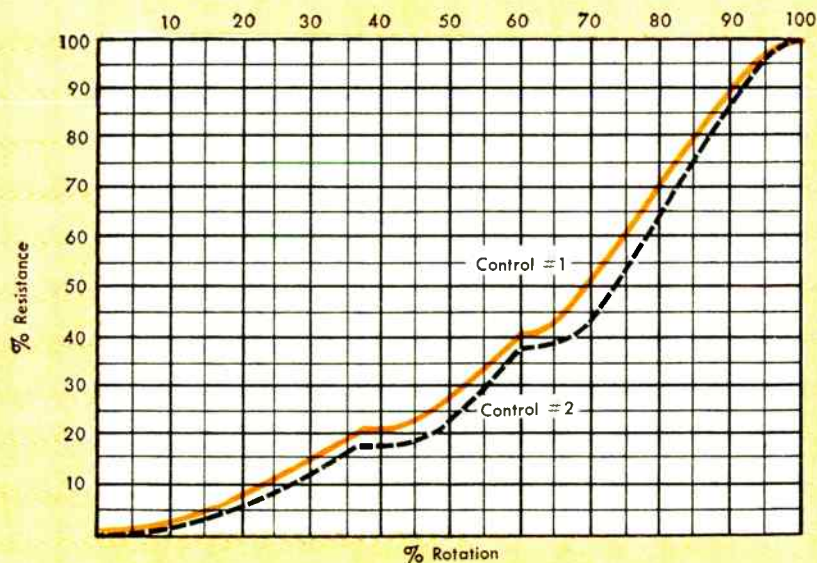

**PRECISE TRACKING** is achieved by electrically aligning and matching both elements on one shaft. Notice how closely these tapers coincide at all points. Tracking like this assures accurate balance between the two channels of a stereo system.

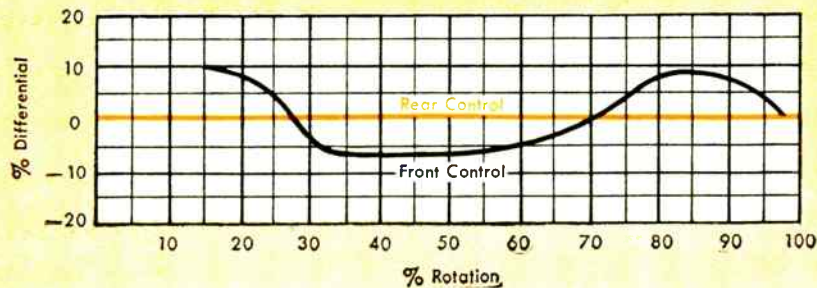

**PRECISE MATCHING** of front and rear elements of the new Mallory dual tandem controls is illustrated by this curve showing resistance differences between the two sections. Differential resistance at any point from 15% rotation to overall is within 10%.

# 24 HOUR DELIVERY OF TRIMPOT® POTENTIOMETERS

500,000 STOCKED BY DISTRIBUTORS AND FACTORIES

Immediate "off-the-shelf" delivery is available of the entire line of standard Trimpot potentiometers — 20 basic models . . . 4 terminal types . . . 3 mounting styles! More than 1/2 million units are stocked by franchised distributors across the nation and at Bourns plants in Riverside, California and Ames, Iowa with distributors selling at factory prices in quantities to 2000 pieces. Wherever you are, whatever standard unit you need, there's a Trimpot source close at hand waiting to fill that rush order . . . no need to hold up your prototype or production projects. This fast service is made possible by mechanized production processes, enlarged facilities, and greatly expanded engineering and production staffs. All this is part of our intent to provide the finest customer service program. It is another Bourns plus — in addition to the high quality, reliability, and performance that have won Trimpot potentiometers a place in major missile, aircraft and commercial electronic systems. Write for price quotations and list of representatives and distributors — today. Let us assist you with your special requirements as well.

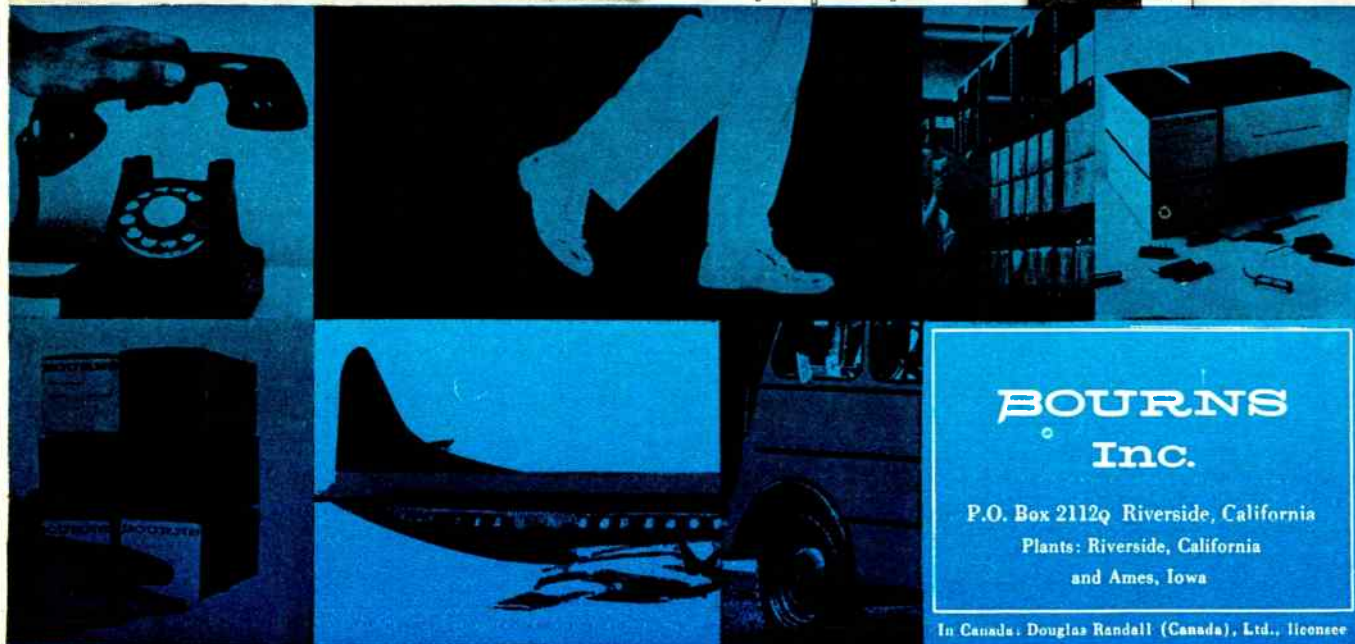
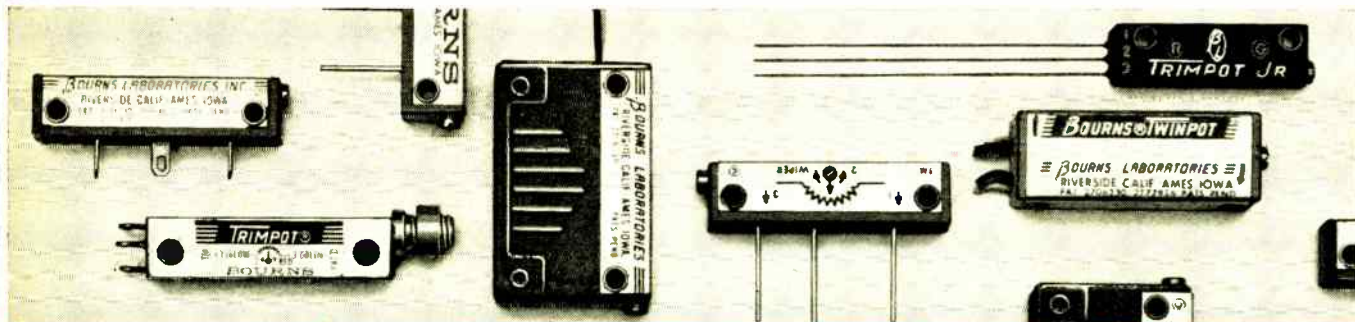

**BOURNS**  
Inc.

P.O. Box 2112q Riverside, California  
Plants: Riverside, California  
and Ames, Iowa

In Canada: Douglas Randall (Canada), Ltd., licensee

Exclusive manufacturers of TRIMPOT®, TRIMIT®, Pioneers in potentiometer transducers for position, pressure and acceleration.



# Calls for More Research \$

Study endorsed by industrial, scientific leaders criticizes money limits on U. S. research

THOSE CRITICAL of U. S. performance in the scientific race with the Soviet Union have new ammunition this week in a highly critical report endorsed by top figures in science and industry. These figures include fifteen such names as General Electric's research director C. G. Suits, Union Carbide vice president A. B. Kinzel and U. S. space chief T. K. Glennan.

The report finds the USSR is fast outpacing the U. S. and that the Navy, probably typical of the whole defense establishment, needs to double its budget for basic research. Doubling Navy's research budget would cost \$40 to \$50 million.

## Comparisons

The study by Arthur D. Little Inc. of Cambridge, Mass., is endorsed by the members of the Naval Research Advisory Committee. The study indicates the Navy's basic research program is inadequate and implies the rest of our Federal science effort is no better. The year-and-a-half study cost \$125,000.

The U. S. is found to be still ahead or at least even with the Soviets in all branches of science except physical chemistry and geophysics. But the Soviets are de-

veloping at an alarming rate. They are training basic researchers 50 percent faster than the U. S.

The Navy's research program is shown to stack up poorly against industries such as electronics, chemicals, petroleum and pharmaceuticals. Here the average company devotes 16 percent of its R&D budget to basic research—twice the Navy's 8 percent. In the past decade these firms increased the basic research part of their R&D programs by a factor of 4.5 compared to the Navy's 1.5.

Some industry officials recommend that the Navy double its basic research effort without delay.

Enough manpower is said to be available now to expand the entire Defense Department's basic research program by 70 percent. But a serious shortage of personnel is developing. While national R&D activities are expanding 10 percent a year, the number of scientists and engineers is increasing only 5 percent. Only two percent of the nation's scientists and engineers, some 15,000, are engaged in basic research. Only 20 to 30 percent of the physicists and chemists with PhD's ever publish basic research papers after their doctoral theses.

## Russian Tape Recorder

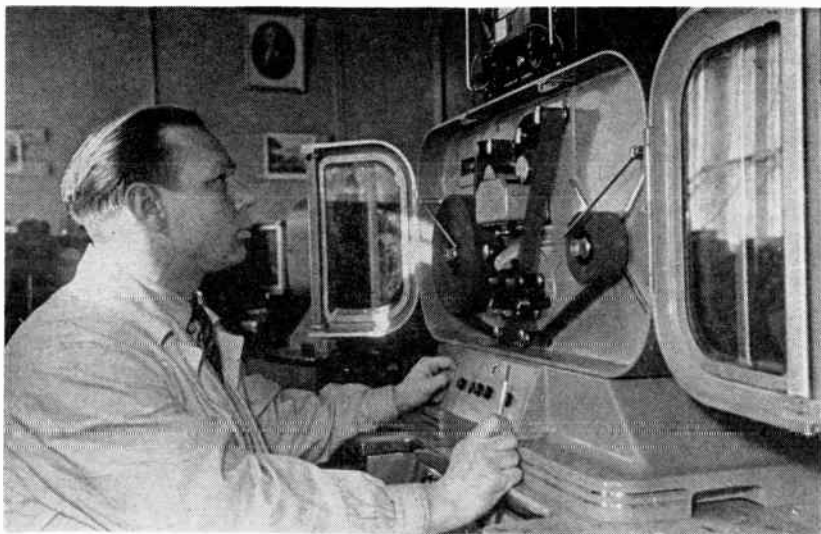

Soviet Union model KZM-6 tape recorder is being regulated by electrician V. Melnikov. Recorder is part of equipment manufactured by the Leningrad "Kinap" plant. This plant's original widescreen head for a newsreel camera won a Grand Prix at 1958 Brussels Fair

# ROHN SELF SUPPORTING COMMUNICATION TOWER

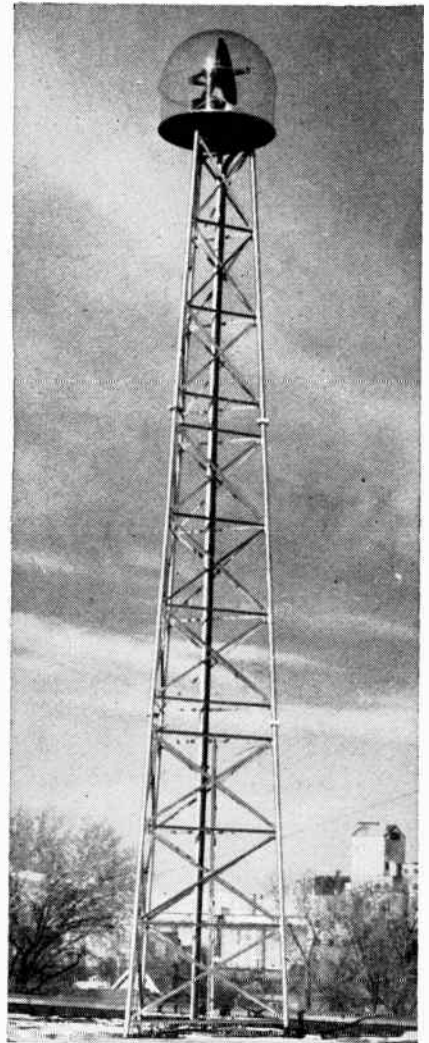

(This radar weather tower of KSTP-TV, Minneapolis, uses the 3 lower sections of the ROHN "Self-Supporting" tower. Note construction, design and size.)

### HERE ARE THE HIGHLIGHTS OF THE ROHN "SS" TOWER:

- ★ 130 ft. in height, fully self-supporting!
- ★ Rated a true HEAVY-DUTY steel tower, suitable for communication purposes, such as radio, telephone, broadcasting, etc.
- ★ Complete hot-dipped galvanizing after fabrication.
- ★ Low in cost—does your job with BIG savings—yet has excellent construction and unexcelled design! Easily shipped and quickly installed.

FREE details gladly sent on request. Representatives coast-to-coast.

**ROHN** Manufacturing Co.

116 Limestone, Bellevue,  
Peoria, Illinois

"Pioneer Manufacturers of  
Towers of All Kinds"

# NEW FROM NARDA



**Wide Range**

**KLYSTRON POWER SUPPLY— \$495<sup>00</sup>**

Model 438

## ***Operates more Klystrons than any comparable unit!***

This new Narda Wide Range Klystron Power Supply operates virtually all medium and low voltage Klystrons, as well as some high voltage tubes (at reduced power output). It literally operates more Klystrons, including Sperry and Varian tubes, than any other unit in its price range!

What's more, all components, including tube sockets, are operated within manufacturers' ratings. (Many other supplies exceed plate-cathode,

cathode-filament or socket-ground voltage ratings.)

Want more information about this new Power Supply that gives you greater versatility and longer trouble-free service at lower cost? Then write us for complete spec sheets. Ask, too, for your free copy of our complete catalog. Address: Dept. E-6.

### **FEATURES**

- 250-700 volt Beam Supply, 0-65 ma.
- 0-1000 volt Reflector Supply
- Accurate Ten-Turn Dial Calibration
- 5 mv max. Reflector Ripple
- Diode Protection Circuit
- Oil Filled Capacitors in High Voltage Filters
- Square Wave Modulation 0-150 Volts, 300 to 3000 cps.
- Saw Tooth Modulation 0-150 Volts, 30 to 180 cps.
- Sine Wave Modulation 0-150 Volts, 60 cps.



the **narda** microwave  
corporation

118-160 HERRICKS ROAD, MINEOLA, L. I., N. Y. • PIONEER 6-4650



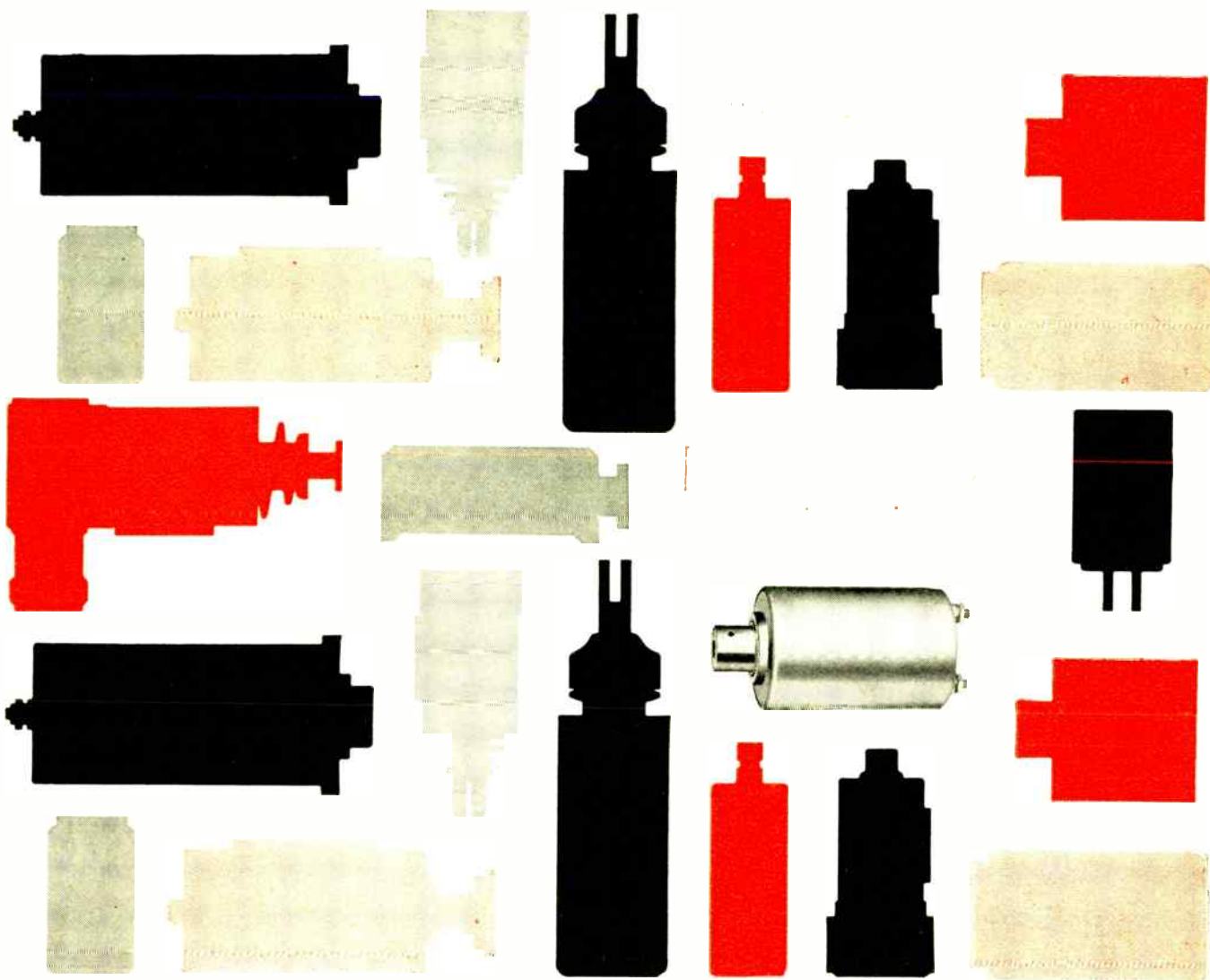

# LET CANNON HELP YOU WITH YOUR DC SOLENOID PROBLEMS

Cannon is one of America's largest producers of dc solenoids... a pioneer in engineering a wide range of special types, including hermetically sealed and high-temperature models. Multiple-strip solenoids for keyboard operation—locking types requiring no holding current—and miniature and sub-miniatures as small as 1/2 inch in diameter are now in standard production. If you have a problem involving dc solenoids, Cannon offers a complete selection... for any application.



Cannon has prepared a new engineering catalog containing valuable information about dc solenoids. Theory, principles of operation, and advantages of dc solenoids are presented simply and authoritatively. Write for your free copy to:



Where only the **best** is good enough  
... you'll see

## Krohn-Hite

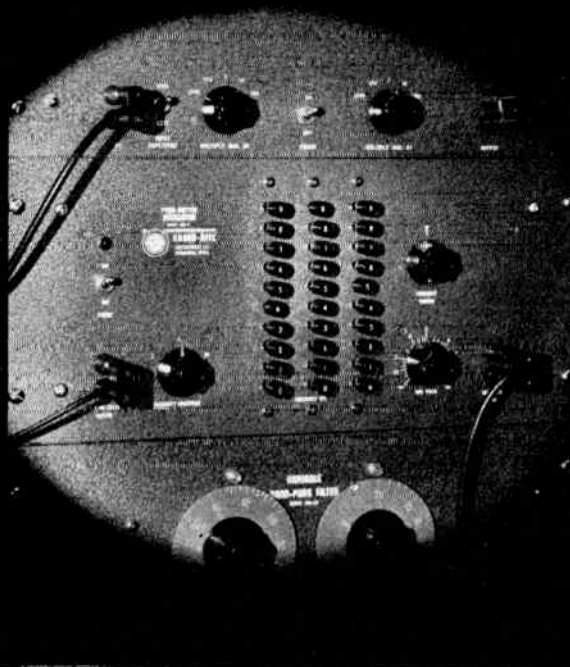

### *electronic instruments*

In basic electronic instruments for lab or test work, *less than the best* may be a dangerously bad bargain. Unexpected limitations — of reliability, range, precision — can throw out weeks of work on today's jobs, and can make tomorrow's tougher jobs untouchable. The *best* instrument of its type is probably a bit more expensive, but it's worth buying . . . because you can believe in it today, and will rely on it tomorrow. An example is the Krohn-Hite Model 440-A wide range push-button oscillator illustrated here.

Exactly because K-H instruments *are* good enough even for tomorrow's most critical work, they are increasingly chosen today where true reliability and precision are needed.

**Oscillators** — .001 cps to 520 kc, dial or push-button tuning, less than 0.1% distortion, sine wave and square wave outputs.

**Power Supplies** — zero to 600 volts dc, zero current to 1 ampere, regulation .001%, ripple less than 100  $\mu$ v, internal impedance 0.1 ohm to 100 kc.

**Power Amplifiers** — 10 to 50 watts, dc to 1 mc, transformer or direct coupled, 0.005% distortion.

**Tunable Electronic Filters** — variable from .01 cps to 200 kc, band pass, band rejection and servo types.

*Write for your free copy of the new Krohn-Hite Catalog*

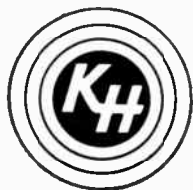

**Krohn-Hite** CORPORATION

580 Massachusetts Avenue,  
Cambridge 39, Mass.

World Radio History

## MEETINGS AHEAD

Oct. 26-28: Aeronautical & Navigation Electronics, East Coast Conf., PGANE of IRE, Lord Baltimore Hotel, Baltimore.

Oct. 28-29: Michigan Industrial Electronics Exposition, Electronics Representatives Inc., Detroit Artillery Armory, Oak Park, Mich.

Oct. 29-30: Electron Devices Meeting, PGED of IRE, Shoreham Hotel, Washington, D. C.

Nov. 3-5: Mid-American Electronics Conf., MAECON, Municipal Auditorium and Hotel Muehlenbach, Kansas City, Mo.

Nov. 4-6: Automatic Control, National Conf., PGAC & PGIE of IRE, Sheraton-Dallas Hotel, Dallas.

Nov. 5-6: Instrumentation Conf., School of Engineering, Louisiana Polytechnic Institute, Ruston, La.

Nov. 9-11: Radio Fall Meeting, IRE, EIA, Hotel Syracuse, Syracuse, N. Y.

Nov. 9-11: Instrumentation Conf., PGI of IRE, Biltmore Hotel, Atlanta.

Nov. 10-12: Electrical Techniques in Medicine & Biology, AIEE, ISA, PGME of IRE, Sheraton Hotel, Philadelphia.

Nov. 16-20: American Rocket Society, Annual Meeting, Washington, D. C.

Nov. 16-20: Magnetism & Magnetic Materials, AIEE, AIM, APS, IRE, ONR, Detroit.

Nov. 17-19: Northeast Electronics Research and Engineering Meeting, Annual, NEREM, Commonwealth Armory, Boston.

Nov. 23-24: Solid Facts about Solid State, Symposium, ISA, IRE, Ben Franklin Hotel, Philadelphia.

Dec. 1-3: Eastern Joint Computer Conference, AIEE, ACM, PGEC of IRE, Hotel Statler, Boston.

Mar. 21-24, 1960: Institute of Radio Engineers, National Convention, Coliseum & Waldorf-Astoria Hotel, N. Y. C.

There's more news in ON the MARKET, PLANTS and PEOPLE and other departments beginning on p 140.



# Widen the scope of component design

...with ALUNDUM\*  
high-purity fused alumina grain

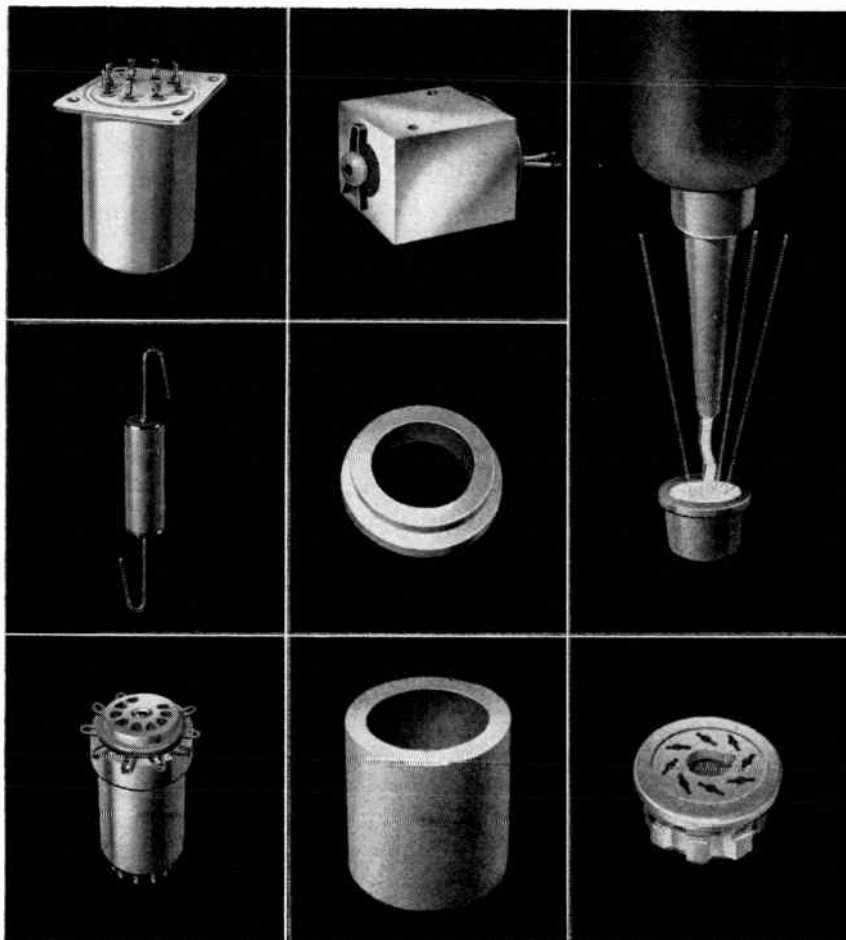

Here is a super-refined, highly versatile ceramic grain that gives electronic component designers real creative latitude. With its superior electrical and mechanical properties to work with, even the most advanced design concepts can be translated into practical products efficiently and economically.

Electrochemically refined to extreme purity, the outstanding performance of this Norton ALUNDUM Grain in 500 and 900 mesh size, has long made it a favorite for coating the heaters of radio and television tubes. It's readily available for use throughout the electronics industry — not only in the above mesh sizes but also in a large range of coarser sizes — for virtually limitless applications.

For example, ALUNDUM grain combined with epoxy resins or silicone compounds makes possible superior potting, encapsulating, and sealing agents. Again, used as a basic ingredient in ceramic type mixes or in insulating powders, it readily lends itself to casting, molding or extruding of sleeves, shells, tubes, collars, etc. And in every case, it makes design easier . . . processing more profitable.

Check the exceptional characteristics of ALUNDUM Fused Alumina Grain in the table below. Then get in touch with a Norton Engineer for specific details on your precise requirements. He'll be glad to describe the application of this and other types of Norton Refractory Grain to electronic component design. Write to NORTON COMPANY, Refractories Division, 939 New Bond St., Worcester 6, Mass.

**ALUNDUM Fused Alumina Grain**  
Gives You these Superior Properties  
. . . and many more!

- High Dielectric Strength**
- High Electrical Resistance**
- High Heat Conductivity**
- High Resistance to Thermal Shock**
- High Mechanical Strength**
- High Dimensional Stability**
- Extreme Hardness**
- Excellent Abrasion Resistance**

*Available in a wide range of grain sizes*

\*Trade-Mark Reg. U. S. Pat. Off. and Foreign Countries



**REFRACTORIES**

Engineered... **R**... Prescribed

Making better products... to make your products better

# HOW MUCH HEAT CAN

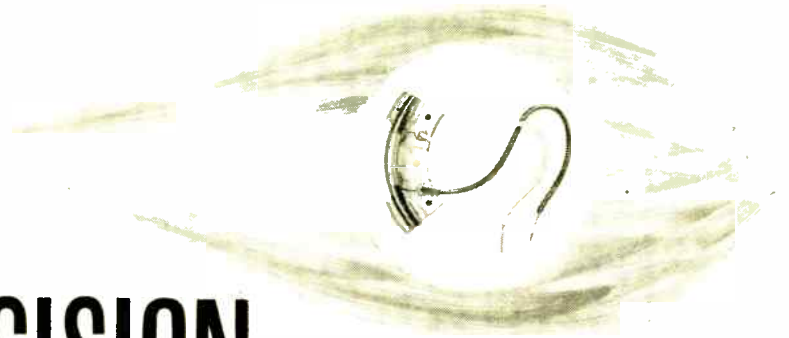
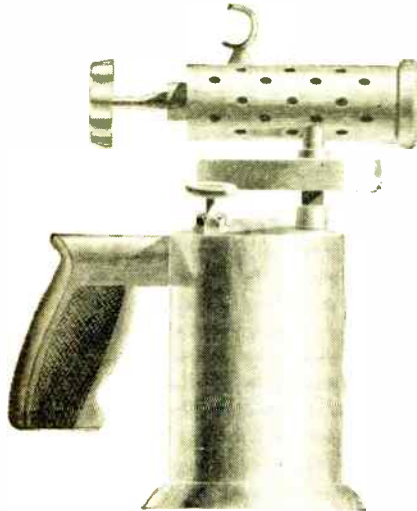

# PRECISION POTENTIOMETERS TAKE?

Special Ketay sector potentiometers have been designed to operate in ambient temperatures up to 500° C.

Ketay precision single-turn, multi-turn, rectilinear and sector potentiometers for control and instrumentation purposes feature compactness and high sensitivity. They are custom engineered for applications once considered too severe because of shock, vibration, torque, resolution or destructive environment.

Potentiometers that meet the most rigid specifications result from:

*Creative Engineering*—for example, very accurate single-turn ganged potentiometers in size 9 with linearity as fine as 0.15% and 2" diameter units with linearity as fine as 0.07%.

*Superior Materials*—selection to give optimum service for particular performance and operational requirements.

*Advanced Manufacturing Techniques*—such as the ability to weld taps to a single turn of wire as small as 0.0004" diameter (1/10 the diameter of a human hair).

Ketay potentiometers are being produced in a wide range of types and sizes, from tiny precision pick-offs to complex function and multi-wiper units.

*Ketay precision components:*

SYNCHROS  
RESOLVERS  
POTENTIOMETERS  
SERVO MOTORS  
TACHOMETERS  
SERVO AMPLIFIERS  
GYROSCOPES

*Catalogues available*



**\* NORDEN \***

Division of United Aircraft Corporation

**KETAY DEPARTMENT, Commack, Long Island, N.Y.**





Meter Relays: 2" and 3"; AC and DC



Edgewise: Vertical, DC



Wide-Vue: 2½", 3½", 4½"; AC and DC

# These are Simpson panel instruments...



Round: 3", DC



Rectangular: 4", 4½", 5½", AC or DC, RF; 7" and 9", DC or RF



Front Adjust Relay: 2½", 3½", 4½"; DC. Rectangular also.

# engineered and built to stay accurate...

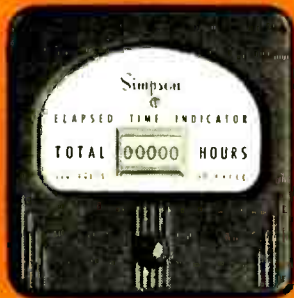

Elapsed Time: 3½"; 60-cycle AC



Fan Shape: 4½", AC or DC



Modernistic: 2½", 3½", 4½", 5½"; AC, DC, RF

## available from stock or custom-built

# METERS FOR EVERY NEED

# Simpson

ELECTRIC COMPANY

5203 W. Kinzie St., Chicago 44, Ill.

Phone: ESTebrook 9-1121

In Canada: Bach-Simpson Ltd., London, Ontario

# TWA'S EXPANDED ADDS MORE FLIGHTS...



## Larger, faster Super Sky Merchant Fleet provides more

- **Across The U.S.A.**, TWA's expanded Super Sky Merchant Fleet adds more flights... offers more service with great, all-cargo Super-H Constellations, to provide the most widely scheduled air freight service. Daily service to New York, Philadelphia, Pittsburgh, Columbus, St. Louis, Kansas City, Chicago, Los Angeles and San Francisco.
- **Overseas to Europe**, TWA's new Super Sky Merchants now offer four transatlantic flights each week to provide service to Shannon, London, Frankfurt, Paris, Zurich, Geneva, Milan, Rome.

*Whenever—whatever you ship, specify TWA.  
Call your Freight Forwarder or your nearest  
TWA Air Freight office today.*

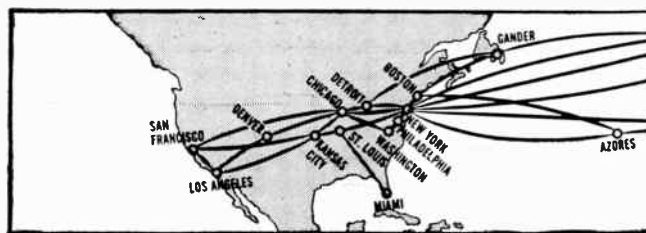



# SKY MERCHANT FLEET OFFERS MORE SERVICE!

NEW SERVICE STARTS OCTOBER 1



widely scheduled air freight service than ever before

- **Huge Cargo Doors** permit handling of extra-length items, and make it possible to load bulky machinery and equipment without disassembling.
- **Pressurized** and temperature-controlled cabins mean almost anything goes by TWA—from live animals and perishables to delicate electronic equipment.
- **Spacious Compartments** and reinforced flooring do away with almost all restrictions on the weight and size of your shipments.

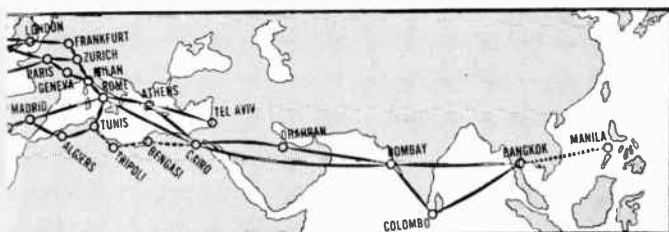

**SHIP THE FASTEST WAY**  
**SHIP TWA**  
**USA • EUROPE • AFRICA • ASIA**

# 100 "G" SYNCHRO

*Uniquely Designed to Withstand 100 "G" Shock Test... 20 "G" Vibration Test from 10 to 2500 Cycles... 20 "G" Acceleration Test...*

BURTON BROWNE ADVERTISING

- -55°C to +85°C temperature range. Higher if desired.
- 26V rotor excitation.
- .210 amps, 2 watt.
- 40 millivolts null voltage.
- 11.8 ± .5V max. stator output voltage.
- 35 + J145 rotor impedance.
- Withstands 10 lbs. lead pull test.
- Aluminum housing.

A complete line of synchros in sizes 8, 10, 11 and 15 is offered for your CX, CDX, CT, TX, TDX, TR and RS applications.



Type 4073-07.

**Oster**®

## Other Oster Synchros For Hi Temp Applications

Distinctive Oster features such as stainless steel housing and temperature stabilization are available for hi temp units.

*You are invited to consult Oster engineers on your synchro requirements.*

### OTHER PRODUCTS INCLUDE:

Servos	Computers
Resolvers	Indicators
Motor Tachs	Servo Mechanisms
DC Motors	Servo Torque Units

**John Oster**

### MANUFACTURING CO.

*Your Rotating Equipment Specialist*  
**Avlonic Division**  
 Racine, Wisconsin

**EASTERN** 310 Northern Blvd. • Great Neck, Long Island, New York  
**OFFICE** Phone: HUinter 7-9030 • TWX Great Neck N.Y. 2990

**WESTERN** 5233 South Sepulveda Blvd. • Culver City, California  
**OFFICE** Phone: EXment 1-5742 • UPTon 0-1194 • TWX S. Mon. 7671

*Engineers For Advanced Projects:*

Interesting, varied work on designing transistor circuits and servo mechanisms.  
 Contact Mr. Robert Burns, Personnel Manager, in confidence.



# RCA SILICON RECTIFIERS

DIFFUSED-JUNCTION  
TYPES

Another Way  
RCA  
Serves You  
Through  
Electronics

## RCA TYPES FOR INDUSTRIAL and MILITARY POWER SUPPLIES

RCA TYPE NUMBERS	MAXIMUM RATINGS Absolute-maximum values: For supply frequency of 60 cycles and with resistive or inductive load.							CHARACTERISTICS				
	Peak Inverse Voltage (VOLTS)	RMS Supply Voltage (VOLTS)	DC Reverse Voltage (VOLTS)	FORWARD CURRENT, DC				AMBIENT TEMPERATURE		At Ambient Temp. of 25°C		At Ambient Temp. of 150°C
				50°C Ambient (MA)	100°C Ambient (MA)	150°C Ambient (MA)	Surge One-Cycle (AMP)	Operating (°C)	Storage (°C)	Max. Forward Voltage Drop (DC) at indicated DC Forward Current (VOLTS)	Max. Reverse Current (DC) at Max. Peak Inverse Voltage ( $\mu$ A)	Max. Reverse Current (averaged over one complete cycle) at Max. Peak Inverse Voltage ( $\mu$ A)
IN536	50	35	50	750	500	250	15	-65 to +165	-65 to +175	1.1 at 500 ma	5	400
IN537	100	70	100	750	500	250	15	-65 to +165	-65 to +175	1.1 at 500 ma	5	400
IN538	200	140	200	750	500	250	15	-65 to +165	-65 to +175	1.1 at 500 ma	5	300
IN539	300	210	300	750	500	250	15	-65 to +165	-65 to +175	1.1 at 500 ma	5	300
IN540	400	280	400	750	500	250	15	-65 to +165	-65 to +175	1.1 at 500 ma	5	300
IN1095	500	350	500	750	500	250	15	-65 to +165	-65 to +175	1.2 at 500 ma	5	300
IN547	600	420	600	750	500	250	15	-65 to +165	-65 to +175	1.2 at 500 ma	5	350

## RCA TYPES FOR MAGNETIC AMPLIFIERS and BLOCKING CIRCUITS

RCA TYPE	Peak Inverse Voltage (VOLTS)	RMS Supply Voltage (VOLTS)	DC Reverse Voltage (VOLTS)	50°C Ambient (MA)	100°C Ambient (MA)	150°C Ambient (MA)	Surge One-Cycle (AMP)	Operating (°C)	Storage (°C)	At Ambient Temp. of 25°C	At Ambient Temp. of 150°C	
IN440-B	100	70	100	750	500	250	15	165	-65 to +175	1.5 at 750 ma	0.3	100
IN441-B	200	140	200	750	500	250	15	165	-65 to +175	1.5 at 750 ma	0.75	100
IN442-B	300	210	300	750	500	250	15	165	-65 to +175	1.5 at 750 ma	1.0	200
IN443-B	400	280	400	750	500	250	15	165	-65 to +175	1.5 at 750 ma	1.5	200
IN444-B	500	350	500	650	425	0	15	150	-65 to +175	1.5 at 750 ma	1.75	200
IN445-B	600	420	600	650	400	0	15	150	-65 to +175	1.5 at 750 ma	2.0	200

## RCA TYPES FOR TV and RADIO RECEIVERS and GENERAL PURPOSE

RCA TYPE	MAXIMUM RATINGS Absolute-Maximum Values: for supply frequency of 60 cps and with capacitor input to filter					CHARACTERISTICS						
	Peak Inverse Voltage (VOLTS)	RMS Supply Voltage (VOLTS)	FORWARD CURRENT (UP TO 75°C)			AMBIENT TEMPERATURE		At Ambient Temperature of 25°C			At Ambient Temperature of 100°C	
			DC (AMP)	Peak Recurrent (AMP)	Surge for a "turn-on" transient = 2 milliseconds (AMP)	Operating (°C)	Storage (°C)	Max. Instan- taneous Forward Voltage at Instantaneous Forward Current = 15 amps (VOLTS)	Peak Inverse Volts = 400	Peak Inverse Volts = 500	Peak Inverse Volts = 400	Peak Inverse Volts = 500
1N1763	400	140	0.5	5	35	100	-65 to +150	3	100	—	1	—
1N1764	500	175	0.5	5	35	100	-65 to +150	3	—	100	—	1



... immediately available from your local  
**RCA SEMICONDUCTOR  
DISTRIBUTOR!**

QUALITY is the reason designers of high-reliability equipment specify RCA Silicon Rectifiers. FAST SERVICE is the reason they order through their local RCA SEMICONDUCTOR DISTRIBUTOR.

All RCA Silicon Rectifiers are Welded and Hermetically Sealed. Entertainment types are subjected to rigid quality control procedures to provide top quality and performance. In addition, RCA types for Industrial Power Supplies and Magnetic Amplifiers undergo these extensive tests to assure reliability and long life.

- 100% high-temperature dynamic test at full load current and rated voltage
- 100% reverse leakage current test
- 100% forward characteristic test
- 100% pressure-seal test
- 100% temperature cycling test

So, whatever your requirements for Silicon Rectifiers—or transistors—for fast service check with your local RCA SEMICONDUCTOR DISTRIBUTOR. For quality products, specify RCA. You benefit from this combination!



**RADIO CORPORATION OF AMERICA**  
Semiconductor Products—Distributor Sales • Harrison, New Jersey

*Last year, traffic accidents killed 37,000, injured 1,400,000*

**... and they wasted Five Billion Dollars!**

Traffic accidents' human toll is so tragic we sometimes overlook their staggering economic waste. Five Billion Dollars in lost wages, medical expenses, insurance costs and property damage! Your business—every business—shares in this loss. So you have a double interest in helping reduce traffic accidents. And you *can* help! Drive safely and obey the law yourself . . . certainly. But go further. Use your influence to promote safe driving and urge strict law enforcement. To make your efforts more effective, join with others working actively to reduce traffic hazards in your community. *Support your local Safety Council!*

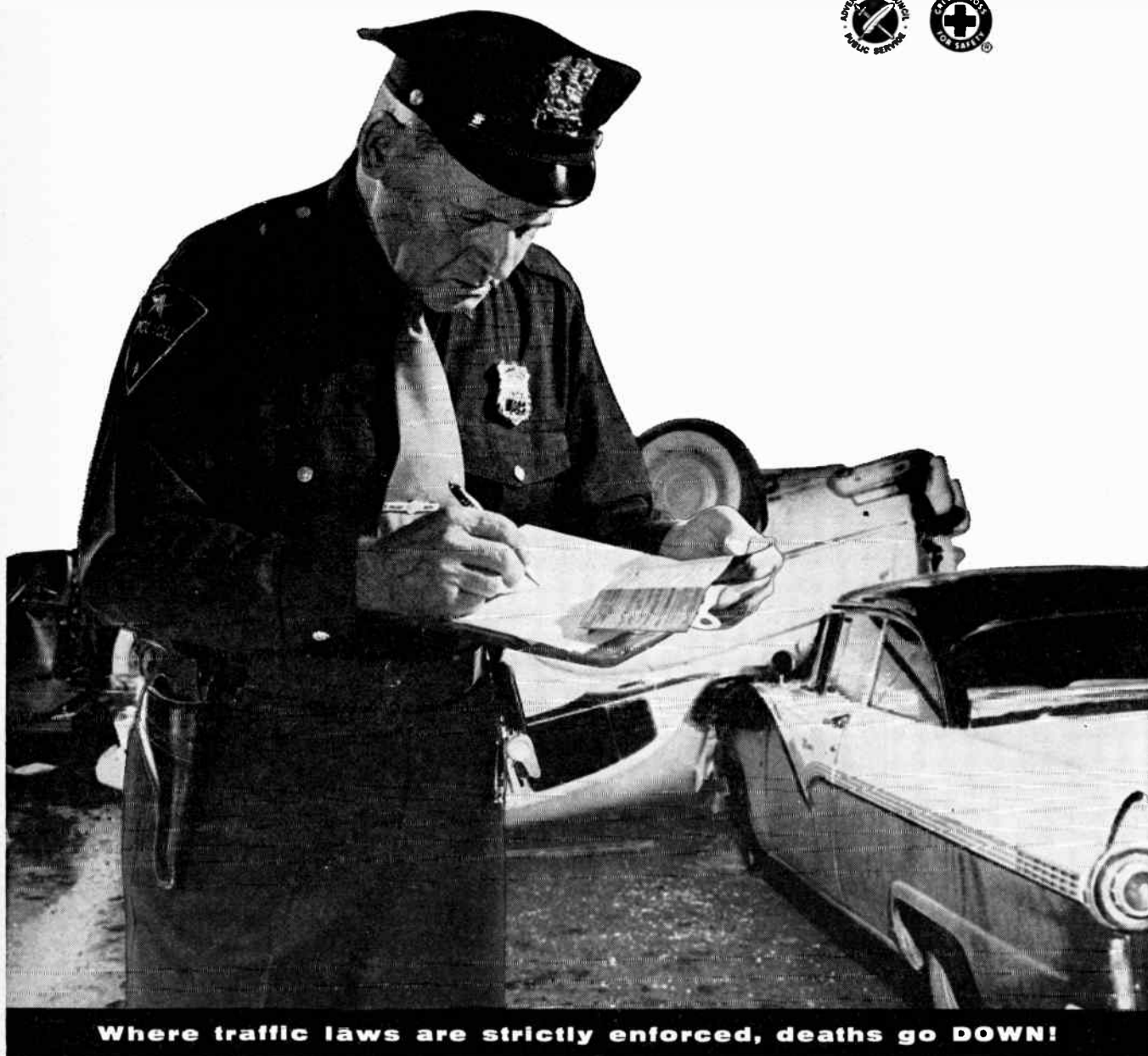

**Where traffic laws are strictly enforced, deaths go DOWN!**

*Published in an effort to save lives, in cooperation with the National Safety Council and The Advertising Council.*





AN ACHIEVEMENT  
IN DEFENSE ELECTRONICS

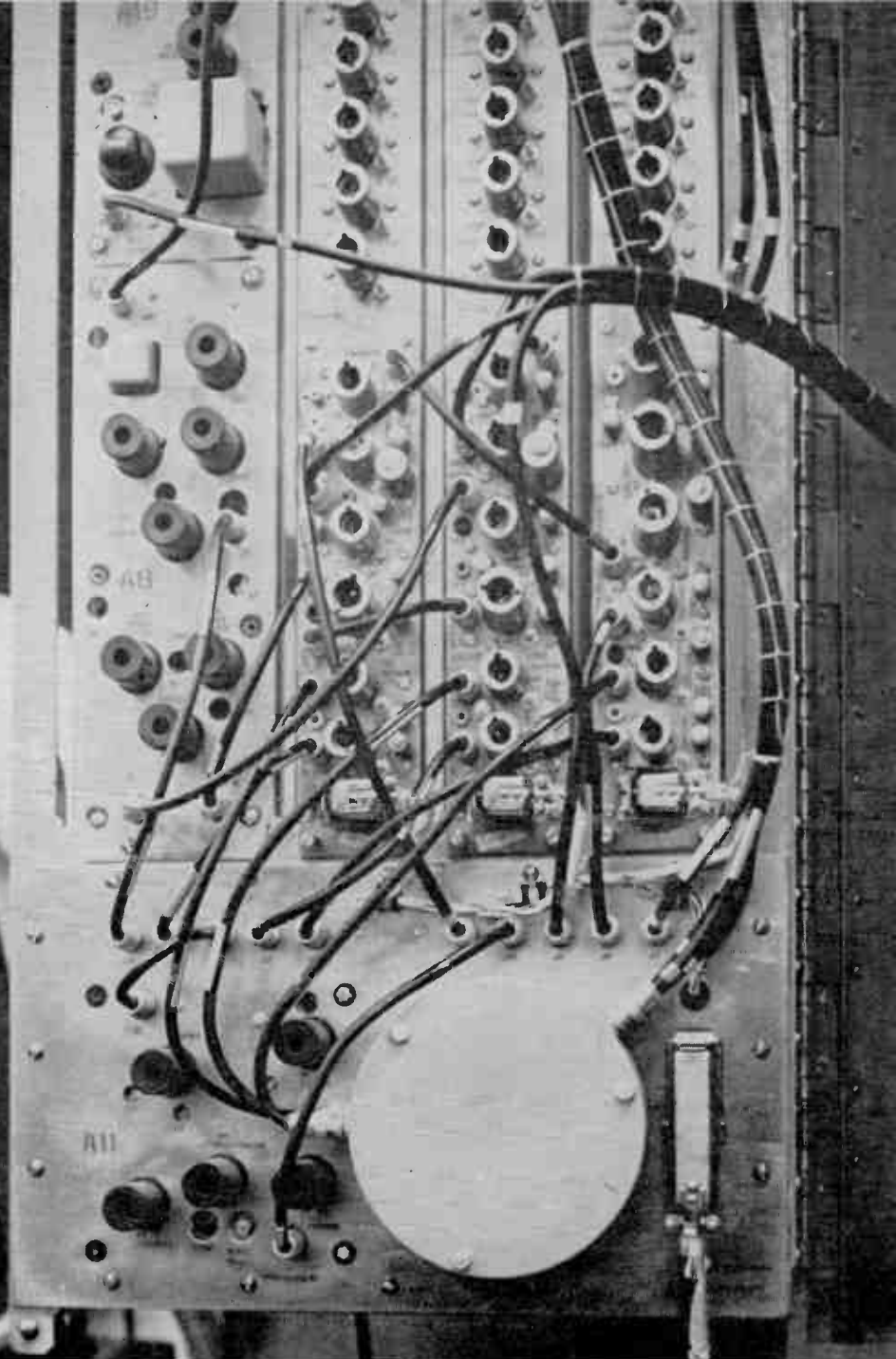

## NEW SONAR SIGNAL PROCESSOR DOES WORK OF 1,000 UNITS

The first sonar signal processors to utilize time compression are being produced by General Electric. These new processors were developed in cooperation with the United States Navy. Extracting only critical bits of transmitted and received signals in series, one unit can perform as many correlating operations on a continuous signal—in the same time—as a parallel processor with thousands of units.

Excellent improvement in signal-to-noise ratio also makes these new processors effective against background levels which have formerly made certain signals undetectable by any other practical means. The new equipment is also designed to handle signals from more than one transducer.

This advance in sonar signal processing is typical of General Electric's many achievements in defense electronics.

227-3

*Progress Is Our Most Important Product*

**GENERAL  ELECTRIC**

DEFENSE ELECTRONICS DIVISION • HEAVY MILITARY ELECTRONICS DEPT. • SYRACUSE, N. Y.

World Radio History

KAY ELECTRIC . . . first in Noise Figure Measurement

ALL NEW!

**KAY**

# Therma-Node

CAT. NO. 770

**NEW NOISE  
GENERATION  
TECHNIQUE  
COVERS**

**0.5 TO 1100 MC—**

**ACCURATE TO ±0.1 DB**

*No Gas Discharge Tubes,  
Diodes, or External Cables*



The new Kay Therma-Node is shown here operating in conjunction with a Kay DRD (Direct Reading Digital) Attenuator (Model 40-0)

The new Kay Therma-Node is a highly accurate commercial noise generator based on the measurement of the noise temperature of a heated resistive element. It covers an extremely wide frequency range of 0.5 to 1100 mc, either fixed or tuned, is accurate to ±0.1 db, and provides noise temperatures ranging from 2000° K to 2400° K readable to ±2%—sufficient to accommodate noise figure measurements up to 10 db. Lower noise temperatures (down to room temperatures) and various impedances are attainable with suitable matching networks and attenuators. No gas discharge tubes, diodes, or external cables are required. The resistive element that generates the noise has a life expectancy of more than 10,000 hours of continuous or intermittent use; the few active devices used in the Therma-Node are of solid state, reducing maintenance to a minimum. The unit can be operated on 117V., 60 cps or 24 volt battery.

Write for  
Kay Catalog 1959-A

**SPECIFICATIONS**

**FIXED TUNING RANGE:** 1-500 mc.  
Output Impedance: 50 ohms.  
Maximum VSWR: 1.2 VSWR from 4 mc to 200 mc; 1.4 VSWR from 2 mc to 400 mc; 2.0 VSWR from 1 mc to 500 mc.  
Noise Temperature: 2000°-2400° K, measured within 2%.

**VARIABLE TUNING RANGE:** 5-1050 mc.  
Output Impedance: 50 ohms.  
Maximum VSWR: 1.1 at center frequency.

Minimum Bandwidth for Average VSWR of 1.4: From 200 to 1050 mc—200 mc; below 200 mc the unit is broadband down to 1 mc.  
Noise Temperature: 2000°-2400° K, measured within 2%.  
Dimensions: 10½" x 7" x 4".  
Weight: 8 lbs.  
Price: \$495.00, f.o.b. factory.

**OTHER KAY NOISE GENERATORS**

Instrument & Cat. No.	Frequency Range (mc)	Noise Figure Range (db)	Output Impedance (ohms)	Price f.o.b. factory
Mega-Node 240-B	5-220	0-16 at 50 ohms 0-23.8 at 300 ohms	unbal.—50, 75, 150, 300, ∞ bal.—100, 150, 300, 600, ∞	\$365.00
Mega-Node 175-A	50-500	0-19	balanced—300	\$365.00
Mega-Node 403-A	3-500	0-19	unbalanced—50	\$365.00
Mega-Node-Sr. 250-B	10-3000	0-20	unbalanced—50	\$790.00
Rada-Node 600-A	5-400	0-23.8 depending on impedance	unbalanced as specified	\$1495.00
	10-3000	0-20	unbal. nom. 50	\$1965.00
	1120-26,500	15.28 or 15.8	waveguide	†
Micro-Node 1080-A	3700-4200	0-15.8	waveguide	\$795.00
Microwave Mega-Nodes*	1120-26,500	15.28 or 15.8	waveguide	\$175.00 to \$595.00

† Price varies with Microwave Mega-Node discharge tube used as accessory.  
\* Ideally suited for noise figure measurement in radar communication.

**KAY ELECTRIC COMPANY**

Dept. E-10

Maple Avenue, Pine Brook, N. J.

Capital 6-4000



in or out of outer space

**E-I**

**GLASS-TO-METAL  
SEALS**

**- universally specified as the reliable line!**

FOR COMMERCIAL EQUIPMENT AND VITAL SPACE AGE PROJECTS - Proof of the rugged reliability of E-I glass-to-metal seals is the fact they are employed on vital missile and rocket programs... are specified for commercial equipment by leading manufacturers industry-wide. E-I offers the widest range of standard terminals for maximum design flexibility... fast service on "specials" for unusual specifications... a broad selection of miniature components... and economical custom sealing of your assemblies. Call or write for complete information today.



PLUG-IN CONNECTORS



CUSTOM SEALING



SEALED TERMINALS



TRANSISTOR CLOSURES



MINIATURE CLOSURES



MULTIPLE HEADERS



THREADED SEALS

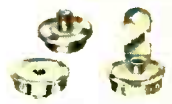

SINGLE LEAD TERMINALS

**ELECTRICAL  
INDUSTRIES**



A Division of Philips Electronics, Inc MURRAY HILL, NEW JERSEY

Patented in Canada, No. 523,390; in United Kingdom, No. 734,582; licensed in U. S. under No. 2561520

# you are looking at the best UNIVERSAL COUNTER-TIMER

*Presenting* the new **CMC 226B**



**and here's the proof...**

## ENGINEERED FOR THE USER

CMC's new universal counter-timer is human engineered to eliminate costly "cockpit trouble." Take a look at the clean, functional lines.

And inside, this tastefully styled instrument uses modular circuitry to simplify maintenance and cut weight. Nine tubes have been eliminated, lowering power drain and operating temperature and increasing reliability. Weight is only 40 lbs.

## TECHNICALLY SPEAKING

Direct reading, 0 to 1.2 mc. Time interval, 1 microsecond to 1 million seconds. Period, 0 microsecond to 1 million seconds. Stability of 2 parts in  $10^7$ , with an option of 5 parts in  $10^8$ . Sensitivity 0.1 volt rms.

Three input channels. Automatic decimal point indication. Reads directly in kilocycles, cycles, or microseconds.

Three independent, continuously adjustable trigger level controls for full rated sensitivity at any voltage level between -150 and +300 volts.

Oscilloscope marker signal to speed start and stop trigger level adjustment for TIM of complex waveforms; trigger level adjustment for amplitude discrimination in frequency and period measurement. Drives the CMC fast printer and most other types of printers and data handling equipment.

## DO ALL THESE JOBS PRECISELY DO THEM EVERY TIME

Measure frequency, time interval, period, phase shift, frequency ratio, rpm, flow, velocity, and many other basic physical quantities.

## NOW THE PRICE

\$1100 fob Sylmar, California. Rack mount \$10 extra. 220 kc Model 225C with similar specifications, \$840 fob Sylmar.

## WANT MORE DATA?

Your nearby CMC engineering representative will be happy to arrange a demonstration and provide you with complete technical information. Or you may write Department 1810.



**Computer-Measurements  
Company** A Division of Pacific Industries, Inc.

12970 Bradley Avenue • Sylmar, California

Phone: EMpire 7-2161

22



# New from Japan . . .

## Important advance in short-haul, multi-channel communications

Microwave 60-channel voice transmission over a non-optical path up to 300 MILES is now possible without repeater stations.

NEC's High Sensitivity Reception System, by extending threshold level and improving S/N ratio 10 to 13 db makes this hop with only 1/20 of the power output required for conventional systems.

A 100 W transmitter in the 1,800-mc band, for example, has a scatter path of 100–150 MILES. A conventional FM system requires 2 KW output and at least one repeater station to connect the same distance over a non-optical path.

By eliminating high-power amplifiers and repeater stations, the High Sensitivity Reception System results in considerable reduction in initial investment. Savings in maintenance and power consumption are estimated at 40% or more.

Extensive propagation tests have been made, and NEC is now prepared to supply commercial users and government agencies anywhere in the world. Please write for detailed information.

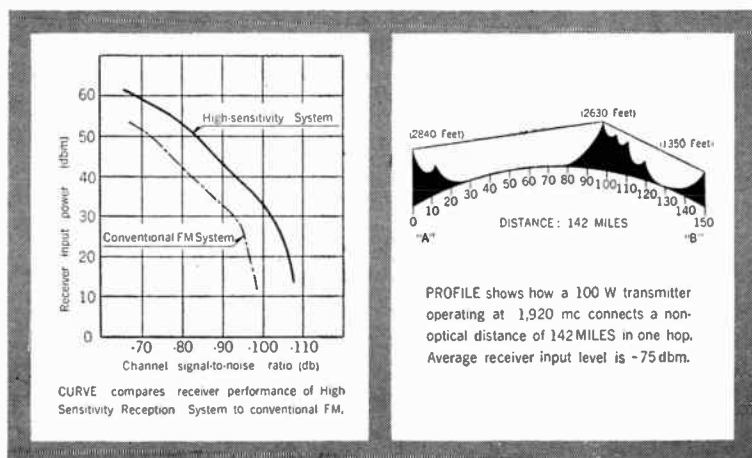
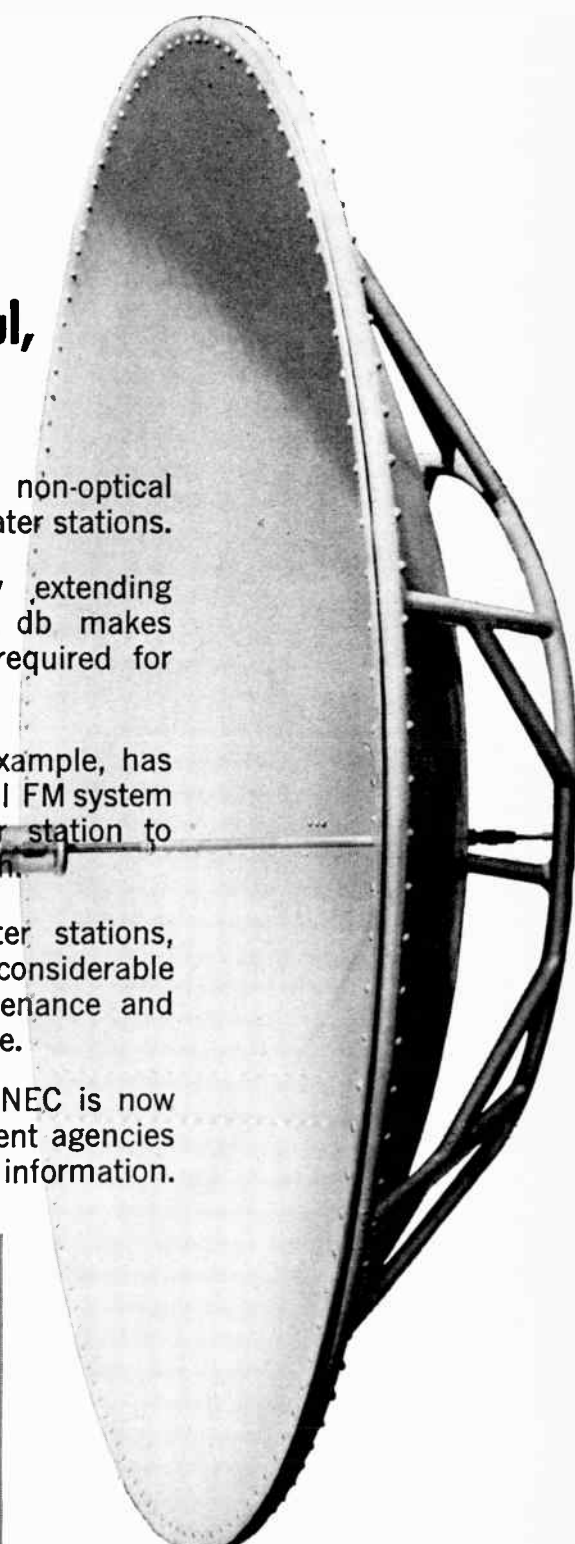

**Nippon Electric Company Ltd.**

Tokyo, Japan

Electronics / Communications Systems

# creating controls

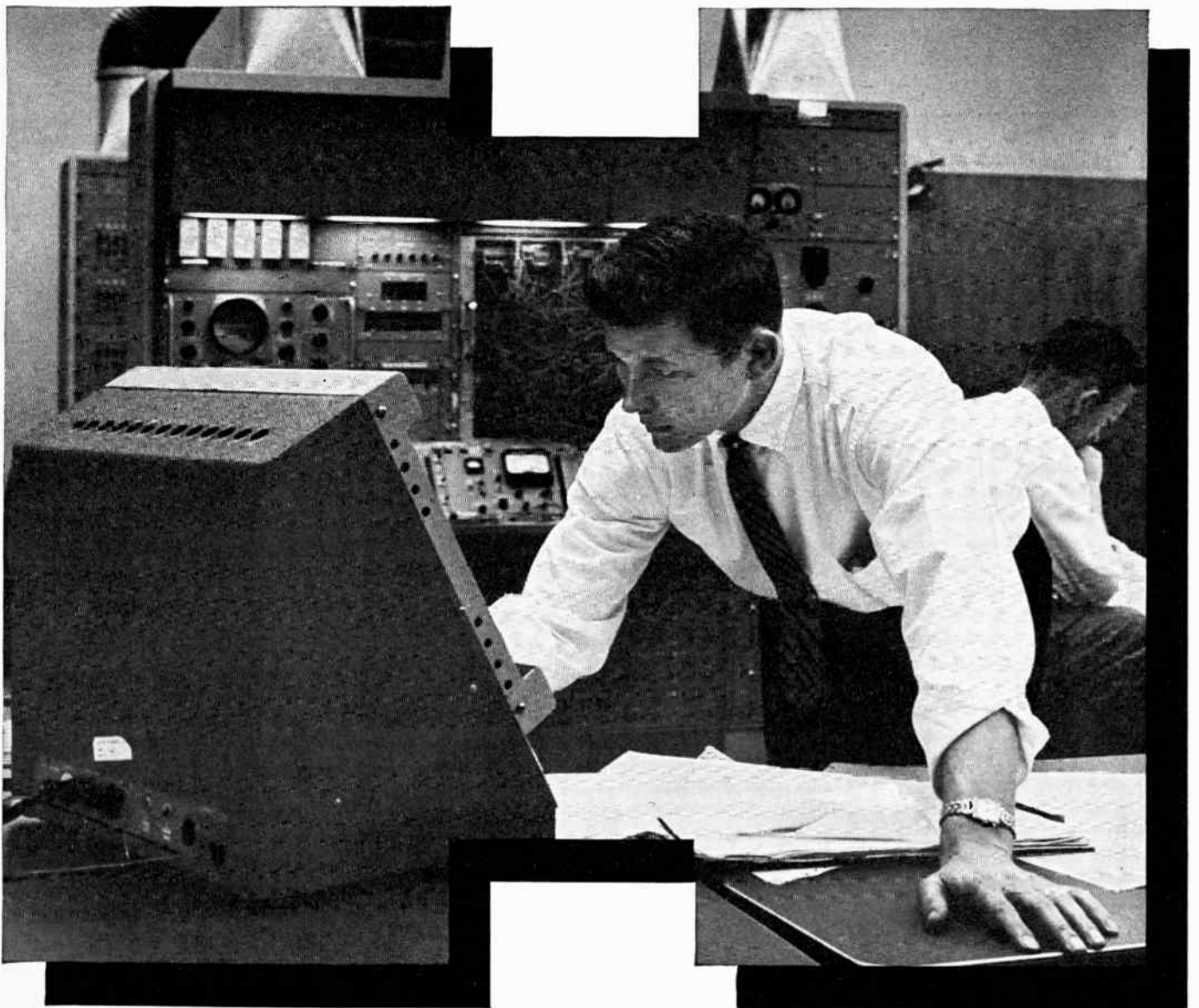





**Everywhere Hughes systems and missiles are employed, Hughes Field Engineers insure maximum utilization and field performance.**

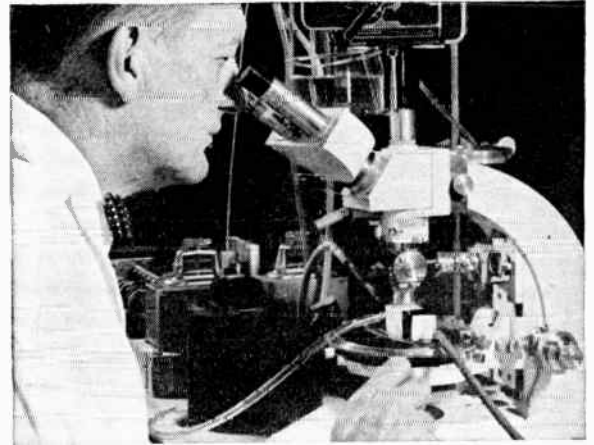

**Developing new semiconductor materials, physicists at the Semiconductor Division of Hughes Products utilize highly advanced techniques.**

## for the space age

Operating with accuracy at speeds far beyond man's ability to reason and act, the control systems produced by Hughes-El Segundo are blazing new trails in the state of the art.

Recognized as the leader in airborne control systems, Hughes is responsible for the controls in our most advanced weapons systems. And, today, Hughes engineers and scientists are expediting work on even more advanced systems which will help carry man on his first probes into space.

This work demands engineers of special ability, who are capable of translating theory into hardware of fantastic accuracy and dependability. A large share of engineering time at Hughes El Segundo is spent in the continuing development of these systems... and in the development of equipment and methods to support the program.

The systems philosophy is characteristic of all Hughes activities...covering the spectrum of electronic progress: space vehicles, plastics, nuclear electronics, infrared devices, advanced data processing and display systems, microwaves, global communications, ballistics missiles and many

others. These activities provide stimulating outlets for creative engineering talents.

Hughes Products, the commercial activity of Hughes, has assignments for imaginative engineers in several areas of research in semiconductor materials and electron tubes.

The great variety of advanced projects...the stability stemming from a position of leadership...and Hughes engineering-orientation creates an ideal environment for the engineer or scientist interested in advancing his professional status.

*Newly instituted programs at Hughes have created immediate openings for engineers experienced in the following areas:*

Logical Design	Communications
Digital Computers	Thin Films
Infrared	Microwave Tubes
Plasma Physics	Circuit Design & Evaluation
Field Engineering	Systems Design & Analysis
Quartz Crystal Filters	Semiconductor Circuit Des.

*Write in confidence to Mr. Wally Peterson  
Hughes General Offices, Bldg. 6-D 10, Culver City, Calif.*

*Creating a  
new world with  
ELECTRONICS*

**HUGHES**

HUGHES AIRCRAFT COMPANY

*Culver City, El Segundo, Fullerton, Newport Beach,  
Malibu and Los Angeles, California  
Tucson, Arizona*

**ATTENTION!**  
**Assembly**  
**Specialists**

# Cleco's Automatic Torque Control Tools can Speed up your production---

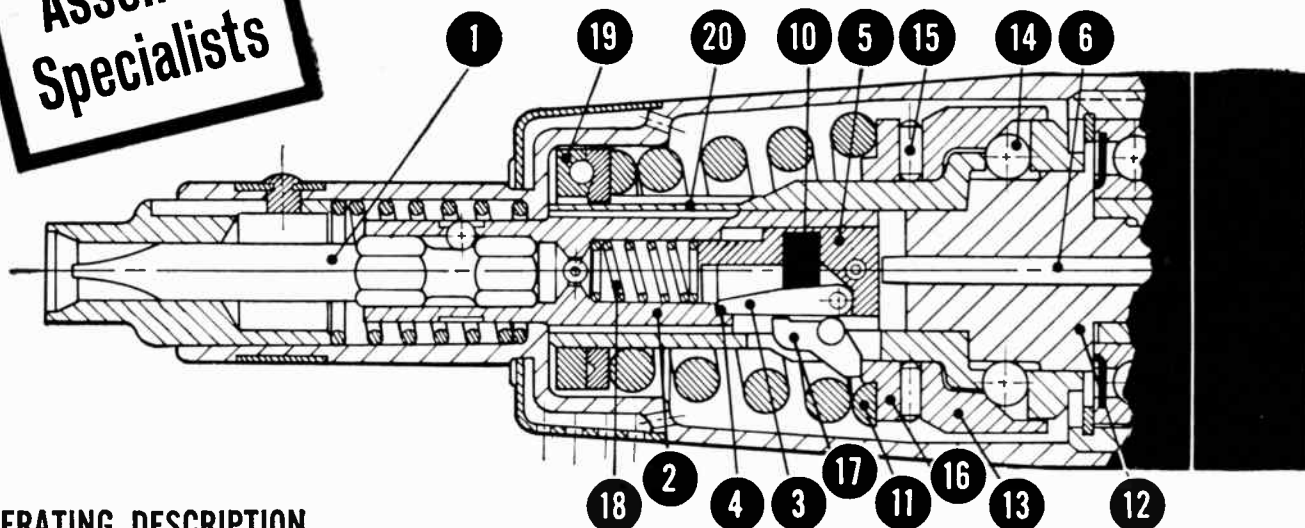

## OPERATING DESCRIPTION

### OF THE CLECOMATIC\* SCREWDRIVER - NUT RUNNER. An automatic start and stop tool.

Tool is started by pushing bit (1) against the work, movement of the bit moves spindle (2) into contact with latch (3) at shoulder (4). Latch is fastened to latch body assembly (5) which continues movement to throttle valve rod (6) and on to throttle valve (7) which, then opens at seat (8) admitting air to the tool, at which time compression in spring (9) is increased. Latch is held in engagement with shoulder by rubber spring (10). During run down cycle, bit is continuously held against work.

When required torque is reached at the driving spindle it is transmitted to pinion spindle (12) causing the hexagonal portion of pinion spindle to overcome the force exerted against it by the preset torque spring (11) acting thru ball retainer (13) and balls (14). The balls climb to the hexagonal crests forcing ball retainer away from the motor, and transmitting the motion thru thrust bearing (15) and thrust plate (16) pivoting latch dog (17) against, and disengaging, latch from shoulder, allowing latch body

No other nutsetter compares with Cleco's automatic 14 and 16 Series Right Angle Nutsetters for running down nuts and bolts to uniform tightness... quickly, because it is the only nutsetter employing the unique Clecomatic principle.

Torque is preset to precise specifications. When specified foot pounds are obtained, the air supply is shut off at the driving spindle. Torque adjustments are easily made externally—without disassembling the tool.

These dependable tools give you consistent quality control. Operator cannot over torque nut or bolt. When minimum air pressure is available to produce the desired torque, an increase in air pressure will not appreciably affect preset torque in the Clecomatic. Cleco Right Angle Nutsetters help improve your production efficiency, too! Hazardous, tiring tool kick is greatly reduced, and these rugged tools weigh less than competitive torque

\*Trademark

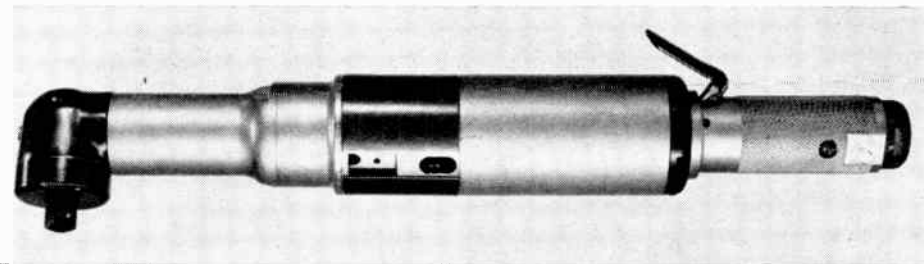

This 16 ANS-500 model weighs only 7.5 lbs. and is 17 $\frac{3}{8}$  inches long. Angle head is 2 $\frac{1}{2}$  inches high. Both recessed socket heads and double-end spindles (reversible) are available. For individual operator comfort and efficiency, throttle lever can be revolved 360° to any desired position.

control wrenches. Your operators can produce more units per hour without extra effort... *end-of-shift slow down due to fatigue can be substantially decreased.*

Both the 14 and 16 Series are equipped with a non-friction clutch which permits long periods of maintenance free operation. All planetary gear trains have three equally spaced idlers. The same motor, handle, and clutch is used on different gear trains in each series. The tools are quickly and simply assembled and disassembled.

To see just how much these exclusive Cleco tools can do for your production operation, call your local Cleco sales engineer for a job tryout. There is no obligation.

## CLECO AIR TOOLS

A Division of REED ROLLER BIT COMPANY  
 P. O. Box 2119 • Houston 1, Texas, U.S.A.  
 IN CANADA: Cleco Pneumatic Tool Company of Canada, Ltd.  
 927 Millwood Road, Leaside (Toronto), Ontario



# help you get better quality control!

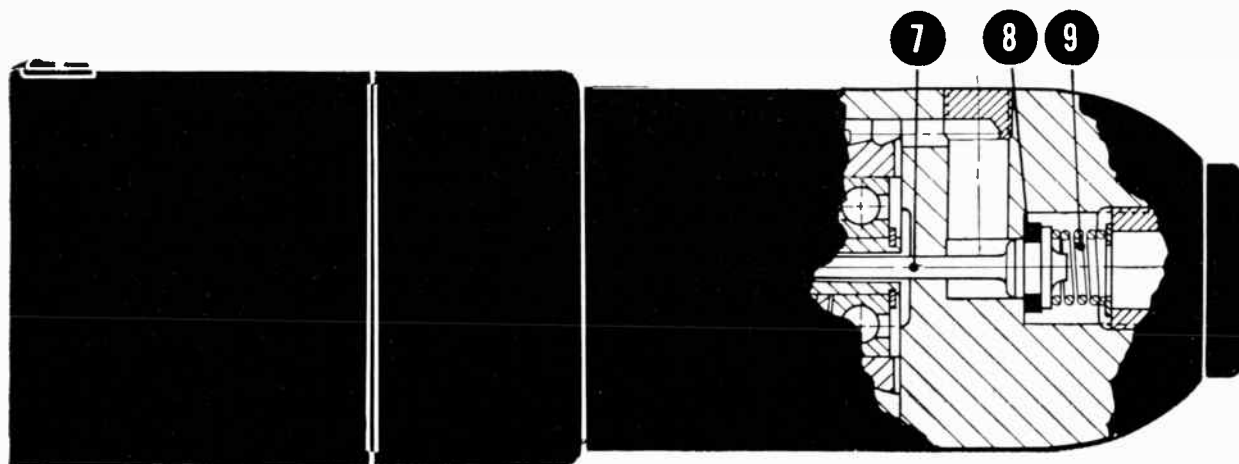

## Originated and solely produced by Cleco® Air Tools.

assembly, rod, and throttle valve to move forward, urged by compression in throttle to valve spring, thus automatically shutting off air supply to motor—even though operator may continue pushing against the work. At the time latch body assembly moves forward it compresses spring (18).

Pressure between bit and work is released permitting compression in latch body spring to move latch body assembly back to starting position and

thus permit latch to again engage with shoulder in spindle, completing the cycle.

To change torque setting, clutch assembly is simply removed from the tool and adjustment nut (19) screwed in or out on drive shaft (20) increasing or decreasing compression in torque spring thus raising or lowering the torque as desired. These tools are available in speeds ranging from 400 to 2900 r.p.m.

**For screwdriving and nutsetting the completely automatic Clecomatic, originated and solely produced by Cleco, gives unprecedented speed, quality control, and economy.**

**This unique screwdriver — nut runner:**

**Starts and Stops Automatically.** The operator merely engages the screw with the bit, the tool does the rest. There is minimum impact or vibration to tire the operator — production slow-down at the end of a shift is reduced.

**Positively Holds Torque.** Preset the torque to your most critical specifications, then forget it. An accurate, no-drift locking device positively maintains torque control. Increased air pressure will not appreciably affect torque setting. Non-friction clutch is easily removed and adjusted when torque change is desired.

**Uses Less Air.** Air motor operates only during actual rundown. Less air is required per job. Tool wear is greatly reduced.

**Is Easy To Handle.** The Clecomatic is shorter, weighs less. Automatic start and stop action eliminates bothersome triggers and levers.

**Helps Reduce Parts Inventory.** Gears, motors, and finders of the Clecomatic are interchangeable with Cleco No. 10 Series Drills and Screwdrivers. The Clecomatic is quickly converted from pistol grip to straight handle as required.

Model 10 RSA-10K Clecomatic Reversible Screwdriver has a speed of 700 r.p.m. Weighs 2 lbs. 8 ozs. and is only 10¾ inches long. Speed range of the #10 Clecomatic is 400 r.p.m. to 2900 r.p.m. The Clecomatic is available in reversible and non-reversible models, in either pistol grip or straight handles.

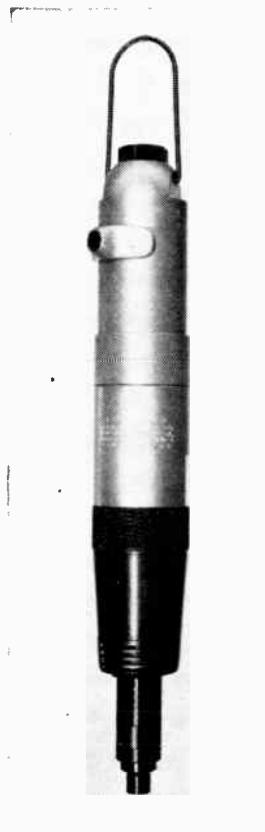

- Send free descriptive literature on: Clecomatic Screwdriver — Nut Runner.....
- Right Angle Nutsetter.....
- Have your representative contact us.....

Name \_\_\_\_\_ Title \_\_\_\_\_

Company \_\_\_\_\_

Address \_\_\_\_\_

City \_\_\_\_\_ State \_\_\_\_\_

# MOTOROLA

## TEMPERATURE COMPENSATED

# ZENER DIODES

### TO .0005% / °C

NEW silicon diffused junction  
precision components  
for applications demanding  
extreme stability... reliability

ELECTRICAL CHARACTERISTICS, at 10.0 ma

Type Number	Voltage Range @ 10.0 ma (25°C Ambient) Volts	Voltage-Temperature Coefficient %/°C	Temperature Range °C
1N2620	8.9-9.7	.01	0 to +75
1N2620/A	8.9-9.7	.01	-55 to +100
1N2620/B	8.9-9.7	.01	-55 to +150
1N2621	8.9-9.7	.005	0 to +75
1N2621/A	8.9-9.7	.005	-55 to +100
1N2621/B	8.9-9.7	.005	-55 to +150
1N2622	8.9-9.7	.002	0 to +75
1N2622/A	8.9-9.7	.002	-55 to +100
1N2622/B	8.9-9.7	.002	-55 to +150
1N2623	8.9-9.7	.001	0 to +75
1N2623/A	8.9-9.7	.001	-55 to +100
1N2623/B	8.9-9.7	.001	-55 to +150
1N2624	8.9-9.7	.0005	0 to +75
1N2624/A	8.9-9.7	.0005	-55 to +100
1N2624/B	8.9-9.7	.0005	-55 to +150

• Maximum Dynamic Impedance: 15 ohms at 10 ma (all types)

IMMEDIATELY AVAILABLE  
FROM STOCK

Contact your nearest Motorola  
Semiconductor distributor  
for off-the-shelf delivery.

REGIONAL OFFICES:

RIDGEFIELD, NEW JERSEY  
540 Bergen Boulevard  
Whitney 5-7500  
from New York WI 7-2980

CHICAGO 39, ILLINOIS  
5234 West Diversey Avenue  
Avenue 2-4300

HOLLYWOOD 28, CALIFORNIA  
1741 Ivar Avenue  
Hollywood 2-0821

OUTSIDE U.S.A. AND CANADA WRITE: MOTOROLA INTERNATIONAL, S.A.  
4545 West Augusta Boulevard  
Chicago, Illinois



MOTOROLA, INC., 5005 E. McDOWELL, PHOENIX, ARIZONA

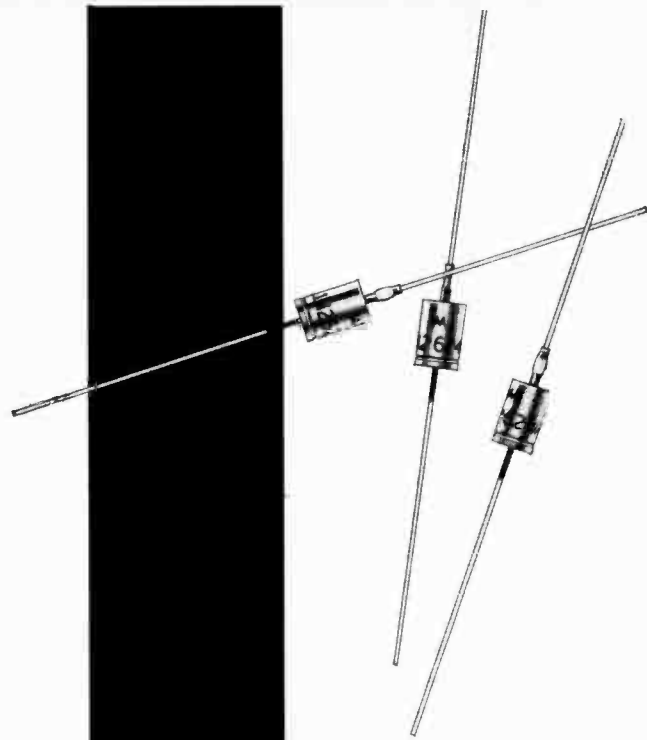

Offering temperature coefficients as low as .0005% per °C and temperature ranges as wide as -55 to +150°C, these new Motorola devices provide an extremely stable 9.3 volt reference source. The new axial-lead, flangeless package (only .22" x .35") is ideal for automatic insertion in printed circuit boards and simplifies connections to terminal strips. Units meet or exceed mechanical and environmental requirements of MIL-S-19500 providing the same reliable operation as Motorola's standard zener diodes.

These new Motorola diodes are designed for such voltage reference applications as digital voltmeters, precision high-stability oscillators, frequency meters, analog to digital converters and precision DC power supplies. And, they are available, now, from your Motorola Semiconductor Distributor.

#### NEW MIL SPEC ZENERS ALSO AVAILABLE

Three new Motorola 10 watt zeners (1N1353-1N1358-1N1361), the first ever produced to military specifications, are now available. Contact your nearest regional office for complete information.



# Save this Guide to Oak Choppers

Lightweight side contacts  
Leaf spring damping members  
Side contact snubbers

Lightweight armature and patented amplitude limiter give remarkable phase angle stability and adjustment in any mounting and at low temperatures

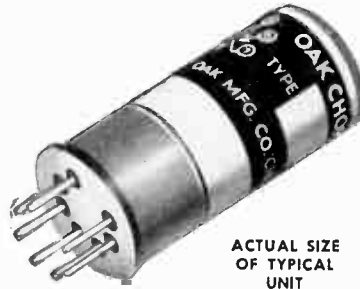
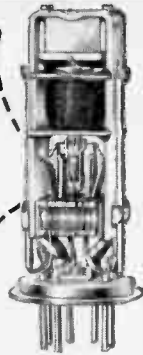

ACTUAL SIZE OF TYPICAL UNIT

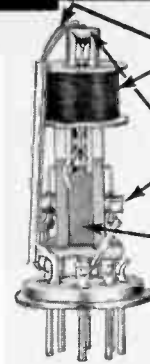

No organic materials other than Teflon are used in switch unit

All contact insulation and supports are metal-to-glass construction

Oriented ceramic magnet (patented design) eliminates parts, gives remarkable simplicity and ruggedness

## MINIATURE SERIES 600—MOST STABLE IN ITS CLASS

METICULOUS ENGINEERING combined with exhaustive testing provides a line of SPDT choppers which exhibit unusual stability and low noise. While the specifications shown here are necessarily abbreviated, they will help you make a preliminary appraisal. For complete details on any unit, send us the type number and a description of your application with its circuitry.

## MINIATURE SERIES M—SMALLEST, MOST RUGGED IN ITS CLASS

**SERIES 600**—MIL C4856, Class B, Type 1. Capacity between switch terminals and ground, 15 uuf average. Contact symmetry, within 10°. Weight, less than 1 oz.  
**SERIES M**—MIL C4856, Class B, Type 1, Grade 2. Capacity between switch terminals and ground, 3-5 uuf. Contact symmetry: 0-500 cps, within 10°; at 1000 cps, within 20°. Weight, less than 3/4 oz.

### STANDARD MOUNTING AND TERMINAL STYLES—Modifications Available on Special Order

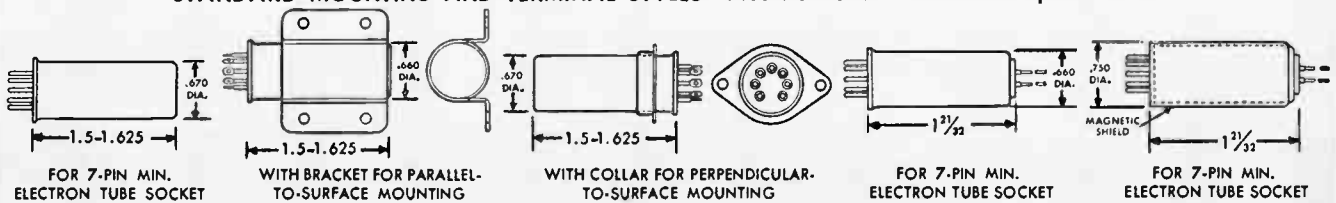

	SERIES 600						SERIES M For Shock and Vibration Conditions
	Types { 607 NC-600 602 603	Type 610	Type 604	Type 612	Type 605	Types { 608 609 NC-600A	Types { M5-1 M5-2 M5-3
Nominal Drive Freq. and Voltage	400 ± 20 cps at 6.3 v	400 ± 20 cps at 6.3 v	380-500 cps at 6.3 v	400 ± 20 cps at 6.3 v	400 ± 20 cps at 6.3 v	60 ± 5 cps at 6.3 v Aperiodic from 10-100 cps	4-8 Volts, 10-1000 cps. Aperiodic. Coil Current 60 ma at 400 cps Coil Res. 85 Ohms
Phase Lag at Nominal Drive Freq. and Voltage	65° ± 5° at 400 cps (25° C)	65° ± 5° at 400 cps (25° C)	75° ± 10° at 400 cps (25° C)	90° ± 10° at 400 cps (25° C)	180° +10° -0° at 400 cps (25° C)	20° ± 5° at 60 cps (25° C)	10 cps: 10° ± 5° 60 cps: 15° ± 5° 400 cps: 55° ± 10° 1000 cps: 110° - 0° (25° C)
Contact Dwell Time at Nominal Drive Freq. and Voltage	150° min (25° C)	140° max (25° C)	150° min (25° C)	150° min (25° C)	160° ± 10° (25° C)	165° to 170° at 60 cps	160° to 170° (25° C)
Contact Rating Into Resistive Load (Maximum)	CONTINUOUS: 10 v at 2 ma INTERMITTENT: 15 v at 2 ma	CONTINUOUS: 50 v at 2 ma INTERMITTENT: 100 v at 2 ma	CONTINUOUS: 10 v at 2 ma INTERMITTENT: 15 v at 2 ma	CONTINUOUS: 10 v at 2 ma INTERMITTENT: 15 v at 2 ma	CONTINUOUS: 50 v at 2 ma INTERMITTENT: 100 v at 2 ma	CONTINUOUS: 15 v at 2 ma INTERMITTENT: 50 v at 2 ma	CONTINUOUS: 10 v at 1 ma INTERMITTENT: 12 v at 2 ma
Life Expectancy (Optimum Conditions)	Up to 5000 hours	Up to 1000 hours	Up to 5000 hours	Up to 5000 hours	Up to 5000 hours	Up to 10,000 hours	Up to 10,000 hours
Switching Speed With DC Int Coil	Less than 1 Millisecond	Less than 1 Millisecond	Less than 1 Millisecond	Less than 1 Millisecond	Less than 1 Millisecond	Less than 800 Microseconds	Less than 200 Microseconds

**OAK** MFG. CO.   
1260 Clybourn Ave., Dept. G, Chicago 10, Ill.  
Phone: MOhawk 4-2222

SWITCHES CHOPPERS VIBRATORS  
ROTARY SOLENOIDS TUNERS  
PACKAGED CIRCUITRY

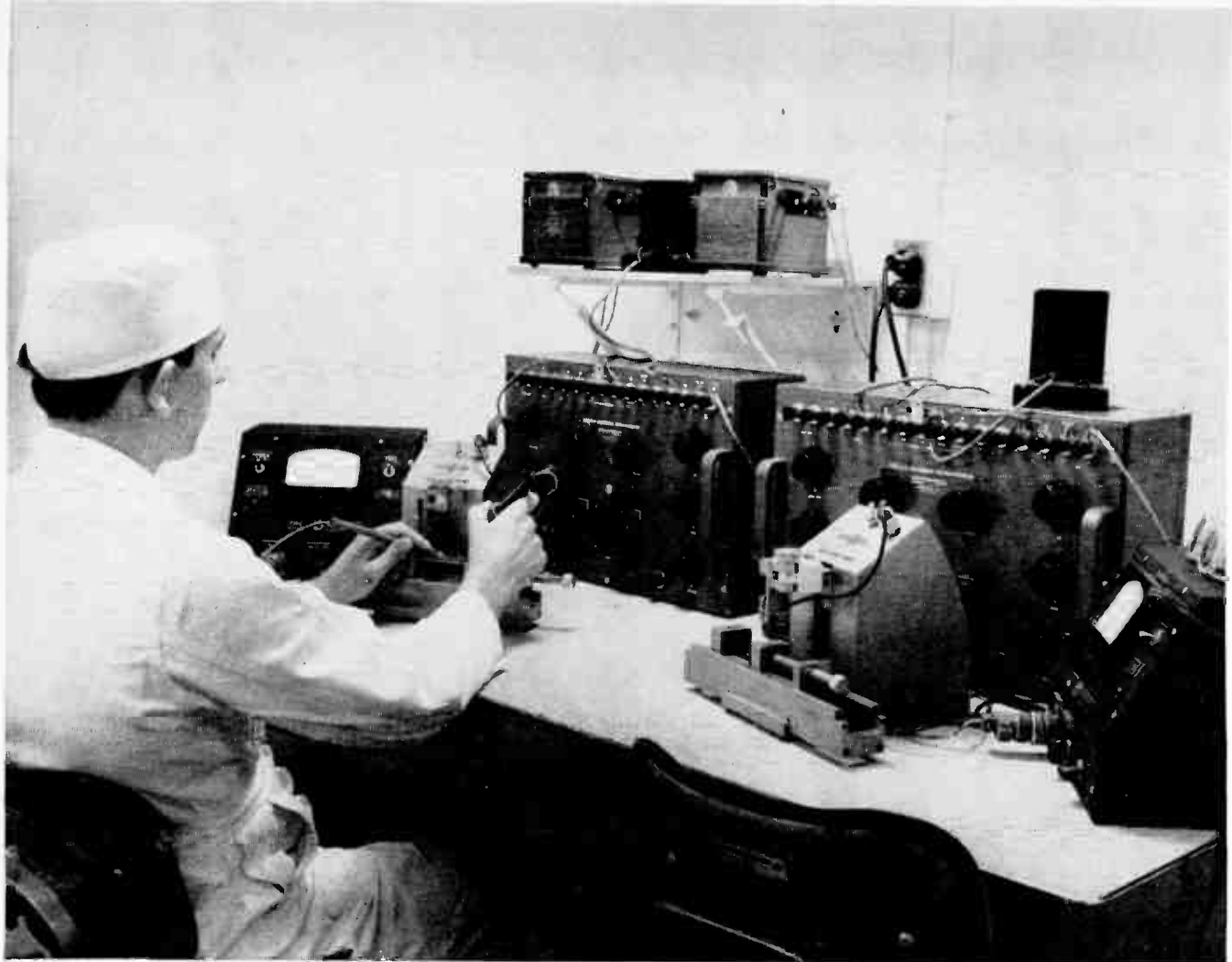

Operator making a routine quality control test of type and resistivity on silicon characterization crystal.

## Round-the-clock operations at new Du Pont plant assure you of ample supplies of Hyperpure Silicon

Du Pont's new Brevard, N. C. HYPERPURE Silicon plant—with a 70,000 lbs./yr. capacity—is now operating at high production rate to assure you of a prompt supply of high-purity silicon in the form, grade and quantity you need. Du Pont is uniquely qualified to serve you because of its experience as pioneer producer of semiconductor grades of silicon. This experience includes installing the first full-scale commercial silicon plant in the world and frequent expansion of productive facilities since then.

**Single crystals** of Du Pont HYPERPURE Silicon are now available in a wide range of resistivities, thanks to Du Pont's new research and manufacturing techniques. Each has a specially prepared "spec. sheet."

**Here's more news:** Du Pont recently completed a \$3,000,000 Technical Service Laboratory specifically

designed, equipped and staffed to handle customer problems. Here, highly trained Du Pont Technical Specialists are available to discuss any difficulties in crystal growing or manufacture you may encounter.

Du Pont HYPERPURE Silicon is also available in densified cut rods... and rods specially designed for float-zone refining in Grades 1, 2 and 3, with carefully controlled purity levels. As an additional service, Du Pont offers doping material at no additional cost.



Free booklet is available upon request. It describes the manufacture, properties and uses of HYPERPURE Silicon. E. I. du Pont de Nemours & Co. (Inc.), Pigments Dept., Silicon Development Group, Wilmington 98, Delaware.

HYPERPURE SILICON



BETTER THINGS FOR BETTER LIVING  
...THROUGH CHEMISTRY



**more exclusive advantages** for applications demanding extreme sensitivity, stability, versatility

# PANORAMIC'S SPA-4 SPECTRUM ANALYZER

## 10 mc to 44,000 mc

CHECK THESE IMPORTANT FEATURES:

**THREE PRECISELY CALIBRATED AMPLITUDE SCALES** — 40 db log, 20 db linear, 10 db power — for simultaneous measurement of signals having large or small amplitude differences and for reliable power point measurements. Front panel control selects scale.

**CAL—SYNC SELECTOR** simplifies sweep rate settings from 1 cps-60 cps to any submultiple of power line frequency.

**ONE TUNING HEAD** — 10 mc to 44,000 mc. Direct reading frequency scale with  $\pm 1\%$  accuracy.

**TWO INDEPENDENT FREQUENCY DISPERSION RANGES:** Continuously adjustable; 0-70 mc for wide band investigations. 0-5 mc for extremely stable narrow band analysis. Negligible Internal Frequency Modulation permits extremely narrow analysis free of FM problems.

**VARIABLE I.F. BANDWIDTH 1 KC TO 80 KC** for analysis of wide or narrow pulsed r.f. signals.

**PUSH-BUTTON FREQUENCY RANGE SELECTOR.** Automatically couples proper mixer and oscillator of desired band, illuminates applicable input connector and slide rule dial calibrations.

**SYNCHROSCOPE OUTPUT WITH 40 DB GAIN** for observations of input signal envelopes.

**ACCURATE MEASUREMENT OF SMALL FREQUENCY DIFFERENCES.** A self-contained marker oscillator, modulated by a calibrated external generator, provides accurate differential marker pips as close as 10 kc.

**WAVEGUIDE INPUT CONNECTORS** for 10.88 kmc to 44 kmc and type N connectors from 10 mc to 10.88 kmc.

PANORAMIC'S SPA-4 PROVIDES EXCEPTIONAL USABLE SENSITIVITY

BAND	RF SENSITIVITY
1- 10 — 420 MC	-95 to -105 dbm
2- 350 — 1000 MC	-90 to -100 dbm
3- 910 — 2200 MC	-90 to -100 dbm
4- 1980 — 4500 MC	-80 to -95 dbm
5- 4.5 — 10.88 KMC	-80 to -95 dbm
6- 10.88 — 18.0 KMC	-70 to -90 dbm
7- 19.0 — 26.4 KMC	-60 to -85 dbm
8- 26.4 — 44.0 KMC	-55 to -85 dbm

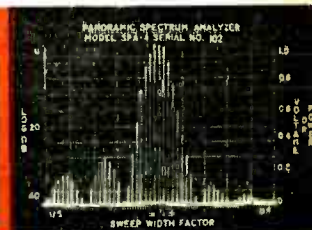

\*measured when signal and noise equal 2x noise

Analysis of pulsed signal on Model SPA-4. Sweep rate here was synchronized with PRF to show the individual spikes.

Tremendous flexibility and many unique advances of Panoramnic's compact SPA-4 make it unsurpassed for visually analyzing FM, AM and pulsed signal systems; instabilities of oscillators; noise spectra; detection of parasitics; studies of harmonic outputs; radar systems and other signal sources.

Write, wire or phone today for detailed SPA-4 specification bulletin.

**PANORAMIC RADIO PRODUCTS, INC.**  
530 South Fulton Avenue, Mount Vernon, N.Y. • Phone: OWens 9-4600  
Cables: Panoramnic, Mount Vernon, N.Y. State

World Radio History

CIRCLE 91 ON READER SERVICE CARD

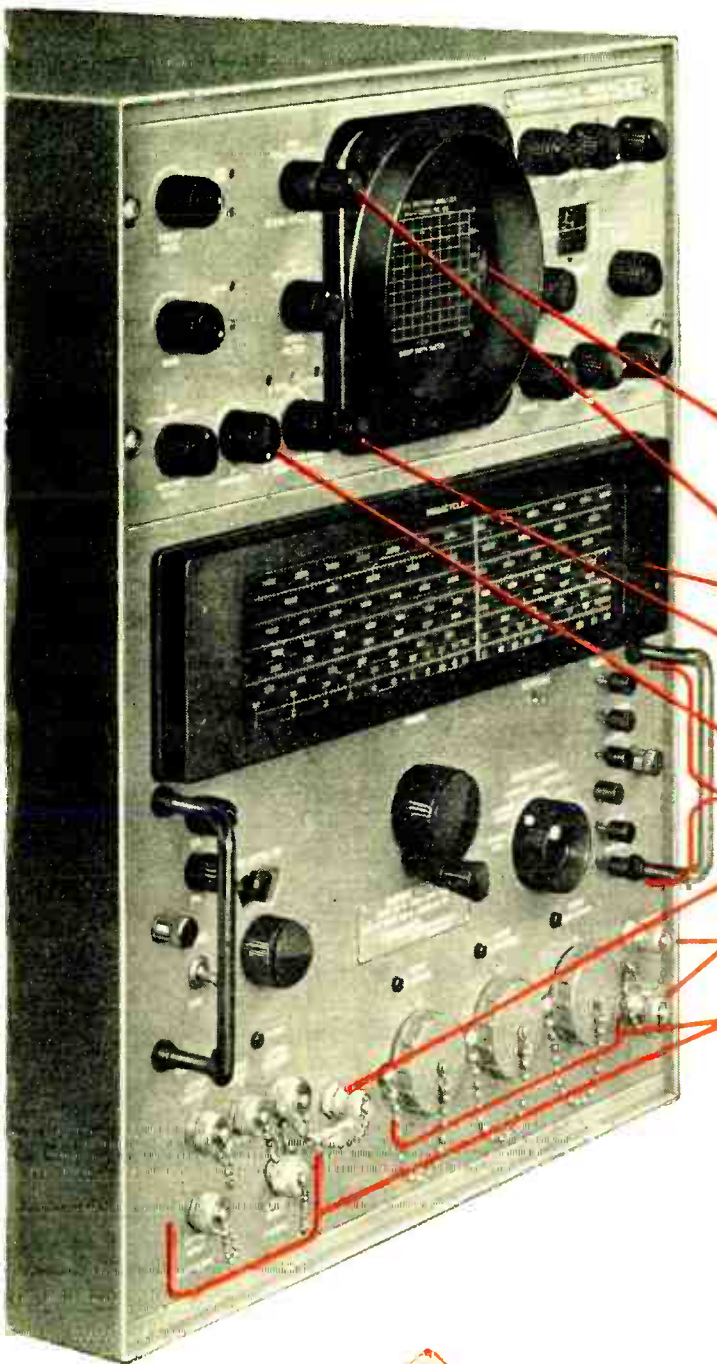

the pioneer  
is the leader



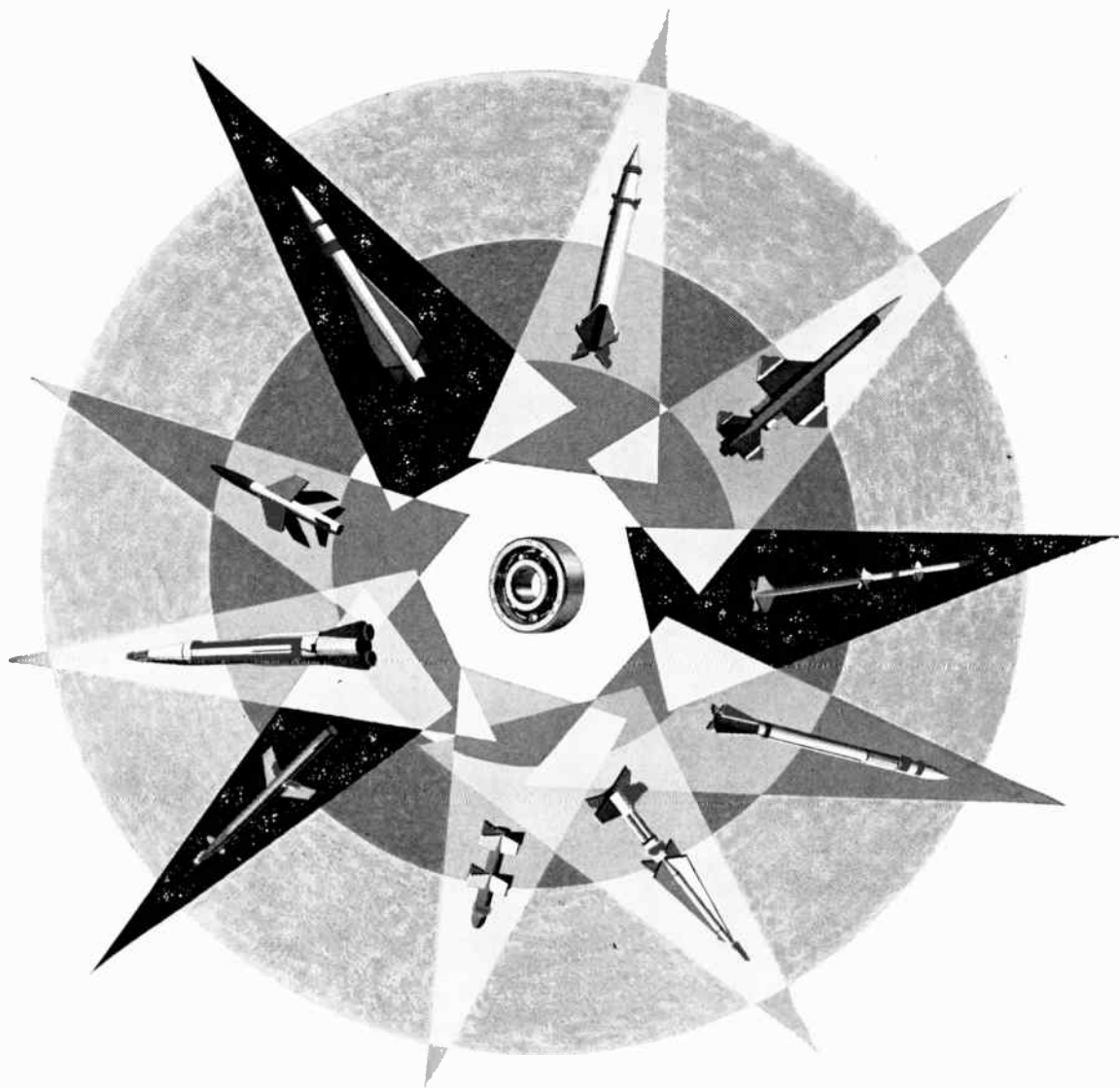

THOR  
 MACE  
 TITAN  
 HAWK  
 ATLAS  
 NIKE B  
 BOMARC  
 NIKE ZEUS  
 SPARROW I  
 SPARROW II  
 SPARROW III  
 NIKE HERCULES  
 SIDEWINDER  
 REGULUS II  
 VANGUARD  
 PERSHING  
 BULL PUP  
 POLARIS  
 CORVUS  
 FALCON

## *U.S. Major Missile Makers Depend on **N.D.** Reliability!*

In super-precision high speed gyro rotors for guidance systems . . . or in delicately precise instrumentation . . . more and more missile manufacturers are turning to New Departure for *proven reliability!*

**N.D. reliability starts in design** . . . constant research in bearing geometry, metallurgy and lubricants enables N.D. to create the new and unorthodox designs that are solving today's speed, temperature and miniaturization problems.

**N.D. reliability is maintained in manufacturing** . . . where advanced methods and successive inspections pay off in unerring prototype precision and uniformity . . . to ASA and AFBMA standards.

**N.D. reliability costs no more** . . . the growing number of America's leading missile manufacturers that are counting on N.D. reliability is proof in itself . . . it costs no more. In fact, many manufacturers find it costs less!

**N.D. availability is added assurance** . . . while original orders are delivered in quantity when and where they're needed, strategically located inventories prevent lost time and shortages in vitally important missile projects.

For immediate information call or write Department L.S., New Departure Division, General Motors Corporation, Bristol, Connecticut.



# NEW DEPARTURE

**MINIATURE & INSTRUMENT BALL BEARINGS**

*proved reliability you can build around*



# modern communications methods

By **SAMUEL WEBER**  
Associate Editor, **ELECTRONICS**

**PROBLEMS OF MODERN  
COMMUNICATIONS  
PROPAGATION  
OVER-THE-HORIZON SYSTEMS  
EXOTIC SYSTEMS  
MODULATION  
TRANSMISSION AND  
INFORMATION THEORY**

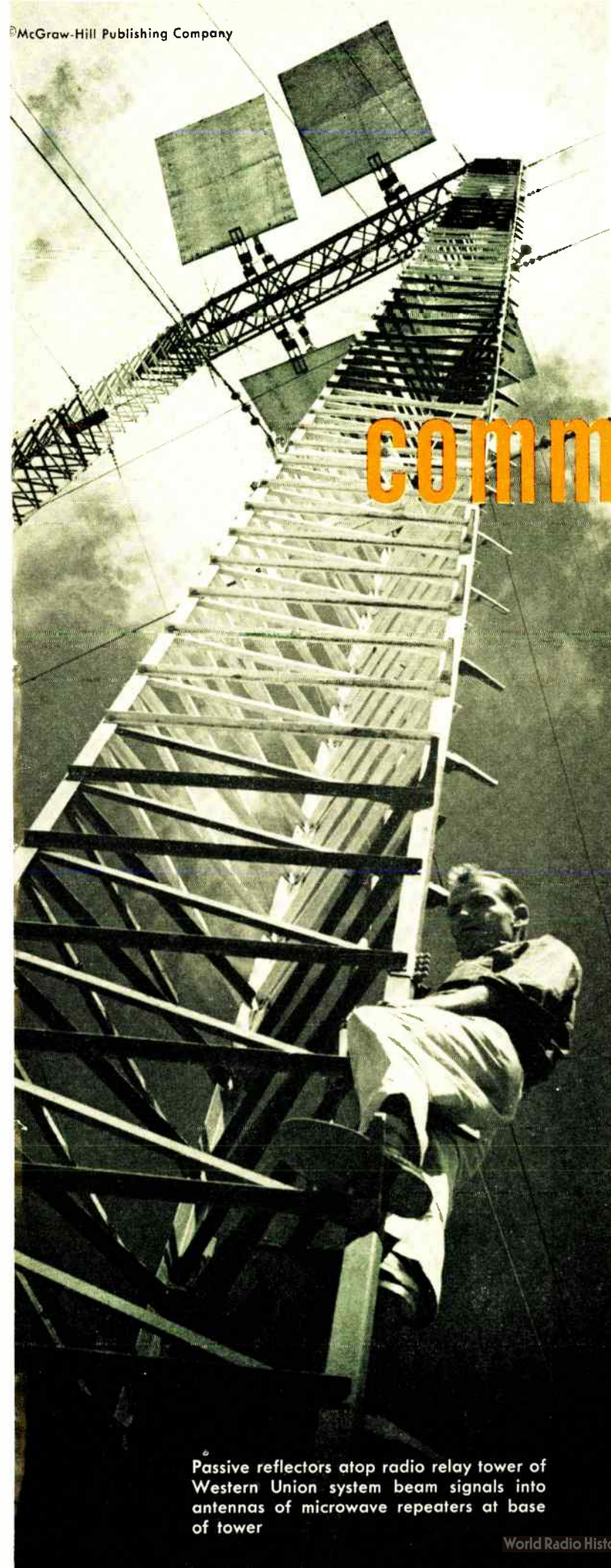

Passive reflectors atop radio relay tower of Western Union system beam signals into antennas of microwave repeaters at base of tower

THE IDEAL COMMUNICATION SYSTEM has been described as a radio transceiver from which one could dial any person from any point; if he did not answer, you would then know he was dead.

Whether this whimsical system proposed by a telephone company executive is indeed ideal is a question outside the scope of this report. The technical feasibility of such a system is another matter.

In the last decade, tremendous progress has been made in communications. Advanced techniques incorporating the principles of information theory, systems utilizing scatter propagation modes, new antenna designs, and use of higher and higher frequencies have all combined to advance the state of the art to a point where we can at least talk about the ideal transceiver.

Despite this progress, however, the communications capabilities of our technology are not quite keeping up with traffic density. It has been predicted that traffic will increase about eight times by 1970.<sup>1</sup> This same prediction states that technically we are capable of handling the expected load, but only if the magnitude of the problem is recognized and sufficient engineering and management effort devoted to it.

The increased demands on world communications systems are primarily based on economic, political, military and sociological considerations. But as this report will indicate, improvements in technology also add to the problem by providing more data which must be transferred more quickly.

The radio communications engineer is finding that his is not a static field in which everything there is to know is known, but rather that his is a growing art, upon which ever greater demands are being made by those very industries whose progress has sometimes overshadowed less dramatic developments in communications.<sup>2</sup>

The problems facing the communications engineer are indeed challenging. There are still many questions unanswered about the environment on earth which affects communications. Yet we are on the threshold of moving into the environment of space to expand our communications capabilities manyfold. With this step, many problems will be solved. But, as with all technological advances, many new problems will be created.

# problems of modern

**From the signal fires of the aborigine to today's machines spewing data at a rate too high for a man alone to absorb, the central problem of communications engineering has always been to transfer information quickly, reliably and economically from one point to another**

THE TREND toward global communications is reflected in the growth of overseas public telephone service between the United States and other areas of the world as shown in Fig. 1. In 1953, approximately 1½ million overseas telephone calls were made. In 1960, this total will have doubled and by 1970, it is anticipated that 21 million messages will be transmitted to various parts of the world. These figures do not include the vast traffic, certain to develop, involving the transmission of data from computers, both business and scientific, nor do they reflect the need for global television channels, which require much

more bandwidth than ordinary telephone circuits.

The present transAtlantic telephone cable, installed in 1956, will have its capacity exceeded in 1962. An advanced, transistorized cable under development, which will have more than twice the capacity of the present cable, will be swamped by 1965.

**THE MILITARY**—Our political and military commitments abroad have created a vast communications problem for our armed forces and our allies. Consider the communications requirements of the modern army. A U. S. field army operates in a territorial area of approximately 90 by 120 miles. In this area are concentrated about 20,000 pieces of equipment involving 70 million channel miles of communications!<sup>3</sup> This complex array must operate within the exigencies of combat with faultless reliability, and must, at the same time be compatible with the mobility requirements of a modern army.

Consider also the problems facing the Air Force. Our policy of deterrence, requiring the maintenance of a high degree of retaliatory power, is based on the ability to communicate instantly with planes in the air and bases throughout the world. In addition to the requirements for long-range integrated communication systems, there are many complex weapons systems that involve communications setups.

The Navy's problems are equally complex. Thus, the military problem may be summed up by saying





FIG. 1—Bar graph indicates that overseas telephone traffic is rapidly overtaking capacity of present and future facilities

Rugged reliability of today's military communications systems is typified by this installation, part of the White Alice system

# communications

that the necessity for operating on a global basis requires effective control over the operations of the various organizations concerned, regardless of location on or above the earth's surface, and under all conditions of atmospheric or ionospheric electrical disturbances, weather or enemy interference.

These military problems are responsible for concerted efforts on the part of the military to integrate and consolidate their communications capabilities, as reflected in programs such as the Army's Universal Integrated Communication System (UNICOM) or the Air Force's communication system AIRCOM.

**NATIONAL PROBLEMS**—On a national level, h-f radio communication within the continental limits of the United States is rapidly approaching the point of spectrum saturation. Increased demands for frequency allocations on the part of mobile, aircraft and marine interests, as well as common carriers have aggravated the situation so that there is now tremendous effort along two fronts to alleviate the problem. One is the extension of the spectrum to higher frequencies and the other is the quest for greater efficiency in use of available spectrum space.

The requirements for high information rate coupled with low probabilities of error and reasonable power level lead naturally to wideband systems operating in the high-frequency (3 to 30 mc) region of the radio spectrum. The need for direct, long-distance high-

frequency circuits has brought about the current study and exploitation of scatter systems.

**SCATTER**—The inherently fluctuating nature of known scattering media has resulted in great interest in statistical methods for optimum detection and filtering in the presence of low signal-to-noise ratios and in multipath and fading phenomena. Since situations of this kind may lead to high probabilities of error in reception, a powerful incentive exists for the study and eventual application of information theory to error detection and correction codes.

Because of the impending exhaustion of the available r-f spectrum, one of the fundamental problems of modern communications is the close and critical study of existing modulation systems in the interest of making more space available in the existing radio spectrum and the study of coding theory for the elimination of message redundancy.

Perhaps one of the most challenging problems of all is that of interference, both natural and manmade. The ever-increasing number of users of the r-f spectrum is creating a rapidly deteriorating situation which is under active study, but for which no clear solution yet exists. The answer lies somewhere in the realm of statistical technique using the most sophisticated methods to learn, not only how to live with interference, but also something of its nature, extent, effects and control.

**TABLE I — FREQUENCY-PROPAGATION CHARACTERISTICS**

Band	Classification	Primary Propagation Characteristics	Advantages	Disadvantages
15 - 30 kc	vlf	Ground wave	Propagational stability independent of ionospheric disturbances; one-frequency operation; no fading	High power required; also, large antennas; low keying speeds; subject to noise from lightning.
30 kc - 3 mc	l-f to m-f	Ground wave in daytime — ground and sky wave at night	Antennas can be smaller; reliable continuous area coverage such as in broadcast band	Subject to variations in atmospheric conditions
3 - 30 mc	h-f	Sky wave — ionospheric reflection	Long distances achieved with relatively low powers	Long and short term variability of optimum frequency; subject to ionospheric disturbances
30 - 300 mc	vhf	Line of sight (4/3 earth's radius) with irregular ionospheric reflection (sporadic E)	Reliable for shorter distances at low power; not subject to atmospheric noise; antennas can be highly directive	Subject to man-made interference; requires repeaters
300 - 3,000 mc	uhf	Line of sight through earth's atmosphere. 4/3 earth radius	Atmospheric and man-made noise extremely low	Subject to multipath fading from ground reflections; high attenuation from vegetation; receiver noise significant
3,000 - 30,000 mc	shf	Strictly line of sight. 4/3 earth radius	Extremely small, highly directive antennas — possible to conserve power. Little interference from ground reflections	Subject to scattering and absorption losses from rain drops; reflection from man-made objects. Receiver noise limits range

# propagation

Communication from point to point on the earth's surface is both aided and defied by the environment imposed by nature

BETWEEN THE transmitter and receiver of a radio communications link, lies a combination of earth, water, air and ionosphere which represents the obstacles to be overcome by electromagnetic waves being propagated.

The behavior of the waves in traversing these media is dependent upon many factors, not all of which are understood. Primarily, these factors are: the transmitting frequency, antenna characteristics, the orientation of the transmission path in the earth's magnetic field, the time of day, the conditions of daylight and darkness along the path, the season of the year, solar activity, the electrical characteristics of the path of the surface waves, the condition of atmospheric ionization at various levels, the range and the receiver antenna characteristics.'

**FREQUENCY BANDS** —In discussing propagation

characteristics, it is convenient to classify the various modes into bands of frequencies which exhibit similar propagation effects. Of course, the changes in characteristics with frequency are not abrupt, since nature never works in this manner, but rather certain propagation effects become negligible beyond the defined limits. Table I furnishes a brief summary of the major characteristics of the bands now in use.

**THE H-F BAND** —For many years the high-frequency range from 3-30 mc has been the main channel for long range communications. The main reason for the widespread use of this band, which uses ionospheric reflections as the propagation mechanism, is its ability to cover great distances with low-power transmitters. Typical transoceanic circuits can reach 2,000-7,000 miles in length, operated with transmitters rated at from 1 to 50 kw.

Unfortunately, the ionospheric reflection propagation mode is adversely affected by many factors which reduce the reliability of this form of communication.

**THE ENVIRONMENT** —The earth's atmosphere does not end abruptly, but for practical purposes extends as a shell surrounding the earth somewhat over 250 miles up. The lowest layer, or troposphere, extends about 10 miles up and contains almost all the atmospheric gases. The earth's weather, consisting of storms, warm or cold fronts and air masses, does



not rise above this level. From the troposphere outward to about a 30-mile height is a region of high ozone content, the stratosphere, which is characterized by nearly constant temperature and does not affect radio propagation directly.

Above this region lie stratified layers of ionized particles created by bombardment of air molecules by radiation from the sun. These layers have no sharp boundaries and their altitude and density vary with the time of day, season and sunspot activity. The layers and their characteristics are summarized in Table II. This region is called the ionosphere.

Each layer of the ionosphere has different characteristics, passing some frequencies and reflecting others. Since the ion density is dependent on the effects of the sun, it is natural to expect daily as well as seasonal variations in the layer geometry. Geographical variations are exhibited as well.

The sun's effect on the ionosphere is manifested in the existence of a critical frequency  $f_c$  which depends upon ion density and is defined as the highest frequency that may be reflected from any particular layer. The critical frequency in turn determines the best frequency to be used when reflecting a radio signal from the ionosphere. This is known as the maximum usable frequency or MUF, and is determined by the relation  $MUF = f_c \sec \theta$ , where  $f_c$  is the critical frequency and  $\theta$  the angle of incidence. Because of the continual changes in the ion densities of the various layers, the MUF is subject to constant change and adjustment.

Another term associated with ionospheric reflection is called the lowest useful high frequency or LUF, which represents the lowest high frequency that may be transmitted without interruption due to ionospheric changes, and without excessive ionospheric attenuation. The LUF is controlled by the lower part of the E layer where most absorption takes place.

**SUNSPOTS AND MAGNETIC STORMS**—One of the main difficulties with h-f communications is its dependence on solar activity. Networks of ionospheric sounding stations built up by commercial communications organizations, universities and government laboratories

are necessary for the gathering of data on the diurnal and seasonal variations of the ionosphere caused by disturbances from the sun.

This data is translated into short-term predictions of the approach of magnetic storms which may cause temporary outages, and much effort is also being expended on long-term predictions of future ionospheric behavior, to plan the optimum frequencies for various circuits years in advance.

The activity of the sun is conventionally expressed by a relative sunspot number  $R$ . This number for any given day is based on a formula which takes into account the number of sunspot groups visible on the sun's surface, the total number of spots in all the groups and location of and conditions at the observatory. Sunspot numbers dating back to 1749 based on recorded observations of sunspots are available. There is a remarkable correlation between annual mean values of  $R$  and the corresponding index of geomagnetic activity. It is known that the variations in the earth's magnetic field, especially at times of magnetic storms are caused by disturbances in the ionosphere, also originating with the sun.<sup>5</sup>

During periods of sunspot maxima, the electron density of the ionosphere increases with corresponding increase in the MUF, widening the band of available frequencies for transmission. However, periods of sunspot maxima are characterized by sudden ionospheric disturbances (SID) from solar flares sometimes followed by magnetic storms. Both these phenomena severely affect h-f communications by producing increased absorption and a lowering of the MUF. Magnetic storms are more frequent in sunspot maximum years but are more disrupting to communications in sunspot minimum years because the limits between the MUF and LUF are more easily narrowed.

Because of the unusual level of sunspot activity beginning in the mid 1950's and peaking at about 1957, severe disruption of radio service is being experienced during the present downward trend in the sunspot cycle and is expected to reach a maximum during the period of September 1959 through September 1962.<sup>7</sup>

**TABLE II — MAJOR CHARACTERISTICS OF IONIZED LAYERS**

	Height of Max. Ionization	Max. Avg Electron Density ( $N_e$ ) Electrons/cm <sup>3</sup>	Time of Occurrence	$\frac{N_e \text{ Sunspot Max.}}{N_e \text{ Sunspot Min.}}$	Density of Neutral Particles Per cm <sup>3</sup>	Frequency ( $f_o$ ) at 1945 Equinox
D layer	60 km (37 mi)	$1.5 \times 10^4$	daytime only	2	$8 \times 10^{15}$	—
E layer	100 km (62 mi)	$1.5 \times 10^5$	24 hr	1.5	$6 \times 10^{12}$	3.7 mc
F <sub>1</sub> layer	200 km (125 mi)	$2.5 \times 10^5$	daytime only	1.56	$1 \times 10^{11}$	4.9 mc
F <sub>2</sub> layer	300 km (186 mi)	$1.5 \times 10^6$	24 hr	4	$2 \times 10^{10}$	10.5 mc
E <sub>s</sub> layer	100 km (62 mi)	Sporadic patches of ionization density far higher than normally found at this elevation. Predominates in summer, but not predictable for $f_{oE_s}$ or time of occurrence.				

Courtesy RCA Service Company, Camden, N. J.

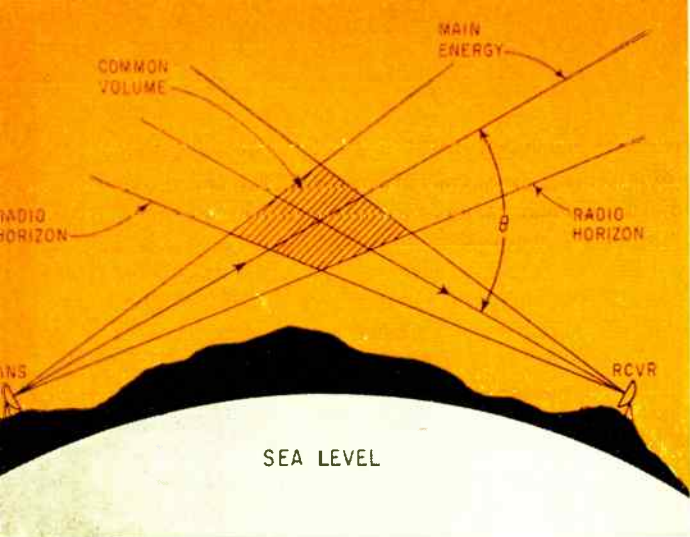

FIG. 2—Sketch shows typical geometry of tropospheric scatter system

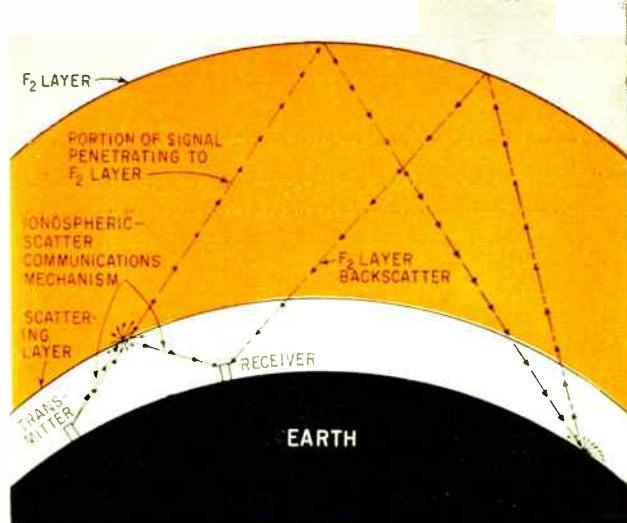

FIG. 3—Backscatter from the ionosphere causes fading or distortion of signal; this is a serious problem with ionospheric scatter

# over-the-horizon

New understanding of the propagation mechanism is extending long-distance communication into the vhf-uhf region, once thought to be limited by the horizon

IT HAS LONG been known that with sufficient power levels it is possible to receive signals beyond the horizon at frequencies once thought useless for long-range propagation.

Propagation by forward scattering in the troposphere is as yet not fully understood, but it is believed that the phenomenon may be explained by either of two theories<sup>1,2</sup>: (1) scattering by partial reflection from elevated layers in the troposphere where there is a rapid change of refractive index over a small range of height associated with temperature and humidity changes; (2) the existence of a series of scattering centers or blobs in which the refractive index differs from the mean value of surrounding areas. The scattering takes place within the common volume indicated by the sketch of Fig. 2 showing the arrangement of the antennas in a typical scatter link.

The forward-scattering mechanism involves a large transmission loss and it becomes necessary to use high-gain, narrow-beam antennas in both directions. The effect of the scattering angle  $\theta$  between the receiving and transmitting beams is significant and is kept as small as possible by choosing transmitting and receiving sites so as to have an unobstructed view of the horizon. Maximum range of

tropo scatter is of the order of 700 miles.

**CHARACTERISTICS**—The characteristics which distinguish tropo scatter are as follows: (1) the received signal strength is fluctuating continuously due to its large number of randomly varying components; (2) hourly, daily and monthly variations of the mean signal level may reach 10 to 20 db or more; (3) consistently usable signals are obtainable at ranges exceeding 400 miles; (4) the useful frequency range extends from 100 to 10,000 mc although the longest paths are usually obtained below 1,000 mc; (5) the path transmission loss can be 100 db greater than the free-space attenuation; (6) the wide bandwidth possible at tropo-scatter frequencies make the mode useful for the transmission of television signals as well as several hundred telephone channels.

Because of the fading characteristics of the tropo scattered signal, diversity reception is virtually essential, the spatial variety usually being used.

**IONOSPHERIC SCATTER**—Scattering of vhf signals in the 30 to 300-mc range due to turbulence in the ionosphere, is responsible for another propagation mode which is assuming great importance in long-range communications. Highly reliable, moderate capacity service at ranges up to about 1,200 miles are obtainable with careful engineering using average powers of 10 to 100 kw.

The primary advantage of this propagational mode is that when used at frequencies above the MUF, it possesses extremely high long- and short-term reliability with single-frequency operation. This is true even in geomagnetic locations such as the polar regions where SID's can completely disrupt h-f long-distance circuits. In fact, during such periods, the scatter signal is likely to be improved.



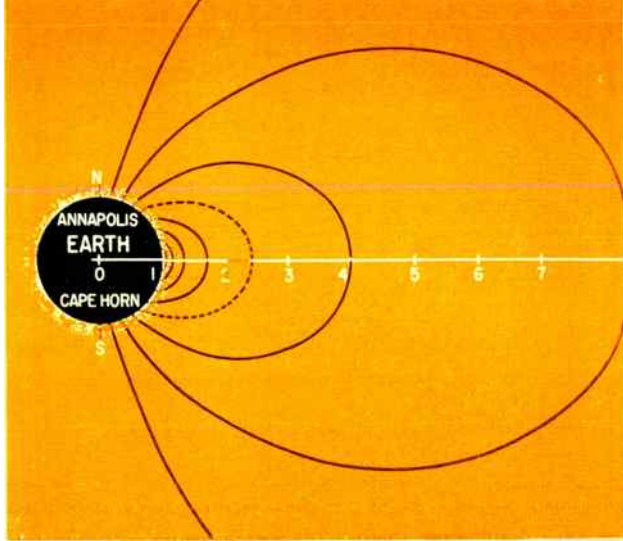
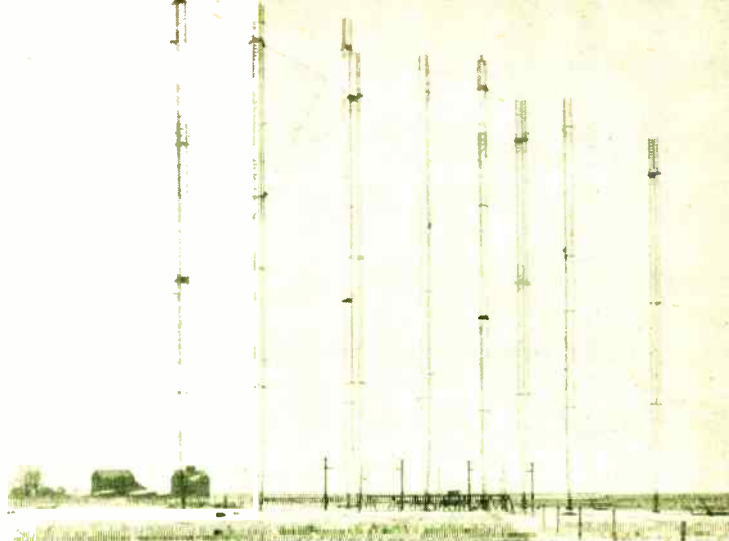

FIG. 4—Path followed by 15.5-kc transmission from Annapolis to Straits of Magellan along flux lines of earth's magnetic field



This huge corner reflector antenna is part of ionospheric scatter link used in DEWline project

# systems

However, one serious difficulty that has been experienced with iono scatter is multipath delay, which is especially serious in FSK (frequency-shift keyed) transmissions on teletypewriter circuits. Multipath delay is caused by backscatter, illustrated in Fig. 3.

**METEOR BURST**—The brute force methods of ionospheric scatter have led to another technique known as meteor burst. In early experiments with iono scatter, it was discovered that signal enhancement was intermittently caused by reflections from ionized meteor trails. Further exploitation of this phenomenon, resulted in working systems.<sup>10, 11</sup>

Since that time, numerous organizations have experimented with this mode of propagation. Present systems have demonstrated modest communications capacity up to 1,200 miles using low-power transmitters, simple antennas and low-cost gear.

The burst type system requires a means of initiating transmission by the received signal and a medium for storage of the information while awaiting optimum transmission conditions.

**WHISTLERS**—It is now known that whistlers result when the low-frequency r-f components from lightning discharges propagate thousands of miles above the earth along the flux lines of the earth's magnetic field, and down again to a conjugate point in the opposite hemisphere.<sup>12, 13</sup>

Whistlers are audio-frequency radio waves of which most of the energy is concentrated in the 1 to 8-kc range. The lower frequencies travel slower than the high so that the received signal sounds like a whistle of descending pitch. There may be repeated reflections of whistlers at either end of the path, resulting in evenly spaced echoes. Up to 20 echoes after one static lightning crash have been noted.

There are no whistlers at the equator because of the short dispersion range, nor at the poles because of the absence of lightning.

The reason for interest in the whistler mode is that it could provide secure communications, free of interference or jamming. This has been verified by an experimental transmission at 15.5 kc from a Navy transmitter at Annapolis which was received at its conjugate point in the Straits of Magellan. Figure 4 shows the path.

**VERY LOW FREQUENCY**—There is now considerable interest in propagation at frequencies down to about 1 kc because of its outstanding stability and freedom from interruption due to ionospheric disturbances. In addition, vlf is characterized by extremely low attenuation of the ground wave and almost total reflection of the sky wave from the lower edge of the ionosphere, resulting in the long-range capability of this mode.

Modern theory explains vlf propagation at great distances by assuming that the earth's surface and the lower ionosphere are sharply bounded. Between these boundaries multiple reflections take place in the form of various modes, somewhat like a parallel plate waveguide.<sup>14</sup>

In addition to the application of vlf to global communications, there are also potential uses in long-range navigational systems and storm tracking. It has also been proposed that vlf signals can be used as a single source of standard frequency which can be made available on a world-wide basis.<sup>15</sup>

Another interesting property of vlf is its ability to penetrate and propagate through water. Hence, it offers interesting possibilities as a means of communicating with submerged submarines on a world-wide basis.

## Design Considerations for Satellite Systems

To understand some of the parameters involved in practical satellite systems, consider these preliminary design figures worked out by D. T. Worthington of the Rome Air Development Center ARDC<sup>10</sup>.

The designs are based on the expressions:

$$(1) P_T = \frac{64 \pi^2 F K T B (S/N) R^4}{G_T G_R \lambda^2 a^2} \text{ for a passive sphere reflector}$$

$$(2) P_T = \frac{16 \pi^2 F K T B (S/N) R^2}{G_T G_R \lambda^2} \text{ for an active system}$$

where  $P_T$  is the transmitter output in watts,  $R$  is the distance from ground station to satellite and return,  $S/N$  is the desired system signal-to-noise ratio,  $F$  is the noise figure of the receiver,  $K$  is Boltzmann's constant,  $T$  is the reference receiver temperature (290 K),  $B$  is the receiver bandwidth in cps,  $G_T$  is the transmitter antenna gain,  $G_R$  is the receiver antenna gain,  $a$  is the radius of the passive sphere, and  $\lambda$  is the wavelength of the radiation.

**PASSIVE SYSTEM:** Assume 100-ft diameter spheres at altitude of 1,000 nautical miles; approximately 12 satellites in a syn-

chronized polar orbit passing midway between Europe and North America are required for continuous coverage. System design based on  $S/N$  ratio of 20 db, use of parametric amplifiers in the receiver, 120-ft dishes for receiving and transmitting antennas, and a frequency of 5 kmc. Power output would be in the order of 0.35 watt/cycle or approximately 7 megawatts for a 20-mc bandwidth. Such a system could be obtained by using seven one-megawatt or fourteen 500-kw transmitters feeding one antenna dish. To achieve continuous communications, separate tracking facilities are required.

**ACTIVE SYSTEM:** Assume an active satellite repeater is placed in orbit at a 22,000 mile height, a bandwidth of 20 mc required. If we assume 1,000 mc as operating frequency,  $S/N$  of 20 db and a receiver noise figure of 6 db, the ground antenna is a 60 ft dish and the satellite antenna a 3½-ft dish, then  $5 \times 10^{-6}$  watt per cycle is required and approximately 100 watts transmitter output for 20-mc bandwidth. This satellite must remain stationary with respect to the earth and must be spin stabilized and altitude-controlled. In addition, nuclear power supplies appear to be a must.

# exotic systems

As man extends his conquest of space, his voice will also blanket all corners of the earth

ALL THE METHODS of long distance communications previously discussed have their limitations be it range, bandwidth capability or reliability. Our entry into the space age and the rapid development of our capability for transporting large payloads into space now offer a new system of global communications which, theoretically, has no limitations. There are many problems yet to be solved, but the requirements for global capacity are so demanding, and the military necessity so urgent, that it is safe to predict that communication by satellite will be an established method within 5 years. Significantly, this will be the first tangible, commercially applicable result of our costly space program.

**TYPES** —Satellites for communications may be classified into two distinct types. These are: passive reflectors in which there are no electronics carried in the satellite, and which act as reflecting antennas to relay the signal from one point on earth to another; and active repeaters which contain electronics to amplify the signal before relaying. A variation of the latter type utilizes a delayed transmission scheme

by storing the data until commanded to release it by a ground receiver station. This has the advantage that the satellite need not be simultaneously in view of the two stations.

**ORBITS** —The orbital characteristics of satellites determine their maximum capabilities for communications. For a circular orbit, the period of revolution is given by the expression,  $T = 2\pi\sqrt{r^3/gM}$ , where  $r$  is the distance from the center of the earth,  $g$  is the gravitational constant and  $M$  is the earth's mass. Using this equation to plot period as a function of height above the earth's surface, it can be seen that if a satellite were to be stabilized at a height of 22,300 miles, it would have an orbital period of 24 hours and would thus appear to hover directly over some point on the earth's surface at the equator.

A number of equally spaced 24-hour satellites is required to provide a given length circuit between two stations at the same latitude for various distances between terminals.<sup>17</sup> For an equatorial satellite, no coverage is provided near the poles, but at the equator, continuous coverage of 10,000 miles is possible.

**TECHNICAL PROBLEMS** —The technical difficulties associated with achieving a synchronized 24-hr orbit are great. Not only must the initial launching be accomplished with great precision, but some method must be provided for correcting orbital variations by control from the earth during the entire life



of the satellite. In addition, some sort of stabilization and attitude control is necessary to keep the antennas properly oriented. Although these problems represent a challenge of the highest order to modern engineering, they are not insurmountable, and indeed, an active project along these lines, which will be described later, is being pursued.

Within our more immediate capability, however, are low-level orbit satellites of both the active and passive types. These can be placed into equatorial, polar or inclined orbits with relative ease.

Both active and passive repeaters present different problems and advantages. The active repeater would require only low-power transmitters for space and ground equipment, and could provide its own signal for acquisition and tracking. On the other hand, the electrical components must be extremely reliable and capable of long life under severe environment.

The passive satellite is the simplest and most reliable system. It could consist of a large sphere with a reflective coating or a flat plate. The main disadvantage would be the necessity for using high-power ground transmitters and complex tracking facilities. In the case of the sphere, irregularities in the shape caused by impact of micrometeorites might result in scintillation distortion of the signal.

Table III compares four types of proposed satellites and lists their relative merits and disadvantages.<sup>12-16</sup>

**PROJECTS IN PROGRESS**—Although a few years ago these concepts were considered in the realm of science fiction, satellites of the active and passive types are scheduled to be launched in the near future.

Project Courier is the name of the U. S. Army Signal Corps program being administered by the Ad-

vanced Research Projects Agency (ARPA). Courier is conceived as a delayed-relay satellite orbiting at relatively low altitude. Information from a ground station previously stored on magnetic tape will be transmitted back to the station to which it is addressed by a coded command.

While the ground station is receiving messages addressed to it or through it, it may also be transmitting on a different frequency traffic to be delivered by the satellite to other stations. By transmitting at high rates during the short time the satellite is in view of each station, a traffic-handling capacity equivalent to 20 continuously operating teletypewriter channels, each of 100 wpm is achievable.

The first phase of this project is scheduled to take place in spring, 1960, when an Air Force rocket vehicle will place the Courier into a 650-mi-high circular orbit with a 30-deg north and south inclined path. The payload, consisting of a 57-in. diam sphere weighing 475 lb in orbit, will have a 6 to 10 million bit storage capacity. Nominal operating frequency will be in the 2-kmc band.

Frequency modulation will be used, and the traffic will be primarily designed to handle low-priority logistic data in teletypewriter circuits.

For power, the Courier will rely on nickel-cadmium storage batteries to back up 16,000 to 17,000 silicon solar cells arranged symmetrically around the sphere in patches, so that energy is supplied regardless of orientation. The entire system is designed to be operational for a minimum of one year.

The first phase will be followed by subsequent firings of one each in 1961 and 1962. The ultimate goal is a 24-hr equatorial real-time repeater satellite, which is planned for the 1962 launch.

Task Steer, another ARPA active repeater pro-

**TABLE III — COMPARISON OF SATELLITE SYSTEMS**

Type	Advantages	Disadvantages
Low level, passive (1,000 to 5,000 mi)	No satellite electronics required No attitude control position required Bandwidth and use restricted only by power output and frequency High reliability	Doppler shift in frequency Many required in nonsynchronous orbit In synchronous orbits, several are required depending on height and range High power per cycle of bandwidth required Possibility of interference Requires complex tracking facilities
Low level, active (1,000 to 5,000 mi)	Low transmitter power required Minimizes interference Less complex and costly tracking and acquisition equipment	Doppler shift Multiple satellites required for wide coverage Requires extreme reliability of electronic components Satellite power source needed Bandwidth and use fixed by design Attitude and position control required
24-hr orbit, passive	No satellite electronics required No attitude control positions required Bandwidth and use not restricted Reliability Larger area coverage per satellite No Doppler shift	Large power requirement per cycle of bandwidth Probability of interference Large ground installation Not usable as satellite-to-satellite relay
24-hr orbit, active	No special ground site requirements Minimizes interference Low transmitter power required Large area coverage per satellite No Doppler shift Can be used as satellite-to-satellite or satellite-to-space relay	Bandwidth and use fixed by design Requires extreme reliability of electronic components Attitude and position controls required Satellite power source required

gram for establishing communication between ground points in the United States and aircraft in the polar regions is about 2 years away.

**PROJECT ECHO**—Some time next Spring, a passive satellite in the form of a 100-ft inflatable Mylar aluminized sphere will be placed in orbit at a height of approximately 1,000 miles above the earth and an inclination of 50 deg to the equator.

Project Echo, a communication experiment using this satellite as a passive repeater, is being sponsored by the National Aeronautics and Space Administration with the cooperation of the Jet Propulsion Laboratory of California Institute of Technology, and Bell Telephone Laboratories.

The sphere weighing approximately 150 lb will be packaged in a small container prior to launching. At the proper altitude after launching, water previously injected will vaporize and inflate the sphere.

Transmission will take place between the 85-ft dish at Goldstone Dry Lake 100 miles northeast of Los Angeles and a special horn-reflector antenna, now under construction at Bell Laboratories' Holmdel,

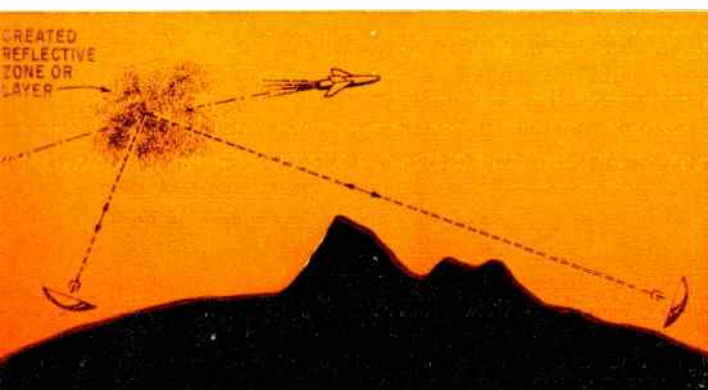

FIG. 5—Artificial ionosphere is released by missile or aircraft to provide reflecting layer for long-distance communication

N. J. site. At 1,000 miles altitude, a mutual sighting time between these two locations is estimated to be a maximum of 12 minutes.

Transmission frequencies will be about 1,000 mc to JPL from Holmdel, and near 2,500 mc in the opposite direction. F-m will be used with a deviation of  $\pm 150$  kc at the highest modulation frequency of 3 kc.

Tracking and prediction of the orbital passes for this satellite are major problems. Accordingly, plans for overcoming these are complex. JPL will auto-track the sphere from rough orbits predicted by the Goddard Space Research Center computer facilities in Washington, D. C. Data from this tracking will enable Goddard to predict passes accurately. Coded data will then cause the antennas to track automatically, backed up by optical tracking gear.

**MOON RELAY**—Use of the moon as a relay is a technique with a long history. The U. S. Army Signal Corps first bounced radar signals off the moon in

1946. Since that time, there have been many experiments at various frequencies which show the feasibility of using the moon as a passive relay for long-distance trans-oceanic communication. In 1954, f-m pulse and voice communication at 220 mc was first reported.<sup>20</sup>

Useful frequencies for moon communication are limited on the low end by ionospheric attenuation and meteor scattering, and on the high end by attenuation from oxygen and water vapor in the atmosphere. At frequencies around 10,000 mc this attenuation is fairly low and ionospheric effects such as Faraday rotation are small. It has been estimated that information rates as large as those obtained with meteor burst systems are possible, but with the advantage of continuous transmission for as long as the moon is visible to both the transmitter and receiver.<sup>22</sup> Such a system would operate at 10,000 mc with a peak transmitter power of 250 kw using a 60-ft dish, a bandwidth of 200 kc and pulsed f-m with a 5- $\mu$ sec pulse length.<sup>21</sup>

The U. S. Navy is now setting up a communications link between Washington, D. C. and Hawaii by way of the moon, using two 84-ft dishes at each end. From a military standpoint, the chief advantage of the system will be reliability and resistance to jamming. Mutual sight time between the two stations in this installation is limited to from 4 to 14 hours daily, depending on the moon's orbit.

**ARTIFICIAL IONIZATION**—Instead of depending on the erratic behavior of the natural ionosphere, it is possible to provide a relatively stable beyond-the-horizon communication link by the creation of an artificial layer of material capable of scattering electromagnetic waves in a given zone of the upper atmosphere.<sup>23</sup> A radio beam incident on the artificial layer at a given angle is caused to be scattered to a distant receiver. Figure 5 shows one method of establishing such a system.

There are several materials available that may be effectively used for establishing the reflective layer. The most obvious is metallic chaff in the form of fine particles or foil of aluminum or copper. Another material is nitric oxide, which when released in daytime, is acted upon by sunlight and reacts with atoms of oxygen in the atmosphere to produce a dense cloud of ionized particles. Ionized gases such as carbon tetrachloride, carbon tetrafluoride or sulfa hexafluoride may be released into the atmosphere by rockets or jet-type aircraft. All these materials may be released in a variety of ways by aircraft, balloons, missiles, or even fired by artillery.

**OPERATION SMOKEPUFF**—Actual investigation of the feasibility of this approach is being made in at least one program sponsored by the Air Force Cambridge Research Center. This program, being carried out by the Stanford University, is called Operation Smokepuff and is basically concerned with investigation of the properties of the earth's atmosphere at great heights and with commercial communications applications.



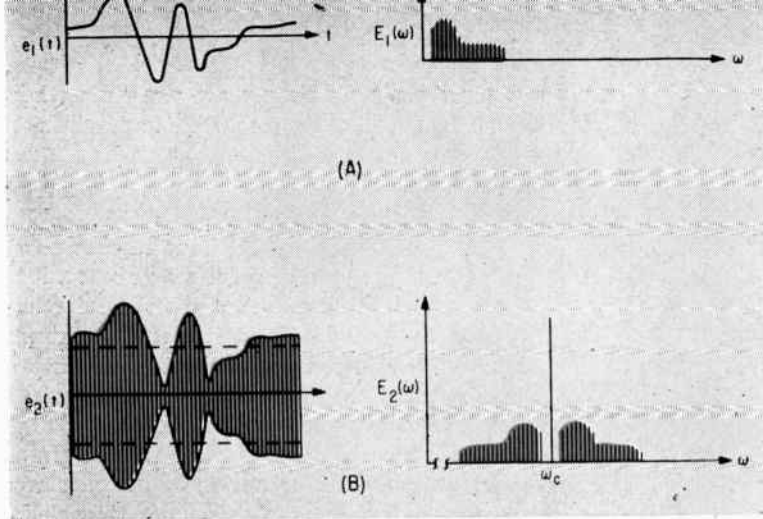

FIG. 6—Modulating signal (A) is represented in both frequency and time domain. Modulated r-f carrier (B) contains two symmetrical sidebands and carrier component

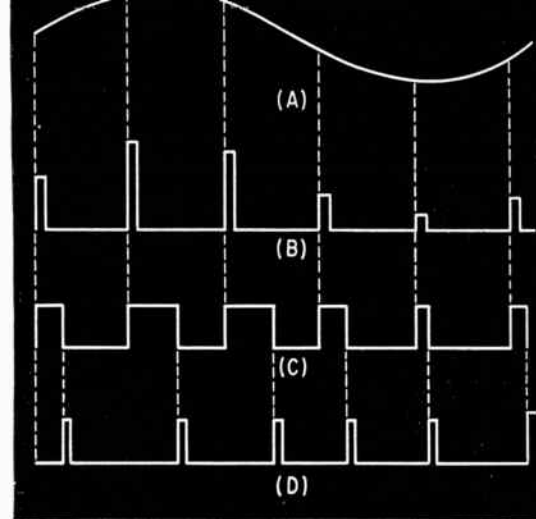

FIG. 7—Various pulse modulation schemes (A) original signal (B) pam (C) pdm (D) ppm

# modulation

Optimum modulation method is required for best use of the propagation medium. Engineers are not always agreed on what is optimum

COMMUNICATION is the transmission of information; this implies that the best communication system is that which can relay the desired message with the maximum of efficiency and reliability under any of the detrimental conditions likely to be imposed by the environment.

Part of the environment, of course, is the ever-increasing crowding of the r-f spectrum. Therefore, one of the important criteria for judging the merits of a particular modulation method is how well it utilizes available spectrum space. Another is how effectively it overcomes the noise imposed on it by manmade or natural causes.

**AMPLITUDE MODULATION**—The oldest and simplest modulation method is a-m. Figure 6A shows a representation of a signal in both the time and frequency domain, and Fig. 6B shows a similar representation of an r-f carrier modulated by the signal.

It can be seen that the two sidebands produced by this method are identically symmetrical in amplitude and phase with respect to the carrier. The phase and amplitude relations between sideband components

and the carrier are critical, and any disturbance in these relations can alter the nature of the modulation.

Examination of the a-m signal reveals that duplicate information is contained in both sidebands. In addition, since the carrier is considered always at a constant amplitude and frequency, it contributes nothing in the way of information. These characteristics indicate that a-m is wasteful of spectrum space and power as well.

One of the most serious defects of amplitude modulation is its susceptibility to distortion from phase shifts of the various components of the modulated signal. In long-distance communications circuits, such as h-f radio and scatter which rely on ionospheric return, disturbances in the medium can and do result in selective fading of the various signal frequency components, leading to excessive intermodulation and harmonic distortion in the detector.

It must not be supposed that because of these shortcomings, that a-m is on the way out. The detection techniques for this type of modulation are straightforward and simple, resulting in reliable economic equipment. Also, the capital investment in presently existing a-m equipment precludes the immediate abandonment of a-m on economic grounds.

**FREQUENCY MODULATION**—Frequency modulation possesses a number of features which make it attractive particularly for long-range communications. In an f-m system, a certain amount of exchange between bandwidth and signal-to-noise ratio is possible. It can be shown that when the peak noise amplitude is less than one half the peak signal amplitude, the signal-to-noise ratio varies directly as the frequency deviation. In addition, in an f-m trans-

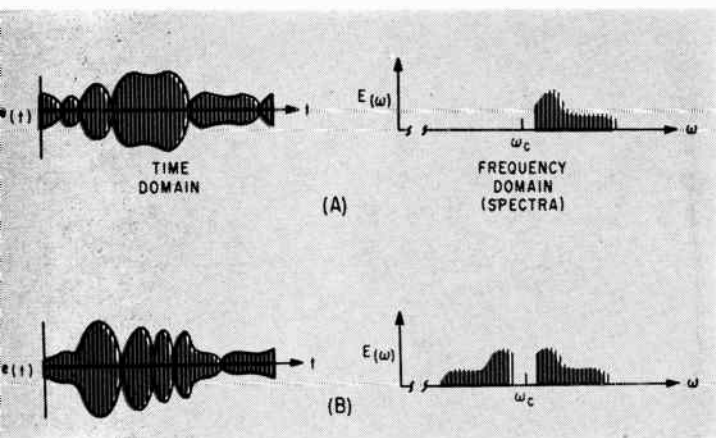

FIG. 8—Waveforms and spectra of (A) single sideband signal and (B) double sideband suppressed carrier

mitter, the r-f amplitude is a constant and independent of the modulation index. For a given plate dissipation and plate-circuit efficiency, the output power of an f-m transmitter is twice that of an a-m type. Other important characteristics in favor of f-m are its ability to reduce interference arising from impulse noise because of the limiting action of the receiver, and the ability to eliminate cochannel interference because of its inherent capture effect.

On the other side of the coin, however, is the fact that f-m is essentially a wideband system and requires a relatively large channel width. In addition, f-m suffers from the effects of frequency-selective fading in the presence of multipath delay, just as a-m does. This takes the form of intermodulation noise and channel level instability.

**PULSE MODULATION** —In recent years, a number of pulse modulation schemes have been developed which lend themselves to time-division multiplexing techniques for the simultaneous transmission of many channels of information. Figure 7 illustrates some of these methods.

Since the sampling rate used in time-division multi-

plex systems must be at least two times the highest signal frequency, the required bandwidth of pulse systems is many times that needed by a-m or f-m systems.

**SINGLE SIDEBAND** —Although single sideband techniques have been used for many years, it has been only in the last decade that their merits have been widely recognized and exploited for long-range, high-frequency radio transmission. Initial interest was stimulated by the increasing crowding of the 2 to 30-mc frequency range with consequent high levels of interference from other radio signals. In addition, the advantages of elimination of the carrier and the superior performance of ssb under the selective fading conditions of long-range propagation have extended the application areas of this form of modulation to mobile, naval and aircraft communications, and into the vhf and uhf portions of the spectrum.

As was illustrated in Fig. 6, the a-m signal carries redundancy in the form of duplicate sidebands and unnecessary power in the form of a carrier which serves merely as a reference for the receiver. It is obvious from a glance at Fig. 6A that elimination of one sideband and the carrier will result in the transmission of the same intelligence, but at a saving of half the spectrum space occupied by a-m. Reduction in signal bandwidth also permits the receiver bandwidth to be cut in half, with attendant signal-to-noise improvement of 3 db.

At the receiver, the detection process consists of a frequency-translation of the ssb r-f signal down to the audio spectrum. To accomplish this translation process, the carrier must be present at a frequency close to that of the original suppressed carrier. In practice, a deviation between the local and transmitter carrier frequencies of as little as 50 cps can cause loss of intelligibility of speech signals under conditions of low signal-to-noise ratio.

**FREQUENCY CONTROL** —This implies a stringent requirement on frequency control for ssb systems which results in a general increase in complexity

## FISK ON SINGLE SIDEBAND

Bert Fisk is head of the Communications Security Section of the Radio Division at the U. S. Naval Research Laboratory. He is a strong proponent of ssb communications and has helped guide the Navy's comprehensive program in frequency-stabilized h-f ssb. Here is what he says about ssb:<sup>23</sup>

"Rather than considering ssb as a modulation method, we prefer to think of ssb as a frequency-translating process in which, for example, the voice spectrum is translated from the original audio range of 300-3,000 cycles up to a suitable r-f channel of let us say 6,000,300-6,003,000 cycles to facilitate electromagnetic transmission and then retranslated back to 300-3,000 cycles at the receiving end, without the transmission of a carrier, mirror-image signal, or other spurious signals. This definition points up several of the advantages that are inherent in ssb. First, the r-f spectrum required to transmit a given signal by means of ssb is exactly that of the original signal, thus maximum use can be made of the available r-f spectrum. Second, since

only essential signals are transmitted by ssb, without superfluous carrier or mirror image sideband, a power saving of at least 9db is achieved. Third and most important, of all, frequency-stabilized ssb systems are affected far less adversely by the transmission disturbances inherent in ionospheric transmission than are a-m, f-m, or any of the double sideband systems.

". . . The primary disadvantages of frequency stabilized ssb are complexity and cost; however, this aspect may be deceiving in that one set of ssb equipment in many services is capable of handling the same amount of communications as can be carried by several sets of more primitive types of communication equipment, so that cost factor may actually be on the side of ssb.

"It has been determined that for most suppressed carrier ssb services, a frequency accuracy and stability that is never poorer than one part in  $10^7$  is adequate; however, the development of small sized frequency standards is progressing so rapidly that one part in  $10^8$  has become commonplace."



## COSTAS ON DOUBLE SIDEBAND

John P. Costas is a consulting engineer in the Heavy Military Electronic Equipment Department of the Defense Electronics Division of General Electric Company. He believes that dsb has characteristics which make it superior in many ways to ssb. Here are his comments to *ELECTRONICS*:<sup>21</sup>

"Although very little publicity is being given dsb at present, this modulation technique is being developed and applied to a wide variety of tasks by the General Electric Co. and others.

"In a recent test, sponsored by RADC, the dsb system gave disappointing results compared to ssb on the basis of single word intelligibility scoring. At the completion of the test, tape reruns and equipment checks indicated a malfunction of the phase-control system in the synchronous receiver. Only an about eight of the test runs was the synchronous receiver operating properly. However, on these few runs, the dsb system consistently outscored ssb.

". . . an improved dsb system . . . when tested against ssb will permit a more accurate evaluation of the relative merits of these two modulation methods for h-f voice service.

"One of the serious obstacles to the application of dsb or ssb to uhf airborne service is doppler shift. . . . The dsb system has the unique advantage of being able to derive frequency and phase error information from the normal intelligence sideband energy without requiring special pilot emissions. We have converted one standard Air Force transceiver to dsb synchronous detection and have demonstrated lock-in times of under 20 milliseconds with doppler errors in the order of 5 kc.

"The ability of a dsb system to preserve the waveform of intelligence is an advantage of great value when high-speed serial data is to be transmitted.

"The dsb system contains an inherent frequency diversity feature as a consequence of the transmission of both upper and lower sidebands. In addition, the use of coherent detection can . . . enhance the effectiveness of a space diversity receiving capability.

"The basic dsb system, with certain minor variations, is ideally suited for secure communications use. This area of application is being actively developed by General Electric, but security considerations prohibit disclosure of details."

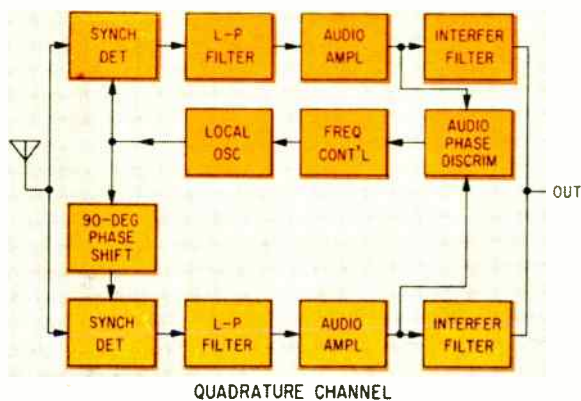

FIG. 9—Simplified synchronous receiver used for the reception of dsbsc signals

and cost of the equipment and is one of the chief technical problems in airborne applications because of doppler shift.

There are four possible methods of carrier transmission and frequency control: (1) single sideband suppressed carrier suppresses the carrier as far as possible (40 to 60 db below peak power output) at the transmitter while frequency control is accomplished independently at receiver and transmitter by precision oscillators; this method is highly desirable, but difficult to achieve; (2) the carrier is transmitted at all times, but reduced to about 20 db below the transmitter peak power; slow-acting afc system controls frequency error at receiver; this method has been used for many years, but does not enjoy full benefits of ssb; (3) pilot carrier is transmitted for short intervals at gaps in message; afc circuit at receiver is activated by carrier bursts; this appears most practicable for airborne systems as a means of rapid correction due to doppler shift; (4) one sideband and full carrier is transmitted at

all times and demodulation accomplished in a linear or square-law detector with no afc or local carrier required; this has the advantage of being compatible with conventional a-m receivers.

### DOUBLE SIDEBAND SUPPRESSED CARRIER—

Although the merits of ssb seem to be considerable, there are some who maintain that these are not as substantial as claimed when examined in the light of actual practice or when compared to the characteristics of double sideband suppressed carrier transmission.<sup>22</sup>

Figure 8B shows the appearance of a double sideband suppressed carrier wave. As previously stated, the relative phases and amplitudes of the two sideband components must be preserved to maintain intelligibility. In a dsbsc system, this is usually accomplished by some form of synchronous detection, in which the phase of a local oscillator is adjusted so that the contributions of the two sidebands reinforce each other.

Figure 9 is a block diagram of a simplified synchronous receiver. In this device, the synchronous detector in the quadrature channel has the characteristic of producing no output when the local oscillator is of the proper phase. When the oscillator drifts from this value, audio appears in the quadrature channel and d-c signal is developed in the discriminator which can be used to automatically adjust the oscillator phase.

Since the control signal is derived from the sideband components only, transmission of the carrier can be eliminated. One of the features of this type of receiver is that it can also receive conventional a-m, ssb, narrow-band f-m, phase modulation and c-w.

The arguments by proponents of dsbsc are considerably weakened by the spectrum-saving ability of ssb.

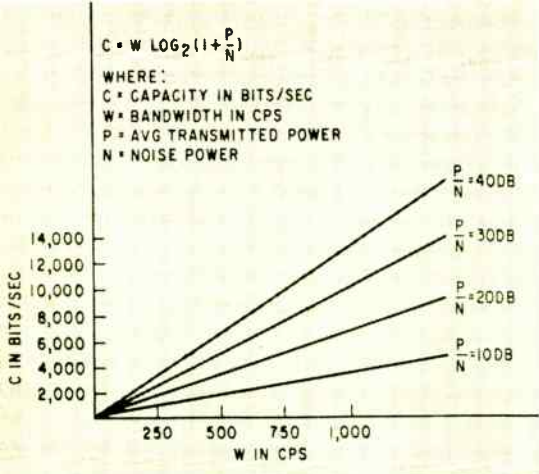

FIG. 10—The relationship between channel capacity, bandwidth and signal-to-noise ratio

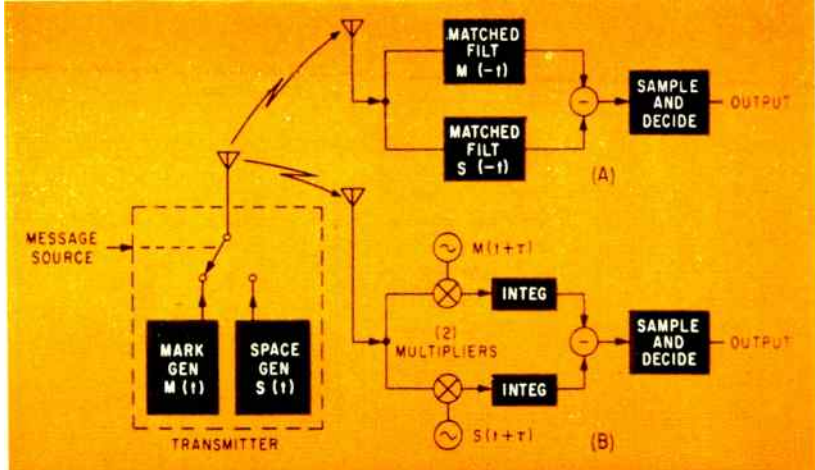

FIG. 11—MARK-SPACE transmission system with (A) matched-filter receiver and (B) multiplier-integrator receiver

# transmission and

In the past decade, information theory has made profound changes in the way communications engineers evaluate systems. These new concepts hold the key to victory in the battle for bandwidth

THE PROBLEMS of transmitting messages through noise have received considerable theoretical study in recent years, directed primarily toward determining the limits on performance imposed by the nature of the messages to be transmitted and the characteristics of the medium. The two major areas of effort have been coding theory and reception theory, the first concerned with optimum encoding of messages for transmission through noise, and the second with optimum processing of received signal and noise.

These efforts have arisen from the comparatively recent establishment of the new science known as information theory, which had its formal birth with the publication of a classic paper by Shannon in 1948.<sup>25</sup> Shannon's work is an application of Wiener's philosophy that statistical concepts are the proper language for the study of communications systems.<sup>27</sup>

**TRANSMISSION RATE**—Shannon's fundamental theorem relates the theoretical maximum transmission rate  $C$  of a channel to the bandwidth and signal-to-noise ratio. This is illustrated in Fig. 10.<sup>28</sup>

If a transmitting source is sending information at a rate  $H$  over a noisy channel with capacity  $C$ , and

$H$  is less than  $C$ , Shannon shows that there exists an encoding scheme which permits information to be sent over the channel with arbitrarily small error rate. If  $H$  is greater than  $C$ , there is no way of achieving error-free transmission.

Although Shannon's theory allows certain conclusions to be drawn about the ultimate capabilities of a communication channel, it does not tell us how to achieve them. Thus, the promise held out by coding theory has never been realized despite a decade of intensive effort, although it now appears that we are on the threshold of a breakthrough.

Information theory contains the key to the transmission of digital data with low probability of error. It is obvious that the probability of error can be reduced simply by repeating the message sufficiently many times, but this is inefficient. Shannon's theorem shows that it is not necessary; arbitrarily high reliability can be obtained with arbitrarily low redundancy when  $H$  is less than  $C$ . The difficulty is that the only known method of achieving the Shannon ideal requires encoding of very long message blocks.

It has been impossible until recently to make full use of this method because the decoding operation required a memory with a capacity beyond that which was technically realizable. Recent work by Fano, Elias and Wozencraft at MIT indicates that a practical solution is possible. In simple terms, instead of storing a complete "codebook" in its memory, the computer retains only the mathematical relationships necessary to compute the proper code upon receiving a message.

**RECEPTION THEORY**—Another line of approach to communication through noise which has been notably successful is in the field of reception theory. Out of this has arisen a class of devices which use the principle of coherent detection to distinguish signals submerged in noise.



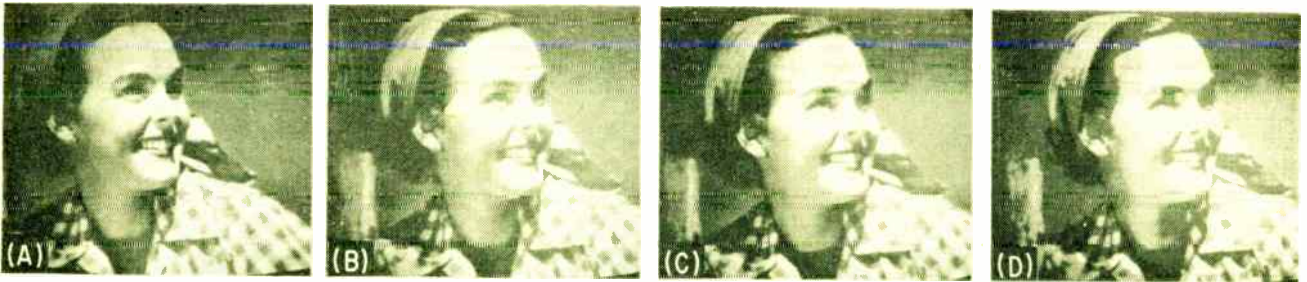

Examples of pulse-code modulated tv pictures in experimental system developed by Bell Telephone Laboratories. (A) is direct off-the-air picture (B) obtained using a 6-digit code and transmitted over standard telephone cable (C) 4-digit code and (D) 3 digits. Code includes synchronization information. In actual use, more than 6 digits may be necessary

# information theory

The principle reason for the efficiency of coherent detection is that the receiver is optimally designed for completely specified signal waveforms and completely known prior signal probabilities and noise statistics. The full advantages of coherent detection can only be realized when all this information is available to the receiver.

In the simplest case of additive white Gaussian noise, and a single signal that is either present or absent, the optimum receiver cross-correlates the incoming mixture of signal and noise with a locally supplied replica of the transmitted waveform, and compares the result with a fixed threshold. When the output of the correlator exceeds the threshold level, the signal is assumed to be present.

The required operation of cross-correlating the received signal with a locally supplied replica can be performed by passing the received signal through a linear filter whose impulse response is the time-reverse of the transmitted waveform (matched filter) or by multiplying the received signal with a replica of the transmitted waveform and integrating the result (multiplier-integrator).

Figure 11 shows two simple mark-space systems, one using matched filters in the receiver, and the other multiplier integrator combinations.<sup>30</sup> In each the decision as to whether a mark or space was sent is made by comparing samples of the mark and space channel outputs taken at an instant close to the end of the signal interval. The receiver must know when to take these samples, and this depends on the path delay between transmitter and receiver.

Recent theoretical and experimental studies have led to a near-optimum receiver design for the reception of signals transmitted through a multipath medium. This development, the Lincoln Lab RAKE, (an experimental teleprinter system), is essentially an application of coherent detection since the RAKE receiver cross-correlates the received mixture of

multipath signal and noise with a locally generated replica of the multipath signal without noise.<sup>30</sup>

**PULSE CODE MODULATION** — Information studies show that pulse code modulation is a nearly ideal means of transmission. In this system, the signal is sampled periodically and each sample is quantized and transmitted as a digital binary code. At the receiver, decoding takes place and yields a reproduction of the original signal. The chief advantage of pcm is that the detecting device must only recognize the presence or absence of a pulse, and the system can withstand large degradation from noise before it will fail.

An experimental pcm system for the transmission

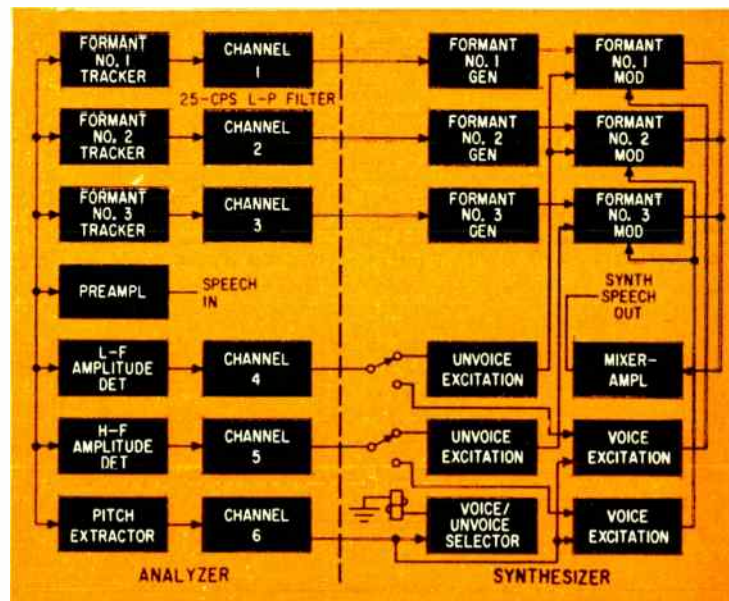

FIG. 12—Speech bandwidth compression system developed by Melpar, Inc.

of color and monochrome tv signals has been developed at Bell Telephone Laboratories.<sup>81</sup> The system uses a 7-digit code to quantize the tv signal and transmits it over 22 gage telephone cable. Use of transistor repeaters to regenerate the signal every few miles results in distortionless transmission.

**BATTLE FOR BANDWIDTH**—The concepts of information theory also hold promise of improving the efficiency with which we can use the available frequency spectrum. The most promising area is the reduction of redundancy in modulation.

Commercial tv as we know it today is a brute force method which contains much more repetitious information than is necessary for the reproduction of a visual scene. The existence of such redundancy makes it reasonable to suppose that codes can be found that remove the repeated information and permit the compression of the signal.

These factors are the basis of a system of tv bandwidth reduction which has achieved a four-to-one reduction for commercial tv in real time.<sup>82</sup> The method is based on studies of the human eye which

is found to be insensitive to rough quantization of grey levels at color boundaries of the picture, provided the boundaries are correctly located and the texture of the picture is left undisturbed. The boundary position is coded to remove part of the residual redundancy.

**SPEECH COMPRESSION**—Similar bandwidth savings can be accomplished by elimination of the inherent redundancy of human speech. The information rate required to transmit a speech signal is about 20,000 bits/sec, whereas the basic information content of the speech signal is approximately 60 bits/sec. Significant advances have been made in speech compression techniques in recent years. They rely on devices which function in a manner analogous to that of the vocal mechanism.

A block diagram of such a device is shown in Fig. 12.<sup>84</sup> It consists of an analyzer which derives control signals from the original speech signal.

The author thanks the many individuals and companies whose time and material were instrumental in the formulation of this report.

## REFERENCES

- (1) J. E. Hacke, Jr., The Future Natural, Technological and Social Environment of Global Communications, Paper presented at 2nd National Symp on Global Comm, St. Petersburg, Fla., Dec 1958.
- (2) D. S. Rau, Radio Communications—A Renascent Art, *Trans IRE on Comm Sys*, CS-6, No. 2, Dec 1958.
- (3) R. E. Lacy, Progress and Problems in U. S. Army Communications, *Proc IRE*, 47, p 650, May 1959.
- (4) K. Henney (Editor), "Radio Engineering Handbook", Section 24-19, McGraw-Hill Book Co., New York, N. Y., 1959.
- (5) G. Millington, The Sunspot Cycle and Radio Communications, *Point-to-Point Telecommunication*, June 1957.
- (6) L. C. Kelley, Forecast of Ionospheric Storms and Radio Communications 1959-1962, U. S. Army Signal Radio Propagation Agency, Fort Monmouth, N. J.
- (7) H. C. Booker and W. E. Gordon, Theory of Radio Scattering in the Troposphere, *Proc IRE*, 38, p 401, 1950.
- (8) H. T. Friis, A. B. Crawford and D. C. Hogg, A Reflector Theory of Propagation Beyond the Horizon, *Bell System Tech J*, 36, p 627, 1957.
- (9) J. L. Hollis, An Experimental Equipment to Reduce Teleprinter Errors in the Presence of Multipath, *Record of Nat'l Symp On Extended Range and Space Comm*, Oct, 1958.
- (10) B. M. Sifford and W. R. Vincent, Meteor Bursts Provide Communications Path, *ELECTRONICS*, p 42, Aug 29, 1958.
- (11) G. W. L. Davis, Canadian Meteor Burst Communications, paper presented at Nat'l Symp on Extended Range and Space Comm, Oct 1958.
- (12) L. R. O. Storey, PhD Dissertation, Cambridge University, England.
- (13) R. A. Helliwell, Whistlers and Very Low Frequency Emission, Paper presented at meeting of US Nat'l Acad of Sci, June, 1957.
- (14) J. R. Wait, The Mode Theory of VLF Ionospheric Propagation for Finite Ground Conductivity, *Proc IRE*, p 761, June 1957.
- (15) J. A. Pierce, Intercontinental Frequency Comparison by VLF Radio Transmission, *Proc IRE*, p 794, June 1957.
- (16) R. M. Golden, R. V. Langmuir, R. S. MacMillan, W. V. T. Rusch, A New VLF C-W Transmitter for Ionospheric Investigation—KM2X1X, *Proc IRE*, p 1381, Aug, 1959.
- (17) D. C. MacLellan, Some Aspects of the Use of Space Satellites For Communications, *Record of Nat'l Symp on Extended Range and Space Comm*, Oct 1958.
- (18) J. R. Pierce and R. Kompfner, Transoceanic Communication by Means of Satellites, *Proc IRE*, March 1959.
- (19) D. T. Worthington, Satellite Communications System, Paper presented at Global Comm Symp II, St. Petersburg, Fla.
- (20) J. H. Trexler, Lunar Radar Echoes, *Proc IRE*, p 287, Jan 1958.
- (21) T. B. A. Senior, K. M. Siegel, H. Weil, The Influence of Radar Reflection Characteristics of the Moon on Specifications for Earth-Moon-Earth Communications Systems, U. of Mich Radiation Lab Report.
- (22) H. G. Busignies, Long Distance Communication System, US Patent No. 2,871,344 (assigned to ITT Laboratories).
- (23) B. Fisk, US Naval Research Laboratory, private communication, Aug 18, 1959.
- (24) J. P. Costas, General Electric Co., private communication, July 24, 1959.
- (25) J. P. Costas, Synchronous Communications, *Proc IRE*, p 1713, Dec 1956.
- (26) C. E. Shannon, "The Mathematical Theory of Communications", The U of Illinois Press, Urban, Ill., 1949.
- (27) N. Wiener, "Cybernetics", John Wiley & Sons, Inc, New York, 1949.
- (28) *The Leukart Demodulator*, Sept 1957.
- (29) D. Van Meter, Melpar, Inc., private communication, Aug 1959.
- (30) R. Price and P. Green, A Communication Technique for Multipath Channels, *Proc IRE*, 46, p 559, 1958.
- (31) R. L. Carbrey, Paper delivered at meeting of IRE PGCS, Utica, N. Y., Oct 5, 1959.
- (32) R. E. Wernikoff, On the Efficient Representation of Pictorial Data, Melpar Research Report 59/1, Melpar, Inc, Boston, Mass.
- (33) W. Schreiber, C. F. Knapp and N. D. Kay, Synthetic Highs—An Experimental TV Bandwidth Reduction System, 84th SMPTE Convention, Detroit, Mich., Oct 1958.
- (34) S. J. Campanella, Melpar, Inc., private communication, Aug 24, 1959.





**1003-C VIDEO TRANSMISSION TEST SIGNAL GENERATOR**

Produces all necessary SMP standard modulated staircase, color bar, composite sync, burst, and color. Regulated power supply.

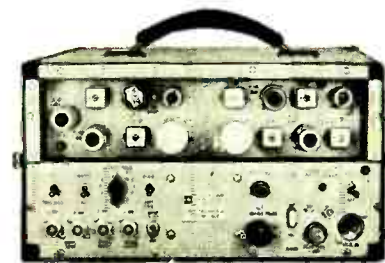

**1004-B VIDEO TRANSMISSION TEST SIGNAL RECEIVER**

Very rapid and accurate measurements of differential phase and differential gain characteristics of video facilities. Responds to standard staircase test signal modulated with 3.58mc, or any differential phase or gain test signal.

# VIDEO TRANSMISSION TEST EQUIPMENT

In Daily Use by All Major Networks, Stations and Telephone Co. Coaxial Cable, Microwave, and Intercity Facilities.

ALL CARRYING CASE UNITS IMMEDIATELY ADAPTABLE TO STANDARD RACK MOUNTING

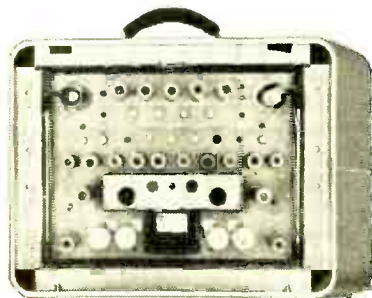
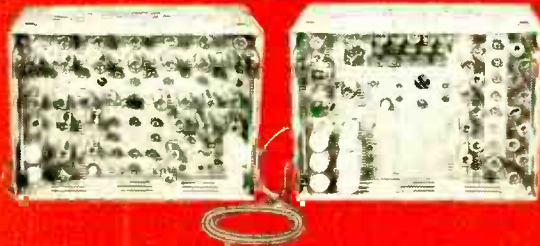

**1008-A VERTICAL INTERVAL KEYS**

Permits test and control signals to be transmitted simultaneously with program material, between frames of TV picture. Any test signal (multiburst, staircase, color bar, etc.) may be added to the composite program signal. Test signals are always present for checking transmission conditions without impairing picture quality. The home viewer is not aware of their presence.



**1073-CR SINE SQUARED (SIN<sup>2</sup>)—SQUARE WAVE GENERATOR**

Produces new waveform for testing TV or other pulse and/or system for amplitude and phase characteristics. Sin<sup>2</sup>—Square wave pulse is equivalent to TV camera signal and is more accurate than a Square Wave in indicating ringing. Video test signal adjustable for 1.0 volts or 1.4 volts peak to peak. Now in use by major TV networks and telephone companies.

AT THE FRONTIERS OF ELECTRONICS  
COLOR TV • INDUSTRIAL INSTRUMENTATION • TELEMETRY



## TELECHROME MANUFACTURING CORP.

28 RANICK DRIVE AMITYVILLE, N. Y. Lincoln 1-3600

Cable Address: COLORTV

TWX: AMITYVILLE NY2314

Midwest Engineering Division—106 W. St. Charles Rd., Lombard, Ill., MAYfair 7-6026

Western Engineering Division—13635 Victory Blvd., Van Nuys, Calif., State 2-7479

*“...an investment  
that makes  
all other  
investments  
worthwhile”*

JOHN COLLYER  
Chairman of the Board  
The B. F. Goodrich Company



“For much of our nation’s progress, technologically, economically and socially, we must look to the excellence of our institutions of learning, whose students of today will be the scientists, the managers, the statesmen and the cultural and religious leaders of tomorrow.

“It is the responsibility of the American people and American industry to provide the financial aid so urgently needed now by our colleges and universities.

“Join this important crusade. Contribute today to the university or college of your choice. You will be making *an investment that makes all other investments worthwhile.*”

If you want more information on the problems faced by higher education, write to:  
Council for Financial Aid to Education, Inc., 6 E. 45th Street, New York 17, N. Y.

*Sponsored as a public service, in cooperation with the  
Council for Financial Aid to Education*

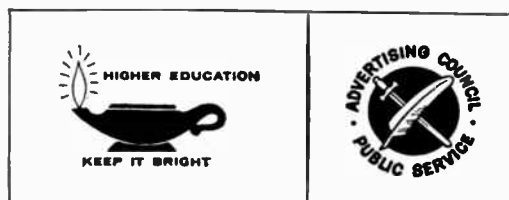



# ELECTRONIC DETECTION...

*tremendous challenge to  
creative engineers in a  
field whose growth must  
parallel the space age*

... At General Electric, detection system engineering has become a profession in itself—offering electronic engineers financial and career opportunities not found in many other electronics fields.

Advanced radar detection systems offer probably the most effective method of determining location, direction, and speed of in-flight missiles or aircraft. And the General Electric Company has played—and continues to play—a leadership role in the conception, design, and development of advanced radar detection systems for science and National Defense.

In line with this role General Electric needs more qualified personnel. Right now General Electric needs electronics engineers, mathematicians, data processing specialists with the capabilities to make positive contributions toward the solution of urgent defense problems.

But unlike many companies, General Electric offers qualified personnel—with a minimum of three years in radar design and development or related phases—career opportunities with the growth potential for which they have been looking.

If this challenge interests you compare General Electric's self-development opportunities in the privacy of your own home. Write for this brochure today.



Compare self-development opportunities at General Electric

- Please send me your brochure describing your self-development program.
- I am enclosing my resume for your consideration.

T. M. George, Supervisor  
Personnel Administration  
Section E228-5  
Missile Detection Systems Section  
General Electric Company  
Syracuse, New York

NAME \_\_\_\_\_

DEGREE \_\_\_\_\_

ADDRESS \_\_\_\_\_

CITY \_\_\_\_\_ STATE \_\_\_\_\_

MISSILE DETECTION SYSTEMS SECTION  
HEAVY MILITARY ELECTRONICS DEPARTMENT

**GENERAL  ELECTRIC**

# are you silicon wait-bait?



## avoid unnecessary delays

# GT DELIVERS SILICON TRANSISTORS IN 24 TO 48 HOURS!

No need to get hung up with delays or hooked by unkept promises! GENERAL TRANSISTOR delivers sample quantities of GT Silicon Transistors in 24 to 48 hours... production quantities in 2 to 4 weeks!

These are not mere claims, but firm promises on which you can base your design and production schedules.

Quality? Yes — plenty of weight here without waiting. General Transistor is today one of the largest suppliers of highly dependable devices, delivering quality in quantity.

For full information — and fast delivery — call your local General Transistor representative, or contact us directly. Write for Silicon Brochure S-100.

### GENERAL TRANSISTOR CORPORATION

91-27 138th Place, Jamaica 35, New York  
Phone: Hickory 1-1000



A Few of the GT Alloyed Junction Silicon Transistors Now Available

- HIGH SPEED SWITCHING
- MEDIUM SPEED SWITCHING
- HIGH VOLTAGE
- HIGH SPEED LINEAR AMPLIFIER
- MEDIUM SPEED LINEAR AMPLIFIER

PNP:	2N1219	2N1220	2N1221	2N1222	2N1223
$V_{CB0}$	30 v	30 v	30 v	30 v	40 v
$V_{CE0}$	25 v	25 v	25 v	25 v	40 v
$V_{EB0}$	20 v	20 v	10 v	10 v	10 v
$I_{CO}$	.1 $\mu$ a max.	.1 $\mu$ a max.	.1 $\mu$ a max.	.1 $\mu$ a max.	.1 $\mu$ a max.
$h_{FE}$	18 min.	9 min.	—	—	—
$f_{ab}(mc)$	5 min.	2 min.	5 min.	2 min.	2 typ.
$h_{fe}$	—	—	18 min.	9 min.	6 min.

FOR IMMEDIATE DELIVERY FROM STOCK, CONTACT YOUR NEAREST AUTHORIZED GENERAL TRANSISTOR DISTRIBUTOR OR GENERAL TRANSISTOR DISTRIBUTING CORP., 91-27 138TH PLACE, JAMAICA 35, NEW YORK. FOR EXPORT: GENERAL TRANSISTOR INTERNATIONAL CORP., 91-27 138TH PLACE, JAMAICA 35, NEW YORK. PRECISION MAGNETIC RECORDING HEADS AVAILABLE FROM GENERAL TRANSISTOR WESTERN CORP., 6110 VENICE BLVD., LOS ANGELES, CALIF.





Eel River survey in northern California used a helicopter to transport microwave distance measuring equipment. Use of the instrument in the survey, conducted by California's Department of Water Resources, resulted in an estimated 50 percent savings. The helicopter made even further economy possible

# Electronic Surveying

New applications of radar principles and other electronic developments reduce field time and simplify data processing in surveying operations

By **ALAN S. ROSENTHAL**, Cornell University, Ithaca, N. Y.

**ELECTRONIC ADVANCES** CONTINUE to have major effects on every phase of engineering. Recent developments in surveying equipment and techniques have significantly changed a basic civil engineering operation, opening an important new market to electronic instrument manufacturers.

Many electronic devices are making it possible to survey areas that were formerly considered inaccessible and are cutting working time substantially. Computers are bringing drastic reductions in data-processing time.

**VISIBLE-LIGHT**—Surveying and map-making operations require distance measurements to be far more accurate than those possible with ordinary

radar techniques. The Geodimeter gives this accuracy using modulated visible light to measure the distance between two stations. The instrument is an optical phase comparison system used at night. A block diagram is shown in Fig. 1.

Visible light is passed through a Kerr cell and reflected from a distant target. The Kerr cell is an electronic shutter that marks the beam for phase comparison. It is a glass vessel containing highly purified nitrobenzene between two electrodes. The application of a voltage to the electrodes orients the dipole molecules of the fluid in the direction of the field. As a result, the cell's refractive properties are a function of the applied voltage. A d-c reference voltage with an a-c signal superimposed upon it is

applied to the cell; thus, the light beam that passes through is modulated.

The same a-c signal that is applied to the Kerr cell is used to power the multiplier phototube. The circuit is so designed that the tube is operative only when the modulated light is at a zero point. The action of the phototube must be synchronized with the light signal. Delays caused by finite wire lengths are compensated for by the variable light-delay unit inside the instrument. This delay unit permits accurate calibration before measurements are made.

The oscillator is designed to operate at 30 mc. The resulting quarter wavelength is 2.5 m. If the reflector is moved 2.5 m to the position shown in Fig. 2B, the phototube will still record a null. But moving the reflector a smaller distance,  $d$ , makes it necessary to move the phototube an equivalent distance for a null reading as in Fig. 2C.

The variable electrical delay unit has the effect of repositioning the receiver. The delay unit is calibrated so that when a null is obtained the dial gives a direct distance reading corresponding to the delay introduced in the phototube response.

This reading alone would only give the fraction of 2.5 m lengths between the transmitter and reflector. Changing the frequency a few kilocycles and again determining the null gives the number of quarter wavelengths in the measured distance.

**MICROWAVES**—Another distance measuring device working on similar principles is the Tellurometer. Instead of using visible light waves, it operates with microwaves. In this instrument, the null detector is replaced by a cathode-ray tube from which the desired distance may be read.

Since the instrument does not use visible light, it does not demand the night operation. It can be used under unfavorable weather conditions, but its accuracy is then reduced because of wave refraction by the atmosphere.

**ADVANTAGES AND LIMITATIONS**—Both visible-light and microwave devices have been used extensively in precise surveying and mapping work. Users report successful operation with accurate results.

The range of the visible-light instrument can be as great as 30 miles. The accuracy of these electronic surveying instruments, while adequate for most operations, is limited primarily by atmospheric diffraction of the measuring wave. In each of the systems described, careful temperature and pressure measurements must be made and appropriate distance corrections applied. The corrections become particularly important when using the microwave instrument.

The United States Air Force has been doing a considerable amount of research on this problem of atmospheric wave diffraction. Results show that frequent measurements of atmospheric conditions made between the receiver and reflector significantly improve accuracy.

**AIR SURVEYING**—When electronic surveying is carried on from the air, areas formerly considered inaccessible can be explored and mapped. Aircraft have been used to transport ground equipment from



Micro-dist uses an r-f signal to measure distances. The two stations are interchangeable, one acting as an interrogator, the other as a responder. The time lapse between the original pulse and the return signal gives a measure of distance. Manufactured by Cubic Corp., the unit measures distances from 250 ft to 50 miles

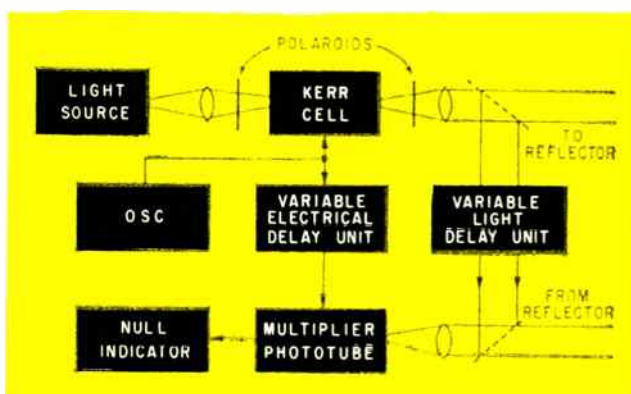

FIG. 1—Visible-light distance measuring circuit uses a crystal oscillator to power the Kerr cell and the multiplier phototube through a variable electrical delay. The variable light delay inside the instrument is calibrated to compensate for significant electric delays

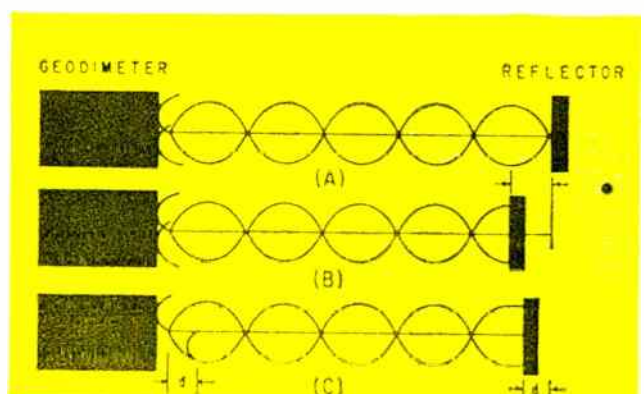

FIG. 2—The wave produced by the light source and Kerr cell has a wavelength of 10 m. When the reflector is moved fraction of 2.5 m, a null is no longer recorded. A mechanical movement shown in (C) or an electrical one brings back the null reading





Geodimeter uses modulated light reflected from prisms to measure the distance between stations. Berg Hedstrom's model 4 unit shown here is portable with a maximum range of three to five miles and a minimum of fifty feet

station to station, but electronic circuits now make it possible to use the airplane as an intrinsic part of the measuring procedure.

The Shoran system and its more accurate modification, Hiran, are designed for such work. In these systems two portable ground stations are used in conjunction with an airborne receiver, transmitter and timing unit. The airborne transmitter sends out two 0.8 microsecond pulses at a repetition rate of 931 pulses per second on two frequencies in the 220 to 260 mc band. One frequency is used for each ground station, and the transmitter is switched from one frequency to the other at 20 cps.

Each ground station is a responder beacon which amplifies and retransmits a signal on a common frequency in the 220 to 320 mc band. These pulses are returned to the airborne unit, and the time between the interrogation and response pulse is interpreted in terms of distance.

The circuit is designed to provide a continuous record of the distance from the plane to each station. Instead of actually measuring time or distance from transmitted to received pulse, the system makes the received pulse coincide with a reference pulse.

**ELECTRONIC MAP-MAKING**—When air photographs are taken, electronic circuits play an important part in the processing procedure. New developments in this area include stereo-plotters that produce contour lines and topographical maps directly from air photographs.

A completely new approach to the field of air mapping is the use of air-carried gravity meters to determine topography. Since local changes in the shape of the earth cause changes in gravitational force, measurement of these changes provides useful data for map making.

Two major difficulties encountered in air-carried gravity meter systems are meter stabilization and the determination of aircraft motion and position. Gyro systems provide some stabilization, but airplane position and acceleration must be carefully noted. Although data may be taken under normal flying

conditions, excessive air turbulence invalidates the observations. Aircraft position must be accurately determined, and systems such as Hiran or doppler radar in conjunction with pressure altimeters are usually used.

A major disadvantage of most air-surveying techniques is a loss of accuracy. The accuracy of the results cannot compare with those of ground methods, but the speed with which an area can be mapped and the ease with which it can be reached make the method valuable, especially for military work.

**COMPUTERS**—New electronic equipment is thus playing an ever-increasing role in gathering survey data and translating them into maps. Not to be neglected are the many uses for computers in the processing of these data. Digital computers are used for checking traverses for geometrical closure and adjusting angular errors, for computing adjusted bearings and trial closures and for computing plane coordinates. Computers have repeatedly proven their value by making possible the thorough and accurate evaluation of large quantities of data. Despite high rental costs, surveying companies find that for organized operations of sufficient size, the use of computers is economically justified.

#### BIBLIOGRAPHY

- Erik Bergstrand, The Geodimeter System, presented at the International Association of Geodesy Symposium, May 8, Washington, D. C., unpublished paper.
- R. S. Duggan, Jr., A New Aerial Surveying System, *IRE 1959 Conference Proc*, p 114, June 1959.
- Paul W. Jordan, Hiran Instrumental Developments, presented at the International Association of Geodesy Symposium, May 6, Washington, D. C., unpublished paper.
- Lucien LaCoste, Airborne Gravity Measurement, presented at the Society of Economic Geologists meeting, Apr. 1959, El Paso, Texas.
- Lucien LaCoste, Surface Ship Gravity Measurements on the Texas A. and M. College Ship, the "Hidalgo," *Geophysics*, 26, p. 309, Apr. 1959.
- C. J. Montgomery, Some Applications of Electronic Computers to Surveying Problems, *Surveying and Mapping*, 19, p 43, Mar. 1959.
- Austin C. Poling, The Geodimeter and Tellurometer, *Journal of the Surveying and Mapping Division Proc ASCE*, 84, p 1617, Apr. 1958.
- Moody C. Thompson, Jr., Harris B. Janes, and Frank E. Freethy, Atmospheric Limitations on Electronic Distance Measurement Equipment, *NBS Report 6060*.





# Analog Techniques

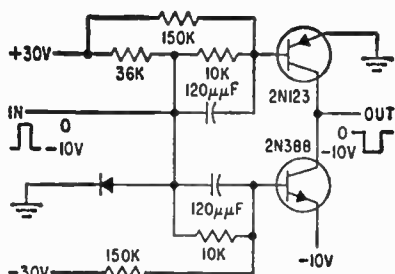

FIG. 2—Transistor switches have drop of less than 50 mv when delivering 50 ma

sonably good quality.

Writing speed is faster than that of raster-scanning systems and comparable to that of systems using crt masks. Brightness is either better or equal to other systems if the same beam current and accelerating voltage are used. Character shape and definition are superior because each dot can be positioned as desired without degenerating the rest of the character, unlike raster-scanning and harmonic-synthesis techniques. In the crt mask-type system, some distortion in character shape is practically unavoidable owing to the difficulty of maintaining a well balanced post-deflection system for a shaped beam.

## System Description

Solid-state devices are used to display 40 characters on the screen of a commercial oscilloscope in the system shown in the block diagram in Fig. 1. The characters include letters A through Z, numerals 0 through 9 and four special characters—slash sign, plus and minus signs and period. This model has been operating for an extended period without failure.

The blocking oscillator in Fig. 1, operating at a frequency of about 300 kc, functions as a clock generator. The dot binary counter and its associated diode decoding matrices counts from zero to 31. Only the first 20 positions are used however because the maximum number of dots assigned to a character is nineteen (letter W). The character binary counter decodes to 64 positions; however, only 40

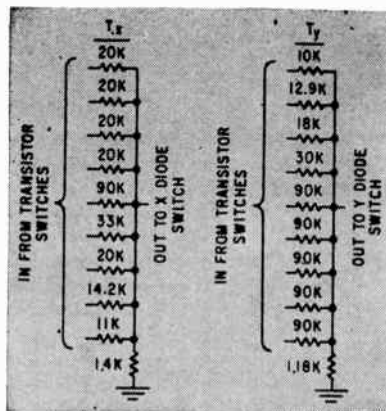

FIG. 3—Resistor networks rely on analog-computer summing-network techniques to establish coordinates for letter T

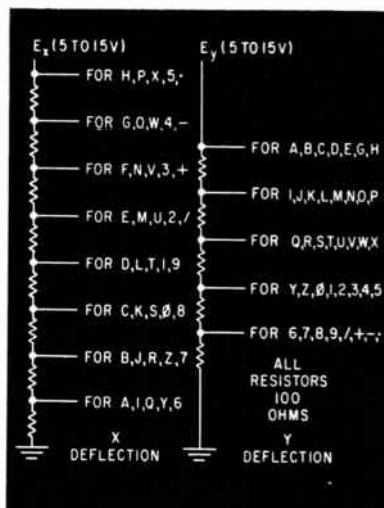
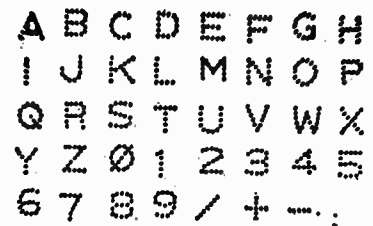

FIG. 4—Major deflection voltages for the X and Y components of the letters indicated are determined with these networks

positions are used to sequentially select the characters and symbols. The character counter will ultimately be replaced by an input register receiving outside information in digital form.

Pulses from the clock generator are fed to the dot counter at all times except during dot-counter reset. After each character has been completed, reset is accomplished by the next pulse through the turn-off diode logic gates. At this time, a pulse is sent to the character counter to advance it to the next position during a 10 to 15- $\mu$ sec period established by a one-shot



High-definition display can easily be modified to add new symbols and does not require special crt

multivibrator. During this period, the dot counter is held at reset position ready for the next character cycle. After the last character in the display has been completed, both dot and character counters are reset.

In the present systems, this period, from a few to 30 milliseconds, is established by another one-shot multivibrator. Eventually this function will be controlled by a buffer storage, where information for a complete display will be repeated periodically to avoid flicker in the presentation.

Each decoded output from the dot counter is applied through power inverters to a pair of transistor switches like that shown in Fig. 2. Switch output is either virtually at ground level or a precise -10 volts. Transistor switch on time is about 3  $\mu$ sec, which may be called the dot period. However, to eliminate transient traces, the scope is unblanked only during the middle of the dot period. Unblanking is accomplished after a 1- $\mu$ sec delay established by a one-shot multivibrator. A blocking oscillator with a duration of 1 to 1.5  $\mu$ sec provides the unblanking pulse, as shown in Fig. 1. The unblanking pulse in turn is applied to the Z input of the oscilloscope.

## Character Generation

The dots that form each character are generated by two resistor networks, one for the X and the other for the Y component voltages. Networks for the letter T are shown in Fig. 3. The top resistors in each

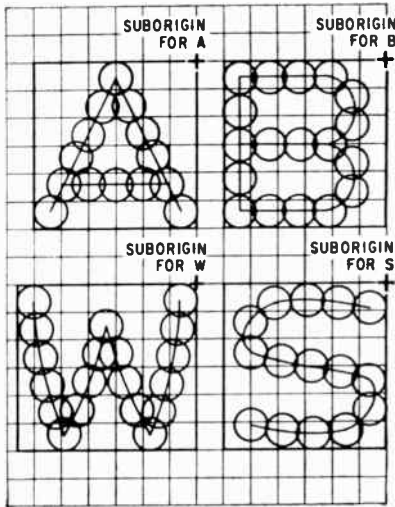

FIG. 5—Sample characters show how coordinates are measured from suborigins

network determine the relative position of the first dot in terms of  $X$  and  $Y$  component voltages. One pair of transistor switches drives the first  $X$  and  $Y$  resistors of all networks. A second pair of switches drives the second pair of resistors in each network, etc.

The character dot voltages developed across the resistors are superimposed on the  $X$  and  $Y$  major position voltages and fed to 40 pairs of diode switches. The diodes function as SPST switches with their outputs fed to the  $X$  and  $Y$  deflection amplifiers of the oscilloscope. Since only one pair of diode switches is selected at a time by the character counter through the push-pull drivers, there is no cross-channel interference.

The  $X$  and  $Y$  major deflection voltages could come from digital decoders that would decode position information from input registers. They would be fed directly to the deflection system without merging with the dot voltages at the input points of the diode switches. Alternately, the position and dot voltages could be separately applied to two independent deflection systems, either magnetic or electrostatic, or a combination of both, depending on the type crt used. In the present system, major deflection voltages are tapped from the dividers in Fig. 4.

### Circuit Description

The counters (flip-flops), decoding diode matrices and gates are

conventional digital circuits. Signal levels are such that  $-10$  volts is designated as binary ONE and no voltage as binary ZERO. The turn-off diode logic is made of many OR-AND circuits in parallel and merged to a single OR circuit that triggers the one-shot multivibrator. The diode logic block cycles the dot counter according to the number of dots assigned to a character. Thus the system starts forming the next character without the delay that would occur in a system with a cycle time fixed to accommodate the character requiring the largest number of dots.

The transistor switch in Fig. 2 is essentially a complementary inverter, with the output switched between  $-10$  volts (variable to adjust character size) and zero volts. Drop across the conducting transistor is less than 50 mv when delivering a load current of about 50 ma.

### Resistor Networks

To avoid simultaneous equations, the resistor networks in Fig. 3 are designed as follows: The 40 characters are laid out on graph paper as shown by the examples in Fig. 5. Each character is assigned a 6 by 6-cm square with suborigins as indicated. Dot centers are measured

from the suborigins. The coordinates of these values are inversely proportional to the corresponding resistors. Considering impedance levels and total current required from a transistor switch, the upper and lower limits of these resistors are established as 100,000 and 10,000 ohms, respectively. In-between values of resistance are scaled accordingly.

A padding resistor is added between output and ground so that output impedance and attenuation factors are made the same for all summing networks with different numbers of resistors. To achieve this, it is necessary to find the network with the least total resistance, in this case the  $X$  component of the letter  $W$ . Using this resistance value as a reference and without adding a padding resistor, the padding resistors of the other networks are calculated.

### Diode Switch

The 6-diode bridge-type switch<sup>2</sup> is shown in Fig. 6. For precision low-level switching, it may be necessary to match silicon diodes and to provide temperature control. However, for this application, using only two silicon diodes and four germanium diodes with relatively high back resistance was found satisfactory.

Transmission gain of the diode switch is made close to unity by using a large coupling capacitor so that the combined source impedance is about equal to the output impedance of the resistor network (about 1,000 ohms). Discharge time constant of the capacitor is made much larger than the character duty cycle to avoid noticeable drooping at the output.

The push-pull driver in Fig. 7 is a two-stage inverter that converts a single-ended signal (0 to  $-10$  volts) to  $+10$  and  $-10$  volts, so that it can be used to drive the diode switch. This circuit may be eliminated from the system if balanced signals are available from the counter.

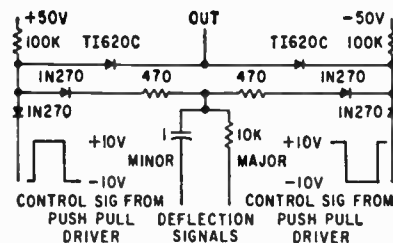

FIG. 6—Two silicon diodes and four germanium diodes with high back resistance form satisfactory bridge-type switch

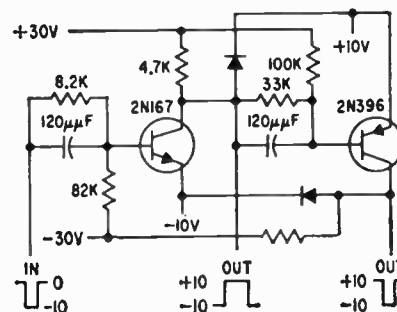

FIG. 7—Push-pull driver converts single-ended input to output signal that switches between  $-10$  and  $+10$  volts

### REFERENCES

- (1) G. A. and T. M. Korn, *Electronic Analog Computers*, McGraw-Hill Book Company, New York, 1956.
- (2) J. Millman and T. H. Puckett, *Accurate Linear Bidirectional Diode Gates*, *Proc IRE*, 43, p. 27, Jan. 1955.



# Soft Solder Conductivity

Choosing a solder on the basis of its conductivity may be advantageous when more than one solder satisfies design and production requirements

By ALVIN B. KAUFMAN,

Head, Materials/Devices Research Section, Research and Analysis Dept., Litton Industries, Beverly Hills, Calif.

SOLDER'S ROLE in securing reliable electrical connections under environmental extremes has received much attention recently.<sup>1</sup> However, the electrical characteristics of solder, in terms of reliability and circuit performance, are often overlooked.

A solder is usually selected to satisfy such design and production requirements as plastic or melting temperature, solderability, tensile strength and environment. In many applications, the solder's conductivity is unimportant. Sometimes, however, con-

ductivity is of major importance.

Although no solder approaches copper in conductivity, some solders are 100 to 400 percent more conductive than others. As shown in Table I, tin-lead-based solders have conductivities 7.5 to 15 percent that of copper and indium-based solders have a top of 22 percent. Conductivity (or its reciprocal, resistance) is compared at 20 C. Such a comparison is adequate between -65 C to 185 C. Temperature-resistance coefficient variations between solders imply that at cryogenic or elevated temperatures the conductivity relationship can change, and the inferior solder may become superior.

Conductivity values given are based on volume rather than mass since volume is considered in most wiring or solder joint terminations. Tensile and impact strength from -320 F to melting points are given in literature previously referenced.<sup>1</sup>

Soft solders are generally an alloy. Any binary alloy has a lower melting point than either metal<sup>2</sup> and less conductivity than the more conductive metal. Tin-based solders are subject to allotropic changes at low temperatures unless alloyed with about 0.1 percent bismuth or 0.25 percent antimony.<sup>3</sup> Allotropic change in tin from Beta (white) to Alpha (gray) phase seriously affects its conductivity and strength.

When extremely low connection resistance is required, a tight wire-to-wire connection, soldered for adhesion and corrosion resistance, appears adequate. In most connections, the solder path has enough volume and conductor-to-conductor spacing is so close that the connection probably does not introduce any appreciable resistance. The use of solder as a long electrical path is not recommended except in high-resistance circuits. Solder-coating printed wiring does not contribute greatly to its conductivity.

Table I is believed to contain the first compendium of the electrical conductivity of soft solders. Data was gathered by the author through empirical tests and literature search.

Table 1—Characteristics of Soft Solders

Name	Composition	Con-duc-tivi-ty <sup>a</sup>	Tensile Strength (psi 68 F) <sup>b</sup>	Plas-tic	Li-quid (deg F)
<b>TIN-LEAD-BASED SOLDERS<sup>c</sup></b>					
Tin	100Sn	15	1,800	450	450
Lead	100Pb	8	1,780	621	621
Sb 5	95Sn-5Sb	13	5,900	450	468
.....	95Sn-5Ag	14	14,000	415	430
.....	90.5Sn-9.5Bi	10	.....	.....	.....
.....	90Sn-10Pb	13	.....	361	415
Sn 70	70Sn-30Pb	12	6,150	361	367
Sn 63	63Sn-37Pb	11	6,273	361	361
Sn 60	60Sn-40Pb	11	6,300	361	370
Sn 50	50Sn-50Pb	11	6,273	361	414
Ag 1.5	97.5Pb-	7.5	3,600	580	588
	1.5Ag-1Sn				
Ag 2.5	97.5Pb-2.5Ag	8.1	3,600	580	585
<b>INDIUM AND BISMUTH-BASED SOLDERS</b>					
Indium	100In	24	.....	.....	.....
Indal-loy <sup>d</sup> 1	50In-Sn	12	515	.....	314
2	80In-Ag & Pb	13	1,050	.....	243
3	90In-Ag	22	2,050	.....	446
5	25In-Pb & Sn	7.8	5,100	.....	280
7	50In-Pb	6	3,050	.....	419
10	25In-Pb	4.6	4,100	.....	446
Cerro-cast <sup>e</sup>	16Bi-48Sn-36Pb	4.6	6,000	.....	302
	98Bi-2Sn	0.7	.....	.....	~500

(a) Conductivity (as percentage of copper) is expressed in terms of International Annealed Copper Standard at 20 C (68 F). Values are accurate within 10 percent. Indium values were obtained from Reference 4 (b) Short term tensile strength. For long term holding strength, derate to approximately 0.1 of value noted (c) QQ-S-571c federal specification (d) Indium Corp. of America (e) Cerro de Pasco Corp.

## REFERENCES

- (1) A. B. Kaufman, Solders for Nuclear and Space Environments, ELECTRONICS, 32, p 51, Sept. 4, 1959.
- (2) E. Hausmann and E. P. Slack, "Physics", Third Edition, p 266, D. Van Nostrand Co., New York, 1948.
- (3) ASTM Symposium on Solder, STP 189, American Society for Testing Materials, Philadelphia.
- (4) Indalloy Intermediate Solders, Indium Corp. of America, Utica, N. Y.

# Unconventional Technique

Easy-to-set-up instrument measures voltage-standing-wave ratio of very-high-frequency antennas with a simple R-C directional coupler

By J. HANSON, Project Engineer, Sinclair Radio Laboratories, Ltd., Downsview, Ontario

**T**HIS instrument measures the voltage-standing-wave ratio (vswr) of an antenna. It operates in the 150 to 175-mc region and is completely transistorized. The instrument contains an oscillator, directional coupler and meter indicator.

## Operation

The variable-frequency oscillator (Fig. 1) provides a signal voltage at the required frequency within the vhf band. This signal is fed through a directional coupler to the antenna. Any mismatch at the antenna reflects power back to the directional coupler.

The coupler has two outputs which are selected in sequence. These outputs are d-c voltages which are proportional to forward and reflected powers to and from the antenna. First one, then the other is selected for amplification and presentation on a calibrated meter scale.

Gain of the d-c amplifier is adjustable so that the forward power reading can be set on the meter scale, and the reflected power read in proportion. The meter is calibrated in vswr units.

## Oscillator

The oscillator (Fig. 2) uses a mesa transistor which has an  $f_a$  of 480 mc and a power output of about 20 mw across the vhf band. Phase-shifting and impedance transforming network  $C_1$ ,  $L_1$ , and  $L_2$  provide maximum positive feedback around the transistor to compensate for the excessive phase shift of this transistor.

Oscillator output is inductively coupled to a single-turn loop feeding a 50-ohm coaxial cable. The

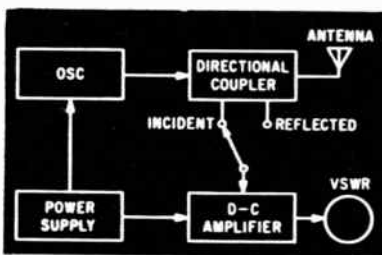

FIG. 1—Meter of vswr-measuring instrument is first adjusted with switch on incident



Meter is set to infinity with set level-read switch at set level (incident power setting)

cable goes to the junction of  $R_3$  and  $D_1$ , the directional-coupler input.

## Directional Coupler

The accuracy of the directional coupler determines the basic accuracy of the instrument. A broad-band device is required to maintain calibration over the operating range. To do this in a small volume, an R-C coupler is used. Essentially, this coupler is independent of frequency.

According to transmission-line theory, the voltage and current at any point on a line may be expressed as the sum of two waves, incident and reflected.<sup>1</sup> At any point on the line

$$e = e_i + e_r \quad (1)$$

and

$$i = i_i + i_r \quad (2)$$

where  $e_i$ ,  $i_i$ , and  $e_r$ ,  $i_r$ , are voltages and currents of incident and reflected waves, respectively.

If the line impedance is a constant,  $Z_0$ , then  $e_i = Z_0 i_i$ ,  $e_r = Z_0 i_r$ , and  $e = Z_0 i$ . From Eq. 2

$$Z_0 i = Z_0 i_i - Z_0 i_r = e_i - e_r \quad (3)$$

Solving Eq. 1 and 3 for  $e_i$  and  $e_r$ ,  $e_i = (1/2)(e + Z_0 i)$  and  $e_r = (1/2)(e - Z_0 i)$ . The vswr on the line is (using magnitude values only)

$$\frac{(e_i + e_r)/(e_i - e_r)}{[(e + Z_0 i) + (e - Z_0 i)] / [(e + Z_0 i) - (e - Z_0 i)]}$$

Thus, the vswr can be determined by adding and subtracting voltages proportional to the line voltage and the line current.

Figure 3A shows the equivalent circuit of the directional coupler. The incident section of the coupler produces an output proportional to the sum of a current-proportional voltage and the line voltage, and the reflected section of the coupler produces an output proportional to the difference of a current-proportional voltage and the line voltage.

## Directional-Coupler Design

The coupler system can be analyzed as a pair of bridges connected in parallel (Fig. 3B). For simplicity all impedances are considered resistive except  $Z_L$ , which represents the antenna load transformed through the transmission line.

Assume that detector currents  $I_{d1}$  and  $I_{d2}$  are proportional to the coupler output voltages. Bridge 2 is balanced only when  $Z_L = 50$  ohms (resistive). Thus, for any other value of  $Z_L$ ,  $I_{d2}$  flows and a reflected power reading is obtained. Since Bridge 1 is balanced for reflected energy when  $R_0 = 50$  ohms, it responds only to incident power.



# for Measuring VSWR

One design condition of these bridges is that when  $Z_L = 0$  (the short-circuiting, maximum vswr condition), the detector currents should be equal. This will be true if the detector voltages across the diodes are equal. This condition exists when

$$V_{13} - [V_{43}(R_2)/(R_1 + R_2)] = V_{43}(R_2')/(R_1' + R_2')$$

However,

$$V_{4a} = V_{13} \left[ \frac{Z'(R_1 + R_2)}{R_3(Z' + R_1 + R_2) + Z'(R_1 + R_2)} \right]$$

Thus

$$V_{4a} = V_{13} \left[ \frac{Z'(R_1 + R_2)}{R_3(Z' + R_1 + R_2) + Z'(R_1 + R_2)} \right] \left[ \frac{R_2'}{R_1' + R_2'} + \frac{R_2}{R_1 + R_2} \right] \quad (4)$$

The product of the bracketed pair can only be unity if the condition for detector-current equality is to hold. It can be shown that the same criterion holds for  $Z_L = \infty$  (open circuit). Of the terms comprising this condition, all are constant with  $Z_L$  except  $Z'$ . The left-hand term of Eq. 4 approaches a constant as  $R_3$  ( $Z' + R_1 + R_2$ ) becomes small. Thus  $R_3$  should be as small as possible,

allowing for sensitivity requirements. These considerations show that there is a small residual error in the coupler, depending upon the sensitivity required. The values of the directional-coupler resistors shown in Fig. 2 are a compromise.

The theoretical variation between detector outputs at open and short circuit is about 4 percent. In practice this can rise to about 8 percent, depending on the accuracy with which the components are resistive at the frequency in use.

A coaxial type mount was used for resistors  $R_3$  and  $R_3'$ , holding the impedance approximately constant at 50 ohms through the coupler. The whole unit is enclosed in a conducting outer case.

## D-C Amplifier

A balanced, temperature-compensated, 2-stage amplifier provides sufficient gain to drive the meter. The amplifier is basically a differential amplifier connected so that thermal and other drift effects tend to cancel. The balanced arrangement also ensures zero voltage across both the input and output

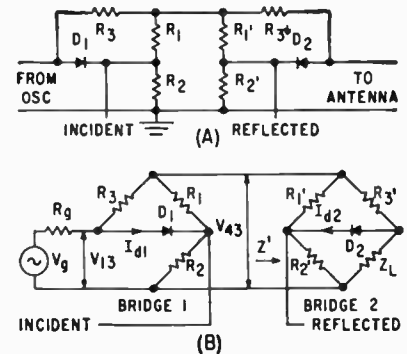

FIG. 3—Equivalent circuit of directional coupler (A); shown as bridge circuits (B)

terminals under quiescent conditions. This arrangement is particularly advantageous at the input since the operation of the amplifier is thus independent of any difference in the d-c resistance of the two halves of the directional coupler.

To expand the vswr scale between 1 and 3, some compression is added to the amplifier with a diode across the meter. This compression puts the vswr meter at 2 for about 20 percent of full scale.

The d-c current gain of the transistors varies somewhat with temperature, upsetting the operating point of the final stage. To compensate for this, the high-impedance bias supply for the first stage is thermistor compensated. To maintain good short-term stability, the input transistors are mounted together in a heat sink giving them in effect, a long thermal time constant. The thermistor is mounted on the first stage heat sink.

When setting up the instrument, the meter is set at maximum while monitoring the forward power level. Then the reflected power ratio is read directly in vswr with switch S1 (Fig. 2) in the *reflected* position. The meter scale extends from one to infinity. Its scale is nonlinear, making readings of vswr > 10 impractical. For readings from 1 to 5, accuracy is 10 percent; from 5 to 10 (vswr), 20 percent.

## REFERENCE

- (1) R. T. Adams and A. Horvath, Broad-Band Reflectometers at High Frequencies, *Electrical Communications*, p 118, June 1955.

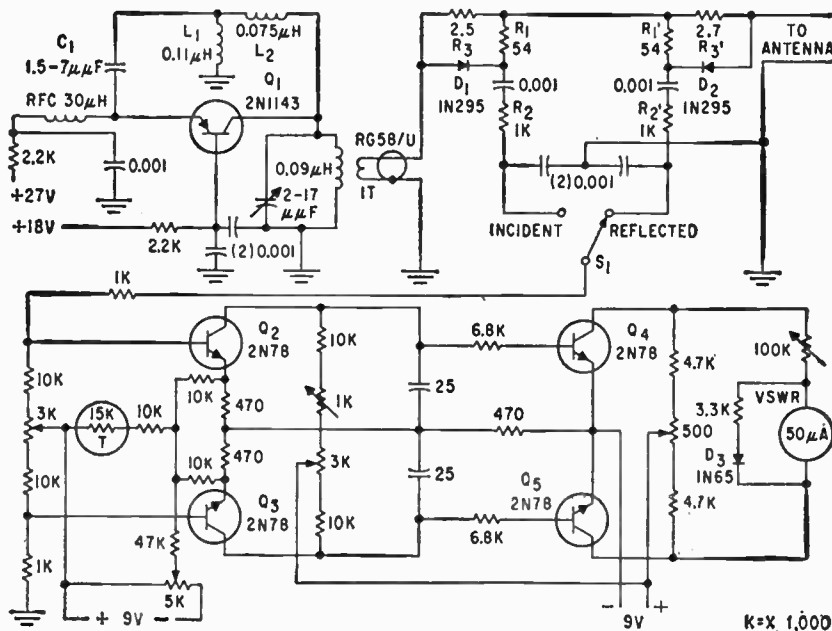

FIG. 2—Directional-coupler section of the instrument couples oscillator to the antenna and furnishes incident and reflected power samples to the d-c amplifier

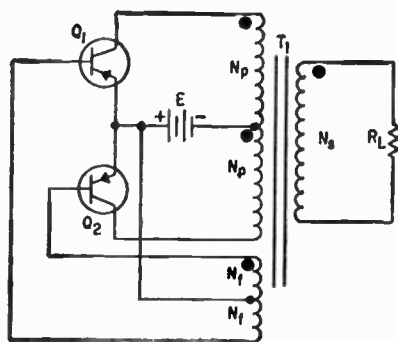

FIG. 1—Simplified schematic of oscillator-type power supply

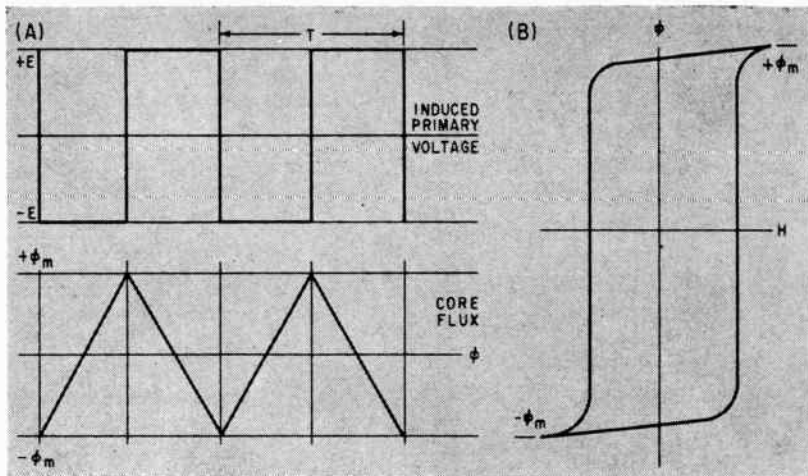

FIG. 2—Idealized waveshapes of primary flux and voltage in the transformer (A) and dynamic B-H hysteresis loop of transformer core (B)

# Equations for Designing

WITH THE DEVELOPMENT of high-current switching transistors, the d-c to d-c power supply has a new look. Transistorized power supplies are being utilized in applications that require small size, light weight and high efficiencies. Efficiencies ranging from 80 to 90 percent can be obtained. In addition, transistor power supplies contain no moving parts. A design procedure for engineering such a d-c to d-c power supply to meet specified operating characteristics is described in this article.

## Operation

Figure 1 shows a simplified circuit of the oscillator-type power supply to be discussed. The transistors act as an ON-OFF switch to obtain a square wave a-c output voltage from a d-c source. This square wave can be stepped up or down by transformer  $T_1$  for a desired output level and rectified to give a d-c output voltage. The transistors are switched ON or OFF by a feedback winding on the transformer, one transistor going ON (conducting) while the other transistor goes OFF.

Assume that the windings are phased as shown. If  $Q_1$  is switched ON (conducting),  $Q_2$  is OFF and the battery voltage  $E$  is applied to the top half of the primary, inducing a constant  $d\phi/dt$  in the core (Fig.

2). When the core saturates,  $d\phi/dt$  falls to zero. From Faraday's Law,  $e = -N(d\phi/dt)$ . Therefore, with  $d\phi/dt = 0$ , the induced feedback voltage must also be zero. At this point, with no base drive on either transistor, both transistors are OFF. There is no flux-producing current in either primary and the field now collapses, changing the direction of  $d\phi/dt$ .

This reversal of  $d\phi/dt$  induces a voltage of opposite polarity in the feedback windings of the transformer, thus turning  $Q_2$  ON and keeping  $Q_1$  OFF. Now  $d\phi/dt$  is again constant in the negative direction until the core saturates, thus giving one cycle of operation.

From the plot shown in Fig. 2A it can be seen that the flux  $\phi$  has an excursion of  $+\phi_m$  to  $-\phi_m$ , where  $\phi_m$  is the saturation flux. This change of flux occurs in a half cycle or  $T/2$  seconds, where  $T$  is equal to the period of one cycle. In  $T/2$  seconds, the flux changes from  $+\phi_m$  to  $-\phi_m$  or a total change of  $2\phi_m$ . The average induced voltage is equal to the total change of flux divided by the time of the flux change. That is:

$$E = \frac{N_p 2\phi_m}{T/2} \times 10^{-8} \quad (1)$$

also

$$T = 1/f \quad (2)$$

and

$$\phi = BA. \quad (3)$$

Combining these equations,

$$E = 4fN_pAB_m \times 10^{-8} \quad (4)$$

where  $E$  is in volts,  $f$  is frequency in cps,  $N_p$  is number of primary turns or  $\frac{1}{2}$  the total primary-winding turns,  $A$  is area of core in in.<sup>2</sup>,  $B_m$  is saturation flux density in lines/in.<sup>2</sup>.

## Core Selection

A core that has a high saturation flux and a low magnetization current has the ideal characteristics for transformer  $T_1$ . A square hysteresis loop is not required. There are many types of core materials on the market that will satisfy these requirements.

If the exact B-H hysteresis loop is not given for the core by the manufacturer, one can easily obtain this characteristic of the core material. To do so, one must measure and indicate both the flux and the magnetizing force simultaneously (see Fig. 2B) and record both at once on an cro screen. This can be done by the test circuit shown in Fig. 3, using the following relations: magnetizing force,  $H$ , in oersted, is

$$H = \partial F / \partial L_f \cong F / L_f, \quad (5)$$

where  $L_f$  is the mean length of magnetic path; magnetomotive force,  $F$ , in gilberts is



Here is a lucid development of basic design equations for a transistor d-c supply. Using power transistors, this type of supply can result in efficiencies from 80 to 90 percent. The design procedure is explained in detail

By THEODORE HAMM, JR., Lawrence Radiation Laboratory, University of California, Livermore, California

# Transistor Power Supplies

$$F = 0.4\pi iN. \quad (6)$$

Combining these equations,

$$H = 0.4\pi Ni/L_f.$$

From Fig. 3,  $i_p = e_1/R_1$ . Instantaneous magnetizing force

$$H = 0.4\pi N_p e_1/R_1 L_f.$$

Therefore, a horizontal deflection proportional to  $H$  can be presented on a cro screen by applying  $e_1$  to its horizontal deflection plates.

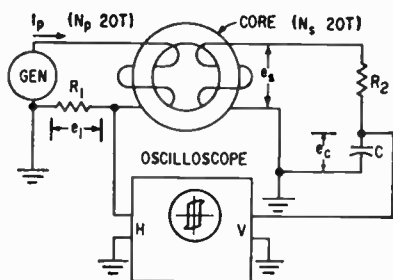

FIG. 3—Test circuit for measuring core flux density  $B$  against magnetizing force

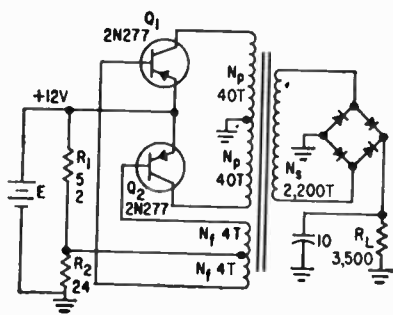

FIG. 4—Oscillator-type power supply with all circuit values shown

Since  $\phi$  can be obtained as a voltage, it can be viewed vertically on the cro by using an RC integrating circuit with  $R_2 \gg 1/\omega C$ . This voltage can be applied to the vertical deflection plates of a cro and the voltage corresponding to  $H(e_1)$  can be applied simultaneously to the horizontal plates to produce the  $B$ - $H$  curve for the core material on the cro screen.

To obtain a voltage proportional to  $\phi$  we integrate Faraday's Law:

$$\phi = (1/N) \int e_s dt.$$

The voltage across the capacitor  $C$  in Fig. 3 is

$$e_c = (1/C) \int i_s dt.$$

As the ratio of  $R_2$  to  $1/\omega C$  is 200:1 at the test frequency,

$$e_s \approx i_s R_2.$$

Substituting,

$$e_c = 1/R_2 C \int e_s dt. \quad (7)$$

From Faraday's Law,

$$e_s = (N_s/10^8) \times d\phi/dt, \quad (8)$$

where  $N_s$  is the number of secondary terms.

Combining the last two equations and integrating over one cycle,

$$2e_c = (N_s/10^8 R_2 C) \int_{-\phi_m}^{+\phi_m} d\phi,$$

and

$$2e_c = (N_s/10^8 R_2 C) \times 2\phi_m.$$

Substituting for  $\phi_m$  the peak-to-peak voltage  $2e_c$  is

$$2e_c = 2N_s B_m A_c / 10^8 R_2 C,$$

where  $A_c$  = effective area of core in in<sup>2</sup>.

And

$$A_c = A \times S, \quad (9)$$

where  $S$  is the stacking factor.

The instantaneous voltage drop  $e_c$  across capacitor  $C$  is directly proportional to the instantaneous flux density in the core. Thus,

$$B_m = \frac{e_c R_2 C \times 10^8}{N_s A_c}.$$

$B_m$  can be measured at any frequency, but  $H_m$  must be measured at the frequency at which the core is to be operated. The higher the frequency, the wider the hysteresis loop and the higher the core losses. For testing, the core  $N_p$  and  $N_s$  can have a 1:1 ratio with about 20 turns. This is not critical.

## Transformer Design

From Eq. 4 we have

$$N_p = E \times 10^8 / 4f A_c B_m, \quad (10)$$

where  $E$  is the battery voltage (Fig. 1). A good choice of frequency is 1,000 cps. The higher the frequency, the higher the core losses. The lower the frequency, the more turns required and the higher the copper losses. Saturation flux density is given by the manufacturer or by the method described above, using the oscilloscope  $B$ - $H$  presentation.

Here are sample calculations on

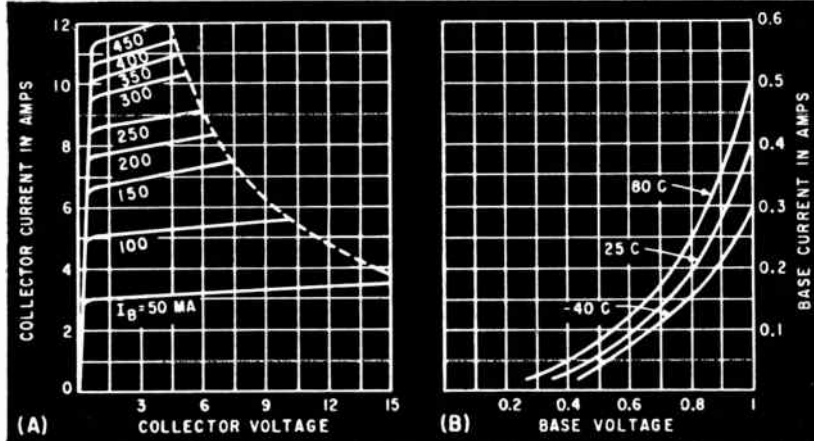

FIG. 5—These common-emitter characteristics of the 2N277 show output curves at 25 C (A) and input curves at several temperatures (B)

the transformer design using an Arnold Deltamax toroidal tape core 3T4178-D1. Let  $B_m = 80,000$  lines/in<sup>2</sup> (measured by above method),  $A_c = 0.125 \times 0.75 = 0.094$  in<sup>2</sup>,  $E = 12$  v,  $E_s = 600$  v,  $I_s = 170$  ma,  $R_L = 3,500$  ohms,  $P_o = 102$  w, and  $f = 1,000$  cps. Assume a transformer efficiency of 90 percent, or  $\text{Eff} = 0.9$ . These values are substituted into the primary-turns equation

$$N_p = 12 \times 10^8 / 4 \times 10^3 \times 0.094 \times 8 \times 10^4 = 40 \text{ turns.}$$

$N_s$ , the secondary turns, can be found by

$$N_s = N_p (E_s / E) \times 1 / \text{Eff} = 2,200 \text{ turns.}$$

$R_e$ , the equivalent transistor load resistance, is

$$R_e = (N_p / N_s)^2 R_L = 1.15 \text{ ohms.} \quad (11)$$

### Transistor Selection

When the transistor is in saturated operation, parameter variations are held to a minimum and transistor heat dissipation is at a minimum.

Germanium power transistors are good for this application below temperatures of 80 C because of their low collector saturation resistance and low cost. Germanium power transistors have collector saturation resistances of less than 1 ohm, whereas typical silicon power transistors have collector saturation resistances values of 5 ohms.

$I_p$ , the transistor switching current, is found by

$$I_p = E / R_e$$

to be equal to 10.5 amp.

A common emitter configuration

is chosen because larger input powers are necessary for the common collector and common base configurations, thus giving lower transformer efficiencies. A 2N277 transistor, which is low priced, was chosen for this application (Fig. 4). The base current is determined by the collector  $EI$  characteristics shown in Fig. 5A. For the transistor to operate at saturation with a collector current at saturation of 10.5 amp, the base bias must be at least 400 ma. To insure saturation the

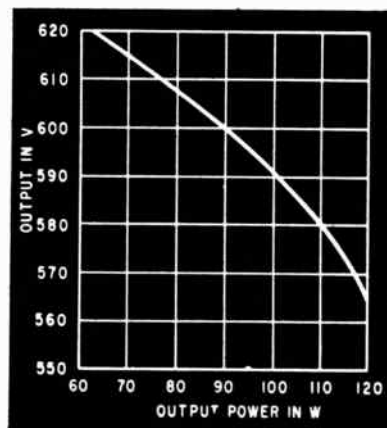

FIG. 6—Output characteristics of the supply for different loads

base should be biased to 500 ma or more.

$R_{cs}$ , the collector saturation resistance, is low, and  $R_1$  should be  $\gg R_{cs}$ . Therefore, let  $R_1$  be 5 ohms.

As

$$R_2 = E / I_b,$$

where  $I_b$  is the transistor base current,

$$R_2 = 24 \text{ ohms.}$$

The base drive is taken from the base  $EI$  characteristics (Fig. 5B). For a base current of 500 ma, approximately 1 volt of base drive  $E_b$  is needed. Feedback turns  $N_f$  is found from

$$\begin{aligned} N_f &= N_p (E_b / E) \times 1 / \text{Eff} \\ &= 40 \times 1 / 12 \times 1 / 0.9 = 3.7 \text{ turns;} \\ &4 \text{ turns were used.} \end{aligned}$$

### Transformer Winding

The primary was wound on the core by hand, then the core was wrapped with glass tape, dipped in clear Glyptal and baked in an oven. The secondary was wound by a toroid-coil-winding machine. Then the core was again wrapped with glass tape, dipped in Glyptal and baked. Finally, feedback turns were wound, and the core wrapped with tape.

Wire sizes were based on 700 circular mils per amp. Winding wire sizes are: primary—no. 12, secondary—no. 29, feedback—no. 24.

### Performance

If the power supply does not oscillate after construction, switch the feedback leads to the transistors. The measured d-c output voltage  $E_o$  was 590 v for  $R_L = 3,500$  ohms. Due to the high frequency used, the d-c output voltage is easy to filter. With a 10- $\mu$ f capacitor as a filter, the ripple was 0.2 percent.

Output power vs output voltage was measured for different loads (Fig. 6). For a  $\pm 20$ -percent change in load there was only an 8-percent change in output voltage. Regulation can be improved by using different feedback turns ratios. This power supply has an over-all efficiency of 80 percent. If greater efficiency is needed, one should choose a core with smaller magnetizing force.

If the design of the power supply is to be held to close specifications, the saturation flux should be measured by the oscilloscope method as described above.

### BIBLIOGRAPHY

- E. Baldinger and W. Czafa, Designing Stable Power Supplies, ELECTRONICS, Sept. 1959.
- Edward Gordy and Peter Haspenpusch, New-Design Transistor Regulated Power Supply, ELECTRONICS, Oct. 9, 1959.
- L. P. Hunter, "Handbook of Semiconductor Electronics", p 13-26 to 13-28, McGraw-Hill Book Co., Inc., New York, 1956.
- D. L. Waldelich, Diode Rectifying Circuits with Capacitance Filters, Trans A/EE, 60, p 1, 161 to 1,167, 1941.
- O. H. Schade, Analysis of Rectifier Operation, Proc IRE, 31, p 341 to 361, July 1943.



# NEW

**... MAINTAINS POSITIVE CONTACT**  
with a printed circuit board over a dimensional range of .057 - .072.

A No. 20H29401-4 plastic polarizing key is furnished with each connector. This key can be inserted into the contact slot of any contact position. The use of this polarizing key will reduce the usable contacts by two.

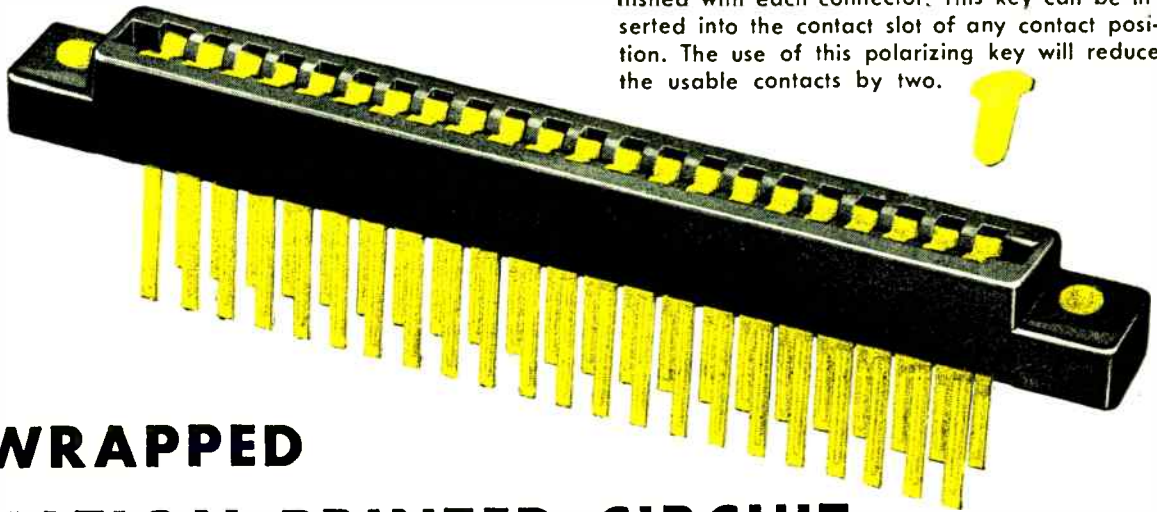

No. 29401

## WIRE WRAPPED TERMINATION PRINTED CIRCUIT CONNECTOR

FOR 1/16" COPPER CLAD LAMINATED BOARDS.

Voltage Ratings:	A C RMS	D C
Sea level (Adj. terminals)	1030	1330
Altitude 3.4 H.G. (50,000 ft.)	300	500
Altitude 1.3 H.G. (70,000 ft.)	190	400

Recommended Withstanding Voltage:	A C RMS	D C
Sea level (Adj. terminals)	2320	1000
Altitude 3.4 H.G. (50,000 ft.)	730	1100
Altitude 1.3 H.G. (70,000 ft.)	425	900

Insulation is glass filled Diall with a flame retardant. The 44 contacts are phosphor bronze with a silver plate of .0002 and .00003 min. gold plate finish. The inventory problem is simplified by providing a single connector that can be polarized in any position.

Current Rating  
Contact resistance at 7.5 amperes measured with nominal thickness printed-wire board  
Insulation resistance

10 Amperes

0.0027 Ohms Max.  
5000 Megohms Min.

AVAILABLE FOR  
IMMEDIATE DELIVERY

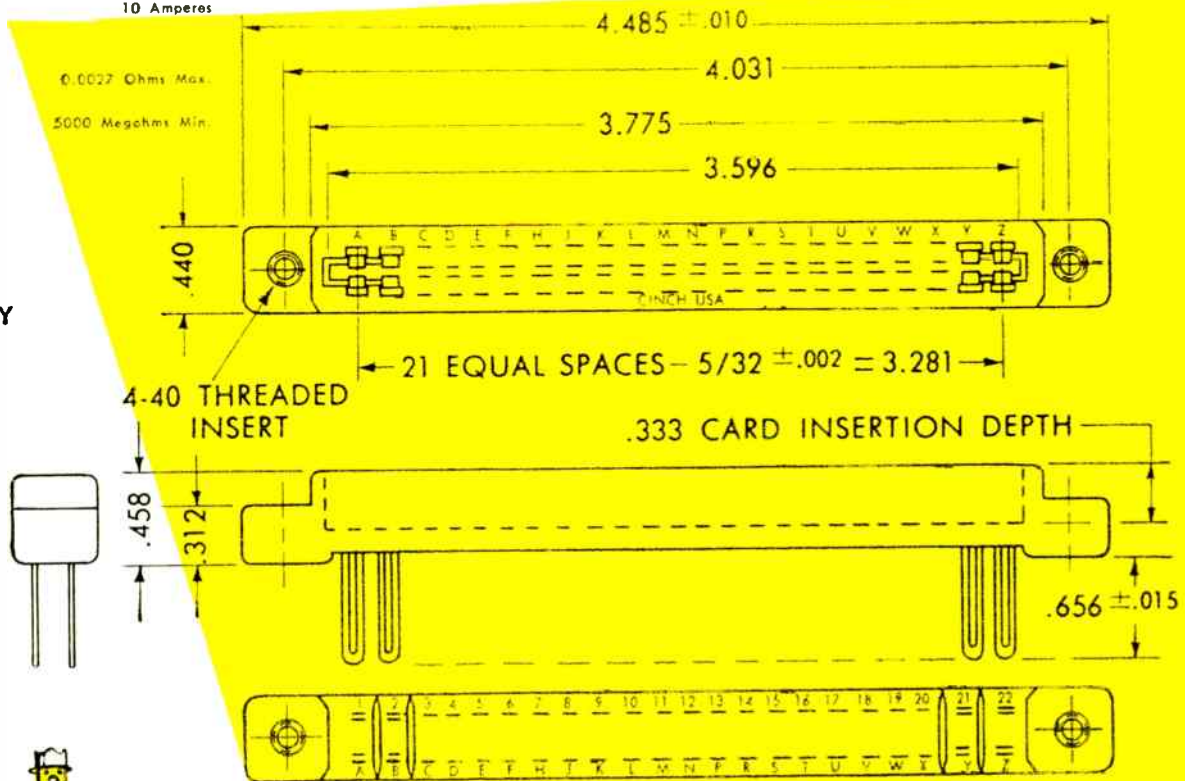

Centrally  
located plants at  
Chicago, Illinois;  
Shelbyville, Indiana;  
La Puente, California;  
St. Louis, Missouri



**Cinch**  
ELECTRONIC  
COMPONENTS

**CINCH MANUFACTURING COMPANY**

1026 South Homan Ave., Chicago 24, Illinois  
Division of United-Carr Fastener Corporation, Boston, Mass.

World Radio History

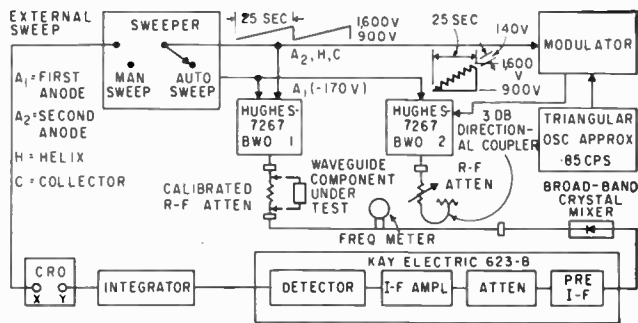

FIG. 1—System block diagram shows input waveshapes used

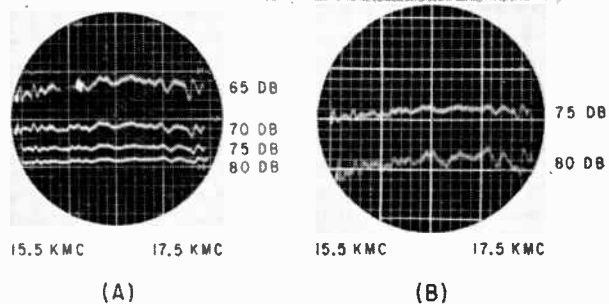

FIG. 2—Dynamic range (A) and resolution (B) are demonstrated

# Recording Attenuation of Waveguide Components

Swept frequency method is used to test for attenuation of up to 80 db. Scope traces of attenuation vs frequency are photographed

By G. EDELCREEK, Electronic Engineer, Stavid Engineering, Inc., Plainfield, N. J.

OSCILLOSCOPE PRESENTATIONS of attenuation vs frequency for waveguide components are obtained and photographed for record purposes using the method indicated in Fig. 1.

The sweeper is used to drive two voltage-tuned K-band backward-wave oscillators (bwo). The first bwo is used as the signal source and bwo 2 is used as a local oscillator for the crystal mixer. The first anode ( $A_1$ ) of the bwo's controls the power output, and is set so that there is sufficient power to bias the crystal mixer properly.

The second anode, helix, and collector ( $A_2$ ,  $H$ ,  $C$ ) control the frequency of oscillation. A triangular shaped wave of approximately 140 v peak amplitude modulates  $A_2$ ,  $H$  and  $C$  of bwo 2. This assures that the frequency of bwo 2 is swept past the frequency of bwo 1 twice during each cycle of the triangular wave shape period.

The i-f pulses thus obtained are amplified, detected, integrated and

then presented to a d-c oscilloscope, which is externally swept by the sweeper at the same rate and in synchronism with the  $A_2$ ,  $H$  and  $C$  of the bwo's.

## Attenuation Measurement

Attenuation measurements are made by setting the calibrated r-f attenuator to values approximating the loss in the component to be measured. The proper amount of i-f attenuation is placed in the circuit in order to assure that the i-f amplifier does not saturate. Sweeps at known attenuation values are displayed and photographed on the cro; the calibrated r-f attenuator is then removed from the circuit and the component to be measured is inserted. Another sweep is made and photographed. The sweep made with the test component can then be referenced to the sweeps made with the r-f calibrated attenuator.

Figures 2A and 2B show sweeps made with the calibrated attenuator. The ripples shown are due to

variations in detector characteristics over the 2-kmc swept band.

## Performance

The actual amounts of attenuation that have been read successfully are lower than the theoretical value by 15 db because of r-f leakage. Resolutions of  $\pm 1$ db are possible with this method. The system is capable of reading losses as small as 1 db, as well as large amounts, if there is sufficient attenuation in the i-f attenuators to prevent saturation of the amplifiers.

If resolution better than  $\pm 1$ db is required, it is recommended that the HP 416A ratio meter be used. However, this method is restricted to attenuation values of approximately 30 db maximum.

By switching to manual sweep, one can examine any anomaly, such as resonances, anywhere in the band very rapidly.

The work reported here was performed under contract to the Bell Telephone Labs, Whippany, N. J.



## NATIONAL MIL-SPEC KNOBS

In stock! For immediate delivery! And produced by National! . . . a complete line of standard plastic control knobs made in conformance with MS-91528. There are four basic types: round, pointer, spinner (each with or without skirts) and dial skirted round . . . available in three different shaft sizes. Finishes are gloss, matte, or to your color specifications . . . in all Mil-Spec sizes.



Knobs: Made of plastic, type III, class H2, per Specification L-P-349. Set Screws: Cadmium plated, class 3, type II, per Specification QQ-P-416. Inserts: Brass, composition 4, hard, per Specification QQ-B-613.

## NATIONAL CHOKES

R-45 series, a new family of ferrite bead chokes for use as filament chokes, parasitic suppressors, and series elements of low-pass filters for frequencies from 5 to 200 mc. Insulated with an impregnated fiberglass sleeving, these chokes will handle 2 amperes of filament current with voltage drop of less than 0.02 volts, temperatures to the Curie point of 125°C.

R-40 series ferrite-core chokes. . . extremely high Q for small size. They are primarily for use in networks and filters at frequencies from 50 kc to 1500 kc, and as resonant elements in IF and RF circuits. Fungus-proof varnish impregnation per MIL-V-137A.

### R-25

series MIL-inductance chokes for high frequency circuits, as filament chokes and peaking coils, inductance per MIL-C15305A, coil forms per MIL-P-14, and impregnation per MIL-V-173A.

### R-33, R-50 and R-60

series RF coils are wound on molded phenolic forms per MIL-P-14 and coated with a tough, fungus-resistant varnish. R-50-10 choke is wound on a powdered-iron coil form instead of phenolic.

## NATIONAL'S EXCLUSIVE "FLUSH MOUNT" CAPTIVE NUTS

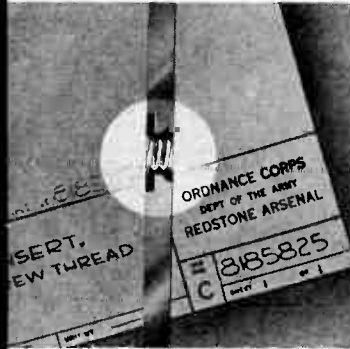

Flush fit on both sides of aluminum sheet to provide permanent tapped holes. Available in Five sizes for use in metal thickness from 1/16" up—in thread sizes from 2/56 up. No special tooling required. Drilled or Punched round hole  $\pm .002$  only requirement.

MATERIAL: Stainless steel 303 as per MIL S-853A.

FINISH: Passivated as per MIL P-12011.

Four additional types also available, including one type which provides a permanent thread in thin aluminum that meets MIL SPECS P-11268, E-5400 and E-16400. A complete line of CAPTIVE STUDS is also available.

## PRECISION RIGHT ANGLE AND VERNIER DRIVES

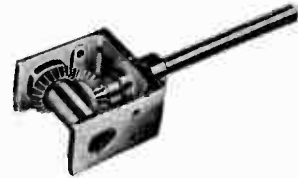

Type PRAD: Right angle drive for remote operation of low torque units. Designed for continuous low-speed operation (loads up to 50" ounces), and intermittent high speed operation (up to 500 RPM) with loads up to 100" ounces. Less than 1 1/2° backlash; drives and shafts of various lengths; various size output hubs; brass gears; stainless steel shafts, bushings and sleeves; die cast zinc housings.



Type RAD: Right angle drive. For ganging capacitors, potentiometers or other parts in heretofore inaccessible locations on chassis. Die cast zinc housing gears.

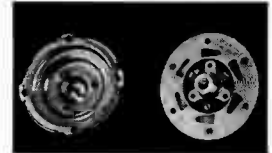

Type AN: Time-tested vernier mechanism. Designed for use with any 3/16" National knobs and others. Drive ratio: 5 to 1; drive shafts: 3/16", 1/4" or to specifications; fully insulated output shaft coupling; output hub fits 1/4" shaft; readily adaptable to many types of drives.



Type AVD: Vernier mechanism. Similar to type AN (above) except that output-shaft is non-insulated. Dimensions: over-all diameter 2-9/16", length 1-15/32"

## OTHER NATIONAL COMPONENTS

In addition to knobs, chokes, drives and captive hardware, National Radio Company also manufactures a complete line of dials, coil forms, condensers, tanks, grid and plate caps, IF transformers, tube and crystal sockets, ceramic insulators, bushings, spreaders, couplings, terminal assemblies, other electronic and electro-mechanical components. For specific design or development applications problems, write or call.

## NATIONAL RADIO COMPANY, INC.

A wholly owned Subsidiary of National Company, Inc.

Melrose 76, Mass.



# Chart Gives Thermal Changes

By WILLIAM L. PATERSON\* Inland Testing Laboratories, Cook Electric Co., Chicago, Ill.

TAKING calibration data and plotting results of thermistors used for temperature measurement represents substantial effort. A similar problem occurs when it is necessary to predict over a wide temperature range the junction saturation currents of germanium transistors and diodes as required in the measurement of thermal resistance or in design of bias-stabilizing circuits.

Resistances of thermistors and inverse currents of germanium junctions, as well as the logarithms of these quantities, are nonlinear functions of temperature. As a result, a definite curvature occurs in the plot of either quantity on semi-log paper. Curvature becomes more pronounced as temperature range is extended beyond a few degrees. Use of a nonlinear temperature scale reduces both relationships to straight-line plots with consequent reduction in the amount of data required to establish curves.

All phenomena governed by activation energies, including resistance and conductance of thermistors, saturation currents of *pn* junctions and many chemical reactions, exhibit a variation with

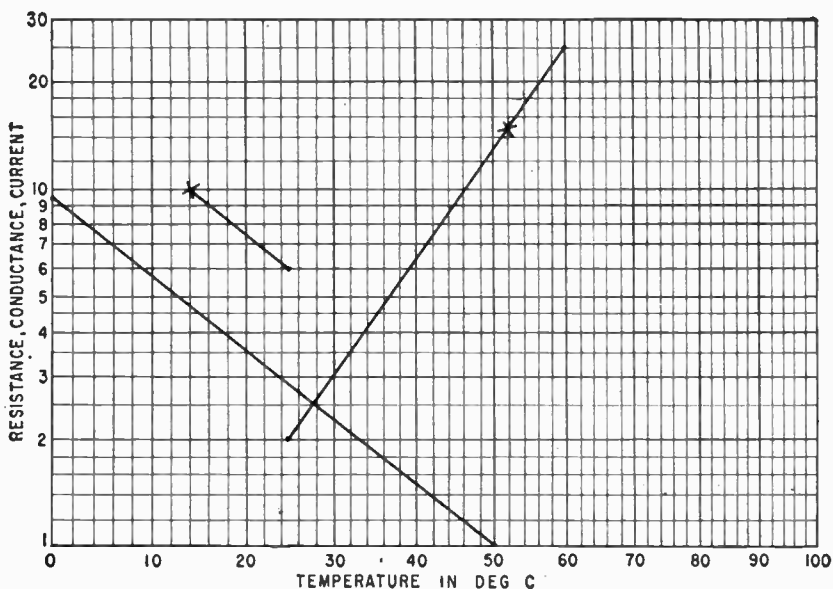

FIG. 1—Because of logarithmic vertical scale, ordinates may be shifted to other cycles

temperature that can be reduced to  $X = Ae^{B/T}$ , where  $X$  is resistance, conductance, current, etc.;  $A$  is a constant having the same dimensions as  $X$ ;  $B$  is a constant dependent on activation energy; and  $T$  is absolute temperature.

The chart is constructed so that this equation plots as a straight line. Temperature may be entered on the chart directly in degrees Centigrade without conversion to

Kelvin. Since the vertical scale is logarithmic, any ordinate may be shifted one or more cycles without affecting operation of the chart, as is done in the examples shown in Fig. 1.

### Examples

The  $I_{co}$  of a transistor has been found to be  $20 \mu a$  at  $25 C$  and  $250 \mu a$  at  $60 C$ . When mounted on its heat sink and operating at normal dissipation,  $I_{co}$  is  $150 \mu a$ . What is its junction temperature?

Draw a line through points  $25 C, 20 \mu a$  and  $60 C, 250 \mu a$ . On this line at  $150 \mu a$ , temperature is  $52 C$ .

A series of thermistors is described as having a resistance ratio from zero to  $50 C$  of 9.5. Resistance of one unit at  $25 C$  is 600 ohms. At what temperature will its resistance be 1,000 ohms?

Draw a line from the point  $50 C, 1$  to the point  $0 C, 9.5$ . All thermistors of the given type will have characteristics parallel to this line. Draw a line parallel to the one just drawn passing through the point  $25 C, 600$  ohms. At 1,000 ohms, temperature is  $14 C$ .

Calibration of thermistor resistances using two known points,

\* Now with Hoffman Electronics, Evanston, Ill.

## Mouse-Back Transmitter



Visitors to 1959 International Trade Fair in Zagreb, Yugoslavia, saw radio-equipped mice in USAF School of Aviation Medicine display. Transistorized 20-gram unit transmits biological data to satellite telemetry system for retransmission to ground



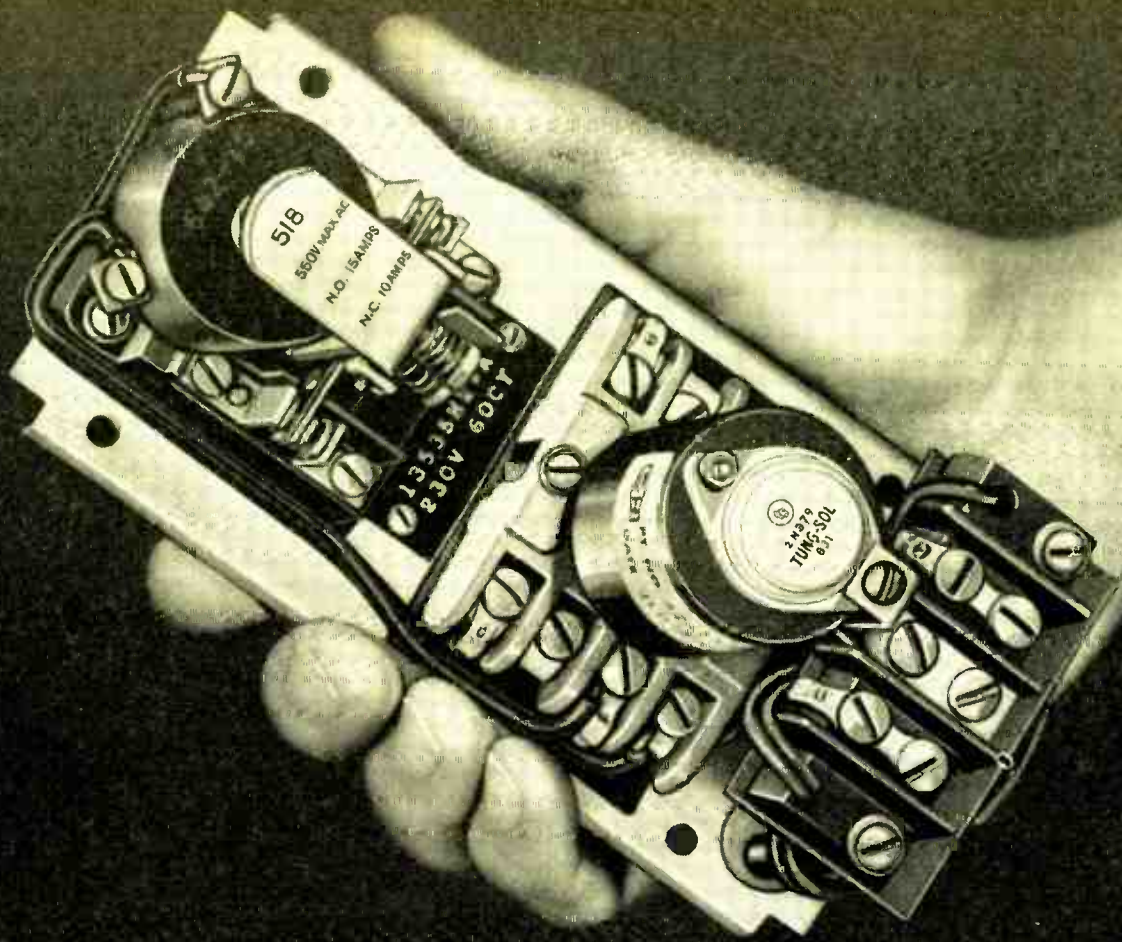

Cutler-Hammer's new sensitive, heavy-duty transistorized relay. The Tung-Sol germanium transistor, power type 2N379, is at the center of the plug-in module, electronic heart of the relay.

# New versatile relay relies on Tung-Sol semiconductor

Tung-Sol semiconductors furnish the combination of sensitivity and ruggedness needed for Cutler-Hammer's new transistorized relays. The Tung-Sol units react quickly and display unflinching electrical stability. They resist shock and vibration, and stand up under the most severe industrial service.

The cold weld seal found in all Tung-Sol power and high power transistors—an exclusive development of Tung-Sol research—contributes heavily to the long-life reliability Cutler-Hammer values. Cold welding gives a true hermetic, copper-to-copper seal and eliminates heat damage, "splash" and heat-caused

moisture. The special seal stays vacuum-tight, moisture-proof even through "breathing".

If you need the power-saving, space-saving features of semiconductors . . . if your circuit calls for tubes—you can be assured of premium performance when you specify Tung-Sol. Tung-Sol makes both to a single high quality standard. Our applications engineers, expert in both vacuum tube and semiconductor problems, can give you an impartial recommendation for the circuit complement that most efficiently answers your design needs. Tung-Sol Electric Inc., Newark 4, New Jersey.



**TUNG-SOL**<sup>®</sup>  
World Radio History

# Bristol miniature pressure switch features ultra-reliable precision pressure element. Exclusive design provides outstanding resistance to shock, vibration, acceleration and overpressures.

These Bristol miniatures, widely proved in modern aircraft, are designed for switching electrical circuits in response to pressure changes in air, fuels, lubricants, hydraulic fluids, other gases and liquids.

Bristol's specially designed Ni-Span element is silver brazed to the stainless steel base assuring greater reliability than ordinary soft-soldered construction. Result: accurate, reliable, repeatable performance in any position, at temperatures from  $-65^{\circ}\text{F}$  to  $+250^{\circ}\text{F}$ , and under Mil Spec environmental requirements.

Write for Bulletin AV2010 on Bristol Miniature Gage and Absolute, Adjustable and Differential Switches. The Bristol Company, Aircraft Components Division, 152 Bristol Road, Waterbury 20, Conn. B. 44



## SPECIFICATIONS (Fixed pressure setting models)

**Normal Working Range** — 0 to 100 psi absolute, gage, or differential

**Burst Pressure** — exceeds 250% of normal working pressure

**Electrical Ratings** — 5 amp at 125 v, 60 cycle, inductive or resistive  
4 amp at 30 vdc resistive  
2.5 amp at 30 vdc inductive

**Dielectric Strength** — 500 v rms between terminals and from terminals to case (MIL-S-8801)

**Life at Rated Electrical Load** — 40,000 cycles at 125 vac  
25,000 cycles at 28 vdc

**High Temperature Exposure & Operating** — (MIL-S-8801)  $250^{\circ}\text{F}$

**Low Temperature Exposure & Operating** — (MIL-S-8801)  $-65^{\circ}\text{F}$

**Shock, 30 g, 3 axes** — (MIL-S-8801) no change

**Vibration** — (MIL-S-8801) no contact chatter, no switch damage

300-600 cpm at 0.050" d.a.—set point change—none  
operating differential change—none

600-4500 cpm at 0.036" d.a.—set point change— $1/4$  psi  
operating differential change— $1/2$  psi

4500-30,000 cpm at 10 g—set point change— $1/4$  psi  
operating differential change— $1/2$  psi

**Diameter**— $1.5/16$

**BRISTOL** FINE PRECISION INSTRUMENTS FOR OVER 69 YEARS

e.g., ice point and boiling point of water, is also possible. For very accurate temperature measurement it is well to plot a third point to verify that the ideal relationship is being followed.

## Magnetic Core Operates Counter

By E. H. Sommerfield Product Development Corp., Endicott, N. Y.

SINGLE-TRANSISTOR circuit generates trains of pulses in which each successive pulse is lower in amplitude than the preceding pulse. Number of pulses generated before pulse amplitude diminishes to some predetermined value is known.

The circuit is made into a counter by applying its output to the input of a voltage-sensing device that indicates when input voltage drops to a specified level. Thus its primary application is in timing circuits requiring a negative-going staircase input. Since a number of these cir-

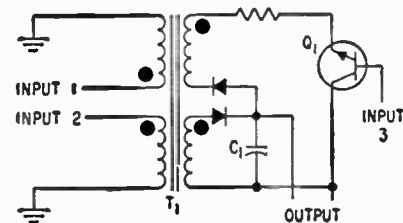

FIG. 1—Circuit delivers pulses of decreasing amplitude to operate counters

cuits can be driven in series from a single constant-current driver, synchronization with different counting rates is possible.

### Operation

A negative pulse applied to input terminal 1 in Fig. 1 drives the core of transformer  $T_1$  in one direction of magnetic saturation. A subsequent positive pulse applied to input terminal 2 drives the core to magnetic saturation in the reverse direction. When the direction of magnetization within the core is reversed, a pulse is generated in the lower secondary winding that charges capacitor  $C_1$  and also provides a pulse at the output terminals of the circuit. A positive pulse applied to input 3, the base of transistor  $Q_1$ , causes it to conduct, and  $C_1$  discharges through  $Q_1$  and



the upper secondary winding, driving the core back to its first direction of magnetization. However, the level of magnetization is lower because of circuit losses.

A positive pulse is again applied to input 2, again reversing direction of magnetization of the core and generating a pulse in the lower secondary winding. This action again charges  $C_1$  and delivers a pulse at the output terminals but of lower amplitude than the preceding output pulse. By alternating the application of pulses to inputs 2 and 3, a series of pulses diminishing in amplitude appears at the output terminals. A new train of pulses is generated by first applying another negative pulse to terminal 1 and the applying pulses alternately to terminals 2 and 3.

### Conditions

Certain conditions must be met for proper circuit operation. With full drive at input 2, the value of capacitor  $C_1$  and the number of turns of the two secondaries must be selected to ensure a net loop flux gain of less than one. Output must be sampled between the beginning of the input to terminal 2 and the beginning of the input to terminal 3. This is the time that  $C_1$  is charged to different levels. At other times  $Q_1$  discharges  $C_1$ .

Output must be buffered when driving any load that would seriously disturb the energy stored on  $C_1$  during the interval it remains charged. The time interval between the end of the pulse that is applied to input 2 and the beginning of the pulse that is applied to terminal 3 has a definite relationship to the value of  $C_1$  and the number of turns in the two secondaries.

The transistor acts as a voltage switch to transfer energy stored on  $C_1$  into the core. As such, collector voltage for  $Q_1$  is supplied by  $C_1$ , which in turn is charged from energy supplied from the driving source via terminal 2.

Since flux in the core is decreasing, the number of counts is indirectly determined by the flux capacity of the core as well as the values of all of the previously mentioned components. Accuracy of the count is affected by all tolerances in the flux loop.

## NEW IDEAS IN PACKAGED POWER

for lab, production test,  
test maintenance, or as a  
component or subsystem  
in your own products

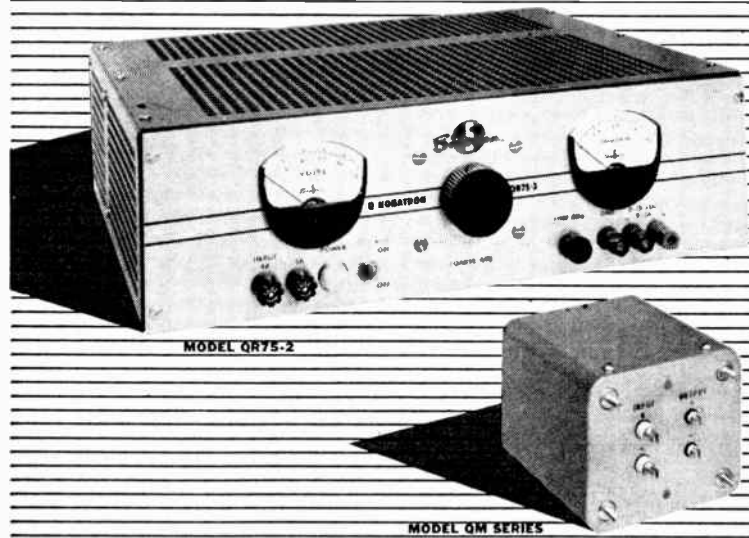

## 3 new Sorensen transistorized d-c supplies can solve your lab, production and design problems

In the Sorensen "Q" Series, you can select from the most complete line of fully transistorized, highly regulated low-voltage d-c supplies on the market: **QR-Nobatrons**, (shown above, left) with output continuously adjustable down to zero volts, are ideal for labs or wherever maximum flexibility is required. Two models, QR36-4A and QR75-2, put out respectively 0-36V at up to 4 amps and 0-75V at 2 amps. Regulation of QR36-4A is  $\pm 0.025\%$  or 4 MV for combined line and load variations. Input: 115vac 50-400 cps available for either bench or rack-panel ( $5\frac{1}{2}'' \times 19''$ ) use.

**Q-Nobatrons**®, with 2:1 adjustable output, can render outstanding service in semi-permanent lab set-ups, in production test, or integrated into your own product. Available in 15 models up to

200 watts capacity with 6, 12 or 28 volts out. Specs and packaging are similar to QR models above. Models for  $\pm 0.25\%$  or  $\pm 0.05\%$  regulation are available. Lower wattages are available two to a single rack panel ( $3\frac{1}{2}''$  or  $5\frac{1}{4}'' \times 19''$ ).

**QM-Series**, solder-into-the-circuit supplies (shown above, right) mount like a potted transformer or choke and come in 36 variations: nine voltages from 3.0 to 36vdc, regulated  $\pm 0.05\%$ ; and four wattages, 2, 4, 8 and 15. Input 50/60 and 400 cps at 115vac. (Incidentally, Sorensen also offers similarly packaged DC-to-DC and DC-to-AC converters.)

Ask us, or your nearest Sorensen representative, for the complete story on these precision transistorized regulated d-c supplies.

E.42



### SORENSEN & COMPANY, INC.

Richards Avenue, South Norwalk, Connecticut

WIDEST LINE OF CONTROLLED-POWER  
EQUIPMENT FOR RESEARCH AND INDUSTRY

IN EUROPE, contact Sorensen-Ardag, Zurich, Switzerland. IN WESTERN CANADA, ARVA. IN EASTERN CANADA, Bayly Engineering, Ltd. IN MEXICO, Electro Labs, S. A., Mexico City. NEREM '59 Commonwealth Armory, Boston, Nov. 17, 18 & 19

# New Film Deposits Improve Resistors

CERTAIN NITRIDES, silicides and oxides, studied at Battelle Memorial Institute, Columbus, Ohio, under contracts from the Wright Air Development Center are now found to extend advantages for thinfilms used for electronic components.

Of the nitrides studied, chromium-titanium-nitride appears most promising for resistive applications. By adjusting film thickness and nitriding temperature, resistances of 60 to 800 ohms per square can be obtained. The resistance range can be extended above these values by masking, spiraling, or meandering. Evaluations indicate that the materials possess desired characteristics for high-temperature precision resistors.

## Stable Films

Chromium-silicon films appear more stable than the nitride films, according to E. H. Layer, a Battelle specialist in solid state research. They do not change appreciably in resistance even when exposed to 500 F for thousands of hours without protection from air. Most interesting were films deposited from 24 percent chromium and 76 percent silicon, both weight percent. Depending upon the temperature of the substrate on which the film is deposited, and the thickness of the film, resistance can be varied from 100 to 10,000 ohms per square. Investigation of chromium-silicon films have not yet been completed.

Indium oxide, when formed as a film, has a resistivity in the range from  $10^{-3}$  to  $10^{-2}$  ohm cms. Because such films have high transmittance and low resistance characteristics, and are rugged, they are useful as transparent electrodes. They have also been fabricated as heaters.

The use of indium oxide films in the latter application is particularly feasible because they may be applied to substrates without heating film or substrate above 300 F. Thus the films may be applied safely to plastics, for example to plastic-bonded electroluminors, such as are used for electroluminescence.

The thin films will complement

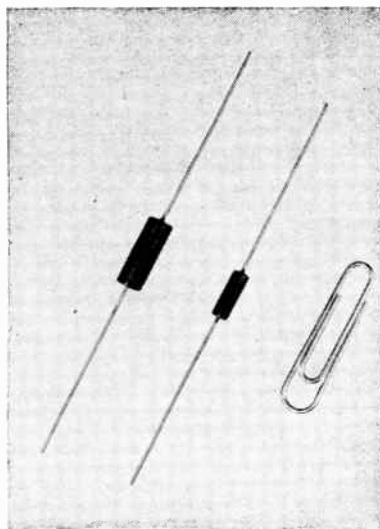

Smaller sized deposited-carbon resistor does an even better job than its much larger predecessor. Development already means bigger missile payloads, and will find application everywhere that miniaturization is a prime consideration

and extend advantages of resistors, potentiometers, photoconductors, resistance thermometers and even windshield heaters.

## Carbon Alloy Deposit

A method of deposited carbon resistor manufacture, exclusive with International Resistance Co., Philadelphia has resulted in reduction in size and weight by more than 50 percent. Such miniaturization means immediate and significant increases in payload in guided missiles, and important space saving in all forms of precision electronic equipment.

Development of the carbon alloy deposit required redesign of almost every element in the resistor. An insulating spiral path, which determines the resistance value, is now diamond-cut in the much harder alloy film, rather than sand blasted as formerly. The result is a much more precise incision, with consequent improvement in stability and reliability.

The highly conductive terminating point which bonds the end-cap connections to the film, is still another development. Over the resistance element are two new types of moisture resistance undercoat, also

especially developed for this product.

Completing the double-barrier insulation is a new-type molded break-resistant casing which, though heavy duty, is well within MIL size. This molded insulation results in improved load-life characteristics, better dielectric characteristics, and greater opposition to the effects of moisture. It provides all the advantages of ceramic solder sealed types, without the hazards of seal leakage, breakage and low dielectric strength.

These improved resistors are available in  $\frac{1}{4}$  watt,  $\frac{1}{2}$  watt and one watt sizes, in resistances from 10 ohms to 25 megohms. Standard tolerance is one percent, although 0.5 and 2 percent types are also available.

## Aluminum-Clad Circuits Ready for Applications

DIFFICULTIES in soldering on aluminum-clad laminates, mentioned in developments in composite laminates, *ELECTRONICS*, Sept. 11, 1959, are reported solved by a French licensee of an American process developed for plating aluminum parts.

The General American Transportation Company, who make freight cars and tank cars, have a process for plating on aluminum parts, called Kanigen, which is used just to make aluminum parts solderable. Their French Kanigen licensee, Societe Europeenne De Revetement Chimique, has solved the aluminum-clad laminate soldering problem for printed circuits with this nickel plating and has obtained patents on the process.

Very briefly, their method consists of applying a mask to the non-circuit portions of the aluminum. They then Kanigen nickel plate the circuit portions directly on the aluminum. Finally, the masked portions are then dissolved out in caustic soda, leaving a nickel plated aluminum circuit which can be



a continuing series on technical topics  
of specific interest to engineers

Folio 59-7

REFERENCE  
DATA FILE



## notes on the life expectancy of capacitors

*"At half past nine by the meet'n-house clock,—  
Just at the hour of the Earthquake shock!  
What do you think the parson found,  
When he got up and stared around?  
The poor old chaise in a heap or mound,  
As if it had been to the mill and ground!  
You see, of course, if you're not a dunce,  
How it went to pieces all at once,—  
All at once, and nothing first,—  
Just as bubbles do when they burst.  
End of the wonderful one-hoss shay.  
Logic is logic. That's all I say."*

From the "One-Hoss Shay" by  
Oliver Wendell Holmes

The designer and builder of the One-Hoss Shay achieved an interesting objective of some modern-day designers—a product utilizing component materials of great uniformity and well-coordinated life expectancy.

In capacitor design the One-Hoss Shay concept would result in enormously expensive units since materials normally vary in their physical and electrical characteristics. Therefore, the manufacture of capacitors with perfectly uniform characteristics from one to the next would involve a complex process of detailed selection of their component materials, and uniform assembly procedures. Economical and practical capacitors must accordingly be designed with two points in mind:

- 1) They will have a finite, but should have a very low, failure rate.
- 2) They will have a finite, but should have a long, life expectancy.

Exact determination of these levels for any capacitor design is a complex process of analysis and testing. A few of the highlights of these methods will be discussed below.

It has previously been shown (1) that the life expectancy of paper-oil dielectric capacitors is inversely proportional to the fifth power of the applied DC voltage. Further studies (2) indicate that one responsible mechanism for this exponential relationship is gassing of the oil. The life expectancy was also found to be halved for each ten degree Centigrade increase in operating temperature, over the normal range. This effect is probably analogous to the familiar chemical rule concerning the electrolytic action rate of solutions. Thus the actual measured life under a set of test conditions can be translated into expected life under another set of conditions of voltage and temperature, as follows:

$$L_2 = \left(\frac{E_1}{E_2}\right)^5 \cdot T_1 \cdot 2^{-\left(\frac{t_2 - t_1}{10}\right)}$$

where  $L_2$  = expected life in hours  
 $E_1$  = test voltage  
 $E_2$  = actual working voltage  
 $T_1$  = time duration of test in hours  
 $t_1$  = test temperature in degrees Centigrade  
 $t_2$  = actual operating temperature in degrees Centigrade

This relationship applies only to a failure caused by the actual degradation of the paper-oil dielectric brought about by the stresses of voltage and temperature. It would be most misleading to say that each and every failure experienced in any production lot will obey this law—some failures may be the result of manufacturing errors or material flaws.

This basic formula, although evolved for paper-oil capacitors, appears to apply to other types, such as mica and plastic film, but the fifth power law does not hold for these types since their molecular structure is significantly different. A voltage exponent of seven to ten appears to be appropriate for these types. It is also possible that the rule of halving of life expectancy with each ten degree Centigrade rise in temperature may not strictly apply to materials other than paper-oil because of their inherently different sensitivity to temperature, and due to different ranges of operating temperature. These points are the subject of much continuing investigation.

The formula shown has thrown a new light on the use of accelerated conditions as a production evaluation tool. Accelerated tests have, in certain instances, become a processing procedure, offering two major advantages:

- 1) So-called "early" failures can be eliminated to a high degree by proper over-stressing.
- 2) Life expectancy can be better evaluated since measured results are available in a short time.

Thus accelerated, or "screening," tests can serve a highly useful purpose where very high degrees of reliability are required, and must be measured or estimated quickly. This processing and evaluation, of course, involve additional expense, and are therefore not used for run-of-the-mill products. They also do not ensure a good product if the design or manufacturing controls are basically inadequate, and must never be used to sort good units from an inherently bad population.

One additional point should be made before we summarize an example: since, unlike the One-Hoss Shay, we cannot have all production capacitors fail simultaneously, some attention must be paid to the distribution of the failures with regard to time. It is important to know the shape of the failure rate curve.

Some hypothetical numbers can be used to illustrate the previous discussion. Assume that a group of 200 silvered mica button capacitors, designed for 500 WVDC and 125°C., is subjected to an accelerated test of 1000 VDC and 150°C. for 50 hours. At the end of this time, a failure level of one per cent is found, and the failures have occurred at 10 and 40 hours (we assume they are "pure" dielectric failures). Assuming a voltage exponent of 8 to apply, we may use the expected life equation as follows:

$$L_2 = \left(\frac{1000}{500}\right)^8 \cdot T_1 \cdot 2^{-\left(\frac{125-150}{10}\right)}$$

therefore,  $L_2 = 1435 T_1$

or, under actual conditions, these failures would have occurred at 14,350 and 57,400 hours of continuous operation. These failures then represent 0.035 and 0.009 per cent failures per 1000 hours, respectively. These times to failure correspond to over 16 and 65 years of normal, intermittent service.

#### References:

- 1) J. R. Weeks, Capacitor Life Testing, Bell Laboratories Record, Vol. XXIV, No. 8, August, 1946.
- 2) Harold Basseches and Mary W. Barnes, Gassing of Liquid Dielectrics Under Electrical Stress, Industrial and Engineering Chemistry, Vol. 50, No. 6, June, 1958.

SC-59-B

SANGAMO ELECTRIC COMPANY, Springfield, Illinois  
--designing towards the promise of tomorrow



# DIRECT READOUT POTENTIOMETRIC VOLTMETER

## O N E W O O

An extremely versatile high precision DC measuring instrument, the new Hallamore Potentiometric Voltmeter, Model 0181, offers important advantages for application both in the laboratory and in systems calibration. It may be used as a null detector, quasi-deflection potentiometer, or galvanometer. Instrument may be removed from portable case for standard rack mounting. Galvanometer demounts from unit for separate use when required. Direct readout is provided on 6 decade switch dials, as well as on the galvanometer. Operating range...0-10 VDC, Accuracy...  $\pm 0.025\%$ ,  $\pm 3$  microvolts. This exclusive Hallamore development affords high stability and resolution...operates from conventional power sources...will stabilize within 15 minutes. For detailed information concerning specifications, applications, and early delivery, write Hallamore Electronics Company, 714 N. Brookhurst St., Anaheim, California. Phone PR 4-1010: a division of The Siegler Corporation.



# HALLAMORE

Engineers with an interest in the design of high precision electronic equipment, send resume c/o O. M. Snow, Engineering Recruitment,

ad no. 99

World Radio History

soldered with ease. The plating, being a nickel phosphorus alloy, responds to soldering techniques much easier than does pure nickel. According to word received here, the patented French process is now being used in making the aluminum-clad printed circuits.

Of interest in this connection, General American Transportation Company has been successful in developing coats applied to beryllium, titanium, magnesium and steel to make missile parts solderable.

## Long-Lived Capacitors

WORKING and shelf life of ten years are achieved in electrolytic capacitors developed by Plessey. These Hyperlytic capacitors are available in many capacities between  $\frac{1}{2}$  and 12,000 $\mu$ f. Construction with a high-purity etched foil anode material,

## Magnetics Research

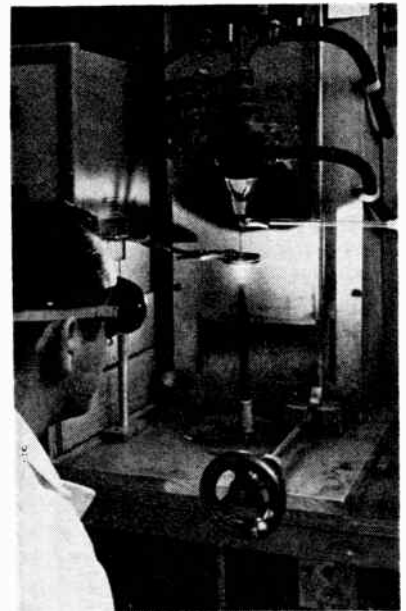

A new method for growing single ferrite crystals, which is an adaptation of a process for growing synthetic gems, has been developed by International Telephone & Telegraph Laboratories, Nutley, N. J. The technique uses high-frequency radio energy in a small metal loop to generate the high temperature. A specially prepared powder, sifted through the loop and heated to 2,000 F, cools into a monocrystal.

Significance: Availability of more and better ferrite monocrystals for basic research in magnetics. Magnetic properties are more easily understood by working with the single ferrite crystal, according to Fred Muller, Director of ITT's Physical Sciences & Materials Lab, Clifton, N. J.



together with special manufacturing techniques, provides a stable capacitor having low leakage and high insulation resistance.

One series has a temperature range of  $-30$  deg C to  $85$  deg C and very low leakage currents. The other series has a somewhat higher leakage current but with a working temperature range of  $-20$  C to  $50$  C.

The standard capacitance tolerance is  $-20$  to  $50$  percent, but closer limits can be worked to on request. Where required, capacitors can be wound in such a way that self inductance is reduced to a minimum so as to enhance performance at the higher audio frequencies.

## Scan Converter For Air Traffic

THE INCREASE in air traffic today, combined with the high performance jet aircraft, has emphasized the severe traffic control problem for the many control centers and towers, as well as radar monitoring posts. All this accounts for the great interest in components and materials developed for this area (see *ELECTRONICS*, p 66, July 10).

Radar-to-television conversion equipment widely used in Federal Aviation Agency Control Centers throughout the country, have been furnished by a French-developed bright display system for radar data that enables air traffic controllers to work in lighted rooms, rather than in a state of semidarkness.

The recent installation of scan conversion equipment at Los Angeles now makes the FAA Control Center program complete. The system, developed by Intercontinental Electronics Corp., INTEC, of Mineola, N. Y. uses a TI-400 Scan Converter which transforms the PPI radar signals to tv through the INTEC TMA-403X video transformation tube.

The FAA will also install scan conversion equipment in towers at New York, Indianapolis and Chicago. To date over 225 of these systems have been sold to the Navy, FAA, IT&T, Raytheon and Farnsworth.



# Lapp

## ANTENNA STRAIN INSULATOR

The Lapp porcelain rod insulator shown at the top of the illustration develops 12,000 lb. strength, and is suitable for the most severe electrical and mechanical duty. It is available with rain shield and/or corona rings. All hardware is silicon aluminum alloy. Smaller insulators, in porcelain or steatite, are suited to lighter duty for strain or spreader use. Lapp engineering and production facilities are always ready for design and manufacture of units to almost any performance specification. Write for Bulletin 301, with complete description and specification data. Lapp Insulator Co., Inc., Radio Specialties Division, 159 Sumner Street, LeRoy, N. Y.



# Lapp

# "Mother" Boards Take Small Modules

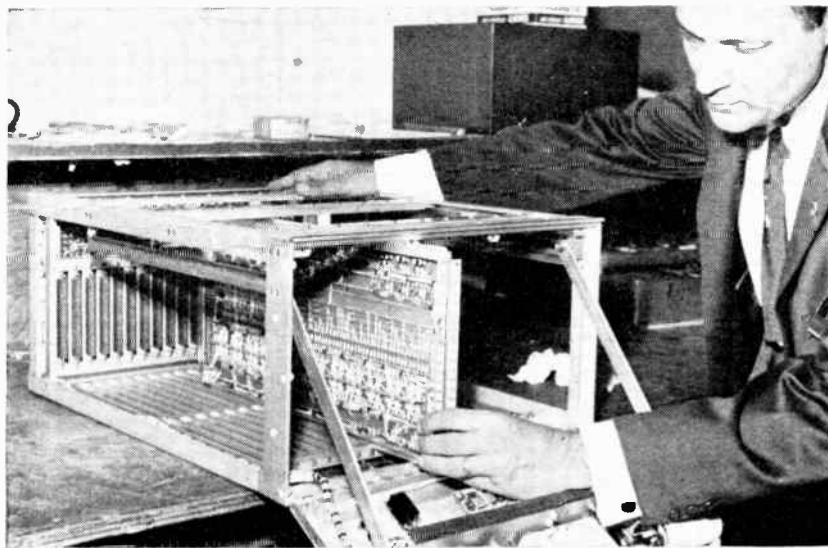

**Mother boards consolidate small modules in transistorized military equipment**

MOTHER BOARD assembly method for transistorized equipment combines advantages of conventional chassis wiring with printed circuit module assembly. It can be particularly useful in scheduling production of large transistorized systems, since modules facilitate an assembly-line type of production.

The boards shown are being made by CGS Laboratories, Wilton, Conn., as part of military models of the firm's new transistorized teletype code converter. There are more than 500 components on the completed mother board shown above. It carries 32 modules, each with 2 transistors and 10 or more resistors and capacitors. In addition, several groups of resistors and capacitors are mounted on the main board.

All components, except for matrices, terminals, some resistors and capacitors, wiring, connectors and bulky components, are assembled

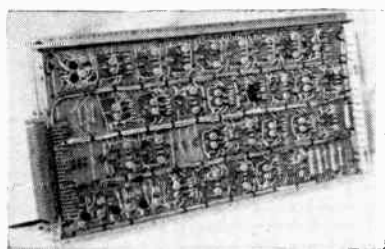

**Closeup of completed mother board**



**Modules are prepared with leads by conventional methods**



**Lines of terminals are used as channels for hookup wiring**

on small printed circuit boards about 2 inches square. This greatly reduces the complexity of assembly, test, repair and replacement of circuit elements.

Modules are assembled individually on benches. Short, bare hookup wires are soldered in place and gathered with a twist in pyramidal fashion over the modules. The bundling provides protection and

facilitates easier handling.

Mother boards are prepared with terminals, frames and miscellaneous components. The terminals are aligned vertically and horizontally in rows. Code numbers printed on the top strip of the frame key terminal positions.

Modules are fastened to the mother board with clinch nuts. Spaghetti tubing is placed as required on the short hookup wires and they are soldered to the terminals. The horizontal lines of terminals provide channels in which the bulk of connecting wiring is laid, as though the panel were a harness board.

The small boards are epoxy-glass laminate and the large boards are the same material in an aluminum frame. Two of the large boards are mechanically-joined back-to-back to form large plug-in modules which are inserted in the frame housing the complete converter.

## Induction Desolders P.C. Board Components

By **D. H. LAPRAY**, Industrial Heating Dept., General Electric Co., Shelbyville, Ind.

ALTHOUGH THERE are many reliable techniques for soldering printed wiring assemblies, there has been little development of equipment specifically for desoldering printed wiring board assembly joints for repair and component replacement or salvage.

An induction desoldering and soldering device for these applications has been developed in cooperation with GE's Light Military Electronics Department. It offers about 20 percent saving in time while improving salvage yields and reliability of resoldered joints.

It consists basically of a small induction heater with a special inductor coil, a vacuum system and associated controls. The coil focuses h-f energy in the selected solder junction. Heat is generated by transformer action; the coil acts as



Precise Uniformity  
 makes possible accurate resistor  
 life predictions...from  
100 hours to 100 years!



Here is the complete family of Allen-Bradley  
**HOT MOLDED COMPOSITION RESISTORS**

The exclusive hot molding process—developed and perfected by Allen-Bradley—produces resistors so uniform in their characteristics that, when combined with the analysis of test data accumulated over the years, it becomes possible to *accurately* predict the “life” of an Allen-Bradley resistor—from 100 hours to 100 years.

After years of carefully compiling test information obtained by Allen-Bradley Environmental Laboratories, as well as from many independent laboratories, power nomographs have been developed which show the relationship between power input, temperature rise, ambient temperature, life, and permanent resistance change for the standard Allen-Bradley composition resistors.

Inasmuch as catastrophic failure is unknown to occur with Allen-Bradley resistors, the design engineer can safely develop circuitry where predictable changes of characteristics are known and uniform. Furthermore, with Allen-Bradley resistors, changes due to humidity

are temporary and cause no permanent damage to the resistors. Voltage characteristics and temperature characteristics are uniform and are known factors. No other composition resistors possess such uniformity of mechanical configuration, electrical characteristics, and life performance as do these A-B quality resistors.

The power nomographs published in the Allen-Bradley Technical Bulletin 5000E will eliminate all uncertainty of circuitry design in relationship to resistors—provided Allen-Bradley “quality” resistors are used. You will find this information very useful. Bulletin 5000E will be sent to you upon your request.

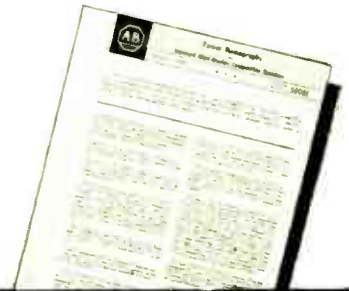

**ALLEN - BRADLEY**

Quality  
**ELECTRONIC COMPONENTS**

Allen-Bradley Co., 110 W. Greenfield Ave., Milwaukee 4, Wis. • In Canada: Allen Bradley Canada Ltd., Galt, Ont.

Typical input-output wave forms of transistor circuit show rise and fall times of 0.5  $\mu$  sec. and 250 mc timing signal

**TEST HIGH-SPEED SEMICONDUCTORS WITHOUT GUESSWORK**

*The EG&G Type 2236A Milli-Mike Oscilloscope ... the only oscilloscope capable of measuring the performance of high-speed semiconductors.*

The Milli-Mike Oscilloscope reproduces pulse rise time on the order of a tenth of a millimicrosecond at relatively low signal voltages without the use of amplifiers. Frequencies as high as 3,000 megacycles and voltage levels of 40 to 50 millivolts can be detected and recorded.

**PERFORMANCE DATA**

	Vertical (TW)	Horizontal
Sensibility	.054 v/trace width	0.30 v/trace width
Nominal Spot Size (trace width)	0.002 inch	
Deflection	27 v/inch (nominal)	150 v/inch
Frequency Response	DC to greater than 3,000 mc (-3db at approx. 2,000 mc)	
Input Impedance	50 or 100 ohms	
Writing Speed	$3 \times 10^{11}$ trace widths/sec.	

Let EG&G's experience in sub-millimicrosecond measurements assist you in the development, inspection and quality control of high-speed semiconductors.

The EG&G Milli-Mike Oscilloscope—one of a family of millimicrosecond instruments—is now being used to solve problems in measurement of recovery time of diodes, decay times of scintillators, discontinuities in transmission lines and as a synchroscope in high resolution radar systems.



**EDGERTON, GERMESHAUSEN & GRIER, INC.**

160 BROOKLINE AVENUE, BOSTON 15, MASS.  
1622 SOUTH "A" STREET, LAS VEGAS, NEV.

World Radio History

the primary and the junction as a secondary.

The device can be used on single-sided boards without plated or eyeletted holes, or single- and double-sided boards with plated or eyeletted holes.

To remove components, a heat-extract cycle is used. The solder joint is centered over the coil with a spotlight (Fig. 1). When sufficient heat has been generated to melt the solder, heating power is turned off. A vacuum pulse is then applied to remove the molten solder and provide a cooling flow of air over the component. Leads and junctions are left clean and pre-tinned.

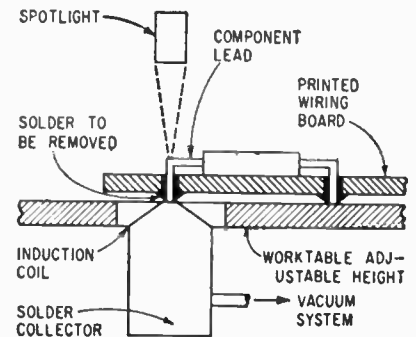

FIG. 1—Arrangement of basic parts of induction desoldering device

To solder new components in the board, only the heating cycle is used and solder is manually applied. This cycle can also be used to dress joints improperly formed during dip or flow soldering.

In comparison with soldering iron methods, the induction method reduces probability of heat damage, improves solder joint reliability and simplifies removal of multilead components.

Since the coil does not get hot, it can touch insulation without damage. Rapid heating of the solder, followed by cool air flow prevents buildup of heat in temperature-sensitive components.

Complete removal of old solder prevents a common cause of unreliable resoldered joints. At soldering temperatures, solder alloys with the base metal of conductors, converting it to a new alloy with a higher melting point. Each time the solder is remelted, the alloying action continues and the solder also picks up oxides and contaminants.

Removing multilead components





Printed wiring assembly is placed over work coil until solder is melted and sucked off board

such as transformers and relays normally requires a spanning iron and some method of bleeding off melted solder, or the use of several irons at once. Nonuniform heating, space limitations and crimped or clinched leads further complicate the procedure. The induction device frees each lead in sequence, so the part can be lifted free from the board without stressing leads.

## Two-Level Tote Tray Avoids Waste Motions

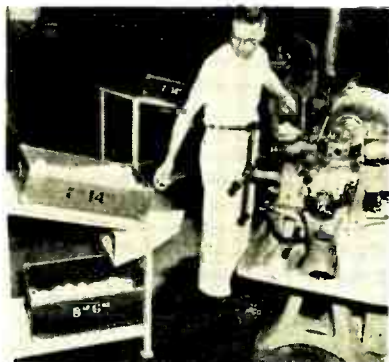

Operator of plastic parts finishing machine drops finished piece and picks up blank with single arm motion

TOTE TRAY CART equipped with a delivery chute and 2 lightweight fibre tote trays reduces waste motion in "pick up" and "put away" parts handling operations. Top tray holds unfinished parts and is inclined toward the operator at an easy to reach height. Finished parts are dropped into the bottom tray through the chute. The trays shown, made by National Vulcanized Fibre Co., Wilmington, Del., are stenciled with tare weights.

# POW AIR

## A NEW CONCEPT IN STANDARD 2" BLOWERS

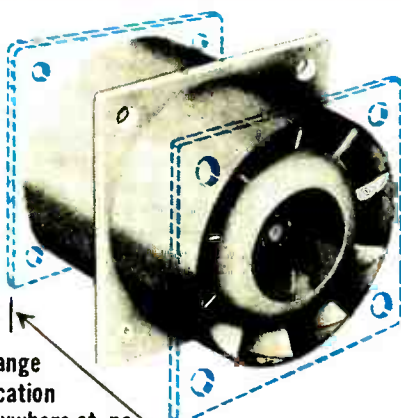

Flange location anywhere at no additional cost.



Introduces  
New Series HP and HF

Now you can select a mounting flange location to best suit your application. Complete tooling available for either square or round flanges with a choice of hole size and positioning. AC or DC Motors, up to 22,000 RPM.

## 3 TIMES THE PERFORMANCE

Yes, up to 3 times the pressure at comparable flows of similar units, or the same performance at a 15% speed reduction. Change your design thinking now.

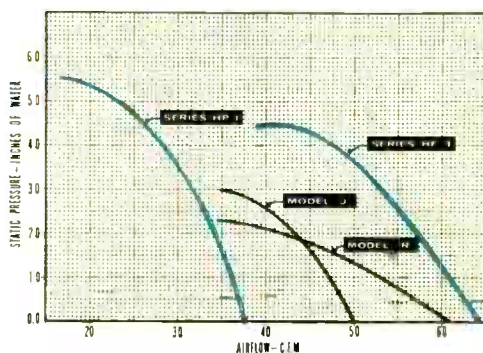

Consult our Sales Engineering Staff for full information.

**DEAN & BENSON RESEARCH**

Division of Benson Manufacturing Co., Kansas City 1, Mo.

# On The Market

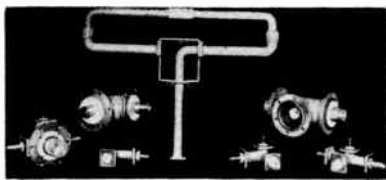

## Rigid Coaxial Lines made of aluminum

TELERAD MFG. CORP., 1440 Broadway, New York 18, N. Y. Aluminum rigid coaxial lines may be ob-

tained in various standard designs or custom units designed to meet the customer's rigid requirements. All units meet the 3 megawatt MIL-I-Spec 26600 for r-i specs.

**CIRCLE 200 ON READER SERVICE CARD**

## Tv Camera Cable with vinyl jacket

TIMES WIRE AND CABLE CO., INC., Wallingford, Conn. Tv camera cable contains the specified number of hookup wires as well as several coax cables. Conductors are of different

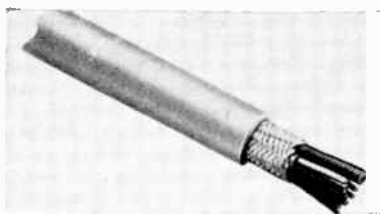

colors for circuit and function identification. Overall shield and jacket prevents radiation and crosstalk. Entire cable has an extra-heavy vinyl jacket so that even a dolly can run over it without damage.

**CIRCLE 201 ON READER SERVICE CARD**

## Switch Assemblies multiple-gang

MICRO SWITCH, Freeport, Ill. The 28AS series of rotary selector switch assemblies feature "cock-and-fire" actuating mechanism and non-tease circuitry, for aircraft,

electronic and computer panels, other areas where mounting surface is at a premium. They can be provided with 2 to 8 plastic enclosed spdt basic switches, switching sequences factory adjusted to customer requirements.

**CIRCLE 202 ON READER SERVICE CARD**

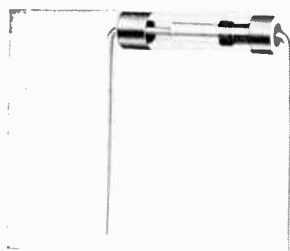
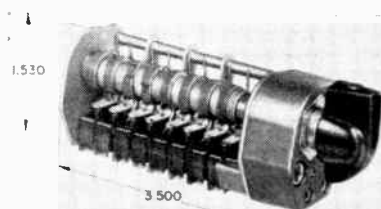

## Sealed Fuse current-sensitive

NETWORKS ELECTRONIC CORP., 14806 Oxnard St., Van Nuys, Calif. Glass-enclosed, this fuse is 100 percent humidity proof and guaranteed to meet any specified resistance to atmospheric conditions. Unit with-

stands temperature from  $-100$  F to  $+400$  F, vibration of 10 to 500 cps at 15 g's maximum, and shock of 50 g's for 11 millisecond. Fuse is dimensioned to dissipate heat produced by the maximum rated current under any special blowing time and temperature conditions.

**CIRCLE 203 ON READER SERVICE CARD**

## Power Supply high current

KROHN-HITE CORP., 580 Massachusetts Ave., Cambridge 39, Mass. Model UHR-211 power supply features output voltage of 130 to 500 v d-c; current, zero to 1,000 ma at any voltage setting and at any line



voltage over the operating range. Regulation is less than 0.004 percent plus 0.004 v; ripple, less than 0.2 mv rms. It is expressly designed to meet requirements of high current capabilities, with ultrahigh regulation, in a stable, low ripple power supply.

**CIRCLE 204 ON READER SERVICE CARD**

## X-Band Magnetron rugged design

MICROWAVE ASSOCIATES, INC., Burlington, Mass. MA-218 is a mechanically tunable X-band magnetron with a range of 9,300 to 10,000 mc. It is rated at a nominal 7 kw peak with peak input of 4.5 am-

peres at 6 kv and 0.002 duty ratio. Pulse-to-pulse a-m jitter has been reduced to provide outstanding radar definition and a new tuning drive mechanism enables accurate, smooth adjustment of individual tubes to specific frequencies without spectrum analyzer or frequency meter checks. Unit is designed for

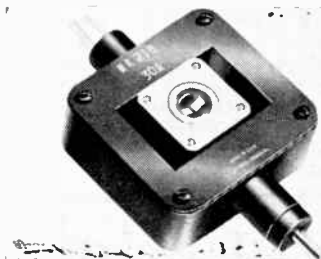



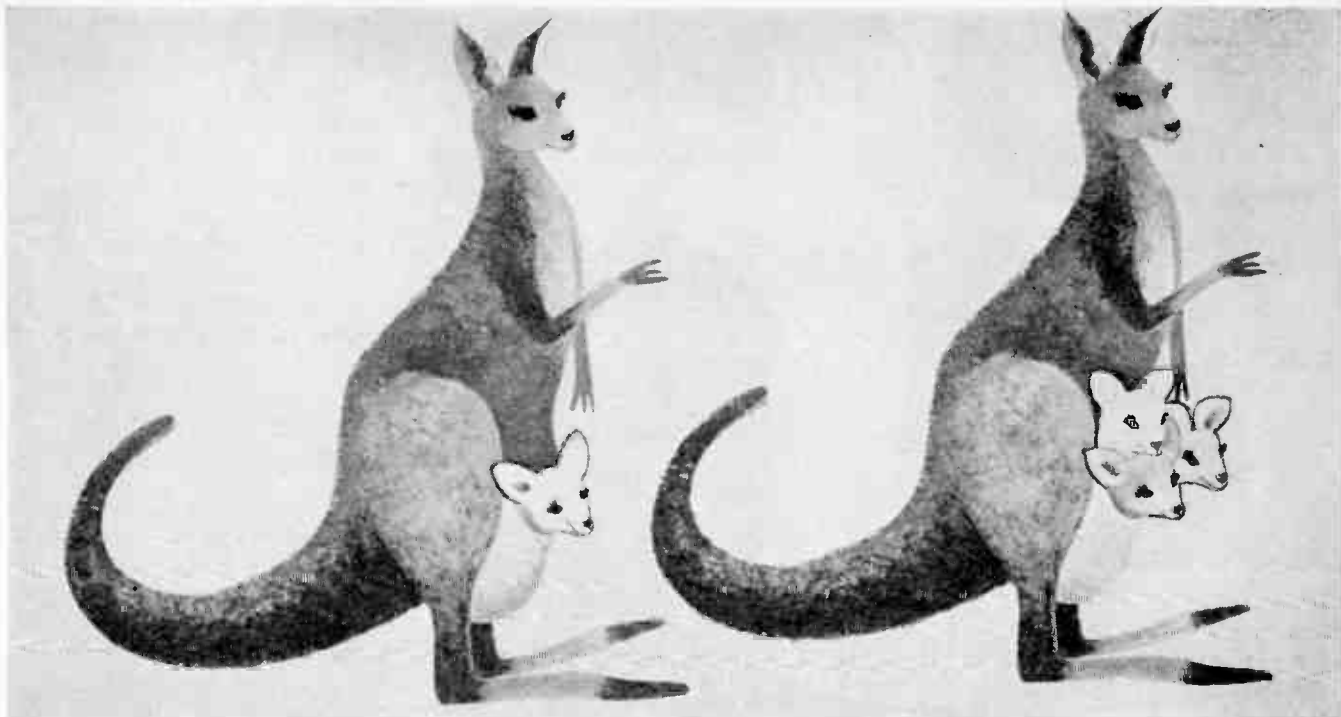

**TRIPLE** THE CAPACITY  
AT NO INCREASE IN SIZE

**NEW** FROM

**JFD**



**MINIATURE  
TRIMMER  
SEALCAP®**

From JFD, pioneer in precision electronic components, comes the most important new miniature trimmer development in years!

Now you can have *triple* the range previously attainable in a miniature trimmer capacitor — at *no* sacrifice in volume — with new MAX-C Sealcaps.

Imagine the possibilities in your circuitry!

This new series incorporates revolutionary new advances in trimmer production which combines the advantages of a thin dielectric gap with the structural strength and ruggedness of a heavy wall glass tube. The result is a broad capacitance tuning range

at a *300 per cent* saving in volume over other presently available piston trimmer caps.

Also, MAX-C Sealcaps feature a new sealed interior construction that locks out all atmospheric effects, locks in stable performance under critical extremes of altitude, vibration, shock, temperature and other rigorous environmental conditions.

These new trimmers along with the complete JFD line of miniature and subminiature trimmers, and LC tuners offer you new dimensions in design. For complete data, write today for bulletin #221.

**MINIATURE PANEL MOUNT MAX-C SEALCAP SERIES**

Model	Min. Max. (Pf)	DISTANCE BEYOND PANEL	MAXIMUM DIAMETER
MC601	1.0 14.0	2 <sup>3</sup> / <sub>4</sub> "	5/16"
MC603	1.0 28.0	1 <sup>1</sup> / <sub>16</sub> "	5/16"
MC604	1.0 42.0	2 <sup>3</sup> / <sub>2</sub> "	5/16"
MC606	1.0 60.0	1 <sup>1</sup> / <sub>2</sub> "	5/16"
MC609	1.0 90.0	1 <sup>3</sup> / <sub>4</sub> "	5/16"

Also available in printed circuit lug and lead, and 4 wire lead type.

**JFD**

Pioneers in electronics since 1929  
**ELECTRONICS CORPORATION**

1462 62nd Street, Brooklyn, New York

JFD International, 15 Moore Street, New York, New York

JFD Canada Ltd., 51 McCormack Street, Toronto, Ont., Canada

\*TRADEMARK

# TEXAS INSTRUMENTS

*sensistor* \*

## SILICON RESISTORS

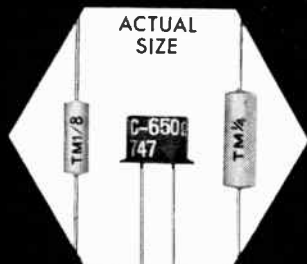

Immediately Available  
Off-the-shelf

From

## Lafayette Radio



Your Authorized  
TI Distributor

Available now for immediate delivery, TI *sensistor* silicon resistors give you a positive temperature coefficient of  $+0.7\%/^{\circ}\text{C}$  for your temperature sensing and for temperature compensating applications in amplifiers... computer switching circuits... servos... power supplies.

STANDARD AVAILABLE RESISTANCES  $25^{\circ}\text{C}$ ; 100, 120, 150, 180, 220, 270, 330, 390, 470, 500, 560, 680, 820, and 1000 ohms.

Type No.	Watts	Resistance Tolerance %
TM $\frac{1}{4}$	$\frac{1}{4}$	$\pm 10$
TM $\frac{1}{8}$	$\frac{1}{8}$	$\pm 10$
TC $\frac{1}{8}$	$\frac{1}{8}$	$\pm 10$

Get delivery now at factory prices on these or any of TI's complete line of use-proved and guaranteed semiconductors and components in the following quantities:

1 - 499:

*sensistor* silicon resistors

1 - 999:

carbon film resistors, silicon and germanium transistors, silicon diodes and rectifiers

1 - 99:

*tan-TI-cap* tantalum capacitors



*Lafayette Radio*

Dept. TI-J

BOSTON 10, Mass.  
110 Federal St.  
HU 2-7850

JAMAICA 33, N. Y.  
165-08 Liberty Ave.  
AX 1-7000

PLAINFIELD, New Jersey  
139 W. 2nd St.  
PL 6-4718

NEWARK 2, New Jersey  
24 Central Ave.  
MA 2-1661

NEW YORK 13, N. Y.  
100 6th Ave.  
WO 6-5300

\*Trademark of Texas Instruments Incorporated

critical, jitter-free, pulsed-doppler and moving target indicator applications.

CIRCLE 205 ON READER SERVICE CARD



## Strip Chart Recorder small and simple

RUST INDUSTRIAL Co., 130 Silver St., Manchester, N. H. Rustrak strip chart recorder, for 0-150 v or 0-300 v a-c (rectifier movement), is priced from \$69.50 to \$83.95, depending on range. Units feature inkless rectilinear recording free from distortion, house a 63-ft roll of pressure-sensitive paper. Various chart speeds available up to 30 in. per hr.

CIRCLE 206 ON READER SERVICE CARD

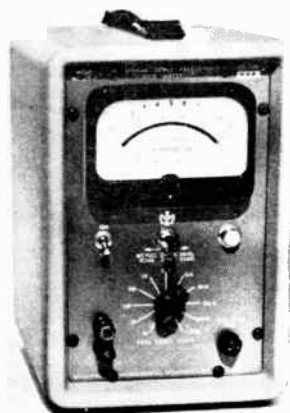

## Ohmmeter linear scale

MILLIVAC INSTRUMENTS Division of Cohu Electronics, Inc., Box 997, Schenectady, N. Y. Model MV-279A direct-reading ohmmeter has a linear scale. Instead of measuring the current flowing through the unknown resistance from a fixed voltage source, it measures the voltage drop produced across the unknown

resistor by a constant current. This results in an accuracy of 0.25 percent full scale, or 1 percent absolute. Meter has 11 measuring ranges from 1 ohm to 1 megohm full scale. Featured in the unit is a stable, reliable d-c amplifier circuit. A high-quality plug-in d-c modulator, rated at 10,000 hr guaranteed life, is used.

CIRCLE 207 ON READER SERVICE CARD

## Bonding Solution for fluorocarbons

THE JACLIN MFG. Co., Lufbery Ave., Wallingford, Conn. Fluorobond solution makes materials such as Teflon or Kel-F bondable in a maximum of 15 sec by either simple dipping, brushing or spray methods. Excellent bond strengths are obtained with no adverse effect on the electrical properties of the material in thicknesses as low as 0.0005 in.

CIRCLE 208 ON READER SERVICE CARD

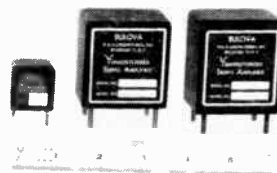

## Servo Amplifiers high temperature

BULOVA R & D LABORATORIES, INC., Woodside 77, N. Y. Three high-temperature servo amplifiers meet applicable military standards and operate within specifications between  $-55$  and  $+125^{\circ}\text{C}$ . They are fully potted, include silicon transistors, meet a variety of application needs, and range in power output from 3.5 to 12 w for driving motors from size 11 to 18. Maximum output voltage is 40 v rms.

CIRCLE 209 ON READER SERVICE CARD

## Winding Heads increase flexibility

BOESCH MFG. Co., INC., Danbury, Conn. FT-6 winding head adapts toroidal coil winding machine models TW-201, TW-251, TW-200 and TW-300 for heavier gages of wire (No. 20 to No. 32) on small, medium or large core sizes, or to wind



interfering  
**electromagnetic  
energy**

within the frequency range of

**30 cps to 10.7 kmc**

...can be investigated, analyzed, monitored and measured  
to the highest practical degree of accuracy with Stoddart

**Radio Interference & Field Intensity Measuring Systems.**

Stoddart RFI Measuring Equipment is approved for use by all departments of the Department of Defense. Military and commercial equipments are identical... were designed and manufactured to Military Equipment Specifications to meet the requirements of Military Measurement Specifications. Equipments are portable, dripproof, dustproof, and ruggedized for all-weather field use... precise and dependable for sensitive-selective laboratory measurements.

Applications include interference measurement and location, frequency conservation and allocation studies, spectrum signatures, antenna propagation studies, field intensity surveys, RF energy surveillance and monitoring, and verification of the electronic compatibility of modern weapons systems, i.e., missile firing and guidance, computer, telemetering and communications; the measurement of all rotating electrical devices, transmitting and receiving equipment, or any system or equipment capable of producing unwanted radiated or conducted electrical disturbances.

Stoddart instruments are available as individual self-contained units covering specific frequency ranges, or in rack-mounted console systems for laboratory, mobile, airborne and marine use.



**M-40A (AN/URM-41)**  
30 cps to 15 kc



**NM-10A (AN/URM-6B)**  
14 kc to 250 kc



**NM-20B (AN/PRM-1A)**  
150 kc to 25 mc

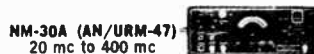

**NM-30A (AN/URM-47)**  
20 mc to 400 mc



**NM-50A  
(AN/URM-17)**  
375 mc to 1000 mc



**NM-60A  
(AN/URM-42)**  
1 Kmc to 10.7 Kmc

**our sales engineering department**

will give you individual consideration and information in the areas of interference problems or measurement with which you are particularly concerned... provide engineering bulletins, military specification information, descriptions of new measurement techniques and applications... class or individual instruction in the operation, calibration, and maintenance of Stoddart instruments. For prompt service please call "Sales Engineering", HOLLYWOOD 4-9292.

Lease-purchase and lease-rental agreements available  
Immediate delivery

Send for complete literature

**STODDART**  
AIRCRAFT RADIO CO., INC.  
6644 Santa Monica Blvd., Hollywood 38, Calif., HO 4-9292



**serving 33 countries in radio interference control**

BUILD ON...

# EASTERN

TEMPERATURE CONTROL EXPERIENCE:

## AVIONIC COOLING

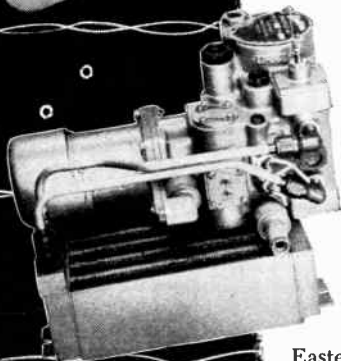

Eastern cooling packs for electronic subsystems extend operating ranges to altitudes where air cooling becomes ineffective. 'Black box' designs can be more compact—reliable even at five times the speed of sound.

These liquid cooling systems are completely self-contained—provide such components as pumps, heat exchangers, air impellers, reservoir, coolant flow and temperature interlocks and similar parts.

Cooling capacities of existing systems range from 1,000 to 22,000 watts dissipation rates. Eastern cooling packs take ambient temperatures from  $-55^{\circ}\text{C}$  to  $+55^{\circ}\text{C}$  in stride, and perform to altitudes of 60,000 ft.

Extensive experience in missile applications has enabled Eastern to develop systems unusually compact and light as well as highly reliable. At the same time, Eastern is able to provide at minimum cost equipment engineered to a specific need by using missile-proved components designed to your system configuration.

Turn to Eastern for space-, weight-, and cost-saving solutions to your hottest cooling problem. Write for New BULLETIN 360.

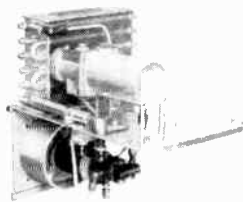
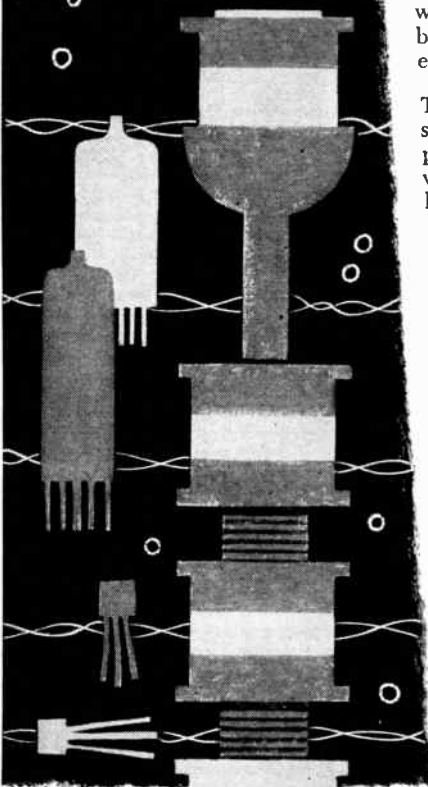

liquid cooling units for 50 to 50,000 watts dissipation

PIONEERS OF THE THERMAL FRONTIER

**EASTERN INDUSTRIES INCORPORATED**

100 SKIFF STREET  
HAMDEN 14, CONN.



more turns of smaller wire. Three shuttles and ring gears are currently available for the FT-6 head. The FT-6S winds coils to a minimum residual i-d of  $\frac{1}{8}$  in.; FT-6M works to a minimum of  $\frac{1}{2}$  in.; and FT-6L winds to  $\frac{3}{8}$  in. minimum.

CIRCLE 210 ON READER SERVICE CARD

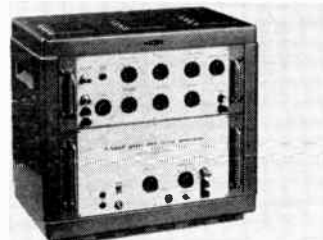

### Generator double pulse

MARCONI INSTRUMENTS, 111 Cedar Lane, Englewood, N. J. Model 3352 double pulse generator produces a pulse coincident with the prepulse and an identical additional pulse delayed by an accurately known time interval. Prf ranges from 0.95 cps to 3 mc without duty cycle limitations. Minimum pulse width is 90 msec; rise time is 10 msec from 75 ohm source. Maximum output is 50 v from 1,000 ohms. Double pulses are particularly valuable for measuring the resolution of high speed circuits. The instrument is supplied ready for rack mounting.

CIRCLE 211 ON READER SERVICE CARD

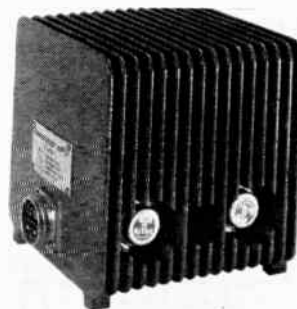

### D-C/D-C Converters transistorized

ELECTRODYNAMIC INSTRUMENT CORP., 2508 Tanglely Road, Houston 5, Texas. The TS series transistorized d-c/d-c converters will supply a continuous output of 200 w. The compact, ruggedized fin-case design





"BEST IRON WE'VE HAD in the plant," says William Fish, a production supervisor of General Radio, Cambridge, Mass. This company has switched to G-E Midget irons for soldering *both*

delicate and heavy joints in their Type 1862-B Megohmmeters—jobs which formerly required *both* a heavy and a light iron. G-E Midget iron's light weight also helps reduce fatigue.

## 50 G-E Midget irons do work of 100 former irons at General Radio Co., boost production 25%

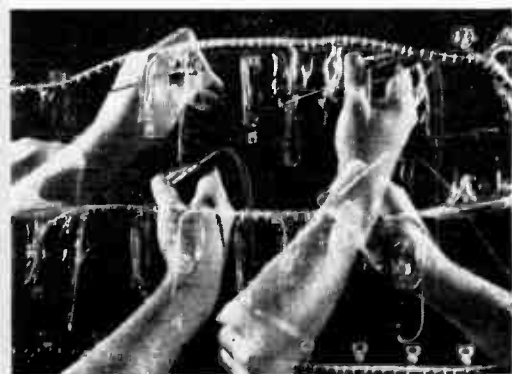

**FASTER HEAT RECOVERY** and lower maintenance of G-E soldering irons have been proved by many manufacturers under their own production conditions—along with competitive soldering irons. If you would like to compare General Electric irons with the irons you are now using, call your G-E distributor.



**DELIVERY TODAY** is now possible on popular soldering irons and other General Electric heaters and devices from a local distributor near your plant. Your replacement inventory may be reduced. For the name of your nearest stocking distributor for G-E heaters and devices, call your General Electric Apparatus Sales Office.



**SAVINGS ACHIEVED** by several users and information about the construction features of General Electric soldering irons are included in a new bulletin, "Save While You Solder," GED-3553. For a copy, call your G-E distributor or write Section 724-3, General Electric Company, Schenectady 5, New York.

**GENERAL**  **ELECTRIC**

World Radio History

CIRCLE 145 ON READER SERVICE CARD

# PRECISION

## Geared To Your Product Needs

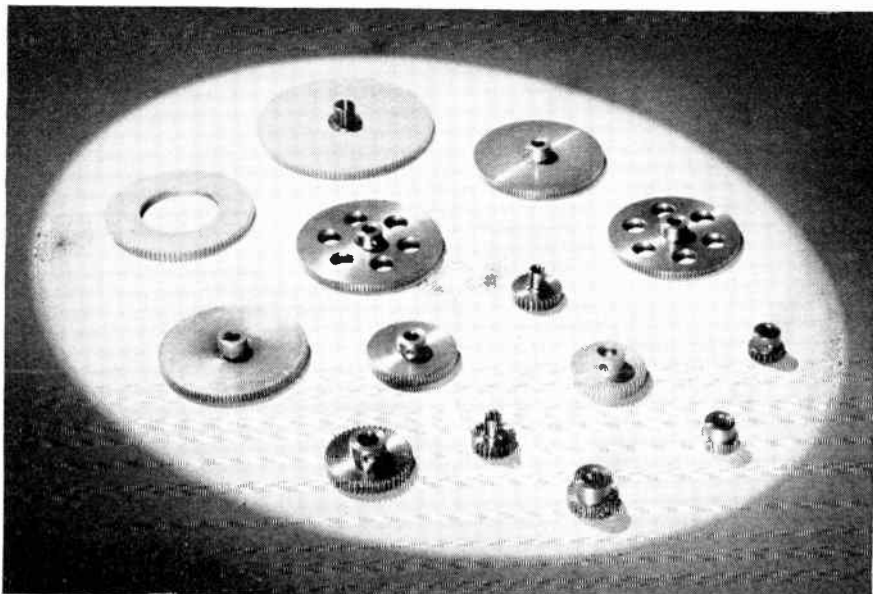

## APPCO *Certified* STOCK GEARS

32 TO 120 PITCH . . . A.G.M.A. PRECISION #1, 2 & 3

Every tooth a masterpiece in finish and motion . . . every gear to the most exacting A. G. M. A. precision standards . . . all meet Government specifications—that's the quality of APPCO Certified Precision Stock Gears. The precision of every gear Certified to assure engineers and production men of their exact requirements for every precision product.

APPCO Certified Precision Stock Gears are available for quick deliveries in 32, 48, 64, 72, 96 and 120 diametral pitches of 14½° and 20° pressure angles. Each gear designed with dimensions proportional to their diametral pitch for minimum weights and space considerations.

The fine precision and certified testing permits the use of APPCO Gears in precision assemblies of all types—airborne, shipboard, missile or stationary. APPCO Gears are usable in the engineering prototypes or breadboard design . . . will qualify uniformly for use in actual model pre-production or production manufacturing areas. Each gear is completely sealed on a shipping tray with plastic cover . . . always "factory fresh" and free of dust, corrosion and scratches.

Put extra precision into your products. Write for APPCO catalog to Atlas Precision Products Co., Castor and Kensington Avenues, Philadelphia 24, Pennsylvania.



GET FREE  
CATALOG



MEMBER



Division of  
**PRUDENTIAL INDUSTRIES INC.**

provides a high heat dissipation to size ratio, with a resulting efficiency of better than 85 percent. Inadvertent reversal of input polarity or a short across output will not damage the units. Models are available in any input voltage from 6 v d-c to 110 v d-c, and with a wide range of customer-specified output voltages.

**CIRCLE 212 ON READER SERVICE CARD**

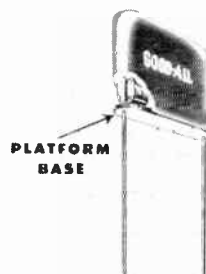

## Slim Capacitors with platform base

GOOD-ALL ELECTRIC MFG. Co., 112 W. 1st St., Ogallala, Neb. Type 602 slim-line capacitor with Mylar dielectric and miniature mounting platform of epoxy glass laminate. Base seats it securely on printed circuit chassis to withstand extreme vibration. For transistor use and available in 50 v. 0.01 through 0.33  $\mu$ f. They have extended foil construction and are coated with epoxy.

**CIRCLE 213 ON READER SERVICE CARD**



## Terminal vibration-proof

HU-BAR TERMINALS Co., 8721 Rindge Ave., Playa Del Rey, Calif. The Vibrapruf terminal for etched circuit and terminal boards features a countersunk and knurled



# New!

Cutting costs of  
Switch Installation...  
your job...and Centralab's

## Centralab Printed Circuit Switches

the greatest advance  
in switch design  
in decades

The CENTRALAB Series 20 Printed Circuit Switch provides these cost-saving advantages:

- 1** Elimination of switch wiring errors.
- 2** Simultaneous connection of all switching leads during dip soldering of etched circuit boards.
- 3** No hardware is required for rigid anchoring of switch to the board.

### SPECIFICATIONS:

**Construction:** 1 3/4" high x 2" wide laminated phenolic sections. Bolted construction multiple sections and staked single or dual section assemblies.

**Switching Combinations:** 1 pole—12 positions through 6 pole—2 positions. Also available with dual concentric shafts for A.C. line switch or 1/2 watt variable resistor, equipped with printed circuit terminals.

**Rating:** 2 amperes at 15 volts D.C., 150 ma. at 110 volts A.C. (make and break, resistive load).

**Insulation:** Laminated phenolic type PBE per specification MIL-P 3115. Voltage breakdown 1000 volts RMS.

**Rotational Life:** 10,000 cycles minimum.

For complete physical and electrical specifications on CENTRALAB Printed Circuit Switches ask for Bulletin EP-757.

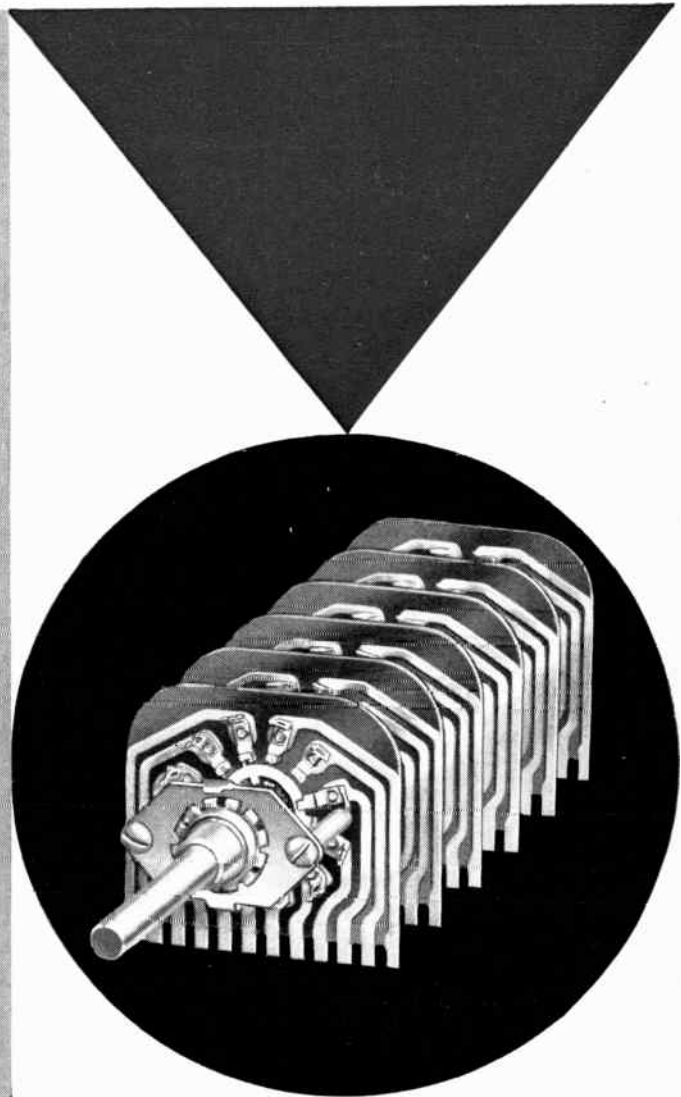

# Centralab

P-5956

A Division of Globe-Union Inc.  
914J E. KEEFE AVE. • MILWAUKEE 1, WIS.  
In Canada: 669 Bayview Ave., Toronto 17, Ont.

VARIABLE RESISTORS • ELECTRONIC SWITCHES • PACKAGED ELECTRONIC CIRCUITS • CERAMIC CAPACITORS • ENGINEERED CERAMICS

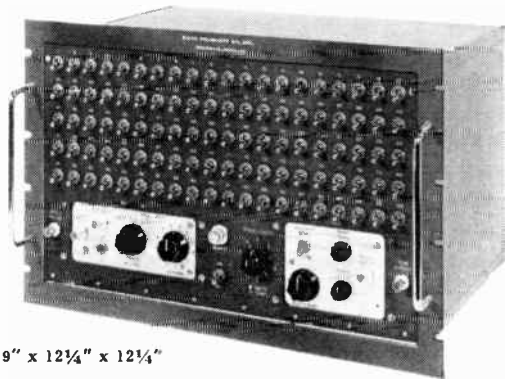

Actual size: 19" x 12¼" x 12¼"

## **NEW** TRANSISTORIZED PULSE PATTERN GENERATOR

**Provides remarkable versatility for military and industrial electronic testing applications**

This is Data Products' *new, remarkably versatile* General-Purpose Pulse Pattern Generator. It provides a simulated and flexible time division pulse pattern for a broad range of military and industrial electronic testing applications.

If you manufacture or use electronic equipment that employs a time division multiplex principle, you'll be interested in the new test set's specifications:

- Generates a pulse pattern of any length from one to 100 pulses.
- Pulse rate is continuously variable from 10 to 100,000 pulses per second.
- Can be driven by either internal or external oscillator.
- Can be driven by an external oscillator at a pulse rate as low as desired to 100,000 per second.
- State of each pulse in a pulse sequence can be independently controlled from the front panel. Each pulse assumes a mark or a space condition depending on the position of the switch which represents that particular pulse. There are 100 switches—representing 100 possible pulse positions.
- Output level for the mark (ONE) position is continuously variable from zero to plus 10 volts. Output level for the space (ZERO) position is continuously variable from zero to minus 10 volts. Output impedance is 1,000 ohms nominal.
- Eight microsecond cycle pulse output (occurring at beginning of each pulse sequence) is provided.
- Two microsecond clock pulse output (occurring every pulse time) is provided.
- Can provide up to plus or minus 30 percent pulse width bias. Provided primarily to simulate baud bias conditions in teletype systems.
- Operates from a nominal 117 volts, 50-400-cycle power system.
- One microsecond rise and fall time.
- Tone keyer optionally available.

YOU CAN GET detailed information on Data Products' new Pulse Pattern Generator. Write or call Data Products if you would like to see a demonstration of the instrument's versatility. Or you can write or call for detailed specifications or descriptive literature. Ask if you would like to discuss your specific application requirements with a Data Products application engineer.



**DATA PRODUCTS CO., Inc.**

7320 WESTMORE ROAD ROCKVILLE, MD.  
GArden 4-6750, TWX ROCKVILLE, MD. 999

shank which provides superior electrical and mechanical contact; this insures protection against loosening in the board. Another feature is that it uses less surface area on the top side of the plated board, but more contact surface area, electrically and mechanically, within the countersunk portion of the plated hole. A considerable increase in "G" loads is possible.

**CIRCLE 214 ON READER SERVICE CARD**

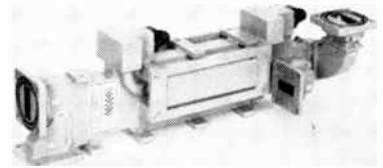

### **X-Band Circulator** high power

RANTEC CORP., Calabasas, Calif. Model CXL four port circulator operates at a power level of 1 megawatt peak, 1,000 w average over the range 8.5 to 9.6 kmc and provides isolation greater than 20 db with an insertion loss of less than 0.5 db. Ambient temperature range, -55 to 100 C; pressurization, 30 psi gage; input and output mates with RG-68/U (1½ by 3); waveguide length, 12½ in.; weight, 3½ lb.

**CIRCLE 215 ON READER SERVICE CARD**

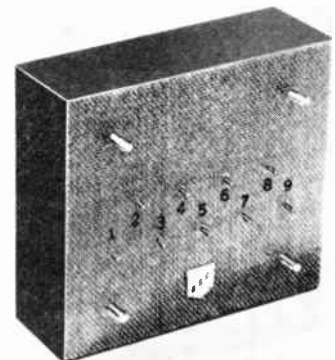

### **Delay Lines** four-in-one

ESC CORP., 534 Bergen Blvd., Palisades Park, N. J. Model 71-30 contains four delay lines in a single unit. Each of the four has a 1.0 μsec delay, with a characteristic impedance of 1,000 ohms. Dimensions are 3 in. by 2½ in. by 1 in. Unit is cased



# How far can an engineer go at

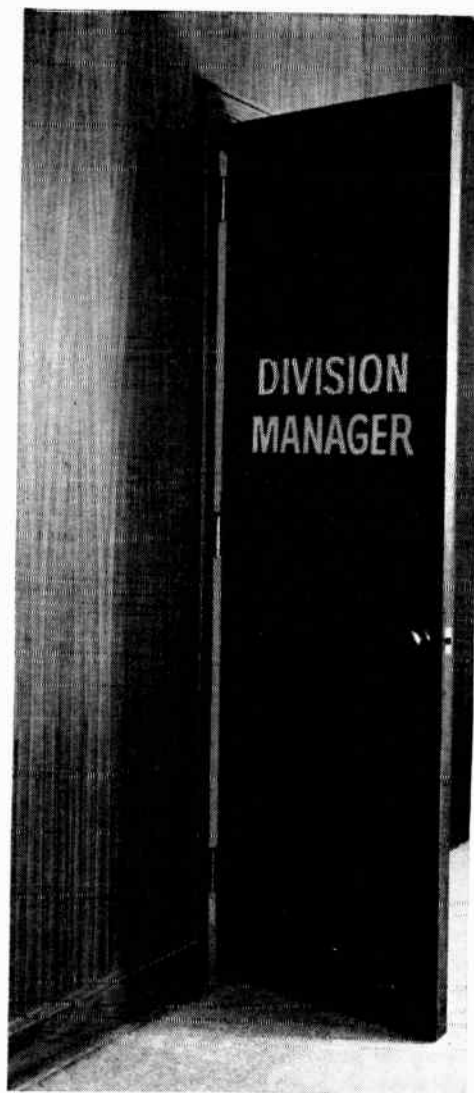
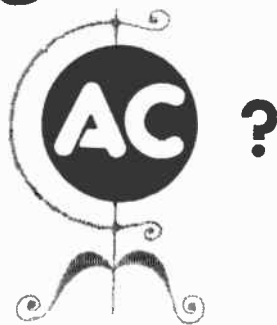

Someday your name may go on the door of a top-management office of the AC Division . . . or of the General Motors Corporation. This is part of GM's "open door" policy. This means that not only is every GM door open to every employee, but that every open door represents opportunity. Today AC helps fulfill the large demand for inertial guidance systems (with the AChiever) and many other electro-mechanical, optical and infra-red devices. In the future AC will supply even more instrumentation needs—both military and commercial—for the "space era." Your long-range prospects at AC can hardly be equaled. You'll gain invaluable experience working shoulder to shoulder with recognized experts on many assignments. You'll enjoy highest professional status, which can be enhanced by working on advanced degrees at engineering schools located near AC facilities. You can work at AC facilities across the country or around the world. In short, if you are a graduate engineer in the electronic, electrical or mechanical fields, *you can go places at AC, because AC is going places.* This is worth looking into. Just write the Director of Scientific and Professional Employment: Mr. Robert Allen, Oak Creek Plant, Dept. B, Box 746, South Milwaukee, Wisconsin. It may be the most important letter of your life.

Inertial Guidance Systems • Afterburner Fuel Controls • Bombing Navigational Computers  
Gun-Bomb-Rocket Sights • Gyro-Accelerometers  
Gyroscopes • Speed Sensitive Switches • Speed Sensors • Torquemeters • Vibacall • Skyphone

AC SPARK PLUG  THE ELECTRONICS DIVISION OF GENERAL MOTORS



H. D. Elverum, Supt. of Assembly  
Honeywell Aeronautical Division

“Production Engineers  
... here are opportunities  
to join a group  
responsible for production of  
advanced space controls”

“A unique feature of man’s explorations in space is his utter dependence on automatic controls. Flight controls, environment controls, instrumentation and data processing, inertial guidance and navigation . . . these are the work areas of Honeywell Aero, a division of the world’s largest producer of automatic controls.

“Our group at Honeywell is concerned with production in these advanced control fields. Currently, we have openings for electronic and mechanical assembly engineers. These men will be responsible for placing into production such complex devices as platforms, floated gyros, accelerometers, vertical and rate gyros, calibrators, and computers. They will work directly with Design Engineers through design—be responsible for introducing production know-how and techniques into original design—for estimating, processing, and tooling during the pre-production phase—for coordinating assembly and calibration efforts during initial production phases.

“If you are a qualified production engineer interested in a rewarding career with Honeywell Aero, send information on your background, interests, and accomplishments to Bruce D. Wood, Technical Director, Dept. 849F.”

MINNEAPOLIS  
**Honeywell**   
AERONAUTICAL DIVISION

1433 Stinson Blvd. N.E., Minneapolis 13, Minnesota

To explore professional opportunities in other Honeywell operations coast to coast, send your application in confidence to H. D. Eckstrom, Honeywell, Dept. 849F, Minneapolis 8, Minnesota.

in molded epoxy and has a glass melamine board with gold-plated pins. Designed to meet all environmental requirements, it is used in p-c applications, and is particularly suitable to dip soldering techniques.

CIRCLE 216 ON READER SERVICE CARD



### Printer Relay transistorized

NORTHERN RADIO Co., Inc., 147 W. 22nd St., New York 11, N. Y. Type 237, model 1, transistorized printer relay is designed to be used as a coupling device between a d-c teleprinter signal loop and the printer selector magnet. It replaces electro-mechanical signal relays and the associated d-c power supplies that are normally used with printers. The unit effectively isolates the reactance of the printer selector magnet, presenting a resistive termination to the signal loop. Several printers equipped with this device can, therefore, be connected in series with the same signal loop without harmful interaction between them. The printer relay may be used with either polar or neutral keyed signals.

CIRCLE 217 ON READER SERVICE CARD

### Carrier Amplifier multichannel

CONSOLIDATED ELECTRODYNAMICS CORP., 360 Sierra Madre Villa, Pasadena, Calif. System CD-2 is a multichannel carrier amplifier available in 4, 6, 8, or 12-channel systems which include an appropriate matching oscillator/power supply. It is suitable for airborne,



# Editorial Conference: Friday 9:30 AM



## Bill MacDonald, 33 years an Editor, Feeds a Growing Boy

Electronics, like a growing boy, has a voracious appetite—an appetite for information about technical developments, new markets, business potentials...

*electronics* magazine has the job of feeding information to the industry in a balanced editorial diet so that the quality and quantity of editorial will more than meet industry requirements.

Editor W. W. MacDonald inspires respect from his 26-man editorial staff, and justly so, Mac has been, successively, an Associate Editor, Executive Editor and then Editor of *electronics*. Before joining *electronics* he had been Managing Editor of "Electrical Merchandising" and Editor of "Radio Retailing." A senior member of the Institute of Radio Engineers, he has devoted 33 years to editing McGraw-Hill publications.

Mac is responsible for *electronics* editorial. True, he has far more assistance from his highly trained, professionally mature staff than do most

business publication editors. Fifteen members draw upon direct engineering experience in the electronics field. Four editors gained electronics experience in the armed services. Four others came to *electronics* with backgrounds in journalism, finance, and marketing. The balance of the staff comprise the Art Director and his assistants.

But the Editor of *electronics* is a perfectionist and never satisfied. He is constantly raising the standards by researching his readers, going into the field, sounding out his staff.

And what does Mac's editorial contribution mean?

That the reader of *electronics* is kept best informed about his industry, and is therefore most apt to progress in it. If your subscription to *electronics* is expiring, if you're not a subscriber, fill in the box on the Reader Service Card. It's easy to use. Postage is free.

**electronics** /

A McGraw-Hill Publication • 330 West 42nd Street, New York 36, N. Y.



World Radio History



The Industry's First Complete Line of

# METAL

## Multi-Turn Precision Potentiometers



Spectrol's sturdy new metal multi-turns are as tough to push out of shape as Sir Spectrol, our man in armor. Available in eight models, featuring anodized aluminum cases with 3/16 inch thick walls that absorb no moisture — dissipate more heat faster and stay dimensionally stable. These armored pots, four 3-turn and four 10-turn, will operate from  $-55^{\circ}\text{C}$  to  $+125^{\circ}\text{C}$  and withstand relative humidity of 95%.

You can choose diameters of 7/8, 1, 1-5/16 and 1-13/16 inches in both three and 10-turn models. Standard linearity tolerance is  $\pm 0.25\%$  with special linearity available to  $\pm 0.020\%$ . Like Sir Spectrol, the man in the iron suit, the new metal multi-turns will take a respectable jolt. They function to 20g vibration from 55 to 2,000 cps and withstand 30g shocks.

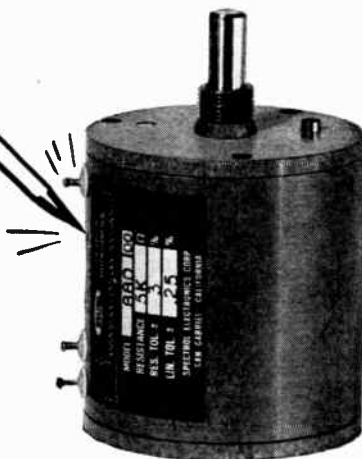

For more details, call your Spectrol engineering representative listed in the yellow pages or write us direct. Please address Dept. 1810A.

MODEL	540	530	580	560	780	790	880	840
No. of coil turns	10	3	10	3	10	3	10	3
Diameter (inches max.)	3/8	3/8	1	1	1 1/8	1 1/8	1 1/8	1 1/8
Standard resistance range in ohms ( $\pm 3\%$ )	25-125K	10-36K	25-150K	10-40K	30-300K	10-90K	50-400K	20-120K
Special resistance to	250K	75K	250K	75K	750K	240K	1 meg	330K



**ELECTRONICS CORPORATION**

1704 South Del Mar Avenue  
San Gabriel, California

*Be sure your pot's in armor!*

mobile, or fixed-base applications and provides practically distortion-free amplification of low-level transducer output voltages in the d-c to 200 cps range. Its use permits these signals to be fed directly to a recording oscillograph.

**CIRCLE 218 ON READER SERVICE CARD**



### Wide-Band Amplifier all solid state

PACKARD BELL COMPUTER CORP., 1905 S. Armacost Ave., Los Angeles 25, Calif. Model 261 is a wide-band, completely solid state, true differential instrumentation amplifier with a solid state chopper. Noise from all sources is less than  $10 \mu\text{v}$  at a bandwidth of 200 kc. Input impedance is as high as 100 megohms, and common mode rejection is 120 db. Unit is designed to work with strain gages, thermocouples and other low signal level devices. Extreme reliability is achieved through the elimination of all moving parts.

**CIRCLE 219 ON READER SERVICE CARD**

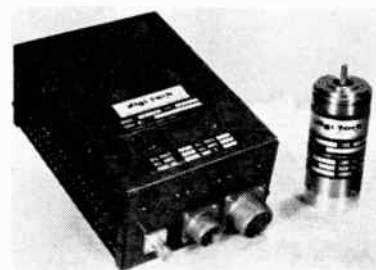

### Stepping Motors nonoscillating

THE TELLER Co., Butler, Pa. The Digitork instrument size digital step motor and solid state control features: precise bidirectional controlled step output for input signals up to 3 kc, high instantaneous response rates, high step resolution, and linear response. Motors provide excellent torque to speed characteristics with outputs ranging from



# NOW... COMPLEMENTARY CIRCUIT ECONOMIES

## with **INDUSTRIAL** NPN-PNP POWER TRANSISTOR PAIRS

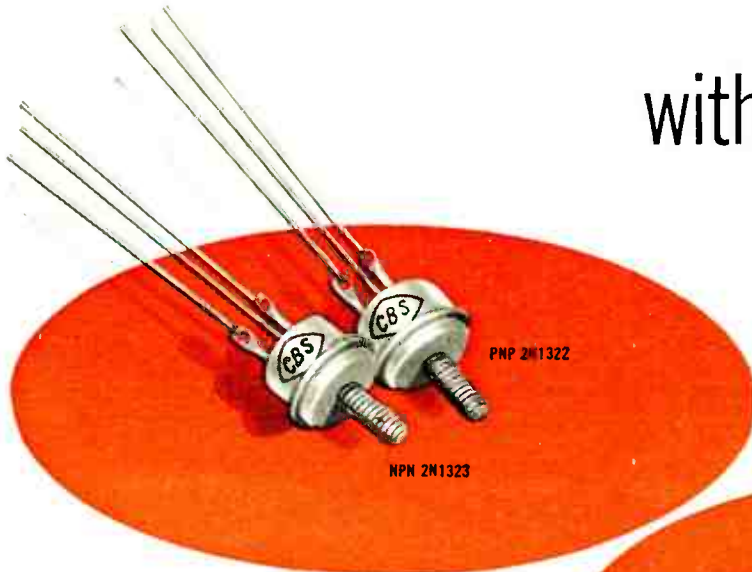

Complementary pairs of CBS NPN and PNP power transistors eliminate input and output transformers in push-pull circuits. Resulting advantages are many: Economy. Miniaturization. Improved frequency response. Ease of applying negative feedback. Etc.

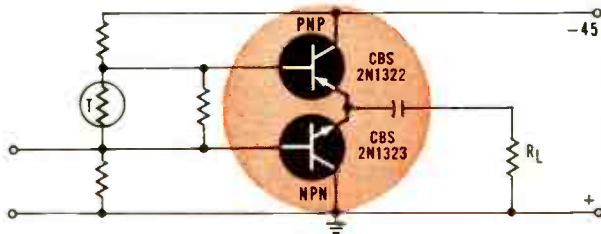

Typical Industrial Complementary Push-Pull Amplifier

### INDUSTRIAL NPN-PNP POWER TRANSISTOR PAIRS

NPN Type	Package	Max. W. Diss. "	Max. $V_{CB0}$ †	Max. $V_{CES}$ ‡	Min. $h_{FE}$ ( $I_C=0.5A$ )	Max. Thermal Res. °C/W	PNP Type
2N1321	Male	20	35	30+	30	3	2N1320
2N1329	Female	20	35	30+	30	3	2N1328
2N1323	Male	20	60	45+	30	3	2N1322
2N1330	Female	20	60	45+	30	3	2N1078
2N1325	Male	20	80	60+	30	3	2N1324
2N1332	Female	20	80	60+	30	3	2N1331
2N1327	Male	20	100	80+	30	3	2N1326
2N1334	Female	20	100	80+	30	3	2N1333

All types have: Max. collector current, 3 amps; storage temperature, -65 to +85°C. †25°C base mounting temperature. ‡Polarity: NPN positive, PNP negative. † $I_{CES} = 10$  ma.

Enthusiastic acceptance of the diamond-package line of CBS NPN-PNP power transistors has disclosed a demand for additional pairs in industrial packages. These new industrial types make possible the same design economies of complementary circuitry. Mounted in TO-10 and TO-13 male and female packages, they are supplied with solder lugs or flying leads. And they feature high voltages (up to 100 volts) and proven quality (they exceed the MIL-T-19500A specification). The new units add another complete industrial line to the growing lines of CBS complementary power transistors for audio, control, voltage-regulation, servo and computer applications. Check circuit and abbreviated data. Write for complete data sheets: Industrial types, Bulletin E-360; diamond types, E-355. Order now from your local Manufacturers Warehousing Distributor. Watch for a higher power line soon.

*More reliable products  
through Advanced Engineering*



**semiconductors**

**CBS ELECTRONICS**, Semiconductor Operations  
A Division of Columbia Broadcasting System, Inc.

Sales Offices: Lowell, Mass., 900 Chelmsford St., GLENVIEW 4-0446 • Newark, N. J., 32 Green St., MARKET 3-5832  
Melrose Park, Ill., 1990 N. Mannheim Rd., ESTEBROOK 9-2100 • Los Angeles, Calif., 2120 S. Garfield Ave., RAYMOND 3-9081

# PHILCO

TECHREP DIVISION

## ANNOUNCES

## NEW GROUND-FLOOR OPPORTUNITIES IN ENGINEERING

As the pioneer in electronic field services, PHILCO is now moving into the broader field of Electronics . . . researching . . . engineering . . . designing and performing engineering modifications of global communication systems, world-wide radar defense networks, and missile systems and components.

### OUR NEW FLEXIBLE POLICY LETS YOU —

- Choose Your Own Field of Interest
- Choose Your Own Location

### WHILE PROVIDING

— constant career guidance  
... professional growth ...  
top compensation and the  
very best in employee  
benefits.

### WRITE TODAY

Let us review your professional experience and desires, so that we may arrange a confidential consultation in your city.

MR. CLIFFORD F. GRAEBE, *Personnel Manager*

**PHILCO TECHREP DIVISION, Dept. 39-A**

22nd & Lehigh Ave., Philadelphia 32, Pa.

NAME: \_\_\_\_\_

ADDRESS: \_\_\_\_\_

CITY: \_\_\_\_\_ STATE: \_\_\_\_\_

**P.S. Please Enclose Resume.**

1 in. oz for the instrument size to 100 in. lb for a large industrial size and with steps per revolution from 36 to 108. They are rated for continuous, intermittent, or stalled operation through a 24 to 250 v d-c range.

**CIRCLE 220 ON READER SERVICE CARD**

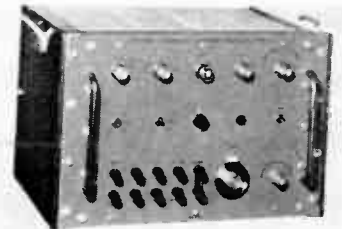

### Function Generator has 37 waveforms

MARCONI INSTRUMENTS, 111 Cedar Lane, Englewood, N. J. Model L51 generates over 37 different waveforms for testing servomechanisms, vibration studies, medical research and geological problems as well as programming automatic systems and analog computation. Sine waves with frequencies from 500 cps to 0.0005 cps (one cycle every 33 minutes) are generated with total harmonic distortion less than 1 percent. Maximum voltages are 150 v peak to peak. Ramps, triangular waves, sawtooth and trapezoidal functions are available singly or repetitively. One-half or one complete cycle may be obtained, and a prepulse can be used to start recording equipment so that the initial response of the system under analysis may be observed.

**CIRCLE 221 ON READER SERVICE CARD**

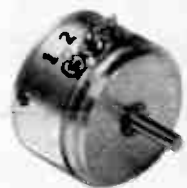

### Potentiometer split winding

PRECISION LINE INC., 63 Main St., Maynard, Mass. Split winding potentiometer features independent linearity to 0.25 percent, continuous rotation to 1,000 rpm, wide range



# Electro Instruments Model A12 D.C. Amplifier

Totally transistorized—dissipates only 7 watts.  
Long term drift less than 2 microvolts.  
.01% linearity and stability.  
100 megohms input impedance—40 milliohms output impedance.  
1 db DC to 10 KC.  
Noise less than 10 microvolts wideband.  
Single ended or differential input.  
Operates to specifications from 0° to 50° C.  
Self-contained power supply—operates on any line frequency  
from 50-400 cps.  
Mil-type chopper gives unmatched reliability for the life of the  
instrument.  
7" x 19" panel accommodates 8 instruments.

**Plug-in attenuators** of the A12 provide convenience, flexibility and economy. Special variations, gain settings, etc., can be tailored to your system at no extra cost.

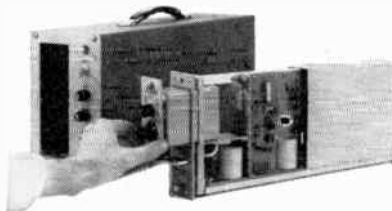

## FULLY TWO YEARS AHEAD of the FIELD!

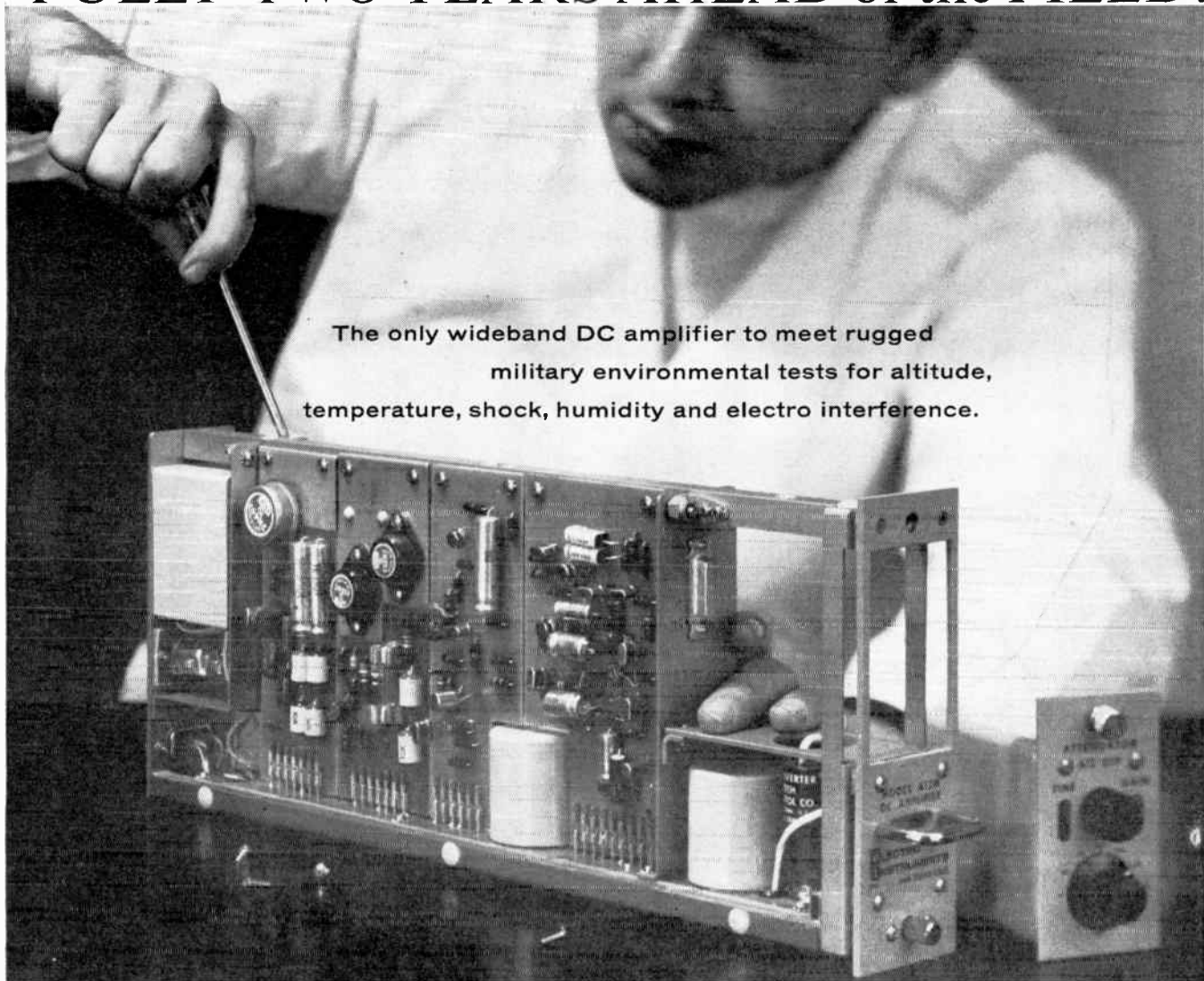

The only wideband DC amplifier to meet rugged  
military environmental tests for altitude,  
temperature, shock, humidity and electro interference.

### Electro Instruments, Inc.



3540 AERO COURT  
SAN DIEGO 11, CALIF.

# ENGINEERS REALLY GROW AT EMERSON ELECTRIC

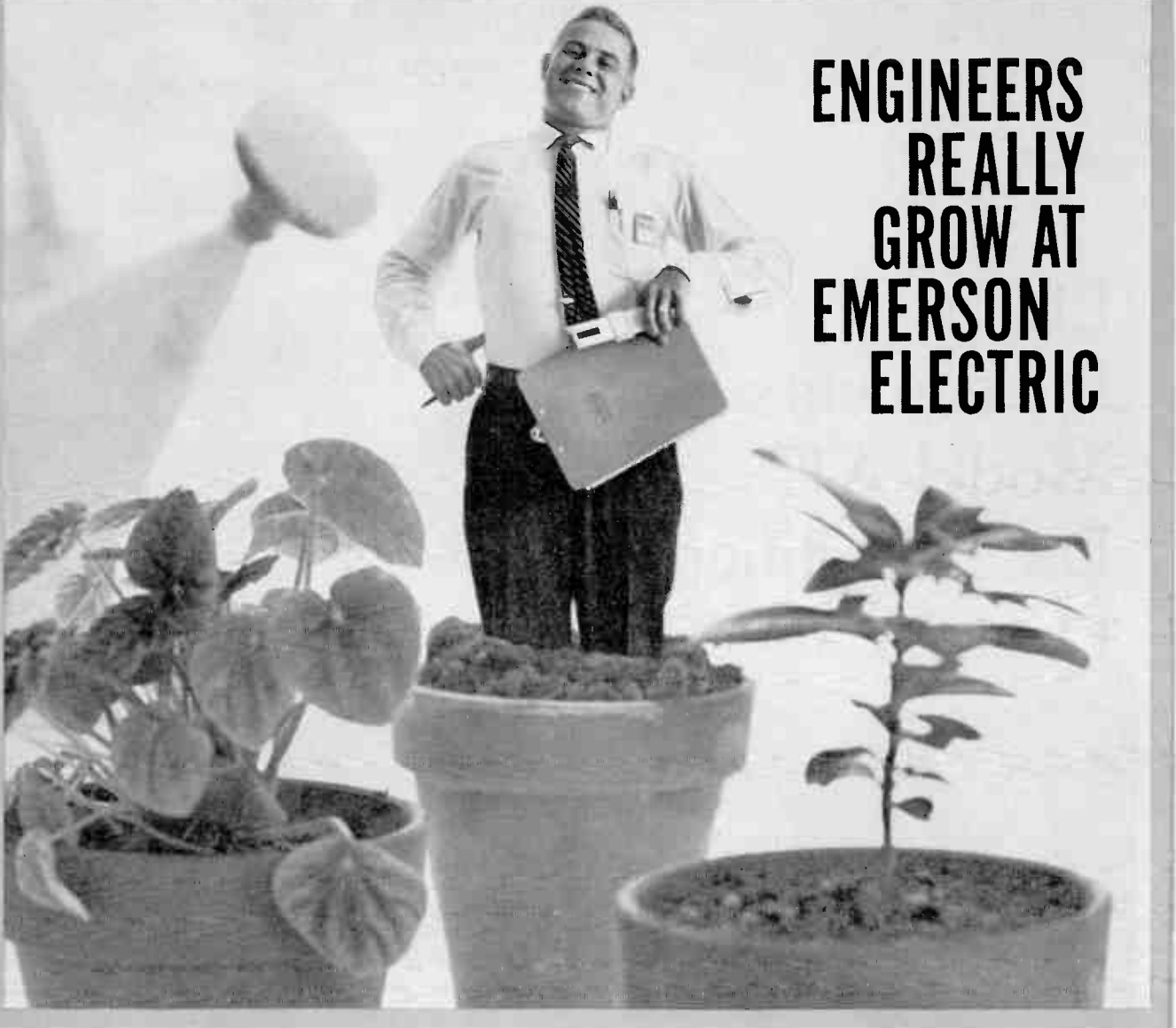

GO...  
AND  
GROW...  
WITH  
EMERSON

Engineers are a hardy breed... and the right *growing* conditions can make them flourish far beyond expectations.

Emerson Electric provides the most "fertile soil" available. Proof? So many of our engineers have come so far in so few years, with a research and development staff that is one of the finest in the entire industry.

We owe this achievement to many important considerations... not to a magic "green thumb". We provide our engineers with elbow room, they're not bogged down with non-technical details. Encouragement of original ideas, an unusually cooperative and close spirit, elimination of formalities... these and other factors are *real* at Emerson.

It has paid off exceedingly well for engineers and company alike: Emerson has grown from \$45 to \$90 million annually in just five years! *You* can easily become part of this "garden spot" for growing engineers. Just write us today for an interview at our expense.

ELECTRONICS and AVIONICS DIVISION

# EMERSON

8100 FLORISSANT AVENUE



# ELECTRIC

ST. LOUIS 36, MISSOURI





## ... AND YOU CAN GROW AT EMERSON TOO!

- RADAR SYSTEMS ENGINEERS
- SERVO ENGINEERS
- COMPUTER ENGINEERS  
(analog & digital)
- ELECTRONIC SUPPORT EQUIPMENT DESIGN ENGINEERS
- INFORMATION THEORISTS
- COMMUNICATIONS SYSTEMS ANALYSTS
- RELIABILITY ENGINEERS
- TECHNICAL WRITERS  
(electronic background)

Emerson needs individuals who can make significant contributions in an initial stage concept-oriented program. Assignments in our radiation division, for example, involve radar development, parametric amplifiers, electronic scanning and complete radar fire control systems.

We emphasize the systems approach, which means Emerson engineers explore and contribute in many diversified areas. This climate of creative freedom has paid off in solid achievements.

If your talents can be better utilized by assuming greater responsibilities, you owe it to your future to contact us at once.

Send complete resume to R. L. Middleton.

**EMERSON ELECTRIC**



**ELECTRONICS and AVIONICS DIVISION**

8100 W. FLORISSANT • ST. LOUIS 36, MO.

of resistance values with resolution dependent on size from 1 1/8 in. diameter to 3 in. diameter. Ambient temperature of the units is -50 C to 100 C. They are designed to meet salt spray, humidity, vibration and shock requirements of MIL specs.

**CIRCLE 222 ON READER SERVICE CARD**

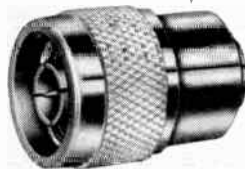

## Terminations completely shielded

MICROLAB, 71 Okner Parkway, Livingston, N. J. The TO series open circuit and TS series short circuit terminations are carefully designed to present identical electrical lengths. Phase difference is less than 0.1 cm over entire frequency range from d-c to 13,000 mc. Extremely rugged and compact, the terminations provide laboratory stability and accuracy even under the most severe environmental conditions. They are provided with male or female connectors of type N, BNC, TNC, C, or HN. Overall length is 1.2 in. Weight is 0.6 to 1.6 oz.

**CIRCLE 223 ON READER SERVICE CARD**

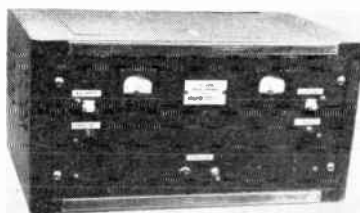

## F-M Receiver less than 200 w drain

ALTO SCIENTIFIC Co., INC., 855 Commercial St., Palo Alto, Calif. Model XN-305-A f-m receiver can be tuned  $\pm 15$  mc from its center frequency of 288 mc. With an input sensitivity (for limiting) of 10 mv, a video output of 2 v peak is obtained with a 20 mc swing. The instrument's output discriminator has a linearity of 5 percent over a

# NEW UNIVERSAL KLYSTRON POWER SUPPLY



We call it the PRD Type 812...you'll call it the answer to all your klystron power supply problems.

This completely new unit consists of four, separate, regulated supplies: beam, reflector, grid, and heater... and combines digital read-out of beam and reflector voltages plus outputs for operating two klystron tubes simultaneously.

PLUS a special feature for the prevention-of-cruelty to klystrons: The grid and reflector modulation voltages are clamped to the cw level in square wave or pulse operation.

The Type 812 also features superior regulation to reduce ripple and noise to an all-time low. Clean modulation characteristics assure a rise and decay time which will not exceed 2 microseconds.

You also get the following full set of PRD extras:

- digital read-out for beam and reflector voltages
- dual outputs for simultaneous operation of two klystrons
- front-panel-check calibration of grid and reflector voltages
- multirange overload protection for beam current
- safety lock when transferring from + to - grid voltage
- external triggering of internal pulse generator

Write for complete data.



**POLYTECHNIC RESEARCH & DEVELOPMENT CO., INC.**

Factory & General Office:  
202 Tillary St., Brooklyn 1, N.Y.  
ULster 2-6800

Western Sales Office:  
2639 So. La Cienega Blvd., Los Angeles 34, Calif.  
UPLon 0-1940



The 6116/TE-39 ruggedized Reflex Klystron thermally tunes a band of 8500 to 9660 MC by means of a diode within the vacuum envelope. Tuning speed over the required frequency range is 0.7 seconds min. to 3.0 seconds max.

The 6940/TE-58 is identical to the 6116, but has special characteristics limiting spectrum width and spectrum continuity under adverse load conditions.

The 6845/TE-59 is similar in electrical and mechanical characteristics to the 6116 but may be operated under pulsed conditions with minimum frequency modulation.

## BENDIX RUGGEDIZED REFLEX KLYSTRONS WITH THERMAL TUNING

The 6116/TE-39 Klystron tube combines ruggedized construction and *thermal tuning*. The combination provides a desirable tube for use in airborne radar and similar applications. Ruggedization makes possible a frequency jitter of less than  $\pm 1.3$  MC . . . at vibration levels up to 10 G at 50 cps. Thermal tuning provides a twofold advantage. It permits tuning the tube over its entire operating frequency remotely without mechanical means—and the tube can be

repeatedly cycled throughout its tuning range without damage or deterioration.

These Reflex Klystrons are but one example of how Bendix Red Bank technology can help you meet specialized tube needs. For information on these tubes . . . and on backward-wave oscillators and traveling-wave tubes . . . write RED BANK DIVISION, BENDIX AVIATION CORPORATION, EATONTOWN, NEW JERSEY.

West Coast Sales & Service: 117 E. Providencia Ave., Burbank, Calif.

Export Sales & Service: Bendix International Division, 205 E. 42nd St., New York 17, N.Y.  
Canadian Distributor: Computing Devices of Canada, Ltd., P.O. Box 508, Ottawa 4, Ontario

**Red Bank** Division



20 mc band, while the total i-f bandwidth is 24 mc. Video response ranges from 100 cps to  $4\frac{1}{2}$  mc.

**CIRCLE 224 ON READER SERVICE CARD**

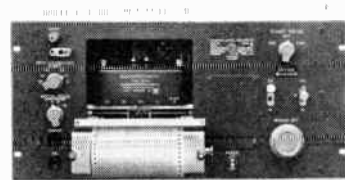

### Level Recorder transistorized

GENERAL RADIO Co., West Concord, Mass. Type 1521-A is a transistorized, high-writing speed, 20 cps-200 kc graphic level recorder with a wide variety of uses. It records the rms magnitude of an a-c voltage (on a logarithmic scale) rather than the instantaneous value, and can plot the output of an a-c device as a function either of time or some other parameter that can be made time dependent, such as frequency. Unit is priced at \$995.

**CIRCLE 225 ON READER SERVICE CARD**

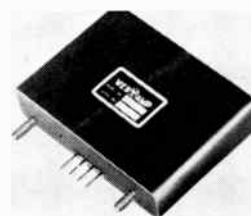

### Inverter crystal controlled

WESTAMP INC., 11277 Massachusetts Ave., Los Angeles 25, Calif. Model P301 lightweight static inverter measures only 1 in. by  $3\frac{1}{2}$  in. by  $2\frac{7}{8}$  in. and is capable of driving a 30 w synchronous motor load. Standard unit operates from a 28 v d-c source and can be made to maintain any selected frequency to within  $\pm 1$  percent.

**CIRCLE 226 ON READER SERVICE CARD**

### Power Transformers three models

TRIAD TRANSFORMER CORP., 4055 Redwood Ave., Venice, Calif. Three power transformers for use with silicon rectifiers all provide output



voltages of 40 CT/20CT/10, with current ratings of 100 ma (F-90X), 300 ma (F-91X) and 1 ampere (F-92A). Designed to supply the d-c voltages for transistors through a full wave bridge or bridge rectifier from 115 v 60 cycle source, they may also be used in voltage doubler circuits at one-half the rated current.

**CIRCLE 227 ON READER SERVICE CARD**



### Coax Attenuators 1-12.4 kmc

WEINSCHEL ENGINEERING, 10503 Metropolitan Ave., Kensington, Md., has available 1-12.4 kmc fixed coaxial attenuators with type TNC connectors (male/female, double male or double female). They are made with film resistors for maximum stability under pulse power, as well as humidity and temperature cycling. Attenuation range is 1 to 20 db; impedance, 50 ohms.

**CIRCLE 228 ON READER SERVICE CARD**

### Medical Modality uses short wave

THE REMINGTON RAND DIVISION of Sperry Rand Corp., Utica, N. Y. The Diapulse medical equipment uses a principle of pulsed short wave electrical energy for stimulating physiologic tissue responses. It is expected to aid in the control of infections and other diseases.

**CIRCLE 229 ON READER SERVICE CARD**

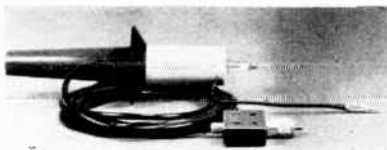

### H-V Probe for oscilloscopes

TEKTRONIX, INC., P. O. Box 831, Portland 7, Ore. Type P1000 h-v probe for oscilloscopes is rated at 12 kv d-c or rms, 25 kv peak. Attenuation ratio is 1,000 to 1;

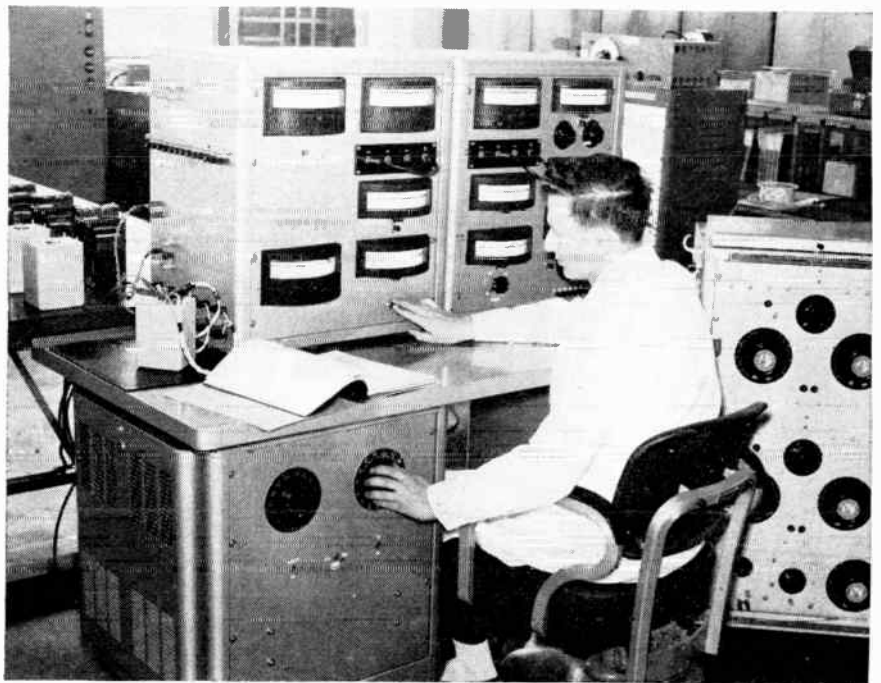

## It costs less to RENT AN **ELECTRONICS LABORATORY** than to buy one

You can save costly investment in laboratory equipment and staff... and still get top-quality R/D services... by using the complete product testing and evaluation facilities of United States Testing Company. Since 1880 thousands of clients in all industries have used our services to get:

#### Improved Product-Design Through Testing

Our test engineers will set up an evaluation program that "locks in" with each step of your product development from design to prototype to finished product.

#### An Independent Laboratory

We present a completely objective, unbiased approach to your design evaluation problems. All reports to clients are impartial, factual and confidential.

#### Economical Handling of Peak Loads

We are equipped to take over your peak loads *immediately* at a fraction of what it would cost your company to maintain a staff of the necessary calibre.

#### Product Qualification

Tests run by United States Testing Company are recognized by military and government procurement agencies in placing a product on the Qualified Product list.

#### Facilities and Services

**Electronic Laboratory**—evaluates electronic components and systems in communications and industrial fields; includes automated facilities for low-cost collection of reliability data.

**Environmental Laboratory**—simulates high-low temperatures, humidity, altitude, immersion, salt spray, sand and dust, rain, fungus, vibration, shock, acceleration, etc.

**Materials Testing Laboratory**—conducts tension, compression and transverse tests on metals, ceramics, plastics, rubber and wood materials; spectographic analysis and X-ray also available.

**Mechanical Laboratory**—evaluates mechanical, electro-mechanical hydraulic and pneumatic devices.

**Chemical Laboratory**—covers all fields including physical and biological chemistry; also infrared spectrophotometry.



Send for your free copy  
of bulletin 5801 describing our  
complete services and facilities.

**United States Testing Co., Inc.**  
1415 Park Avenue, Hoboken, N. J.

Branch Laboratories

BOSTON • BROWNSVILLE • DALLAS • DENVER • LOS ANGELES  
MEMPHIS • NEW YORK • PHILADELPHIA • PROVIDENCE • TULSA

The  
World's Most  
Diversified  
Independent  
Laboratory.



## TUBE PROBLEM:

The Armed Forces needed a new version of the 6J4 reliable tube type which would provide a tube life of almost 1000 hours. Existing tubes of this type had an average life of only 250 hours. In addition, this new tube had to be produced under ultra-high quality control standards.

## SONOTONE SOLVES IT:

By making improvements in the cathode alloy and setting up extremely tight controls in precision, manufacture and checking, Sonotone engineers produced a 6J4WA with a *minimum* life of 1000 hours... most running *much longer*.

## RESULTS:

The Sonotone 6J4WA is one of three reliable tubes now being manufactured under U. S. Army Signal Corps RIQAP (Reduced Inspection Quality Assurance Program), monitored by the U. S. Army Signal Supply Agency. And the same rigid quality standards apply to Sonotone's entertainment type tubes as well.

Let Sonotone help solve *your* tube problems, too.

# Sonotone

Electronic Applications Division, Dept. TRR-109

ELMSFORD, NEW YORK

Leading makers of fine ceramic cartridges, speakers, microphones, tape heads, electron tubes.

In Canada, contact Atlas Radio Corp., Ltd., Toronto

rise-time, 12 milli $\mu$ sec; frequency response, d-c to 30 mc; input impedance, 2.5  $\mu$ f paralleled by 100 megohms. A compensating network at the oscilloscope end of the probe cable permits adjustment to oscilloscope input capacitances from 20  $\mu$ f to 47  $\mu$ f. Probe is 12 in. long including handle, and has a 12-ft cable.

CIRCLE 230 ON READER SERVICE CARD



## Electronic Relay

3 in. by 4 in. by 5 in.

BERKELEY INSTRUMENT Co., P. O. Box 346, Berkeley Heights, N. J. Model 101 is a compact 15-ampere electronic relay. Grid input allows only 20  $\mu$ a to flow through the control contacts, permitting the use of any type of on-off controller. The resistance in the contact circuit may be as high as 100,000 ohms and still operate the relay satisfactorily. Unit is conservatively rated at 1,800 w resistive load.

CIRCLE 231 ON READER SERVICE CARD



## Capacitor solid-tantalum

SPRAGUE ELECTRIC Co., North Adams, Mass. This tiny solid-electrolyte Tantalex capacitor embedded in a notched phalanx-shaped ceramic wafer 0.3 in. square was

# GUARANTEED

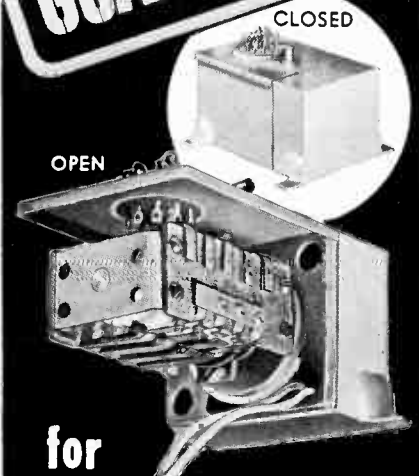

for  
**100,000 CYCLES**  
and  
**800,000 BREAKS**

# NEW

miniaturized  
solenoid actuated

## CAM SWITCH

- ✓ Hermetically sealed
- ✓ Extremely compact, light weight
- ✓ "Reliability engineered" for guaranteed performance
- ✓ Shock & vibration tested in conformance with MIL-E-5272A
- ✓ Operates 24 to 30 volts, DC, at 125°C ambient
- ✓ Rating, 1 amp.
- ✓ Size, 1 3/4" x 1 1/2" x 2 3/4"
- ✓ 7-pole, 18-position shorting with interrupter and homing

Designed to meet standards for guided missile systems, this new Cam Switch is typical of special designs by Tech Labs which can be easily adapted to specific needs. Write for complete data.

# TECH

LABORATORIES, INC.

PALISADES PARK,  
NEW JERSEY

CIRCLE 173 ON READER SERVICE CARD



developed for use in the Signal Corp-RCA micromodule electronic super-miniaturization project. Capacitances as high as 30  $\mu\text{f}$  at 1 v or 10  $\mu\text{f}$  at 3 v are contained in a wafer only 25 mils thick.

**CIRCLE 232 ON READER SERVICE CARD**

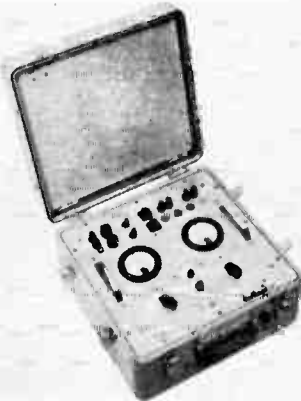

### Modulation Test Set for field or lab

AVTRON MFG. INC., 10409 Meech Ave., Cleveland 5, Ohio. Model T97 modulation test set measures frequency and voltage modulation, stability characteristics, and transients of aircraft and ground power systems. Self-calibration provisions are incorporated, as well as separate oscillographic outputs for simultaneous recording of both frequency and amplitude modulation. Voltage modulation is  $\pm 0.05$  percent on 0.5 percent scale and  $\pm 0.13$  percent on 2.5 percent scale. Frequency modulation is  $\pm 0.025$  percent on 0.25 percent scale and  $\pm 0.062$  percent on 1.25 percent scale.

**CIRCLE 233 ON READER SERVICE CARD**



### Contact Plug spring-loaded

SEAELECTRO CORP., 610 Fayette Ave., Mamaroneck, N. Y. A spring-loaded probe or plug provides positiv

# DISTORTION ANALYSIS 20 cps to 600 kc

Two Marconi Wave Analyzers for evaluating the individual components of complex waveforms.



### WAVE ANALYZER Model 455E

Measures harmonics, intermodulation and noise in audio signals and also in modulation envelopes of rf carriers up to 500 mc.

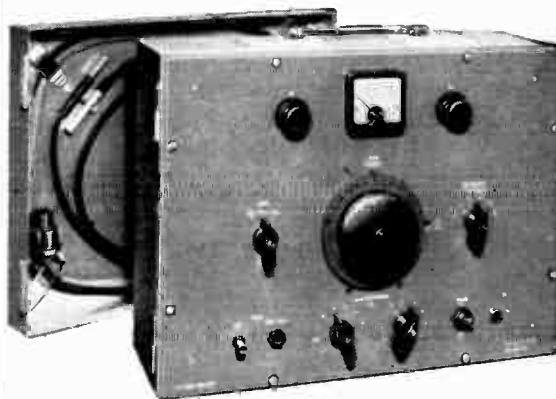

### HF WAVE ANALYZER Model 1270

Covers ultrasonic frequencies up to 600 kc. Particularly suitable for use on wide-band-modulation systems such as multi-channel links.

### SPECIFICATIONS

#### Model 455E

Frequency Range: 20 cps to 16 kc.  
Input Range: 30  $\mu\text{v}$  to 300 volts.  
Input Impedance: 0.1 to 2.5 megohms.  
Crystal filter gives 4-cps selectivity.  
RF Inputs: 100 kc to 500 mc, 1 to 4 volts.  
Power-line or battery operation.

#### Model 1270

Frequency Range: 10 to 600 kc.  
Input Range: 20  $\mu\text{v}$  to 2 volts.  
Input Impedance: 75, 600 & 10,000 ohms.  
Fundamental rejection filters for distortion measurement down to -90 db.

Send for leaflets B153

## MARCONI INSTRUMENTS

AM & FM SIGNAL GENERATORS  
AUDIO & VIDEO OSCILLATORS  
FREQUENCY METERS  
VOLTMETERS · POWER METERS  
DISTORTION METERS  
FIELD STRENGTH METERS  
TRANSMISSION MONITORS  
DEVIATION METERS  
OSCILLOSCOPES, SPECTRUM &  
RESPONSE ANALYZERS  
Q METERS & BRIDGES

111 CEDAR LANE · ENGLEWOOD · NEW JERSEY

TELEPHONE: LOWell 7-0607

Canada: Canadian Marconi Co · Marconi Building · 2442 Trenton Ave · Montreal 16  
Marconi Instruments · St. Albans · Herts · England

**POINT-to-POINT . . . NONSTOP!**



**SERVOSCOPE®**

plays a role from T square to Touchdown

SERVOSCOPE servo system analyzers are being used today in every phase of the aviation industry, from take-off on new ideas through autoflight and flight-training systems to radar traffic control. They have even invaded the ticket office where automatic, reservations-handling systems are being set up! Look at some of the areas where SERVOSCOPE plays a part!

— Aerophysics — Flight Test Instruments — In-Flight Instruments — Airborne Radar Seeker Servo Systems — Network Response — Computers and Servomechanisms — Autopilot and Damper Testing Simulating Rate Gyro — Frequency Response Characteristics of Components and System Loops of Autopilot and Aircraft Flight Controls — Antenna Servo Drive Tests — Aircraft Electronic Servo System Testing — Servo System Analyses in Servo Test Program (Flight Training) — Frequency Response on Electro-hydraulic Servo System — Testing of Radar Systems

A full line of five models provides a full range of essential features, such as: wide-range coverage (.001 to 100 cps); fast direct-setting and read-out; high-accuracy measuring of phase, transient response, and gain, and many other features.

The same features which make SERVOSCOPE play so many parts in the aviation field lead to wide use in Missiles, Instrumentation, Communication, Navigation, Electronic and Electrical Engineering, Education, Computers and in many others.

Acquaint us with your servo analysis problems. Specification and application data is available. Request TDS 1100-1.

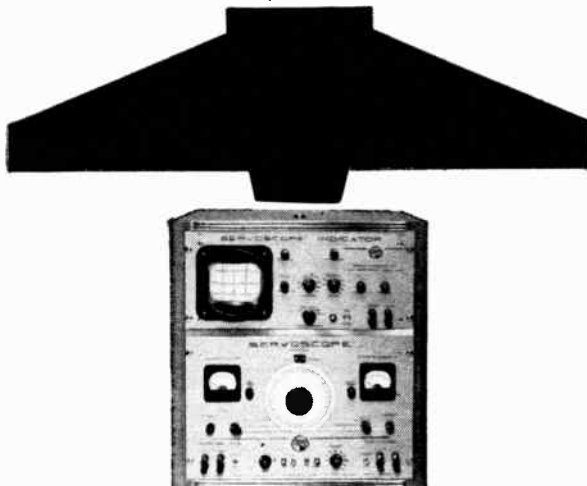

**SERVO CORPORATION of AMERICA**

20-20 Jericho Turnpike • New Hyde Park, L. I., New York

World Radio History

through-connection from practically zero to a maximum of 2.5 oz necessary for its full travel of 0.187 in. Contact probe is of plunger-type construction and is activated by pressure applied axially. Wiring is accommodated by the turret lug. Series PL-20 terminal incorporates regular features of the Press-Fit line.

**CIRCLE 234 ON READER SERVICE CARD**

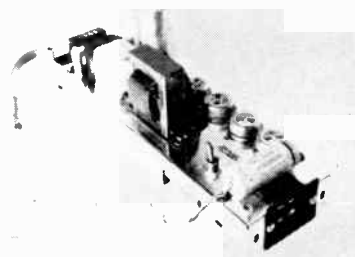

**Power Supply for mobile radio**

KAAR ENGINEERING CORP., 2995 Middlefield Road, Palo Alto, Calif. The 8044 transistor power supply operates from a 6-v battery and can be integral part of sectionalized mobile radiotelephone unit. It was designed for Kaar TR500 series mobile units. It provides operating plate voltages for both the transmitter and receiver. The power supply convertible from 6-v to 12-v input.

**CIRCLE 235 ON READER SERVICE CARD**



**Resistance Network high accuracy**

THE DAVEN Co., Livingston, N. J., announces a resistance network for a-c analog computer applications. A typical unit packages 6 a-c matched resistors, up to 2.0 megohms each, in less than 2½ cu in. and weighs less than 2½ oz. Approximate equal value resistor can be matched to better than 0.005 percent over a temperature range



# AMPERITE

## THERMOSTATIC DELAY RELAYS

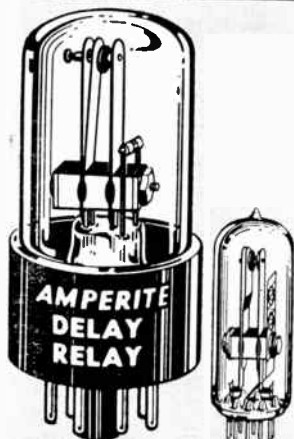

### 2 to 180 Seconds

Actuated by a heater, they operate on A.C., D.C., or Pulsating Current.

Hermetically sealed. Not affected by altitude, moisture, or climate changes.

SPST only—normally open or closed.

Compensated for ambient temperature changes from  $-55^{\circ}$  to  $+70^{\circ}$  C. Heaters consume approximately 2 W. and may be operated continuously. The units are rugged, explosion-proof, long-lived, and—inexpensive!

TYPES: Standard Radio Octal, and 9-Pin Miniature . . . List Price, \$4.00. Standard Delays

Also—Amperite Differential Relays: Used for automatic overload, under-voltage or under-current protection.

**PROBLEM? Send for Bulletin No. TR-81**

# AMPERITE BALLAST REGULATORS

Amperite Regulators are designed to keep the current in a circuit automatically regulated at a definite value (for example, 0.5 amp.) . . . For currents of 60 ma. to 5 amps. Operate on A.C., D.C., or Pulsating Current.

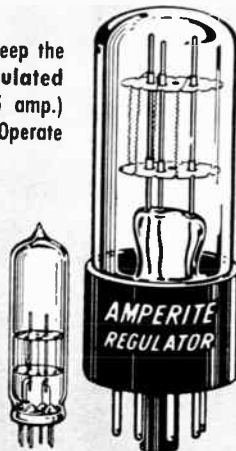
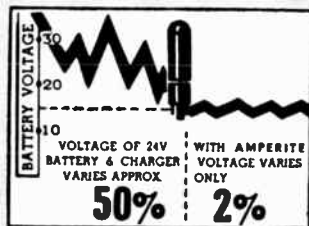

Hermetically sealed, they are not affected by changes in altitude, ambient temperature ( $-55^{\circ}$  to  $+90^{\circ}$  C.), or humidity . . . Rugged, light, compact, most inexpensive . . . . . List Price, \$3.00.

Write for 4-page Technical Bulletin No. AB-51

# AMPERITE

561 Broadway, New York 12, N. Y. . . . CAnal 6-1446  
In Canada: Atlas Radio Corp., Ltd., 50 Wingold Ave., Toronto 10

CIRCLE 136 ON READER SERVICE CARD

a company  
is known by  
the company  
it keeps

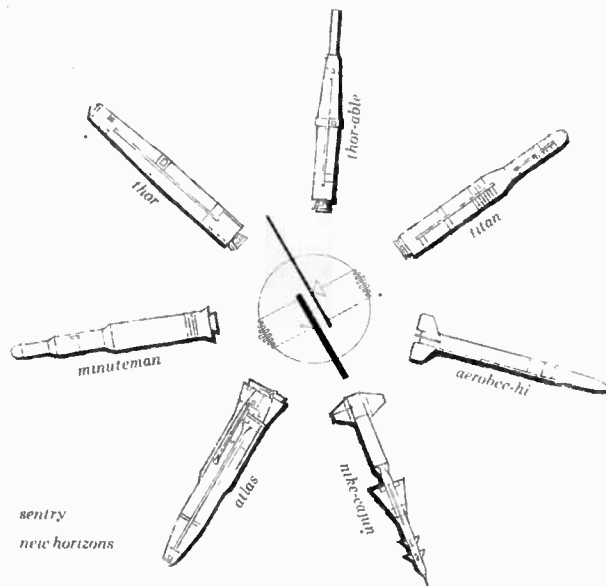

Just 3 years ago, POWER SOURCES, INC., was founded on the premise that in most critical applications all vacuum tube, rotary and vibrator power supplies must be superseded by completely transistorized supplies in order to provide the ultimate in reliability, efficiency and miniaturization. The truth of this premise is proven daily in performance by POWER SOURCES equipment currently being used in major missile and space programs. One of the more recent dramatic proofs is the discovery of two POWER SOURCES Model PS-2008 Converters found still operating after the recovery of a THOR-ABLE nose cone from the Atlantic. Tests revealed that the converters continued to function perfectly after the ordeal of the launching and flight, the tremendous shock and temperature of re-entry, and the great pressure generated by the impact of the re-entry vehicle with the sea.

Continued specialization in transistorized supplies will soon result in the announcement by POWER SOURCES of a completely new line of regulated power supplies for Ground Support Equipment and Computer applications, and a new line of sine-wave inverters for industrial applications.

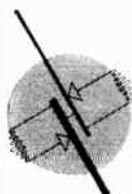

Specify POWER SOURCES  
BY  
POWER SOURCES, INC.

Burlington, Massachusetts

# RECONNAISSANCE SYSTEMS

**ADVANCED RECONNAISSANCE** system developments at **Melpar** provide unusual opportunities for the technical advancement of participating professional personnel. Technological challenge in an area vital to our national defense assures our engineers and scientists that their contributions will have lasting significance. **Melpar's** reconnaissance systems engineering department has achieved national recognition for its outstanding accomplishments in the fields of acquisition, processing, and interpretation of intelligence. Techniques resulting from our deep probes into advanced aspects of electronics, optics, and physics are being quickly translated into operational equipment for the armed forces.

*Positions in the following areas offer particular challenge at this time:*

Reconnaissance Systems	Detection & Identification Systems
Airbourne Equipment	Antenna & Radiation Systems
Ground Data Handling Equipment	Chemistry Laboratory
Simulation & Training Systems	Applied Physics Laboratory
Communication & Navigation Systems	Production Engineering
Ground Support Equipment	Quality Control

**Melpar's** remarkable growth continues to create attractive opportunities for the exceptional engineer and scientist. Your own intellectual dimensions govern remuneration and assignments.

INTERVIEWS ARRANGED IN YOUR LOCALE

*For Details  
Wire Collect or Write to:  
Professional  
Employment Supervisor*

**MELPAR INC**  
A SUBSIDIARY OF WESTINGHOUSE AIR BRAKE COMPANY  
3306 Arlington Boulevard, Falls Church, Virginia  
In Historic Fairfax County  
10 miles from Washington, D. C.

of -15 C to +65 C. Reactive match at 400 cycles can be held as close as 20  $\mu$ v per v for a 6 resistor network.

**CIRCLE 236 ON READER SERVICE CARD**

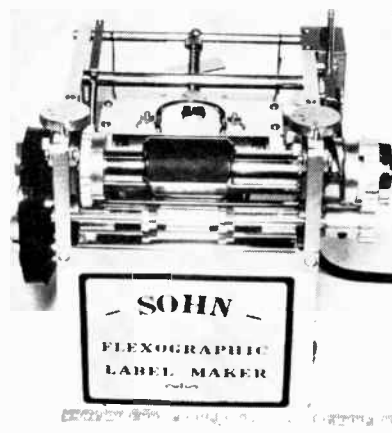

## Label Maker portable size

SOHN MFG., INC., P. O. Box 87, Plymouth, Wisc. The Flexographic label maker prints and die cuts on pressure sensitive label paper, or score cuts on gum, heat seal or plain paper. Unit weighs 40 lb, is simple to operate, prints 6,000 labels per hour.

**CIRCLE 237 ON READER SERVICE CARD**

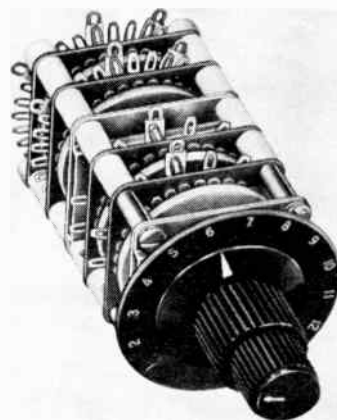

## Miniature Switches dual-shaft

SHALLCROSS MFG. Co., Selma, N. C. A series of rotary switches with dual concentric shafts can save considerable panel space in instruments, computers, and other commercial and military equipment. A total of 8 switch decks may be ganged, with the inner shaft con-



trolling up to 4 of the 8 decks. Versatile design makes it possible to combine two separate and entirely different switching actions on the two concentric shafts. Multi-leaf wipers, silver alloy button contacts staked in glass epoxy decks, Nylon bushings, and salt spray-resistant hardware assure stable contact resistance of less than 0.002 ohm for better than 10,000 operations.

**CIRCLE 238 ON READER SERVICE CARD**

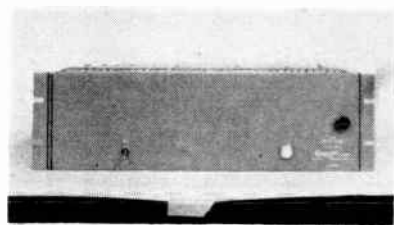

### Multiplexer high speed

EPSCO, INC., 275 Massachusetts Ave., Cambridge, Mass. The TMX-841-S multiplexer is a solid state, high speed, precision electronics switch that can be used to sample a maximum of 20 data inputs with a full scale voltage range of  $\pm 10$  v. It has an inherently high transfer accuracy and low noise level. Unit will provide a time shared data output pulse train of high accuracy to be used with the Epsco Transicon Datrac to increase the number of data channels to be digitized. TMX multiplexers can be provided to handle from 2 to 40 channels, utilizing a single power supply.

**CIRCLE 239 ON READER SERVICE CARD**



### Tubular Capacitors plastic cased

AEROVOX CORP., New Bedford, Mass. Type PTT miniature tubular electrolytics utilize Polycap construction which provides excellent protection against humidity to assure maximum capacitor life. The units will handle full sized loads and are

## When Top Quality Capacitors Are Required Specify Pyramid Mylar® or Tantalum

**UP TO 1000 MFD-VOLTS IN LESS THAN 2/100  
OF A CUBIC INCH**

**...PYRAMID TANTALUM CAPACITORS**

Miniaturized to provide maximum space economy.

New Pyramid Tantalum slug capacitors have cylindrical cases and contain a non-corrosive electrolyte. Due to the special construction of materials used in the manufacture of Pyramid Tantalum slug capacitors, these units are both seep and vibration proof. In addition, this type of capacitor assures long service life and corrosion resistance—made to meet MIL-C-3965 Specifications.

Commercially available immediately, these new Pyramid Tantalum capacitor units have an operating range between  $-55^{\circ}\text{C}$  to  $100^{\circ}\text{C}$  for most units without any de-rating at the higher temperature.

**PYRAMID MYLAR®...  
-30°C to +125°C ...**

**SMALLEST FILM CAPACITORS MADE!**

Pyramid new Mylar capacitors have extremely high insulation resistance, high dielectric strength and resistance to moisture penetration.

Commercially available immediately, Pyramid Mylar capacitors have an operating range between  $-30^{\circ}\text{C}$  to  $+125^{\circ}\text{C}$  with voltage de-ratings above  $+85^{\circ}\text{C}$ . Pyramid wrapped Mylar capacitors—Series Nos.: 101, 103, 106 and 107 have the following characteristics:

Construction Styles:	Basic No.	Type Winding	Shape
	101	Inserted Tabs	Flat
	103	Extended Foil	Flat
	106	Inserted Tabs	Round
	107	Extended Foil	Round

**Tolerance:** The standard capacitance tolerance is  $\pm 20\%$ . Closer tolerances can be specified.

**Electrical Characteristics:** Operating range for Mylar capacitors—from  $-55^{\circ}\text{C}$  to  $+85^{\circ}\text{C}$  and to  $+125^{\circ}\text{C}$  with voltage de-rating.

**Dissipation Factor:** The dissipation factor is less than 1% when measured at  $25^{\circ}\text{C}$  and 1000 CPS or referred to 1000 CPS.

Insulation Resistance:	Temperature	1R x mfd	Maximum IR Requirements
	$25^{\circ}\text{C}$	50,000	15,000 megohms
	$85^{\circ}\text{C}$	1,000	6,000 "
	$125^{\circ}\text{C}$	50	300 "

Pyramid Mylar capacitors are subject to the following tests:

**Test Voltage**—Mylar capacitors shall withstand 200% of rated D.C. voltage for 1 minute at  $25^{\circ}\text{C}$ .

**Life Test**—Mylar capacitors shall withstand an accelerated life test of 250 hours with 140% of the voltage rating for the test temperature. 1 failure out of 12 is permitted.

**Humidity Test**—Mylar capacitors shall meet the humidity requirements of MIL-C-91A specifications.

Complete engineering data and prices for Pyramid Mylar and Tantalum Capacitors may be obtained from Pyramid Research and Development Department.

© DU PONT REGISTERED TRADEMARK

CAPACITORS—RECTIFIERS  
FOR ORIGINAL EQUIPMENT—  
FOR REPLACEMENT

**PYRAMID**

**ELECTRIC CO.**  
NORTH BERGEN, N. J.

EXPORT: 458 Broadway, N.Y. 13, N.Y. • CANADA: Wm. Cohen, Ltd.—7000 Park Ave., Montreal





## -measures both in-phase and quadrature voltage ratios - with high accuracy

This instrument cancels quadrature effects, giving a sharp, true null.

In eliminating quadrature voltage, this Gertsch bridge achieves an in-phase ratio accuracy as good as 0.001%. Quadrature voltage ratios are read as rectangular coordinates, tangent of phase-shift angle, or magnitude of phase-shift angle in degrees directly.

Write for complete data in Bulletin CRB.

- SELF-CONTAINED PHASE-SENSITIVE DETECTOR
- SIX-PLACE RESOLUTION
- TWO FREQUENCY RANGES
  - 30 TO 1000 CPS
  - 50 TO 3000 CPS

**Gertsch**

**GERTSCH PRODUCTS, Inc.**

3211 South La Cienega Boulevard, Los Angeles 16, California  
Upton 0-2761 - Vermont 9-2201

CIRCLE 132 ON READER SERVICE CARD

## MEET ROLLY CHAREST



Associate Editor  
**electronics**

### RESUME:

Charest, Roland J., Boston University, BS in Journalism. Formerly New England editor for **electronics**. Navy sonarman. Writer, reporter, editor for Lynn Item, Boston Globe, Boston Traveler. Won a New England Associated

Press (AP) award in 1955 for writing feature articles in the major city newspaper class.

### PRESENT OCCUPATION:

Rolly Charest supports Managing Editor Jack Carroll for editorial content accuracy and expediting putting each weekly issue to bed. Rolly reworks headlines for greater readability, is involved in makeup, and helps polish editorial content. Rolly's across-the-board background assures you accuracy in the face of journalistic pressures; articles in this week's issue that could be held over to the next deadline, but are not. The readers' interests come first!

### REFERENCES:

If you're not a subscriber, if your subscription is expiring, if you will miss exciting features "in-the-works" by **electronics** 26-man staff, fill in box on Reader Service Card. Easy to use. Postage is free.

**electronics**

A McGraw-Hill Publication • 330 W. 42nd St., New York 36

rugged enough for applications in industrial equipment, as well as all limited space assemblies. They are rated for operation at a temperature range of -30 C to +65 C, and are available in a complete selection of capacitances at voltage ratings of 3, 6, 10, 12, 15, 25 and 50 vdcw.

CIRCLE 240 ON READER SERVICE CARD



## Miniature Connector high-temperature

HARCO LABORATORIES, INC., 77 Olive St., New Haven, Conn., announces a line of thermocouple connectors with ceramic inserts which are designed to withstand temperatures up to 1,000 F and can be used in power as well as thermocouple circuits. Present models are available in 5, 9 and 11 contact configurations within a shell of 1 1/2 in. o-d. The pins and sockets are available in chromel, alumel, copper, constantan and iron with welded, soldered or brazed connections for up to No. 14 wire.

CIRCLE 241 ON READER SERVICE CARD



## Voltmeter transistorized

SOUTHWESTERN INDUSTRIAL ELECTRONICS CO., 10201 Westheimer Road, Houston 19, Texas. Model R-3 voltmeter measures a-c voltages from 1 mv to 1,000 v full scale in 14 ranges over a 10 cps to 200 kc frequency range; plus and minus d-c voltages from 1 v to 1,000 v full scale in 7 ranges; electrometer input from 0 to 1 v d-c and center-scale resistances from 10 ohms to 10 megohms in seven steps. Overall



# universal transistor tester

**\$59.50**

MEASURES  $I_{co}$ , ALPHA

MEASURES DIODE FORWARD AND REVERSE CURRENTS

TESTS FOR SHORT CIRCUITS

Battery-operated, portable model TT-1 provides quick, reliable measurements on both PNP and NPN transistor types of low, medium and high power. Universal panel receptacle and test leads accommodate all standard and special types. Dual scale on precision 50- microamp ammeter indicates transistor leakage and gain, diode forward and reverse currents. Ideal for laboratory, production or field test. Strong, shock-resistant case.



Write for complete specifications.

**REFLECTONE**

THE REFLECTONE CORP. • STAMFORD, CONN.  
CIRCLE 93 ON READER SERVICE CARD

# specify... G-E 85C TANTALYTIC\* CAPACITORS

for low-voltage a-c and d-c applications requiring superior performance, small size.

- Dependable operation over a temperature range of  $-55C$  to  $+85C$ .
- Longer shelf life and operating life than previous units.
- Polarized, non-polarized, etched, or plain foil Tantalitic capacitors are available.

SPECIFYING INFORMATION on G-E's complete Tantalitic line is available from your nearest Apparatus Sales Office, or write for GEC-808D, to General Electric, Section 449-12, Schenectady 5, N. Y.

\*Registered Trademark of General Electric Co.

**GENERAL ELECTRIC**



I get shortest  
etching  
time  
with  
**HUNT**  
**ETCHANTS**

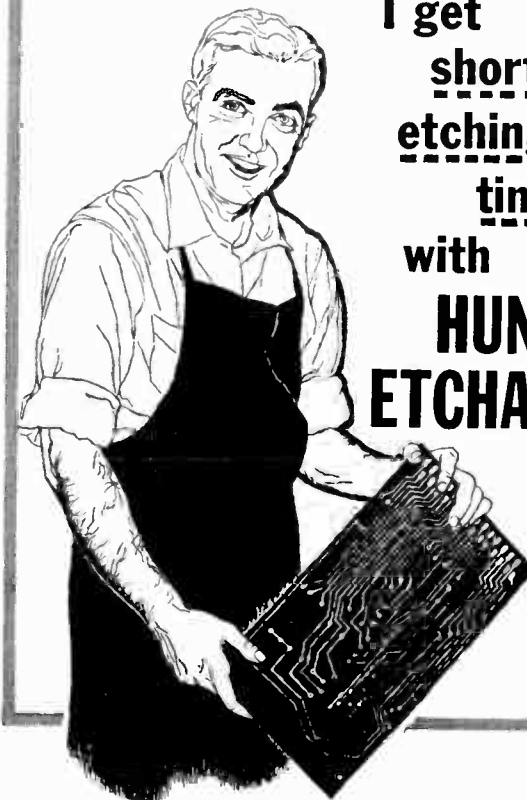

## HUNT R.C.E. for PRINTED CIRCUIT BOARDS

(Rapid Circuit Etch)

Hunt R. C. E. is a proprietary etchant, formulated to etch printed circuits fast and to speed up production. It offers these 6 big advantages:

- 15% increase in etching speed
- Fast action over entire circuit
- Uniformly smooth etching
- Easily removed by washing
- Substantial increase in capacity
- Freedom from fumes

## HUNT SCE for SOLDER-PLATED CIRCUIT BOARDS

(Solder Circuit Etch)

This ready-prepared product is designed to etch solder-plated circuit boards more easily, more effectively than it has ever been done before. You'll find that Hunt S. C. E.

- Etches rapidly at room temperatures
- Has a high capacity for copper
- Never attacks the circuit
- Has guaranteed uniformity, and is of the highest quality because of rigid laboratory control

Hunt S. C. E. is essentially an oxidizing solution with the capacity to keep the oxidized copper permanently in solution. Although many acids will etch copper, S. C. E. solution has the peculiar property of not attacking the solder... but giving fast, odorless etching of the copper.

WRITE TO NEAREST HUNT BRANCH FOR:

TECHNICAL BULLETIN NO. 1 — "The Etching of Copper by Hunt R. C. E. Solution."

TECHNICAL BULLETIN NO. 3 — "The Etching of Solder Plate Circuit Boards by Hunt S. C. E. Solution"

FOR SUPERIOR RESULTS AROUND THE CLOCK USE HUNT GRAPHIC ARTS CHEMICALS

**PHILIP A. HUNT  
COMPANY**

PALISADES PARK, N. J.

BRANCHES IN PRINCIPAL CITIES

In Canada: Philip A. Hunt Company (Canada) Ltd.  
77 Leslie Street, Toronto



**marion**  
advancement  
in instrument  
design

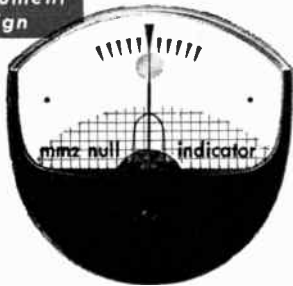

**MEDALIST\* null indicators**

READABLE... WIDE RANGE SENSITIVITY

Modern MEDALIST design provides for greater readability and modern styling in minimum space. Unique core and magnet structure provides  $\frac{1}{2}$   $\mu\text{o}/\text{mm}$  sensitivity at null point with sharp square law attenuation to 100  $\mu\text{a}$  at end of scale in Type A. Internal resistance is 2000 ohms. Other sensitivities available. ASA/MIL  $2\frac{1}{2}$ " mounting. Standard and special colors. Bulletin on request. Marion Instrument Division, Minneapolis-Honeywell Regulator Company, Manchester, N. H., U. S. A.

\*T.M. Reg. U.S. Pat. Off. U.S. & Foreign Patents  
Copyright © 1958, Marion

**marion**  
"WHERE ELECTRONICS MEETS THE EYE"  
**meters**



CIRCLE 140 ON READER SERVICE CARD

accuracy is better than 3 percent on all voltage readings. Transistor circuitry insures ruggedness and reliability and eliminates warm-up time to give instantly stable operation, while battery power eliminates transient powerline disturbances.

CIRCLE 242 ON READER SERVICE CARD

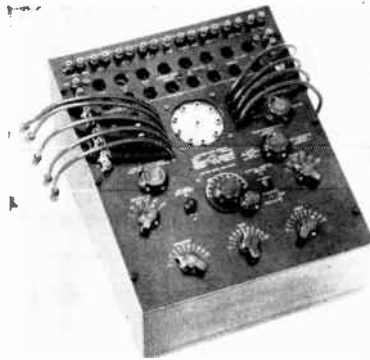

**V-T Bridge direct-reading**

GENERAL RADIO Co., West Concord, Mass. Type 1661-A dual-purpose v-t bridge, with an amplification-factor range of 0.001 to 10,000, can be used to measure not only l-f dynamic coefficients of tubes, but also of transistors, over wide ranges of values under a variety of operating conditions. Designed to operate in the 270-400 cps or 1,000-cps range, it makes use of a-c null-measurement techniques, with special consideration to phase shift and capacitance errors to insure a wide operating range.

CIRCLE 243 ON READER SERVICE CARD

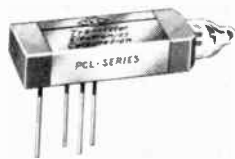

**Indicator Light for p-c boards**

TRANSISTOR ELECTRONICS CORP., 3357 Republic Ave., Minneapolis 26, Minn. PCL transistor driven indicator light for direct mounting on p-c boards is  $\frac{1}{2}$  in. high and  $\frac{1}{8}$  in. wide. With wire leads, it can be inserted and dip soldered on the board as a single component. It operates from signals as low as 2 v,

**FOR DEPENDABLE VIBRATION-PROOF TUBE SUPPORT**

**MINI-SPRING®**



Mini-Spring is the choice for positive holding action. Designed for "tight squeezes" that miniature electron tubes demand. Easy to install—no extra chassis piercing necessary. Specify Mini-Spring and be sure!

AVAILABLE IN QUANTITY AT YOUR LOCAL DISTRIBUTOR, OR WRITE FOR BULLETIN NO. 100. SPECIALS MADE TO YOUR ORDER.

THE **Staveland** COMPANY  
INCORPORATED

41-51 North Saxon Avenue, Bay Shore, N. Y.  
Distributor Inquiries Invited.

CIRCLE 184 ON READER SERVICE CARD

ripple at full load is only

**0.005%**

with new



**POWER & BIAS SUPPLY FOR TRANSISTORIZED EQUIPMENT #1020**

- includes power transformer, full-wave silicon diode rectifier circuit, electrolytic capacitor input filter followed by a two-power transistor (2-2N256) cascaded filter circuit providing extraordinary ripple rejection • output voltage: 0-30 VDC continuously variable, monitored by dual-range voltmeter (0-6, 0-30 VDC) • continuous output current capacity: 150 ma @ 0-12V; 200 ma @ 12-24 V; 300 ma @ 24-30V • 0.5A fuse protects against short circuit • comparable in purity of output and in voltage and current capacity to transistorized supplies selling for several hundred dollars • ideal for laboratory, development and service work on transistors and transistorized equipment
- rugged grey wrinkle steel case (5" h, 4" w, 5 $\frac{1}{2}$ " d)

**KIT \$19.95 WIRED \$27.95**

\*\* Add 5% in West.



Compare this versatile, dependable Model 1020 at your neighborhood EICO distributor. For free catalog on 65 models of EICO test instruments, hi-fi and amateur gear, write to Dept. E-10

**ELECTRONIC INSTRUMENT CO., INC.**  
33-00 Northern Blvd., Long Island City 1, N.Y.

168 CIRCLE 168 ON READER SERVICE CARD

World Radio History

**SINCE 1925**

**EDO CORPORATION**  
College Point, L.I., N.Y.

CIRCLE 190 ON READER SERVICE CARD  
OCTOBER 23, 1959 • ELECTRONICS



is available in 14 models to fit combinations of signals and voltages in computers, data processors, control and signal systems.

**CIRCLE 244 ON READER SERVICE CARD**

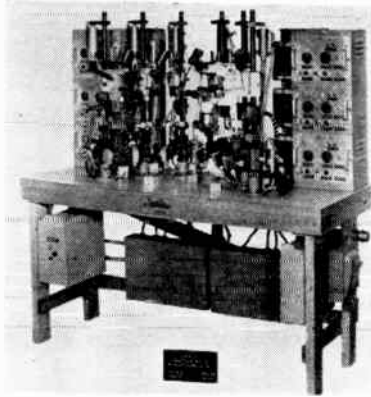

### Sealing Machine semiautomatic

KAHLE ENGINEERING Co., 3322 Hudson Ave., Union City, N. J., announces the number 3130 six-position semiautomatic sealing machine for making the final seal on glass diodes. Production capacity is from 300 to 500 sealed diodes per hr. By the time the machine tender finishes loading the six sealing stations, the first seal has been completed and is ready to be unloaded. Machine is 6 ft long, 5 ft high and 3 ft wide. It weighs 600 lb and has pull-out sections for easy maintenance.

**CIRCLE 245 ON READER SERVICE CARD**



### Slotted Clamp for mounting motors

PRECISION MECHANISMS CORP., 577 Newbridge Ave., East Meadow, N. Y., announces No. 2014 clamp for mounting motors, potentiometers, synchros, and other types of servo style components. Clamp is available in two sizes which accommodate a broad range of rotating shaft units. Slotted design provides easy engagement and broadens the area in which the hold-down screw may be placed. The wedge shape

# FIRST Airborne Atomic Frequency Standard

## Uses HERMES CRYSTAL FILTER

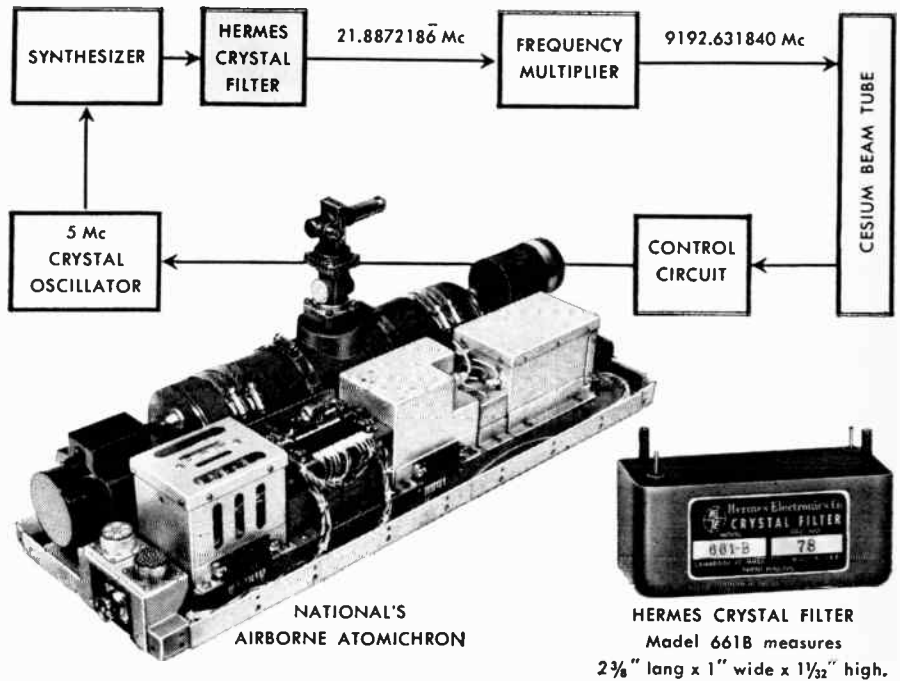

The National Company's Atomichron is the world's most accurate and stable instrument of its kind. It compares the precise unvarying resonance of the cesium atom which occurs at exactly 9192.631840 Mc with the output of a Crystal Oscillator. One of the critical problems in the development of the Atomichron was the elimination of spurious responses which occurred while generating the cesium frequency by a complex synthesis technique. The use of a Hermes Crystal Filter, Model 661B, between the Synthesizer and the Multiplier (see block diagram above) removed all spurious responses and allowed exactly 21.8872186 Mc to pass to the Multiplier.

Hermes Crystal Filters were selected for this critical application because of their sharp frequency characteristics, small size, and excellent performance over a wide range of severe environmental conditions. Close cooperation between the Engineering Departments of the two companies contributed to the rapid development of this new frequency standard. Hermes Crystal Filter's characteristics, Model 661B, include: Center Frequency: 21.8872186 Mc; Bandwidth at 6db: 6Kc; Bandwidth at 60db: 15 Kc; Insertion Loss: 3db max; Temperature Range: -55°C to +85°C.

Whether your selectivity problems are in transmission or reception, AM or FM, mobile or fixed equipment, you can call on Hermes engineering specialists to assist you in the design of your circuitry and in the selection of filter characteristics best suited to your needs. Write for Crystal Filter Bulletin.

*A limited number of opportunities is available to experienced circuit designers. Send Résumé to Dr. D. I. Kosowsky.*

The new name for HYCON EASTERN, INC. is

## Hermes Electronics Co.

75 Cambridge Parkway • Dept. A • Cambridge 42, Massachusetts



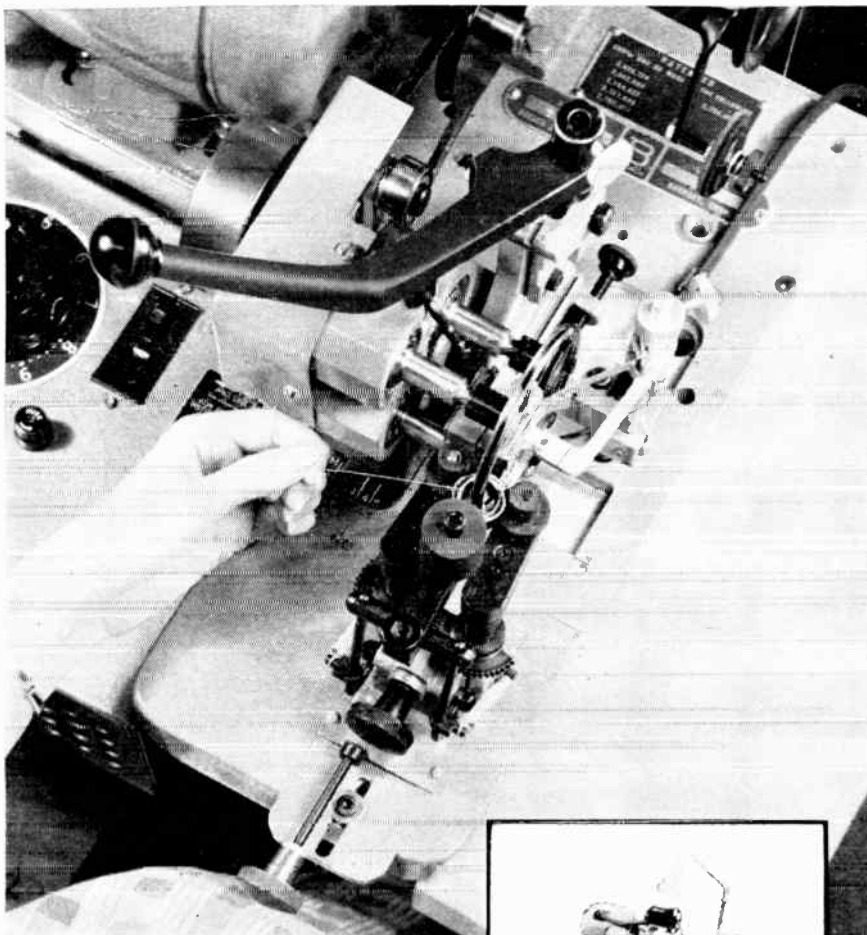

# BOESCH

*semi-automatic  
toroidal winders*

- Wind #20 to #42 AWG wire with constant uniformity at speeds up to 1200 RPM.
- Finished coils from 7/32" ID through 5" OD.

Low cost, high production winders. Core oscillated manually, clamped manually. Both machines wind standard size cores without additional attachments — use interchangeable shuttle heads. Capabilities identical except that TW-251 has built-in turns counter and variable speed motor.

Accessory, electronic, predetermined turns counters available for both machines . . . automatically stop winding at a preset number of turns — results in faster winding because operator does not have to watch counter. Both the TW251 and TW201 are bench-type machines with the following standard equipment: motor, core holder, shuttle opening lever, wire tension device, predetermined mechanical linear counter, reversing switch, 3" shuttle head, choice of 3" standard or 3S shuttle with slider.

*Write for complete data.*



**BOESCH MANUFACTURING  
COMPANY, INCORPORATED  
DANBURY, CONNECTICUT**

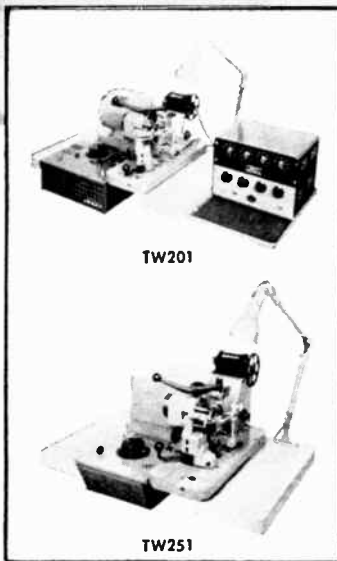

and use of 18-8 corrosion resistant steel provide very high holding capacity. Requirements of MIL-E-5400 are fulfilled.

**CIRCLE 246 ON READER SERVICE CARD**



## Electronic Timer for x-ray counting

HAMNER ELECTRONICS CO., INC., Princeton, N. J. Model N-801 timer is a compact rack mounted, glow-tube type, driven from a stable 100 or 1,000 cycle oscillator selectable by a front panel switch. It has a preset time from ½ sec to 10,000 sec in steps of ½ sec, 1, 2, 5, 10, 20, 50, 100, 200, 500, 1,000, and 10,000 sec. Provisions are made for elapsed time measurements to 1,000 sec, or to 10,000 sec. Timing accuracy, limited only by oscillator stability, is better than 0.1 percent per day.

**CIRCLE 247 ON READER SERVICE CARD**

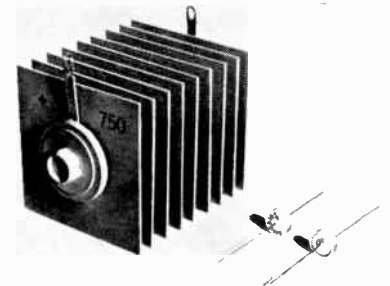

## Silicon Rectifier wafer-type

AUDIO DEVICES, INC., 620 E. Dyer Road, Santa Ana, Calif. The 40E5 epoxy ceramic encapsulated silicon diode replaces bulky selenium rectifiers in a variety of applications. It is rated to handle 750 ma with a resistive load. It has a rating of 500 ma with a capacitive load and peak inverse rating of 400 v.

**CIRCLE 248 ON READER SERVICE CARD**

## Diode-Triode 9-pin miniature

RADIO CORP. OF AMERICA, Harrison, N. J. The 6CN7 is a twin diode/high-mu triode intended for use in





## NEW EXPERIMENT IN TELEPHONY

*It could speed up "dialing." Bell Laboratories people created it—and now it's being tested.*

The telephone you see above embodies an important new concept. It "dials" by means of push buttons—promises more convenient telephoning. Bell System engineers are currently testing it for public reaction. Bell Telephone Laboratories developed it.

The Laboratories' invention of the transistor makes it possible. For the transistor permits a new kind of calling signal generator, mounted within the instrument.

To insure ease of operation, psychologists studied human reactions to various finger pressures and sizes and arrangements of buttons. All factors affecting speed and accuracy were thoroughly evaluated. Electrical and mechanical engineers brought together the human and physical factors, created a practical piece of apparatus. Industrial designers worked out the functional shape.

The new instrument sends a calling signal quite different from that of your present telephone. This poses a problem. Complex automatic switching must be changed to handle the new signals as well as the old ones. Switching engineers must devise ways to make this change in *thousands* of central offices—economically.

Most of the challenges have been met. Final judgment on this new concept depends on the outcome of field tests. Meanwhile, Bell Laboratories continues in its task of originating and developing devices to improve your Bell System telephone service.



**BELL TELEPHONE LABORATORIES**

WORLD CENTER OF COMMUNICATIONS RESEARCH AND DEVELOPMENT



## now to prove moisture resistance!

Up-up! It's just not worth housemaid's knee to prove you *might* have a pot that can pass Procedure 106-A! Oh, it might take the steamin', alright — but just wait 'til it "breathes" when it's cold! And if you want the acid test — add a dash of polarizing voltage!

But you can count on one pot to withstand the moisture and temperature cycling of MIL-STD 202A: — ACEPOTS have had the engineering design to pass 106-A with ease, even with polarizing voltage! For example, the terminal header is of our exclusive epoxy-impregnated fibreglass, with special case locking to keep out moisture. The shaft end is sealed with high-temperature silicone rubber O-rings bearing seals. Inside, special bronze bearings and precious anti-oxidizing winding and contact metals guard against corrosion. So if moisture-resistance tests make you damp and dour — see your ACErep!



*This 7/8" ACEPOT<sup>®</sup>, as with all our pots, incorporates these exclusive moisture- and corrosion-resistant features.*

**ACE** ELECTRONICS ASSOCIATES, INC.  
99 Dover Street, Somerville 44, Mass.  
Somerset 6-5130 TMX SMVL 181 West. Union WUX

Acepot<sup>®</sup> Aceltrim<sup>®</sup> Aceso<sup>®</sup> Aceohm<sup>®</sup> \*Reg. Appl. for

wide variety of applications in black-and-white and color tv receivers. The diode units of the tube are useful in phase-detector and horizontal afc discriminator circuits. The triode unit is well suited for use in horizontal-oscillator-control, sync-amplifier, and audio-amplifier circuits. Tube has a mid-tapped heater to permit operation from a 6.3-v or a 3.15-v supply. The heater with parallel arrangement is controlled for warm-up time to insure dependable performance in tv receivers employing series heater-string operation.

**CIRCLE 249 ON READER SERVICE CARD**

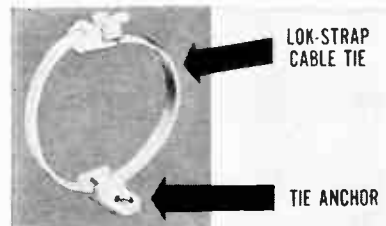

## Nylon Cable Ties reusable devices

PANDUIT CORP., 14461 Waverly Ave., Midlothian, Ill. "Lok-Strap" cable ties form neat, secure wire bundles with minimum time and effort. They can be opened, closed and readjusted repeatedly without damage, without special tools. Wire may be traced, added or removed from the harness quickly and easily at any time. Used with Panduit tie anchors, the "Lok-Strap" assembly becomes an efficient cable clamp which supports bundles and anchors them solidly in any desired position. These cable ties and tie anchors have excellent electrical insulating characteristics, high tensile strength and a service temperature range from -65 F to +300 F.

**CIRCLE 250 ON READER SERVICE CARD**

## Pick-Up Head Hall effect

GRH HALLTEST Co., 157 S. Morgan Blvd., Valparaiso, Ind., announces Hall effect pick-up heads using indium-arsenide and indium-antimonide Hall generators mounted between soft magnetic ferrite pole pieces. The advantage over conventional inductive pick-up heads is





# NO PIGEONHOLES

In some industries a man is boxed off by his title. In most fields, for example, a management man won't talk the same language as a design engineer.

The Electronics man, however, is not easily pigeonholed. Whatever his title, whatever his department, this engineering oriented man

influences the buying and specifying of electronic equipment.

*electronics* is edited to reach the important areas of the electronics industry . . . the men who, regardless of title, influence the purchase of products, materials and service. This is why it pays to advertise in *electronics* and *electronics* BUYERS' GUIDE.

The Electronics man "buys" what he reads in

## electronics

A McGraw-Hill Publication

330 West 42nd Street, New York 36, N. Y.



**BUSINESS REPLY MAIL**

NO POSTAGE STAMP NECESSARY IF MAILED IN THE UNITED STATES

6¢ Postage Will Be Paid By

**ELECTRONICS**

Reader Service Dept.

330 West 42nd Street

New York 36, N. Y.

FIRST CLASS  
PERMIT NO. 64  
(SEC. 34.9 P.L.&R.)  
NEW YORK, N. Y.



**BUSINESS REPLY MAIL**

NO POSTAGE STAMP NECESSARY IF MAILED IN THE UNITED STATES

6¢ Postage Will Be Paid By

**ELECTRONICS**

Reader Service Dept.

330 West 42nd Street

New York 36, N. Y.

FIRST CLASS  
PERMIT NO. 64  
(SEC. 34.9 P.L.&R.)  
NEW YORK, N. Y.





the independence of the tape speed. This even makes static testing of tapes possible. The new units do not show distortion at higher frequencies and thus simplify the circuitry of the amplifier.

**CIRCLE 251 ON READER SERVICE CARD**



### Time Delay Relay miniaturized

AGA DIVISION, Elastic Stop Nut Corp. of America, Elizabeth, N. J. Time delay relay, 4½ in. high by 1½ in. wide by 1½ in. deep, is designed for highest accuracy, reliability and ruggedness. Unaffected by voltage variations, it recycles instantaneously. Other advantages are timing ranges easily adjusted to a time-setting as low as 30 millisecc with a repeat accuracy of 5 percent (3 timing ranges available covering 0.030 to 2 minutes). Units can be supplied for delay on energizing or de-energizing; coils in a range of voltages available for a-c or d-c circuits; dpdt single break contact arrangements and hermetically sealed or dust-tight housings with octal-plug, solder lug or AN connector terminals.

**CIRCLE 252 ON READER SERVICE CARD**

### TWT Amplifier p-m focused

MENLO PARK ENGINEERING, 711 Hamilton Ave., Menlo Park, Calif. Model TA-49PM permanent magnet focused twt amplifier is a lightweight, compact unit applicable to many uses in the operating frequency range 12.0 to 16.0 kmc. The ruggedized power supply provides 0.1 percent regulation, with maximum ripple on the helix less than

## BORG TRIMMING MICROPOTS ELIMINATE FINE ADJUSTMENT PROBLEMS...



Borg Trimming Micropot® Potentiometers permit fine adjustments because of 40 turn lead-screw actuation. No hunting is required to make even the most critical adjustments. Settings remain stable. Unique contact carrier assembly drive prevents damage when either end of linear excursion is reached. Wide range of resistance values . . . 10 to 30,000 ohms. Other values on special order.

Available with insulated wire leads, printed circuit terminals or solder lugs. May we send you complete data?

Write for catalog BED-A90.

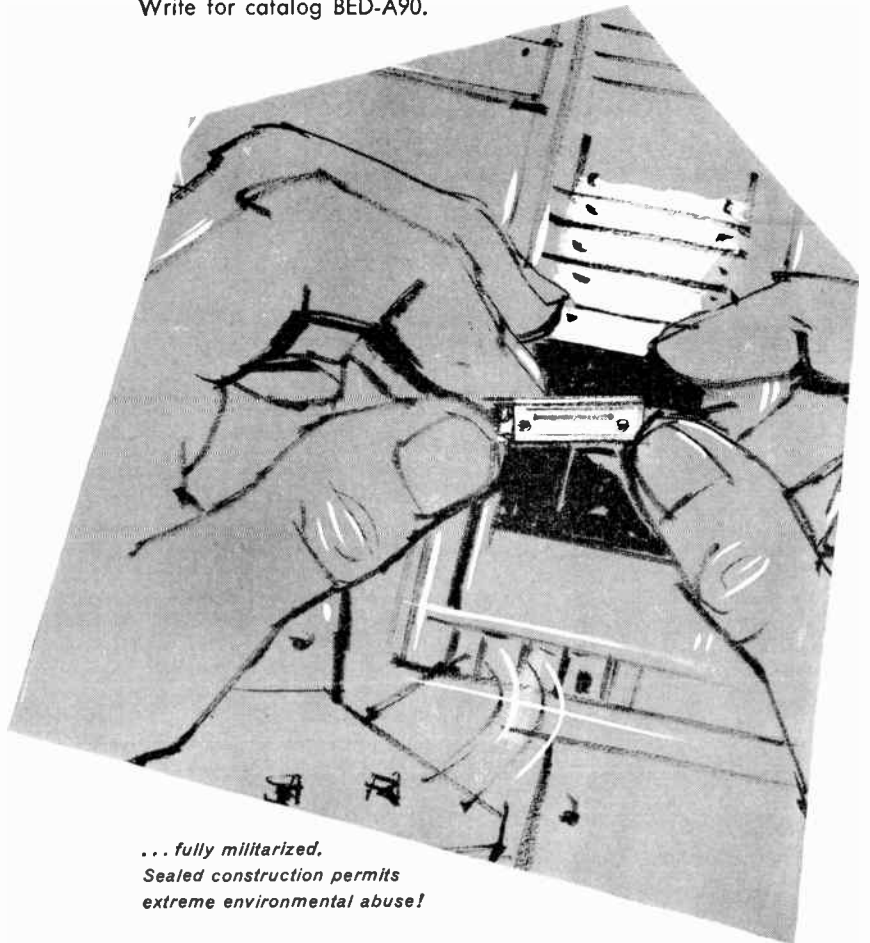

*... fully militarized.  
Sealed construction permits  
extreme environmental abuse!*

Write for Catalog BED-A90



**BORG EQUIPMENT DIVISION**  
AMPHENOL-BORG ELECTRONICS CORPORATION  
JANESVILLE, WISCONSIN

MICROPOTS • MICRODIALS • INSTRUMENT MOTORS • FREQUENCY STANDARDS

# ANOTHER FIRST...

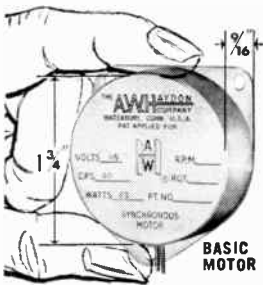

THE ONLY

# Electro-Reliable

## A.C. TIMING MOTOR

*Thinner... Quieter...  
More Reliable... More Versatile*

### FINGER-THIN...

Only 9/16 Inches Short... Only 1 3/4 Inches in Diameter... very compact... reduces the size of your equipment.

### WHISPER-QUIET...

Strictly an electrical motor... practically noiseless... no rattling of gears or ratchets.

### HIGH TORQUE...

1/4 oz. inch at the rotor with an instantaneous start and stop... requires only 2 1/2 watts... can replace larger motors in recorders, controls and telemetering equipment.

### HIGHEST RELIABILITY...

Longer life... no one-way gears or ratchets to fail... provides millions of operations without any trouble.

### SPECIFICATIONS

**Standard Voltage Ratings:**  
6, 12, 24, 115, 230 Volts  
**Frequency:**  
60 CPS Standard  
25, 50 CPS Available  
**Power Input:** 2.5 Watts  
Maximum (60 CPS)

#### BASIC MOTOR

**Weight:** 4 ounces  
**Speed:** 300 RPM  
**Torque:** 1/4 oz.-in.  
**Length:** 9/16 inch

#### WITH INTEGRAL GEAR TRAIN

**Weight:** 5 ounces  
**Speed:** 300 RPM to 1/6 RPH  
**Torque:** 30 oz.-in. @ 1 RPM  
**Length:** 7/8 inch



WITH INTEGRAL GEAR TRAIN

CIRCLE 95 ON READER SERVICE CARD

© 1959



Send for Special Illustrated Bulletin AWII MO-806  
**The A.W. HAYDON Company**

235 NORTH ELM STREET  
WATERBURY 20, CONNECTICUT

Custom Design & Manufacture Of Electronic  
And Electro-Mechanical Timing Devices

"Another FIRST by  
Kahn Research"

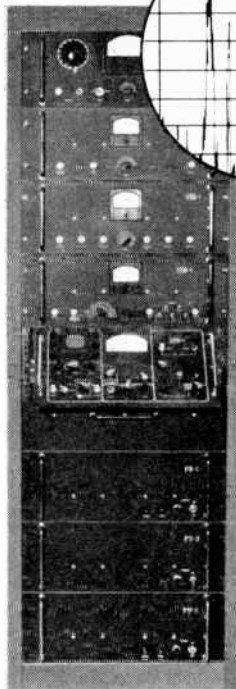

# Now

... all the advantages of high power SSB with standard AM transmitters.

For years, government and commercial communicators throughout the world have used Kahn Adapters to convert conventional high frequency AM transmitters to SSB operation. They have done so because of tremendous savings in equipment, maintenance costs, and major improvements in overall system performance. These advantages are not restricted to existing equipment but apply to completely new installations as well.

The reason behind this quiet revolution is simple. Kahn Adapters can be used with any standard high level AM transmitter. Thus, the many inherent advantages of high efficiency Class C sideband amplification can be fully realized... including a power improvement of 2.5 times that of a linear system with equal total plate dissipation. As a result, this modern technique is widely recognized as the first proven solution to high power and super power SSB communications.

Thoroughly proven by extensive use, the Model SSB-58-1A single or two independent sideband adapter system is specifically tailored for Voice, FSK Teletype, Data and Facsimile applications.

10 mv. Front panel metering is provided for helix voltage, helix current, and beam current.

CIRCLE 253 ON READER SERVICE CARD

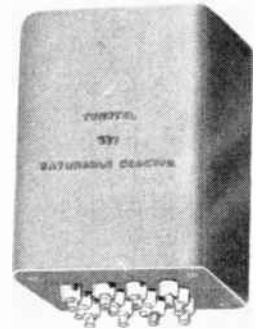

### Amplifiers servo-magnetic

TOROTEL, INC., 5512 E. 110th St., Kansas City, Mo., introduces a line of servo-magnetic amplifiers for 2-phase 400-cycle servo motors. Voltage ratings are 26 and 115 v with power rating from 2.5 to 15 w. MIL-T-27 size cans not to exceed FA. Weight of largest unit is under 2 lb.

CIRCLE 254 ON READER SERVICE CARD

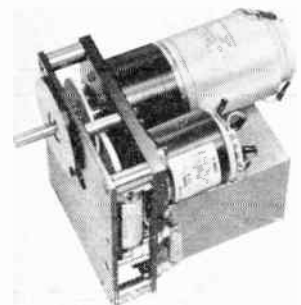

### Servo Repeater 120 rpm top speed

INDUSTRIAL CONTROL Co., 805 Albin Ave., Lindenhurst, L. I., N. Y. The 770A is a precision servo repeater designed to follow the position of a remote synchro. It operates directly from the 117 v, 400 cps line, and includes servo motor, gearing, control transformer and servo amplifier all in one compact package. An output driver shaft is provided, and an accurate register positions the assembly in mounting. Maximum output torque is 30 oz.-in., and stiffness 3 oz.-in./deg. A size 18 CT is used for minimum stator drain and best accuracy. The am-



**KAHN RESEARCH LABORATORIES, Inc.**  
22 PINE STREET, FREEPORT, N. Y. FReeport 9-8800

\* Write for illustrated Brochure



# Introducing **ATR** CUSTOMIZED Karadio

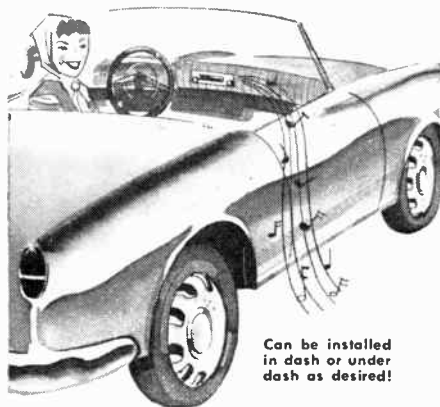

Can be installed  
in dash or under  
dash as desired!

for  
*small import cars*  
and  
*compact U.S. cars*

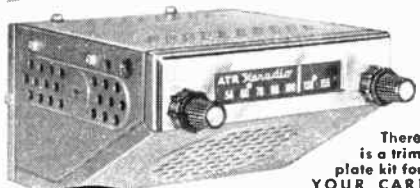

There  
is a trim  
plate kit for  
YOUR CAR!

## **ATR** CUSTOMIZED Karadio

### • VIBRATOR-OPERATED with Tone Control

The ATR Customized Karadio is a compact, new, self-contained airplane-styled radio for small import and compact American cars. This economical unit is perfect for all small cars because it can be easily and inexpensively installed in-dash or under-dash on most any make or model automobile—and its powerful 8-tube performance provides remarkable freedom from engine, static, and road noises. ATR Karadios are built to look and fit like original equipment with sleek, modern styling and solid, single-unit construction. They offer many customized features and provide highest quality fidelity—yet cost for less than comparably designed units. The ATR Customized Karadio comes complete with speaker and ready to install... and is the ideal way to add fun and value to your small import or American automobile!



ATR KARADIO  
... is ideal  
for small import  
cars or com-  
pact American  
cars! Unit is  
completely self-contained—extremely compact!  
Can be mounted in-dash or under-dash—where-  
ever space permits! For 6 volt or 12 volt!

**SEE YOUR JOBBER OR WRITE FACTORY**

• "A" Battery Eliminators • DC-AC Inverters • Auto Radio Vibrators

**ATR** AMERICAN TELEVISION & RADIO CO.  
Quality Products Since 1931  
SAINT PAUL 1, MINNESOTA, U. S. A.

CIRCLE 96 ON READER SERVICE CARD  
ELECTRONICS • OCTOBER 23, 1959

plier's transistor-magnetic circuits guarantee long life and good reliability.

CIRCLE 255 ON READER SERVICE CARD

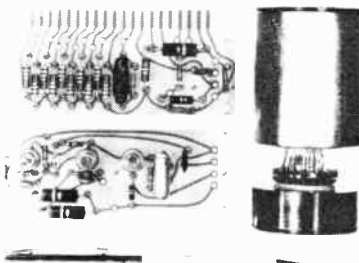

### Miniature Module for use in counters

BURROUGHS CORP., P. O. Box 1226, Plainfield, N. J. DC-110 miniature decade counter module combines solid state devices and the miniature shielded beam switching tube in a circuit capable of resolving pulses at 250 kc rates. Electrical outputs are provided to operate remote Nixie indicator tubes, printers, and to perform other circuit functions. Advantages include total power consumption of only 2 w; and elimination of as many as 90 components from the counting circuit.

CIRCLE 256 ON READER SERVICE CARD

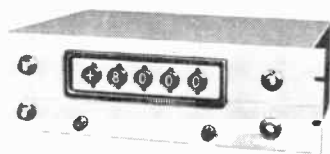

### Digital Voltmeter medium speed

ELECTRO INSTRUMENTS, INC., 3540 Aero Court, San Diego 11, Calif. Model 8409 four-digit, all-electronic digital voltmeter is capable of making 50 measurements per sec. It features totally transistorized logic circuits;  $\pm 1$  digit accuracy; automatic polarity; automatic, manual and remote ranging; 1,000 megohm input impedance; BCD and decimal output; direct printed operation; provision for external reference voltage; and modular construction throughout.

CIRCLE 257 ON READER SERVICE CARD

# YOKE DISTORTION your problem?



Uniform magnetic fields  
Produced in Celco  
Precision  
Deflection  
Yokes  
Minimize  
**SPOT  
DISTORTION**



Exclusive Celco core materials make it possible to achieve faster recovery times, minimum hysteresis, high linearities and maximum sensitivities.

Contact Celco Engineering Department for a fast solution to all your yoke problems.

Celco produces a complete line of standard or special commercial and military precision deflection yokes.

**Celco**  
Constantine Engineering  
Laboratories Co.

Main Plant: MAHWAH, N. J. Davis 7-1123

- Pacific Division - Cucamonga, Calif. - YUkon 2-2688
- Central Division, Lanesboro, Pa. - Ulysses 3-3500
- Southern Division, Miami, Fla. - Wilson 5-2164

CIRCLE 177 ON READER SERVICE CARD 177

# THE GUIDE TO INDUSTRIAL ELECTRONIC WIRE & CABLE

including  
**ALPHLEX® TUBING  
& LACING CORD**

- now over 5,000 items
- industry's most comprehensive line
- Alpha Wire products are IN-STOCK at electronic parts distributors coast to coast. Write for your free catalog to Dept. 1 59

ALPHA WIRE CORPORATION  
200 Varick Street, New York 14, N. Y.

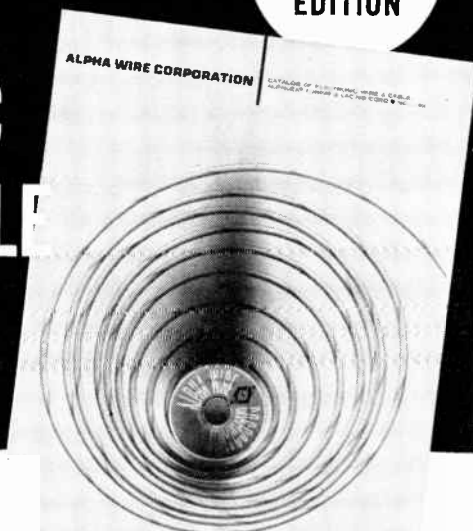

CIRCLE 97 ON READER SERVICE CARD

## Literature of

### MATERIALS

**Ferrites.** Ferromagnetic Distributors, 15015 Ventura Blvd., Sherman Oaks, Calif. A 20-page brochure contains detailed characteristics, physical properties and applications notes on over 37 basic types of ferrites.

CIRCLE 285 ON READER SERVICE CARD

### COMPONENTS

**Variable Transformer.** The Superior Electric Co., 83 Laurel St., Bristol, Conn. The 8-page Powerstate Bulletin P159 contains complete technical data on the 10B series small variable transformer which boosts rating but not size or price.

CIRCLE 286 ON READER SERVICE CARD

**Subminiature Paper Capacitors.** Astron Corp., 255 Grant Ave., East Newark, N. J. Two 4-page product engineering bulletins, No. A-110 and A-115 deal with subminiature glass-to-metal sealed tubular capacitors types AQF and TQF respectively.

CIRCLE 287 ON READER SERVICE CARD

**Transformers.** Stavid Engineering, Inc., Plainfield, N. J. Bulletin MC559 describes a line of high power pulse transformers and inductor devices.

CIRCLE 288 ON READER SERVICE CARD

### EQUIPMENT

**Instrumentation Recorder.** Ampex Instrumentation Division, 934 Charter St., Redwood City, Calif., has available a 4-color brochure on the FR-600 instrumentation recorder which offers a frequency response to 250 kc in direct recording and to 20 kc in f-m work.

CIRCLE 289 ON READER SERVICE CARD

**SSB Transmitter Adapter.** Kahn Research Laboratories, Inc., 22 Pine St., Freeport, N. Y. A 4-page illustrated brochure describes model SSB-58-1A adapter system, a technique for converting existing a-m communications transmit-

## The new NORTHERN RADIO catalog is your buyers guide to FREQUENCY SHIFT COMMUNICATION EQUIPMENT



Complete descriptions and specifications... the only book of its kind in the field!

- 68 Pages • 34 Items
- 34 Photographs • 20 Block Diagrams
- the Industry's FOREMOST and COMPLETE line of Quality Communication Equipment!

Write on your letterhead for your copy today  
**NORTHERN RADIO COMPANY, INC.**  
149 W. 22nd St., New York 11, N. Y.  
IN CANADA: NORTHERN RADIO MFG. CO. LTD., OTTAWA, ONT.

## EMERGENCY SUB-CONTRACT MANUFACTURING

- ✓ Electronic
- ✓ Electrical
- ✓ Mechanical

### ASSEMBLY • WIRING • SOLDERING MACHINING • DESIGNING • TESTING

Let us quote highly competitive prices and prompt delivery on one or a million units... to your specifications or designed by our engineers to your requirements.

Phone or write today!

### Write for New FACILITIES MANUAL



...listing in detail over 130 operations performed for our nation-wide customers.

PHONE

Gladstone 5-1697

## PARAPLEGICS MFG. CO.

10076 Franklin Avenue, Franklin Park, Ill.

CIRCLE 98 ON READER SERVICE CARD



# the Week

ters to ssb operation without engineering modifications.

**CIRCLE 290 ON READER SERVICE CARD**

**Interchangeable Typewriter Type.** Remington Rand, 315 Park Ave. South, New York 10, N. Y. A method of using an electric typewriter for quick, convenient typing of special symbols and equations needed in the field of engineering is the subject of booklet R-8964.6.

**CIRCLE 291 ON READER SERVICE CARD**

**Electronic Galvanometer.** Kin Tel Division of Cohu Electronics, Inc., 5725 Kearney Villa Road, San Diego 12, Calif. Bulletin 14-10 presents specifications and a complete description of a multipurpose electronic galvanometer.

**CIRCLE 292 ON READER SERVICE CARD**

**D-C VTVM.** Hewlett-Packard Co., 275 Page Mill Road, Palo Alto, Calif. Volume 10 No. 11-12 of the *Journal* fully describes model 412A d-c vtm, a precision unit with extended sensitivity and high stability.

**CIRCLE 293 ON READER SERVICE CARD**

**Amplifiers and Preamplifiers.** Instruments for Industry, Inc., 101 New South Road, Hicksville, N. Y., offers a 4-page color brochure on an expanded line of wide band, i-f and transistorized amplifiers and preamplifiers.

**CIRCLE 294 ON READER SERVICE CARD**

**Digital Voltmeters.** Non-Linear Systems, Inc., Del Mar, Calif., has produced a 20-page, two-color bulletin on series 30 digital voltmeters for measurement of a-c and d-c voltages and voltage ratios.

**CIRCLE 295 ON READER SERVICE CARD**

## FACILITIES

**Airborne Armament Control.** General Electric Co., 600 Main St., Johnson City, N. Y. Bulletin SPJ-4-658 details experience in radar, infrared, amplidynes, servomechanisms, lead-computing gun sights, bomber defense systems, and guidance and control units for missiles.

**CIRCLE 296 ON READER SERVICE CARD**



**SS-5**  
DP-DT spring return  
0.5-amp. @ 125v ac-dc.  
U.L. Inspected.

**SS-15**  
SP-ST pushbutton, momentary  
contact. 1-amp. @ 125v ac.  
U.L. Inspected.

**SS-16**  
3-position special.  
3-amps. @ 125v ac.  
U.L. Inspected.

## UNIQUE ELECTRICAL PRODUCT



**SS-31**  
3-Position. 3-amps  
@ 125v ac.  
U.L. Inspected.

**SS-32**  
SP-DT. 1-amp.  
@ 125v ac-dc  
U.L. Inspected.

**SS-33**  
DP-DT. 3 amps  
@ 125v ac.  
U.L. Inspected.

## DESIGN IDEAS OFTEN BEGIN



**SS-50**  
DP-DT miniature.  
0.5-amp. @ 125v ac-dc.  
U.L. Inspected.

**SS-34**  
3P-DT. 3-amps.  
@ 125v ac.  
U.L. Inspected.

**SS-36**  
SP-DT. 6 amps.  
@ 125v ac.  
U.L. Inspected.

## WITH THESE VERSATILE



**SS-26-1**  
SP-DT. 3-amps  
@ 125v ac.  
U.L. Inspected.

**SS-9**  
SP-DT spring return.  
3-amps @ 125v ac.  
U.L. Inspected.

**SS-18**  
4-position special.  
3-amps. @ 125v ac.  
U.L. Inspected.

## STACKPOLE SWITCHES!

Get This GUIDE TO MODERN SWITCHING

Ask for 8-page Switch Bulletin RC-11D

World's largest slide switch line—over 12 low cost standard types—dozens of economical adaptations. NEW colored knobs. Special conventional and miniaturized switches designed and produced for large quantity users. *Electronic Components Division, STACKPOLE CARBON COMPANY, St. Marys, Pa.*



Another **FIRST** from



## NEW PACKAGED PRECISION DRIVE UNITS

Now, for the first time you can obtain precision drive units complete in one package. ALI Drives save time, trouble and money—eliminate the need of procuring and assembling separate indicators, dials, knobs, gears, etc. And, with ALI Precision Drive Units you know you have a unit that will do the required job without a possibility of error. Use them with rotary components such as solvers, syncros, potentiometers, inductors, capacitors, tuning coils, etc.



**REQUIRE NO  
ADDITIONAL PARTS**

**TYPE PDW-1 PRECISION  
DRIVE, WORM . . .**  
Accuracy 1 min. of arc

A worm gear, shaft positioner for accurate repeatable positioning and indicating. Features: no backlash, compact design, long life, rugged construction. Mechanism utilizes a 180-1 ratio allowing direct dial readings of 1 minute of arc. Has hairline indicator, large engraved dials.



**ARE COMPLETE UNITS  
IN THEMSELVES**

**TYPE DSD-2  
DUAL SPEED DRIVE . . .**  
Accuracy 6 mins. of arc

A precision gear reducer for highly-accurate repeatable positioning and indicating. Inner dial for coarse positioning, outer dial for fine positioning plus in-line input and output shafts and the availability of a wide range of ratios through 72-1. No backlash.



**3 TYPES AVAILABLE**  
all meet Mil-E-4970 (USAF)

**TYPE DSD-3  
DUAL SPEED DRIVE . . .**  
Accuracy 12 mins. of arc

An economical precision gear reducer for positioning and indicating. Features: no backlash, in-line input and output shafts, compact design. Like Type DSD-2, it has inner dial for coarse positioning, outer dial for fine positioning.



Write for full details  
**ACTON  
LABORATORIES INC.**

Subsidiary of Technology Instrument Corp.  
517 MAIN STREET, ACTON, MASS.  
COLONIAL 3-7756

## NEW BOOKS

### Logical Design of Digital Computers

By M. PHISTER, Jr.

John Wiley and Sons, Inc., New York, 1958, 408 p, \$10.50.

THE author's intention to present a text on the basics of the logical design of digital computers is very adequately realized in this book.

As is established in the preface, only synchronous circuit components are considered, and no material on component circuit design is included. The author summarizes and provides an abundance of references at the close of each chapter.

**Text Use**—This book is an excellent text for a one semester graduate course or advanced undergraduate course oriented toward a survey of digital computer components and a basis understanding of the arithmetic techniques employed to synthesize a complete system from these component parts.

VELIO A. MARSOCCI, Dept. of Electrical Engineering, Stevens Institute of Technology, Hoboken, N. J.

### Free Radicals as Studied by Electron Spin Resonance

By D. J. E. INGRAM.

Academic Press, Inc., New York, 1958, 274 p, \$9.50.

MICROWAVE engineers will be pleasantly surprised by the applications described in this book. Normally, we tend to think of microwaves in connection with radar and communications. Electron spin resonance studies, however, are applications of microwaves to chemistry, biology and medicine.

A free radical is defined as a molecule, or a part of a molecule, in which the normal chemical binary has been modified so that an unpaired electron is left associated with the system. The presence of such an electron gives the free radical an extremely high chemical reactivity and also a magnetic moment due to the uncompensated spin of this unpaired electron. The high chemical reactivity

HR-92 X-Y

## RECORDER



- Flat bed — Full Chart visibility
- Unitized Construction
- Critically damped response
- Simplified control panel
- Clip-on pen — Interchangeable for multicolor traces
- Standard 8½ x 11 paper
- Unconditionally guaranteed for one year.

### RUGGED "All Purpose" X-Y RECORDER

The HR-92 is a null-seeking servo-type plotter designed to draw curves in Cartesian coordinates on regular 8½ x 11 graph paper. It employs conventional chopper amplifiers, 2-phase motors and a potentiometer rebalance. Reference voltages are furnished by mercury cells. Control panel has zero set and continuously-variable attenuator for each axis. Separate standby and power switches are provided. Two axes are electrically and mechanically independent. By moving an internal jumper lead, a high impedance potentiometer input can be made available.

#### SPECIAL FEATURES:

- Amplifiers easily removed if servicing ever becomes necessary. Electrical connections all contained in two plugs for each amplifier.
- Each amplifier channel (including transformer power supply) independent of rest of system.

WRITE FOR:  
New X-Y Recorder Circular #717-3  
showing complete specifications and photographs.



**houston  
instrument**  
corporation

1717 Clay Ave. • Houston 3, Texas  
CA 5-6964

CIRCLE 99 ON READER SERVICE CARD  
OCTOBER 23, 1959 • ELECTRONICS



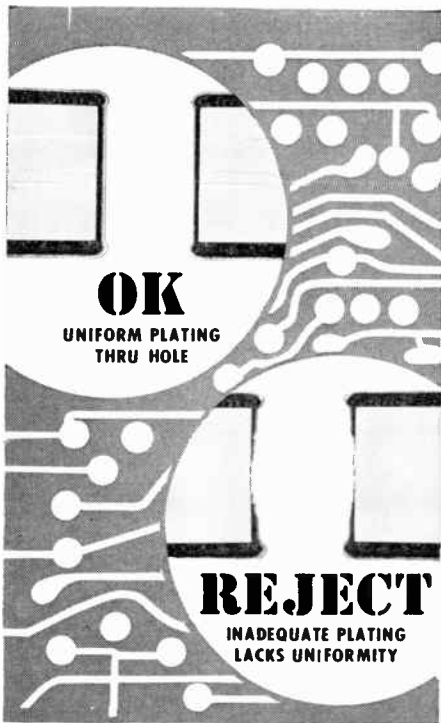

**Printed Circuit  
Reliability  
through Quality  
Control**

If your printed circuit is vital to the flight of a guided missile it must not fail. It may even undergo a 100% inspection at every stage of manufacture.

Bureau quality control is more than a method of inspection. It is also a check on the causes of rejects to weed them out. Our production techniques eliminate even "acceptable" flaws because we are striving to produce *perfect* boards. This is why Bureau circuits, whether tested 100% or on a scientific-sample basis, are consistently better than statistics predict. To put reliable circuits into your product, investigate the Industrial Division of the Bureau of Engraving, Inc.

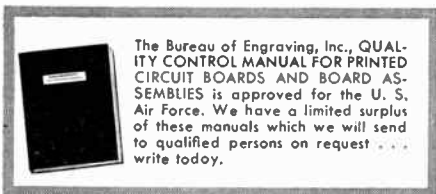

The Bureau of Engraving, Inc., QUALITY CONTROL MANUAL FOR PRINTED CIRCUIT BOARDS AND BOARD ASSEMBLIES is approved for the U. S. Air Force. We have a limited surplus of these manuals which we will send to qualified persons on request... write today.

Member of the Institute of Printed Circuits

**BUREAU OF ENGRAVING, Inc.**

Industrial Division

504 South 4th St.

Minneapolis 15, Minn.

Telephone Federal 9-8721



CIRCLE 100 ON READER SERVICE CARD

ELECTRONICS • OCTOBER 23, 1959

makes the free radical of extreme interest in chemical processes and its magnetic moment makes it amenable to detection by electromagnetic means.

In the electron spin resonance techniques, the system is perturbed by a large magnetic field of approximately 10,000 gauss and the resonance absorption between the new energy levels are observed in the microwave range, most commonly X-band. The first four chapters treat the basic theory and experimental techniques of the electron spin resonance. Details are given on spectrometer construction and calculation of molecular constants from the experimental data. The last five chapters present the results of measurements on a variety of free radicals and those produced by irradiation and polymerization. The nonspecialist will find the last chapter on biological and medical applications extremely interesting.

In view of the expansion of microwave spectroscopy, electron spin resonance and maser activity, it appears that the microwave engineer will have to learn some chemistry and quantum mechanics in order to speak intelligently with his customers.—MORRIS ETTEBERG, *Polytechnic Institute of Brooklyn, Brooklyn, N. Y.*

### Proceedings of the Symposium on Electronic Waveguides

*Polytechnic Press, Brooklyn, New York, 1958, 418 p., \$5.00.*

Edited by Jerome Fox

ELECTRONIC waveguides are guiding propagation media in which free or nearly free electrons are found in the space in which the electromagnetic waves propagate.

The Microwave Research Institute of the Polytechnic Institute of Brooklyn, as the eighth volume in its symposia series, has presented an up-to-date consolidation of some of the more important contributions to the state of the art in electronic waveguides. This volume covers travelling wave tubes, plasmas, mode theory, large signal theory and other problems involving the interaction of electromagnetic waves and electron beams or streams. It is a relatively discon-

## TYPE 310-B Z-ANGLE<sup>®</sup> METER



**Audio & Ultra-Sonic**

#### FEATURES:

- Direct Readings of: Impedance (Ohms), Phase Angle (Degrees), Dissipation Factor (D), Storage Coefficient (Q)
- 30 cps to 40 kc Frequency Range
- Internal 60 and 400 cps Test Signals
- Simple to Operate — Only One Balancing Step
- Compact and Portable

The 310-B measures impedances directly in the polar form  $Z/\pm\theta$  (i.e., magnitude in ohms and phase angle in degrees). Any R.I.C. combination can be measured from pure resistance, capacitance or inductance to complex impedances. Only one balancing control is used. The condition of sliding balance, frequently encountered when measuring low Q reactances with conventional bridge circuits, cannot exist with the Type 310-B.

Measurements can be made of impedances from 0.5 to 100,000 ohms, from 30 cps to 40 kc. Up to 20 kc, impedance magnitude accuracy  $\pm 1\%$  and  $\pm 2^\circ$  for angle. From 20 to 40 kc, accuracy decreases somewhat. Uses include measurements of amplifiers, electro-acoustic transducers, transmission lines, filters, indicating meters and transformers. Fig. 1 shows some typical measurements. Rapid production testing and sorting of electrical components without individual balancing is another application.

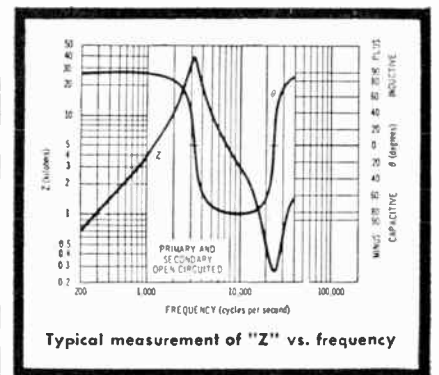

Typical measurement of "Z" vs. frequency



**ACTON  
LABORATORIES, INC.**

A Subsidiary of Technology Instrument Corp.

517 MAIN ST., ACTON, MASS.

Sales Engineering Office

1225 W. Olympic Blvd., Los Angeles, Calif.

CIRCLE 181 ON READER SERVICE CARD 181

Available soon!

# THE NEW TELREX CATALOG AND TECHNICAL DATA BOOK



Reserve your copy!

Just write us on your company letterhead; your free copy will be sent as soon as available. Please address requests to Dept. TC.

A veritable handbook on antennas and systems everyone in communications, commercial or military, will find informative and helpful. Complete information on everything from antennas and towers to rotation and indication systems.



ASBURY PARK 25, NEW JERSEY, U.S.A.

CIRCLE 101 ON READER SERVICE CARD

nected series of papers presented at the Symposium on Electronic Waveguides held in New York in April 1958.

For those well-versed in electromagnetic field theory and the interaction between these fields and free or nearly free electrons, this book will serve as a useful survey of the accomplishments in the field as of the date of the presentation. It is an excellent reference for the expert in the field, but far too complex for the student or novice.

To this reviewer, its major contribution is the exceptionally well-documented references at the end of each paper, which in total furnishes one of the best bibliographies in this field that has ever reached print.—J. H. VOGELMAN, *Technical Director, Directorate of Communications, RADC, Griffiss Air Force Base, N. Y.*

## THUMBNAIL REVIEWS

**Foundations of Information Theory.** By A. Feinstein, McGraw-Hill Book Co., Inc., New York, 1958, 135 p. \$6.50. Concise, rigorous exposition of fundamentals of mathematical theory of information. Though prior knowledge is not assumed, familiarity with concepts of elementary probability theory and space is required.

**Techniques of Magnetic Recording.** By J. Tall, The Macmillan Co., New York, 1958, 472 p., \$7.95. Differs from previous books on magnetic recording in that a great deal of good material on unusual recording techniques is presented.

**General Electric Transistor Manual.** General Electric Co., Syracuse, N. Y., 1958, 168 p., \$1.00. This third edition includes 108-p expanded application and theory section.

**Nuclear Radiation Detection.** By Wm. J. Price, McGraw-Hill Pub. Co., Inc., New York, 382 p., \$9.00. Basic information on all important nuclear radiation detectors in use today. Last chapter is devoted to the electronic circuitry used in detection equipment and covers pulse shaping, linear amplifiers, pulse amplitude discriminators scaling circuits, counting-rate meters and small-current electrometers.

Announcing . . .

## LABORATORY STANDARD R. F. VOLTMETERS

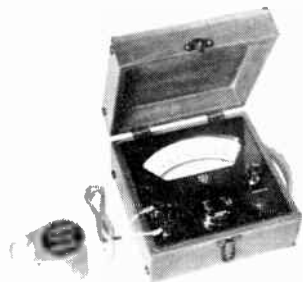

- Flat response to 100 megacycles/sec.
- Ideal for checking V T V M's
- Calibrate on D.C. or 60 cycles/sec.
- Can be certified by Bureau of Standards
- Separate thermocouple units available in ranges 1 volt, 3 volts and 10 volts
- Also units for 30 volts and 100 volts with less frequency range

Write for Bulletin 800.



**Rawson**  
ELECTRICAL INSTRUMENT CO.  
fine instruments since 1918

111 Potter Street • Cambridge, Mass.

No quicker, more accurate way to get information on PRODUCTS and SERVICES than . . . .

## electronics BUYERS' GUIDE

keep it  
at your  
fingertips!

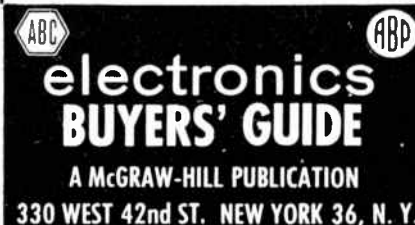



**Epoxy Resins.** By I. Skeist, Reinhold Pub. Corp., New York, 1958, 293 p, \$5.50. Uses of epoxy resins in the electronics industry makes this book of special interest.

**Interference between Power Systems and Telecommunication Lines.** By H. R. J. Klewe, St. Martin's Press Inc., New York, 1958, 256 p, \$12.50. Design information for coexistence of telecommunication and power lines.

**Vacuum Tube Characteristics.** By A. Schure, John F. Rider Pub., Inc., New York, 1958, 96 p, \$1.80. Intermediate level book discusses creation and application of load lines for the calculation of gain, power output and harmonic distortion using practical examples.

**Automatic Process Control.** By D. P. Eckman, John Wiley and Sons, Inc., New York, 1958, 368 p, \$9.00. Undergraduate level textbook begins with process analysis and carries into behavior of closed-loop systems.

**Selections from Modern Abstract Algebra.** By R. V. Andree, Henry Holt and Co., New York, 1958, 212 p, \$6.50. Level is suitable for the undergraduate student. Many problems and examples illustrate the lucid text which covers such topics as number theory, Boolean algebra, groups, matrices and fields.

**Dilogarithms and Associated Functions.** By L. Lewin, MacDonald and Co., London, 1958, 353 p. Most thorough and complete exposition of dilogarithms published so far. Suitable for the mathematician wishing to acquaint himself with this rather uncommon mathematical function.

**English-Russian, Russian-English Electronics Dictionary.** McGraw-Hill Book Co., New York, 1958, 952 p, \$8.00. Compiled from sources in the U. S., U.K and U.S.S.R., this dictionary lists about 22,000 Russian and 25,000 English terms in the fields of electronics theory and applications.

**Nomography.** By L. I. Epstein, Interscience Pub., Inc., New York, 1958, 134 p, \$4.50. Methods of nomograph construction are covered along with underlying theory.

**Fundamentals of Digital Computers.** By M. Mandl, Prentice-Hall, Inc., New York, 1958, 297 p, \$9.00. Technical level introduction to digital computers covering basic mathematic notations and codes. Explains how circuits and components are combined to form integral computer units. Special features of various commercial computers are also considered.

## NEW "STANDARD" with SPECIAL CAPABILITIES

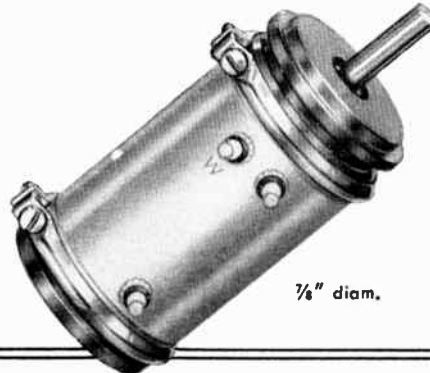

- Rugged Anodized Aluminum Housing
- Operation Up to 150°C
- 5.5 watts @ 85°C (derated to 0 @ 150°C)
- Resistance Range from 250 ohms to 300K ohms

Those are just a few of the important performance features you get with the new Gamewell RVG-14-MT10 multi-turn potentiometer. It fully meets applicable sections of MIL-E-5272A and NAS-710 — and much more. It gives you extras that often save you the cost of a "special."

Available in 10, 5, or 3 turns, with tap locations limited only by physical spacing. Write for detailed specifications and catalog of other stand-

ard Gamewell potentiometers. Special pots supplied whenever necessary. Bring *all* your pot problems to THE GAMEWELL COMPANY, Dept. 13C, Newton Upper Falls 64, Mass.



**PRECISION POTENTIOMETERS**

"Integrals of High Performance"

CIRCLE 113 ON READER SERVICE CARD

## VALUABLE 64 PAGE REFERENCE SECTION

in electronics BUYERS' GUIDE

Prepared especially by the 25-man editorial staff of electronics, this 64-page section is designed to assist the buyer by providing him with market data, electronics applications, market distribution, market reports and books, industry organizations and services.

**electronics BUYERS' GUIDE  
and Reference Issue**

A McGraw-Hill Publication

330 West 42nd Street

New York 36, New York





## Ewen Knight In New Home

EWEN KNIGHT CORP., developer and manufacturer of radio sextants, radiometers, and other complex microwave components, recently moved from Needham, Mass., to a new and larger laboratory and manufacturing facility in the Cerel-Perini Industrial Park at East Natick, Mass.

Harold I. Ewen, president and technical director, says the new office, research and manufacturing areas, occupying 30,000 sq ft, will provide both the added space and specialized facilities necessary to keep pace with the company's program of planned expansion.

Holder of eight "firsts" in the field of radio astronomy, Ewen Knight builds low noise receivers and receiver systems. These include exotic receiver components such as masers and parametric amplifiers, and more conventional amplifiers using vacuum tubes.

Types of low noise (sensitive) receivers include passive radar, Doppler navigation, long-range radar receivers, exotic communications systems for either space or ground based operation, radio telescope and/or radio astronomy receiving equipment (including sextants), and missile range acquisition tracking and safety systems. The firm is currently developing maser conversion kits for radar.

Group directors of Ewen Knight's research and development program, functioning under Harold Ewen, are Hays Penfield, Edwin Richter and John Campbell. Leo F. Mulhern is executive vice-president, and Robert H. Farwell, vice-president.



## Appoint Kuhn Chief Engineer

LYNCH CARRIER SYSTEMS, INC., San Francisco, Calif., has appointed

Henry G. Kuhn to the position of chief engineer.

Kuhn has had more than 20 years' experience in communications with particular emphasis upon carrier telephone/telegraph circuitry and equipment. His most recent employment was with Lenkurt Electric Co., San Carlos, as executive staff engineer specializing in carrier telephone, remote control and communication switching systems.

## Scott Joins Motorola

EDWARD SCOTT, radio engineer for the city of Glendale, Calif., since 1948, has joined the engineering staff of Motorola Radio Corp., at their Burlingame, Calif., office as

assistant area systems engineer. Prior to his civil service work, Scott was employed with Lee DeForest at his laboratories in Hollywood.



## Gulton Fills Executive Post

APPOINTMENT of W. R. G. Baker as chairman of the executive committee of the board of directors of Gulton Industries, Inc., Metuchen, N. J., has been announced.

Baker, president of the Syracuse University Research Corp. and former vice president of the General Electric Co., was elected to the board of the diversified electronics firm last year.

Joining him on the executive committee are George S. Jones, partner, Wertheim and Co., and William G. Stott, vice president, Morgan Guaranty Trust Co., N. Y.

Associated with the original growth of the electronics industry, Baker has been past president of the Electronic Industries Association and the Institute of Radio Engineers as well as chairman of the IRE Professional Groups.

## Set Up New Corporation

ULTEK CORP., Palo Alto, Calif., is a newly formed electronic organiza-



# ARE YOU PROPERLY GEARED FOR MINIATURIZATION?

**LEVIN**® INSTRUMENT LATHES

PRODUCE SMALL INSTRUMENT PARTS BETTER

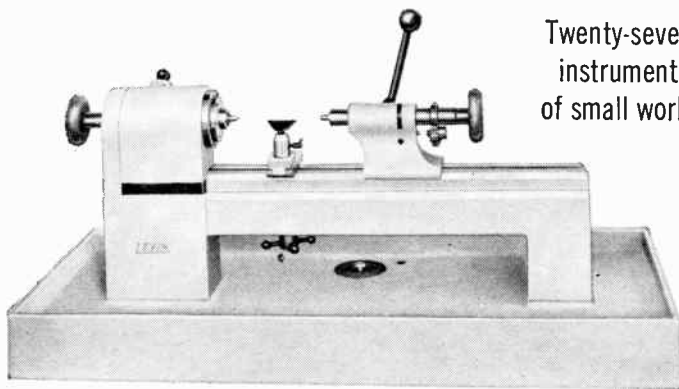

Twenty-seven models of instrument lathes for all types of small work. Collet capacity

5/16" or 3/16". Levin Instrument

Lathes are used wherever fine work is being done. Over 11,000 lathes in use.

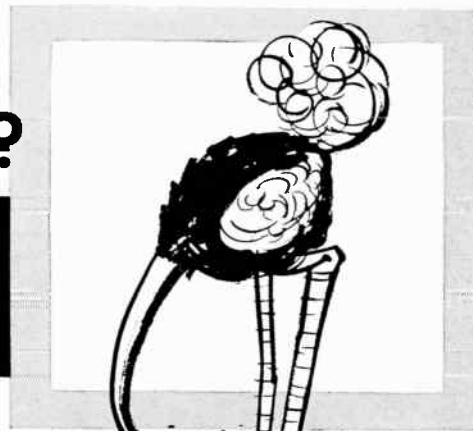

For complete details of Levin Instrument Lathes and accessories send for catalog T.

Louis Levin & Son, Inc., 3610 So. Broadway, Los Angeles 7, Calif.

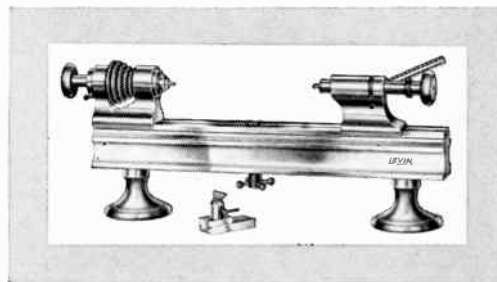

CIRCLE 114 ON READER SERVICE CARD

**NEW** from the  
*Grayhill Sketch Book*

## PLUNGER TYPE BINDING POST Series 29-100

For fast, positive test connections

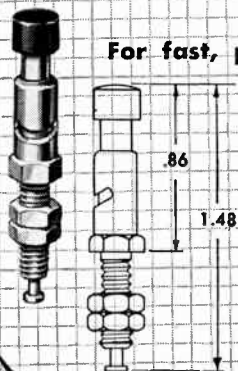

- Spring-loaded plunger allows fast connect-disconnect.
- Spring pressure insures positive contact.
- Extends only 3/4" in front of panel.
- Made of nickel-plated brass.
- Molded phenolic button caps—standard red or black, other colors on special order.

- Model 29-100—#8-32 NC-1 threaded stud.
- Model 29-101—Banana Plug
- Model 29-104—Molded phenolic insulating washers.

Write For Complete Details

"Pioneers in  
Miniaturization"

**Grayhill**  
INC.

Phone: Fleetwood 4-1040

# MAXIMUM SENSITIVITY



X BAND  
MODEL MMX-2

with LEL's

## MATCHED MIXER-PREAMPLIFIERS

The MMX-2 is the newest X Band matched mixer-preamplifier assembly offered by LEL. Covering a frequency range of 8.5 to 9.6 KMC, the MMX-2 provides an 8 mc bandwidth, a maximum noise figure of 7.5 db, and a minimum power gain of 25 db. I.F. power output of 0.5 watt across 50 ohms is provided at 30 or 60 mc center frequency. Other microwave receiver front ends are available for C, S, L, and KU bands with integral preselector, local oscillator and AFC circuits if desired.

**LEL**

380 OAK STREET  
COPIAGUE, L.I., N. Y.

CIRCLE 192 ON READER SERVICE CARD

World Radio History

Components and assemblies  
ride high, wide and handsome  
with **GHS HERMETIC  
SEALING**

## SURVIVAL IN INNER SPACE

Spanking new products off the drawing boards hold high promise... until their natural enemies "gun them down" with destructive environmental forces. Why not consider hermetic sealing — the proven technique that builds an impenetrable shield against 7 major causes of product failure? By use of inert gas filling, GHS Hermetic Sealing permanently rids your components and systems of any of the common hazards of corrosion, dust, fungus, altitude pressures, etc., which can seriously affect their rated performances. Let us show you how to preserve the quality reputation of your products with hermetic sealing.

### RE-USABLE HERMETIC SEALS

Pressurized GASEALS for static sealing assure absolute protection against gases and liquids under severe conditions of temperature and environment.



#### GASEALS

Available in many sizes and shapes for Aircraft, Missiles, Electronics, Industrial and Military Applications

WRITE OR CALL TODAY FOR HERMETIC SEALING BROCHURE, AND GASEAL BULLETIN NO. 258A



#### GENERAL HERMETIC SEALING

CORP.  
99 E. HAWTHORNE AVE.  
VALLEY STREAM, L.I., N.Y.  
VALley Stream 5-6363

ELECTRONIC SUB-SYSTEMS ■ MEGPOTS ■ GASEALS  
TOGGLE SWITCHES ■ HERMETIC SEALING SERVICES

tion specializing exclusively in the production and development of electronic vacuum pumps and related equipment.

Officers of the new concern are Lewis D. Hall, president; Reid W. Dennis, vice president; and J. William Sugg, secretary-treasurer. Other present staff department heads include Charles F. Brothers, Charles A. Piercey, Victor H. Soules and Buck W. Wong.



## Burke Heads Up Siegler Program

IN A MOVE reflecting the continuing growth and importance of its military business, The Siegler Corporation has announced plans for integrating all its defense activities.

John J. Burke, who has been elected a vice president of the corporation, will direct the new program. He will coordinate the military activities of the Hallamore, Olympic, Hufford and Bogen-Presto divisions of Siegler which are participating in the missile and space age aspects of the national defense program.

Previously, Burke was executive vice president of the Hallamore Electronics Division of Siegler.

## Plant Briefs

Transistor Specialties, Inc., has leased a new 10,000 sq ft building in Plainview, N. Y. Company intends to specialize in the fields of photoelectronics, infrared, data

# electronics READER SERVICE CARDS

...have increased the flow  
of product and service  
literature to readers.

...have helped increase  
manufacturers' sales.

Reader Service Cards have  
been provided to get quick and  
easy information on products.

Avail yourself of this Service  
to get all the information you  
need.

Manufacturers are cooperating  
wholeheartedly with the Service  
to supply information  
promptly.

**electronics**  
A MCGRAW-HILL PUBLICATION  
330 WEST 42nd ST. NEW YORK 36, N. Y.



processing, ferrite controls, digital controls, transistor circuitry and to design and manufacture electronic measuring, counting and detecting devices.

Servotronics, Inc., Buffalo, N. Y., is a newly established corporation producing electromechanical servo devices for the aircraft and missile industry.

The Narda Ultrasonics Corp. has expanded into a 10,000 sq ft second building adjacent to its main plant in Westbury, L. I., N. Y.

Cambridge Thermionic Corp., Cambridge, Mass., has under way a plant expansion program which will provide a total of 30 percent additional floor space for manufacturing, experimental, and testing facilities.

C. P. Clare, president, broke ground recently for an 18,000 sq ft addition to the general offices and factory of C. P. Clare & Co., Chicago, Ill. The latest expansion move will double present laboratory space and add to office and production facilities.

## News of Reps

Wilson H. Zimmerman of Syracuse, N. Y., has been appointed to represent Centralab, Milwaukee, Wisc., in the upper New York State territory, except for the eight southern counties of the state.

In Tioga, Broome, Delaware, Ulster, Sullivan, Orange, Dutchess, and Putnam counties, Centralab will be represented by George P. Marron of Westfield, N. J.

E. V. Roberts and Associates, manufacturers' rep, has added Jerry Porter to its staff as electronics sales engineer specializing in the servicing of distributors in the Los Angeles area.

Appointment of Western Engineering Co. of Phoenix and Denver, as manufacturers' rep for Filtors, Inc., Port Washington, N. Y., is announced. Rep will cover Arizona, Colorado, eastern Idaho, eastern Montana, Utah, Wyoming, New Mexico, and El Paso, Texas.

## NEW SOLUTION TO RELAY TESTING PROBLEMS

### SCHMELING MODEL 140 UNIVERSAL RELAY ANALYZER

Quantitatively checks relay operation under actual contact current



...FOR FAST,  
ACCURATE,  
TESTING OF  
RELAYS

- Precise Check of Pull-in and drop-out Voltage
- Exact Measurement of Contact Make and Break Time
- Accurate Evaluation of Contact Bounce
- Overlap Time on Make Before Break and Break Before Make Contacts
- Contact Resistance Measurement under Both Load and Dry Current Conditions

AUTOMATIC MODELS AVAILABLE — Call or write for complete information on standard and automatic models, today!

## Schmeling Electronics

DIVISION OF RARITAN INDUSTRIES CORP.

20 FIRST STREET, KEYPORT, NEW JERSEY, U.S.A.

DESIGNERS AND MANUFACTURERS OF QUALITY TEST EQUIPMENT

CIRCLE 103 ON READER SERVICE CARD

## BEST BY DESIGN

### — Not by Chance

Constant attention to the wants and needs of users, has been worked into the finished recorder by trained designers, who devote their entire effort to producing the best in direct-writing recorders. *E-A Recorders* are designed to be the best. Performance has proved their superiority.

Ask for Catalog 657



PRODUCT REPRESENTATIVES IN MOST PRINCIPAL CITIES

### The ESTERLINE-ANGUS Company, Inc.

Pioneers in the Manufacture of Graphic Instruments

Dept. E, P. O. Box 596, INDIANAPOLIS 6, INDIANA

# NEW NYLON & THERMO-PLASTIC PARTS from GRC

Economically mass produced on fully automatic patented machines GRC nylon parts are available from stock in many sizes and types. GRC uses single cavity techniques, molds in one automatic cycle, gets accurate, uniform parts, ready for immediate use.

These advantages, these economies, apply too, to tiny made-to-order parts to your specifications . . . in quantities of 25,000 to many millions. Write for bulletin describing GRC's unique method for injection molding small plastic parts or send prints for quotation. Ask about our zinc alloy die castings tool.

See us at the Metals Show

BOOTH #1019

NO SIZE TOO SMALL  
Maximum size 1 1/4"  
long—.03 oz.

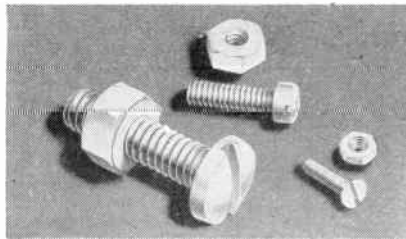

## NYLON SCREWS & NUTS

Brand new nylon hex nuts in ten sizes (#2 thru 5/16" added to GRC's complete line of nylon screws. GRC's single cavity molding technique gives exceptional uniformity, accuracy, and economy to the outstanding properties of nylon fasteners.

Take advantage of nylon's high strength to weight ratio, built-in electrical insulating properties, stability, resilience and elasticity. GRC molded nylon fasteners, nuts and screws, set screws, screw insulators, washers, etc.—are available from stock in a wide range of types, sizes and lengths.



WRITE, WIRE, PHONE NOW for GRC's new catalog of die cast and molded fasteners.



### GRIES REPRODUCER CORP.

World's Foremost Producer of Small Die Castings  
151 Beechwood Ave., New Rochelle, N. Y. • NEW Rochelle 3-8600

CIRCLE 104 ON READER SERVICE CARD

## COMMENT

### Sober Reappraisal

I don't suppose I'm much different from other engineers who feel a sense of responsibility for the disparity between our national aims and our national accomplishments. With a Soviet rocket right now circling the backside of the moon on its way back to earth, I'm beginning to wonder where we went wrong.

We have good men working on guidance systems, and our systems are as accurate as can be designed. Yet we can't match the Soviet feat insofar as precision is concerned. I don't know too much about our rocket people, but it would seem to me that our massive technology should be able to develop a rocket that matches the Lunik launcher in power and reliability. Instead, the Atlas not only blows up on the launching pad but destroys the pad too—it'll be out of commission for months.

Is it in the level of educational merit? Perhaps we need a sober reappraisal of engineering education to ensure an adequate supply of talented engineers. Perhaps, although the idea is repugnant to me personally, we need federal subsidy for engineering education.

Perhaps too we need to reappraise our aims, both as engineers and as citizens. Maybe we're working toward the wrong goals.

It's frustrating to stand by and watch the Soviets streak forward into space and not be able to do anything about it. One feels as if there should be a call to arms, something to which one could respond by doing constructive work instead of stewing in an agony of frustration.

T. J. FRANKLIN  
LAS CRUCES, N. M.

## .. . Electrical Coil Windings

For 40 years . . . specializing in all types of coils to customers' specifications. Design or engineering assistance available on request.

# COTO-COIL CO., INC.

SINCE 1917

65 Pavilion Avenue Providence 5, Rhode Island

CIRCLE 105 ON READER SERVICE CARD

## MEET ED DeJONGH

Associate Editor, electronics  
MARKET RESEARCH EXPERT



A graduate of Oberlin, BA, and Harvard Business School, MBA, Ed DeJongh is the researcher and analyst who is responsible for "Market Research", "Figures of the Week", sales estimates, sales forecasts, marketing news, and developments in marketing. Ed is constantly preparing for a year-end statistical issue and forecast for the following year. If you're not a subscriber, if your subscription is expiring, if you need market data in your work, fill in box on Reader Service Card. Easy to use. Postage free.



**electronics** 

A McGraw-Hill Publication

330 West 42nd Street, New York 36, N. Y.

We started late; let's remember that. Some nine years late. Measured that way, we've moved fast. And our goals were high while our effort was not; he who thinks he is winning never puts out all possible effort. Add to this one very important philosophical fact: we concentrate, as a nation, on the ways of peace. Warlike efforts are to us an ugly expediency of war. To many of us war is remote be-



# switching COAX?

## AT X BAND

you need

# TRANSCO Y-40

V

Q

K

X

S

L

P



AT 11 KMC

VSWR 1.1

INSERTION LOSS .2 db

CROSSTALK 30 db

Another broadband Coaxial Switch is added to an ever-expanding line, the Y-40 is specifically designed for unexcelled performance through X-Band.

Only at Transco will you find the broad variety — the exact Coaxial Switch you require! Transco specializes in designing and manufacturing microwave components and systems for transmission control that meet your every need!

Send for complete  
product data

## TRANSCO PRODUCTS INC.

12210 NEBRASKA AVENUE  
LOS ANGELES 25, CALIFORNIA

cause we put it out of our thoughts, and a competition so savage and bitter as to smack of war is kept in the same remote corner. Only those close to defense planning think constantly in terms of the massive effort required for massive competition.

Perhaps we concentrate too much on comfort; that is a decision implicit daily in the individual actions of all our citizens. We are not sternly disciplined, austere conservative of our energy and our treasure. It takes a crisis to move us, as a nation, to critical effort. But many of us—reader Franklin included—recognize the crisis; the degree to which his sense of frustration is shared by others in the engineering fraternity demonstrates this. And we are moving.

Reappraisals, especially reasoned, sober, intelligent ones, are good for us. Let us be careful, however, that we don't, like the dog in the fable, drop the pork chop in grabbing for the reflection.

### Heart Pacer

I would appreciate knowing the affiliation of L. D. Trump and R. L. Skinner, who developed the heart pacer described in the Research & Development section of the Sept. 25 issue of *ELECTRONICS* ("Simple Heart Pacer is Highly Reliable," p 92).

Your publication is one I read thoroughly, and is excellently constructed.

C. C. SHEPARD

MOTORESEARCH Co.  
RACINE, WISC.

Authors Trump and Skinner are affiliated with Ensco Inc., of Salt Lake City. The omission of this information was an oversight.

### Genuine Interest

The word "genuinity" is used in the *Electronics Newsletter* item about the second Venus radar probe (p 11, Sept. 25). Is this a new word or did it slip by your editors?

K. R. FORTMAN

SANDIA CORP.  
ALBUQUERQUE, N. M.

No word; just sounds good.

# SEE IT!

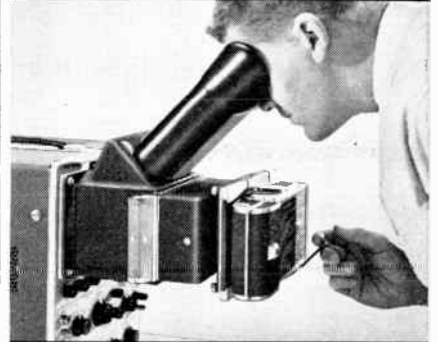

# SHOOT IT!

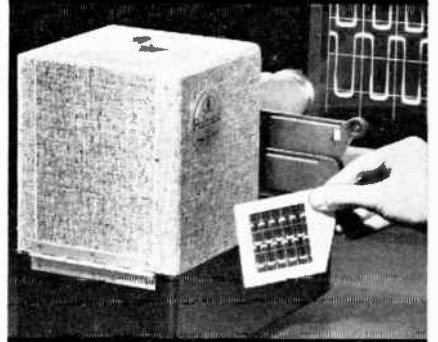

# SHOW IT!

...in only

# 2 MINUTES

## on Polaroid® Land Projection Film

Just a few minutes from the time you record oscilloscope traces with this new Beattie Oscilloscope and Polaroid® Land Film Type 46, you can project a transparency. Also produces 60 sec. paper prints with the new, very fast Polaroid® 3000 Speed Film. Records up to 10 traces on a single frame and offers these many other advantages:

- Direct binocular view of CRT while recording.
- Non-reversed image.
- Camera swings back for easy access to lens and shutter, or lifts off completely. Can be rotated.
- Electric shutter-actuator available.
- Attaches easily to bezel of 5" CRT. Adaptable to other sizes. No special tools.

"Polaroid" ® by Polaroid Corp.

Write today for full details

**B** BEATTIE-  
**C** COLEMAN inc.

1000 N. Olive St., Anaheim, California  
Branch: 437 Fifth Ave., New York, N.Y.

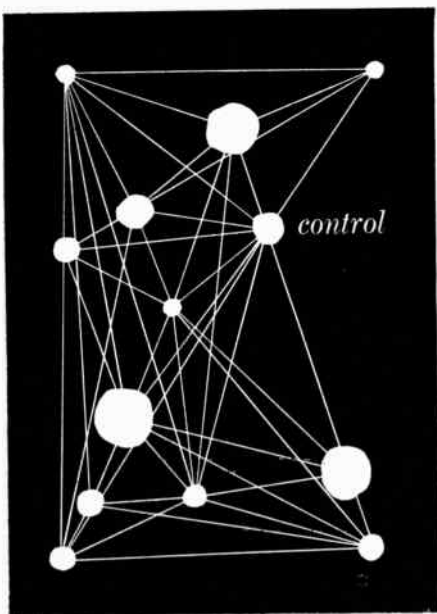

## careers in control of space

For 74 years, Minneapolis Honeywell has pioneered and led the development and production of advanced automatic controls. Today, with work in this area more demanding and more rewarding, new opportunities exist for engineers.

**PRODUCTION:** Develop and establish assembly processes for a wide range of products. Requires background in complex devices such as gyros, accelerometers, flight systems, and a thorough knowledge of production processes.

**COMPONENT APPLICATION:** Senior development engineer (BSEE) to pioneer as specialist on radio noise suppression. Also, a specialist in application of capacitors to aid and guide design engineers.

**INSTRUMENTATION:** Development and design in the critical areas of test instrumentation for Aero Division products. Two years' experience in test instrumentation desired.

**FIELD SERVICE:** Monitor airborne system performance in U.S. and overseas. Conduct training, liaison with military. BSEE preferred, or graduate engineer with high electronic aptitude.

*If you're interested in a challenging career in advanced automatic controls, write Mr. Bruce D. Wood, Technical Director, Dept. 849E.*

**Honeywell** 

AERONAUTICAL DIVISION  
1433 Stinson Blvd. N.E., Minneapolis 13, Minnesota  
To explore professional opportunities in other Honeywell operations coast to coast, send your application in confidence to H. D. Eckstrom, Honeywell, Minneapolis 8, Minnesota.



## DEVICE DEVELOPMENT ENGINEER



26,000 TI transistors will be produced from slices of germanium crystal seen in container above being inserted into diffusion furnace. Magnified in circle above are 3/ of more than 1,000 transistor hearts per slice.

your future:  
a challenging opportunity  
with an industry leader

Now take advantage of maximum professional growth at Texas Instruments by participating in development of the most advanced semiconductor-component devices. Working with the newest facilities, take part in:

- **DEVICE DEVELOPMENT** Development of new devices by studies in solid-state diffusion, alloying of metals and semiconductors, vacuum deposition of metals, surface chemistry, and solid state physical measurements.
- **SURFACE STUDIES** Surface reactions and surface energy phenomena on silicon and germanium.
- **ADVANCED COMPONENT DESIGN** Development of new components by studies of deposition of thin films, electrolytic studies such as anodic oxidation rates and film structures.
- **NUCLEAR RADIATION** experiments on semiconductor materials and devices.

With TI, receive liberal company-paid benefits, including profit sharing (last year 15% of base salary).

*Interviews will be held in your area soon. If you have an Electrical Engineering, Physical Chemistry or Physics degree and experience in semiconductor or related development areas, please send a resume to:*

H. C. Laur, Dept. 201-E-EL  
(for immediate Eastern appointment)  
1141 E. Jersey Street, Elizabeth, New Jersey

OR  
C. A. Besio,  Dept. 201-EL

**TEXAS INSTRUMENTS**  
INCORPORATED  
SEMICONDUCTOR - COMPONENTS DIVISION  
POST OFFICE BOX 312 • DALLAS, TEXAS

World Radio History

## Immediate Openings

\* OVERSEAS  
and in the  
UNITED STATES  
ASSIGNMENTS

for  
**RADIO**  
and  
**MICROWAVE**  
**ENGINEERS**

and  
**TECHNICIANS and TECHNICAL WRITERS**  
(Family may accompany)

**RADIO ASSIGNMENTS.** Require some Telecommunication System and/or Propagation Path Test Experience.

**MICROWAVE ASSIGNMENTS.** Require 3-5 years' general experience in route design and equipment specifications. Installation or operation of telecommunication-systems experience also helpful.

Send resumes to  
J. J. QUIRK

**TELEVISION ASSOCIATES of INDIANA**  
Incorporated

E. BARKER AVE., (LAKELAND)  
MICHIGAN CITY, INDIANA

\*U. S. Citizenship required.

## ELECTRONIC ENGINEERS

A leading, independent research organization has two positions available for men with BS or MS degrees in electronic engineering from accredited colleges. Men with 1-10 years' experience in development of vacuum tube, transistor or relay circuits, or recent college graduates will be considered. Salary commensurate with qualifications. Interesting, unusual work in data transmission and retrieval and digital computing. Non-military work within small group. Individual effort recognized—good job security—ideal working conditions. All benefits. Long-established firm located on Chicago's North Shore. Forward your resume in confidence.

P-2404 Electronics  
520 N. Michigan Ave., Chicago 11, Ill.

## TECHNICAL DIRECTOR

\$25,000  
Plan and coordinate the work of scientists, engineers, and technicians in fast expanding firm with solid financial backing. R & D in advance military electronics of most challenging nature. Profit sharing.  
MONARCH PERSONNEL  
28 East Jackson Blvd. Chicago 4, Ill.



WE'RE LOOKING  
FOR A MAN  
LIKE Bernoulli



$$P_0 v_1 + h_a d_a v_1 g + \frac{1}{2} d_a v_1 V_1^2 = P_0 v_2 + h_a d_0 v_2 g + \frac{1}{2} d_0 v_2 V_2^2$$

## —WITH A MODERN TURN OF MIND

*Bernoulli pushed through the first frontier of hydrodynamics.*

*Today the underwater-to-air-to-underwater SUBROC antisubmarine missile is being developed at Goodyear Aircraft.*

*If you have a Bernoullian bent, this program will appeal to you — and so will the company — the people and the organization.*

*So, too, will rock-solid programs in astronautics — already underway at Goodyear Aircraft — destined to throw light on the dark side of the moon.\**

*If you're good, we'll sign you in. If we sign you in, you won't want to leave — for reasons as sound as your future. And ours.*

*Write: Mr. Charles Jones, Director of Technical & Scientific Personnel, Goodyear Aircraft Corporation, Akron 15, Ohio.*



**GOOD YEAR AIRCRAFT**

\* Programs in rocket propulsion, interplanetary guidance, nose cones, advanced black boxes, crew-escape capsules — also in ground support systems for missiles, radar structures, radomes, radiation research, structures engineering.

*Explore new areas at IBM in*

# PHYSICS

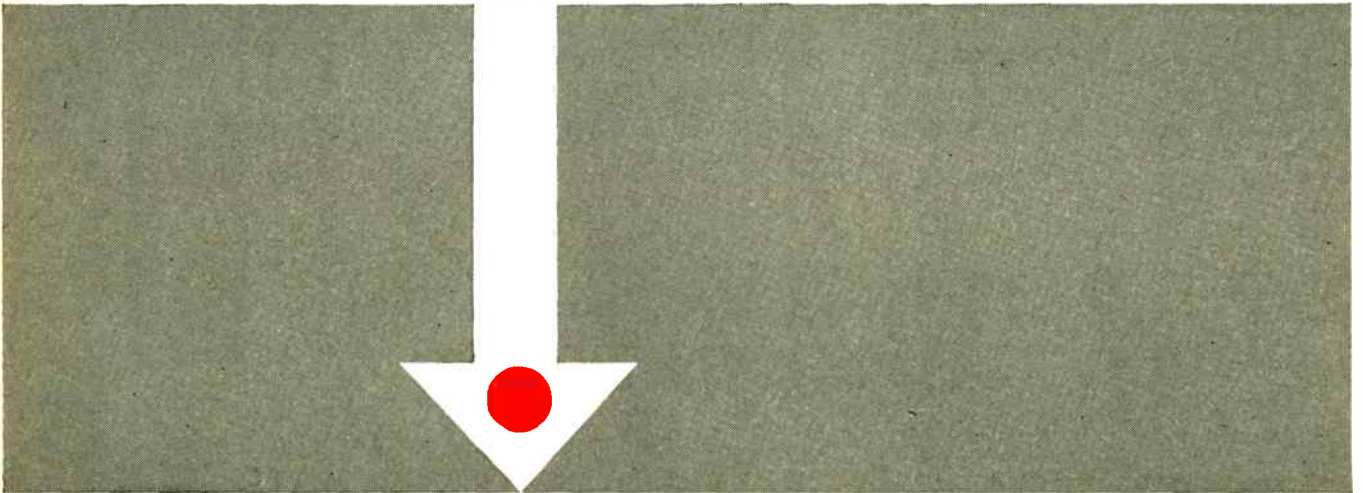
**At IBM, scientists, mathematicians and engineers are currently engaged in many unique assignments in advanced physics. For example:**

1. Photoelasticity is being studied to determine strain propagation as a function of time in solids. This work is designed to clarify laws governing impulse strain waves, as well as to determine dynamic stresses that exist in impact and other phenomena.
2. Fundamentals of the magnetic properties of materials are under study. The immediate interests are spin-wave investigations, particularly those relating to the switching times of remagnetization and spin-wave propagation in polycrystalline materials.
3. Optical techniques, with organic and inorganic thin films, are being used to examine the properties of absorption phenomena in surfaces and substrates.

You'll find a wide range and diversity of career areas at IBM. Advancement is rapid, due in part to the demands of a constantly expanding program of research and development, and in part to a long-continued record of promoting from within, based on individual merit and achievement. Depending on your field of interest and on your abilities, you may work alone or as a member of a small team. You'll be given all the specialized assistance you need.



**CAREERS AVAILABLE  
IN THESE AREAS:**

Acoustics	Mathematics
Aerodynamics	Mechanics
Astrophysics	Nuclear Physics
Cryogenics	Optics
Inertial Control	Semiconductors
Magnetics	Solid State

**QUALIFICATIONS:**

B.S. or Advanced Degree in Physics, Electrical Engineering, Engineering Physics, or Mathematics — plus proven ability to assume a high degree of technical responsibility in your sphere of interest.

**SOME ASSIGNMENTS  
NOW OPEN INCLUDE:**

Investigation of theoretical device design and experimental proof of feasibility for ultra-high-speed transistor; P-N junction technology; surface studies; optimization of semiconductor fabrication.

Creating techniques for solving boundary value problems, such as field theory of structures (Green's function methods, for example), or stress wave propagation in solids.

Study of flow and pressure distributions in hydrodynamic transients, to provide information for the development of a comprehensive theory of short duration (pulse), high Reynold's number fluid-flow systems.

Determining dynamic behavior of micromagnetic fields by applying low-level, high-frequency circuit knowledge for small, closely coupled circuits as a result of Hall effect studies.

Study of basic scientific phenomena in the field of energy conversion; design of experiments for the investigation of electrical discharge in various environments and investigation of distribution and loss of energy. The objective is to develop energy conversion techniques that exceed the limited performance and efficiency of existing conversion methods.

Physical-mathematical studies to determine how complex control problems may be solved with digital computers. Applications in missile systems and special-purpose computer systems.

Development of magnetic devices for use in logic switching and computer "memory." Experience in fundamentals of nonlinear magnetics necessary.

Write, outlining background and interests, to:  
**Mr. R. E. Rodgers, Dept. 554J4**  
**IBM Corporation**  
**590 Madison Avenue**  
**New York 22, N. Y.**

# IBM

World Radio History

INTERNATIONAL BUSINESS MACHINES CORPORATION

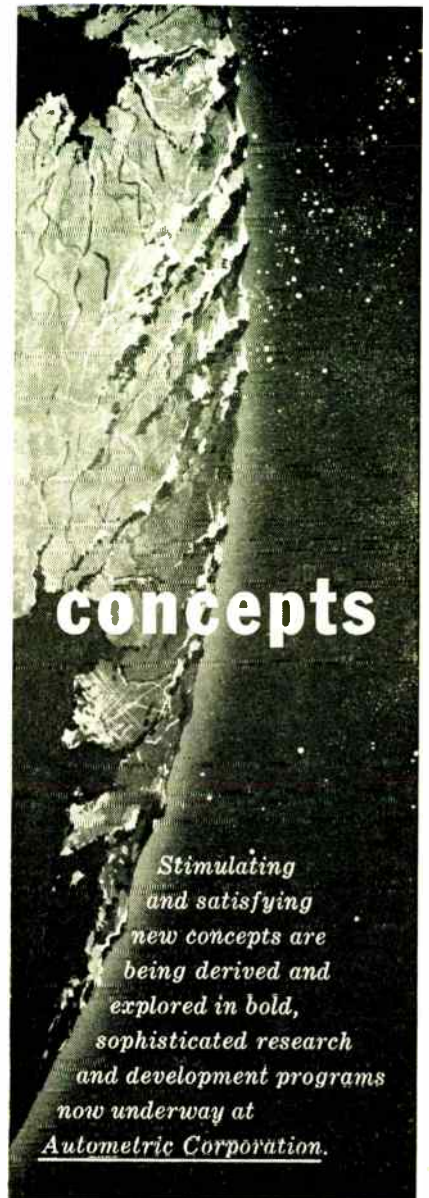

**concepts**

*Stimulating  
and satisfying  
new concepts are  
being derived and  
explored in bold,  
sophisticated research  
and development programs  
now underway at  
Autometric Corporation.*

Excellent opportunities exist for

**ELECTRONIC ENGINEERS**

with three years' minimum experience in vital areas of reconnaissance data reduction, mapping methods and color television systems.

- digital computer development: circuit and logical design
- television systems, circuits and displays
- printed circuit design and packaging

Qualified persons are invited to contact Mr. S. Shelby, Personnel Administrator

**AUTOMETRIC**  
**CORPORATION**

1501 Broadway, New York 36, NY

## ELECTRONIC ENGINEERS

... Positions at several levels including supervisory  
 ... High salaries — commensurate with ability and experience

Interesting and challenging positions with Republic Aviation Corporation for electronic engineers to develop test equipment, methods and procedures for determining the conformance of complex electronic equipment to AF and Company quality control specifications and standards.

Work closely with other engineering groups and electronic manufacturers to determine types of equipment required to test and simulate flight operations of radar, navigation, fire control, and other types of electronic systems.

Develop procedures and methods for use of electronic test equipment. Assist supervision with manufacturing problems. Investigate malfunctioning of electronic equipment off and on aircraft. Prescribe corrective action. Make recommendations in methods and procedures as may be required to meet new developments in the electronic fields.



Send resume in confidence to: Mr. William Walsh

**REPUBLIC AVIATION**

Farmingdale, Long Island, N. Y.

Less than 1 hour from New York City

## CHALLENGING OPPORTUNITIES IN RESEARCH AND DEVELOPMENT

**ELECTRONIC  
 ENGINEERS**

**SYSTEMS  
 ENGINEERS**

Design of electronic instrumentation for underwater ordnance. Analytical and experimental treatment of scientific research problems in the fields of hydrodynamics, acoustics, electronics, network theory, servo-mechanisms, mechanics, information theory and noise analysis including analogue and digital computations.

**THE  
 PENNSYLVANIA STATE UNIVERSITY  
 ORDNANCE RESEARCH LABORATORY**

P. O. Box 30

**University Park, Pennsylvania**

- Opportunities for Graduate Study
- Faculty Appointments for Qualified Applicants
- Excellent Working and Living Conditions

Send Resume To:

**ARNOLD ADDISON  
 Personnel Director**

## electronic instrument development engineers

Minimum of 5 years of applicable experience required. An advanced degree desirable but not essential.

*Because* Boonton pioneers in developing such fundamental precision measurement instruments as the "Q" meter and other pacesetting electronic devices, your opportunity to engage in creative research is unusually great. As a member of our development team, you'll be exchanging ideas with men who have made notable contributions to the state of the art. By joining our staff now, your opportunities to make contributions to our expanding product line will be great.

If your experience lies in:

- CIRCUIT ANALYSIS AND SYNTHESIS
- VHF OR UHF MEASUREMENT TECHNIQUE
- PRECISION MEASUREMENT OF FUNDAMENTAL PHYSICAL QUANTITIES

then we urge you to write or call Mr. J. P. VAN DUYNE, Engineering Manager.

**BOONTON**

**RADIO Corp.**

BOONTON New Jersey

World Radio History

## STANFORD RESEARCH INSTITUTE

offers unique opportunities to

## ELECTRONIC ENGINEERS

in

**Industrial Product Planning  
 and Market Research**

Challenging techno-economic research positions for men with BSEE degrees and five years experience in product design, product planning or industrial marketing in the electronics field.

Research programs in our Economics Division involve top level contacts with manufacturers and users of electronics equipment to determine specifications and markets for COMPUTERS, MICROWAVE DEVICES, CONTROL DEVICES, OFFICE EQUIPMENT, INSTRUMENTATION AND COMPONENTS.

Responsible assignments, industrial level salaries and desirable San Francisco Bay Area living complement an atmosphere conducive to professional growth and development.

Write to:

R. K. Ditmore

**STANFORD RESEARCH INSTITUTE**

Menlo Park, California

## CREATIVE PHYSICIST OR ELECTRICAL ENGINEER

Develop advanced equipment for semi-conductor manufacture. Two senior positions open at Manufacturing Laboratory in Forest Hills, Pennsylvania.

Requires M.S. or equivalent in Physics or Electrical Engineering with major in solid state and three to five years experience in this field. Attractive salary, benefit programs, and promotional opportunities for the qualified applicants selected.

Send resume and detailing accomplishments and salary requirements to:

R. L. SAUER  
**WESTINGHOUSE ELECTRIC CORPORATION**  
 P. O. BOX 2278  
 PITTSBURGH 30, PENNSYLVANIA

## CHIEF SCIENTIST—MATHEMATICIAN

with experience in dealing with orbital calculation & space problems. To head up new group in newly created Space & Flight Vehicle Div. of prominent manufacturer. Send resumes to:

J. COOPER  
**DRAKE PERSONNEL**  
 29 E. Madison St., Chicago 2, Ill. FI 6-8700

**Need Engineers?**

Contact them through this

**EMPLOYMENT OPPORTUNITIES section**



## SEARCHLIGHT SECTION

(Classified Advertising)

BUSINESS OPPORTUNITIES  
EQUIPMENT - USED or RESALE

### DISPLAYED RATE

The advertising rate is \$24.75 per inch for all advertising appearing on other than a contract basis. Contract rates quoted on request. AN ADVERTISING INCH is measured  $\frac{3}{4}$  inch vertically on one column, 3 columns—30 inches—to a page. EQUIPMENT WANTED or FOR SALE ADVERTISEMENTS acceptable only in Displayed Style.

### UNDISPLAYED RATE

\$2.40 a line, minimum 3 lines. To figure advance payment count 5 average words as a line. PROPOSALS, \$2.40 a line an insertion. BOX NUMBERS count as one line additional in undisplayed ads. DISCOUNT of 10% if full payment is made in advance for four consecutive insertions of undisplayed ads (not including proposals).

### BUSINESS OPPORTUNITY

Capital available. Wanted—Ideas in chemical, electronics & related fields with sufficient potential to form the basis of new company. Liberal stock participation available. RO-2865, Electronics, Class. Adv. Div., P. O. Box 12, N. Y. 36, N. Y.

### WANTED

**ALLEN-BRADLEY  
RESISTORS & POTENTIOMETERS  
LEGRI S COMPANY**

391 Riverdale Ave. Yonkers 5, N. Y.

CIRCLE 460 ON READER SERVICE CARD

**LOOKING FOR  
USED/SURPLUS ELECTRONIC  
EQUIPMENT/COMPONENTS?**

For an up-to-date listing of such equipment see Searchlight Section of Oct. 16th  
WRITE TODAY!

## CONTACTS

**"HOW TO MAKE MONEY  
IN  
Mobile Radio Maintenance"**

AUTHORITATIVE GUIDEBOOK  
ABOUT THE BOOM IN TWO-WAY MOBILE-RADIO  
GIVES FACTS, FIGURES, PAY RATES,  
WRITE TODAY!

LAMPKIN LABORATORIES, INC. Instruments Div. BRADENTON, FLA.

CIRCLE 461 ON READER SERVICE CARD

## PROFESSIONAL SERVICES

**YARDNEY ELECTRIC CORP.**

"Pioneers in Compact Power" •  
Electro-Chemical Generators of Energy  
"from milliwatts to megawatts" •

40-50 Leonard Street New York 13, N. Y. WOrth 6-3100 T.M.

## ELECTRONIC

WAR TERMINATION INVENTORIES

WRITE OR WIRE FOR INFORMATION ON OUR COMPLETE LINE OF SURPLUS ELECTRONIC COMPONENTS. ALL PRICES NET F.O.B. PASADENA, CALIFORNIA

# C&H

## SALES CO.

2176-E East Colorado St.  
Pasadena 8, California  
RYan 1-7393

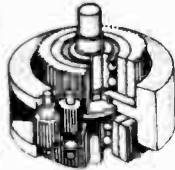

### SIMPLE DIFFERENTIAL WITH BALL-BEARING SUN GEARS

The 1:1 reverse ratio spur gears are 48-tooth, 32 pitch brass with 3/16" available face. On one side, the shaft is 23.64" dia. for 11/16" and has a pin hole, then increases in dia. to .377" for the remaining 3/16" of length. On the other side, the shaft is .377 dia. 1/4" lg. 2-13/16" dia. is required to clear the body. Stock no. A6-115.....each \$15.00

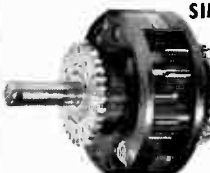

### SIMPLE DIFFERENTIAL WITH SPACED-OUT SUN GEARS

1:1 reverse ratio spur gears are aluminum, 3/32" face, 32 pitch, 32 tooth on one side, 48 tooth on the other. The body is 3/4" thick, but the sun gears are spaced out so that they are 1 1/2" apart. 1/4" dia. shaft on each side is 23/32" long. OA length 3 1/8". Requires 1-23/32" dia. to clear the body. Stock no. A6-124.....each \$4.50

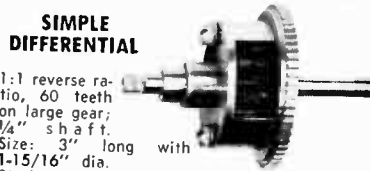

### SIMPLE DIFFERENTIAL

1:1 reverse ratio, 60 teeth on large gear; 1/4" shaft. Size: 2" long with 1-15/16" dia. Stock no. A6-104.....each \$3.95

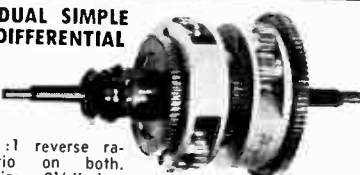

### DUAL SIMPLE DIFFERENTIAL

1:1 reverse ratio on both. Size: 3 1/4" long x 1-7/16" dia. Shaft size: 1/8" and 5/32". Stock no. A6-107.....each \$7.50



### SPERRY VERTICAL GYRO

Part #653265. Motor 115 volts, 3 phase, 400 cycle, 8 watts, 20,000 RPM. 3-minute runup, synchro pickoffs, roll 360°, pitch 85°. Synchro excitation 26 volts, 400 cycle, 150 m.a. Vertical accuracy  $\pm 1/2^\circ$ . Weight 3 1/2 lbs. Approx. dim. 5 3/4" L, 4 1/2" W, 4 1/2" H. Price \$35.00

### MINNEAPOLIS-HONEYWELL RATE GYRO (Control Flight)

Part no. JG7005A, 115 volts A.C., 400 cycle, single phase potentiometer take off resistance 530 ohms. Speed 21,000 r.p.m. Angular momentum 2 1/2 million, CM<sup>2</sup>/sec. Weight 2 lbs. Dimensions 4-7/32 x 3-29/32 x 3-31/64. Price \$22.50

### VARIABLE SPEED BALL DISC INTEGRATORS (All Shafts Ball Bearing Supported)

No. 145 Forward & Reverse 2 1/4-0-2 1/4. Input shaft spline gear 12 teeth 9/32" dia. 3/8" long. Output shaft 15/64" dia. x 15/32" long. Control shaft 11/32" x 3/8" long. Cast aluminum construction. Approx. size 3" x 3" x 2 3/4".....\$17.50

No. 146 Forward & Reverse 4-0-4. Input shaft spline gear 12 teeth 9/32" dia. 3/8" long. Output shaft 15/64" dia. x 9/16" long. Control shaft 11/64" dia. x 11/16" long. Cast aluminum construction. Approx. size 4 1/2" x 4 1/2" x 4". \$18.50 ea.

### SMALL DC MOTORS

(approx. size overall 3 3/4" x 1 1/4" dia. x 2", 10,000 rpm.)  
5067043 Delco 12 VDC PM 1" x 1" x 2", 10,000 rpm. \$7.50  
5067126 Delco PM, 27 VDC, 125 RPM, Governor Controlled 15.00 ea.  
5069600 Delco PM 27.5 VDC 250 rpm 12.50  
5069625 120 rpm, mfr. Delco, 27 VDC governor controlled .....\$15.00  
5069230 Delco PM 27.5 VDC 145 rpm 15.00  
5068750 Delco 27.5 VDC 160 rpm w. brake 6.50  
5068571 Delco PM 27.5 VDC 10,000 rpm (1x1x2") 5.00  
5069790 Delco PM, 27 VDC, 100 RPM, Governor Controlled 15.00 ea.  
5069800 575 rpm, mfr. Delco, 27 VDC, PM reversible governor controlled, equipped with 27 VDC clutch .....\$17.50  
5072735 Delco 27 VDC 200 rpm governor controlled 15.00  
5BA10A118 GE 24 VDC 110 rpm 10.00  
5BA10AJ37 GE 27 VDC 250 rpm reversible 10.00  
5BA10AJ52 27 VDC 145 rpm reversible 12.50  
5BA10AJ50, G.E., 12 VDC, 140 rpm 15.00  
5BA10FJ401B, G.E. 28 VDC, 215 rpm, 10 oz. in., 7 amp. contains brake 15.00  
5BA10FJ421, G.E. 26 VDC, 4 rpm, reversible, 6 oz. in., .65 amp 15.00

### SILICON RECTIFIERS

1N1454 25 amp. 100 volts \$3.00  
1N1455 25 amp. 200 volts \$3.50  
1N1456 25 amp. 300 volts \$4.00  
1N1457 25 amp. 400 volts \$4.50  
1N1451 5 amp. 200 volts \$1.25  
1N1452 5 amp. 300 volts \$1.50  
1N1447 .750 amp. 200 volts .75  
1N1448 .750 amp. 300 volts .85

### HONEYWELL VERTICAL GYRO MODEL JG7003A-1



115 volts, 400 cycles, single phase, 35 watts. Pitch and roll potentiometer pickoffs 890 ohms, 40 volts max. AC or DC. Speed 20,000 rpm, ang. momentum 12,500,000 gm-cm<sup>2</sup>/sec. Erection system 27 VAC, 400 cycles, time 5 min. to 1/2". Weight 5.5 lbs. Price \$35.00 each





**USE  
STONITE  
CUSTOM-MADE  
COILS!  
ASSURE SAFETY,  
LONG LIFE**

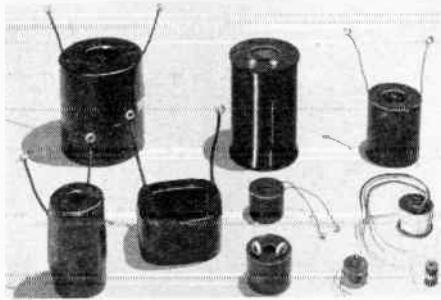

For industrial, electronic and armed forces applications, STONITE coils are designed and engineered to strictest specifications.

Here is outstanding manufacturing versatility, covering this wide range of STONITE custom-made coils:

- PAPER SECTION • FORM WOUND • LAYER BOBBIN  
PRECISION WINDING • HIGH TEMPERATURE COILS  
COPPER AND ALUMINUM CONDUCTORS**  
Round—Square—Rectangular  
Also Round, Square, Rectangular tubing

SPECIFY  
**Stonite**  
These influentials tell why:

- BOUNDLESS EXPERIENCE, QUALITY CONTROL
- WIDEST SIZE RANGE. ANY QUANTITY
- TOP RESEARCH, ENGINEERING FACILITIES
- FINEST MATERIALS, WINDING SERVICES, ADVANCED TOOLING
- CONTINUOUS PROCESSING CHECKS, RIGID INSPECTIONS
- WIDEST, MOST VERSATILE RANGE OF APPLICATIONS

Write, describing your requirement and request a sales engineer call. Also ask for the illustrated STONITE brochure S-30.

**Stonite  
COIL CORPORATION**  
ROUTE #130  
YARDVILLE 3, NEW JERSEY  
UNIPER 7-7323

CIRCLE 107 ON READER SERVICE CARD  
ELECTRONICS • OCTOBER 23, 1959

International Telephone and Telegraph Corporation ..... 61

JFD Electronics Corporation..... 141

Kay Electric Company..... 80

Kahn Research Laboratories..... 176

Krohn-Hite Corporation ..... 70

L. E. L. Inc..... 185

Lafayette Radio ..... 142

Lambda Electronics Corp. .... 3

Lampkin Laboratories Inc..... 195

Lapp Insulator Co., Inc..... 135

Levin & Son, Inc., Louis..... 185

Litton Industries ..... 166

Mallory & Co., Inc., P. R..... 64 65

Mareconi Instruments ..... 161

Marion Electrical Instrument Co..... 168

Melpar, Inc. .... 161

Metals & Controls, a Division of Texas Instruments Incorporated ..... 23

Microwave Associates, Inc..... 41A

Minneapolis-Honeywell ..... 150

Moseley Company, F. L..... 27

Motorola, Inc. .... 88

Mullard Overseas Ltd..... 57

Narda Microwave Corporation..... 68

National Radio Company, Inc..... 127

New Departure Division..... 92

Nippon Electric Co..... 83

Norden Division of United Aircraft..... 72

Northern Radio Co. Inc..... 178

Norton Company ..... 71

Oak Mfg. Co..... 89

Ohmite Mfg. Company..... 36 37

Oster Mfg., Co., John..... 76

Page Communications Engineers..... 34

Panoramic Radio Products Inc..... 91

Paraplegles Mfg. Co..... 178

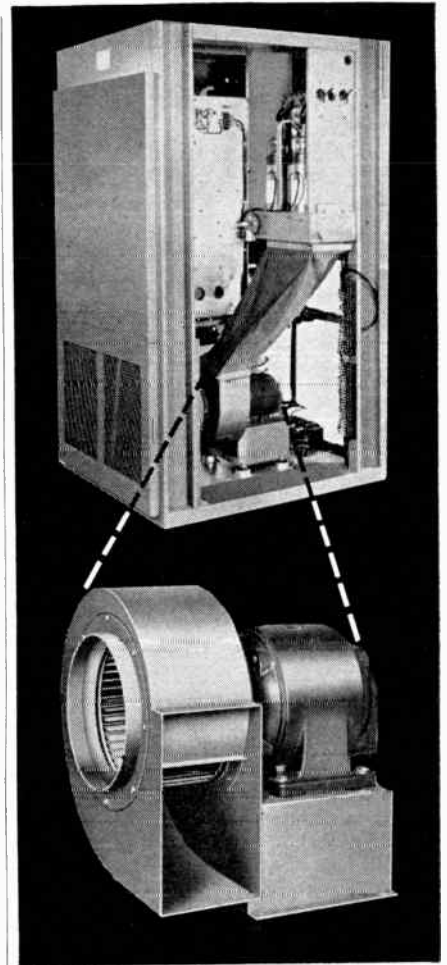

*Peerless Electric*<sup>®</sup>  
**BLOWERS COOL POWER  
TRIODE IN TRANSMITTER  
EQUIPMENT**

• A dependable Peerless Blower was selected to cool this valuable piece of transmitter equipment. The blower was specially designed to operate continually, without breakdown, in arctic or tropic conditions.

We're used to working to customer, government and association standards or specifications. We engineer, design and manufacture the entire blower or fan . . . including the motor. That's why we unconditionally guarantee each unit we manufacture.

Contact us today!  
We're interested in your inquiry!

*Peerless Electric*  
FAN AND BLOWER DIVISION  
**THE Peerless Electric**<sup>®</sup> CO.  
FANS • BLOWERS • ELECTRIC MOTORS  
W. MARKET ST. • WARREN, OHIO

CIRCLE 197 ON READER SERVICE CARD 197



THE  
**PENNSYLVANIA PLAN:**  
**100%**  
**financing**  
**for your**  
**new plant**

Complete financing for Lease-Purchase of a new plant is available in labor-surplus areas of Pennsylvania through combined efforts of lending institutions, non-profit community organizations and the Pennsylvania Industrial Development Authority. Interest as low as 2%, with deferred amortization, can be applied on up to one-half of total plant cost.

100% financing is also available in other areas of the State, provided by community organizations, banks, insurance companies and other sources. You select the community you want. You specify plant construction details or choose one of several plant "shells" now being readied for completion.

**100% Financing at a Glance . . .**  
**Industrial Plant Construction Costs—**  
*Subscribed by local non-profit community sponsored builder-owner corporations.* 20%  
*2nd Mortgage Loan, Pennsylvania Industrial Development Authority.* 30%  
*1st Mortgage Loan obtained from banks, insurance companies and similar lending institutions.* 50%  
*Total financing, secured through local subscriptions and mortgage loans, without cash investment by the manufacturer.* 100%



For free copy of "Plant Location Services" pamphlet, or for details on 100% financing, write or call:

Pennsylvania Department of Commerce  
 South Office Building  
 555 State Street, Harrisburg, Pa.  
 Phone: CEDar 4-2912

Peerless Electric Co., The . . . . . 197  
 Pennsylvania Department of Commerce. 198  
 Phalo Plastics Corporation. . . . . 55  
 Phileo Corporation . . . . . 154  
 Polytechnic Research & Development Co. Inc. . . . . 157  
 Power Sources, Inc. . . . . 163  
 Pyramid Electric Co. . . . . 165

Radio Corporation of America. . . . . 77, 4th Cover  
 Ramo-Wooldridge . . . . . 6  
 Rawson Electrical Instrument Co. . . . . 182  
 Raytheon Company . . . . . 2nd Cover  
 Reflectone Corp., The. . . . . 167  
 Rohu Mfg. Co. . . . . 67  
 Royal Electric Corp. . . . . 54

Sunborn Company . . . . . 26  
 Sungamo Electric Company. . . . . 133  
 Schmeling Electronics . . . . . 187  
 Servo Corporation . . . . . 162  
 Simpson Electric Company. . . . . 73  
 Sonotone Corp. . . . . 160  
 Sorensen & Company, Inc. . . . . 131  
 Spectrol Electronics Corp. . . . . 152  
 Sprague Electric Company. . . . . 5  
 Staver Co. . . . . 168  
 Stavid Engineering, Inc. . . . . 8, 9  
 Stackpole Carbon Co. . . . . 179  
 Stoddart Aircraft Radio Co., Inc. . . . . 143  
 Stonite Coil Corporation. . . . . 197  
 Sylvania Electric Products, Inc. . . . . 2, 39, 40, 41, 42

Tech Laboratories, Inc. . . . . 160  
 Telechrome Mfg. Corporation. . . . . 109  
 Telrex Laboratories . . . . . 182  
 Temeo Aircraft Corp. . . . . 35  
 Transco Products, Inc. . . . . 189  
 Trans World Airlines (TWA). . . . . 74, 75  
 Tung-Sol Electric Inc. . . . . 129

United States Testing Co., Inc. . . . . 159

Veeder-Root Inc. . . . . 38  
 Weinschel Engineering . . . . . 14

Westinghouse Electric Corporation. . . . . 196  
 Weston Instruments . . . . . 49

PROFESSIONAL SERVICES . . . . . 195

CLASSIFIED ADVERTISING  
 F. J. Eberle, Business Mgr.

EMPLOYMENT OPPORTUNITIES. 190-194

EQUIPMENT  
 (Used or Surplus New)  
 For Sale . . . . . 195

WANTED  
 Equipment . . . . . 195

ADVERTISERS INDEX

Autometric Corporation . . . . . 193  
 Boonton Radio Corporation. . . . . 194  
 C & H Sales Company. . . . . 195  
 Drake Personnel . . . . . 194  
 Goodyear Aircraft Corporation. . . . . 191  
 Honeywell, Aeronautical Div. . . . . 190  
 International Business Machines Corp. 192-193  
 Legri S., Company. . . . . 195  
 Monarch Personnel . . . . . 190  
 Pennsylvania State University. . . . . 194  
 Republic Aviation . . . . . 194  
 Sanford Research Institute. . . . . 194  
 Television Associates of Indiana, Inc. . . . . 190  
 Texas Instruments Incorporated. . . . . 190  
 Westinghouse Electric Corporation. . . . . 194

This index is published as a service. Every care is taken to make it accurate, but ELECTRONICS assumes no responsibilities for errors or omissions.





# ARE YOU MAKING THE SAME MISTAKE IN DEPOSITED CARBON RESISTORS?

Switch to IRC Molded Deposited Carbon Resistors—"PRE-SHRUNK" for miniaturization.

If you have anything to do with miniaturizing components, be prepared for a pleasant surprise.

IRC has reduced the size of Molded Deposited Carbon Resistors in the 3 most popular wattage ratings at the same ambient, an improvement made possible through the use of a unique IRC alloy film and a new high-temperature coating.

IRC  
MDC1X

This means that you can now choose a smaller unit with wattage equivalent to the one you formerly specified. Weight and space savings, as it happens, are especially significant in the most-used sizes.

## COMPARE

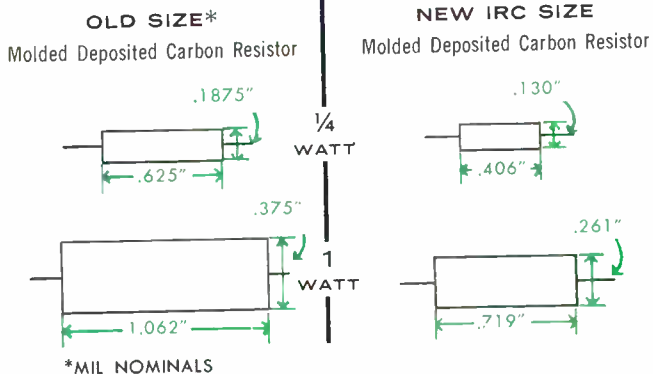

These SIZE REDUCTIONS also result in nearly corresponding weight reductions.

MIL Type	IRC Type	Length Nominal	Diam. Nominal	Min. Ohms	Max. Ohms	Max. Volts Continuous	WATTAGE		
							MIL 70°C	IRC 70°C	IRC 125°C
RN60	MDA	.406	.130	10	5M	300	1/8	1/4	1/8
RN65	MDB	.594	.203	10	5M	350	1/4	1/2	1/4
RN70	MDC	.719	.261	5	25M	500	1/2	1	1/2

## IRC EXCEEDS MIL SPECIFICATIONS

IRC Resistors are designed for MIL-R-10509C Characteristic B requirements.

INTERNATIONAL RESISTANCE CO., Dept. 379, 401 N. Broad St., Phila. 8, Pa. • In Canada: International Resistance Co., Ltd., Toronto, Licensee

## DERATING CURVE FOR IRC MOLDED RESISTORS

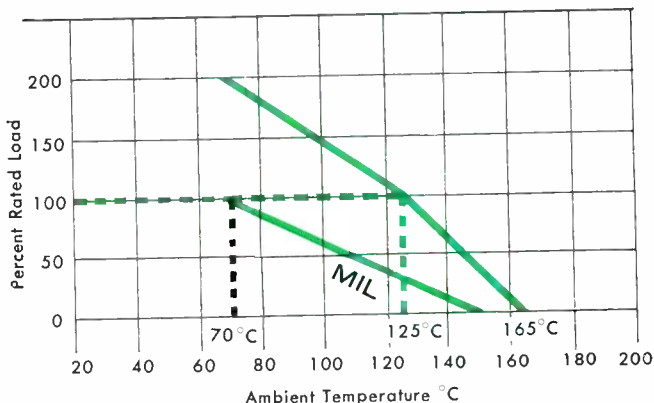

## IRC HAS GREATER LOAD LIFE RESERVE

IRC Molded Deposited Carbon Resistors exhibit excellent heat dissipating characteristics. Size for size, IRC Resistors will run cooler under any load condition and take sudden overloads with very low permanent change. Load life is superior to that of hermetically sealed resistors which cost three times as much!

## IRC HAS DOUBLE-BARRIER INSULATION

Resistance element is coated with a moisture-resisting material, then encased in a molded, break-resistant dielectric case which, though heavy-duty, is well within MIL size.

Write for Bulletin B-9C



the big  
**PLUS FOUR**  
 in tubes  
 for hi-fi!



**RCA-7025...**

"low noise and low hum" characterize the performance of this high-mu twin triode—ideal for your pre-amplifier designs.

**RCA-7199...**

"versatility" keynotes the applications for this tube—a sharp-cutoff pentode and a medium-mu triode in one envelope—for low-level stages.

**RCA-6973...**

"compact, but powerful" can describe monophonic and stereophonic power amplifiers designed around this 9-pin miniature—a pair in Class AB1 can deliver up to 20 watts output.

**RCA-7027-A**

"power deluxe"—up to 76 watts with only 2% distortion from a pair in Class AB1 audio service—new structure design provides exceptional electrical stability and reliability.

From pre-amplifier to power amplifier, mono or stereo, you can design a comprehensive line of high-fidelity products around these 4 RCA tube types. And your designs with RCA tubes add up to recognition . . . for quality, performance, prestige. Contact your RCA Field Representative for details. For technical data, write RCA Commercial Engineering, Section J-19-DE4, Harrison, N. J.

**EAST:**  
 744 Broad St., Newark 2, New Jersey,  
 HUmboldt 5-3900

**MIDWEST:**  
 Suite 1154, Merchandise Mart Plaza,  
 Chicago 54, Ill., WHItEhall 4-2900

**WEST:**  
 6355 East Washington Boulevard, Los  
 Angeles 22, Calif., RAymond 3-8361

ANOTHER WAY RCA SERVES YOU THROUGH ELECTRONICS



**RADIO CORPORATION OF AMERICA**  
 Electron Tube Division  
 Harrison, N. J.