

OCTOBER 2, 1959

electronics

A MCGRAW-HILL PUBLICATION

VOL. 32, No. 40

PRICE SEVENTY-FIVE CENTS

Coincident-Current Memory Matrix

Cut-Rate Tubes:

L E MC GRAY
989 ECHOLS ST
MEMPHIS TENN 11

From

RECORDER



Completely Transistorized

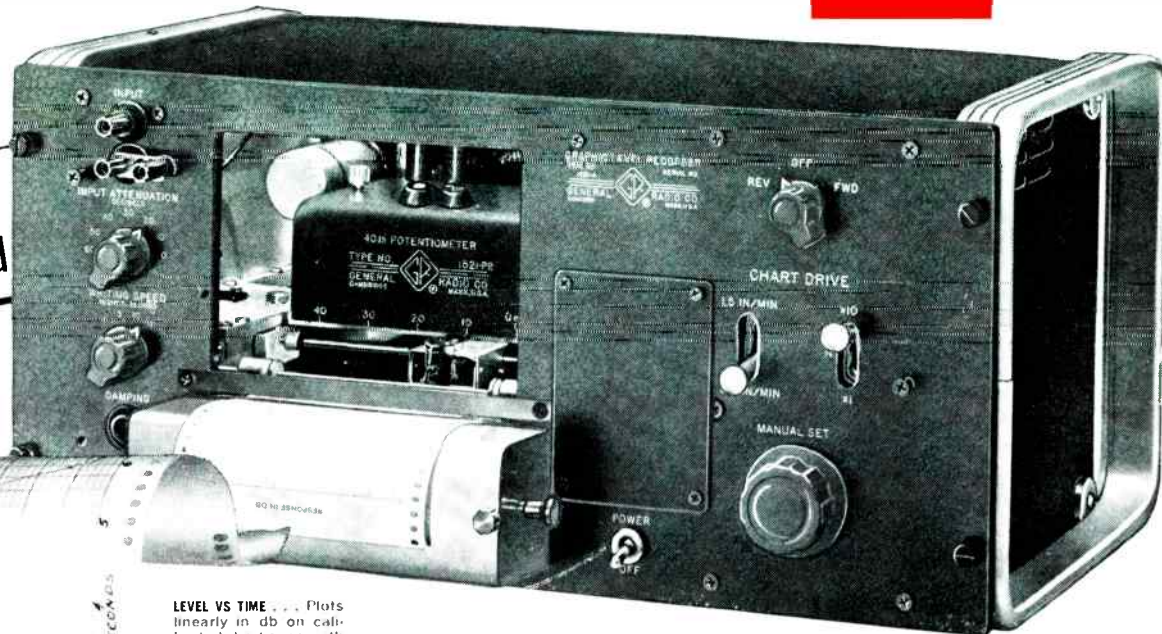

LEVEL VS TIME . . . Plots linearly in db on calibrated chart paper with 4" recording width.

The Type 1521-A Graphic Level Recorder* provides permanent ink records of the response of electronic and electro-acoustical devices as a function of either frequency or time. It can also be used as a linear dc recorder.

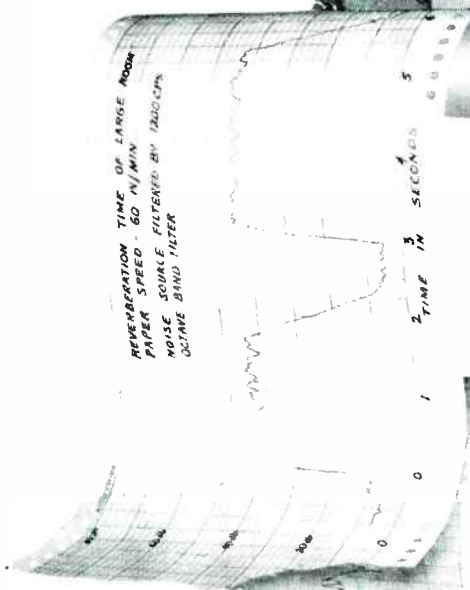

LEVEL VS FREQUENCY
Paper drive readily couples to the frequency control shaft of a generator of analyzer to produce frequency response plot automatically.

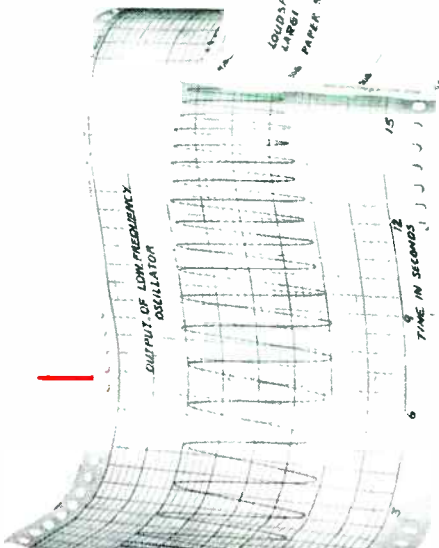

DC VS TIME . . . Easily converts to a linear dc recorder capable of plotting instantaneous value of waveform from dc to 10 c.

- ★ Traces the rms level of ac voltages from 20 cps to 200 kc.
- ★ High Sensitivity . . . 1-mv minimum input level, corresponds to 0-db point on chart paper.
- ★ Input Ranges . . . 40 db . . . 20-db and 80-db ranges provided by accessory plug-in Potentiometers . . . 0.8v full scale for dc recording, with accessory Linear Potentiometer.
- ★ 60-db Calibrated Attenuator changes 0-db level from 1 mv to 1v in 10-db steps.
- ★ Rms Response . . . preferable to peak or average response, as it is more nearly independent of input signal waveshape.
- ★ Four Pen Writing Speeds . . . 1, 3, 10, and 20 in/sec (10, 30, 100, and 200 db/sec with 40-db Potentiometer) with less than 1-db overshoot.
- ★ Four Paper Speeds . . . 2.5, 7.5, 25, and 75 in/min. Accessory slow-speed motor provides speeds from 2.5 to 75 in/hour. Recorder can be driven in reverse as well as forward.
- ★ Static Accuracy is better than 1/64" or 0.4% of full scale; fast servo system with low overshoot provides excellent dynamic accuracy.
- ★ Input Impedance . . . 10 kΩ for ac level recording, 1 kΩ for dc recording.
- ★ Can be either bench or rack mounted.
- ★ Drive and Link Units available for coupling to generator or analyzer; chart papers available calibrated linearly, logarithmically, or for use with G-R Sound Analyzer.

*Patent No. 2,581,133

**Type 1521-A Graphic Level Recorder
with 40-db Potentiometer . . . \$995.**

Write for Complete Information

GENERAL RADIO COMPANY

WEST CONCORD, MASSACHUSETTS

1927
First Beat-Frequency
Oscillator

NEW YORK AREA
Broad Ave. of Linden
Ridgefield, N. J.
N. Y. WOrth 4-2722
N. J. WHinny 3-3140

CHICAGO
6605 W. North Ave.
Oak Park Ill.
Village 8-9400

PHILADELPHIA
1150 York Rd.
Abington, Pa.
HAncock 4-7419

WASHINGTON, D.C.
8035 Thirtieth St.
Silver Spring, Md.
JUiniper 5-1088

SAN FRANCISCO
1182 Los Altos Ave.
Los Altos, Cal.
WHitecliff 8-8233

LOS ANGELES
1000 N. Seward St.
Los Angeles 38, Cal.
HOLlywood 9-6201

IN CANADA
99 Floral Pkwy.
Toronto 15, Ontario
CHerry 6-2171

Issue at a Glance

A MCGRAW-HILL PUBLICATION
Vol. 32 No. 40

JAMES GIRDWOOD, *Publisher*

W. W. MacDONALD, *Editor*

JOHN M. CARROLL, *Managing Editor*

Associate Editors: Frank Leary, Michael F. Tomaino, Howard K. Janis, Sylvester P. Carter, Roland J. Charest, William P. O'Brien, George Sideris, John F. Mason, William E. Bushor, Thomas Emma, Samuel Weber, Sy Vogel, Leslie Solomon, M. M. Perugini, George J. Flynn.

Pacific Coast Editor (Los Angeles) Harold C. Hood; *Midwestern Editor (Chicago)* Harold Harris; *New England Editor (Boston)* Thomas Maguire.

Art Director, Harry Phillips, Roy Thompsen.

Production Editor, John C. Wright, Jr., Bernice Duffy.

Market Research, Edward DeJongh.

Editorial Assistants, Gloria J. Filippone, Arlene Schilp, Patricia Landers, Carol Weaver.

BRUCE A. WINNER, *Advertising Sales Manager*. R. S. Quint, *Assistant Advertising Sales Manager and Buyers' Guide Manager*. Fred Stewart, *Promotion Manager*. Frank H. Ward, *Business Manager*. George E. Pomeroy, *Classified Manager*. Hugh J. Quinn, *Circulation Manager*.

New York: Donald H. Miller, Henry M. Shaw, William J. Boyle. *Boston:* Wm. S. Hodgkinson. *Philadelphia:* Warren H. Gardner. *Chicago:* Harvey W. Wernecke, Martin J. Gallay. *Cleveland:* P. T. Fegley. *San Francisco:* T. H. Carmody, R. C. Alcorn. *Los Angeles:* Carl W. Dysinger, D. A. McMillan. *Denver:* J. Patten. *Atlanta:* M. Miller. *Dallas:* Gordon L. Jones, Robert T. Wood. *London:* E. E. Schrimmer. *Frankfurt:* Michael R. Zeynel.

Business

Was Moonshot 4th USSR Try? Here's how it was done technically...	26
Where Cut-Rate Tubes Come From. Malpractices need policing?...	31
Noise Control Market Grows. Meter sales reach \$1 million.....	34
Instrument Men Look Ahead. Report on the ISA conference.....	37
Shoptalk	4
Electronics Newsletter	11
Washington Outlook	14
Financial Roundup	17
25 Most Active Stocks.....	17
Market Research	20
Current Figures	20
Meetings Ahead	38

Engineering

Square-loop ferrite cores fixed in four arrays on one plane are used in new memory system. See p 50.....	COVER
High Magnetic Fields for Advanced Research. Art of generating these fields is improving, and advancing research.....	By H. Kolm 43
Sensitive Transducers Use Crystal Oscillator. Measuring small changes in physical variables.....	By L. J. Rogers 48
Compact Memories Have Flexible Capacities. Access is provided by coincident-current memory.....	By D. Haagens 50
Electromechanical Switches for Telemetry Systems. Specifications, performance and application data for commutators.	By A. S. Kramer 54
Analog Computer Aids Heart Ailment Diagnosis. Computer circuit measures blood flow rate.....	By R. L. Skinner and D. K. Gehmlich 56
Power Supply Design Using Silicon Diodes. Equalized diode strings allow high voltage, high current supplies.....	By H. A. Kampf 60
Determining Isolator Standing-Wave Ratio. Nomograph determines vswr of isolators and pads.....	By J. D. Albright 64

Departments

Research and Development. Highly Sensitive Electronic Chopper...	66
Components and Materials. Surfaces: Key to Semiconductor Progress?	70
Production Techniques. Acid-Peroxide Etch Safe, Sure.....	76
On the Market.....	80
Literature of the Week.....	92
Plants and People.....	94
News of Reprs.....	97
Comment	98
Index to Advertisers.....	106

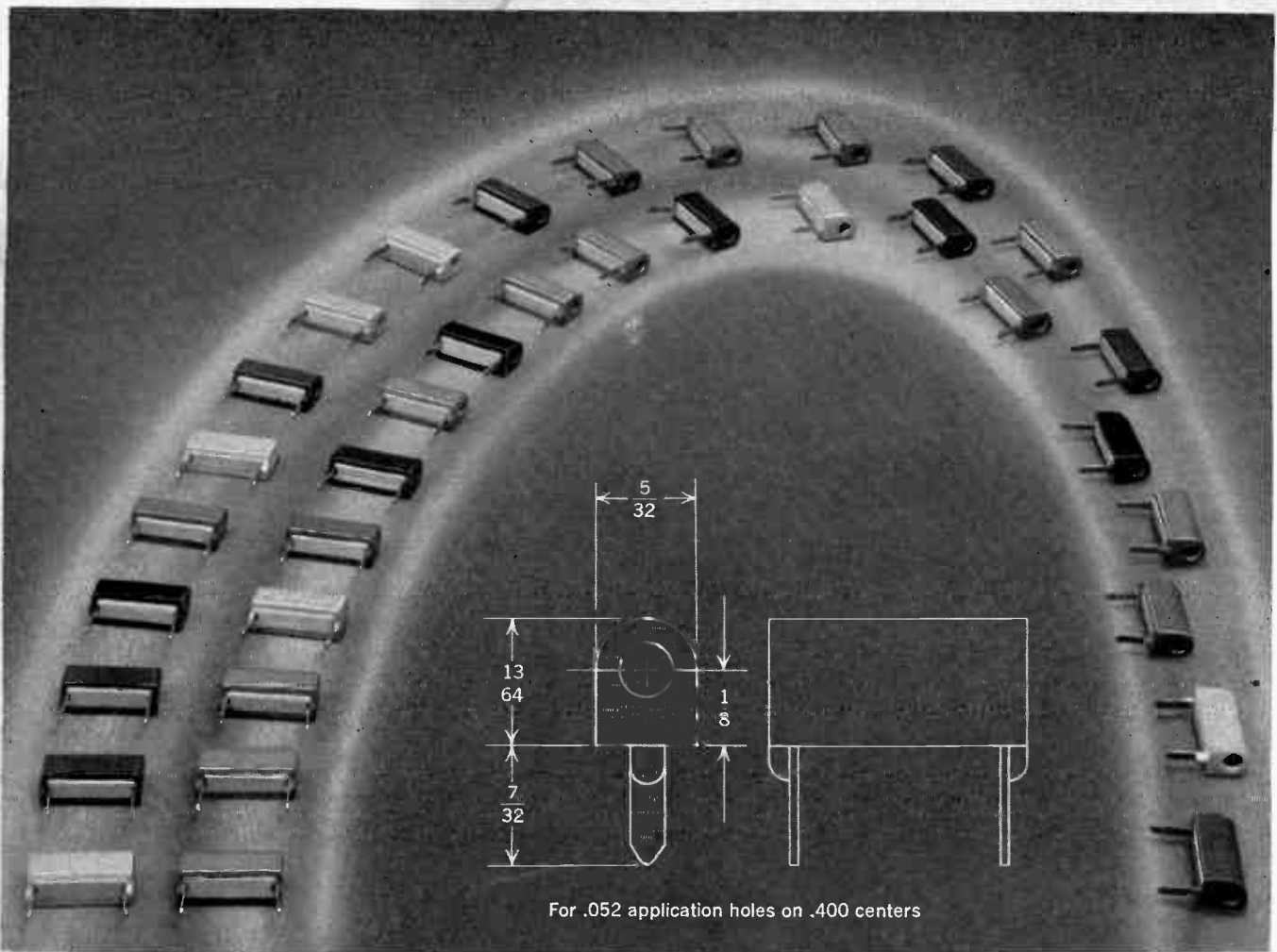

Patents Pending

New Test Jacks for Printed Circuits

Designed for permanent assembly to printed circuit boards, these new test jacks by Ucinite are easily accessible to standard .080 test probes and eliminate the need for individual adaptor boards.

Simple, economical construction ensures reliability and reasonable cost. Gold-over-silver-plated beryllium copper contacts provide dependable, low-resistance connections. Nylon bodies are available in eleven standard code colors specified as follows: Part number (119437) plus letter suffix . . . A-Opaque

White, B-Red, C-Black, D-Brown, E-Green, F-Orange, G-Blue, H-Yellow, J-Gray, K-Violet, L-White translucent.

With an experienced staff of design engineers plus complete facilities for production of metal and plastic parts and assemblies, Ucinite is capable of supplying practically any requirement for fasteners, connectors, switches and other small metal and metal-and-plastics assemblies. Call your nearest Ucinite or United-Carr representative for full information or write directly to us.

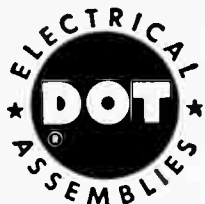

Manufactured by

The UCINITE COMPANY

Division of United-Carr Fastener Corporation, Newtonville, Mass.

Arnold Builds World's Largest Permanent Magnet...Used in Atomic Research

Vital Statistics on the Big Magnet

Here's how the world's champion permanent magnet weighed in: 1720 pounds of Alnico V in the assembly . . . a keeper weighing 225 pounds . . . a total shipping weight of a little over 2 tons.

Overall dimensions of the magnet assembly, as illustrated at right, were 52½" x 36" x 10", with a gap length of 16.5". The gap volume was 1584 cu. inches, and the density at the center of the gap was 1100 gauss.

Approximately 500,000 ampere turns were required to magnetize the big unit, which was shipped magnetized and keepered. It was designed for use in auxiliary equipment serving a breeder reactor for the Argonne National Laboratory, operated by the University of Chicago for the U.S. Atomic Energy Commission. Actual service is in an electro-magnetic pump for pumping fluid metals.

Vital Suggestion for Your Requirements

The facilities and wealth of experience that produced this world's largest permanent magnet are ready to bring you advantages, too.

Arnold permanent magnets are available in all types of Alnico and other magnet materials, from large castings like the Argonne unit to very small sintered parts weighing less than a gram. Many sizes and types of Alnico magnets are carried in stock for immediate delivery.

Special assemblies—such as rotors, traveling wave tube and magnetron magnets, etc.—may be supplied jacketed to facilitate mounting and give added protection to the magnet. Arnold also can supply large magnet assemblies for mass spectrometer and other measuring applications, where a high degree of stability and uniformity of field is required.

● Ask for a copy of Bulletin GC-106C, for more information on Arnold permanent magnets and other products, (tape cores, powder cores, etc.) Write *The Arnold Engineering Company, Main Office and Plant, Marengo, Illinois.*

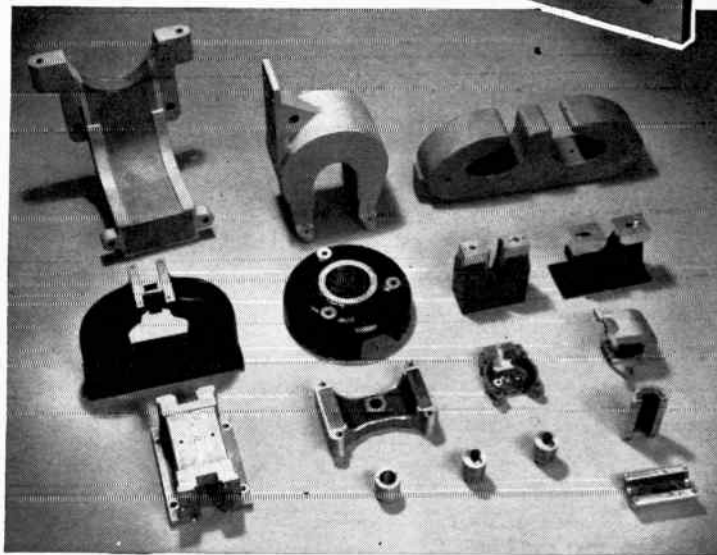
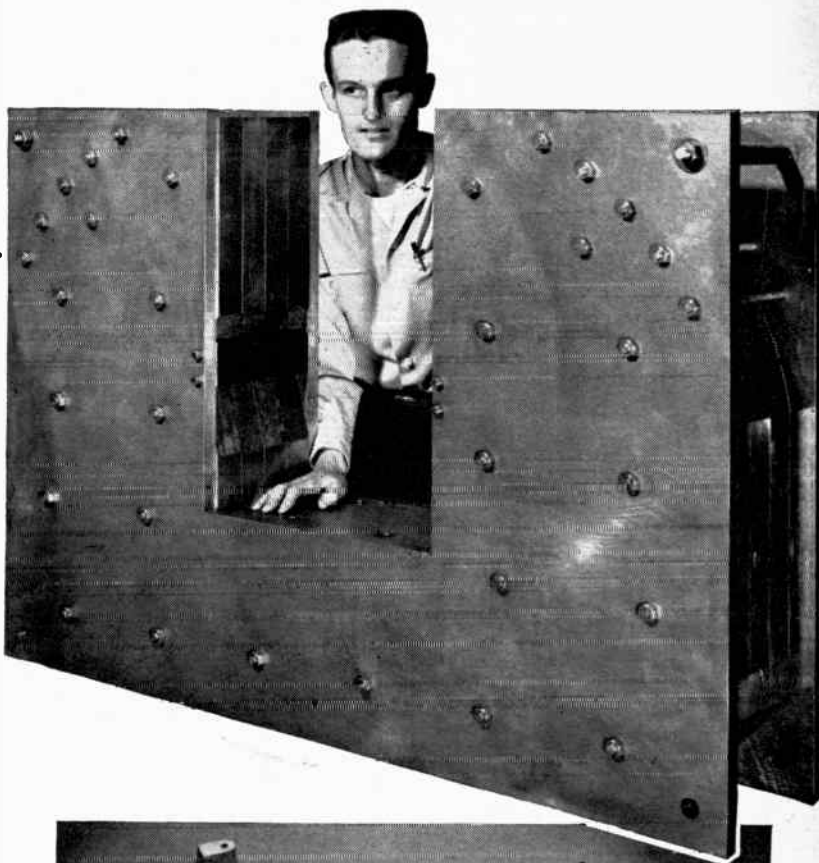

Top: the world's largest permanent magnet, built by Arnold for Argonne Labs, was designed to supply a field of 1100 gauss in a gap of 16½ inches. Bottom: a typical group of the permanent magnet assemblies that Arnold supplies for rotors, traveling wave tube, wave guide and magnetron magnets, mass spectrometer and other measuring applications, etc.



ARNOLD

SPECIALISTS in MAGNETIC MATERIALS

BRANCH OFFICES and REPRESENTATIVES in PRINCIPAL CITIES
Find them FAST in the YELLOW PAGES

ADDRESS DEPT. E-910

electronics

October 2, 1959 Vol. 32, No.40

Published weekly, including the ELECTRONICS BUYERS' GUIDE and REFERENCE Issue in mid-June as part of the subscription, by McGraw-Hill Publishing Company, Inc., James H. McGraw (1860-1948) Founder.

Executive, Editorial, Circulation and Advertising Offices: McGraw-Hill Building, 330 W. 42 St., New York 36, N. Y. Longacre 4-3000. Publication Office: 99-129 North Broadway, Albany 1, N. Y.

See panel below for directions regarding subscriptions or change of address. Donald C. McGraw, President; Joseph A. Gerardi, Executive Vice President; L. Keith Goodrich, Vice President and Treasurer; John J. Cooke, Secretary; Nelson L. Bond, President, Publications Division; Shelton Fisher, Senior Vice President; John R. Callahan, Vice President and Editorial Director; Joseph H. Allen, Vice President and Director of Advertising Sales; A. R. Venezian, Vice President and Circulation Coordinator.

Single copies in the United States, U. S. possessions & Canada 75¢; \$1.50 for all other foreign countries. Buyers' Guide in the United States, U. S. possessions & Canada \$3.00; all other foreign \$10.00. Subscription rates—United States and possessions, \$6.00 a year; \$9.00 for two years; \$12.00 for three years. Canada, \$10.00 a year; \$16.00 for two years; \$20.00 for three years. All other countries, \$20.00 a year; \$30.00 for two years; \$40.00 for three years. Second class postage paid at Albany, N. Y. Printed in U.S.A. Copyright 1959 by McGraw-Hill Publishing Co., Inc.—All Rights Reserved. Title registered in U. S. Patent Office. BRANCH OFFICES: 520 North Michigan Avenue, Chicago 11; 68 Post Street, San Francisco 4; McGraw-Hill House, London E. C. 4; 85, Westendstrasse, Frankfurt/Main; National Press Bldg., Washington 4, D. C.; Six Penn Center Plaza, Philadelphia 3; 1111 Henry W. Oliver Bldg., Pittsburgh 22; 55 Public Square, Cleveland 13; 856 Penobscot Bldg., Detroit 26; 3615 Olive St., St. Louis 8; 350 Park Square Bldg., Boston 16; 1301 Rhodes-Haverty Bldg., Atlanta 3; 1125 West Sixth St., Los Angeles 17; 1740 Broadway, Denver 2; 901 Vaughn Bldg., Dallas 1. ELECTRONICS is indexed regularly in The Engineering Index.

Subscription: Address correspondence to: Fulfillment Manager, Electronics, 330 W. 42nd St., New York 36, N. Y. Allow one month for change of address, stating old as well as new address, including postal zone if any. Subscriptions are solicited only from persons engaged in theory, research, design, production, management, maintenance and use of electronics and industrial control components, parts and products. POSITION and COMPANY CONNECTION must be indicated on subscription orders.

Postmaster: please send form 3579 to Electronics, 330 W. 42nd St., New York 36, N. Y.



Member ABP and ABC

MAKE OR BUY. If the primary problem facing a components manufacturer today is possible product-line obsolescence (Shoptalk, ELECTRONICS, p 4, Sept. 25), the second is most certainly competition. There is a growing trend in today's competition: more of it comes from the customers.

Increasingly our field editors report that original-equipment-manufacturing companies are making this or that component in quantity. But most of these manufacturers are in the government or precision-instrument sections of our industry.

It is not a question of want to, it's a question of have to. Or so they think. The components required are often not for sale at any price. Therefore, the OEM firm makes them.

The answer for the components maker is one that good salesmen have urged since the beginning of time: "Never say no to a customer." In this business, it may make him your competitor.

DOUGHNUTS. Signs in many "coffee &" shops on the eastern seaboard admonish the dunker to keep his eye upon the doughnut and not upon the hole.

For at least six years ELECTRONICS has indeed kept its eye on tiny ferrite "doughnuts," magnetic cores used in digital computer memory planes. Our cover story for April 1953 dealt with one of the original memory planes, made up of 1/4-in. cores. This cover, lovers of modern art tell us, ranks as one of the all-time "bests".

This week's cover story also deals with ferrite memory cores. The cores have changed in six years. Now we have to show them in a greatly enlarged insert. That's part of the story of our industry: make it smaller, and better.

Coming In Our October 9 Issue . . .

STELLARATOR PLASMA HEATING. In experiments with the stellarator leading to controlled thermonuclear power production, hydrogen gas is confined by a twisted toroidally-shaped magnetic field. An r-f field applied parallel to the magnetic field partially ionizes the gas, and a d-c or audio pulse then raises the temperature to about 10⁶ C. R. L. Gamblin of Princeton University's Project Matterhorn has already described the r-f generator used in this system (ELECTRONICS, p 50, July 3) and next week he reveals the details of the equally interesting ohmic heating pulse equipment.

NEW APPROACH TO REGULATION. In a series-regulated power supply, the regulating characteristics can be improved if the gain of the error-signal control loop is increased. E. Gordy and P. Hasenpusch of Roswell Park Memorial Institute in Buffalo, N. Y. show how a similar improvement can be obtained by using a constant current through a fixed resistor as a reference and by use of an error-correcting amplifier to lower the output impedance of the regulated supply. They describe a supply with regulation within 30 mv from zero load to 900 ma at 36-v output.

3-D PACKAGING. Space technology is placing an increasing premium on space, weight and ruggedness for electronic equipment in missiles and other space vehicles. By using miniature components now available from manufacturers and a newly applied method of joining wire leads, members of the staff of MIT's Instrumentation Laboratory have developed an electronic packaging technique based on the mounting and wiring of circuit components in a miniature three-dimensional unit mass. E. C. Hall and R. M. Jansson claim advantages over printed circuit techniques.

For Portable Communication...

NEW RAYTHEON CK7246

1.25 VOLT SUBMINI TRIODE

OPERATES TO 500 MC.

This Raytheon filamentary subminiature triode was developed under U. S. Signal Corps contract, and is now commercially available for use in battery-operated communications equipment. Circuit applications include:

- Superregenerative detector
- High frequency oscillator
- Class C amplifier
- Frequency multiplier
- Mixer

TYPICAL OPERATING CHARACTERISTICS Class A Amplifier

Filament voltage (dc).....1.25 v.
 Filament current.....150 ma.
 Plate voltage.....105 v.
 Plate current.....4.5 ma.
 Grid voltage.....-2.5 v.
 Transconductance.....2700 μ mhos
 Amplification factor.....22

Class C Oscillator (465 mc.)

Filament voltage (dc).....1.25 v.
 Filament current.....150 ma.
 Plate voltage.....105 v.
 Plate current.....6 ma.
 Grid current.....0.9 ma.
 Power output.....60 mw.

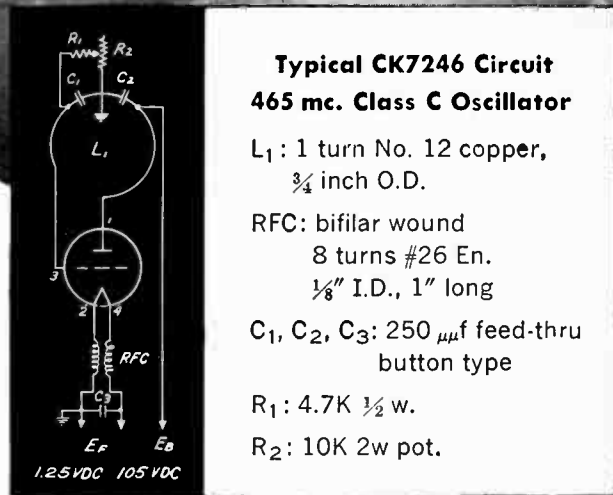

Typical CK7246 Circuit 465 mc. Class C Oscillator

L_1 : 1 turn No. 12 copper,
 $\frac{3}{4}$ inch O.D.
 RFC: bifilar wound
 8 turns #26 En.
 $\frac{1}{8}$ " I.D., 1" long
 C_1, C_2, C_3 : 250 μ f feed-thru
 button type
 R_1 : 4.7K $\frac{1}{2}$ w.
 R_2 : 10K 2w pot.



INDUSTRIAL TUBE DIVISION

55 CHAPEL STREET, NEWTON 58, MASSACHUSETTS

RELIABLE MINIATURE & SUBMINIATURE TUBES • GAS & VAPOR TUBES • CATHODE RAY TUBES • HARD-GLASS POWER TUBES
 BOSTON: Blgelow 4-7500 • NEW YORK: Plaza 9-3900 • CHICAGO: NATIONAL 5-4000 • LOS ANGELES: NOrmandy 5-4221
 BALTIMORE: SOuthfield 1-1237 • CLEVELAND: Winton 1-7716 • KANSAS CITY: Plaza 3-5330
 GOVERNMENT SALES . . . BOSTON: Blgelow 4-7500 . . . WASHINGTON, D. C.: MEtropolitan 8-5205 . . . DAYTON: Baldwin 3-8128

Small order and prototype quantities available directly from your local Raytheon electronic parts distributor

Last year, traffic accidents killed 37,000, injured 1,400,000

... and they wasted Five Billion Dollars!

Traffic accidents' human toll is so tragic we sometimes overlook their staggering economic waste. Five Billion Dollars in lost wages, medical expenses, insurance costs and property damage! Your business—every business—shares in this loss. So you have a double interest in helping reduce traffic accidents. And you *can* help! Drive safely and obey the law yourself . . . certainly. But go further. Use your influence to promote safe driving and urge strict law enforcement. To make your efforts more effective, join with others working actively to reduce traffic hazards in your community. *Support your local Safety Council!*

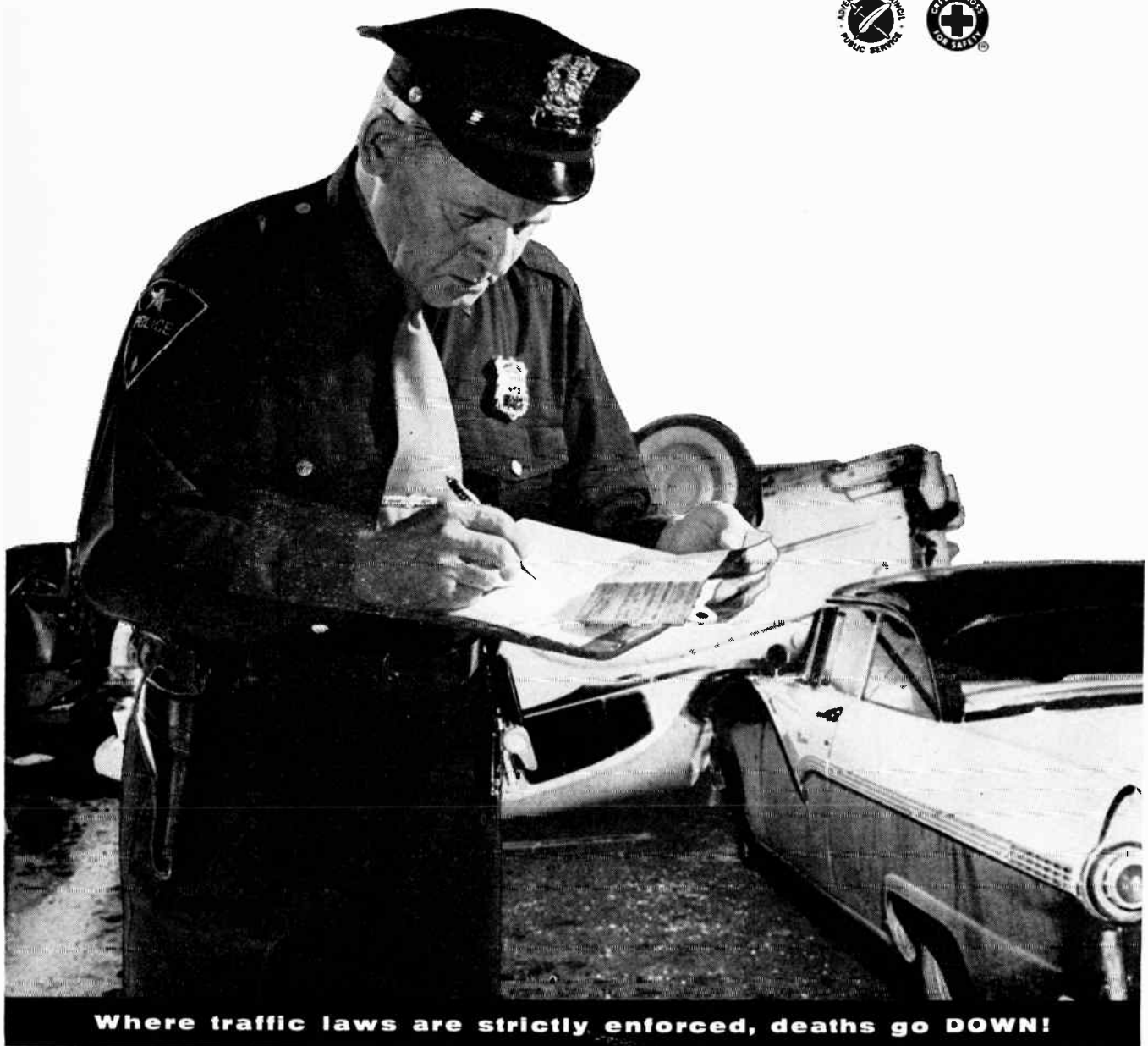

Where traffic laws are strictly enforced, deaths go DOWN!

Published in an effort to save lives, in cooperation with the National Safety Council and The Advertising Council.

The new concept of electronic equipment manufacture



A new philosophy:

*** Made for everyday use**

Wide range available

Modern techniques

Flow production

Automatic inspection

Easy servicing

* The conception of tools for the electronic industry is new. Tools, that is, which are accurate, yet as simple to operate and so robust that they will stand up to hard daily use. Naturally, here is an idea conceived by Philips. Why naturally? Because the great Philips organization is itself a whole electronic industry. From its vast accumulated experience of electronic instrumentation has flowed the idea of hardy, reliable, electronic tools, simple to use, simple to service in any part of the world. A new idea. A good idea.

Dependable **PHILIPS** tools 
for the electronic industry

Sold and serviced by Philips Organizations all over the world

Further information will gladly be supplied by:

N.V. Philips Gloeilampenfabrieken, Eindhoven, the Netherlands

World Radio History

GM 5602 High Frequency Oscilloscope

Cathode Ray Tube: DH 10-78
Flat faced 10 cm tube, EHT - 4 kV
Vertical Amplifier: 3 c/s - 14 Mc/s
(-3 ± 1/2 dB)
Sensitivity 75 mV/cm,
calibration accuracy 3%
Signal delay line 0.3 μsec.
Time base: 0.2 μsec/cm - 10 msec/cm
Calibration accuracy 3%
Horizontal magnification: X 2, X 5
Cathode-follower probe available.



The price - a pleasant surprise

NEW RAYTHEON SILICON TRANSISTORS



Diffused-Base "MESA" Construction

- NPN: High Speed, High Gain Switches
- NPN: High Frequency and Video Amplifiers
- Close parameter control
- Up to 50 megacycles minimum f_{α}

High Voltage PNP Fusion Alloy Transistor

- $V_{CEO} = -100$ volts max.
- $V_{CBO} = -80$ volts max.
- $V_{EBO} = -60$ volts max.

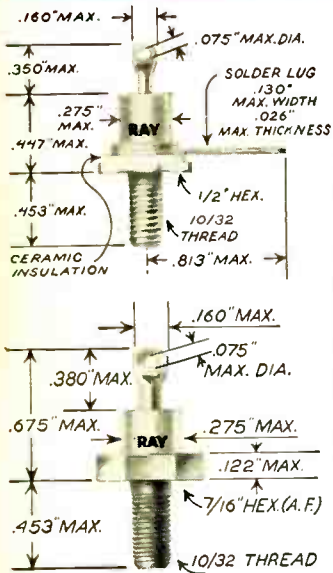

New 4 Amp Silicon Rectifiers (Temperature Range -65°C to $+165^{\circ}\text{C}$)

NON-INSULATED		INSULATED STUD	Peak Operating Voltage -65°C to $+165^{\circ}\text{C}$ volts	Ave. Rectified Current		Reverse Current max. μA at Specified Voltage		
Cathode to Stud	Anode to Stud			25°C amps.	150°C amps.	25°C	150°C	volts
1N2512	1N2512R	1N2518	100	4.0	1.0	2.0	250	100
1N2513	1N2513R	1N2519	200	4.0	1.0	2.0	250	200
1N2514	1N2514R	1N2520	300	4.0	1.0	2.0	300	300
1N2515	1N2515R	1N2521	400	4.0	1.0	2.0	300	400
1N2516	1N2516R	1N2522	500	4.0	1.0	2.0	350	500
1N2517	1N2517R	1N2523	600	4.0	1.0	2.0	400	600

NEW RAYTHEON GERMANIUM TRANSISTORS



- Complementary circuitry with Raytheon PNP types
- Highest reliability
- Excellent fast switching characteristics
- Low saturation voltage

High Speed Switches (Temperature Range -65°C to +175°C)

Type	V _{CB} max. volts	I _{CO} V _{CB} = 6 volts max. μA	V _{EB} max. volts	H _{FE} I _C = 10 ma V _{CE} = 5 volts min.	V _{SAT} I _b = 2.5 ma I _c = 5 ma max. volts	f _{ab} I _F = 1 ma V _{CE} = 6 volts ave. Mc	R _b ave. ohms	C _{ob} ave. μμf
2N1386	25	.1	3	30	.6	60	60	3.5
2N1387	30	.1	3	20	.6	50	60	3.5

High Frequency and Video Amplifiers (Temperature Range -65°C to +175°C)

Type	V _{CB} max. volts	I _{CO} V _{CB} = 15 volts max. μA	F _i V _{CE} = 6V I _E = 1 ma Mc	R _{in} * at 10 Mc ave. ohms	R _{out} * at 10 Mc ave. ohms	Power Gain at 10 Mc ave. decibels	Gain-Bandwidth Product ave. Mc
2N1388	45	.5	60	500	5000	20	75
2N1389	50	.5	30	500	5000	15	45
2N1390	20	.8 @ 6V	12	400	6000	12	—

*Measured resistive component of the impedance

High Voltage PNP (Temperature Range -65°C to +160°C)

Type	V _{CB} max. volts	V _{CE} max. volts	I _{CO} max. μA	H _{FE} I _B = 0.1 mA V _{CE} = -0.5 V ave.	R _{SAT} max. ohms	V _{EB} max. volts
2N1275	-100	-80	1.0	15	60	-60

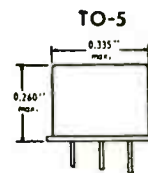

E3-44

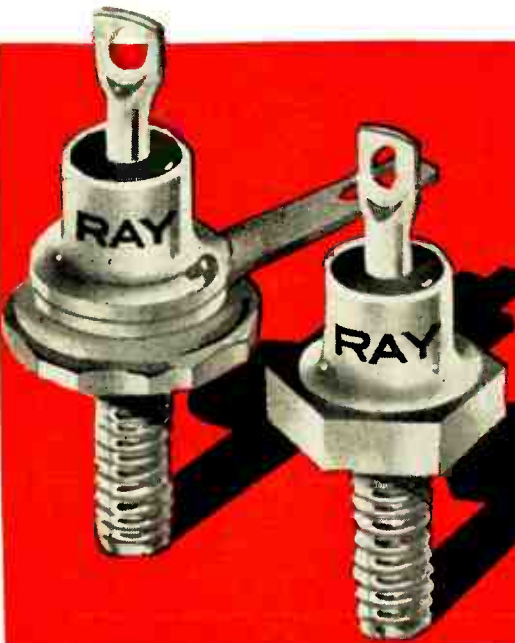
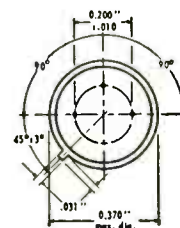

NEW RAYTHEON 4 AMP SILICON RECTIFIERS

3 Constructions for design and operating convenience

- STUD INSULATED
- STUD CONNECTED TO CATHODE
- STUD CONNECTED TO ANODE

- Low reverse current
- High forward conductance
- Fast reverse recovery
- Exceptional stability

NPN Switches - Medium Current High Frequency, High Gain (Temperature Range -65°C to +85°C)

Type	V _{CB} max. volts	f _{ab} min. Mc	H _{FE} ave. I _C = 50 mA V _{CE} = 1.0 V	R _{SAT} ave. ohms
2N438	25	2.5	25	2
2N439	20	5.0	45	2
2N440	15	10.0	70	2

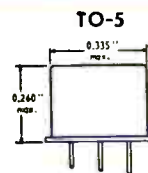

E3-44

NPN High Gain IF and Converter For Broadcast and Auto Radio (Temperature Range -65°C to +85°C)

Type	Circuit Usage	V _{CE} max. volts	I _{CO} max. μA	C _{ob} f = 1 Mc ave. μμf	Gain 455 Kc db
2N1366	Converter	12	20	11	28*
2N1367	IF	12	20	11 ± 3	38

*Conversion Gain

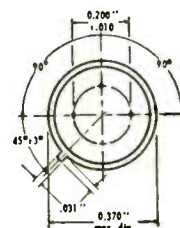

SEMICONDUCTOR DIVISION

RAYTHEON COMPANY

SILICON AND GERMANIUM DIODES AND TRANSISTORS • SILICON RECTIFIERS • CIRCUIT-PAKS

New York, Plaza 9-3900 • Boston, Hillcrest 4-6700 • Chicago, National 5-4000 • Los Angeles, Normandie 5-4221 • Orlando, Garden 3-1553
Syracuse, Granite 2-7751 • Baltimore, Southfield 1-0450 • Cleveland, Winton 1-7716 • Kansas City, Plaza 3-5330 • San Francisco, Flerside 1-7711
Canada: Waterloo, Ont., Sherwood 5-6831 • Government Relations: Washington, D. C., Metropolitan 8-5205

*This unique "extra"
fifth digit...*



*...provides 100%
over-ranging...ten times
greater resolution at decade
voltage points where other 4-digit
voltmeters change ranges and lose
one full digit of resolution.*

The KIN TEL Model 501 4-digit, over-ranging digital voltmeter measures DC from ± 0.0001 to ± 1000.0 volts with $0.01\% \pm 1$ digit (of reading) accuracy. An extra fifth digit in the left decade indicates "0" or "1" to provide ten times greater resolution at decade (1, 10, 100) voltage points than standard 4-digit voltmeters. Ranging and polarity indication are entirely automatic. The measured voltage, decimal point and polarity symbol are displayed on an in-line readout in a single plane—no superimposed outlines of "off" digits.

An adjustable sensitivity control permits decreasing sensitivity to allow measurement of noisy signals. Ten-line, parallel input printers can be driven directly, and converters are available for driving other types of printers, typewriters, and card or tape punches. The input may be floated up to 25 volts DC above or below chassis ground with no degradation in performance, and up to 250 volts DC with slight decrease in accuracy. Stepping-switch drive coils are energized with DC as in telephone-type service to provide long, trouble-free operation.

The 501 is one of a complete line of KIN TEL digital instruments. Others include AC converters, AC and DC preamplifiers, ratiometers, and multi-channel input scanners.

IMPORTANT SPECIFICATIONS

Display...Six decades display 5 digits (Left digit "0" or "1" only), decimal point, polarity symbol. Ranging and polarity indication are automatic. Projection system readout employs bayonet-base lamps with 3000-hour minimum life rating. Readout contains no electronic circuitry and can be remotely mounted.

Automatic Ranges... ± 0.0001 to ± 1000.0 volts DC in four ranges: 0.0001 to 1.9999; 02.000 to 19.999; 020.00 to 199.99; 0200.0 to 1000.0

Accuracy... $0.01\% \pm 1$ digit (of reading).

Input Impedance...10 megohms on all ranges at null.

Reference Voltage...Chopper-stabilized supply, continuously and automatically referenced to standard cell.

Stepping-Switch Drive...DC voltage within stepping-switch manufacturers rating applied by transistor drive circuit at rate of approximately 20 steps per second.

Controls...Three: on-off; sensitivity; and mode of operation (standby, normal, print auto, print remote).

Printer Drive...Built-in for parallel input printers. Automatic or remote.

Dimensions and Net Weights...Control unit: 45 lbs, 5 1/4" H x 19" W x 16" D.
Readout: 10 lbs, 3 1/2" H x 19" W x 9" D.

Price: \$2995

KIN TEL manufactures electronic instruments for measurement and control, and closed circuit TV. Representatives in all major cities. Write for detailed literature or demonstration.



5725 Kearny Villa Road, San Diego 11, California. Phone: BRowning 7-6700

ELECTRONICS NEWSLETTER

SOVIET MOON STRIKE was made possible by highly sophisticated tracking, computing and telemetering equipment after the powered phase of the third stage's flight ended, if a report of a "significant technical advance in the second Soviet cosmic rocket" is accurate. Declared the East Berlin *Berliner Zeitung*: "Until now, slight deviations in the trajectory of the rocket after finishing active phase were not correctible. Significant technical advance (permits) small corrections in its flight, even (during) passive stage, by radio signals from the Earth." If this report is correct it means that the Soviets have not only an extremely efficient tracking system and some kind of attitude controls—perhaps auxiliary jets—in the third stage rocket, but also an extremely fast and accurate data-processing system on the ground. High-speed computer had to figure out the extremely complex ballistic trajectory, compute the moon's path, from these figure out optimum intercept point, and then compute backwards to calculate the orbital corrections for the rocket; finally, the corrections would have to be communicated to the coasting rocket by means of a command guidance system. For more on the moonshot, see p 26.

Tropospheric scatter transmission of 500 pulse code modulated signals over a 93-mile path has been accomplished by Army Signal Research and Development Laboratory, Ft. Monmouth, N. J. A 12-voice channel pcm signal was transmitted. Previously, the use of pcm multiplex equipment with microwave systems was limited to line-of-sight distance.

FOREIGN ELECTRONICS COMPANIES are posing an increasingly serious threat to our industry. Sylvania president Robert E. Lewis tells **ELECTRONICS**. "For one thing, we in this country have got to produce more for wages paid." Lewis, just back from a trip to Europe, agrees there is no single answer to growing foreign competition. But he urges more U S. awareness of the problem. He feels "everything possible" must be done in these areas: (1) Industry must exercise greater cost control, give away less knowhow and develop more new products; and (2) Government should cooperate more with industry in its trade policy, soften its tariff and import regulations to benefit the electronics industry since foreign governments staunchly support electronics abroad.

New Jersey Turnpike Authority last week became the first U.S. highway authority to use a solid-state computer when it put into operation a Remington Rand Univac Solid State System. Equipment costs \$347,000, rents for \$6,950 a month.

ELECTRONIC CALIBRATION CENTER of National Bureau of Standards Laboratory, Boulder, Colo., will set up new facilities for calibration

at: (1) high frequencies for voltage, power, impedance, attenuation and field strength; (2) in the microwave region, for precision power, impedance, attenuation, frequency and noise calibrations; (3) for the low-frequency region, covering instruments, resistors and resistance apparatus, inductance and capacitance, standard cells, current and voltage transformers, ratio devices and miscellaneous types of low-frequency apparatus. This year there has already been some expansion of the low-frequency calibration service with the availability of new NBS equipment and techniques.

INTERMETALLIC SEMICONDUCTOR DEVICES

will see increasing use in the next 10 years to meet special requirements like high temperature, nuclear environment and high frequency, according to J. A. Morton, Bell Telephone Laboratories vice-president. Morton reports that one Bell intermetallic device, a gallium arsenide high-speed computer diode, is in pilot production. The use of III-V compounds will be evolutionary, he says, not revolutionary. Of more immediate interest to the industry, he feels, is fuller exploitation of recent germanium and silicon device breakthroughs. Among these are the diffusion technique, and the Esaki or tunnel diode.

EXTENDED LOW-FREQUENCY RANGE

is a feature of the new CV-107 magnetic tape recorder-reproducer just delivered by Mincom division of Minnesota Mining and Manufacturing Co. to Sandia Corp., Albuquerque, N. M. Three low-frequency tracks ranging from $\frac{1}{2}$ cycle to 100 kc can operate simultaneously with four analog tracks whose frequency response ranges from 400 cycles to 1.0 mc. The seven video channels are put on a single $\frac{1}{2}$ -inch tape.

Automatic programming of a jet engine performance test will be carried out by a system being designed and built in Datex Corp., Monrovia, Calif., a Giannini Controls Corp. division, for Avco's Lycoming division. Punched paper tape input will be used. System will yield a complete test record of pressure, temperature, vibration, position and counter data.

EMBOSSING MACHINE

which electronically translates punched card or paper tape data onto plastic cards or metal plates is being produced by Dashew Business Machines, Culver City, Calif. Operating at an average speed of some 235 characters a minute, the Datatyper 410 reads cards or tape electrically, servos an embossing wheel over the card and lowers it quietly to make the impression. Electronic control not only ups speed and cuts noise but also permits reshuffling punched data on the way from source to plate.

platinum clad tungsten wire is most efficient for high temperature applications



Platinum clad tungsten wire is ideally suited to modern requirements for high power vacuum tube grid and other high temperature applications. Because of its superior physical properties at elevated temperatures, tungsten provides the more rigid, refractory core material required by high power tubes; it also exhibits lower interaction with platinum. Unlike molybdenum, platinum clad tungsten is readily hot-stretched to take a permanent setting and lends itself to fabrication into grids employing conventional fixtures and spot welding procedures. Available in diameters from .001" and up. Write for Technical Bulletin.

BAKER PLATINUM DIVISION • 113 ASTOR STREET
NEWARK, N. J.

CIRCLE 100 READERS SERVICE CARD



WRITE FOR LITERATURE



precious metal contacts for high-reliability

For high-reliability and long operating life, precious metal contacts in pure or alloyed forms of silver, platinum, palladium and gold are very definitely indicated. These contacts provide unmatched high resistance to atmospheric corrosion, deformation, arc erosion, binding and metal transfer. Baker precious metal contacts are supplied as wire, rod, sheet and in a complete line of fabricated forms. Facilities are also available for manufacture to your specifications. Write for Baker Contact catalog.

BAKER CONTACT DIVISION • 207 GRANT AVE., E. NEWARK
HARRISON P. O., N. J.

CIRCLE 101 READERS SERVICE CARD

DOMESTIC DIVISIONS: AMERICAN PLATINUM & SILVER DIVISION, AMERSIL QUARTZ DIVISION, BAKER CONTACT DIVISION, BAKER DENTAL DIVISION, BAKER SETTING DIVISION, BAKER PLATINUM DIVISION, CHEMICAL DIVISION, EAST NEWARK INDUSTRIAL CENTER, HANOVIA LAMP DIVISION, HANOVIA LIQUID GOLD DIVISION, IRVINGTON-BAKER REFINING DIVISION, D. E. MAKEPEACE DIVISION, NATIONAL ELECTRIC INSTRUMENT DIVISION, RESEARCH AND DEVELOPMENT DIVISION, H. A. WILSON DIVISION. **COMPANIES ABROAD:** ENGELHARD INDUSTRIES OF CANADA, LTD. TORONTO, ENGELHARD INDUSTRIES OF QUEBEC, LTD. MONTREAL, ENGELHARD INDUSTRIES, LTD. LONDON, ENGELHARD INDUSTRIES A. G. ZURICH, ENGELHARD INDUSTRIES PTY., LTD. MELBOURNE, SOCIEDAD SURAMERICANA DE METALES PRECIOSOS S. A. BOGOTA, INDUSTRIE ENGELHARD S. P. A. ROME, ENGELHARD INDUSTRIES OF SOUTHERN AFRICA, LTD. JOHANNESBURG. **ASSOCIATED COMPANIES:** ACME TIMBER INDUSTRIES LTD., SOUTH AFRICAN FOREST INVESTMENTS LTD., SOUTH AFRICA, AZOPLATE CORPORATION, CHARLES ENGELHARD, INC., NUCLEAR CORP. OF AMERICA, INC., U.S.A.

for low cost purification and drying of hydrogen and other gases

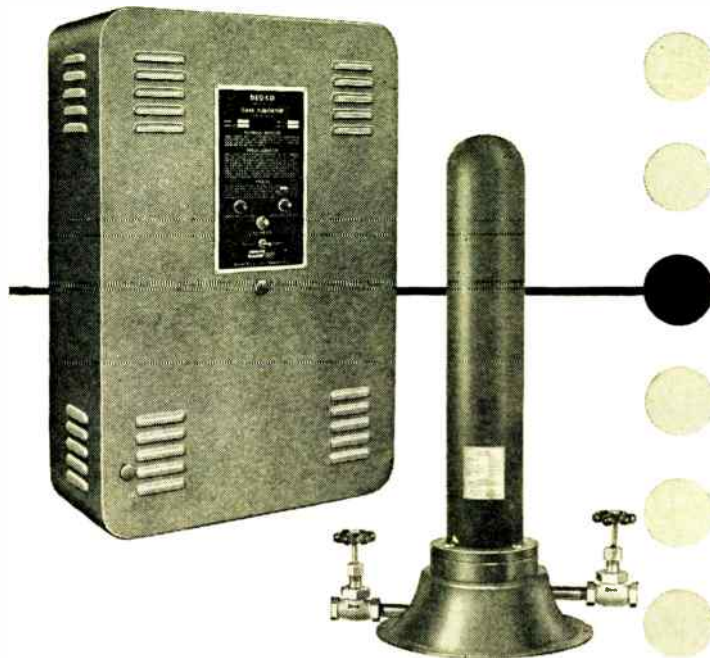

The Deoxo Catalytic Purifier is combined with an extremely efficient automatically operated drying unit to provide oxygen-free hydrogen that is ideally pure and dry. The combined units are identified as the Deoxo Dual Puridryer. It supplies hydrogen with less than one part oxygen per million — dried to a dew point of -100°F . No inert gas purging is needed. The Deoxo Dual Puridryer can also be used with other gases such as: Nitrogen, Argon, Helium and saturated hydrocarbons, with equally fine performance. Write for descriptive literature.

CHEMICAL DIVISION • 113 ASTOR STREET
NEWARK, N. J.

CIRCLE 102 READERS SERVICE CARD

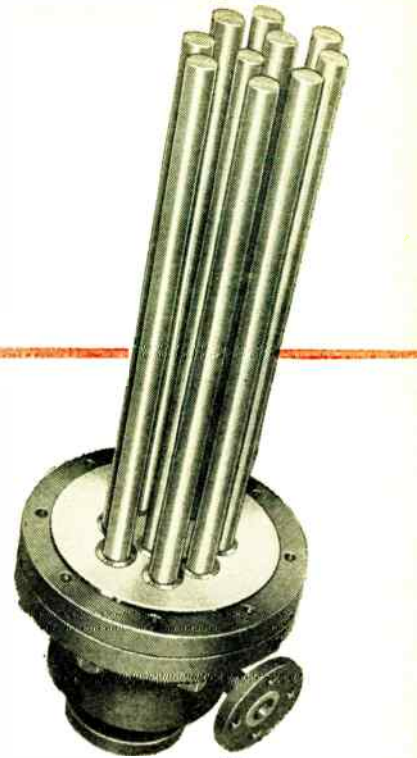

platinum clad sheet, tubing and wire for low cost corrosion-resistant equipment

Platinum clad sheet tubing and wire make it possible to incorporate all the important corrosion resistant qualities of the noble metals in equipment, at minimum cost. Platinum clad is pure platinum or an alloy of platinum so securely bonded to a base metal body that the composite metal can be fabricated. The gauge of the platinum metal can be specified to requirements. The process guarantees continuous pin-hole-free platinum cladding to withstand high temperatures without oxidation.

BAKER PLATINUM DIVISION • 113 ASTOR STREET
NEWARK, N. J.

CIRCLE 103
READERS SERVICE CARD



Professor Rudolph Rancid

(Somewhere in Lower California)



Q. — "What's that you have in your hand, Doctor?"

A. — "This here? Why it's a CINEMA Custom Modular Switch. And I'm not a doctor."

Q. — "Oh. Are you an electronic physicist?"

A. — "No. I'm an avocado farmer."

Q. — "My, that certainly is a strange combination."

A. — "Sure is, and I'm going right down to patent my new tree that grows these things."

Q. — "Do you think every tree should bear CINEMA Custom Modular Switches?"

A. — "They better not or I'll have to go back to farming those darn avocados."

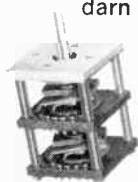

The gentleman is right about it being a CINEMA ENGINEERING Custom Modular Switch,

but unlike an avocado it doesn't grow on a tree. Years of exhaustive experimentation and development have gone into CINEMA switches, whose reliability has been measured, weighed and forecast. Ruggedly constructed and precisely designed, they are available in a wide range of sizes made to individual pole and position requirements at low cost. Contact our local representative, or write for our catalog 17S.



CINEMA ENGINEERING

DIVISION AEROVOX CORPORATION

1100 CHESTNUT • BURBANK, CALIF.

WASHINGTON OUTLOOK

WASHINGTON—THE AIR FORCE'S PROJECT to develop the F-108 all-weather fighter-interceptor aircraft is slated for cancellation this year, a high-level Defense Dept. official has told ELECTRONICS. The F-108, under development by a team of contractors headed by North American Aviation, is designed to carry more electronic apparatus than any combat plane ever built.

Among the electronics contractors now in the program: Hughes Aircraft, radar and fire control system; Garrett Corp.'s Airesearch Manufacturing div., central air data computing system; ITT's Federal div., mission and traffic control system; Electronic Specialty Co., antenna subsystem.

Mock-up of the aircraft was achieved earlier this year. The plane is designed to fly at mach 3 speeds at altitudes 14 miles above the earth. Its combat range is reportedly over 2,000 miles.

The project will be cancelled, Pentagon insiders say, because of two factors: (1) Russia's deemphasis on manned bomber development and production; and (2) the operational deployment of advanced surface-to-air missiles.

Still, the overriding consideration is budgetary. Were it not for the tight budget limitations clamped on the Pentagon for next year's planning, the Air Force would be allowed to continue work on the F-108. The fiscal pressures have pitted the F-108 against other weapon development projects in competition for funds. The result: The F-108 is expected to be ruled a "marginal" project.

- Planning for the fiscal 1961 military budget is now in full swing.

This is the forecast of the new spending plans from top Defense Dept. officials:

Aircraft production will slide under the \$6-billion expenditure level for the first time since Korea. The volume of new orders for planes will dip even more.

Missile production spending will rise roughly \$1 billion to a total of about \$5 billion—close to the rate planned for aircraft procurement. Still unsettled is the question of starting production of the Army's Nike-Zeus anti-ICBM system (Bell Labs). A decision to go ahead would boost missile outlays even more. But odds are the Pentagon will postpone a production order. Many military scientists are still disenchanted with the system's potential.

Electronics buying will continue to rise. Pentagon experts talk about a seven-percent rise over this year's \$1-billion rate for "pure" electronics—excluding electronics for missiles, planes and ships. One big program sure to benefit: Ground communications.

Research and development will continue at this year's \$2.6-billion level. Offsetting cuts in aircraft and missiles, R&D will be given a hefty boost in the Pentagon's \$115-million program supporting basic research. There also will be more applied research on anti-submarine warfare techniques.

- Look for the Federal Communications Commission to initiate action this Fall on squeezing a third tv station into more major cities. Sen. Mike Monroney (D., Okla.), ranking member on the Communications Subcommittee, is building fires under the FCC. He charged in a hasty adjournment rush speech that FCC is dragging its feet.

It was five months ago that FCC proposed dropping in third tv stations in some 21 cities, even if broadcasting range of some stations has to be cut down.

Since then initial action (proposed rule making) has been taken only for Fresno and Bakersfield, Calif., and Birmingham, Ala. FCC claims that because of the many legal and technical problems, cities must be handled on a case-by-case basis. Ripe for action this Fall: Grand Rapids, Mich.; Shreveport, La.; Providence, R. I.; Syracuse and Rochester, N. Y.

Easy-to-use, low cost, precision



FREQUENCY, TACHOMETRY INSTRUMENTS

-hp- 500B Electronic Frequency Meter

Model 500B is a rugged, precision instrument widely used for direct-reading laboratory or production line measurements of ac frequency from 3 cps to 100 KC. With -hp- 508A-D Tachometer Generators or -hp- 506A Optical Tachometer Pickup, the 500B also provides direct tachometry readings.

Typical applications include rf signal beat frequency comparisons, crystal frequency deviations, audio frequency and FM measurements, oscillator stability, machinery rotational speed, average frequency of random events, checking vibration or torsion in gear trains, etc.

Model 500B has an expanded scale feature permitting

any 10% or 30% of selected range to be viewed full scale. It also offers a pulse output synchronous with an input pulse for measuring FM components of input signals or syncing a stroboscope or oscilloscope. Readings are independent of line voltage, input signal or vacuum tube variations. \$285.00.

-hp- 500C Electronic Tachometer Indicator

Model 500C is identical to 500B except for meter calibration which is in rpm for greater convenience in tachometry measurements. With appropriate -hp- transducers (506A or 508A-D series), -hp- 500C will measure rpm from 15 to 6,000,000 rpm in 9 ranges. \$285.00.

-hp- Rotational Speed Transducers

NO MECHANICAL CONNECTION

-hp- 506A Optical Tachometer Pickup measures speeds 300 to 300,000 rpm of moving parts which have small energy or can not be connected mechanically to measuring devices. Employing a phototube and operated by reflected-light interruptions from light and dark areas on a shaft, -hp- 506A may be used with -hp- 500B Electronic Frequency Meter, -hp- 500C Electronic Tachometer Indicator, -hp- 521 and 522 Electronic Counters, and similar instruments. Output voltage is 1 volt rms minimum into 1 megohm; light source is a 21 candlepower, 6 volt automotive bulb; phototube is Type 1P41. \$125.00.



MECHANICAL CONNECTION



-hp- 508A/B/C/D Tachometer Generators are for use with electronic counters or frequency meters in rpm measurements from 15 to 40,000 rpm where direct mechanical connection can be made to the rotating part under measurement. -hp- 508A produces 60 output pulses per shaft revolution. When connected to an indicating instrument calibrated in rps, it permits direct readings in rpm. Relationship between output

voltage and shaft speed is virtually linear to 5,000 pps, simplifying oscilloscope presentation of shaft speed as a function of time for analyzing clutches, brakes and acceleration rates.

-hp- 508B, C and D are identical to -hp- 508A except output is 100, 120 and 360 pulses per revolution respectively, and output voltage peaks at successively slower shaft speeds. -hp- 508A, B, C or D, \$100.00.

Data subject to change without notice. Prices f.o.b. factory

HEWLETT-PACKARD COMPANY

4870A PAGE MILL ROAD • PALO ALTO, CALIFORNIA, U.S.A.
CABLE "HEWPACK" • DAVENPORT 5-4451
FIELD REPRESENTATIVES IN ALL PRINCIPAL AREAS



Ask about new -hp- 200 KC oscilloscope—\$435⁰⁰

a new concept...

ELECTRONICS CAPITAL CORPORATION

A \$16,500,000 institution devoted to the management and capital needs of the electronics industry.

Electronics Capital Corporation is the first and largest Small Business Investment Company specifically licensed to provide long-term capital for the growth and expansion of electronics companies throughout the United States.

OFFICERS AND DIRECTORS

Charles E. Salik, *President*
President, Electronics Investment Corporation

Richard T. Silberman, *Executive Vice President*

Dr. Neil H. Jacoby
Dean of the Graduate School of Business Administration
University of California, Los Angeles

Dr. Joseph M. Pettit
Dean of the School of Engineering,
Stanford University

Donald C. Duncan
Director, Contract Sales
Beckman Instruments

Alfred J. Coyle
Partner, Hayden, Stone & Co.

David Salik
Industrialist

Bernard Koteen, *Secretary*
Partner, Koteen & Burt

Louis J. Rice, Jr.
Vice President, Director, First National Bank, San Diego

Send for informative brochure "Long-Term Capital for the Electronics Industry"
ELECTRONICS CAPITAL CORPORATION, 1400 Fifth Ave., San Diego, Calif.

Instruments Show Net Gains

INSTRUMENT MANUFACTURERS are making record financial news this Fall. Survey by American Management Association reveals that this year instrument makers have budget hikes of 29.7 percent in amounts spent on research and development, as compared to last year. Instruments ran second only to automotive R&D in a study of 23 industry groups.

• **Beckman Instruments**, Los Angeles, achieved record high sales of \$44,872,768 for the fiscal year ending June 30. This is an increase of 13 percent over last year. Net income after taxes came to \$1,771,689, equivalent to \$1.30 a share. Last year, the company sustained a loss of 70 cents a share. For fiscal 1959 Beckman R&D expenditures were \$3,453,608, approximately 8 percent of sales. Last year the firm spent \$4,061,960, or 10 percent of sales on R&D.

• **Victoreen Instrument Co.**, Cleveland, reports earnings of \$219,465, or 15 cents a share, for the six months ended June 30. This is a 24-percent increase over last year's first six months. Sales for the first half of 1959 were also up sharply to \$3,629,259, as compared with \$1,593,382 in the first six months of 1958. Increase on this sales figure is 125 percent.

• **Leeds & Northrup**, Philadelphia, manufacturer of industrial process control instruments, instrumentation for nuclear reactors and public utilities control gear, reports net earnings of \$1,353,000, or \$1.68 a share, for the fiscal year ended May 31. For the same period in 1958, earnings were \$1,112,000 or \$1.35 a share. Net shipments for the latest period were \$35,962,000, compared with \$35,262,000 the year before. The company is presently outfitting a \$2-million research and development center, which was opened last week in North Wales, Pa.

• **Electronic Assistance Corp.**, Red Bank, N. J., which includes

instruments in its diversified line, now reports a sales order backlog of about \$4 million, as compared to \$375,000 last February. Included in this figure is a contract for approximately \$1½ million with the Navy for radar altimeters.

• **Electronic Engineering Co.**, Santa Ana, Calif., announces work in process to be at the highest level in company history. The firm has a consolidated net income of \$48,300 on sales of \$1,800,000 for the six-month period ending June 28, 1959 and expects a year-end sales total of more than \$5 million. Heavy shipments of electronic instrumentation, timing systems and data processing equipment from now to year's end are expected to greatly increase billings.

25 MOST ACTIVE STOCKS

	WEEK ENDING SEPTEMBER 18			
	SHARES (IN 100's)	HIGH	LOW	CLOSE
Avco Corp	807	135½	124½	124½
Sperry Rand	681	23¾	22½	22½
Raytheon	650	50¾	45½	46½
Gen Tel & Elec	616	70¾	68	68½
Int'l Tel & Tel	577	33½	30¾	30¾
Gen Elec	559	78½	76	76½
Univ Control	440	17¾	15¾	16¾
Gen Dynamic	410	49	45½	46½
Burroughs	400	30¾	29½	30
Littlon Ind	385	115¾	105¼	108½
Westinghouse	352	89½	85¾	88½
RCA	345	59¾	56¾	57¾
Zenith Corp	343	102¼	93¼	93¾
Texas Inst	331	134¾	122½	124¼
Elec & Mus Ind	311	7¾	7¼	7¼
Victoreen Inst	272	13¾	11	11½
Lear Inc	253	14	12½	12½
Beckman Inst	251	53½	48	48½
Gen Inst	209	23¾	20¾	21½
Dynamics Corp	185	8¾	7¾	8
Philco Corp	182	24¾	22¼	22½
El-Tronics	181	1¼	1¾	1½
Siegler Corp	180	26½	24½	24¾
Admiral	175	19¼	17¼	17¼
Reeves Sndcrft	173	7¾	7¼	7¾

The above figures represent sales of electronics stocks on the New York and American Stock Exchanges. Listings are prepared exclusively for ELECTRONICS by Ira Haupt & Co.

NEW PUBLIC ISSUES	No. of Shares	Issue Price
Faradyne Electronics	200,000	5
Allied Radio	333,335	16½
Shell Electronics	17,000	2
Missile Systems Corp	53,000	1¼

STOCK PRICE AVERAGES

	Sept. 16, 1959	Aug. 19, 1959	Change From One Year Ago
Electronics mfrs.	84.59	88.89	+40.6%
Radio & tv mfrs.	90.75	94.81	+31.1%
Broadcasters	101.49	107.44	+71.7%

Lepel
HIGH FREQUENCY INDUCTION HEATING UNITS

BAKING BOMBARDING SOLDERING MELTING HARDENING ANNEALING

Lepel induction heating equipment represents the most advanced thought in the field of electronics... the most practical and efficient source of heat developed for numerous industrial applications. You are invited to send samples of work with specifications. Our engineers will process and return the completed job with full data and recommendations without cost or obligations.

FLOATING ZONE UNIT FOR METAL REFINING AND CRYSTAL GROWING

A new floating zone fixture for the production of ultra-high purity metals and semi-conductor materials. Purification or crystal growing is achieved by traversing a narrow molten zone along the length of the process bar while it is being supported vertically in vacuum or inert gas. Designed primarily for production purposes, Model HCP also provides great flexibility for laboratory studies.

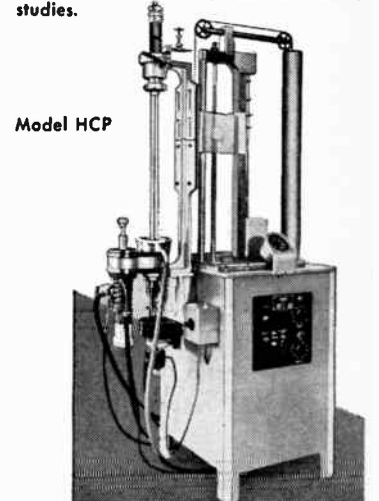

Features

- A smooth, positive mechanical drive system with continuously variable up, down and rotational speeds, all independently controlled.
- An arrangement to rapidly center the process bar within a straight walled quartz tube supported between gas-tight, water-cooled end plates. Placement of the quartz tube is rather simple and adapters can be used to accommodate larger diameter tubes for larger process bars.
- Continuous water cooling for the outside of the quartz tube during operation.
- Assembly and dis-assembly of this system including removal of the completed process bar is simple and rapid.

Electronic Tube Generators from 1 kw to 100 kw. Spark Gap Converters from 2 kw to 30 kw.

WRITE FOR THE NEW LEPEL CATALOG

All Lepel equipment is certified to comply with the requirements of the F.C.C.

LEPEL HIGH FREQUENCY LABORATORIES, INC.
55th STREET and 37th AVENUE, WOODSIDE 77, N. Y.

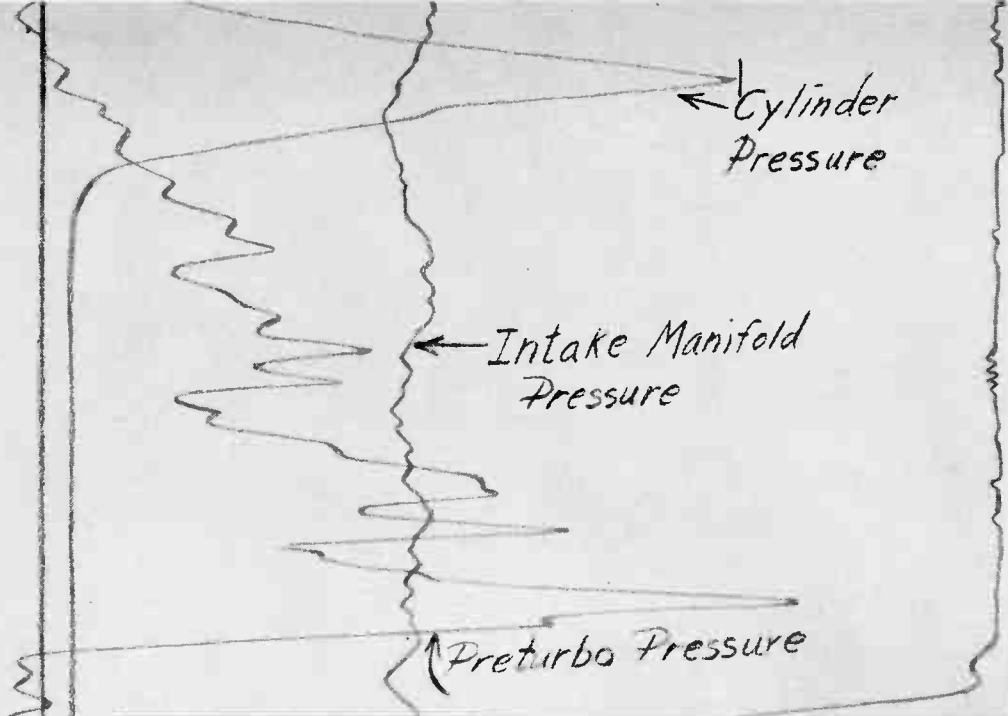

This is a record of leadership

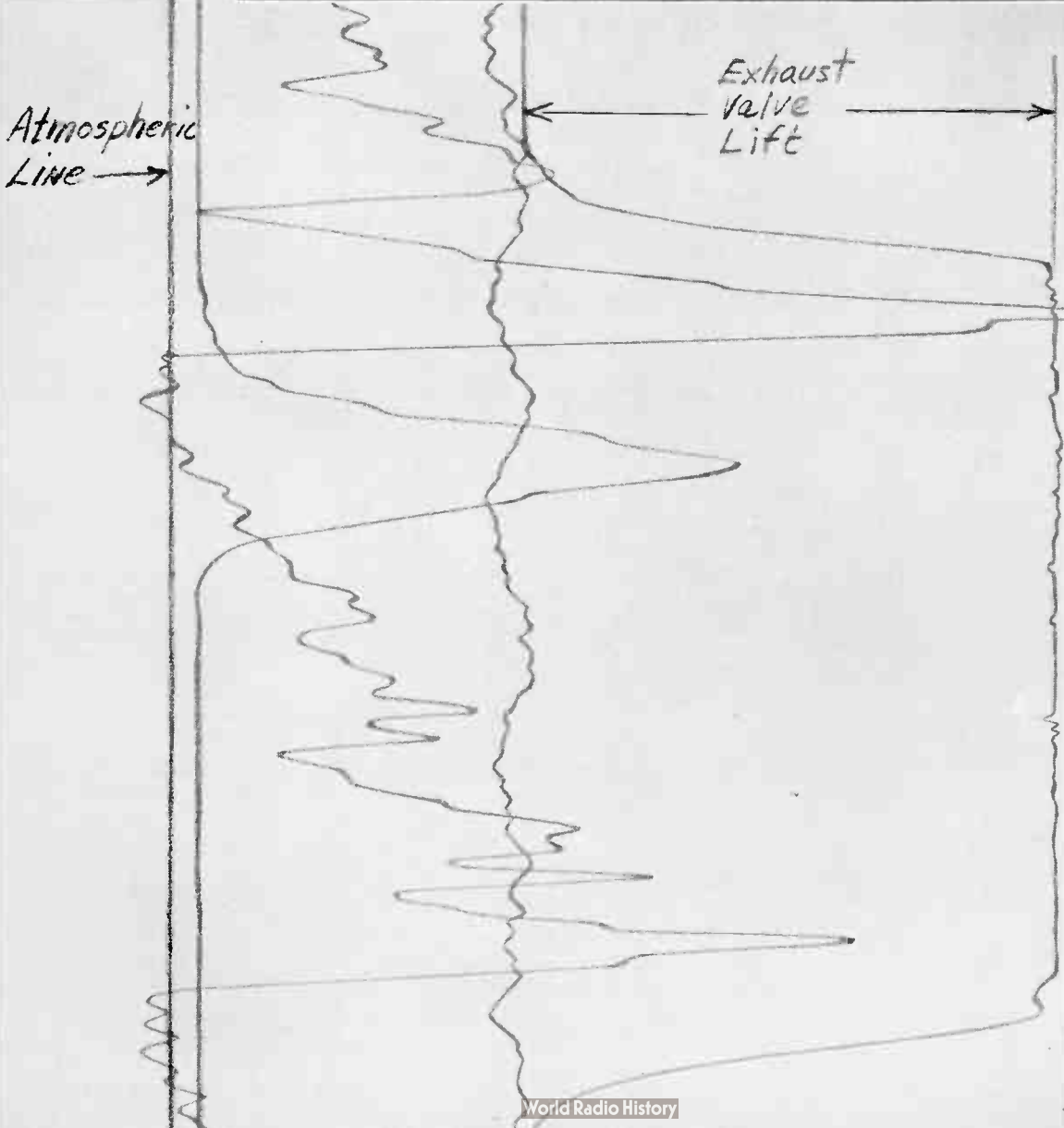



The Worthington Corporation used a Honeywell 906 Visicorder to chart the heartbeat of a Worthington Tripower diesel engine. These Tripower (oil fuel, dual fuel, or spark ignition gas) engines have a fourteen inch bore, an eighteen inch stroke, and develop more than 265 h.p. per cylinder at 450 RPM.

The Visicorder used in these tests makes a direct, instantly-readable record of the pressure variations in the exhaust manifold, cylinder, and intake manifold to determine optimum valve

timing and engine configuration. The Visicorder also produces a permanent record of strain gauge measurements taken on the frame and other critical engine parts.

For the manifold and cylinder pressures, strain gauge pressure transducers and a strain gauge amplifier were used. For the valve lift patterns, a linear potentiometer powered with a small battery was connected directly to the Visicorder.

Analysis of these data has led to changes in the Tripower engine for best performance.

in diesel engine research

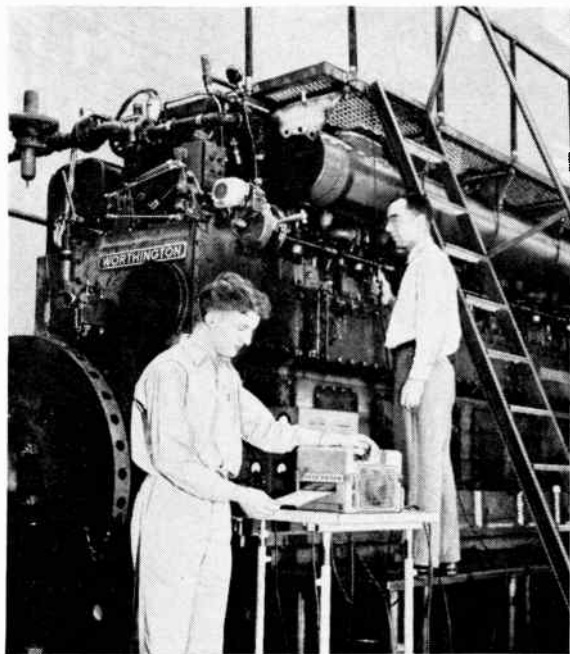

Ted Dupler (left) and John McAllister, Worthington Engine Research Engineers, measure intake manifold, cylinder, and exhaust manifold pressures and valve stroke on a Tripower with a Honeywell 906 Visicorder

The Honeywell Visicorder is the pioneer and unquestioned leader in the field of high-frequency, high-sensitivity direct recording oscillography. In research, development and product testing everywhere, instantly-readable Visicorder records are pointing the way to new advances in product design, rocketry, computing, control, nucleonics . . . in any field where high speed variables are under study.

The new Model 906A Visicorder, now available in 8- and 14-channel models, produces longitudinal grid lines simultaneously with the dynamic traces, time lines, and trace identification by means of new accessory units.

To record high frequency variables—and monitor them as they are recorded—use the Visicorder Oscillograph. Call your nearest Minneapolis-Honeywell Industrial Sales Office for a demonstration.

Reference Data: Write for Visicorder Bulletin
Minneapolis-Honeywell Regulator Co.,
Industrial Products Group, Heiland Division
5200 E. Evans Ave., Denver 22, Colo.

Honeywell



Industrial Products Group

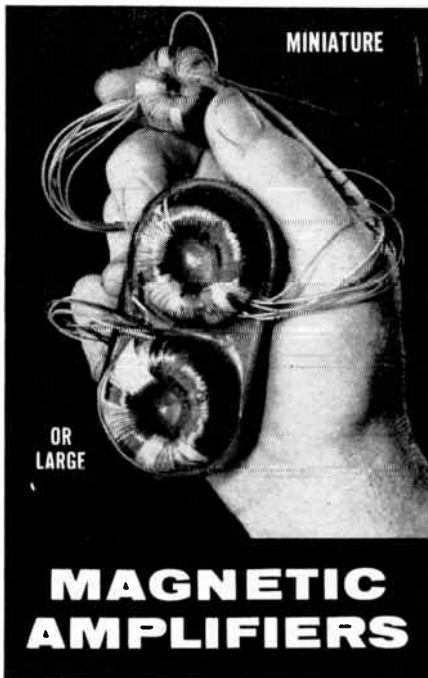

**Complete, from Design
to Finished Product,
by FORBES and WAGNER**

Our modern facilities comprise precision toroid winding, impregnating, assembling, encapsulation and testing to provide completely matched units for use in magnetic amplifiers.

Illustration shows a miniaturized magnetic amplifier with matched cores. The larger amplifier with matched units has been only partially potted to show the Toroidal Coils.

As in all Forbes and Wagner components, great emphasis is placed on quality... quality in design, materials and fabrication. Write for brochure giving the complete F & W story.



These modern Toroidal Coil Winding Machines cover a wide range of core and wire sizes.

Electrical Engineers, here is an opportunity to really grow. We offer, as a small company, (with large resources) a happy friendly relationship. No high-hat officials that you seldom see, much less know, to decide your future. Here the president is one of the boys—all working together for growth of company and personal reward. You'll like it here. Replies held in strict confidence.

forbes and wagner, inc.
347 Central Avenue
Silver Creek, N. Y. • Phone FR-7202

MARKET RESEARCH

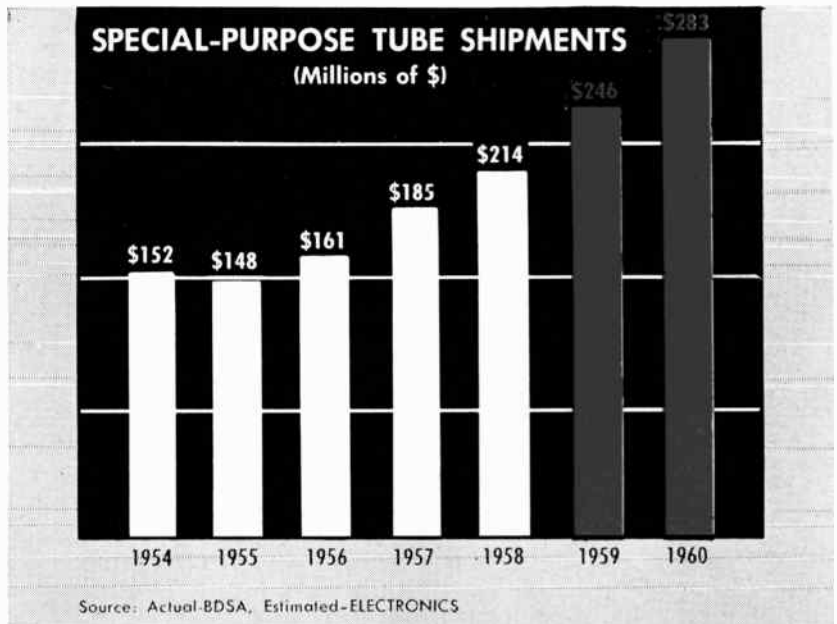

Special-Tube Sales Run High

SPECIAL-PURPOSE TUBES are currently the market favorite of the electron-tube business, according to reports from Business and Defense Services Administration.

Electron tube statistical report by BDSA shows shipments or sales of power and special-purpose tubes have risen from \$152 million to \$214 million between 1954 and 1958 (see chart).

In its midyear review of the electronics industry, the government agency predicts electron-tube sales should increase over 1958 by more than 10 percent and that most of this increase will come from transmitting and special-purpose tubes.

ELECTRONICS estimates that 1959 sales of special-purpose tubes will increase by 15 percent over 1958 and that 1960 sales will show a 15-percent gain over 1959. This rate of increase would bring dollar sales of the special tubes up to \$246 million in 1959 and \$283 million in 1960.

Comparison of special-purpose tube sales by type shows that high vacuum tube sales have increased by 30 percent over the five-year period, while klystron sales have increased by more than 100 percent.

Of course, not all types of spe-

cial-purpose tubes are enjoying the same rate of increase as the table below, extracted from the BDSA report, shows:

Years:	1954	1955	1956	1957	1958
TOTAL S-P TUBES.....	152	148	161	185	214
High vacuum.....	30	31	37	37	39
Gas and vapor.....	18	17	17	17	18
Klystrons.....	14	16	21	25	29
Magnetrons.....	51	42	42	44	50
F'wd & B'kwd Wave.....	—	1	2	6	17
Duplexers.....	7	6	5	6	7
Lighthouse.....	6	6	7	13	13
CR light emit., etc. ¹	15	17	19	23	25
Miscellaneous ²	11	12	11	14	16

¹ Also includes storage and camera tubes; tv picture tubes excluded.

² Includes phototubes; photocells; radiation detection tubes; spark gaps; beam deflection tubes; decade counters; electronic switches; mechanical transducers; orbital beam tubes; and vacuum capacitors, switches, and gages. Excludes X-ray tubes.

Forward and backward wave tube sales have multiplied 17 times in 4 years while lighthouse (uhf planar) tubes sales have almost doubled in three years.

FIGURES OF THE WEEK

LATEST WEEKLY PRODUCTION FIGURES

(Source: EIA)	Sept. 11, 1959	Aug. 14, 1959	Change From One Year Ago
Television sets	141,146	149,314	-2.85%
Radio sets, total	313,098	261,210	+6.05%
Auto sets	106,741	69,288	+19.65%

LATEST MONTHLY SALES TOTALS

(Add 000)	July 1959	June 1959	Change From One Year Ago
Rec. Tubes, value	\$29,786	\$33,099	+10.61%
Rec. Tubes, units	36,394	37,421	+18.18%
Pic. Tubes, value	\$14,684	\$15,137	+32.18%
Pic. Tubes, units	750	767	+36.47%

Need Better Electrical and Thermal Conductivity in a Glass-to-Steel Hermetic Terminal?

For most applications, solid 446 stainless alloy electrodes are best suited to our users needs. They are ideally suited to the perfect mating between our V24M glass and the pin. This fusion of glass and metal together with compression accounts for the rugged leak-proof character of Fusite Terminals under rough production handling and makes for easy solderability.

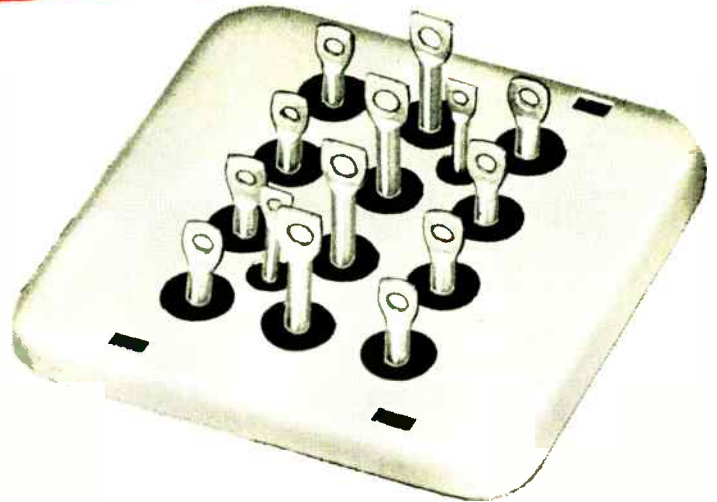

CONSIDER THE PLUS OF COPPER CORED ELECTRODES

When your application indicates the need for greatly improved electrical or thermal conductivity, you still need not sacrifice these inherent Fusite advantages. At slight additional cost, any of our terminals can be ordered with electrodes that have a copper core of as much as 25% of the total electrode area. Copper cored wire has up to 10 times increased current carrying capacity, yet, you maintain nearly all the advantages of solid 446 stainless.

Would you like to make tests?

Write Department M-5

THE **FUSITE** CORPORATION

6000 FERNVIEW AVE., CINCINNATI 13, OHIO

Woodford Mfg. Co., Versailles, Kentucky.

In Europe: FUSITE N. V. Königsweg 16, Almelo, Holland



New life test data prove superior

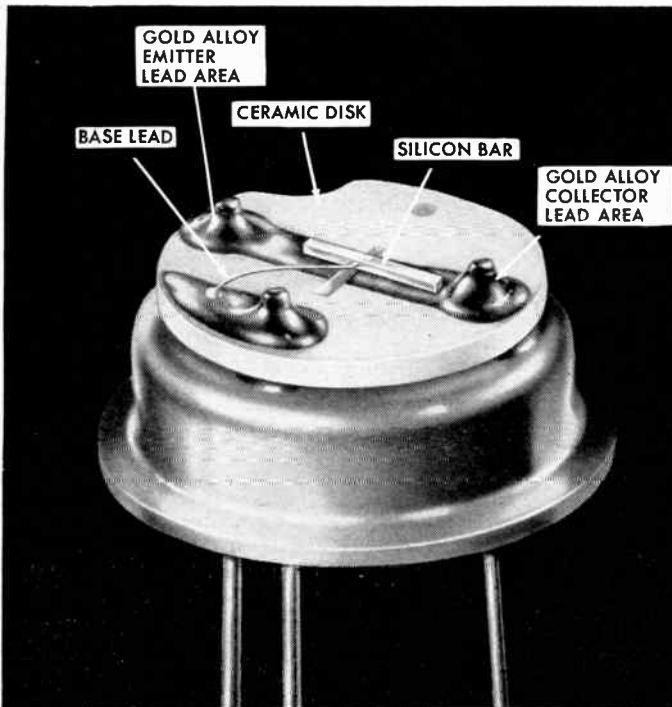

Magnified photo of silicon transistor showing Fixed Bed Construction. All parts are firmly fastened, with no suspended parts except wire lead. Transistor reacts as a solid block in resisting shock and vibration.

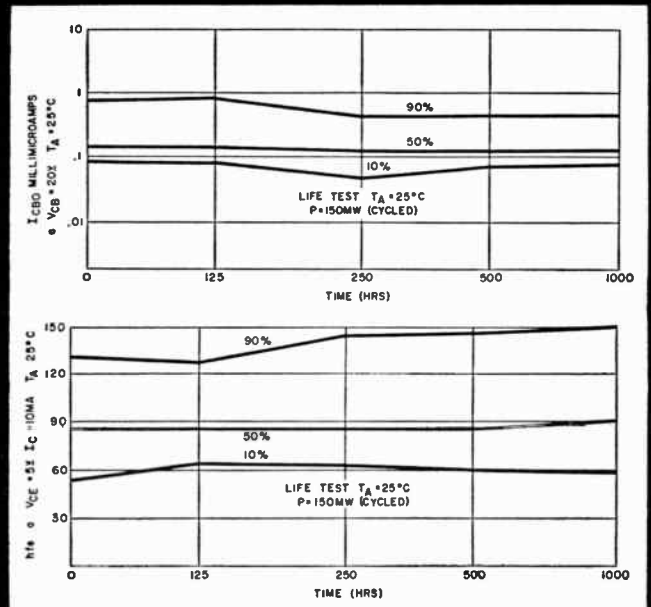

Charts show extreme stability of performance throughout 1000 hours of life for beta and I_{CBO} . Test conditions were 150 mw at 25°C, 200°C storage and 25 mw at 125°C. Drift rates were substantially the same under all conditions.

New NPN Tetrodes: Higher gain at high temperature and low current

LARGE QUANTITIES OF TYPES 3N36 AND 3N37 TESTED AND PROVED, HIGH RELIABILITY THE RESULT OF TWO YEARS OF MANUFACTURING EXPERIENCE*

Mechanical Reliability

Test	Results	% Survival
3-ft drop-shock (2500 G's. Mil Srd calls for 500G's)	2 out of 595 did not survive	99.66
Temperature cycling (-55°C to 100°C)	1 out of 375 did not survive	99.78
Life Test Reliability		
Cycled power @ 50 mw (device rated at 30 mw)	6 out of 500 exceeded parameter limits at 1000 hours	98.8
Oven @ 85°C	17 out of 500 exceeded parameter limits at 1000 hours	96.8
Shelf	No parameter failures of 500 units at 1000 hours	100.0

*General Electric's rigid standards call for only a slight shift in parameters to be a "failure." Many of these "failures" are still within EIA limits.

Here are two new germanium transistors that operate on lower voltages, require less current and are more rugged (see box below) than any other transistors that perform a like function. Furthermore, they deliver a high and constant gain at various voltages and at low power dissipation levels. Therefore, they are not only useful at high temperatures, but they also simplify circuit design and eliminate the need for close voltage regulation.

Features: Maximum gain at 1 ma, 5 volts or 5 mw. Flat gain noise factor from 1 ma to 5 ma. **Where to use them:** Mobile communications (made possible the first transistorized portable receiver). Wide band amplifier, oscillator and switching applications for radar and video at frequencies to 200 mc. **Availability:** Now . . . from your General Electric Semiconductor Sales Representative and in stock at your G-E Semiconductor Distributor's.

Absolute Maximum Ratings (25°C)

	2N36	2N37	
Collector voltage to base 1 or base 2 (V_{CB})	+ 7	+ 7	V
Emitter to base 1 or base 2 (V_{EB})	+ 2	+ 2	V
Collector current (I_C)	+ 20	+ 20	ma
Emitter current (I_E)	- 20	- 20	ma
Base 2 current (I_{B2})	2	2	ma
Total Power dissipation	30	30	mw

Electrical Characteristics (25°C)

	2N36	2N37	
Output capacity (C_{ob})	2	1.5	μf
Noise figure (NF)	11	11	db
Input impedance (h_{ie})	100-127	80-110	ohms
Current transfer ratio (h_{fe})	2.2 \angle -81°	1.1 \angle -100°	
Common base cutoff frequency (f_{cb})	50 MIN.	90 MIN.	mc
Common Emitter power gain (G_e)	11.5	9	db
Measurement frequency	60	150	mc

stability of G-E silicon transistors

Uniform characteristics out to 1000 hours exhibited by silicon transistors featuring Fixed Bed Construction

Comprehensive tests performed on General Electric silicon transistors show remarkably stable performance throughout 1000 hours of operation at high temperatures. Each test was run on seven lots of fifty Type 2N337 or 2N338 transistors (part of the series 2N332 through 339). These are the results:

350 units were given a 150 mw operating test at 25°C.

Only two units exceeded parameter limits, a successful performance rate of 99.4 percent.

350 units were given a 200°C storage test.

Only three units exceeded parameter limits, a successful performance rate of 99.1 percent.

Fixed Bed Construction, plus stabilized pro-

cessing makes these results possible. No fluxes, resins or solders are used — only a gold alloy which forms an integral bond between all parts.

Besides the demonstrated electrical characteristics, General Electric's silicon transistors can absorb physical punishment far beyond normal specifications. All parts are solidly fixed together and react as a solid block in resisting shock and vibration. Test units have been fired from a shotgun, struck with a golf club and rattled freely in an auto hubcap for 700 miles—and worked afterward.

Electrically and mechanically, this series of transistors is the most thoroughly tested and proved today—your assurance of high stability and reliability. Call your General Electric Semiconductor Representative for further details.

ABSOLUTE MAXIMUM RATINGS AT 25°C			
	2N332-6	2N337-8	
Collector to base voltage	45	45	volts
Emitter to base voltage	1	1	volt
Collector current	25	20	ma
Collector power dissipation	150	125	mw
Operating temperature	-65°C to 175°C		-65° to 150°C

Absolute Maximum Ratings at 25°C	
Collector to base voltage	20 volts
Emitter to base voltage	15 volts
Collector to emitter voltage	20 volts
Collector current	300 ma
Base current	50 ma
Emitter current	300 ma
Storage temperature	85°C to -65°C
Operating junction temperature	85°C
Power dissipation	150 mw

Now available - 4 new NPN alloy transistors

Four new germanium switching transistors, made by the highly controllable NPN alloying process, are now being warehoused by General Electric and its distributors. The four transistors, Types 2N634, -5, -6 and 2N388, feature extremely consistent parameters. I_{CO} for instance, multiplies up in a normal fashion, so that higher temperature I_{CO} may be predicted from low temperature readings.

The transistors provide 150 mw power dissipation. They are useful in emitter-follower applications in computers, high current flip-flops, and are ideal as complementary devices to PNP computer transistors, such as the 2N396.

For complete information call your General Electric Semiconductor Sales Representative, your G-E Semiconductor Distributor, or write Section S25109, Semiconductor Products Dept., General Electric Company, Electronics Park, Syracuse, New York.

GENERAL ELECTRIC

Semiconductor Products Dept., Syracuse, New York



CONTROLLED RELIABILITY BEYOND DESIGN

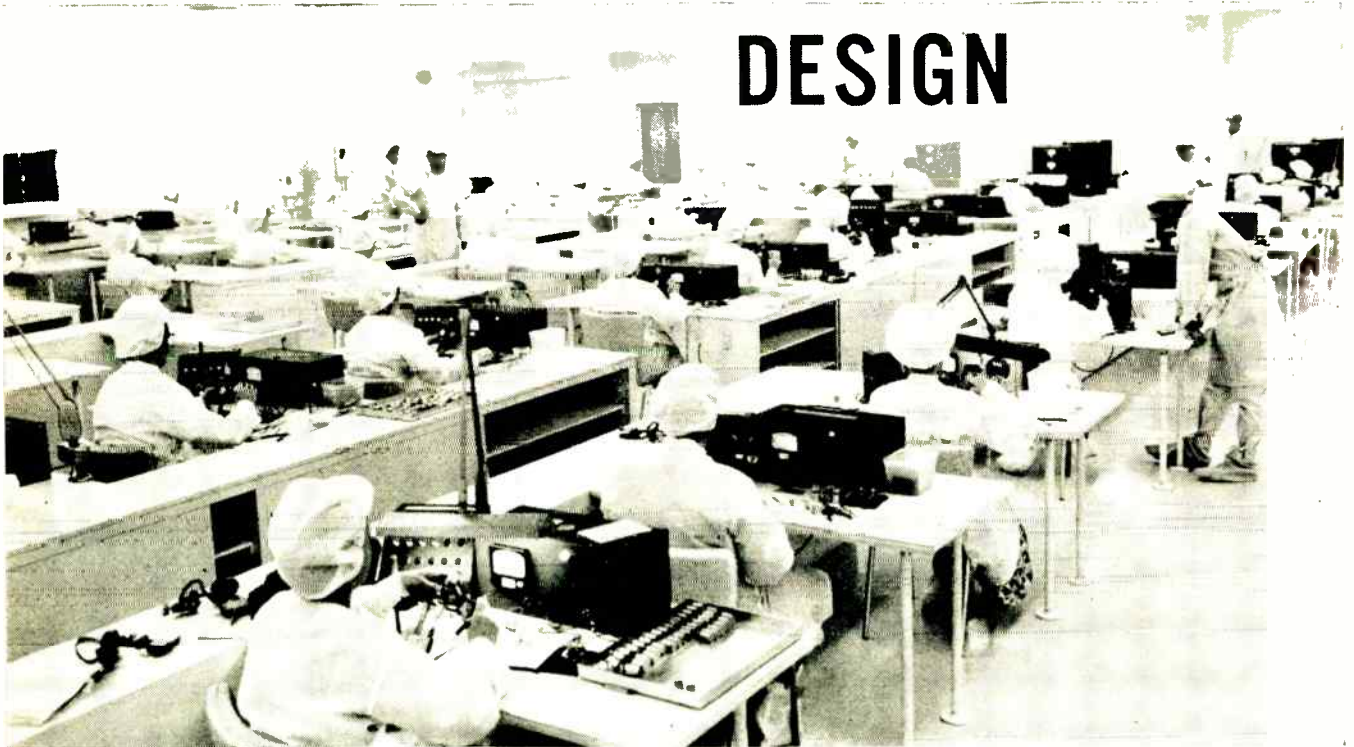

Basic reliability of an electronic component lies in its design. U.S. Relay has gone beyond this step by protecting already-proven designs with a new, contaminant-free production and test facility that is unique in the industry.

A 12,000 square foot manufacturing and test area which incorporates a most elaborate system of temperature, humidity and dust controls, is now in use. Positive pressure rooms, automatic shoe scrubbers, special lint-free garments for employees and air locks are a few of the precautions in effect. Control systems automatically record and warn of increases in air-borne particles, changes in room pressures and ambient temperatures.

Complete laboratories have been installed for testing components under all operating conditions encountered by missiles and conventional aircraft. This includes a specially designed Random Motion, Sine Wave, Vibration test system. Solid state switching for pulsing circuits and Flip-Flop network designs are now being investigated and formalized for production.

Specify U.S. Relay-Electronics components for unparalleled reliability.



For information write to:

U.S. RELAY-ELECTRONICS



A Division of A.S.R. Products Corporation

717 NORTH CONEY AVENUE, AZUSA, CALIFORNIA, DEPT. E

Engineers with relay and/or electromechanical experience desiring employment under ideal working conditions with above average advancement program, contact J. Kendall, Chief Engineer.



SPECIFY SPERRY

SILICON SEMICONDUCTOR DEVICES
...IN VOLUME PRODUCTION

For those applications where reliability and high performance come first, specify Sperry silicon semiconductors—now available in volume production for *your* application. Performance-proved in many exacting systems—both military and commercial—these outstanding silicon devices are ideal for stringent requirements in missile, airborne, computer and industrial applications.

Developed for maximum reliability, Sperry semiconductors are produced with ex-

treme care in advanced manufacturing facilities under constant quality control surveillance. For the highest quality silicon devices—transistors, diodes, and rectifiers—

SPECIFY SPERRY

SPERRY

SPERRY SEMICONDUCTOR DIVISION, SPERRY RAND CORPORATION, SOUTH NORWALK, CONNECTICUT
Sales Offices: Baltimore, Boston, Brooklyn, Chicago, Cleveland, Los Angeles, New Orleans, Philadelphia, San Francisco, Seattle

Was Moonshot 4th USSR Try?

Soviets may have closed information leaks on firings from January to September. Moonshot gear believed similar to Lunik I's

WHEN 858 POUNDS of payload smashed into the lunar dust on Sept. 13, it might well have been, as Vice President Nixon says, the fourth Soviet attempt to hit the moon. Soviet Premier Khrushchev concedes only that "technical defects" prevented a moonshot a week earlier.

Documented information from the USSR already reported (ELECTRONICS, p 22, Feb. 6) made it clear that the Soviet lunar probe or Lunik I launched Jan. 2 was, in fact, intended to strike near the moon's equator. The shot missed by 2,187 miles.

It is quite conceivable that two other unsuccessful attempts were made between February and this month, and that the Soviets tightened up on information leaks.

Although the Soviets had not disclosed the rocket configuration or guidance system used for the moonshot as ELECTRONICS went to press, it is believed that they are similar to the combination that launched and guided Lunik I.

Moscow Radio did say a special guidance system was used for the moonshot that operated for only "a few minutes" during the boost phase of flight. This jibes with the fact that the entire powered phase of Lunik I's flight took about 190 seconds.

Transmitters

First Moscow reports said five transmitters were used as with Lunik I. The frequencies were given as 183.6; 39.968; 20.003; 19.997 and 19.993 mc. The 183.6 transmitter also sent the lunar altimeter signals. Two transmitters, 19.997 and 20.003, were said to be located on the last stage rocket and faded as the carrier approached the moon.

A later report said only three transmitters were carried—two in the payload and one in the final rocket stage.

The Jodrell Bank radiotelescope in Manchester, England, received

coordinate information from the Soviets for the first time and followed the flight until the moment of impact. Consensus in Britain is that the missile had in-flight guidance as well as accuracy in firing. Guidance is thought to be based on use of variable thrust engines for most of the powered flight.

Generally unpublicized was the fact that Air Force scientists from Cambridge Research Center, working at a field station in Hamilton, Mass., began tracking the rocket with the first Tass announcement of its launching, using an 84-ft dish recently completed for moon bounce and other experiments.

The Air Force researchers lost

the rocket's signal on the morning of Sept. 13 when the moon dipped below the horizon, but kept operating. They picked it up at 4:59 p.m., about three minutes before it ceased, apparently upon impact of the payload.

If the same Russian equipment was used to guide the successful moonshot as was used with Lunik I, here's what happened:

Ten minutes prior to launch, the main tracking station began constant transmission of a sine wave to all subsidiary stations. The sine wave established the norm for time, temperature, humidity, pressure and wind. The subsidiary stations corrected to norm and were in

RUSSIAN CH-10 LUNAR ROCKET

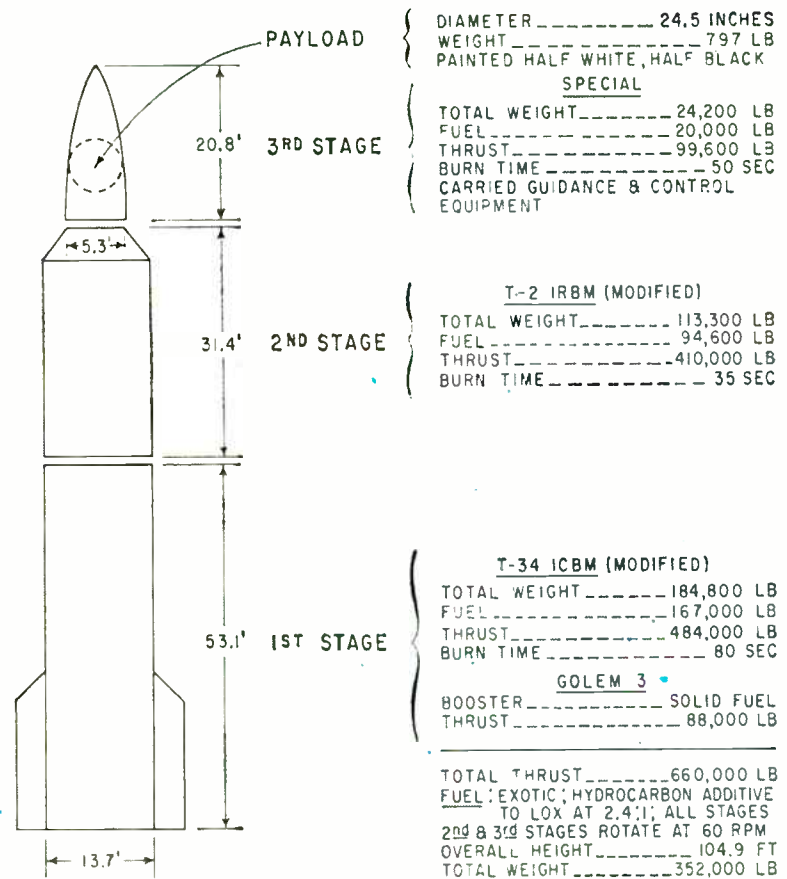

ELECTRONICS' conception of Lunik I configuration based on documented data

phase when their locally generated sine waves were in coincidence with the sine wave transmitted from the main station. Each subsidiary station was equipped with an iridium program-control card identical to the one at the main station, thus establishing the ideal path for the rocket (see *ELECTRONICS*, Feb. 6, for further details).

Tracking

After launch, each subsidiary station sent a signal to the main station indicating whether or not it had the rocket in its beam. Information from the main tracker and all reporting subsidiaries was fed into a master computer which provided a correcting time pulse if necessary. The correcting time pulses went to the beam timer, the timer in the missile and timers at the subsidiary tracking stations. The missile timing pulse was transmitted over the hyperbolic antenna at 2,500 mc.

If any subsidiary station was not in phase with the main tracking station, it was automatically blocked from relaying information. The 85.2-ft hyperbolic antenna was hydraulically actuated. Temperature changes, which cause distortions of the antenna reflector, were measured by thermocouples. These relayed information to a computer. Antenna alignment corrections were then made.

Instrumentation

As *ELECTRONICS* went to press, Moscow reports said a magnetometer in the payload had revealed that the moon does not have a magnetic field or radiation belts. The reports said instruments detected an increased concentration of ionized particles within 6,250 miles of the moon, possibly the result of a "lunar ionosphere" or of a concentration of elements with energies of scores of volts.

Other instruments on Lunik I and probably in the moonshot are:

A micrometeorite erosion gage for measuring micrometeorite particles and skin temperatures; Lunik I instrument chamber temperatures were monitored by conventional thermocouples. A lunar altimeter measured the angle and closing rate between the capsule and the moon.

FOR ABSOLUTE MEASUREMENTS OF CORROSIVE MEDIA

This 1-inch Pressure Transducer takes shock, acceleration, and vibration like no other its size. It was specifically designed to measure pressures of corrosive fuels such as ... red fuming nitric acid (RFNA) and liquid oxygen (LOX). The corrosive media is contained inside a welded stainless steel or NI-Span-C diaphragm. The precision wirewound potentiometer pick-off provides an output signal resolution of 0.25% for most ranges. The TP-100 safely takes up to 100% overpressure with negligible calibration shift. An improved "H" bar linkage between the diaphragm push rod and the pot wiper arm is a major factor in the excellent performance and high reliability of this precision device. All parts are statically and dynamically balanced, the linkage limits the motion and minimizes errors under severe vibration and acceleration conditions.

Write to Dept. 36E



FAIRCHILD TP-100 PRESSURE TRANSDUCER

Specifications and Characteristics

Pressure Range	0-15 to 0-500 psia
Accuracy	Overall band width of $\pm 1.5\%$ including linearity, hysteresis and friction in most pressure ranges
Resolution	0.25% for most ranges
Repeatability	Less than 0.5% depending upon resolution
Vibration	10 to 2000 cps, 15g with less than 1% error 10 to 2000 cps, 35g with less than 2% error
Acceleration	40g with less than 1% error
Shock	100g without damage
Temperature	-54° to $+100^{\circ}$ C

... the smartest move you can make

is to **TRIPLETT VOMs**

*... the world's most complete
line of VOMs for every purpose!*



TRIPLET

*Quality...
First to last*

**TRIPLET ELECTRICAL INSTRUMENT COMPANY
BLUFFTON, OHIO**

TRIPLET

Quality...
First to last

TESTER
STAND



HI-
VOLTAGE
PROBE



MODEL
630-T



MODEL
625-NA

INTERIOR
VIEW
(630)



MODEL
630-PL



MODEL
10

MODEL
631



MODEL
310

Model 639-N Case \$9.50. Handsome, black cowhide leather. Center-cover flaps snap back for full view of scales and complete access to instrument without removal from case.

Model Pt. T-225-A-33 Tester Stand \$0.50. Metal, holds tester in approximately 45° angle; facilitates easy reading.

Probe for High Voltage Testing \$14.50. For models 630, 630-A, 630-PL, 630-APL, and 631. Completely insulated polystyrene; guard-type handle. 11½" long; 48" hi-voltage wire lead with banana plug at tester end. Available in 0-12,000 AC or DC volts, and 0-30,000 AC or DC volts.

Model 630-T \$54.50. Specially designed for telephone maintenance. 2% accuracy on DC. Fused protected circuit protects resistors and meter in ohms ranges. Special neck strap holds instrument, freeing both hands. Banana jack connectors eliminate all shock hazard. Completely insulated case protects from ground.

Model 666-R Pocket VOM \$29.50. Hand size, ideal for electrical maintenance. With recessed range knob it fits easily into case. AC rectifier pre-calibrated unit for easy replacement. Banana jacks at panel top prevent leads falling over meter dial. Single king-size selector switch minimizes incorrect settings, burnouts. Molded case streamlined, fully insulated.

Model 666-HH Pocket VOM \$27.50. Compact, hand-size; 3" meter integral with panel, adjusted to 400 microamperes at 250 millivolts. Only 3 jacks necessary for all ranges. 19 ranges.

Model 625-NA \$54.50. Dual sensitivity for extra ranges; large mirror scale for super readability. 3-color meter scale 5" long 6" instrument, 0-50 microamp. AC volts at 10,000 O/V for checking many audio and high impedance AC circuits usually requiring VTVM. 38 ranges. Molded insulated case.

Interior View showing advanced engineering features of all Triplet VOMs. Molded mounting for resistors and shunts allows direct connections without cabling. Eliminates shorts. Longer life.

Model 630 \$44.50. Popular, streamlined; long meter scales for easy reading. Outstanding linear ohm scale; low reading 1 ohm, high 100 megs. Single king-size selector-switch minimizes incorrect settings, burnouts. High sensitivity: 20,000 ohms per volt DC; 5,000 AC. Molded, fully insulated case.

Model 630-A \$54.50. Laboratory type; ½% resistors for greater accuracy. Long mirrored scale eliminates parallax. Banana jacks, low resistance connections; high flux magnet increases ruggedness. Single king-size selector switch minimizes incorrect settings, burnouts. Molded fully insulated case.

Model 630-PL \$44.50. Instant-vision, wider spread scales; streamlined case; handsome modern design. Unbreakable window. Outstanding linear ohm scale; low reading .1 ohm; high to 100 megs. Single king-size selector switch minimizes incorrect settings, burnouts. 5 to 500,000 cps frequency response in AC measurements. DC Polarity Reversing switch. High sensitivity: 5,000 ohms per volt AC; 20,000 ohms per volt DC.

Model 10 Clamp-On Adapter \$14.50. Checks line loads with model 310 (can also be used with 6 other models). Instant, accurate, safe. No circuit breaking or work interruption. Easy range switching. Available in 6 AC Ammeter ranges: 0-6-12-30-60-120-300. Clips around single wire to read AC. Amperes direct. Use with adapter 101 to instantly divide 2-conductor cords. Molded case fully insulated, black plastic with engraved white markings.

Model 630-APL \$54.50. Laboratory type with ½% resistors, more accurate movement. Long mirrored scales eliminate parallax. Unbreakable window. Single king-size switch minimizes incorrect settings, burnouts. 5 to 500,000 cps frequency response in AC measurements. DC Polarity Reversing switch. High sensitivity: 5000 ohms per volt AC; 20,000 ohms per volt DC. Molded case fully insulated.

Model 630-NA \$74.50. Super DeLuxe with 70 ranges—nearly double conventional types. Frequency compensated from 35 cps to 20 kc. Temperature compensated. Accurate within 1½% full scale reading on DC. Large open front meter easy to read. Unbreakable window. Mirrored scale. Meter protection against overloads. Molded fully insulated case.

Model 631 Combination VOM and VTVM \$64.50. Two fundamental units at the price of a single tester. The No. 1 instrument for all electronic men. Battery operation assures VTVM stability and long life. Sensitivity PLUS. 1.2 volt (VTVM) range is equal to more than nine million ohms per volt. Large easy to read meter with unbreakable face. Single king-size selector switch minimizes incorrect settings, burnouts. Molded case fully insulated.

Model 310 \$34.50. The only complete miniature VOM with 20,000 ohms per volt and selector range switch. Self-shielded against strong magnetic field. Rugged, high torque, bar-ring instrument. Unbreakable plastic meter window. Converts to common probe—frees one hand—by fitting interchangeable test prod into top. Standard sensitivity 20,000 ohms per volt DC, and 5,000 ohms per volt AC. Accuracy 3% DC. Molded fully insulated case.

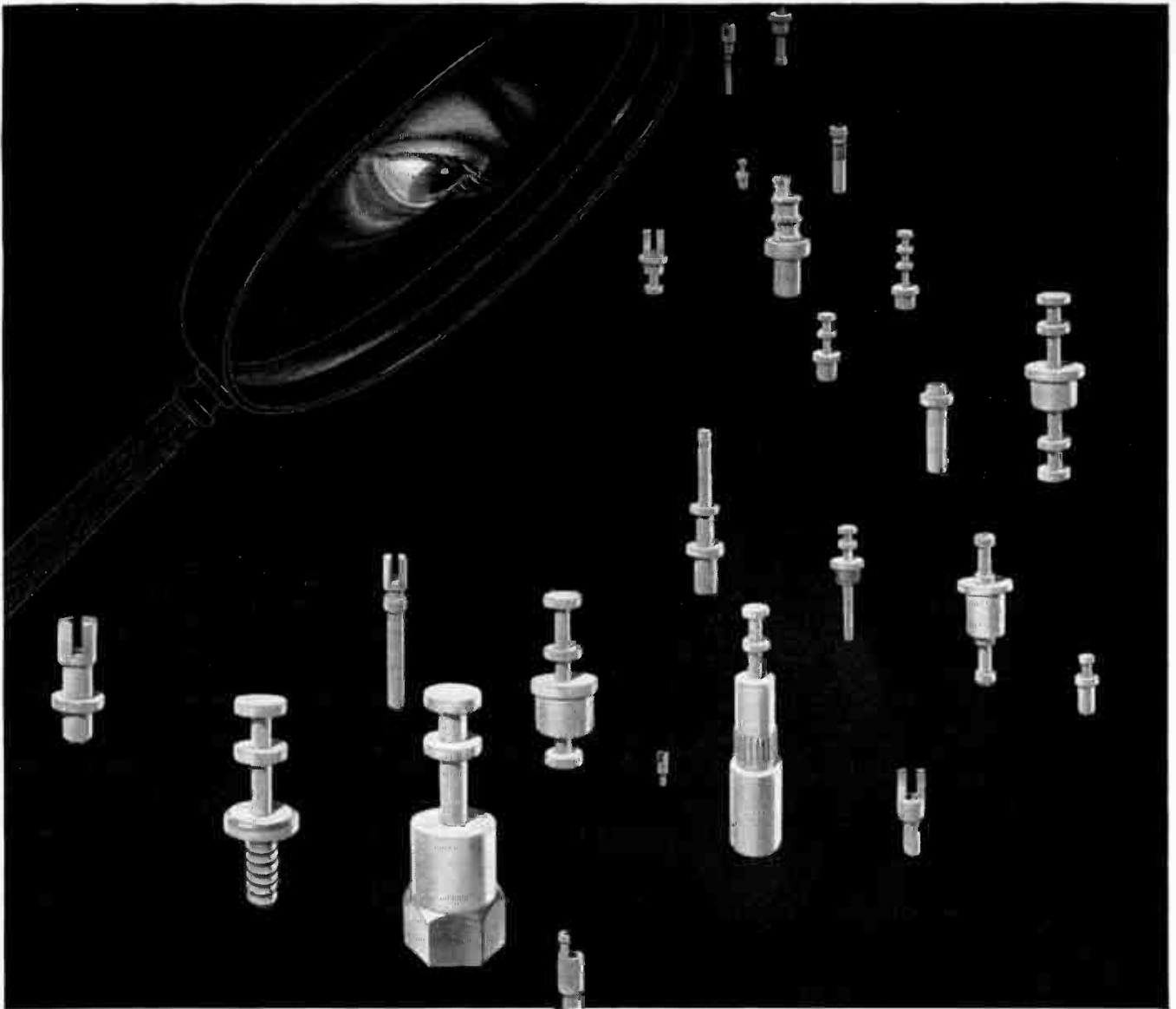

The CAMBION Line contains more than 60 types of solder terminals including both conventional and printed circuit types. All meet or surpass applicable military specifications.

Millions pass the same rigid inspection

There are more than 30,000,000 CAMBION® Solder Terminals in stock . . . swage-mounting, thread-mounting, press-mounting types . . . single, double, and triple turret types . . . feed-through, double-ended, hollow, and split types. And *all* were manufactured under the same extremely rigid quality control standards.

Starting with top quality brass per QQ-B-626a, each CAMBION Solder Terminal is precision machined to close tolerances, then electroplated with silver. (Other finishes available: electro-tin, hot-tin cadmium, gold flash, or gold plate.) A microscopic cross-sectional analysis is made of plating thickness on all significant surfaces. In addition, dimensional and visual quality control checks are made per MIL-Q-5923C. Small wonder CAMBION Solder Terminals *guarantee* you the precision you need. And, they're always immediately available in any quantity.

All CAMBION Products are made under the same high manufacturing standards. Get complete details on CAMBION capacitors, swagers, hard-

ware, insulated terminals, coils, coil forms, and many other guaranteed electronic components. Contact your local CAMBION Distributor or write Cambridge Thermionic Corporation, 437 Concord Avenue, Cambridge 38, Mass. On the west coast: E. V. Roberts and Associates, Inc., 5068 West Washington Blvd., Los Angeles, Calif. In Canada: Cambridge Thermionic of Canada, Limited, Montreal, P. Q.

CAMBION Terminal Boards are available in any quantity both in standard and miniature all-set boards or designed precisely to your specifications. Special CAMBION swaging machines assure proper insertion of terminals . . . eliminate danger of cracking rivet portion of terminal or the board . . . protect structural integrity of both parts.

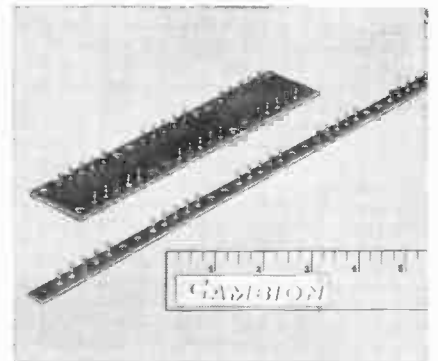

CAMBRIDGE THERMIONIC CORPORATION
CAMBION®

The guaranteed electronic components



Where Cut-Rate Tubes Start

Net sales of cut-rate tubes this year may hit \$20 million. Manufacturers say malpractices require industry policing

DO-IT-YOURSELF TUBE CHECKERS will sell about \$40 million worth of tubes this year. Industry estimates are that almost half of these—or \$20 million worth—will be merchandised under so-called private labels.

There are now between 20,000 and 30,000 tube checkers in retail stores today, according to industry surveys. Each machine sells an average of 16 tubes a week, nets about \$15.

Tallies by major tube manufacturers indicate that 12 percent of the consumer replacement market is being filled through tube checkers. The manufacturers charge that half of these sales involve tubes of questionable origin.

Malpractice Exists

Most major tube makers take a dim view of the so-called “drug store” tube checker, **ELECTRONICS** learned. Reason for this, say the tube makers, is that certain malpractices have accompanied the growth of the test-it-yourself tube market.

Major tube manufacturers allege that certain tube-checker operators obtain tubes under the guise of fraudulent tube sales orders for overseas shipment. Such purchases at factory door are exempt from the 10-percent federal excise tax on purchases for the domestic market.

One sales executive says the volume of tubes obtained this way runs to about \$8 million a year. Unlike certain other commodities, radio tubes purchased for shipment abroad carry no obligation on the part of the buyer to prove that they are actually shipped. A dishonest operator can get by with a written statement that shipment has been made.

In the absence of government regulations, manufacturers themselves are curbing dishonesty of this type by checking sales orders of tubes for export. If company specialists find an order that's out of line with the tube needs of the foreign country, the order is

immediately sent back — unfilled.

Another block in the path of the dishonest “export” operator is the growing industry practice of marking export tubes in special ways. One firm uses a different colored plastic base, another uses an entirely different overseas trademark and carton. Such export tubes that turn up on the domestic market immediately arouse suspicion.

Tube manufacturers also claim knowledge of cases where purchases of certain tube types by small original equipment manufacturers far exceeded their actual requirements.

These extra tubes have sometimes found their way to the retail market via the dishonest checker operator. However, industry policing of apparently padded orders has cut down this practice.

Although at one time a sizable number of manufacturer-rejected tubes found their way to market, major producers have virtually

eliminated this activity. Current practice in most large plants now calls for complete destruction of all tubes failing to pass quality control.

Industry opinion holds that there is a small segment of the tube checker market that relies on overage distributor shelf stock and on military surplus gear purchased for the tubes and other components it contains. Action by police and better business groups has turned up establishments equipped to wash markings off tubes and replace them with bogus identification and so-called private labels.

Cleanups Pay Off

The slick operator, while still on the scene, is probably on the way out in most parts of the country.

Several industry spokesmen in off-the-record comment express the feeling that a reduction in the elasticity of radio tube prices would aid in curbing malpractices.

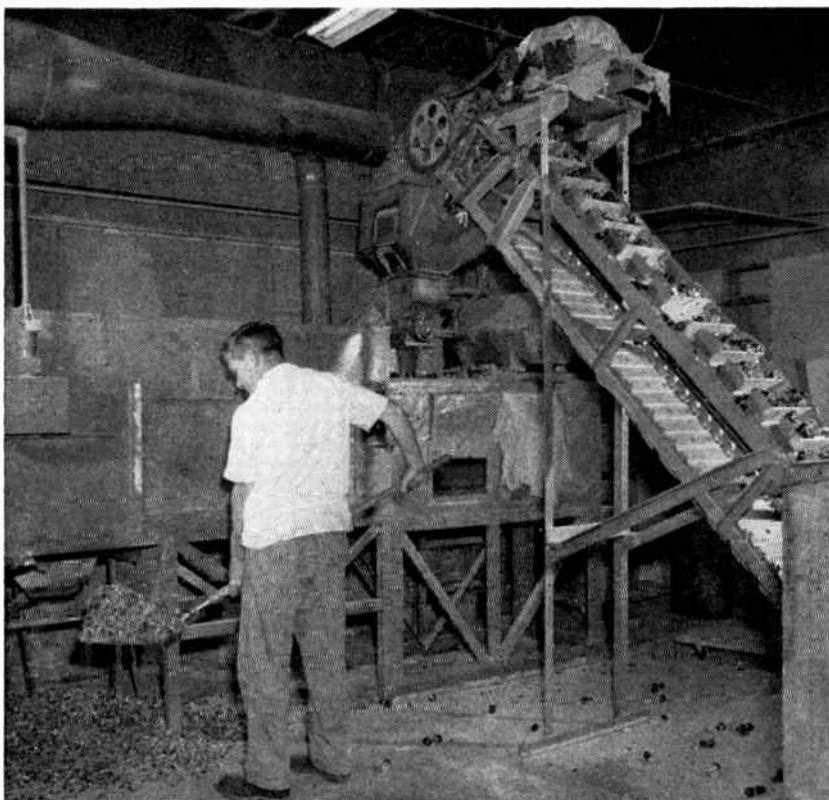

To prevent factory rejects from falling into dishonest hands, tube makers set up crushing machines like this one at Sylvania's plant at Emporium, Pa.

SUPRAMICA® 555 ceramoplastic

the world's most nearly perfect
precision-moldable electronic insulation

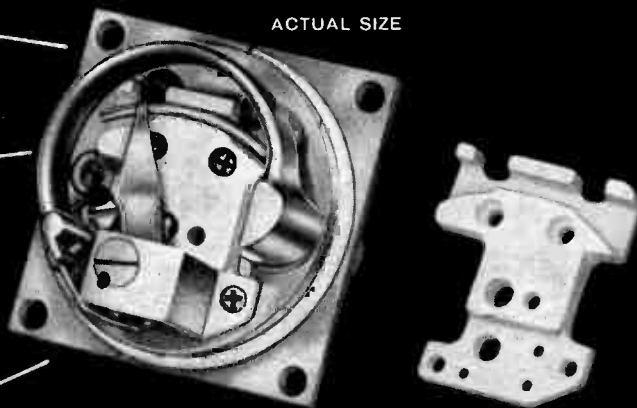
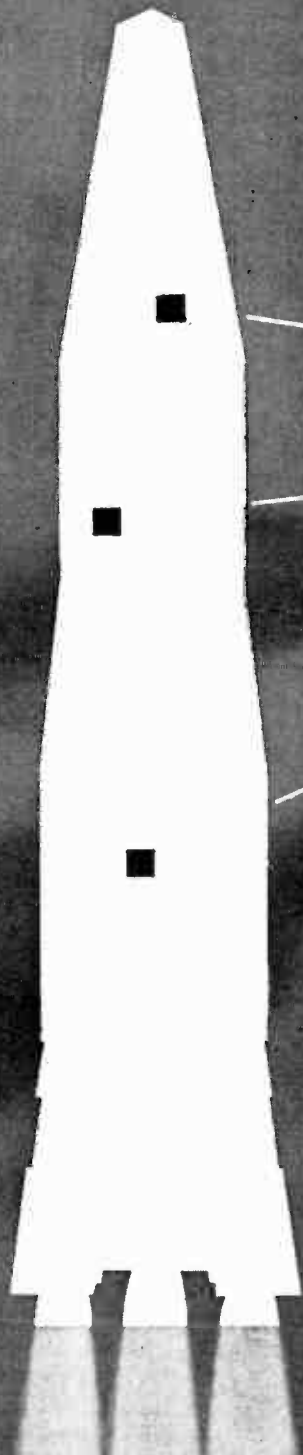

for total reliability... at high temperatures
... specified in **BOURNS Inc.** transducers

Why did BOURNS, INC. select SUPRAMICA 555 ceramoplastic as the insulating base for its ultra high-temperature differential pressure transducers?

BOURNS' engineers cite three reasons... each a contribution to the total reliability of these airborne telemetering devices. "First is temperature. The sensitive element of the mechanism must withstand high operating temperatures. Next, SUPRAMICA 555 offers a combination of excellent insulating characteristics, which are essential to the highly accurate functioning of the potentiometer. In addition, this ceramoplastic material is readily moldable into complex shapes, such as that required for this intricate part."

For other applications SUPRAMICA 555 is used under operating conditions as high as +700°F. . . . SUPRAMICA 555 is one of the many ceramoplastic and glass-bonded mica insulation materials produced by MYCALEX CORPORATION OF AMERICA, in precision-molded and machinable formulations. Whatever your insulation need there is a MYCALEX product to meet it—for example, SUPRAMICA 620 machinable ceramoplastic, which has a maximum operating temperature of +1550°F. Write today outlining your design problem for specific information.

General Offices and Plant: 120-H Clifton Blvd., Clifton, N. J.
Executive Offices: 30 Rockefeller Plaza, New York 20, N. Y.

WORLD'S LARGEST MANUFACTURER OF GLASS-BONDED MICA AND CERAMOPLASTIC PRODUCTS



addo-x

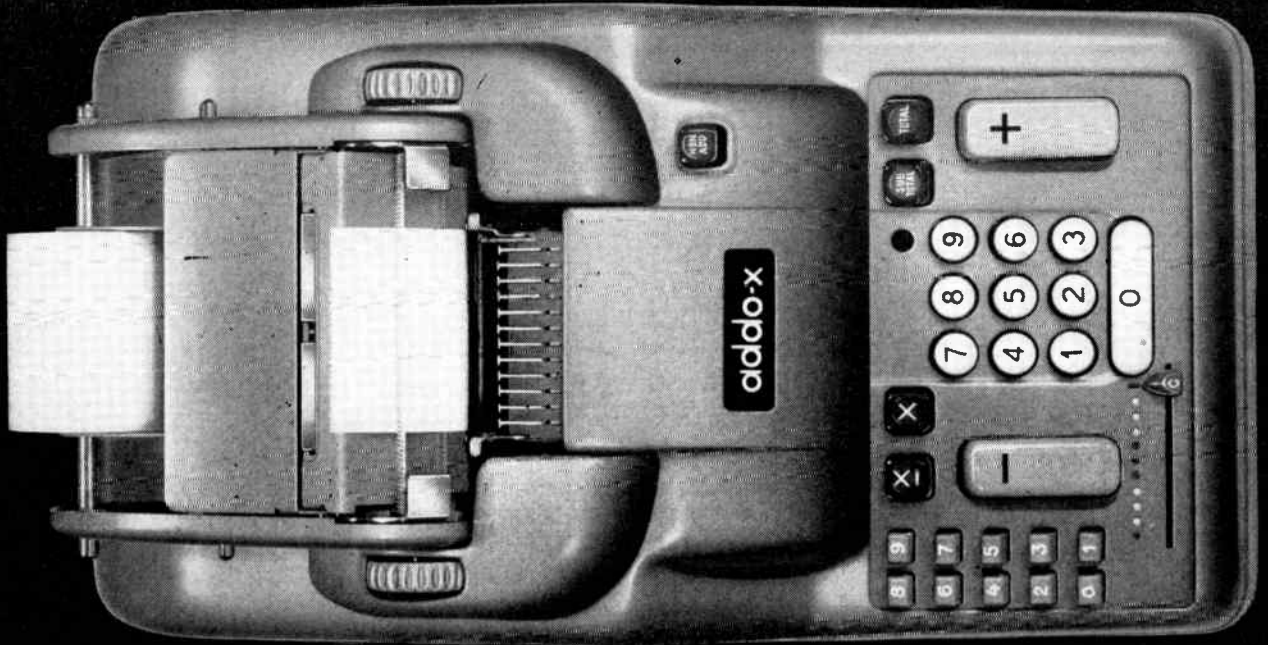

▶ **automatic multiplier 2341E at conventional adding machine cost**

a versatile, double keyboard machine—provides essentially calculator performance and speeds up all percentage, invoice, job cost and payroll computations——no stroke counting is required——has completely automatic multiplication feature——saves times and increases reliability

"addo-x" stands for a family of versatile, time-proven adding and calculating machines

——backed by nation-wide service facilities——lifetime guarantee repair parts availability

see your dealer for on-your-job proof or write: "addo-x" 300 Park Avenue, New York 22, NY

NEW SPRAGUE MODEL 500 INTERFERENCE LOCATOR

PORTABLE, VERSATILE
UNIT PINPOINTS SOURCE
OF INTERFERENCE



This improved instrument is a compact, rugged and highly sensitive interference locator—with the widest frequency range of any standard available unit.

New improvements in Model 500 include: *greatly increased sensitivity*, meter indications proportional to carrier strength, transistorized power supply. Engineered and designed for practical, easy-to-operate field use, it is the ideal instrument for rapid pinpointing of interference sources by electric utility linemen and industrial trouble shooters. Model 500 tunes across the entire standard and FM broadcast, shortwave, and VHF-TV spectrums from 540 Kc to 216 Mc. For full details send for brochure IL-102.

SPRAGUE ELECTRIC COMPANY
35 MARSHALL ST. • NORTH ADAMS, MASS.

SPRAGUE®

THE MARK OF RELIABILITY

Noise Control Market

Meter sales have just hit the \$1-million-per-year level—and they're expected to double by '62



Portable meters like this one by General Radio Co. are proving their value to municipal and industrial administrators in curbing noise

ELECTRONIC noise meter market annual sales have quietly climbed to a \$1-million level this month, according to a review of third-quarter sales. Manufacturers estimate this figure, which has more than doubled in the past three years, will double again by 1962.

Both industrial and municipal agencies, through considerations of finance and health, have been instrumental in the growth of this market.

On the municipal level, more than 100 principal cities, including Los Angeles, Cincinnati, Cleveland, Milwaukee and Seattle, have become customers for electronic noise-measuring equipment.

This gear ties in with enforcement of municipal ordinances which express noise control statutes in terms of maximum permissible decibel levels. Without measurement equipment, it is virtually impossible to enforce such ordinances.

Buy Portable Gear

Most municipal expenditures cover portable equipment which can be operated by police officers with a minimum of training. These units are equipped with non-directional microphones, and contain a

calibrated attenuator, an amplifier, an indicator and weighting circuits. The weighting circuits are used to modify amplifier response to conform approximately with the response of the human ear to pure tones at specified levels. Such units are usually battery-operated.

One device being widely used by both municipal and industrial groups is a portable meter weighing 1 pound, 14 ounces, small enough to fit in a coat pocket (see photo). It has a range of from 40 to 136 db. It has three frequency characteristics that can be selected by a main control switch. It is battery-operated, sells for \$150.

In general, anti-noise laws as applied to vehicles, state the manner in which noise shall be measured with full particulars on distance, location and type of noise-meter equipment to be used. Purchase of equipment for such municipal application accounts for about 40 percent of the market.

In Milwaukee, for example, the law states that "the maximum permissible noise from a motor vehicle at a distance of 20 ft to the right of the right rear wheel shall be 95 db."

Most cities having laws like this

Grows

fix maximum levels at 95 db, although distance of measurement varies from one city to another. An idea of the motorist's situation in noise control may be had from comparison between an auto and a boiler shop, which registers about 140 db when going full blast. A subway train at a distance of 20 ft registers 110 db, while ordinary conversation at a distance of 3 ft takes place at about 80 db.

Strong Industry Interest

Industrial interest in noise measurement accounts for about 60 percent of the present noise meter market, and is helped to grow in part by the fact that full advantage is being taken by workers of compensation benefits payable for impairment of hearing. Payments ranging in the thousands of dollars may be collected by a worker whose hearing is damaged while on the job. In many states there is no limit to the maximum medical benefits payable for this.

Instrument System Tests Jet Engines



GRAHAM AFB, FLA.—Technician in almost-soundproof blockhouse checks performance of T-37 jet engine—visible through porthole—on control room instrument panel.

Put together by base maintenance men, instrumentation system cost about \$35,000. Particular emphasis is placed on compatibility of thrust, vibration and temperature measurements.

2N393 Micro-Alloy Transistors For Modern Computer Circuitry

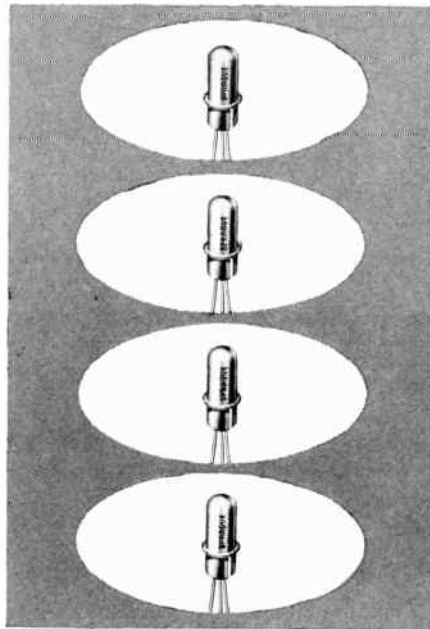

Sprague Electric Company offers high-speed, high-gain, 2N393 micro-alloy transistors to meet the demands of modern computer switching applications in the megacycle range. Low saturation resistance, low hole storage, and exceptionally good life characteristics make these micro-alloy transistors top performers in computer circuits as well as in general high frequency applications.

Made by electrochemical manufacturing techniques, Sprague Micro-Alloy Transistors are uniformly reliable and very reasonably priced.

Sprague micro-alloy transistors are fully licensed under Philco patents. All Sprague and Philco transistors having the same type numbers are fully interchangeable.

For complete engineering data sheets on the types in which you are interested, write Technical Literature Section, Sprague Electric Company, 35 Marshall Street, North Adams, Massachusetts.

CIRCLE 116 ON READER SERVICE CARD

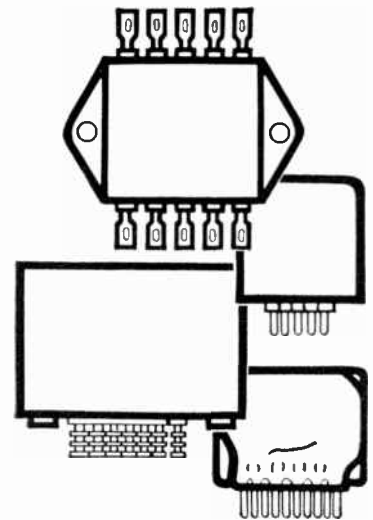

Sprague offers
a wide variety of

MAGNETIC SHIFT REGISTERS

for aircraft, missiles,
computers, and controls

Just the right case styles... types of sealing... number of stages... read and write provisions you need! Sprague magnetic Shift Register Assemblies are matched to your *specific* application requirements to make them your best buy!

Standard designs are easily modified to meet most system requirements. All are 100% pulse performance-tested before they leave the plant.

For engineering assistance on your Shift Register problems, write to Special Products Division, Sprague Electric Company, Union St., North Adams, Mass.

SPRAGUE®

THE MARK OF RELIABILITY

CIRCLE 35 ON READER SERVICE CARD 35



Star Performer

Actors often complain about restriction to the same type of role. It's easy to think of the man who always plays gangsters, the one never seen without a cowboy hat, and the fellow who can act nothing except romantic parts.

REL's unchallenged world leadership in tropospheric scatter equipment may overshadow REL achievements in other areas of specialized radio communications.

For example, another sector of REL preeminence is point-to-point apparatus, both long and short range. REL systems provide four to 240 voice channels, at frequencies from 130 mc to 2400 mc.

Among the special advantages available in point-to-point apparatus by REL are the patented, low distortion SERRASOID™ modulator; the crystal mixer receiver, with its lower noise figure; and the same remarkable reliability developed for the rigorous demands of militarized tropo scatter (Specification MIL-R-9657A, USAF).

The point to remember in point-to-point communications is equipment by REL.

Radio Engineering Laboratories • Inc

A subsidiary of Dynamics Corporation of America

Dept. E • 29-01 Borden Ave • Long Island City 1, NY



*Creative careers at REL await a few exceptional engineers.
Address résumés to James W. Kelly, Personnel Director.*

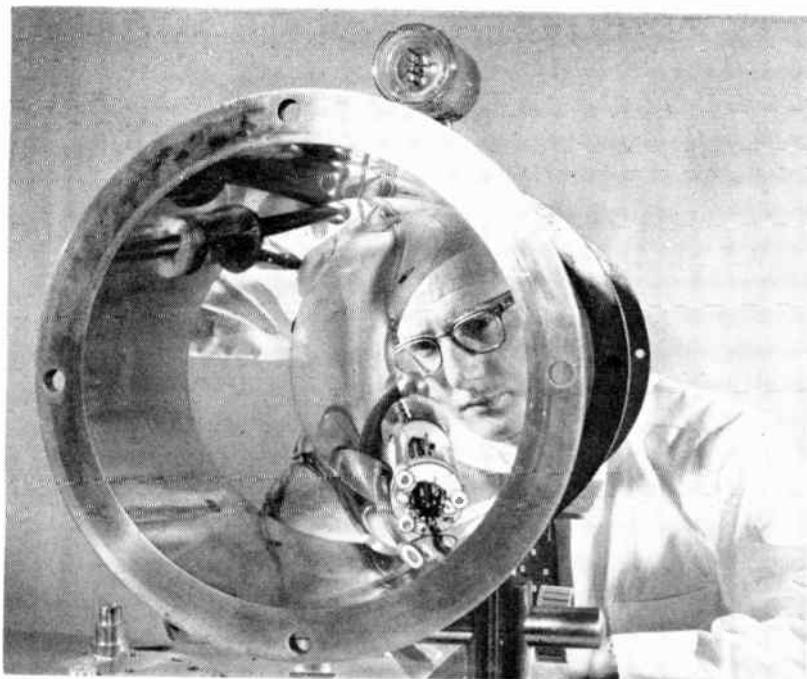

Ammonia maser type atomic clock for testing relativity theory in orbiting satellites is checked by Hughes scientist H. L. Lyons, inventor of first atomic clock. Such equipment typifies today's approach to instrumentation as . . .

Instrument Men Look Ahead

ISA conference points to more industrial applications and international cooperation

CHICAGO—"Perhaps the most striking feature of this entire conference is the fact that its major emphasis falls on non-military rather than military activity."

This comment by a visitor to the recently concluded 14th annual conference of the Instrument Society of America here last week contains what is perhaps the most significant aspect of the present trend of instrument development.

International Flavor

Another significant aspect of the meeting was the international scope of its presentations and membership. The exhibit theme, "World Progress in Instrumentation" was highlighted by experts from Great Britain, Europe and Japan who delivered technical papers detailing new instrument developments.

Counter to much present-day scientific activity, which is aimed at military technology, this conference covered the following fields: Automation of industrial processes, conduct of scientific research, exploration of outer space and operation of nuclear power sources.

As is the case with other segments of our industry, instrument makers are beginning to find overlapping areas of interest. This was evidenced by occasional displays here of equipment in the data processing field. One such exhibit showed a machine which processes data at the rate of 10,000 samples a second. Another showed a detailed representation of a computer-operated plant.

On the non-technical level, sessions examined the instrumentation problems of management. Included were talks on the economic justifications of instrumentation, personnel training needs created by instrumentation, and organizing research work.

400 Exhibits Shown

The conference, which ended last Friday, presented about 190 talks in 60 sessions and was further enhanced by almost 400 exhibits showing the present state of instrument technology. This participation is up 15 percent from the peak activity record set in 1954 by ISA's 9th annual conference.



In OLD Industrial Country

Bristol, Tenn.-Va. is a vital part of the industrialized Tennessee Valley development which is one of the most diversified manufacturing areas in our country.

You'll have plenty of friendly industrial neighbors to share their experience with you and, better yet, you'll find major customers for your OEM products right among these neighbors on your own doorstep!

You see, this is OLD industrial country and it's expanding by leaps and bounds as new industry moves in to serve the old. There are important contracts for your production right here in the heart of Bristol, Tenn.-Va. Come and we'll help you investigate them.

Let Ford, Bacon & Davis
Tell You the Whole Story



This nationally famous engineering firm has prepared an exhaustive analysis of Bristol's industrial potential. Write for your copy today—Dept. E1059.

Bristol
INDUSTRIAL DEVELOPMENT BOARD
of the Twin Cities of
BRISTOL • TENN. - VA.



**5 TO 70%
WEIGHT OF
MICA UNITS...**

ONLY 2½ TO 50% OF SPACE VOLUME!



Hi-Q CERAMIC POWER AND TRANSMITTING CAPACITORS

- *Higher Frequency Ratings*
- *Higher Current Ratings*
- *Higher Temperature Ratings*

Radically different... HP Ceramic Dielectric Capacitors now make it possible to miniaturize large electronic equipments. Serving heavy-duty applications previously limited to mica capacitors, HP units surpass the performance of micas in many characteristics and provide extraordinary space and weight reductions.

Designed for higher frequency operations, the ceramic dielectric retains its properties at frequencies above 1000 megacycles. HP units have much higher current ratings for a given size than comparable mica capacitors. They can be operated at higher temperatures without derating... 105°C versus 70°C for mica units before derating for voltage... 45°C versus 30°C for mica before derating for current. They will meet all requirements of MIL-C-5A for moisture resistance.

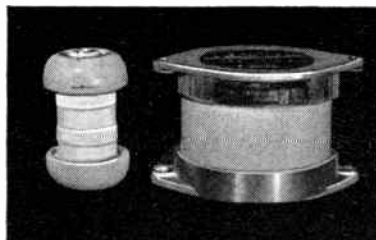

A size reduction is dramatically illustrated when comparing an HPD rated at 25 amps with a conventional CM85 mica capacitor.

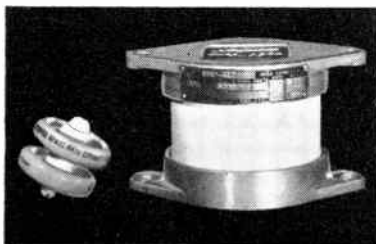

Connecting two HPA units in series still affords remarkable savings in size and weight when compared with a CM80 mica capacitor.



**AEROVOX
CORPORATION**

Write for complete technical literature to...

OLEAN, NEW YORK

MEETINGS AHEAD

Oct. 5-7: Communications Symposium, National Conf., PGCS of IRE, Hotel Utica, Utica, N. Y.

Oct. 5-9: Society of Motion Picture & Television Engineers, Annual Convention and Exhibit, Hotel New Yorker, New York City.

Oct. 5-9: Audio Engineering Society, Convention and Exhibit, Hotel New Yorker, New York City.

Oct. 6-7: Value Engineering, EIA, Engineering Dept., Univ. of Penn., Museum Auditorium, Philadelphia.

Oct. 6-8: Radio-Interference Reduction, Annual, Armour Research Foundation of Illinois Institute of Tech., Chicago.

Oct. 6-9: High-Temperature Technology, International Symposium, Stanford Research Inst., Conf. Grounds, Asilomar, Calif.

Oct. 7-9: Canadian IRE Convention, Automotive Building, Exhibition Park, Toronto, Canada.

Oct. 7-9: Vacuum Technology, National Symposium, Sheraton Hotel, Philadelphia.

Oct. 11-16: American Institute of Electrical Engineers, Fall General Meeting, Hotel Morrison, Chicago.

Oct. 12-14: National Electronics Conf., AIEE, EIA, IRE, SMPTE, Hotel Sherman Chicago.

Oct. 19-22: Semiconductor Symposium, Fall Meeting, Electrochemical Society, Deshler-Hilton Hotel, Columbus, O.

Oct. 26-28: Aeronautical & Navigation Electronics, East Coast Conf., PGANE of IRE, Lord Baltimore Hotel, Baltimore.

Nov. 3-5: Mid-American Electronics Conf., MAECON, Municipal Auditorium and Hotel Muehlenbach, Kansas City, Mo.

Nov. 17-19: Northeast Electronics Research and Engineering Meeting, NEREM, Annual, Commonwealth Armory, Boston.

Mar. 21-24, 1960: Institute of Radio Engineers, National Convention, Coliseum & Waldorf-Astoria Hotel, New York City.

There's more news in ON the MARKET, PLANTS and PEOPLE and other departments beginning on p 80.



CONSIDER...

Lockheed's endless-loop tape recorders

DEVELOPED[™] FOR SPACE COMMUNICATIONS, the recording capabilities of Lockheed's new endless-loop tape recorders are creating interest wherever the need exists for stored data in a critical environment. The original design is now operational in delayed and continuous recording and playback of stored data. Its endless-loop mechanism records and plays back in the same direction of tape travel . . . without rewind.

Variations of this lightweight, small size, low power consumption unit are available in a wide range of tape speeds and multiplicity of tracks. For more information on advanced recording techniques to meet your recording needs, write Marketing Branch, Lockheed Electronics and Avionics Division, 6201 East Randolph Street, Los Angeles 22, California.

Look to Lockheed for LEADership in Electronics

LOCKHEED ELECTRONICS & AVIONICS DIVISION

REQUIREMENTS EXIST FOR STAFF AND SUPERVISORY ENGINEERS

World Radio History

CIRCLE 39 ON READER SERVICE CARD

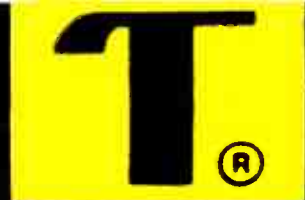

INDUSTRY'S MOST COMPLETE SILICON RECTIFIER LINE

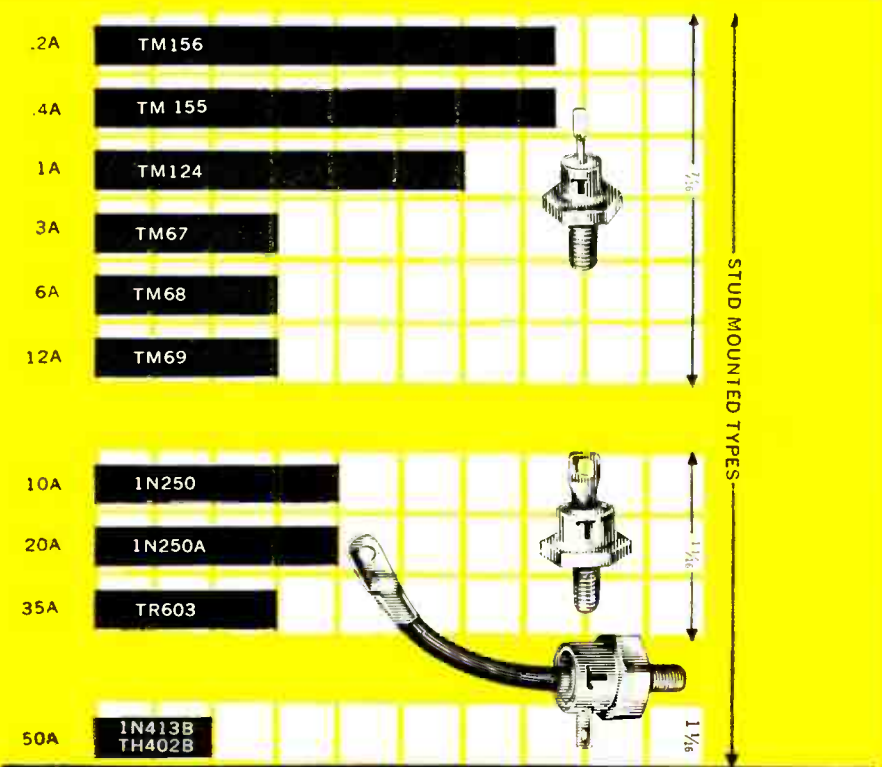
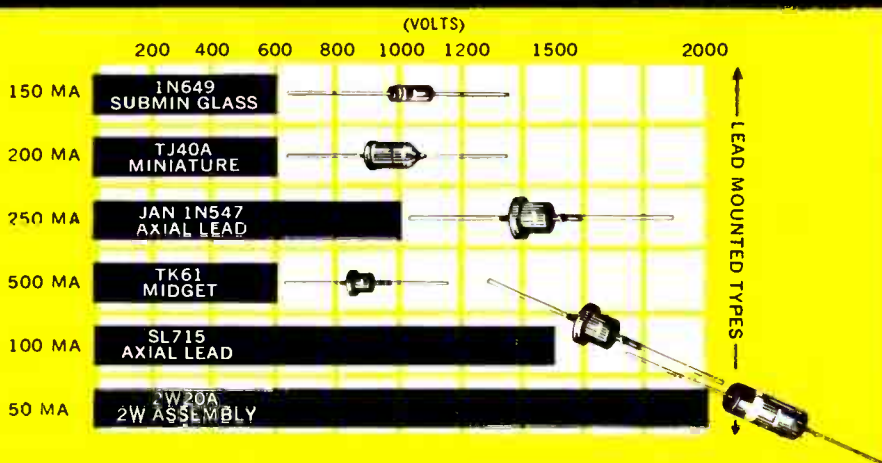

SILICON CERAMIC BASE RECTIFIERS

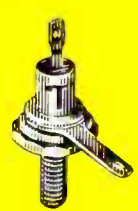

Fig. 1

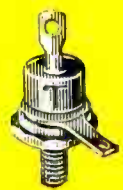

Fig. 2

Ceramic base rectifiers of compact design now eliminate the need for insulating hardware and "reverse polarity" units. These rugged stud-mounted silicon power rectifiers achieve their versatility by virtue of an alumina ceramic disc mounted between the top hat assembly and the hex base. The ceramic disc offers low thermal resistance and high electrical insulation properties. Further, bridge assemblies of more simplified and standardization of components is subsequently advanced.

The ceramic base rectifiers are available in 1/2" hex base configuration up to 12 amperes @ 150°C case, and in 1/16" hex base configuration up to 20 amperes @ 150°C case.

For example:

Type	Peak Recurrent Inverse Voltage (Volts)	Maximum Average Forward Current @ 150°C Case (amps)	Figure
1N 341/C	400	.400	1
1N 250 A/C	200	20	2

For further information write in for bulletin TE-1351R.

Number 12, 13, 14 and 15 in a series of 37 new Transitron Products to be announced before 1960!

... designed to meet ALL your circuit requirements: current, voltage, temperature, size ... now available from Transistron.

A complete description of the lead and stud mounted types, which are summarized below, is in bulletin TE-1351.

We welcome your inquiries concerning special requirements such as high frequency, fast recovery and high voltage applications.

SILICON CONTROLLED RECTIFIER

Handling 10 KW Power



Transistron's Silicon Controlled Rectifier is a PNP High power bistable controlled switching device. It is analogous to a thyatron or ignitron, with far smaller triggering requirements and microsecond switching. The low forward voltage drop permits high current ratings and provides high efficiency with low cooling requirements. The PNP design permits higher voltage ratings and lower saturation resistance than power transistors. This permits the smallest packaging for high power control yet made possible.

NOW AVAILABLE IN TRANSISTRON'S NEW PACKAGE

Type	Minimum Peak Reverse Voltage (Volts)	Minimum Forward Breakdown Voltage (Volts)	Maximum Average Forward Current (amps)	
			at T case = 100°C	at T case = 25°C
TCR102	100	100	10	20
TCR202	200	200	10	20
TCR302	300	300	10	20
TCR402	400	400	10	20

Maximum Storage Temperature Range -65°C to +150°C
Maximum Operating Temperature Range -65°C to +125°C

Send for Bulletin TE-1356A

MIDGET RECTIFIER 1 AMP @ 100°C

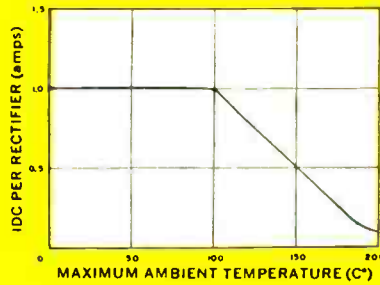

Transistron announces, higher ratings and smaller size in a lifetested lead mounted silicon rectifier. By establishing a high level of designed quality, these rectifiers feature reliable 200°C operation. Remember, the size is SMALLER, the flange is GONE! These units will meet all electrical and environmental requirements of the JAN-1N 547 series.

Type	Peak Recurrent Inverse Voltage (Volts)	Maximum Average Forward Current		Maximum Forward Voltage @ 25°C (Volts) (Milliamps)
		@ 200°C (Milliamps)	@ 100°C (Amps)	
TK61	600	100	1.0	1.0 @ 750
TK41	400	100	1.0	1.0 @ 750
TK21	200	100	1.0	1.0 @ 750

Write for bulletin PB-58

HIGH CURRENT RECTIFIERS

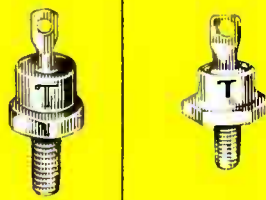

Now, from Transistron, stud-mounted silicon power rectifiers which combine high power handling ability with a minimum of size and weight ... The extremely low forward resistance and thermal impedance of these units allow operation up to 12 amperes @ 150°C case temperature in the 1/16" hex base configuration, and similarly up to 35 amperes @ 150°C case temperature in the 1/8" hex base configuration. Still further, the inherently low leakage currents and high peak inverse voltage ratings allow flexibility in the design of both power supply and magnetic amplifier circuits.

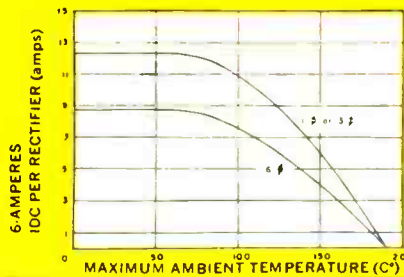

Type	Peak Recurrent Inverse Voltage (Volts)	Maximum Forward Voltage @ 25°C (Volts) @ (Amps)	Maximum Average Inverse Current 150°C (Milliamps)
TM68	600	1.1 @ 6	2
TM58	500	1.1 @ 6	2
TM48	400	1.1 @ 6	2
TM38	300	1.1 @ 6	2
TM28	200	1.1 @ 6	2
TM18	100	1.1 @ 6	2
TM8	50	1.1 @ 6	2

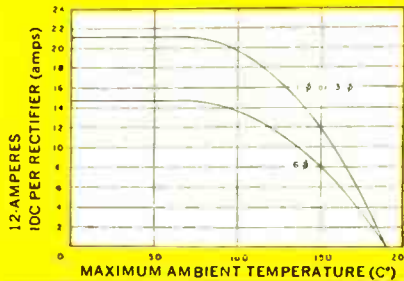

Type	Peak Recurrent Inverse Voltage (Volts)	Maximum Forward Voltage @ 25°C (Volts) @ (Amps)	Maximum Average Inverse Current 150°C (Milliamps)
TM69	600	1.2 @ 12	2
TM59	500	1.2 @ 12	2
TM49	400	1.2 @ 12	2
TM39	300	1.2 @ 12	2
TM29	200	1.2 @ 12	2
TM19	100	1.2 @ 12	2
TM9	50	1.2 @ 12	2

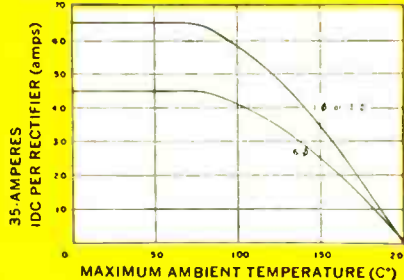

Type	Peak Recurrent Inverse Voltage (Volts)	Maximum Forward Voltage @ 25°C (Volts) @ (Amps)	Maximum Average Inverse Current 150°C (Milliamps)
TR603	600	1.5 @ 100	5
TR503	500	1.5 @ 100	5
TR403	400	1.5 @ 100	5
TR303	300	1.5 @ 100	5
TR203	200	1.5 @ 100	5
TR153	150	1.5 @ 100	5
TR103	100	1.5 @ 100	5
TR53	50	1.5 @ 100	5

*Averaged over one cycle with rectifier operating at full rated current and voltage into a resistance load

Transistron

electronic corporation • wakefield, massachusetts

Leadership in Semiconductors SEE YOUR LOCAL AUTHORIZED TRANSISTRON DISTRIBUTOR FOR QUANTITIES FROM 1-999.

World Radio History



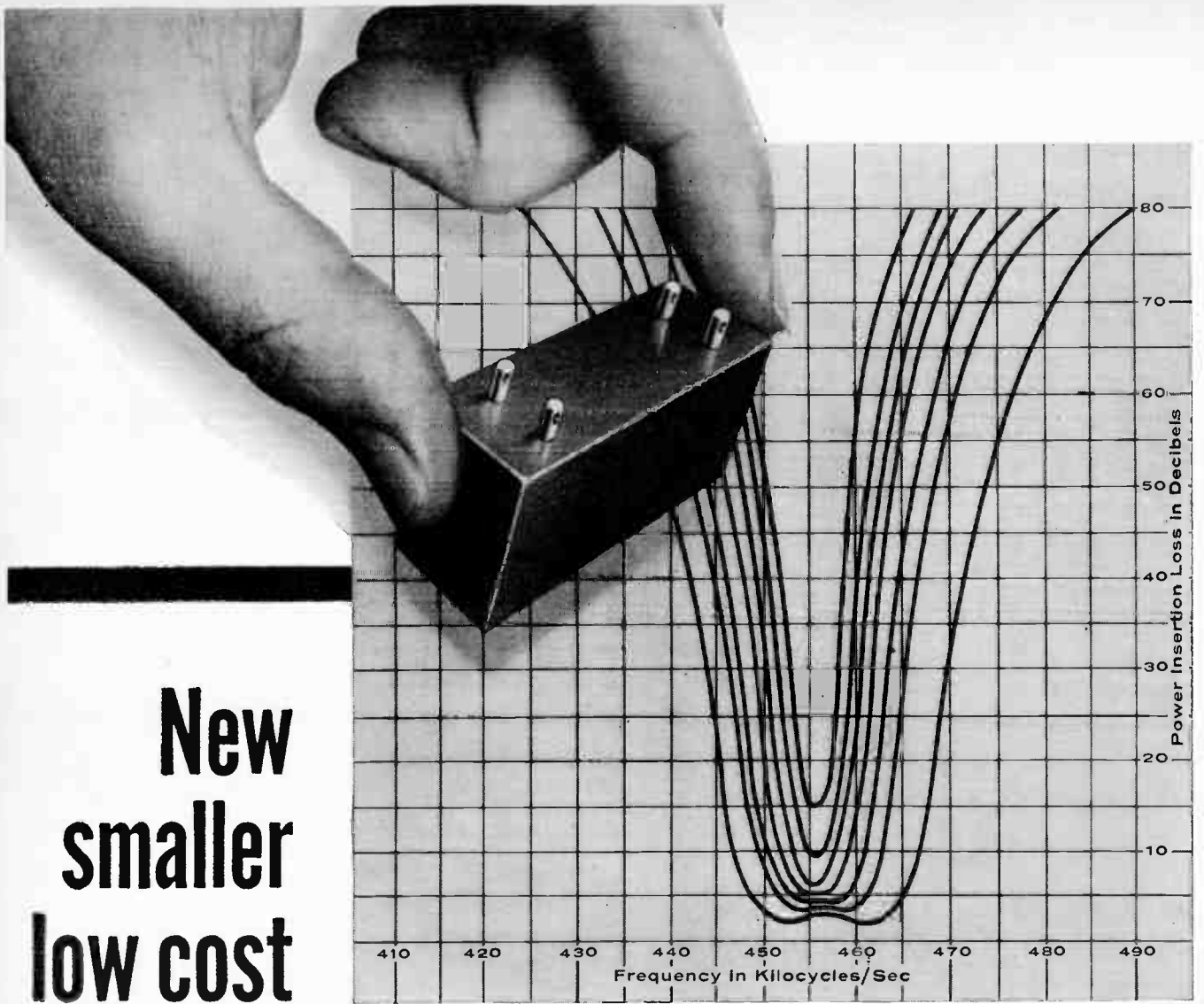

New smaller low cost

"i.f." filter!

...built-in bandwidth selection...frequency stability!

It's the new CLEVITE COMBINATION I. F. FILTER (TC series)! Shape factors from 3-1 to 6-1. Pick one specific bandwidth from a wide range . . . or reduce costs even further with multiple bandwidths built into one package. Compare these specifications:

BANDWIDTH RANGE
4 KC - 20 KC
CENTER FREQUENCIES
400 KC - 600 KC
TEMPERATURE RANGE
-40°C. to + 85°C. operating
-100 C. to + 100 C. storage

DIMENSIONS:

4 Section	5 Section	6 Section
3/4" x 1" x 1 1/8"	3/4" x 1" x 2 1/8"	3/4" x 1" x 2 3/8"

NOMINAL, INPUT, OUTPUT IMPEDANCES

2700 OHMS (4 & 6 section)
2700 OHMS in 400 OHMS out (5 section)

Features same stable "PZT" material as Clevite Transfilter and Ladder Filters (TF, TO, and TL series). Frequency stability is $\pm 0.13\%$ over the operating temperature range. Case is epoxy resin potted with 4 terminals. Applications include amateur transmitters, low cost mobile communication systems, comb filters.

CLEVITE ELECTRONIC COMPONENTS

DIVISION OF

**CLEVITE
CORPORATION**

3311 Perkins Avenue • Cleveland 14, Ohio

MAGNETIC HEADS, PIEZOELECTRIC CRYSTALS,
TRANSDUCERS, CERAMICS AND ELEMENTS

Field sales engineering offices in Newark, Chicago and Los Angeles.

Write for Bulletin 9408
for complete details.

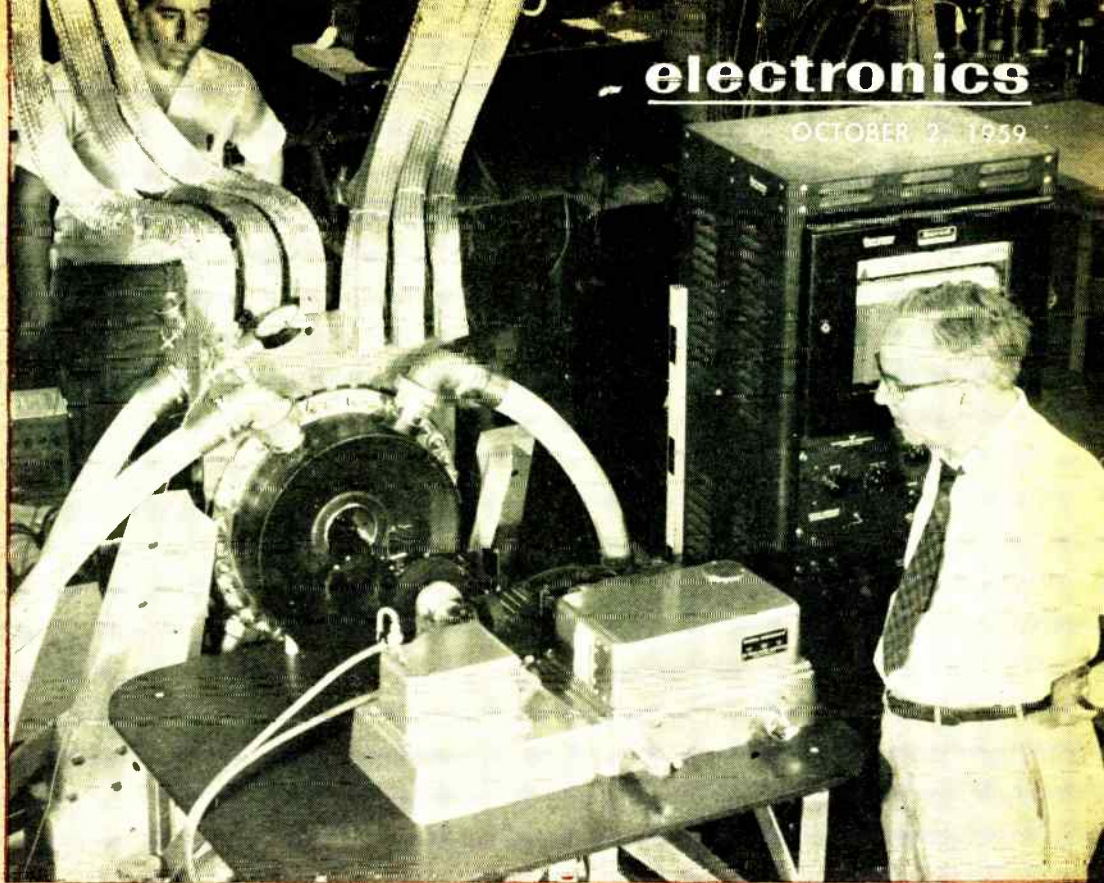

Infrared experimental setup using high magnetic field. This experiment is also shown in the Faraday-Rotation drawing. Construction of magnet (center of photo) is shown in Fig. 1

High Magnetic Fields For Advanced Research

Today there is a renewed interest in the art of generating high magnetic fields. This survey discusses the evolution of the art, its future development, and the part it plays in research work

By **HENRY H. KOLM**, Lincoln Laboratory, MIT, Lexington, Mass.

IN RESONANCE MEASUREMENTS and maser research, plasma studies for thermonuclear fusion, investigation of the energy band structure of semiconductors, millimeter and submillimeter radiation for communications and missile detection—high magnetic field intensity is an indispensable research tool.

Moderate-size magnetic fields up to about 30 kilogauss can be produced readily in the air gap of an iron circuit. Beyond this range iron saturates; thus higher fields must be generated by circulating current

in air-core magnets. Pulse techniques produce high-fields but for accurate measurements many experiments require continuous or essentially continuous fields.

APPLICATIONS—A magnetic field is valuable in research because it exerts a torque on a magnetic dipole and it exerts a force on a moving charge. Two derivative effects are that a space-varying field exerts a force on a dipole and a time-varying field exerts a

force on a stationary charge.

Achieving very low temperatures has long been one of the chief motives for generating very high fields. A paramagnetic salt is heated (reversibly) if its dipoles are aligned by an applied field. If a thermally isolated paramagnetic salt specimen at the lowest temperature achievable by evaporation, say 1K, is allowed to demagnetize, its temperature drops by an amount depending upon the initial magnetization. Temperatures of the order of 0.001K can be reached this way with fields beyond the range of iron magnets. At even lower temperatures, where the paramagnetic dipoles remain frozen for lack of energy, one achieves further cooling with the same technique, applying sufficiently high fields to align the much weaker dipoles of the nuclei rather than the atoms. This technique of adiabatic demagnetization also serves as an absolute calorimetric tool.

A broad category of uses involves application of a magnetic torque to the magnetic moment of orbiting or spinning atomic electrons. This torque causes the magnetic moment to precess about the field direction. Precession frequency appears as a shift or splitting of spectral lines, known as the Zeeman effect. This phenomenon provided one of the earliest experimental verifications of quantum mechanics, and since resolution of these measurements is proportional to field intensity, it inspired the first efforts to generate very high continuous fields. More recently the same phenomenon has been exploited in a variety of maser amplifiers based on the magnetic splitting of spectral lines. The Faraday effect or magneto-optic rotation is closely related and provides one-way elements (gyrators) in the microwave range as well as ultra high-speed shutters in the optical range.

By observing the resonance of magnetic dipoles in a solid, one can use these dipoles as probes to investigate the internal fields in para-, ferro- and anti-ferromagnetic materials. Such resonance measurements have contributed greatly to our understanding of the solid state, and many of them require very high applied fields to compete with the natural internal fields in crystals.

As a deflecting force, a magnetic field permits the lossless confinement of charged particles in the cyclotron and all other circular particle accelerators. Very high fields deflect and analyze high-energy

particles of terrestrial and cosmic origin in cloud chambers, photographic-track plates and mass spectrographs. Present research into thermonuclear fusion involves the greatest high-field effort of all time. Continuous solenoidal magnetic fields of unprecedented volume are needed to confine particles in magnetic bottles, or in the giant doughnut tube of the stellarator; pulsed fields of unprecedented energy are being used to study plasmas in the wake of a magnetically driven shockwave.

The cyclotron mechanism has also been used to measure the effective mass of charge carriers in solids. Since the orbital period of a circulating charged particle depends only on its charge-to-mass ratio and the magnetic field intensity, and not on the particle energy, identical charge carriers in a solid circulate in unison. This "cyclotron resonance" at microwave frequencies has yielded direct measurements of the effective masses of charge carriers in germanium and silicon, which in turn has provided valuable information in the energy-band structure of these semiconductors. Unfortunately the microwave frequencies used were too low to permit comparable measurements in other materials in which higher defect density prevented carriers from completing an orbital rotation before being scattered. Such measurements can only be made at substantially higher frequencies in the infrared region, and in correspondingly higher fields. This circumstance inspired the most recent attack upon the problem of high-field generation.

As pulsed fields in the 100 to 400 kilogauss range became available at Lincoln Laboratory, it was possible to make the first direct measurement of the effective mass of charge carriers in other semiconductors: indium antimonide and indium arsenide, and in bismuth, a semimetal. Information about such materials is needed for development of infrared detectors, thermoelectric elements for heat transfer and power conversion, and future semiconductor devices requiring higher carrier density.

A promising application of cyclotron resonance in high magnetic fields is in obtaining coherent, high-power sources of radiation in the mm and submm range.

HISTORY OF THE ART—In 1923, Kapitza made the first effort to generate very high magnetic fields.¹ He obtained 500 kilogauss for several millisecc by draining a battery of storage cells through a very small magnetic coil, and produced 300 kilogauss for several millisecc in a larger magnet powered by the short-circuit current of a 2-megawatt a-c generator.

In 1936, Bitter² at MIT began developing a water-cooled electromagnet capable of maintaining fields of the order of 100,000 gauss continuously and over volumes considerably larger than Kapitza's magnet. Highly accurate Zeeman effect measurements made possible by Bitter's 1-inch-caliber, 100,000-gauss magnet provided much valuable spectroscopic data. The 60,000 gauss field in Bitter's four-inch-caliber magnet established a record in low-temperature experimentation.

HIGH MAGNETIC FIELDS AND ELECTRONICS.

Fundamental research work that uses high magnetic fields requires sophisticated instrumentation for precise measurements. Stabilization of power supplies, generation and manipulation of high fields, will all involve electronic equipment—perhaps equipment yet to be designed. Some of this research, such as investigating the energy-band structure of semiconductors, may lead to improved or new electronic devices. Furthermore, as methods and materials used to generate high magnetic fields improve, so will the electronic devices such as microwave tubes, that use these fields.

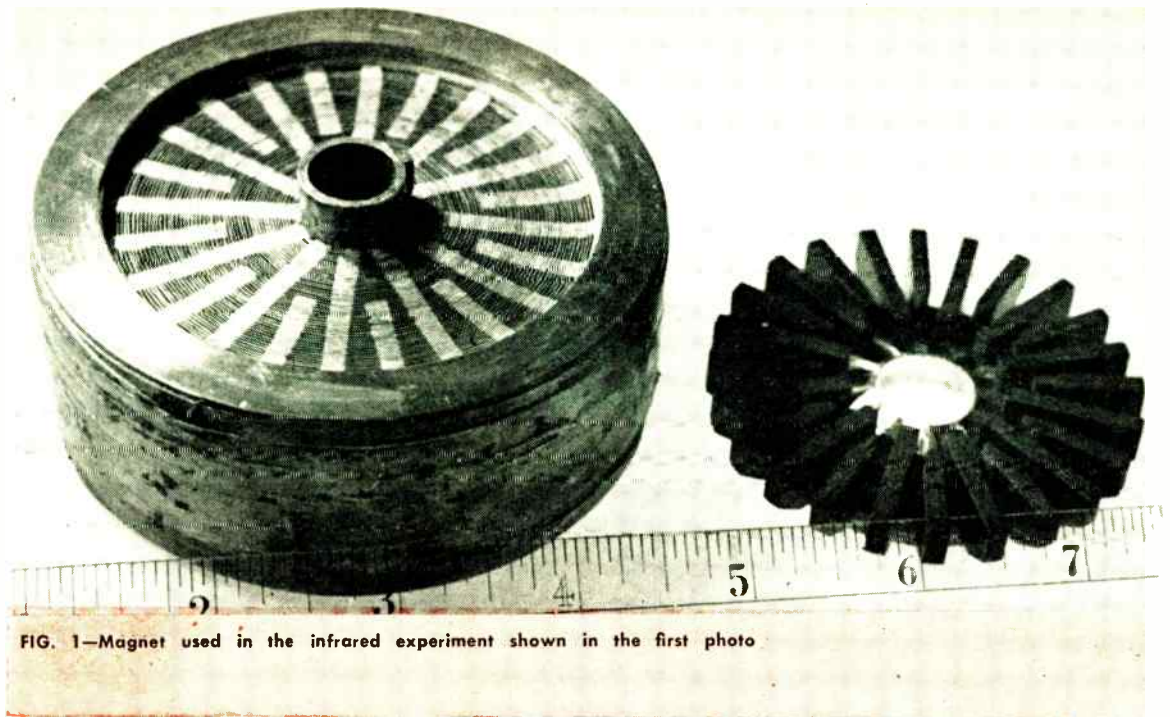

FIG. 1—Magnet used in the infrared experiment shown in the first photo

Bitter's installation, which was a 1.7 megawatt station, has been duplicated elsewhere. Several similar facilities are now under construction notably a 2-megawatt station at Tohoku University in Japan, a 4-megawatt station at the University of Leiden, and a 7.5-megawatt station at Berkeley. However, all of these new magnets are designed to achieve larger field volumes rather than higher fields, and the 100,000-gauss field of Bitter's 1-inch magnet still remains the record for continuous operation. In the case of pulsed magnets, Kapitza's 500,000-gauss field is still the record.

PULSED-FIELD WORK — An electromagnet has zero efficiency. Since the entire power input into a magnet must be removed as heat, there are serious constraints upon the design of powerful continuous-operation magnets. It is considerably easier to design magnets for single-pulse operation, relying on thermal inertia to keep the magnet from melting and utilizing energy stored capacitively, inductively, chemically or mechanically. The art is most expediently divided into three categories of operation: long pulses, intermediate pulses and short pulses.

Long pulses are characterized by resistance-limited current and for practical purposes include the range of 1 to 100-millisecond duration. Kapitza's work and other early attempts fall into this category, and a newer approach to this technique has recently been developed at Harvard¹. They discharged a capacitor bank at several kv through a pulse transformer into a small helix of several turns having great mechanical strength. Ignitrons prevented voltage back swing. To maximize the field, the copper helix was pre-cooled with liquid nitrogen. The copper began to fail mechanically at about 350 kilogauss. Levine at the Air Force Cambridge Research Center is experimenting with a new type of coil in which the forces near the center are reduced substantially by imparting a toroidal component to the field lines; such

force-free structures look promising in both the long and intermediate-pulse range.

The intermediate range of 50 to about 1,000 μ sec was explored by Foner and Kolm². By omitting the transformer and using a triggered air gap for switching, operation was moved well into the oscillatory domain. Resistive losses during the first half-period became negligible compared to the magnetic energy stored in the magnet, making it possible to use considerably stronger helices made of beryllium copper. The highest field generated reproducibly (without explosion of the coil) in this manner is 750 kilogauss of 120- μ sec duration in a $\frac{3}{8}$ -in caliber helix; the technique is probably limited to about 900 kilogauss. The short-time limit of the technique, which is reached with a single turn conductor, was then explored by the Harvard group who ultimately reported shorter pulses of over a megagauss before failure of the conductors. The intermediate range is limited by the fact that mechanical strength as well as space factor suffer when using coils with an excessive number of turns. In the millisecond range it is therefore more expedient to use transformers or a form of energy storage which is more efficient at lower voltages, such as batteries or generator flywheels. The short-time limit of the technique is imposed by the inefficiency of energy transfer into a single turn, whose inductance becomes small compared to lead inductance so that most of the stored energy is wasted.

Below about 50 μ sec it is therefore expedient to use the flux concentrator, a highly efficient air-core transformer whose operation is based upon the fact that skin depth at these frequencies is small compared to coil dimensions. A massive cylindrical conductor of reasonably large outside diameter and whose inside funnels down to a comparatively small caliber at the center is provided with one or more radial slots and surrounded by a coil of several turns which can be efficiently powered to produce a short.

Sensitive Transducers Use

Precise measurement of displacement, temperature, pressure and other variables is possible with this simple but flexible system

By L. J. ROGERS, Special Instrumentation Div., Union Carbide Olefins Co., South Charleston, W. Va.

SENSITIVE crystal oscillator circuit using only one-tube provides an efficient means of measuring many kinds of variables. The circuit uses a small, nonhazardous sensing head which can be remote from the oscillator and other parts of the control system.

Actuation is accomplished by a wide range of physical variables, and the method is being used in chemical plants and hazardous locations. Use in medical research and in aircraft and missile guidance systems appears practical because of the remoteness of the sensing head and the absence of hazardous potentials.

System Performance

Measurement of various phenomena by capacitive or inductive transducers is limited only by the ingenuity of the designer.^{1,2} Trans-

ducers can be built to measure pressure, displacement, temperature and similar properties where a physical dimension or an electrical parameter is altered. The alteration may be sensed as a change in resistance, capacitance or inductance.

Once the transducer has converted a primary measurement into an electrical parameter change, the sensitive oscillator³ shown in Fig. 1 provides a large corresponding d-c output voltage. Several advantages are gained by using this apparatus. Of major importance to many industries is the fact that the energizing potential is remote from the measuring site. A distance of many hundred feet between oscillator and sensor is practical.

The apparatus is reliable because it is not complex, yet for certain configurations, it will yield up to 250 volts per $\mu\mu\text{f}$ of transducer ca-

pacitance change. In a typical open system used under laboratory conditions, long-term stabilities equivalent to $0.002 \mu\mu\text{f}$ are easily achieved with cell capacitance of $50 \mu\mu\text{f}$. This is accomplished by using a crystal-controlled electron-coupled oscillator as the r-f source. In certain low-frequency chopper applications, resolution between 0.0001 and $0.00001 \mu\mu\text{f}$ is attained.

System Description

A remote tank circuit, shown in Fig. 1, consisting of an inductor and associated tuning capacitors, is acted on by the parameter under measurement. A change in the variable will cause a perturbation of the total capacitance, inductance or resistance of this remote tank circuit thereby shifting its operating point by an amount proportional to the change in C, L or R. With link coupling, this change is made to react on a similar measuring tank circuit located in the electronics package. The perturbation affects the measuring tank circuit as though acting on it directly.

The r-f voltage generated by the oscillator is applied across the measuring tank circuit and its amplitude extracted by a detector circuit. Amplitude variations of this voltage contain the desired intelligence.

The crystal-controlled, electron-coupled oscillator of Fig. 1 is connected in a "triode-tetrode" configuration¹ and supplies r-f voltage to the measuring tank. This tank circuit may be tuned to the frequency of the oscillator or to a higher harmonic, usually the third. For example, when high sensitivities of the order of 50 to 250

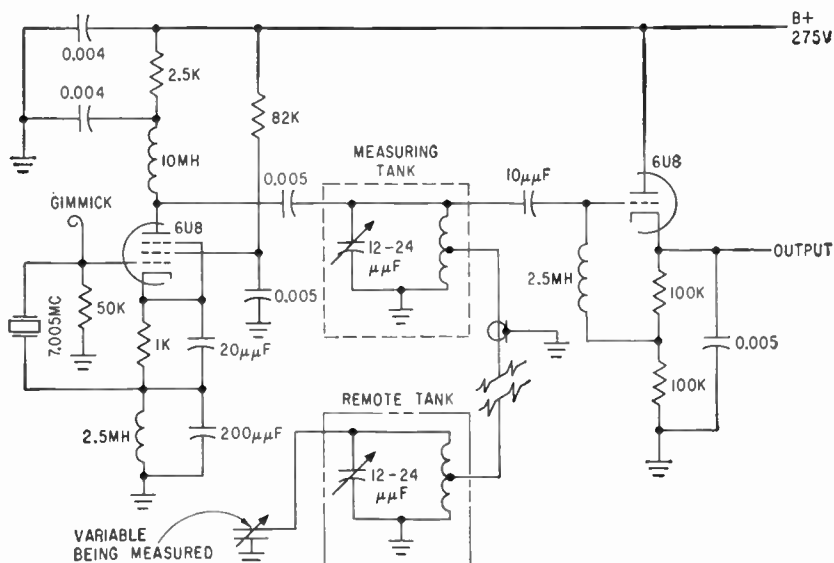

FIG. 1—Sensitive oscillator feeds local and remote tank circuits. Changes in the variable being measured affect the tuned circuits. Output can give up to 250 volts per $\mu\mu\text{f}$ change in the variable parameter

One-Tube Crystal Oscillator

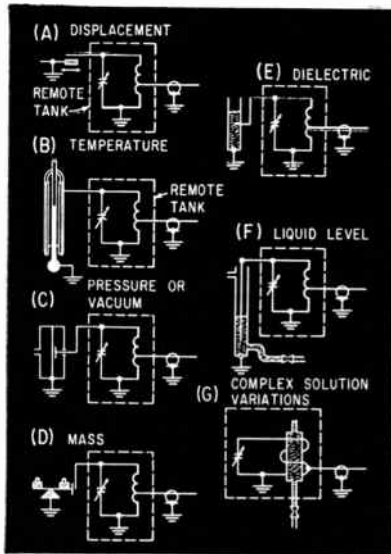
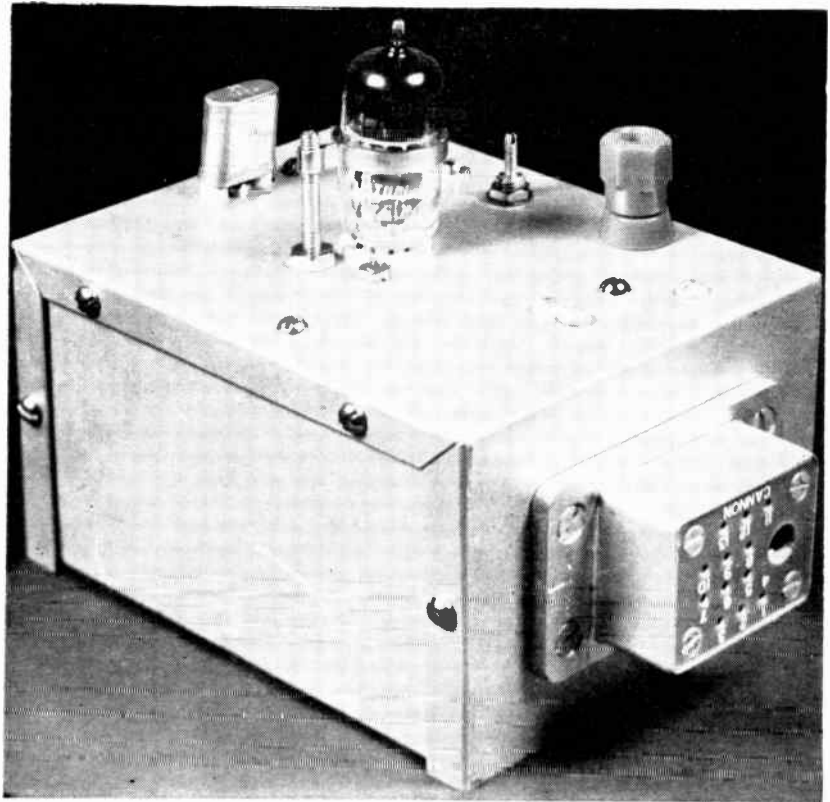

FIG. 2—Remote tank circuit can be made into many types of very sensitive transducers

Electronic package can be located several hundred feet from transducers



volts/ μmf are desired, an oscillator frequency of 7 mc and tank circuit resonant frequencies of 21 mc are used. For less sensitivity and greater linear voltage spans, both oscillator and tank are adjusted to the 7-mc oscillator fundamental frequency. The remote tank circuit is then tuned to a selected side of the combined system resonance curve so that direction is added to amplitude information.

Coaxial cables commonly used for link coupling the remote and measuring tank circuits include RG-62/U and RG-59/U. Tapping points are determined experimentally to suit the particular situation but these are reproducible between units and require only minor adjustments during calibration. For high precision work, particularly in non-modulated applications, each tank circuit may be individually temperature compensated in an oven by adjusting small variable negative-temperature-coefficient ceramic trimmers until minimum temperature effects are noted during oven temperature cycling.

An infinite impedance detector connected across the measuring tank circuit extracts r-f amplitude variations resulting from the primary measurement. Output signal impedance levels are of the order of 100,000 ohms so additional circuits or indicators can often be actuated directly. In a typical unit where a plate voltage of +275 v is applied, output voltages vary from 15 to 150 volts. A 40 volt span, linear to within about ± 1 percent, is available at the 45 to 85-volt level in the 7-mc fundamental system. It is believed that the entire package can be transistorized if space, weight or power supply limitations become critical factors.

Advantages

Designers and instrument engineers using transducers are aware of the many advantages of simple yet sensitive conversions of an electrical parameter change to a large d-c voltage.

Figure 2 shows a few measurements which have been applied to the control system. An obvious

means for producing capacitance change, labeled displacement, is also used to measure temperature, pressure or vacuum, mass and other parameters. If the dielectric of a capacitor is changed rather than the displacement of its plates, it will also produce a response proportional to the dielectric constant change and the cell constant. An analogous situation occurs if the dielectric constant of a liquid medium is constant, but the amount or level changes. A complex measurement occurs when a sample, usually liquid, is enclosed in the tank coil. Variations in the sample dielectric constant and ionic concentration and mobility within the sample will react on oscillator frequency and therefore on the output signal.

REFERENCES

- (1) R. R. Batcher and W. Moulie, "The Electronic Control Handbook," p 39, Caldwell-Clements, Inc., 1946.
- (2) Allen B. Dumont Laboratories, Inc., "Transducers," Instrument Division, Second Edition, p 4, 1953.
- (3) C. W. Capehart, R. B. Fertig, and L. J. Rogers, "Electronic System for Indicating Minute Parameter Changes," U. S. Patent No. 2,831,166, Assigned to Union Carbide Corporation.
- (4) W. A. Edson, "Vacuum Tube Oscillators," p 224, John Wiley and Sons, Inc., 1953.

Coincident-current technique for digital data buffer memories permits compact construction. Capacity can be increased by adding plug-in packages, and systems can provide random and/or sequential access

By DANIEL HAAGENS,

Engineering Manager, General Ceramics Corp., Keasby, N. J.



THE FRONT COVER. Production worker examines memory plane using ferrite memory cores for possible flaws

Buffer memory in foreground is checked out by engineer. Memory is a 144-character, 4-bit, coincident-current system →

Compact Memories Have

COMMON REQUIREMENT of data-handling systems is temporary storage of information transmitted at one rate and processed or received at a different rate. Situations in which this requirement must be met are magnetic tape input to digital computers, transmission of digital data over communications systems and manual keyboard input to digital systems. It is also required for data conversion from one medium, such as punched cards, paper tape and magnetic tape, to another.

Small to medium capacity random-access memories for normal digital data operations are also needed.

Buffering of digital data may be accomplished by such means as magnetic shift registers, small magnetic drums or by a portion of a larger memory if the system has one. The problem can also be solved with coincident-current memory techniques such as described in this article.

The coincident-current approach makes possible unusual flexibility in equipment design, is often more economical and makes possible much smaller memories. These advantages result from the asynchronous nature of coincident-current operation and the rapid access it affords.

Memory System

Modular design of the new Ferramic core coincident-current memory to be described permits storage capacities up to 8,192 bits, with sequential or random access. Transistors are used throughout, and the memory is provided with drive and sense circuits as well as address and output registers. Stable square-loop characteristics and conservative circuit design allow operation over an ambient temperature range from zero to 50 C without external forced cooling. The relay-rack mounted unit is 14 in. deep and has a panel height of 5½ in. It is less than half the size of com-

parable systems (about 0.7 cu ft). Density rate is about 2,400 components/cu ft.

The unit is designed and packaged so that the same basic circuit elements could comprise either random or sequential access systems. A wide range of storage capacity was also considered essential, so it was designed to permit convenient expansion of capacity by using a limited number of standard etched circuit cards.

The first unit designed has a storage capacity of 144 characters of four binary digits each. Specifications called for independent loading and unloading operations and a sequential mode with no limitation on the manner in which the two operations were ordered. The combined rate of operations was to be no less than 100,000 cps, allowing 10 μsec/operation. One additional control input permits resetting the address registers of the memory to the initial address within 10 μsec. Another clears the entire memory to

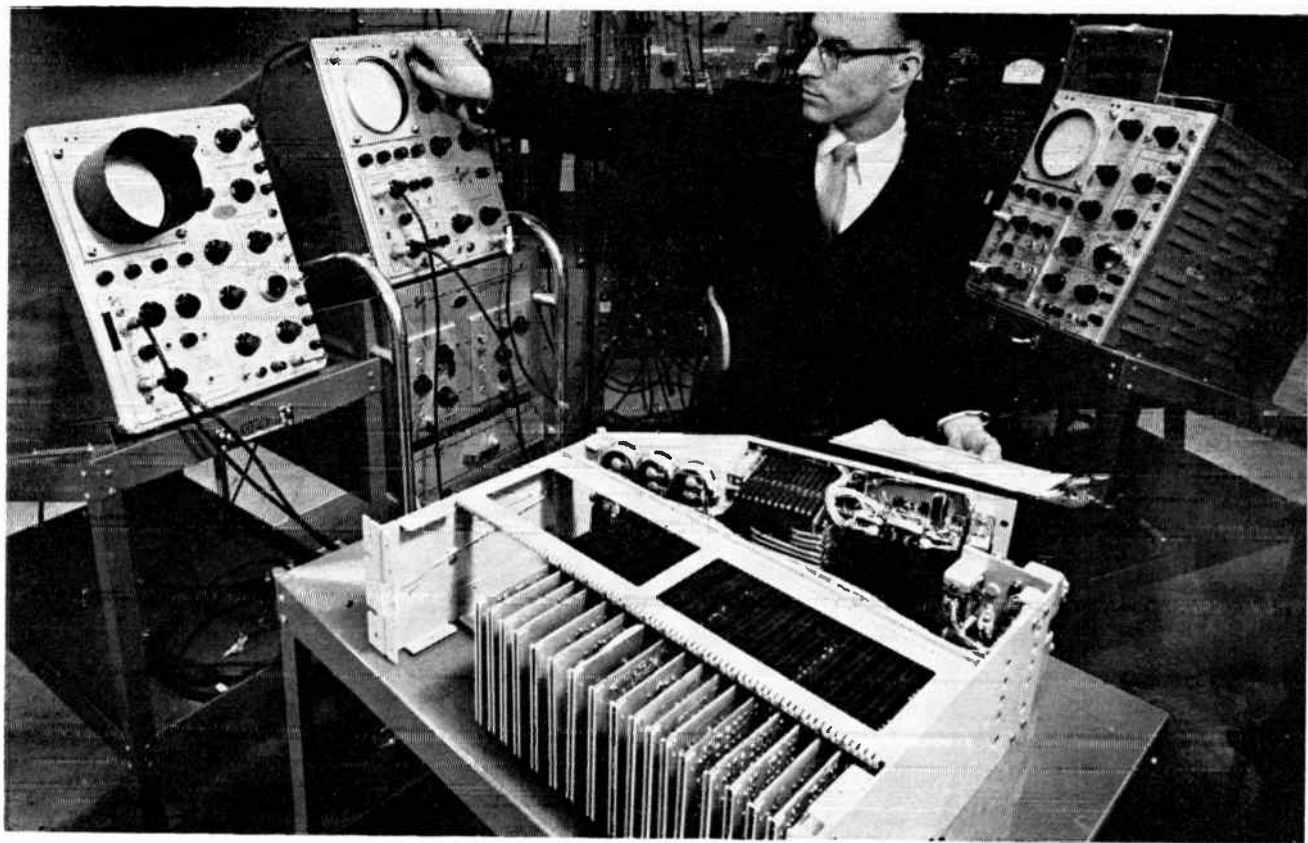

Flexible Capacities

binary zero within 75 μ sec.

External control signals set the load and unload flip-flops in the timing generator in Fig. 1, as well as reset and clear one-shot multivibrators, also part of the timing generator. Input information signals actuate the inhibit drivers, one for each memory array. All four arrays are on one memory plane.

Timing Signals

Amplified timing generator signals control timing pulses for the sense amplifiers, the inhibit drivers, the *X* and *Y* load and unload address counters, the output register and a clear pulse for the memory planes. The *X* and *Y* load and unload address counters provide conditioning levels to the coincidence gates, which are incorporated in the drive circuits for both *X* and *Y* loading and unloading. These circuits in turn are coupled to the *X* and *Y* transformer matrices, which sequentially drive the *X* and *Y* lines of the memory planes with the load

and unload current pulses.

The inhibit drive pulse is gated with the input information signals at the inhibit drivers, determining the information pattern to be stored in the selected memory addresses. The stored information is read out during the unload period and amplified by sense amplifiers that are turned on by the unload sense output during the unload cycle. The sense amplifier outputs actuate the flip-flops of the output register, which provide output information levels at the output connector.

Selection System

To simplify the *X* and *Y* line selection and drive circuits and to reduce currents in the drive transistors, pulse transformers are used to supply the drive lines with the selection currents on both load and unload cycles.

In the 144-character memory, the memory cores are arranged in four 9 by 16 arrays, with the *X* and *Y*

drive lines of each connected in series. For example, in the *X* side, 16 transformers drive the 16 lines. The transformers are arranged in a four by four square array as shown in Fig. 2. Each transformer has one output winding and two input windings. One input is used for load drive, the other for unload drive. The transformers are isolated from each other by diodes and are connected to permit independent selection on load or unload.

Turns ratio of the transformers is 5:1 between either primary and the secondary. Drive current on each *X* line is 150 ma. The driving transistor therefore must supply 30 ma to the primary. Resistors R_1 and R_2 are selected so voltage at the emitter of Q_1 is slightly negative when the unload drive pulse is absent. Since the bases of transistors Q_2 are clamped to ground, all current passing through R_2 goes through Q_1 . When the drive pulse occurs, Q_1 is cut off and the emitters of Q_1 and all Q_2 transistors rise un-

til a Q_2 transistor conducts.

The correct Q_2 was selected by removing the positive input current from its base resistor R_3 . Current from R_2 is transferred to the selected X unload drive transformer line. The value of R_3 keeps diode D_1 from being cut off. The base of Q_2 is therefore kept near ground potential and acts as a constant-current source. One of the unload drive return transistors, Q_3 , has been selected in a similar manner. As a result, only one transformer has current through its primary. The Y selection is accomplished in a similar manner.

out in the following manner: Each array of 9 by 16 cores has a sense winding brought to two terminals through a coaxial lead and then connected in the same manner to the sense amplifier input. The four inhibit windings are connected in series with their junction points brought out (five leads from the memory plane for the four inhibit windings). Since output of the inhibit drivers is derived from the secondary of a transformer, no ground return is necessary on the inhibit windings, and the inhibit drivers and inhibit windings can be connected in series. This arrange-

taining a positive bias on succeeding amplifiers.

In the sense amplifier in Fig. 3, Q_1 is a drift transistor with low output capacitance. Transistor Q_1 amplifies linearly the 20-mv sense output signal from the memory planes. Output of Q_1 is coupled to Q_2 through a pulse transformer, with impedance matched to the input of Q_2 .

A full-wave rectifier is necessary at the secondary of the transformer because sense output can be of either polarity. An enabling signal turns on the sense amplifier to permit it to discriminate between an output from the memory cores during an unload and a load cycle. Transistor Q_2 supplies sufficient power to operate a flip-flop in the output register.

Inhibit Driver

The inhibit driver circuit in Fig. 4 uses the same basic approach as used in the load and unload selection circuits. In the quiescent state, Q_2 conducts and its emitter is at a negative potential just below ground. The emitters of Q_1 and Q_2 are tied together, and the base of Q_1 is grounded. Therefore, Q_1 remains cut off until Q_2 is cut off. Quiescent current through Q_2 of about 15 ma flows through one of the primaries of the pulse transformer. With an inhibit signal and a binary ZERO on the data input lead, the base of Q_2 becomes sufficiently positive to cut it off. Emitter voltage rises until the common-based transistor Q_1 starts to conduct, causing current to flow through the other transformer primary. Therefore, the transformer field is reversed.

Secondary transformer current is ten times quiescent primary current. Transistor Q_3 is connected to the output of the transformer secondary and acts as a diode with very low forward drop, allowing the inhibit output to be disconnected from any transformer secondary recovery currents that might otherwise occur during high duty cycles. The input circuit to Q_2 has constant base drive for all conditions when a binary ONE data input is applied and no inhibit action is desired. A 3,600-ohm resistor between ground and the collector of

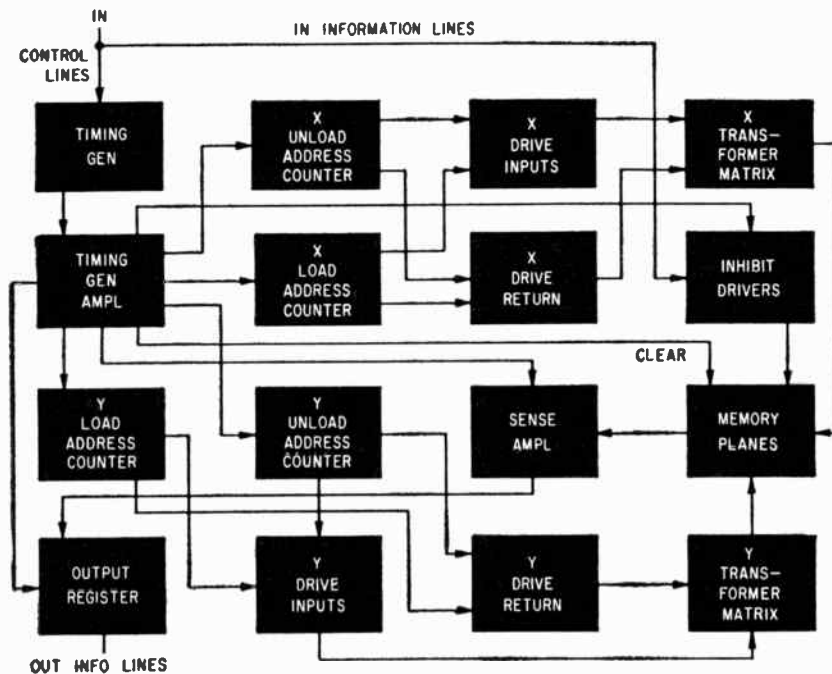

FIG. 1—Input information signals actuate inhibit drivers for each of four memory arrays

This method of drive-line selection permits expansion by varying number of transformer plug-ins, input drive-circuit and return drive-circuit cards. If the address is always the same for load and unload, transformer returns can be connected in common for load and unload, cutting the number of return drive-circuit transistors in half.

Since input current requirements of Q_2 and Q_3 are low, the address decoder inputs can be supplied from diode gates driven directly from the flip-flops in the address registers.

The memory planes are mounted on a plug-in package and have the sense and inhibit windings brought

ment permits clearing all memory cores with a single long pulse through all the series inhibit windings, and no cycling of the memory address counters is necessary.

Flip-Flops

The transistorized flip-flops in the memory are stabilized against saturation, so that wide variations in h_{fe} can be tolerated.

The one-shot multivibrators are similarly stabilized and they are a variation of the basic bistable circuit.

All flip-flops are arranged to swing between +2 and -8 v, so that it is possible to connect gating chains to the flip-flop outputs main-

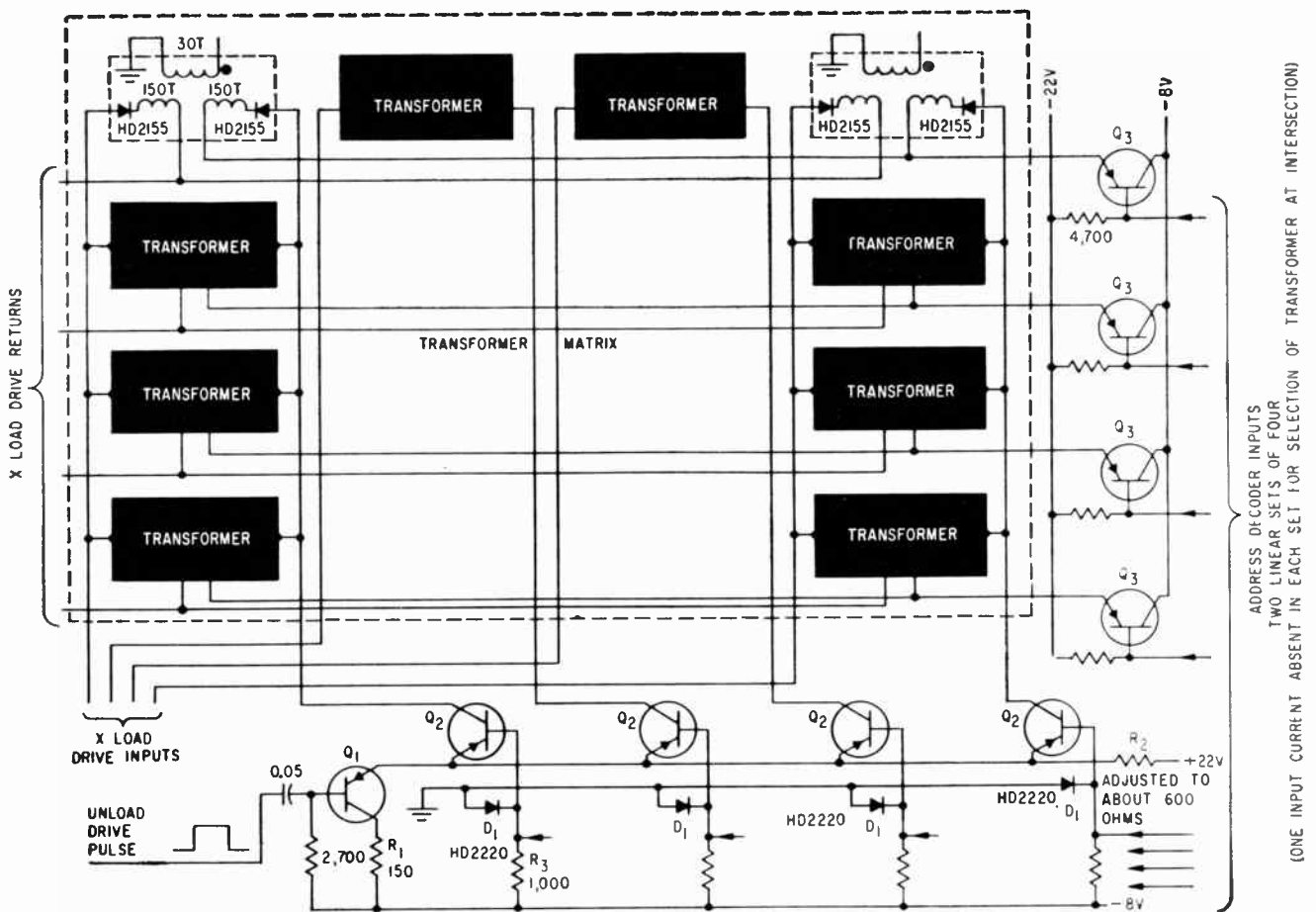

FIG. 2—Each transformer in 4 by 4 square array has one input for load drive and another for unload drive

Q_1 damps excessive transients at the end of the inhibit cycle. Current through Q_2 is adjusted to proper value at the factory.

The transistors in all these circuits are computer-type transistors with carefully controlled cut-off currents held below $6 \mu\text{amp}$. All circuits are stabilized for I_{off} .

Using the general configuration

of this memory, by adding plug-in packages containing flip-flops, drive circuits, sense amplifiers and inhibit drivers, capacity both in number of words stored and in number of binary digits in each word can be easily expanded or contracted. Random-access memories of similar capacities can readily be constructed. Address registers in such

memories would not be coupled together as counters. In general in a random-access memory only one address register is necessary, rather than separate ones for load and unload, since the address for loading and unloading is the same.

Other Designs

Other designs have been constructed including a memory of 32 characters with four bits to the character and a memory of 144 characters with 8 bits to the character. Memories with other capacities are presently reaching the prototype stage.

The sequential-access memory using individual registers for load and unload can replace shift registers in some applications.

It is possible to arrange this type of memory to be reversible in the load or unload mode. This arrangement permits reversal of the time ordering of information in data transmission and processing devices. Combined random and sequential access can be provided.

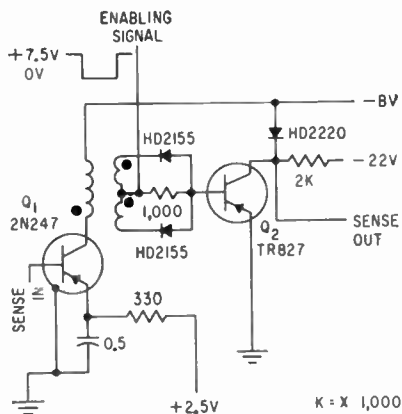

FIG. 3—Sense amplifier requires full-wave rectifier at input to second stage

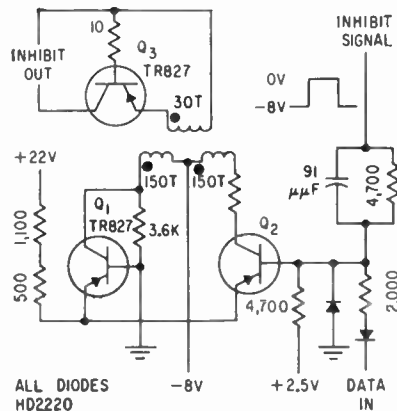

FIG. 4—Inhibit driver uses transistors with carefully controlled cutoff currents

Electromechanical Switches

Specifications, performances and applications are given for typical electromechanical commutators used for long-range sampling and programming

ELECTROMECHANICAL commutator applications are similar to the electronic commutator applications previously reviewed.¹ Most of the electromechanical models listed can be used in pulse duration modulation (pdm) and pulse amplitude modulation (pam) systems. The IRIG standards² apply.

It should not be assumed that electromechanical and electronic types are interchangeable in all cases. Among considerations influencing choice are size, weight, sampling speed, available power, life expectancy and price.³ A survey of telemetering practice is also referenced.⁴

Typical specifications for an electromechanical commutator are given in Table I. Such a commutator, or sampling switch, would be suitable for airborne or missile applications. The motor and gear box are contained in the housing, which can be hermetically sealed.

Manufacturers' specifications and performance reports for several representative types of commercially-available models are listed in Table II.

REFERENCES

- (1) A. S. Kramer, Electronic Commutators for Multiplex Telemetering, *ELECTRONICS*, 32, p 76, Sept. 25, 1959.
- (2) Inter-Range Telemetry Working Group, Inter-Range Instrumentation Working Group Recommendation No. 102-55, IRIG Secretariat, White Sands Proving Ground, 1955.
- (3) M. M. Kronzler, Commutators for Airborne Multiplex Telemetering, *ELECTRONICS*, 32, p 16, July 3, 1959.
- (4) A. A. McKenzie and H. A. Manogian, Telemetering, *ELECTRONICS*, 29, p 153, April 1956.

Table I—Typical Electromechanical Commutator Specifications

Characteristic	Specification
Sampling Rate	3,600 samples per second
Contact Resistance	0.1 ohm
Capacitance	1 μ fd between contacts
Interchannel Resistance	100 megohms
Noise	20 μ v to 30 μ v
Typical Load Impedance	1 megohm
Motor Power	115 v, 400 cps, 1 phase
Size	3 $\frac{1}{2}$ \times 3 $\frac{1}{2}$ \times 3 in.
Weight	3.5 lb

Table II—Specifications, Performance Data

Manufacturer and Model	Manufacturer's Description	Duty Cycle (%)	Speed (samples per sec)
ASC Type ANM	Graphite	50 to 90	4,050 to max
	Metal		
BEP	TSC-200	c	3,600
	TSC-50	d	max
	TSC-51	d	
DAV	rotary sampling switch		240
ELT	CQ10828		
	CQ108210	50	
	CQ108212		
GDI Minicom Series 900	rotary sampling switch	40 to 90	2,000 to max
GDI Permabrush	rotary sampling switch	40 to 75	2,500 to max
IDL 500334	rotary commutating switch		225
IDL 500197	rotary telemetering commutator		840
MYC TM 55	Graphite Gold	f	to 1,800 rpm
ROD P/N S-512	rotary multiplexing switch	optional	900 per pole
ROD P/N S 206	rotary sampling switch	60	250 per pole

(a) Typical value for graphite brushes (b) Typical value for metallic contacting surface (c) Signal section, 90 \pm 5, and trigger section, 62 \pm 10 per cent "on-time" in non-shorting operation (alternate contacts open) (d) 62.5 \pm 5, non-shorting operation; 40 \pm 10, shorting operation (e) Contact noise (f) Any duty cycle up

for Telemetry Systems

By **A. S. KRAMER**, Senior Technical Specialist, Allen B. DuMont Laboratories, East Paterson, N. J.

and Applications of Representative Electromechanical Commutators

Contact Resistance (ohms)	Capacitance ($\mu\mu\text{f}$)	Inter-channel Resistance (ohms)	Noise	Tolerable Signal Levels	Typical Load Resistance (ohms)	Input Motor Power	Applications
100 ^a 1 ^b	10 between channels	100 meg min	20 μv -10 mv (@ 15 mv-5 v inputs ^c)	5 v max	100,000 10,000	115 v 400 cps 1 or 3 phase, or 28 v-dc	pdm/fm, pdm/pm pam telemetry
10 or less	6 5.5 5.5	100 meg 100 meg	50 μv p-t-p	10 v max between studs		115 v 400 cps 1 phase, or 28 v d-c	pdm telemetry pam telemetry pam telemetry
less than 0.025							pam telemetry pdm telemetry
0.1 max	<1 between channels	10 meg min	$\leq 10 \mu\text{v}$ per ma of current ^c	100 μv to 150 v	1 ohm to 1 meg		pam, pdm telemetry; sampling, selecting and counting
0.01 to 1 p-t-p	2	over 100 meg	less than 10 μv	10 μv to 10 v	100 ohm or more	3 watts min	subminiature telemetry multicoder
5 to 50 p-t-p	less than 1	10 meg to 1,000 meg	<0.01 % of signal	100 μv to 200 v	10,000 to 100,000	10 watts min	telemetry, automatic quality checking
0.1 max	5.5	100 meg min	5 mv	30 v max	5,000	115 v 400 cps 1 phase	airborne tele- metering, sam- pling, programming
	5 between pins		less than 20 mv	5v d-c max-		115 v 400 cps 1 phase	missile, satellite, space vehicle telemetry
0.5-10 ^a 0.1-1 ^b	3.5 max between pins	10 ¹⁴ min @ 500 v	<1 mv p-t-p	handles signals in mv range	100 ohms to 1 meg	optional	pam telemetry pdm telemetry
10 max			0.4 mv 25 mv max p-t-p ^d	low 40 mv high 2.5 v	500 ohms 1 meg	optional	pdm telemetry
50 max	2		25 mv at 25 amp sig- nal level	250 mv			industrial sampling systems

to limit of commutator plate (g) Values for low-level and high-level poles, respectively.

Key to Manufacturers

ASC Applied Science Corp. of Princeton.

BEP Bendix-Pacific Division, Bendix Aviation Corp.

DAY Daven Co.

ELT Electro-Tec Corp.

GDI General Devices, Inc.

IDL Instrument Development Laboratories, Inc.

MYC Myalex Electronics Corp.

ROD Rotary Devices Corp.

Computer integrates curve of dye concentration in blood stream to obtain flow rate. Measuring technique leads to more thorough diagnosis of heart malfunctions without injuring patient or disturbing the cardiovascular system

By **ROBERT L. SKINNER**, Chief Engineer and **DIETRICH K. GEHMLICH**, Consultant, Enesco, Inc., Salt Lake City, Utah

Analog Computer Aids

THE HUMAN HEART performs a function vital to life as it pumps blood throughout the circulatory system. A complete knowledge of its functions and malfunctions, therefore, is of prime importance to the medical profession. An important step in treating heart disorders is the complete and accurate diagnosis of the ailment. One such diagnostic procedure is the measurement of the actual volumetric output of blood from the heart which is known to change under different conditions of stimulation.

One method that has recently

been developed to measure relative cardiac output is the dye curve method. This operation requires that a small quantity of dye be injected into the bloodstream above the heart (the venous side of the heart). A detector which measures the concentration of dye in the bloodstream is placed at the exit of the heart and monitors the dye concentration at that point as the blood passes by. A typical curve showing the distribution of the dye in the blood as it passes a monitoring point is indicated in Fig. 1A. As a result of fusing and mixing of dye and blood, the main body of

the dye concentration is first detected, followed by a gradual falling off in dye concentration. At some time t_1 , the blood has completely circulated through the body system and returned to the heart. The main concentration of dye has now become more and more diffused in the blood and the resultant maximum concentration is lower as the blood circulates past the detector a second time. The third time the blood circulates past the detector, there is an even smaller increase in concentration. After a long period of time, the original dye has become completely mixed with the blood in the system and the result is a uniform increase in concentration throughout the entire blood volume. This is indicated by a leveling off toward an asymptotic value of dye concentration indicated in Fig. 1A.

Measurement Model

The area under the dye curve is proportional to the rate of flow of blood from the heart, assuming that no recirculation takes place. The model for such a measurement, made as shown in Fig. 2, produces the concentration-time curve of Fig. 1B. Since there is no recirculation, the integral of this dye curve from time t_1 until such time

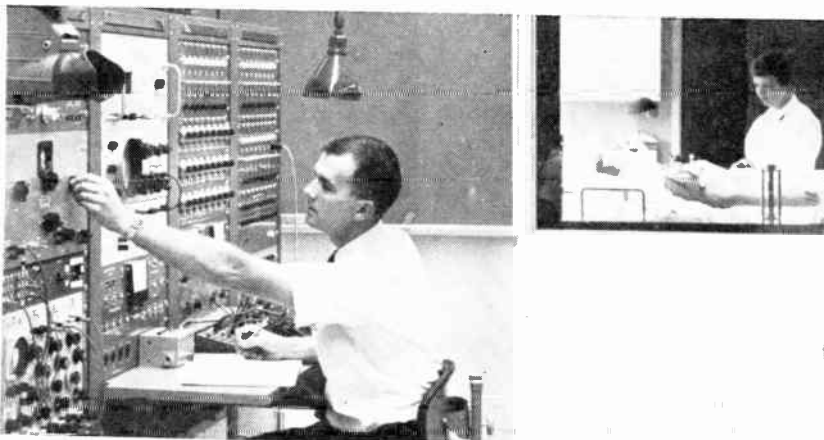

Analog computer in foreground is being used as a diagnostic tool for cardiac disorders. Device has been successfully used on dogs and human patients

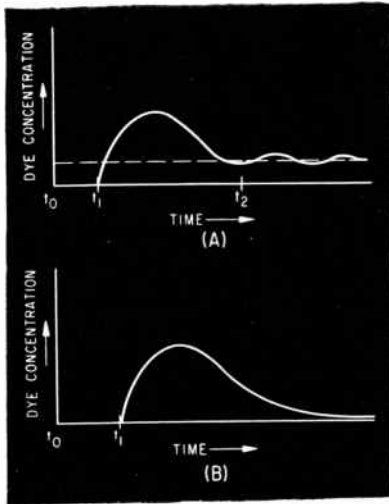

FIG. 1—Actual dye concentration-time curve in (A) must be made to conform to the ideal curve of (B)

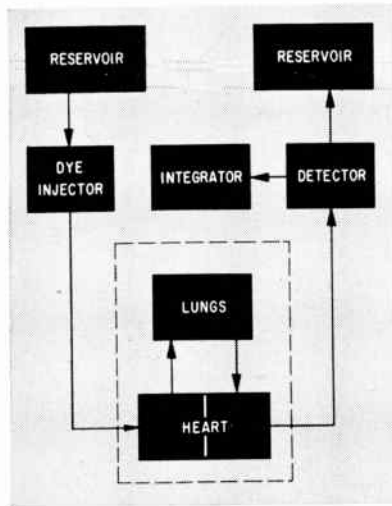

FIG. 2—In ideal test, system has two separate reservoirs avoiding the problem of recirculation

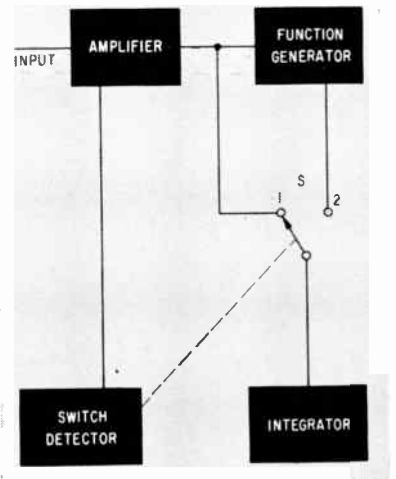

FIG. 3—Basic circuit operation includes amplification and integration of the ideal dye curve

Heart Ailment Diagnosis

as the concentration returns to essentially zero is a direct measure of the flow rate through the heart and lungs. A comparison of Figs. 1A and 1B indicates that the curves are similar, but that the ideal curve approaches zero exponentially, while recirculation causes the actual curve to approach some constant value and remain there. The integral of the dye curve for the true system for all values of time would never reach a constant value, but would steadily increase. To obtain a finite integral of the true dye curve which accurately represents cardiac output, it becomes necessary to make the true dye curve conform to the theoretical one by eliminating recirculation.

Measuring Circuit

The circuit involved in the blood flow rate measurement performs several functions. It detects the exponent corresponding to the exponential decay of the true dye curve before recirculation begins. It generates an exponentially decaying function having the same exponent as that of the original dye curve decay and the same initial value. After the decay of the original dye curve has remained exponential for a given time and before recirculation begins, switching ac-

tion is provided which substitutes the exponentially decaying function generated by the equipment for the actual dye curve from that time on. Finally, it integrates the area under the actual dye curve until switching takes place and then it integrates the area under the exponentially decaying curve generated within the unit.

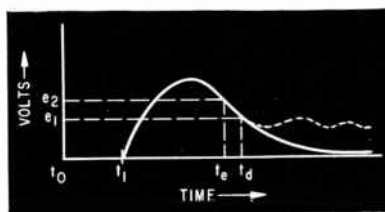

FIG. 4—Voltage-time curve decays exponentially at t_1 , and the value of k is determined. Switching takes place at t_d

This operation is described in block form in Fig. 3. The original dye curve similar to that of Fig. 1A is fed into an amplifier and to an integrator through switch S , which is normally in position 1 as shown. At some time after the dye curve has gone through its peak, it begins an exponential decay shown starting at time t in Fig. 4. This point is detected by the switch detector which, after a preset delay,

throws the switch into position 2 at time t_d . Previous to time t_d , the function generator has been sensing the waveform of the true dye curve. When the switch is thrown into position 2, this function generator generates an exponentially decaying function with the same exponent as that of the original dye curve between t_1 and t_d and with an initial value e_1 . The integrator effectively integrates the area under the solid curve of Fig. 4 giving a direct measure of the actual blood flow rate. Switch S remains in position 2 and the integral of the dye curve remains as a voltage at the output of the integrator until the equipment is reset.

Obtaining the Exponent

At some time t , after the true dye curve has reached its peak and decreases, it begins to decay exponentially. During this exponential decay the equation of the dye curve is of the form $y = A_2 e^{-k(t-t_1)}$. Taking the natural logarithm of both sides, $\ln y = \ln A_2 - k(t - t_1)$. The derivative of $\ln y$ with respect to t is equal to $-k$. The second derivative of $\ln y$ with respect to t is equal to zero. These equations show that the necessary exponent k can be obtained by first

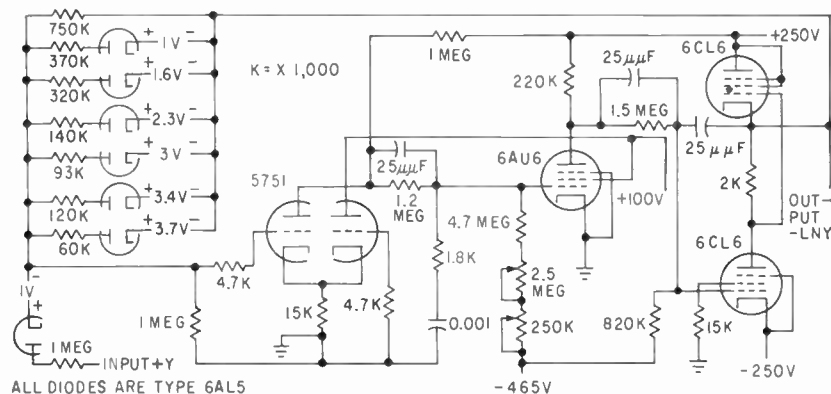

FIG. 5—Output of function generator is exponentially decaying curve in which the exponent is determined by other components of the system

taking the logarithm of the dye curve and then taking the first derivative of the result. This operation is performed by using a logarithmic function generator and a differentiator circuit to perform the first differentiation. The function generator circuit is shown in Fig. 5. The output of the derivative circuit is constant and has a value of k only when the dye curve is exponentially decaying.

Function Generator

A typical exponentially decaying function can be represented by the equation $y = Ae^{-kt}$ where A is the initial value of the function and k

is the exponent. Next, by taking the derivative of both sides, $dy/dt = -kAe^{-kt} = -ky$. Integrating both sides of this equation, $y = -k \int y dt$. The solution for such an equation can be obtained very readily by using the analog computer setup as shown in Fig. 6. The circuit is so connected that the voltage A is equal to e_1 (Fig. 4) when switching takes place at time t_a . The exponent k is determined from the exponential decrease of the true dye curve before switching takes place (during the interval t_0 to t_a). Thus, the instant the initial-condition switch S is opened, the output is in the form of an exponentially

decaying function starting at $-A$ volts and decaying to zero at a rate determined by the exponent k .

Switching and Integrating

At the instant the dye curve begins to decay exponentially, the output of the differentiating circuit is $-k$. The switching point is therefore set at some predetermined time after k becomes negative.

Integration of the dye curve as a function of time is accomplished using an analog computer type integrator shown in Fig. 7.

Complete System

The complete system diagram is indicated in Fig. 8. The multiplier is a commercial electronic multiplier unit.

All dye curves are prerecorded on tape and played directly into the input terminal of the dye curve integrator. The maximum signal of the dye curves is approximately 0.5 v. Therefore, the signal is pre-amplified by a factor of 10 using amplifier 1. The 0.01- μ f capacitor is inserted in parallel with the 5-megohm feedback resistor to decrease the high-frequency noise on the incoming dye curve wave. The reset switch around amplifier 2 is held closed, thereby holding the

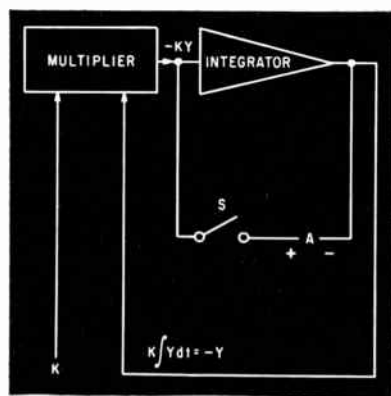
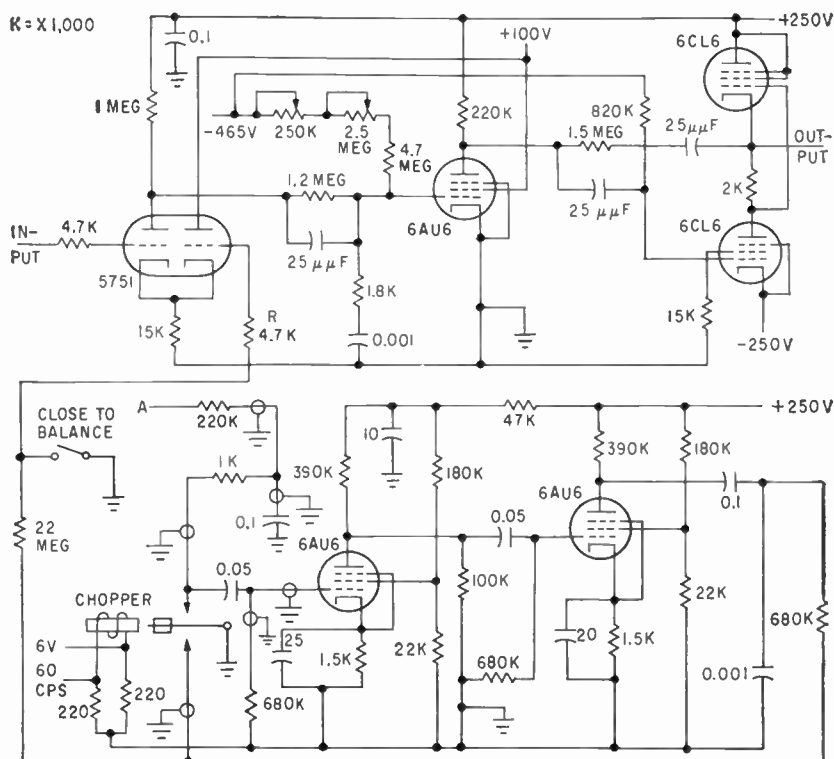

FIG. 6—Basic multiplier-integrator circuit gives area under dye-time curve for measurement of blood flow rate

FIG. 7—Operational amplifier is used alone with R grounded for each of the amplifiers in Fig. 8 except No. 2. The integrator requires the stabilized chopper with A connected at the input and R connected as shown



output of the integrator to zero until just before the dye curve appears. At this time the reset switch is opened, and amplifier 2 integrates the original dye curve until time t_s in Fig. 4. At time t_s , the switching action takes place, and the exponentially decaying curve from amplifier 7 is fed into the integrator.

To determine the desired switching time, the dye curve is fed to the function generator as well as to the integrator. The function generator gives an output equal to $\ln y$ (y representing the dye curve). Amplifier 3 differentiates this output making it equal to $+k$. This waveform is compared to a positive voltage obtained from a potentiometer. The two inputs are added and amplified through amplifier 8. The combination is then passed through another potentiometer and amplifier 9 and applied to the coil of relay K_1 . For all positive values of k , as well as zero, the output of amplifier 9 is adjusted to have sufficient amplitude to energize relay K_1 . This effectively places a short circuit around the feedback elements of amplifier 10, forcing its output to remain at zero as long as relay contact K_1 remains energized or in the No. 2 position. Thus, relay coil K_2 is not energized, and all contacts on that coil remain in their normally closed position, as indicated on the diagram.

At some time shortly after t_s or at least near t_s , k has reached a negative value large enough to connect the output of amplifier 9 and allow the relay to drop open. When this happens, relay K_1 drops into the No. 1 position, and a positive voltage is applied to the input of amplifier 10. This amplifier is connected as a conventional integrator, and it integrates the positive voltage until the output has risen sufficiently to close relay K_2 . This integration process creates a variable delay between the time that k approaches its fixed negative value and the time the actual switching takes place.

In some cases, k goes negative for a short period only and then goes back to zero or a positive value before finally returning to the negative constant value. For this reason, the delay is provided to make sure

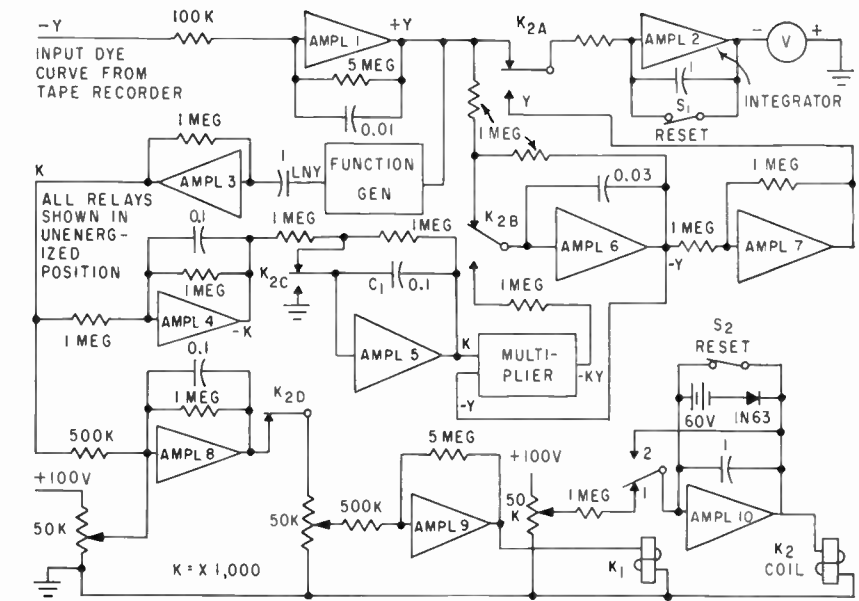

FIG. 8—Complete dye measurement circuit provides for the integration of dye-time curve. Switching is accomplished when K_1 is in position 1, and K_2 coil is energized operating K_{2A} , K_{2B} , K_{2C} and K_{2D} .

k stays at a negative value for some time before the integrator is switched from the true curve to the generated exponentially decaying function. The delay can be adjusted by changing the positive voltage applied to the input of amplifier 10. Since relay system 2 closes on approximately 40 v, the output of amplifier 10 is limited to 60 v by the battery and diode combination in the feedback circuit, preventing the amplifier from saturating. Preset switches S_1 and S_2 must be open at the same time to allow for proper operation of the integrator.

Energizing relay coil K_2 after the preselected time relay has elapsed affects four switches. Contacts K_{2D} open, thereby completely disengaging amplifier 9, forcing its output to go to zero. This effectively locks K_1 in its normally closed position, which in turn locks relay K_2 in a closed position until such time as manual reset occurs.

Sign Changer

Before switching occurs, amplifier 4 acts as a sign changer so that $-k$ is applied to the holding circuit of amplifier 5. Amplifier 5 has been operating at unity gain, continually keeping the value of k stored on the 0.01- μ f capacitor C_1 . When contact K_{2C} opens, the input of amplifier 5 is cut off, and the value of

k at the switching time is retained across C_1 .

This value of k is fed into the multiplier and amplifier 6. Before switching, this amplifier operates at unity gain with the actual value of the dye curve appearing across its 0.03 μ f capacitor. When contact K_{2B} is closed the output of amplifier 6 is at e_1 as shown in Fig. 4. After switching, the amplifier is no longer connected to the initial dye curve but is connected to generate an exponentially decaying voltage which starts with an initial value of e_1 and decays with an exponent of k as determined by amplifier 5.

Since contact K_{2A} has also been energized, the output of amplifier 6 is fed through amplifier 7 which provides the needed sign change, and the function is sent to amplifier 2. Thus the integrator no longer operates on the actual dye curve but integrates the exponential function generated by amplifier 6 and the multiplier unit.

The output of amplifier 2 becomes the integral of a theoretical dye curve which has eliminated the effects of recirculation. The total time integral of the theoretical dye curve is read as a voltage at the output of amplifier 2. This voltage will remain at the output permanently until the whole system is manually reset.

Power Supply Design

High-voltage, high-current silicon diodes make possible a cost reduction in some types of large power supplies. Reliability and long life are other advantages of properly designed units

By H. A. KAMPF, Argonne National Laboratory, Lemont, Illinois

SILICON DIODES as low voltage rectifiers are finding wide application for small power supplies. Silicon diodes are particularly attractive to the designer because of their long life expectancy, high rectification efficiency and low initial cost.

But silicon diodes have seen little service as high power rectifiers where they can give the same advantages. Commercially available diodes have ratings of peak inverse voltage as high as 1,500 v and forward currents of hundreds of amperes. These ratings immedi-

ately indicate that single diode units are useful in applications requiring low voltages and high current. But multiple diode assemblies in a properly designed system can be used for high voltages as well.

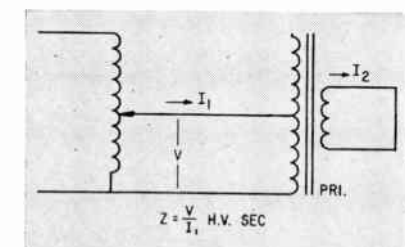

FIG. 1—Circuit is used to find transformer short-circuit impedance

ately indicate that single diode units are useful in applications requiring low voltages and high current. But multiple diode assemblies in a properly designed system can be used for high voltages as well.

The first design considerations of a power supply are the peak inverse voltage and the peak forward current seen by the rectifiers. These are determined by the rectifier circuit, the load characteristics, the filter and the internal impedance of

Low-Power Rectifiers

Commercial power supply transformers up to the 200 v-a size will usually have about 5 to 10 percent impedance, which means that the maximum current they can deliver is limited to 20 to 10 times normal full load current. This current will flow through the diodes into an uncharged filter capacitor or into a short circuit. The diodes must be capable of handling these currents for short periods. Most small diodes rated for about 0.5-amp operation are able to handle 10 times this rating as a 60-cps recurrent peak amperage and about 50 times this amount for up to about 5 milliseconds. Forward current limiting can be accomplished by transformer impedance or by a separate series resistor.

The short circuit impedance of a transformer referred to the high voltage winding can be found as shown in Fig. 1. The primary winding which is normally connected to the line is shorted through an ammeter. The input voltage is raised until rated primary current flows, and the impedance is then $Z = V/I_1$. Peak short-circuit current can then be calculated from this impedance, assuming that rated line voltage is applied to the primary. Results will usually be within 25 percent of the actual peak currents encountered.

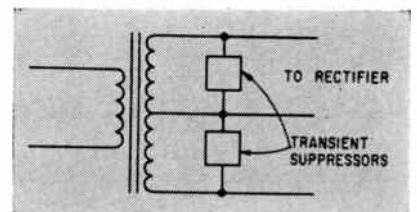

FIG. 2—Transient suppressors are applied to a center-tapped rectifier transformer

A prediction of this accuracy is useful in selecting the diode to be used. Greater accuracy than this requires consideration of nonlinear inductance effects caused by transformer iron and the degree of saturation of the transformer. The same technique for predicting peak currents can be used with greater accuracy on transformers for full-wave bridge and three-phase rectifiers.

The peak inverse voltage rating of the diode must be carefully observed. Once the diode breaks down in the reverse direction, it has little resistance and the reverse current increases almost instantaneously to destructive levels. This danger is further increased by transient surges developed in the transformer during on and off switching and in the inductance of a choke input filter with fast changing load currents.

Small transformers under 200 v-a generally have a d-c resistance from 20 to 50 percent of the inductive reactance. The transient voltages that are developed are therefore proportionately smaller than those developed in high power transformers where the d-c winding

Using Silicon Diodes

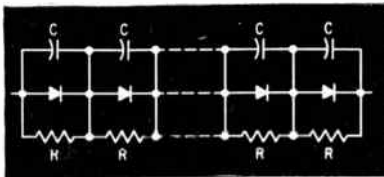

FIG. 3—Resistors compensate diodes for variations in back resistance. Capacitors protect against transients

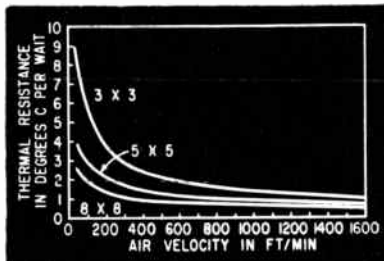
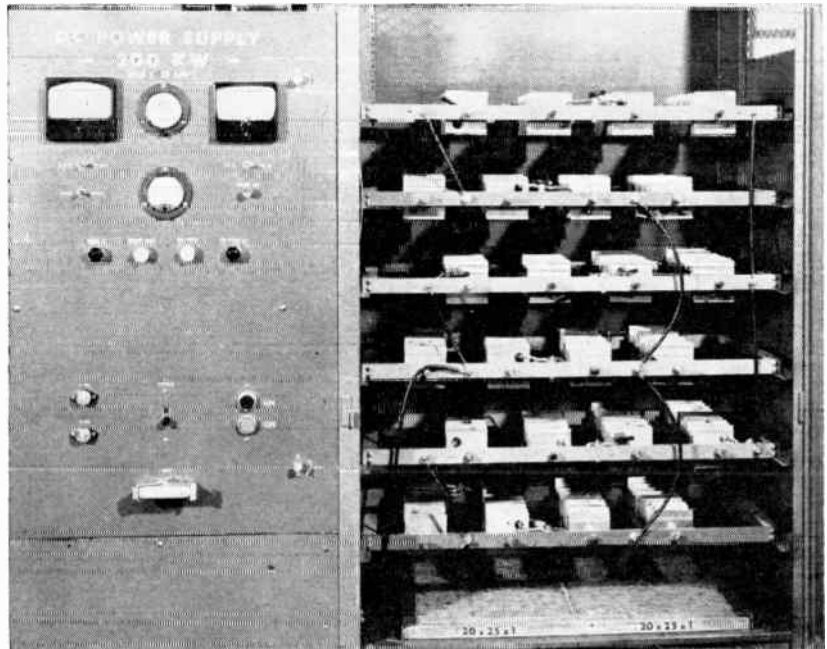

FIG. 4—Thermal resistance of 1/16 in. aluminum. Dimensions are in inches



Power supply delivers 25 amps at 8,000 volts. Operating panel is at left and diode stacks are at right. Schematic is shown in Fig. 5

resistance is made as small as possible to minimize losses.

A diode for a small rectifier system should have a peak inverse voltage rating at least twice the value expected under steady state conditions. The 100-percent safety factor is adequate for most cases where switching transients only are involved.

Rectifiers with choke input filters must have an additional safeguard against transients caused by load variations. Protection from these transient choke voltages can be ob-

tained with a small inexpensive Thyrite or voltage-variable resistor connected in parallel with the inductor.

High-Power Rectifiers

High power rectifier systems involve considerations similar to those already mentioned. The short circuit diode current must be tolerated for a length of time sufficient to operate the protecting fuse or circuit breaker. This current may be hundreds or thousands of amperes, and diodes must be selected

with this factor a primary consideration. The short circuit impedance of the rectifier transformer can be made intentionally high to help reduce short-circuit current but the regulation of the supply will suffer, and a compromise will generally be required.

Parallel operation of diodes to handle larger currents is possible by using parallel reactors or resistors to insure proper division of current. But it is always better to use a diode with enough current capacity and avoid the complexity of paralleling, if at all possible. Diodes now available will handle short-circuit currents as high as 1,200 amp without damage.

Peak Inverse Voltage

The peak inverse voltage appearing across the rectifier because of transients can be many times larger than that predicted from the steady-state a-c circuit. It is usually necessary to have a sufficient number of diodes in series to withstand twice the peak inverse voltage predicted from steady-state conditions. Relatively simple and economical means can then be used to limit transients

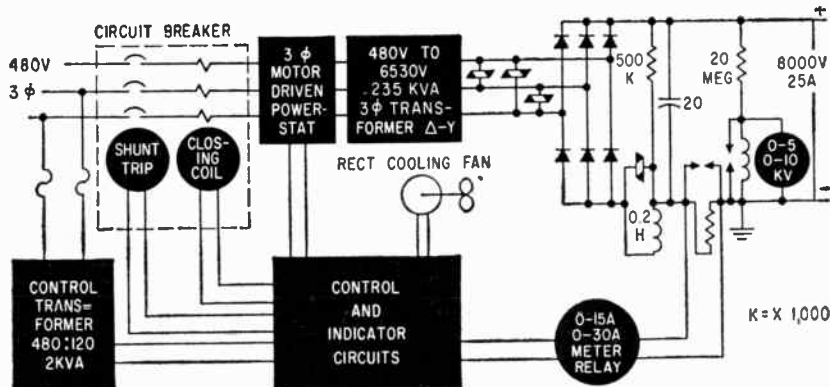

FIG. 5—Power supply uses 40 type 40S3P diodes in series in each of the six legs. Each diode is equalized with a 7,500-ohm resistor and a 1,000 μ F capacitor. The power transformer uses four series thyrite voristors for each phase



Back view of 8,000-volt, 25-amp power supply shows power transformer, thyristor assembly and filter

to less than 1.5 times the normal value and still give a safe design.

A simple transient suppression scheme is shown in Fig. 2. The suppressors can be varistors such as Thyrite, or spark gaps with series current-limiting resistors. Resistors should be selected to limit the spark gap current to about $\frac{1}{3}$ full load current. For example, a rectifier transformer with 2,000 v-rms and 6-amp rms output would require a 1,000-ohm resistor in series with the spark gap.

A varistor should present a similar load to the transformer during the period of the peak voltage of the transient. Typically, the transient would be about twice normal peak voltage. The varistor will represent a load only while the transient is present.

A spark gap, once broken down, will conduct for the remainder of the $\frac{1}{2}$ cycle. But the arc will extinguish on the next $\frac{1}{2}$ cycle if the current drawn by the arc goes through zero at the same time the voltage across the gap and resistor goes through zero. Spark gaps are usually more economical than varistors for power supplies with output voltages above 1,000 volts. They must be adjusted to a wider tolerance, however, if they are to operate satisfactorily at different atmospheric pressures and temperatures.

The resistors used with the spark gaps and the varistors must be able to sustain the heat generated in them. The discharge capacity of typical ceramic wire wound resistors in watt-seconds is about 25 times their wattage rating. That is, a 100-watt resistor will have a discharge capacity of about 2,500 watt-seconds at 30 C for a period of 0.1 second or less.

Most higher current power supplies use a choke input filter. This inductor must have a suppressor to keep rapid changes of load current from developing seriously high voltages across the rectifier. Varistors work well and at the low ripple voltage normally across the inductor, little shunting is caused by the parallel varistor; however, high voltage transients are immediately short circuited.

Diode Connections

The voltage division occurring down a long string of diodes should be fairly even so that the peak-inverse-voltage rating of an individual diode will not be exceeded. This can be accomplished by a parallel resistor and capacitor across each diode as shown in Fig. 3.

The shunt resistors help to divide the reverse voltage properly even though the back resistances of the diodes at a given current may vary widely.

In a power supply using hundreds of diodes, it is practical to select units with similar back resistances for use in series strings. In a three-phase full-wave rectifier the variation of back resistance in each leg can be reduced considerably.

The parallel capacitors act to equalize transients. A value of 1,000 μF is satisfactory in supplies rated from 1 to 25 amp.

Design of the cooling system requires that the power loss of the diodes be known. If the diode manufacturer does not supply this datum it can be calculated from diode characteristics. A diode with a sharp knee in the reverse current region will have about 98 percent of its power loss in the forward direction. But silicon diodes with a soft knee in the reverse direction will have 25 percent of their total power loss in this region. This difference should not be overlooked in making calculations and in using nomograms.¹

The allowable thermal resistance of the heat sink then, in degrees C per watt, is $(T_M - T_A)/W_T$ where T_M is diode operating temperature, T_A is maximum ambient air temperature and W_T is the power loss in the diode.

Figure 4 shows the thermal resistance of several $\frac{1}{8}$ in. aluminum plates. Increasing the thickness to $\frac{1}{4}$ in. lowers the resistance about 25 percent. Plates $\frac{1}{2}$ in. thick will have only about 50 percent as much resistance. Forced air cooling is generally the most reliable and economical method.

Figure 5 is a block diagram of a power supply with an output of 8,000 volts and 25 amperes. The photographs show some of the construction details of this unit.

REFERENCES

- (1) J. S. Gillette and W. B. Mitchell, *Electronic Design*, p 38, July 23, 1958.

BIBLIOGRAPHY

- Federal Telephone and Radio Corp., "Reference Data for Radio Engineers," American Book—Knickerbocker Press, Inc., 3rd Edition, p 547.
 B. C. Biega and H. W. Lord, "Transient Voltages in Rectifier Transformers," *AIEE Paper No. 59-149*.
 R. Lee, "Electronic Transformers and Circuits," John Wiley and Sons, Inc., New York, N. Y., 1955.
 F. W. Gutzwiller, *Electronic Design*, p 32, July 23, 1958.
 J. R. Baum, *Electronic Design*, p 56, July 10, 1959.
 W. Luft, "Taking the Heat off Semiconductor Devices," *ELECTRONICS*, p 53, June 12, 1959.

NATVAR



ISOLASTANE[®] TUBING and TAPE



**RESILIENT,
ELASTIC**

— for sharp bends
and irregular
surfaces



**HEAT
RESISTANT**

—for continuous perform-
ance at temperatures up
to 155°C

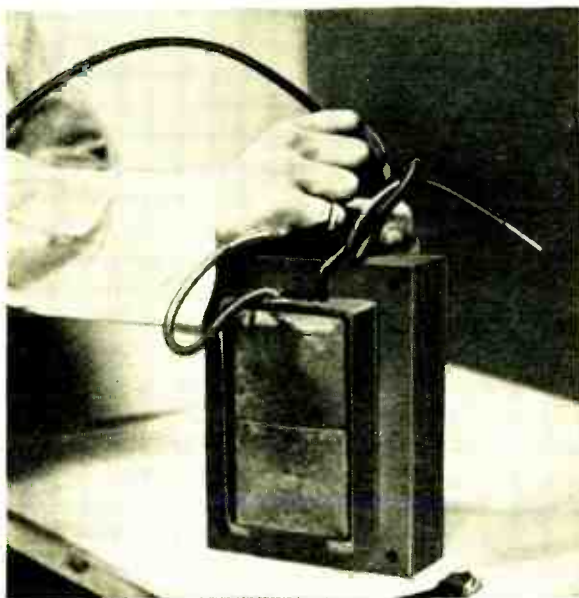

*ISOLASTANE is Natvar's new elastomeric isocyanate type coating for Fiberglas braid and tape. Reg. U.S. Pat. Off.

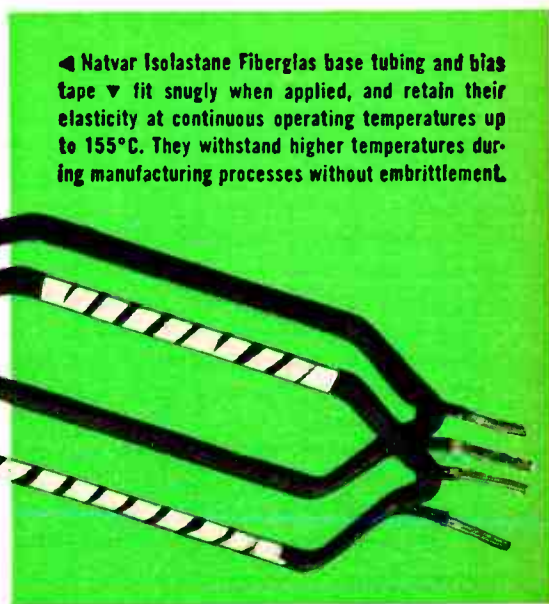

◀ Natvar Isolastane Fiberglas base tubing and bias tape ▼ fit snugly when applied, and retain their elasticity at continuous operating temperatures up to 155°C. They withstand higher temperatures during manufacturing processes without embrittlement.



Natvar Products

- Varnished cambric—sheet and tape
- Varnished canvas and duck—sheet and tape
- Varnished silk and special rayon—sheet and tape
- Varnished papers—rope and kraft—sheet and tape
- Varnished, silicone varnished and silicone rubber coated Fiberglas*—sheet and tape
- Slot cell combinations, Aboglas[®]
- Isoglas[®] sheet and tape
- Isolastane[®] sheet, tape, tubing and sleeving
- Vinyl coated and silicone rubber coated Fiberglas tubing and sleeving
- Extruded vinyl tubing and tape
- Styroflex[®] flexible polystyrene tape
- Extruded identification markers

*T.M. (Reg. U.S. Pat. Off.) OCF Corp.

We will be very happy to supply information on any of our products on request.

Natvar Isolastane is now making important savings possible. It makes it unnecessary to use expensive Class H materials to solve temperature problems during the manufacture of products which do not require Class H rating.

Isolastane is outstanding in its

- ELASTICITY (EXTENSIBILITY)
- RESISTANCE TO HEAT
- RESISTANCE TO CRAZING AND CRACKING
- RESISTANCE TO SOLVENTS, INCLUDING THE ASKARELS
- TOUGHNESS AND ABRASION RESISTANCE
- WET DIELECTRIC STRENGTH
- LOW TEMPERATURE FLEXIBILITY
- FUNGISTATIC QUALITIES

Full technical data and samples are available on request.

NATVAR CORPORATION

FORMERLY THE NATIONAL VARNISHED PRODUCTS CORPORATION
TELEPHONE
FULTON 8-8800
CABLE ADDRESS
NATVAR: RAHWAY, N. J.

201 RANDOLPH AVENUE • WOODBRIDGE, NEW JERSEY

Determining Isolator Standing-Wave Ratio

Nomograph determines vswr produced by isolating attenuator or isolating attenuation required to produce a particular load vswr

By J. D. ALBRIGHT, Air Arm Division, Westinghouse Electric Corp., Baltimore, Md.

WHEN WORKING with transmission lines it is frequently desirable to know the voltage standing-wave ratio which will be produced by a given isolating attenuator, or it is necessary to know what isolating attenuation is required to produce a particular load vswr.

Table I has been plotted to show the generator or isolated vswr produced by a particular attenuator and load. Considering a unilateral attenuator such as a ferrite isolator, the standing wave ratio seen by the generator depends upon the reflected power leaked by the isolator as shown in the insert of Table I. This in turn depends on the reverse attenuation of the isolator and the standing wave ratio which must be reduced.

For values of isolator attenuation greater than 35 db, the S_g curves may be considered as straight lines and extrapolated as far as desired.

The curve calculations were made with the assumption that the isolator itself has a zero reflection coefficient. Such is not the case with any physical device. A small residual vswr may have to be considered in cases where it approaches small values of S_g . The assumption has been made that the isolator has zero forward attenuation. This is not the true physical case. However, the small fraction of a db of for-

ward attenuation normally present in a ferrite isolator can generally be ignored. Forward attenuation which cannot be

ignored is simply added to the reverse attenuation in db in determining the generator vswr from the table.

Table I—Effect of Matched Attenuator on Generator VSWR for Various Load VSWR

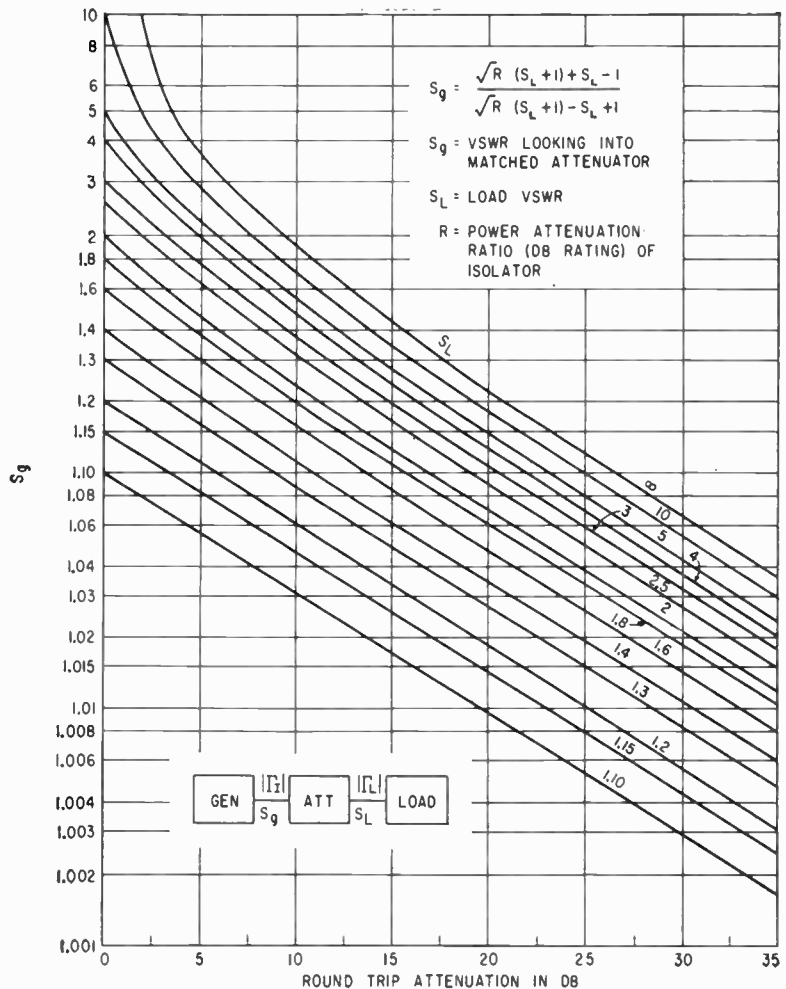

ALLIED CONTROL'S

NEW LINE OF

Sub-Miniature

Telephone Type Relays

Now being manufactured entirely in the U.S.A., not only in its original West German design previously sold in this country by Allied Control Company, Inc. under an agreement with Siemens & Halske Company A. G. Germany but with variations to meet American requirements as well.

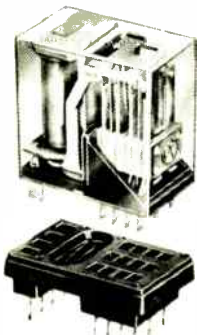

TYPE T154

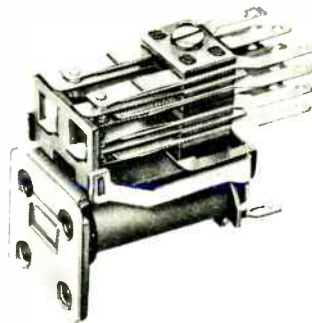

TYPE TA

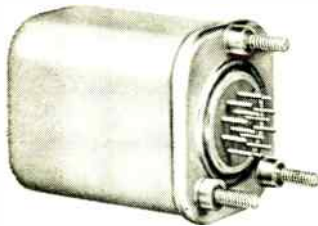

TYPE TAHG

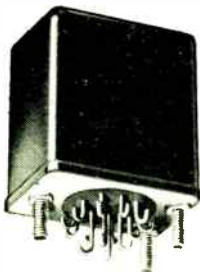

TYPE TAH

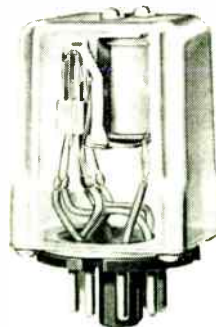

TYPE TADO

PERFORMANCE CHARACTERISTICS

Contact Arrangement

Up to 12 springs maximum form A, B or C

Contact Rating

2 amperes resistive or 1 ampere inductive at 29 volts d-c or 115 volts a-c

Low level or 5 ampere contacts available on request

Standard Coil Voltages

Suitable coil resistances can be supplied for operation at any voltage within the range of 0.5 to 130 volts d-c

Coil Power

Nominal: 700 milliwatts

Minimum Operate Power: 60 to 150 milliwatts depending on application, contact arrangement and coil resistance.

Timing at Nominal Voltage

Operate time: 7.5 milliseconds maximum

Release time: 3.5 milliseconds maximum

Vibration

10-55 cps at .062 inch double amplitude

55-500 cps at a constant 10g

Shock: 25g operational

Enclosure

Open, dust cover or hermetically sealed

Weight

Open type 1.0 ounce maximum

Sealed type 2.0 ounces maximum



ALLIED CONTROL



ALLIED CONTROL COMPANY, INC., 2 EAST END AVENUE, NEW YORK 21, NEW YORK

Highly Sensitive Electronic Chopper

By T. J. MARCUS, Westinghouse Electric Corp., Pittsburgh, Pa.

NONMECHANICAL chopper has been developed in which minimum detectable d-c signal is less than $20 \mu\text{v}$. Several methods are used in the Hall-generator type chopper to reduce field-switching transient duration.

The circuit in Fig. 1 may be divided into power supply, square-wave field driver, Hall generator circuit and amplifier. The chopper element is the Hall generator, and d-c signal voltage to be chopped is applied as control current. The magnetic field for the Hall generator is pulsed by the driver circuit feeding the coil of the core. The output is pulsating d-c voltage that is the product of the two inputs.

When low-level d-c is chopped, a correspondingly low Hall-generator output results. Voltage induced into the Hall generator leads by the changing field must be considered. This voltage can introduce serious errors in the chopped output.

The most effective means used to reduce this transient is a one-turn loop of wire at the air gap connected

to R_1 . This turn picks up the transient and applies it out of phase in series with one of the Hall generator output leads. The potentiometer adjusts for minimum transient voltage.

Transistor Amplifier

The transistor amplifier consists of two stages of class A gain. Capacitor C_1 across the collector resistor of Q_1 attenuates the transient about 20 percent while having negligible effect on the 60-cps signal fundamental. The 60-cps tuned circuit comprising T_1 and C_2 in the collector circuit of Q_2 further reduces the high-frequency transient. The tuned circuit also produces a sinusoidal waveform from the flattened signal fed to it. For convenience, output was measured across the tuned circuit. Another winding isolated from the rest can be used to supply output if desired.

Although 60-cps line voltage is used to produce the magnetic field input for the Hall generator, a properly designed circuit must be

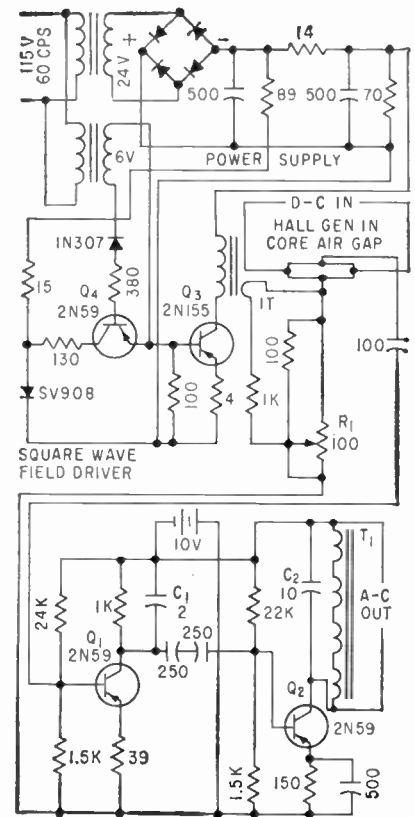
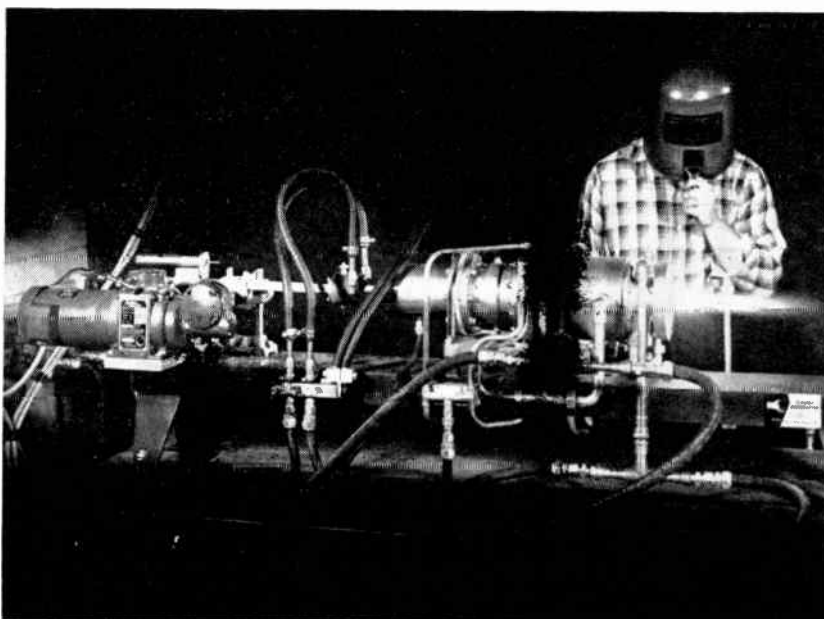

FIG. 1—Most effective means of reducing field switching transient is single loop in air gap that applies out-of-phase voltage to Hall generator lead

Plasma Generator for Heat Tests



Plasma generator by Avco's Research and Advanced Development division was delivered to NASA's Jet Propulsion Lab. Electric arc can produce temperatures of 18,000 F for nose cone tests

used between the line and field winding. The square-wave current driver characteristic prevents changes in collector current owing to line-voltage variation and also prevents changes in collector voltage caused by inductive reactance of the Hall generator magnetic circuit. Base bias of Q_3 is stabilized by an avalanche diode. Transistor Q_1 clamps the base of Q_3 to the stabilized bias point on every other half cycle.

Changes in collector voltage, particularly the voltage transient caused by inductive fly-back in the collector winding, have limited effect on collector current. The constant-current characteristic is obtained by shifting base voltage of Q_3 in relation to the fixed bias point. If supply voltage rises, base bias voltage is reduced, tending towards

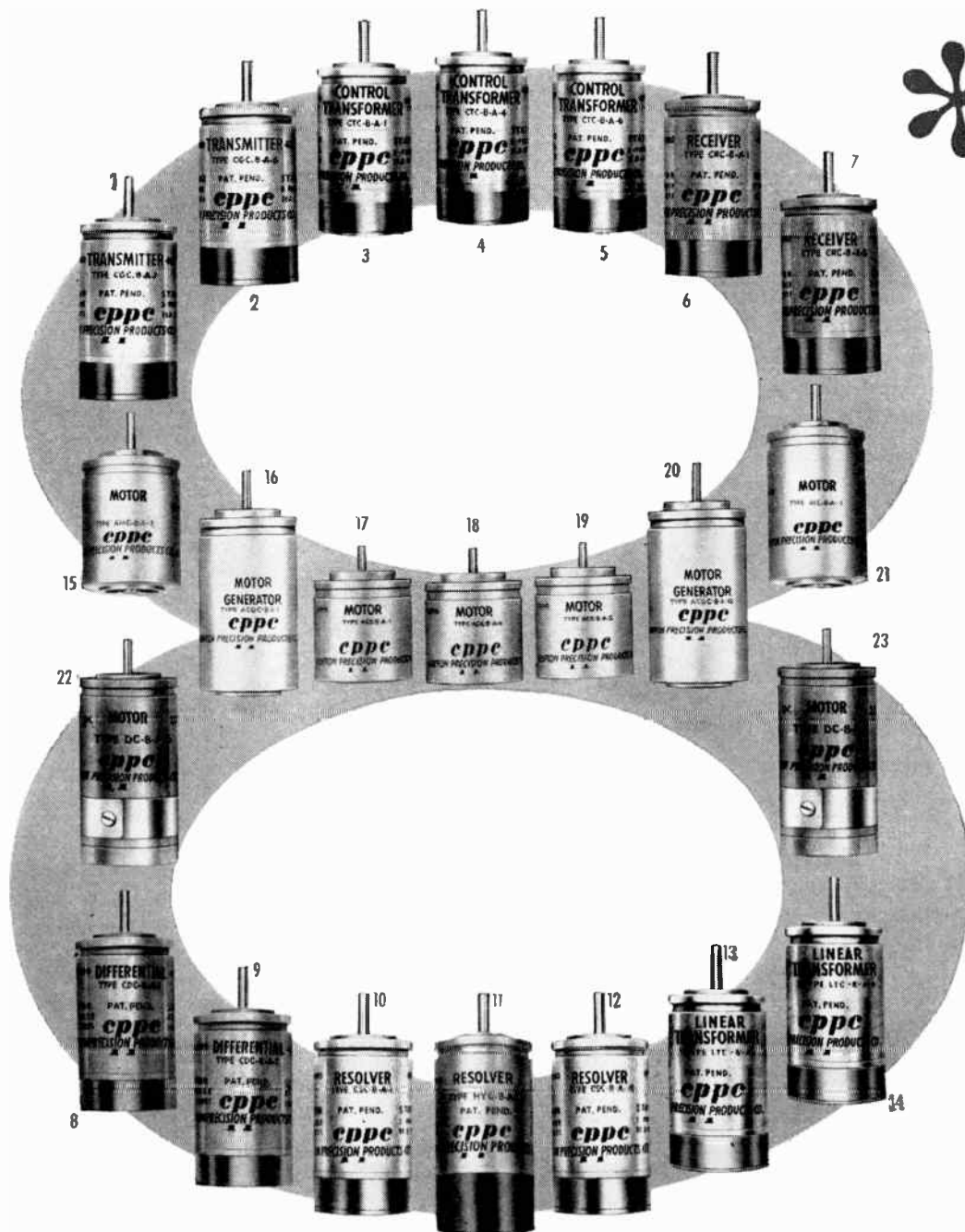

A PARTIAL SHOWING. OVER 60 DIFFERENT SIZE 8 ROTARY COMPONENTS AVAILABLE

Clifton Precision's size 8 rotary components have been tried and proven by customers over the past 4 years. More than 50,000 have been shipped. These are the most accurate and best tested (because they are use tested) size 8 rotary components on the market today.

1. Torque transmitter (26v. input) 2. Torque transmitter (115v. input) 3. Control transformer (lo Z) 4. Control transformer (hi Z) 5. Control transformer (very hi Z) 6. Torque receiver (26v. input) 7. Torque receiver (115v. input) 8. Torque differential (lo Z) 9. Torque differential (hi Z) 10. Electrical resolver (.5 t.r.) 11. Precision computing resolver (feedback winding) 12. Electrical resolver (1 t.r.) 13. Linear transformer (115v. input) 14. Linear transformer (26v. input) 15. Servo motor (1" length, .40 in-oz stall torque) 16. Motor generator (10v. input) 17. Servo motor (53/64" long) 18. Servo motor (35v. center tap) 19. Servo motor (26v. center tap) 20. Motor generator (26v. input) 21. Servo motor (.30 in-oz stall torque) 22. D.C. motor (14v. input) 23. D.C. motor (28v. input)

ENGINEERS — Join the leader in the rotating components field. Write David D. Brown, Director of Personnel, Dept. H-10

CLIFTON PRECISION PRODUCTS CO., INC.

CLIFTON HEIGHTS

cppe
P. A.

Sales Office: 9014 W. Chester Pike, Upper Darby, Pa.—Hilltop 9-1200, TWX Flanders, Pa. 1122

COLD-PUNCH PRINTED CIRCUITS

...this profitable STRIPPIT way!

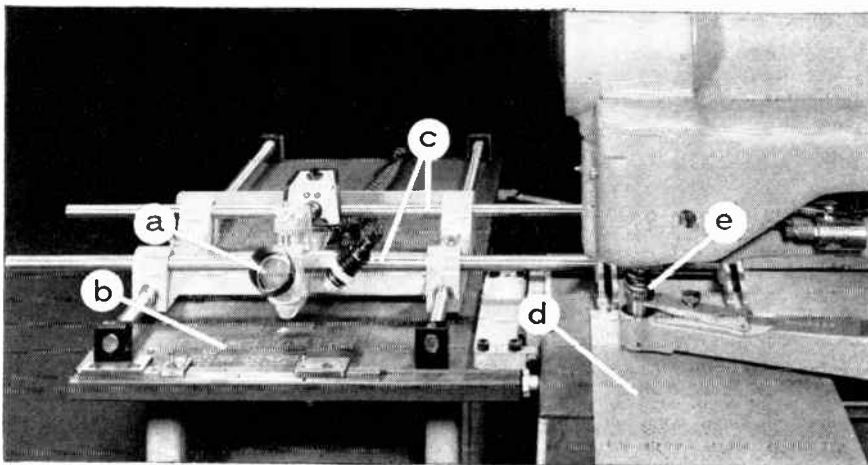

- 1. PUNCH THE TEMPLATE.** The Strippit Dupl-O-Scope (a), precision 4-power optical locator is mounted on Strippit pantograph-like Duplicator. As the Dupl-O-Scope is "sighted-in" on drawing or sample (b), the Duplicator arms (c) position template blank (d) under Strippit Fabricator punch (e) to accurately locate and punch pilot holes in a fraction of conventional layout and template making time.

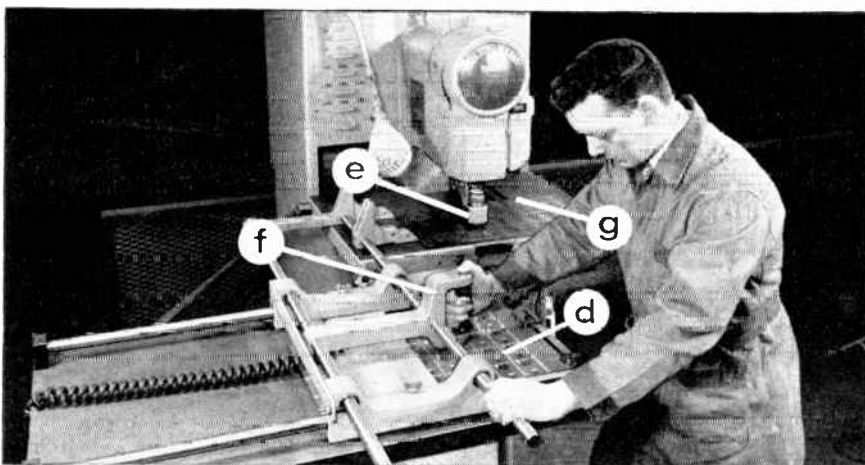

- 2. RAPID-FIRE DUPLICATION FROM TEMPLATE.** Duplicator with Stylus (f) replaces Dupl-O-Scope. As Stylus enters each pilot hole in template (d), it automatically positions work (g) under the punch (e) and trips the punch to produce a hole of desired shape and size in the proper location. Tool changes in the Fabricator punch holder are made in seconds, and anyone can learn to operate the Duplicator in a few minutes. For small to medium runs, there is no easier, faster or more economical method of making clean, accurate perforations in laminates or in chassis up to 1/4" mild steel.

WRITE FOR DEMONSTRATION AT YOUR PLANT! At no obligation, a Strippit Mobile Unit will demonstrate the cost-cutting Strippit Fabricator, Duplicator and Dupl-O-Scope. Write today!

WALES STRIPPIT INC.

225 Buell Road • Akron, New York

In Canada: Strippit Tool & Machine Company, Brampton, Ontario



constant emitter current.

The signal source for keying the magnetic field is taken from a 6-volt isolated winding. Because only half wave is necessary, a diode is placed in series with the 6-volt winding and the base of Q_1 . The 6-volt winding supplies a sinusoidal waveform, but saturation of Q_1 develops the necessary square wave. Hence the base of Q_1 is driven by a square wave. Both transistors are operated class B and are cutoff during one half of the 60-cps wave and are fully conducting during the alternate half.

Accuracy

Error in input d-c versus output a-c is ± 2.5 percent when temperature is varied between -20 and 50 C. The unit is relatively immune to stray 60-cps pickup from the input leads. This test was made at zero d-c input with an iron-constantin thermocouple attached. No shielding of the thermocouple leads was required over the limited length used.

Examination of the square-wave magnetic field showed a faster rise and fall time than any other driver methods could produce. Because the Hall generator magnetic coil is largely inductive, time constant LR prevents instantaneous change of current and magnetic field.

Chopping frequencies other than 60 cps can be used to suit external conditions. The 60-cps frequency is the worst from the standpoint of stray pickup. However, it is readily available.

The chopper can easily be applied as a d-c, a-c or r-f microammeter having a shunt resistance of a fraction of an ohm. Current to be measured is passed through a thermocouple junction. D-c voltage from the thermocouple is applied to the chopper amplifier. Output of the amplifier will then be a function of input current.

CRT Scales Are Parallax Free

INEXPENSIVE method for applying black scale patterns on the inside face of a crt is reported by Allen B. Du Mont Labs. Prototypes have

been made, and the company states that it is feasible to apply the process to production quantities of tubes for particular applications.

A template scale external to the crt screen often causes parallax where precise readout position is required. In such cases, it is desirable to have the scale in substantially the same plane as the phosphor screen.

Pigment for use within the crt envelope must be inert to the action of the electron beam, available, economical and nontoxic. It must lend itself to a convenient method of application.



Interference with precise readout position on crt from parallax is eliminated by applying scale to inside face of tube

The substance used is a special glass milled to a very small particle size and subsequently reduced in hydrogen. This produces a black glass powder that is further refined to disintegrate agglomerates. Blending of powdered clear glass and reduced glass gives a mixture that appears nearly black and offers high contrast. At the same time, it is sufficiently transparent so that when incorporated into a photosensitive binder, it may be photoprinted into the desired scale or pattern onto the inside tube face.

Alternatively, to produce a jet black pattern, the special powdered glass is printed in its white form, without blending, and then subjected to the reducing action of hydrogen within the crt envelope.

After image development, the phosphor may be deposited over the black glass pattern in a conventional manner, and all binders are removed during the normal bakeout of the tube in subsequent processing.

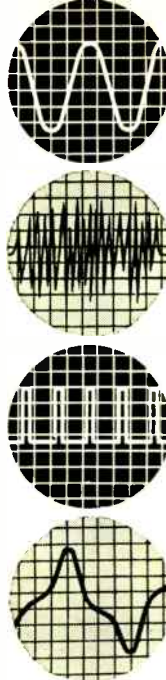

measures
from

100 MICROVOLTS to 320 VOLTS

regardless
of
waveform

TRUE RMS

frequency range 5 to 500,000 cps

FEATURES

Built-in calibrator . . . easy-to-read 5 inch log meter . . . immunity to severe overload . . . useful auxiliary functions

SPECIFICATIONS

VOLTAGE RANGE: 100 microvolts to 320 volts

DECIBEL RANGE: -80 dbv to +50 dbv

FREQUENCY RANGE: 5 to 500,000 cycles per second

ACCURACY: 3% from 15 cps to 150KC; 5% elsewhere. Figures apply to all meter readings

MAXIMUM CREST FACTORS: 5 at full scale; 15 at bottom scale

CALIBRATOR STABILITY: 0.5% for line variation 105-125 volts

INPUT IMPEDANCE: 10 MΩ and 25 μf, below 10 millivolts; 10 MΩ and 8 μf above 10 millivolts

POWER SUPPLY: 105-125 volts; 50-420 cps, 75 watt. Provision for 210-250 volt operation



BALLANTINE VOLTMETER Model 320

Manufacturers of precision Electronic Voltmeters, Voltage Calibrators, Capacitance Meters, DC-AC Inverters, Decade Amplifiers, and Accessories.

Price:
\$425.

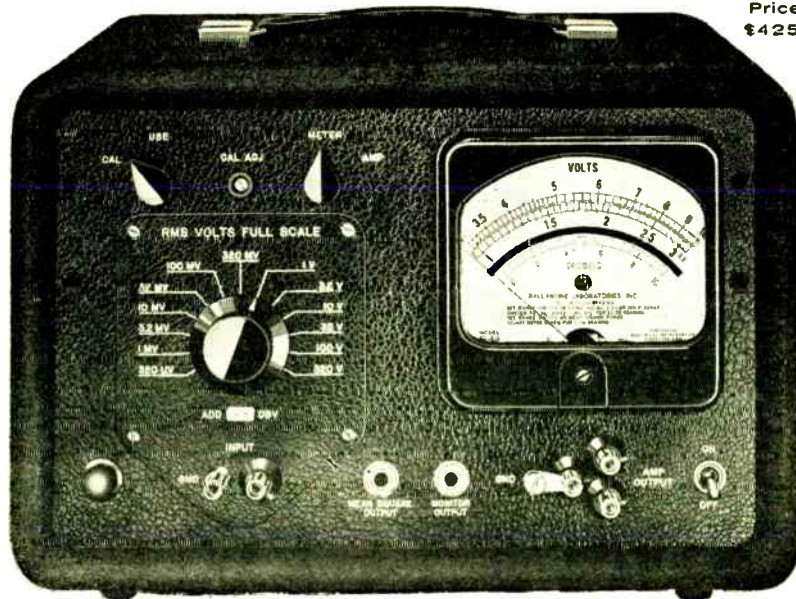

BALLANTINE LABORATORIES, INC. BOONTON, NEW JERSEY

Surfaces: Key to Semiconductor Progress?

BOSTON—RENAISSANCE of interest in semiconductor surfaces coincides with warnings that the physics and device technologies have been outpacing the metallurgy and chemistry of semiconductors.

"Five years ago, every large lab was working on surface studies,"

says Harry C. Gatos, associate head of Lincoln Lab's solid state division. Since then, declares Gatos, many advances in semiconductor technology have been made "more through witchcraft than science." He cites materials technology as the primary rate-determining factor

now in progress of the 11-year-old semiconductor field.

Intermetallics

Semiconductor materials and, in particular, elemental and intermetallic semiconductors have presented the metallurgist with a new challenge, according to Gatos. "In importance, it is comparable to that of high strength, high temperature materials for nuclear power and jet propulsion. It is contrasting in character, however. Semiconductor technology tolerates no safety engineering factors but demands single crystal perfection rather than strength, ultimate purity rather than massiveness . . ."

Two conferences this Fall reflect the revival of interest in surfaces. More than 400 metallurgists and allied researchers met in Boston for a symposium on Properties of Elemental and Compound Semiconductors, sponsored by the AIME. At the Columbus meeting of the Electrochemical Society, Oct. 18-22, a conference will be held on The Surface Chemistry of Metals.

At the Boston meeting, W. C. Dash of GE reported that use of a combination of etching, decoration, and X-ray techniques in studies of Si crystals is completely reliable for detection of dislocations greater than a few microns in length. Combination is reasonably accurate for Ge, but more difficult to apply. Dash said surface damage from mechanical operations, handling is easily removed by etching.

Surface Preparation

Pointing out that frequency response of transistors is limited by uniformity of base thickness and that improperly prepared surfaces contribute to junction irregularity, L. E. Miller of Bell Labs cited 5 factors affecting uniformity of junctions: surface roughness, surface erosion due to high vapor pressure of Si at diffusion temperature, surface alloying, localized differences in rate of diffusion, and improper masking techniques.

Gallium phosphide shows prom-

New 2,500 to 12,000-F Source

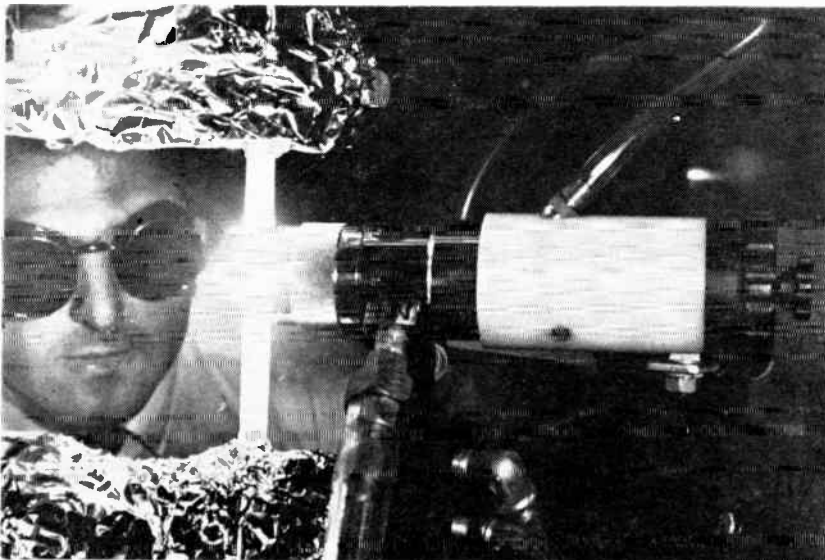

Scientist measures the temperature of the plasma jet flame by using an ultrasonic pulse system. Quartz probes extend into the plasma flame and transmit and receive sound pulses which are converted to temperature measurements

POWERED by a standard welding generator, an inexpensive high-temperature plasma jet, developed by Avco of Wilmington, Mass., may be used to flame-spray refractory oxides and ceramics onto other materials to greatly increase their refractory properties.

Basically, the unit is a high-intensity electric arc consisting of a water cooled tungsten cathode designed to reduce contamination to insignificance, and a copper anode. Weighing but 3½ pounds, the jet can be varied by changing nozzles which are available in 0.25 to 0.50-inch inside diameter.

The unit can also be equipped with a pistol grip handle to develop techniques for arc plasma flame cutting and other applications.

Especially suited to low-cost op-

eration, the unit operates from a standard welding generator, using a commercial bottled gas such as argon, nitrogen or helium and tap water for cooling. At a power level of five kw, it may be operated for an almost unlimited period.

In flame spraying, the material is fed as a powder into the flame, becomes liquid and is hurtled in fine, spherical droplets against the surface to be plated. Initial ceramic spraying experiments have shown that a slightly porous coating is deposited which improves the specimen's surface thermal insulating properties, and resistance to thermal shock. The plasma jet is also used for materials testing and spectroscopic studies.

The new arc is part of Avco's family of plasma generators.

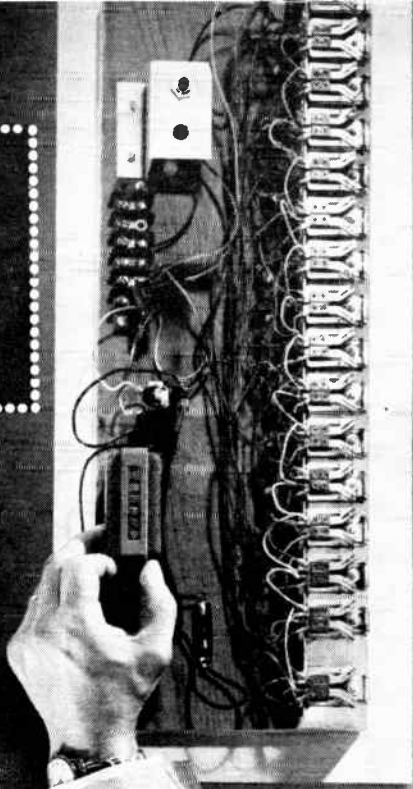
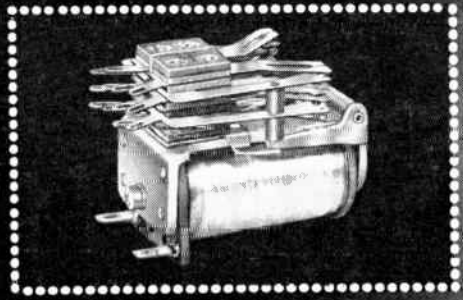

213,149,873
cycles

Test proves reliability of P&B's LS telephone type relay

These 16 LS relays, wired into a self-cycling chain, each operated 213,149,873 times before the test was discontinued. This test was made for a nationally prominent manufacturer and the certified results are available upon request.

Here is proof of the inherent reliability of P&B telephone type relays... and of the kind of performance you can expect when you specify them. LS relays are available with up to 20 springs (10 per stack) and are adaptable for printed circuit mounting.

Whenever multiple switching of loads up to 4 amperes is required, the LS can usually meet space, weight and—importantly—price considerations. Get full information today by calling or writing Zeke R. Smith, vice president, Engineering, or contact your nearest P&B representative.

LS ENGINEERING DATA

GENERAL:

- Breakdown Voltage:** 1,000 volts rms 60 cy. min. between all elements.
- Ambient Temperature:** -55° to $+85^{\circ}$ C.
- Weight:** 3 to 4 oz.
- Dimensions:** $1\frac{1}{2}$ " W. x $2\frac{3}{8}$ " L. x $1\frac{1}{2}$ " H. (4 Form C)
- Enclosures:** Sealed or dust cover (W can)
Sealed or dust cover, up to 6 Form C, single contacts (D can)
- Mountings:** Four #6-32 tapped holes $\frac{3}{4}$ " x $\frac{3}{16}$ " o.c. Other mountings available.

CONTACTS:

- Arrangements:** 20 springs (10 per stack) max.
- Material:** $\frac{1}{16}$ " dia. twin palladium. Other materials available for specific applications.
- Load:** 4 amps @ 115 volts 60 cy. resistive.

COIL:

- Resistance:** 55,000 ohms max.
- Power:** 65 mw DC per movable standard (50 mw possible); 3.5 watts max. at 25° C.
- Voltage:** Up to 200 volts DC.

TERMINALS:

- Contacts:** Three #18 AWG wires.
- Coil:** Three #20 AWG wires.
- Available with octal plug, taper tabs or printed circuit pins.

**P&B STANDARD RELAYS ARE AVAILABLE AT
YOUR LOCAL ELECTRONIC PARTS DISTRIBUTOR**



TS RELAY

Short coil relay is available in AC and DC versions. Long life construction. Can be supplied (DC) with up to 20 springs (10 per stack).



GS RELAY

Excellent sensitivity: 50 mw per movable arm minimum (DC). For applications requiring many switching elements in small space.



BS RELAY

Long coil provides high sensitivity (25 mw per movable arm) and room for slugs for pull-in delays (150 milliseconds max.) or drop-out delays (600 milliseconds max.).

FREE

LS DETERMINATION DATA

Send today for booklet containing certified results of recent test described above. Data includes test circuit, interim and final measurements.

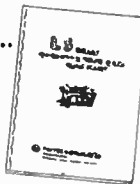

POTTER & BRUMFIELD

DIVISION OF AMERICAN MACHINE & FOUNDRY COMPANY, PRINCETON, INDIANA

IN CANADA: POTTER & BRUMFIELD CANADA LTD., GUELPH, ONTARIO

World Radio History

Walks, Hops and Runs On Pulses

... IN 18° JERKS, UP TO 300 JERKS A SECOND

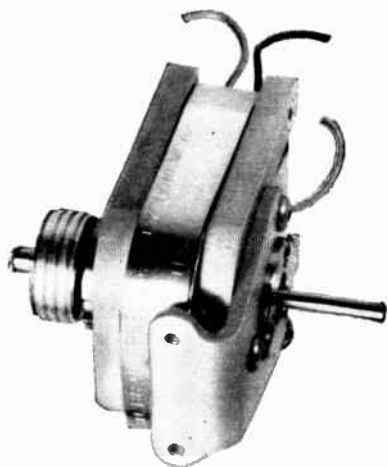

The Cyclonome®

(a stepping motor):

- a device with wires going in and a shaft sticking out.
- looks like a primitive electric motor.
- ratchets magnetically. Has only one moving part, supported by ball bearings.
- runs by alternating magnetic field (variously produced by juice in the wires) in even, powerful jerks, 20 per revolution.
- if hooked up right, according to the dope in our new Bulletin, the number of 18° steps will forever be the same as the number of pulses sent down the wires.
- go by the rules, and you can produce analogs on precision pots or capacitors, find places on magnetic tape or numbers on coding discs, get high speed multi-throw switching, index movie film, or just count bits on drum counters at speeds not otherwise possible.

There are also other things you could do with this motor, we hope, and here is what you have to work with. The Cyclonome has 20 stable positions or 20 steps per revolution ... a max. torque of 80 gm-cm ... an inertia of 0.7 gm-cm² ... a max. pulse rate of 300 pps with pure inertia load of 1 gm-cm² or pure friction of 40 gm-cm. Circuit power requirements range from 1/8 to 40 watts depending on

speed and load. Physically, the motor measures about 1 3/8" x 2 1/2" x 1 3/4" high (except for the shaft) and weighs about 11 ounces.

If your curiosity has now been aroused, we'd be delighted to send you the new Bulletin and tell you whatever else we might know about applying the Cyclonome to your application.

At Canadian I. R. E. Booth 341
NEC-Chicago Booths 188-189

SIGMA INSTRUMENTS, INC.

62 Pearl St., So. Braintree 85, Mass.

ise of solving requirements for rectifiers, transistors at ambient temperatures of 400 C and perhaps higher, R. Davis of Westinghouse reported. Some rectifier characteristics taken at 500 C were presented, showing a rectification ratio of 10:1.

J. M. Axelrod and D. B. Wittry of Hughes told the conference that use of an Electron Probe Micro-analyzer in study of semiconductor alloys permits quantitative analysis of a few cubic microns of volume by means of X-ray emission spectra excited by a focused electron beam. Among applications: diffusion of zinc in gallium arsenide; diffusion of arsenic in Ge and in Ge regrown from solution in aluminum; determination of solubility of gallium in Ge; identification of phases formed during attachment of leads to Si transistors. Micro-analyzer reportedly gave precision comparable to less convenient methods of analysis, and a sensitivity of about about two parts in 10⁵.

Cold Cathode Trigger Diode

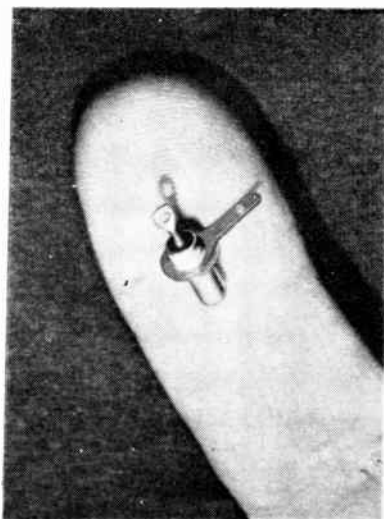

A KEY TUBE for certain missile and armament applications, this tiny cold cathode gas trigger tube has been in large-scale production under a sizable Ordnance contract. Developed by Victoreen Instruments of Cleveland, the diode has commercial possibilities as a voltage sensitive switch, simple timing circuit or R-C oscillator.

The device may be used for trig-

Get out your pencil and help yourself to electronics READER SERVICE

*it's free—it's easy—
it's for your convenience*

Use these handy READER SERVICE CARDS for more information on:

ADVERTISEMENTS—NEW PRODUCTS—
LITERATURE OF THE WEEK

1—Circle the number on the postpaid card below that corresponds to the number at the bottom of Advertisement, New Product item, or Literature of the Week selection.

2—Please print carefully, as it is impossible to process cards that are not readable.

A

FOR SPECIFIC ITEMS IN MULTI-PRODUCT ADVERTISEMENTS

For more information on specific items in multi-product advertisements, print carefully on the Reader Service Card below in Box "A" the circle number of the advertisement and the specific product(s) on which you desire more information.

**HOW TO SUBSCRIBE—
HOW TO RENEW YOUR SUBSCRIPTION
TO electronics**

If you are not a subscriber, or if your subscription is about to expire, to receive electronics regularly, fill in the section "FOR SUBSCRIPTIONS" on a card below. Send no money, electronics will bill you at the address indicated on the Reader Service Card.

Correct amount of POSTAGE must be affixed for all FOREIGN MAILINGS

Correct amount of POSTAGE must be affixed for all FOREIGN MAILINGS

OCT 2 • 59

CARD EXPIRES
DEC 2 • 59

electronics • READER SERVICE CARD • Please Print Carefully

YOUR
NAME

POSITION

COMPANY

ADDRESS

CIRCLE THESE NUMBERS WHEN INTERESTED IN ALL ITEMS SHOWN IN ANY ADVERTISEMENT

1	2	3	4	5	6	7	8	9	10	11	12	13	14	15	16	17	18	19	20	21	22	23	24	25	26	27	28	29	30
31	32	33	34	35	36	37	38	39	40	41	42	43	44	45	46	47	48	49	50	51	52	53	54	55	56	57	58	59	60
61	62	63	64	65	66	67	68	69	70	71	72	73	74	75	76	77	78	79	80	81	82	83	84	85	86	87	88	89	90
91	92	93	94	95	96	97	98	99	100	101	102	103	104	105	106	107	108	109	110	111	112	113	114	115	116	117	118	119	120
121	122	123	124	125	126	127	128	129	130	131	132	133	134	135	136	137	138	139	140	141	142	143	144	145	146	147	148	149	150
151	152	153	154	155	156	157	158	159	160	161	162	163	164	165	166	167	168	169	170	171	172	173	174	175	176	177	178	179	180
181	182	183	184	185	186	187	188	189	190	191	192	193	194	195	196	197	198	199	200	201	202	203	204	205	206	207	208	209	210
211	212	213	214	215	216	217	218	219	220	221	222	223	224	225	226	227	228	229	230	231	232	233	234	235	236	237	238	239	240
241	242	243	244	245	246	247	248	249	250	251	252	253	254	255	256	257	258	259	260	261	262	263	264	265	266	267	268	269	270
271	272	273	274	275	276	277	278	279	280	281	282	283	284	285	286	287	288	289	290	291	292	293	294	295	296	297	298	299	300

INSIDE FRONT COVER INSIDE BACK COVER

FOR SUBSCRIPTIONS:
(CHECK ONE BOX)

NEW RENEWAL

(CHECK ONE BOX BELOW)

DOMESTIC 1 yr. — \$ 6.00

3 yrs. — \$12.00

CANADA 1 yr. — \$10.00

FOREIGN 1 yr. — \$20.00

Product(s) manufactured:

or Service(s) Performed:

A

Circle No.	Product
_____	_____
_____	_____
_____	_____
_____	_____

Correct amount of POSTAGE must be affixed for all FOREIGN MAILINGS

OCT 2 • 59

CARD EXPIRES
DEC 2 • 59

electronics • READER SERVICE CARD • Please Print Carefully

YOUR
NAME

POSITION

COMPANY

ADDRESS

CIRCLE THESE NUMBERS WHEN INTERESTED IN ALL ITEMS SHOWN IN ANY ADVERTISEMENT

1	2	3	4	5	6	7	8	9	10	11	12	13	14	15	16	17	18	19	20	21	22	23	24	25	26	27	28	29	30
31	32	33	34	35	36	37	38	39	40	41	42	43	44	45	46	47	48	49	50	51	52	53	54	55	56	57	58	59	60
61	62	63	64	65	66	67	68	69	70	71	72	73	74	75	76	77	78	79	80	81	82	83	84	85	86	87	88	89	90
91	92	93	94	95	96	97	98	99	100	101	102	103	104	105	106	107	108	109	110	111	112	113	114	115	116	117	118	119	120
121	122	123	124	125	126	127	128	129	130	131	132	133	134	135	136	137	138	139	140	141	142	143	144	145	146	147	148	149	150
151	152	153	154	155	156	157	158	159	160	161	162	163	164	165	166	167	168	169	170	171	172	173	174	175	176	177	178	179	180
181	182	183	184	185	186	187	188	189	190	191	192	193	194	195	196	197	198	199	200	201	202	203	204	205	206	207	208	209	210
211	212	213	214	215	216	217	218	219	220	221	222	223	224	225	226	227	228	229	230	231	232	233	234	235	236	237	238	239	240
241	242	243	244	245	246	247	248	249	250	251	252	253	254	255	256	257	258	259	260	261	262	263	264	265	266	267	268	269	270
271	272	273	274	275	276	277	278	279	280	281	282	283	284	285	286	287	288	289	290	291	292	293	294	295	296	297	298	299	300

INSIDE FRONT COVER INSIDE BACK COVER

FOR SUBSCRIPTIONS:
(CHECK ONE BOX)

NEW RENEWAL

(CHECK ONE BOX BELOW)

DOMESTIC 1 yr. — \$ 6.00

3 yrs. — \$12.00

CANADA 1 yr. — \$10.00

FOREIGN 1 yr. — \$20.00

Product(s) manufactured:

or Service(s) Performed:

A

Circle No.	Product
_____	_____
_____	_____
_____	_____
_____	_____

ONE!

In every industry there's always ONE accepted Product and Data Buying Book...in electronics it's the BUYERS' GUIDE — fundamental in any sales program aimed at the electronics and allied industries. Its 52,000 paid subscribers are important Design-

Research/Production/Management Engineers, who, individually, or working in combination with one another, influence the purchase of products, materials and services... whatever is bought by the entire industry.



electronics 

A MCGRAW-HILL PUBLICATION

330 West 42nd Street • New York 36, N.Y.

BUSINESS REPLY MAIL

NO POSTAGE STAMP NECESSARY IF MAILED IN THE UNITED STATES

6¢ Postage Will Be Paid By

ELECTRONICS

Reader Service Dept.

330 West 42nd Street

New York 36, N. Y.

FIRST CLASS
PERMIT NO. 64
(SEC. 34.9 P.L.&R.)
NEW YORK, N. Y.



BUSINESS REPLY MAIL

NO POSTAGE STAMP NECESSARY IF MAILED IN THE UNITED STATES

6¢ Postage Will Be Paid By

ELECTRONICS

Reader Service Dept.

330 West 42nd Street

New York 36, N. Y.

FIRST CLASS
PERMIT NO. 64
(SEC. 34.9 P.L.&R.)
NEW YORK, N. Y.



gering electronic photoflash units and as a miniature voltage regulator. Tubes can be batch-produced, 2,000 at a time with gas fill and pressure easily varied to suit different applications.

The trigger diode consists of a cylindrical cathode, outer shell, and rod-type anode which is assembled and gas filled. A radioactive substance is placed in the tube to reduce firing time.

Firing Voltage

The diode is designed so that if any voltage less than the critical firing voltage is applied to the tube, the current flow (pulse) would be limited only by the external circuitry. Thus the diode can be triggered into conduction either at a certain point of a lowly increasing supply voltage, or by a low-energy pulse superimposed on a constant voltage less than the firing voltage of the diode. The tube withstands shock of 20,000 G, and vibration 5-55 cycles at 0.06 DA.

Controlled characteristics are exhibited in the forward direction only. Operation in reverse direction is undesirable.

Continuous operation above 5 ma will affect the life of the tube. Because the device is so small, heat dissipated in the tube will create very high internal temperatures, especially at high ambients.

Special Cables

AN AWARENESS of the need for specially engineered cables has moved the Times Wire and Cable Co., of Wallingford, Conn. to offer designers and manufacturers of data processing and transmission equipment a wide range of highly engineered cables on an off-the-shelf service basis.

The cables are to be marketed under the name Datacable and include types to meet all needs for critical data signaling: miniaturized low-capacitance cables, low-loss coaxial cables and several types of shielded twisted pair cables for use in systems requiring low-capacitance balanced lines. In addition, special-purpose multi-conductor cables are available.

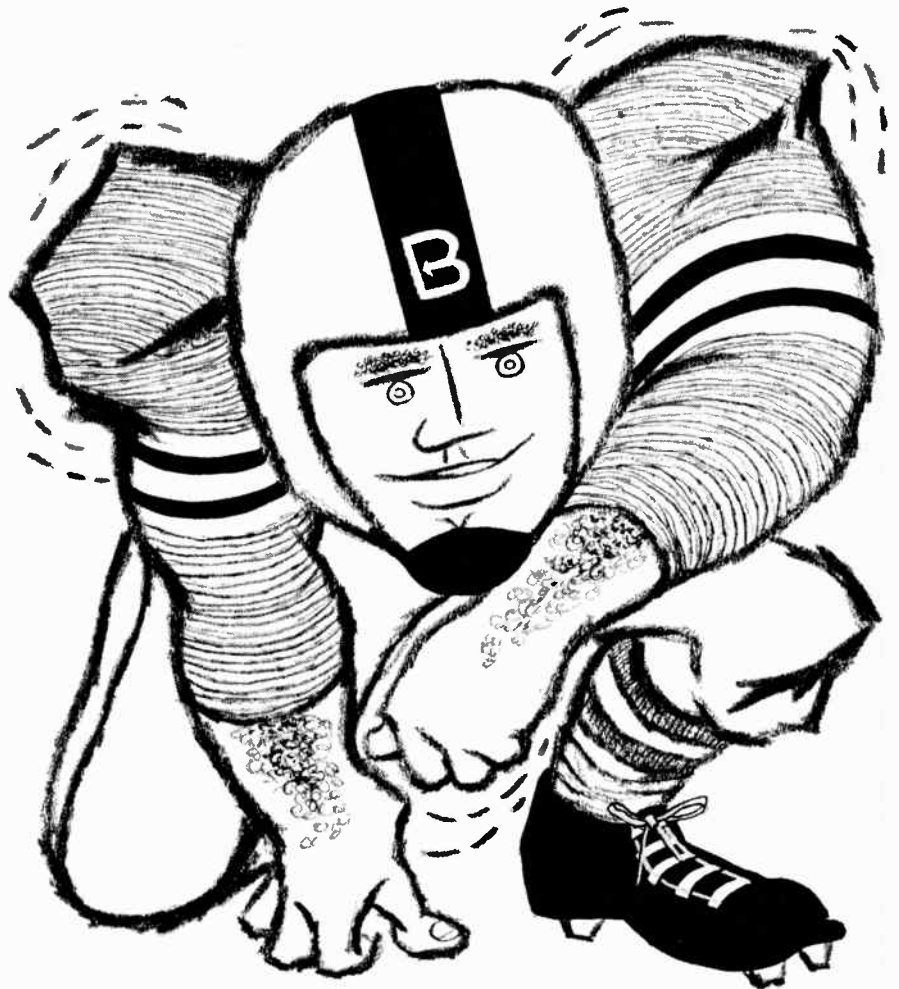

IMPEDANCE: 1,000 MEGOHMS

Nothing gets past the Bradley line

1000 megohms is a powerful lot of resistance for a 6 amp rectifier. That's the reverse impedance of the Bradley REDTOP® silicon diode, and it's 1000 times better than its nearest rival. But 1000 megohms is more than a rating—it's a symptom. You know how tricky it is to produce good semiconductor units. The fact that Bradley turns out stock rectifiers in volume with such ratings is a symptom of fastidious manufacturing practices. Leakage factors like 3 μ amps and switching times like 2 μ secs are results of meticulous material processing and precision assembly in sealed chambers. The extra safety margin in our superior ratings is comfortable to have at critical points in today's tight-tolerance circuits, especially since Bradley diodes cost no more (often less) than the others.



Send us your power specs. We will send you data on applicable diodes.

BRADLEY SEMICONDUCTOR CORPORATION

Formerly Bradley Laboratories Inc.



275 WELTON STREET, NEW HAVEN 11, CONNECTICUT

Acid-Peroxide Etch Safe, Sure

By D. E. KOONTZ, C. O. THOMAS, W. H. CRAFT and I. AMRON,
Bell Telephone Laboratories, Inc., Murray Hill, N. J. and Laureldale, Pa.

Etchant			Average Total Reduction in Thickness (mils)								
% H ₂ O ₂	% HCOOH	% H ₂ O	Copper	1010 Steel	Kovar	499 Ni	Mo	W	Ge	Si	Stnls Steel
80	10	10	0.6	<0.1 ^a	0.1 ^a	0.1 ^a	0.3	0.1	0.3 ^a	<0.1 ^a	<0.1 ^a
45	45	10	5.2	2.8	2.4	0.2 ^a	1	0.3	0.3 ^a	<0.1	<0.1
45	10	45	4.1	<0.1 ^a	0.2	<0.1 ^a	0.4 ^a	0.1	0.2 ^a	<0.1 ^a	<0.1 ^a
33	33	33	8	2.7	0.1	0.3	0.5	0.1	0.2 ^a	<0.1 ^a	<0.1 ^a
10	80	10	1.3	3.7	0.8	0.7	0.2 ^b	<0.1 ^a	0.1	<0.1 ^a	<0.1
10	45	45	2.5	2.3	2.4	1.3	0.2 ^b	0.1	0.1 ^a	<0.1 ^a	<0.1 ^a
10	10	80	2.6	0.1 ^a	0.3	0.2 ^a	0.2 ^b	<0.1 ^a	0.1 ^b	<0.1 ^a	<0.1

In each case, remaining hydrophobic contaminants were less than 1/10 of a monolayer, except: (a) less than approximately 1/10 to 1 monolayer and (b) greater than approximately 1/10 to 1 monolayer

FIG. 1—Thickness reduction and cleanliness of metals etched in hydrogen peroxide—formic acid solution for 2 minutes at 80 C

HYDROGEN PEROXIDE—formic acid—water etches have been developed to supplement the surface cleaning techniques used in production of ultraclean electron tubes. Unlike the majority of chemical etches, these formulations do not suffer from lack of control and reproducibility of chemical and mechanical conditions of etched surfaces.

Formic acid (HCOOH) reacts with many tube metals to form salts which decompose at low temperatures in a safe and controlled manner. The metallic oxides and volatile gases produced are soluble in water and easy to remove.

Scrubbing Action

Hydrogen peroxide decomposes in solution, liberating a gas which scrubs the surface being cleaned or etched. It also oxidizes many organic compounds so that they become water soluble. Its presence effectively increases the strength of the formic acid, influencing its etching characteristics by depolarizing the galvanic cell responsible for acid corrosion of metals. Finally, it increases the oxidation potential of the system, necessary for acid etching of metals below hydrogen in the electromotive series.

Initial investigations were made with various concentrations of formic acid (88 percent by volume solution), hydrogen peroxide (30 percent by volume solution) and

Metal	Experimental Condition					Average Thickness Reduction (Mils)	% Rejects
	% H ₂ O ₂	% HCOOH	% H ₂ O	Temp (°C)	Time (Min)		
Tungsten (Class 6)	33	33	33	65-70	4-5	0.1	5
	"	"	"	65-70	8-10	0.2	5
Molybdenum (Grade 6)	80	10	10	65-70	2-3	0.3-0.5	5
	"	"	"	Room	5-10	0.2	2
	"	"	"	75-80	1/2-3/4	0.2-0.5	10
499 Nickel	45	10	45	55-60	10	<0.1	10
	"	"	"	75-80	10	0.2	5
	"	"	"	65-70	10	0.1	2
	"	"	"	65-70	20	0.2	2
999 Nickel	45	45	10	65-70	10	0.1	5
	"	"	"	65-70	20	0.2	5

FIG. 2—Conditions for producing metal surfaces free of non-wetting contaminants and with uniform and controlled etching

water. Metal samples were etched for 2 minutes in an 80 C bath. The samples had been degreased, but all had at least 1 monolayer of hydrophobic surface contaminants. Results of the experiments are shown in Fig. 1.

Etchant Performance

Experimental conditions were subsequently optimized, with the results shown in Fig. 2. Concentration tolerances were ±10 percent of nominal. Thickness reductions were consistent within ±0.05 mil, the precision of the ball micrometer used for measurements. The major cause of rejects was failure to pass the most stringent tests

for hydrophobic contamination.

The following practical applications of the etchant have been made:

Descaling and cleaning Dumet leads without evidence of destruction or alteration of metal to glass seals. The stems are placed in an ultrasonically-agitated bath of 60 percent formic acid, 10 percent hydrogen peroxide and 30 percent water. The solution also cleans nickel stem extensions.

Removal of molybdenum mandrels from tungsten heater coils. The mandrel may be removed with no visual change in the coil, after 10 minutes at 65-70 C in a solution of 50-75 percent formic acid



Sometimes the best isn't good enough!

When survival could hinge upon the reliability of a single component it is essential that each component be the best available.

Sometimes the best isn't good enough. LFE discovered this in developing Moving Target Indicating Systems and Airborne Computer Systems for military applications. Delay lines of sufficient so-

phistication were not available to keep pace with the rising state of the electronics art. LFE solved this problem by setting up an advanced research group which led to the design and manufacture of a complete line of ultrasonic delay lines to meet the demands of modern technology. This solution is typical of the LFE approach of meeting new problems with new concepts . . . an approach that has contributed to LFE *Leadership from Experience*.

Leadership *f*rom **E**xperience

LABORATORY FOR ELECTRONICS, INC. 1079 COMMONWEALTH AVENUE • BOSTON

ENGINEERS — LFE offers outstanding employment opportunities in Navigation — Radar & Surveillance — and Computer Systems, and in Microwave Instruments and Components.



**"POWER WITH A PUNCH"
EG&G's 7322/1802 ceramic-metal
HYDROGEN THYRATRON**



BIG TUBE PERFORMANCE

in compact modulator circuit design for: End of Line Clipper • Switch • Crowbar

The EG&G 7322/1802 weighs 2.07 pounds, has a height of 5¼ inches and a diameter of 3¾ inches. It can be mounted in any position and is designed to operate at high power levels, high repetition rates and high temperatures.

It also features low cathode input power, low trigger drive requirements, fast warmup and low jitter. Rapid recovery allows operation at repetition rates above 50,000 pulses per second.

The 1802 has withstood 500g shock and 2000 cps vibration at 10g. Ceramic-metal construction permits envelope temperatures to 400° C, ambient temperatures to 125° C.

MIL-ACCEPTANCE TESTING:

Peak Anode Voltage (epy)	25KV	Peak Anode Current (ib)	1000 amps
Average Anode Current (Ib)	1.5 amps	RMS Current (Irms)	40 amps
Pb Factor (epy x ib x prr)	20 x 10 ⁹		

Individual ratings can be exceeded by derating other conditions. Thus the EG&G 1802 has been operated at 30KV anode voltage, or at 2000 amperes anode current, or at a Pb factor of 50 x 10⁹.

PRODUCTION QUANTITIES AVAILABLE



For additional technical data or other information, please write to:

EDGERTON, GERMESHAUSEN & GRIER, INC.

160 BROOKLINE AVENUE, BOSTON 15, MASS. • 1622 SOUTH "A" STREET, LAS VEGAS, NEV.

and 25-50 percent hydrogen peroxide.

Cleaning cathodes and removing copper weld splash after spotwelding Nilvar cathode tabs to nickel cathodes. Pieces are etched 10 minutes at 65-70 C in 80 percent hydrogen peroxide, 10 percent formic acid and 10 percent water.

For glass and ceramics and certain metals which form acidic oxides, cleaning may be improved by using aqueous ammonia in place of formic acid. The work is exposed to the boiling of 5 percent aqueous hydrogen peroxide whose pH is about 11 for 20-30 minutes.

In all applications, reagents must be rinsed from the etching vessel with overflowing water so that work pieces are withdrawn from the bath through a liquid surface free of hydrophobic or non-wetting contaminants. Otherwise, organic contaminants will collect on the surface and recontaminate the work.

(From a paper by the authors in "Symposium on Cleaning Electronic Device Components and Materials", American Society for Testing Materials, Philadelphia, 1959.

Punch Press Makes Ceramic PC Boards

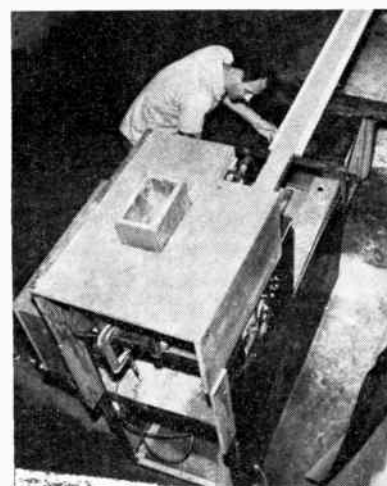

Overhead view of ceramic sheet rolling mill

CONTINUOUS PROCESS for thin sheet ceramic parts such as printed circuit boards is announced by Gladding, McBean & Co., Los Angeles, Calif. The process utilizes metal pierce and blanking techniques. Green ceramic is rolled into sheet which



Green ceramic sheet lies flat on conveyor

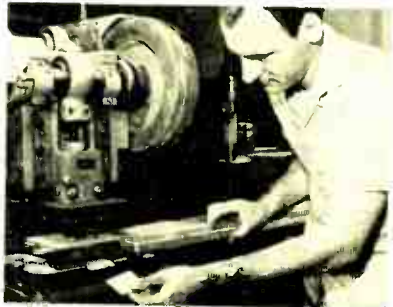

Punch press pierces and blanks part from sheet

is carried by conveyor to a punch press.

The process is being used on high alumina, porcelain and steatite and also applies to other oxides. Sheets in production range from 0.030 to 0.120 inch in thickness and up to 8 inches wide. Size is limited not by rolling equipment, but by present firing facilities.

After forming, sheets are sufficiently resilient for punch press piercing and blanking. Shapes formed are of uniform density with no soft and hard spots, the firm reports. Tooling costs are low if modular designs are followed with all component lead holes located on 1/10 inch centers.

Ferrite Memory Core Inspection Standard

RECOMMENDED methods of magnetic specification and inspection for ferrite cores used in coincident memory systems are covered in Standard 29-59, newly issued by the Metal Powder Industries Federation. It also defines pulse properties and suggests a test instrument setup. The standard, and 13 others covering magnetic cores and components are available at 50¢ each from the federation offices, 60 E. 42 St., New York 17, N. Y.

FIRST
it was
industrial
applications...

THEN
exacting
military
systems...

...and NOW
it's the
TV
MANUFACTURER
who sees the solution
to his problems...



The frame grid is the closest approach to the ideal "Physicist's grid"—electrical characteristics but no physical dimensions. It results in: • higher transconductance per milliamperere • tighter G_m and plate current tolerance • low transit time • low capacitances • lower microphonics • rugged construction



AMPEREX FRAME GRID

The grid-to-cathode spacing tolerance is determined by the carefully controlled diameter of grid support rods (centerless ground) and by frame crossbraces between these rods. Extremely fine grid wire eliminates the "island effect" usually encountered in conventional tubes with equally close grid-to-cathode spacing. Rigid support of fine wires reduces mechanical resonance and microphonics in the grid.

CONVENTIONAL GRID

Grid-to-cathode spacing tolerance depends on accuracy of grid dimension, obtained by stretching on a mandrel, and on tolerances of holes in top and bottom mica rod supports. Diameter of grid wire must be large enough to be self-supporting.



...in
Amperex
FRAME
GRID
TUBES

FOR TV TUNERS

- 6ES8
- 4ES8
- 6ER5
- 2ER5
- 6DJ8

FOR MILITARY REQUIREMENTS
AND
EXACTING INDUSTRIAL APPLICATIONS:

- 6688
- 6688A (MIL-E-1/1218)
- 6922
- 6922 (MIL-E-1/1168)
- 5847 (MIL-E-1/467)
- 5842 (MIL-E-1/466)

AVAILABLE FROM ALL
AMPEREX FRANCHISED DISTRIBUTORS

For additional data write to
Semiconductor and Special Tube Division
Amperex Electronic Corporation
230 Duffy Ave.,
Hicksville, Long Island, N. Y.
In Canada:
Rogers Electronic Tubes & Components,
116 Vanderhoof Avenue, Toronto 17, Ontario

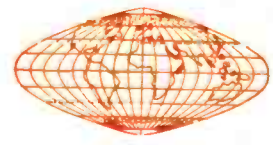

ask **Amperex**

about applications assistance on frame grid tubes for TV and FM tuners, and on reliable premium quality (PQ) tubes for industrial and military applications

On The Market



Environmental Plugs for MIL-C-5015D

CANNON ELECTRIC Co., P. O. Box 3765, Terminal Annex, Los Angeles 54, Calif. MS-R environmental resistant plugs use a moisture sealing grommet at the exit of the wires.

This grommet effectively seals each wire individually and also supports the cable. Advantages of the new plug are a 30 percent saving in plug length and a 25 percent saving in weight as compared with the older MS-E.

CIRCLE 200 ON READER SERVICE CARD

Germanium Transistor glass packaged

TEXAS INSTRUMENTS INC., P. O. Box 312, Dallas, Texas, announces commercial availability of ten types of industrial and six entertainment type *pn-p* glass header alloy junction germanium transistors. The high performance, general purpose units

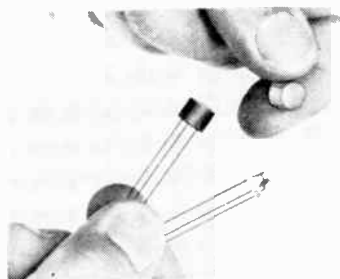

sell for as low as fifty cents. They are manufactured by an almost completely mechanized production process, the Continuous Automatic Testing (CAT) equipment. Company says each machine can test as many as 1800 transistors an hour without possibility of human error.

CIRCLE 201 ON READER SERVICE CARD

Converters analog-to-digital

ELECTRO INSTRUMENTS, INC., 3540 Aero Court, San Diego, Calif. The 7,000 series high-speed, all-transistorized analog-to-digital converters are capable of making up to

1,000 conversions per sec. They feature 0.01 percent sensitivity and resolution, automatic polarity, three or four digit in-line display and transistorized logic circuits. Voltage state BCD outputs are developed for data recorder entry.

CIRCLE 202 ON READER SERVICE CARD

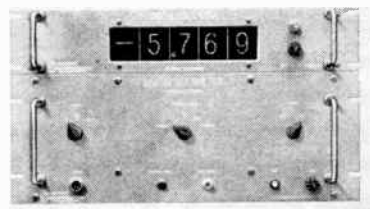

Delay Line miniature unit

CONTROL ELECTRONICS Co., INC., 10 Stepar Place, Huntington Station, L. I., N. Y. The V-397 variable delay line measures 3 in. in diameter and 1 in. in height. Ruggedly constructed and hermetically sealed, it

can be motor driven and has been life tested for over 10,000 hr. Contacts are rhodium plated for long life. Impedance is 1,000 ohms; rise time, less than 0.1 μ sec; delay time, 0 to 1.2 μ sec; attenuation, less than 1 db. Unit meets all applicable Mil Specs.

CIRCLE 203 ON READER SERVICE CARD

Thermostat three-phase

METALS & CONTROLS division of Texas Instruments Inc., 34 Forest St., Attleboro, Mass., announces the Klixon 2862 series of hermetically-sealed, three-phase precision



thermostats for wye-connected circuits. The thermostats, actuated by snap-acting, bimetal disks, are fixed temperature set within a -65 F to $+300$ F range. Switch action is three circuit, spst and can open or close on temperature rise.

CIRCLE 204 ON READER SERVICE CARD

Torque Transmitter hermetically sealed

HOFFMAN LABORATORIES DIVISION, 3740 S. Grand Ave., Los Angeles 7,

Calif. Hermetically sealed torque transmitter is designed to transmit rotary motion through a positive metal-to-metal seal by means of a flexible metal bellows. Electrical, mechanical and hydraulic con-



How to get 55% over-all efficiency in transistorized 6-watt servo amplifier

HIGH-EFFICIENCY SERVO CIRCUIT REQUIRES ...

- no output transformer
- no center-tap motor winding

Higher over-all efficiency than in a conventional Class-B push-pull amplifier is achieved in this servo by use of unfiltered rectified a-c for current supply voltage—with resulting reduction in size, weight and power supply requirements. This higher efficiency means greater transistor reliability, smaller heat sink and/or higher allowable ambient temperatures. Output will remain sinusoidal when amplifier is overdriven.

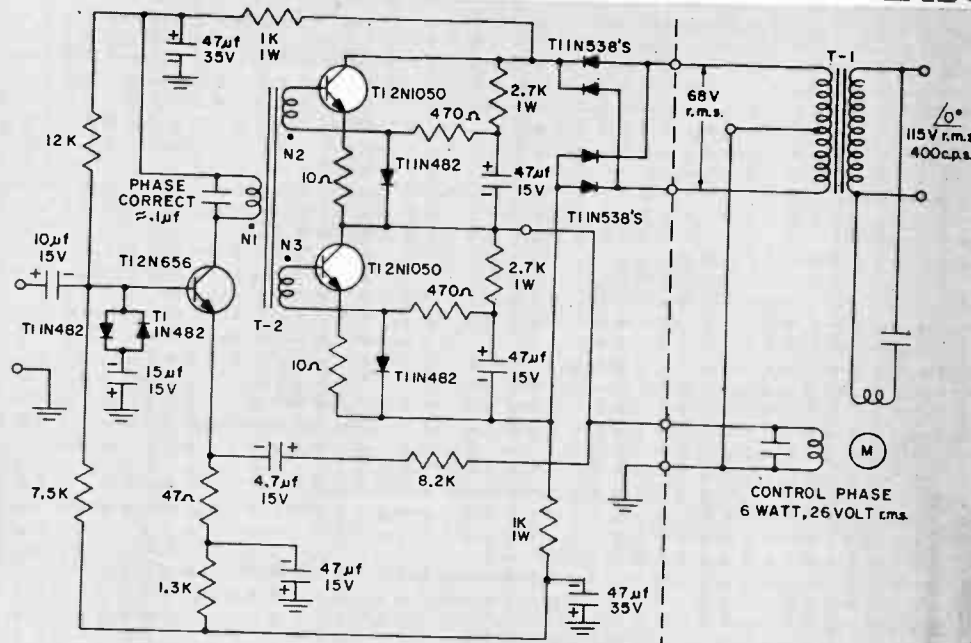
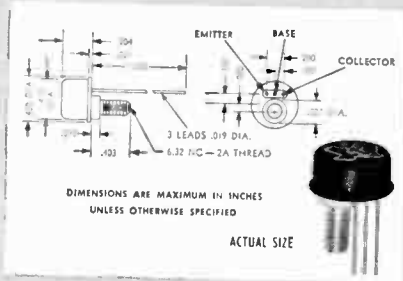

TRANSFORMERS

- T-1 400 cps. 12-watt power transformer step-down 115 volt to 68 volt a.c.
- T-2 400 cps. 65-mw driver transformer. Turns ratio N1 : N2 : N3 = 2 : 1 : 1
Primary Current = 10 ma d-c. Primary Inductance = 1.5 mh.

...with TI 2N1050 N-P-N silicon transistors!

Exclusive TI 2N1047 intermediate-power series now gives you maximum design flexibility plus high efficiency ... all in a miniature package!

Consider the design flexibility made possible by the exclusive features of this series ... 40 watts dissipation at 25°C case temperature ... unique stud mounting for maximum thermal efficiency ... 80- and 120-volt

BV_{CEX} ... 15-ohm R_{CS} ... -65°C to +200°C operating and storage range ... choice of beta spreads.

Apply TI's guaranteed specs to your design situations today. This use-proved series is available off-the-shelf — at factory prices — in 1-999 quantities from your nearby authorized TI distributor, and in production quantities from your TI sales office.



Write on your company letterhead for illustrated TI APPLICATION NOTES on the transistorized servo amplifier.

PARAMETER	TEST CONDITIONS	2N1047	2N1048	2N1049	2N1050	unit
		min. max.	min. max.	min. max.	min. max.	
BV_{CEX} Breakdown Voltage	$I_C = 250 \mu a$ $V_{BE} = -1.5V$	80	120	80	120	v
BV_{EBO} Breakdown Voltage	$I_E = 250 \mu a$ $I_C = 0$	10	10	10	10	v
I_{CBO} Collector Cutoff Current	$V_{CB} = 30V$ $I_E = 0$	15	15	15	15	μa
h_{FE} Current Transfer Ratio †	$V_{CE} = 10V$ $I_C = 200ma$	12 36	12 36	30 90	30 90	—
h_{IE} Input Impedance †	$V_{CE} = 10V$ $I_B = 8ma$	500	500	500	500	ohm
R_{CS} Saturation Resistance †	$I_C = 200 ma$ $I_B = 40ma$	15	15	15	15	ohm
V_{BE} Base Voltage †	$V_{CE} = 15V$ $I_C = 500ma$	10	10	10	10	v

†Semiautomatic testing is facilitated by using pulse techniques to measure these parameters. A 300-microsecond pulse (approximately 2% duty cycle) is utilized. Thus, the unit can be tested under maximum current conditions without a significant increase in junction temperature, even though no heat sink is used. The parameter values obtained in this manner are particularly pertinent for switching circuit design and, in general, indicate the true capabilities of the device.

- germanium and silicon transistors
- silicon diodes and rectifiers
- tanTiCap solid tantalum capacitors
- precision carbon film resistors
- sensistor silicon resistors

TEXAS



INSTRUMENTS INCORPORATED

SEMICONDUCTOR-COMPONENTS DIVISION
13500 N. CENTRAL EXPRESSWAY
POST OFFICE BOX 312 • DALLAS, TEXAS

CURTISS-WRIGHT CORPORATION

Offers Opportunities for Electronics Engineers

A continuing program of product expansion by Curtiss-Wright Corporation is creating the need for engineers and scientists. There are various career positions open to men with the right training, experience and talents . . . challenging projects, rewards and recognition.

ELECTRONICS DIVISION CARLSTADT, N. J.

Electronics Division has four plants, with headquarters at Carlstadt, N. J. Other plants and activities at Caldwell and E. Rutherford, N. J., and at Albuquerque, New Mexico. This division is engaged in the design, development and production of simulation systems for military aircraft, and for commercial jetliners. Additional major projects include simulated and operational radar equipment; anti-submarine sonar; photo reconnaissance trainers; electronic components; instruments; and real time digital computers. Current openings exist for digital computer engineers, radar engineers, sonar engineers, servo engineers, and instrument engineers.

RESEARCH DIVISION QUEHANNA, PA.

The Curtiss-Wright Research Division (40 miles northwest of State College, Pa.) is a major engineering center. Its work is closely coordinated with and supplements the projects at all other divisions. Engineers are needed at all levels for sonics and ultrasonics, circuit design, solid state applications, instrumentation, servos and controls, and communications.

Send resume, including salary requirements, to:

Mr. T. W. Cozine, Mgr.
Executive & Technical
Placement

Curtiss-Wright Corporation
Dept. G-44, Wood-Ridge, N. J.

All replies confidential

CURTISS-WRIGHT
CORPORATION • WOOD-RIDGE, N. J.

trols, instruments, explosion-proof switches, and other apparatus requiring adjustment or control without disturbing hermetic sealing, may be regulated from outside a sealed area by using the new unit. Weighing 0.87 oz. the transmitter is 2½ in. long and ¾ in. in diameter. Minimum life is 100,000 revolutions; operating temperature range, -57 C to 125 C.

CIRCLE 205 ON READER SERVICE CARD

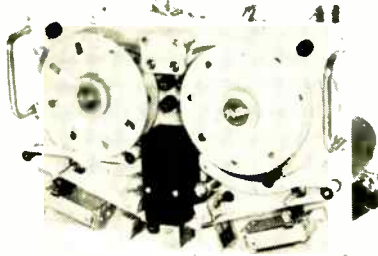

Programmer militarized

POTTER INSTRUMENT Co., INC., Sunnyside Blvd., Plainview, L. I., N. Y. Model 3277 perforated tape programmer for use in military check-out systems conforms to MIL-E-16400. It features bidirectional drive, character reading rates up to 200 per sec, tape widths up to 1 in. and self-contained electronics for control and data playback. Over 500 ft of sandwich mylar tape or 300 ft of paper tape can be accommodated by the self-contained 6 in. reels. Dimensions are 11 in high, 17 in. long, and 11 in. overall depth; approximate weight, 50 lb.

CIRCLE 206 ON READER SERVICE CARD



Capacitors computer-grade

GENERAL ELECTRIC Co., Schenectady 5, N. Y. Computer-grade Alumalytic capacitors with higher capacitance ratings have a new case size, 3 in. in diameter by 5½



Quick-Crimp

BNC connectors

AVAILABLE FROM

AUTHORIZED

AMPHENOL

DISTRIBUTORS

AT FACTORY PRICES

AMPHENOL

distributor division

AMPHENOL-BORG ELECTRONICS CORPORATION
Broadview, Illinois

**CUT RF
ASSEMBLY
TIME
IN
HALF!**



AMPHENOL

Quick-Crimp*

BNC CONNECTORS

Assembly-time savings of 50%, measurable increase in systems reliability—these are the clearcut advantages of AMPHENOL's new Quick-Crimp BNC connectors! Because there are only 3 basic parts plus an optional boot to assemble (compared with as many as 10 in a standard BNC) Quick-Crimps are prepared in half the usual time, even by inexperienced personnel! Because critical pre-assembly work has already been done the finished Quick-Crimp assembly is highly reliable. Let Quick-Crimps solve your RF assembly problems!

Available Now! Write for Complete Cataloging

AMPHENOL

CONNECTOR DIVISION 1830 S. 54th Ave., Chicago 50, Illinois
Amphenol-Borg Electronics Corporation

*U.S. Patent Pending

Where only the **best**
is good enough . . .



MODEL 330-M

Krohn-Hite filters are used

In basic electronic instruments for lab or test work, *less than the best* may be a dangerously bad bargain. Unexpected limitations — of range, reliability, precision — can throw out weeks of work on today's jobs, and can make tomorrow's tougher jobs untouchable.

The *best* instrument of its type is probably a bit more expensive, but it's worth buying . . . because you can believe in it today, and will rely on it tomorrow. An example is the Krohn-Hite Model 330-M tunable electronic band-pass filter, for critical low-frequency applications. Here are some facts about it.

FREQUENCY RANGE: continuous coverage from 0.2 cps to 20 kc, with independent control of high and low cut-off frequencies.

CUT-OFF FREQUENCY ACCURACY: plus or minus 5%.

INSERTION LOSS: zero db plus or minus 1 db in pass band.

ATTENUATION SLOPE: nominal 24 db per octave outside pass band, with peaking circuit to reduce corner-frequency loss.

MAXIMUM ATTENUATION: greater than 80 db.

INPUT IMPEDANCE: approximately 22 megohms plus 20 mmfd.

EXTERNAL LOAD IMPEDANCE: 500 ohms or greater.

HUM AND NOISE: less than 100 microvolts rms.

There's a lot more you should know about the 330-M . . . and about the other Krohn-Hite tunable electronic filters, oscillators, power supplies and amplifiers. In all of them, you'll find the same far-ahead engineering, design and construction. Because K-H instruments *are* good enough even for tomorrow's most critical work, they are increasingly chosen today where true reliability and precision are essential.



Write for your free copy of the new Krohn-Hite Catalog.

Krohn-Hite CORPORATION

580 Massachusetts Avenue, Cambridge 39, Mass.

in. high. Additions to existing line at all voltage ratings give μf values 23 to 275 percent higher than were available before. The 3-v unit in the new case size has a capacitance of 150,000 μf .

CIRCLE 207 ON READER SERVICE CARD

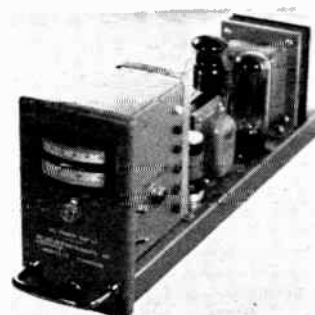

D-C Power Supplies highly regulated

PLUG-IN INSTRUMENTS, INC., 1416 Lebanon Road, Nashville, Tenn. Series of regulated power supplies, modules, for individual or multiple mounting in panels and relay racks. Tube or transistorized models are available in various output currents and voltages, all with line and load regulation better than 0.25 percent, ripple less than 5 mv-rms.

CIRCLE 208 ON READER SERVICE CARD

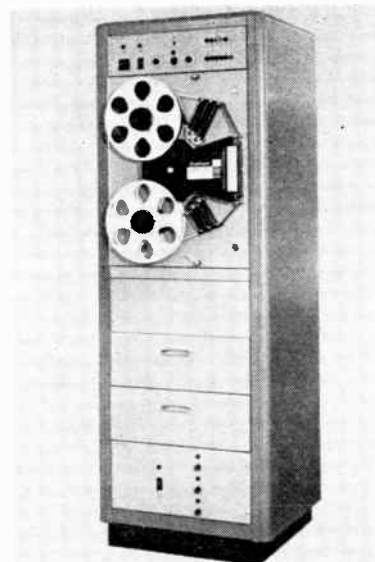

Recorder/Reproducer high-speed

CONSOLIDATED ELECTRODYNAMICS CORP., 300 N. Sierra Madre Blvd., Pasadena, Calif. Type 5-682 recorder/reproducer operates at speeds up to 150 ips. Start and stop

times are a maximum of 3 millisecc, with an accuracy of 0.05 in. Machine can record and reproduce up to 16 tracks in line. Tape widths are $\frac{1}{2}$, $\frac{3}{4}$, $\frac{1}{2}$ and 1 in. Flutter is less than 2 percent peak-to-peak at 10 ips.

CIRCLE 209 ON READER SERVICE CARD

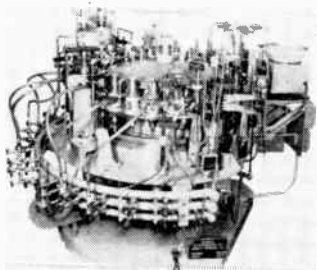

Button Stem Machine for miniature tubes

KAHLE ENGINEERING CO., Union City, N. J. Button stem machine No. 3017 is a 24-head unit designed to make up to 1,000 nontubulated and subminiature electronic tube stems per hr. Machine weighs 4,000 lb; is 5 ft 9 in. high and has a diameter of 5 ft 6 in.

CIRCLE 210 ON READER SERVICE CARD

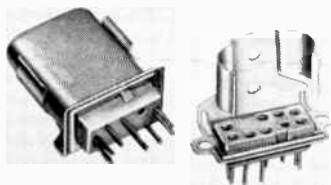

Relay Socket Assembly microminiature

AUGAT BROS., INC., 33 Perry Ave., Attleboro, Mass. Microminiature relay socket assembly for use with relays conforming to MIL-R-5757, features unit packaging of socket and holding clip. Holding clip available in beryllium copper alloy 25 or annealed carbon steel SAE1065, both cadmium plated. Assembly is also available with anti-rotate tab.

CIRCLE 211 ON READER SERVICE CARD

Rise Time Tester high precision

ATRONIC PRODUCTS, INC., One Bala Ave., Bala-Cynwyd, Pa. Model 305 is a complete instrument for meas-

the identical "guts"—but your choice of three cases—three prices with

CHICAGO "sealed-in-steel" TRANSFORMERS

Many of the transformers in the CHICAGO line are available in your choice of three mounting types. Like these three typical units, they are built to the identical electrical specifications and differ only in case, lead termination, and price.

The HERMETICALLY SEALED unit is designed and built in accordance with MIL-T-27A, Grade 4 specifications. It has a premium grade drawn steel case, and is stud mounted. The price of this power transformer (450V. center-tapped AC at 40 MaDC with two filament windings), Part No. PHC-40, is \$12.90.



The identical transformer in S-TYPE construction (Part No. PSC-40) has a steel base cover fitted with a phenolic terminal board. The solder lug terminals are conveniently numbered; unit is flange mounted. The price is \$8.85.

The same electrical performance is available in low-cost C-TYPE construction (Part No. PCC-40). Flange mounted unit has 10 color-coded leads brought out through a fibre board base cover. The price of this "economy model" is only \$5.10.

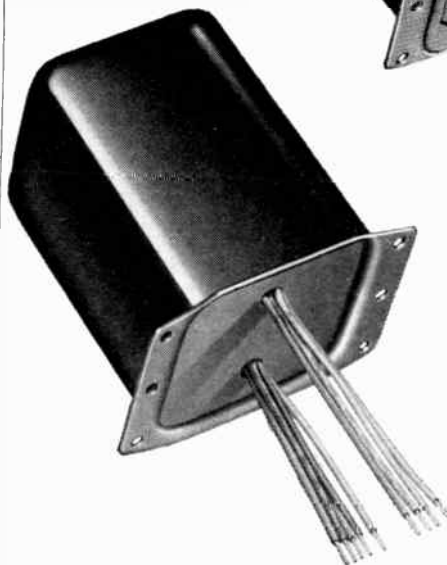

You get this choice only from Chicago Standard. Whether you're interested in meeting military requirements, appearance requirements, mounting requirements, or budget requirements—Chicago Standard can fill your needs. Write for the latest Chicago Standard catalogs for detailed listings of the industry's most complete transformer line.

CHICAGO STANDARD TRANSFORMER CORPORATION
3502 WEST ADDISON STREET • CHICAGO 18, ILLINOIS

atlee CLIPS GAIN IN HOLDING POWER

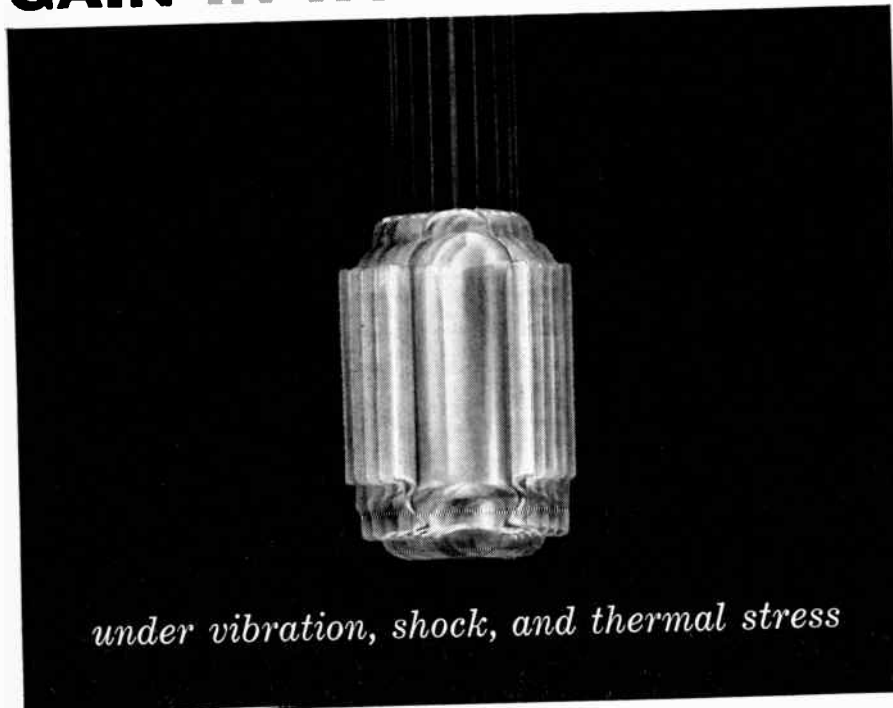

under vibration, shock, and thermal stress

TESTS PROVE IT . . . tests conducted independently by some of the nation's most critical users of component holders.*

the TESTS:

- vibration at 500 cps 90 G peak, and at 2,000 cps 65 G peak, for one minute
- 1,750 impact shocks at 200 G, perpendicular to and also along the axis of the holder
- 100 complete cycles of component insertion and withdrawal
- above tests repeated after 15 minutes exposure to temperature of 500°F.

the RESULTS:

- no visible shifting of the component in the holder
- no resonant frequencies developing under vibration
- temperature had no effect on dynamic holding power
- insertion-withdrawals had no effect on dynamic holding power
- force required to dislodge component increased during tests

the REASONS:

- severe vibration and shock cause the material of the holder to flex slightly, producing a closer "set" of the holder surfaces to the contours of the held component.

atlee component holders *start out* with a tighter-than-usual grip . . . because of proper contours, construction and materials. As environmental stresses increase, this holding power automatically increases to meet the greater demand . . . because the holders actually mold themselves to the components. Here is an equipment designer's dream come true: the greater the stress, the *greater* the security.

DESIGN FOR RELIABILITY WITH atlee — a complete line of superior heat-dissipating holders and shields of all types, plus the experience and skill to help you solve unusual problems of holding and cooling electronic components.

* Names on request.

ATLAS E-E

CORPORATION
47 PROSPECT STREET • WOBURN, MASS.

uring the switching time of *npn* and *pnp* transistors. It will measure with a high degree of precision the rise time or the fall time of high speed transistors in the 5 to 2,000 milliμsec range in 4 scales, and the testing procedure used allows the scale to be calibrated to correspond to a variety of switching time definitions. By sampling and averaging the amplitude of the switched pulse several milliμsec after the input test pulse, excellent correlation is obtained between this measured amplitude and precise crt measurements.

CIRCLE 212 ON READER SERVICE CARD

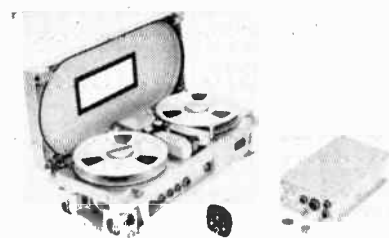

Airborne Recorder miniaturized

AMPEX CORP., Instrumentation Division, 934 Charter St., Redwood City, Calif. AR-200 magnetic tape recorder for airborne data acquisition uses solid-state components. A complete 7-track recording system of two units weighs 90½ lb, occupies 1.6 cu ft, operates up to 100,000 ft at temperatures from -54 to +95 C, withstands shocks of 15 g's. Tape-track configurations offered are up to 14 analog recording tracks, 32 digital tracks, or combination of 7 analog and 16 digital tracks on one 1-in. wide magnetic tape.

CIRCLE 213 ON READER SERVICE CARD

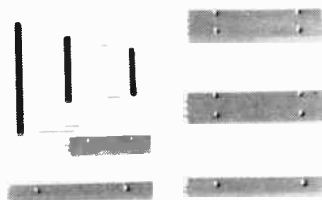

Delay Lines varied case styles

TECHNITROL ENGINEERING CO.,
1952 E. Allegheny Ave., Philadelphia 34, Pa. Series 25J distributed

constant delay lines in hermetically-sealed metal cans and epoxy encapsulated sticks for pig-tail mounting. Delay period is 0.6 μ sec per in. of winding. Maximum delay per 6 in. of winding stick is 30 μ sec. Several windings having the same or different delay time may be cascaded in standard metal cans to produce longer delay periods. Available impedances include 3,900, 5,600 or 7,500 ohms with rise times (per 3.0 μ sec delay) of 0.33, 0.48 and 0.53 μ sec respectively.

CIRCLE 214 ON READER SERVICE CARD



Recording System 6- or 8-channel

SANBORN Co., 175 Wyman St., Waltham 54, Mass. Model 358-5480 direct writing oscillographic recording system is for computer read-out, telemetry recording, d-c monitoring and the like. System linearity is 0.5 percent of full scale (max. chart width 50 divisions); sensitivity, 0.1 v/div; frequency response, 3 db down at 150 cps at 10 division peak-to-peak amplitude; hysteresis, less than ± 0.1 div and gain stability better than 1 percent.

CIRCLE 215 ON READER SERVICE CARD



Transducer System rugged package

ULTRADYNE INC., P. O. Box 3308, Albuquerque, N. M. Model PFS-4 pressure to frequency system com-

0.01%

absolute accuracy

only with EPSCO

REFERENCE VOLTAGE SOURCES



• 0.005% stability

• 1.0 Microvolt resolution down to zero volts

• ± 111.112 volts d-c range

VR-607 (illustrated) - portable, 5 decade switches plus vernier and divider.
VR-607B - portable, 12 binary-coded toggles plus vernier and divider.
VR-608 - rack-mounting, 3 decade switches plus vernier and divider, and front panel null meter.

• Out-perform any other voltage reference source on the market • contain highest quality components: certified standard cells, oil-immersed ultra-stable resistors, high-gain chopper-stabilized amplifiers • being used in the most demanding and critical applications across the country, such as at Convair Astronautics, North American Aviation, Argonne National Laboratory, Massachusetts Institute of Technology, Bell Telephone Laboratories, Goodyear Rubber, Patrick Air Force Base.

Want the full story? Write today for new technical brochure, covering circuit design details, specifications, operating instructions.

EpSCO



— First in data control

EpSCO, Incorporated, Equipment Division, 275 Massachusetts Ave., Cambridge, Mass.
In the West: EpSCO-West, 240 East Palms Rd., Anaheim, California

need high vacuum components?

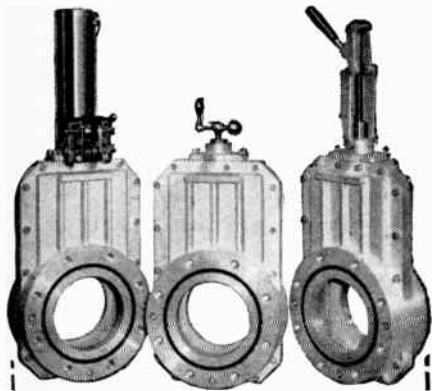

Stokes ST gate type high vacuum valves are available for manual or air operation. Straight through openings provide maximum conductance. Small installation space required... can be mounted in any position. Flanges are standard ASA dimensions. Each valve is helium leak tested with mass spectrometer. Manual and air operated types in 2-, 3-, 4-, and 6-inch sizes—air operated only in 8-inch sizes and over.

STOKES makes a complete line of vacuum components... advance-designed and engineered to help make your vacuum systems more productive. Each unit reflects Stokes' unparalleled experience, pioneering leadership and wealth of basic vacuum technology.

The product list includes: Diffusion Pumps, Vapor Booster Pumps, Mechanical Pumps, Mechanical Booster Pumps, Vacuum Gages, and Valves.

Send for data.

High Vacuum Division
F. J. STOKES CORP.
5563 Tabor Road, Phila. 20, Pa.

STOKES

bins a reactance-controlled subcarrier oscillator and a single-coil variable reluctance type pressure transducer, for measurement of a wide range of absolute, gage, or differential pressures. It is stable over a wide range of temperatures, operates at any one of a large number of IRIG bands, as well as at subcarrier frequencies higher than the highest present IRIG band.

CIRCLE 216 ON READER SERVICE CARD

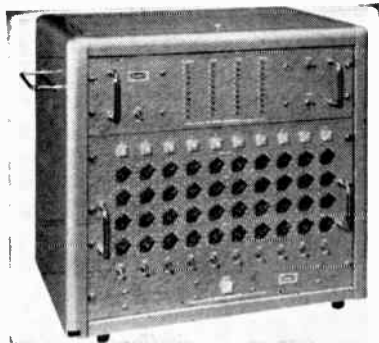

Programmers versatile circuitry

THE REDFORD CORP., Lake Luzerne, N. Y. Sequential program controllers designed for machine automation use solid state, cold cathode components. Programmed machine or process control is obtained by successive relay closures at completion of cumulative preset counts. Winding operations may, for example, be controlled with $\frac{1}{10}$ turn resolution at mandrel speeds to 600 rpm. The unit illustrated, model 12A4P-10 provides 10 sequential predetermined outputs from a 4-decade counter.

CIRCLE 217 ON READER SERVICE CARD

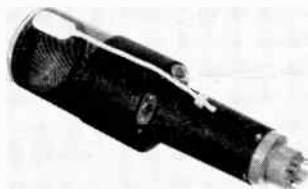

Dual-Beam CRT fast writing rate

ALLEN B. DUMONT LABORATORIES, INC., 750 Bloomfield Ave., Clifton, N. J. Type 5BFP crt for high altitude aircraft, oscilloscope, and indicator use incorporates linear post acceleration for minimum pattern

work in the fields of the future at NAA



ENGINEERS AND PHYSICISTS

*Work on America's most
advanced weapon systems*

Immediate openings for qualified engineers to initiate and evaluate avionics equipment for future manned aerodynamic and space vehicles.

Optimum Qualifications: Analysis of Guidance, Radar, Infra-red, Control, and Communications equipment to determine performance and size.

Minimum Qualifications: Experience in at least one of these fields, plus a degree in electronics, physics, or mathematics.

For more information please write to: Mr. F. K. Stevenson, Engineering Personnel, North American Aviation, Inc., Los Angeles 45, California.

THE LOS ANGELES DIVISION OF

**NORTH
AMERICAN
AVIATION, INC.**



distortion of its two independently controlled beams. It has a flat face plate, integral mu-metal shield, and aluminized screen. The tube is designed for altitudes up to 70,000 ft. Typical operating voltages are post accelerator, 13,250 v; accelerator, 2,750 v; focusing electrode, 600-900 v.

CIRCLE 218 ON READER SERVICE CARD



D-C Power Supply transistorized

TRANSVAL ELECTRONICS CORP., 10401 Jefferson Blvd., Culver City, Calif. Model 5131 regulated supply is designed for application to missile and aircraft ground support equipment, lab test equipment, computer systems, automation equipment and production testing. Output is selectable by switch at 150 or 300 v d-c; input, 115 v a-c ± 10 percent, 60 cps, single phase; ripple, less than 3 mv rms; drift, 0.1 percent maximum in 8 hours; temperature coefficient, output voltage change less than 0.01 percent per deg C, or better on special order.

CIRCLE 219 ON READER SERVICE CARD

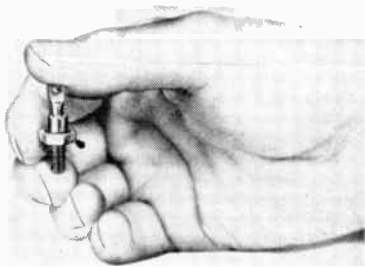

Silicon Rectifier fused alloy device

SYNTRON Co., Homer City, Pa. Style 20 silicon power rectifier is designed for operation at current levels from 1 to 15 amperes (single phase half wave average). Surge ratings are 90 amperes average at

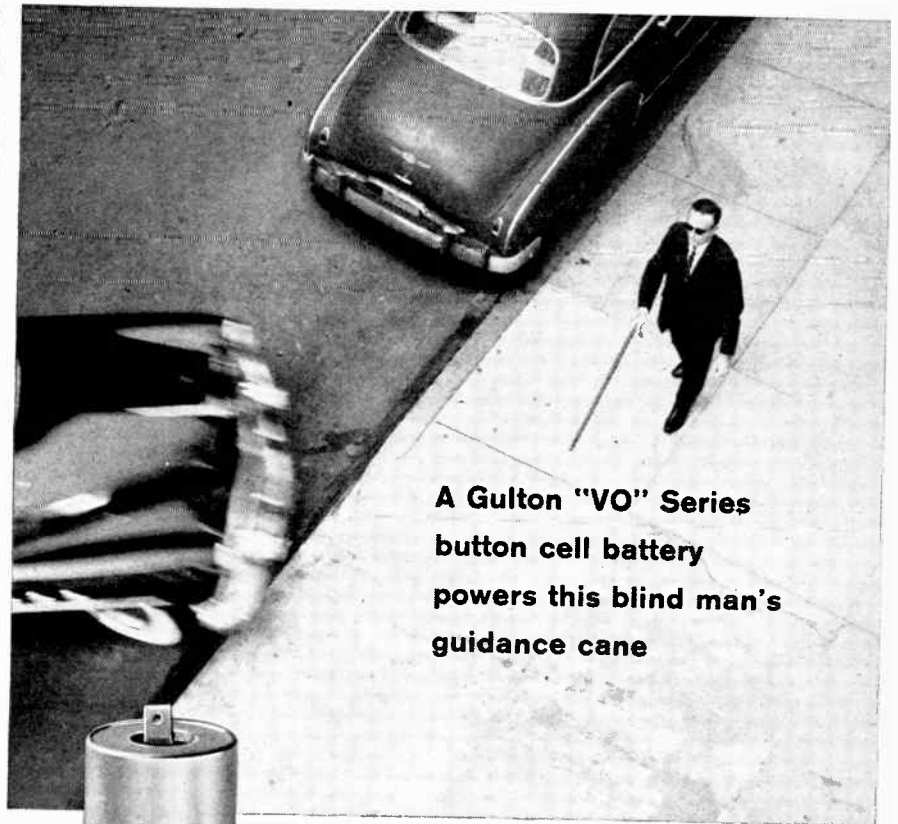

A Gulton "VO" Series button cell battery powers this blind man's guidance cane



rugged... reliable... rechargeable!

The cane in the man's hand is a proximity guidance device designed by Franklin Institute for the blind.

Requirements called for the power supply to be small enough to fit in the handle of the cane, rugged enough to perform well under abuse, and... to be rechargeable.

After extensive testing, designers chose the Gulton "VO" sealed nickel cadmium button cell battery to do the job.

How Can You Use These Batteries?

Powering this and other prosthetic devices is only one of many imaginative uses for these rechargeable batteries. Engineers have already designed them into transistorized radios, photo-flash power packs, missiles - wherever *small size, strength, light weight, long life, complete reliability, no maintenance and easy recharging are desired.*

Most Complete Line Available

"VO" cells are available in capacities of 100, 180, 250, 500 and 1750 mah; have a nominal 1.2 voltage; can be packaged in any combination to meet your voltage specs. Patented sintered plate construction provides exceptional cycling characteristics; highest capacity per unit size. Like more information? Write us for Bulletin No. VO-103.



Available from stock -
GLENNITE BATTERY DISTRIBUTORS
92-15 172nd Street, Jamaica, New York

Gulton Industries, Inc.
Alkaline Battery Division, Metuchen, New Jersey

What makes a missile tick?

At Raytheon, successful design and development of advanced missile weapons systems are the result of a closely knit *team effort* . . . the combined contributions of many engineering minds. And at Raytheon, Missile Engineers enjoy the exceptional rewards and advantages offered by its largest and fastest growing division.

Location: Bedford, Mass. Suburban New England living . . . only minutes from Boston's unexcelled educational opportunities. Relocation allowance. Pick *your* spot on the Raytheon team. Immediate openings for Junior and Senior Engineers with missile experience in the following areas:

- MICROWAVE DESIGN
(Component and Antenna)
- AERODYNAMICS
- COMMUNICATIONS SYSTEMS
- DIGITAL PROGRAMMING
- GUIDANCE SYSTEMS
- RADOME DESIGN
- COMPUTER SYSTEMS
- HEAT TRANSFER
- RADAR SYSTEMS
- OPERATIONS ANALYSIS
- INERTIAL REFERENCE SYSTEMS
- FEED-BACK CONTROL
- AUTO-PILOT
- GROUND SUPPORT
- ELECTRONIC PACKAGING
- TEST EQUIPMENT DESIGN
- ELECTROMECHANICAL
ENGINEERING
(Background in missile control and auto-pilot design)
- MECHANICAL ENGINEERING
(Background in ground handling of large missile systems)
- MICROWAVE TUBE DESIGN

Please send resume to Mr. W. F. O'Melia, Employment Manager, Raytheon Company, Bedford, Massachusetts, or call collect: CRestview 4-7100, Extension 2138.



**MISSILE
SYSTEMS
DIVISION**



6 cycle (0.1 sec) and 50 amperes average at 60 cycle (1.0 sec). Piv's range from 50 to 400 v in 50 v steps. Temperature range is from -65 to +175 C. Unit is mounted on a $\frac{1}{8}$ -in. hexagon stud type case with a glass to metal seal cap. Maximum height is $1\frac{1}{8}$ in.

CIRCLE 220 ON READER SERVICE CARD

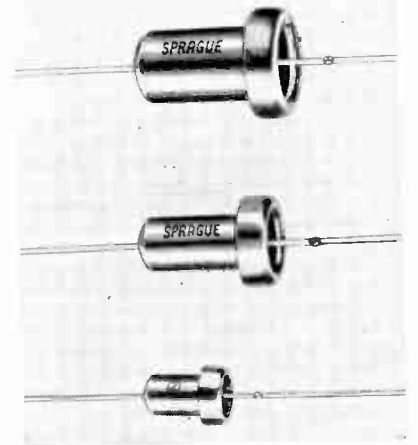

Capacitors cup type

SPRAGUE ELECTRIC Co., North Adams, Mass. Types 131D and 132D Tantalex cup type, wet-electrolyte sintered-anode capacitors operate at -55 C to +85 C at full rated working voltage or up to 100 C with a 15 percent voltage derating. They provide high capacitance in small size, long operating life, long shelf life, capacitance stability, and very low leakage currents.

CIRCLE 221 ON READER SERVICE CARD



Photo-Modulators miniaturized

CAMBRIDGE ELECTRONICS CORP., Box 301, Marshfield Hills, Mass. A line of miniaturized photo-modulators replace old style mechanical vibrators in applications requiring the ultimate in low-noise, low-drift modulating, demodulating, or chop-

ping operation. Models are available to match high impedance vacuum tube input circuits and low impedance transistor input circuits. Chopping frequency is variable from d-c to 800 cps.

CIRCLE 222 ON READER SERVICE CARD



Triode Pentode for audio amplifiers

CBS-ELECTRONICS, 100 Endicott St., Danvers, Mass. Type 50FY8 miniature triode-pentode for compact audio amplifiers combines the voltage and power amplifiers. Needs low plate and screen voltage, provides 2.7 w output in single-ended class A operation. A pair are the only tubes required in a stereo amplifier utilizing the CBS modified simplex circuit which provides up to 3.5 w per channel.

CIRCLE 223 ON READER SERVICE CARD



Low Pass Filter high performance

ELECTRONIC SPECIALTY Co., 5121 San Fernando Road, Los Angeles 39, Calif. LP-267 low pass filter isolates uhf from L-band, provides insertion loss greater than 100 db in stop band of 900 to 1,300 mc, less than 0.5 db in pass band of d-c to 400 mc. Input vswr in pass band is 1.4 maximum. Filter can handle 50 w average power, is normally supplied with type N connectors, weighs less than 5 oz, is size of equivalent length of coax cable.

CIRCLE 224 ON READER SERVICE CARD

ATTRACT AND HOLD TECHNICAL PERSONNEL

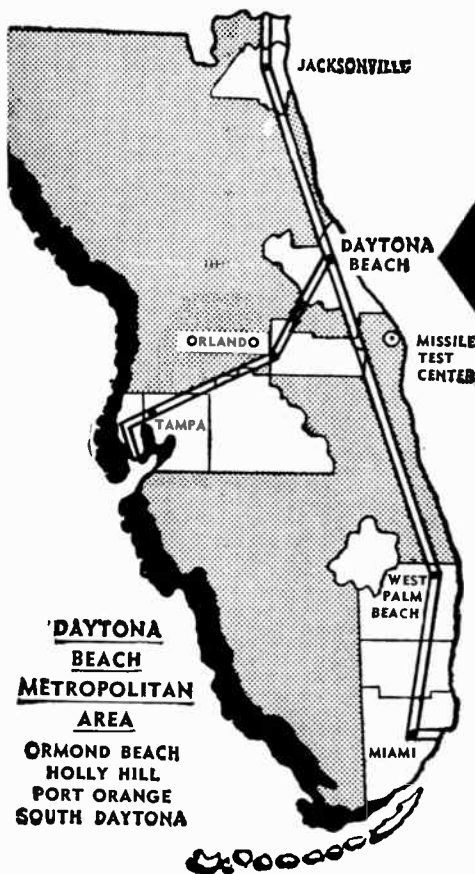

STRATEGIC LOCATION FOR GROWTH INDUSTRIES
DAYTONA BEACH
FLORIDA
Metropolitan Area Industrial Sites

Daytona Beach, the east-to-west terminal on the north-to-south route of the projected Federal Limited Access Freeway System, gives industry a plus for the future.

Write for new101page Industrial Brochure

R. H. MILES, MGR.
INDUSTRIAL DEPARTMENT
CHAMBER OF COMMERCE
DAYTONA BEACH, FLORIDA

CIRCLE 108 ON READER SERVICE CARD

MONITOR'S ENGINEERING TECHNIQUES INSURES COMPONENT OVEN QUALITY

Type RM4-9L Oven with inside noval socket for component mounting



Ambient temperature range: 0°C to +85°C or -55°C to +85°C. Operating temperature set to individual customer requirements. Temperature variation after warm-up is $\pm 1^\circ\text{C}$ to $\pm 2^\circ\text{C}$ depending on ambient range. Temperature stability at constant ambient is $\pm 0.5^\circ\text{C}$. Choice of heater voltages from 6.3V to 115V AC or DC. 15 or 30 watts power consumption depending on ambient. 15 minute warm-up time at -55°C. Base: Choice of 11 or 8-pin octal, 9-pin noval socket in bottom of cavity for mounting of components. Hermetically-sealed thermostat. Low inductance heater winding. Wt. approx. 3 oz.

Choose Monitor Component Ovens, for complete electronic assemblies, built to customer requirements!

Send for NEW, detailed Brochures!



MONITOR PRODUCTS COMPANY

815 Fremont Ave. • South Pasadena, Calif.
 RYan 1-1174

**Technical Staff
Opportunities in**

PSI

SEMICONDUCTORS

Pacific Semiconductors, Inc.—a subsidiary of Thompson Ramo Wooldridge Inc.—announces several challenging Technical Staff positions created by its rapidly expanding development programs for Very High Frequency and Very High Power Silicon Transistors.

We invite inquiries from *Research Physicists* for work in semiconductor materials and solid state diffusion techniques; *Organic Chemists* for surface study research; *Solid State Physicists and Engineers* with experience in transistor development; *Mechanical Engineers* engaged in transistor package and manufacturing equipment development; *Electrical Engineers* experienced in semiconductor device applications and test equipment development.

This organization encourages and rewards resourcefulness and original thinking. Candidates with B.S., M.S. or Ph.D. degrees in physics or engineering should write to:

Technical Staff Placement

Pacific Semiconductors, Inc.



10451 WEST JEFFERSON BOULEVARD, CULVER CITY, CALIFORNIA

Literature of

MATERIALS

Plastics. Durez Plastics Division, Hooker Chemical Corp., North Tonawanda, N. Y. Eight-page bulletin No. D400 contains general data on properties and uses of thermosetting phenolic and diallyl phthalate molding compounds, fire-retardant Hetron polyester resins for reinforced plastics, and phenolic resins for bonding and coating.

CIRCLE 250 ON READER SERVICE CARD

COMPONENTS

Transformers. Triad Transformer Corp., 4055 Redwood Ave., Venice, Calif. Catalog TR-60 lists over 1,000 items and contains several new lines, including micro-miniature transformers and transformers for transistor applications.

CIRCLE 251 ON READER SERVICE CARD

Time Delay Relays. Elastic Stop Nut Corp. of America, Elizabeth, N. J., has available a folder featuring the improved specifications and the variety of applications for each of its various models of dial head Agastat time relays.

CIRCLE 252 ON READER SERVICE CARD

Electromechanical Components. Sterling Precision Corp., 17 Martinecock Ave., Port Washington, L. I., N. Y. A 512-page catalog features over 20,000 electromechanical components.

CIRCLE 253 ON READER SERVICE CARD

EQUIPMENT

Recorders. F. L. Moseley Co., 409 N. Fair Oaks Ave., Pasadena, Calif. A 4-page folder describes an X-Y recorder, a strip chart recorder, a long strip curve follower, and a digital translator.

CIRCLE 254 ON READER SERVICE CARD

Automatic Test Equipment. Stromberg-Carlson, 1400 N. Goodman St., Rochester 3, N. Y., has

DESIGN ENGINEERS ...

your: *"time saving"*
"accurate" answer to...

TRANSISTOR TRANSFORMER PROBLEMS

DESIGN — RESEARCH — DEVELOPMENT

JAMES C-2450 KIT

A unique kit of 12 transformers gives 96 different designs covering 93% of all applications

NET \$44.50



PILOT AND FULL PRODUCTION

Each of 12 kit models available in 5 different case designs



Write or order direct from

Dept. E-10

JAMES VIBRAPOWR COMPANY
4050 N. Rockwell, Chicago 18, Illinois
CO 7-6333

the Week

issued a 24-page booklet on SCATE (Stromberg-Carlson Automatic Test Equipment), a system for testing and monitoring weapons systems.

CIRCLE 255 ON READER SERVICE CARD

Spectrum Analyzers. Panoramic Radio Products, Inc., 514 S. Fulton Ave., Mt. Vernon, N. Y. A complete line of automatic spectrum analyzers with 0.5 cps-44kmc range, unique response curve tracers, and new instrumentation systems are described in a new catalog digest.

CIRCLE 256 ON READER SERVICE CARD

Frequency Divider and Clock. Hewlett-Packard Co., 275 Page Mill Road, Palo Alto, Calif. A 4-page folder deals with model 113AR frequency divider and clock which provides a simple, accurate method for making the time comparisons necessary for adjusting modern frequency standards.

CIRCLE 257 ON READER SERVICE CARD

Inertial Platform. General Electric Co., 600 Main St., Johnson City, N. Y. The illustrated 8-page bulletin GEA-59APJ-65A describes new gimbal platform which operates from -55 to 100 C in very high acceleration environments.

CIRCLE 258 ON READER SERVICE CARD

FACILITIES

Servo Test Equipment. Theta Instrument Corp., 48 Pine St., East Paterson, N. J., has released a 25-page comprehensive report on the latest techniques of control synchro and control resolver testing.

CIRCLE 259 ON READER SERVICE CARD

Capabilities Brochure. Dalmotor Division, Yuba Consolidated Industries, Inc., 1375 Clay St., Santa Clara, Calif. Brochure EI-759 describes the Division's capabilities for the design and manufacture of electronic and electromechanical custom devices and systems.

CIRCLE 260 ON READER SERVICE CARD

GENERAL ELECTRIC VOLTAGE REGULATION IDEA FILE

By C. A. NEUMANN



General Electric Inductrol* regulators automatically maintain precise voltage for computer input and filament supply

Efficient computer performance depends on precise voltage control. Fluctuation of input voltage to the computer, and line voltage changes within the system, require that some reliable device be employed so the computer sees a constant voltage at all times.

PRECISION CONTROL OF INPUT VOLTAGE LEVEL is best obtained with General Electric automatic Inductrol voltage regulators—one three-phase unit for balanced three-phase loads, or three single-phase units for individual phase regulation to correct phase voltage imbalance.

Incoming line voltage level correction is accomplished with one three-phase Inductrol voltage regulator as shown below. Each phase is corrected simultaneously and by the same amount.



An automatic Inductrol voltage regulator will provide a precisely regulated input voltage to the computer, whatever the variation in the supply voltage. Because the General Electric Inductrol voltage regulator is an induction device, an infinite number of voltage level variations can be corrected. Drift-free controls for this equipment assure the most accurate regulation available. With no brushes to wear out, and inherently high short-circuit strength and overload capability, these regulators give long maintenance-free service.

PRECISION CONTROL OF FILAMENT POWER for reliable operation and optimum tube life is another import-

ant application of voltage regulators in a computer system.

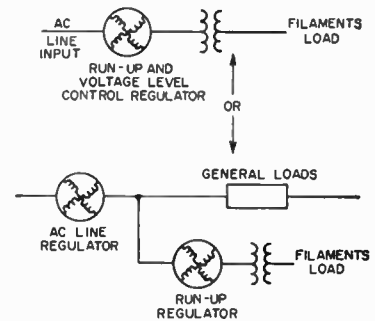

General Electric Inductrol regulators will maintain a constant voltage input to the tube filament within the close tolerances required as shown above, regardless of load fluctuations or input line voltage variations. The same voltage can also run-up the filament voltage from a reduced level, and at a specified rate of speed, if the system requires.

Here is a typical filament-supply circuit requirement: System filament load is 5 kva. Input voltage is 115 volts, single-phase, and is subject to plus and minus 20% incoming line voltage variation. A constant voltage output to the filament load is mandatory, in spite of variations on the line, or variations in the input frequency. Solution to this application problem is a single-phase automatic Inductrol voltage regulator rated AIRS, 60 cycles, 1.25 kva, 115 volts, 43.5 amperes, $\pm 25\%$.

To learn more about matching the benefits of Inductrol voltage regulators to the requirements of your equipment, write to Section 425-23, General Electric Company, Schenectady 5, New York.

* Registered Trademark of the General Electric Company for Induction Voltage Regulators.

Progress Is Our Most Important Product

GENERAL ELECTRIC

A FULL DAY'S WORK FOR A GOOD DAY'S PAY...



IN GROWING *Mississippi*

Workers give their best in Mississippi because they live their best in Mississippi... where the climate is good for working, good for living. We invite you to realize greater profits from your operation by tapping Mississippi's reservoir of trained, conscientious, loyal workers.

For Further Information Contact
MISSISSIPPI AGRICULTURAL AND INDUSTRIAL BOARD
Jackson, Mississippi

CIRCLE 110 ON READER SERVICE CARD

fci
Stabilized Precision Capacitors



TYPE	CAP. RANGE	V.O.C.	TEMP.	P.F.	T.C.	I.R. 25°C	MIN. TOL.	SOAK-AGE
A	.001—20MF	100—30KV	-55°C +85°C	.02% 1KC	-100 PPM/C	10 ⁷ MEG	0.1—	0.01%
B	.001—20MF	600—20KV	-55°C +70°C	.02% 1KC	+800 PPM/C	10 ⁶ MEG	1.0%	3.00%
C	.001—20MF	100—30KV	-55°C +200°C	.02% 1KC	-50 PPM/C	10 ⁷ MEG	0.1—	0.01%
D	.001—20MF	100—60KV	-55°C +125°C	.5% 1KC	+500 PPM/C	10 ⁶ MEG	1.0%	0.10%

ALSO MANUFACTURERS OF:
LOW CURRENT POWER SUPPLIES
2 KVDC—30 KVDC
METALLIZED PAPER & MYLAR CAPACITORS



WRITE FOR FURTHER INFORMATION AND OUR COMPLETE CATALOG

Film Capacitors, Inc.
3400 PARK AVENUE • NEW YORK 56, N. Y.

96 CIRCLE 96 ON READER SERVICE CARD

sponsible for all contract acceptance and fulfillment, together with any contract renegotiations or redeterminations.

Gaul joined Epsco-West last year as senior applications engineer.

Weiss Fills Elco Post

A NEW position, technical assistant to the vice president of sales, recently created at Elco Corp., Philadelphia, has been filled from within the company's own ranks. Samuel Weiss, previously chief engineer with Elco, has been given this new assignment and brings with him nine years of engineering experience at Elco, in addition to his experience prior to his association with that company.

At the same time, Harold Musnit-sky has been given the post of executive engineer at Elco. Musnit-sky was with Garrett Corp., Philadelphia, for 10 years, leading to the position of chief engineer there. He will assume some of the duties of the previous Weiss position.

Plant Briefs

Electro Engineering Works, San Leandro, Calif., manufacturer of electrical and electronic transformers, is planning a 4,000-sq ft expansion of its plant, at a cost of approximately \$17,000. This is the second such expansion for the firm in the past year.

The R. B. Denison Mfg. Co., manufacturer of heavy duty and precision limit switches, has moved into greatly expanded facilities in Bedford, Ohio.

Feedback Controls Inc. recently moved from Waltham, Mass., to a new plant site in Natick, Mass. New facility provides for 100 per cent increase in plant capacity.

Recent addition to the expanding electronics industry in the San Diego area is CES Electronic Products, Inc., a company special-

World Radio History

Now Available
VACUUM PRODUCTS INC.
VACUUM THERMO-COUPLES

★ RANGES

STANDARD — 1 m.a. to 1000 m.a.
UHF — 5 m.a. to 1000 m.a.

★ GENERAL INFORMATION

Vacuum Types - Insulated or Contact
Fast Response - Very Stable
Low Cost - Quick Delivery
As low as .1% reversal

For further information and prices please send for our bulletin

Thermocouple Specialists

VPI **VACUUM PRODUCTS INC.**

19 Beechwood Ave., Mt. Vernon, N. Y.

CIRCLE 111 ON READER SERVICE CARD

MICO Precision Apparatus

NEW HEAVY DUTY 2 & 3 DIMENSIONAL ENGRAVER

FOR Engraving Nameplates Fine Routing Work Profiling Small Objects Making Small Dies and Molds



UHF COAXIAL WAVEMENTERS



2-75 Centimeter Range

Send for Illustrated Catalogs
MICO INSTRUMENT CO.

77 Trowbridge St. Cambridge 38, Mass.

CIRCLE 26 ON READER SERVICE CARD
OCTOBER 2, 1959 • ELECTRONICS

izing in research and development. Heading the firm are H. Leonard Cardoza, president; Richard L. Ensminger, vice president and treasurer; and Robert O. Curran, secretary.

News of Reps

Tally Register Corp. has appointed **Rush S. Drake Associates** to represent the Seattle, Wash., manufacturer of punched paper tape data processing storage, and acquisition equipment throughout the Northwest. Drake, with headquarters in Seattle, will cover Oregon, Washington, Idaho and British Columbia.

Seatronics, Inc., of Seattle, Wash., is named sales rep by Ohio Semiconductors, Inc., Columbus, to cover Washington, Oregon, Idaho and Vancouver, B. C., Canada.

McCarthy Associates Inc., Pasadena, Calif., has been appointed engineering rep firm for Cubic Corp., San Diego. Firm will represent Cubic in southern California and Arizona.

Appointment of the **Fred Sharp Co.**, Cleveland and Dayton, Ohio, as reps for western Pennsylvania and Ohio, has been announced by General Measurements Co., Inc., Newton Highlands, Mass.

Weller-Rahe Co., Worthington, Ohio, electronic sales organization, has been named by Audio Devices, Inc., Santa Ana, Calif., to cover West Virginia and western Pennsylvania.

Harry L. Harkness has joined the **Burt C. Porter Co.**, Seattle electronic engineering rep, as inside salesman. Prior to joining the Porter Co., Harkness was with the industrial engineering section of the Boeing Airplane Co.

The Components Division of **S. Sterling Co.**, Detroit, Mich., has been appointed Michigan rep for the U. S. Semiconductor, Inc., Phoenix, Ariz., manufacturer of products used in defense and space programs.

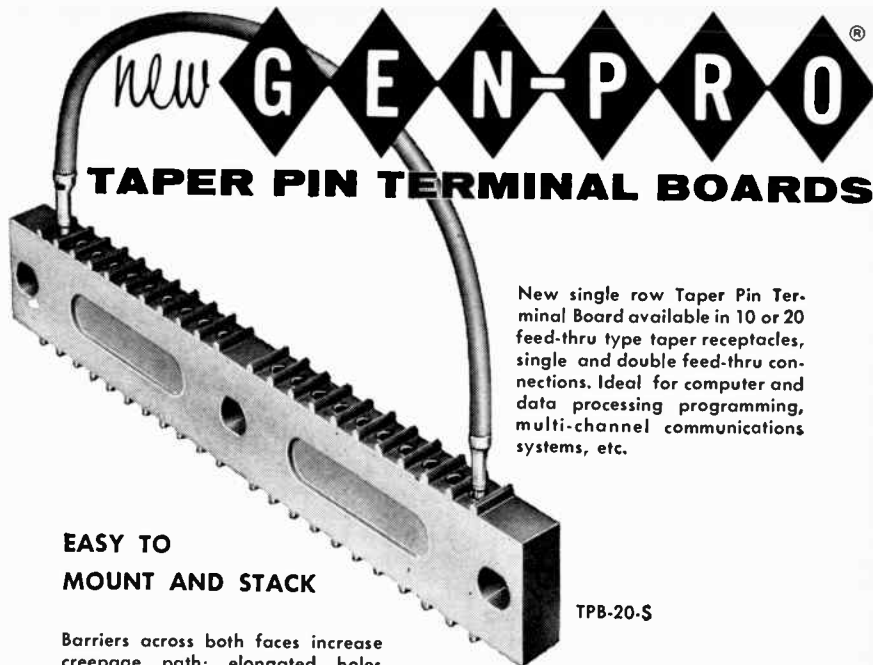

GEN-PRO[®] TAPER PIN TERMINAL BOARDS

New single row Taper Pin Terminal Board available in 10 or 20 feed-thru type taper receptacles, single and double feed-thru connections. Ideal for computer and data processing programming, multi-channel communications systems, etc.

EASY TO MOUNT AND STACK

Barriers across both faces increase creepage path; elongated holes facilitate mounting; nesting projection and recess aid stacking. Brass receptacles provide low contact resistance. 14 lbs. min. pull out with standard solderless taper pins. Molding compound is MAI-60 (Glass Alkyd) of MIL-M-14E.

TPB-20-S

Gen-Pro boards have passed Navy 2,000 ft. lb. high shock requirements as specified by MIL-S-901B.

WRITE NOW FOR FURTHER DETAILS

GENERAL PRODUCTS CORPORATION

Over 25 Years of Quality Molding

UNION SPRINGS, NEW YORK

TWX No. 169

CIRCLE 112 ON READER SERVICE CARD

RIBBONS · STRIPS

— of —

★ PURE TUNGSTEN

★ THORIATED TUNGSTEN

★ MOLYBDENUM

★ SPECIAL ALLOYS

and OTHER METALS

IN

ULTRA THIN SIZES

to

TOLERANCES CLOSER THAN COMMERCIAL STANDARDS

by

OUR SPECIAL ROLLING TECHNIQUE

Note: for highly engineered applications—strips of TUNGSTEN and some other metals can be supplied

ROLLED DOWN TO .0003 THICKNESS

• Finish: Roll Finish—Black or Cleaned

• Ribbons may be supplied in Mg. weights if required

For HIGHLY ENGINEERED APPLICATIONS

DEVELOPED AND MANUFACTURED BY

H. CROSS CO.

15 BEEKMAN ST., N. Y. 38, N. Y.

TELEPHONE: WOrth 2-2044
COrtlandt 7-0470

G-E WIRE SONIC DELAY LINES PROVIDE LOWER INSERTION LOSS HIGHER STORAGE RATE

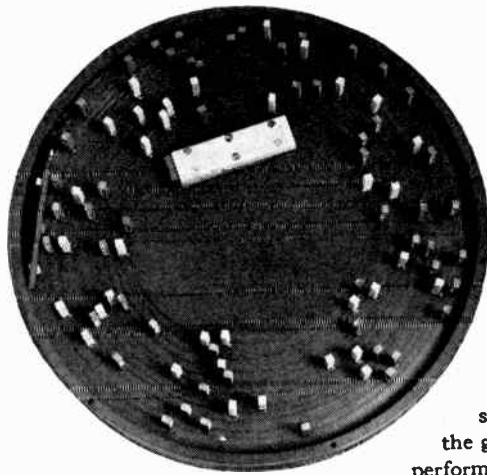

Information storage up to 1.2 mc/s
Delay up to Ten Milliseconds
Adjustable Delay
Small Volume for Length of Delay
Shock and Vibration Resistant
Stable over Wide Temperature Range

Wire Sonic Delay Lines employ a special alloy wire as the delay medium. G.E. uses both piezoelectric and magnetostrictive transducers to provide the greatest possible range of system performance. Piezoelectric transducers assure *minimum insertion loss* for fixed inputs and/or outputs while the magnetostrictive transducers provide intermediate taps, both fixed and adjustable.

For complete development information write to Defense Industries Sales, Sect. 227-28C

GENERAL ELECTRIC

DEFENSE ELECTRONICS DIVISION
HEAVY MILITARY ELECTRONICS DEPARTMENT, SYRACUSE, NEW YORK

CIRCLE 113 ON READER SERVICE CARD

COMMENT

Strobe Lights

(Re: your article "New Circuit Improves Stroboscope Versatility," p 116, Aug. 7 . . .)

During World War II, Lear Inc., then of Piqua, O., was producing small, high-speed aircraft motors and using General Radio type 631 Strobotacs for testing them. The limitation of these instruments to a maximum of 14,400 rpm (because of deionization limitations of the Strobotron) made it necessary to view the motors at a submultiple of the operating speed. The Strobotac is essentially a free-running multivibrator with the Strobotron triggered from one polarity of the output square wave; the asymmetrical circuit immediately suggested to me that a duplicate Strobotron plus a storage capacitor and charging circuit might be triggered from the alternate output from the square-wave generator, and that the rebalancing of the circuit with the equalized load might improve stability as well.

This resulted in the fabrication of a number of two-Strobotron Strobotacs. The units were equipped with three speed ranges, the two tubes firing in parallel on the low and medium ranges and alternately on the high-speed range, making viewing possible up to 28,800 rpm and doubling the light available on all ranges.

The instrument described by Mr. Barrett in his article is a greatly refined and embellished device, of course, offering a greater fundamental frequency and flash intensity among other features; but many applications will find the compact, simple, two-neon Strobotron adequate and handier to use. A directly calibrated dial, incidentally, is at least as reliable as, and more accurate than, the calibrated rate meter . . .

CHARLES C. LITTELL JR.
ENGINEERING ASSOCIATES
DAYTON, O.

A Negative Vote

I refer specifically to your July 31 issue, and therein to an editorial by W. W. MacDonald on p 4, and

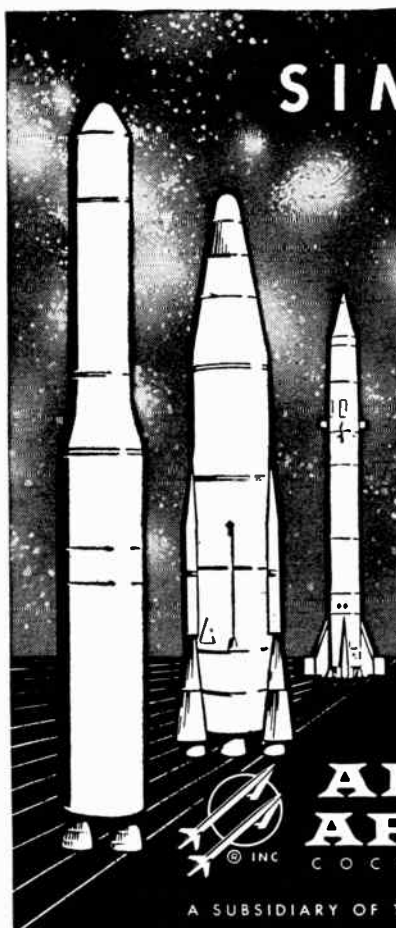

SIMULATION TRAINING AND TEST

EQUIPMENT FOR
AMERICA'S MOST
OUTSTANDING MISSILES

Developed and
Produced by

AIRCRAFT ARMAMENTS

COCKEYSVILLE, MARYLAND

A SUBSIDIARY OF THE UNITED INDUSTRIAL CORPORATION

DO YOU KNOW?

You Can Locate Nearest SALES OFFICES in this year's BUYERS' GUIDE

A one-step method for locating the nearest sales office of every manufacturer listed in the GUIDE. The nearest sales offices to you (with addresses and phone numbers) are listed directly after manufacturers' names in the Manufacturers' Index.

One more reason why advertisers and users of the BUYERS' GUIDE receive extra benefits available in no other place.

electronics BUYERS' GUIDE and Reference Issue

A McGraw-Hill Publication
330 West 42nd St.
N. Y. 36, N. Y.



to an article ("New Security Policy Coming?") by associate editor H. K. Janis on p 34.

I have had 20 years experience with both military and commercial companies. Practically all of my work has been in the field of electronics, and much of it has been of a highly classified nature. I will readily agree that too rigid classification safeguards can cause lack of proper dissemination of information. That is one side of the picture. But on the other extreme, lack of proper commercial company security policy can be very dangerous to the security of the country. There are two sides (or rather extremes) to this security problem, and too much security is the lesser of the two evils by a long shot.

I am in total disagreement with the Supreme Court decision in the William L. Greene case. I consider the Supreme Court decisions along this line to be very close to being traitorous and I, for one, believe that the majority deserve to be impeached.

Both your article and your editorial, which we may assume to be the editorial policy of your magazine, were heavily biased against sensible security measures and in favor of the infamous Supreme Court decision. Do not try to tell me otherwise, I read the editorial and the article twice . . .

THOMAS M. MORSE
N. LITTLE ROCK, ARK.

We're proud of our stand on the Greene case and on the matter of security generally. We believe in the dignity of man—as engineer, as production worker, or as plain citizen—and we doubt that too much "security" is always to be preferred.

Lunik

Re that successful Soviet moonshot: it was bad enough being behind in rocketry; now it seems we have something to learn in guidance and control.

Or is it just that we won't learn to hook up good command guidance with superior inertial devices to get a system that really works?

GENE GOODMAN

PHILADELPHIA



OPPORTUNITIES MUSHROOM AT CBS ELECTRONICS

To keep pace with our rapidly expanding achievements in semiconductor research and development, we are enlarging our semiconductor facilities.

Engineers with vision and ingenuity are invited to participate in dynamic projects, working with the most advanced instruments known to science, in an atmosphere stimulating to scientific exploration and application.

Exciting and rewarding career opportunities are now open to imaginative scientists in the following categories:

- PRODUCTION MANAGER
- ENGINEERING MANAGER
- APPLICATIONS ENGINEERS
- DEVICE DEVELOPMENT ENGINEERS
- DIODE ENGINEERS
- PILOT LINE ENGINEERS
- TRANSISTOR ENGINEERS

Call collect or write:

Mr. Robert S. Harding,
900 Chelmsford Street,
Lowell, Massachusetts,
GLenview 4-0446

ELECTRON TUBES



SEMICONDUCTORS

CBS ELECTRONICS

A Division of
Columbia Broadcasting
System, Inc.

ENGINEERS...PHYSICISTS

NEW opportunities at Motorola in Chicago

give yourself and your family
all the big city advantages at a
relaxed midwest pace, while you
ADVANCE YOUR CAREER



Outstanding career opportunities are waiting at the many Motorola research and development laboratories in the Chicago area. This is your opportunity to advance your career with a swiftly expanding company, working in the most modern and well instrumented laboratories . . . with liberal employee benefits, including an attractive profit sharing plan and association with men of the highest technical competence.

You'll like living in one of the beautiful suburbs of the playground of the midwest, where there are endless social, cultural, and educational activities to choose from the year-round. Exciting life or quiet life—Chicago offers either.



MILITARY POSITIONS OPEN

- Radar transmitters and receivers
- Radar circuit design
- Antenna design
- Electronic countermeasure systems
- Military communications equipment design
- Pulse circuit design
- IF strip design
- Device using klystron, traveling wave tube and backward wave oscillator
- Display and storage devices

CIVILIAN POSITIONS OPEN

- 2-WAY RADIO COMMUNICATIONS
- VHF & UHF Receiver • Transmitter design & development • Power supply
 - Systems Engineering • Selective Signaling • Transistor Applications • Crystal Engineering • Sales Engineers
- PORTABLE COMMUNICATIONS
- Design of VHF & UHF FM Communications in portable or subminiature development.
- MICROWAVE FIELD ENGINEERS



Write to:
Mr. L. B. Wrenn Dept. D
MOTOROLA, INC.
4501 Augusta Blvd., Chicago 51, Ill.

ALSO . . . there are excellent opportunities in
PHOENIX, ARIZONA • RIVERSIDE, CALIFORNIA



MOTOROLA

*Achievement in Action
at Avco . . . for*

SCIENTISTS AND ENGINEERS

Achievement is habit at Avco!
A leader in the field of
atmospheric re-entry, Avco is
now providing significant
contributions to basic and
applied research in Space and
Missile Technology.

Supervisory, Senior and Junior positions
are available in these areas:

- ELECTRONICS
- MATHEMATICS
- PHYSICS AND CHEMISTRY
- COMMUNICATIONS
- MATERIALS
- FLIGHT TEST ENGINEERING
- DESIGN ENGINEERING
- PRODUCT ENGINEERING
- AERODYNAMICS
- APPLIED MECHANICS
- THERMODYNAMICS AND
HEAT TRANSFER

Attractive working environment outside
of metropolitan Boston. The large, fully
equipped, modern laboratory is close
to Boston educational institutions and
cultural events. The division offers a
liberal educational assistance program
for advanced study.

Forward your inquiry to:

Mr. Richard Rubino
Scientific and Technical Relations
Dept. E-10.

Avco

Research & Advanced Development

201 Lowell St., Wilmington, Mass.

ON YOUR COMMAND

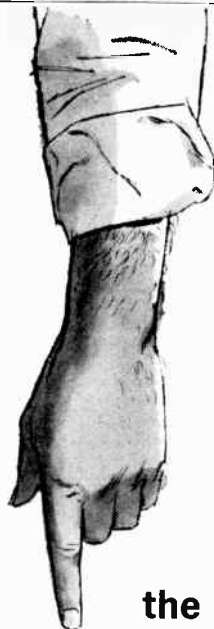

the satellite reports scientific data back to

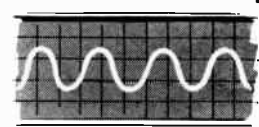
earth.  At the ground station, special communications equipments receive and demodulate space telemetry signals.  A data

processing system analyzes findings which are fed in turn to the satellite control network and the computer memory banks, increasing man's knowledge of his newest frontier. 

The complete system—from the space communication network of the space vehicles to the complex data-processing equipment of the ground station complex is a product of your team—if you're at Philco in Palo Alto—in the San Francisco Peninsula's new electronic center. A position with this trail-blazing group can be yours—now! Graduate engineers are needed for equipment design and for systems engineering, analysis and integration. Write now, in confidence, to
Mr. H. C. Horsley, Engineering Placement.



PHILCO WESTERN DEVELOPMENT LABORATORIES

3875 FABIAN WAY, DEPT. E10 • PALO ALTO, CALIFORNIA

A PART OF THE GOVERNMENT AND INDUSTRIAL DIVISION OF PHILCO CORPORATION

Mechanical and Electrical Engineers who are planning a New York trip be sure to call

**"Longacre
3-4214"**

**Set up an Appointment
at Hamilton Standard's
New York Interview Center**

One quick call and you can arrange an interview that will conveniently fit into your schedule. You owe it to yourself to hear the complete Hamilton Standard story . . . how engineers are being offered stimulating, rewarding assignments . . . enjoying delightful New England living . . . and many impressive benefits with this famed engineering organization . . . now undergoing significant product diversification.

Mechanical Engineers for

- Analysis • Design • Test
- Development and Installation

Electronic Engineers for

- Analysis • Design • Development
(U.S. Citizenship Required)

Products Involved: engine controls; environmental controls; missiles and space vehicles auxiliary power units; hydraulic systems; flight control systems; electronic power supply units; rocket and missile check-out equipment.

Interview in New York at the Hotel New Yorker, 34th St. at 8th Ave., 9 a.m. to 9 p.m., Monday through Saturday. Sundays 1 p.m. to 7 p.m. Call Mr. Jack Fox at Longacre 3-4214. If you are not planning a trip to New York soon, please reply to Mr. A. J. Fehlber, Technical Employment Supervisor at

HAMILTON STANDARD
A DIVISION OF
UNITED AIRCRAFT CORP.

152 Bradley Field Road, Windsor Locks, Connecticut



looking?

Are you an electronics engineer that has been stranded on a technical assignment that isolates you from professional advancement? At GILFILLAN, engineers are confronted with exciting design problems and technical management responsibilities that insure career growth. GILFILLAN provides these opportunities plus a friendly, informal atmosphere that is conducive to scientific achievement. A number of challenging vacancies exist in the following technical areas: Air Traffic Control, Missile Guidance and Support, Radar Systems, Countermeasures, and Microwaves.



DIR. SCIENTIFIC PERSONNEL, DEPT. 61
1815 VENICE BLVD. LOS ANGELES 6, CALIF.

TELEVISION PROJECT ENGINEERS

Growth & diversification program provides opportunity for several development and design engineers. Background should include three to four yrs. of video circuit design, pulse techniques, r-f, camera tube circuitry, and similar activity.

MECHANICAL ENGINEER

Experienced in packaging of electronic equipment of industrial use. Familiar with sheet metal, small castings, and heat transfer problems.

PHOTOSURFACE PHYSICIST

Must be well grounded in development, formation and measurement of photosensitive surfaces. Background should include high vacuum technique, tube design, electron optics and associated skills.

Diamond's long range plans in the INDUSTRIAL market requires well qualified men who will be given RECOGNITION and RESPONSIBILITY commensurate with their abilities.

Please send resume to:
General Manager, Electronics Div.
Diamond Power Specialty Corp.
Box 415, Lancaster, Ohio

**NEED
EXPERIENCED ENGINEERS?**

An employment advertisement in this EMPLOYMENT OPPORTUNITIES section will help you find the engineers you need. It's an inexpensive, time saving method of selecting competent personnel for every engineering job in the electronics field. The selective circulation of ELECTRONICS offers you an opportunity to choose the best qualified men available.

ELECTRONIC ENGINEERS

Opportunities are now available for permanent civilian employment with the U.S. Navy in

SOUTHERN CALIFORNIA

to coordinate design, fabrication and installation of instrumentation systems at air and missile facilities.

Salaries start at \$8810 or \$10,130 depending on the applicant's qualifications.

B.S. degree plus 3-5 years experience in telemetry and search radar, radio receiving and transmitting systems.

These positions also include regular salary increases, excellent leave and retirement plans, and other fringe benefits.

All resumes and inquiries should be submitted to:

Mr. Martin Bazik
District Public Works Office
Eleventh Naval District
San Diego, California

U.S. NAVY

PRODUCT DESIGN ENGINEER

Permanent position. Commercial products only. Chicago area manufacturer of microphones and receivers has an opening for a supervisory engineer. This is a top level position. Candidate must be a graduate engineer with a B.S.E.E. or a graduate of a college level technical school and should have a minimum of 5 years experience as a product design engineer in the electronic component field. Experience should include test equipment maintenance and production line trouble shooting. Will be responsible for final designs of miniature electronic components after receipt of initial proto-types from the research and development group. Excellent salary. Send resume in confidence to: James G. McCracken, Director Industrial Relations.

KNOWLES ELECTRONICS, INC.

10545 Anderson Place
Franklin Park, Illinois
GLadstone 5-3600

MANUFACTURERS REPRESENTATIVES

Openings for experienced component sales engineering organizations interested in the following territories: New England States—Minnesota, Iowa, Wisconsin—South Carolina, Georgia, Alabama—Kansas, Missouri, Arkansas—Louisiana, Mississippi—New Mexico, Arizona.
Firm is well established producer of wide range of electronic wiring devices with excellent product acceptance.

RW-2253, Electronics
520 N. Michigan Ave., Chicago 11, Ill.

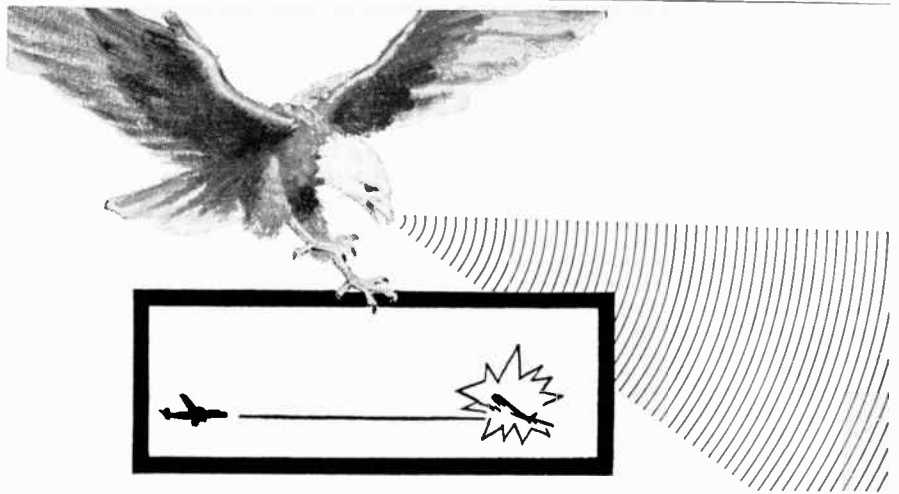

Engineers Face New Challenge as SANDERS "SHARPENS THE EYES OF THE EAGLE"

Latest among many exciting projects now at Sanders Associates is development of a complex terminal guidance seeker system for the Navy's exceptionally accurate air-to-air Eagle missile that can seek out, maneuver to intercept and destroy a target at long range.

Advancing the state-of-the-art is expected at Sanders, where technical firsts include PANAR® radar, TRI-PLATE® microwave products, FLEXPRINT® flexible printed circuits and cabling, subminiature rate gyros and blowers.

If you are an engineer with a creative turn of mind, Sanders offers you a dynamic working environment . . . where ideas are respected and encouraged by engineering management . . . and assignments in a variety of areas.

You will receive competitive salaries plus extensive benefits, and your whole family will enjoy the advantages of Sanders' location in Nashua, New Hampshire, just an hour from downtown Boston. This thriving community in the beautiful New Hampshire hills has excellent schools, fine homes, every recreational facility—and the cost of living is low.

Immediate Openings In:

SYSTEMS ENGINEERING—All levels of engineers to conduct studies, design and analyses of missile and other weapons systems. Applicable areas of interest include: systems integration, coherent radar and missile systems, steerable antenna array techniques, acquisition and surveillance radars, countermeasures, CW pulse transmitters, data processing and guidance. R&D and Field.

RELIABILITY ENGINEERING—All levels of engineers to assume responsibilities for reliability prediction, design reviews, components evaluation, failure effect analysis, redundancy in design and environmental testing.

SPECIFICATION ENGINEERING—All levels of engineers to assure conformance of system, environmental, component and process specifications with applicable military formats. Also to establish and revise company standards.

CIRCUIT DESIGN—Engineer & Sr. Engineer levels to perform design of basic circuits relating to missile and other weapons systems. Areas of interest include tube and transistor application to receivers, modulators, transmitters, range tracking, logic, power supplies, parametric amplifiers and other allied circuits. Knowledge of MIL specs desired.

MECHANICAL ENGINEERING—All levels of engineers to perform broad phases of mechanical engineering activities as pertaining to electronic, missile, airborne and ground equipments. Responsibilities relate to such specialized areas as vibration, stress analysis, heat transfer, plastics and metals, airborne and missile packaging, RF shielding, chassis and structures design, and machine shop techniques.

If you are qualified and interested in one of the above areas, send your resume to
Lloyd R. Ware, Staff Engineer



SANDERS ASSOCIATES, INC.

® Trademark reg. U.S. Patent Office

NASHUA, NEW HAMPSHIRE

Electronic Engineers:

Stimulating projects await you in

The NEW Navy

Dramatic changes in the U.S. Navy are being made through rapidly advancing technology. Nuclear-powered guided missile ships will be the backbone of tomorrow's operational fleet. Electronic sensors, guidance, data transfer, and control systems will be the eyes, ears and brains of these new ships.

Advanced programs for which competent engineers are needed as project managers include the following:

SINGLE SIDE BAND TECHNIQUES AND DIGITAL COMMUNICATIONS • SATELLITE COMMUNICATIONS • MODULAR DESIGN • MISSILE SYSTEM ELECTRONICS • TACTICAL DATA SYSTEMS • ANTI-SUBMARINE WARFARE • OCEAN SURVEILLANCE • ELECTRONIC COUNTER MEASURES • HIGH TEMPERATURE TUBES AND PARTS • SOLID STATE DEVICES • ANTENNA DESIGN • POLARIS MISSILE SYSTEM COMMAND COMMUNICATIONS • ELECTRONIC SYSTEMS COMPATIBILITY • THERMOELECTRICS • COMPUTERS

These programs, and others of equal importance, involve practically every known application of electronic and acoustic technology, and offer ample opportunities for professional development and recognition.

The Navy needs college graduates in electronic or electrical engineering and physics. Graduate degrees and one or more years of experience are desirable but not essential. Job-related graduate study is available with partial tuition borne by the Bureau of Ships. Career appointments are made in accordance with Civil Service requirements.

If you want to make important contributions to these electronics programs, address your inquiry and resume to:

Recruitment Officer, Code 263R
Civilian Personnel Division
Bureau of Ships, Navy Department
Washington 25, D.C.

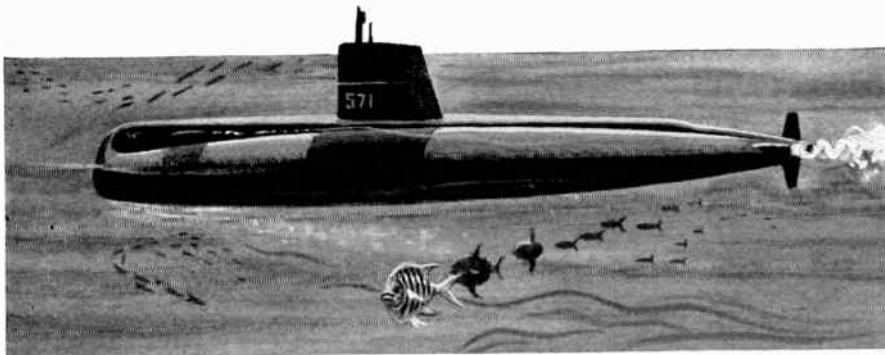

U.S. NAVY

FOR ADDITIONAL INFORMATION

About Classified Advertising,

Contact

The McGraw-Hill
Office Nearest You.

ATLANTA, 3

1301 Rhodes-Haverly Bldg.
JACKSON 3-6951
M. MILLER

BOSTON, 16

350 Park Square
HUBBARD 2-7160
D. J. CASSIDY

CHICAGO, 11

520 No. Michigan Ave.
MOHAWK 4-5800
W. HIGGINS—E. S. MOORE

CLEVELAND, 13

1164 Illuminating Bldg.
SUPERIOR 1-7000
W. B. SULLIVAN—T. H. HUNTER

DALLAS, 2

1712 Commerce St.,
Vaughn Bldg.
RIVERSIDE 7-5117
GORDON JONES—F. E. HOLLAND

DETROIT, 26

856 Penobscot Bldg.
WOODWARD 2-1793
J. R. PIERCE

LOS ANGELES, 17

1125 W. 6 St.
HUNTLEY 2-5450

NEW YORK, 36

500 Fifth Ave.
OXFORD 5-5959
H. T. BUCHANAN—R. P. LAWLESS
T. BENDER

PHILADELPHIA, 3

Six Penn Center Plaza
LOCUST 8-4330
H. W. BOZARTH

ST. LOUIS, 8

3615 Olive St.
JEFFERSON 5-4867

SAN FRANCISCO, 4

68 Post St.
DOUGLAS 2-4600
S. HUBBARD

ELECTRONIC TUBE ENGINEER

FOR PROJECT MATTERHORN AT PRINCETON UNIVERSITY

To set-up and supervise a small tube shop which will supply diagnostic equipment for our expanded thermonuclear research facilities. This man should be thoroughly familiar with all phases of tube technology. He will be responsible for the design and manufacture of electrostatic and magnetic probes, special mass spectrometers, ion gauges, etc.

Project Matterhorn, sponsored by the AEC, has been a controlled fusion research organization at Princeton University since 1951, with well-equipped modern laboratories and professionally outstanding personnel. Inquiries are welcome from qualified engineers who desire a position of responsibility in stimulating surroundings. Additional benefits include 1 month's vacation, major medical insurance, outstanding retirement plan, etc.

Please write R. B. Starbuck, Personnel Director
BOX 451, PRINCETON, NEW JERSEY

• CONTACTS • FOR THE FIELD OF ELECTRONICS

"HOW TO MAKE MONEY IN Mobile Radio Maintenance"

AUTHORITATIVE GUIDEBOOK
ABOUT THE BOOK IN TWO-WAY MOBILE RADIO;
GIVES FACTS, FIGURES, PAY RATES.
WRITE TODAY!



FREE

LAMPKIN LABORATORIES, INC. Instruments Div. BRADENTON, FLA.

BEST PLACE TO STAY IN L.A.

New super-MOTEL, luxury furnishings. Swimming pool, utter privacy, free TV, 24-hr. tel. service. Single rooms or suites. Heart of S.E. industrial area, 10 mins. from dntn. L.A. Handy all freeways. Clean, Commercial rates.

**DOWNEY-CAPRI MOTEL, 8220 Telegraph Rd.
between Lakewood & Paramount Blvds.**

SEARCHLIGHT SECTION

(Classified Advertising)

EMPLOYMENT + BUSINESS
EQUIPMENT — USED OR RESALE

OPPORTUNITIES

—RATES—

DISPLAYED

Individual Spaces with border rules for prominent display of advertisements.

The advertising rate is \$24.75 per inch for all advertising other than Employment.

Employment Opportunities—\$28.67 per inch, subject to Agency Commission.

An advertising inch is measured 7/8" vertically on one column, 3 columns—30 inches—to a page.

UNDISPLAYED

\$2.40 per line, minimum 3 lines. To figure advance payment count 5 average words as a line.

Positions Wanted take one-half of above rate.

Box Numbers in care of our New York, Chicago & San Francisco offices count as one additional line.

Discount of 10% if full payment is made in advance for 4 consecutive insertions.

ADDRESS BOX NO REPLIES TO: Box No.
Classified Acc. Div. of this publication.
Send to office nearest you.
NEW YORK 36: P. O. BOX 12
CHICAGO 11: 520 N. Michigan Ave.
SAN FRANCISCO 4: 68 Post St.

BUSINESS OPPORTUNITIES

French Industrialist desires to contact American Electronics component part manufacturers who would like their products developed in France for the common market countries. Write: Ets. Huyghe, 62, Rue Notre-Dame, Hazebrouck, France.

Wanted—Ideas in electronics or related fields with good potentials. Capital available with stock participation. BO-2704, Electronics.

DISENCHANTED ENGINEERS

If your present employer has failed to utilize your full potential, why not permit us to explore the parameters for your personal qualifications with the many dynamic young companies in aviation, electronics, missiles and rockets. We now have in excess of 4,000 openings in the \$8,000 to \$40,000 bracket, all of which are fee paid. Why wait? Send resume in duplicate at once indicating geographical preferences and salary requirements.

FIDELITY PERSONNEL
1530 Chestnut Street, Philadelphia 2, Pa.
Established 1943

TECHNICAL DIRECTOR \$22,000

Our client, a leading company in the electronics industry needs a technical director who will have complete responsibility over all administrative and engineering personnel in R&D and production of inertial guidance systems. Prefer advanced degree with 8 or more yrs. experience. Mail resume in complete confidence. Client assumes interviewing, moving and agency expense.

ESQUIRE PERSONNEL
202 S. State St. Chicago 4, Illinois

ELECTRONICS-FRANCE

Aggressive well established—since 1932—sales-engineering organization. Best connections to govts & industry, well liked French-American management, will cooperate with U.S. mfrs wishing to enter EUROPEAN COMMON MARKET. Write

RA-2538, Electronics
Class. Adv. Div., P.O. Box 12, N.Y. 36, N.Y.



MANUFACTURERS' REPRESENTATIVES

IN THE ELECTRONIC INDUSTRY

SAMUEL K. MACDONALD, INC.

Manufacturers representatives over 25 years
1531 SPRUCE STREET, PHILA. 2, PA.

Territory: Pennsylvania • New Jersey Delaware • Maryland Virginia • West Virginia District of Columbia	Other Offices: Pittsburgh Baltimore Washington, D.C.
--	---

ADDRESS BOX NO. REPLIES TO: Box No.
Classified Acc. Div. of this publication.
Send to office nearest you.
NEW YORK 36: P. O. BOX 12
CHICAGO 11: 520 N. Michigan Ave.
SAN FRANCISCO 4: 68 Post St.

POSITION VACANT

B.S. and M.S. Electrical Engineers for research work on instrumentation and control problems related to the steel industry. Salary commensurate with training and experience. Large Research Laboratory, Pittsburgh Area. Forward complete resume and salary requirements to P-2283, Electronics.

DON'T FORGET THE BOX NUMBER

PROFESSIONAL SERVICES.

CROSBY LABORATORIES, INC.

Murray G. Crosby & Staff

Radio - Electronics
Research Development & Manufacturing
Communications, FM & TV

299 Robbins Lane, Syosset, New York
WElls 1-3191

ALBERT PREISMAN

Consulting Engineer

Television, Pulse Techniques, Video
Amplifiers, Patent technical consultation.

616 St. Andrews Lane, Silver Spring, Maryland

WANTED ALLEN-BRADLEY RESISTORS & POTENTIOMETERS LEGRI S COMPANY

391 Riverdale Ave. Yonkers 5, N. Y.

GENERATORS

High frequency, 400 cycles, also available in variable voltage and variable frequency at any voltage and phase desired. Driven by constant speed motors or variable speed motors, A.C. or D.C. Control panels also available. Large stock on hand. Write for catalogue and prices.

Reliable Electric Motor Repair Co.
19 California Avenue, Paterson, N. J.

