

APRIL 17, 1959

# electronics

A MCGRAW-HILL PUBLICATION

VOL. 32, No. 18

PRICE SEVENTY-FIVE CENTS

MORNINGSIDE COLLEGE  
LIBRARY  
SIOUX CITY IOWA

## Scoring Practice Missile Shots

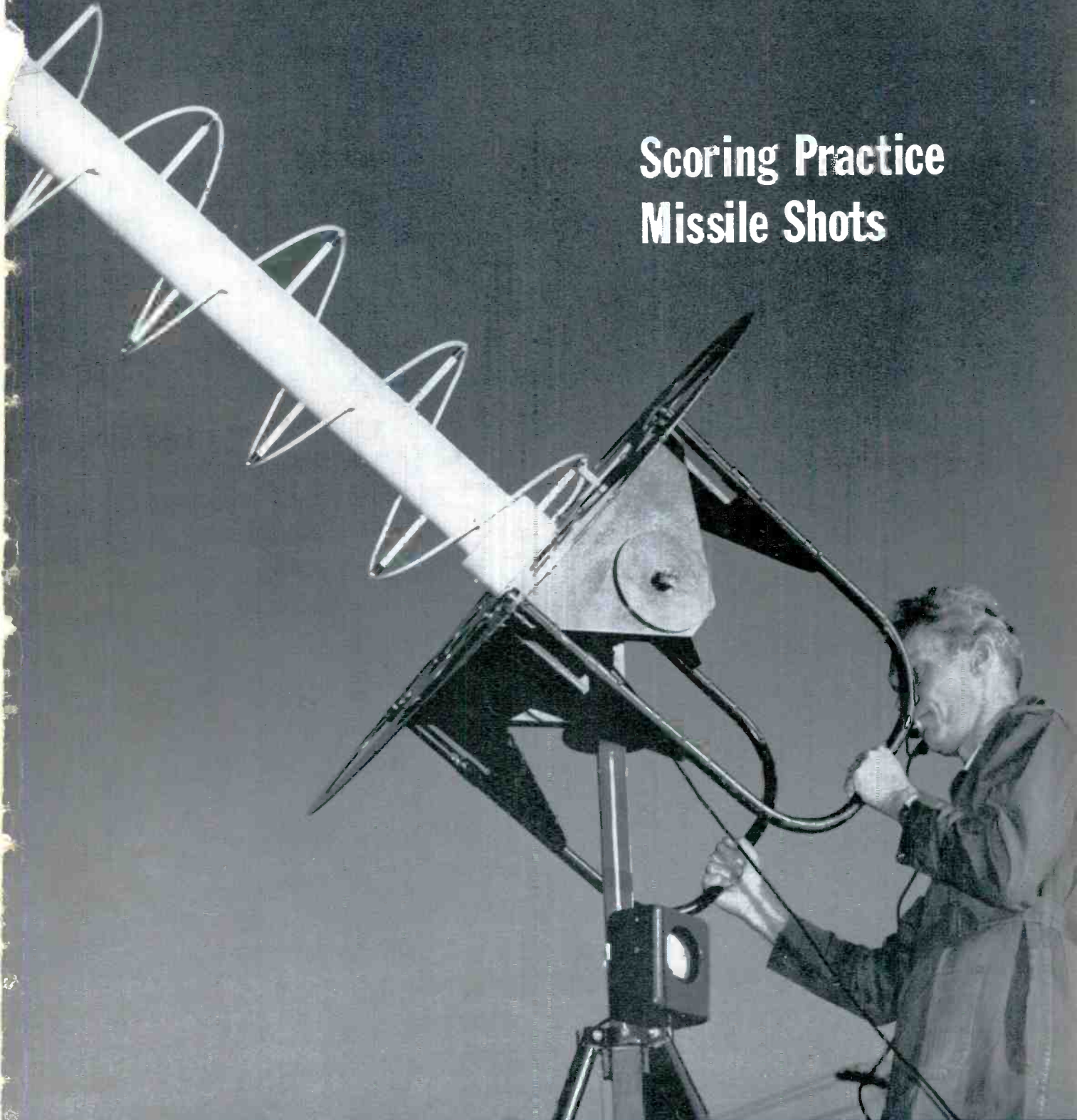

Solving Military Production Problems



**Small  
and Powerful**

# New ADJUSTABLE REGULATED POWER SUPPLY



... provides these regulated outputs:

Output Volts	Regulation (change in output voltage from no load to full load)	Output Current	Change in output volts with $\pm 10\%$ line change
0 to 300v*, dc (continuously adjustable) *120 Cycle Ripple is 1 mv	0.1v	200 ma	$\pm 0.75v$
-150v, dc	0.5v	2 ma	$\pm 1v$

**Plus** two 6.3v, ac unregulated outputs at 5 amperes each, which may be connected in series or parallel

... ALL FROM A COMPACT PACKAGE

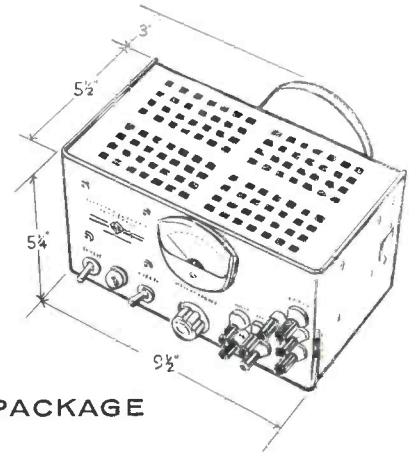

## 120 Watts In 0.2 Cubic-Foot Package...

Excellent performance is obtained by using two regulator circuits. A high-efficiency controlled rectifier maintains the optimum operating voltage for a series regulator, regardless of line-voltage changes, load changes, or changes in output voltage setting. Wide-band regulator circuits and high-frequency by-passing of the output make for low output impedance over a wide frequency range. A large capacity fan provides cooling without dependence on convection, permitting the stacking of any number of units.

Type 1205-B Adjustable Regulated Power Supply, \$290

Write for complete information

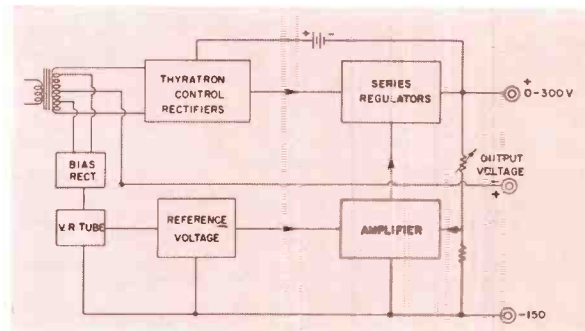

Regulator Block Diagram

## GENERAL RADIO COMPANY

275 MASSACHUSETTS AVENUE, CAMBRIDGE 39, MASSACHUSETTS

**NEW YORK AREA**  
Brook Ave. at Linden  
Ridgefield, N. J.  
N. Y. WOrth 4-2722  
N. J. WHitney 3-3140

**CHICAGO**  
6605 W. North Ave.  
Oak Park, Ill.  
Village 8-9400

**PHILADELPHIA**  
1150 York Rd.  
Abington, Pa.  
HAncock 4-7419

**WASHINGTON, D.C.**  
8055 Thirteenth St.  
Silver Spring, Md.  
JUUniper 5-1088

**SAN FRANCISCO**  
1182 Los Altos Ave.  
Los Altos, Cal.  
WHitecliff 8-8233

**LOS ANGELES**  
1000 N. Seward St.  
Los Angeles 38, Cal.  
HOLlywood 9 6201

**IN CANADA**  
99 Floral Pkwy.  
Toronto 15, Ontario  
CHerry 6-2171

## Issue at a Glance

A McGRAW-HILL PUBLICATION  
Vol. 32 No. 16

JAMES GIRDWOOD, *Publisher*

W. W. MacDONALD, *Editor*

JOHN M. CARROLL, *Managing Editor*

*Associate Editors:* Frank Leary, Michael F. Tomaino, Howard K. Janis, Sylvester P. Carter, Haig A. Manoogian, Roland J. Charest, William P. O'Brien, George Sideris, John F. Mason, William E. Bushor, Ronald K. Jurgen, Thomas Emma, Samuel Weber, Sy Vogel.

*Pacific Coast Editor (Los Angeles)* Harold C. Hood; *Midwestern Editor (Chicago)* Harold Harris; *New England Editor (Boston)* Thomas Maguire.

*Art Director,* Harry Phillips, Roy Thompson.

*Production Editor,* John C. Wright, Jr., Bernice Duffy, Jean L. Matin.

*Market Research,* Edward DeJongh, Marilyn Koren.

*Editorial Assistants,* Gloria J. Filippone, Arlene Schilp, Patricia Landers, Catherine McDermott, Eleanor Schaefer, Carol Weaver.

**BRUCE A. WINNER**, *Advertising Sales Manager.* R. S. Quint, *Assistant Advertising Sales Manager and Buyers' Guide Manager.* Fred Stewart, *Promotion Manager.* Frank H. Ward, *Business Manager.* George E. Pomeroy, *Classified Manager.* Hugh J. Quinn, *Circulation Manager.*

*New York:* Donald H. Miller, Henry M. Shaw, William J. Boyle. *Boston:* Wm. S. Hodgkinson. *Philadelphia:* Warren H. Gardner. *Chicago:* Harvey W. Wernecke, Martin J. Gallay. *Cleveland:* P. T. Fegley. *San Francisco:* T. H. Carmody, R. C. Alcorn. *Los Angeles:* Carl W. Dysinger, D. A. McMillan. *Denver:* J. Patten. *Atlanta:* M. Miller. *Dallas:* Gordon L. Jones, Robert T. Wood. *London:* E. E. Schirmer. *Frankfurt:* Michael R. Zeynel.

### Business

- Solving Production Problems. This answers many questions.....24  
\$75 Million for "Overseas Sage". Most goes to our industry.....29  
What's Ahead In Pay Tv Trials. Five firms may take the plunge...32  
Radar to Contact Venus Again. MIT plans tests in September.....35  
Shoptalk .....4  
Electronics Newsletter .....11  
Washington Outlook .....14  
Financial Roundup .....17  
Over The Counter.....17  
Market Research .....20  
Current Figures .....20  
Meetings Ahead .....36

### Engineering

- Missile Accuracy Detector. Operator positions helix antenna to receive strongest signal from target-missile transponder loop generating separation distance information. See p 42.....COVER  
New Solid-State Devices and Applications. Survey of latest developments in solid-state technology.....By S. Weber 39  
Miss Distance Indicator Scores Missile Accuracy. Missile target separation is measured by transponder loop.....By J. A. Adams 42  
Vidicon-Type Television Camera Tubes. Principal characteristics of 19 commercially available vidicons.....By A. S. Kramer 46  
Scan Converter Aids Phone Line Radar Relay. System transmits data over narrow-band lines...By H. W. Gates and A. G. Gatfield 48  
Direction Finder With Automatic Readout. Bearing averaging scheme improves accuracy....By J. F. Hatch and D. W. G. Byatt 52  
Voltage Regulator Diodes. Military Standard Sizes of Voltage Regulator and Reference Diodes.....By R. F. Edwards 55  
Calibrated Source of Millimicrosecond Pulses. Circuit produces keyed single-shot, or constant repetition pulses...By E. J. Martin 56  
Thermal Design Chart. Nomograph checks transistor thermal safety factor .....By O. D. Hawley and M. Kato 58

### Departments

- Research and Development. Magnetic D-C Amplifier is Drift Free...62  
Components and Materials. Rigid Radome Design Considerations...66  
Production Techniques. New Techniques Discussed at IRE.....70  
On the Market.....74  
Literature of the Week.....82  
Plants and People.....84  
News of Reps.....87  
Comment .....88  
Index to Advertisers.....93

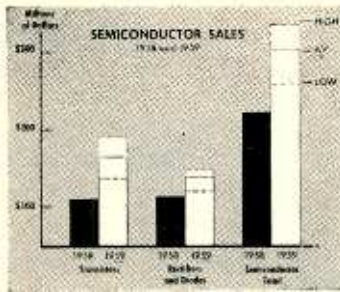

Paul Petrack takes the

stand for **electronics**

ITT (International Telephone & Telegraph Corp.), Components Division, Clifton, New Jersey is a leading electronics manufacturer of electron tubes, fixed capacitors, silicon power diodes, selenium rectifiers, hermetic seals, miniature switches, and other component parts.

Former Chief Engineer, and present Product Manager for silicon products, Paul Petrack is a market expert for electronics components. His functions require him to determine what products will be in greatest demand (according to the industry's latest technical developments) and what products will be the most profitable to market.

According to the subscription records, electronics is sent to your home. Why?

*Because I have more time to read it and more time to digest it.*

Does electronics help you create new business for ITT?

*Yes, by keeping me aware of new developments in industry, the state of the art, and market potentials for existing products, we are better able to direct our efforts toward meeting our product goals.*

What "product image" has electronics conveyed to you over the years?... or, How would you define electronics' position in the electronics industry?

*I consider electronics required reading...it is clear, concise and complete.*

If it's about electronics, it's advertised and read in electronics

# electronics

Published WEEKLY plus the mid-year electronics BUYERS' GUIDE  
A McGraw-Hill Publication • 330 West 42nd Street, New York 36, N. Y.



April 17, 1959 — ELECTRONICS

## C TYPE MAGNETS FOR MICROWAVE APPLICATIONS

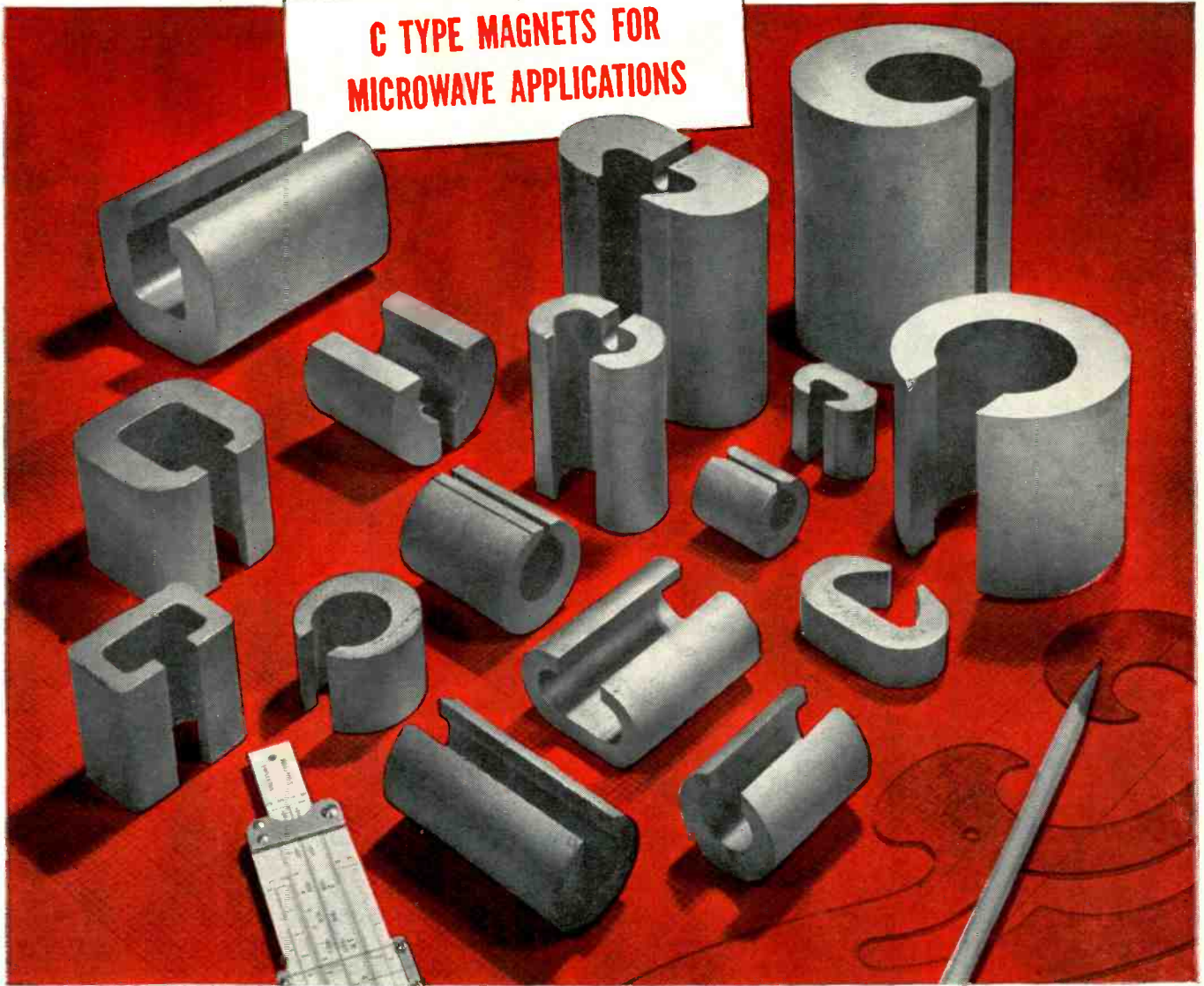

## C TYPE MAGNETS in a wide range of sizes to meet your design needs in ★ Transverse Field Isolators ★ Differential Phase Shifters ★ Duplexers

Arnold C-type Alnico Magnets are available in a wide selection of gap densities ranging from 1,000 to over 7,500 gauss. There are six different basic configurations with a wide range of stock sizes in each group.

The over-all size and gap density requirements of many prototype designs can be met with stock sizes of Arnold C Magnets, or readily supplied in production quantities.

When used in transverse field isolators, Arnold C Magnets supply the magnetizing field to bias the ferrite into the region of resonance, thus preventing interaction between microwave networks and isolating the receiver from the transmitter. These magnets are also used in differential phase shifters and duplexers, and Arnold is prepared to design and supply tubular magnets to provide axial fields in circular wave guides.

A feature of all Arnold C Magnets is the excellent field uniformity along the length of the magnet. Versatility in design may be realized by using multiple lengths of the same size magnet stacked to accomplish the needs of your magnetic structure.

Let us work with you on any requirement for permanent magnets, tape cores or powder cores. ● For information on Arnold C Magnets, write for Bulletin PM-115. Address *The Arnold Engineering Company, Main Offices and Plant, Marengo, Illinois.*

WSW 7428 A



# ARNOLD

SPECIALISTS in MAGNETIC MATERIALS

BRANCH OFFICES and REPRESENTATIVES in PRINCIPAL CITIES  
Find them FAST in the YELLOW PAGES

# SHOPTALK . . .

## electronics

April 17, 1959 Vol. 32, No. 16

Published weekly, with an additional annual BUYERS' GUIDE and REFERENCE Issue in mid-June, by McGraw-Hill Publishing Company, Inc., James H. McGraw (1860-1948) Founder.

Executive, Editorial, Circulation and Advertising Offices: McGraw-Hill Building, 330 W. 42 St., New York 36, N. Y. Longacre 4-3000. Publication Office: 99-129 North Broadway, Albany 1, N. Y.

See panel below for directions regarding subscriptions or change of address. Donald C. McGraw, President; Joseph A. Gerardi, Executive Vice President; L. Keith Goodrich, Vice President and Treasurer; John J. Cooke, Secretary; Nelson L. Bond, President, Publications Division; Shelton Fisher, Senior Vice President; Ralph B. Smith, Vice President and Editorial Director; Joseph H. Allen, Vice President and Director of Advertising Sales; A. R. Venezian, Vice President and Circulation Coordinator.

Single copies 75¢ in the United States and possessions and Canada; \$1.50 for all other foreign countries. Buyers' Guide \$3.00. Subscription rates—United States and possessions, \$6.00 a year; \$9.00 for two years; \$12.00 for three years. Canada, \$10.00 a year; \$16.00 for two years; \$20.00 for three years. All other countries, \$20.00 a year; \$30.00 for two years; \$40.00 for three years. Second class postage paid at Albany, N. Y. Printed in U.S.A. Copyright 1959 by McGraw-Hill Publishing Co., Inc.—All Rights Reserved. Title registered in U. S. Patent Office. BRANCH OFFICES: 520 North Michigan Avenue, Chicago 11; 68 Post Street, San Francisco 4; McGraw-Hill House, London E. C. 4; 85, Westendstrasse, Frankfurt/Main; National Press Bldg., Washington 4, D. C.; Six Penn Center Plaza, Philadelphia 3; 1111 Henry W. Oliver Bldg., Pittsburgh 22; 55 Public Square, Cleveland 13; 856 Penobscot Bldg., Detroit 26; 3615 Olive St., St. Louis 8; 350 Park Square Bldg., Boston 16; 1301 Rhodes-Haverty Bldg., Atlanta 3; 1125 West Sixth St., Los Angeles 17; 1740 Broadway, Denver 2; 901 Vaughn Bldg., Dallas 1. ELECTRONICS is indexed regularly in The Engineering Index.

Subscription: Address correspondence to: Fulfillment Manager, Electronics, 330 W. 42nd St., New York 36, N. Y. Allow one month for change of address, stating old as well as new address. Subscriptions are solicited only from persons engaged in theory, research, design, production, management, maintenance and use of electronics and industrial control components, parts and products. Position and company connection must be indicated on subscription orders.

Postmaster: please send form 3579 to Electronics, 330 W. 42nd St., New York 36, N. Y.



Member ABP and ABC

**HOW IT'S DONE.** We've always liked the phrase, "Ask the man who owns one." And to better serve you, our reader, we often use its first cousin: "Ask the man who does it." This week the asking again pays high dividends.

In a special by-lined article H. W. Vaughan, planning coordinator, Apparatus Division, Texas Instruments Incorporated, discusses problems of production planning and manufacturing of electronic equipment. His question-and-answer presentation makes absorbing reading, as you'll see in "Solving Production Problems" on p 24.

Planning Coordinator Vaughan shares in a new move we're making in our front-of-book pages—that is, having electronics experts write special articles about their business methods for us. We plan more.

**AFTER THE SHOW.** With the Institute of Radio Engineers National Convention and Radio Engineering Show now three weeks past, the editorial staff of ELECTRONICS magazine has evaluated the big week. What did we see and hear? What was really significant? Who did we talk to and what did they say?

During the convention, we had 19 full-time editors on hand in New York. They interviewed nearly 350 top engineers and businessmen. From these interviews came promises of more than 50 feature technical articles—all going above and beyond the technical fare served up at convention sessions. Some of these articles will appear in the very near future. Others will take longer to research, verify and process. From interviews in depth held during show week will also come nearly two dozen exciting stories about the business.

As for the convention technical sessions, a rundown on several top papers will appear in our May 1 issue.

### Coming In Our April 24 Issue . . .

**BLAST OFF!** Man's restless urge for conquest of the unknown has goaded him to the threshold of outer space. No one knows exactly when the first human will hurtle at escape velocity through the cosmos to the moon and planets, but that he will appear certain.

Next week, ELECTRONICS brings you a 16-page Special Report by Associate Editor Manoogian on the vital subject of electronics in space. In laboratories all over the world, the gigantic problems associated with space travel are taxing the ingenuity and the imagination of scientists and engineers. Manoogian's report tells what these problems are, how today's technology can solve some of them, and what the future will probably bring.

To get his story, Manoogian talked to dozens of military specialists, industrial scientists and space-conscious academicians. He pored over hundreds of scientific articles, laboratory reports and other esoteric treatises. The result is a fascinating, up-to-the-minute, comprehensive survey of a field that will have continuously growing impact on our industry.

**TRACKING CONTROL.** An aided-tracking system which matches the electromechanical response of a tracking telescope to the physical and psychological responses of a human operator is described in an article by R. L. Shaum and D. W. Savage of the Sandia Corporation in Albuquerque, New Mexico.

The miniaturized electronic system is designed for continuous positioning control of tracking telescopes, gun turrets, cameras or other equipment to be aimed at moving targets. A computer shapes the signal from the operator's control stick to provide optimum proportion of displacement, acceleration and rate functions of the system. Thus modified, the signal is applied to a servoamplifier and then to the turret drive mechanism electrohydraulically operated.

CK5842

CK5847

 **High** performance

 **High** gain

**LOW** noise

**WIDE** band

with these



**Reliable FRAME GRID\*  
MINIATURE TUBES**

**for military and industrial microwave relay I. F. service**



CK5842 (417A) Triode*		CK5847 (404A) Pentode
27000	$G_m$ ( $\mu$ mhos)	13000
27.0	$I_p$ (mA)	13.5
9.0	$C_{in}$ ( $\mu$ mf)	7.2
1.8	$C_{out}$ ( $\mu$ mf)	3.15
—	$C_{G-P}$ ( $\mu$ mf)	0.05 max.
0.55 max.	$C_{P-K}$ ( $\mu$ mf)	—



\*Grounded Grid Service

Tubes shown actual size

\*Raytheon Frame Grid construction assures: strength and rigidity  
high transconductance • low capacitance • low microphonics



**INDUSTRIAL TUBE DIVISION**  
**RAYTHEON MANUFACTURING CO.**

Reliable Miniature and Subminiature Tubes • Filamentary Tubes • VR Tubes • Rectifiers • Thyratrons • Cathode Ray Tubes  
New York, Plaza 9-3900 • Boston, Blgelow 4-7500 • Chicago, NAational 5-4000 • Los Angeles, NORmandy 5-4221  
Baltimore, SOuthfield 1-1237 • Cleveland, Wlnton 1-7005 • Kansas City, Plaza 3-5330

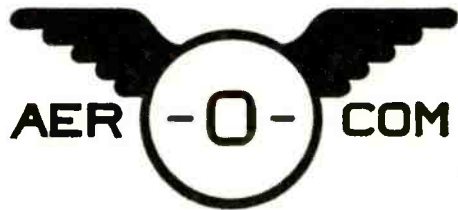

## DEFINITELY DEPENDABLE!

# Aerocom's Dual Automatic Radio Beacon

Reliability is built into every part of this dual 1000-watt aerophare unit. Ruggedly constructed and conservatively rated, it provides trouble-free unattended service, and at truly low operating and maintenance cost. It operates in the frequency range 200-415 kcs, using plug-in crystal for desired frequency.

Uses single phase power supply, nominal 220 volts, 50 or 60 cycles. Consists of two 1 kw transmitters with 2 keyers, automatic transfer unit and weatherproof antenna tuner. Each transmitter housed in separate fan ventilated rack cabinet, with controls in center rack cabinet.

Nominal carrier power is 1000 watts. High level plate modulation of final am-

plifier is used, giving 35% modulation in Type A transmitter or up to 100% modulation in Type B transmitter. P-T switch interrupts tone, permitting voice operation. Operates in ambient temperatures from  $-35^{\circ}\text{C}$  to  $55^{\circ}\text{C}$ , humidity up to 95%.

Standby transmitter is placed in operation when main transmitter suffers loss (or low level) of carrier power or modulation, or continuous (30 sec.) tone, or carrier frequency change of 5 kcs or more. Audible indication in monitoring receiver tells when standby transmitter is in operation.

Antenna may be either vertical tower or symmetrical T type.

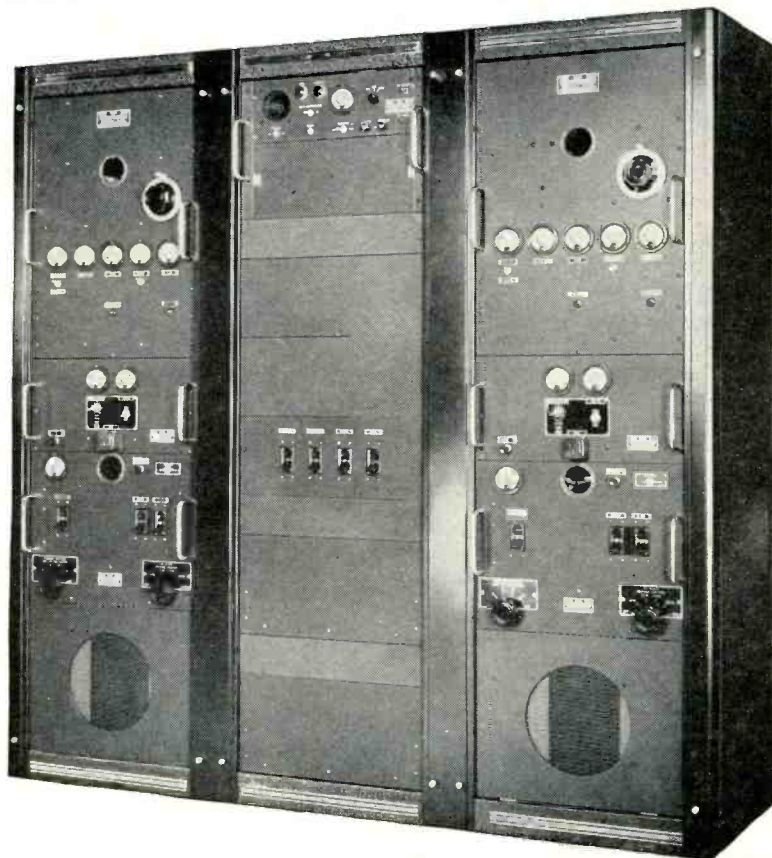

Also available in  
50 WATT  
100 WATT  
400 WATT  
and  
4 KILOWATT  
models

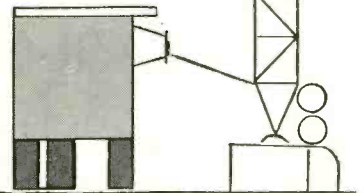

A-101



3090 S. W. 37th AVENUE • MIAMI, FLORIDA



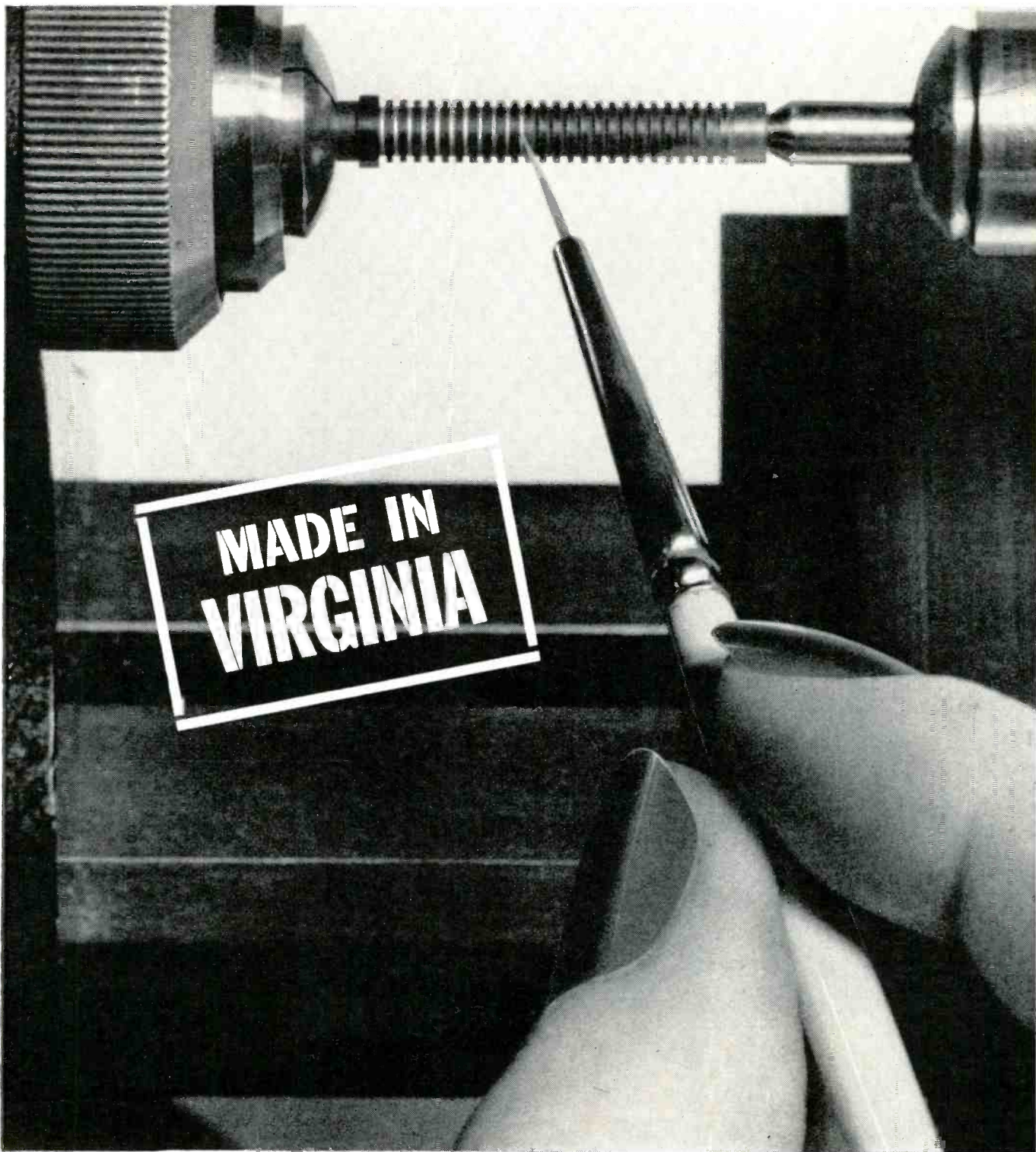

**... WHERE THERE'S A GROWTH SITE FOR YOUR ELECTRONICS PLANT**

This is the hand of a Virginia worker painting an electric circuit 1/10,000 of an inch thick. More than 30,000 such trainable men and women swell Virginia's potential working force each year. Home-rooted, conservative people . . . the kind who've helped make this state's record of labor-management harmony *five times better* than the national average.

That's one reason why the electronics industry is growing far faster in Virginia than in the U. S. as a whole. Your new plant, too, can find a profitable and congenial home in this land of

mild climate, pleasant living and thrifty, friendly government.

Write, telegraph or telephone for more facts or confidential site-finding help in Virginia . . . where you'll enjoy southern production advantages as close as you can get them to the great northeast and mid-west markets.

**Virginia Dept. of Conservation and Economic Development**  
 DIVISION OF INDUSTRIAL DEVELOPMENT

State Office Building, Richmond, Va.

Telephone: Milton 4-4111 Ext. 2255

# specify **OHMITE**®

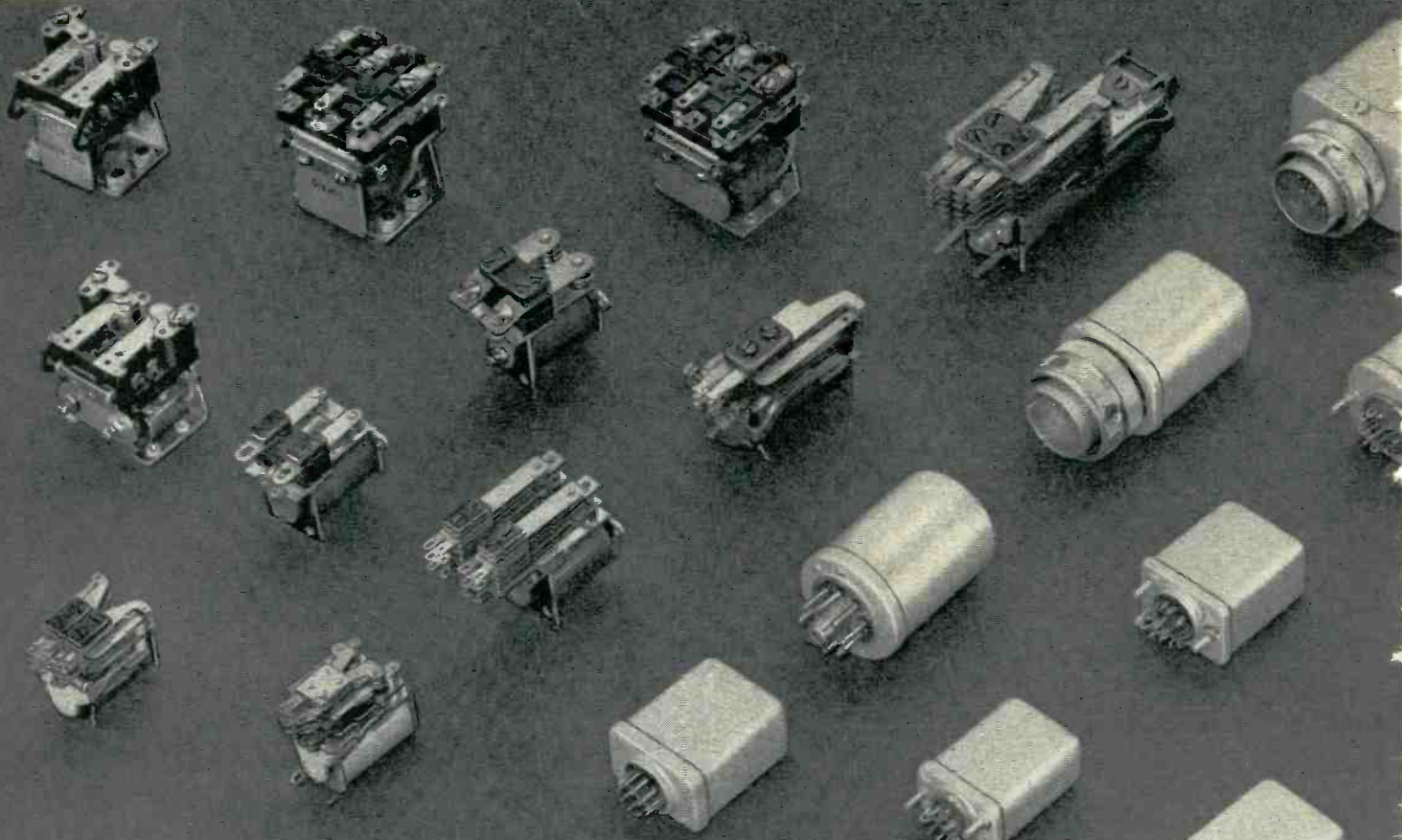

Eleven Standard Models

Typical Relay Enclosures

**EXCLUSIVE! Contact Combinations on New Ohmite Relays are MOLDED\***

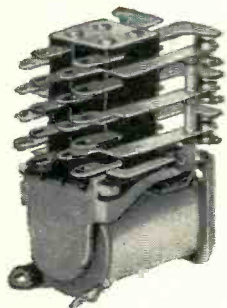

Model TT  
6PDT

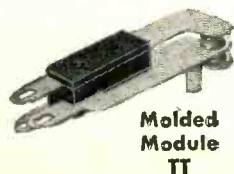

Molded Module TT

Precision and ease of adjustment of the individual contact springs are the result of a revolutionary, new innovation found in two new Ohmite Relays—Models TT and TS. This innovation is the unique "Molded Module"\* contact spring construction. The "module" is a standard, single-pole, double-throw spring combination molded into a single compact assembly. As many as six modules can be incorporated into a single relay.

*\*(Pat. Applied For)*

**QUALITY CONSTRUCTION**—All Ohmite relays embody the same meticulous engineering, strict quality control, and generous use of high-quality materials which have made Ohmite components the standard of the industry. Parts are plated where necessary for corrosion resistance. Springs are of nickel-silver or phosphor-bronze. Contacts are fine silver. Special contact materials, such as silver, tungsten, palladium, or gold alloy, can be supplied. Protection against humidity and moisture is paramount and is accomplished in layer-wound coils, through complete sealing with cellulose-acetate. Relays are available in a wide range of coil operating voltages and contact combinations in both AC and DC types.

**65 TYPES IN FOUR STOCK MODELS**—For fast service, four popular models in the Ohmite relay line are carried in stock in 65 types at the factory, and by Ohmite Distributors from coast to coast.

**HERMETICALLY SEALED AND DUST-TIGHT RELAYS**—You can specify many of the basic Ohmite relays in nonremovable, hermetically sealed enclosures for applications requiring complete relay protection.

# Relays for Reliability

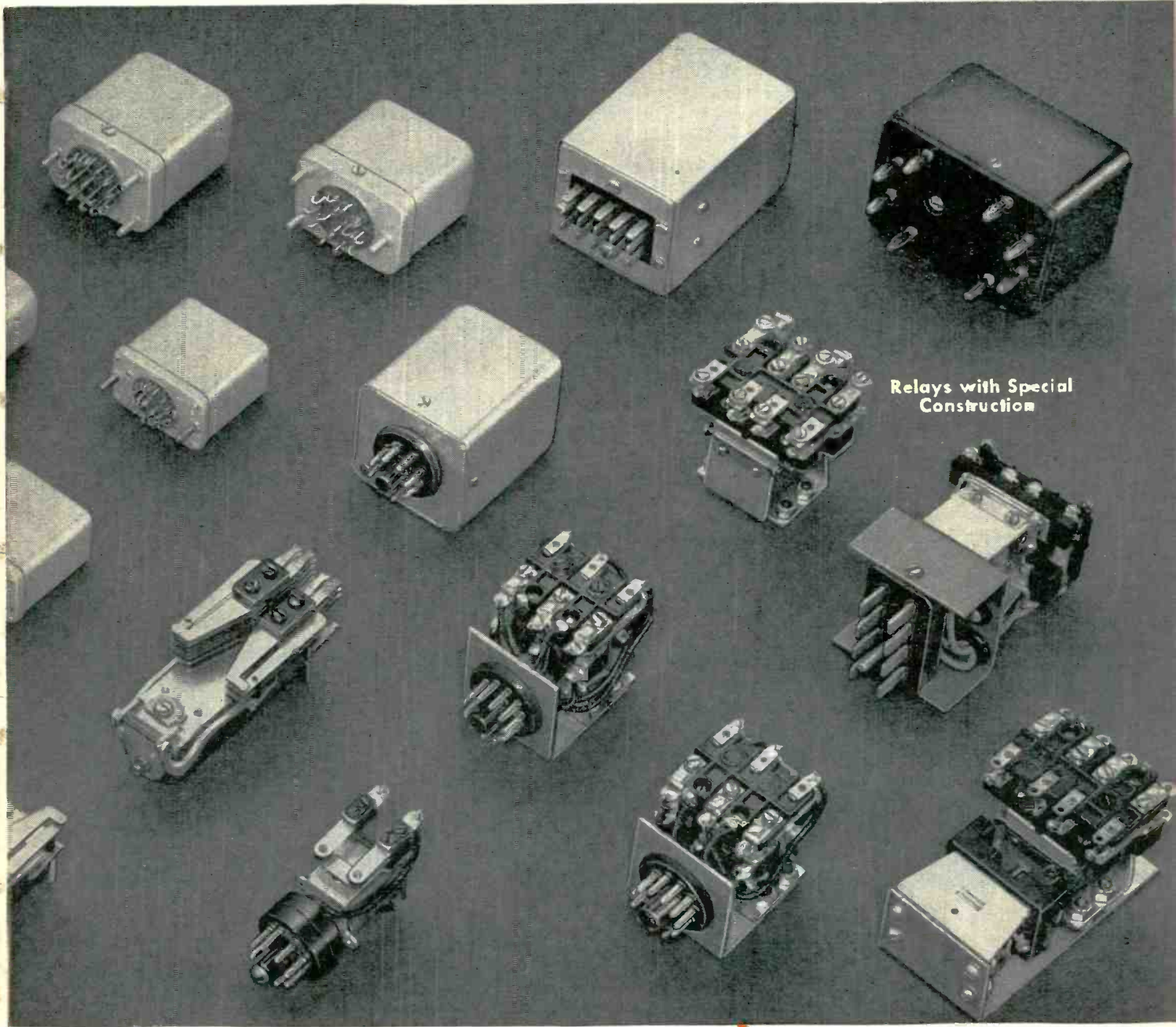

Relays with Special Construction

These high-quality relays are sealed in seamless steel enclosures which are exhausted and filled with dry, inert gas under control of Ohmite engineers. Ohmite hermetically sealed relays are available with either plug-in or solder terminals. Relays are also made with nonremovable dust-tight covers and removable dust covers.

**RELAYS WITH SPECIAL CONSTRUCTION**—Ohmite relays are available with special terminals or special construction, such as relays with push-on or screw terminals, relays with binding-post terminals. Where quantities warrant, Ohmite will manufacture relays made to your specifications. Ohmite can furnish not only special terminals, special contact combinations, contact materials, and coils but also special enclosures, connectors, impregnation, or frames. Ohmite relays can be engineered to meet your special pull-in, drop-out, or time-delay requirements.

*For your special or unusual relay applications, let Ohmite's experienced engineers help you work out the best solution.*

Write on company letterhead for Catalog and Engineering Manual 58.

## OHMITE

MANUFACTURING COMPANY

3610 Howard Street, Skokie, Illinois

RESISTORS	RELAYS	TAP SWITCHES
RHEOSTATS	TANTALUM CAPACITORS	VARIABLE TRANSFORMERS
R.F. CHOKES	DIODES	

# ONLY KIN TEL DIGITAL VOLTMETERS GIVE YOU ALL THESE ADVANTAGES

**1. SINGLE-PLANE READOUT:** KIN TEL digital voltmeters employ a simple projection system to present numbers on a readable single plane... no superimposed outlines of "off" digits... reduced possibility of error. Standard pilot lamps give extra long life.

**2. ADVANCED CIRCUIT DESIGN:** Transistors employed where they contribute to performance and reliability... relay drive coils energized with DC as in telephone type service to provide long, trouble-free operation... automatic, continuous standard cell calibration. No electronic circuitry in readout allows easy remote mounting. Sensitivity control permits stable reading of noisy signals.

**3. MANUFACTURING EXPERIENCE:** KIN TEL has manufactured over 10,000 "standard cell accuracy" DC instruments on a true production line basis. Only by this method, by years of repeated manufacturing experience, by an over-all awareness of the accuracies and tolerances involved, is it possible to guarantee consistent accuracy and reliability... to assure real value for every dollar you invest.

**4. NATIONWIDE APPLICATION ENGINEERING FACILITIES:** KIN TEL has engineering representatives in every major city. An experienced staff of over 200 field engineers is always immediately available to help solve your application problems, provide technical data, or prepare a detailed proposal. Factory level service is available in all areas.

**5. DESIDERATE SPECIFICATIONS (MODEL 401B DC DIGITAL VOLTMETER):** *Display*... 4 digit with automatic polarity indication and decimal placement. Total display area 2" high x 7½" long, internally illuminated. Each digit 1½" high. *Automatic Ranges*... .0001 to 999.9 volts covered in 4 automatic ranges. Sensitivity control provides gain ÷10 setting and least digit sensitivities of .1, 1, and 10 mv. *Accuracy*... 0.01% ±1 digit. *Counting Rate*... 20 counts per sec., providing average balance (reading) time of 1 sec. *Reference Voltage*... Chopper-stabilized supply, referenced to an unsaturated mercury-cadmium standard cell. *Input Impedance*... 10 megohms, on all ranges. *Output*... Visual display, plus print control. Automatic print impulse when the meter assumes balance. No accessories required to drive parallel input printers. *Input*... 115 volt, 60 cycle, single phase, approx. 75 VA. *Dimensions*... Control unit, 5¼" high x 19" wide x 18" deep. Readout display, 3½" high x 19" wide x 9" deep. *Weight*... Approx. 40 lb. *Price*... \$2,450.

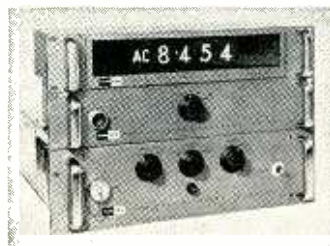

Model 402B AC/DC 4-digit

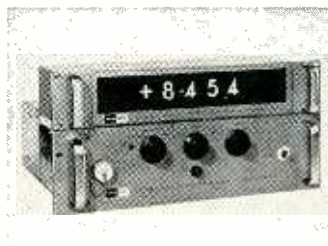

Model 401B DC 4-digit

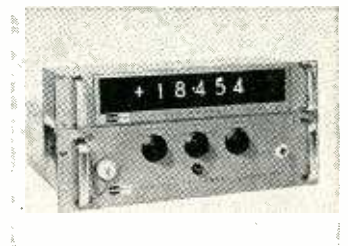

Model 501 DC 5-digit

**6. WIDE RANGE OF MODELS—ACCESSORIES—SPECIAL SYSTEMS:** Versatile "digital building blocks" permit measurement of AC, ohms, ratios of AC and DC, automatic scanning of multiple inputs... 4- or 5-digit models. Preamplifiers increase digital voltmeter sensitivity to 1 microvolt DC, 10 microvolts AC. Buffers permit driving typewriters, tape punches and printers. KIN TEL's Special Products Department can design and manufacture digital instruments to meet special requirements... complete digital systems for data logging, missile checkout and automatic production line testing.



Write today for descriptive literature or demonstration. 5725 Kearny Villa Road, San Diego 11, California

## **ELECTRONICS NEWSLETTER**

**DOPPLER AIR NAVIGATION** system, which is compatible with present airborne VOR equipment and suppresses siting errors caused by obstructions, is announced by Servo Corporation of America. System entails modification of ground VOR gear. Federal Aviation Agency has evaluated use of the system at seven VOR stations where obstructions to siting exist. Firm says its single sideband system frees 50 kc of each of the 100 kc channels allotted to VOR. Since elevation angle as well as course is given by the system, says Servo, a pilot may calculate ground and air-speed with a simple computing aid.

*Air Force intelligence data handling system, designated SAC subsystem 438L, is the subject of a \$752,000 study contract awarded to IBM.*

**NATO ANTISUBMARINE** warfare research laboratory at La Spezia, Italy, to be commissioned May 2, will be managed by Raytheon through a subsidiary which has a nonprofit contract. The ASW center will monitor and analyze oceanographic measurements in selected waters, conduct operational research and analysis and limited development in various phases of antisub warfare.

**TITAN ICBM** is now being pushed rapidly towards operational status. New \$12,125,000 contract for design and development of training base launchers for Titan was awarded last month to American Machine & Foundry Co., bringing its work on the program to \$42 million. Meanwhile, it was learned that design is nearly completed for a Pacific Northwest Titan base. Construction is expected to start by next winter, probably in Idaho. This month bids will be opened for installation of nine Atlas ICBM launchers in the Spokane area.

**X-RAY ULTRAVIOLET** and infrared regions of the electromagnetic spectrum of the sun, stars and nebulae will be explored by NASA astronomical telescopes orbiting 500 mi above the earth on a stabilized platform. This was disclosed as the purpose of a newly formed group in NASA. Another group will aim to put multifrequency radio beacons into a 200 to 500 mi orbit to study distribution of electrically charged particles and electron concentration in the ionosphere.

**BOMARC B** interceptor missile, with solid-propellant booster, will go through a test program in the next few months at Larson AFB, Wash. Boeing is preparing the 500 mi missile for first tests in which it will be harnessed to the ground. About 12 missiles without their ramjet engines and warheads will be fired. Components will be electronically monitored to check reliability. En-

gineers will watch 30-second-long firings on closed-circuit tv in a trailer.

**POLARIS COMMUNICATIONS** systems of the future are the object of a long-term multimillion dollar research contract awarded to RCA. Firm says a number of subcontractors will be involved in study and development work. Meanwhile, Lockheed will start Polaris component and sub-assembly testing with a 200,000 watt Westinghouse amplifier to boost vibration; it causes a 3-ft diameter platform, to which missile parts are attached, to vibrate. Tapes recovered after missile firings will duplicate flight vibration conditions.

**NATIONAL INSTITUTE** for Atmospheric Research is proposed to the National Science Foundation by 13 universities which seek \$71 million over a five-year period. Institute would have labs, planes, computer facility, radar and infrared probing gear, library and shop. Participating universities are Michigan, Johns Hopkins, Wisconsin, Chicago, New York, Florida State, Arizona, Texas A&M, California at Los Angeles, Pennsylvania State, Cornell, St. Louis and MIT.

*Missile detection study contract for an unspecified amount has been received by Sylvania from Rome Air Development Center. Under study will be methods of classifying and tracking targets detected in an ICBM "defensive environment."*

**MISSILE-TYPE MAGNETIC TAPE** is being used to record heartbeat pulsations and blood vessel vibrations of suspected arteriosclerosis victims via plastic cuffs on the wrists and ankles. Lockheed reports it is working with the Heart Research Foundation on early detection of the disease. Taped sounds are converted to mathematical terms and then into points and lines on graphs through computers at the firm's Missiles and Space division at Van Nuys, Calif. Results reportedly can be analyzed to a degree not possible previously. Technique is said to show abnormalities quickly and to indicate severity of the disease if it is present.

**RADIOTELESCOPE** is being built by 10 Ohio State University students directed by professor John D. Kraus under a \$166,000 National Science Foundation grant. Radiation will be received on a flat, tiltable reflector 360 ft long by 100 ft high, reflected to a fixed parabolic antenna 360 ft long by 70 ft high and then to the receiver for recording. NSF says the collecting area of the tiltable antenna will be about equal to a 170-ft diameter steerable dish antenna at about 10 percent of the cost. Earlier grants for the work totaled \$106,650.

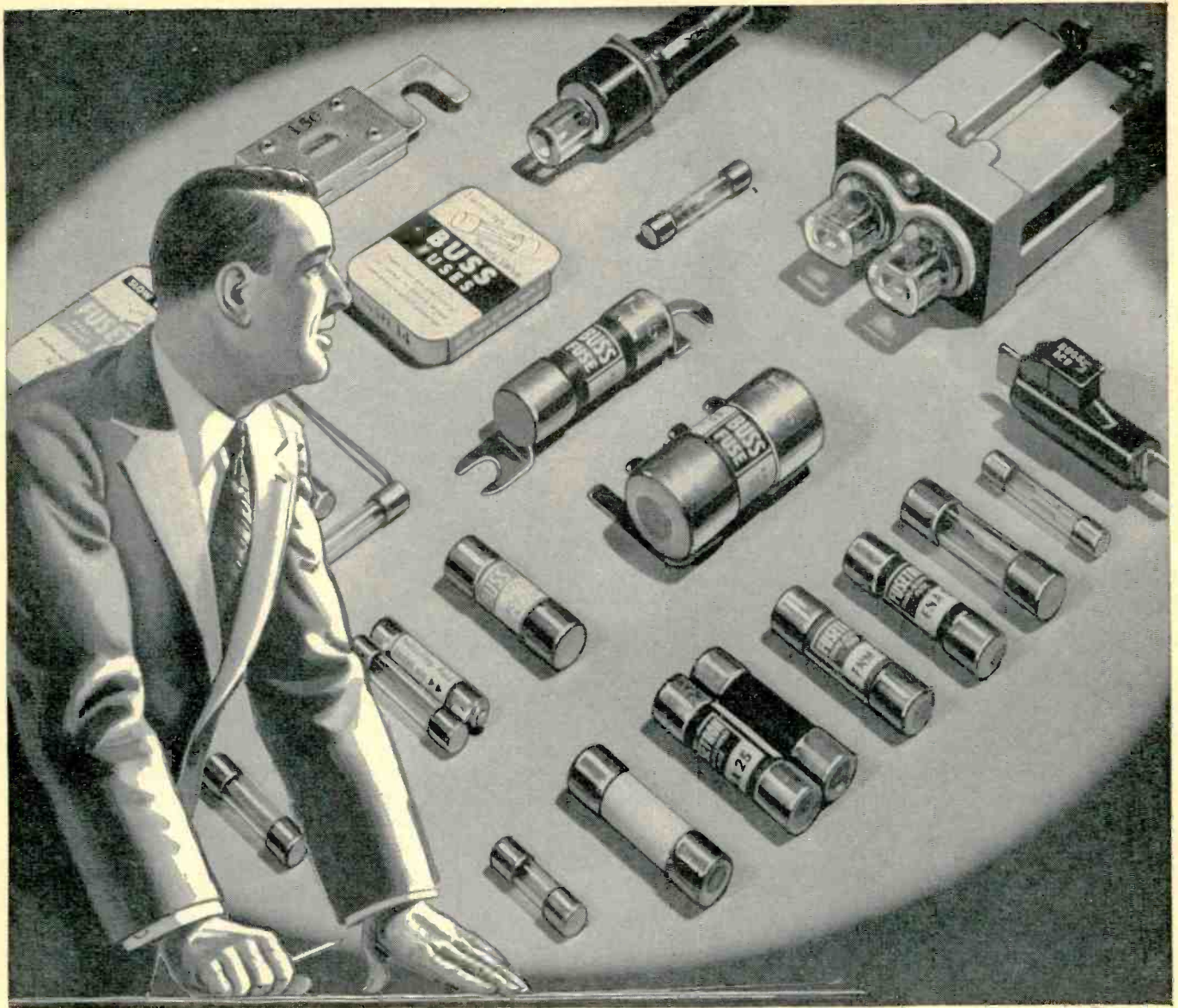

## *BUSS Fuses provide Maximum Protection against damage due to electrical faults*

When an electrical fault occurs, BUSS fuses quickly clear the circuit. By preventing useless damage, BUSS fuses help to get your equipment back in operation sooner. Users of your equipment are safeguarded against the expense of unnecessary repair bills.

BUSS fuse dependability also prevents needless blows that 'knock' equipment out-of-service without cause. Users are protected against irritating and often costly shutdowns due to faulty fuses blowing when trouble does not exist.

### **Electronic Testing Assures Dependability in BUSS Fuses**

Every BUSS fuse is tested in a sensitive electronic device that automatically rejects any fuse not correctly calibrated, properly constructed and right in all physical dimensions.

By specifying BUSS fuses, you are providing the finest electrical protection possible, — and you are helping to safeguard the reputation of your product for quality and reliability. To meet your needs, the BUSS fuse line is most complete.

If you have an unusual or difficult protection problem . . . let the BUSS fuse engineers work with you and save you engineering time. If possible, they will suggest a fuse already available in local wholesalers' stocks, so that your device can easily be serviced.

For more information on BUSS and FUSETRON Small Dimension fuses and fuseholders, write for bulletin SFB.

Bussmann Mfg. Division McGraw-Edison Co., University at Jefferson, St. Louis 7, Mo.

*BUSS fuses are made to protect — not to blow, needlessly*



A COMPLETE LINE OF FUSES FOR HOME, FARM, COMMERCIAL, ELECTRONIC, AUTOMOTIVE AND INDUSTRIAL USE.



## ***From Crosley...*** **Command Receivers for Drones and Missiles**

**Designed** and manufactured by Avco's Crosley Division, Command Receivers are standard equipment aboard most of the nation's missiles. Their job: To receive and act upon instructions from the ground to destroy the missile when its flight path indicates the missile has gone awry.

**In a missile configuration**, the Command Receiver weighs only 12 pounds, has three channels and incorporates a decoder and power supply in a simple pressurized package.

**A second version** of the Command Receiver, employing 12 channels for radio communication, is used in high-performance drones and decoys. In such applications, the Command Receiver actuates control surfaces, directs engine operation and opens the recovery parachute—all by radio-conveyed instructions from the ground.

**A Product of Crosley Engineering**, the Command Receiver has proven itself for the future by the job it is doing in the missiles and drones of today.

*For more information, write to:  
Vice-President, Marketing-Defense Products,  
Dept. E-49, Crosley Division, Avco Corporation,  
1329 Arlington Street, Cincinnati 25, Ohio.*

Unusual career opportunities for qualified scientists and engineers... write Avco, Crosley today.

**Avco**  **Crosley**



Weighting only 12 pounds, Crosley Command Receivers direct destruction of off-course missiles, control drone recovery.

# ITT

## What's New in ITV

Many exciting new uses for closed circuit television save time, life, health and money for industry, military, education and business.

- In the Antarctic, the Navy uses CCTV on a helicopter to picture ice conditions to an ice breaker following.
- A utility using ITV to observe water levels saved three salaries.
- In handling freight, ITV inspected cars and gondolas from a distance.
- Watching oil drilling or diving operations on the ocean floor from the surface.
- Checking factory operations for floors above from the main floor saved time and money.
- Guiding bulldozers run automatically in radioactivity areas from a safe distance.
- Stores and markets cut shoplifting and pilferage with ITV.
- Flame patterns in combustion chambers of engines and boilers may now be observed.
- Large organizations reach dealers through ITV in many cities for simultaneous meetings.
- Traffic flow through tunnels or toll bridges is checked and controlled.
- TV camera on factory roof scans large roofs for fires.



ITT makes a complete and versatile line of closed circuit TV for every military, industrial, business and educational requirement. For bulletins, engineering data and other information call our nearest office.

Los Angeles, Calif. .... EMpire 7-6161  
Detroit, Mich. .... JEfferson 6-4040  
Fort Myers, Fla. ... WYandotte 5-2151  
Washington, D.C. .... EMpire 5-1515  
Denver, Colo. .... AMherst 6-2714  
New York City .... OXford 5-0082  
San Carlos, Calif. .... LYtell 3-2189  
Ft. Worth, Tex. .... JEfferson 5-2056

### Industrial Products Division

International Telephone and Telegraph Corp.  
15191 Bledsoe St., San Fernando, California

Closed Circuit TV • Custom Power Equipment  
Infra Red Equipment • Large Screen Oscilloscopes  
Electronic Instruments • Autopilots for Aircraft

CIRCLE 11 READERS SERVICE CARD

## WASHINGTON OUTLOOK

THE AIR FORCE is evaluating proposals from 13 companies or industry teams competing for a weapon system development contract on WS-138, the air-launched ballistic missile (ALBM). The Pentagon expects to announce a prime contract award by June 1. A second prime contract may be awarded for a back-up project.

Single bids have been made to the Air Research and Development Command by Raytheon, Northrop, Boeing, Martin, Republic, Fairchild, North American Aviation, Temco, RCA and McDonnell.

Team proposals were submitted by General Electric and Douglas Aircraft; Thompson Ramo Wooldridge and Bell Aircraft; and Lockheed and Convair.

Martin, McDonnell, and the Lockheed-Convair team were contractors on the Air Force's Project Bold Orion—a series of experimental airborne rocket launches to demonstrate the feasibility of the ALBM concept.

According to Air Force insiders, at least three different inertial guidance systems figure in the 13 project proposals. Kearfott's system is involved in the Raytheon, GE-Douglas, Martin, McDonnell, Fairchild, Republic, and Temco proposals; Northrop and RCA have their own designs; the other four bidders would use a system designed by NAA's Autonetics division.

- FCC hearings on use of the 25 to 890 mc part of the spectrum have reached an impasse. Until the Pentagon reports on whether the military might swap some frequencies, FCC is stuck. A decision should be made in two or three months.

Commissioner John S. Cross doubts that the military will take some uhf television space in exchange for some more vhf channel space. He says it would render millions of dollars worth of military electronic equipment obsolete and interfere with U.S. international agreements.

Mobile radio interests, pressed for spectrum space, are hitting hard at the big band of uhf tv channels going to waste. Their argument seems convincing in light of the recent report of a broadcasting industry group that prospects for further uhf development are slim.

- NASA is beefing up its electronics facilities at the miniature Cape Canaveral being built at Wallops Island, Va. In addition to the scores of high altitude rockets fired from the base, it is testing elements of the Polaris missile system and the man-in-space Project Mercury program.

In addition, communication and weather satellites will be fired from the site within the next couple of years.

To handle the program, NASA will spend close to \$10 million for additional instrumentation. A new tracking station is slated to be built in Bermuda, to be in service by mid-1960 and costing an estimated \$10-million. The station will not only track satellites and rockets, but will be capable of commanding them, including the man-in-space capsules.

A new 60-ft dish radar to be erected on a 90-ft tower is to be built by Lincoln Laboratories on the mainland behind the island. It will cost an estimated \$2.5 million and be in service within the next year.

A missile destruction system, too, is being installed at Wallops Island.



# NEW TRANSFER OSCILLATOR

Permits your  524 series Counter to measure to 12.4 KMC with true counter accuracy, "low frequency" convenience!

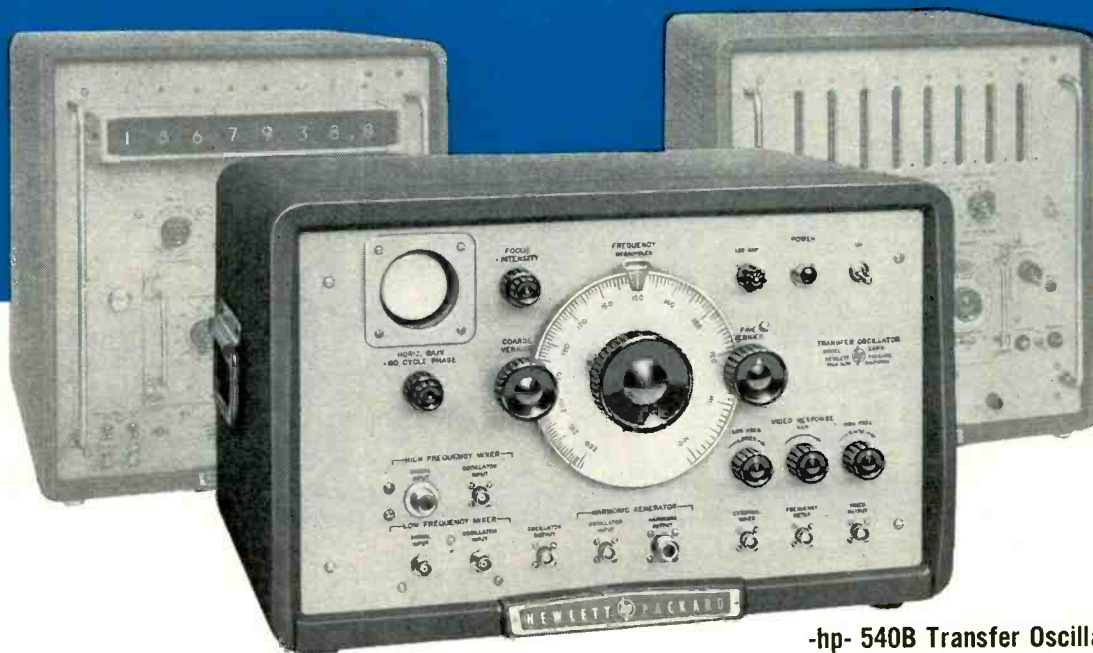



-hp- 540B Transfer Oscillator

Quickly, here's what this new  540B Transfer Oscillator does for you:

Extends frequency counter accuracy far into the microwave region. Permits measurement of pulsed, CW, FM, AM or noisy signals. Provides multiple check for positive accuracy. Measures FM deviation. Requires no external mixer or tuning. Eliminates complex setups.

*Measurements such as those listed above are made with a convenience and accuracy heretofore associated*

*only with much lower frequencies.*

Model 540B is an improved version of the popular  540A. It measures frequencies by comparing harmonic output with the unknown and measuring the fundamental on a counter such as  524 series. The instrument has a self-contained oscilloscope detector for comparison with unknown frequencies. A precision tuning control permits the oscillator harmonic to be locked with the measured frequency.

## Specifications:

<b>Frequency Range:</b>	10 MC to 12.4 KMC	<b>Bandwidth:</b>	Variable. High Freq.: 3 db point adjustable 1 KC to 2 MC. Low Freq.: 3 db point switched from 100 cps to below 10 KC.
<b>Input Signal:</b>	CW, FM, AM or pulse	<b>Output:</b>	1 v rms maximum into 1,000 ohms
<b>Input Signal Level:</b>	Varies with frequency and individual crystals	<b>Oscilloscope Frequency Range:</b>	100 cps to 200 KC
<b>Accuracy:</b>	Depends on input signal. With stable, noise-free CW signal, accuracy approaches that of frequency counters.	<b>Vertical Sensitivity:</b>	5 mv rms/inch at mixer output
<b>Oscillator Frequency Range:</b>	100 MC to 220 MC (fundamental) Above 12.4 KMC (harmonic)	<b>Horizontal Sweep:</b>	Internal, power supply frequency with phase control; or external, 1 v/inch, 20 cps to 5 KC.
<b>Stability:</b>	Less than 0.002% change per minute after warmup	<b>Price:</b>	\$750.00 (cabinet)    \$735.00 (rack mount)
<b>Amplifier Gain:</b>	Variable to 40 db or more		

Data subject to change without notice.

## HEWLETT-PACKARD COMPANY

DEPT. 5492A, 275 PAGE MILL ROAD, PALO ALTO, CALIFORNIA, U.S.A.

Cable "HEWPACK" • Davenport 5-4451

FIELD REPRESENTATIVES IN ALL PRINCIPAL AREAS



world leader in microwave measuring equipment

# NEW FROM TI

## 1N2175 SILICON PHOTO-DEVICE SWITCHES FROM DARK TO LIGHT CURRENT IN 2 MICROSECONDS

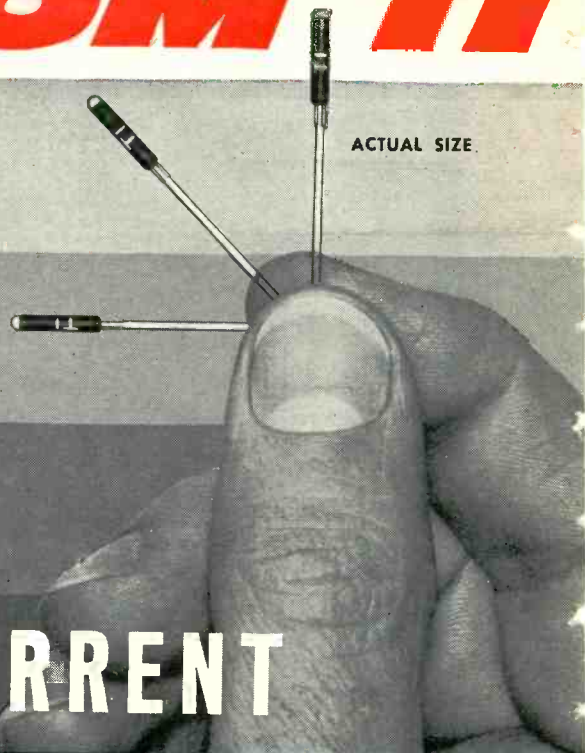

ACTUAL SIZE

**TI 1N2175 subminiature unit is ideal for punch-card or tape data processing, and many other control systems**

Now you can get quadrupled sensitivity and unprecedented design flexibility with the new subminiature TI 1N2175 Photo-Device.

Easily activated, the 1N2175 switches from a low dark current of only  $0.5 \mu\text{a}$  to a high light current of  $1200 \mu\text{a}$  at 1200 ft-candles — *within 2  $\mu\text{secs}$* . Rated at 250 mw at  $25^\circ\text{C}$ , the 1N2175 operates over a range of 1-50 volts, and derates linearly to  $125^\circ\text{C}$ . Minimum operating temperature is  $-55^\circ\text{C}$ .

Specify the TI 1N2175 today and get immediate *off-the-shelf* delivery in 1-999 quantities from all authorized TI distributors and production quantities through TI sales offices.

PHOTOCURRENT CHARACTERISTICS AT  $25^\circ\text{C}$

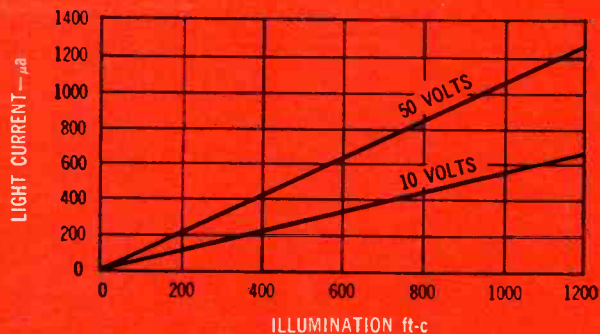

Light source—tungsten filament lamp operated at a color temperature of  $2870^\circ\text{K}$



from THE WORLD'S LARGEST SEMICONDUCTOR PLANT



**TEXAS INSTRUMENTS  
INCORPORATED**

SEMICONDUCTOR-COMPONENTS DIVISION  
POST OFFICE BOX 312 • 13500 N. CENTRAL EXPRESSWAY  
DALLAS, TEXAS

CIRCLE 12 READERS SERVICE CARD

# Instrument Earnings Rise

TODAY'S REPORTS from electronic instrument manufacturers indicate steadily climbing sales and promising growth in this field. Some examples of expanding activity are:

- **Texas Instruments Inc.**, Dallas, cites 1958 as its most successful year with all-time high levels in both sales and earnings. The Texas firm reports sales up 37 percent and earnings after taxes up 60 percent compared with 1957. Last year's sales were \$91,953,845 with earnings of \$6,000,928. Year-end backlog was over \$61 million.

- **Nuclear-Chicago Corp.**, manufacturer of radioactivity detection and measuring instruments, reports a new high in earnings for the six-month period ended February 1959. This total comes to \$261,853, as compared with \$181,469 for the same period in the year preceding. This amounted to 40¢ a share compared with 28¢ a share on the firm's 657,124 shares.

- **Electro-Instruments**, San Diego, Calif., attributes a rise in income to development of new instrument equipment. In the nine-month period ended in February 1959, earnings were 87¢ a share as compared with 66¢ a share for the same period last year. Company officials say customer acceptance of a new transistorized wideband amplifier and a new line of high-speed digital measuring equipment has raised this year's total earnings 29 percent to \$467,301, as compared with the previous total of \$361,652 on 550,000 shares currently outstanding.

- **Assembly Products Inc.**, Chesterland, O., plans a 30-percent plant expansion which will add about 9,600 square feet to the firm's facilities. Company shipments came to \$2,172,383 in 1958, up 4 percent from the 1957 total of \$2,084,719.

- **The Victoreen Instrument Co.**, Cleveland, O., plans financial ex-

pansion by registering 248,394 shares of stock subject to SEC approval. The offering will be made to holders of common stock and debentures at the rate of one new share for four old, or 8 shares for each \$100 of debentures. It is anticipated that \$275,000 of the proceeds will be used in connection with operation of the recently acquired **Kolus Corp.**, and \$125,000 will be used for expansion of the **Tullamore Electronics Corp.** owned by Victoreen.

## OVER THE COUNTER

1958 LOW	BIDS HIGH	COMMON STOCKS	WEEK ENDING	
			Mar. 26 BID	April 3 BID ASKED
3 3/4	20 1/2	Acoustica Assocs	38	31 39 3/8
1 5/8	3	Advance Industries	3 1/4	3 1/8 37/8
3 1/8	6 3/8	Aerovox	8 1/4	77/8 9
5 1/2	15	Appl'd Sci Princet	10 1/4	11 1/4 12
1 1/8	8 7/8	Avien, A	8 5/8	9 1/4 10 1/2
6 3/4	24	Baird-Atomic	27 1/4	28 1/2 33 1/4
9 3/4	13 3/8	Burndy	15 3/4	14 3/4 17
6 3/4	9	Cohu Electronics	8 1/4	7 3/8 9 3/4
11	22 1/2	Collins Radio	33 1/2	33 35 3/4
32 1/2	49	Cook Electric	49	43 1/2 53
4	7	Craig Systems	10 1/4	9 3/4 11 1/4
17 5/8	25 3/8	Eastern Industries	20	19 1/2 22 1/4
1 3/4	8 3/8	Elco Corp	8 1/2	7 1/4 9 1/8
10 1/2	21	Electro Instr	28 3/4	28 32 1/2
34	49	Electronic Assocs	41	40 1/2 46 5/8
5	11	Electronic Res'rch	19	16 1/2 20 3/8
8 1/2	12 3/4	Electronic Spec Co	14 1/4	14 1/8 16 1/2
15 1/4	49 1/2	Epsco, Inc	38	36 42
5 1/2	9 3/8	Erie Resistor	9 5/8	9 1/2 11 1/8
10	17 1/2	Fischer & Porter	15 3/4	15 3/4 17 1/4
5 1/2	10 1/2	G-L Electronics	15 1/4	13 1/2 16 1/4
12	27	Giannini	29	30 1/2 35 5/8
...	...	Haydu Elec Prod	5 1/4	5 1/4 6 1/2
30	39 1/2	Hewlett-Packard	47 3/4	46 50 3/8
23 1/4	48	High Voltage Eng	55	53 59 1/2
1 3/4	3	Hycon Mfg	3 3/8	3 3/4 4 1/2
1 1/8	5 1/8	Industro Trans'tor	4 1/2	5 1/4 6 7/8
...	...	Internat'l Rec'fr	26 3/4	25 3/4 28 7/8
...	...	Interstate Engin'g	31 1/2	30 1/2 33 3/4
1 1/2	4 3/4	Jerrold	6 1/8	6 3/8 7 1/4
21	30	D. S. Kennedy	33 1/4	31 3/4 35 5/8
3 3/4	29	Lab For El'tronics	35	32 36 1/4
19 1/4	28	Leeds & Northrup	28 1/2	28 1/2 31 1/8
2	3 1/8	Leetronics	3 1/8	3 1/4 4
5	18 3/4	Ling Electronics	25 1/4	26 1/2 30 7/8
3 1/4	8 1/4	Magnetic Amplifiers	10	10 1/8 11 1/2
27 1/4	4 1/2	Magnetics, Inc	5 1/8	5 1/4 5 3/4
4 5/8	12	W. L. Maxson	13 1/4	14 1/8 16
10 5/8	29	Microwave Assocs	43	34 44
5 1/4	11 3/4	Midwestern Instr	11	11 1/8 14 1/8
1 1/8	7	Monogram Preci's'n	13 3/4	11 1/4 14 7/8
3 1/2	7 1/4	Narda Microwave	7 3/4	9 3/4 11
...	...	Narda Ultrasonics	11 1/2	10 1/8 12
9 3/4	16 1/2	National Company	20 3/4	19 3/4 22 1/2
14 1/4	56	Nuclear Chicago	39	38 42
4 1/2	7 3/8	Pacific Mercury, A	12 1/4	11 1/4 13 5/8
10 1/8	27 1/2	Packard-Bell	40 1/2	39 44
4 1/4	9 3/8	Panellit, Inc	7 3/8	7 7/8 8 1/2
21	53 3/4	Perkin-Elmer	45 1/4	43 47 1/4
11 3/8	19 1/2	Radiation, A	23 3/4	21 3/4 24 3/8
2 1/8	7 3/8	Reeves Soundcraft	7 7/8	7 5/8 8 3/8
13	32 1/2	Sanders Associates	28 1/2	26 30 3/8
...	...	Silicon Transistor	9 1/2	9 11 1/4
7	12	SoundScriber	18	18 19 5/8
22 3/4	40	Sprague Electric	44 1/2	46 49 1/2
26	35	Taylor Instruments	36 1/4	34 3/4 38 1/2
5 1/2	15	Technical Operat'ns	22	18 24 1/8
5 1/2	15 3/4	Telechrome Mfg	24 1/2	24 1/2 28 1/4
3 1/4	7 3/4	Telecomputing	12 1/4	10 3/4 13 1/8
1 1/8	2 3/4	Tel-Instrument	2 1/2	2 1/2 3
8 3/4	16 1/4	Topp Industries	14 1/4	14 3/8 15 7/8
3 3/4	10 3/4	Tracerlab	12 1/2	11 1/2 13 1/8
1 1/8	3 3/8	Universal Trans'tor	7 1/8	7 1/8 7 5/8
14 1/4	40	Varian Associates	49 3/4	49 1/2 54 1/2

The above "bid" and "asked" prices prepared by the NATIONAL ASSOCIATION OF SECURITIES DEALERS, INC., do not represent actual transactions. They are a guide to the range within which these securities could have been sold (the "BID" price) or bought (the "ASKED" price) during preceding week.



With capability and capacity in both engineering and production, Royal's skills and manufacturing resources are at your service for multi-conductor cables for special applications. Simple or complex constructions, Royal handles them all with precision, for dependable performance.

Send us your specifications, or ask to have a representative call.  
**ROYAL ELECTRIC CORPORATION**  
 301 Saratoga Avenue  
**PAWTUCKET • RHODE ISLAND**

**ROYAL**  
 ELECTRIC  
 ... an associate of  
**CIRCLE 13 READERS SERVICE CARD**

## One-million unit-hours without failure

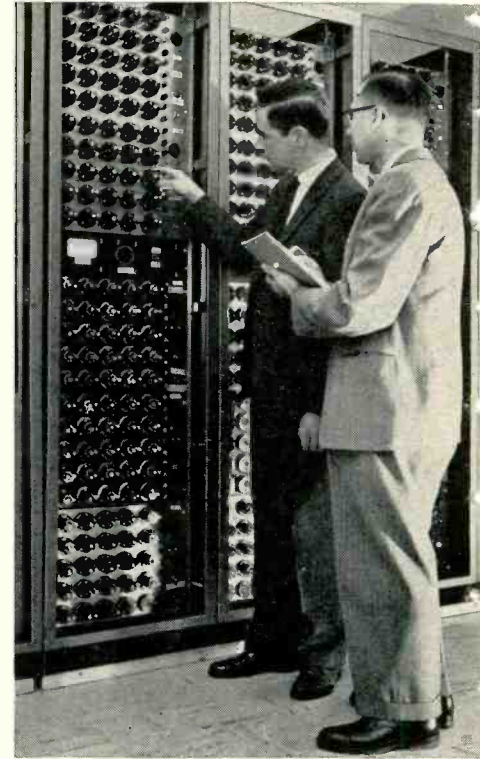
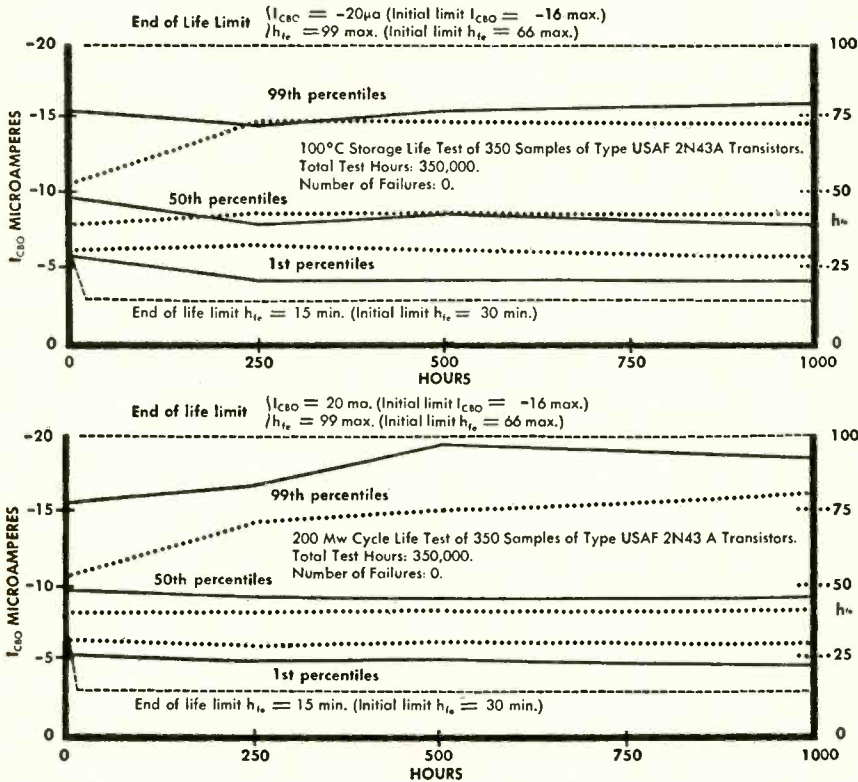

Dick Welch (left), Transistor Evaluation Engineer and Lee Leinweber, Transistor Production Engineering, take readings at cycled-life-test rack. In addition to electrical testing, G-E 2N43A transistors are subjected to all mechanical-test requirements specified in MIL-T-19500/18.

**G-E 2N43A LIFE-TEST DATA OBTAINED AT 1000-HOUR POINTS.** Upper chart shows results of 100°C storage test (25°C storage test not shown). Lower chart shows results of 200 mW operating test. Broken lines in each chart indicate  $h_{TE}$ . Solid lines indicate  $I_{CBO}$  in microamperes. After 1000 hours of testing, there were no failures. The 2N43A transistor's high standard of quality is inherent in all G-E germanium PNP audio and switching transistors.

## 20% Safety Factor for silicon rectifiers aids designers

Designers who now apply their own safety factor to the published peak inverse voltage rating may avoid this step by using G-E low-current silicon rectifiers.

General Electric's PIV figures are set by allowing a 20% safety margin at  $-65^\circ\text{C}$ . This margin is applied at the point of sharp breakdown voltage and increases with temperature until a maximum safety factor of 33% is reached at  $150^\circ\text{C}$ .

If you are derating published PIV figures to provide over-voltage protection, you may be buying costlier cells than you need, or, in series applications, more cells than necessary. Thus the built-in safety margin of G-E low-current silicon rectifiers could save you money. Note: This safety factor is provided for over-voltage protection only. Designs should, in all cases, be maintained within published maximum ratings.

This is only one reason why you should consider G-E low-current silicon rectifiers for all your power requirements. You'll find these devices more attractive to use than ever before—both in quality and price—with equally fine values in low-current silicon stacks. Stud-mounted units are also available. Ask your G-E semiconductor representative for the "big news" on low-current silicon rectifiers.

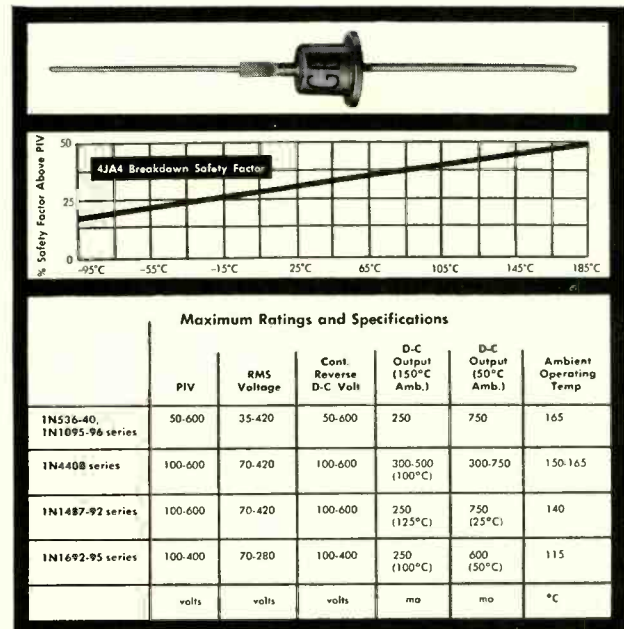

# for General Electric audio transistors

General Electric's 1958 process and quality-control advances were reflected in recent life-test results exhibited by G.E.'s line of germanium PNP audio transistors. Random samples of Type-2N43A transistors were subjected to rigorous mechanical testing . . . drop-shock, detergent-bomb, lead-fatigue (i.e., all the MIL-T-19500/18 mechanical test requirements). Then a total of 1050 Type 2N43A transistors were put on Life Test, with the following results:

350 (10 lots, 35 units each) were given a 100°C storage test for 1000 hours. No failures.

350 (10 lots, 35 units each) were given a 25°C storage test for 1000 hours. No failures.

350 (10 lots, 35 units each) were given a 200 mw cycled-life test for 1000 hours. No failures.

Engineering test data indicate that, without exception, parameters remained stable (see curves at left).

The G-E 2N43A transistor is representative of the outstanding quality built into General Electric's entire line of germanium PNP audio and switching transistors.

RATINGS: AUDIO AND LOW-FREQUENCY SWITCHING TRANSISTORS								
		2N43	2N43A	2N44	2N44A	2N1056	2N1057	
Collector-to-base Voltage (25°C)	$V_{CB}$	-45	-45	-45	-45	-60	-45	volts
Collector-to-emitter V. (25°C)	$V_{CE}$	-30	-30	-30	-30	-75	-45	volts
Total Dissipation (25°C)	$P_C$	240	240	240	240	240	240	mw
Forward D-c Current Gain, Common Emitter $I_C/I_B$ ( $V_{CE} = -1v$ ; $I_C = -20\text{ ma}$ )	$h_{FE}$	53	53	31	31	32	58	
	( $V_{CE} = -1v$ ; $I_C = -100\text{ ma}$ )	48	48	25	25		52	
Collector Cutoff Current ( $V_{CBO} = -45v$ ) ( $V_{CB} = 75v$ ; $I_E = 0$ )	$I_{CO}$	-8	-8	-8	-8		-18	$\mu A$
								$\mu A$

NOTE: All figures represent design-center ratings.

## High frequency transistors modified for higher Beta

Recent design improvements in high frequency switching transistors (Types 2N123 and 2N450) have improved their d-c beta at higher collector currents. The result is higher gain and improved saturation characteristics at these high currents.

Refinements in quality control tests have also been put into practice on the production line. These units are affected: Types 2N123, 2N450 and the 2N396 series. Units are aged at 100°C for 96 hours to stabilize characteristics. All transistors are subjected to a high-pressure detergent test for hermetic sealing. D-C characteristics are warranted to be within the limits shown on specification sheets. As a result, these transistors are now widely accepted in missile computer work and other rigorous applications.

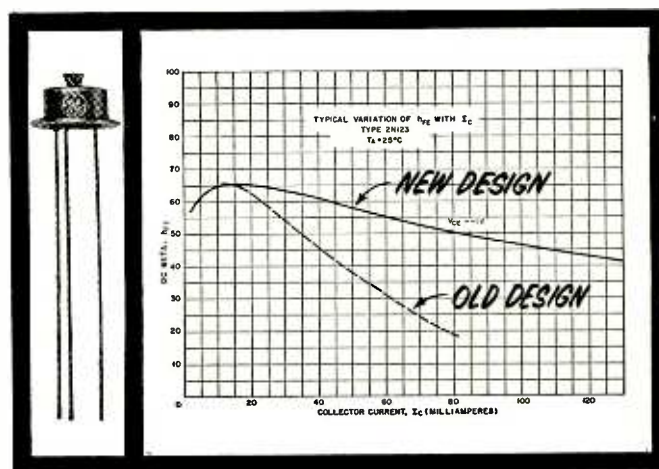

General Electric Company, Semiconductor Products Dept., Section S25459, Electronics Park, Syracuse, N. Y.

GENERAL  ELECTRIC

# Stromberg-Carlson

"TELEPHONE QUALITY"

## Relays

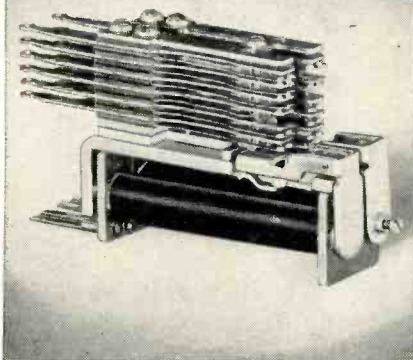

... available immediately for any part of your operation that depends on electromechanical switching.

Proven by many years of meeting the exacting requirements of the telephone industry, these twin-contact relays of unsurpassed reliability are available in many types. The following are representative:

**Type A:** general-purpose relay with up to 20 Form "A" spring combinations. This relay is excellent for switching operations.

**Type B:** a gang-type relay with up to 60 Form "A" spring combinations.

**Type BB** relay accommodates up to 100 Form "A" springs.

**Type C** (illustrated): two relays on the same frame. A "must" where space is at a premium.

**Type E:** has the characteristics of Type A relay, plus universal mounting arrangement. Interchangeable with many other makes.

Complete details and specifications on all Stromberg-Carlson relays are contained in our *new relay catalog*. Contents include: spring combinations, table of equivalents, contact data, variations and special features, plus complete mounting and cover information.

The catalog is available on request.

### STROMBERG-CARLSON

A DIVISION OF GENERAL DYNAMICS CORPORATION

Telecommunication Industrial Sales  
114 Carlson Rd. • Rochester 3, N. Y.



CIRCLE 16 READERS SERVICE CARD

## MARKET RESEARCH

### UNIT TERRITORY PLAN

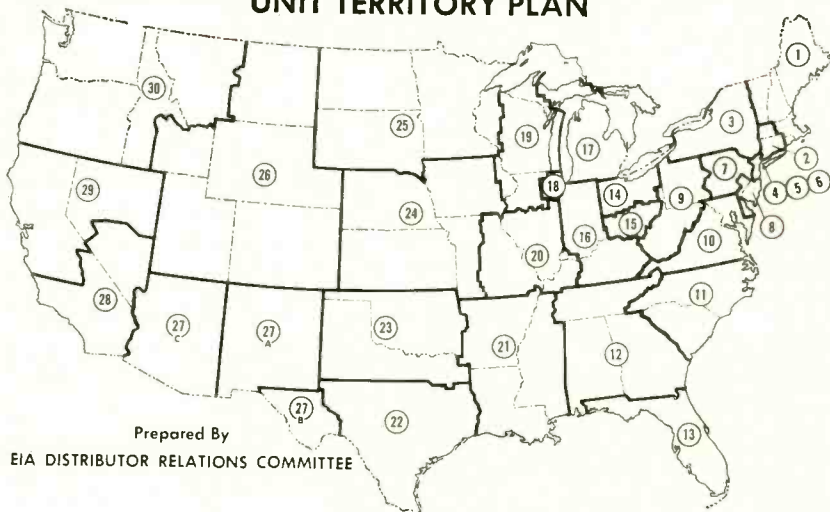

Prepared By  
EIA DISTRIBUTOR RELATIONS COMMITTEE

## New Distributor Plan Ready

NEW TERRITORIAL planning tool for sales managers and market planners in the electronics industry has been completed by Electronic Industries Association.

Tool is a study which divides continental U.S. into recommended sales territories for manufacturers who sell electronic parts to distributors. Rough outline of the recommended territories is shown in above map.

Work was done by Unit Territory Plan Subcommittee of EIA Distributor Relations Committee which began to look into the setting up of distributor sales territories back in 1953.

At that time the subcommittee found post-war growth of the electronics industries had been reflected in substantial increases in the amount of distributor's sales, the number of distributors and the number of lines carried.

As a result of these changes in distributor activity, the group also found that: sales representatives of manufacturers were limited in the sales time they could spend on a specific line; reps were hampered in properly serving distributors because of haphazard methods of designing territories and new manufacturers and new reps had no guide to follow in serving the distributor.

The unit territory plan recommended by EIA was designed to solve these problems. It was based on the following factors: each territory should have a minimum of 35 to 40 parts distributors; minimum potential for each territory should be about 2 percent of total United States replacement parts sales.

Also, salesman should be able to return to his home base each week after seeing every distributor on a trip and, in addition, salesman or rep should be able to give good coverage of all his distributors at least once every 30 to 40 days.

• **Marketing appointment:** E. K. Wimpy has been named manager of marketing research for CBS-Hytron. He was formerly director of general engineering for receiving tube operations.

## FIGURES OF THE WEEK

### LATEST WEEKLY PRODUCTION FIGURES

(Source: EIA)	Mar. 27, 1959	Feb. 27, 1959	Change From One Year Ago
Television sets	94,378	96,248	+20.9%
Radio sets (ex. auto)	259,070	282,163	+32.9%
Auto sets	97,621	112,336	+58.2%

### STOCK PRICE AVERAGES

(Standard & Poor's)	Apr. 1, 1959	Mar. 4, 1959	Change From One Year Ago
Electronics mfrs.	81.38	77.65	+58.5%
Radio & tv mfrs.	95.11	93.67	+111.3%
Broadcasters	92.61	86.80	+62.4%



# THE DIFFERENCE IS IN THE QUALITY

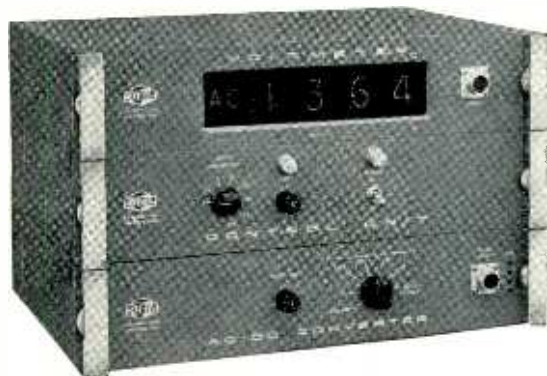

Superior Digital Instrumentation for AC Voltage Measurement

AC VOLTAGE INSTRUMENTATION developed through Cubic Corporation's years-ahead engineering know-how, today guarantees unsurpassed standards of performance. The Cubic AC Converter, available in both manual and automatic ranging models, changes AC input voltages to filtered DC to be read by the Voltmeter and displayed in clear, ultra-brilliant numerals. Full-wave rectification in the Converter assures extreme accuracy over a wide frequency range. High negative feedback provides maximum linearity and stability. The use of vacuum tubes in the Cubic AC Converter is the design feature responsible for high output voltage capability, high input impedance, excellent gain stability, low noise characteristics, protection from the danger of brief overloads. The Converter controls the AC symbol and decimal point, providing direct readout. Precision built, the Converter is accurate, rugged, reliable — another superior Cubic instrument.

CUBIC DIGITAL SYSTEMS can be developed easily to fit any requirement, with unit construction featuring inter-case wiring and standard-size plug-in units. Every Cubic system is "customized" through standard construction. Cubic instruments — Voltmeters, AC Converters, Scanners, Pre-Amplifiers, Printer Control Units and Ratiometers — can be combined as "building blocks" to produce digital systems of "Cubic-customized" versatility.

## S P E C I F I C A T I O N S

### AC CONVERTER

Ranging: Manual, automatic or remotely programmed

Input:	Range	Input Impedance
	.0001 to .9999	1 meg, 25uufd
	1.000 to 9.999	10 meg, 15uufd
	10.00 to 99.99	10 meg, 15uufd
	100.0 to 999.9	10 meg, 15uufd

Accuracy:  $\pm .1\%$  and two digits on all ranges

Linearity: .01%      Stability: .02%

Frequency range: 30-20,000 cps

Typical balance time: 7 seconds (Manual Ranging Model AC-1)

Size: Standard unit, 17"x3½"x11¾". 19" rack fittings, accessories provided.

Model AC-1: Manual ranging; front panel switch

Model AC-2: Automatic ranging; front panel switch selects DC, AC, Automatic, four AC ranges.

Power: All AC instrumentation units are powered by Control Unit C-1.

### DC VOLTMETER

Display: 4 or 5 digits

Absolute accuracy (RMS sum of system tolerances):  $\pm .012\%$  and one digit

Bridge linearity: .003%

Attenuator accuracy: .003% per decade

Input filter: Attenuation starts at 10 cps, increases 24 db/octave

Input terminals: Front panel and rear connector panel

Input impedance: DC, at balance, 10 megohms

Bridge resistance: 50,000 ohms

Balance time: Achieved at rate of 30 steps per second:

Model V-41: Typical, 1 second.

Model V-51: Typical, 1.5 seconds.

Output: Contact closures provided for external readout and recording devices

CUBIC CORPORATION'S electronic tracking systems monitor U.S. defense agency missiles. The skill and experience responsible for the accuracy of these Space Age Cubic systems are also important engineering and production components of Cubic Digital Instruments. For a fast, prove-it-yourself demonstration of Cubic Digital Systems, write or call us or our nearest representative.



CORPORATION

5575 Kearny Villa Road, San Diego 11, Calif.

ELECTRONIC ENGINEERING WITH A DIMENSION FOR THE FUTURE

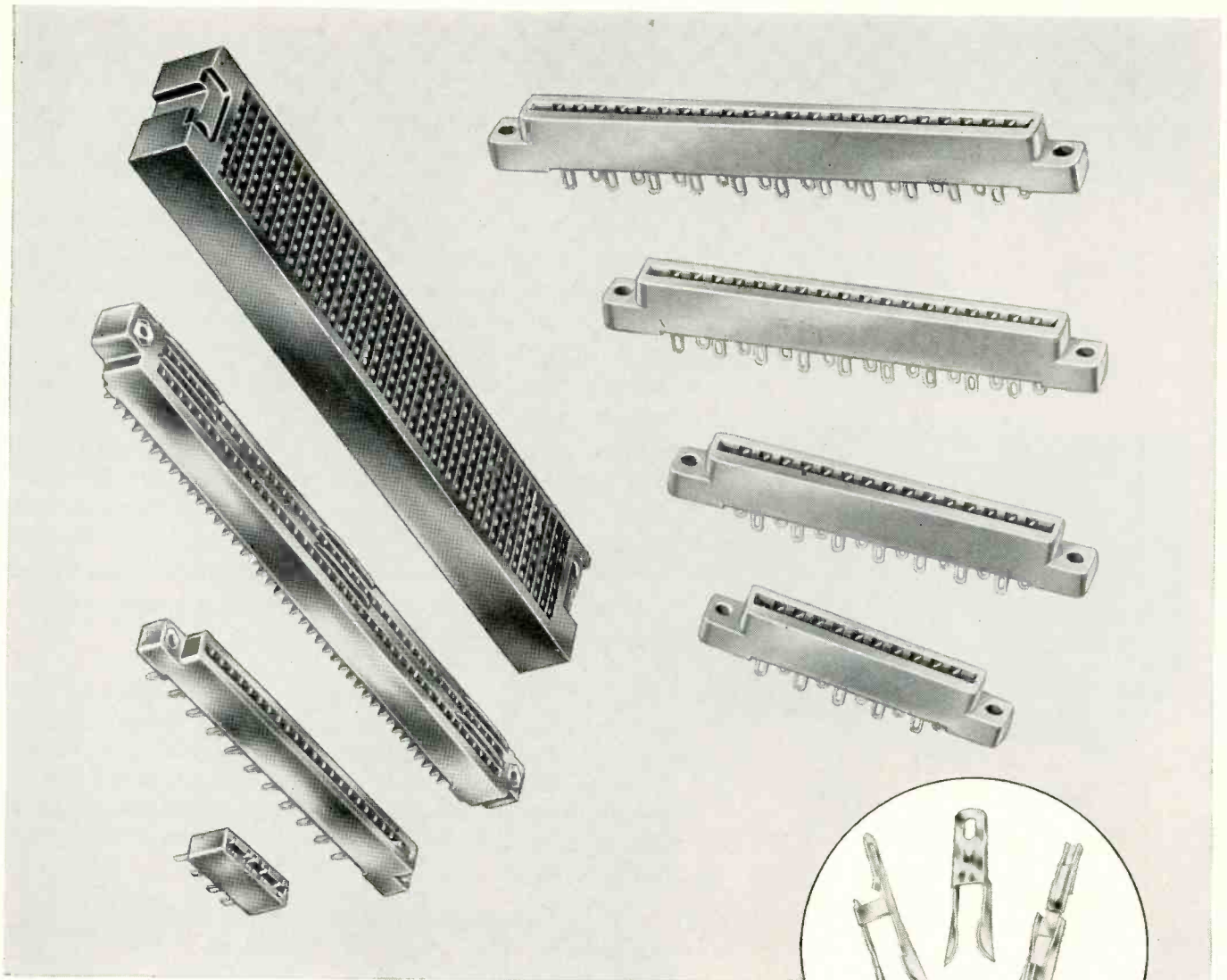

Individual spring contacts are twisted to ensure positive contact.

## *New Twist in* Printed Circuit Connectors!

Only DOT printed circuit connectors by Ucinite give you the advantages of Torsion Contact (U. S. and Foreign patents pending). Contact points are precisely twisted so that they apply powerful, continuous and vibration-proof pressure against the printed circuit board. Wiping action during mating ensures a clean connection. Contact edges are rolled after stamping so that high contact pressures do not result in scoring (as is often the case with sheared-edge

contacts). Polarizing keys are available. Full engineering details on request.

With an experienced staff of design engineers, plus complete facilities for volume production, Ucinite is capable of supplying practically any need for metal or metal-and-plastics assemblies. Call your nearest Ucinite or United-Carr representative for full information or write directly to us.



Manufactured by

**The UCINITE COMPANY**

Division of United-Carr Fastener Corporation, Newtonville, Mass.



# NOW...

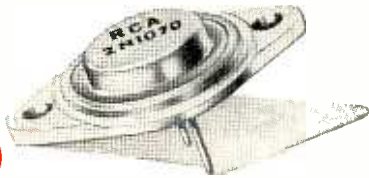

# RCA

DIFFUSED-JUNCTION MESA

# Silicon

# Transistors

- 2N1092—medium power
- 2N1067—intermediate power
- 2N1068—intermediate power
- 2N1069—high power
- 2N1070—high power

Initial types in an outstanding new line—RCA n-p-n silicon transistors offer significant reductions in saturation resistance, and feature excellent beta stability over the entire operating temperature range. These features result from use of RCA's advanced diffused-junction mesa technique. These transistors are designed to meet stringent military, environmental, mechanical, and life test requirements.

RCA silicon transistors offer the equipment designer a wide choice of power-switching capability in industry-preferred cases (JEDEC TO-3, TO-5, & TO-8).

RCA SILICON TRANSISTORS are commercially available in limited quantities through your Authorized RCA Semiconductor Distributor. For technical data contact him. Or, write RCA Commercial Engineering, Section D-19-SD-3, Harrison, New Jersey.

...with excellent beta stability from  $-65^{\circ}\text{C}$  to  $+175^{\circ}\text{C}$  and exceptionally low saturation resistance!

Type	JEDEC Outline	ABSOLUTE-MAXIMUM RATINGS					CHARACTERISTICS								
		Vces <sup>•</sup> (volts)	Vceo <sup>•</sup> (volts)	Collector (amp.)	Transistor Dissip. <sup>‡</sup> (watts)	At Case Temperature of 25°C			At Case Temperature of 175°C			At Case Temperature of 175°C			
						Saturation Resistance			DC Current Gain (Beta)			DC Collector Cutoff Current (I <sub>CBO</sub> )			
						(ohms)		Conditions	Typical	Min.	Conditions	Typical	Max.	Conditions	Typical
2N1092	TO-5	60	30	0.5	1	3	10	I <sub>C</sub> =200 ma.	20	10	I <sub>C</sub> =200 ma.	75	1000	V <sub>CE0</sub> =30 volts	
2N1067	TO-8 <sup>•</sup>	60	30	0.5	2.5	3	10	I <sub>C</sub> =200 ma.	35	15	I <sub>C</sub> =200 ma.	75	1000	V <sub>CE0</sub> =30 volts	
2N1068	TO-8 <sup>•</sup>	60	30	1.5	5	1	2.67	I <sub>C</sub> =750 ma.	38	15	I <sub>C</sub> =750 ma.	75	1000	V <sub>CE0</sub> =30 volts	
2N1069	TO-3	60	45	4	25	0.7	2	I <sub>C</sub> =1.5 amp.	20	10	I <sub>C</sub> =1.5 amp.	150	2000	V <sub>CE0</sub> =30 volts	
2N1070	TO-3	60	45	4	25	0.4	0.67	I <sub>C</sub> =1.5 amp.	20	10	I <sub>C</sub> =1.5 amp.	150	2000	V <sub>CE0</sub> =30 volts	

• "Heat-Sink" mounting clamp supplied.

• Collector-to-emitter breakdown voltage with base connected to emitter.

• Collector-to-emitter breakdown voltage with base open.

‡ At a case temperature of 100°C.

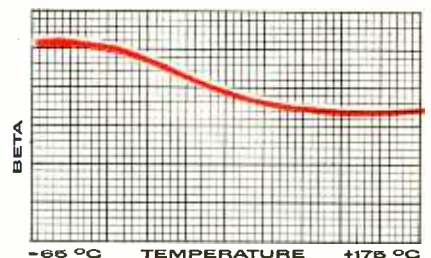

**RADIO CORPORATION OF AMERICA**  
Semiconductor Products  
Distributor Sales  
Harrison, N. J.

**AVAILABLE AT YOUR RCA SEMICONDUCTOR DISTRIBUTOR!**

# Solving Production Problems

In military contract work many planning and manufacturing questions come up. This article examines them—and provides some answers

By H. W. VAUGHAN, Planning Coordinator, Apparatus Division, Texas Instruments Incorporated, Dallas, Tex.

(The problems of production planning and manufacturing of electronic equipment are numerous. This special article examines a mythical \$2,000,000 fixed-price contract for the manufacture of 80 large airborne radars.)

**Q. Who has the responsibility of seeing the project is completed on schedule?**

Both the project engineer and the manufacturing engineer share the responsibility.

**Q. Who has the responsibility for seeing the expected profit is made?**

Management of the operating division. Project performance required is communicated by means of a reasonable cost goal rather than as some percentage of profit.

**Q. How is the schedule set up for the project?**

The major phases of the pre-production effort are adjusted within time available. The end result is usually a horizontal bar chart of the relations of the major phases.

**Q. Does Engineering participate in the schedule making?**

Yes. It is derived jointly.

**Q. What size of group is needed for each major stage of the project?**

The peak group size of seven men would be reached about six months after receipt of contract. This group size would be sustained until three months after initial deliveries. Then reassignment to other activities would reduce the group to four men, more or less.

**Q. Are meetings a waste of time?**

Meetings are an effective means of *direct communication* among several persons. They are not used primarily for decision making; however, they frequently precipitate decisions.

**Q. Is a \$2,000,000 project big enough to rate a full-time buyer?**

Yes. In a large radar, 2,000 of the 3,500 different parts are purchased. This is in a company whose make-or-buy decisions most often fall on the make side for cost, delivery or quality control reasons.

**Q. Assuming the contract calls for buying \$750,000 worth of material, how do you avoid tying up all those dollars for the period of the contract?**

By scheduling vendor deliveries in the most economical manner. To do this, each part is classified by cost into one of three categories. Cost breakpoints are \$.10 and \$10. The lowest category, mainly hardware, requires little capital or storage space and is scheduled in all at once in adequate time for use. The middle category justifies more control. The high cost items are 10 percent by number but 90 percent of gross dollar value. Their shipment is arranged with the vendor to tie up the minimum capital and storage space consistent with his pricing policy.

**Q. Have you got a single formula or procedure for reaching make-or-buy decisions?**

No. The major make-or-buy decisions are considered during the bid preparation and tentative de-

isions made. Later, the manufacturing engineer brings this information up to date.

**Q. How much overage do you order on each item?**

First-contract overage usually averages 4 to 8 percent of purchased cost. Large or stretched-out runs allow you to reduce overage cost. Small runs can skyrocket costs.

**Q. How does the manufacturing engineer keep control of inventory?**

By continual personal review of his inventory control cards. The actual mechanics of control can be handled effectively by many good systems.

**Q. In this process of, more or less, learning-by-doing, who bears the responsibility for errors?**

The manufacturing engineer, no matter what his level, bears his own responsibility for his errors.

**Q. If 100 parts cost less than the 83 that are needed, why shouldn't they be bought?**

We do buy them. But this is a bargain only if the manufacturing engineer makes sure that their full net cost gets into the project.

**Q. How do you know when ma-**



Periodical production meetings bring together manufacturing and project engineers who review whole project status. At this time, buyer, tool engineer, production and quality control representatives contribute to and audit the status

terial or parts are available in your shops?

We use a shortage list. On it are controlled only those parts which are in trouble. The source of the part and information regarding its expected availability are listed.

**Q. Is it possible to get an evaluation of costs after 10 percent of the run to get a preview of final contract profit?**

Most often this can be done. The major work order runs can be so split as to give a good cross section of costs at some partial point.

**Q. Aren't there disadvantages to this split-run procedure?**

On the contrary, it works well all around. We wouldn't want to risk full quantities since tools and parts aren't truly proofed until working equipments are made from them.

**Q. Is around-the-clock work ever justified?**

Definitely yes. If delivery commitment is close, it can be effectively used.

**Q. How can the manufacturing engineer retain the broad viewpoint when the first full radars come off the line and go into final test?**

Orderly postponement of paperwork follow-through can be a real help at this time. Even a change of a tiny screw size can result in 5 or 10 actions.

**Q. What one factor do you consider most important for showing a profit in military production contracts?**

A willingness to cooperate with others.

**Q. When does tooling activity stop?**

Tool-making and improvement continues well beyond the assembly of the first systems. We expect each rerun to have tooling expenses of about 5 percent of the original tooling cost.

**Q. How much use do you make of expeditors?**

In the sense of personnel assigned to work with the shops or vendors to correct "hot" problems, we have none. Production scheduling is represented in each shop, or group of shops, by a dispatcher.

# NEW DESIGN

## LOWERS THE SILHOUETTE ••• RAISES PERFORMANCE

Showing the KDH-130, with free air displacement of 130 cfm, superimposed upon the silhouette of a KD-110, with free air displacement of 110 cfm. This illustrates how KINNEY horizontal design gives you more in a smaller package.



## **Kinney**® HIGH VACUUM

It's not miniaturization — but there are important savings in bulk and height in the famous horizontal design of KINNEY KDH Series Single Stage Duplex High Vacuum Pumps. The objective of this development program aims for practical economies, smooth operation and greater performance for your dollars. You'll like the result... the flexibility it provides in designing your system, the simplification in plumbing and the smooth efficient performance of these KINNEY Pumps. The following table gives you a picture of the KINNEY line of Single Stage Duplex Pumps and the broad selection it affords:

Model	Height	Disp. C.F.M.	Hp Motor	Approx. Wt.
KD-30	2' 1 $\frac{3}{8}$ "	30	1 $\frac{1}{2}$	300#
KDH-65 new	2' 7"	65	3	570#
KDH-80 new	2' 7"	80	5	590#
KDH-130	3' 4 $\frac{5}{8}$ "	131	5	840#
KDH-150 new	3' 4 $\frac{5}{8}$ "	150	7 $\frac{1}{2}$	1055#
KDH-220	4' 10 $\frac{3}{4}$ "	218	10	2100#
KD-310	6' 3"	311	15	3400#
KD-485	6' 7"	486	25	5300#
KDH-530 new	5' 2 $\frac{3}{4}$ "	532	25	4380#
KD-780	6' 7 $\frac{3}{8}$ "	780	40	6700#

**WRITE  
for catalog  
with data.  
It's FREE**

**KINNEY** MFG. DIVISION  
THE NEW YORK AIR BRAKE COMPANY

3565D WASHINGTON STREET • BOSTON 30 • MASS.

Please send me catalog of KINNEY High Vacuum Pumps with Engineering charts.

Name \_\_\_\_\_  
Company \_\_\_\_\_  
Address \_\_\_\_\_  
City \_\_\_\_\_ Zone \_\_\_\_\_ State \_\_\_\_\_

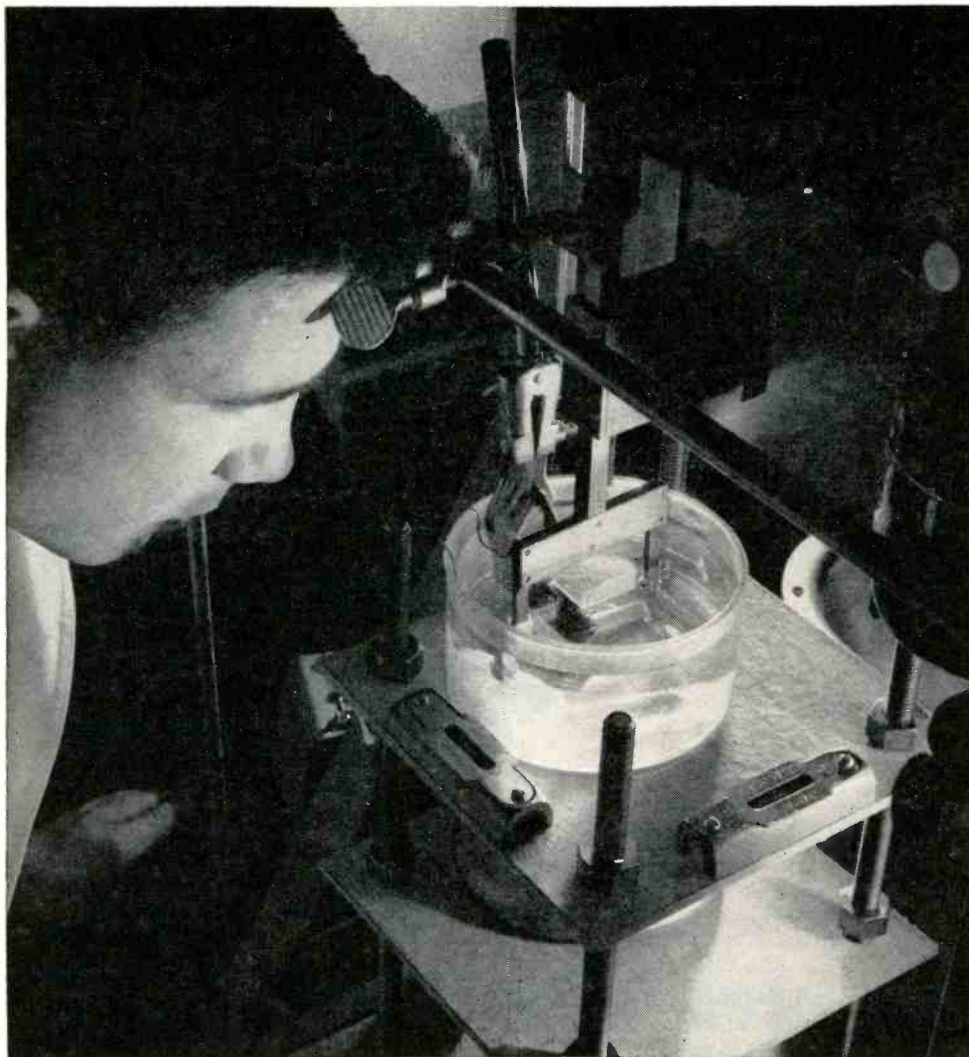

*News from  
Raytheon's  
Semiconductor  
Division...*

**ELECTROLYTIC SLICING—**

This engineer is slicing a germanium crystal by electrolytic means. Up to now semiconductor wafers have been formed by mechanical processes, such as cutting with diamond saws or lapping with abrasive powders. The resulting mechanical damage to the critical surfaces reduces the quality and effectiveness of finished semiconductor devices. Electrolytic slicing of crystals, producing surfaces which are free from the mechanical damage resulting from other methods, is one of the many pioneering activities initiated and carried forward by the scientists and engineers of Raytheon's Semiconductor Division.

**THE PLACE FOR THE MAN WHO IS GROWING  
FASTER THAN HIS ASSOCIATES**

There are openings at Raytheon's Semiconductor Division for scientists and engineers with semiconductor experience and a desire to find more room for personal and career growth. Opportunities exist in the following areas:

**Device Design and Development**  
**Material Development**  
**Mechanization**  
**Circuit Design**  
**Application Engineering**

You are invited to explore the advantages for yourself in associating with Raytheon's Semiconductor Division. Write to Mr. Allen E. Moorhead, RAYTHEON MANUFACTURING COMPANY, Semiconductor Division, 150 California Street, Newton 58, Massachusetts.

*The place for the man who is growing faster...*

**SEMICONDUCTOR DIVISION of**



*Excellence in Electronics*

Tung-Sol moves ahead!

# Now



## High power transistors with new **cold-weld** seal

Improved cold-weld seal  
gives new Tung-Sol  
high-power transistors  
three-way quality boost

- True hermetic, copper-to-copper seal improves transistor thermal characteristics.
- Elimination of heat-damage, heat-caused moisture and "splash" increase reliability.
- Vacuum-tight, moisture-proof cold-weld seal lasts even through "breathing" over long life operation.

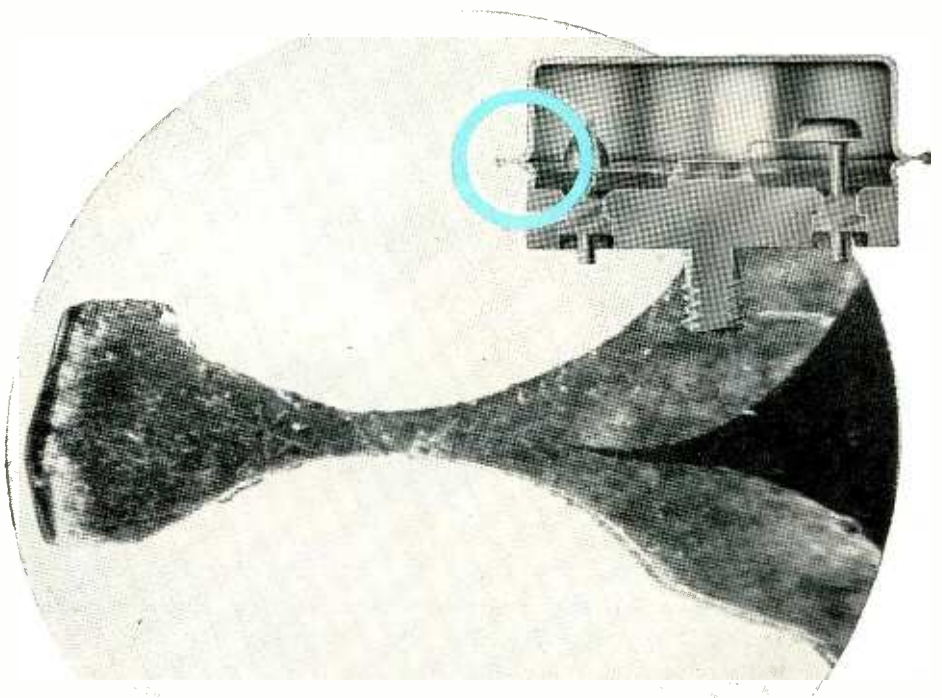

Photomicrograph (45X) shows circled area of cross section of Tung-Sol high-power germanium transistor cold-weld seal. Note absence of seam, indicating actual integration of copper molecules and a true, hermetic, copper-to-copper seal.

Once again Tung-Sol shows the way. Now, for the first time, Tung-Sol brings designers high-power germanium transistors with quality benefits of the advanced cold-weld seal.

The new Tung-Sol types feature a stud-mounted package and maximum collector current of 13 amps. Military environmental tests combine with the radioactive gas leak detection test to assure maximum reliability.

Technological advancements such as this keep Tung-Sol ahead of the field. For full data on the new high-power switching transistors . . . to meet any need with the latest in transistor design and efficiency, contact: Semiconductor Division, Tung-Sol Electric Inc., Newark 4, New Jersey.

 **TUNG-SOL<sup>®</sup>**

thousands of combinations for  
**REMOTE CONTROL  
 SWITCHING**

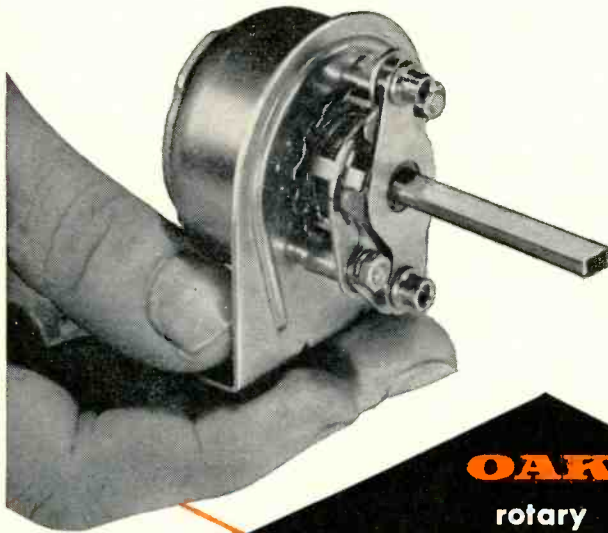

**OAK**  
 rotary  
**SOLENOIDS\***

\*Mfd. under license from  
 G. H. LELAND, INC.

**OAK**  
 low-current  
**SWITCHES**

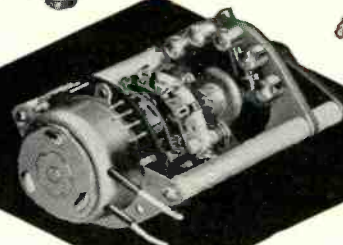
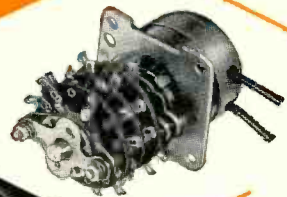
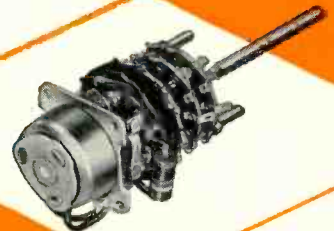
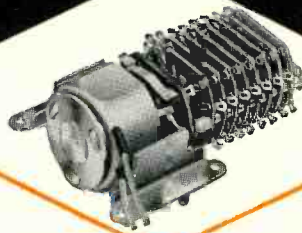
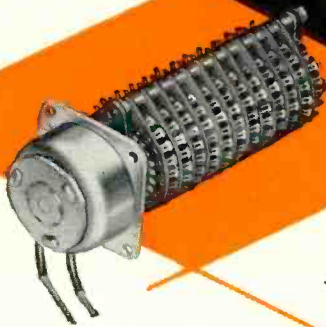

The variety of Oak switches is almost limitless. Combined with Oak rotary solenoids, they provide an assortment of Rotary Selectors that covers almost any low-current application—simple or complex, military or commercial. Oak Rotary Selectors give a *positive* stepping action, even under severe vibration and shock. To help you get the *exact* remote-control unit you require, Oak engineers will be glad to work out special recommendations. Write for copies of the Oak switch catalog and rotary solenoid bulletin with time-saving layout sheets.

SWITCHES • ROTARY SOLENOIDS •  
 CHOPPERS • SPECIAL ASSEMBLIES •  
 VIBRATORS • TUNERS

**OAK** MFG. CO. 

1260 Clybourn Avenue, Dept. G, Chicago 10, Illinois  
 Phone: MOhawk 4-2222

**REMOTE CONTROL  
 SWITCHING**

# \$75 Million for 'Overseas Sage'

Practically all funds for the Tactical Air Command's overseas Air Weapons Control System (212-L) will go to our industry

ESTIMATED COST of the Tactical Air Command's "overseas Sage" will run close to \$75 million, it was learned this week. Practically all will go to the electronics industry. Known as project 212-L, the Air Weapons Control System is being managed by Rome Air Materiel Area.

Only about \$30 million of the estimated \$75 million has been awarded by contract to date. This leaves approximately \$45 million open for new business.

The Air Weapons Control System is a network of radar, communications and data-processing equipment that will cover an area about the size of the state of Montana. The system detects and directs action against aircraft and air-breathing missiles attacking U. S. advance bases overseas.

The entire network is portable and can be set up wherever hostilities are expected. One complete system will be weatherproofed to function in the far north. Work for this Alaskan environment gear will be contracted before July.

Prototype equipment is going to Shaw AFB, N. C., where testing will begin in June. Five radar sites located at air bases in North and South Carolina and Georgia will be tied in with two radar sites at Shaw.

General Electric's heavy military electronics department is in charge of systems integration, engineering and management, plus design and development of data processing and display subsystems. GE's starter contract is in excess of \$13 million (ELECTRONICS, p 11, Feb. 20).

Remington Rand Univac provided the Tactical Air Control System. Ten units plus spares have been delivered to Shaw AFB, N. C. Contract was about \$16 million.

Westinghouse will deliver radar and communications equipment to Shaw in August under a \$1-million contract.

Aircraft surveillance and detec-

tion equipment includes three types of radar:

A short-range radar is used for low-altitude detection. A metal framework antenna is used which may be enclosed in a radome.

A higher-power, medium-range type and a high-power, long-range type are enclosed in air-inflatable spheres.

Electronics division of Westinghouse, Baltimore, is providing prototypes of two radar systems under direct contract with Rome:

MPS/20 is light-weight, highly-mobile, three-dimensional radar, using an air-inflatable antenna.

TPS/22 is search radar, presenting azimuth and range. It has longer range than the MPE-20 3-D radar, uses air-inflatable antenna and is transportable.

## Computers and Data Links

Data-processing equipment consists of a computer group, tracking console, and various indicators for target azimuth, range and height.

Data from the radars is processed automatically. Target information is displayed on ppi scopes. Data is

converted from analog to digital, encoded, and transmitted to other facilities.

Communications equipment ranges from telephone to troposcatter. Ground systems handle voice, teleprinting, facsimile, closed-circuit tv and digital data such as target tracking and assignment messages. These are handled by a time-sharing multiplex automatic system.

Air-ground communication is both digital and voice. Digital data-transmission equipment exists at every facility having a computer.

Westinghouse's TRC-66 — new tactical radio communications equipment — transmits and receives 48 voice conversations simultaneously. Design permits use of this equipment at reduced power in conventional line-of-sight relay systems or at regular power levels in over-the-horizon transmission.

The 48-channel units operate effectively at ranges up to 1,000 mi. With minor modifications the units will handle 240 voice channels over shorter ranges. Unit weight is 2,300 lb.

ORGANIZATION DIAGRAM JOINT AIR/GROUND OPERATION

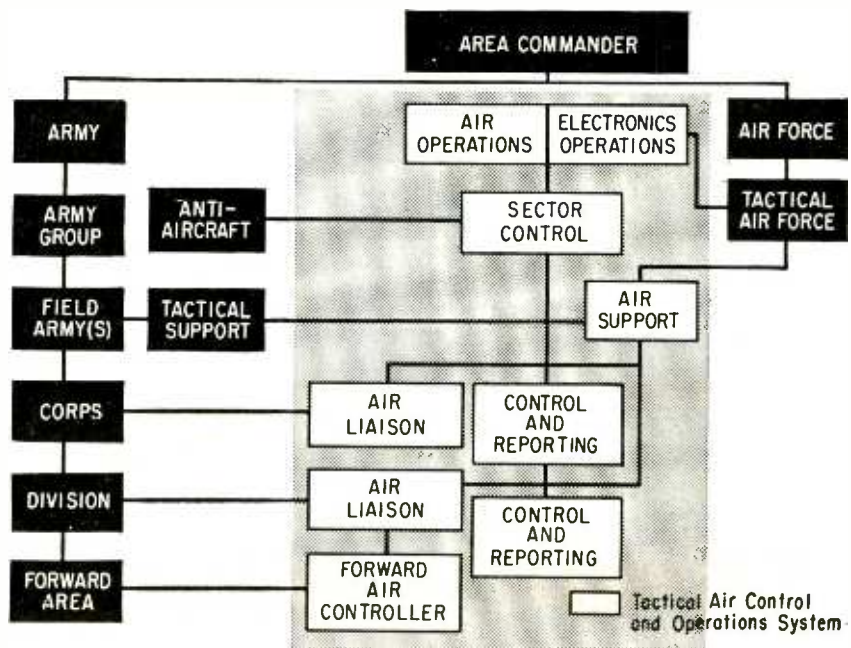

# Design Extra Performance



## LONG SERVICE LIFE

Because of their high energy content and small size, Mallory Mercury Batteries have been used in U.S. satellites. Above is a battery pack for one of the Vanguard projects. In Explorer I, the mercury batteries for the tracking transmitter functioned for 112 days . . . far beyond the 60 days minimum life expectancy.

## LONG SHELF LIFE

Tests recently completed prove that storage for as long as six years causes only slight loss of capacity of the unique Mallory mercury battery system. The curves shown here represent data on a typical group of RM-3 cells. Note how closely the milliamper-hour life stays to the "newly made" value for up to 72 months.

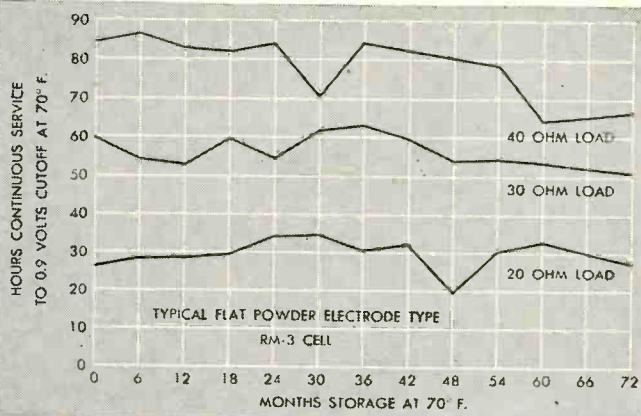

Hours continuous service to 0.9 volts cutoff at 70° F.  
Months storage at 70° F.

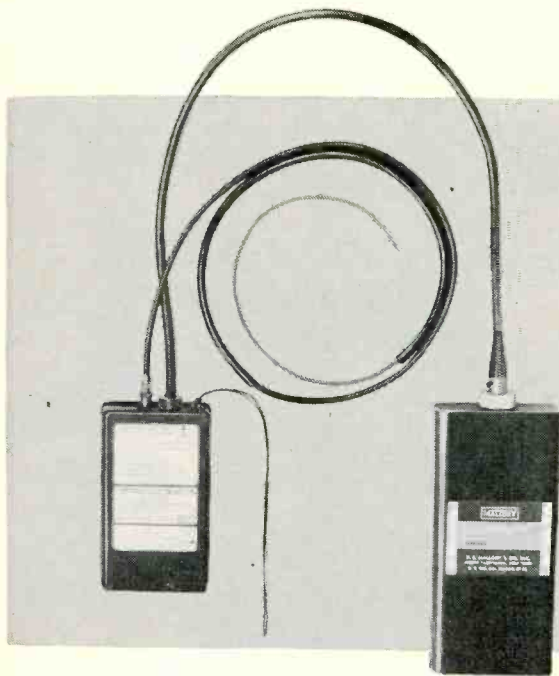

## DEPENDABILITY

Mallory Mercury Batteries supply life-saving power for emergency beacon transmitter made by Telephonics Corporation. Carried by fliers, the transmitter turns on when the flier parachutes out . . . sends signals up to 100 miles to rescue crews. Compact battery pack operates up to 8 hours . . . stays at full strength for months, always ready to deliver power.

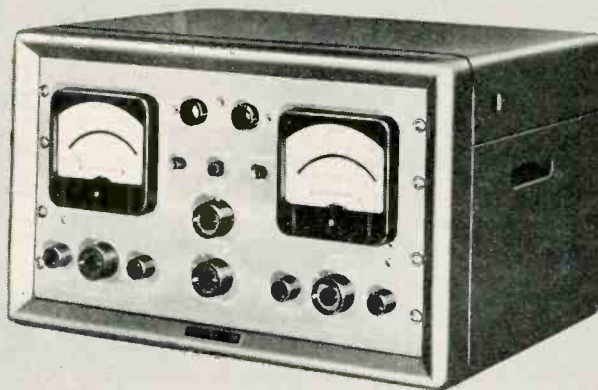

## STABILITY

In the Megatrometer (insulation resistance tester by Mid-Eastern Electronics, Inc.) they give voltage stability better than 0.0005% change per hour. Ten RM-42 cells power tube filaments and the 1000-volt transistorized variable power supply. Same stability gives high precision in telemetering circuits and industrial potentiometers.



# Into Battery-Powered Products

...by using the unique qualities of Mallory Mercury Batteries

Looking for ways to make battery-operated electronic equipment more miniature, more dependable, more stable, more convenient to use? Put the unusual properties of Mallory Mercury Batteries to work . . . in your new designs, and in improvement programs on your present products.

Mercury Batteries—pioneered and perfected by Mallory—do things that no other commercial dry cell can. Their unique chemical system gives them shelf and service life several times that of ordinary batteries. They have high energy per unit volume, and broad temperature range. Their constant energy discharge exactly

matches transistor requirements . . . makes them suitable for use as high-stability reference voltage standards.

A constantly growing list of new electronic products is making use of these batteries. A few typical examples are shown here. Our application engineers will welcome the opportunity to discuss how you can capitalize on them in your own equipment. An extensive line of standard single and multiple voltage batteries is available. Individually-designed packs can be engineered to your specifications. Write today for a consultation, and for latest engineering data.

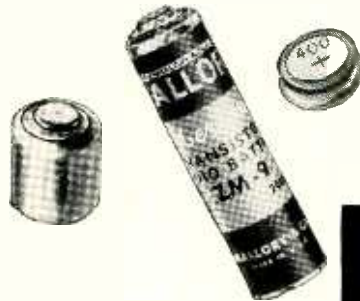

**MALLORY BATTERY COMPANY**  
Cleveland, Ohio

*a subsidiary of*



*In Canada, Mallory Battery Company of Canada, Limited, Toronto 4, Ontario*

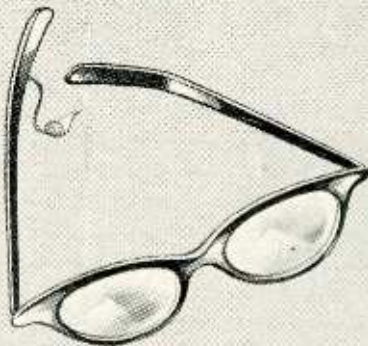

**MINIATURIZATION** Inconspicuous hearing aids and pocket transistor radios are typical of the tiny products which Mallory Mercury Batteries help make possible. They pack a lot of energy into small volume. Latest and smallest model is the RM-312 cell, only 0.305" in diameter and 0.135" thick—rated 36 milli-ampere-hours.

## **SPECIAL BATTERY DESIGNS for MILITARY PROJECTS**

Mallory engineers specialize in developing and manufacturing mercury battery packs for military equipment such as beacon transmitters, missile telemetering, portable communications, sonar equipment, and similar devices. Our extensive experience, and facilities for design, testing and pilot manufacturing are at your service. Call or write for a consultation.

# NEW SPRAGUE MODEL 500 INTERFERENCE LOCATOR

PORTABLE, VERSATILE  
UNIT PINPOINTS SOURCE  
OF INTERFERENCE



This improved instrument is a compact, rugged and highly sensitive interference locator—with the widest frequency range of any standard available unit.

New improvements in Model 500 include: greatly increased sensitivity, meter indications proportional to carrier strength, transistorized power supply. Engineered and designed for practical, easy-to-operate field use, it is the ideal instrument for rapid pinpointing of interference sources by electric utility linemen and industrial trouble shooters. Model 500 tunes across the entire standard and FM broadcast, shortwave, and VHF-TV spectrums from 540 Kc to 216 Mc. For full details send for brochure IL-102.

SPRAGUE ELECTRIC COMPANY  
35 MARSHALL ST. • NORTH ADAMS, MASS.

# SPRAGUE

THE MARK OF RELIABILITY

CIRCLE 26 READERS SERVICE CARD

# What's Ahead In Pay

New chance for toll tv operators has been given by Congressional action. Five firms may be conducting trials within a year

WASHINGTON — Current news from the nation's capital is that at least three companies are making plans for a plunge into pay tv, now that the ice has again been broken by Federal Communications Commission.

FCC's attempt to give pay tv a trial last year was rebuffed by Congress. But this time, with stricter controls, Congressional leaders seem to be willing to go along.

Proponents feel that with luck and quick approvals of applications to the Commission, they could be in operation by early 1960. There may be as many as five companies trying out systems in as many cities.

The FCC plan calls for three-year tryouts with two limitations placed on earlier proposals: one system to a city and no charge to viewers for any equipment needed to receive programs.

Although the first restriction won't be too hard on experimenters, the second will call for heavy capital outlay. Coin boxes and circuits to unscramble the signal can cost from \$50 to \$75 each. In addition, pay-tv men must set up collection systems and pay for programming.

## Twenty Cities Eligible

For the tests, operators must use an existing station in one of the U. S. cities that have four or more operating tv stations. The pay station will program two or three hours of toll tv and broadcast as usual for the remainder of the day.

Where arrangements can be worked out, viewers will be asked to pay for first run movies and sporting events.

FCC approval of the trials was approved by Congress' House Commerce Committee by a narrow 11-10 vote.

Chairman Oren Harris (D., Ark.) explained that the tests would give Congress a yardstick to help decide whether pay tv is in the public in-

terest. Allowing the tests does not, however, prevent Congress from turning thumbs down on toll tv later on.

Zenith Radio is expected to announce momentarily that it is ready to apply for authorization to conduct tests.

Milwaukee will probably be chosen for Zenith's tests since it is near the firm's Chicago headquarters and has a recently orphaned uhf television station. The Zenith Phonevision system uses a coin box or a punch-card device to unscramble the pay signal. The company may try both coin boxes and punched cards.

## Tests Next Year?

A spokesman for Zenith says an application would take three to six months to draw up. If no hearing is held, the application could go through processing in two to three months more. If a hearing is re-

# Atomic Generator



Engineer at The Martin Company's nuclear division tests radioisotopic "battery" which won 1958 Miniaturization Award sponsored by Miniature Precision Bearings, Inc. Atomic generator weighs 5 lb. During its lifetime it can produce power equivalent to that from dry cell batteries 300 times its weight

# Tv Trials

quired, it could add on six months to a year. An additional half-year would be then needed to set up shop and begin broadcasts.

Teleglobe Pay Tv System is negotiating with stations in New York and other cities. Teleglobe president S. Sagall calls the FCC action an opening wedge and is in a hurry to get started. His system transmits an unscrambled video signal but sends through phone lines the audio signal for which the subscriber is billed.

No immediate plans to file have been announced by Skiatron Electronics, whose Subscriber-Vision system uses a punched card as an unscrambler. The firm says it is definitely in the pay tv picture but is holding off any quick decisions due to the burden of financing the receiver decoding device. The firm might make its tryouts in New York if a positive decision is reached.

## Other Firms Watch, Wait

Also holding off is International Telemeter, affiliated with Paramount Pictures Inc. It has concentrated on a wire system which does not come under FCC jurisdiction.

Spokesmen for Blonder Tongue Laboratories, who have a system which broadcasts free and scrambled signals simultaneously, say they will consider applying in the future. The company's Bi-Tran system displaces the free picture when the pay program is tuned in.

Toll tv men say the new regulations will give them a chance to try out their wares. A prior pay tv experiment was a wired system in Bartlesville, Okla. The system collapsed financially.

Areas that may soon have subscription tv salesmen setting up offices are: Chicago, Dallas-Fort Worth, Fresno-Tulare, Harrisburg, Los Angeles, Miami-Ft. Lauderdale, Milwaukee, Minneapolis-St. Paul, New York, Philadelphia, Phoenix-Mesa, Portland-Vancouver, St. Louis, San Antonio, San Francisco-Oakland, Seattle-Tacoma, Washington, D. C., and Wilkes Barre-Scranton.

## Miniature Pulse Transformers

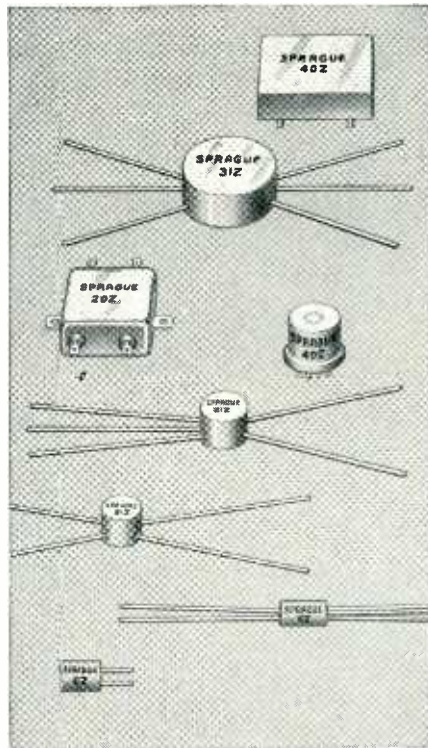

Sprague miniature pulse transformers are ideally suited for application in low-power, high-speed computer circuitry where pulse signals may range up from 20 millimicroseconds and wider in duration, at repetition rates as high as 10 megacycles, with pulse levels ranging from fractions of a volt to several hundred volts.

Typical circuits utilizing Sprague Pulse Transformers include *pulse amplifiers* (for current or voltage step-up, impedance matching, decoupling, pulse inversion and push-pull operation); *pulse shaping and differentiating*; *blocking oscillators* (in regenerative circuits of the triggered and self-triggered type); *general transistor circuits*.

Choose from Sprague's wide variety of mounting styles, shapes and encasements . . . for conventional or printed wiring board assembly.

Write for the complete series of engineering bulletins to Technical Literature Section, Sprague Electric Company, 35 Marshall Street, North Adams, Massachusetts.

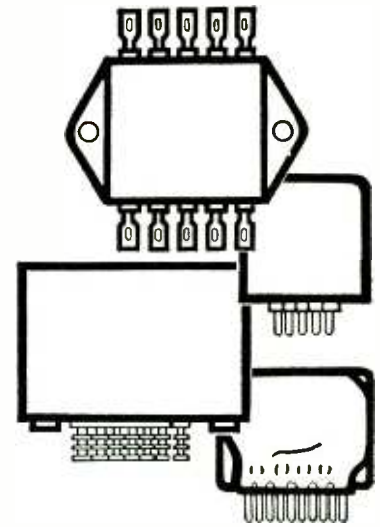

Sprague offers a wide variety of

## MAGNETIC SHIFT REGISTERS

for aircraft, missiles, computers, and controls

Just the right case styles . . . types of sealing . . . number of stages . . . read and write provisions you need! Sprague magnetic Shift Register Assemblies are matched to your *specific* application requirements to make them your best buy!

Standard designs are easily modified to meet most system requirements. All are 100% pulse performance-tested before they leave the plant.

For engineering assistance on your Shift Register problems, write to Special Products Division, Sprague Electric Company, Union St., North Adams, Mass.



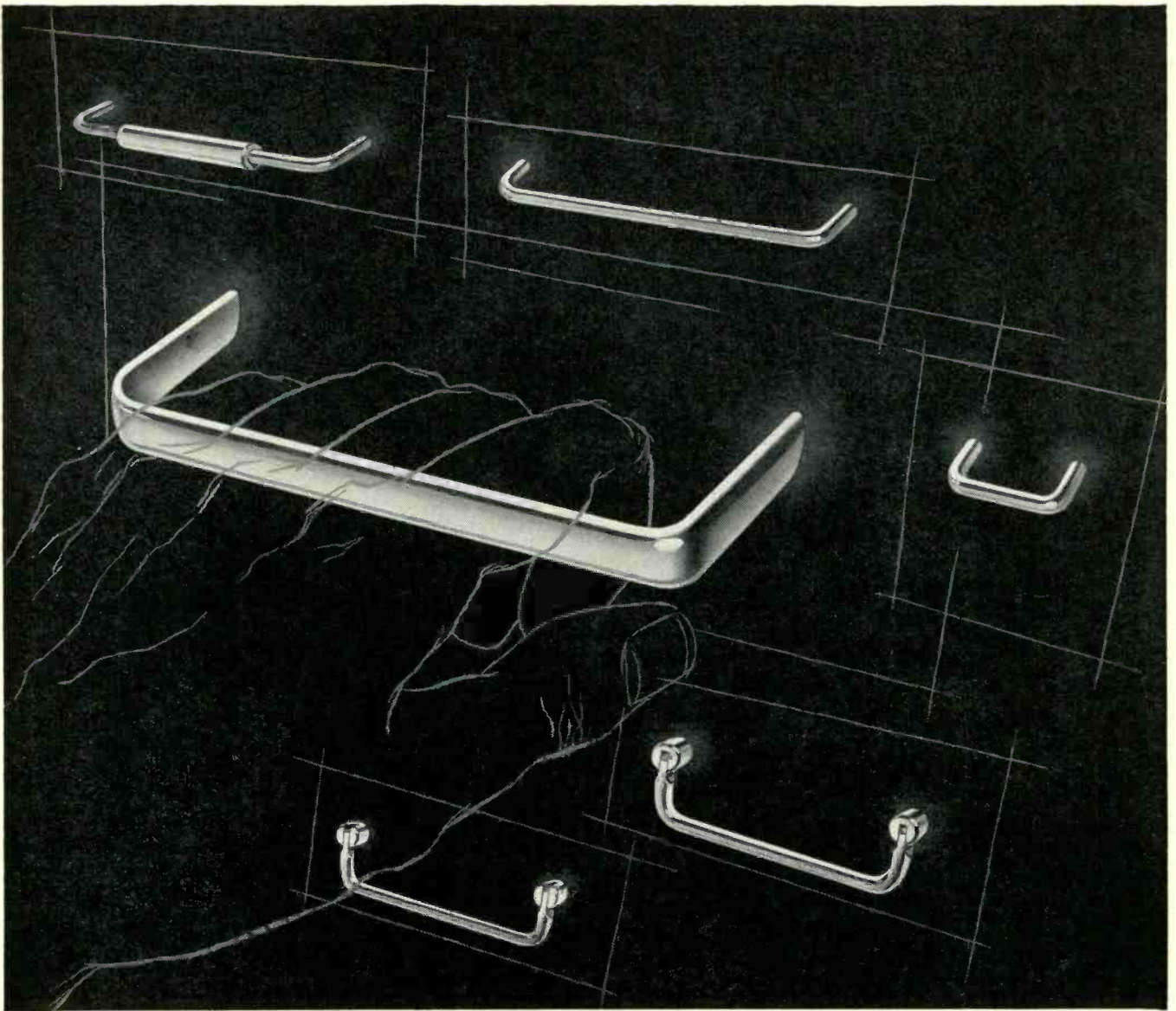

Materials used in the quality-controlled manufacture of CAMBION handles include aluminum, brass and stainless steel. Finishes are of polished nickel, black oxide, and black alumilite. Types available are rigid, adjustable and folding. Folding types are in two different models — designed to fold against the panel in either one or two directions.

## How to handle things better — 28 ways

Made in 28 different standard combinations, CAMBION® panel handles are also custom-made to any specifications, in any quantity. All are of quality materials which meet or better government specifications. In addition to a firm grip, all have an attractive appearance. Polishing before plating removes all surface imperfection, and color buffing after plating adds lasting luster.

Expert engineering and manufacturing skill control production of the complete CAMBION line — terminal boards, solder terminals, insulated terminals, coils, coil forms, capacitors, swagers and hardware. In any quantity of CAMBION components you order you get top quality — with every component guaranteed.

Available locally through Authorized CAMBION Distributors. Or write to Cambridge Thermionic Corporation,

437 Concord Avenue, Cambridge 38, Massachusetts. On the West Coast: E. V. Roberts and Associates, Inc., 5068 West Washington Blvd., Los Angeles, California. In Canada: Cambridge Thermionic of Canada, Limited, Montreal, P.Q.

The CAMBION line of panel and chassis hardware is recognized as the best looking, best behaving, most polished family in its field. Besides handles, other popular members are terminal boards, diode clips, battery clips, miniature plugs and jacks. CAMBION custom hardware can be designed and manufactured on request.

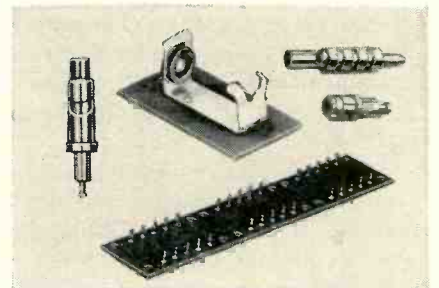

CAMBRIDGE THERMIONIC CORPORATION  
**CAMBION**®

The guaranteed electronic components



# Radar to Contact Venus Again

MIT scientists to stage second series of tests in September when planet is closer to earth

MIT SCIENTISTS were pushing state of the art in maser, radar and radiometry techniques this week in preparation for a second series of radar contacts with Venus, scheduled for September when the planet will come relatively close to earth.

First contacts—and first reported application of solid-state maser in a practical system—were disclosed last month by MIT Lincoln Lab team at Westford, Mass., site of Millstone Hill radar station built with Air Force funds for ballistic missile research (ELECTRONICS, p 19, Dec. 10, '57).

On Feb 10 and 12, '58, Millstone's uhf radar, operating at 440 mc with peak power of 265 kw, bounced signal off cloud-covered Venus. Using solid-state maser developed at Lincoln (ELECTRONICS, p 66, Apr. 25, '58) as preamplifier, pulse-train was picked up by Millstone receiver and recorded on magnetic tape. Waves were just barely detected after round-trip of 56 million miles.

Experiment increased by 100 times the longest range ever attained by radar—reaching out 28 million miles. Strength of return signals was correspondingly decreased by 10 million to 1. Most distant target previously detected by radar was the moon, in 1946.

Maser for Venus experiment was developed by Robert H. Kingston. Because circulators are not yet available, directional coupler was used, resulting in 10 db gain overall, instead of the 20 db which could be available with circulator.

Kingston also devised resonant circuit tuned by capacitor external to cavity wall. Cavity mode was used at pumping frequency of 5,400 mc, and a lumped resonant circuit at amplifying frequency.

Wire loop lying in plane of rf magnetic field at center of cavity was resonated by placing dielectric between loop leads which project out of cavity through small hole in sidewall. Cavity mode was loop-coupled while uhf circuit was coupled externally by means of capacitive probe placed near ungrounded lead from the loop, al-

lowing independent tuning of two resonances. Losses in lumped uhf circuit were overcome by plating loop with lead, thus getting superconductivity—or zero resistance—at liquid helium temperature.

Millstone transmitter has two Eimac X626 klystrons for final power amplification, although only one was used in Venus experiment. Scientists estimate that use of second klystron would increase range by 20 percent. MIT declines to disclose maximum power capability of Millstone radar.

With Millstone transmitting at 265 kw, 30 pulses per second, Venus intercepted at half-watt, and signal strength of only  $10^{-20}$  watt was received back on earth. Power would have to be boosted 16 times to double range.

Next steps in interplanetary radar contacts: repeat of '58 experiment next September; transmitter power boost and refinement of maser techniques to beam signal at Mars; development of real-time data analysis system.

In future, meanwhile, is maser operation in infrared and optical regions, now under study at Lincoln Lab and other U. S. research centers.

## At Test Stand



U. S. Air Force's slim and powerful Titan missile is framed by the sides of the erector at one of Martin-Denver's four static test stands

THE LEGENDARY FIREBIRD, the Phoenix, rose young and strong again and again from flames . . . This is the new Norton Firebird — symbol for the exciting new fused materials made in Norton's electric furnaces.



## New booklet on CARBIDES and other electro-chemicals

Roaring flames gave the legendary Phoenix the power to range far and wide. Similarly, the white-hot fury of modern electric furnaces is Norton's source of power for making carbides for an amazing range of applications.

For example, Norton boron carbide is a starting point for high energy rocket fuels . . . zirconium carbide, today's highest melting point material available in tonnage quantities . . . titanium and silicon carbides, key metallurgical additives.

These versatile products have also gained importance as chemical source materials, high temperature electrical conductors or resistors, refractories and cermet components. Explore their dynamic possibilities as economical, high-efficiency materials for *your* processing requirements. Get the fact-filled booklet shown above. Write NORTON COMPANY, Electro-Chemical Division, 947 New Bond Street, Worcester 6, Massachusetts.



## ELECTRO-CHEMICALS

GIFTS OF THE FIREBIRD: compounds of silicon  
zirconium • boron • aluminum • magnesium  
titanium • chromium • including many borides  
carbides • nitrides • oxides.

## MAKING BETTER PRODUCTS

... TO MAKE

YOUR PRODUCTS BETTER

CIRCLE 29 READERS SERVICE CARD



ACTUAL SIZE

# solve

## YOUR LOGIC CIRCUIT PROBLEMS WITH EPSCO'S NEW

# TDC COMPONENTS

Typical Epsco TDC system application

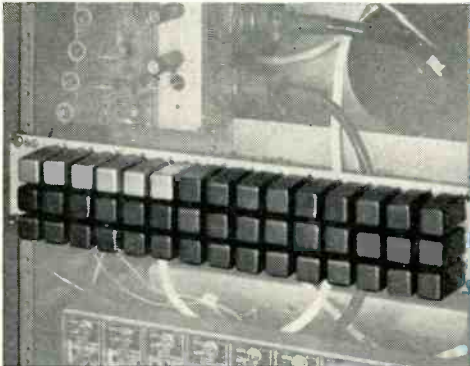

Available now . . . a complete line of fully encapsulated high-loading TRANSISTOR DIGITAL CIRCUITS . . . plug-in components to give you true reliability at very low cost. Epsco TDC's save you engineering time . . . slash space requirements . . . provide flexible, compatible operation.

### AVAILABLE CIRCUITS

- Flip-Flops and Counters
- Diode AND Gates
- Diode OR Gates
- Nor Gates — An Epsco Exclusive
- Parallel Gates
- Cascade Gates
- Inverter Amplifiers
- Non-Inverting Amplifiers
- Emitter Followers
- Power Drivers
- Delay Multivibrators
- Pulse Shapers
- Level Converters
- Neon Indicators
- Incandescent Indicators
- Blocking Oscillators
- Level Shapers
- 6, 12, 18 volt Power Supplies
- Clock Multivibrators (0-200 KC)

Coming soon: complete 1 mc. logic circuit family . . . and we're adding others all the time

- Save Time and Space
- Cut Costs
- Permanent Encapsulation
- Vibration-Moisture Resistant
- Field Proven Circuits
- Low Power Requirements
- High Loading
- Completely Compatible
- In-Line or Tube Socket Mounting
- Easy-Access Test Points

### SPECIFICATIONS

Frequency Ranges . . . up to 400 KC  
 Switching Times  
 Diode Logic . . . . . 0.7 μsec max  
 Transistor Logic . . . . . 1.5 μsec max  
 Signal Voltage Levels  
 ±18 volts, ±6 volts  
 Temperature Range  
 -55°C to +75°C

# Epsco

## COMPONENTS

WRITE FOR FREE BROCHURE — a complete illustrated color brochure plus complete set of engineering inquiry data sheets with detailed performance characteristics, Epsco, Inc., Components Division, Dept. R128, 108 Cummington St., Boston 15, Mass.

## MEETINGS AHEAD

Apr. 12-19: Aircraft and Space Communications, World Congress of Flight, Air Force Assoc., EIA, Las Vegas, Nev.

Apr. 16-18: Southwestern IRE Conf. and Electronics Show, SWIRECO, Dallas Memorial Aud. & Baker Hotel, Dallas.

Apr. 20-21: Analog & Digital Recording & Controlling Instrumentation, AIEE, PGIE & PGI of IRE, Bellevue-Stratford Hotel, Philadelphia.

Apr. 20-22: Instrument Society of America, Southeastern Conf. & Exhibit, Gatlinburg, Tenn.

Apr. 20-22: Man-in-Space Conf., American Rocket Society, Hotel Chamberlain, Hampton, Va.

Apr. 21-22: Electronic Data Processing, IRE Section, Engineering Society Building, Cincinnati, O.

Apr. 22: Medical Electronics, The Electro-Medical Program at the Moore School, PGME of IRE, Univ. of Penn., Philadelphia.

Apr. 28-30: Power Sources Conference, USA Signal Research & Devel. Lab, Fort Monmouth, Shelburne Hotel, Atlantic City, N. J.

Apr. 30-May 1: Controllable Satellites Conf., ARS, M.I.T., Cambridge, Mass.

May 3-7: Electrochemical Society, 115th Annual Meeting, Hotel Sheraton, Philadelphia.

May 4-7: Instrumentation Flight Test Symposium, ISA, Seattle, Wash.

May 4-8: Society of Motion Picture & Television Engineers, Annual Convention, Fontainebleau Hotel, Miami Beach, Fla.

May 5-7: USA National Committee, URSI, PGAP, PCCT of IRE, Willard Hotel, Wash., D. C.

May 6-8: Electronic Components Conference, AIEE, EIA, IRE, WCEMA, Benjamin Franklin Hotel, Philadelphia.

May 6-8: Seventh Region of IRE, Technical Conf. & Trade Show, Univ. of New Mexico, Albuquerque, N. M.

There's more news in ON the MARKET, PLANTS and PEOPLE and other departments beginning on p 74.

# 3-D Radar...Leads... Distance, Altitude

(Pictures on Page 3)  
A revolutionary new 3-D radar capable of detecting enemy air attackers at extreme range and revealing their distance, bearing and altitude to military ground units was revealed today by the Army. The new system, called Frescanar and developed by Hughes Aircraft Company, also sees its target range clearly than ordinary radar which increases the number of targets which can be detected.

## Army Shows Radar With 3d Dimension

By JACK RAYMOND  
Special to The New York Times  
WASHINGTON, Oct. 14—The Army demonstrated a new "three-dimensional" radar device today and called it "one of the most important advances made in electronic detection." The new radar gives simultaneous readings of bearing, distance and altitude; it is designed to be hauled on truck trailers.

## Called Great Advance

# Army Unveil Hughes Radar

Electronically, 'Frescanar' Can 50% Further Than Previous

WASHINGTON, Oct. 14—The Army Tuesday unveiled a field radar system that simultaneously computes bearing and altitude. It employs a single antenna housed in an inflatable frame designed to become the electronic eyes of defenses.

## New Radar Imp Air Defense for

WASHINGTON.— Field armies now have a truly effective defense against any kind of attack except that from ballistic missiles within a year, Army officials said last week.

Statement came at the unveiling of a new type of radar as a key element of the Monitor system, which will save men training time, and increase the mobility and effectiveness of air defense in tactical groups.

KEY to the new thing known now are needed. An additional that the entire more mobile the equipment used same job. The move at good speed off set up and be minutes.

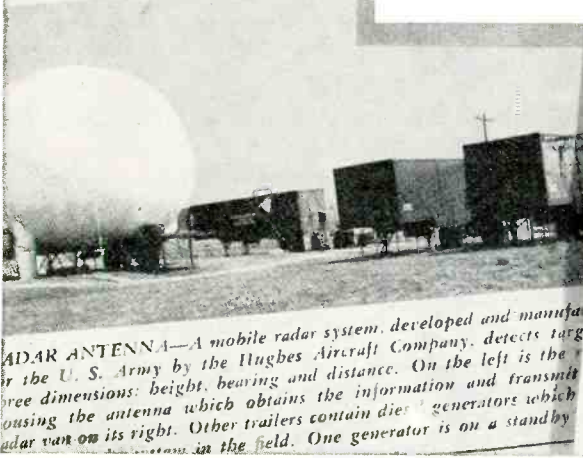

ADAR ANTENNA—A mobile radar system, developed and manufactured by the U. S. Army by the Hughes Aircraft Company, detects target in three dimensions: height, bearing and distance. On the left is the antenna which obtains the information and transmits it to the ground units. Other trailers contain diesel generators which power the antenna. One generator is on a standby.

# Army Unveils A Faster Radar System

WASHINGTON.— A radar system that is faster, more reliable and more rugged than present equipment was unveiled by the Army here Tuesday. Nicholas A. Bezovich, of Hughes Aircraft Co. said a single antenna does the work of three.

## Army Shows Radar With 3d Dimension

WASHINGTON, Oct. 14—The Army demonstrated a new "three-dimensional" radar device today and called it "one of the most important advances made in electronic detection." The new radar gives simultaneous readings of bearing, distance and altitude; it is designed to be hauled on truck trailers.

## Called Great Advance

# Army Unveil Hughes Radar

Electronically, 'Frescanar' Can 50% Further Than Previous

WASHINGTON, Oct. 14—The Army Tuesday unveiled a field radar system that simultaneously computes bearing and altitude. It employs a single antenna housed in an inflatable frame designed to become the electronic eyes of defenses.

## New Radar Imp Air Defense for

WASHINGTON.— Field armies now have a truly effective defense against any kind of attack except that from ballistic missiles within a year, Army officials said last week.

Statement came at the unveiling of a new type of radar as a key element of the Monitor system, which will save men training time, and increase the mobility and effectiveness of air defense in tactical groups.

KEY to the new thing known now are needed. An additional that the entire more mobile the equipment used same job. The move at good speed off set up and be minutes.

# J.S. Reveals New Radar Instrument

A "3-D" radar that for the first time automatically computes distance, bearing and altitude of far-away targets was unveiled today by the Army in Washington.

## Army Shows Radar With 3d Dimension

WASHINGTON, Oct. 14—The Army demonstrated a new "three-dimensional" radar device today and called it "one of the most important advances made in electronic detection." The new radar gives simultaneous readings of bearing, distance and altitude; it is designed to be hauled on truck trailers.

## Called Great Advance

# Army Unveil Hughes Radar

Electronically, 'Frescanar' Can 50% Further Than Previous

WASHINGTON, Oct. 14—The Army Tuesday unveiled a field radar system that simultaneously computes bearing and altitude. It employs a single antenna housed in an inflatable frame designed to become the electronic eyes of defenses.

## New Radar Imp Air Defense for

WASHINGTON.— Field armies now have a truly effective defense against any kind of attack except that from ballistic missiles within a year, Army officials said last week.

Statement came at the unveiling of a new type of radar as a key element of the Monitor system, which will save men training time, and increase the mobility and effectiveness of air defense in tactical groups.

KEY to the new thing known now are needed. An additional that the entire more mobile the equipment used same job. The move at good speed off set up and be minutes.

# Army Unveils Revolutionary Radar Device

WASHINGTON, Oct. 14—The Army demonstrated a new "three-dimensional" radar device today and called it "one of the most important advances made in electronic detection." The new radar gives simultaneous readings of bearing, distance and altitude; it is designed to be hauled on truck trailers.

## Army Shows Radar With 3d Dimension

WASHINGTON, Oct. 14—The Army demonstrated a new "three-dimensional" radar device today and called it "one of the most important advances made in electronic detection." The new radar gives simultaneous readings of bearing, distance and altitude; it is designed to be hauled on truck trailers.

## Called Great Advance

# Army Unveil Hughes Radar

Electronically, 'Frescanar' Can 50% Further Than Previous

WASHINGTON, Oct. 14—The Army Tuesday unveiled a field radar system that simultaneously computes bearing and altitude. It employs a single antenna housed in an inflatable frame designed to become the electronic eyes of defenses.

## New Radar Imp Air Defense for

WASHINGTON.— Field armies now have a truly effective defense against any kind of attack except that from ballistic missiles within a year, Army officials said last week.

Statement came at the unveiling of a new type of radar as a key element of the Monitor system, which will save men training time, and increase the mobility and effectiveness of air defense in tactical groups.

KEY to the new thing known now are needed. An additional that the entire more mobile the equipment used same job. The move at good speed off set up and be minutes.

# Hughes Radar

WASHINGTON, Oct. 14—The Army demonstrated a new "three-dimensional" radar device today and called it "one of the most important advances made in electronic detection." The new radar gives simultaneous readings of bearing, distance and altitude; it is designed to be hauled on truck trailers.

## Army Shows Radar With 3d Dimension

WASHINGTON, Oct. 14—The Army demonstrated a new "three-dimensional" radar device today and called it "one of the most important advances made in electronic detection." The new radar gives simultaneous readings of bearing, distance and altitude; it is designed to be hauled on truck trailers.

## Called Great Advance

# Army Unveil Hughes Radar

Electronically, 'Frescanar' Can 50% Further Than Previous

WASHINGTON, Oct. 14—The Army Tuesday unveiled a field radar system that simultaneously computes bearing and altitude. It employs a single antenna housed in an inflatable frame designed to become the electronic eyes of defenses.

## New Radar Imp Air Defense for

WASHINGTON.— Field armies now have a truly effective defense against any kind of attack except that from ballistic missiles within a year, Army officials said last week.

Statement came at the unveiling of a new type of radar as a key element of the Monitor system, which will save men training time, and increase the mobility and effectiveness of air defense in tactical groups.

KEY to the new thing known now are needed. An additional that the entire more mobile the equipment used same job. The move at good speed off set up and be minutes.

# A new field... a new future... for the forward-looking engineer!

The first radar system capable of simultaneously detecting range, bearing and altitude from a single antenna, transmitter, and receiving channel... Frescanar is a major breakthrough in radar technology.

Developed by Hughes Fullerton, the Frescanar antenna operates on a new electronic principle called *frequency scanning*: The position of the radar beam is changed by varying the frequency of electromagnetic energy applied to the antenna. Thus the beam can move at lightning speed to handle more targets with greater accuracy than with conventional radar.

This unique concept opens entirely new fields for radar... including a great many as yet unexploited. Hughes Fullerton needs creative engineers who can step in and help develop these new military and civilian applications.

While Hughes Fullerton places emphasis on advanced development, it is a completely integrated engineering and manufacturing organization... whose activities cover a wide range of electronic and electromechanical applications.

Now expanding rapidly, Hughes is offering imaginative engineers a number of new positions. If you are interested in stimulating work with solid opportunity for personal and professional growth, we invite your inquiry. Please contact Mr. L. V. Wike at address below.



GROUND SYSTEMS DIVISION  
PERSONNEL SELECTION AND PLACEMENT  
HUGHES AIRCRAFT COMPANY  
FULLERTON, ORANGE COUNTY, CALIFORNIA

© 1959, H. A. C.

# 3-D Radar Developed by Hughes

Computes Bearing, Range, Altitude in Single Operation

Three-dimensional, hemispheric radar detection developed by Hughes Aircraft is now in use on Navy ships

NEW YORK  
WEDNESDAY, OCTOBER 15, 1958

# Army Gets Improved Field Radar

WASHINGTON, Oct. 14—The Army today unveiled a new field radar system that simultaneously computes distance, bearing and altitude.

# 3-Dimensional Radar Is Displayed by Army

By JAMES W. BRADY  
Special to The Tribune

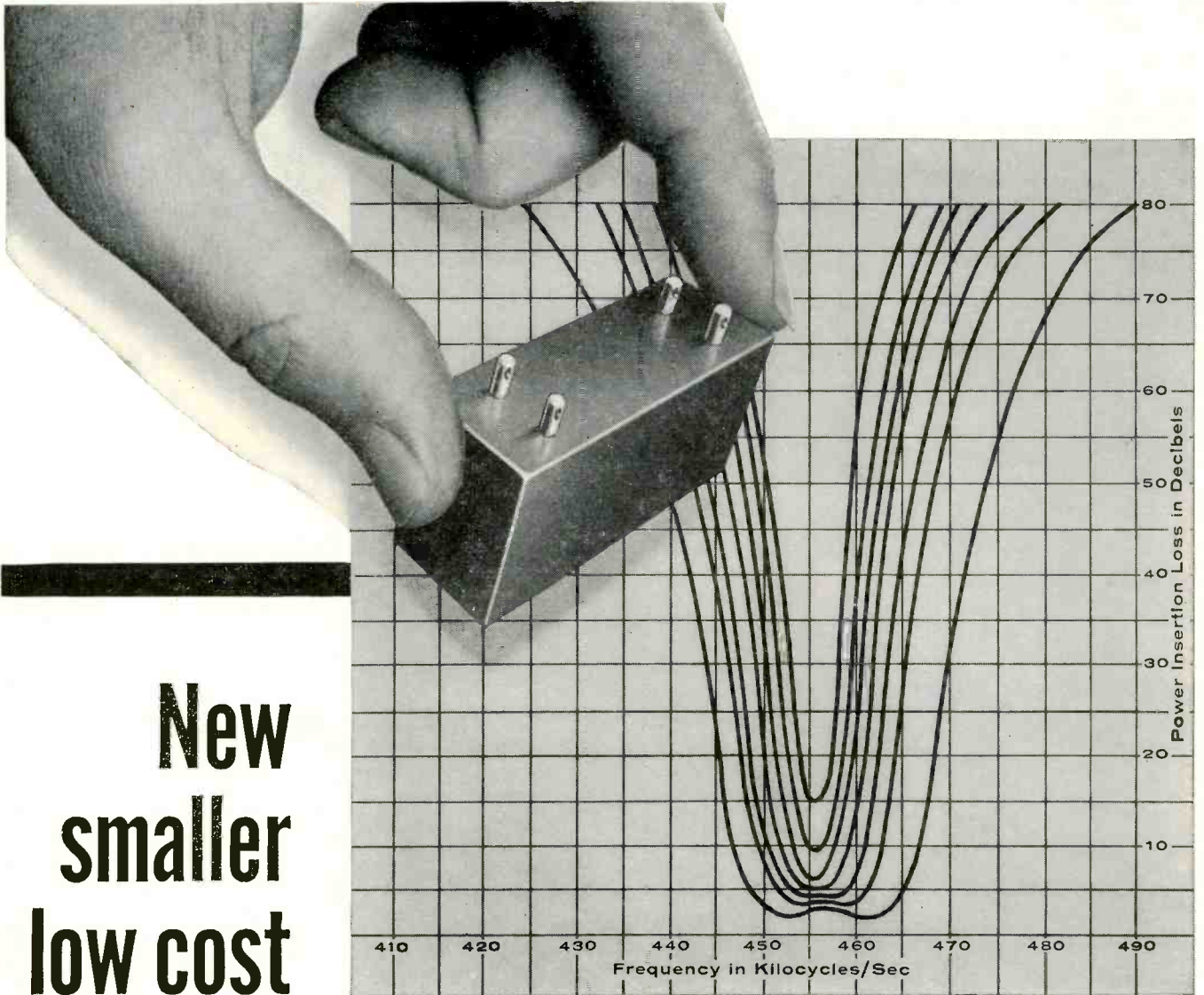

# New smaller low cost

**i.f.  
filter!**

*...built-in bandwidth selection...frequency stability!*

It's the new CLEVITE COMBINATION I. F. FILTER (TC series)! Shape factors from 3-1 to 6-1. Pick one specific bandwidth from a wide range . . . or reduce costs even further with multiple bandwidths built into one package. Compare these specifications:

**BANDWIDTH RANGE**  
4 KC - 20 KC  
**CENTER FREQUENCIES**  
400 KC - 600 KC  
**TEMPERATURE RANGE**  
-40°C. to + 85°C. operating  
-100°C. to + 100°C. storage

**DIMENSIONS:**

<b>4 Section</b> 3/4" x 1" x 1 1/2"	<b>5 Section</b> 3/4" x 1" x 2 1/4"	<b>6 Section</b> 3/4" x 1" x 2 1/2"
<b>NOMINAL, INPUT, OUTPUT IMPEDANCES</b>		2700 OHMS (4 & 6 section) 2700 OHMS in 400 OHMS out (5 section)

Features same stable "PZT" material as Clevite Transfilter and Ladder Filters (TF, TO, and TL series). Frequency stability is  $\pm 0.13\%$  over the operating temperature range. Case is epoxy resin potted with 4 terminals. Applications include amateur transmitters, low cost mobile communication systems, comb filters.

Write for Bulletin 9408  
for complete details.

## CLEVITE ELECTRONIC COMPONENTS

DIVISION OF

**CLEVITE  
CORPORATION**

3311 Perkins Avenue • Cleveland 14, Ohio

MAGNETIC HEADS, PIEZOELECTRIC CRYSTALS,  
TRANSDUCERS, CERAMICS AND ELEMENTS

Field sales engineering offices in Newark, Chicago and Los Angeles.



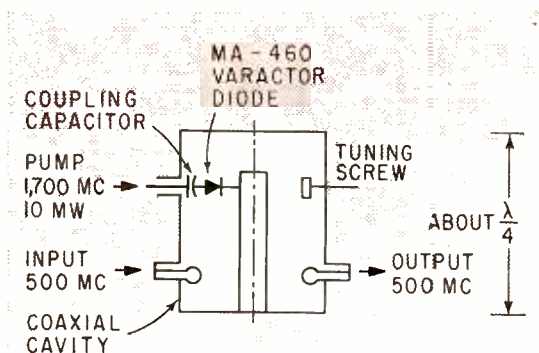

FIG. 1—Sketch of the Harris parametric amplifier developed at Microwave Associates. It has been used as a preamplifier in uhf-tv, radar and amateur reception

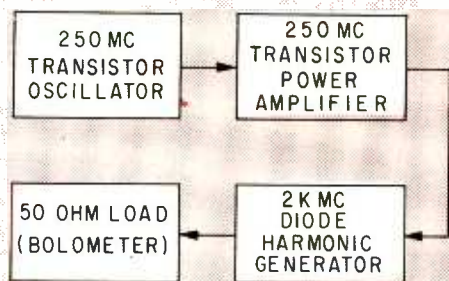

FIG. 2—Block diagram of the tubeless microwave power source developed at Philco. System is capable of 10 mw output

# New Solid-State Devices and Applications

Advances in solid-state technology are profoundly influencing the shape and performance of electronic systems in many areas. Some new devices and applications are outlined in this article

By **SAMUEL WEBER**, Associate Editor

SOLID-STATE TECHNOLOGY continues to advance both in new devices and new applications. Basic research into properties of semiconductor materials, quantum-mechanical amplifiers such as masers and mavers, and luminescent and photoconductive phenomena is making it possible for solid-state devices to successfully perform more and more of the functions.

**COMMUNICATIONS**—Influence of the evolution of the parametric amplifier and solid-state maser is already being felt in communications, as these new microwave devices are being rushed from the laboratory into the field. In the region below 1,000 mc, diode mavers have demonstrated their worth in satellite-tracking radars, IGY research receivers, uhf television receivers, and amateur radio reception.<sup>1</sup> In the vhf-uhf region, measured noise figures of 1 db have been achieved, with the parametric

amplifier configuration shown above in Fig. 1.

Above 1,000 mc where sky noise is sufficiently low, the maser will soon be widely used. It is expected to form the basis of satellite communications systems and space vehicle communications systems, for which the noise figure of conventional receivers may be prohibitive.

Meanwhile, masers have improved results obtained at NRL with their giant radio telescope in the study of thermal radiation from outer space.

**MICROWAVE POWER SOURCE**—Replacement of klystrons or other relatively bulky microwave power sources by solid-state generators could enable future U.S. satellites to transmit in the desirable 1,000-2,000-mc range without increasing weight or size requirements.

A microwave generator in the S-band region has been developed using solid-state elements.<sup>2</sup>

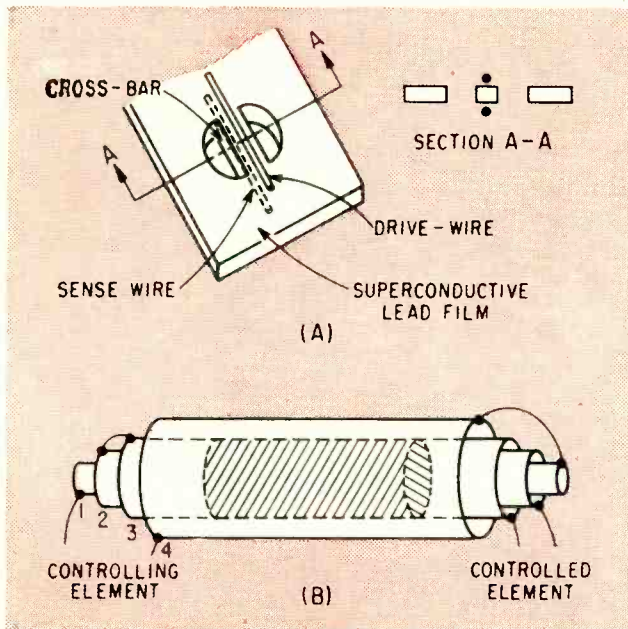

FIG. 3—New cryotron geometries: (A) IBM's superconducting ring; (B) the Richards concentric cylinder cryotron

The device is based on a transistor oscillator and amplifier combined with a diode harmonic multiplier. Arrangement of the elements is shown in Fig. 2.

In the practical version, the diode used is a Transistron S-555G operating in the eighth harmonic mode. The oscillator and amplifier are two Philco high-frequency power transistors operating at 250 mc. The system is capable of 10-mw output power at 2 kmc with an efficiency of 2.3 percent. Modulation is achieved by varying the back bias on the diode. Little modulating power is required.

**COMPUTERS**—In modern digital computers, speed is the criterion by which performance is judged. The most obvious way to attain greater speed is to make faster random-access memories and reduce computer size.

**CRYOTRONS**—Computer circuits using superconductor elements (cryotrons) are receiving increased attention because of their small size and potentially high speeds. The original cryotron consisted of a helical coil wound about a straight wire. Because of high inductance of the coil and low resistance of the controlled element, response time  $L/R$  was poor. To improve speed, resistance can be increased by using thin films in place of solid conductors. To decrease the inductance, several geometries have been proposed to eliminate the use of coils in any form.

The basic structure of one type of superconducting element using thin films<sup>3</sup> is shown in Fig. 3A. Superconducting rings are formed by a crossbar located over a hole cut out of the film. A drive wire placed over the hole applies the magnetic field. A change in the flux pattern linking the crossbar is detected by the sense wire. 8 by 8 memory planes have been constructed using these elements with a

switching speed of 10 millimicrosec, and storage capacity of 160 bits/in.<sup>2</sup>

Another cryotron construction is illustrated in Fig. 3B. Here a concentric cylinder structure offers the advantage of small size and rugged construction, and limits the magnetic field to a small volume, thus reducing the inductance.<sup>4</sup>

In this construction, consisting of thin films on a fine central wire, current is passed through cylinders 2 and 3 in opposite directions so that the net field at the outer surface of 3 is zero. The controlling current passes through cylinders 1 and 4 in opposite directions so that only the current in 1 produces a field in the region of 3. Presence or absence of this field causes the shaded section of cylinder 3 to be either resistive or superconductive. Since cylinder 3 can support large currents without becoming resistive through self-induction, high current gain is possible.

**SWITCHING TRIODE**—Joining the ranks of solid-state switching devices is a diffused silicon three-terminal element called a  $pn\pi n$  triode.<sup>5</sup> The  $\pi$  region is a high resistivity  $p$ -type layer sandwiched between  $n$  and  $np$  layers diffused on either side. Fig. 4 shows the arrangement.

With collector  $N_2$  reverse-biased, all the junctions except  $N_1\pi$  are forward-biased. The  $V-I$  characteristic through the device is at first determined by the  $N_1\pi$  junction reverse characteristics. As the current increases  $\alpha_2$  rises from an initially low value toward unity. When the current density in the  $\pi$  region rises to a value such that the sum of the  $pnp$  and  $npn$  alphas reach unity, the unit becomes regenerative and current is limited by the external circuit.

When the triode is switched to the on state, electrons are injected into the  $\pi$  region, resulting in low saturation resistance, in the order of one ohm.

These  $pn\pi n$  triodes have a wide range of applications in logic circuits. They are also potentially useful in impulse switching of memory cores, since they are capable of switching currents as large as 80 amp in 150 millimicrosec.

**STEPPING TRANSISTOR**—A semiconductor stepping device has recently been developed by Bell Telephone Laboratories scientists Ross, Dasaro and Loar and is illustrated in Fig. 5A<sup>6</sup>. It consists of a sheet of silicon containing an  $n$ -type region (2) bounded by two  $p$ -type regions (1) and (3).  $n$ -type

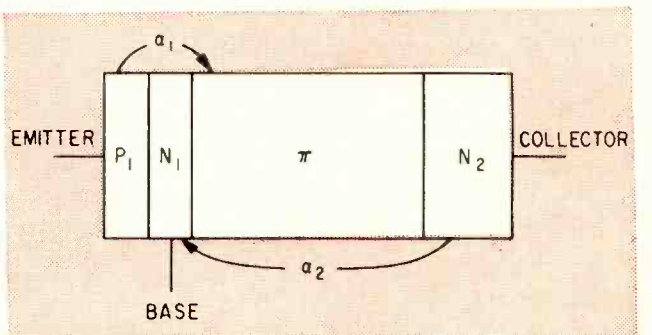

FIG. 4—Simplified sketch of the Fairchild  $pn\pi n$  switching triode

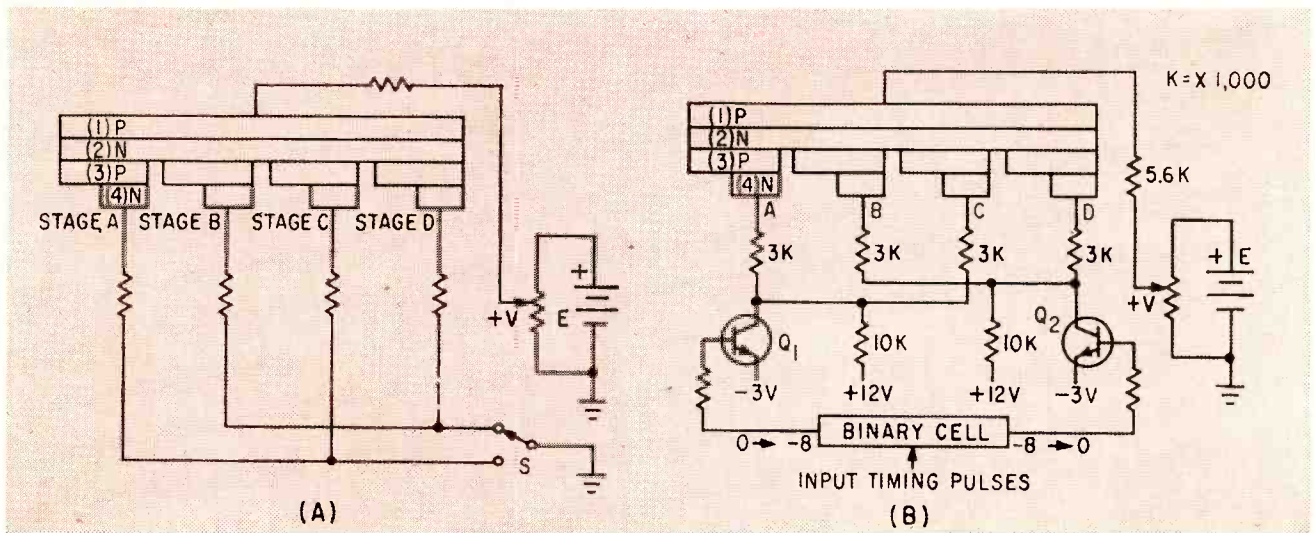

FIG. 5—Basic connection (A) of Bell Labs stepping transistor. In practical circuit (B), output is obtained for each stage of device

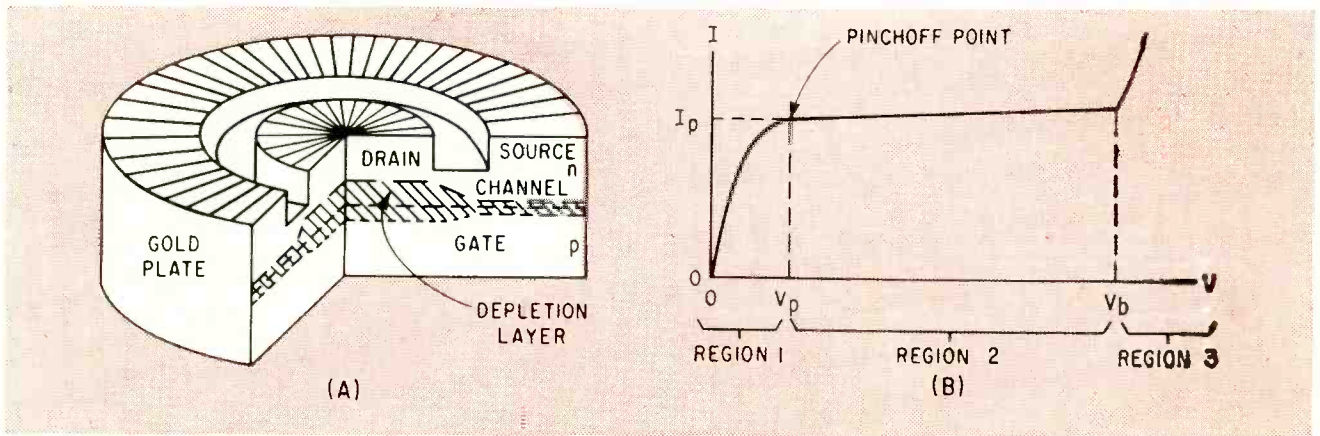

FIG. 6—Bell Labs field-effect current limiter structure (A) and typical operating characteristics of the device (B)

contacts (4) surmount each *pnp* region thus formed.

In Fig. 5A with contact *S* closed, stage *B* is conducting, causing carrier emission across the junction (1-2). Degree of concentration depends upon resistivity of region (2) and the current. Some carriers enter the region of adjacent stage *C*, which is then primed for conduction. On rapid transfer of contact *S*, conduction is transferred to stage *C*.

The transfer can only be in one direction. If stage *D* is connected while *B* is conducting, nothing happens since transfer can only occur between adjacent stages. This lockout feature enables two stages to be connected with only one of them conducting.

In practical circuits a pulse generator takes the place of the mechanical switch *S*. To get an output for each stage of the device, the output leads from alternate stages are connected together as shown in Fig. 5B. Each group is then connected to the collector of a transistor which is alternately turned on and off by the pulse generator.

**FIELD EFFECT LIMITER**—A new device similar in structure to the field-effect transistor shows promise as a circuit element. Figure 6A shows the construction of the field-effect current limiter.

As voltage applied to the drain is increased, formation of a depletion layer in the channel causes the device resistance to increase. When the depletion layer extends through the entire channel, further increases in voltage have no effect on the current. Figure 6B shows typical characteristics. Pinchoff currents and voltages range from  $10\mu\text{a}$  at 1 volt to 10 ma at 30 v.

The nonlinear behavior of the field-effect current limiter makes possible a wide range of practical applications.

Other applications are in wave-shaping clipping, stair-step generators and digital-to-analog converters.

#### REFERENCES

- The papers listed below were all presented at the 1959 Solid-State Circuits Conference.
- (1) A. Uhlir, Jr., Amplification by Nonlinear Reactance.
  - (2) M. M. Fortini and J. Vilms, Solid-State Microwave Power Source.
  - (3) C. J. Kraus, Pro's and Con's on a Superconducting Memory.
  - (4) R. K. Richards, Proposed New Cryotron Geometry and Circuits.
  - (5) V. H. Grinich and I. Haas, Application of  $\text{PN}\pi\text{N}$  Triode Switches.
  - (6) E. F. Kovanic, Circuit Applications of Stepping Transistors.
  - (7) E. I. Doucette, Some Circuit Applications of the Field Effect Current Limiter.

# Miss Distance Indicator

Separation between missile and target within 10- to 3,990-foot range is measured electronically using nonradar technique. Transponder and antenna systems in missile and target form space-coupled, oscillating loop whose frequency depends on separation distance

By J. A. ADAMS, The Ralph M. Parsons Co., Los Angeles, Calif.

**D**ESTRUCTIVE RANGES of missiles vary from a few feet to several thousand feet. Since inert warheads are usually used in practice firings, a method must be provided to indicate the closest approach of a missile to a target so that the effectiveness of the shot can be evaluated. This article describes a miss distance indicator (MDI) that does not use pulsed or Doppler radar techniques.

## System Concept

The system, called Parami (Parson Active Ring-Around Miss Indicator), consists of a target transponder, a missile transponder, a recording ground station and various high-gain directive antennas. Airborne equipment includes one transponder with a single antenna in the target and a much smaller transponder using either a single or dual antenna in the missile. Two carrier frequencies in the uhf region link the airborne trans-

ponders and contain distance information in the form of pulse frequency. Since the stronger carrier frequency is used to provide the necessary information to the ground station, the system is self-telemetering.

A calibrating technique is used which permits the airborne and recording units to be calibrated simultaneously and on demand. Calibration is initiated manually from the ground station and requires 20 sec to perform. Thus, it is possible to assure system accuracy just prior to intercept.

## System Operation

A simplified block diagram of the basic airborne system is shown in Fig. 1. The two airborne units, the missile transponder and target transponder, constitute a space-coupled, oscillating loop. At the missile, a signal is received on carrier frequency  $f_2$  and retransmitted on carrier frequency  $f_1$ . At the target, the carrier frequency  $f_1$  transmitted from the missile is received and transmitted on carrier frequency  $f_2$ .

High system gain permits the signal to pass around the loop in a regenerative fashion, the period of oscillation varying as the distance between the two transponders changes. This oscillation appears as pulse modulation on each stable carrier. The stronger of the two transmitted signals from the target transponder is telemetered to the ground recording station which then converts the transmitted signal into distance measurement.

Frequency of the space-loop

oscillations depends upon the fixed delay built into the equipment and the variable delay resulting from the distance between the two airborne units. This oscillating, or data, frequency, varies in accordance with the equation

$$f = \frac{1}{(t_0 + 2R/c)}$$

where  $f$  equals data frequency,  $t_0$  equals total equipment delay,  $2R$  equals round trip distance between transponders and  $c$  is the velocity of light.

Highest frequency at which the system can oscillate (zero distance) is controlled by the fixed equipment delay. Since this delay in the system is 20  $\mu$ sec, the oscillating frequency is limited to 50 kc.

## Calibration Technique

Fixed delay  $t_0$  in the target transponder can vary with temperature under extended airborne conditions; therefore, a method was pro-



THE FRONT COVER.—Helix antenna picks up airborne transponder signals indicating distance between target and missile

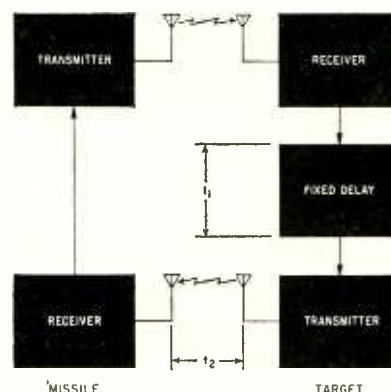

FIG. 1—Transponder loop. Two carrier frequencies serve to measure closure distance, telemeter data to ground station and carry calibration commands

# Scores Missile Accuracy

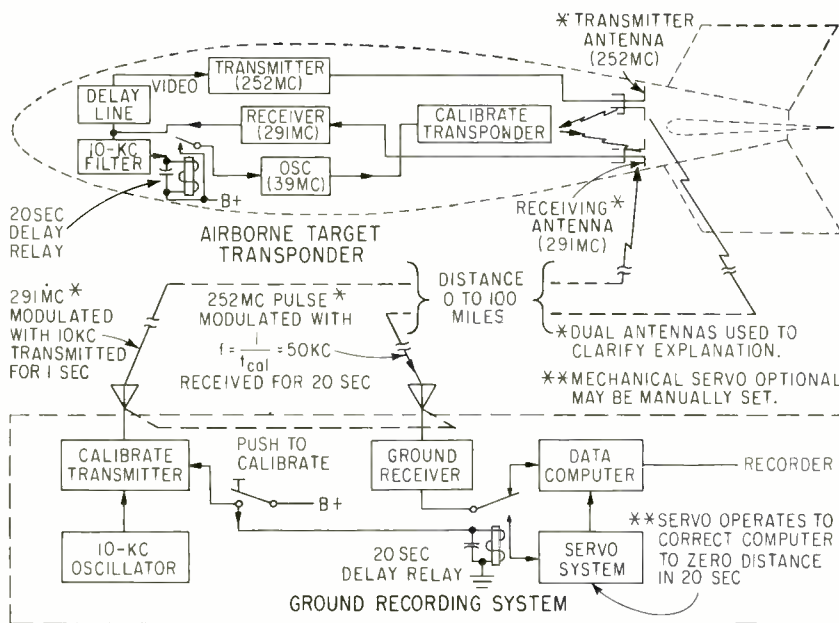

FIG. 2—Calibration system. Variations of individual components with temperature, voltage and signal level add in same direction permitting use of simple calibrate transponder

vided to continuously determine the value of  $t_c$ . This is done by causing the target transponder to oscillate with a calibrated transponder. A block diagram of the calibration system is shown in Fig. 2.

Since the calibrated transponder is mounted close to the target transponder, the oscillating frequency received at the ground station is

$$f = 1/t_c$$

When this information is received by the ground station, a single zero adjustment is made. Thus, by making the ground recorder zero agree with the equipment delay, any variation in zero drift in either the recorder or target transponder is cancelled. Zero calibration is initiated only on command from the ground station.

## Target Transponder

A block diagram of the target transponder is shown in Fig. 3. The target transponder uses a grounded-grid, trf, 6-stage receiver. Variable input impedance to the control-grid is made largely resistive; therefore, three controlled stages can be staggered so that the effective overall detuning resulting from gain control is cancelled.

The video amplifier has a small linear operating range requirement, and performs efficiently with low plate and screen potentials. These characteristics result from the large agc loop gain used in the system which holds the receiver output within  $\pm 2$  db for an input variation of about 80 db. Two pentodes make up the video amplifier and produce a small signal distortion over the  $\pm 2$  db amplitude range requirement.

Output of the video amplifier drives two limiters which remove noise from the top and bottom of the signal. The limited signal is passed through a lumped-constant delay line to a diode clipper which re-

moves the delay line ripple and sharpens the pulse triggering the modulator pulser.

Video amplifier gain and limiter bias are adjusted so that noise from the receiver output triggers the modulator circuit during no-signal conditions. Prior to intercept, therefore, a continuous noise signal (used to provide initial system activation) is transmitted from the target transponder. The spectrum of the radiated noise peaks at about 50 kc because of recovery time inherent in the modulator pulser.

Peak power output of the target transponder is determined from the required input of a missile transponder receiver and the system loop losses for a given maximum separation of the target and missile. Losses resulting from the attenuation of space are determined by the equation

$$a = 37 + (20 \log f) + (20 \log d)$$

where  $f$  equals the operating frequency in mc and  $d$  equals distance of operation in miles. These requirements together with the safety factor made it necessary to design a target transmitter capable of developing 100 watts peak power output.

## Target Transmitter

The target transmitter consists of a master oscillator driving a power amplifier. A 600-v modulating pulse is applied to the output of the master oscillator and is, in effect, linearly modulated up to the point of saturation. Although the power amplifier is supplied with a relatively high cutoff bias, the

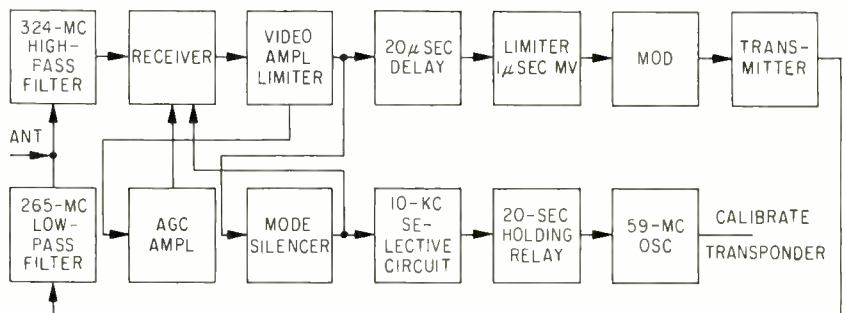

FIG. 3—Simple target transponder circuit is used to keep weight and size to a minimum

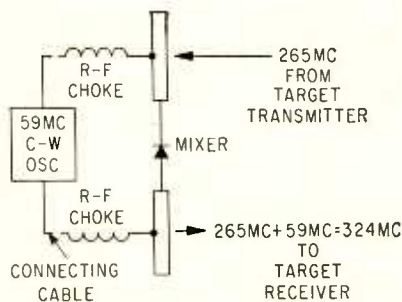

FIG. 4—R-f chokes in calibrate transponder isolate cable from mixer. If mounted close to main target antenna, total delay through transponder is 0.002  $\mu$ sec

modulating pulse exceeds the cut-off potential causing the amplifier to produce 100-watt output pulses. Rise times of 0.1  $\mu$ sec or less are obtained with excellent delay stability.

### Calibrate Transponder

Associated with the target transponder is a calibrate transponder which provides zero calibration for the recording station. The calibrate, or reference, transponder consists of a nonresonant pickup antenna and a crystal diode mixer arranged as shown in Fig. 4.

The mixer is driven with a 59 mc c-w oscillator which heterodynes with the 265-mc input from the target transmitter to give an output of 324 mc. This output is then radiated to the target receiver thereby completing the oscillating loop.

When the calibrate transponder is installed within two feet of the target transponder, the total delay of the space plus the calibrate delay is 0.01  $\mu$ sec. This value is less than the resolution of the system; therefore, it can be considered zero. Correction to exact zero can be made in the recording equipment if necessary. This method of calibrating includes all active components in the target installation; thus the zero is correct for all antenna configurations and antenna coax lengths.

### Remote Activation

Since the calibrate transponder should not be active during system operation, means are provided to activate the unit remotely. The method used is shown in Fig. 2.

At any time prior to intercept, a 1-kc, 1- $\mu$ sec pulse train is transmitted from a 324-mc command

transmitter located at the recording station. A 10-kc bandpass filter in the target receiver output actuates a 20-sec time delay relay in the target completing the high-voltage circuit to the 59-mc oscillator. When this occurs, the calibrate loop is complete and the target system rings at a frequency equivalent to a near zero distance.

Information received by the ground station is inserted into the recording equipment. Thus, the absolute delay through the target transponder can be determined remotely and on demand without use of additional carrier frequencies.

### Missile Transponder

There are several missile transponders each designed according to size and weight specifications and useful range. A block diagram of the missile transponder described is shown in Fig. 5.

A 265-mc input signal is applied to the cathode of the grounded-grid input amplifier. The plate of this stage is tuned by an inductor which

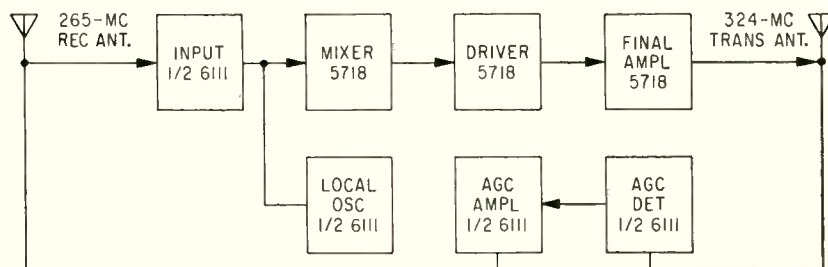

FIG. 5—Receiver and transmitter in missile transponder use two 100-ohm antennas in parallel to give terminal impedance of 50 ohms

also serves as the impedance-matching unit to drive the cathode of the grounded-grid mixer. The local oscillator feeds a 59-mc signal to the cathode of the mixer through a capacitor.

The plate of the mixer is tuned to the sum frequency of 324 mc by another inductor which also serves to match the impedance into the cathode of driver stage. Similarly, driver stage is tuned by an inductor which serves to match the impedance into the cathode of final amplifier.

The agc detector is diode connected. It rectifies the output of the final amplifier negatively and feeds the resultant negative pulses to the agc amplifier. Positive-going pulses

developed at the plate of the agc amplifier are a-c coupled to the input of the input amplifier. A diode is used to clamp the positive half cycle while the negative half cycle is stored by two capacitors thereby providing agc bias to input stage.

### Ground Station

The ground station converts signals received from the airborne target responder into a measurement of the distance between the target transponder and the missile transponder. Also, the ground station provides a means for zero calibration.

A six-stage trf type receiver is used which is similar to the target transponder receiver except that it is preceded by a manually tunable r-f filter having a bandwidth of 1 mc. Output pulses from the receiver are amplified and limited at a high-level point to eliminate all possible external interferences. A 10- $\mu$ v input signal to the receiver produces a pulse with a 0.2  $\mu$ sec jitter at the

limiter output. Final receiver output after limiting is a 30-v pulse obtained from a 500-ohm cathode follower.

### Recording Sequence

The receiver is followed by a divider which subsequently supplies information in a form that can be converted to usable data. Recording action at an early model ground station is described using the waveform sequence diagram shown in Fig. 6.

Line A shows the input from the receiver. This signal has a frequency of  $f = 1/(t_0 + 2R/c)$  or 50 kc at zero distance. Line B shows the divider output which consists of 8 bistable multivibrators

without feedback. One half of the cycle from  $t_0$  to  $t_2$  corresponds to 128 input events and is, therefore,  $128t_s + 128t_{sp}$   $\mu$ sec long where  $t_{sp}$  is space delay equal to  $2R/c$ .

A phantastron interval generator is triggered at  $t_0$  on line C and runs to  $t_1$  on line D. This interval is set to equal  $128t_s$ , thereby becoming the system zero adjustment.

The bistable difference multivibrator is set by the output of the interval generator at  $t_1$  on line E and is reset at the half cycle event of the divider at  $t_2$ . The positive interval of the bistable difference multivibrator is then  $128t_{sp}$ .

Total interval of the difference multivibrator, line E, is in error by an amount equal to 128 times the missile delay. This value amounts to about 128 times 0.2  $\mu$ sec or 25.6  $\mu$ sec. The interval corrector multivibrator is set to 25.6  $\mu$ sec, line F, to subtract 25.6  $\mu$ sec from the total in line E. This multivibrator is stable under all conditions to  $\pm$  one percent which corresponds to  $\pm$  one foot.

The positive pulse remaining in line E keys a pip oscillator into operation, shown on line G, which is set to a frequency corresponding to 10 ft per pip. Interval between pips is known to be 0.00203  $\mu$ sec times 128 round trips times 10 feet or a total elapsed time of 2.604  $\mu$ sec which corresponds to 384.02 kc. This frequency becomes the system slope adjustment.

At a time prior to  $t_1$ , a reset pulse is derived in the interval generator at time  $t_3$ , shown in line H. This pulse is used to reset all counter tubes to zero every printing cycle and also feeds a coincidence tube to form a print pulse.

The ten-foot pips are counted in a beam-switching tube which sweeps from zero to the maximum number indicated producing a steady negative voltage at the anode selected as shown in line I. At time  $t_3$ , the tube is reset thereby causing the anode voltage to rise positively. This rising voltage is differentiated, line J, and fed to a gas coincidence tube. Only the last number in a count holds the counter negative; therefore, this number is the only one which can go positive, or reset, to make coincidence.

A counter tube has ten separate outputs each of which supplies a voltage for coincidence. Since twenty-four outputs are used to record a total distance, three counter tubes and 24 coincidence tubes are required.

As the range increases from zero, the 10-foot counter goes through 1 cycle per 100 ft. Each time the 10-foot counter completes a cycle, the output is counted in the 100-foot counter. Each 100-foot counter cycle is counted in the 1,000-foot counter to a total range of 3,990 ft.

Outputs of the coincidence tubes, line K, are fed into pen-driver tubes which isolate the coincidence tubes and lower the source impedance. Pen drivers supply positive pulses to the styli which provide the necessary contact to voltage-sensitive recording paper. This paper is 4.5-in. wide and has 25 range styli and 3 timing styli aligned across the width of the paper. A sample record showing a typical intercept at 3,000 fps is given in Fig. 7.

### Antennas

One type of target antenna which has been used successfully is a multiple crossed dipole array. Four electric dipoles with equal cophased currents form a square loop excepting that the dipoles are tilted approximately 30 deg from their common plane. This antenna radi-

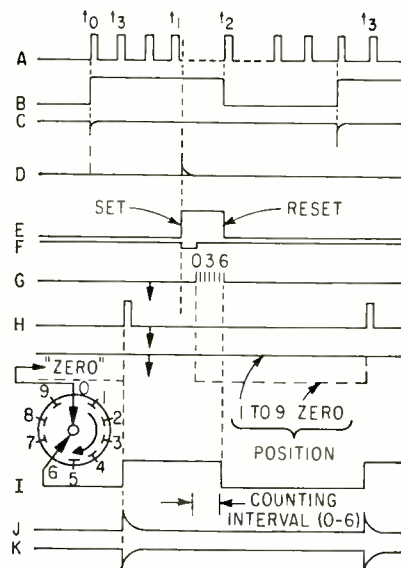

FIG. 6—Recorder waveform sequence. Time-multiplying principle of data reduction used in conjunction with digital recorder provides adequate accuracy and response

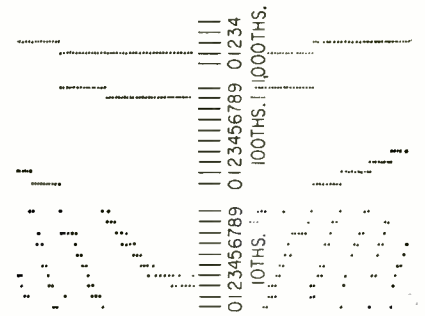

FIG. 7—Sample record. Maximum closure rate was 3,000 fps and tape speed  $4\frac{3}{8}$  ips

ates an omnidirectional circularly polarized field with very small nulls (about 1 db). Bandwidth is in excess of 40 mc at center frequency and the assembly is structurally stable.

The type of antenna used in the missile is controlled by physical configuration of the middle body and available space. The antenna used consists of crossed one-quarter wave slots located in the nose section. One slot is resonated to 265 mc and the other to 324 mc thereby creating the effect of separate antennas. Bandwidth for each slot is about 7 mc and the overall radiation pattern of the antenna approximates a spherical configuration with nulls appearing off to the sides of the rocket.

A helix antenna is used to receive the target transponder signal on the ground. This antenna provides a gain of 5 db and eliminates nulls resulting from unlike polarization. Since beam width is 40°, the severity of the tracking problem over long range operation is reduced. Electrical bandwidth is sufficient to give good results on the 265 mc and 324 mc frequencies used.

With a 5 db antenna gain, a receiver sensitivity of 117 db below 1 volt in the ground station and elevations on the order of 20,000 ft, the signal from the target transmitter is adequate to record consistently at distances in excess of 100 miles.

### REFERENCES

- (1) V. F. Cartwright, PARAMI—Parsons Active Ring-Around Miss Indicator, Feb 1957, Engineering Report No. 133, The Ralph M. Parsons Co.
- (2) ITT Handbook, "Space Attenuation Between Isotropic Antennas", p. 751, Fourth Edition
- (3) G. H. Brown and Woodward, Circularly-Polarized Omnidirectional Antennas, RCA Rev., p 259, June 1947.

# Vidicon-Type Television

Chart lists important characteristics of nineteen vidicons available commercially for a variety of television pickup applications

Table I—Commercially Available Vidicon Camera Tubes

Tube Type and Manufacturer	Description	Deflection/ Focus	Sensitivity	Spectral Response in Angstroms
RCA RCA 6198A	Small tv camera tube for industrial applications	Both magnetic	Can function with only 100 ft-c incident illumination	Good from 4,500 to 6,500
RCA 6198	Small tv camera tube for industrial applications	Both magnetic	Can function with only 100 ft-c incident illumination	Good from 4,500 to 6,500
RCA 6326	Small tv camera tube for film pickup	Both magnetic	Works with same illumination levels as movie cameras	Good from 4,500 to 6,700
RCA 6326A	Small tv camera tube for color tv cameras	Both magnetic	Works with same illumination levels as movie cameras	Good from 4,500 to 6,700
RCA 7038	Small tv camera tube for live scenes and film pickup	Both magnetic	Min illumination for live scene pickup is 2 ft-c	Good from 4,400 to 6,700
RCA 7262	Small tv camera tube for transistorized cameras	Both magnetic	Min illumination for live scene pickup is 2 ft-c	Good from 4,400 to 6,700
General Electro- dynamics Corp. GEC 7226A	Ruggedized vidicon for transistorized cameras	Both magnetic	0.5 ft-c gives 0.2 $\mu$ a optimum signal output current	Peak at 4,800; good from 3,800 to 5,800
GEC 7226	Short-length vidicon for transistorized cameras	Both magnetic	0.5 ft-c gives 0.2 $\mu$ a optimum signal output current	
GEC 7325	Vidicon for live scenes with low illumination	Both magnetic	0.5 ft-c gives 0.2 $\mu$ a optimum signal output current	Peak at 4,800; good from 3,800 to 5,800
GEC 6198A	Small tv camera tube for industrial applications	Both magnetic	0.3 ft-c gives 0.025 $\mu$ a optimum signal output current	
GEC 6326A	Small tv camera tube for broadcast applications	Both magnetic	2 to 8 ft-c gives signal output current from 0.1 to 0.2 $\mu$ a	
GEC 7336	Small tv camera tube for industrial applications	Both magnetic	0.5 ft-c gives 0.2 $\mu$ a optimum signal output current	Peak at 4,800; good from 3,800 to 5,800
Westinghouse WL-6326A	Small tv camera tube for film and live pickup	Both magnetic	0.2 ft-c gives 0.003 $\mu$ a output current	Peak at 5,400; good from 4,500 to 6,400
WL-6198A	Small tv camera tube for industrial applications	Both magnetic	Same as WL-6326A	Same as WL-6326A
WL-7290	Small tv camera for slow-speed scanning	Both magnetic		Good from 3,000 to 6,000
General Electric GL-6198A	Small tv camera tube for closed-circuit tv use	Both magnetic	3 to 10 ft-c produces output current of 0.1 to 0.2 $\mu$ a	Peak at 5,500; good from 4,500 to 6,500
Machlett ML-7351	Small tv camera tube for industrial use at low light levels	Both magnetic	Can televise scenes with 0.1 ft-c on faceplate	Peak at 6,000; good from 5,600 to 6,300
ML-7291	Small tv camera tube for film pickup	Both magnetic	0.6 ft-c gives 0.05 $\mu$ a output current	Peak at 5,500; good from 4,600 to 6,400
ML-6198	Small tv camera tube for industrial use	Both magnetic	3 to 10 ft-c produces output current of 0.1 to 0.2 $\mu$ a	Same as ML-7291



# Camera Tubes

By **ARTHUR S. KRAMER**, Senior Technical Specialist, Research Div., A. B. DuMont Laboratories, East Paterson, N. J.

Resolution in Lines	Special Considerations	Applications and Features
600	Signal electrode should be electrostatically shielded for best results	For use in light-weight compact tv cameras for industrial applications. Has tipless structure
600	Same as RCA 6198A	Same as RCA 6198A except has a side tip on the glass envelope
600	Precautions should be taken to keep tube in a vertical position with faceplate up	For use in compact tv camera for film pickup; for broadcasting or itv applications. Has tip on side of envelope
600	Optical system must provide depth of focus to give sharp image on photoconductive layer	For use in compact color tv cameras using method of simultaneous pickup of film or live subjects
600	When used for live pickup at 10 to 20 ft-c, 0.02 $\mu$ a dark current is required	Same as RCA 6326A
600	Deflecting yoke and focusing coil should be designed so no beam landing errors are produced	For use in small, transistorized cameras, monochrome or color; for broadcast or itv
	Ruggedized, nonmicrophonic picture tube	Transistorized cameras where space is restricted and heat dissipation must be minimized
	Heater current is only 150 ma	Same as GEC 7226A
	Can be operated in any position and in high ambient noise environments	For televising live scenes with as little as 0.2 ft-c illumination on the faceplate
	Special particle shield keeps loose particles from falling on light-sensitive surface	Same as RCA 6198A
	Can be operated with dynamic focusing	Freedom from blemishes makes it suitable for all high-quality applications such as broadcast
	Can be operated in any position	For televising live scenes in broadcast applications
600	Maximum faceplate illumination is 1,000 ft-c	For film and live pickup applications. Illumination same as for motion picture film cameras
600	Maximum faceplate temperature is 60 C	For industrial applications. Same illumination as WL-6326A
	Maximum faceplate temperature is 45 C	For slow-speed scanning applications. Transmits high resolution information over conventional audio circuits
600	Maximum faceplate temperature is 60 C	For closed-circuit applications such as stores, banks, process control, etc.
500	Maximum faceplate illumination is 100 ft-c	For industrial applications at low light levels with limited subject motion
600	Maximum faceplate temperature is 60 C	For film pickup applications. Takes considerable overbeaming without picture distortion
600	Maximum faceplate illumination is 1,000 ft-c	For industrial applications. Has spectral response close to that of the human eye

# Scan Converter Aids

Remote radar system transmits information over narrow-band lines using storage method of bandwidth compression. Encoder at remote site converts polar-coordinate display into rectilinear television display, modulates one of six carriers with video and applies single-sideband output to phone line

By **HARRY W. GATES** and **ALLEN G. GATFIELD**,

ITT Laboratories, a division of International Telephone and Telegraph Corp., Fort Wayne, Ind.

**A**NY RADAR REMOTING system designed to send high-frequency radar information over low-bandwidth lines must either sacrifice resolution or substitute extended frame times to achieve its purpose. In the case of real-time systems, picture quality is usually sacrificed to use low-bandwidth circuits. Opposed to this system is the method of substituting time for bandwidth through storage techniques. In the storage method of bandwidth compression, no picture quality need be sacrificed if the time substitution is compatible with operational requirements.

## System Description

Narrow-band television relay equipment built for the CAA Technical Development Center and described in this article has the capability of remoting radar infor-

mation over narrow-bandwidth circuits with the storage method of bandwidth compression. The heart of this equipment is a scan-conversion storage tube with two separate electron guns. In the first scan conversion, one electron gun writes the radar picture on the storage

surface while the other gun in this tube, employing slow television sweeps, reads the radar picture and converts it to a television type picture. The slow-scan television signal is converted to a modulated carrier signal and then applied to a narrow bandwidth transmission

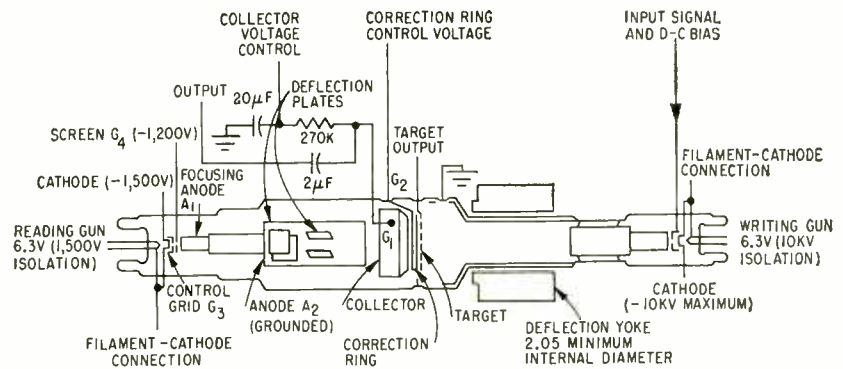

FIG. 1—Cross-section of the scan-converter storage tube used in encoder and decoder units

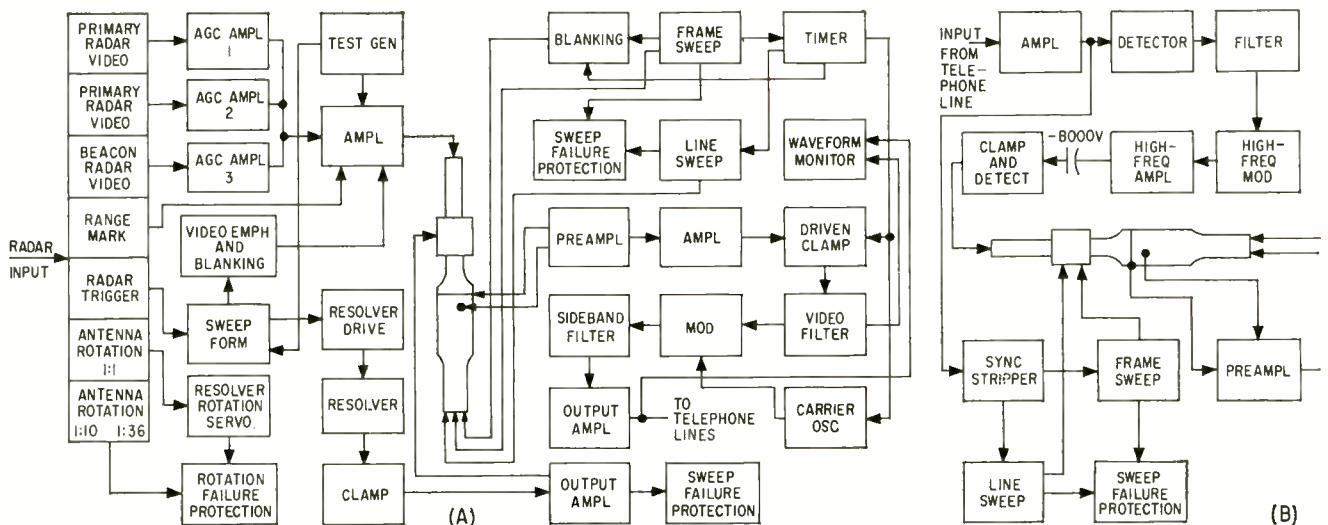

FIG. 2—Block diagram of air traffic control radar relay system shows (A) encoder and (B) decoder. Connecting link can be telephone lines or

# Phone-Line Radar Relay

line. After demodulation at the receiving end, the signal is written on the storage surface of a second scan-conversion tube. The second gun of this tube then reads the slow-scan picture and converts it to conventional television which is displayed on any number of standard monitors or television projectors.

## Scan-Conversion Tube

The scan-conversion tube used is the TMA-403X manufactured by Compagnie Generale de Telegraphic sans Fil of Paris, France, and marketed in this country by the Intercontinental Electronics Company. The main advantages of the TMA-403X over previously available tubes of the same general type are the considerably higher resolution obtainable and the ease of elimination of writing-beam reading-beam crosstalk. In the TMA-403X crosstalk is eliminated by mixing the signals appearing at the target and the collector of the tube in a cathode-coupled stage of the video pre-amplifier. Only one potentiometer is then required as a balance control to obtain crosstalk cancellation.

Figure 1 is a line diagram showing the essential parts of the TMA-403X scan-conversion tube. The reading gun in the left half of the tube charges one surface of the target membrane to approximately the



Air Route Traffic Control Center personnel at Indianapolis Airport monitor traffic situation using radar and video data from remote site

potential of the collector  $G_1$ , shown in Fig. 1. A thin aluminum film on the other surface of the target membrane is attached to a metal support ring. This ring is operated at near ground potential. Because of the proximity of these electrodes there is danger of destruction of the target if the collector  $G_1$  is raised to a potential greater than +50 v above the target voltage. A second collector  $G_2$  is used to reduce the level of the parasitic shading signal, the signal appearing in camera tubes operating with a secondary emission ratio greater than 1. The potential of  $G_2$  is approximately the same as the potential of  $G_1$ . The output signal from the target is of the order of one mv across a load impedance of 30,000 ohms; hence, a preamplifier is required preceding the video amplifier.

Depending upon how the tube is operated, it is possible to read the output signal between 500 and 5,000 times before erasure of the written information occurs. Storage is controlled by the voltage applied to the collector, the writing-beam current, and the reading-beam current. Erasure of the stored information is accelerated by reversing the volt-

age relationship between the target and the collector. For most applications the gray-scale presentation is of professional television quality.

## Functional Description

Figure 2 is a functional block diagram of the narrow-band television relay equipment. The equipment functions can most easily be described by considering two separate units, namely, the encoder at the remote radar site and the decoder at the Air Route Traffic Control Center hundreds of miles away. The connecting link between the encoder and the decoder can be either standard telephone lines, special telephone lines, or a microwave link depending upon availability.

## Encoder

Referring to Fig. 2A, the encoder performs the conversion of radar information from polar coordinates to narrow-band rectilinear coordinates. At the extreme left of the diagram are shown the various radar inputs with provisions for selecting the desired radar video or combinations thereof. Since only one source of trigger and antenna information is used, any combined display must be from synchronized

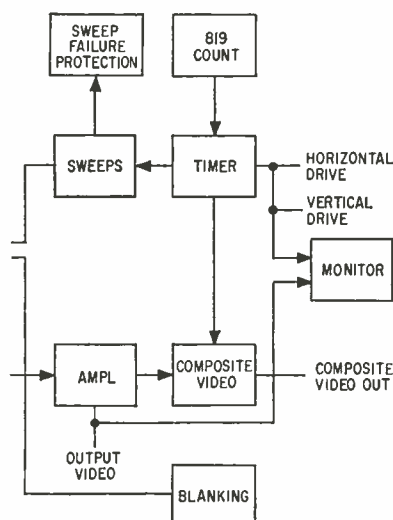

microwave relay

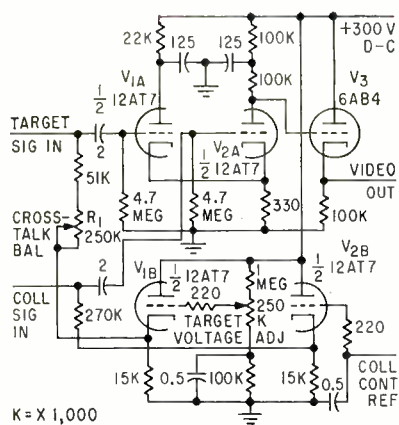

FIG. 3—Encoder video preamplifier used in system

radar systems.

Video circuitry in the encoder writing section includes three agc amplifiers for three separate video signals. Video is mixed with range markers and blanking pulses and, after appropriate amplification, the composite signal is applied directly to the writing gun grid of the scan conversion tube. Sweep for the writing section of the encoder is initiated by the incoming radar trigger and is applied to the resolver by the use of standard resolved-sweep techniques. A rotation-failure protection circuit has been included to switch off the writing gun accelerating voltage if the rotation stops or falls below 2 rpm. To increase the accuracy of synchronizing with antenna rotation a two-speed synchro system is used.

The reading section of the encoder includes the slow-scan rectilinear sweep circuits and the necessary video circuitry to read the information from the storage target and convert this information

into a modulated carrier signal which can be transmitted over telephone lines.

### Master Timer

The master timer sets the line-blanking repetition rate and time. The basic repetition rate is generated by a variable preset binary counter, counting from a 400-cps standard. The exact time of the beginning of each sweep is synchronized to the carrier waveform. The master timer also supplies line blanking pulses to the blanking circuit and to the driven clamps in the modulator.

Line sweep initiated by the timer pulse is a linear sawtooth which is coupled to the deflection plates of the reading section of the scan conversion tube. A protection circuit is provided here also to cut off the reading gun power supply in case of a sweep failure.

Frame sweep is also a linear sawtooth coupled to the other set of deflection plates. Composite blanking applied to the grid of the reading gun is made up from the frame blanking and the line blanking pulses.

Video from the scan conversion tube is obtained from the target and collector by the preamplifier. This preamplifier performs the function of subtracting the target signal from the collector signal thereby cancelling crosstalk, in addition to video amplification. After amplification, the video signal passes to the modulator where it is clamped and then filtered to limit the bandwidth. The modulator is balanced to cancel out the video components and yield only single

sideband and carrier outputs. After passing through the upper-sideband filter, the single-sideband output goes to the output amplifier and then to the telephone line.

### Decoder

The decoder at the receiving end of the telephone line converts the slow-scan rectilinear information to a wide-band or standard television picture as shown in Fig. 2B. The signal from the telephone line enters the demodulator where it is first amplified to the proper level. The signal is then detected and filtered, thus restoring it to its original video form. For application to the writing-gun grid of the scan conversion tube this video is first remodulated by a high-frequency carrier and then clamped and detected at a  $-8,000$ -v grid potential. The demodulator circuits also supply signals to the sync separator where the frame-sweep and line-sweep sync pulses are removed. The frame-sweep and line-sweep circuits in the decoder operate much in the same manner as in the encoder.

The reading section of the decoder contains the timing, sweep, and video circuits required to read the information from the scan-conversion-tube target and convert this information into a standard television display. A commercial television timer, modified to permit either standard 525 lines/frame or 819 lines/frame operation, supplies the drive pulses, composite, sync and mixed blanking. The sweeps are standard television sweeps except that they are applied to the electrostatic deflection plates of the

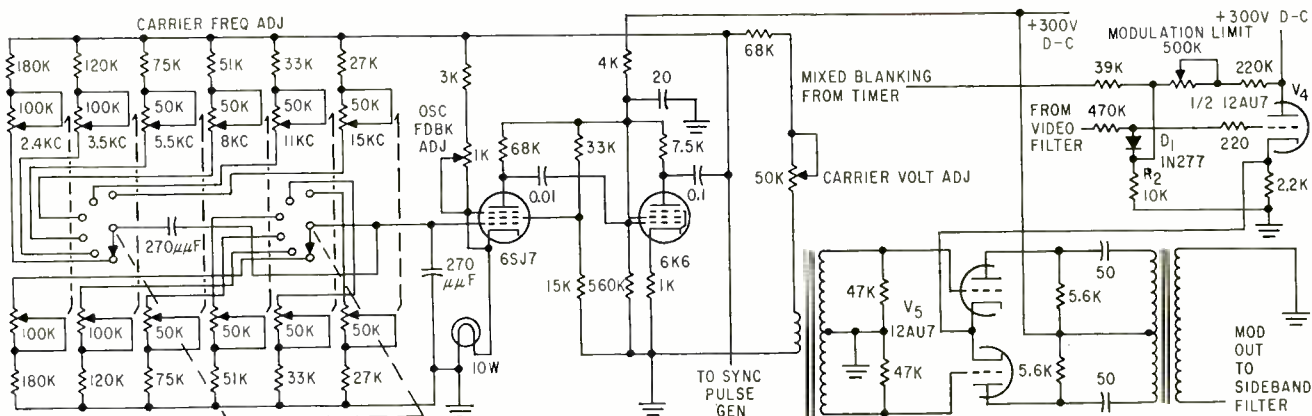

FIG. 4—Balanced modulator which yields two sidebands and carrier, eliminating original video

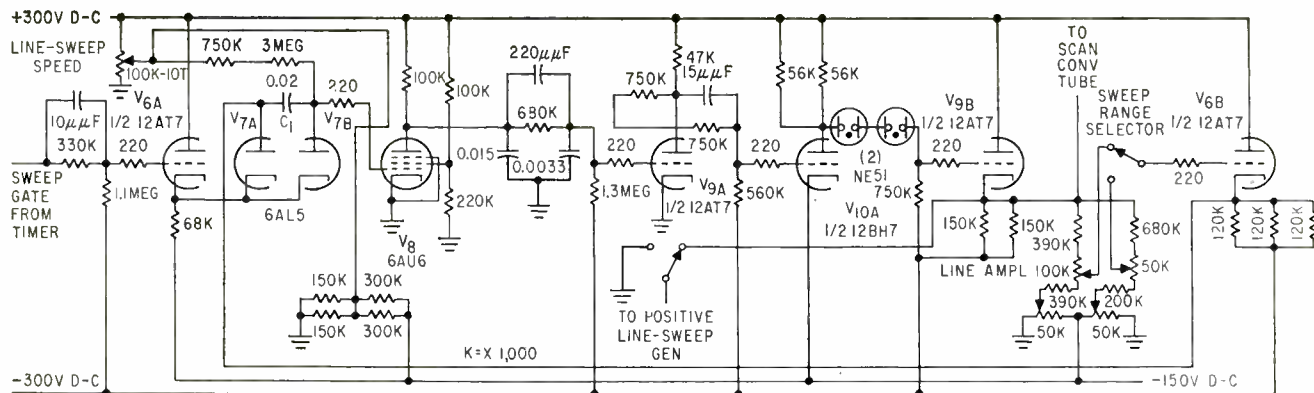

FIG. 5—Encoder line sweep generator is basically a linear R-C sawtooth generator

scan-conversion tube. The video signal is read from the target and collector of the scan-conversion tube by the preamplifier in much the same fashion as in the encoder. The preamplifier used here has a bandwidth of 7.5 mc and a special lead circuit which compensates for the lag at the tube elements, thus improving the response. The video amplifiers are of standard television design. Their output is fed directly into a studio-type television monitor modified to permit operation on either 525 or 819 lines/frame.

#### Encoder Read-Out

Signal output from the target and the collector of the scan-conversion tube must go through stages of preamplification before it is of sufficient amplitude to be sent to the video amplifier. In addition, the crosstalk balance operation takes place in the preamplifier. Figure 3 is a schematic of the encoder video preamplifier. The decoder preamplifier is quite similar in design except for the different frequencies and time constants used and the method of balance.

Also on the preamplifier chassis are cathode follower regulators for supplying the target and collector reference voltages and for improving the time constants associated with the main power supplies.

The functions of inversion, adding and amplifying are accomplished by tubes  $V_{1A}$  and  $V_{2A}$ . The amount of target signal subtracted from the collector signal is determined by the setting of crosstalk balance control  $R_1$ . Cathode follower  $V_3$  allows coupling from the preamplifier to the modulator.

From the preamplifier the signal is next sent to the video amplifier and modulator. Figure 4 is a schematic of the modulator. After video amplification, the signal enters a clamp which is driven by a composite blanking signal supplied by the encoder timer and the frame sweep. From the clamp to the modulator, direct coupling is used to retain the d-c component. Cathode followers drive the filters which limit the video bandwidth of the signal to be placed on the carrier. The network formed by diode  $D_1$  and resistor  $R_2$  prevents 100-percent modulation except during the blanking period. Driver  $V_4$  drives the special balanced modulator  $V_6$ . This circuit is especially designed for narrow-band use. The conventional balanced modulator yields two sidebands, suppressed carrier, and the original signal which is normally far removed from the carrier in frequency and may be eliminated by a tuned circuit or a simple high-pass coupling. In the case of narrow bandwidth transmission this procedure is not practical since the signal and the carrier are at approximately the same frequency. The balanced modulator of Fig. 4 is designed to yield two sidebands and the carrier while the original signal is balanced out. A gang switch is used to switch the carrier frequency and the sideband filters thus permitting six different carrier frequencies depending upon the telephone-line bandwidth available. Sideband filters remove the upper side band and part of the carrier to provide vestigial sideband operation. Output of the sideband filter is transformer coupled

to the output amplifier.

The line sweep generator of the encoder read-out shown in Fig. 5 is basically a negative feedback linearized R-C sawtooth generator. The action is somewhat different from the conventional bootstrap circuit in that the charging voltage is held constant while the bottom or negative end of the sweep-forming capacitor is driven negative. The effect of this is to maintain a nearly constant voltage across the charging resistor, thereby maintaining a constant charging current and a linear sawtooth output. Clamp driver  $V_8$  accepts the line-sweep gate from the line timer and drives the clamp diodes  $V_{7A}$  and  $V_{7B}$  which clamp both ends of the sweep capacitor  $C_1$  during retrace time. A small sawtooth voltage appears on the positive side of  $C_1$  and is coupled directly to the amplifier, consisting of  $V_9$ ,  $V_{9A}$  and  $V_{10A}$ . This amplifier is direct-coupled throughout and by the use of loop-stabilizing networks the high-frequency components are also passed.

It is necessary to use two sweep ranges to cover the sweep times from 15 to 207 millise. This is accomplished with the sweep-range selector switch and appropriate resistors. These resistors change the closed-loop gain of sweep system.

The equipment was designed and developed under contract C13ca-632 with the Technical Development Center of the Civil Aeronautics Administration, Indianapolis. Technical supervision and assistance from the CAA was provided by R. Sorenson, Branch Chief, J. Hoffman, Senior Project Engineer, and G. Laxson, Project Engineer.

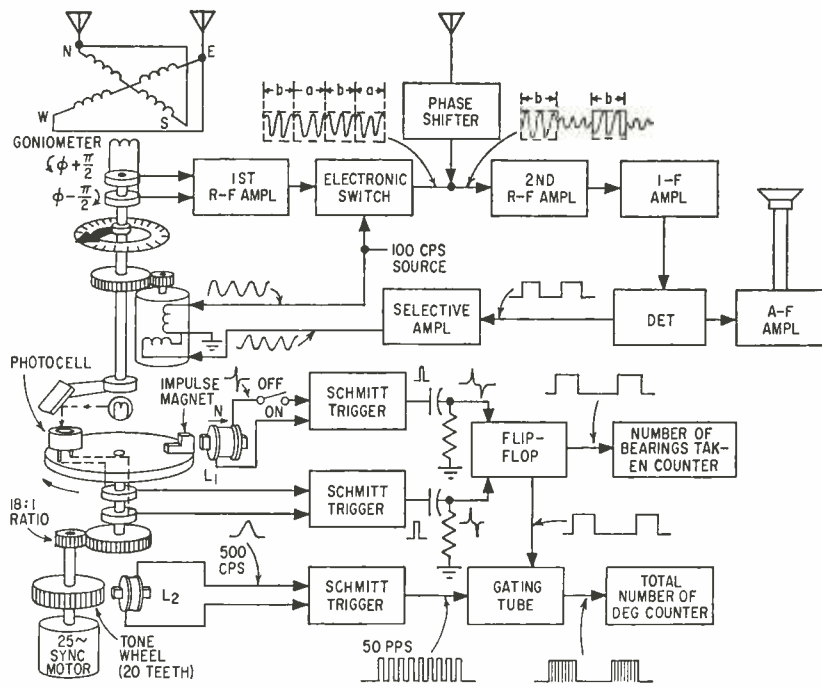

FIG. 1—Automatic direction finder

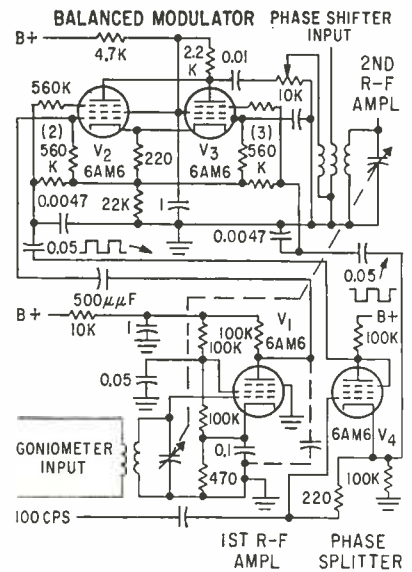

FIG. 2—Electronic switching circuit. Continuous aural monitoring is ensured

# Direction Finder With

Accuracy of direction finder is improved by averaging readings to compensate for rapid changes in indications caused by wave interference. Position of goniometer shaft is detected photoelectrically and converted into pulses which operate decade counters

By J. F. HATCH and D. W. G. BYATT, Marconi's Wireless Telegraph Co., Ltd., Chelmsford, England

EFFECTIVENESS of high-frequency direction finders in the 1.5- to 30-mc band has always been questionable because of the apparent wide deviation of waves from the direct path between transmitter and receiver. Since this deviation is the result of multipath ionospheric propagation, accuracy of bearings obtained depends on propagation conditions regardless of how carefully the direction finder is constructed.

It has been shown experimentally that the accuracy of bearings on fluctuating signals can be improved by using the average of a number of bearings measured at frequent intervals. A device capable of automatically recording instantaneous

bearings and averaging them over any reasonable period of time both for c-w or interrupted signal transmission is described.

A block diagram of the direction finding system is shown in Fig. 1. The goniometer is automatically rotated to the minimum point in a

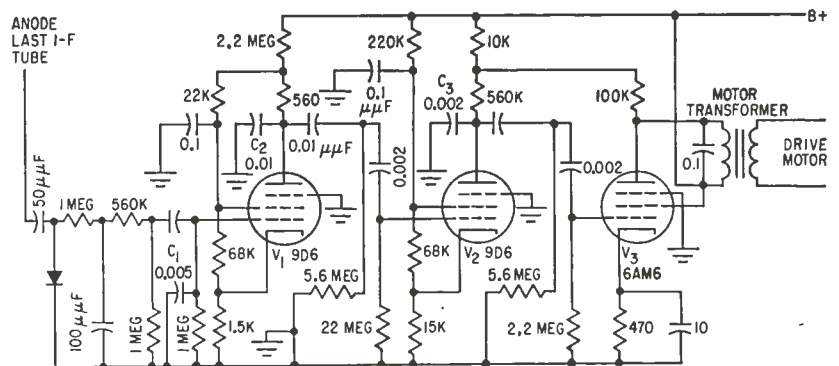

FIG. 3—Selective amplifier. Automatic gain correction of receiver together with limiting stage of amplifier produces polar pattern with sharp minimum

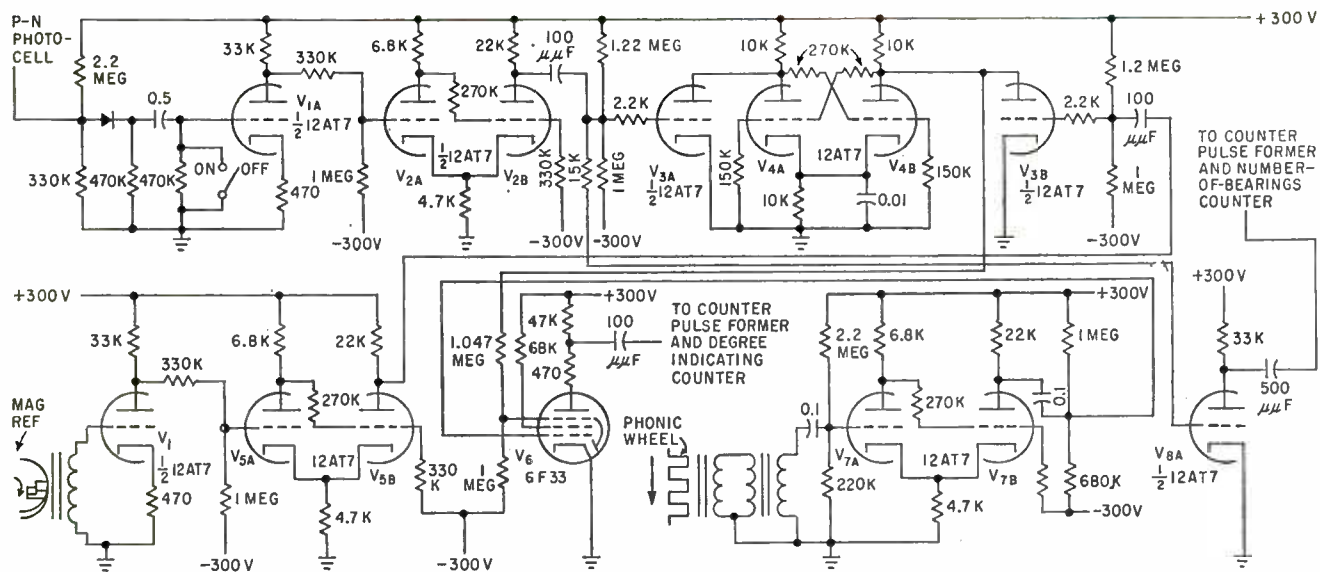

FIG. 4—Phasemeter circuits. Elaborate squaring circuits are not required since inputs from photo-cell and magnetic-reference and phonic-wheel coils are constant. Input signals are squared by Schmitt trigger circuits, differentiated and made into unidirectional pulses. Signal from phonic wheel is sharpened and used to modulate bearing pulse

# Automatic Readout

figure eight radiation pattern by a motor drive system. Because of the field conditions within a goniometer, its output is essentially that of loop antenna which has a null position when the plane of the loop is perpendicular to the incoming wave. A phase difference of 180 deg exists between the voltages obtained on either side of this null.

Induced voltage from the goniometer is passed through an r-f amplifier to an electronic switch whose output changes phase by 180 deg as first one and then the other tube in a cathode-coupled pair conducts. A phase-splitting tube driven by a 100-cps source is used to alternately cut off the cathode-coupled tubes.

Output of the electronic switch is applied to a coil which is coupled to two other coils; one connected to an omnidirectional sense antenna through a phase-shifting network and the other to the second r-f tuning circuit. The phase-shifting network is adjusted so that its output signal opposes the *a* signal developed by the electronic switch and adds to the *b* signal.

After passing through the r-f,

i-f and detector stages of the receiver, and the selective motor drive amplifier, the a-c zeroing signal operates a small motor which drives the goniometer. A phase angle of 90 deg is required between the two coils of this motor. Since one coil is energized directly from the power supply ripple which is in-phase with the input to the phase-splitter tube in the electronic switch, the amplifier is designed to shift the driving signal by 90 deg.

## Figure-Eight Pattern

As the goniometer passes through the null of the figure eight radiation pattern, the r-f signal generated changes phase by 180 deg. Instead of the r-f signal from the sense antenna cancelling the *a* signal from the electronic switch, it now cancels the *b* signal. The motor drive output then reverses phase causing the goniometer to reverse its direction. Through repetition, the goniometer finally settles on the zero point in the figure eight radiation pattern.

The pointer connected to the goniometer shaft indicates the di-

rection of arrival of the wave, but generally wanders considerably as the result of wave interference and lateral deviation errors. These errors are reduced by finding the average position of the pointer.

To prevent loading the goniometer, a beam of light is used to indicate the position of the pointer. The beam is deflected with a prism so that the light intersects the circular path described by a *p-n* junction photocell attached to a rotating disk below. It has been found that a 0.72-sec interval between light-beam interceptions gives a reasonable sampling rate.

Also attached to the rotating disk is a small magnet used to produce a reference pulse each time stationary coil *L*<sub>1</sub> is passed. A twenty-toothed phonic wheel fixed to the shaft of the 25-cps synchronous driving motor generates a 500-cps signal as it passes coil *L*<sub>2</sub>. Since the motor speed is 18 times that of the rotating disk, each pulse generated by the phonic wheel is equal to one deg angular displacement of the goniometer.

Pulses from coil *L*<sub>1</sub> are sharpened

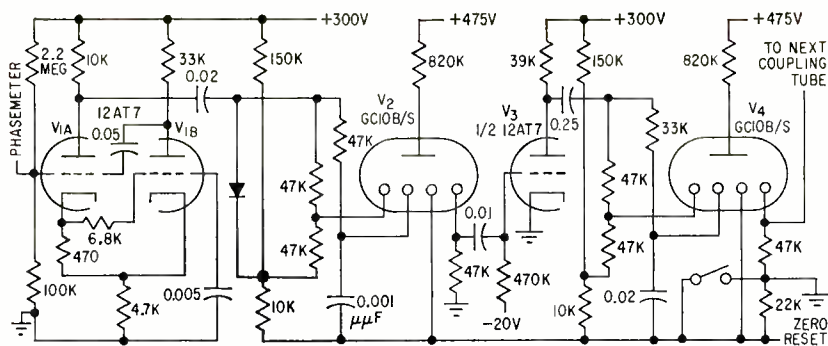

FIG. 5—Counter circuits provide useful bearing information regardless of rapidly fluctuating goniometer dial

by a Schmitt trigger. The trigger pulses operate a flip-flop which causes the gating tube to conduct and pass the 500-cps tone generated by the phonic wheel.

The pulse from the photocell occurs at the angular position of the pointer corresponding to the bearing from true north as established by reference coil  $L_1$ . This pulse trips the flip-flop thereby cutting off the gating tube and stopping the 500-cps pulse train. Thus, pulse bursts representing instantaneous position of the pointer in deg from north appear on the anode of the gating tube every 0.72 sec.

The pulses are additively displayed on a bank of six decade-counter tubes. The number of bearings taken is obtained from the flip-flop and displayed on a second bank of counters. By dividing the reading on the total-number-of-deg counter by the reading on the number-of-bearings-taken counter, the average bearing is obtained.

#### Electronic Switch

A schematic diagram of the electronic switch is shown in Fig. 2. Tube  $V_1$  in the first r-f stage serves to isolate the goniometer from the balanced modulator tubes  $V_2$  and  $V_3$  and they provide some amplification. The high plate feed resistance and plate stray capacitance of  $V_2$  and  $V_3$  provide a 90-deg phase shift of the goniometer signal. This phase shift is necessary to compensate the difference between the outputs of the goniometer and the sense antenna.

The r-f signal applied to the electronic switch passes through  $V_1$  to the grid of  $V_2$ . Since the signal is then fed from the cathode of  $V_2$  to  $V_3$ , the signal on  $V_3$  is 180 deg out-of-phase with the signal on  $V_2$ .

Tubes  $V_2$  and  $V_3$  are made to conduct alternately by the 100-cps drive applied to their suppressor grids by phase-splitting tube  $V_4$ . Thus, the phase of the r-f current in the common anode circuit of  $V_2$  and  $V_3$  is reversed each half cycle of the drive frequency.

#### Selective Amplifier

A portion of the receiver output is separately rectified and applied to the three-stage selective amplifier shown in Fig. 3. Capacitors  $C_1$ ,  $C_2$ , and  $C_3$  develop the 90-deg phase shift required between the two coils of the goniometer drive motor. They also constitute a low-pass filter with sharp cut off above 150 cps which tends to prevent noise and modulation components of the received signal from blocking the grids and hindering amplification of the 100-cps signal.

Overall gain of the selective amplifier circuits is such that the motor will exert its full torque when the goniometer is only three deg off the true null. When the goniometer is further from the null, the output to the motor is held constant by the limiting action of tube  $V_1$ .

#### Phasing Circuits

The phasing circuits are shown in Fig. 4. Input signals are squared by Schmitt triggers, differentiated and made into unidirectional pulses by tubes  $V_{3A}$  and  $V_{3B}$  through use of common anode loads. These tubes operate flip-flop  $V_4$  to produce the bearing pulse whose length is proportional to the bearing of the transmitter.

The 500-cps signal from the phonic wheel is sharpened by Schmitt trigger  $V_7$  and is used to indicate the length of the bearing

pulse (in deg) by modulating the bearing pulse in  $V_6$ . The number of bearings taken is obtained from  $V_2$  and amplified by  $V_{8A}$ .

#### Counter Circuits

Outputs of the phasemeter are taken to two decade counter chains; the first is fed by  $V_6$  and contains six counter tubes used to count the total number of degrees; the second is fed from  $V_{8A}$  and contains four counter tubes used to indicate the number of bearings taken. The first stages of a counter chain are shown in Fig. 5.

Tube  $V_1$  is used in a conventional pulse-forming circuit to drive the GC10B/S counter tube. Each counter tube is connected to the next by way of one half of a 12AT7. When the first counter passes zero, a pulse at its output is fed to the next counter. This action continues from counter to counter.

The total count that can be registered is dependent on the bearing of the transmitter. For bearings of 0 to 100 deg, the number-of-bearings-taken bank of four counters runs out after about two hours. For bearings larger than 100 deg, the time decreases linearly until at 359 deg the total-number-of-deg bank runs out first after 35 minutes.

#### Performance

In assessing improvements attained by the time averaging technique, it should be remembered that a skilled manual operator averages bearings by the swinging bearing technique over a short period. Therefore, overall improvement is less than it would be if the operator recorded spot bearings.

Phase tracking problems between omni- and spaced-antennas have not been found serious down to a bandwidth of 1 kc. Any misphasing causes lack of torque rather than bearing errors.

Thanks are due to the engineer-in-chief of the M. W. T. Co. for permission to publish this article. Original work on an electronic method of time averaging was done by G. L. Gridale and acknowledgments are due to members of his group who were associated with the detailed circuit work. Others who assisted in evaluating the direction finder were D. S. Palmer, H. G. Hopkins and W. C. Bain.



# Voltage-Regulator Diodes

Silicon voltage-regulator diodes provide power dissipation of 250 mw to 10 watts and voltage ratings of 4.7 to 150 volts

By **ROBERT F. EDWARDS**, President's Assistant for Planning, International Rectifier Corp., El Segundo, Calif.

**Table I—Requirements for 250-mw Semiconductor Voltage-Regulator Diodes Under MIL-E-1/1238**

Part No.	$E_Z$ Nominal (v d-c)	$I_Z$ Max (ma)	$I_Z$ Surge (ma)	Test $I_Z$ Nom (ma)	Min $E_Z$ at Test $I_Z$ (v d-c)	Max $E_Z$ at Test $I_Z$ (v d-c)	$Z_Z$ Max (ohms)	Temp Stability Max $E_Z/^\circ\text{C}$ at $I_Z$ test (v d-c)	Reg at 10% Max $I_Z$	Current (ma d-c) at 90% Max $I_Z$	$E_Z$ Reg (v d-c)
1N750	4.7	45	540	25	4.23	5.17	3	0.05	4.5	40.5	0.5
1N709	6.2	36	440	25	5.58	6.82	4.1	0.06	3.6	32	0.6
1N716	12	19	230	12	10.8	13.2	10	0.08	1.9	17	1
1N718	15	15	180	12	13.5	16.5	13	0.09	1.5	13	1.5
1N720	18	12	150	6	16.1	19.8	17	0.09	1.2	11	1.8
1N722	22	10	125	4	19.8	24.2	24	0.095	1	9	2

$E_Z$  is Zener voltage       $I_Z$  is Zener current       $Z_Z$  is dynamic impedance in the Zener region

SILICON VOLTAGE-regulator and reference diodes are a dividend of the military services' development effort in silicon rectifiers.

Tables I and II list standard sizes, their power dissipation ratings and nominal Zener voltages. The standard sizes are based on wattage dissipation. Figure 1 shows typical temperature derating curves for higher power units. Temperature is ambient for pigtail types and case for stud types. These curves are not part of the standard and may vary from manufacturer to manufacturer.

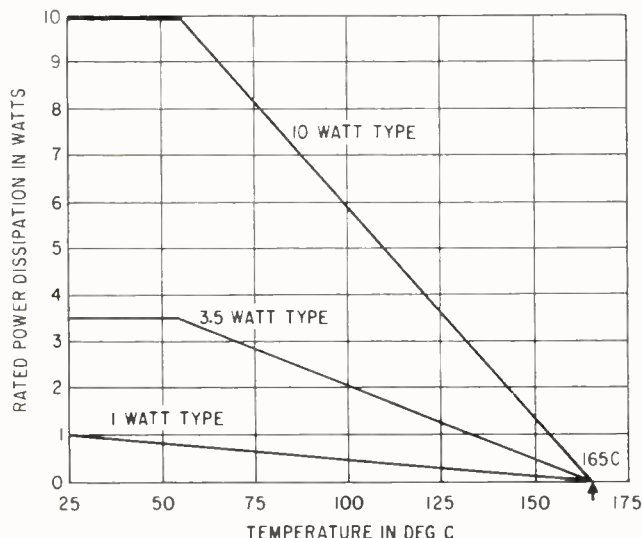

**FIG. 1—Typical curves for derating power dissipation of voltage regulators according to case or ambient temperature**

Units covered by specifications MIL-E-1/1235-36-37 and 1060 are those selected as standards by a joint services-industry conference at Fort Monmouth in April, 1958. Those covered by MIL-E-1/1238, dated October 28, 1958, use glass diodes; this specification is also used by the other services as a basis for purchasing.

**Table II—Military Standard Silicon Voltage-Regulator Diodes and Voltage Reference Unit**

Part Number	Specification Number	Ratings		Mfg Style
		watts	volts	
1N1777	MIL-E-1/1235 (SigC)	1	18	pigtail
1N1781		1	27	pitgail
1N1791		1	68	pitgail
1N1795		1	100	pitgail
1N2052	MIL-E-1/1237 (SigC)	3.5	100	stud
1N2053		3.5	150	stud
1N1804	MIL-E-1/1236 (SigC)	10	6.2	stud
1N1807		10	8.2	stud
1N1353		10	12	stud
1N1358		10	22	stud
1N1361		10	27	stud
1N750	MIL-E-1/1238 (SigC)	0.25	4.7	pitgail
1N709		0.25	6.2	pitgail
1N716		0.25	12	pitgail
1N718		0.25	15	pitgail
1N720		0.25	18	pitgail
1N722		0.25	22	pitgail
1N430*	MIL-E-1/1060	0.25	8.4	special

\*Voltage reference unit

# Calibrated Source of

Simple and inexpensive generator of calibrated pulses uses coaxial discharge line to produce millimicrosecond pulses on a keyed single-shot basis, or at a constant repetition rate. Unit works into a 50-ohm load

By E. J. MARTIN, JR., University of Kansas Research Foundation, Lawrence, Kansas

**P**ULSE-FORMING system, precision voltage measuring circuit, and line-charging power supply are combined to make an extremely convenient, versatile instrument for studying millimicrosecond pulse techniques.

## Discharge Line

In the circuit shown in Fig. 1, pulses are formed by charging a specially designed section of coaxial line between the charging resistor,  $R_1$ , and the magnetically operated coaxial line switch,  $S_1$ , while the switch is in its normally open position, then discharging this section of line into a 50-ohm load when  $S_1$  is closed.

The charging resistor limits the charging current drawn from the line-charging power supply, and also maintains a virtually open-circuited termination at the upper end of the pulse-forming line. Once the line section between  $R_1$  and  $S_1$  has been fully charged to some potential  $V$ , closure of  $S_1$  by current passing through the actuator coil,  $L_1$ , causes this section of line to act as a generator with a 50-ohm internal impedance working into a 50-ohm transmission line, presumed to be terminated in its characteristic impedance. Consequently, a positive step of amplitude  $V/2$  volts travels down the line toward the load.

Since no potential difference can exist across the contacts of  $S_1$  once they are closed, a negative step of amplitude  $V/2$  volts, downward from the original line potential  $V$ , must simultaneously travel up the line from  $S_1$  towards  $R_1$ . In-phase

reflection of this negative-going pulse at the virtual open circuit presented by  $R_1$ , brings the potential on the line to zero volts, as the negative step is transmitted back down the line through the closed contacts of  $S_1$  towards the load at the end of the output transmission line. Thus the voltage pulse which ultimately reaches the load has an

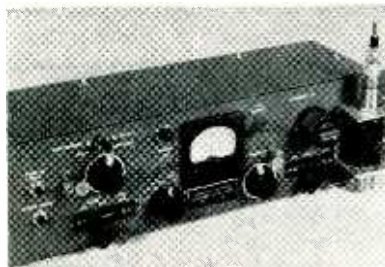

Overall view of calibrated pulser, showing arrangement of controls

amplitude equal to one half of the potential to which the line section between  $R_1$  and  $S_1$  was originally charged and a duration equal to twice the electrical length, measured in time, of this line section.

Precise setting of the pulse amplitude is made at  $R_2$ . Adjustment of pulse width is made by connecting a length of line between the line switch,  $S_1$  and  $R_1$ . The physical length of this line is governed by the propagation velocity for the type of cable used and may be calculated from

$$W = \left( \frac{2l}{v} \right) + K$$

where  $W$  is the time duration or width of the pulse desired,  $l$  is the

physical length of the line, and  $v$  is the velocity of propagation for the line.

From the equation, it is obvious that in the discharge line pulse generator, the lower limit on the width of the pulses is fixed by the value of  $K$ . This value is dependent upon the physical construction of both the line section containing  $S_1$  and the line section containing  $R_1$ . More specifically, the value of  $K$ , and consequently the minimum attainable value of  $W$ , is fixed by the minimum distance between contacts of the coaxial line switch and the line-charging resistor.

The upper limit on pulse width is dependent only upon the length of time that  $S_1$  remains closed. The upper limit on pulse repetition rate is fixed either by the time required for the line to become fully charged to the potential  $V$ , once the line switch has opened, or by the fastest rate at which the line switch can be made to operate. In practice, the line recharging time can usually be made significantly shorter than the shortest attainable period of line-switch operation.

## Voltage Measurement

Accurate determination of the line charging potential is accomplished with the zero-current voltage measuring circuit. Indicator potentiometer  $R_3$  is first calibrated against a known voltage supplied by an internal secondary standard cell,  $E_1$ . The digital indicator dial associated with  $R_3$  is set to a reading equal to the known potential of  $E_1$ , then, with the function selector

# Millimicrosecond Pulses

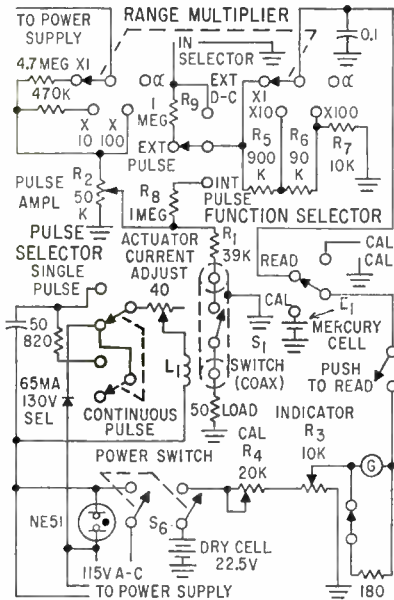

FIG. 1—Circuit diagram of calibrated pulse generator

switch on CALIBRATE,  $R_6$  is set for zero deflection of the galvanometer,  $G$ , when the galvanometer shunt switch is closed. Once  $R_6$  has been calibrated, unknown voltages can be measured by placing the function switch on READ, readjusting  $R_6$  for zero deflection of  $G$  and then reading the unknown voltages directly, to three significant figures, from the digital indicator dial. The source of the unknown voltage that is to be measured is selected by the setting of the input selector switch.

A voltage divider,  $R_5$ ,  $R_6$  and  $R_7$ , is arranged for range multiplications of 1, 10 and 100. The potentiometer  $R_5$  and the voltage divider resistance tolerances are one tenth of one percent. In the internal pulse position, it is possible to read directly the amplitude of the output pulse, rather than the potential to which the pulse-forming line is charged.

## Construction

The discharge line pulse-forming system is a section of a 50-ohm coaxial line. The center conductor is a C. P. Clare, Type RP-5441 magnetically-operated, mercury-wetted switch mounted between the inner transition pieces of two

General Radio, Type 874 cable connectors. Details of the inner conductor assembly are shown in Fig. 2.

The RP-5441 switches consist of a set of single-pole, double-throw contacts sealed in a small glass envelope which contains a pressurized atmosphere of hydrogen along with a small quantity of liquid mercury. These switches must be operated in a vertical position, with contacts at the upper end, and not submerged in the mercury reservoir.

The pulse selector circuit, used to actuate the magnetically operated switch, is shown in the CONTINUOUS position for the generation of pulses at a sixty-cycle repetition rate. The switch locks in the continuous position, but has a spring return from the single-pulse position.

Binding posts at the input selector allow the instrument to be used as a limited-range d-c voltmeter. Binding posts at the function selector switch are used to check the standard cell against a laboratory standard, without opening the instrument case.

Precision resistors  $R_5$  through  $R_8$  constitute a special plastic-encapsulated network manufactured by the Reon Resistor Corp.

## Operation

Two modes of operation are possible. First, the pulse height is adjusted by  $R_2$  to perform some desired function in a given pulse circuit and subsequently the amplitude of this pulse is determined by adjusting  $R_3$  for galvanometer balance. Alternatively a pulse of a given amplitude may be obtained by first adjusting  $R_3$  until the desired pulse height appears on the digital

indicator, and then adjusting the pulse amplitude control for balance of the galvanometer. This feature, in addition to the provision for measuring external d-c voltages, make the calibrated pulser a versatile instrument.

While the multiplier ranges provided by the voltage divider give a theoretical voltage-measuring capacity up to 1,000 volts, potentials in excess of 500 volts across the precision resistor network result in enough resistor heating to cause temporary loss of the overall one-percent accuracy of the instrument.

The calibrated pulser has produced pulses from somewhat less than one millimicrosecond to over 0.3 microsec duration at amplitudes up to 150 volts. The discharge-line section has also been used with external power supplies to produce pulses of even greater amplitude. Pulse rise times have been estimated to be about 0.3 millimicrosec or  $3 \times 10^{-10}$  sec. When the discharge-line section is used with external power supplies, pulses of comparable quality are obtained up to amplitudes of approximately 500 volts, corresponding to a line-charging potential of 1,000 volts. For greater amplitudes, the quality of the pulse deteriorates rapidly due to arcing across the contacts of the line switch.

A new model of the calibrated pulser, now being constructed, provides for the production of negative pulses as well as positive pulses, and will improve the meter reading circuit for better protection of both the galvanometer and the internal standard cell. A modification of the voltage divider circuit will measure d-c voltages to the full 1,000-v range. It may also provide for a variable pulse repetition rate over a range of approximately 30 to 200 cps.

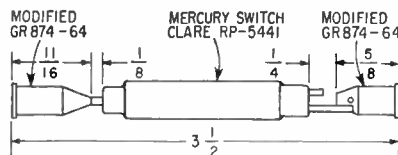

FIG. 2—Coaxial switch and line configuration

## BIBLIOGRAPHY

- (1) D. A. Lewis and F. D. Wells, "Millimicrosecond Pulse Techniques," p 99-107, Pergamon Press, N.Y.C., 1955.
- (2) R. L. Wigington and N. S. Nahman, "Transient Analysis of Coaxial Cables Considering Skin Effect," *Proc IRE*, p 166, Feb., 1957.

# Thermal Design Chart

Nomograph enables circuit designers to determine safety factor in terms of power dissipation and thermal resistance when using power transistors

By O. D. HAWLEY and M. KATO,

Nortronics, A Division of Northrop Corp., Hawthorne, Calif.

**A** DIFFICULT PROBLEM confronting the designer of transistorized equipment is making calculations necessary to insure conservative thermal design. This problem becomes acute when dealing with power transistors.

Since many designs are a matter of cut and try, thermal calculations are tedious, and sometimes difficult. Actual power ratings are dependent on temperature and a realistic concept of safety factor is needed. This article explains the ratings in terms presented on the manufacturers' data sheets. An expression for safety factor is developed. A nomograph is also presented which implements the necessary thermal calculations and can be used to determine the safety factor inherent in any design.

## Junction Temperature

When the manufacturer's rating for maximum junction temperature is exceeded, the life of a transistor may be shortened even if the junction is not immediately destroyed. The junction temperature is related to ambient temperature  $T_a$ , power dissipated  $P_c$ , and the thermal resistance  $R_t$  from the ambient to junction by the expression,  $T_j = T_a + P_c R_t$ , where temperature is in degrees C, power in watts and thermal resistance in deg C/watt. This may be described by reference to Fig. 1.

With no power dissipated in the transistor, the junction temperature is the same as ambient temperature (point A). When power is applied and dissipation in the transistor increases, the temperature also increases along line AO whose slope is equal to the thermal resistance from the junction to the ambient medium.

The majority of power tran-

sistors carry two maximum ratings. Both maximum junction temperature and maximum power dissipation are usually specified. These are shown on the temperature-dissipation diagram in Fig. 1.

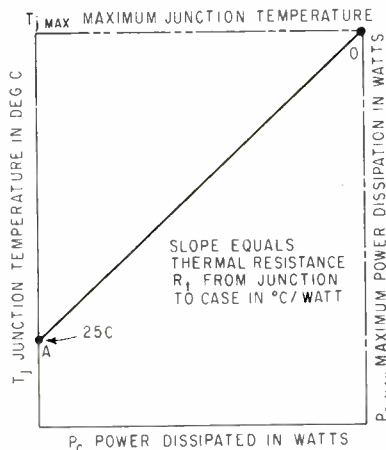

FIG. 1—Temperature-dissipation diagram showing maximum ratings usually supplied by transistor manufacturer's data

sistors carry two maximum ratings. Both maximum junction temperature and maximum power dissipation are usually specified. These are shown on the temperature-dissipation diagram in Fig. 1.

In most power transistors, the line AO connecting the point corresponding to zero dissipation at 25 C with the point corresponding to maximum power at

## Safety Factor

The concept of safety factor is based on the general engineering definition,  $SF = S_u/S_w$ , where  $SF$  is the safety factor,  $S_u$  is the ultimate stress, and  $S_w$  the working stress.

The safety factor is the ratio of ultimate stress to working stress. The allowable junction temperature rise over 25 C is analogous to ultimate stress since a rise in excess of this value results in a short life if not immediate failure. This figure divided by the actual junction temperature rise in a given application results in a realistic safety factor. A reference of 25 C is used since many manufacturers rate their transistors at maximum power when the case is maintained at 25 C. Apparently, higher power cannot be achieved even with a cooler case because of mechanical stresses induced by the thermal gradient between case and junction.

Safety factor can be expressed by  $SF = (T_{jmax} - 25)/(T_j - 25)$ , where  $T_{jmax}$  is the maximum allowable junction temperature

# DELCO POWER TRANSISTORS

**NEW TYPES**



**MILITARY  
COMMERCIAL**

TYPICAL CHARACTERISTICS AT 25°C

EIA	2N297A*	2N297A	2N665**	2N553
Collector Diode Voltage (Max.)	60	60	80	80 volts
HFE ( $I_c = 0.5A$ ) (Range)	40-100	40-100	40-80	40-80
HFE ( $I_c = 2A$ ) (Min.)	20	20	20	20
$I_{co}$ (2 volts, 25°C) (Max.)	200	200	50	50 $\mu a$
$I_{co}$ (30 volts, 71°C) (Max.)	6	6	2	2 ma
$F_{ae}$ (Min.)	5	5	20	20 kc
T (Max.)	95	95	95	95°C
Therm Res. (Max.)	2	2	2	2° C/W

\*Mil. T 19500/36 (Sig. C.)

\*\*Mil. T 19500/58 (Sig. C.)

NOTE: Military Types pass comprehensive electrical tests with a combined acceptance level of 1%.

Delco Radio announces new PNP germanium transistors in 2N553 series — the 2N297A and 2N665, designed to meet military specifications. These transistors are ideal as voltage and current regulators because of their extremely low leakage current characteristics. All are highly efficient in switching circuits and in servo amplifier applications, and all are in *volume* production! Write today for complete engineering data.

**DELCO RADIO**

Division of General Motors • Kokomo, Indiana

BRANCH OFFICES

Newark, New Jersey  
1180 Raymond Boulevard  
Tel: Mitchell 2-6165

Santa Monica, California  
726 Santa Monica Boulevard  
Tel: Exbrook 3-1465

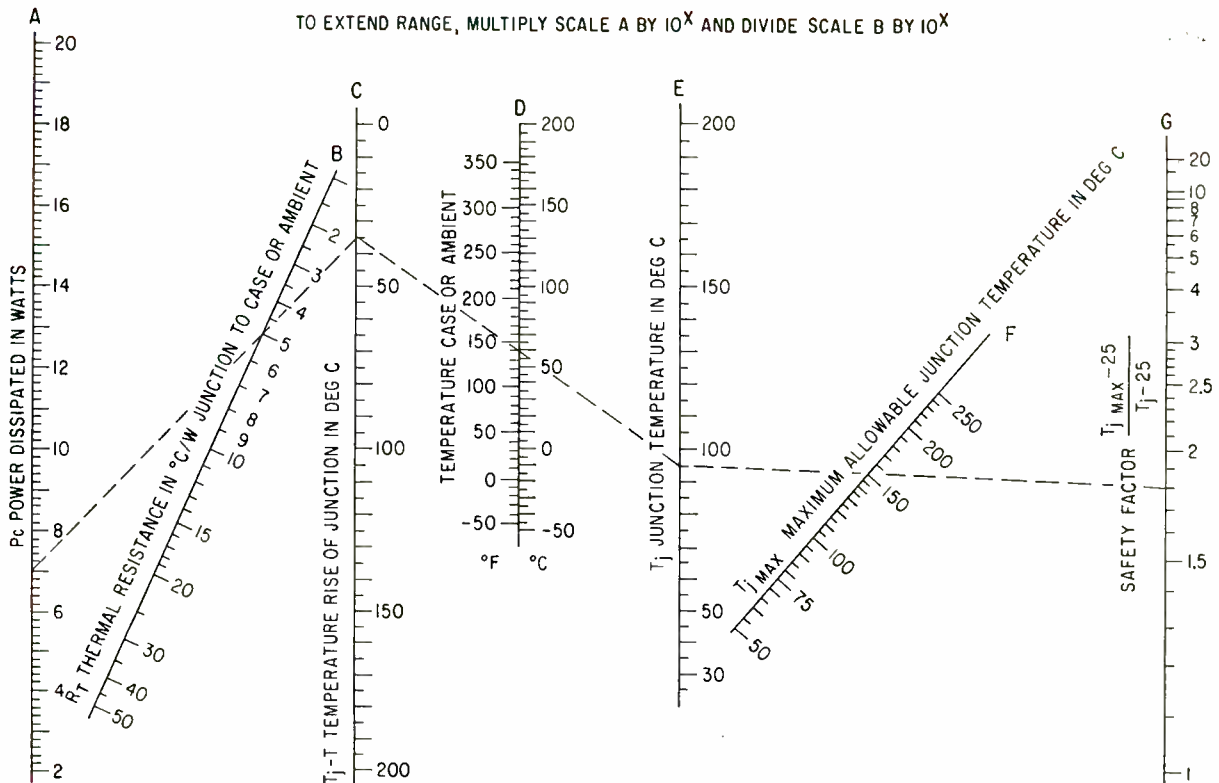

FIG. 2—Nomograph for determining safety factor inherent in a given thermal design

in deg C, and  $T_j$  is the actual junction temperature in deg C.

Another method of expressing the concept of safety factor is to use the maximum allowable power as the ultimate stress and the working power plus the power equivalent of case temperature as the working stress. This results in the expression  $SF = P_{o,max} / \{P_o + [(T_c - 25)/R_c]\}$  where  $P_{o,max}$  is the maximum allowable power dissipation in watts at a case temperature of 25 C,  $P_o$  is the actual power dissipation in watts, and  $T_c$  is the case temperature in deg C.

**Using Nomograph**

To solve the equations relating thermal resistance, power dissipated, ambient temperature, junction temperature and safety factor, a nomograph has been developed and is shown in Fig. 2. The following example illustrates the use of the nomograph.

(1) Determine the power being dissipated in the transistor by measurement in the actual

circuit. In the example shown, this is assumed to be 7 watts.

(2) Determine the thermal resistance from junction to ambient medium. The thermal resistance from case to ambient can be determined by measuring the change in case temperature for a known change in power dissipated. The thermal resistance from junction to ambient medium is the sum of the thermal resistance just determined and the thermal resistance from junction to case given in the manufacturer's data sheet. In the example, the total thermal resistance is 5 deg C/watt.

(3) Draw a line from the known power dissipated on scale A through the thermal resistance value on scale B. The extension of this line intersects scale C at the rise of the junction temperature above ambient. This is 35 C.

(4) Draw a line through the point just located on scale C and the ambient temperature on scale D. The extension of this

line intersects scale E at the actual junction temperature (95 C).

(5) From this point, draw a line through the maximum allowable junction temperature on scale F. The value used in the example is 150 C. Extension of this line intersects scale G at the inherent safety factor. This turns out to be 1.8.

Range of the nomograph can be extended by multiplying scale A by some power of 10 and dividing scale B by an equal quantity, or by multiplying B by some power of 10 and dividing A by an equal quantity.

The nomograph can also be used to solve the required thermal resistance for a given safety factor, ambient temperature, power dissipated, and maximum allowable junction temperature.

By considering scale B as thermal resistance from junction to case and scale D as case temperature, calculations can be made based on case temperature using similar procedures.

# NOW!

## Use your electronic counter as an accurate digital voltmeter and integrator

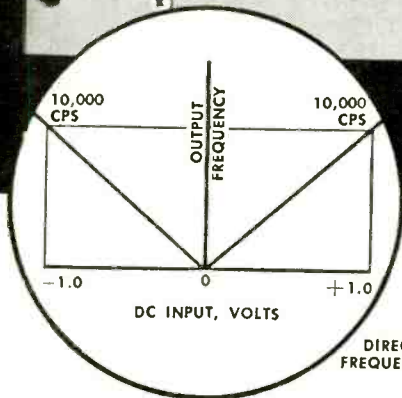

## New Dymec Voltage-to-Frequency Converter

- Multiple input ranges, either polarity
- Inherent noise-averaging characteristics
- Output frequency 0 cps to 10 KC
- 1 megohm input impedance
- 0.1% accuracy
- Easily used in remote and automatic programming applications

Here is a compact new instrument which embodies a truly unique approach to the analog-to-digital conversion problem. You can now make accurate, dependable voltage measurements with your standard electronic counter, viewing results in direct, digital form on the counter. The instrument and its associated counter also serve as an electronic integrator permitting direct measurement of the time integral of dc voltages and other variables without time-consuming manual data reduction and analysis. These characteristics make the DY-2210 an ideal basic component for data handling systems.

The new DY-2210 converter generates output pulses at a rate proportional to the dc signal voltage. This renders the instrument virtually insensitive to noise, and makes possible average measurements of pulsating voltages and currents. The voltage measuring interval is determined by the associated counter. Either positive or negative voltages can be measured without reversing leads or switching. Immediate shipment from stock. For complete details or demonstration see your Dymec representative or write direct for information.

### CONDENSED SPECIFICATIONS

- Input Voltage Ranges:** 0 to 1, 10, 100 and 1,000 v dc; manual selection.
  - Input Impedance:** 1 megohm, 200  $\mu$ f shunt, all ranges.
  - Input Polarity:** Positive or negative. Polarity automatically sensed.
  - Output Frequency:** Zero to 10,000 cps.
  - Accuracy:** Within 0.1% full scale.
  - Calibration:** Against internal mercury cell or external voltage standard.
  - Power:** 115 v  $\pm$  10%, 60 cps, 35 watts.
  - Dimensions:** Cabinet model, 7 $\frac{1}{4}$ " wide, 11 $\frac{1}{4}$ " high, 10 $\frac{1}{4}$ " deep. Rack mount model, 19" wide, 3 $\frac{1}{2}$ " high, 10 $\frac{3}{4}$ " deep.
  - Price:** \$650.00 (Rack) \$660.00 (Cabinet).
- Data subject to change without notice. Prices f.o.b. factory.*

Write for details

**dy**  
DYMEC INC.

(formerly Dynac, Inc.)

5168E Page Mill Road • Palo Alto, Calif., U.S.A.

DAvenport 6-1755

Field representatives in all principal areas

# Magnetic D-C Amplifier Is Drift Free

MAGNETIC instrument amplifier offers a practical and accurate means of testing circuit components where absolute reliability of the d-c amplifier is of prime importance. The d-c amplifier was developed at the U. S. Naval Ordnance Lab.

The all-magnetic system shown in Fig. 1 can readily meet requirements for instrument applications demanding unusual stability, linearity, freedom from zero drift and long-term reliability.

It is feasible to build a simple magnetic amplifier for an ink recorder that, without impairing accuracy and dynamic performance, can measure signal voltages of 10 to 100 mv and signal currents of 2 to 50  $\mu$ amp. Similar or even smaller measurements could readily be made with a vacuum-tube amplifier, but choppers and other electronic complications would be needed.

Magnetic amplifiers are particularly suitable for extending the sensitivity of electrical multi-range instruments and moving-coil ink recorders. They also may be used in connection with phase-sensitive rectifiers for the measurement of various a-c quantities, such as a-c potentiometer circuits and a-c

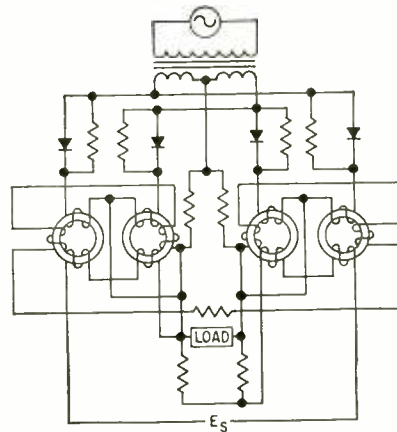

FIG. 1—Voltage-controlled, self-balancing push-pull circuit with voltage feedback requires no vacuum tubes

bridge networks. Voltage dividers and shunts may be provided to extend the voltage and current ranges of such electronic arrangements.

Magnetic-amplifier operated ink recorders are also well suited to signal mixing operations, such as the algebraic summation of signal voltages and currents. Multiplication of signals can be carried out through use of two thermocouples. One is heated by current of a value that is the algebraic sum of two derived currents, and the other by their difference.

Another multiplication operation can be performed by replacing the two thermocouples with two magnetic-amplifier multiplying circuits. These provide the square term of the algebraic sum of two derived currents and the square term of their differences.

These d-c amplifiers offer the advantages resulting from the elimination of movable parts and vacuum-tube components. Self-balancing magnetic amplifiers, employing the combination of magnetic positive feedback and electric (galvanic) negative feedback exhibit the stability, linearity and freedom from zero drift that are basic requirements in electric instrument applications. They further offer the possibility of reducing actual response time to its minimum value of one-half cycle of the power-supply frequency.

This material was abstracted from U. S. Naval Ordnance Laboratory Report for Feb. 1959.

## VLF Controls Garage Doors

RADIO-CONTROLLED garage-door operator designed by Delco Radio division of General Motors operates in the frequency range between 5 and 10 kc. Fifty channels in this frequency range can be used, with 100 cps for each channel.

Most present-day phantom operation of such units occurs on those devices using higher frequencies. In the higher r-f frequencies, phantom signals can originate from long distances, many coming from aircraft.

In the 5 to 10-kc range, it is difficult to radiate signals over long distances because good antennas must be several miles in length. Because this frequency range falls into the short-range communications category, it is more suitable for garage door controls where ranges are measured in feet. Possibility of interferences with established communications services are

## Stereo for Automobiles

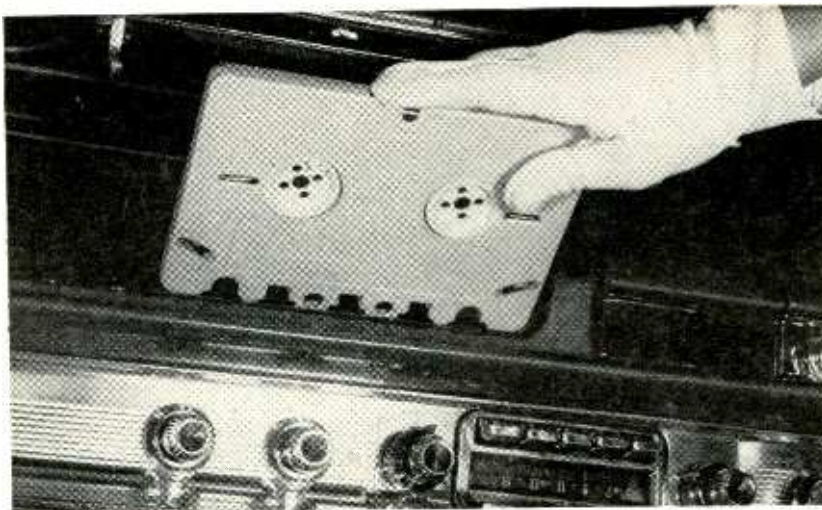

Experimental stereophonic tape system has been developed for automobiles by Delco Radio division of General Motors. The tape cartridges offer up to 30 minutes of playing time per side, and the amplifier is transistorized



# LIONEL

# says . . .

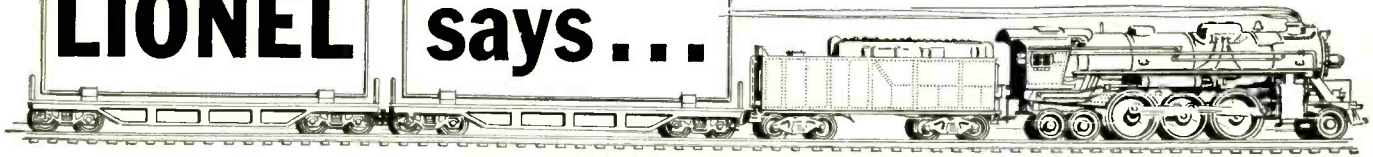

*"Jones & Lamson Comparators help us make difficult inspection jobs easy. Delicate, intricately-shaped parts are inspected speedily and accurately. Our savings in time and money are substantial."*



*checking the critical dimensions of an armature commutator*

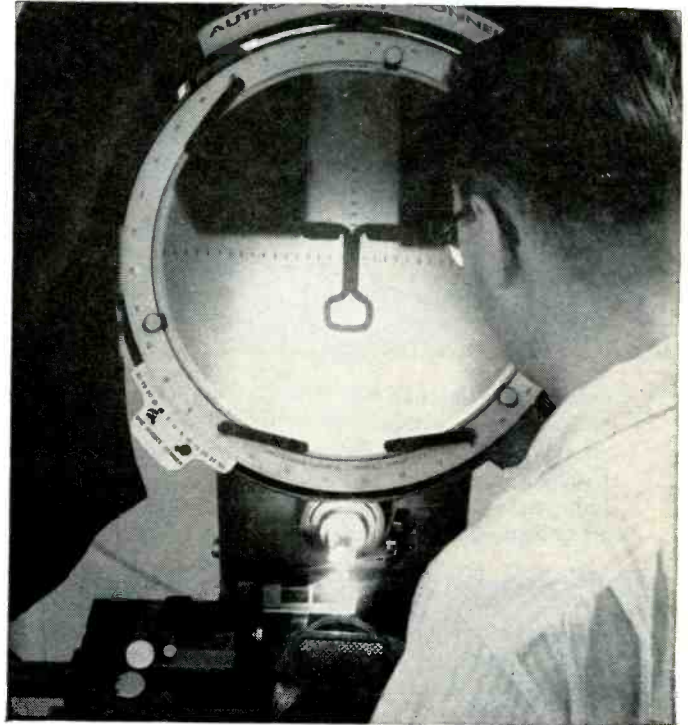

*new "T" rail is one of many parts held to very close tolerances*

Many manufacturers of mass-produced precision parts and components face these demanding inspection requirements: — *Speed*, to keep pace with production; *Extreme accuracy*, for tolerances as close as .0001"; *Flexibility*, because of variety of parts, and different types of inspections and measurements needed; *Reliability*, for sure quality control; *Ease of operation and maintenance*, for steady day-in, day-out performance.

THE LIONEL CORPORATION is but one of many, many firms that have found Jones & Lamson Optical Comparators fill all these requirements.

J&L Optical Comparators are available in a range of 13 different models, both bench and pedestal types. Write today for our new Comparator Catalog LO5700.

*"World's oldest and largest builder of precision optical comparators"*



# JONES & LAMSON



MODEL PC-14

JONES & LAMSON MACHINE COMPANY, Dept. 710, 539 Clinton Street, Springfield, Vermont

# COLD-PUNCH PRINTED CIRCUITS

...this profitable STRIPPIT way!

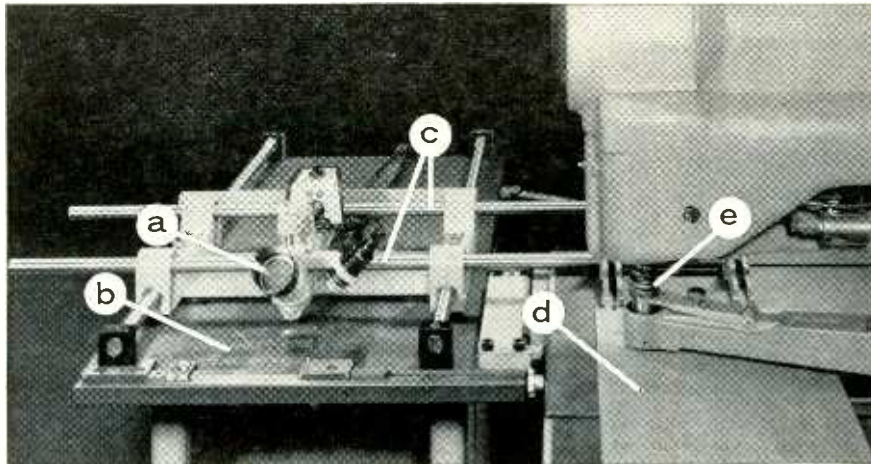

- 1. PUNCH THE TEMPLATE.** The Strippit Dupl-O-Scope (a), precision 4-power optical locator is mounted on Strippit pantograph-like Duplicator. As the Dupl-O-Scope is "sighted-in" on drawing or sample (b), the Duplicator arms (c) position template blank (d) under Strippit Fabricator punch (e) to accurately locate and punch pilot holes in a fraction of conventional layout and template making time.

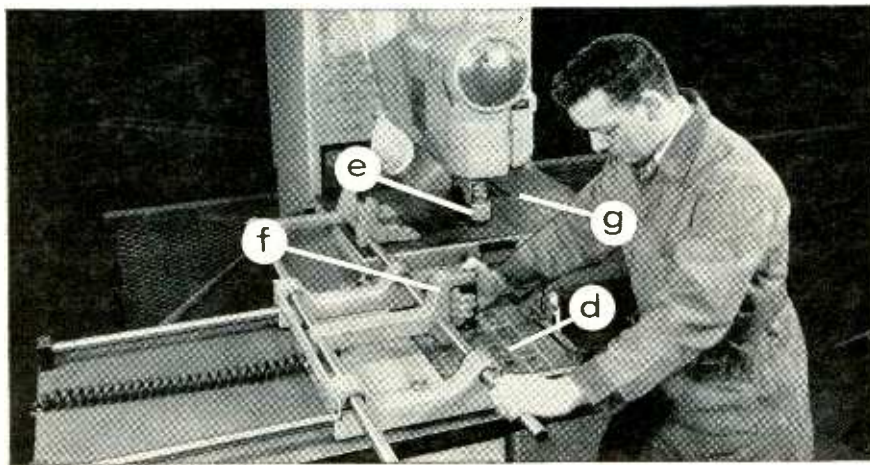

- 2. RAPID-FIRE DUPLICATION FROM TEMPLATE.** Duplicator with Stylus (f) replaces Dupl-O-Scope. As Stylus enters each pilot hole in template (d), it automatically positions work (g) under the punch (e) and trips the punch to produce a hole of desired shape and size in the proper location. Tool changes in the Fabricator punch holder are made in seconds, and anyone can learn to operate the Duplicator in a few minutes. For small to medium runs, there is no easier, faster or more economical method of making clean, accurate perforations in laminates or in chassis up to 1/4" mild steel.

**WRITE FOR DEMONSTRATION AT YOUR PLANT!** At no obligation, a Strippit Mobile Unit will demonstrate the cost-cutting Strippit Fabricator, Duplicator and Dupl-O-Scope. Write today!

**WALES STRIPPIT INC.**

225 Buell Road • Akron, New York

In Canada: Strippit Tool & Machine Company, Brampton, Ontario



practically eliminated.

The control receiver uses five transistors, two crystal diodes and a semiconductor rectifier. The single-tuned antenna is a ferrite rod design with coils positioned on the rod to resonate with a fixed capacitor at the desired channel. The first two stages are straight audio amplifiers. The third stage (driver) feeds a selective circuit that helps select the correct frequency.

The signal from the transmitter in the automobile is an unmodulated carrier. As it is fed through the receiver, it is accepted by the tuned circuits and passes on through the sensitive-relay control transistor, which energizes the sensitive relay and the power relay.

## Code System

A simple code system has been developed, since analysis of the electrical noise in this frequency band shows a modulated envelope in all random radiations. The receiver is designed to accept the unmodulated transistor signal and to reject any modulated noise carrier.

If a signal is fed into the receiver from the spurious source, it will pass through the amplifier stages and into the tuned transformer circuit. Even if this spurious signal is of the right frequency, it will be modulated. The modulation is removed, amplified and fed to the sensitive relay control transistor in the form of reverse bias so that the spurious signal cannot energize the sensitive relay.

The transmitter uses two transistors, a low-power audio type as an oscillator and a Delco Radio power transistor as a power amplifier to drive the ferrite-rod tuned antenna. With about 5 watts of power, a predictable range of 60 to 100 ft is obtained. The transmitter draws current only as long as the button on the instrument panel is depressed.

## Ultrasonics Controls Nuclear Machinery

ULTRASONICS will control a group of complex maintenance machinery for reactor repair. The prototypes, developed by Babcock & Wilcox, are required to maintain advanced type

reactors that use circulating liquid metal as the atomic fuel.

Consisting of six units, the fleet will be independently and remotely controlled from a control console. A closed-circuit tv, built by Diamond Power Specialty, and a four-ft thick lead glass window will make the radioactive work area easily visible in the control room of the reactor.



Nuclear specialist uses closed-circuit tv to study responses of remotely controlled tow truck to his commands

Largest and most complex of the machines is a three-ton fork-lift truck with three arms. The most versatile of the three is a mobile manipulator capable of duplicating many human wrist and arm functions. The two auxiliary arms can lift a small wrench or a 1,000-pound object 15 ft.

The other electronically controlled units are a tow truck for transporting radioactive loads; a pipe welder that can complete a high-integrity 6-in. weld in 30 sec, equipped with a tv camera to permit examination; a pipe cutter that can cut a 10-in. dia. pipe; and a 50-ton flying-rope crane with a drive mechanism located in an accessible position behind the radiation shield rather than on the bridge in the radioactive work area.

Separate panels manned by two technicians provide remote control points for the maintenance force. Coded commands are transmitted ultrasonically to the robots. Commands are then decoded by the units and carried out. The system is also capable of sending operational sounds to the control-panel operators.

ONLY BRUNING'S NEW, YEARS-AHEAD COPYFLEX 675 OFFERS SO MANY OPERATOR ADVANTAGES!



SHE FLICKS A FINGER  
TO GET THE

**HEIGHT OF CONVENIENCE!**

Just flick a switch, and you change the machine and feedboard height of Bruning's new Copyflex 675 reproduction machine to suit your convenience. Motor-driven floor jacks raise or lower machine to give you a feedboard height from 35" to 39"!

That's just one of many new, advanced operating conveniences that include an exclusive four-way tracing tray that adjusts to stack or to permit fast removal of tracings . . . a feed band system that eliminates curling and wrinkling of tracings . . . enclosed, easy-to-load feed rods for roll stock . . . a unique system of vacuum ports in the feedboard that hold large sheets and roll stock in position, and a split-shade lamp control that enables simultaneous insertion of different materials.

Add to these advantages the 675's 46-inch printing width, a mechanical speed of up to 75 f.p.m., and a fast-printing 7,500 watt lamp variable to 5,000 watts.

Why not investigate the years-ahead whiteprinter that gives your operators MORE to do MORE for you.

**BRUNING**

*Copyflex*

The Bruning Man is your expert on Diazo reproduction. He's backed by a company with over 60 year's experience.

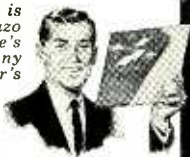

Charles Bruning Company, Inc., Dept. 4-UU  
1800 Central Road, Mount Prospect, Ill.  
Offices in Principal U.S. Cities  
In Canada: 105 Church Street, Toronto 1, Ont.

Please send me my free booklet on the new Copyflex Model 675.

Name \_\_\_\_\_ Title \_\_\_\_\_  
Company \_\_\_\_\_  
Address \_\_\_\_\_  
City \_\_\_\_\_ County \_\_\_\_\_ State \_\_\_\_\_



FIG. 1—Preparing the CW-413/FPS(XD-1) radome for structural testing. It is a truncated spherical shell with an equatorial diam of 26½ ft, base diam of 20 ft and wall thickness of ⅛ in. It is composed of 55 panels bolted together

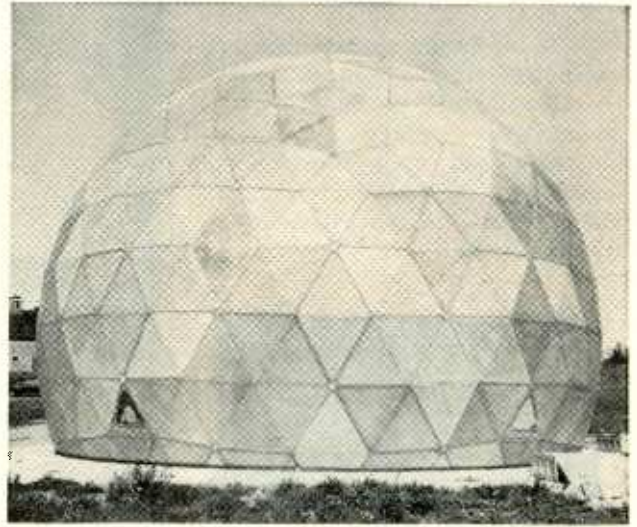

FIG. 2—Space frame radome CW-396A is currently in use on the DEW Line, in FEAF and in Europe. It has an equatorial diam of 55 ft, and a base diam of 50 ft. The diaphragm is 1/16 in. and the flanges are 3 in. deep and ¼ in. thick

## Rigid Radome Design Considerations

By PHILLIP DAVIS and ALBERT COHEN, Staff Members, Massachusetts Institute of Technology, Lincoln Lab., Lexington, Mass.

RIGID RADOMES maintain their shape because of the inherent stiffness of their component parts. They protect radar antennas from environmental conditions such as high winds and precipitation effects. An ideal radome provides effective and adequate protection for the antenna system without causing interfer-

ence to the radar transmission. But a practical radome design is most often a compromise between structural performance and electrical performance. This article is concerned only with rigid radomes for ground use.

High wind velocities have the greatest influence on radome de-

sign. Although it is not feasible to design a radome to be tornado-proof, it can be designed to withstand hurricanes and arctic winds. Even though only limited data on high winds are available, the most reliable information indicates that winds of 140 mph occur occasionally; 185 mph occur once in 20 years and 200 mph are possible.

Glaze ice particles can be a problem but in the Arctic, for example, freezing rain and drizzle storms occur less than 0.1 percent of the time. Ambient temperature range for radomes varies from -65 to +165 F. This wide range can lead to embrittlement of radome material at low temperatures and loss of mechanical properties at high temperatures. Extremes in humidity can also be a problem.

### Fabrication Materials

In addition to mechanical considerations, radome materials should exhibit low dielectric constant and low loss tangent to minimize effect on electromagnetic radiation. These conditions have been satisfied by using plastics reinforced with fibrous glass. Table I

Table I—Properties for Parallel Laminates of Glass-Fiber Reinforcement, Polyester Resin (Mil-R-7575)

Laminate	181	184	Mat
Tension			
Modulus (Initial).....	2.62 × 10 <sup>6</sup> psi	3.06 × 10 <sup>6</sup> psi	1.30 × 10 <sup>6</sup> psi
Strength.....	38,000 psi	40,000 psi	18,000 psi
Compression			
Modulus.....	2.94 × 10 <sup>6</sup> psi	2.9 × 10 <sup>6</sup> psi	1.55 × 10 <sup>6</sup> psi
Strength.....	36,000 psi	23,000 psi	18,000 psi
Flexure			
Modulus.....	2.5 × 10 <sup>6</sup> psi	2.5 × 10 <sup>6</sup> psi	1.09 × 10 <sup>6</sup> psi
Strength.....	45,000 psi	40,000 psi	19,200 psi
Dielectric Constant 8,500-10,000 mc.....	4.2	4.2	4.2
Dissipation Factor 8,500-10,000 mc.....	0.020	0.020	0.020

# Now 4 CHR High Temperature TEFLON<sup>®</sup> Tapes

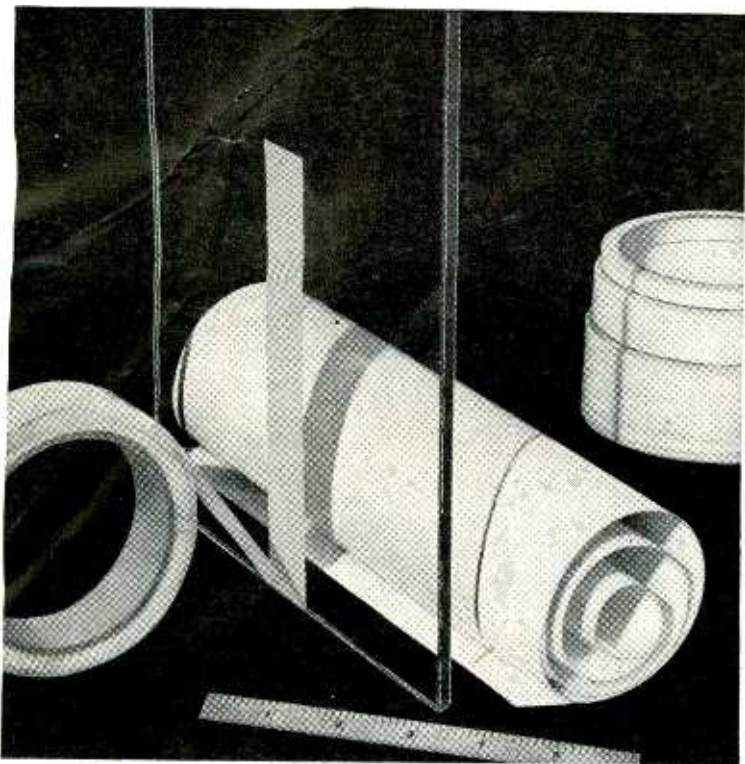

## Pressure-Sensitive TEFLON Tapes

*easy to apply in both electrical  
and mechanical applications*

The electrical uses of Temp-R-Tape include slot lining, inter-layer and interphase insulation, harness bundling, wrapping for microwave components, transformer coils, capacitors and high voltage cables, etc.

As a low friction, non-stick facing, Temp-R-Tape applications range from facings for film guides in sensitive electronic instruments to the facing for heat sealing bars, forming dies, chutes, guide rails, etc.

Chemical resistant facing applications include masking tape in high temperature dipping operations.

All four of these pressure-sensitive Teflon tapes are available from stock in rolls and in sheet form. In addition to Teflon tapes, CHR also makes a fiberglass tape with thermal curing, pressure-sensitive silicone adhesive (Temp-R-Tape GV) and silicone rubber coated fiberglass tape with thermal curing, pressure-sensitive silicone adhesive (Temp-R-Tape SGV).

**FREE SAMPLES** and folder — write, phone or use inquiry service.

- $-100^{\circ}\text{F}$  to  $500^{\circ}\text{F}$  applications
- Class H and Class C insulation
- Non-stick and low friction facing
- Chemical resistant facing

**TEMP-R-TAPE T** is a .006" pressure-sensitive Teflon tape with  $-100^{\circ}\text{F}$  to  $400^{\circ}\text{F}$  ( $-70^{\circ}\text{C}$  to  $200^{\circ}\text{C}$ ) temperature range. It has high dielectric strength, low power factor, negligible moisture absorption, high elongation, is non-corrosive and non-contaminating. Meets Class H Temperature requirements.

**TEMP-R-TAPE TH** is a .013" pressure-sensitive Teflon tape with  $-100^{\circ}\text{F}$  to  $400^{\circ}\text{F}$  temperature range. It is similar to Temp-R-Tape T except that it is made of .010" Teflon film to which .003" silicone polymer adhesive has been added. Often used where a single, thicker dielectric barrier is desired or where a more rigid, abrasion resistant wrap is required.

**TEMP-R-TAPE C** is a .002" pressure-sensitive, thermal curing Teflon tape with  $-100^{\circ}\text{F}$  to  $500^{\circ}\text{F}$  temperature range. It is made with a cast Teflon film which provides dielectric strength (2750 v/m) higher than any other type of Teflon film. When cured in place, it will operate at temperatures up to  $500^{\circ}\text{F}$  and will withstand much higher temperatures for short periods. Meets Class H and Class C temperature requirements.

**TEMP-R-TAPE TGV** is a thermal curing, pressure-sensitive Teflon impregnated fiberglass tape with  $-100^{\circ}\text{F}$  to  $500^{\circ}\text{F}$  temperature range. Although it is used extensively for mechanical and electrical applications, its dielectric strength is lower than other Temp-R-Tapes.

### **CHR products include:**

**COHRLastic Aircraft Products** — Airframe and engine seals, firewall seals, coated fabrics and ducts

**COHRLastic Silicone Rubber Products** — Silicone rubber moldings and extrusions, silicone rubber sheets, silicone sponge rubber

**Temp-R-Tapes** — Pressure sensitive, thermal curing Teflon and silicone tapes

**Allied Products** — COHRLastic silicone cements and conductive gasketing



Leader In Fabrication of Silicone Rubber

## CONNECTICUT HARD RUBBER COMPANY

Main Office: New Haven 9, Connecticut

after  
**60**  
years

...no soldering  
application's  
too difficult!

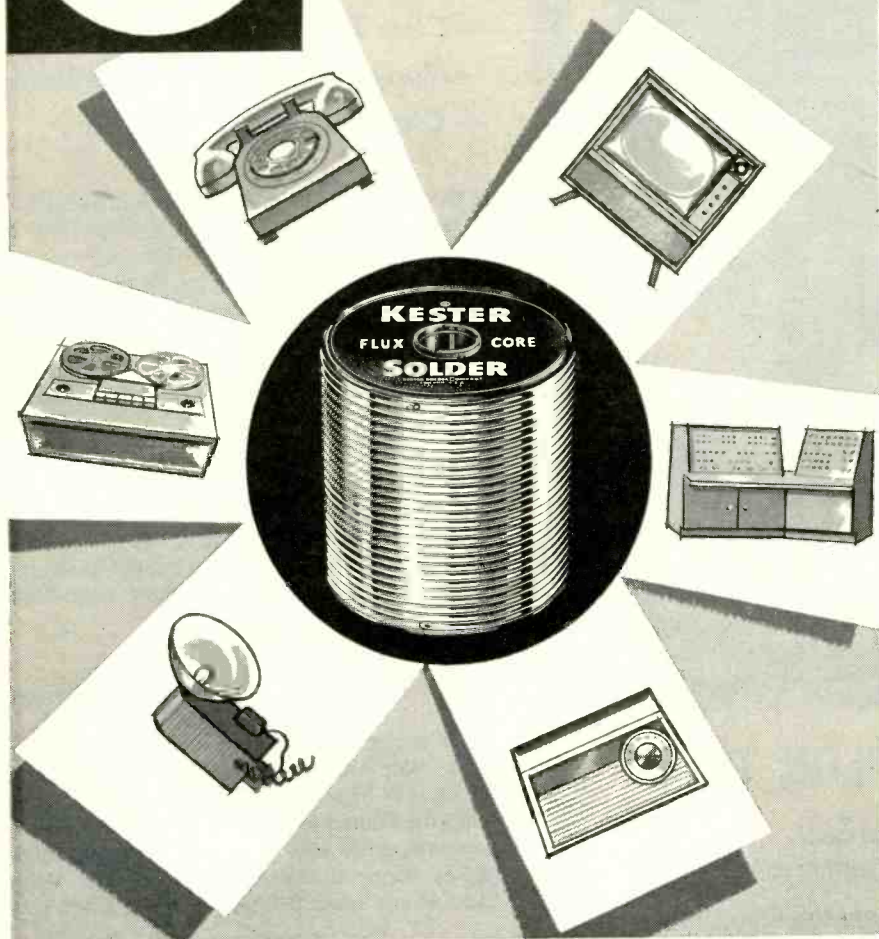

# Kester Solder

Kester's latest development . . . "44" RESIN-CORE SOLDER has a perfected activated resin flux for faster assembly line soldering. Like all Kester Flux-Core Solders, it will solve many circuit design and development requirements. Used by leading electronic manufacturers everywhere.

Other Rosin-Resin Flux-Core Solders also available as well as many "Specialized" Flux-Core Solders.

Write today for free 78-page Kester technical manual "SOLDER... Its Fundamentals and Usage."

## KESTER SOLDER COMPANY

4204 Wrightwood Avenue, Chicago 39, Illinois  
Newark 5, New Jersey • Brantford, Canada

Over 60 Years' Experience In Solder And Flux Manufacturing

shows some structural and electrical characteristics for typical reinforced plastics used. Cost of reinforced plastics is reasonable, materials are available readily and fabrication is not overly complicated.

### Radome Structure

The type of radome structure most likely to provide good performance is a thin, uniform-thickness-wall spherical shell. This is true if the wall thickness remains small by comparison to the wavelength of the radiated energy. A design using the materials outlined in Table I calls for a wall thickness of the order of  $\frac{1}{2}$  of a wavelength or less. Other designs based on sandwich type construction or half wavelength wall thicknesses are also possible.

Analysis for the thin spherical shell shows that the mode of failure is general buckling or dimpling of the panel from external pressure. Buckling tests for the shell in Fig. 1 show that the critical stress is equal to  $0.147 E (t/R)$  where  $E$  is elastic modulus,  $t$  is skin thickness and  $R$  is shell radius.

Plastic foam is a most suitable material for some radome applications since the dielectric constant and loss tangent are so low that, for the most part, the thin-wall electromagnetic restriction no longer applies. An efficient use of material is in the two-skin sandwich wall often used by airborne radome designers.

Another technique for efficient use of material is the dielectric space frame. This technique involves an inversion in the structural role of importance played by the skin and flanges. Usually, the skin is the primary structure in the uniform thickness shell while the flanges play a secondary role of transmitting interpanel loads. In the space frame, the primary structure is the dielectric framework. The thin diaphragms merely transmit wind-pressure loads to the framework to which they are attached. Figure 2 shows a radome of this type.

### Electrical Performance

Tests made on the space-frame antenna show that from uhf up



through L-band frequencies, less than 0.3-db loss in antenna gain through the radome was indicated. Distribution of the antenna radiation in space is only slightly disturbed. The major effect appears to consist of side-lobe smoothing and null fill-in. No deleterious effects to antenna impedance or antenna pointing accuracy were caused by the radome.

#### S-Band Performance

At S-band, tests also indicate satisfactory performance for operational use. Loss in gain was about 0.5 db and net increase in side lobe level was two db at a -25 db level. Again, no effects to impedance or pointing accuracy of the antenna were discernible.

Work reported in this article was performed with the joint support of the Army, Navy and Air Force.

### Glass-Enclosed Resistors

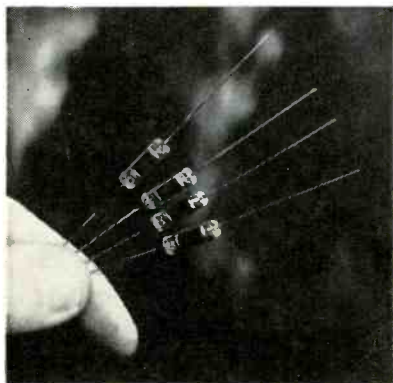

Samples of glass-enclosed film resistors have true glass-to-metal seals

PRECISION FILM RESISTORS with true glass-to-metal seals have been introduced by Corning Glass Works. The new components are completely impervious to moisture and meet requirements of MIL-R-105-09C, Characteristic B.

#### One-Fourth Watt Units

Now in pre-production, the new resistors will be available in engineering quantities by the end of next month. First unit will be rated at one-fourth watt with anticipated resistance range of 10 ohms to 0.5 megohm at 300 v at 70 C with de-rating to 150 C.



**SS-5**  
DP-DT spring return  
0.5-amp. @ 125v ac-dc.  
U.L. Inspected.

**SS-15**  
SP-ST pushbutton, momentary  
contact. 1-amp. @ 125v ac.  
U.L. Inspected.

**SS-16**  
3-position special.  
0.5 amp. @ 125v ac-dc.

## THINK HOW YOU CAN



**SS-31**  
3-Position. 3-amps  
@ 125v ac.  
U.L. Inspected.

**SS-32**  
SP-DT. 1-amp.  
@ 125v ac-dc.  
U.L. Inspected.

**SS-33**  
DP-DT. 3 amps  
@ 125v ac.  
U.L. Inspected.

## IMPROVE YOUR PRODUCT



**SS-50**  
DP-DT miniature.  
0.5-amp. @ 125v ac-dc.  
U.L. Inspected.

**SS-8**  
3P-DT. optional  
detent. 1 amp. @ 125v ac.

**SS-27**  
SP-DT spring return.  
3-amps @ 125v ac.  
U.L. Inspected.

## WITH THESE LOW COST



**SS-26-1**  
SP-DT. 3-amps  
@ 125v ac.  
U.L. Inspected.

**SS-9**  
SP-DT spring return.  
3-amps @ 125v ac.  
U.L. Inspected.

**SS-18**  
4-position special.  
0.5 amp. @ 125v ac  
for 10,000 cycles.

# STACKPOLE SWITCHES!

Get This **GUIDE TO MODERN SWITCHING** ▶

Ask for 8-page Switch Bulletin RC-11D  
World's largest slide switch line—over 12 low cost standard types—dozens of economical adaptations. NEW colored knobs. Special conventional and miniaturized switches designed and produced for large quantity users. *Electronic Components Division, STACKPOLE CARBON COMPANY, St. Marys, Pa.*



# New Techniques Discussed at IRE

EXPERIMENTAL METHODS of obtaining component densities equivalent to a million or more parts per cubic foot were discussed in 2 papers delivered at the production techniques session, IRE Convention.

C. D. Head, of Varo Manufacturing Co., and D. W. Moore, of Servomechanisms, Inc., described how their firms evaporate basic materials on substrates. The techniques may be used to form circuit functions rather than a conventional aggregation of components.

Both firms employ electron bombardment to vaporize basic materials. This method can be used to deposit single substances. Metallic alloys can be deposited without fractioning problems by vaporizing the elements separately and mixing them in the vapor phase.

Head showed how a conventional resistor-capacitor network is made as a single component (Fig. 1) by depositing conductive and resistive materials on a dielectric substrate (ELECTRONICS, p 22, July 11, 1958). Varo is developing an ion gun which may permit printing circuits under electronic control.

Servomechanisms is depositing thin films of square loop magnetic materials which perform as computer memory and logic elements. Stepping pulses can be used to move information from point to point

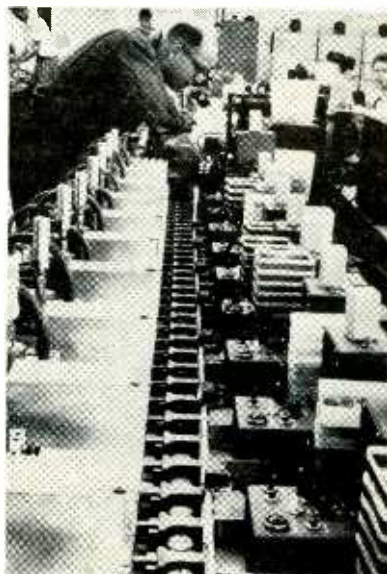

Modular test stations make up Texas Instruments in-line transistor tester

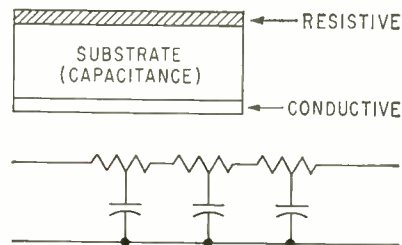

FIG. 1—Functions of resistors and capacitors are lumped by Varo

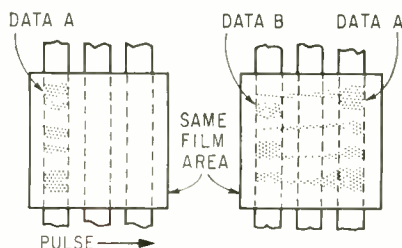

FIG. 2—Servomechanisms method of electronically transferring recorded data

non-mechanically, shifting the location of the information written in the film (Fig. 2). A film resolution of 100 Angstrom units is feasible.

Uses of flexible printed wiring to reduce cabling volume and weight were outlined by W. B. Wilkens, of Sanders Associates, Inc. Extensible cables can be wound on reels or accordion-pleated. This type of cabling can also be constructed as twisted pairs, shielded cable (Fig. 3A) or can be wrapped around oscillating parts as an alternative to

slip rings. Matrix wiring (Fig. 3B) allows feeders to be spotwelded into trunk lines. Coaxial cables are made by placing urethane foam between the conducting layers.

Ed Millis, of Texas Instruments, Inc., described a high-volume transistor tester constructed of plug-in in-line modular test stations. Loaded by 3 or 4 persons, it will make up to 18 go-no-go tests and sort up to 10 categories at rates up to 2,000 units an hour. Photocells read punched cards to actuate rejection and sorting mechanisms.

Evolution of electron tube stem-making machinery was traced by Matthew M. Bell, of RCA. Production rates have risen from 400 an hour in early machines to 1,300-1,500 an hour at present. A machine to produce 2,500 stems an hour is in development and future machines may produce up to 10,000 an hour, Bell said.

On the fourth floor of the Coliseum, a number of production machines were shown. Among those with new features are:

Associated American Trading Division: automatic universal coil winder. Hopper-fed coil forms are positioned on a turret-type arbor, wound, hot-waxed or cemented, baked and unloaded. The machine

## New Potting Gel Is Transparent

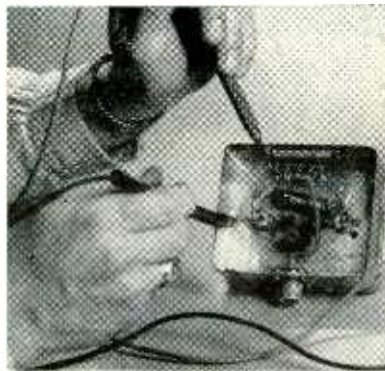

Silicone potting material which permits visual and instrument inspection of components in a potted assembly is announced by Dow Corning Corp., Midland, Mich. Dielectric gel is prepared by mixing thick liquid with catalyst. Pot life is over 12 hours at 80 F. Cure may be varied from 30 minutes to 48 hours, with curing temperatures of 40 C to 150 C. Test probes can be inserted into gel. Gel's memory causes holes to heal.



## ANTENNA FOR ARMY HAWK RADAR SYSTEM

Raytheon is prime contractor for both Army Hawk and Navy Sparrow III.

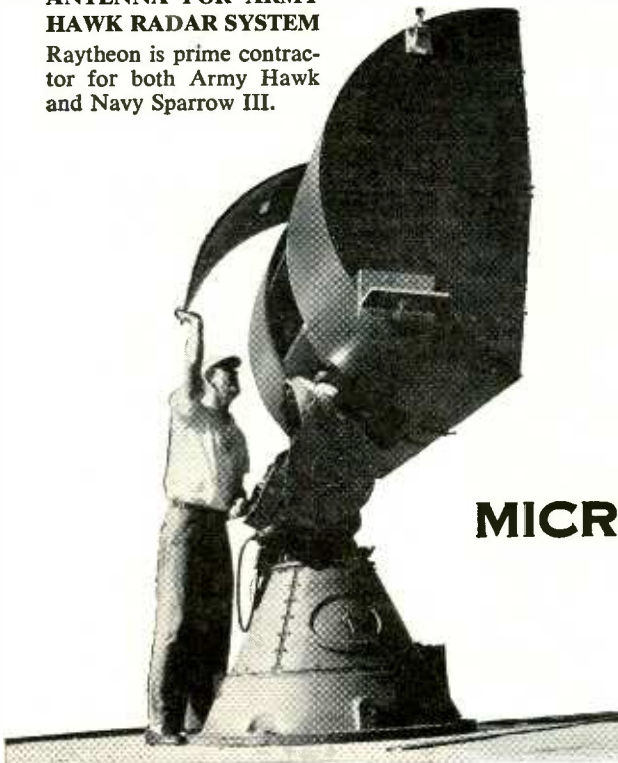

## MICROWAVE ENGINEERS

ANTENNA • RF COMPONENTS

### ...FOR RAYTHEON'S LONG-RANGE PROGRAM OF ADVANCED MISSILE DEVELOPMENT

Engineers and physical scientists interested in professional association with a *future* in the challenging areas of microwave development and design should consider Raytheon's advantages.

Senior and intermediate engineers with BS or advanced degrees and appropriate experience are needed for microwave equipment and component development and design of the most advanced types.

- **Antenna (ground, airborne and missile application).**
- **RF Components (strip-line, broadbanding techniques; high-power components, filters, rotary joints, mixers).**

You and your family will enjoy the advantages of living in the Boston metropolitan area. Modern benefits.

Please send complete resume to William F. O'Melia, Raytheon Manufacturing Company, Missile Systems Division, Bedford, Massachusetts.



# Thinking of the Future?

Where you are today is important . . . but where you will be tomorrow is the crucial factor that you should be considering. If your present path has limited opportunities for promotion and creativity . . . give thought to the advantages that could be yours at Westinghouse. Here, scientists and engineers are translating their thoughts of the future into concrete reality . . . and, in the process, they are building rewarding careers with a company that values and respects the inquiring mind.

## A PARTIAL LIST OF CAREER OPENINGS:

- Microwave Systems & Components
- Radar Systems
- Network Synthesis
- Analogue and Digital
- Computer Design
- Solid State Devices
- Electronics Instructors
- Communications Circuitry
- Field Engineering
- Technical Writing
- Electronic Packaging
- Operations Research

### WRITE TO:

A. M. Johnston, Dept. 899  
Westinghouse Electric Corporation  
P. O. Box 746  
Baltimore 3, Maryland



We will send you our illustrated brochure "New Dimensions" . . . a tour of Westinghouse-Baltimore and a picturesque introduction to gracious living in Maryland.

# Westinghouse

## BALTIMORE

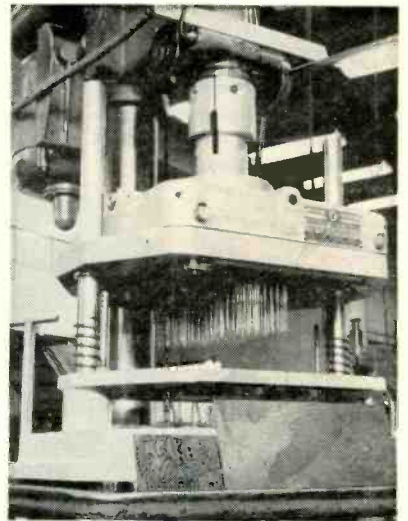

Hundreds of drifts operate simultaneously in Zagor machine

stops when out of materials or if wax temperature falls.

Boesch Manufacturing Co.: pre-loader for shuttles used in winding toroidal cores as small as  $\frac{1}{8}$  inch inside diameter. Magnet wire is coiled inside a tubular shuttle like a long, thin spring, enabling the shuttle to hold about 6 feet of wire.

Coil Winding Equipment Co.:

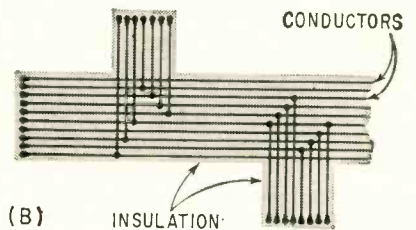
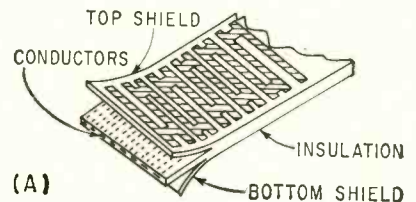

FIG. 3—Variations in Sanders Associates flexible printed cable

several production models of turret-type coil winder shown as a development model last year. Bobbins are continually brought into winding position on an indexing platform.

Industrial Winding Machine Corp.: small toroid winder. Three rollers hold and rotate the core. Manual controls permit repositioning of the core and readjustment of winding sectors, core rotation or

shuttle clearance during winding. George Stevens Manufacturing Co.: air-operated escapement mechanism for connected series coil winding. The wire feed is auto-

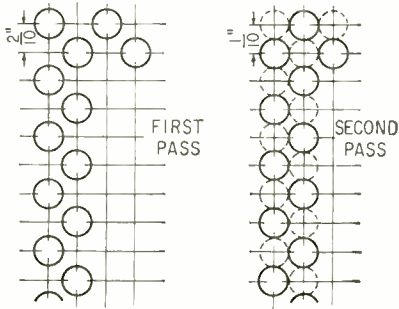

FIG. 4—Two passes with drills on 0.2 inch centers produce a 0.1 inch grid

matically stepped from coil to coil. The operator can set up another mandrel while a series of coils is being wound.

Universal Manufacturing Co.: an inductance comparator to guide winding or permalloy or ferrite toroidal cores. Instead of following a turns counter, the operator watches an oscilloscope. A reference trace is set in the 'scope. When the trace of the coil being wound matches the reference trace, the operator stops the machine. Range is 0.001 to 11.1 Henries.

Cobehn, Inc.: automated solvent cleaning units. One cleans transistors on their foam plastic carrying trays. The tray is placed on a mandrel which oscillates under a series of cleaning heads. The heads alternately spray solvent and air.

Zagar, Inc.: a gearless multiple spindle driller capable of drilling up to 2,000 holes in epoxy printed circuit boards in a single pass. Collets permit drills to be slipped on and off spindles. Spindles can be set in a fixed pattern or interchangeable grid. Holes can be drilled in a 1/10 inch grid on 2 passes (Fig. 4).

## Mechanical Bond Not Factor in Glass Seal

RESEARCH by the National Bureau of Standards indicates that a chemical diffusion process and not mechanical interlocks between the materials determines strength of glass to metal and ceramic to metal seals. Details are contained in *J. Research NBS 62, 107, (1959) RP 2942.*

# NOW DROP TUBE



## TEMPERATURES

AS MUCH AS 130°C

*prolong tube life—increase reliability*

**atlee** FULL-CONTACT TUBE COOLING SHIELDS provide MAXIMUM tube cooling through

- FULL CONTACT with tube
- FULL CONTACT with shield
- FULL CONTACT with chassis

The new **atlee** FULL-CONTACT tube-cooling shield, with exclusive "delta-wave"  $\Sigma\Sigma\Sigma\Sigma$  insert and flat-mounting shield base, provides a spectacular reduction of envelope temperatures even under extreme operating conditions. Tests prove a drop of 130°C below bare-bulb temperatures, and 80°C below levels reached with JAN shields and standard N.E.L. inserts.

Here is a significant advance in the fight against equipment failure even under conservative operating conditions. Further, where tubes must operate close to maximum ratings, it means a real reduction in the inevitable penalty of shorter tube life.

DESIGN FOR RELIABILITY WITH **atlee** — a complete line of dependable heat-dissipating holders and shields of all types, plus the experience and skill to help you solve unusual problems of holding and cooling electronic components.

# ATLAS E-E

CORPORATION

47 PROSPECT STREET • WOBURN, MASS.



Get the complete story in your free copy of this fact-filled Bulletin!

# ON THE MARKET

## Power Relay heavy-duty

GUARDIAN ELECTRIC MFG. Co., 1621 West Walnut St., Chicago 12, Ill. A new 25-ampere heavy-duty power relay is said to have electrical characteristics equivalent to or even greater than those of bulkier de-

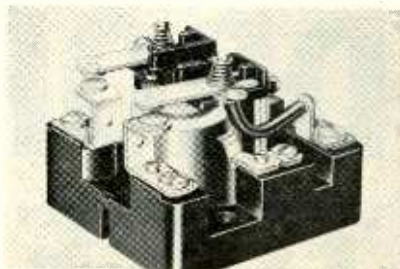

vices; is designed to meet UL specifications. Contact arrangement of the 2210-U relay is 2pst, normally open. Coil assembly can be removed and replaced in a few minutes. Contact assemblies can also be rapidly replaced, if necessary, by simply removing terminal screws. **Circle 200 on Reader Service Card.**



## Random Noise Source direct reading

KAY ELECTRIC Co., 14 Maple Ave., Pine Brook, N. J. The Mega-Node catalog No. 240-B is a calibrated random noise source giving direct noise figure readings. It provides a

choice of balanced or unbalanced output, each with several impedances: unbalanced output impedances are 50, 75, 150, 300 ohms and infinity; balanced are 100, 150, 300, 600 ohms and infinity. Frequency range is 5 to 220 mc. **Circle 201 on Reader Service Card.**

## R-F Choke Coil ultra small

ESSEX ELECTRONICS, Berkeley Heights, N. J., announces a new ultra small miniature r-f choke coil known as the Wee-Ductor. It covers a full range of inductances

from 0.10  $\mu$ h to 1,000  $\mu$ h, yet it measures only 0.150 in. in diameter by 0.375 in. long, occupying a volume of less than 0.0066 cu in. The Wee-Ductor design allows for a high current rating at 125 C operating temperature. **Circle 202 on Reader Service Card.**



## Airborne Oscillator voltage-controlled

DATA-CONTROL SYSTEMS, INC., 39 Rose St., Danbury, Conn., has available the AOV-4S airborne voltage-controlled oscillator. Features of the rugged transistorized

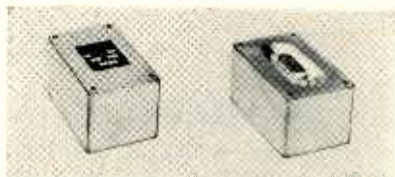

units are their novel silicon junction diode networks; use of silicon

transistors permitting use in ambient temperature to 125 C; excellent linearity  $\pm 0.5$  percent maximum deviation from best straight line; low power drain and high stability in cases of supply voltage variations. **Circle 203 on Reader Service Card.**

## Elapsed Time Counter accurate unit

STERLING PRECISION CORP., 17 Matinecock Ave., Port Washington, N. Y. The T819 elapsed time counter is used with various electromag-

netic pick-offs. It is mounted on the T806 gyro test turntable and other precision gyro test equipment, for use in accurately measuring table rate of rotation over a fixed angular table interval. **Circle 204 on Reader Service Card.**



## Transducers long stroke

AUTOMATIC TIMING & CONTROLS, INC., King Of Prussia, Pa. High

output and low impedance secondary windings are features of the new smaller differential transformers of which linear stroke is 70 percent of coil length. The



**PRESENTING A  
TRANSPARENT**

(No Amber Tint)  
**SLEEVING FOR  
MIL-I-631C**

*Grades a and b  
Applications*

**Resinite  
EP-69C  
VINYL INSULATION  
SLEEVING**

Now — the many advantages of a transparent sleeving (without amber tint) are available in conformance to MIL-I-631C (Grades a and b, Class I and II, Cat. 1) and AMS-3630-B. New Resinite EP-69C permits easy identification of color-coded wires and full readability of printed coding. An all-purpose material, EP-69C surpasses all MIL-I-631C requirements and offers these valuable properties:

**HIGH DIELECTRIC**  
900 volts/mil. (.016" wall. Other wall thicknesses proportionate).  
**FULL SIZE RANGE**  
#20 AWG through 2½" ID

**NO TACKINESS**  
Slips easily over wires for harness assemblies.  
**WIDE TEMP. RANGE**  
-75°F to 185°F  
(-60°C to 85°C)

**FLAME RESISTANT**  
**FUNGUS RESISTANT**  
**5 COLORS**  
Transparent, black, white, red, blue.

**CORROSION RESISTANT**  
**SOFT-WOUND SPOOLING**  
Exclusive Resinite packaging delivers full-round, (not flattened) sleeving.

*Whatever your insulation sleeving problem, there's an appropriate Resinite material. Call your Resinite distributor or write for samples and performance data.*

**Resinite**



THE *Borden* CHEMICAL COMPANY Resinite Department  
Plants: Santa Barbara, Calif. • No. Andover, Mass.

SPECIALISTS IN VINYL SLEEVING AND TUBING FOR THE AIRCRAFT, ELECTRONICS, ELECTRICAL AND PHARMACEUTICAL FIELDS

# REDUCE BREAKDOWN FAILURES



The use of a thermo-plastic insulation material has resulted in an economically priced molded carbon resistor of markedly improved endurance and long term stability.

Type N resistors subjected to several one-hour cycles of immersion in boiling water — while DC polarized — have revealed only negligible changes in resistance. Continuous operations at 150°C caused no damage to the component.

The new Type N resistor, a deposited carbon film fired onto a porcelain rod, is first tropicalized with multiple coatings of panclimatic lacquers to give it long term moisture resistance, and is then molded in a thermo-plastic material.

This molded insulation has an effective resistance in the order of  $10^{13}$  ohms. Its inherent thermal conductivity is approximately ten times that of air, resulting in substantially improved load life under conditions involving excessive or high wattage dissipation. Similarly, Type N resistors may be soldered as close to the insulation as desired without fear of melting or deforming the cover.

One added advantage of the Type N is that the original markings on the resistor body remain visible and legible through the transparent molded material.

Welwyn Type N carbon resistors meet the requirements specified by MIL-R-10509B, and are available in all values, ranging from 10 ohms through 1 megohm. For complete data and specifications write to Welwyn International, Inc., 3355 Edgecliff Terrace, Cleveland 11, Ohio.



**SAMPLES AVAILABLE ON REQUEST.**

smaller transducers are designed for linear displacement from  $\pm 0.5$  to  $\pm 8.0$ . Ratio of output voltage, at range limit, to null voltage is 1,000:1. Linearity of  $\pm 0.5$  percent over a temperature range of  $-60$  to 250 F is attainable. Circle 205 on Reader Service Card.



## Digital Tachometer no missed counts

DYNAPAR CORP., 5150 Church St., Skokie, Ill. A new electronic tachometer has been developed for simplified digital measurement of gasoline engine or electric motor speeds, belt conveyor and slow speed shafts, etc. The Dynacounter digital tachometer covers the entire range of engine speeds from  $\frac{1}{2}$  rpm to 50,000 rpm. It reads speed to one revolution of 1/10 sec; within 10 rpm in 1/100 sec, at all speeds. Exclusive advantage of indicating rpm continuously eliminates need of dial tachometers. Circle 206 on Reader Service Card.

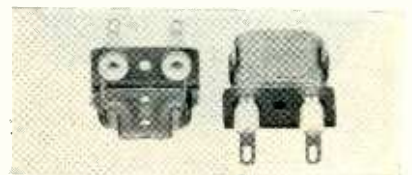

## Socket Assembly for crystal cans

AUGAT BROS., INC., 33 Perry Ave., Attleboro, Mass., has developed a new crystal holder socket assembly specifically designed for military-type HC-6/U and HC-13/U standard size crystal cans. It features compact unit construction that eliminates use of separate socket and holder, thus reducing overall package size and weight. The clip is fabricated of beryllium copper, alloy 25 per QQ-C-533, and cadmium-plated per QQ-P-416A, type II, class

2. Two Teflon insulated jacks with phosphor bronze, silver-plated, gold flashed contacts are press fitted into the assembly to receive the crystal pins. Circle 207 on Reader Service Card.

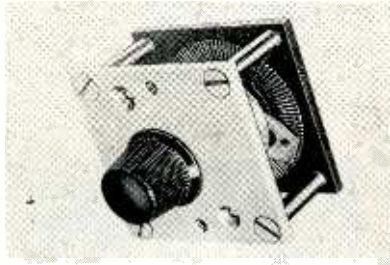

### Switch commutator type

THE DAVEN CO., Livingston, N. J. has developed a new commutator type switch, Spec. 7122, for use in Datalink receivers, telemetering systems, high-speed commutators, and applications where 100 shorting positions or 50 nonshorting positions are required in an extremely small physical space. The switch has 100 positions in a panel space of only  $1\frac{3}{4}$  in. sq. Depth is  $\frac{3}{8}$  in. It is a single pole unit. Circle 208 on Reader Service Card.

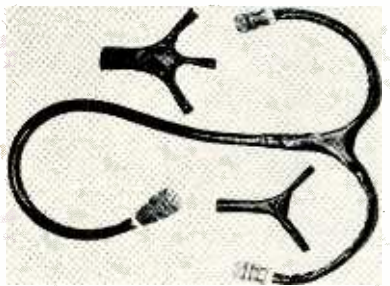

### Cable Assemblies zipper Y's and T's

THE ZIPPERTUBING Co., 752 S. San Pedro St., Los Angeles 14, Calif. New zipper Y's and T's permit instant construction of complete waterproof cable assemblies, on the spot. Now Zippertubing is wrapped around the wire bundle, then zipped shut by means of an attached metal or plastic track. At the point of a branchout, the wires are split into various channels and a Y or T zipped around them. Zipper end bells also are available to cover and protect connectors. Junction of the

Where only the **best**  
is good enough . . .



MODEL UHR-240

## Krohn-Hite power supplies are used

In basic electronic instruments for lab or test work, *less than the best* may be a dangerously bad bargain. Unexpected limitations — of reliability, range, precision — can throw out weeks of work on today's jobs, and can make tomorrow's tougher jobs untouchable.

The *best* instrument of its type is probably a bit more expensive, but it's worth buying . . . because you can believe in it today, and will rely on it tomorrow. An example is the Krohn-Hite Model UHR-240 ultra-high-regulation power supply. Here are some facts about it.

**MAIN DC OUTPUT:** zero to 500 volts, continuously adjustable, at zero to 500 milliamperes.

**REGULATION:** less than 0.001% plus 0.002 volt from no load to full load.

**LINE STABILIZATION:** less than 0.003% plus 0.003 volt, for 10% change.

**OUTPUT IMPEDANCE:** DC — less than  $(0.005 + 0.00002 \times \text{output volts})$  ohm; AC — less than 0.05 ohm plus 0.1 microhenry.

**RIPPLE:** less than 0.1 millivolt rms.

**DC BIAS OUTPUT:** zero to minus 150 volts, continuously adjustable, at zero to 5 ma; regulation less than 1%.

**DC HEATER OUTPUTS:** 5 to 12.6 volts, adjustable, at zero to 2.5 amperes.

**AC HEATER OUTPUTS:** two, each 6.3 volts at 10 amperes.

There's a lot more you should know about the UHR-240 . . . and about the other Krohn-Hite power supplies, oscillators, tunable electronic filters and amplifiers. In all of them, you'll find the same far-ahead engineering, design and construction. Because K-H instruments are good enough even for tomorrow's most critical work, they are increasingly chosen today where true reliability and precision are needed.



Write for your free copy of the new Krohn-Hite Catalog.

**Krohn-Hite** CORPORATION

580 Massachusetts Avenue, Cambridge 39, Mass.

# need high vacuum components?



Stokes Series H Microvac were designed by vacuum specialists . . . are industry engineered to meet your needs . . . give you more pumping capacity per dollar. The integral construction includes dynamic balancing, valves, motor, belt guard, and automatic lubrication—there are no extras to buy. A complete line of Microvac include capacities from 17 to 500 cfm. For fast, efficient pump-down—you can depend on Stokes Microvac Series H Pumps.

STOKES makes a complete line of vacuum components . . . advance-designed and engineered to help make your vacuum systems more productive. Each unit reflects Stokes' unparalleled experience, pioneering leadership and wealth of basic vacuum technology.

The product list includes: Diffusion Pumps, Vapor Booster Pumps, Mechanical Pumps, Mechanical Booster Pumps, Vacuum Gages, and Valves.

Send for technical data on any or all . . . without obligation.

High Vacuum Division  
F. J. STOKES CORP.  
5565 Tabor Road, Phila. 20, Pa.

## STOKES

CIRCLE 47 READERS SERVICE CARD

Y or T to the rest of the cable is accomplished with high temperature tapes or potting compounds. Circle 209 on Reader Service Card.

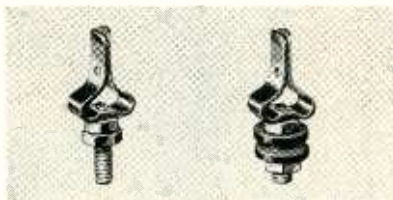

### Tiny Test Clips two new types

GRAYHILL, INC., 561 Hillgrove Ave., La Grange, Ill., announces two new miniature test clips known as the 2-20 (with threaded stud) and the 2-24 (with molded phenolic insulating washers). Designed to allow rapid connections without manual opening and closing of jaws, the clips are ideal for breadboard work, as well as for testing resistors, transistors, capacitors and other pigtail type components. Circle 210 on Reader Service Card.

### Voltage Regulator 30-finger unit

ELECTRIC REGULATOR CORP., Pearl St., Norwalk, Conn., announces a new 30-finger Regohm voltage regulator. The 4K Regohm is designed to handle the heavy currents encountered in battery charger applications; and for exciter and main field generator control. Small sized, lightweight, it can regulate sets up to 600 kva, 1800 rpm. Circle 211 on Reader Service Card.



### Small Switch for tape recorders

ROBERTSHAW - FULTON CONTROLS Co., 911 E. Broad St., Richmond 19, Va. A new switch, not much bigger than a paper clip, automatically shuts off a tape recorder if the tape should break. The device incorporates a nonmagnetic

Nylon leaf with rounded surfaces, over which the tape passes. In the event of tape breakage, pressure upon the leaf is released, shutting off the recorder. The main body of the switch is less than 1½ in. in length. It is UL approved at 3 amperes, 250 v a-c. Movement differential is 0.233 in. maximum, and operating force is as low as 6 grams. Circle 212 on Reader Service Card.



### Tape Reader photoelectric

BENDIX COMPUTER DIVISION, 5630 Arbor Vitae St., Los Angeles 45, Calif., announces the model PR-2 photoelectric paper tape reader. Capable of accepting any five, six or seven channel numeric tape for computer input, the unit is ideal for reading tapes from all types of off-line recording devices. The new reader operates at 400 characters per sec and will stop or start on one character. Circle 213 on Reader Service Card.

### Cutting Head for stereo disks

BOGEN-PRESTO, a division of The Siegler Corp., P.O. Box 500, Paramus, N. J., announces an advanced stereo disk cutting head. An entirely new Presto designed feedback coupling technique permits high frequency recording at previously unobtainable levels. The S1 can simultaneously cut at high velocity and still maintain stability. Distortion is barely perceptible. An advanced design feature permits quick change of stylus. The S1 need not be removed from the feed mechanism during stylus change thereby saving much time and preventing foreign material from getting into the fine gaps. Circle 214 on Reader Service Card.



PANEL SPACE LIMITED? SPECIFY

# DIALCO® 2-Terminal

## Sub-Miniature Pilot Lights

- COMPACT
- RUGGED
- OMNIDIRECTIONAL
- PLASTIC DOMES
- COMPLETELY INSULATED

Also available with "Taper-Tab" quick-connect terminals

BACK of panel insertion

OR FRONT of panel insertion

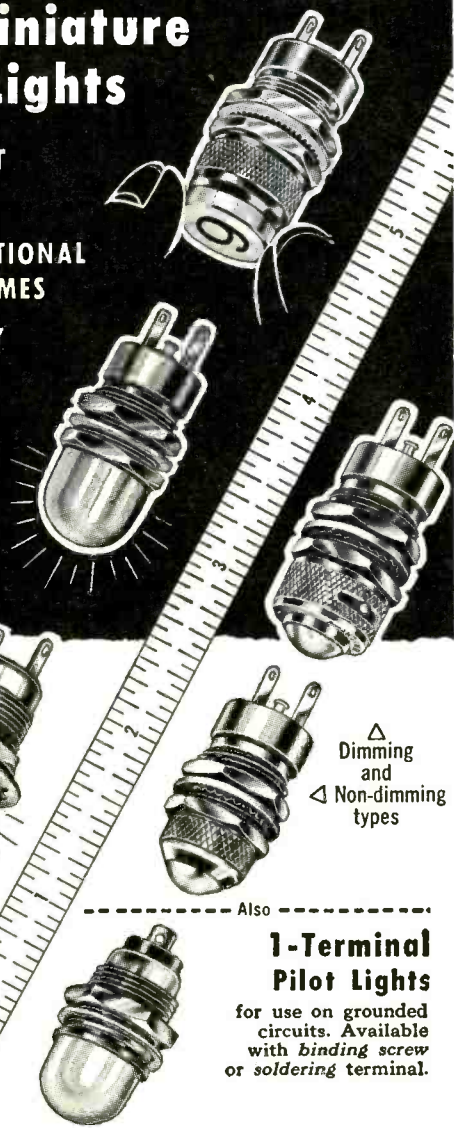

△ Dimming and  
◁ Non-dimming types

Also  
**1-Terminal Pilot Lights**  
for use on grounded circuits. Available with *binding screw* or *soldering terminal*.

DIALCO's expanded line of sub-miniature lights conform to all applicable Mil Specs. Use T-1 $\frac{1}{4}$  midget incandescent lamps—1.3 to 28 V. Spring mounted *Lens-with-Message* is readily positioned *after* installation... Mount from *back* of panel in 15/32" clearance hole; or from *front* of panel in 17/32" hole... 7 lens colors... Shown approx. actual size (top to bottom): No. 134-3830-375-6... No. 101-3830-951... No. 101-5030-951... No. 109-3830-111... No. 111-3830-111... No. 107-1930-951.

Complete details in Brochures L-156 A and L-157.

**SAMPLES ON REQUEST—AT ONCE—NO CHARGE**



Foremost Manufacturer of Pilot Lights

# DIALIGHT CORPORATION

58 STEWART AVE., BROOKLYN 37, N. Y. ● HYacinth 7-7600

DIALIGHT CORP., 58 Stewart Ave., Brooklyn 37, N. Y.

- Send brochures on Sub-Miniatures     Selection Brochures     Pilot Light Catalogues

Name ..... Position .....

Company .....

Address .....

CIRCLE 48 READERS SERVICE CARD

ELECTRONICS—April 17, 1959

## Coaxial Attenuators

## Terminations

## Impedance Transformers

DC to 2500 mcs.

using type BNC, TNC, and N coaxial connectors



TYPE BNC

Type HFA Attenuator  
Type HFT Termination

TYPE TNC

Type HFA/T Attenuator  
Type HFT/T Termination

TYPE N

Type HFA/N Attenuator  
Type HFT/N Termination

TYPE BNC

Type HFAM Impedance Matching Transformer

ARI presents an integrated line of coaxial attenuators, terminations, and impedance matching transformers for use in the DC to 2500 mcs frequency range. To provide the user with a greater flexibility than heretofore realized, type BNC, TNC, and N coaxial connectors are incorporated in this family of attenuators and terminations. The impedance matching transformers use type BNC coaxial connectors.

The attenuators and terminations exhibit a nominal impedance of either 50 or 75 ohms and a maximum V.S.W.R. of 1.2 at the highest rated frequency.

The impedance matching transformers have been designed to match, with minimum loss, 50 to 75 ohms, 50 to 93 ohms, and 75 to 95 ohms, over the frequency range of DC to 1000 mcs.

### CHARACTERISTICS

Model	ATTENUATORS & TERMINATIONS						IMPEDANCE MATCHING TRANSFORMERS		
	HFA & HFT		HFA/T & HFT/T		HFA/N & HFT/N		HFAM		
Input/output impedance, ohms	50, 75	50, 75	50, 75	50, 75	50	50	50, 75, 93	50, 93	50, 75
Nominal attenuation (db)	1, 2, 3, 4, 6, 10, 12, 15, 20 / 2, 3, 6, 10, 20		1, 2, 3, 4, 6, 10, 12, 15, 20 / 2, 3, 6, 10, 20		1, 2, 3, 4, 6, 10, 12, 15, 20		minimum loss		
Frequency range (mcs)	DC-1000		DC-2000		DC-2500		DC-1000		
Maximum V.S.W.R	1.2 at 1000 mcs		1.2 at 2000 mcs		1.2 at 2500 mcs		1.2 at 1000 mcs		
Connectors	Type BNC		Type TNC		Type N		Type BNC		

For full information and prices write to

# Applied Research inc.

76 SOUTH BAYLES AVENUE, PORT WASHINGTON, NEW YORK

CIRCLE 49 READERS SERVICE CARD



# EXPANDED RESEARCH

to advance new concepts of  
SPACE FLIGHT

⊕ Expanded Research programs to meet the most complex technological requirements of the Space Age are only one of the far-reaching objectives of the new multi-million-dollar Lockheed Research Center, near Los Angeles. Destined to become one of the nation's major research installations, its programs are broad in scope and designed to investigate new frontiers of space flight.

⊕ A primary consideration in planning the new Research Center was to provide environment for scientific freedom and ideal research conditions—using the most advanced equipment available. This modern, integrated research facility will touch almost every aspect of aviation and transportation—leading toward exploration into completely new or relatively undeveloped fields of science and industry.

⊕ On completion, most of Lockheed's California Division's research facilities will be located in this single area. The Center will provide complete research facilities in all fields related to both atmospheric and space flight—including propulsion, physiology, aerodynamics and space dynamics; advanced electronics in microwave propagation and infrared; acoustics; mechanical and chemical engineering and plasma/magneto-hydrodynamics; thermal electricity; optics; data communications; test and servo-mechanisms.

⊕ The first phase of the advanced research building program has already begun—with initial construction of a \$5,000,000 supersonic wind tunnel and high-altitude environmental test facilities.

⊕ Scientists and engineers of high caliber are invited to take advantage of outstanding career opportunities in this new Lockheed Research Center. Openings now exist for thoroughly qualified personnel in: Electronics; aero and thermo dynamics; propulsion; servo-mechanisms; materials and processes; structures and stress; operations research; research in optics, infrared, acoustics, magnetohydrodynamics, instrumentation, mechanics and hydraulics; mathematics and in all phases of design.

⊕ Write today to: Mr. E. W. Des Lauriers, Manager Professional Placement Staff, Dept. 15043, 1708 Empire Avenue, Burbank, California.

# LOCKHEED

## CALIFORNIA DIVISION

BURBANK, CALIFORNIA

## Literature of

### MATERIALS

**Polyethylene Insulation.** E. I. du Pont de Nemours & Co., Inc., Wilmington 98, Del., has available in booklet form a report which provides the industry with guideposts to designing polyethylene insulation which is free from the effects of corona. Circle 225 on Reader Service Card.

### COMPONENTS

**Precision Pots.** Markite Corp., 155 Waverly Place, New York 14, N. Y., has published a complete catalog of precision pots which are built around a conductive plastic element that defies wear and breakdown under severe environmental conditions. Circle 226 on Reader Service Card.

**Circuit Breakers.** Wood Electric Co., 244 Broad St., Lynn, Mass., has issued a catalog containing a crisp arrangement of specifications and construction details on its line of circuit breakers. Circle 227 on Reader Service Card.

**Switches and Actuators.** ElectroSnap Corp., 4218 W. Lake St., Chicago 24, Ill. Catalog ES-59 is a 52-page complete bound reference on basic switches and actuators. Circle 228 on Reader Service Card.

**Miniature Coaxial Cables.** The Rex Corp., West Acton, Mass., has available a 4-page catalog containing full information on its complete line of miniature coaxial cables—both military and commercial specification types. Circle 229 on Reader Service Card.

**Motors and Blowers.** Heinze Electric Co., 685 Lawrence St., Lowell, Mass. Catalog No. 6-59 illustrates and describes a wide selection of subfractional horsepower motors and blowers. Circle 230 on Reader Service Card.

**Varactors.** Microwave Associates, Inc., Burlington, Mass., has published a 12-page booklet de-

## the Week

cribing the varactor, a *pn* junction semiconductor diode designed for low loss at high frequencies. Circle 231 on Reader Service Card.

**Tubings.** Wm. Brand & Co., Inc., Willimantic, Conn., has issued manual 59T, a 24-page catalog on Turbo extruded and coated tubings. Circle 232 on Reader Service Card.

**Pulse Transformers.** The Gude-man Co., 340 W. Huron St., Chi-cago 10, Ill. Catalog TR019 illus-trates and describes a line of pulse transformer and delay line prod-ucts. Circle 233 on Reader Ser-vice Card.

### EQUIPMENT

**Control Meter.** International In-struments Inc., P.O. Box 2954, New Haven 15, Conn. A four-page folder illustrates and describes the model 2545 miniature elec-tronic control meter. Circle 234 on Reader Service Card.

**High Vacuum Pumps.** F. J. Stokes Corp., 5500 Tabor Road, Philadelphia 20, Pa. The SC series of small compound high vacuum pumps, in 2 and 3 cfm capacities, are described in bulletin 990. Circle 235 on Reader Service Card.

**Sound Instruments.** H. H. Scott, Inc., 111 Powdermill Rd., Maynard, Mass. Booklet SIP gives full de-tails on the company's sound level meter, sound analyzer and other instruments. Circle 236 on Reader Service Card.

### FACILITIES

**Magnetic Core Memory.** Com-puter Control Co., Inc., 92 Broad St., Wellesley 57, Mass. Bulletin TCM covers random access mag-netic core memories. It also an-nounces availability of the services of the company's logical design-ers, circuit designers, and sys-tems engineers for your digital problems. Circle 237 on Reader Service Card.

## STOP PLAYING BLINDMAN'S BUFF!

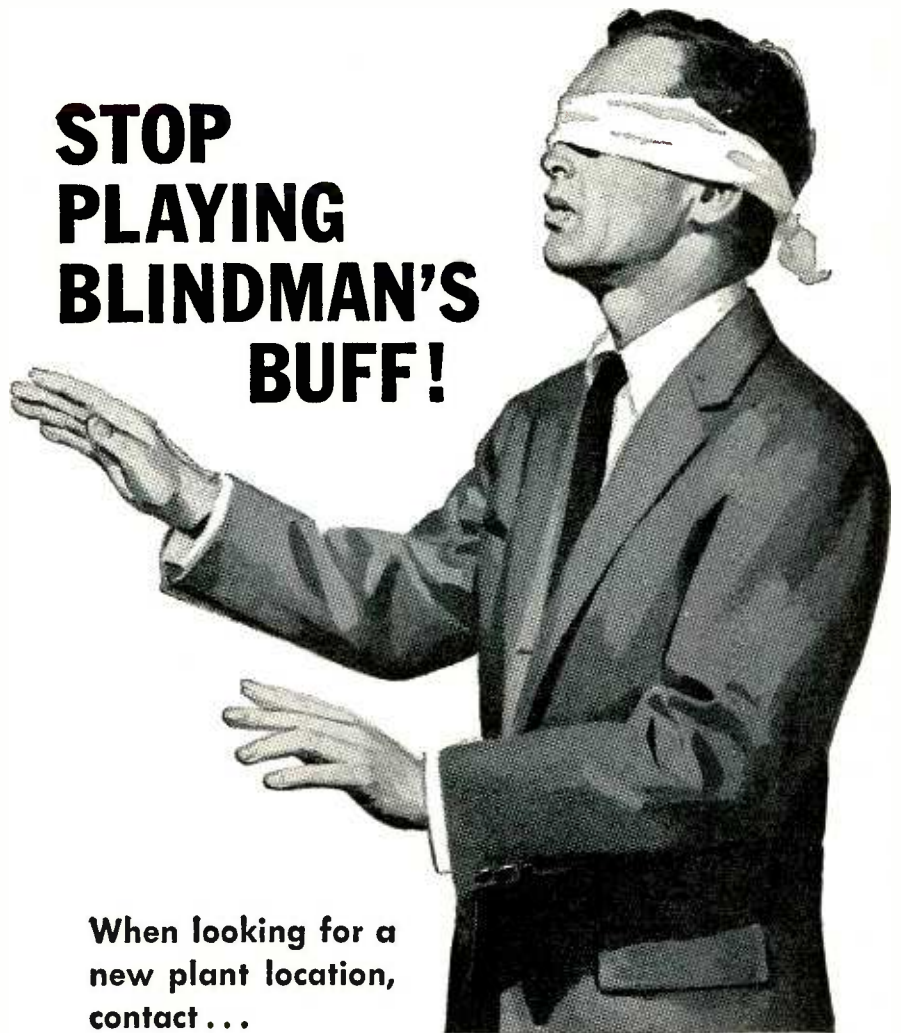

When looking for a  
new plant location,  
contact ...

## GPU *Site-Service* ...

the one central source of plant site information  
for nearly half of Pennsylvania and New Jersey

No need to be hit or miss. Let GPU *Site-Service* pinpoint a plant location that exactly meets your requirements. This complete, cen-tralized service has detailed information on sites of all sizes, water resources, technical and educational facilities, supplies and sup-pliers, and skilled labor for one of the nation's most desirable industrial areas. Wire, write or phone today. Your inquiry will receive prompt, *confidential* attention.

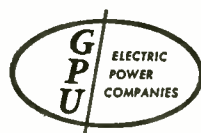

Metropolitan Edison Co.  
Pennsylvania Electric Co.  
New Jersey Power & Light Co.  
Jersey Central Power & Light Co.

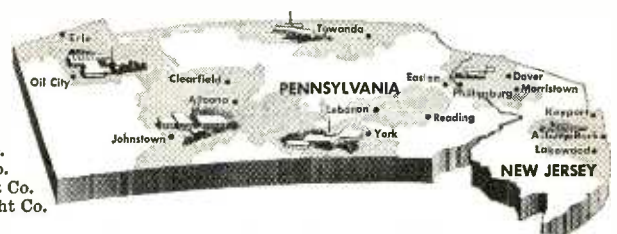

## GENERAL PUBLIC UTILITIES CORPORATION

Att: Wm. J. Jamieson, Area Development Director, Dept. E-1  
67 Broad St., New York 4, N. Y. Whitehall 3-5600



## Temco Expands Quarters

ENGINEERS of Temco Aircraft Corp. are completing their move into a 52,000 sq ft addition (below dotted white line) to the company's engineering center at Garland, Texas. Both the engineering center and the general office building, joined to it by a vaulted white-roofed lobby, were completed in 1957. The new addition brings the engineering area to more than 150,000 sq ft.

The new facilities contain a spectrograph room and dust-free climate-controlled areas for the receiving, inspection and functional testing of critical-tolerance electronic and missile systems.

One area in the addition is occupied by Temco's advanced technology group and its supporting laboratories. There are also areas for printed circuitry development and Fiberglas forming.

The expanded quarters were added as a result of increasing company activity in the electronics and missile system fields. In 1956, Temco announced a five-year plan to have at least half its sales in electronics and missiles by 1961. The firm is ahead of its forecast. More than 25 percent of sales were in these categories in 1958.



### GPL Promotes W. C. Cooper

ELECTION of Walter C. Cooper as assistant vice president of General Precision Laboratory Inc., Pleas-

antville, N. Y., has been announced.

Cooper, who joined GPL in 1949 as manager of government contracts, will retain these responsibilities and assume additional duties as an officer of the company.

### NEI Acquires New Facilities

PAUL HINES, president of New England Instrument Co., manufacturers of conductive plastic and precision wire-wound potentiometers, recently signed a long-term lease for additional new facilities in Waltham, Mass. The building will house the company's engineering and sales departments.

Company will continue to maintain its other engineering and

manufacturing facilities in Waltham, Mass., and Woonsocket, R. I.

Latest addition brings total space to 15,000 sq ft. The expansion was prompted by the rapid growth and acceptance of the company's new lines of conductive plastic and precision wire-wound potentiometers.

## Fellendorf Takes Helm

GEORGE W. FELLENDORF has acquired Radio City Products Co., Inc., and Reiner Electronics Co. of Easton, Pa., from Milton Reiner, founder of both companies.

New owner has been with the companies since early 1958 as contracts manager, and more recently as general manager. Prior to joining the Easton firms he was vice-president of Instruments for Industry, Inc., Hicksville, Long Island.

Fellendorf will have the title of president and general manager of both firms, and is concentrating on the development of an increased engineering staff, as well as increasing the production capabilities of the organizations. Reiner has been named chairman of the board of directors, and will be associated with the companies as a technical consultant.



### Bowmar Elects Top Executive

W. F. HOEPPNER was recently elected vice president of Bowmar Instrument Corp., Ft. Wayne, Ind. He will be responsible for future

# RESEARCH ENGINEERS

## Electronic and Electro-Mechanical

**COMMUNICATIONS & COUNTERMEASURES** To direct and supervise group of physicists, engineers and technicians in projects involving weapons systems, ranging, detection, atmospheric measurements, etc. Conversant with practical and theoretical implications of defensive or offensive systems.

**ULTRASONICS** To direct group of physicists, engineers and technicians in research and development of sonic and ultrasonic equipment for commercial and military applications, and encompassing all aspects of ultrasonic research. Requires qualities of leadership and compatibility with highly skilled scientific minds.

**SERVOS & CONTROLS** Will direct and supervise group of engineers, physicists and technicians in research and development in electro-mechanical devices, servos, industrial controls and instrumentation. Excellent opportunity in applied research in this field.

Degree required in engineering or science with a minimum of 5 years related experience. These positions are with the Research Division, at Quehanna, in the picturesque area of North-Central Pennsylvania, 40 miles from State College, home of Pennsylvania State University.

Send resume including salary requirements to: Mr. T. W. Cozine, Manager, Executive & Technical Placement, Curtiss-Wright Corporation, Dept. RD-65, Wood-Ridge, New Jersey.

*All replies confidential*

# CURTISS-WRIGHT

CORPORATION • WOOD-RIDGE, N.J.

## Meet John Mason

Associate Editor, electronics  
MILITARY ELECTRONICS EXPERT

### Resumé:

Mexico City College, Mexico, BA. Air Force officer, navigator with 32 combat missions; Director of Flight Training, Pathfinder Radar School; head of Loran School. News editor, associate editor of aeronautical trade magazine, wrote free lance aviation articles. Recalled to Air Force, 1951, and studied at Georgetown Graduate School. Assigned to Libya, then Munich. Wrote news stories plus daily digest of iron curtain radio news.

### Present Occupation:

As an associate editor of electronics John is deeply involved with the technical and business aspects of military electronics (the current \$4.5-billion government market) and draws heavily on his electronics and Air Force background.



### References:

John is typical of the 26-man staff of specialists who edit electronics . . . men who produced 2,856 pages of editorial material during 1958. A mature, experienced staff, averaging 36 years of age, these people are dedicated to serving the needs of the reader of electronics. If your subscription to electronics is expiring, or if you are not a subscriber . . . if you will miss reading some of the exciting articles John Mason is planning for the near future . . . fill in the box on the Reader Service Card. It's easy to use. Postage is free.



## electronics

A McGraw-Hill Publication • 330 West 42nd Street, New York 36, N.Y.

## Full Measure of Precision...

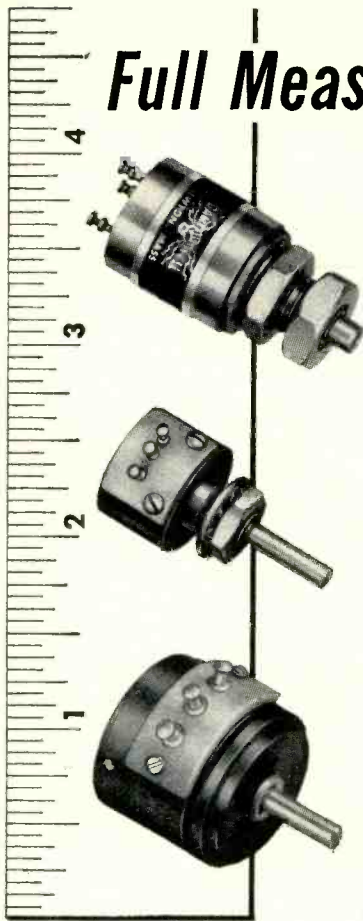

In addition to their space and weight saving advantages, RVG Precision Potentiometers provide high accuracy characteristics you'd ordinarily expect only in conventional, larger pots. These units meet or exceed all applicable MIL specs, are rugged and resistant to extreme shock and vibration. All can be ganged. Plenty of design potential! For outline of suggested applications, write THE GAMEWELL COMPANY, Newton Upper Falls 64, Massachusetts.

**RVG-8T** — 1/2" diam. Trimmer and precision servo types. Rated 2 watts at 85°C derated to 0 watts at 150°C. Resistance ranges from 20 ohms to 50K ohms (100K available). Linearities: standard for trimmer ±3%; servo ±1% (±0.5% or better available when resolution permits). Trimmers stocked in 10 values from 100 ohms to 75K.

**RVG-10** — 5/8" diam. Threaded bushing standard. Servo mount and ball bearings also available. Max. Res. 30,000 ohms: ±5%. Min. Res. 25 ohms: ±5%. Linearity (standard) ±0.5%.

**RVG-14** — 7/8" diam. Servo mount with sleeve bearings standard. Ball bearings also available. Max. Res. 50,000 ohms: ±5%. Min. Res. 40 ohms: ±5%. Linearity (standard) ±0.5%, (special) 0.25%.



PRECISION  
POTENTIOMETERS

CIRCLE 53 READERS SERVICE CARD

**IMMEDIATE DELIVERY ANYWHERE IN THE NATION**

# COSMIC

ELECTROLYTIC  
AND  
PAPER TUBULAR  
**CONDENSERS**

"35 YEARS OF PROVEN DEPENDABILITY"

**COSMIC CONDENSER CO.**  
853 WHITTIER STREET, BRONX, N. Y.  
LUdlow 9-3360

CIRCLE 54 READERS SERVICE CARD

## WE EMPLOY THE HANDICAPPED

WE FIND  
IT'S GOOD BUSINESS



A MAJOR  
ELECTRONICS MANUFACTURER

planning and expansion of the company through new product and market development and acquisitions.

For 17 years Hoepfner was associated with the Ft. Wayne plants of Farnsworth Electronics Co. and Farnsworth Television and Radio Corp. as vice president in charge of finance and administration, vice president in charge of manufacturing, assistant to the president and controller.



## Advance Hall At P. R. Mallory

JAMES M. HALL was recently named chief engineer of the semiconductor division of P. R. Mallory & Co. Inc., with headquarters in Indianapolis, Ind. He will direct the engineering activities of the semiconductor department which produces silicon rectifiers and other semiconductor devices.

Hall was previously a section engineer in semiconductor engineering for the Mallory Co. He came to Mallory in 1956 from Minneapolis-Honeywell where he was engaged in transistor engineering.

## Elect Krafve Raytheon V-P

RICHARD E. KRAFVE has been elected to the newly created position of group vice-president—commercial for Raytheon Mfg. Co., Waltham, Mass.

At the same time his resignation as vice-president of Ford Motor

Co., Dearborn, Mich., was announced.

In his new position Krafve will direct and coordinate the activities of those divisions engaged in the manufacture and distribution of commercial and industrial products. He will also be responsible for planning and directing the commercial acquisition and expansion activities of the company.

## News of Reps

The Industrial Test Equipment Co., New York, N. Y., names the **Ellenje Co.** of Palo Alto, Calif., and **Landis Associates** of Los Angeles to represent its Phazor and Iteco product lines of electronic test equipment.

**Robert B. Stahlhut** of St. Louis, has been appointed a manufacturer's rep for **Price Electric Corp.**, Frederick, Md., to cover the St. Louis, Kansas City, and Wichita areas.

**Panellit, Inc.**, Skokie, Ill., has appointed **Matney & Hanna Co.** of Kansas City, Mo., to handle its lines of industrial annunciators, control panels and information systems, including data loggers and scanners, in western Missouri and most of Kansas.

**Precision Instrument Co.**, San Carlos, Calif., maker of instrumentation tape recorders, has named **V. T. Rupp Co.** as sales engineering reps for southern California, Arizona, New Mexico and southern Nevada.

**The Mosher & Peyser Co.**, of Needham, Mass., has been appointed New England sales rep for **Columbus Electronics Corp.**, Yonkers, N. Y., manufacturer of double diffused silicon rectifiers and other semiconductor devices.

**The Wincharger Corp.**, Sioux City, Iowa, names two new organizations to represent its Government Products Division:

**Premmco, Inc.**, will cover California and Nevada. **The C. F. L. Co., Inc.**, will handle Colorado, Utah, Wyoming and Idaho.

## SOME NOT SO PLEASANT VARIATIONS



"Variety is the spice of life", a canned-food manufacturer tells us. This holds true in a great many fields. In mathematics, few studies are as fascinating as the calculus of variations. In music, what could be more pleasant than Brahms' "Variations on a Theme by Haydn"?

But in electricity, equipment designers are often faced with some not so pleasant variations in line voltage. Neither mathematics nor music is of much help here.

The best solution to date is a Raytheon custom magnetic-amplifier voltage regulator which, in a weather radar, successfully stabilizes single-phase line variations ranging from 105 to 125 volts, and holds them to within  $\pm 1\%$  of 115 volts. This is in spite of the fact that line frequency variations are as much as  $\pm 5\%$ , and ambients from  $-45$  F to  $+45$  F.



Raytheon engineers have solved a variety of such voltage regulation problems. Why not tell them yours? Simply contact:

VOLTAGE REGULATOR MAN  
Raytheon Manufacturing Company  
Magnetic Components Product Dept.  
Section 6120  
Waltham 54, Massachusetts



## Dalmotor Cybermotive Devices

...by **YUBA**

from  
**Design  
to  
Production**

Yuba is constantly developing specialty components for use in integrated electronic systems. Yuba's proven capabilities for research, design, development and production assure you of the finest in precision equipment. *In the field of airborne motors and generators, for example, Yuba's Dalmotor Division has moved ahead. They will design and produce to your strict specification—with minimum lead time. Here are several of the Dalmotor Division's carefully produced precision products:*

Nike Hercules  
Alternator



Motor  
Generator



Instrument  
Generator



Torque Motor



Also producers of signal converters, radio sondes, special purpose computers, telemetering and communications systems, special instrumentation.

**DALMOTOR DIVISION**  
1375 Clay Street  
Santa Clara, California



**YUBA CONSOLIDATED  
INDUSTRIES, INC.**

Plants and Sales Offices

**NATIONWIDE**



CIRCLE 57 READERS SERVICE CARD

## COMMENT

### Obsolete Russian Electronics

I am enclosing a page torn from the February issue of *USSR*, a Russian magazine which is distributed in this country in exchange for our being allowed to distribute a similar magazine in Russia.

I am sending it to you because of on p 60 there is a picture of the radio compartment of the Russian TU-104A jet airliner. What caught my eye in this picture is the remarkable age and the obvious source of the radio equipment shown. The radio receiver is either an identical copy or an actual BC-348 communications receiver which was widely used by our Armed Forces from 1942-1945 and which has long since been retired. The transmitter showing above the receiver appears to be an identical copy of the Collins ART-13, which was a relatively advanced autotuned transmitter used in the latter days of the War, but one which has also long since been superseded in aircraft use in this country.

DWIGHT C. BAUM  
EASTMAN DILLON, UNION SECURITIES & CO.  
LOS ANGELES

### Slot Antenna

Thank you for publishing my article ("Slot Antenna Array for Missiles and Aircraft," p 56, Feb 27). In the figures on p 57 are some errors I feel should be called to the attention of your readers.

The radiation patterns of Figs. 2 and 3 are for the circularly polarized slot antenna mounted in a  $10 \times 10$  wavelength flat ground plane rather than in the missile as implied by the captions. Figures 4 and 5 are not Smith chart plots, but rather the radiation characteristics of the circularly polarized slot when mounted in the missile. The radial lines are labeled in degrees of aspect angle, and the circular lines are constant intensity contours, 3 db per 10 units. The caption is correct in referring to the "maximum and minimum coverage" in the sense that the polarization of the linearly polarized pickup antenna used in making these measurements was

## Need Lint-Free Acid-Resistant Synthetic Uniforms?



Angelica "engineers"  
your uniform problems



GOWNS  
CAPS  
HOODS  
BOOTS  
GLOVES  
COVERALLS  
SHIRTS  
TROUSERS  
DRESSES  
SMOCKS

Angelica has worked with hundreds of electronic parts manufacturers, "engineering" their lint or acid problem. Angelica, the world's largest manufacturer of washable uniforms, has sales representatives in all major cities, trained to discuss your problems, to assure you of getting uniforms that meet your specific needs.

Write or call the nearest Angelica Regional Sales Office today.



**Angelica  
UNIFORMS**

1427 Olive St., St. Louis 3, Mo.  
107 W. 48th St., New York 36, N. Y.  
177 N. Michigan Ave., Chicago 1, Ill.  
1900 W. Pico Blvd., Los Angeles 6, Calif.

CIRCLE 58 READERS SERVICE CARD

April 17, 1959 — ELECTRONICS



rotated through 360 deg. at each aspect angle. Figures 4 and 5 are plots of the maximum and minimum response of the circularly polarized slot to this variable linear polarization.

Although the circularly polarized slot antenna makes an ideal array element, the article deals primarily with the characteristics of the element itself, and not with any particular array configuration. Hence, your use of the word array in the title and the word antennas in the caption of Fig. 6 may also be confusing to some readers.

E. J. WILKINSON  
SYLVANIA ELECTRIC PRODUCTS INC.  
WALTHAM, MASS.

### Industrial Hazards (Wildlife Division)

I read your survey "Looking Ahead in Engineering" (p 125, Mar. 13) and found the comments of studies of frog neurons extremely interesting. The thinking machines that will eventually be developed from such studies will indubitably require special handling.

I suggest that any engineer working with such a machine wear gloves. This will minimize his chance of developing warts.

J. L. K. BROWN  
LOS ANGELES

Well, we knew that the guys operating on the Sidewinder carried special kits containing flasks of high-potency snakebite medicine—but we always thought that the relationship between frogs and warts should be filed under Tales, Old Wives' type.

### Radar Foils

(Re Comment, p 114, Feb. 20): Both your editor and reader Kigan have a point. As your editor says, a radar-transparent airfoil would be nonreflective. But a completely absorptive airfoil would not reflect either, and it *would* be opaque. The essential thing is that mere opacity is not enough; the element of absorption is required, and the opacity, while incidental, would be an associated property.

C. H. CHANDLER  
BOSTON

## Meet Bill Bushor and Sam Weber

Associate Editors, **electronics**  
FEATURE ARTICLE EXPERTS



### Resumés:

Bushor, William E., Lawrence Institute of Technology, BSEE, I. R. E. member. 9 years experience: U.S. Army (communications chief), Bell Aircraft (air-to-air missile), G. M. Research Labs, Sperry Gyroscope, etc. Member Society Technical Writers.

Weber, Samuel, Virginia Polytechnic Institute, BSEE, I. R. E. member. 10 years diverse engineering experience: U. S. Navy, Barlow Electrical Mfg. Co., Curtiss-Wright, etc. Primarily in communications, uhf and microwave components and design, jet engine test instrumentation.

### Present Occupations:

Bill Bushor is preparing a series to appear in 1959 on medical electronics comprising diagnostics, therapeutics, prosthetics, and clinical and operative aids.

Sam Weber is working on "Sophisticated Communications Methods" for the October 1959 issue. Report covers scatter systems, meteorburst transmission, satellite relays, carrier systems, etc.

### References:

If you're not a subscriber, if your subscription is expiring, if you will miss exciting features "in-the-works" by **electronics** 26-man staff, fill in box on Reader Service Card. Easy to use. Postage free.



# electronics

A McGraw-Hill Publication • 330 West 42nd Street, New York 36, N. Y.

# RCA offers unlimited opportunities for SCIENTISTS and ENGINEERS

You are invited to inquire about important openings at RCA's Electron Tube center in Harrison, New Jersey (just 15 miles from New York City). To qualify, you should have a degree in . . .

**ELECTRICAL ENGINEERING  
PHYSICS • METALLURGY • CERAMICS  
MECHANICAL ENGINEERING**

RCA-Harrison is a major R & D center for the following activities connected with receiving and special purpose electron tubes:

**DESIGN OF . . .**

ELECTRON TUBES • CIRCUITS

**DEVELOPMENT OF •**

TUBES AND CIRCUITS  
TUBES FOR NEW APPLICATIONS  
NEW MATERIALS  
NEW TECHNIQUES  
METHODS FOR  
FABRICATING ELECTRON TUBES

**AND . . .**

TECHNICAL PUBLICATIONS ENGINEERING

Phone or Write

Mr. J. F. McPartland, DEPT. J-235  
Humboldt 5-3900



**RADIO CORPORATION  
OF AMERICA**  
415 South Fifth Street  
ELECTRON TUBE DIVISION  
HARRISON, NEW JERSEY



Navigation Systems

Communication  
Systems

Servos

Transistors

Transmitters

Receivers

Antennas

## CAREER OPPORTUNITIES

With a company making premium grade electronic equipment for aircraft for over 30 years. Located in the beautiful lake region of Northern New Jersey, less than 35 miles from New York City.

- Transistor Circuit Engineer
- Tacan Engineers
- Receiver Engineers
- Transmitter Engineers  
(VHF & UHF Frequencies)
- Navigation Equipment  
Engineers
- Antenna Design Engineer
- Technical Writers
- Test Lab Engineers

Enjoy the pleasure of working in a new laboratory in a company whose products are known as the highest quality in the industry.

Write or call collect: Personnel Manager

### AIRCRAFT RADIO CORPORATION

Boonton, N. J. DE 4-1800—Ext. 238

## MB SEEKS ENGINEERS

- Electronic • Acoustic
- Mechanical • Dynamics
- Hydraulic • Vibration
- Loudspeaker

For its new product program. World's largest producer of dynamic testing equipment is expanding its scope and offers exciting opportunities for engineers. For further information call or write J. M. Wirtz, Personnel Manager, MB Manufacturing Company, A Division of Textron Inc., P. O. Box 1825, New Haven 8, Conn. In New Haven, call FULton 9-1511. In New York, call CAnal 6-4246.

### PROJECT ENGINEERS SENIOR & STAFF POSITIONS \$9,000—\$16,000

Challenging design and development opportunities for engineers with radar, antenna or communications systems experience. Advanced developmental studies, translation of systems concepts to hardware, and developmental design of same. Please contact: Frank Hanley, 64 East Jackson Blvd., Room 904, Chicago 4, Ill., WAhah 2-1884.

THIS EMPLOYMENT OPPORTUNITIES SECTION offers a quick, effective solution to your manpower problems. Because its readership is confined to just the type of men you need, waste circulation is avoided.

## FOR ADDITIONAL INFORMATION About Classified Advertising

Contact The McGraw-Hill  
Office Nearest You

- ATLANTA, 3  
1301 Rhodes Haverly Bldg. JACKson 3-6951  
M. MILLER
- BOSTON 16  
350 Park Square HUBbard 2-7160  
D. J. CASSIDY
- CHICAGO, 11  
520 No. Michigan Ave. MOhawk 4-5800  
W. HIGGINS D. C. JACKMAN
- CLEVELAND, 13  
1164 Illuminating Bldg. SUperior 7-7000  
W. B. SULLIVAN P. M. BUTTS
- DALLAS, 2  
1712 Commerce St., Vaughn Bldg.  
Riverside 7-5117  
GORDON JONES F. E. HOLLAND
- DETROIT, 26  
856 Penobscot Bldg. WOodward 2-1793  
D. M. WATSON
- LOS ANGELES, 17  
1125 W. 6 St. HUntleY 2-5450  
T. H. HUNTER
- NEW YORK, 36  
500 Fifth Ave. OXFord 5-5959  
H. T. BUCHANAN R. P. LAWLESS
- PHILADELPHIA, 3  
Six Penn Center Plaza LOcust 8-4330  
H. W. BOZARTH T. W. McCLURE
- ST. LOUIS, 8  
3615 Olive St. JEFFerson 5-4867
- SAN FRANCISCO, 4  
68 Post St. DOuglas 2-4600  
S. HUBBARD

*Engineers—INVEST  
your resume in LFE\**

IMMEDIATE OPPORTUNITIES:

- \*CIRCUIT DESIGN
- \*QUALITY CONTROL
- \*MICROWAVE
- \*COMPUTERS
- \*TRANSISTOR
- \*SENIOR PHYSICIST
- \*SENIOR PROJECT ENGINEERS
- \*RELIABILITY
- \*RADAR & SYSTEMS
- \*FLIGHT TEST
- \*FIELD ENGINEERS
- \*ELECTRONIC ENGINEERS



Send resume to:  
Professional Placement Director  
75 Pitts Street  
Boston 14, Mass.

LABORATORY  
FOR ELECTRONICS

**DISENCHANTED  
ENGINEERS**

If your present employer has failed to utilize your full potential, why not permit us to explore the parameters for your personal qualifications with the many dynamic young companies in aviation, electronics, missiles and rockets. We now have in excess of 4,000 openings in the \$8,000 to \$40,000 bracket, all of which are fee paid. Why wait? Send resume in duplicate at once to:—

FIDELITY PERSONNEL  
1218 Chestnut Street, Philadelphia 7, Pa.

**SOLID STATE SYSTEM**

MANAGER: \$20,000+  
New scientist for technical direction and management of systems engineering group for military application (Physics or E.E.). Unusual opportunity to demonstrate skill with an outstanding company. Client assumes all expenses.

MONARCH PERSONNEL  
28 East Jackson, Chicago 4, Illinois

**POSITIONS!**

To satisfy your objectives and use your best talents! S.E.E. helps many distinguished companies and organizations to obtain able men at all levels. No placement fees to you. Send resume for appraisal & full information.

Scientists, Engineers & Executives, Inc.  
1926-17th St., N. W. Washington 6, D. C.

**MANUFACTURERS'  
REPRESENTATIVES**  
IN THE ELECTRONIC INDUSTRY  
CONTRACT RATES GIVEN ON  
REQUEST. WRITE  
ELECTRONICS



**SAMUEL K. MACDONALD, INC.**  
manufacturers representatives over 25 years  
1531 SPRUCE STREET, PHILA. 2, PA.  
Territory: Pennsylvania • New Jersey  
Delaware • Maryland  
Virginia • West Virginia  
District of Columbia  
Other Offices:  
Pittsburgh  
Baltimore  
Washington, D.C.

engineers  
scientists

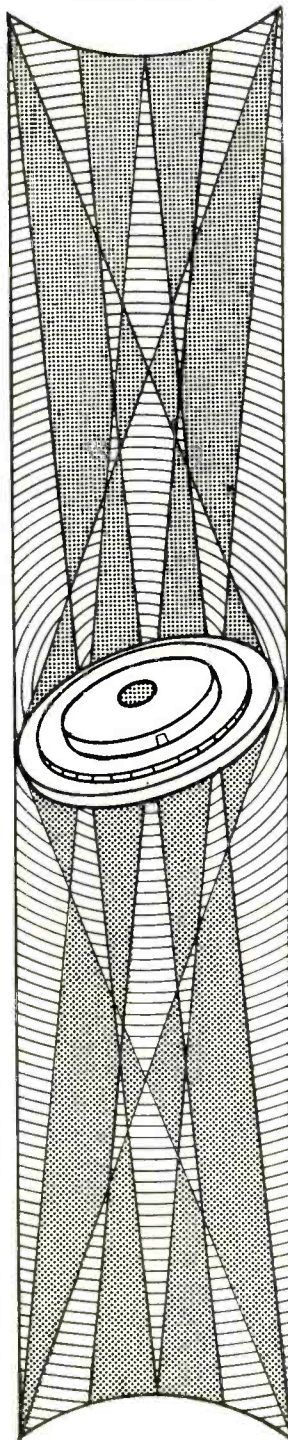

**FROM VISION  
TO KNOWLEDGE  
TO ADVANCED  
SYSTEMS**

Republic's  
Missile Systems Division  
offers you  
challenge in the  
forward areas of  
Missile Technology

Progressive scientific thinking at the Missile Systems Division is making broad state-of-the-art advances in missile technology. Typical of the significant programs you can contribute to are advanced ECCM, sophisticated anti-ICBM and missile guidance systems, satellites for strategic weapon applications and the Swallow SD-4 combat surveillance system.

*There are openings for*

**MICROWAVE ENGINEERS**

Design of microwave antennas and components for airborne navigation systems

**COMPUTER ENGINEERS**

Digital data transmission, digital and pulse circuitry, and digital computer logic and storage

**FLIGHT CONTROL ENGINEERS**

Automatic flight control systems, inertial guidance and stable platforms.

Send resume in complete confidence to:  
Mr. Paul Hartman,  
Engineering Employment, Dept. 11D-3

**MISSILE SYSTEMS DIVISION**

**REPUBLIC AVIATION**

223 Jericho Turnpike, Mineola, Long Island, N. Y.



**DISPLAYED RATE**

The advertising rate is \$24.75 per inch for advertising appearing on other than a contract basis. Contract rates quoted on request. AN ADVERTISING INCH is measured 7/8 inch vertically on one column, 3 columns—30 inches—to a page. EQUIPMENT WANTED or FOR SALE ADVERTISEMENTS acceptable only in Displayed Style.

**UNDISPLAYED RATE**

\$2.40 a line, minimum 3 lines. To figure advance payment count 5 average words as a line. BOX NUMBERS count as one line additional in undisplayed ads. DISCOUNT of 10% if full payment is made in advance for four consecutive insertions of undisplayed ads (not including proposals.)

The publisher cannot accept advertising in the Searchlight Section, which lists the names of the manufacturers of resistors, capacitors, rheostats, and potentiometers or other names designed to describe such products.

Send NEW ADS or inquiries to Classified Adv. Div. of Electronics P. O. Box 12, N. Y. 36, N. Y.

**Antenna Pedestal SCR 584—MP 61B**

Full azimuth and elevation sweeps, 360 degrees in azimuth, 210 degrees in elevation. Accurate to 1 mil. over system. Complete for full tracking response. Including pedestal drives, selsyns, potentiometers, drive motors, control amplifiers. From stock delivery. Ideal for antenna pattern ranges, radar systems, radio astronomy, any project requiring accurate response in elevation and azimuth. Complete description in McGraw Hill Radiation Laboratory Series, Volume 1, page 284 and page 209, and Volume 26, page 233.

**RADAR**

From Stock Delivery  
 Skysweep Antenna Pedestal. SCR 584 & 784  
 Search-track Radars. MPN-1B GCA. APS-10, APS-31, APS-33 Airborne.  
 Navy Weather-Eye Radars  
 Microwave plumbing—over 1,000 items.  
**RADIO RESEARCH INSTRUMENT CO.**  
 550 Fifth Avenue, N. Y. 36, N. Y. JUdson 6-4691

**INDUSTRIAL SPACE  
 For Rent**

Exceptionally clean, light industrial four-story building—40,000 sq. ft. per floor, located in Paterson, New Jersey area—good labor—low tax area.

Would cooperate in working out desirable lease with interested company. Might even interest myself financially in established business

**CHARLES H. READE, Owner**  
 135 Hoboken Ave., Jersey City 2, N. J.  
 OT. 3-3012

WE BUY . . .

**ALLEN-BRADLEY  
 RESISTORS and  
 POTENTIOMETERS**

at highest prices.

Submit your offerings To:

**LEGRI S. COMPANY**  
 391 Riverdale Ave.  
 YONKERS 5, NEW YORK

TYPES AB; CD; EF—J—JJ—JJJ—JJJJ and G's

**POTENTIOMETERS**

From stock in all values.

**LEGRI S COMPANY**

391 Riverdale Ave. Yonkers 5, N. Y.  
 Phone YO 9-6000

**lab grade TEST EQUIPMENT for sale**

standard brands—military surplus (new or professionally reconditioned) experienced problem solvers and budget-cutters

**ENGINEERING ASSOCIATES**  
 434 Patterson Road Dayton 19, Ohio

*Your Inquiries to Advertisers*

*Will Have Special Value . . .*

—for you—the advertiser—and the publisher, if you mention this publication. Advertisers value highly this evidence of the publication you read. Satisfied advertisers enable the publishers to secure more advertisers and—more advertisers mean more information on more products or better service—more value—to YOU.

## SEARCHLIGHT Equipment Locating Service

*No Cost or Obligation*

This service is aimed at helping you, the reader of "SEARCHLIGHT", to locate Surplus new and used electronic equipment and components not currently advertised. (This service is for USER-BUYERS only). How to use: Check the dealer ads to see if what you want is currently advertised. If not, send us the specifications of the equipment and/or components wanted on the coupon below, or on your own company letterhead to:

**SEARCHLIGHT EQUIPMENT LOCATING SERVICE**  
**c/o ELECTRONICS—Classified Advertising P.O. Box 12, New York 36, N. Y.**

Your requirements will be brought promptly to the attention of the equipment dealers advertising in this section. You will receive replies directly from them.

SEARCHLIGHT EQUIPMENT LOCATING SERVICE, c/o Electronics, P. O. Box 12, New York 36, N. Y.

Please help us to locate the following used equipment:

NAME..... TITLE..... COMPANY.....  
 STREET..... CITY..... ZONE..... STATE..... 4/17/59

# NEW PROGRAMS

have created

# IMMEDIATE OPENINGS

for top quality engineers  
with experience in —

- Preliminary Analysis
- Aerodynamics
- Flight Dynamics
- Structural Dynamics
- Aero-Thermodynamics
- Flight Simulation
- Space Communication
- Space Instrumentation
- Radar Systems & Techniques
- Electronic Countermeasures
- Guidance
- Instrumentation
- Electronics Test Design
- Computing
- Reliability
- Human Factors

Well paid jobs for qualified people.  
Relocating expenses paid.  
For information on these and other engineering positions, write:

**B. J. Ralph, Dept. 451**  
**Missile Division**  
**North American Aviation, Inc.**  
**12214 Lakewood Blvd.**  
**Downey, California**

**MISSILE DIVISION**   
NORTH AMERICAN AVIATION, INC.

## INDEX TO ADVERTISERS

Aeronautical Communication Co. ....	6
• American Television & Radio Co. ....	93
Angelica Uniforms .....	88
• Applied Research Inc. ....	81
• Arnold Engineering Co. ....	3
Atlas E-E Corporation .....	73
Avco Manufacturing Co. ....	13
• Bomac Laboratories Inc. ....	3rd Cover
Borden Chemical Co., Resinite Dept. ...	75
Bruning Co., Inc., Charles .....	65
• Bussmann Mfg. Div. McGraw-Edison Co. ....	12
• Cambridge Thermionic Corporation ...	34
• Clevite Electronic Components Div. of Clevite Corporation .....	38
Connecticut Hard Rubber Co. ....	67
• Cosmic Condenser Co. ....	86
• Cubic Corporation .....	21
• Curtiss-Wright Corporation .....	85
Delco Radio .....	59
• Dialight Corporation .....	81
• Dymec, Inc. ....	61
Electronics .....	2, 85
• Epsco, Inc. ....	36
• Gamewell Company, The .....	86
• General Electric Co. Semiconductor Products Dept. ...	18, 19
General Public Utilities Corporation ...	83
• General Radio Company .....	2nd Cover
• Hewlett-Packard Company .....	15
• Hughes Aircraft Company .....	37
• International Telephone & Telegraph Industrial Products Div. ....	14
Jones & Lamson Machine Co. ....	63
• Kester Solder Company .....	68
Kinney Mfg. Div. of the New York Air Brake Co. ....	25
• Kintel, a Div. of Cohn Electronics, Inc. ....	10
• Krohn-Hite Corporation .....	79
Lockheed Aircraft Corp. ....	82
Mallory & Co. Inc., P. R. ....	30, 31
North American Aviation, Inc. ....	93
Norton Company .....	35
• Oak Mfg. Co. ....	28
• Ohmite Manufacturing Co. ....	8, 9
Philbrick Researches, Inc., George A. ...	94

• See advertisement in the June, 1958 Mid-Month ELECTRONICS BUYERS' GUIDE for complete line of products or service.



## "A" BATTERY ELIMINATORS



For  
**Demonstrating and Testing Auto Radios**  
TRANSISTOR OR VIBRATOR OPERATED  
6 Volt or 12 Volt!

New Models . . . Designed for testing D.C. Electrical Apparatus on Regular A.C. Lines. Equipped with Full-Wave Dry Disc Type — Rectifier, Assuring Noiseless, Interference-Free Operation and Extreme Long Life and Reliability.

TYPE	INPUT A.C. Volt 60 Cycles	D.C. OUTPUT		SHIP. WT.	USER PRICE
		VOLTS	AMPERES Cont. Int.		
610C-ELIF	110	6	10 20	22	\$42.95
		12 -or-	6 12		
620C-ELIT	110	6	20 40	33	59.95
		12 -or-	10 20		

**SEE YOUR JOBBER OR WRITE FACTORY**  
✓ NEW MODELS ✓ NEW DESIGNS ✓ NEW LITERATURE  
• "A" Battery Eliminators • DC-AC Inverters • Auto Radio Vibrators



**AMERICAN TELEVISION & RADIO CO.**  
Quality Products Since 1931  
SAINT PAUL 1, MINNESOTA, U. S. A.

CIRCLE 61 READERS SERVICE CARD

The plus  
is  
precision!

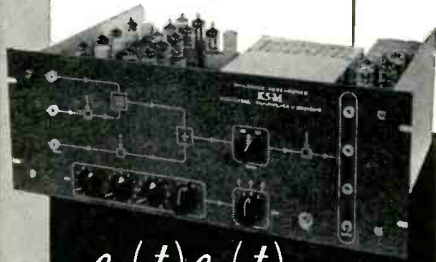

$$\frac{e_1(t)e_2(t)}{e_3(t)}$$

## NEW analog multiplier-divider by Philbrick

This is Philbrick's K5-M — which provides improved long term stability. Accuracy, including drift, is better than 0.10v in all 4 quadrants.

### FEATURES:

- Accepts 3 variable inputs  $e_1, e_2, e_3$  and yields  $e_1 e_2 / e_3$
- 3-digit decade provides adjustable scaling voltage
- Useful response even beyond 10 kcps.
- Needs no auxiliary equipment to obtain products, ratios, squares, square roots, etc.
- Requirements: 115vac filament power; 110ma at  $\pm 300$ vdc
- Mounts on standard 7" rack panel

Here's a new and higher degree of precision, speed, and flexibility at your fingertips for analog computation, correlation, precision modulation, control, many other applications.

For full informaton, write:

GEORGE A.

**PHILBRICK**  
RESEARCHES, INC.

285 Columbus Ave., Boston 16, Mass.  
Commonwealth 6-5375

THE ANALOG WAY IS THE MODEL WAY

• Radio Corporation of America .....	23, 4th Cover
• Raytheon Mfg. Co. ....	5, 26, 71, 87
Royal Electric Corp. ....	17
San Jose Chamber of Commerce .....	94
Sprague Electric Co. ....	32, 33
Stackpole Carbon Co. ....	69
Stokes Corp., F. J. ....	80
Stromberg-Carlson .....	20

• Texas Instruments Incorporated .....	16
• Tung-Sol Electric Inc. ....	27

• Ucinite Co. Div. of United-Carr Fastener Corp. ....	22
-------------------------------------------------------	----

Virginia Dept. of Conservation and Economic Development .....	7
---------------------------------------------------------------	---

Wales Strippit, Inc. ....	64
• Welwyn International, Inc. ....	76
Westinghouse Electric Corp. ....	72

Yuba Consolidated Industries, Inc. ....	88
-----------------------------------------	----



Manufacturers Representatives .....	91
-------------------------------------	----

### CLASSIFIED ADVERTISING

F. J. Eberle, Business Mgr.

EMPLOYMENT OPPORTUNITIES .....	90, 91
--------------------------------	--------

EQUIPMENT (Used or Surplus New) For Sale .....	92
------------------------------------------------------	----

WANTED Equipment .....	92
---------------------------	----

### ADVERTISERS INDEX

Aircraft Radio Corporation .....	90
Engineering Associates .....	92
Fidelity Personnel .....	91
Hanley, Frank .....	90
Laboratory for Electronics .....	91
Legri S. Company .....	92
MB Manufacturing Company .....	90
Monarch Personnel .....	91
Radio Corporation of America .....	90
Radio Research Instrument Co. ....	92
Reade, Charles H. ....	92
Republic Aviation (Missile Systems Div.)	91
Scientists Engineers & Executives .....	91

• See advertisement in the June, 1958 Mid-Month ELECTRONICS BUYERS' GUIDE for complete line of products or services.

This index is published as a service. Every care is taken to make it accurate, but ELECTRONICS assumes no responsibilities for errors or omissions.

Yes, we chose  
Santa Clara  
County\*  
California



...and we're  
glad to  
be here!\*

Mr. H. Myrl Stearns, President of Varian Associates, explains the desirability of their Santa Clara County location this way:

"Clean atmosphere ranks first among the reasons for our enthusiasm over this area. However, other advantages are also important in the manufacture of products such as our Klystron tubes.

"The many electronic research facilities, an ample supply of skilled technicians, plus top-ranking educational institutions nearby, have been key factors in our rapid growth."

When a well-known firm endorses a community, the reasons are significant. Talk with the people at Varian. Let their experience forecast your future in this livable community at the southern tip of San Francisco Bay.

### WRITE FOR FREE REFERENCE DATA

Take a minute now to send for the informative booklet, "What Does Santa Clara County, California offer the ELECTRONICS INDUSTRY?"



CIRCLE 63 READERS SERVICE CARD  
April 17, 1959 — ELECTRONICS

## Sir Francis Drake Cracks a Case

One foggy day in 1588, a single ship of the Spanish Armada managed to sneak behind Drake's entire British fleet lying in the English Channel off Plymouth Hoe, and drop a 10 pounder smack in the middle of a bowling match between Sir Francis and his friend Walter Raleigh.

The new radar was caught completely by surprise. Had the IFF (Identification: Francis or Foe?) system failed? Was the operator tuned to the wrong Channel? Was there something wrong with the tubes? Drake was determined to find out. He was inside the shack in a trice, whatever that is. "Avast!" he roared at the radarman, "I must inspect those tubes!"

Drake picked up a magnetron and looked at it. "Aha!" he ex-

claimed. "Just as my razor-keen mind suspected!" With that, he seized the hapless operator by the throat and shook him like a tumblerful of sidecars. "I arrest you for stealing Bomac tubes\* and substituting these inferior substitutes, WILLIAM SHAKESPEARE!"

"I confess, how'd you guess?" said Shakespeare, ever the poet.

"Elementary for a razor-keen mind like mine," answered Drake.

"Only you could have conceived the cunning scheme of replacing Bomac tubes with factory seconds labeled "Bethmac" as a publicity stunt for your new play — Macbeth!"

"Yours is a razor-keen mind indeed!" marveled Shakespeare as they led him away. "I haven't even written Macbeth yet!"

"Plenty of time where you're going," said Drake — and went off to bowl over the Armada.

No 13 of a series . . . BOMAC LOOKS AT RADAR THROUGH THE AGES

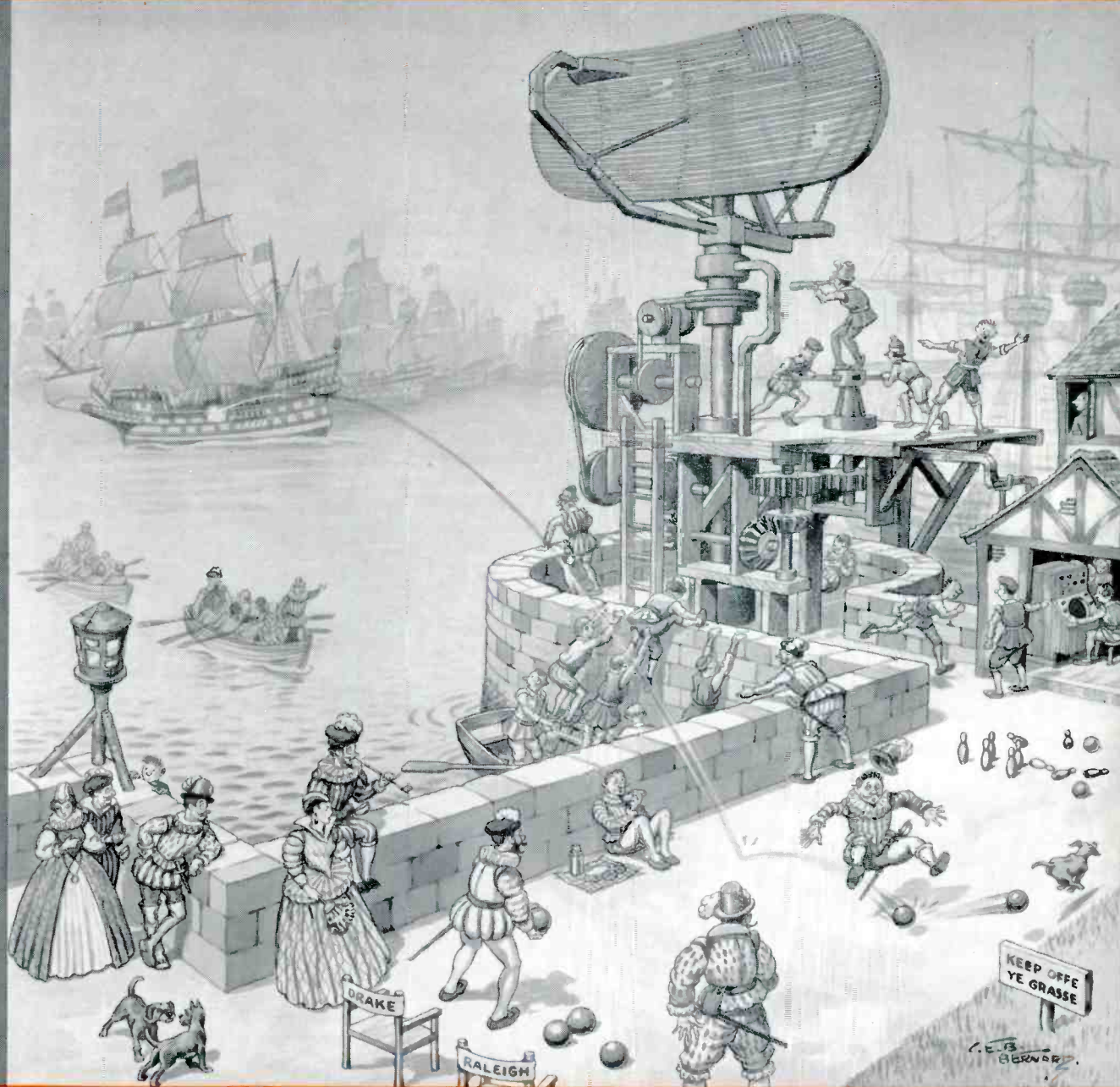

\* Bomac makes the finest microwave tubes and components either side of the English Channel

WRITE FOR FREE SIX PAGE FOLDER

**Bomac** LABORATORIES, INC.

Salem Road, Beverly, Massachusetts

Leaders in the design, development and manufacture of TR, ATR, PFe-TR tubes; shutters;

Offices in major cities—Chicago • Kansas City • Los Angeles • Dallas • Dayton • Washington •

# RCA TUNABLE MAGNETRONS...

DECLASSIFIED

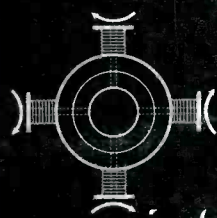

a new  
concept  
in tuning  
reliability

You are looking at the first published picture of the tuned-coupled cavities of an RCA Tunable Magnetron. In development for several years, this unit is setting a new standard of reliable magnetron performance—because it provides an effective tuning system outside the high electrical field region of the anode. Here are a few of the advantages: RCA's coupled-cavity tuning (1) does away with tuner arcing, and galling, or jamming—(2) provides a rugged mechanical tuning system thus minimizing vibration-induced frequency modulation—(3) offers improved mode stability at high rates of rise of voltage pulse—(4) permits uniform power output across the tuning range of the magnetron—(5) lends itself to "customized" tube designs for virtually any magnetron frequency and power requirement.

Designed for superior performance throughout long life, RCA New-Concept Tunable Magnetrons are now offered in a wide choice

of designs for either hand- or servo-drive tuning. And note this: *They have been thoroughly proved for operating reliability and long life in microwave systems under the most adverse conditions of military field environment.*

For information on RCA Tunable Magnetrons—and how RCA's Coupled-Cavity tuning concept can help solve your problems involving the application of tuned magnetrons—call the RCA Field Office nearest you.

#### INDUSTRIAL TUBE PRODUCTS SALES

- Newark 2, N. J., 744 Broad Street, Humboldt 5-3900
- Chicago 54, Illinois, Suite 1154, Merchandise Mart Plaza, Whitehall 4-2900
- Detroit 2, Michigan, 714 New Center Bldg., TRinity 5-5600
- Los Angeles 22, Calif., 6355 E. Washington Blvd., Raymond 3-8361

#### GOVERNMENT SALES

- Newark 2, N. J., 744 Broad St., Humboldt 5-3900
- Dayton 2, O., 224 N. Wilkinson St., Baldwin 6-2366
- Washington 6, D. C., 1625 "K" St., N. W., District 7-1260

## What You "Need To Know"

Oscillating frequency is determined by the electrical dimensions of mechanically actuated tuning lines (external to tube anode). Cavities store RF energy through electrical coupling to the anode—resulting in vastly improved mode stability. Unlike other tuning methods, new RCA Coupled-Cavity tuning assures optimum mechanical and electrical tube performance—because tuner and anode structures can be designed independently!

RCA Tunable Magnetrons For Pulsed Oscillator Service					
Type No.	Frequency Range (Mc)	Tuning System	Peak Power Output (kw)	Duty Cycle	RRV kv/μsec.
7008	9500-9600	Servo-tunable	230	0.001	225
7110	8500-9600	hand-tunable	220	0.001	225
7112	8500-9600	remote-tunable	220	0.001	200
7111	3500-9600	hand-tunable	220	0.001	200
A-1127	8500-9600	hand-tunable	280	0.001	200
6865-A	8750-9600	hand-tunable	220	0.001	180
A-1086-G	8750-9600	hand-tunable	240	0.001	160

New RCA Microwave Tube folder (1CE-180). A handy listing of RCA Magnetron and Traveling-Wave Tubes and their salient characteristics. Free—from RCA Commercial Engineering, Section D-19-Q-3 Harrison, N. J.



**RADIO CORPORATION OF AMERICA**

® **Electron Tube Division**

**Harrison, N. J.**