

APRIL 10, 1959

MORNINGSIDE COLLEGE
LIBRARY
MORNINGSID CITY IOWA

electronics

A MCGRAW-HILL PUBLICATION

VOL. 32, No. 15

PRICE SEVENTY-FIVE CENTS



New Uses
For Citizens
Radio

Why Missile Control Signals Fail

Creative Microwave Technology

Published by MICROWAVE AND POWER TUBE DIVISION, RAYTHEON MANUFACTURING COMPANY, WALTHAM 54, MASS., Vol. 1, No. 2

NEW ONE-WATT COMMUNICATION KLYSTRONS COVER GOVERNMENT AND COMMON CARRIER BANDS

Designed primarily for use in microwave relay links, the QK-661 and the QK-754, one-watt transmitter klystrons, operate at frequencies of 7,125 to 8,500 Mc and 5,925 to 6,425 Mc, respectively. The QK-661 is the first tube of its kind to cover the entire government band. The QK-754 is the first of a planned series of tubes to cover the entire communications band.

Both are mechanically tuned, integral-cavity, long-life, reflex-type tubes. The QK-754 uses a coaxial output; the QK-661, a waveguide output.

To insure efficient operation the tubes are available with integral cooling fins or with a heat-sink attachment suitable for connection to the chassis.

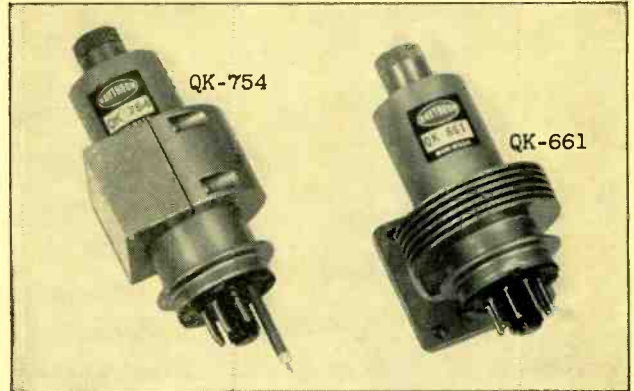

Typical operating characteristics

	QK-754	QK-661
Frequency Range	5925 to 6425 Mc	7125 to 8500 Mc
Power Output	1.5 watts	1.6 watts
Electronic Tuning (to half-power pts)	50 Mc	25 Mc
Modulation		
Sensitivity (10 V pk-to-pk mod volt)	1 Mc/V	600 Kc/V
Temp. Coefficient	± 0.1 Mc/°C	± 0.1 Mc/°C

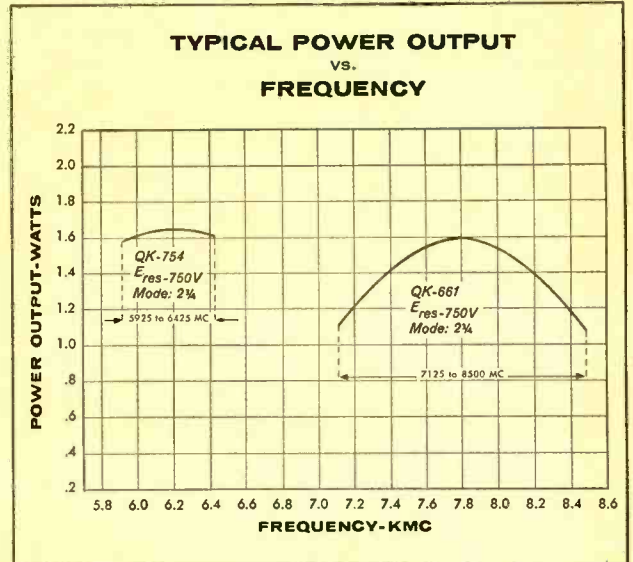
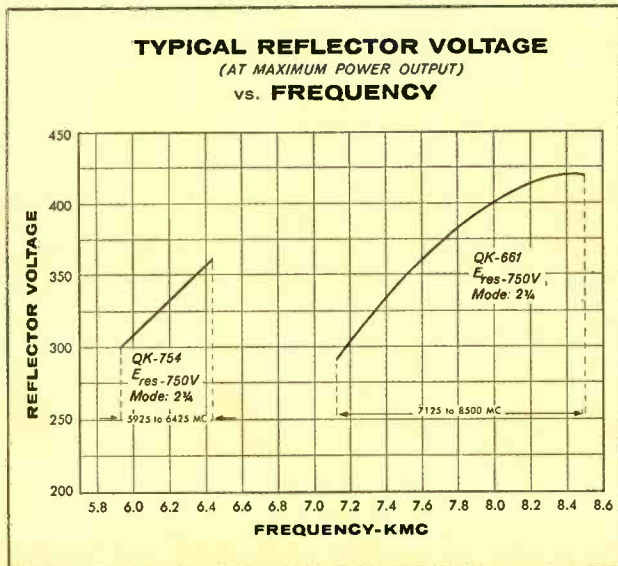

You can obtain detailed application information and special development services by contacting: Microwave and Power Tube Division, Raytheon Manufacturing Company, Waltham 54, Massachusetts

Excellence in Electronics



A LEADER IN CREATIVE MICROWAVE TECHNOLOGY

Issue at a Glance

A McGRAW-HILL PUBLICATION
Vol. 32 No. 15

JAMES GIRDWOOD, *Publisher*

W. W. MacDONALD, *Editor*

JOHN M. CARROLL, *Managing Editor*

Associate Editors: Frank Leary, Michael F. Tomaino, Howard K. Janis, Sylvester P. Carter, Haig A. Manoogian, Roland J. Charest, William P. O'Brien, George Sideris, John F. Mason, William E. Bushor, Ronald K. Jurgen, Thomas Emma, Samuel Weber.

Pacific Coast Editor (Los Angeles) Harold C. Hood; *Midwestern Editor (Chicago)* Harold Harris; *New England Editor (Boston)* Thomas Maguire.

Art Director, Harry Phillips, Roy Thompsen.

Production Editor, John C. Wright, Jr., Bernice Duffy, Jean L. Martin.

Market Research, Edward DeJongh, Marilyn Koren.

Editorial Assistants, Gloria J. Filippone, Arlene Schilp, Patricia Landers, Catherine McDermott, Eleanor Schaefer, Carol Weaver.

BRUCE A. WINNER, *Advertising Sales Manager.* R. S. Quint, *Assistant Advertising Sales Manager and Buyers' Guide Manager.* Fred Stewart, *Promotion Manager.* Frank H. Ward, *Business Manager.* George E. Pomeroy, *Classified Manager.* Hugh J. Quinn, *Circulation Manager.*

New York: Donald H. Miller, Henry M. Shaw, William J. Boyle. *Boston:* Wm. S. Hodgkinson. *Philadelphia:* Warren H. Gardner. *Chicago:* Harvey W. Wernecke, Martin J. Gallay. *Cleveland:* P. T. Fegley. *San Francisco:* T. H. Carmody, R. C. Alcorn. *Los Angeles:* Carl W. Dysinger, D. A. McMillan. *Denver:* J. Patten. *Atlanta:* M. Miller. *Dallas:* Gordon L. Jones, Robert T. Wood. *London:* E. E. Schirmer. *Frankfurt:* Michael R. Zeynel.

BUSINESS

Why Missile Signals Fail. Report on Arctic propagation studies.....	32
Marketing Revolution Spreads. Single sales source cuts costs.....	39
Big Army Contract Due Soon. UNICOM—and what it will do.....	42
New Spectrum Study Urged. What broadcasters are discussing.....	47
Shoptalk	4
Electronics Newsletter	11
Washington Outlook	14
Financial Roundup	23
Over The Counter.....	23
Market Research	26
Current Figures	26
Meetings Ahead	50

ENGINEERING

Citizens band radio finds use at airports for communicating with service vehicles. See p 55.....	COVER
New Citizens Radio Rules Spur Equipment Development. Commercial equipment for use in new citizens bands.....	By L. G. Sands 55
Digital Tachometer Aids in Turbine Design. Digital tachometer is highly accurate.....	By J. K. Goodwin 58
Impedance Measurements of Living Tissue. Checking is done with a plethysmograph.....	By S. Bagno and F. M. Liebman 62
Selection Guide for Silicone Dielectrics. Tabulation presents significant data on silicone insulating materials.....	By C. G. Currin 64
Tunable F-M Multiplex Adapter. Heterodyne system eliminates filter design in f-m multiplex circuit.....	By W. B. Bernard 66
How to Design Low-Cost Audio Filters. Modified cathode follower used in simple filter circuit.....	By W. D. Fryer 68
Silicon Power Rectifiers. Table lists specs, currents and voltages of military standard units.....	By R. F. Edwards 71
Audio Amplifier Design Cuts Plate Dissipation. Added signal in audio amplifier cuts plate dissipation.....	By R. B. Dome 72
Clock Source for Electronic Counters. Stable, fixed-frequency oscillator eliminates elaborate circuits.....	By T. F. Marker 76

DEPARTMENTS

Research and Development. A-M Sidebands Transmit Stereo.....	78
Components and Materials. Semiconductor Solid Circuitry.....	82
Production Techniques. Air Gage Measures Radome Walls.....	86
On the Market.....	90
Literature of the Week.....	124
New Books	126
Thumbnail Reviews	127
Plants and People.....	128
News of Reps.....	131
Comment	132
Index to Advertisers.....	143



...SYNONYM for PRECISION in TIMING

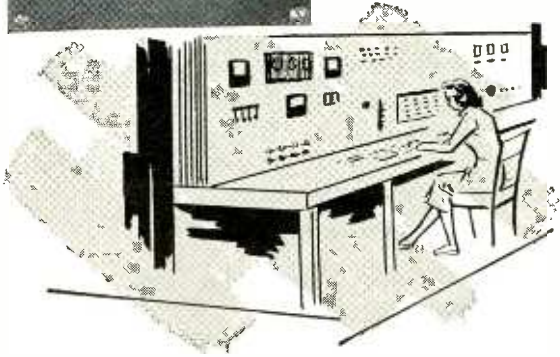
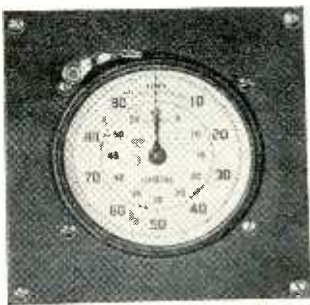

For timing requirements in research, testing or production... if the need for *precision* is paramount... the choice is STANDARD.

Recognized as THE criterion by which other timers are judged (and *calibrated*), STANDARD Elapsed Time Indicators are noted for their long life under continuous use.

Large enough to work with handily and read readily, STANDARD timers are electric clutch controlled by manual or automatic switch or by electric circuits or output of electronic tubes. Units are synchronous motor driven... available for flush panel mounting or portable use... equipped for manual or electric zero reset.

For ultra precision timing with AC current, models available for 400 CPS operation. Also available: 400 CPS power supply operating from DC source.



Request descriptive Catalog No. 198

MODEL	SCALE DIVISIONS	TOTALIZES	ACCURACY
S-100	1/5 sec.	6000 sec.	±.1 sec.
S-60	1/5 sec.	60 min.	±.1 sec.
SM-60	1/100 min.	60 min.	±.002 min.
S-10	1/10 sec.	1000 sec.	±.02 sec.
S-6	1/1000 min.	10 min.	±.0002 min.
S-1	1/100 sec.	60 sec.	±.01 sec.
MST	1/1000 sec.	.360 sec.	±.001 sec.
MST-500	1/1000 sec.	30 sec.	±.002 sec.

THE STANDARD ELECTRIC TIME COMPANY

89 LOGAN STREET
SPRINGFIELD, MASSACHUSETTS

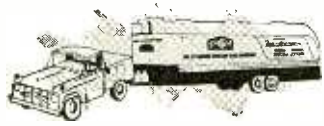

Travelling Display—
Watch for showing
in your area. See
complete STAND-
ARD Systems in
operation.

ALSO MANUFACTURERS OF:



CIRCLE 1 READERS SERVICE CARD

April 10, 1959 — ELECTRONICS

Lambda Power Supplies have been the first choice of engineers in every independent poll



The only power supplies guaranteed for 5 years

This unprecedented five-year guarantee is the strongest proof of consistent trouble-free power supply performance ever offered. It is bolstered even further by a series of independent surveys which prove that Lambda equipment is preferred by more than 50% of the engineers who specify power supplies.

CHECK LIST: LAMBDA REGULATED DC POWER SUPPLIES

Model	Style	Voltage Range (VDC)	Current Range (MA DC)	Regulation Impedance Ripple (Table I)	6.3 VAC Output (Amps)	Meters	Output Voltage Control	Output Terminals	Size Weight (Table II)	Price (U.S. and Canada) F.O.B. Factory College Pt., N. Y.
REGULATED POWER SUPPLIES - RACK MOUNTING										
TRANSISTORIZED										
LT-1095	Rack	0-32	0-1000	A	—	None	Rear	Rear	S-1	285.00
LT-1095M	Rack	0-32	0-1000	A	—	2 1/2" rect	Rear	Rear	S-1	315.00
LT-2095	Rack	0-32	0-2000	B	—	None	Rear	Rear	S-1	365.00
LT-2095M	Rack	0-32	0-2000	B	—	2 1/2" rect	Rear	Rear	S-1	395.00
TUBE REGULATED										
C-280	Rack	0-200	0-200	C	10A	None	Rear	Rear	S-2	184.50
C-280M	Rack	0-200	0-200	C	10A	3 1/2" rect	Rear	Rear	S-2	214.50
C-281	Rack	125-325	0-200	C	10A	None	Rear	Rear	S-2	159.50
C-281M	Rack	125-325	0-200	C	10A	3 1/2" rect	Rear	Rear	S-2	189.50
C-282	Rack	325-525	0-200	C	10A	None	Rear	Rear	S-2	169.50
C-282M	Rack	325-525	0-200	C	10A	3 1/2" rect	Rear	Rear	S-2	199.50
C-480	Rack	0-200	0-400	D	15A	None	Rear	Rear	S-2	259.50
C-480M	Rack	0-200	0-400	D	15A	3 1/2" rect	Rear	Rear	S-2	289.50
C-481	Rack	125-325	0-400	D	15A	None	Rear	Rear	S-2	244.50
C-481M	Rack	125-325	0-400	D	15A	3 1/2" rect	Rear	Rear	S-2	274.50
C-482	Rack	325-525	0-400	D	15A	None	Rear	Rear	S-2	259.50
C-482M	Rack	325-525	0-400	D	15A	3 1/2" rect	Rear	Rear	S-2	289.50
C-880	Rack	0-200	0-800	E	20A	None	Rear	Rear	S-3	340.00
C-880M	Rack	0-200	0-800	E	20A	3 1/2" rect	Rear	Rear	S-3	370.00
C-881	Rack	125-325	0-800	E	20A	None	Rear	Rear	S-3	315.00
C-881M	Rack	125-325	0-800	E	20A	3 1/2" rect	Rear	Rear	S-3	345.00
C-882	Rack	325-525	0-800	E	20A	None	Rear	Rear	S-3	360.00
C-882M	Rack	325-525	0-800	E	20A	3 1/2" rect	Rear	Rear	S-3	390.00
C-1580	Rack	0-200	0-1500	F	30A	None	Rear	Rear	S-4	550.00
C-1580M	Rack	0-200	0-1500	F	30A	3 1/2" rect	Rear	Rear	S-4	580.00
C-1581	Rack	125-325	0-1500	F	30A	None	Rear	Rear	S-4	575.00
C-1581M	Rack	125-325	0-1500	F	30A	3 1/2" rect	Rear	Rear	S-4	605.00
C-1582	Rack	325-525	0-1500	F	30A	None	Rear	Rear	S-4	650.00
C-1582M	Rack	325-525	0-1500	F	30A	3 1/2" rect	Rear	Rear	S-4	680.00
28	Rack	200-325	0-100	G	3A	None	Rear	Rear	S-5	59.50
28M	Rack	200-325	0-100	G	3A	3 1/2" rect	Rear	Rear	S-5	89.50
29	Rack	100-200	0-100	H	3A	None	Rear	Rear	S-5	69.50
29M	Rack	100-200	0-100	H	3A	3 1/2" rect	Rear	Rear	S-5	99.50
32	Rack	200-325	0-300	J	2 @ 5A	None	Rear	Rear	S-6	139.50
32M	Rack	200-325	0-300	J	2 @ 5A	3 1/2" rect	Rear	Rear	S-6	169.50
33	Rack	100-200	0-300	J	2 @ 5A	None	Rear	Rear	S-6	154.50
33M	Rack	100-200	0-300	J	2 @ 5A	3 1/2" rect	Rear	Rear	S-6	184.50
50R	Rack	0-500	0-500	K	2 @ 5A	4 1/2" rect	Front	Fr & rear	S-7	420.00
		0-50	Bias	L						
		0-200	High Imped.	M						
REGULATED POWER SUPPLIES - PORTABLE AND BENCH										
25	Bench	200-325	0-100	G	3A	None	Front	Front	S-8	69.50
26	Bench	100-200	0-100	H	3A	None	Front	Front	S-8	79.50
50	Bench								S-9	440.00
										See Model 50R above
71	Portable	0-500	0-200	N	2 @ 5A	3 1/2" rect	Front	Front	S-10	310.00
		0-50	Bias	P						
		0-200	High Imped.	Q						

TABLE I
DC OUTPUT VOLTAGE REGULATION, IMPEDANCE, RIPPLE

REGULATION Line (105-125 VAC)	Load (min to max)	INTERNAL IMPEDANCE (ohms)		Ripple, rms (millivolts or %)
		Less than	Less than	
A 0.15% or 20MV	0.15% or 20MV	0.50	1 mv	
B 0.15% or 20MV	0.15% or 20MV	0.025	1 mv	
C 0.15% or 0.3V	0.25% or 0.5V	6	3 mv	
D 0.15% or 0.3V	0.25% or 0.5V	1.3	3 mv	
E 0.15% or 0.3V	0.25% or 0.5V	1.5	3 mv	
F 0.15% or 0.3V	0.25% or 0.5V	0.75	3 mv	
G 1%	1%	10	10 mv	
H 1%	1%	10	5 mv	
J 1%	1%	4	10 mv	
K 0.15% or 0.1V	0.5% or 0.3V	2	8 mv	
L 0.1%	unregulated	3,300	2 mv	
M 0.1%	unregulated	17,500	5 mv	
N 0.15% or 0.3V	0.15% or 0.3V	4	5 mv	
P 0.1%	unregulated	5,500	2 mv	
Q 0.1%	unregulated	25,000	5 mv	

TABLE II
SIZES AND WEIGHTS

Size H x W x D (Inches)	WEIGHT	
	Net (lbs)	Shipping (lbs)
S-1 3 1/2 x 19 x 14 1/2	35	65
S-2 5 1/4 x 19 x 14 1/2	53	80
S-3 7 x 19 x 14 1/2	84	100
S-4 8 3/4 x 19 x 14 1/2	120	140
S-5 5 1/4 x 19 x 8	19	23
S-6 10 1/2 x 19 x 9 1/4	42	52
S-7 10 1/2 x 19 x 14 1/4	89	140
S-8 8 x 14 x 6	19	23
S-9 12 1/2 x 22 x 15	110	158
S-10 13 x 8 1/2 x 14 1/2	49	85

GENERAL SPECIFICATIONS

Sufficient tolerance is incorporated in the specifications to allow for normal commercial component and tube deviations. Tube replacements may be made with any equivalent tubes meeting E.I.A. specifications.

INPUT 105-125 VAC, 50-400 CPS, single phase. Exceptions: Models 50, 50R and 71 - 105-125 VAC, 50-60 CPS.

DC OUTPUT Voltage Range: Continuously variable over ranges specified, except where otherwise noted.

Current Range: The current ranges given apply to the entire DC output voltage range, and for input voltages from 105 to 125 VAC. No "de-rating" is necessary.

Polarity: Either positive or negative terminal may be grounded.

AC OUTPUT The AC output is unregulated, isolated and ungrounded. It has a value of slightly higher than 6.3 V

(when fully loaded) at an input of 115 VAC. This value allows for voltage drop in connecting leads. Dual outputs may be connected in series or parallel.

DUTY CYCLE Continuous duty at full load.

METERS Where meters are indicated, a separate voltmeter and milliammeter are provided.

OVERLOAD PROTECTION Ample protection is provided against external overload and internal failure conditions by means of fuses.

Circuit breakers of the magnetic, "trip-free" type are employed in Models 50, 50R, 71 and LT series as protection against external overloads. And in the LT series, the transistor complement is independently protected by special transistor circuitry.

STYLE Rack Models are designed for mounting on standard 19" relay racks.

Bench Models are provided with compact, specially-designed, ventilated cabinets equipped with carrying handles. The power supply units may be removed from their cabinets for mounting in standard relay racks (except Models 26 and 71).

RATINGS AND COMPONENTS All components used are of the highest quality and are operated well within manufacturers' ratings. Hermetically-sealed, oil-filled capacitors are used exclusively, except in LT series, where special high purity foil, long-life electrolytics are used. "C" and "LT" series power supplies use hermetically-sealed magnetic components exclusively. Ample safety factors are provided in the design to insure the long life, and the dependable, trouble-free operation so desirable in industrial and laboratory applications.

All specifications and prices subject to change without notice.



LAMBDA ELECTRONICS CORP.

11-11 131 STREET • COLLEGE POINT 56, NEW YORK

INDEPENDENCE 1-8500 CABLE ADDRESS: LAMBDA TRON, NEW YORK

Keep this check list handy

SHOPTALK . . .

electronics

April 10, 1959 Vol. 32, No. 15

Published weekly, with an additional annual BUYERS' GUIDE and REFERENCE Issue in mid-June, by McGraw-Hill Publishing Company, Inc., James H. McGraw (1860-1948) Founder.

Executive, Editorial, Circulation and Advertising Offices: McGraw-Hill Building, 330 W. 42 St., New York 36, N. Y. Longacre 4-3000. Publication Office: 99-129 North Broadway, Albany 1, N. Y.

See panel below for directions regarding subscriptions or change of address. Donald C. McGraw, President; Joseph A. Gerardi, Executive Vice President; L. Keith Goodrich, Vice President and Treasurer; John J. Cooke, Secretary; Nelson L. Bond, President, Publications Division; Shelton Fisher, Senior Vice President; Ralph B. Smith, Vice President and Editorial Director; Joseph H. Allen, Vice President and Director of Advertising Sales; A. R. Venezian, Vice President and Circulation Coordinator.

Single copies 75¢ in the United States and possessions and Canada; \$1.50 for all other foreign countries. Buyers' Guide \$3.00. Subscription rates—United States and possessions, \$6.00 a year; \$9.00 for two years; \$12.00 for three years. Canada, \$10.00 a year; \$16.00 for two years; \$20.00 for three years. All other countries, \$20.00 a year; \$30.00 for two years; \$40.00 for three years. Second class postage paid at Albany, N. Y. Printed in U.S.A. Copyright 1959 by McGraw-Hill Publishing Co., Inc.—All Rights Reserved. Title registered in U. S. Patent Office. BRANCH OFFICES: 520 North Michigan Avenue, Chicago 11; 68 Post Street, San Francisco 4; McGraw-Hill House, London E. C. 4; 85, Westendstrasse, Frankfurt/Main; National Press Bldg., Washington 4, D. C.; Six Penn Center Plaza, Philadelphia 3; 1111 Henry W. Oliver Bldg., Pittsburgh 22; 55 Public Square, Cleveland 13; 856 Penobscot Bldg., Detroit 26; 3615 Olive St., St. Louis 8; 350 Park Square Bldg., Boston 16; 1301 Rhodes-Haverty Bldg., Atlanta 3; 1125 West Sixth St., Los Angeles 17; 1740 Broadway, Denver 2; 901 Vaughn Bldg., Dallas 1. ELECTRONICS is indexed regularly in The Engineering Index.

Subscription: Address correspondence to: Fulfillment Manager, Electronics, 330 W. 42nd St., New York 36, N. Y. Allow one month for change of address, stating old as well as new address. Subscriptions are solicited only from persons engaged in theory, research, design, production, management, maintenance and use of electronics and industrial control components, parts and products. Position and company connection must be indicated on subscription orders.

Postmaster: please send form 3579 to Electronics, 330 W. 42nd St., New York 36, N. Y.



Member ABP and ABC

SPACE COMMUNICATIONS. Talking to satellites and space ships will entail solving propagation problems that are literally out of this world.

Under sponsorship of the Air Force Cambridge Research Center, field stations all over the U. S., in Alaska, Greenland, Norway and Sweden, have been studying how signals from radio stars are bent, absorbed and otherwise abused as they penetrate the various layers of the earth's atmosphere. The Air Force's reason for settling in Eskimosville is that atmospheric and ionospheric propagation effects are most pronounced in the auroral zone.

Getting this first complete story on what's new under the midnight sun took New England Editor Maguire to project headquarters at Cambridge Research Center and to field stations in the Boston area. For Maguire's complete report on this wide ranging project, together with a rundown on a few new facts on interplanetary communication, see p 32.

TRENDS AND TALKS. Broadcasters from all over the U. S. had their say on a number of important issues at the recently concluded Chicago convention of the National Association of Broadcasters.

On hand to hear them was Electronics' Midwestern Editor, Hap Harris. Among the important developments he reports is the implementation of last year's FCC ruling allowing private microwave hookups by broadcast stations. A growth in station automation is also noted. For news on this and other trends, see p 47.

Coming In Our April 17 Issue . . .

SOLID-STATE PROGRESS. One of the most dynamic areas of our industry is in solid-state technology. Vast changes in circuits and circuit elements are augured by today's basic research into the properties of semiconductors and other materials. Already, many new devices and applications are in modern electronic systems.

Next week, Associate Editor Weber brings you up to date on some of the newest contributions of the solid-state treasure house. You'll learn how parametric amplifiers are proving their worth in the field, how a new microwave power source may revolutionize satellite communications, how computers are being shrunk by the use of new cryotron elements and thin films. You'll get details on the new solid-state version of the stepping tube and the versatile field effect current limiter.

MISSILE SCORING. In missile testing, since inert warheads are usually used, a method to indicate the closest approach of a missile to the target must be provided. A miss-distance-indicator system that uses neither pulsed nor doppler radar techniques is described by J. A. Adams of the Ralph M. Parsons Co., in Los Angeles.

The system consists of target and missile transponders, a recording ground station and high-gain directive antennas. Two uhf carrier frequencies carrying distance information in the form of pfm are used in the link between transponders.

IMPROVED DIRECTION FINDER. The effectiveness of direction-finders used in the 1.5 to 30-mc band for navigation has always been limited by multi-path propagation in the ionosphere, which causes rapid changes in indicated bearings.

According to J. F. Hatch and D. W. G. Byatt of Marconi Wireless and Telegraph Co., of England, accuracy can be greatly improved by averaging a number of readings over a period of time. Their article describes a system which performs this function automatically.

SPRAGUE® RELIABILITY in these two dependable wirewound resistors

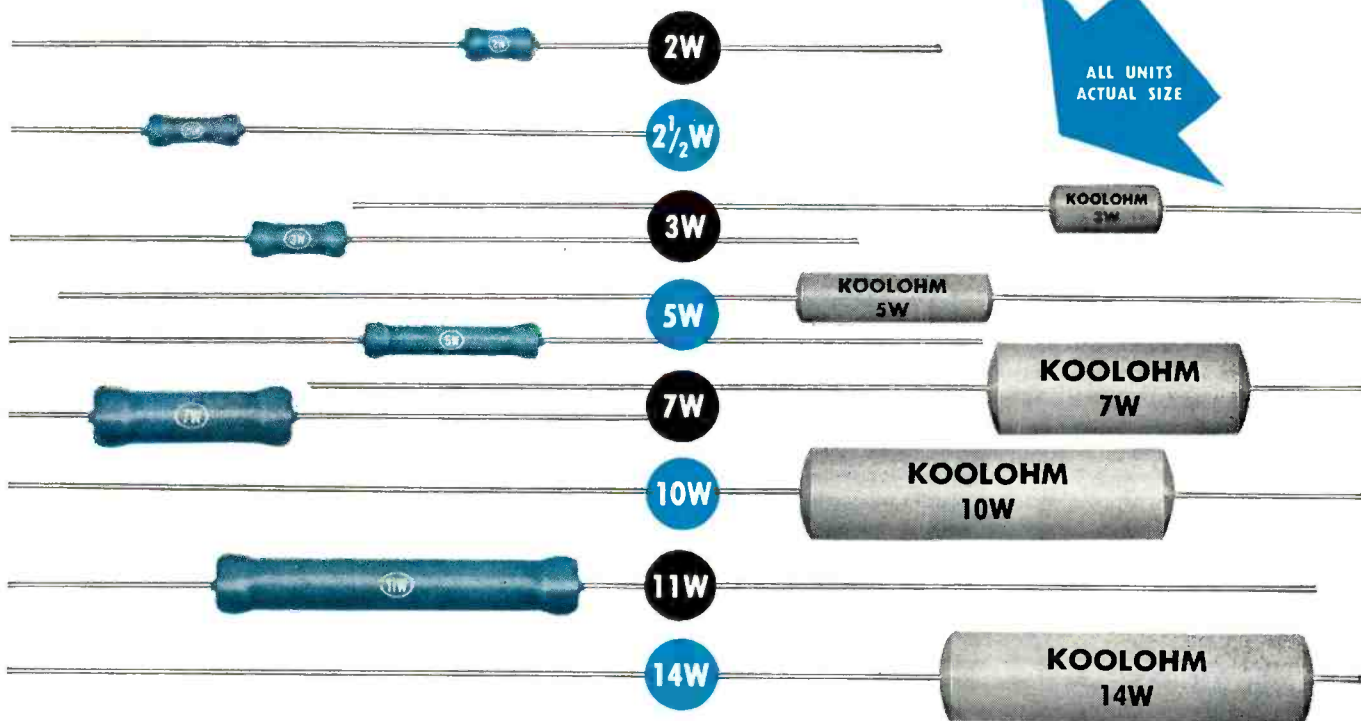

MINIATURE *Blue Jacket*® VITREOUS-ENAMEL POWER RESISTORS

Sprague's new improved construction gives even greater reliability and higher wattage ratings to famous Blue Jacket miniature axial lead resistors.

A look at the small *actual sizes* illustrated, emphasizes how ideal they are for use in miniature electronic equipment with either conventional wiring or printed wiring boards.

Get complete data on these dependable minified resistors, write for **Engineering Bulletin 7410**.

TAB-TYPE BLUE JACKETS: For industrial applications, a wide selection of wattage ratings from 5 to 218 watts are available in Sprague's famous Tab-Type Blue Jacket close-tolerance, power-type wirewound resistors. Ideal for use in radio transmitters, electronic and industrial equipment, etc. For complete data, send for **Engineering Bulletin 7400A**.

SPRAGUE ELECTRIC COMPANY

35 MARSHALL STREET • NORTH ADAMS, MASS.

NEW SMALLER SIZE *KOOLOHM*®

INSULATED-SHELL POWER RESISTORS

New Koolohm construction features include welded leads and winding terminations—Ceron ceramic-insulated resistance wire, wound on special ceramic core—multi-layer non-inductive windings or high resistance value conventional windings—sealed, insulated, non-porous ceramic outer shells—aged-on-load to stabilize resistance value.

You can depend upon them to carry maximum rated load for any given physical size.

Send for **Engineering Bulletin 7300** for complete technical data.



SPRAGUE COMPONENTS: RESISTORS • CAPACITORS • MAGNETIC COMPONENTS • TRANSISTORS
INTERFERENCE FILTERS • PULSE NETWORKS • HIGH TEMPERATURE MAGNET WIRE • PRINTED CIRCUITS

ELECTRONICS IN BRITAIN

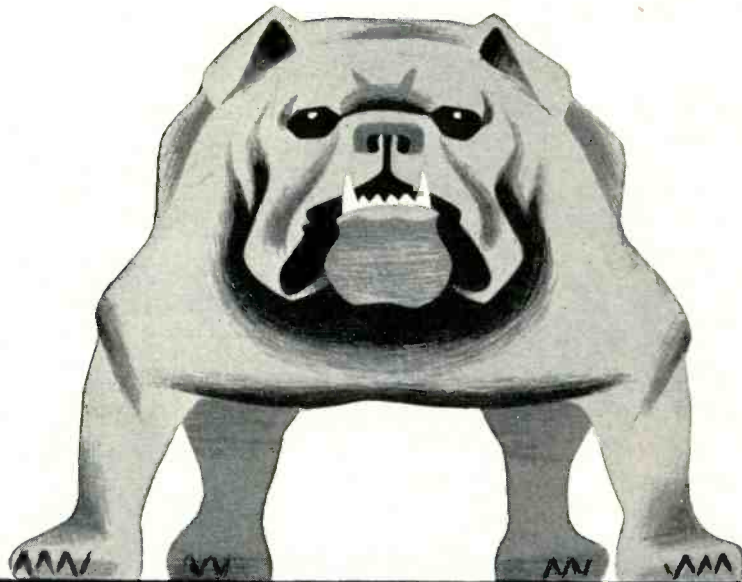

SEVEN TUBES FOR STEREO



EF86 6267

High gain AF input pentode with exceptionally low noise, low hum and low microphony.



ECC83 12AX7

Double triode, low hum, low microphony, low noise, high gain tube.



ECL82 6BM8

Miniature triode pentode for use as audio amplifier and output tube. Two tubes in ultralinear push-pull can supply up to 7 watts of stereo power per channel.



EL84 6BQ5

Miniature 12 watt high slope pentode. A medium power high fidelity tube particularly suitable for compact stereo circuits, up to 17 watts per channel.



EL34 6CA7

Highly sensitive 25 watt pentode. Two tubes in ultralinear push-pull providing up to 34 watts output, particularly suited for compact integrated stereo amplifiers.



EZ81 6CA4

Miniature full wave cathode type rectifier with high voltage and with good regulation supplying up to 150mA.

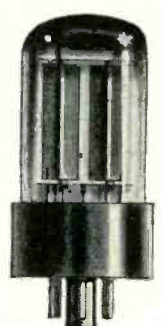

GZ34 5AR4

Bantall full wave cathode type rectifier, supplying high voltage with good regulation and with currents up to 250mA.

Supplies available from:
In the U.S.A.

International Electronics Corporation
81 Spring Street, N.Y. 12, New York,
U.S.A. Worth 6-0790.

In Canada

Rogers Electronic Tubes & Components
116 Vanderhoof Avenue, Toronto 17,
Ontario, Canada. Hudson 5-8621.

Mullard

ELECTRONIC TUBES used throughout the world

"Mullard" is the Trade Mark of Mullard Ltd., and is registered in most of the principal countries of the world.

MULLARD OVERSEAS LTD., MULLARD HOUSE, TORRINGTON PLACE, LONDON, ENGLAND



IF YOU DON'T MIND THE SCORE *

VITREOUS ENAMEL
POWER RESISTORS
MAY DO



The Temperature Coefficient of power wire wound resistors is a lot like golf. The higher the "score" the worse the performance. Even on special order, vitreous enamel coated PWW's are not guaranteed for a temperature coefficient of less than ± 80 p.p.m. (and they often run up duffer scores) whereas IRC Resisteg Coated Power Wire Resistors consistently average ± 25 p.p.m.

The reason is simple. Vitreous enamel units are cured at temperatures of 1200°F or over. At this temperature the turns of wire tend to loosen, shift and even short. Finer wire is therefore used to achieve wider spacing and turns are tension wound. The end result is a high tempera-



Vitreous Enamel Power Resistors best guaranteed score is at least ± 80 p.p.m. for Temperature Coefficient and then only on special order. But the par for IRC Resisteg Coated Resistors is only ± 25 p.p.m.

ture coefficient, and a substantial resistance change for any change in temperature.

On the other hand, IRC Resisteg Coated Resistors are cured at only 205°F or less, can be wound with a larger diameter wire, more closely spaced, and without extra tension. The Temperature Coefficient is about ± 25 p.p.m. after the cure or only slightly higher than that of the original wire. So why work with the high handicap resistor coating? Insist on IRC Resisteg Coated PWW's.

Write for new Power Wire Wound Resistor Bulletin C-1C.



Wherever the Circuit Says



INTERNATIONAL RESISTANCE COMPANY, Dept. 375, 401 N. Broad Street, Philadelphia 8, Pa.

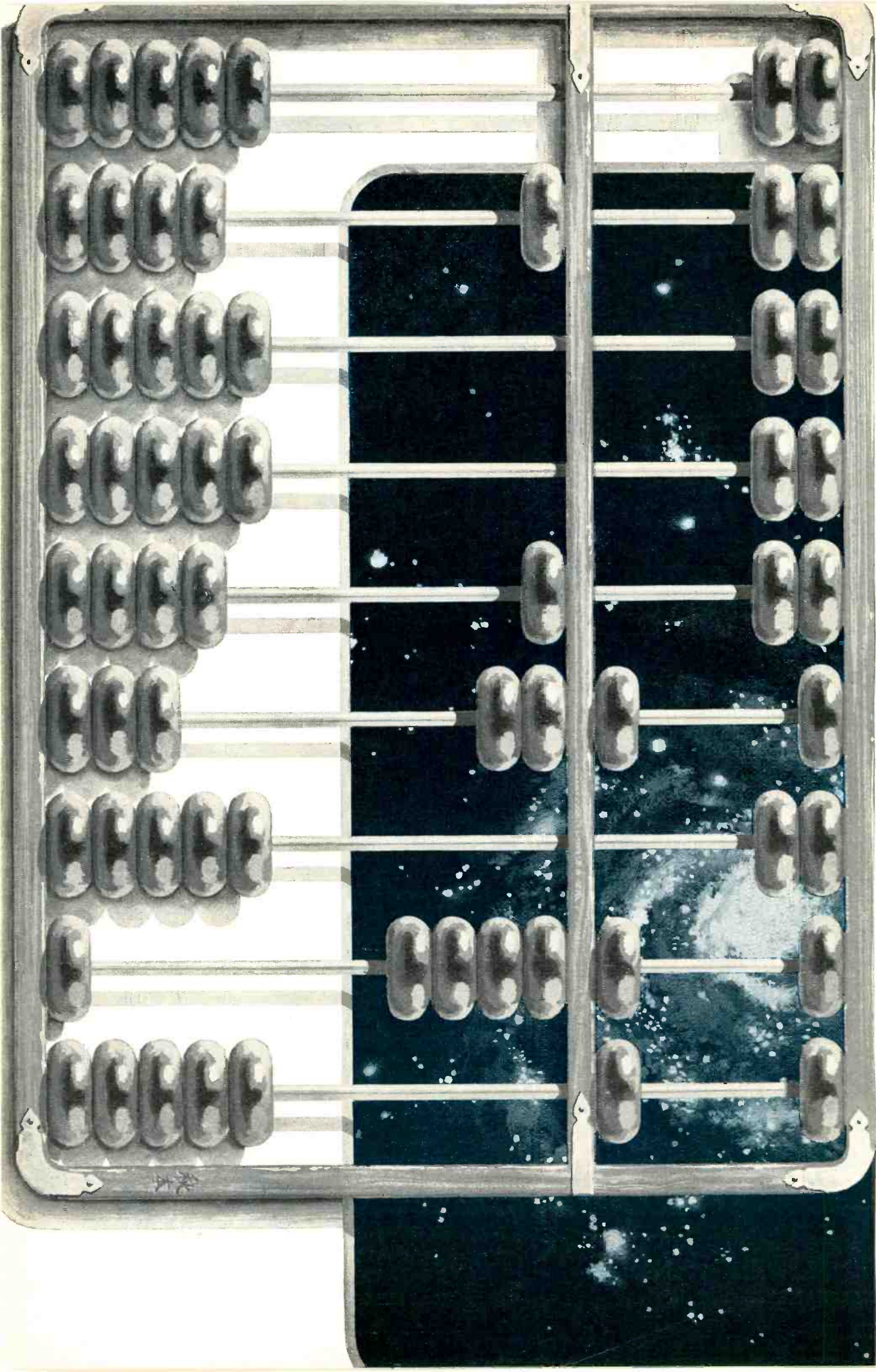



COMPUTER



RESEARCH

COMPUTER RESEARCH: Though computers cannot yet approach the memory capacity and versatility of the human brain as an information processing device, Lockheed research scientists are engaged in building artificial neurons patterned closely after those of the brain. Neurons are connected in large networks and their behavior patterns observed. Information obtained through this research is being used in the solution of elementary problems in learning and pattern recognition. Progress in this field is symbolized by the abacus — earliest form of computer.

EXPANDING THE FRONTIERS OF SPACE TECHNOLOGY

Lockheed's activities in the missile field began before World War II when the company designed and flew a pilotless aircraft for the Army Air Corps. Today the Missiles and Space Division embraces every facet of research and development, engineering, test, and manufacture. It has complete capability in more than 40 areas of science and technology, from concept to operation.

The Division's advanced research and development programs now under intensive study provide a fascinating challenge to creative engineering. These programs include: man in space; space communications; electronics; ionic, nuclear and solar propulsion; magnetohydrodynamics; oceanography; computer research and development; operations research and analysis; human engineering; electromagnetic wave propagation and radiation; materials and processes and others.

Such programs reach far into the future and deal with unknown environments. It is a rewarding future which scientists and engineers of outstanding talent and inquiring mind are invited to share. Write: Research and Development Staff, Dept. D-22, 962 W. El Camino Real, Sunnyvale, California.

"The organization that contributed most in the past year to the advancement of the art of missiles and astronautics."

NATIONAL MISSILE INDUSTRY CONFERENCE AWARD

Lockheed / **MISSILES AND SPACE DIVISION**

Weapons Systems Manager for the Navy POLARIS FBM; DISCOVERER SATELLITE; Army KINGFISHER; and Air Force Q-5 and X-7

SUNNYVALE, PALO ALTO, VAN NUYS, SANTA CRUZ, SANTA MARIA, CALIFORNIA
CAPE CANAVERAL, FLORIDA • ALAMOGORDO, NEW MEXICO • HAWAII

.01 db precision for
20 db measurement
with changes of .1 db
in level of r. f. source

WEINSCHEL

dual channel

INSERTION LOSS

TEST SET

Systems Accuracy .02 db/10 db

20 db attenuation range, direct.

40 db range with partial r.f.

substitution. Frequency Range:

20 MCS to 90,000 MCS

KEY INSTRUMENTS

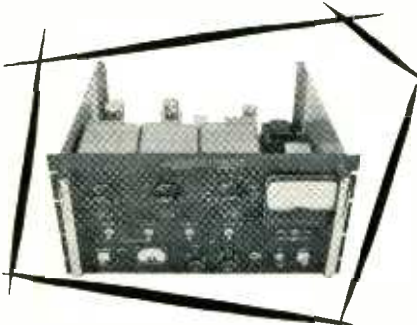

**Attenuation Calibrator,
Model BA-5**

Combines Precise Audio Substitution Attenuator, Bolometer Preamplifier and Level Indicator.

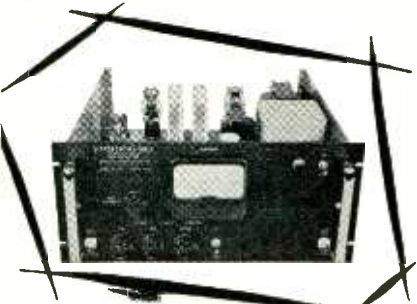

**Differential Null Detector,
Model ND-1**

Specifically designed for two channel loss measurements.

For theory, method, required instruments and recommended accessories, request Application Notes #4.

Weinschel Fixed Coaxial Attenuators cover the frequency range of DC to 12 KMC.

Write for complete catalog,

specifying frequency range of interest.



Weinschel Engineering
KENSINGTON, MARYLAND

CIRCLE 11 READERS SERVICE CARD

WASHINGTON OUTLOOK

HOUSE APPROPRIATIONS COMMITTEE investigators have made a full-scale study of reliability efforts in ballistic missile projects. Major conclusions: industry has not produced sufficiently durable and reliable units; there is inadequate testing of units in advance of final assembly; and military inspectors and inspection techniques have not kept pace with the complexities of modern weapons.

The committee proposes that reliability requirements be written into military specs. The Pentagon is also urged to place more emphasis on simultaneous environmental testing and simulated flight testing of units.

- **The Navy is pushing** a new program to improve tactical communications between shore installations and air, surface and underwater forces. Objective is to increase the range and reliability of radio voice communications and allow teletypewriter communications between commanders. Single-sideband gear is being introduced.

Right now, the stress is on line-of-sight ship-to-air and air-to-air communications. Major reliance is on double-sideband equipment in the ultrahigh frequency range. Here the Navy plans to boost power and incorporate rapid frequency-shifting features.

Navy is also evaluating an optical short-range tactical communications system. This will involve flashing light and provide multi-channel voice, teletypewriter or facsimile capabilities.

Also in the works is a plan to upgrade shore-to-fleet communications—increasing the reliable range, transmission speed and traffic capacity. New equipment for this shore-to-ship linkage will be installed on submarines and selected surface vessels.

To improve radio reception capabilities of completely submerged subs, construction of a very low frequency transmitting station in **Maine is being stepped up**, while construction of a companion transmitter in **Guam is planned**.

In shore communication networks, point-to-point circuits are being converted to single-sideband equipment with as many as 16 channels. Sometime this year the Navy will also start operating a Washington-Pearl Harbor circuit using the moon as a passive relay. This will provide great reliability and be immune to jamming.

Special R&D emphasis is being placed on two-way communications between submerged subs. The Navy considers as promising long-range underwater communications in the audio-frequency band.

- **Even though** the Air Force's fiscal 1960 budget provides funds for procurement of 40 more of Convair's electronics-laden, Mach 2 medium-range B-58 bomber, Pentagon insiders say the project is vulnerable to new production cutbacks. Sixty-six planes are now on order or have been delivered. Some officials are backing a plan to convert the plane into a long-range interceptor aircraft armed with air-to-air missiles.

The project was almost scuttled last fall when the new budget was put together. Although the project has survived, there are some influential Washington officials—either eager-beaver budget-cutters or backers of rival projects seeking more funds—still gunning for the B-58.

In top-level Pentagon councils arguments are still heard that the project should be trimmed or eliminated. The claims: the plane has only a "limited stand-off missile capability" and would require "reconfiguration" to handle presently planned air-to-surface missiles; that the plane's chief virtue is high speed over target—a bomber capability no longer considered as vital as before.

Now from **CLEVITE** . . .

HIGH POWER TRANSISTORS



Clevite offers new types with improved reliability and power handling capacity.

EIA REGISTERED TYPES WITH:

- Improved seal for long life.
- Saturation voltage less than 1 Volt at increased maximum rated current of 15 amperes.
- Average thermal resistance 0.7°C per watt.
- Current gain controls: 60-150 at 5 amperes.
- 100% test for resistance to transient burn out.
- Either standard pins or solder lugs.

TECHNICAL DATA

Typical Electrical Characteristics at 25°C

	2N1147 2N1146	2N1147A 2N1146A	2N1147B 2N1146B	2N1147C 2N1146C
Collector to Emitter Voltage Shorted Base (I _C = 1 amp)	30V (Min)	40V (Min)	60V (Min)	75V (Min)
Saturation Voltage (I _C = 15 amps)	1.0V (Max)	1.0V (Max)	1.0V (Max)	1.0V (Max)
DC Current Gain (I _C = 5 amps)	60-150	60-150	60-150	60-150
DC Current Gain (I _C = 15 amps)	35	35	35	35
Absolute Maximum Ratings				
Collector Current	15 amps	15 amps	15 amps	15 amps
Collector to Base Voltage	40V	60V	80V	100V
Collector to Emitter Voltage	40V	60V	80V	100V
Power Dissipation at 70°C Case Temperature	25W	25W	25W	25W
Junction Temperature	95°C	95°C	95°C	95°C

CLEVITE

TRANSISTOR PRODUCTS

241 Crescent St., Waltham 54, Mass. TWInbrook 4-9330

A DIVISION OF



OTHER CLEVITE DIVISIONS:

- Cleveland Graphite Bronze • Brush Instruments
- Clevite Electronic Components • Clevite Harris Products
- Clevite Ltd • Clevite Ordnance • Clevite Research Center
- Intermetall G.m.b.H. • Texas Division

Tensolite

RELIABLE HIGH TEMPERATURE WIRE & CABLE

Tensolite facilities are devoted exclusively to the engineering and manufacturing of miniature plastic insulated wire and cable—featuring Teflon insulation for high temperature (−90 deg. C. to +250 deg. C.) applications. 100 percent inspections before, during and after manufacture, part of the most rigid quality control program in the industry, assures reliability of the finished product.

"TEFLON" INSULATED CABLE

From large sizes using 6 AWG wire down to subminiature cables with 36 AWG single conductors, Tensolite makes multi-conductor cables to your specifications. Tensolite cables utilize the maximum number of conductors in a minimum of area—saving weight and space. They're available as ribbon cable or in standard round configurations. For demanding applications, we recommend individual conductors of our FLEXOLON wire.

HOOK-UP WIRE

TYPE E-EE TO MIL-W-16878

FLEXOLON WIRE

A new concept in high temperature insulation developed by Tensolite's research and development laboratories. FLEXOLON wire provides the best properties of wrapped and extruded fluorocarbon insulation. Important features of this versatile hook-up and lead wire are:

- Solid colors and striped combinations.
- Most flexible of all hook-up wire construction.
- High temperature range of −90 deg. C. to +250 deg. C.
- Greatest miniaturization in MIL-SPEC hook-up wire (smallest hook-up wire in the world).
- High dielectric strength (far exceeds required 600 V and 1000 V ratings).
- Consistent concentricity.
- Superior cut-through resistance.

TENSOLON WIRE

Insulated with TFE fluorocarbon high temperature resin.

Choose from:

Spiral wrapped...with special cross-lapped construction and unlimited color coding; striping that meets commercial and military specifications.

Extruded...featuring an extruded homogeneous Teflon TFE resin (solid and inked stripe combinations).

TENSOLEX WIRE

Insulated with extruded vinyl plastic.

Types B and C meet MIL-W-16878. They are high temperature hook-up wires rated for continuous use from −55 deg. C. to +105 deg. C. with or without nylon jackets.

TENSOLEX WIRE

Types WL and SRIR are manufactured in accordance with the joint Army-Navy specification JAN-C-76 (Qualification approval Certificates Nos. 13725 and 13606A).

Types LW and MW are general purpose hook-up wires specifically designed for radio, instrument, and military electronic applications. Designed to meet MIL-W-76A, they are recommended for use at temperatures up to 80 deg. C. in the internal wiring of electrical and electronic equipment.

TENSOLITE WRAPPED VINYL WIRE

Super-flexible wire designed for miniaturization applications at operating temperatures from −40 deg. C. to +60 deg. C.

AIRFRAME WIRE

TENSOLON AIRFRAME WIRE

Insulated with high-temperature resin, it is manufactured in compliance with MIL-W-7139A. Important features are:

- −90 deg. C. to +250 deg. C. temp. range.
- 600 Volt and prescribed overload operation.
- Rugged, abrasion resistant construction.
- Short-time operation in event of fire.
- High resistance to chemicals.
- Excellent flexibility.

COAXIAL CABLE

TENSOLON MINIATURE COAXIAL CABLE

Designed to meet MIL-C-17B, it is ideal for high frequency operation from −90 deg. C. to +250 deg. C. Insulation assures extremely low loss, high dielectric strength, and complete resistance to moisture and chemicals. A great variety of outer jackets permits the selection of cable well suited for many application requirements.

MAGNET WIRE

TUFFLON MAGNET WIRE

High temperature Teflon insulated magnet wire—designed to meet MIL-W-19583—is ideal for coils and windings requiring high temperature application. It is supplied in wall thicknesses ST, HT, TT and QT and AWG sizes 18 through 44.

OTHER PRODUCTS

Ignition Cable

Low Capacitance Cable

Wire Coated with Teflon

Teflon Inks

Asbestos Wire
to MIL-C-25038

Air Dielectric Cable

100X FEP Resin

Bondable Wire

Antenna Wire

Low Noise Cable

100% Shielded Wire

Etched Wire

Thermocouple Wire

Tempered Magnet Wire

Ribbon Cable Shielded
and Unshielded

High Flex Wire and Cable

Double Quad Lead Wire

Nickel Plated Conductor



Tensolite

INSULATED WIRE CO., INC.

West Main Street, Tarrytown, New York • Telephone: MEdford 1-2300

Pacific Division: 1516 N. Gardner Street, Los Angeles, California

FLEXOLON is a trademark of Tensolite Insulated Wire Co., Inc. • TEFLON is a registered trademark of the du Pont Company

ENGINEERING FACTS ABOUT

TEFLON®

FLUOROCARBON RESINS

NUMBER 2
IN A SERIES

ELECTRICAL
DESIGN
WIRING
RELIABILITY

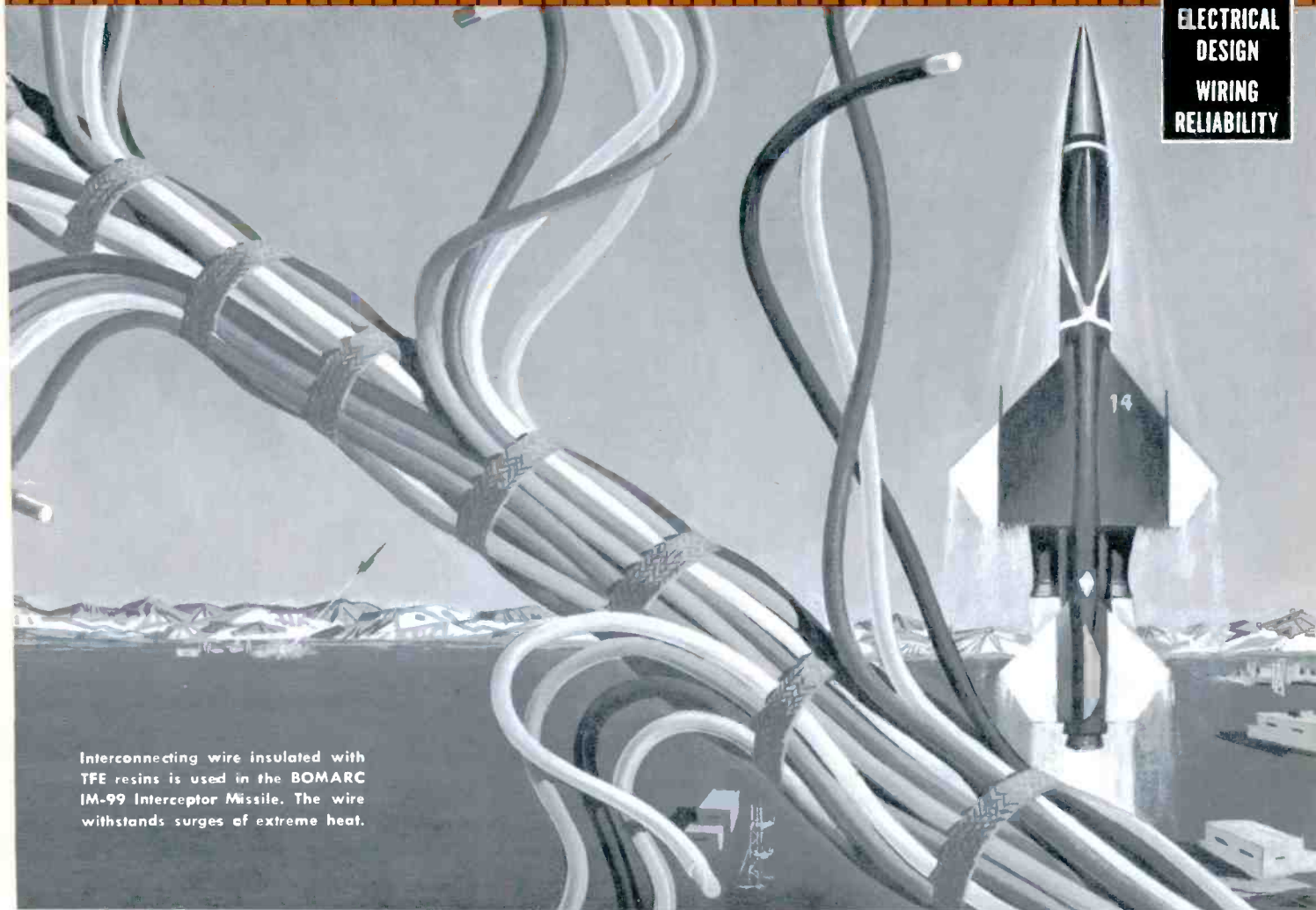

Interconnecting wire insulated with TFE resins is used in the BOMARC IM-99 Interceptor Missile. The wire withstands surges of extreme heat.

Insulation of TFE resins meets stringent specifications, with cost and weight savings

TEFLON resins are unique as dielectric materials. No other wire and cable insulations are able to offer such outstanding resistance to so great a number of extreme ambient conditions. No other insulations can provide such excellent electrical properties in the face of widely different operating requirements.

In guided missiles, for example, wire and cable insulated with TFE resins must withstand extreme heat, extreme cold, proximity to highly corrosive oxidizers and fuels, exposure to corrosive hydraulic fluids, flexing, vibration, and other mechanical stresses. Yet—under a combination of these conditions—signal and power are delivered with minimum transmission losses.

TFE resins are conservatively rated for a continuous

upper operating temperature of 260°C. In intermittent use they can withstand bursts of heat lasting for minutes at temperatures as high as 538°C. (1000°F.). The dielectric properties of TFE-fluorocarbon resins are extremely stable over great ranges of frequency, temperature and time.

In the next three pages you will see how TFE resins can help you overcome many severe design conditions—with savings in weight, space and costs!

DU PONT

REG. U. S. PAT. OFF.

BETTER THINGS FOR BETTER LIVING . . . THROUGH CHEMISTRY

OVER

*Measurements made on commercially available hookup-wire samples

der severe environmental stresses.

Insulation of TFE resins meets stringent specifications, with cost and weight savings

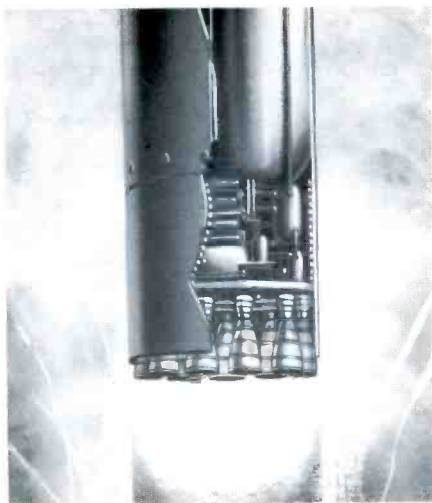

ROCKETDYNE—Wire insulated with TFE resins is used to insure maximum reliability in Rocketdyne engines for the Thor and Atlas missiles. In these applications, the insulation must withstand high-temperature overloads, possible exposure to corrosive or reactive missile fuels, the severe cold of liquid fuel temperatures, and extreme vibration and shock. (Photo courtesy of Rocketdyne, a division of North American Aviation.)



DEW LINE—TFE resins were selected as coaxial cable dielectrics for many of the radar circuits for the Dew Line project, to insure reliability in arctic environments. This insulation design enabled considerable weight and space savings for equivalent power capacity, an important factor in arctic transportation. TFE resins maintain excellent dielectric properties despite the cold, and do not crack or embrittle at low temperatures.

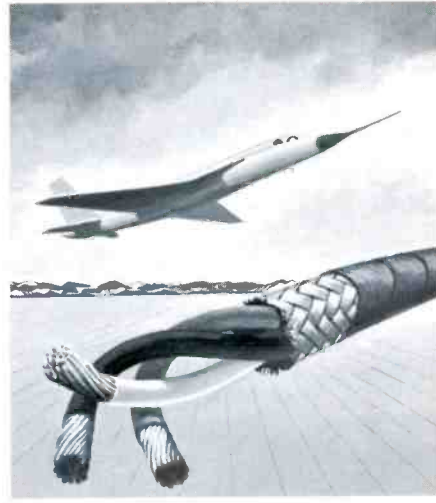

NORTH AMERICAN A3J MULTI-CONDUCTOR CABLE—In the design of the A3J Bomber, engineers at North American Aviation found that wire insulated with TFE resins could save precious weight, without sacrificing reliability. This three-conductor cable using primary insulation of Du Pont TFE-fluorocarbon resins enabled a weight saving of 8 lbs. per 1,000 feet of cable. (Photo courtesy of North American Aviation.)

Design specifications involving cramped spaces, tight wiring and high ambients are often best met by wire insulated with TFE resins. The resins simplify assembly. Their excellent high temperature cut-through resistance and high dielectric strength make possible the use of miniaturized types of wire and cable. TFE resins withstand high transient overloads. Soldering-iron and dip-soldering temperatures do not injure them. Their use speeds production.

TFE resins offer a recognized economic advantage over other insulations, even though the others may have a lower initial cost. Savings during manufacture of assemblies, reduced inspection costs, fewer service failures and

lower maintenance costs are only a few of the ways TFE resins save money. In aircraft and guided missiles where every ounce of weight lifted requires a large power expenditure, the use of TFE resins is desirable on economic grounds alone.

Insulation of TFE resins is rapidly becoming a design standard where extreme environmental conditions are encountered in service or storage. Even for service where ambient conditions are undemanding, TFE resins are finding use because of *reliability* due to their non-aging characteristics. The service and storage life of equipment can be extended with insulation of TFE resins, regardless of ambient conditions.

FOR MORE INFORMATION . . .

You'll want to know just what types of wire and cable insulated with TFE resins are available for your use. Call your local supplier of TFE-fluorocarbon resins for product and property data (he's listed in the Yellow Pages under "Plastics"). For any unanswered technical question about these resins, write to: E. I. du Pont de Nemours & Co. (Inc.), Polychemicals Dept., Rm. 2524, Nemours Bldg., Wilmington 98, Delaware

In Canada: Du Pont of Canada Limited, P. O. Box 660, Montreal, Quebec

TEFLON is Du Pont's registered trademark for its fluorocarbon resins, including the TFE (tetrafluoroethylene) resins discussed herein.

TEFLON®

TFE-FLUOROCARBON RESINS



BETTER THINGS FOR BETTER LIVING . . . THROUGH CHEMISTRY

A MILLION FEET KEPT IN FACTORY STOCK *

TEFLON[®]

WIRE AND CABLE

BY

REX

*In addition to major stock kept in Los Angeles at Mil-Spec Supplies, 17468 Ventura Blvd.

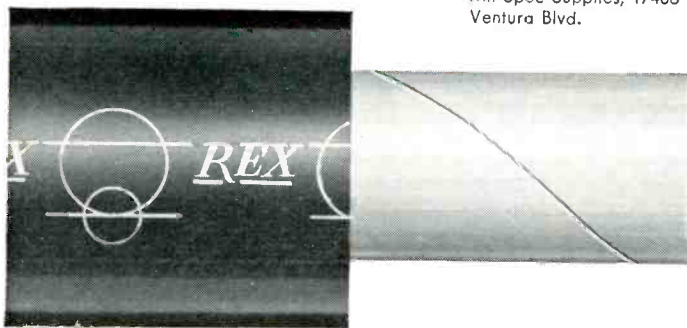

VERSATILITY IN WIRE SIZES — Rex carries in stock standard sizes of Teflon insulated hook-up wire, from #32E to #10EE.

VERSATILITY IN EXPERIENCE — Rex has had long experience extruding Teflon TFE Resins, Teflon FEP Resins and other halogenated materials — can wrap and jacket with Teflon and Teflon-impregnated Fiberglas.

VERSATILITY IN FACILITIES — Rex is your best source for all types of high temperature hook-up wires, miniature coaxial and multi-conductor cables — has cabling facilities second to none among Teflon insulators.

Rex Durastriping for color-coding is indestructible — better than inks. Rex special cables always receive 100% inspection. Rex's testing laboratory is qualified to perform under Mil Q-5923.

Send for complete technical data

THE **REX** CORPORATION

Subsidiary of American Enka Corporation
Hayward Road, West Acton, Mass.

®Reg. Trademark,
E. I. Du Pont De Nemours

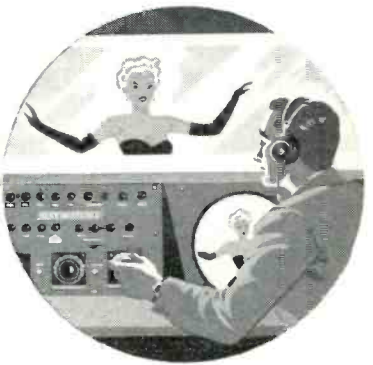
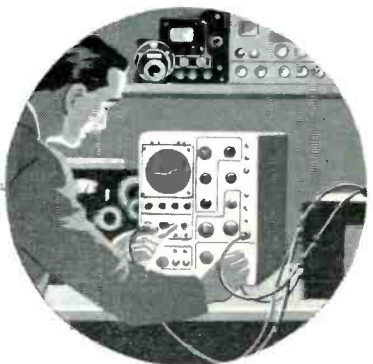
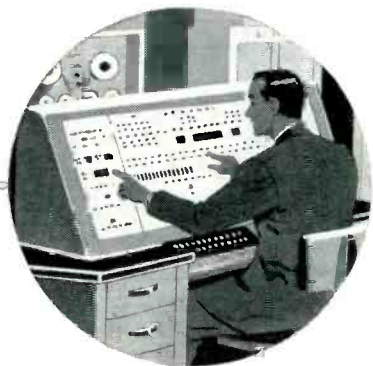

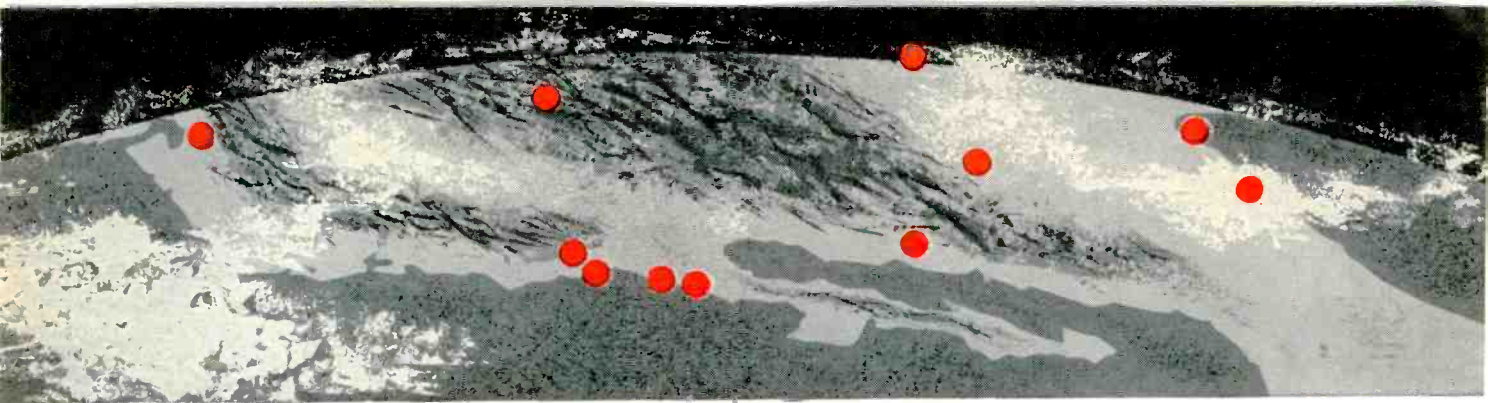

Where the shape of things to come

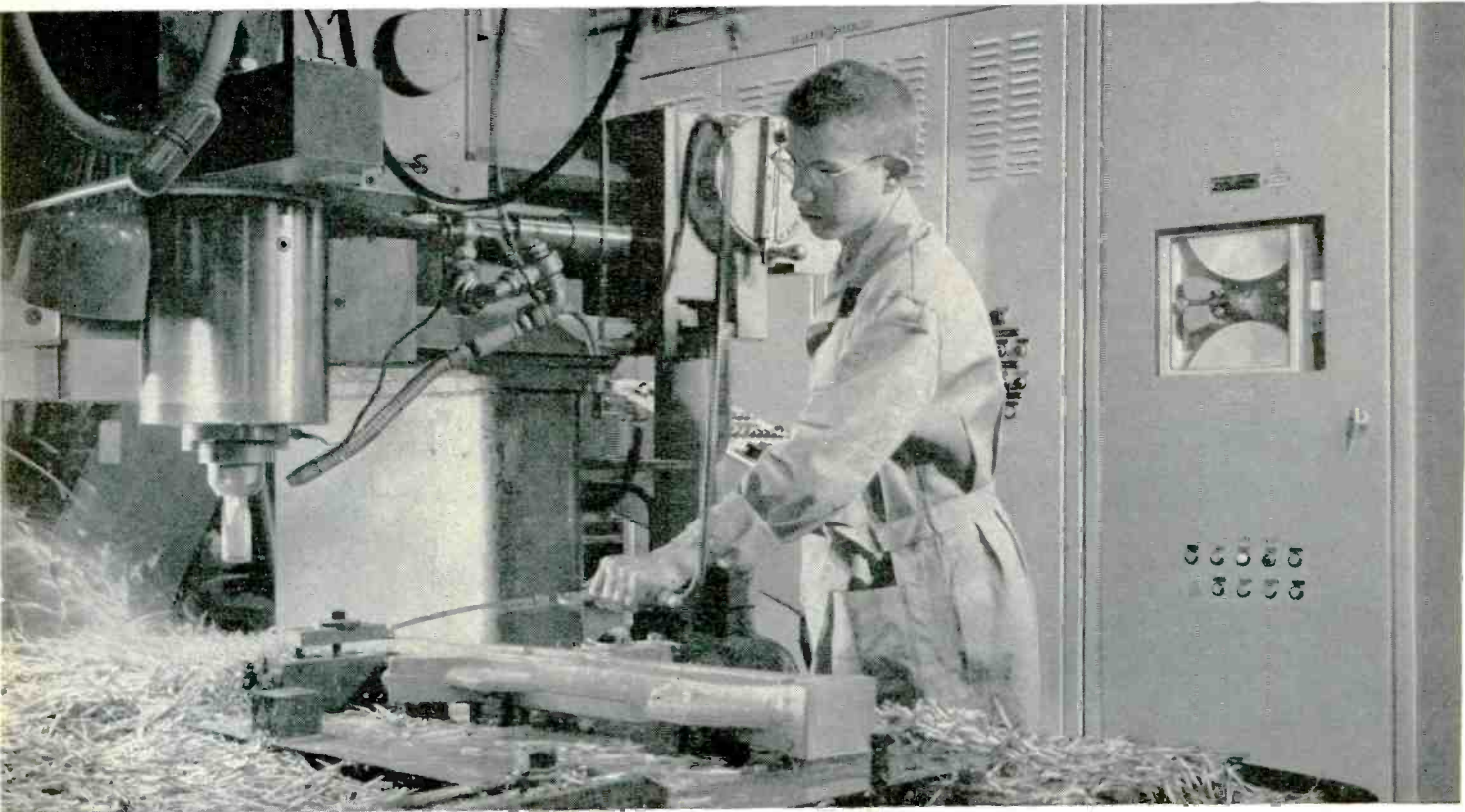

is programmed by AMPEX tape recorders

The profiler above is shaping parts for new Lockheed Electras. Exact tool positions are being defined by command signals—as many as 200 per second—from the Ampex FR-100 in the control system to the right of the machine.

The accuracy of such a milling operation increases with the number of points defined per inch of tool motion. One reel of magnetic tape defines millions of points, programming up to 1½ hours of continuous machine operation. Recycling a tape loop will program an entire run of identical work-pieces.

Shaping parts by command signals from Ampex-equipped automatic control systems is now routine production operation at such places as Lockheed in Burbank, Martin at Denver, Rohr at Chula Vista, Convair at Ft. Worth and San Diego, and Giddings & Lewis at Fond Du Lac, to mention only a few.

Even though punched cards and paper tape are still proving

adequate for many of today's less-sophisticated automatic control installations, systems engineers are increasingly interested in the superior speed and data-handling advantages of magnetic tape. An Ampex FR-300, for instance, can extract a short burst of digital information equal to that on an entire punched card in less than 4 milliseconds, including start and stop.

In configurations like the one illustrated, the advanced Ampex FR-100A, with its 14 tracks on 1-inch tape, has ample reserve for extra functions. Six tracks may be used for tool-position coordinates; others for start, stop, coolant, or even voice instructions.

Whether you believe the future of automatic control lies in point-to-point positioning, continuous-path control, or both—Ampex magnetic tape recorders have built-in reserve capabilities which make them worthy of consideration as a component for any control system designed for tomorrow's needs.

First in magnetic tape instrumentation



AMPEX INSTRUMENTATION DIVISION
934 Charter Street, Redwood City, California
Offices in USA and Canada. Engineering representatives cover the world.

Consumer Shares Hold Firm

AS 1959 MOVES into its second quarter, financial reports from consumer electronics firms indicate a favorable financial position and good prospects for the year.

• **Philco Corp.**, Philadelphia, has begun implementation of an agreement with **Thorn Electrical Industries, Ltd.**, London. Terms call for making Philco's designs and developments in radio and monochrome tv available to Thorn for manufacture and sale in the United Kingdom. In addition, Thorn acquires all issued capital stock of Philco (Overseas) Ltd., the Philadelphia company's radio and tv unit in England.

• **Zenith Radio Corp.**, Chicago, announces record sales of \$195,041,624, a 22 percent increase for 1958 over the \$160,018,978 total for 1957. Profits for last year came to \$12,116,165 or \$12.30 a share, compared with \$8,165,577 or \$8.29 a share in 1957.

• **Electro Voice Inc.**, Buchanan, Mich., has offered 150,000 shares of common stock on the public market through F. S. Moseley & Co., N. Y. Net proceeds will be used for retiring short-term loans and adding to plant facilities. Consolidated net sales for the Michigan firm last year totaled \$8,493,419, an increase of \$1,302,457 over 1957. The firm's principal products include speaker systems, microphones and audio equipment.

• **Olympic Radio and Television**, Long Island City, N. Y., reports expectations of a high sales peak during the early part of this year. This is based on an increase in January of 33 percent over the same period in 1958. Public interest in stereo is seen as the spur.

• **The Magnavox Co.**, Ft. Wayne, Ind., reports that sales for the first half of this year look promising although a slight dip in earnings was noted for the last half of 1958. Net earnings during that period totaled \$2,222,000, as com-

pared with \$2,407,000 for the first six months of last year. The firm reports back orders of "well over \$40 million in both industrial and military products."

• **Admiral Corp.**, Chicago, reports a small decline in 1958 sales which totaled \$170,777,126, compared with \$172,663,167 in 1957. The difference in earnings is reportedly due to operating losses by the firm's now discontinued plastics division.

OVER THE COUNTER

1958	BIDS	COMMON	WEEK ENDING		
LOW	HIGH	STOCKS	Mar. 20		
			BID		
			BID ASKED		
3 3/4	20 1/2	Acoustica Assocs	29	38	44
1 7/8	3	Advance Industries	3 1/2	3 1/4	4
3 1/8	6 5/8	Aerovox	6 7/8	8 1/4	9 1/4
5 1/2	15	Appl'd Sci Princet	11 1/2	10 1/4	12 1/4
1 1/8	8 7/8	Avien, A	8 1/4	8 5/8	10
6 3/4	24	Baird-Atomic	27	27 1/4	31 3/4
9 3/4	13 3/8	Burndy	16 1/2	15 3/4	17 3/4
6 3/4	9	Cohu Electronics	8 3/8	8 1/4	9 1/8
11	22 1/2	Collins Radio, A	31 1/2	33 1/2	37 3/4
10 1/4	22 1/4	Collins Radio, B	31 1/2	33 1/2	37 1/4
4	7	Craig Systems	9 3/8	10 1/4	11 3/8
17 5/8	25 3/8	Eastern Industries	22	20	23 7/8
1 3/4	8 3/8	Elco Corp	8 5/8	8 1/2	9 5/8
10 1/2	21	Electro Instr	27 3/4	28 3/4	32
34	49	Electronic Assocs	46	41	47 3/4
5	11	Electronic Res'rch	20	19	23
8 1/2	12 3/4	Electronic Spec Co	13 1/4	14 1/4	15 3/8
15 1/4	49 1/2	Epsco, Inc	36	38	45 5/8
5 1/2	9 3/8	Erie Resistor	9 3/4	9 5/8	11 1/4
10	17 1/2	Fischer & Porter	15 3/8	15 1/4	17 3/4
5 1/2	10 1/2	G-L Electronics	15	15 1/4	17
12	27	Giannini	27 1/4	29	32 3/4
...	...	Haydu Elec Prod	5 1/4	5 1/4	6 1/2
30	39 1/2	Hewlett-Packard	43 1/2	47 3/4	51 5/8
23 1/4	48	High Voltage Eng	64 1/2	55	66 1/2
13 1/4	3	Hycon Mfg	4 1/4	3 5/8	4 7/8
1 1/8	5 1/8	Industro Trans'or	3 1/2	4 1/2	5 5/8
...	...	Internat'l Rec't'r	—	26 1/4	29 1/8
...	...	Interstate Engin'g	—	31 1/2	34 5/8
1 1/2	4 3/4	Jerrold	5 3/4	6 1/8	6 3/4
21	30	D. S. Kennedy	31 3/4	33 1/4	37 3/4
3 3/4	29	Lab For El'tronics	36 3/4	35	39 5/8
19 1/4	28	Leeds & Northrup	29 1/4	28 1/2	31 1/2
2	3 1/8	Leetronics	2 5/8	3 1/8	4 1/4
5	18 3/4	Ling Electronics	23	25 1/4	29 1/4
3 1/4	8 1/4	Magnetic Amplifiers	10	10	11 5/8
2 7/8	4 1/2	Magnetics, Inc	5 1/4	5 1/8	5 3/4
4 5/8	12	W. L. Maxson	13 3/8	13 1/4	16 1/4
10 5/8	29	Microwave Assocs	40	43	48 1/4
5 1/4	11 3/4	Midwestern Instr	11 5/8	11	13 3/8
1 1/8	7	Monogram Prec's'n	11 3/4	13 3/4	15 1/8
3 1/2	7 1/4	Narda Microwave	7	7 3/4	9 1/8
...	...	Narda Ultrasonics	8 1/2	11 1/2	13 3/8
9 3/4	16	National Company	21 1/2	20 3/4	23 1/4
14 1/4	56	Nuclear Chicago	40	39	44
4 1/2	7 3/8	Pacific Mercury, A	13 1/4	12 3/4	15 1/8
10 1/8	27 1/2	Packard-Bell	40	40 1/2	44
4 1/4	9 3/8	Panellit, Inc	7 1/2	7 3/8	8 3/8
21	53 3/4	Perkin-Elmer	49 1/2	45 1/4	51 7/8
11 3/8	19 1/2	Radiation, A	21 3/4	23 3/4	25 7/8
2 1/8	7 3/8	Reeves Soundcraft	8 1/4	7 7/8	9 1/8
13	32 1/2	Sanders Associates	27	28 1/2	32 1/2
...	...	Silicon Transistor	7 3/4	7 3/4	9 1/2
7	12	SoundScriber	19 1/2	18	20 1/8
22 3/4	40	Sprague Electric	43 1/2	44 1/2	49
26	35	Taylor Instruments	36 1/2	36 1/4	39 5/8
5 1/2	15	Technical Operat'ns	—	22	35 5/8
5 1/2	15 3/4	Telechrome Mfg	21	24 1/2	29 7/8
3 1/4	7 3/4	Televcomputing	11 3/4	12 1/4	14 1/2
1 1/8	2 3/4	Tel-Instrument	2 3/4	2 1/2	3
8 3/4	16 1/4	Topp Industries	13 1/4	14 1/4	16 5/8
3 3/4	10 3/4	Tracerlab	12 3/4	12 1/2	14 3/8
1 1/8	3 3/8	Universal Trans'or	7 5/8	7 5/8	11 1/8
14 1/4	40	Varian Associates	46 3/4	49 3/4	55 1/4

The above "bid" and "asked" prices prepared by the NATIONAL ASSOCIATION OF SECURITIES DEALERS, INC., do not represent actual transactions. They are a guide to the range within which these securities could have been sold (the "BID" price) or bought (the "ASKED" price) during preceding week.



AMPEX: turning point for tape

Magnetic recording has reached the point where a better tape, by itself, can significantly improve the performance of your equipment. Anticipating this, Ampex has developed its Instrumentation Tape to assure the highest capability that the state of the art requires.

Precision tape reliability comes principally from the properties of its coating. And Ampex combines oxide preparation and careful coating techniques with the exclusive Ferro-Sheen process to produce the smoothest, most cohesive, most uniform of precision tapes. The result is measurably higher signal-to-noise ratios, and much less tape wear.

This, with its squared-up hysteresis curve, makes Ampex Instrumentation Tape ideal for all recording systems: direct, FM-carrier, PDM, and NRZ-digital.

Ampex Instrumentation Tape is available on hubs, NAB-type or die-cast magnesium - alloy Precision Reels. Widths of 1/4", 1/2" and 1" are standard on either Mylar* or acetate base, in the following lengths, reel diameters, and base thicknesses:

AMPEX STANDARD TAPE LENGTHS (feet)		
REEL DIAMETER	BASE THICKNESS (mils)	
	1.0	1.5
7"	1800	1250
10 1/2"	3600	2500
14"	7200	5000

*DU PONT TRADEMARK

For complete specifications or additional tape literature, write

AMPEX MAGNETIC TAPE

934 CHARTER STREET, REDWOOD CITY, CALIF.

CIRCLE 18 READERS SERVICE CARD

100 CPS X-Y RECORDING

with immediate
readout

THE NEW SANBORN
MODEL 670 OPTICAL
X-Y RECORDER HAS

- ★ 1% linearity
- ★ frequency response
3 db down at 130 cps
independent of amplitude
- ★ writing speeds to
2500 in/sec.
- ★ 8" x 8" direct print
paper chart
- ★ trace monitoring on
phosphorescent screen

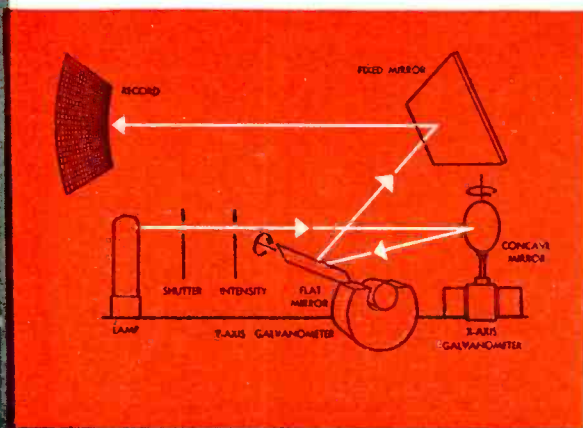
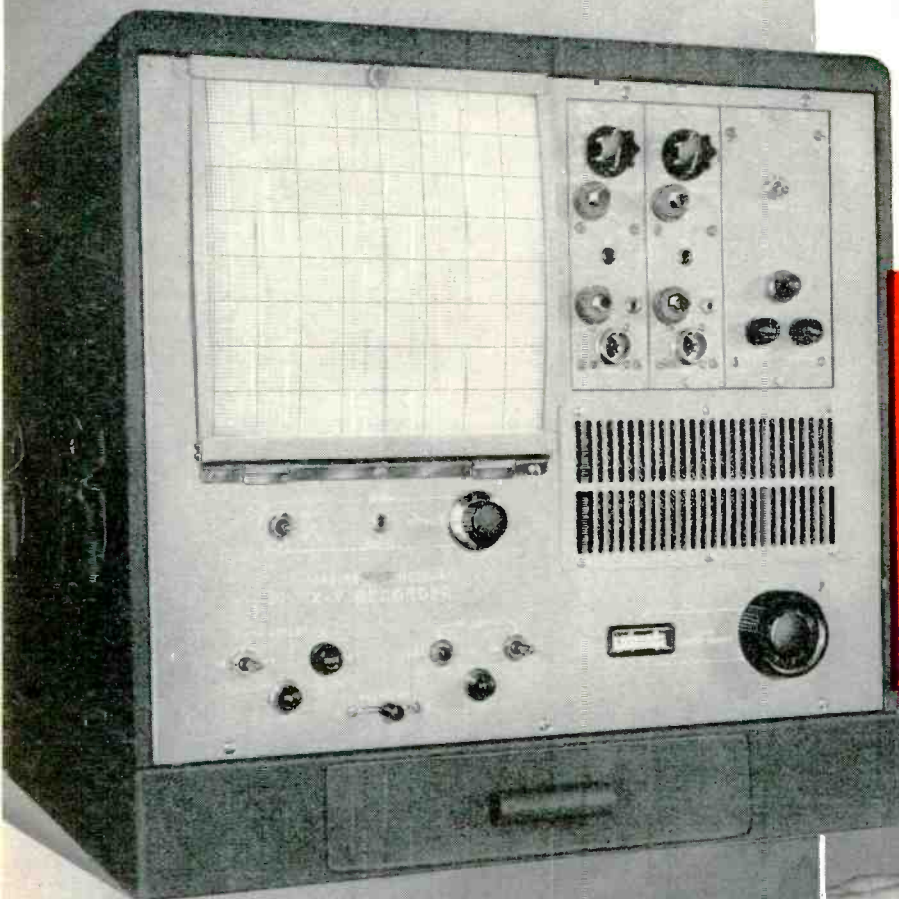

X-Y RECORDING never before possible with electromechanical instruments can now be done with the new Sanborn Model 670 X-Y Recorder. Direct writing on ultraviolet-sensitive recording paper by a beam deflected by optical galvanometers makes possible the combination of fast writing speed and 130 cps frequency response not found in any other X-Y recorder. Transistor characteristics, acceleration and vibration of mechanical parts and events of similar short duration can be recorded with linearity of 1% of full-scale and at trace speeds as fast as 2500 inches per second. Square wave response exhibits no greater than 1/2% overshoot at any amplitude; sensitivities as high as 62.5 uv/inch (depending on preamplifier used).

PLOTS OCCUPY AN 8" x 8" RECORDING AREA and can be previewed or monitored on the instrument's phosphorescent screen. An Axis Record switch to print X and Y axes on the record, and a Beam Intensity Control to assure maximum trace clarity, are among the front panel controls provided. An 8" x 8" sheet of the ultraviolet-sensitive chart paper (stored in drawer at base of cabinet) is easily placed on the back of the hinged screen. Brief post exposure in normal room light is the only developing process.

OPTIONAL INTERCHANGEABLE PREAMPLIFIERS for each axis presently include the Model 850-1300B DC Coupling and Model 850-1200 Phase Sensitive Demodulator; a Carrier Preamplifier, High Gain Preamplifier and a time base generator are now in development. Driver Amplifiers are compact, fully transistorized plug-in units with single-ended input and output. Galvanometers are low resistance, low voltage units of rugged, enclosed construction; sensitivity and damping are independent of coil temperature. Accessible, unitized circuitry also extends to the power supplies — a front-panel plug-in for both preamplifiers and a second supply for both driver amplifiers. A built-in blower provides constant, forced filtered air cooling. The Recorder can be rack mounted in 15 3/4" of panel space, or housed in its own 20" x 20" x 21 1/4" optional portable cabinet.

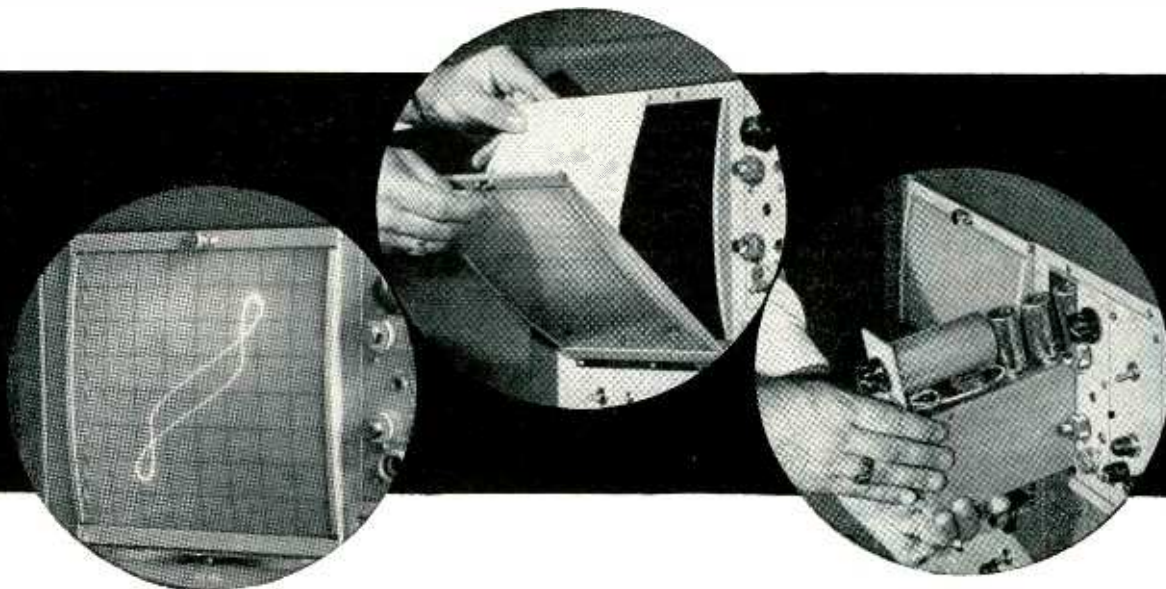

Ask your local Sanborn Sales-Engineering Representative for complete information on the Model 670 X-Y Recorder, or write the Industrial Division in Waltham, Mass.

SANBORN COMPANY

INDUSTRIAL DIVISION • 175 Wyman Street, Waltham 54, Massachusetts

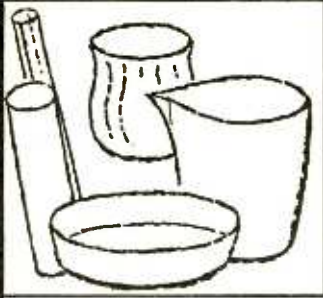

**OFFERS THE FINEST
PROPERTY VALUES
FOR FINER PRODUCTS**

- Absolute Chemical Purity
- Extreme Heat Resistance
- Thermal Shock Resistance
- Chemical Inertness
- Outstanding Electrical Properties
- Full Range Radiant Energy Transmission

In laboratories and other applications where critical requirements must be met, there is no room for second best. Vitreosil possesses properties of greatest value for: ultra-violet applications, metallurgical investigations, chemical research, photochemistry, spectroscopy, and many uses in physical, optical and electrical research as well as product operations.

Vitreosil is available in an unusually wide variety of types and sizes—Or, we'll be happy to fabricate to your specifications. Write us about your requirements today. For your convenience, use the coupon below. See our ad in *Chemical Engineering Catalog*.

**THERMAL AMERICAN
FUSED QUARTZ CO., INC.**
18-20 Salem Street,
Dover, New Jersey

Please send technical data on

Company _____
Name _____
Street _____
City _____ Zone _____ State _____

CIRCLE 21 READERS SERVICE CARD

MARKET RESEARCH

Predicts Boom for New Diode

PARAMETRIC amplifier diode industry sales will total many million units annually within three years, predicted Paul Petrack, silicon products manager for the ITT Components division, at its recent industrial sales meeting.

The parametric diodes will be widely used as high speed switching devices in computers and long range communication, Petrack says. Computer use will be especially heavy.

By 1962 average unit price of the parametric amplifier diode is expected to drop to about \$1.50. This diode was introduced on the market only a few months ago at average price of \$150. Price quickly dropped to \$35.

Silicon diode and rectifier industry sales this year will top \$50 million, says Bob Deutsch, division's field sales manager. Estimate is almost double sales of \$26 million in 1958. New zener diodes will get sizable chunk of the 1959 total, about \$9 million, he says.

Combined industry sales of tantalum capacitors and glass seals will hit \$33 million, Deutsch says. Tantalum capacitor sales total in 1958, according to industry estimates, was about \$20 million or nine million units. ITT's production of tantalum capacitors has been in limited quantities. But it expects to swing into large scale production soon.

Selenium rectifier industry market still looms large, says Walter F. Bonner, division's selenium products manager. Sales will total \$22 to \$23 million in 1959, he says. This estimate compares with sales of \$26 million in 1958 and forecast of sales of \$19 million in 1960. At present market is divided between \$5 million of home entertainment sales and \$18 million of industrial and other sales.

● Development cycle for new components can be materially shortened by developing applications along with the component, says Charles Thornton, vice president of ITT Labs. For instance, ITT shaved two years off the nor-

mal component development span for a new parametric amplifier diode by parallel development of the application, an r-f amplifier subsystem for a display unit. Integration of component and application development efforts provided division's sales force with a ready-made component market, Thornton points out.

● Military demand will result in rising sales of special resistors for the next few years. Needs are for low wattage hi-stability resistors (1/8th watt or less) of the deposited carbon and metal film types. Demand for these resistors for use in military equipment is expected to be 50 percent greater in 1959 than it was in 1958. Current average usage rate of these resistors to transistors in military equipment is 2½ to 1, some authorities claim. Unit prices range from seven cents to almost a dollar, with considerable demand for the higher priced types.

● Ultrasonic equipment sales added up to \$25 million in 1958 and should hit \$50 million this year, claims Narda Ultrasonics Corp. Some industry leaders say there will be a \$150-million annual market for ultrasonics equipment within five years.

● Magnetic tape sales volume will reach \$40 million at retail value in 1959, predicts Frank B. Rogers Jr., executive vice president of Reeves Soundcraft Corp. The many tape recorders sold in the past few years has increased the market considerably, he adds.

FIGURES OF THE WEEK

LATEST WEEKLY PRODUCTION FIGURES

(Source: EIA)	Mar. 20, 1959	Feb. 20, 1959	Change From One Year Ago
Television sets	94,648	115,909	+3.5%
Radio sets (ex. auto)	269,051	273,854	+57.7%
Auto sets	100,804	106,066	+150.6%

STOCK PRICE AVERAGES

(Standard & Poor's)	Mar. 25, 1959	Feb. 25, 1959	Change From One Year Ago
Electronic mfrs.	80.63	76.18	+54.0%
Radio & tv mfrs.	95.96	86.66	+106.4%
Broadcasters	94.30	84.25	+61.1%



Subminiaturization — State of the Art

The trend to new techniques in subminiaturization has brought up some weird approaches! While there may be some merit to the technique illustrated, there is a definite shortage of little people.

Although this trend to smaller and smaller systems and components presents certain production problems, reliability is never sacrificed at Hughes. To provide you with subminiaturized products that stand up under the most severe of environmental conditions, Hughes utilizes the most advanced equipment in the industry.

The following three pages give you three specific examples of reliable Hughes components. You'll find full details on Hughes Zener diodes, TONOTRON*

storage tubes, and precision crystal filters.

In addition to these, other Hughes Products devices which provide you with this "built-in" reliability include: special-purpose oscilloscopes... precision crystal filters... rotary switches... thermal relays... MEMOTRON® and TYPOTRON® display storage tubes... diodes, transistors and rectifiers with uniform performance... and industrial systems which automate a complete and integrated line of machine tools.

*Trademark of H.A.C.

For additional information regarding any component or system please write: Hughes Products, Marketing Dept., International Airport Station, Los Angeles 45, California.

Creating a new world with *ELECTRONICS*

HUGHES PRODUCTS

© 1959, HUGHES AIRCRAFT COMPANY

SEMICONDUCTOR DEVICES • STORAGE AND MICROWAVE TUBES • CRYSTAL FILTERS • OSCILLOSCOPES • RELAYS • SWITCHES • INDUSTRIAL CONTROL SYSTEMS

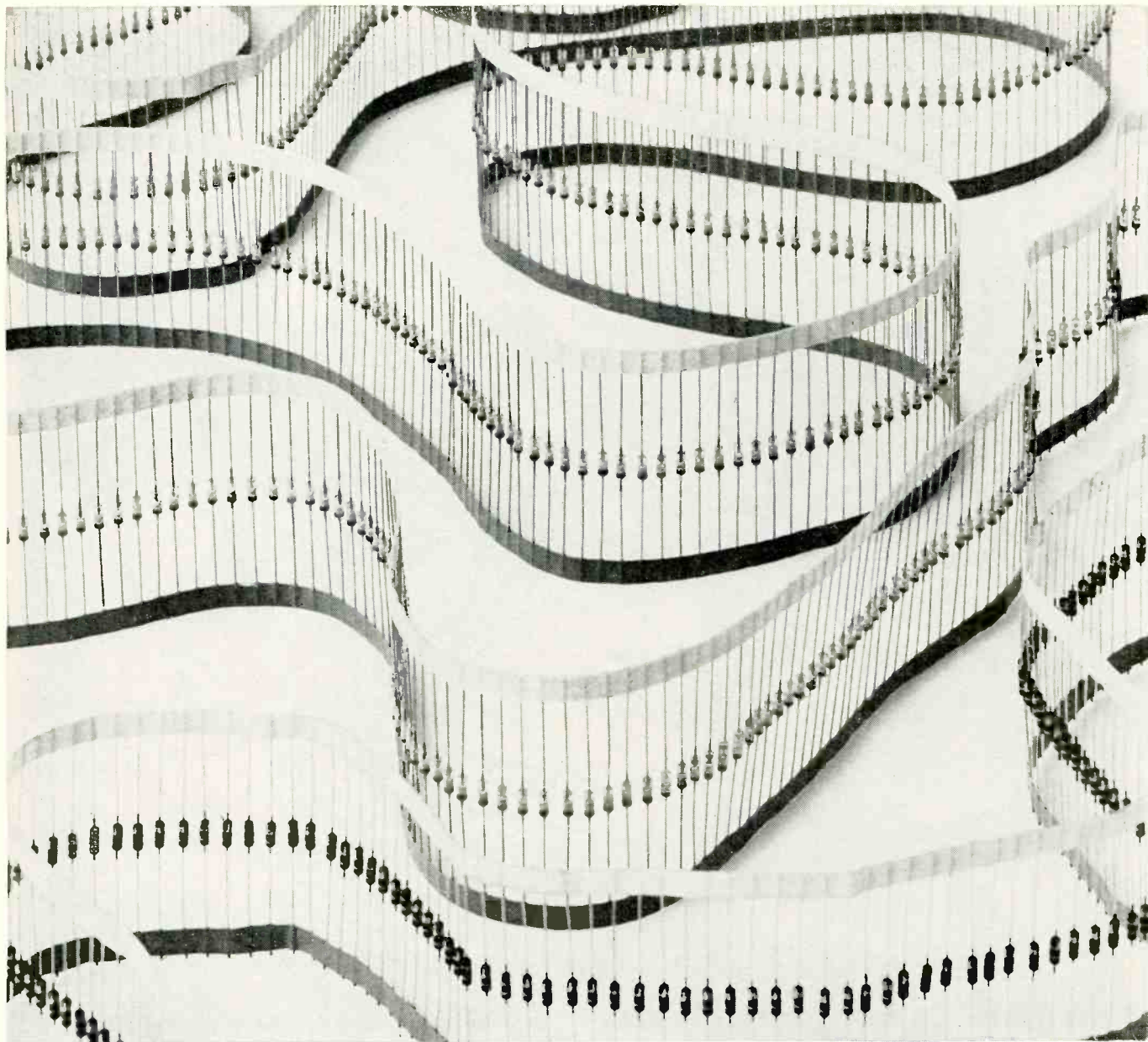

ZENER DIODES IN A PROVEN GLASS PACKAGE

Now you can get high-performance voltage-regulator diodes in the famous, hermetically-sealed Hughes glass envelope. These diodes have an outstanding characteristic: sharp regulation of reverse voltage. This means that you can use them—with confidence—in clipping, clamping, coupling, and compensation circuits to obtain *dependable voltage regulation*. In addition, they retain this stability, together with low dynamic resistance, throughout a wide range of operating temperatures.

To obtain your copy of specifications covering the family of more than a dozen types of Hughes Silicon Voltage-Regulator Diodes, please write: Hughes Products, Semiconductor Division, Marketing Department, P.O. Box 278, Newport Beach, California.

CHARACTERISTICS

Nominal Voltage: 2 volts to 30 volts

Power Dissipation: 250 milliwatts

Maximum Dynamic Resistance: 10 to 75 ohms

Operating Temperature Range: -65° to 175° C.

Dimensions, Diode Glass Body: Maximum Length: 0.265" max.

Maximum Diameter: 0.105" max.

Creating a new world with ELECTRONICS

HUGHES PRODUCTS

© 1959, HUGHES AIRCRAFT COMPANY

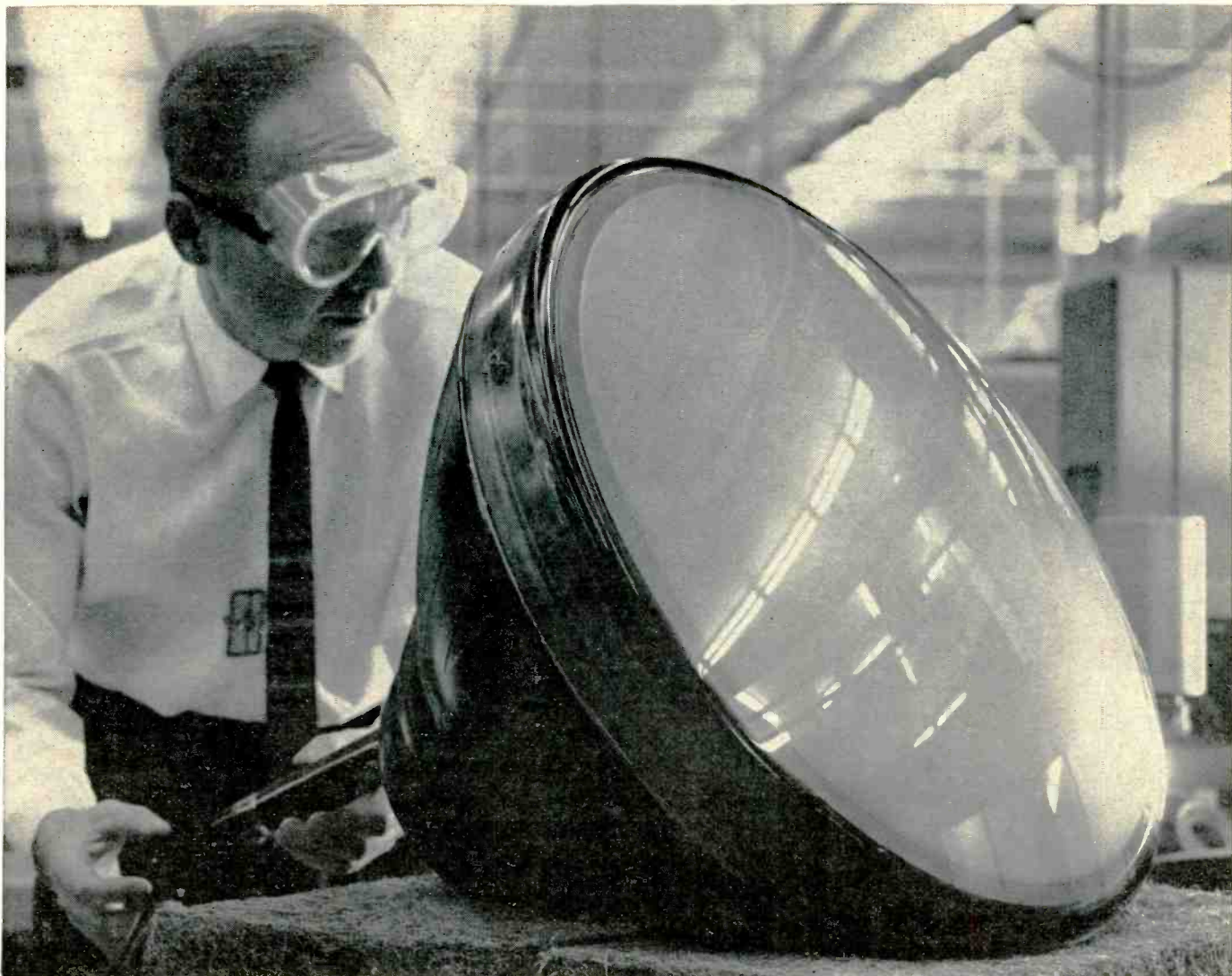

THE FIRST 21" STORAGE TUBE

High light output! Controlled Persistence! Full gray scale!

The Hughes 21" TONOTRON* tube offers you a new level of sophistication in displays for: Air traffic control, Combat situation plotting, Radars, Large-scale read-out, Medical diagnosis, Industrial television, and Slow-scan displays.

This new TONOTRON tube provides high light output, integration abilities, full gray scale, controllable persistence, and a very large display area—all in one envelope!

Hughes also announces a 21" character-writing TYPOTRON® storage tube, which gives you the *added* capability

of high-speed digital character display. The 21" TYPOTRON tube is ideally suited for any of your digital read-out requirements. In addition, this unique TYPOTRON tube offers you either character read-out or spot writing modes—or a combination of both capabilities.

Both the 21" TONOTRON Tube and the 21" TYPOTRON tube are now available for delivery. For additional information please write: Hughes Products, Electron Tubes, International Airport Station, Los Angeles 45, California.

Creating a new world with ELECTRONICS

HUGHES PRODUCTS

*Trademark of Hughes Aircraft Co.

© 1959, HUGHES AIRCRAFT COMPANY

SEMICONDUCTOR DEVICES • STORAGE AND MICROWAVE TUBES • CRYSTAL FILTERS • OSCILLOSCOPES • RELAYS • SWITCHES • INDUSTRIAL CONTROL SYSTEMS

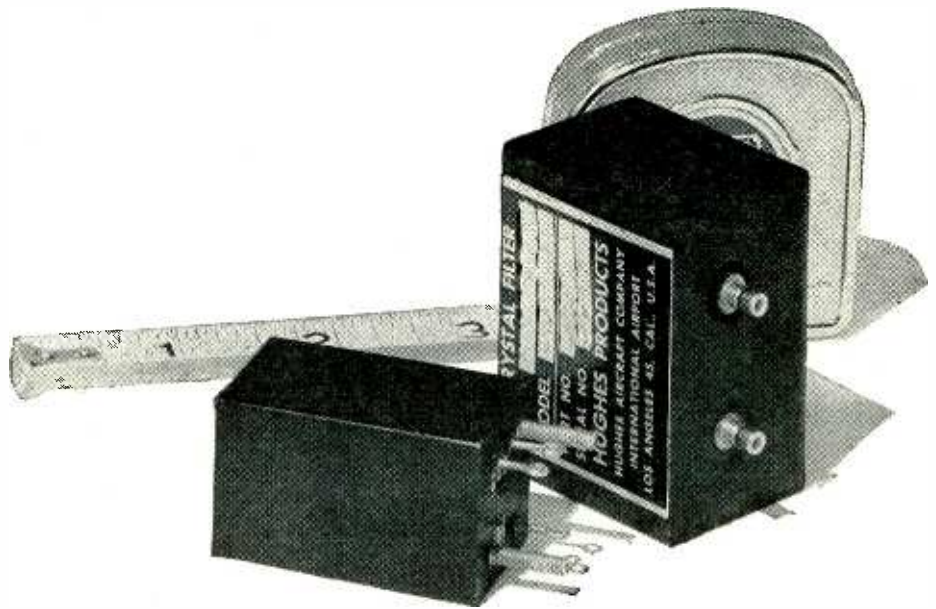

PRECISION PERFORMANCE LEVELS set by Hughes Crystal Filters

Now you can obtain high performance crystal filters previously available only for special military developmental contracts and Hughes-built systems. Utilizing unique design and advanced manufacturing techniques, these Hughes crystal filters provide a degree of performance previously unobtainable.

These crystal filters have center frequencies of 30 kc to 30 mc. In addition, you can take advantage of seven distinct features:

1. High frequency filtering
2. High selectivity
3. Low passband ripple
4. Low insertion loss
5. Small size and weight
6. Excellent temperature stability
7. Excellent shock and vibration stability

A complete engineering service for network and filter design is available to you. To obtain specifications for crystal filter types currently available, or for information concerning engineering capabilities, please write: Hughes Products, Marketing Dept., International Airport Station, Los Angeles 45, California.

TYPICAL BANDPASS FILTERS DELIVERED BY HUGHES PRODUCTS

	<u>No. 1</u>	<u>No. 2</u>	<u>No. 3</u>
Center Frequency	30 mc	10 mc	6 mc
6 db bandwidth	170 kc	40 kc	2 kc
60/6 db bandwidth ratio	1.35	2.3	1.4
Minimum Stop-band Attenuation	60 db	60 db	60 db
Maximum Passband Ripple	±1 db	±0.6 db	±0.75 db

Creating a new world with ELECTRONICS

HUGHES PRODUCTS

© 1959, HUGHES AIRCRAFT COMPANY

SEMICONDUCTOR DEVICES • STORAGE AND MICROWAVE TUBES • CRYSTAL FILTERS • OSCILLOSCOPES • RELAYS • SWITCHES • INDUSTRIAL CONTROL SYSTEMS

IN '59:

**NEW
NEW
NEW**

**LOOK...
FEATURES...
PERFORMANCE...**

for the famous

WESTON

301

**panel
instrument
series!**

Yes . . . the trusted, familiar WESTON 301 LINE has undergone a big change this year. You'll find these 3½-inch, pace-setting instruments looking different . . . doing more for you . . . working better and longer.

The renowned Cormag® mechanism, now standard, permits mounting on magnetic or nonmagnetic panels, close to other instruments, without special adjustments. It makes the "301" immune to the effects of stray magnetic fields.

The new 301 line is available in D-C, R-F and A-C rectifier types, as well as in moving iron A-C types with capabilities of obtaining controlled ballistic characteristics — even including critical damping.

A new, modernistically styled, Bakelite case — round or rectangular — is standard in this completely new line. These cases are interchangeable for A-C and D-C models.

You'll be interested, too, in the new 2½-inch Weston panel instruments — the 201 group. They match in appearance the 301 group and incorporate the same new features.

For full information, contact your local Weston representative . . . or write to Weston Instruments, Division of Daystrom, Inc., Newark 12, N. J. *In Canada: Daystrom Ltd., 840 Caledonia Rd., Toronto 19, Ont. Export: Daystrom Int'l., 100 Empire St., Newark 12, N. J.*



WESTON

Instruments



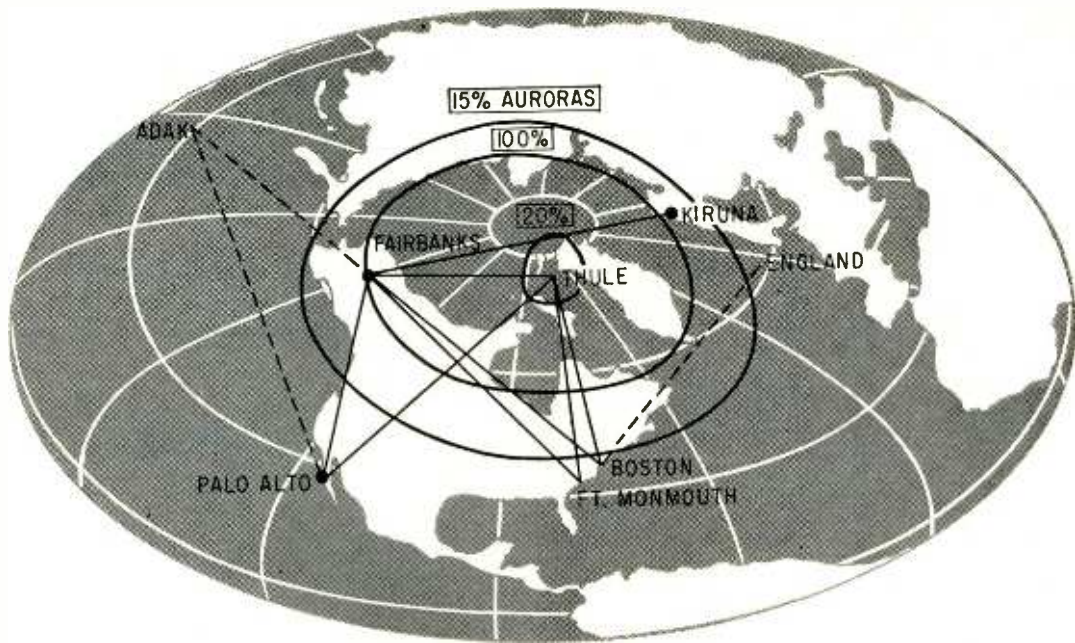

Polar projection map shows auroral belts, propagation paths used by Arctic blackout study teams. Solid lines indicate paths now in use; broken lines, proposed additions

Why Missile Signals Fail

Air Force radioastronomy and propagation teams on two continents investigate auroral effects on celestial, earth-based signals

CELESTIAL, earth-based radiation piercing top-of-world auroral zones is under investigation by Air Force on two continents in stepped-up programs for vital missile, space travel information.

Radioastronomy and communications techniques are expected to yield significant data for missile detection and guidance, trans-auroral and transpolar communications, astronavigation, and earth-ship communications for space vehicles.

Sites, Contractors

Sponsored by Cambridge Research Center and Rome Air Development Center, researchers are working at U. S. field stations from Boston to Palo Alto; in Fairbanks, Alaska; Thule, Greenland; Adak in the Aleutians; Kiruna in northern Sweden; and at five sites in Norway.

Participating contractors include Stanford U., Stanford Research Institute, Avco, Harvard, University of Alaska Geophysical Institute, Sweden's Kiruna Observatory and Norwegian Defense Research Establishment, Air Force says.

Using the radio stars and the sun

as tools, radioastronomy researchers want to find out what happens to signals from outer space when they pass through the ionosphere and troposphere, particularly in auroral zones.

Groundwork for radioastronomy and communications studies is laid by mapping auroral zones and probing state of the ionosphere at various times.

Aurora is basically a particle stream resulting from solar flares.

Under direction of Jules Aarons, AFCRC team is conducting backscatter experiments at Plum Island, 40 miles from Boston. Using a yagi on rotating mast and transmitting in 18 mc region, researchers plot aurora by means of ppi screen, also probe structures and heights of ionospheric layers, measure depth and rate of change of auroral zones.

New Program Starts

Sponsored by Rome ADC, Stanford Institute is conducting experiments in Fairbanks to determine effect of aurora on vhf and uhf radars. Experimental radars are operated at frequencies of 200, 400 and 800 mc. Sixty-foot parabolic

reflectors, horn fed, comprise antenna system. Transmitters vary in average power from 20 kw at 400 mc to 5 kw at 800 mc.

AFCRC started new phase of atmospheric propagation effects program this month at Sagamore Hill, Hamilton, Mass. Reoriented program is follow-up of earlier work on astral rf emission, uses "point" radio star sources instead of sun as transmitter.

Measure Scintillations

At Fairbanks, under sponsorship of Rome ADC, University of Alaska's Geophysical Institute is measuring amplitude and phase scintillations imposed on radio waves by Arctic ionosphere. Emissions from radio stars in Cygnus and Cassiopeia are being monitored. A phase switch, phase-sweep and phase track interferometer system consisting of two sidereally-driven, equatorially-mounted, 28-foot parabolas, spaced 300 feet apart and aligned East-West, are used to measure scintillations. System operates at 223 and 456 mc.

In northern Sweden, above the Arctic Circle, Kiruna Observatory

researchers under contract with AFCRC are studying auroral propagation characteristics. Swedish team is recording transpolar signals sent at 12 and 18 mc from IGY transmitter at College, Alaska, and studying absorption of cosmic ray energy by ionosphere. Effect of aurora on noise background is also being explored.

Also at Kiruna, radioastronomy equipment in 35 to 65 mc range is being used to study auroral effects on apparent star motion—what occurs in way of scintillation and refraction.

Studying Ionosphere

To help build geographically valid picture of auroral effects on signals, AFCRC has installed absorption data equipment at five field stations conducted by Norwegian Defense Research Establishment. They study absorption of cosmic noise in ionosphere.

AFCRC ionospheric studies directed by Hallock S. Marsh concentrate on Arctic blackout, using hf, principally in 12, 18 and 30 mc bands. Ionospheric receiving equipment monitors Thule and Fairbanks 12 and 18 mc sounder signals, as part of AFCRC in-house work.

Stanford U., under AFCRC contract, is instrumenting stations at Palo Alto, Boston, Ft. Monmouth and Fairbanks for synoptic study of 12 and 18 mc sounder signals from Thule and Fairbanks. Adak may eventually be fifth station.

Broad spread will reveal scope of Arctic ionospheric disturbances, whether general or fairly local. Stations will receive same signal simultaneously at 3 frequencies, to give idea of auroral effects and amount of absorption in heavily ionized regions.

Stanford will analyze data, set up special studies to supplement routine amplitude and multipath mode observations. With aid from Harvard, it will analyze lf-vlf info around hf blackout periods.

Avco is investigating possibilities of forecasting anomalous refractive, scintillation and absorption effects, with special emphasis on northern latitude problems.

Upcoming in AFCRC program: study of round-the-world echoes and attempted correlation with Arctic anomalies.

for continuous high temperature environments—

TEFLON*

insulated
**WIRE and
CABLE**
from . . .

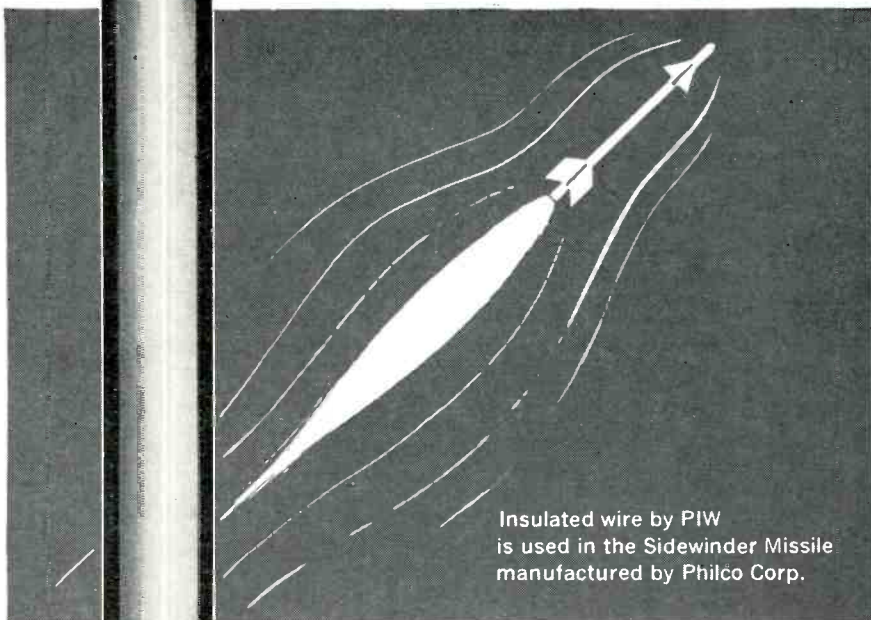

Insulated wire by PIW
is used in the Sidewinder Missile
manufactured by Philco Corp.

Only Teflon wire and cable insulation offers you so great a latitude in overcoming temperature problems and intermittent overloads. Only one manufacturer—PHILADELPHIA INSULATED WIRE offers you the facilities, services and skills born of 125 years of experience in wire fabricating.

We are suppliers of wire insulated with Du Pont TFE resin—material which was tested at 300° C, and which still maintained its excellent dielectric strength 6 months later.



This new PIW general catalog, which lists our complete line of wire and cable products in both vinyl and TEFLON, is now on press. Write for your free copy today!



*Du Pont registered trademark

PHILADELPHIA INSULATED WIRE COMPANY

200 NORTH THIRD STREET, PHILADELPHIA 6, PENNSYLVANIA
MARKET 7-0456

**“I know my product
does better than this...
but how can I prove it?”**



Yes, your customers are *always* right . . . *when there's no proof to the contrary*. But when you can prove *on the record* that performance is up to guarantee, then there's no further argument. And you can give them that record by building into your product a Veeder-Root Counter as a standard, integral part . . . to count in any terms or units your customers could want. This is easy to do . . . and inexpensive, too. Let us figure it out for you. Write.

You always “Know the score” when you count on Veeder-Root!

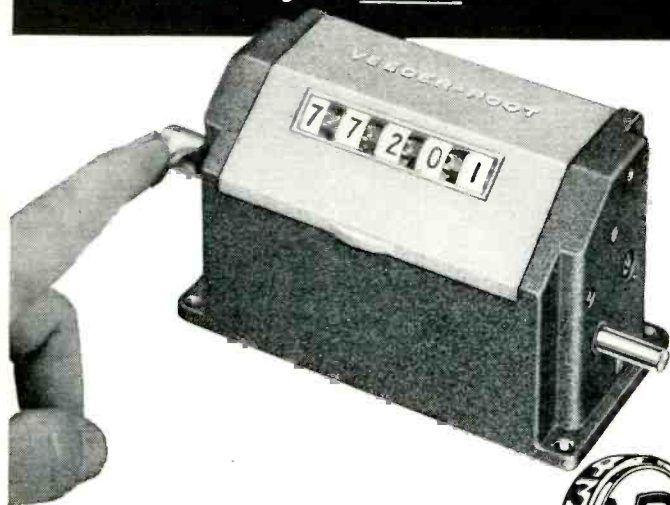

**NEW
High Speed, Quick Reset
REVOLUTION COUNTER**

This is one of scores of types of counters made by Veeder-Root for manual, mechanical and electrical counting. This counter runs at speeds up to 6,000 rpm . . . resets to zero with one flick of the lever. Also available with predetermining feature.

Everyone can Count on



Veeder-Root Inc.

Hartford 2, Connecticut

Hartford, Conn. • Greenville, S. C. • Altoona, Pa. • Chicago
New York • Los Angeles • San Francisco • Montreal

Offices and Agents in Principal Cities

FROM FAIRCHILD

MESA TRANSISTORS IN SILICON

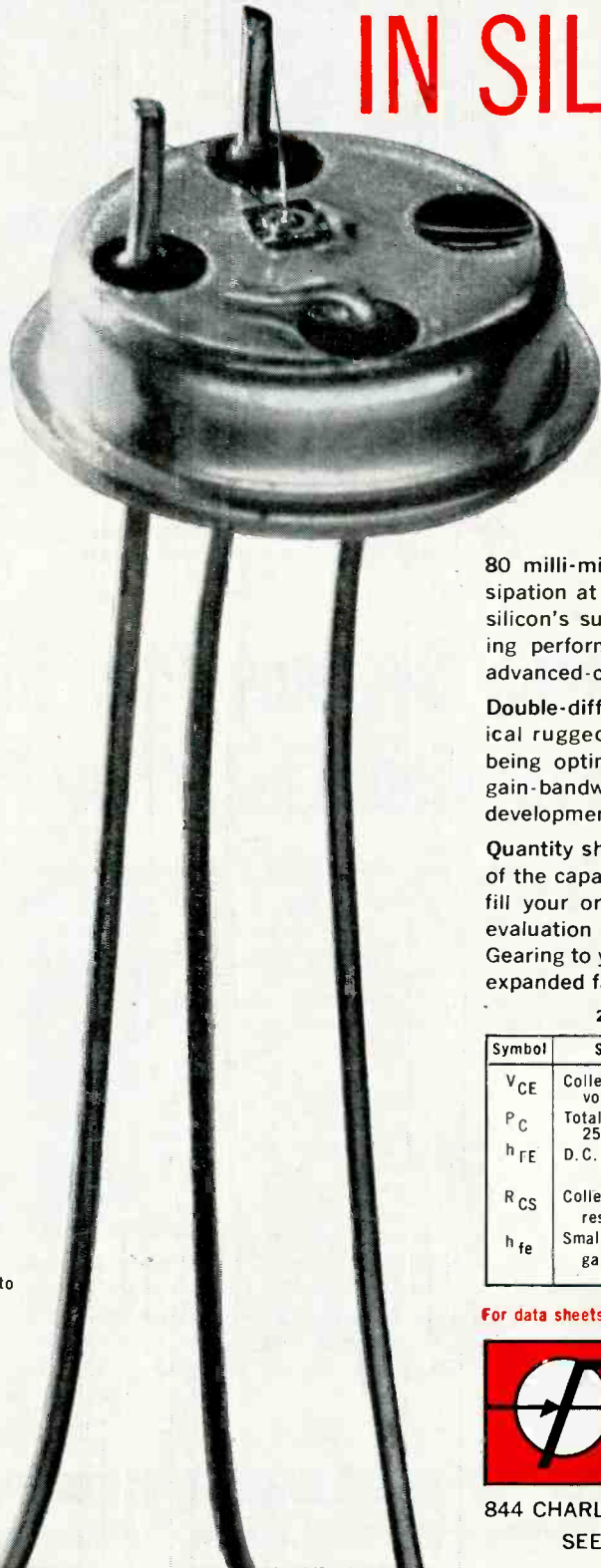

Greatly enlarged photo
of Fairchild 2N696
before capping

80 milli-micro-second rise time with 2 watts power dissipation at 25° C. This speed and power is combined with silicon's superior high-temperature reliability. The switching performance that this affords has a place in every advanced-circuit evaluation program.

Double-diffused mesa-type construction provides mechanical ruggedness and excellent heat dissipation besides being optimum for high-frequency performance (typical gain-bandwidth product 80 Mc). This type is under intense development everywhere. Fairchild has it in production.

Quantity shipments now being made give conclusive proof of the capabilities of Fairchild's staff and facilities. We can fill your orders promptly. You can start immediately on evaluation and building of complete prototype equipment. Gearing to your future production needs, Fairchild will have expanded facilities to over 80,000 square feet by early '59.

2N696 and 2N697 — NPN SILICON TRANSISTORS

Symbol	Specification	Rating	Characteristics	Test Conditions
V_{CE}	Collector to Emitter voltage (25° C.)	40v		
P_C	Total dissipation at 25° C. Case temp.	2 watts		
h_{FE}	D. C. current gain		2N696—20 to 60 2N697—40 to 120	$I_C = 150\text{ma}$ $V_C = 10\text{v}$
R_{CS}	Collector saturation resistance		3.5 Ω typical 10 Ω max.	$I_C = 150\text{ma}$ $I_B = 15\text{ma}$
h_{fe}	Small signal current gain at $f=20\text{Mc}$		5 typical	$I_C = 50\text{ma}$ $V_C = 10\text{v}$

For data sheets, write Dept. A-4



844 CHARLESTON RD. • PALO ALTO, CALIF. • DA 6-6695
SEE US AT BOOTH 96 NEC CONVENTION

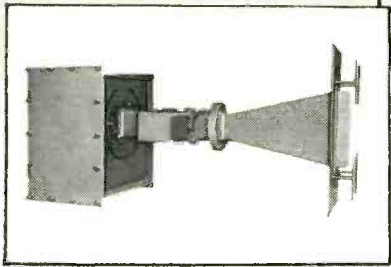
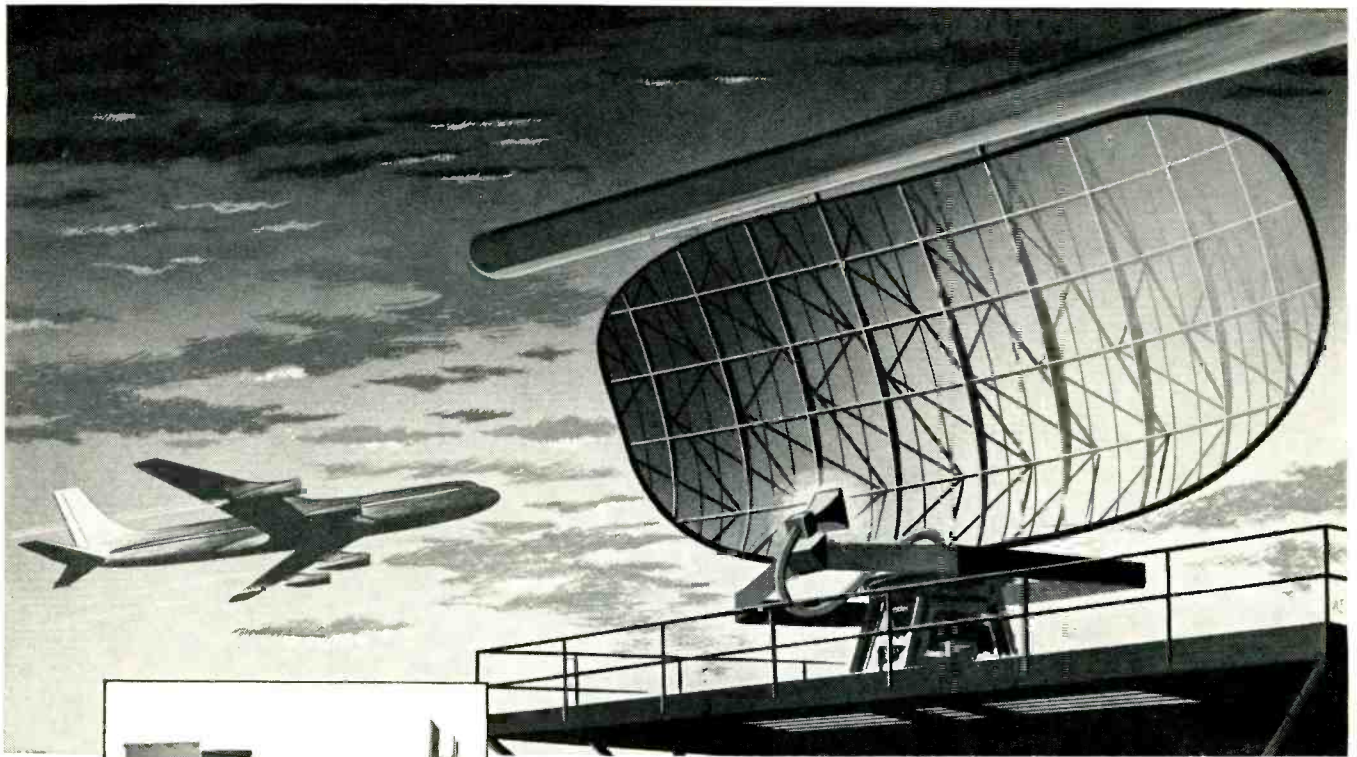

Added performance for added safety. New I-T-E antenna system will extend the range of airport surveillance radars to 50 miles radius, 30,000 ft. coverage.

I-T-E circular polarization feed system penetrates rain, clouds and dust to give more positive location of traffic in poor weather.

Advanced I-T-E Antenna Systems Play Important Roles In FAA Airways Modernization Program

Surveillance radars at major airports throughout the country will soon be equipped with completely new antenna systems for added safety in the control of jet age air traffic. This project will mark the second phase in the FAA's program to improve their performance and extend their range. I-T-E has participated in both phases.

Initially, I-T-E developed and supplied kits for adapting circularly polarized feed to existing ASR-2 and -3 antennas. This modification provided clearer, more easily observable scope displays, uncluttered by echos from clouds, rain or dust. And now, under a new FAA contract, I-T-E has embarked upon the design and production of 50 replacement antenna systems which will extend the range of ASR-1, -2, and -3 surveillance radars to 50 miles, coverage to 30,000 feet. The new systems will also provide

the advantages of circular polarization.

I-T-E is also engaged in another phase of airways modernization—the production of TACAN (TACTical Air Navigation) antenna systems for both land and shipboard use. Advanced types are now under development. Other I-T-E antenna projects range from compact systems for ultraprecision tracking radars to multi-megawatt giants for distant early warning.

If you are faced with a problem concerning antenna systems—for radar or scatter communications—benefit from I-T-E's extensive design experience and production facilities. Address your inquiry to I-T-E Special Products Division, and ask for your copy of I-T-E's valuable Antenna Handbook (2nd Edition).

Engineers: Challenging opportunities are available at I-T-E in radar and scatter communication antenna system design.

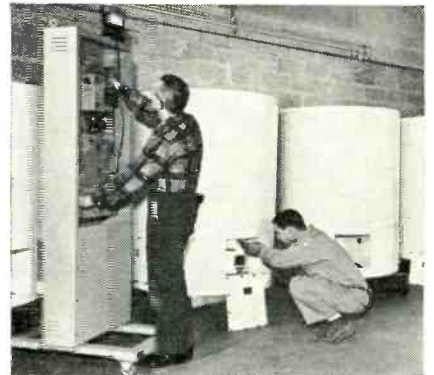

For more accurate air navigation. I-T-E technicians perform final tests on TACAN antenna systems and control consoles. In operation, precision modulated antenna signal provides suitably equipped aircraft with direct indications of range and bearing.



I-T-E CIRCUIT BREAKER COMPANY

Special Products Division • 601 E. Erie Avenue • Philadelphia 34, Pa.

MICROWAVE GENERATORS

950 to 21,000 mc

with **MORE MODULATION CAPABILITIES**

The extremely wide range of pulse width, delay and repetition rate are read directly on the front panel of Polarad microwave generators. In addition these units provide broadband internal FM and CW modulation, versatile external modulation capability and a sync output for all signals. These features provide the largest choice of microwave test signal combinations available in signal generators.

Internal pulse rise and decay: 0.1 microsecond.*

External pulse modulation: positive or negative polarity, 10 to 10,000 pps, 0.2 to 100 microseconds width.*

Output synchronization pulses: positive polarity, delayed and undelayed.

Rugged construction. Quick, easy inspection and servicing. Continuous UNI-DIAL tuning in each frequency range. Non-contacting tuning cavity chokes.

For every application, 950 to 21,000 mc.

Model	Frequency Range	Power Output
MSG-1	950 to 2,400 mc	0 dbm (1 milliwatt) to -127 dbm, directly calibrated
MSG-2	2,000 to 4,600 mc	
PMX	4,200 to 8,000 mc 6,950 to 11,000 mc	
MSG-34	4,200 to 11,000 mc	
PMK	10,000 to 15,500 mc 15,000 to 21,000 mc	+10 dbm (10 milliwatts) to -90 dbm

AND MICROWAVE POWER SOURCES — 1,050 to 17,500 mc.

High power output: 14 to 700 milliwatts depending on frequency. Modulation: Internal square wave or external FM and square wave.

FREE LIFETIME SERVICE ON ALL POLARAD INSTRUMENTS

POLARAD ELECTRONICS CORPORATION

43-20 34th Street
Long Island City 1, N. Y.

Representatives in principal cities

MAIL THIS CARD for specifications. Ask your nearest Polarad representative (in the Yellow Pages) for a copy of "Notes on Microwave Measurements."

MODULATION CAPABILITIES*

Generates CW, FM, internal pulse, internal square wave. Or can be externally modulated.

Pulse delay: adjustable from 2 to 2,000 microseconds.

Pulse repetition rate: adjustable from 10 to 10,000 pps.

Pulse width: adjustable from 0.2 to 10 microseconds.

Linear sawtooth internal FM modulation, 10 to 10,000 cps, 5 mc minimum frequency deviation.

Internal or external, pulse or sine wave synchronization.

*Models MSG-34, PMX and PMK

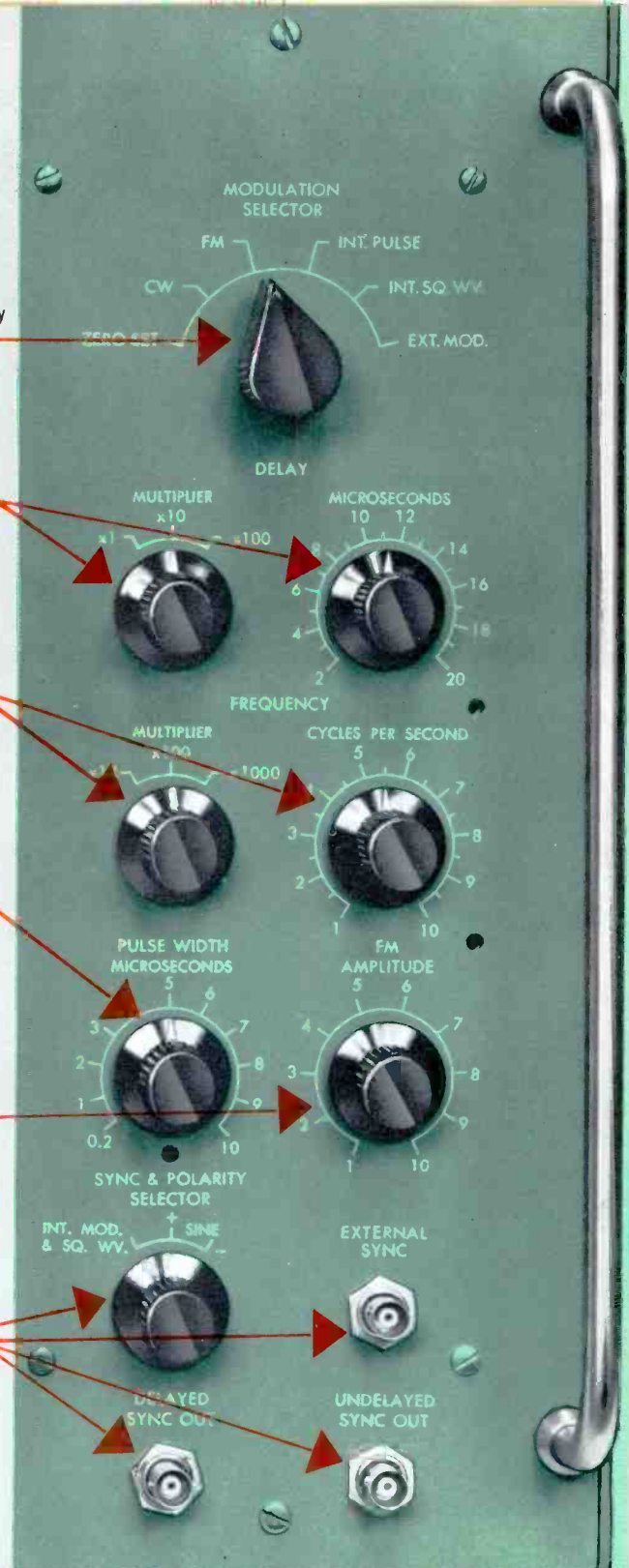

POLARAD ELECTRONICS CORPORATION:

Please send me complete specifications for:

Microwave Signal Generators,

_____ to _____

Microwave Power Sources,

_____ to _____

My application is: _____

Name _____

Title _____ Dept. _____

Company _____



MICROWAVE GENERATORS

18,000 to 50,000 mc.



MICROWAVE SIGNAL GENERATORS

18,000 to 39,000 mc

7 interchangeable plug-in tuning units
Calibrated power output: -10 to -90 dbm
Direct-reading attenuator, accurate to 2%

MICROWAVE POWER SOURCES

18,000 to 50,000 mc

9 interchangeable plug-in tuning units
High power output: 10 mw from
18,000 to 33,520 mc.
Between 9 and 3 mw in higher ranges,
depending on frequency.

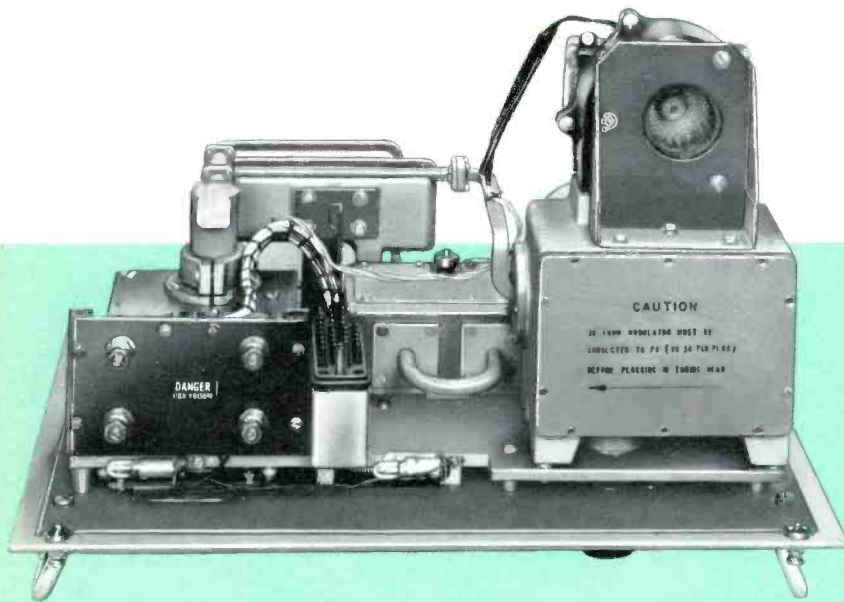

PLUG-IN INTERCHANGEABILITY

Now you can work at Extremely High Frequencies with one basic microwave generator, using only the tuning units in the ranges you require immediately. Later, as your work expands to other frequencies, add only tuning units — not complete generators.

All instruments provide: a direct reading wavemeter, indicating frequency to 0.1% accuracy; continuous tuning over entire range; 1,000 cps internal square-wave modulation — or external modulation; direct waveguide output connectors. All are designed for quick, easy inspection and servicing.

Postage
Will be Paid
by
Addressee

No
Postage Stamp
Necessary
If Mailed in the
United States

MAIL THIS CARD
for specifications. Ask
your nearest Polarad
representative (in the
Yellow Pages) for a copy
of "Notes on Microwave
Measurements".

FREE LIFETIME SERVICE
ON ALL POLARAD
INSTRUMENTS

BUSINESS REPLY CARD
First Class Permit No. 18, Long Island City 1, N. Y.

POLARAD ELECTRONICS CORP
43-20 34th St., Long Island City 1, N. Y.



**POLARAD
ELECTRONICS
CORPORATION**

43-20 34th Street Long Island City 1, N. Y.
Representatives in principal cities

Marketing Revolution Spreads

Single sales source for commercial products cuts distribution costs, permits automated system of inventory controls for distributors

REVOLUTION in commercial electronic parts distribution is evoking trade-wide comment this week as major manufacturers voice enthusiasm for recently-installed marketing systems.

"This is no longer a product-oriented business," says John T. Thompson, manager of Raytheon's 10-month-old Distributor Products Division.

"Where once the emphasis was on manufacturing, it's now on distribution. Logistics of distribution represent two-thirds of cost - - engineering and production only one-third."

Raytheon's DPD, though an internal marketing agency, is charged with full profit-and-loss responsibility. Consolidated source of supply has its own merchandising, trade relations and market research organization. It purchases outright from manufacturing divisions, has full responsibility for inventory control, and is the company's single sales source for distributors.

DPD has no role in government sales, which are negotiated directly with Federal agencies, nor in sales to original equipment manufacturers. But original equipment sales system includes "cutoff point." If OEM sale is under specified quantity, transaction will be steered through Distributor Products Div.

In some areas of country, DPD works through district managers;

in others, through manufacturers' reps. Outside of the U. S., the company sells through its International Division.

Only factory-dealer relationships remaining in the firm's commercial sales structure are in marine products, where only 350 dealers are involved; and in Radarange, 120 dealers.

In addition to stocking complete line of receiving tubes, semiconductors, magnetrons, power tubes, industrial tubes and other components, DPD also stocks and sells non-Raytheon products, such as tv picture tubes. The division controls the quality of non-Raytheon products, which carry the Raytheon label. "We buy engineering and manufacturing," DPD Manager Thompson points out. He sees the possibility of a substantial marketing field in product families which are his firm's interests.

Aid to Company

Besides making money for the division, marketing of another firm's products can be as beneficial to manufacturing divisions and the company as a whole. A distributing division can build a market first, then maybe convince manufacturing divisions to get into the business. In a sense, a distribution section's sales history of product is best possible type of market research.

Across-the-board marketing division, plus distribution of outside companies' products, also provide cross-fertilization in sales, engineering, manufacturing. Feedback from the company's sales force is a helpful byproduct.

Integral part of the distribution operation is an automated distributor-stocking plan which keeps lower inventory levels on distributors' shelves, reduces stocktaking, accelerates flow of tubes to them.

How It Works

Past sales, inventory records for two years are studied in setting up a controlled inventory.

With inventory levels for various tubes established, coded IBM cards are inserted into each five-pack of tubes on distributor's shelves. As packages are used to fill dealer orders, clerk places key-punched card into collection box in stockroom. Box is emptied daily, part of it going to the manufacturer's automated warehouse and constituting part of weekly order. Stub from card remains with distributor for checking purposes.

At warehouse, automatic card re-producer punches full-size IBM card with tube type, unit price, distributor's identification number. Automatic sorter classifies tube in ascending numbers, then tabulator totals quantity of each type needed to replace last week's sales by distributor, and extends price.

Output of tabulator becomes packing slip for warehouse and invoice for distributor. Each new carton contains a new card.

Invoices are mailed from warehouse when tubes are shipped. Customers' terms are 2 percent discount on invoices paid 40 days from invoice date, thus eliminating peak purchasing tied to calendar months.

Inventory control levels can be increased by placing a conventional purchase order noting that new shipment should include controlled inventory cards. Inventory can be lowered by withholding cards.



Tomorrow's problems are discussed at Raytheon's new distributor products division



“Tiny” Yewell takes the stand for **electronics**

Paul G. Yewell is president of Yewell Associates, Inc., Burlington, Massachusetts — an electronics manufacturers’ representative firm.

Manufacturers’ representatives play a key role in the distribution of electronics products and equipment, accounting for a far larger portion of the sales of instruments and components than do representatives in the average American industry. This type of technical selling is a highly specialized business, in the case of Yewell Associates, Inc., requiring graduate engineers, trained as salesmen, capable of discussing detailed specifications or demonstrating instrumentation or other products.

During 1958 the eight firms that “Tiny” Yewell represents ran a total of 150 $\frac{2}{3}$ pages of advertising in electronics.

Mr. Yewell, do you consider your manufacturers made a wise media selection in concentrating so many advertising pages in electronics magazine?

“Definitely, I have been reading electronics for years and consider advertising in the publication is fundamental in any sales program aimed at the electronics industry. Its advertising pages constitute a veritable ‘supermarket’ of electronics products and services being manufactured today.”

If it’s about electronics, it’s advertised and read in electronics

electronics

Published WEEKLY plus the mid-year electronics BUYERS’ GUIDE
A McGraw-Hill Publication • 330 West 42nd Street, New York 36, N. Y.



A NEW PRODUCT FROM TRANSITRON...

IMPROVED SWITCHING SILICON DIODES

Transitron's advanced solid-state development program has now produced the industry's most versatile selection of computer switching diodes.

High forward conductance and 0.3 micro-second inverse recovery are combined with low 125°C leakage currents. The performance of logic circuits in the 10 ma region is improved with the low capacity (3 $\mu\mu\text{f}$) 1N806-1N807 diodes. Higher current circuitry can be reliably operated using 1N808-1N809 diodes.

For less stringent temperature environments, Transitron also provides a selection of standard 100°C fast switching diodes.

Production quantities of all types are immediately available from stock. Small quantity requirements can be obtained from your authorized Transitron distributor.

FAST SWITCHING SILICON DIODES, SUBMINIATURE GLASS PACKAGE

Type	Minimum Forward Current @ 1 V (ma)	Max. Rev. Current @ Specified Voltage (μa . @ volts)		Minimum Saturation Voltage @ 100 μa . (25°C) (volts)	Reverse Recovery (256 JAN)			
		25°C	125°C		Max. Rec. Time μsec	Rec. Level μa	I ma	V volts
1N809	100	1.0 @ 200	50 @ 200	220	0.3	350	30	35
1N808	100	1.0 @ 100	50 @ 100	110	0.3	350	30	35
1N807	4*	.5 @ 175	50 @ 175	200	0.3	100	5	40
1N806	4*	.5 @ 100	50 @ 100	110	0.3	100	5	40
		25°C	100°C	25°C				
1N663	100	5 @ 75	50 @ 75	100	0.5†	200	5	40
1N658	100	.05 @ 50	25 @ 50	120	0.3	500	5	40
1N659	6	5 @ 50	25 @ 50	55	0.3	88	30	35
1N660	6	5 @ 100	50 @ 100	110	0.3	88	30	35
1N661	6	10 @ 200	100 @ 200	220	0.3	88	30	35
1N643	10	1 @ 100	15 @ 100	200	0.3†	200	5	40
1N662	10	20 @ 50	100 @ 50	100	0.5†	400	5	40

* Maximum 1 mc capacity = 3 $\mu\mu\text{f}$ (-10 Volts)

† IBM Modified "Y" Circuit

Temperature Range -55°C to 150°C

For complete data, write for bulletins PB-51 and TE-1350.

TRANSISTORS • RECTIFIERS • DIODES • REGULATORS • VOLTAGE REFERENCES



Transitron



electronic corporation • wakefield, massachusetts

Why Boeing offers
ENGINEERS
better opportunities





BOMARC, backed by one of the largest production orders in the field of missiles, and other rapidly expanding missile and space-age projects at Boeing offer exceptional career opportunities. Openings also available with Minuteman solid-propellant ICBM.



Boeing research facilities, most extensive and complete in the industry, give you the solid backup you need to grow in professional stature and get ahead faster. Precision microwave interferometer, above, typifies creative assignments open now in Research, Design, Production, and Service.



Engineers working in radar and communications are supported by self-sufficient Boeing laboratories, housing equipment such as nation's first automatically recording, precision boresight error range, above. Other openings in infrared techniques, radar and beacon systems, electronic circuitry, and guidance and control systems.

Write *today* for your free copy of the 24-page book "Environment for Dynamic Career Growth." Indicate your degree(s) and field of interest. Address: Mr. Stanley M. Little, Boeing Airplane Co., P.O. Box 3822 - ENB, Seattle 24, Washington.

BOEING

Big Army Contracts

Study award for Army's global communication system, UNICOM, will be let this month. System will provide full-time circuits

FIRST STUDY contract for Army's new global communications system, UNICOM (Universal Integrated Communication System), will probably be awarded by the end of this month. More than 25 firms reportedly submitted bids to study the gigantic project that compares in scope with that of USAF's global communication system, AIRCOM, (ELECTRONICS, p 14, Feb. 27).

UNICOM will be a complete system, connecting points within the U.S., between continents, to support areas and into combat areas, tying in on a compatible basis with each local tactical system employed.

A common system will handle all the major requirements of military communication—command control, warning, weapons systems, intelligence and logistic and administrative communication support.

What It Offers

UNICOM will provide:

- User-to-user service (men and machines)—in addition to store-and-forward service;
- Fully automatic circuit and message switching;
- Automatic integral on-line encryption and decryption;
- Standardized signaling rates, transmission systems and components.
- Automatic and manual terminal instruments;
- Automatic error control;
- Integrated data manipulation, processing and storage capability;
- Increased transmission speeds;
- Multi-mode operation (voice, teletypewriter, data, facsimile, and video); and
- Improved trunking means and configuration.

Some of UNICOM'S key details:

The basic switching plan of UNICOM is circuit switching. Since a great volume of military traffic does not require the instantaneous service provided by the circuit-

switching arrangement, the system provides for message-relay service through electronic switching centers.

Full-time circuits provide the ultra-speed requirements of weapons systems, early warning and critical intelligence on a point-to-point basis.

Direct customer-to-customer service is provided through the circuit switching exchanges which operate similarly to automatic dial switchboards. The customer—man or automatic machine—can have any of several input/output terminals such as voice instrument, a graphic device, a printed page, or any of several data transmission or electronic data processing kinds of equipment.

Complete security is provided by the on-line automatic security devices included as an integral part of each switching center. Data processing equipment in the Automatic Data Service Center will perform filtering and analysis operations on intelligence data which require such processing.

Automatic monitors, integral to the switching centers, sense the

Searches Data



Tubeless memory machine with 22-track magnetic tape transport developed by ITT Laboratories spins tape past "read-write" head at 500 ft per minute and conducts data research at rate of 30,000 characters per second.

Due Soon

continuity of each leg of the circuit and cause automatic restoral through an adjacent or alternate channel in the event of failure of the primary channel.

Early warning data is sent from the source to various agencies located through the world with a speed-of-service of less than one minute. When weapons systems are integrally tied into the early warning system, full-time circuits with automatic restoration may be used.

Speeds of service through the Automatic Message Exchange depend upon the message length and precedence assigned. For messages of approximately 100 words in length, a speed of service in the order of one minute will be achieved when right-of-way precedence is assigned.

Digitalized Data

Nominal information rates of 3.5 kc, 50 kc and 5 mc will be accommodated by the trunk circuits. Exact rates and bandwidths are being considered by a Joint Committee on Communication Standards.

All transmitted information, including that which is basically analog (voice, graphic, video) appears in encrypted, digitalized form utilizing standardized rates over the common transmission system. Error-control devices are incorporated in the transmission channels, in accordance with the inherent reliability of the particular medium used to derive the channel.

By 1965, UNICOM may have high altitude communication satellites in a stabilized orbit providing wide-band, real-time global communications. As an interim program, satellites will be utilized as couriers of bulk intercontinental message traffic.

Tropospheric scatter communication is presently available; however, drones and lighter-than-air vehicles are being studied and tested for use as elevated microwave repeaters to provide wide band, real-time communications to meet this forthcoming requirement.

AIRPAX

*produces complete systems
as well as components*

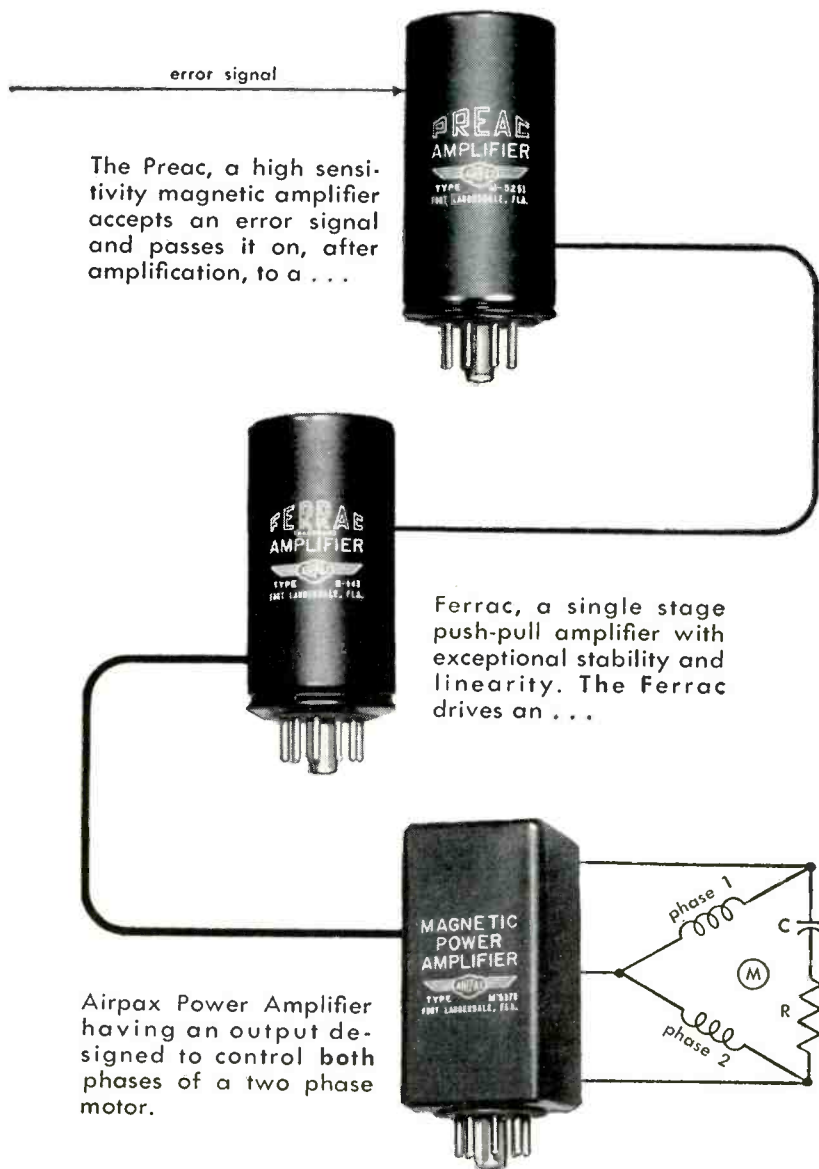

The Preac, a high sensitivity magnetic amplifier accepts an error signal and passes it on, after amplification, to a . . .

Ferrac, a single stage push-pull amplifier with exceptional stability and linearity. The Ferrac drives an . . .

Airpax Power Amplifier having an output designed to control both phases of a two phase motor.

All units are hermetically sealed and meet or exceed pertinent military specifications for temperature, shock and vibration.

*Completely encased system
or individual components*



SEMINOLE DIVISION • FORT LAUDERDALE, FLORIDA



JERROLD'S

versatile new

900A Sweep Generator Covers The Range of Three Regular Instruments!

It's the most *versatile* Sweep Generator in the electronics industry... this one instrument covers *all* your needs from 1/2 MC to 1200 MCS, for **IF's, radar, video, telemetering and communications!**

Specifications: In two ranges—0.5 MC to 400 MC and 275 MC to 1200 MC—the instrument supplies a sweep signal with center at any frequency from 500 KC to 1000 MC and with sweep widths as broad as 400 MC and as narrow as 100 KC. The RF output—carefully monitored by matched, crystal diodes feeding a two-stage, push-pull AGC amplifier—is flat within ± 0.5 db at full sweep width up to 800 MCS and ± 1.5 db from 800 MCS to 1200 MCS. When using sweep widths as narrow as 20 MCS flatness at any center frequency is approximately ± 0.15 db. **\$1260⁰⁰**

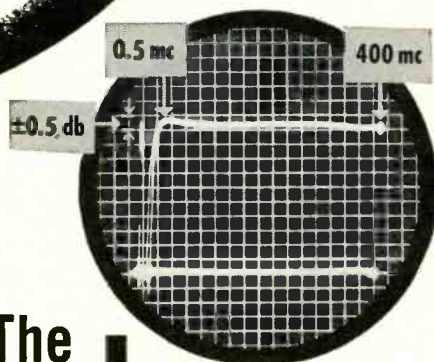

- **HIGH OUTPUT!**

.25 volt RMS on VHF—
.5 volt RMS on UHF!

- **WIDE SWEEP WIDTHS!**

From 100 KC up
to 400 MCS!

- **FLAT OUTPUT!**

Flat to $\pm .5$ db on
widest sweep width!

MODEL 900A IS NOW IN QUANTITY PRODUCTION!

Write today for on the spot demonstration of this versatile instrument!

JERROLD

ELECTRONICS CORPORATION Industrial Products Division

Dept. TED 30, The Jerrold Building

Philadelphia 32, Pa.

DOT makes **J NUTS** with a difference

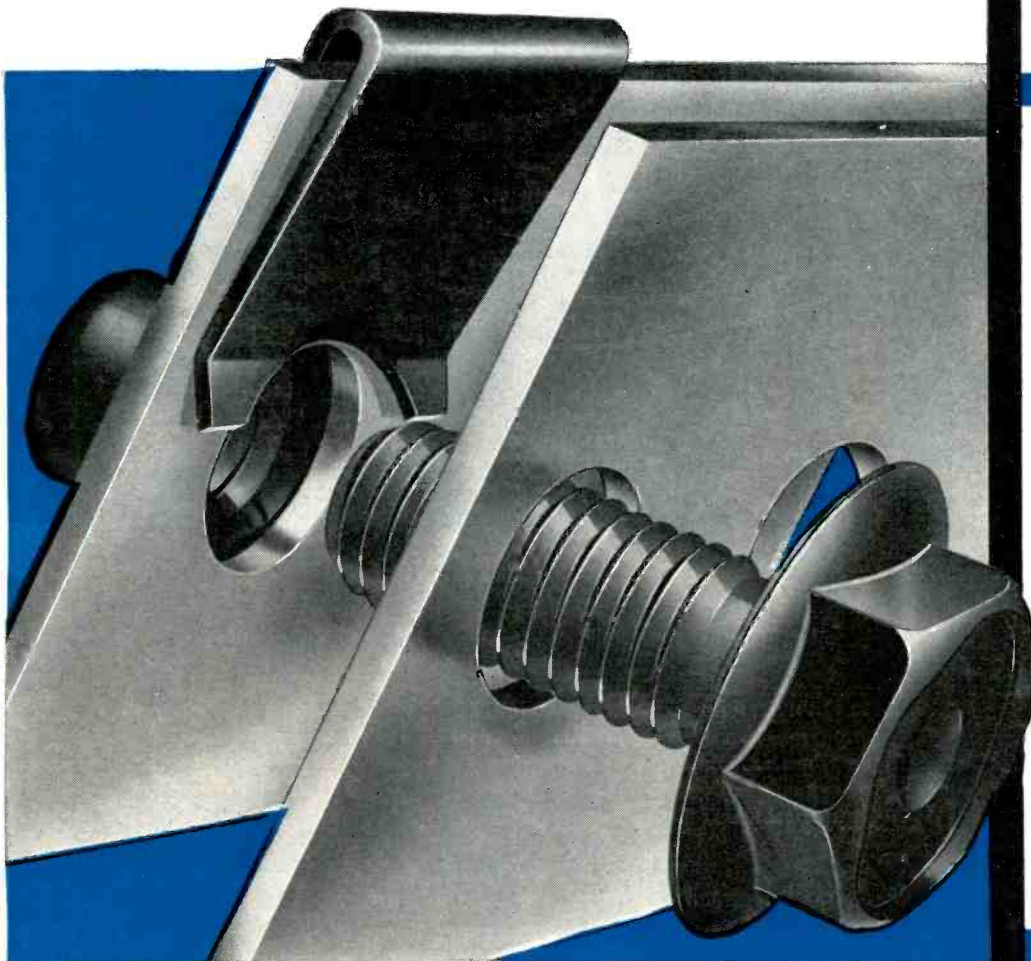
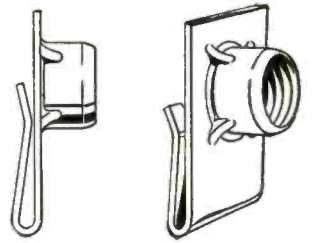

- FLUSH SEATING
- SELF-RETAINING
- SELF-TENSIONING
- LOW COST
- CAREFUL WORKMANSHIP

It takes a little extra care in the drawing operation to make really reliable J-nuts in volume but it's well worth the trouble. It reduces internal strains in the barrel so that DOT J-nuts stand up to working loads considerably better than the average fastener of similar construction.

Available in three thread sizes (5/16"-18 and 24, 1/4-20) and to fit three ranges of material thickness (.030" to .065"), DOT J-nuts are made of carbon steel. They hold themselves in place over stamped holes so that preassembly is practical in cases where the actual bolting operation comes at the end of a series of other operations.

Full details on request.

CARR FASTENER COMPANY

Division of United-Carr Fastener Corporation, Cambridge 42, Mass.

MAKERS OF **DOT** FASTENERS

AT LAST!

A Precision 200 KC Scope with Dual Trace Presentation!



NEW MODEL 122A

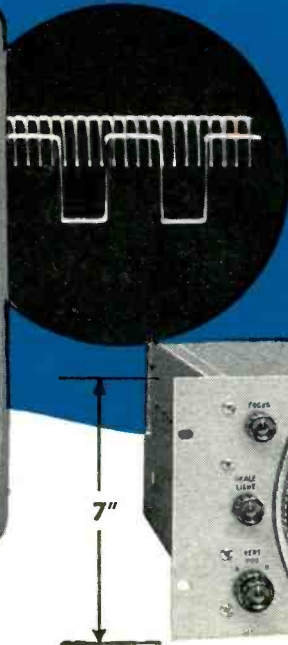

Here at last is a 200 KC oscilloscope—priced at just \$625—giving you “big-scope” versatility and the time-saving convenience of simultaneous two-phenomena presentation.

Engineered to speed industrial, mechanical, medical and geophysical measurements in the 200 KC range, the new hp 122A has two identical vertical amplifiers and a vertical function selector.

The amplifiers may be operated independently, differentially on all ranges, alternately on successive sweeps, or chopped at a 40 KC rate.

Other significant features include universal optimum automatic triggering, high maximum sensitivity of 10 mv/cm, 15 calibrated sweeps with vernier, sweep accuracy of $\pm 5\%$ and a “times-5” expansion giving maximum speed of 1 $\mu\text{sec}/\text{cm}$ on the 5 $\mu\text{sec}/\text{cm}$ range. Trace normally runs free, syncing automatically on 0.5 cm vertical deflection, but a knob adjustment eliminates free-run and sets trigger level as desired between -10 and $+10$ volts. Rack or cabinet mount; rack mount model only 7” high.

For complete details, write or call your hp representative, or write direct.

HEWLETT-PACKARD COMPANY

5140A PAGE MILL ROAD • PALO ALTO, CALIFORNIA, U.S.A.
CABLE “HEWPACK” • DAVENPORT 5-4451
FIELD REPRESENTATIVES IN ALL PRINCIPAL AREAS

BRIEF SPECIFICATIONS hp 122A

Sweep: 15 calibrated sweeps, 1-2.5 sequence, 5 $\mu\text{sec}/\text{cm}$ to 0.2 sec/cm, accuracy $\pm 5\%$. “Times-5” expander, all ranges. Vernier extends 0.2 sec/cm range to 0.5 sec/cm.

Trigger selector: Internal + or -, external or line. Triggers automatically on 0.5 cm internal or 2.5 v peak external. Displays base line in absence of signal. Trigger level selection -10 to $+10$ v available when automatic trigger defeated.

Vertical Amplifiers: Identical A and B amplifiers, 4 calibrated sensitivities of 10 mv/cm, 100 mv/cm, 1 v/cm and 10 v/cm; $\pm 5\%$ accuracy. Vernier 10 to 1. Balanced (differential) input available on all input ranges. With dual trace, balanced input on 10 mv/cm range. Input impedance 1 megohm with less than 60 μmf shunt. Bandwidth DC to 200 KC or 2 cps to 200 KC when AC coupled. Internal amplitude calibrator provided.

Function Selector: A only, B only, B-A, Alternate and Chopped (at approx. 40 KC).

Horizontal Amplifier: 3 calibrated sensitivities, 0.1 v/cm, 1 v/cm, 10 v/cm. Accuracy $\pm 5\%$. Vernier 10 to 1.

Bandwidth DC to 200 KC or 2 cps to 200 KC, AC coupled.

General: 5AQP1 CRT, intensity modulation terminals at rear, power input approximately 150 watts, all DC power supplies regulated.

Price: (Cabinet or rack mount) \$625.00.

Data subject to change without notice. Prices f.o.b. factory.



now offers 8 different precision scopes

New Spectrum Study Urged

There's also new interest in f-m radio, private microwave, video tape, station automation

CHICAGO—Broadcasters this week are evaluating the recently concluded 37th annual convention of the National Association of Broadcasters held here.

Some say the most important aspect of the convention was the attention focused on possible spectrum reallocation.

Representative W. G. Bray (R-Ind.) explained a resolution he recently introduced in Congress. It would set up a commission of non-government experts to study government spectrum use.

J. S. Patterson, deputy director of the Office of Civil and Defense Mobilization, agreed with Bray that a spectrum study should be conducted, and told broadcasters that no military group was demanding tv channels 2 to 6.

What Broadcasters Say

NAB vice president J. F. Meagher told the group that as of March 1 of this year, 725 commercial f-m stations were authorized, with 591 of these now in operation. One year ago the totals were 604 authorizations with 540 in operation. There are now 15 million f-m receivers in use in the U. S.

One broadcaster, M. H. Hanna, WHCU, Ithaca, N. Y., said there was no future for f-m radio unless it can be made a mass communication medium. He proposed all radio should be f-m rather than a-m.

Transistor TV Set



Japanese portable tv set using 32 transistors is going into trial manufacture at Tokyo Shibaura Electric. Eight in. screen set operates on 30 watts from two batteries of 22 and 6 volts, weighs 32 lb and is 12 x 17 x 11 in.

A newly-formed group, the F-M Association of Broadcasters, formerly the F-M Development Association, has emerged from the convention. To date, no comment from FMAB has been made regarding opinion that all radio should be f-m, but remarks on this viewpoint may be forthcoming later on this year.

Private Microwave Links

A spokesman for the Jefferson Standard Broadcasting Co., Charlotte, N. C., described the successful operation of a private microwave link between station WBTV in Charlotte and station WBTW in Florence, S. C. Private links for broadcasters were approved by FCC late last summer.

The two stations are now able to combine talent and other facilities for more effective programming despite the 94 miles separating them. Broadcaster interest in the private link may point the way to construction of similar installations later in the year.

Equipment advances attracted a measure of attention, with standardization of recording playback heads for video tape machines emerging as one of the most salient steps forward.

The manager of station WJBK-TV, Detroit, cautioned equipment panelists against concluding that taped tv would be the answer to daily aches and pains. Another panelist reported several Hollywood companies are planning to get into video tape syndication.

Ampex spokesmen described improvements and accessories made for their recorders, including a timer which measures tape runs to an accuracy of 0.0014 percent, and a cue track for voice recording.

A new tape recorder for video was introduced by Radio Corporation of America. Company spokesmen pointed out it was compatible with "any standard recorder." It also lets the broadcaster start with a monochrome unit and include color modules later.

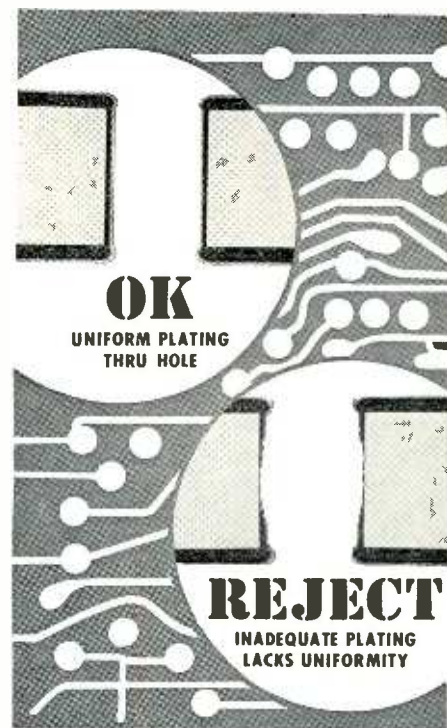

**Printed Circuit
Reliability
through Quality
Control**

If your printed circuit is vital to the flight of a guided missile it must not fail. It may even undergo a 100% inspection at every stage of manufacture.

Bureau quality control is more than a method of inspection. It is also a check on the causes of rejects to weed them out. Our production techniques eliminate even "acceptable" flaws because we are striving to produce *perfect* boards. This is why Bureau circuits, whether tested 100% or on a scientific-sample basis, are consistently better than statistics predict. To put reliable circuits into your product, investigate the Industrial Division of the Bureau of Engraving, Inc.



Member of the Institute of Printed Circuits

BUREAU OF ENGRAVING, Inc.

Industrial Division

504 South 4th St.

Minneapolis 15, Minn.

Telephone FEderal 9-8721



CIRCLE 40 READERS SERVICE CARD

COMBAT MOBILITY

*telecommunications move
up-front with the advance*



***Kleinschmidt teletypewriters maintain constant contact,
in print, between U. S. Army command and field positions***

On the go...bouncing over bunker or beachhead...Kleinschmidt teletypewriters accurately, efficiently send and receive printed messages. Developed in cooperation with the U. S. Army Signal Corps, these units instantly provide both sender and receiver with identical data...*printed on*

paper! In recognition of its quality, Kleinschmidt equipment is manufactured for the U. S. Army under the Reduced Inspection Quality Assurance Plan. This kind of proved experience is now available for unlimited advances in electronic communications for business and industry.

KLEINSCHMIDT

DIVISION OF SMITH-CORONA MARCHANT INC., DEERFIELD, ILLINOIS
Pioneer in teletyped communications systems and equipment since 1911

WHEN IT COMES TO MINIATURE CONTROLS...

✓ CHECK THE OVERALL SIZE...

including switch, if needed. For practical space-saving ability, Stackpole miniature "F" Controls lead the way — only 0.637" in diameter behind the panel for the entire length of both control and switch.

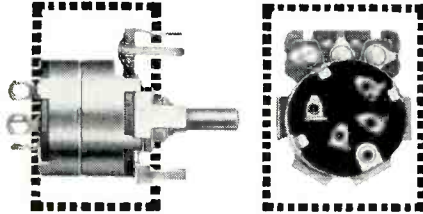

Photos show side and rear views of a Stackpole F Control with 2-pole switch. Dotted lines indicate behind-panel space occupied by a conventional "miniature" control.

Notice how Stackpole's small switch size perfectly complements the miniature control . . . saves precious chassis space where it's needed the most.

✓ FEEL and HEAR THE SWITCH ACTION...



for the tease-proof, positive "feel" and audible "click" only a true snap-action switch provides. "B"-Series switches used on "F" Controls have the same time-proven mechanism as larger Stackpole control switches. They're U.L. Inspected for 1 amp. @ 125v ac-dc; 4 amps @ 25v dc.

✓ CHECK THE COMPLETENESS OF BOTH CONTROL and SWITCH LINES

Printed wiring, wire-wrap, or standard lug terminals as well as fold-tab or threaded bushing mountings are available on all Stackpole miniature "F" controls. Both SPST and DPST switches can be supplied.



STACKPOLE

miniature "F"-series
VARIABLE RESISTORS

Electronic Components Division

STACKPOLE CARBON COMPANY, St. Marys, Pa.

In Canada: Canadian Stackpole Ltd., 550 Evans Ave., Etobicoke, Toronto 14, Ont.

FIXED & VARIABLE COMPOSITION RESISTORS • SLIDE & SNAP SWITCHES • IRON CORES • CERAMIC MAGNETS
FIXED COMPOSITION CAPACITORS • CERAMAG® FERROMAGNETIC CORES
HUNDREDS OF CARBON, GRAPHITE, AND METAL POWDER PRODUCTS.

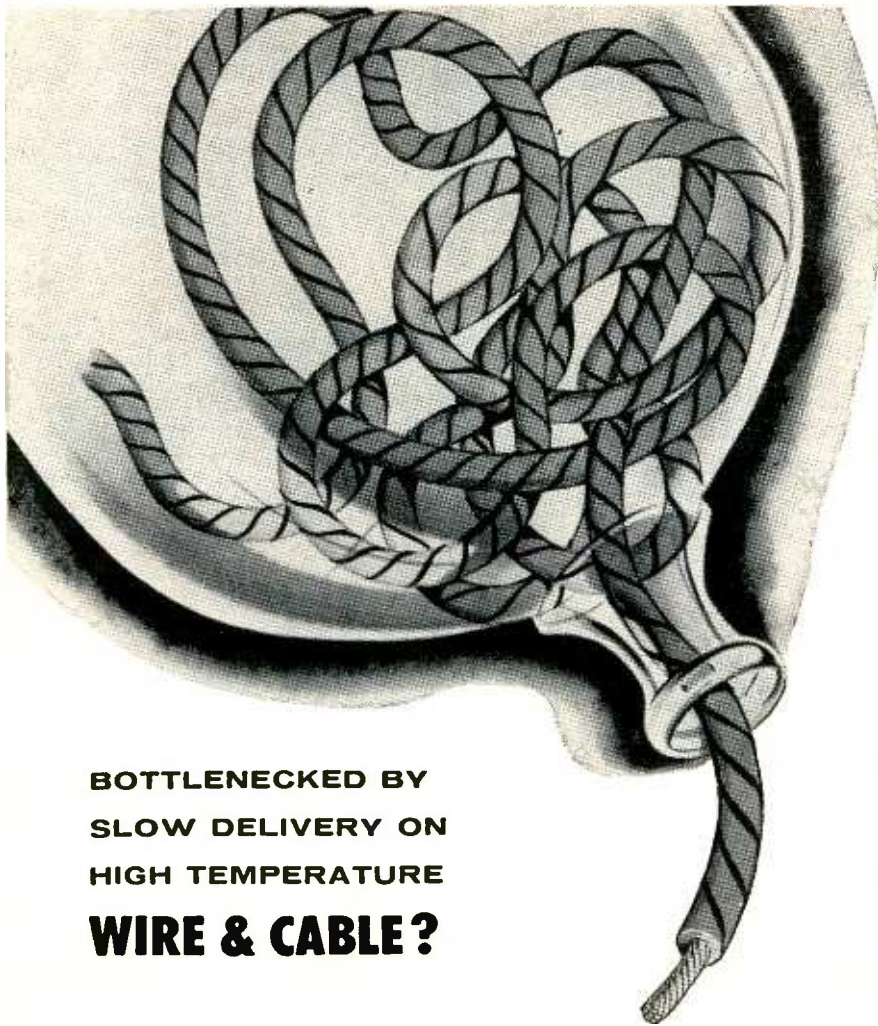

**BOTTLENECKED BY
SLOW DELIVERY ON
HIGH TEMPERATURE
WIRE & CABLE?**

Save Time WITH Super-Temp

**MAGNET WIRE
LEAD WIRE
MINIATURE CABLES
JUMBO CABLES
LACING CORDS
TUBING
SPECIALTY WIRE
TEFLON TAPES**

Fastest delivery . . . highest quality . . . optimum reliability . . . these are the qualities that make Super-Temp's TEFLON insulated, high temperature wires first choice all the time. Super-Temp has the right wire, cable or tubing, designed for specific applications, or can fabricate them to your particular requirement.*

NEED IT FAST? . . . SEE SUPER-TEMP FIRST!

FREE!

Send For
Valuable
NEW 64
Page
Catalog



Super-Temp

American Super-Temperature Wires, Inc.

8 West Canal Street, Winooski, Vermont • UNiversity 2-9636

General Sales Office: 195 Nassau St. • Princeton, N. J. • Walnut 4-4450

Agents in principal electronic manufacturing areas

*DuPont's TFE Resin

MEETINGS AHEAD

Apr. 12-19: Aircraft and Space Communications, World Congress of Flight, Air Force Assoc., EIA, Las Vegas, Nev.

Apr. 13-15: Protective Relay Conf., A & M College of Texas, College Station, Tex.

Apr. 14-15: Industrial Instrumentation & Control Conf., PGIE of IRE, Armour Research Foundation, Illinois Inst. of Tech., Chicago.

Apr. 16-18: Southwestern IRE Conf. and Electronics Show, SWIRECO, Dallas Memorial Aud. and Baker Hotel, Dallas.

Apr. 20-21: Analog & Digital Recording & Controlling Instrumentation, AIEE, PGIE & PGI of IRE, Bellevue-Stratford Hotel, Philadelphia.

Apr. 20-22: Instrument Society of America, Southeastern Conf. & Exhibit, Gatlinburg, Tenn.

Apr. 20-22: Man-in-Space Conf., American Rocket Society, Hotel Chamberlain, Hampton, Va.

Apr. 21-22: Electronic Data Processing, IRE Section, Engineering Society Building, Cincinnati, O.

Apr. 22: Medical Electronics, The Electro-Medical Program at the Moore School, PGME of IRE, Univ. of Penn., Philadelphia.

Apr. 28-30: Power Sources Conference, USA Signal Research & Devel. Lab, Fort Monmouth, Shelburne Hotel, Atlantic City, N. J.

Apr. 30-May 1: Controllable Satellites Conf., ARS, M.I.T., Cambridge, Mass.

May 3-7: Electrochemical Society, 115th Annual Meeting, Hotel Sheraton, Philadelphia.

May 4-6: Aeronautical Electronics, National Conf., PGANE of IRE, Biltmore Hotel, Dayton, O.

May 4-7: Instrumentation Flight Test Symposium, ISA, Seattle, Wash.

May 4-8: Society of Motion Picture & Television Engineers, Annual Convention, Fontainebleau Hotel, Miami Beach, Fla.

May 5-7: USA National Committee, URSI, PGAP, PGCT of IRE, Willard Hotel, Wash., D. C.

There's more news in ON the MARKET, PLANTS and PEOPLE and other departments beginning on p 90.

Radio Receptor

silicon
diodes

**IN ANY
COMBINATION
OF
CHARACTERISTICS**

*high speed • high conductance • high temperature
high voltage • high back resistance*

General Instrument semiconductor engineering has made possible these Radio Receptor diodes with a range of characteristics never before available to the industry.

The types listed here are just a small sampling of the complete line which can be supplied in volume quantities for prompt delivery. Write today for full information.

Including the industry's most versatile diode with uniform excellence in all parameters

1N658

GENERAL PURPOSE TYPES		FAST RECOVERY TYPES	HIGH CONDUCTANCE TYPES	
1N456	1N461	1N625	1N482	1N484A
1N457*	1N462	1N626	1N482A	1N484B
1N458*	1N463	1N627	1N482B	1N485
1N459*	1N464	1N628	1N483	1N485A
		1N629	1N483A	1N485B
			1N483B	1N486
			1N484	1N486A

* JAN Types

PLUS a large group of special DR numbers developed by General Instrument Corporation with characteristics that far exceed any of the standard types listed above!



Semiconductor Division

GENERAL INSTRUMENT CORPORATION

65 Gouverneur Street, Newark 4, N. J.



GENERAL INSTRUMENT CORPORATION INCLUDES F. W. SICKLES DIVISION, AUTOMATIC MANUFACTURING DIVISION, RADIO RECEPTOR COMPANY, INC. AND MICAMOLD ELECTRONICS MANUFACTURING CORPORATION (SUBSIDIARIES)

GENERAL INSTRUMENT DISTRIBUTORS: Baltimore: D & H Distributing Co. • Chicago: Merquin Co. • Cleveland: Pioneer Electronic Supply • Los Angeles: Valley Electronics Supply Co., Burbank • Milwaukee: Radio Paris Co., Inc. • New York City: Hudson Radio & Television Corp., Sun Radio & Electronic Co. • Philadelphia: Herlach & Rademan, Inc. • San Diego: Shanks & Wright Inc. • San Francisco: Pacific Wholesale Co. • Seattle: Seattle Radio Supply • Tulsa: Oil Capitol Electronics

Depreciation Reform — Why Industry Needs A Modern Tax Policy

A shockingly large proportion of our industrial plant and equipment is obsolete. As indicated by an earlier editorial in this series, over \$95 billion would have to be spent—and spent soon—to bring our industrial facilities up to the best modern standards. Yet plans for 1959 call for little more than \$30 billion of actual spending—barely enough to make a start on this backlog of modernization.

At the heart of the problem of obsolescence is a federal tax policy that discourages business from replacing inefficient facilities. It is the purpose of this editorial to spell out a tax reform Congress can make this year—with little cost in terms of tax revenue—that would go a long way toward removing the barrier to modernization of plant and equipment. This reform is a more realistic system of tax deductions for depreciation and obsolescence of productive facilities.

A Barrier to Modernization

Industry abounds with examples of old and obsolete facilities—despite large expenditures made in the past few years. Two-thirds of our metalworking equipment is over ten years old. Over half the capacity of our chemical process industries was installed before December 1950. Only a minor fraction of our railroad freight moves in new freight cars or the new push-button freight yards.

The tax law bears a large part of the responsibility for this lag in modernization because of its important influence on business investment in plant and equipment. For many years the tax law has permitted as a deduction from income “a reasonable allowance” for wear and tear and obsolescence of productive facilities. These annual deductions affect business investment in several ways.

- They are the way a company recovers its investment in plant and equipment.
- They determine in large measure, the amounts of money that are spent each year to replace and modernize facilities.
- Furthermore, the schedule for depreciation often determines **when** a specific machine or building is actually replaced.

The law requires that depreciation deductions be spread over the “useful life” of a building or machine. But the periods of useful life for tax purposes today still depend heavily upon tables drawn up by the Treasury almost 20 years ago. These tables reflect the replacement practices of depression years. Also, they were compiled at a time when the pace of technological progress in industry was much slower than it is now. **For nearly all types of equipment the indicated period of useful life is longer—sometimes much longer—than most experts consider realistic at today’s rate of technological advance.**

The result of these outmoded depreciation schedules is that the recovery of investment is dragged out, and the replacement of obsolete equipment is delayed.

In The Right Direction

Congress should establish, by law, the right to use shorter depreciation periods on productive equipment. It should do so in a way that would free industry from obsolete concepts of the rate of technological change and would provide incentives to install new equipment and produce new products.

The tax reform act of 1954 made some progress in this direction—but not enough. It introduced new methods for calculating depreciation—the declining balance and the sum-of-the-years' digits—which enable a business to recover most of the investment in a new facility in the early years of its useful life. However, these new methods do not accomplish their desired purpose when the supposed "useful life" is still an unrealistically long period of years.

Industry is by no means free from blame for the failure to bring depreciation policy into line with the needs of a modern, growing economy. According to Joel Barlow, president of the Tax Institute, "management has largely ignored the Commissioner's invitation . . . to come into the Internal Revenue Service office and make a case for shorter depreciable lives by establishing technological obsolescence."

The failure of many companies to see their own interest in more realistic depreciation not only holds them back from modernizing their own facilities but also lends support to the Treasury in its continued adherence to an out-dated policy.

A Suggestion For Reform

An excellent model for reform of the depreciation policy in our tax law is the system used successfully in Canada for a decade. In Canada, all productive equipment may be depreciated at relatively fast rates assigned to each of 14 broad categories. The Canadian system permits depreciation up to twice as fast as the antiquated tables of useful

lives now followed in the U. S. It also gives the individual business far greater flexibility in determining depreciation schedules that fit its own needs and experience.

For example, in the category or "bracket" covering general machinery a taxpayer in Canada may depreciate up to 20% of the machine's value annually, on a declining balance basis. In the U. S. the fastest rate at which many types of machinery can be depreciated is only 10%. In other categories, from tools and dies to buildings and pipelines, the Canadian system also allows faster depreciation and provides greater incentive to invest in new facilities.

The cost of this reform in terms of lower tax revenue would be small—probably less than \$500 million in the first year. And even this would merely be postponed, not permanently lost. Indeed, there is a very good prospect that tax revenue would not suffer at all. The increase in spending for new plant and equipment resulting from this tax reform would mean an increase in wages and profits—and therefore in taxes—in industries that produce machinery and other capital goods.

A realistic tax policy on depreciation would provide a badly needed incentive for industry to replace obsolete and inefficient facilities with up-to-date plants and equipment. It would step up our rate of technical advance and economic progress. And it would put U. S. industry in better shape to meet the growing competition from other countries that have grasped the advantages of fully modern technology.

This message was prepared by the McGraw-Hill Department of Economics as part of our company-wide effort to report on opportunities for modernization in industry. Permission is freely extended to newspapers, groups or individuals to quote or reprint all or part of the text.

Donald McGraw
PRESIDENT

McGraw-Hill Publishing Company, Inc.

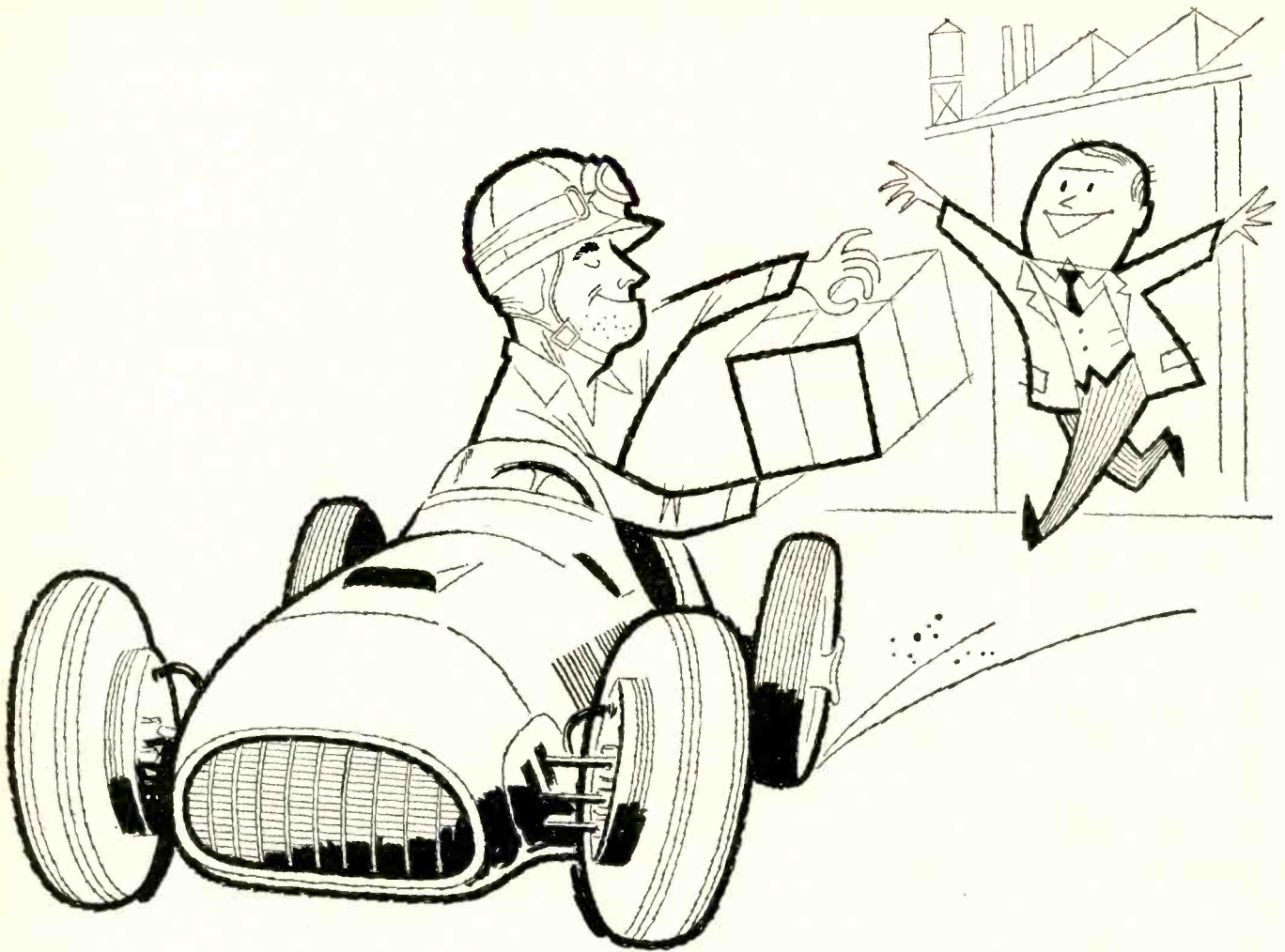

Need Electronic Components — **FAST?** *... Call Your Mallory Distributor*

Depend on your nearby Mallory distributor for quick delivery of short orders . . . and the very best in electronic components. You'll save precious production or research time by getting exactly what you need, when you need it.

Your local Mallory distributor stocks a diversified line of Mallory capacitors, resistors, controls, rheostats, mercury batteries, vibrators, and silicon rectifiers—the same top-quality components that

leading manufacturers chose for original commercial and military equipment.

Prompt delivery, often within hours of your call, can help you meet tight schedules. Your Mallory distributor is a good man to keep in mind when you tackle a rush job.

For the name of your nearest distributor, call our local District Office, or write to us in Indianapolis.

Depend on MALLORY for Service!

P. R. MALLORY & CO. INC.
 Distributor Division, Dept. A.
 P.O. Box 1558, Indianapolis 6, Indiana





Class D units may be used extensively at airports

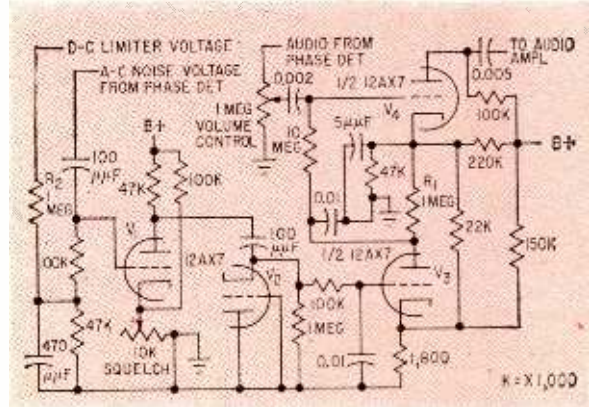

FIG. 1—Squelch circuit for reducing noise interference

Citizens Radio Revision Spurs Equipment Design

Recent revision of citizens radio service frequency allocations now permits four classes of stations. Old ham 11-meter band is now available. Brief synopsis of commercially available equipment is tabulated and special attention is given to new noise silencer, squelch and selective-signaling circuits

By **LEO G. SANDS**, Consultant, Ridgewood, N. J.

RECENT REVISION of FCC rules governing Citizens Radio Service has spurred development of new equipment. This article describes commercially available equipment designed to use the revised frequencies.

CLASSES OF STATIONS—Class-A stations may be operated between 460.05 and 460.95 mc or between 462.55 and 466.45 mc using either a-m or f-m modulation at a maximum power input of 60 watts to the final amplifier. No restrictions on antenna systems have been imposed except in regard to safety of aircraft.

Class-B stations may be operated only on 465 mc using either a-m or f-m modulation with up to 5 watts input to the final amplifier.

Class-C stations may be operated for control purposes only (model aircraft or boats, garage doors, etc.) on 26.995, 27.045, 27.095, 27.145, 27.195 and 27.255 mc with all frequencies crystal controlled. Power input to the final amplifier is limited to 5 watts except stations using 27.255 mc may use up to

30 watts input. This latter frequency is available on a shared basis with other services including medical electronics.

Class-D stations may be operated between 26.965 mc and 27.225 mc using a-m modulation only. Power input to the final amplifier is limited to 5 watts, and the transmitters must be crystal controlled.

Table I lists typical commercially available equipment for these new citizen bands.

CLASS-A EQUIPMENT — Several manufacturers build f-m mobile units for operation between 450 and 470 mc to specifications that meet the requirements of the industrial, public safety, and land transportation services. The same equipment may be used in class-A citizens radio applications even though the technical standards are not as rigid.

One of the available receivers for class A use employs triple conversion. Two r-f stages precede the first mixer. The 50-mc i-f is amplified and passed to the second mixer whose 10-mc i-f is ampli-

of a tone generator at the transmitter by the normally closed pulsing contacts of a telephone dial.

CLASS-B EQUIPMENT—Typical of the class-B equipment is the transceiver whose schematic is shown in Fig. 3. A 6AF4 tube, V_1 , serves as a self-excited power oscillator when transmitting and a superregenerative r-f amplifier when receiving. Tube V_3 serves as the a-m modulator when transmitting and as the audio power amplifier during reception. Tube V_2 doubles as first audio stage for the receiver and as the transmitter speech amplifier.

The receiver quench oscillator, tuned by L_1 and C_1 , is disabled by a pair of switch contacts when transmitting. Tuning is accomplished by bending one of the plates of C_2 at one end of the tuned line. The plate is slotted to form a large and a small section. The small section permits fine adjustment of frequency.

CLASS-C EQUIPMENT—Previously, only 27.255 mc was available for control purposes. Now that the FCC has made five new control channels available, the service will be more useful to hobbyists and others who employ radio for remote control of model aircraft or boats, and garage doors.

The transmitting equipment is usually simple. The control signal may be tone-modulated a-m and a number of different tones may be used to enable control of several functions using one frequency. A typical tone-control transmitter is shown in Fig. 4. This unit uses filament type tubes and receives power

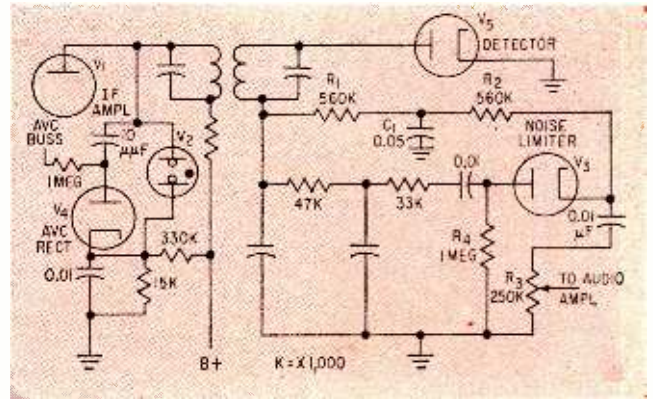

FIG. 6—Noise limiter for ignition interference

from self-contained A and B batteries. Receivers used on model planes are usually transistorized.

CLASS-D EQUIPMENT—Several manufacturers are building radiotelephones for use in this new band. A typical unit is shown in the block diagram of Fig. 5. The receiver is a double-conversion superdyne type.

A noise limiter is almost essential in a 27-mc a-m receiver, particularly if used in or about motor vehicles, because of ignition interference. A two-step noise silencing system is shown in Fig. 6.

High amplitude pulses are clipped at the plate of the last i-f amplifier V_1 by NE-2 neon tube V_2 which fires momentarily and shunts the plate load of V_1 . Diode V_3 serves as an electronic switch and opens the audio circuit momentarily when noise pulses are received. This action occurs for such a short duration that audio distortion is avoided.

Diode V_3 is in series with the signal path to the first audio amplifier. Under normal conditions, the cathode of V_3 is slightly more negative than its plate because it is connected through R_1 and R_2 to a more negative point on the diode load. When the diode conducts, it appears as a closed switch. The audio signal developed across volume control R_3 is approximately the same as that across R_4 .

When a large noise pulse is received, the plate of V_3 swings more negative than its cathode due to the time delay caused by the R-C network R_1 and C_1 . This cuts off diode V_3 which now appears as an open switch preventing the noise pulse, as well as the audio signal, from reaching volume control R_3 . The circuit recovers quickly and the cathode of V_3 again becomes more negative than its plate and becomes a closed switch allowing audio signals to pass.

ANTENNAS—For class-B equipment, the usual transceiver antenna is a 6-in. vertical rod that plugs into a receptacle mounted to the top of the metal cabinet. A ground-plane antenna is often used and for point-to-point communication, corner reflector antennas affording up to 10 db forward gain are sometimes used.

For class-D equipment, a base-loaded whip antenna less than 24-in. long has been developed. While not as efficient as a full quarter-wave whip, the actual results are generally satisfactory.

Table I—Typical Commercially Available Equipment for new Citizens Bands

Mfr and Model	Class	Power Consumption			Features
		Re-ceive	Trans-mit	Power Output	
Bendix 2V13E	A	112 w	225 w	10-12 w	Used in general mobile service
Kaar Eng. Corp. TR500	A	70 w	105 w	4-5 w	Triple conversion superhet
Secode RPD-634	A	Decoder, accessory
Vocaline Corp. JRC400-JRC425	B	18 w	18 w	...	JRC425 has mike push-to-talk. JRC400 has manual panel switch
CG Electronics Corp. T-12	C	Tone control transmitter
Int. Crystal Mfg. Corp. CTZ-5	D	Double conversion superhet
Morrow Radio Mfg. Corp. Moradio Trans-Receiver	D	Double conversion superhet
Kaar TR325	D	3.3 amp	6/12 v	...	Double conversion superhet
Telebeam Ind. Magic Wand	D	Top of vehicle mounted, 24-inches long

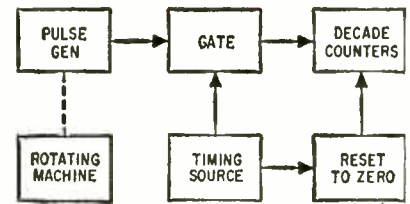
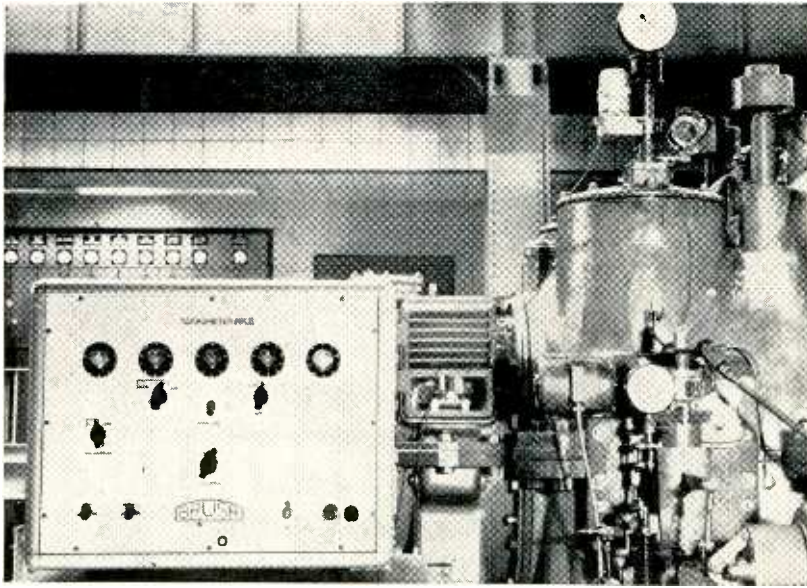

FIG. 1—Tachometer system counts pulses produced during a fixed time interval by pulse generator connected directly to rotating machine

Tachometer measures rotation speed of turbine in series of tests following installation of turbine in power station

Digital Tachometer Aids

DESIGN AND DEVELOPMENT of steam turbines requires accurate measurement of the rotational speed of the blading system. Vibrations set up in individual blades and blade batches must be correlated with this rotational speed for detailed analysis.

Tachometer accuracies of at least 0.01 percent are required for these analyses. A block diagram of a

tachometer system designed for this purpose is shown in Fig. 1.

The tachometer counts pulses from a pulse generator coupled directly to the rotating shaft. The pulses pass through a time-operated gate to a series of decade counters. The counters display the number of pulses passed through the gate in a precisely known time. After a suitable display time, the

counters are returned to zero for the next count.

The most successful pulse generator used with the tachometer has a rotor and stator, each having 30 slots cut in the periphery. Thus, for one revolution of the rotor, 30 changes in capacitance are produced.

These capacitance changes are used to frequency modulate an oscillator. The resulting f-m signal is demodulated, and the 30 voltage pulses produced are fed to the tachometer circuits. By setting the gating time at 2 sec, a direct count in rpm is provided on the decade display.

The tachometer, shown in Fig. 2, uses digital techniques throughout. It was made as versatile as possible so that it could also be used as a general purpose frequency-measuring instrument. Therefore, a decade scaler was incorporated providing a second range 10 times the basic range.

The counting ranges are zero to 20,000 pps (zero to 40,000 rpm) and zero to 200,000 pps (zero to 400,000 rpm). Accuracy is better than 0.005 percent on both scales. This is equivalent to \pm one pulse on the basic range and \pm 10 pulses on the scale-of-ten range.

Table I—Switching Sequence in Auto-Locking and Gating Unit

Tube	Initial State	After First Gate Pulse	After Second Gate Pulse	After 5, 10 or 15 sec	After 200 Millisec
V ₂₁	On	Off	On	On	On
V ₂₂	Off	On	Off	Off	Off
V ₂₇	Off	On	Off	Off	Off
V ₂₃	Off	Off	On	Off	Off
V _{24A}	On	On	Off	Off	On
V _{24B}	Off	Off	On	On	Off
V _{26A}	Off	Off	On	Off	Off
V _{26B}	On	On	Off	On	On
V _{25A}	Off	Off	Off	On	Off
V _{25B}	On	On	On	Off	On

Tachometer counts up to 400,000 rpm on two scales at an accuracy of 0.005 percent. Pulses generated by capacitor unit connected directly to rotating machine are passed through accurately controlled gate. By generating 30 pulses for each revolution and holding gate open for two minutes, direct indication in rpm is provided on counting tubes. Unit also provides one-minute gating period, and gate can be kept open for batch counting. Timing unit that controls gate can also be used as frequency standard

By JOHN K. GOODWIN,

Research Division, Brush Electrical Engineering Co. Ltd., East Leake, Loughborough, Leics, England

in Turbine Design

The instrument has two internal gating periods, one and two sec. Provision for external gating is also incorporated, enabling random pulses to be counted (such as in batch counting) to a maximum of 99,999 on the basic range.

Input and Limiting Stage

The voltage required at the input circuit shown in Fig. 3 is reasonably low so that the instrument will not normally require external pre-amplifiers. A minimum of 1.5 v peak-to-peak is required. Maximum voltage is about 10 v peak-to-peak.

Triode V_{1A} functions as a class-A amplifier. Resistor R_1 prevents the input circuit from being loaded should the tube be driven into grid current by excessive input voltage.

Output from V_{1A} is R-C coupled to V_{1B} , which operates as a cathode follower near cutoff. Positive-going output from cathode follower V_{1B} is fed to Schmitt trigger V_2 . The Schmitt trigger produces rectangular pulses with a rise and decay time of approximately one μ sec. These pulses are differentiated by capacitor C_1 and resistor R_2 . The negative-going pulse is removed by the diode shunting R_2 .

When using the basic counting range, the pulses are fed directly to

the gating unit. However, when V_{2B} is connected to the scale-of-ten divider, output is applied to V_{3A} through C_2 . The negative pulses trigger the Eccles-Jordan binary divider, V_3 , and the positive pulses are removed by the coupling diodes.

Scale-of-Ten Divider

The divider consists of the four cascaded Eccles-Jordan binary di-

viders shown in Fig. 3. This arrangement would provide a division ratio of 16, but, by inserting suitable feedback loops, the division ratio is reduced to 10. The circuit operates up to 500 kc.

Thus the input and limiting stage and the scale-of-ten divider produce pulses corresponding to input or one-tenth input frequency.

The timing panel shown in Fig.

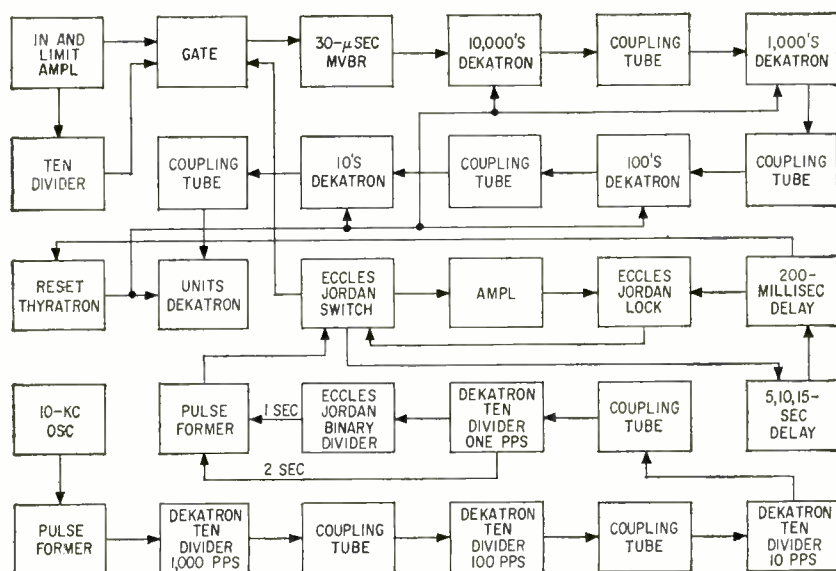

FIG. 2—Digital system displays number of pulses passed through accurately controlled gate in one or two-sec intervals to indicate shaft velocities to 40,000 rpm on basic scale or to 400,000 rpm using scale-of-ten divider

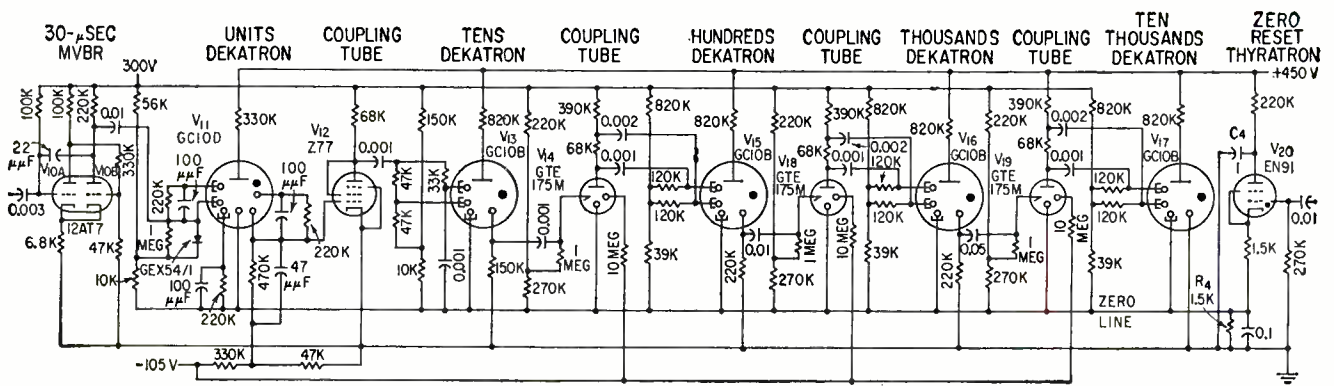

FIG. 5—Display unit indicates pulses passed by gate on Dekatron tubes. Tetrode thyatron returns Dekatrons to zero at end of counting period

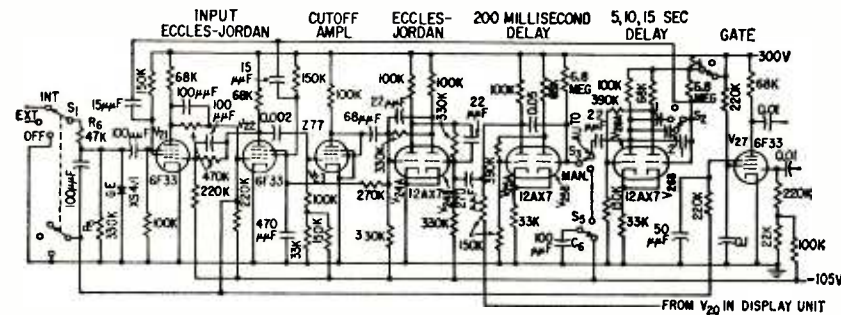

FIG. 6—Gate permits pulses to pass to display unit during gating period. Display can be retained for 5, 10 or 15 sec by switching in different capacitors in delay multivibrator. Additional 200-millisecond delay provides time for counting tubes to be returned to zero

the differentiated gating pulses.

Initially, V_{21} is conducting, developing a bias that is applied to the control grid of V_{22} and to the suppressor grid of V_{27} , the gate tube. The gating pulse switches V_{21} off and V_{22} on. This switching also removes the bias from the suppressor of V_{27} . At the end of the gating period, the second gating pulse switches V_{22} off and V_{21} on again.

Tube V_{23} is initially biased off and does not conduct until the second gating pulse. When V_{22} is cut-off by the second gating pulse, the control-grid potential on V_{23} is raised, permitting the tube to conduct.

Dual triode V_{24} is an Eccles-Jordan trigger with V_{24A} initially conducting. The drop in plate voltage on V_{23} is coupled to the control grid of V_{24A} , switching it off and switching V_{24B} on. In this state, a bias is coupled back to the suppressor of V_{22} , locking it off.

Dual triodes V_{25} and V_{26} form two one-shot multivibrators connected in series. A delay to permit reading the display is provided by V_{26} . Display time may be set at 5, 10 or 15 sec by switch S_2 , to suit different operators and applications.

Actual delay depends on the interval between timing pulses. Multivibrator V_{26} is set for 3, 8 or 13 sec delay, so for a 2-sec timing period, actual display time is 5, 10 or 15 sec. For the one-sec period, the multivibrator is set for 4, 9 or 14 sec.

Push-button switch S_3 permits instantaneous counts. To use this switch, the delay circuit controlling display time is switched out of the circuit by S_3 . Hence, the display remains after the count until the push button is pressed a second time. Then the display tubes are returned to zero, and a new count is taken automatically.

Tube V_{28B} is initially conducting. After the second gating pulse, when V_{21B} is switched on, V_{28B} is switched off. Tube V_{28A} conducts for the duration of the display.

Multivibrator V_{25} provides a 200-millisecond delay during which the Dekatrons in the display unit are returned to zero. When V_{26A} is switched off at the end of the display period, V_{25A} is switched on. This applies a trigger to the resetting thyatron in the display unit.

After the 200-millisecond period, V_{25B} is switched on again, returning

V_{21} to its original state. With V_{24A} conducting again, the bias is removed from the suppressor of V_{22} for the next count.

Push-button switch S_5 normally connects C_6 to -105 v. After a manual count, S_5 is pressed. This applies the negative charge stored by C_6 to the control grid of V_{20B} , initiating the 200-millsec delay, and the Dekatrons are returned to zero.

Pentode Gate

Pentode V_{27} is used as the gating tube. The bias produced on the control grid of V_{22} is applied to the suppressor of V_{27} , keeping it cut off. When conduction is switched from V_{21} to V_{22} , this bias is removed, permitting the gate to pass pulses from either the input limiting amplifier or from the scale-of-ten divider.

Control-grid bias on V_{27} is kept at a level that prevents conduction except when pulses of relatively high amplitude are applied. This is done to prevent formation of a pedestal when suppressor grid bias is removed. It also suppresses spurious pulses from the scale-of-ten divider.

The spurious pulses are produced in suppressing the division ratio from 16 to 10 by the feedback loops. These spurious pulses are accentuated by the differentiating action of C_1 and R_2 .

When the suppressor bias is removed, the grid signals are passed to the plate and to the display unit. After the timing period, V_{21} conducts again, and the control grid of V_{22} is biased to cutoff. The same bias is also applied to the suppressor of V_{27} , cutting off the gate. Pulses applied to its control grid are therefore blocked.

Impedance Measurements

Transistorized device measures changes in impedance of living tissue resulting from nonrhythmic fluctuations of blood content. Changes of as little as 0.1 percent of the total tissue impedance can be detected by a resistance bridge and phase-sensitive detector that scans the bridge unbalance

By **SAM BAGNO** and **FREDERICK M. LIEBMAN, D.D.S.**

Walter Kidde Co., Newark, N. J. Dept. of Physiology, Dental College, New York University, New York, N. Y.

RHYTHMIC FLUCTUATIONS of blood content cause body tissue during the cardiac cycle to expand or contract with consequent change in tissue impedance. A device which detects and records these impedance variations is known as a plethysmograph. The plethysmograph to be described will detect changes in blood volume caused by nonrhythmic smooth-muscle activity in the walls of the blood vessels (vasoconstriction or dilation), as well as changes in extravascular fluid content and ionic changes of the tissue. These three causes of impedance change can be distinguished from one another only to

the extent that their occurrence can be controlled under experimental conditions.

Operation

To measure impedance changes caused by vasomotor activity, a 50-kc signal is modulated by the unbalance of an impedance bridge. A pulsating unbalance results from the rhythmic changes in blood volume of the tissue being measured. These are the volume-pulse changes that coincide with the cardiac cycle.

However, nonpulsating change in resistance unbalances the bridge and requires a change in setting of

the 25,000-ohm potentiometer for rebalance. The potentiometer is calibrated in ohms making the steady-state change in resistance equal to the difference between the new and previous potentiometer setting.

A schematic of the circuit is shown in Fig. 1. Transistor Q_1 in conjunction with T_0 constitutes an oscillator that generates approximately 50 kc. The output of T_0 is fed to emitter follower Q_2 which isolates the oscillator from the rest of the circuit.

Transformer T_1 supplies R_1 , R_2 , R_3 , the 25,000-ohm potentiometer and the tissue segment which form a bridge circuit. The bridge permits measurement of resistances independently of the contact resistances. This is accomplished by using a four terminal connection, I_1 and I_2 to supply the current input and E_1 and E_2 to detect the voltage drop across the resistance being measured. The voltage drop across E_1 and E_2 is counteracted by the voltage from T_2 to form a null circuit.

The bridge also balances out noise fluctuations. The variation in impedance with the cardiac cycle is measured by the fluctuations it imparts to an electrical potential. Since the impedance fluctuations are generally less than 0.1 percent of the total impedance, their order of magnitude approaches the noise fluctuations in the voltage used to measure them. Use of the bridge to minimize noise insures that the modulation of the output of the

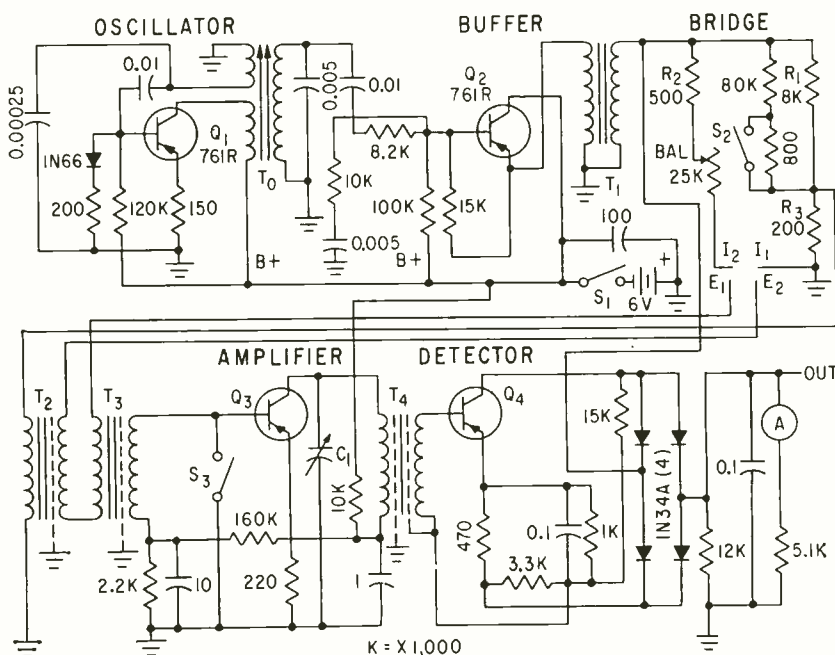
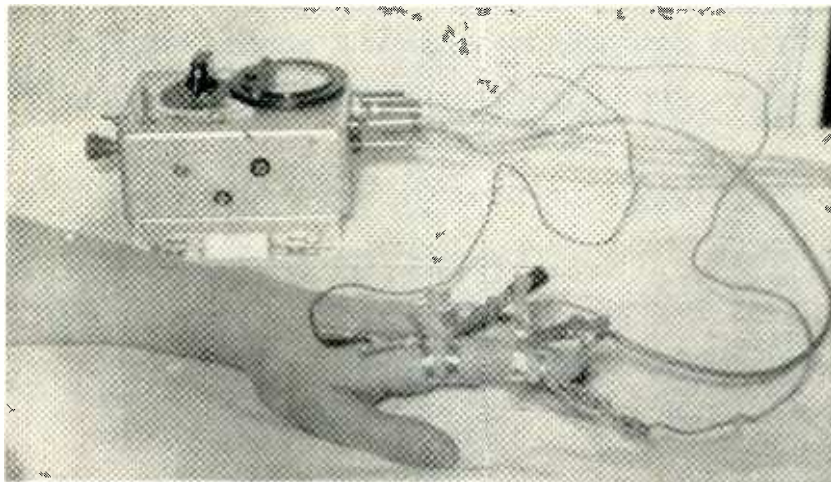

FIG. 1—Circuit of the plethysmograph. A change in tissue impedance unbalances the bridge

of Living Tissue



Electrode arrangement for living tissue impedance measurement

bridge is basically due to the variations in the resistance of the tissue segment.

The voltage picked off across E_1 and E_2 , which is the voltage drop across the tissue segment, is subtracted from the voltage drop across R_3 to establish the null. This is accomplished by the use of 1:1 coupling transformer T_2 which transfers the voltage drop across R_3 so it is in series and bucking the E_1 - E_2 potential. Once the bridge is balanced any subsequent difference in potential is impressed across the high-impedance primary of T_3 . The secondary of step-down transformer T_3 matches the input impedance of a grounded-emitter stage Q_3 while the primary presents a high impedance so that practically no current flows between points E_1 and E_2 . Common-emitter amplifier Q_3 amplifies the unbalanced potential of the bridge. Impedance matching transformer T_1 couples the amplifier to a phase detector. Variable capacitor C_1 , in conjunction with the core of T_0 , adjusts the phase of the unbalanced bridge signal to a reference coming directly from the generator. Both signals feed the phase-sensitive detector. Closing switch S_3 , after placing the electrodes and activating the circuit, eliminates any signal from the bridge and permits phase adjustment through T_0 so that the galvanometer reading is

initially zero. It also permits a check on phase adjustment at any time during a recording session.

Determining Null

Since the instrument measures the pulsating variation of the absolute value of impedance, the bridge null adjustment is simplified by using a phase-sensitive detector to scan bridge unbalance. Therefore, small unbalanced quadrature components of the impedance do not affect the null of the detector and the null measuring circuit is relatively independent of small variations in phase. Thus the bridge can be balanced simply by the 25,000-ohm potentiometer.

In operation the vascular volume-pulse modulates the 50-kc signal so that the output of the bridge fluctuates on either side of a null. The phase detector demodulates the 50-kc unbalanced signal without distortion. This is true even when the bridge is so well balanced that the 50-kc carrier of the modulated signal coming from the bridge is completely eliminated and only the sidebands remain. The phase detector thus permits the use of a simple adjustment.

The unit is powered by four 1.5-v pencil batteries. Because of the low voltage and high frequency of the signal, switches with gold plated contacts are used.

In previous electrical impedance circuits the current was kept constant and the output of T_2 was balanced by a potentiometer against the potential detected along the segment of tissue being measured. In this circuit the voltage is held constant. The output of T_1 is in series with the potentiometer and the current output of T_1 is adjusted so that the voltage drop along the test segment is balanced. This modification is important because of the low-voltage power supply and the noise level of the transistors. If the voltage were allowed to vary in proportion to the impedance of the tissue the voltage drop could approach the upper limit of the batteries and the voltage drop could be so low that the noise level of the transistors would be reached.

Detection

The modulated signal due to the unbalance of the bridge is amplified and drives the base of the detector Q_4 . The detector circuit is similar to one described in the literature.¹

If the resistance of the tissue remains constant there is no pulsating or other unbalance of the bridge and the signal from the bridge is unmodulated or zero. Under these conditions the signal driving the base of Q_4 is the constant bias voltage derived from the voltage divider and filter capacitor in the emitter-collector circuit of Q_4 . The resultant collector voltage is proportional only to the rectified reference signal, thus its adjacent half waves will have the same amplitude. As a result, the current on the a-c side of the rectifier will be a sinusoidal current without a d-c component, hence a d-c pulse will not be detected.

To obtain the d-c component, both sets of half waves pass through detector Q_4 . Any alteration in the sensitivity of the detector cannot affect the balance.

REFERENCE

(1) S. Bagno and J. Fasal, Intruder Alarm Uses Phase-Sensitive Detector, p 106, ELECTRONICS, Feb. 14, 1958.

Selection Guide for

Silicone insulating materials are desirable for electronic applications that demand environmental extremes. Here is guide that presents significant data

By **C. G. CURRIN**, Project Leader, Electrical Laboratory, Dow Corning Corporation, Midland, Michigan

Table 1—Physical and Electrical Properties of Silicone Insulating Materials

Use	Silicone Insulation Available in the Following Form	60-cps Electric Strength in volts/mil ^a	Dielectric Properties	
			Vol. Resistivity, in ohm/cm Conditioned 48 hr/50/23 C	Dielectric Constant ^b
Processing Materials Encapsulation and Filling	Room-temp.-vulcanizing silicone rubber	400	0.5×10^{14}	3
	Molded silicone rubber	400	5×10^{14}	3
	Filled solventless silicone resin	325	0.5×10^{14}	3.3
	Dimethyl Silicone Fluid, Electrical Grade Silicone Compound	400	1×10^{14}	2.7
Winding and Coil Impregnation	Impregnating varnish	2,000 ^d	1×10^{14}	3.1
	Solventless silicone resin	350	0.5×10^{16}	2.8
	Modified silicone resin	2,000 ^d	1×10^{14}	3.2
Surface Coating	Silicone varnish	2,000 ^d	1×10^{14}	2.7
	Silicone fluid	2,000 ^b	1×10^{14}	2.7
Adhesives	Pressure-sensitive adhesive	600 ^d	1×10^{14}	2.8
	Silicone rubber adhesive	400	0.2×10^{14}	2.9
Terminal, Connector Sealant	Room-temp.-vulcanizing silicone rubber	400	0.5×10^{14}	3
Capacitor Impregnation	Silicone compound	500 ^c	0.2×10^{16}	2.8
	Silicone fluid, electrical grade	400	1×10^{14}	2.7
	Solventless silicone resin	350	0.5×10^{16}	2.8
Insulating Materials & Components Wire Insulation	Silicone modified wire enamel	3,000 ^d	2×10^{14}	3.7
	Silicone bonded glass served wire	100	1×10^{14}	3.5
	Silicone rubber	400	1×10^{14}	3
Molded Parts	Resin molding compound	350	1×10^{14}	4.4
	Silicone rubber	400	5×10^{14}	3
Laminate (for terminal strips, coil forms, etc.)	Silicone-glass laminate	300	1×10^{14}	3.6
Varnished Glass Cloth	Silicone varnished glass cloth and sleeving	1,500 ^d	1×10^{14}	3
Extruded Parts	Silicone rubber sleeving, capacitor bushings, etc.	400	1×10^{14}	3

a—Unless otherwise noted, electric strength is for 0.10-inch insulation thickness measured using 1/4 inch ASTM electrodes at room temperature by continuously increasing the test voltage 500 volts/sec.

b—Measured at 1,000 cps; dielectric constant usually varies less than 10 percent from 50 cps to 100 mc.

c—Values are only a guide, since many factors of considerable magnitude are involved: different products of the same type, different manufacturers, widely different requirements of each application, different processing methods. Although these data are the best available, they may differ by a factor of 10 or more from experience with a particular silicone in a single application. Data tabulated for 200 C and 400 C are generally extrapolated from test results at 225 C to 300 C.

d—Measured on 0.003-inch-thick film on aluminum panel.

Silicone Dielectrics

SILICONES comprise a premium grade of insulation noted for their combination of engineering properties. As shown in Table I, silicone insulation is available in a wide range of forms.

The dielectric properties of silicones remain relatively constant over a wide temperature range. In most cases, high electric strength and low dielectric

constant are little affected by temperature. Dielectric losses are usually lower at temperatures of 200 C and above.

Other characteristics, advantageous in many electronic applications, include physiological inertness, resistance to weathering, water repellency, relatively high thermal conductivity and arc resistance.

At 25 C

Dissipation Factor		Mechanical Properties of Different Types	Reliability Average Life* in Hours at Temperature C			
at 100 cps	at 1 mc		200 C	250 C	300 C	400 C
0.010	0.003	200-400 percent elongation, 100-400 psi tensile strength	3,000	300	5 ⁱ
0.003	0.001	100-600 percent elongation, 300-1,500 psi tensile strength	20,000	5,000	500	<0.1
0.006	0.002	8,000 psi flex strength, 4,000 psi tensile strength	730,000	>10,000	> 2,000	> 10
0.00005	<0.0001	20-1,000 cst viscosity	715,000 ^e	7,500 ^e	>100 ^e ^j
0.0002	0.0005	Evaporation 24 hr/200 C—2.0-5.0 percent	20,000	<20	<2 ^j
0.004	0.003	Low bond strength at 200 C	60,000	4,000	350	10
0.002	0.001	7,500 psi flex strength, 3,500 psi tensile strength	>20,000	>5,000	>1,000	>5
0.003	0.003	High bond strength at 150 C	6,000	300	30	<1.0
0.002	0.001	High water repellency	60,000	4,000	300	10
0.00005	<0.0001	21 dynes/cm surface tension	100,000	5,000	400	10
0.005	0.002	Available on tapes with glass cloth, silicone rubber, Teflon, or aluminum backing	20,000	4,000	100	0
0.001	0.001	5-25 lb/in peel strength, silicone rubber to aluminum	20,000	5,000	500	<0.1
0.010	0.003	200-400 percent elongation, 100-400 psi tensile strength	3,000	300	5 ^j
0.0002	0.0005	Penetration, worked, 250-350	20,000	<20	<10 ^j
0.004 ^f ⁱ	Capacitors hermetically sealed	Dependent upon other materials used in making the capacitors.			
0.008 ^f ⁱ	Capacitors need not be sealed				
0.004	0.018	Passes 1 X mandrel test	10,000	400	15
0.004	0.003	Repeated scrape abrasion; 70-120 strokes	>100,000	50,000	800	50 ^j
0.004	0.001	200-450 percent elongation, 600-1500 psi tensile strength	10,000	2,500	250	<0.1
0.006	0.004	12,000 psi flex strength; 4500 psi tensile strength	>200,000	>50,000	>10,000	>200
0.003	0.001	100-600 percent elongation; 300-1500 psi tensile strength	20,000	5,000	500	<0.1
0.004	0.001	10,000-50,000 psi flex strength; 15,000-30,000 psi tensile strength	20,000	5,000	300	15
0.005 ^g	0.002	Flexible thin high-voltage insulation	>100,000	10,000	1,000	25
0.004	0.001	200-450 percent elongation, 600-1500 psi tensile strength	20,000	5,000	500	<0.1

e—Measured on 0.010-in. thickness using 0.50 in. spherical electrodes.

f—Measured at 1,000 cps in combination with capacitor tissue.

g—In absence of oxygen.

h—Measured on 0.001-in. thickness using 0.50 in. spherical electrodes.

i—Not applicable.

j—Not suggested for use at 400 C for even short durations.

Tunable F-M Multiplex

Novel heterodyne system eliminates complex filter design for multiplex f-m reception. Different subcarrier frequencies may be accommodated by varying oscillator frequency. Up to 50-kc bandwidth is obtained using 455-kc center frequency. Muting circuit removes audio output when no subcarrier is present

By **W. B. BERNARD**, Capt., U.S.N., Bureau of Ships, Washington, D. C.

MULTIPLEX f-m systems are coming into more and more use for the transmission of one or more channels of intelligence in addition to the primary channel that carries the standard f-m broadcast. At the present time most of these multiplexed channels are used for commercial music service. Some stations are using multiplex on an experimental basis for the transmission of the second channel of a stereophonic broadcast.

The first channel of such programs are carried on the primary f-m carrier.

When there is only one subcarrier associated with the primary signal, the minimum means of separating it from the primary signal is by a high-pass filter. Since an elementary form of filter is not likely to give sufficient discrimination against the stronger primary signal, a multisection filter is usually used.

When the use of a more complex filter is considered, phase shift properties become important. Usually it is easy to calculate the phase response of a filter in the stop

band, but the calculation of the phase response in the passband becomes involved. The optimizing of phase-shift characteristics also presents problems. A simple high-pass filter suffers from the difficulty that an unnecessarily wide band of noise is presented to the detector which can result in an inferior signal-to-noise ratio at the detector output.

When the best signal-to-noise ratio is desired at the output of the multiplex system, or if more than one subcarrier is being transmitted, it becomes necessary to use band-pass filters to select the desired information and reject the noise and undesired signals. As no multiplex standards have as yet been set, it may become necessary at some later date to set the filters to other than the original frequencies. The adjustment of a multisection filter to a new frequency is a complicated process usually calling for the redesign and replacement of filter components.

Filter Problems

A modern wide-range, high-fidelity audio system may have considerable response at the subcarrier frequency. As there is not a great difference between the audio frequencies to be recovered and the frequency of the subcarrier itself, problems arise in the satisfactory filtering of the detector output.

These difficulties may be greatly reduced or eliminated by heterodyning the subcarrier up to a new higher frequency. At the higher



Tuning heterodyne adapter to desired subcarrier of f-m transmission. Heterodyne adapter couples to multiplex outlet of any f-m tuner

frequency, the selectivity necessary for the selection of the desired signal may be obtained by conventional tuned circuits and detection may be accomplished with conventional f-m detection circuits. The block diagram of a heterodyne adapter is shown in Fig. 1. The subcarrier signal is coupled from the multiplex output of an f-m tuner (before deemphasis) to the adapter mixer where it beats with a local oscillator to produce a 455-kc i-f output signal.

This desired output signal is selected by tuned circuits, amplified, limited and detected.

R-F Circuits

The circuit of the experimental adapter is shown in Fig. 2. The multiplex subcarrier from the f-m receiver is coupled to the adapter

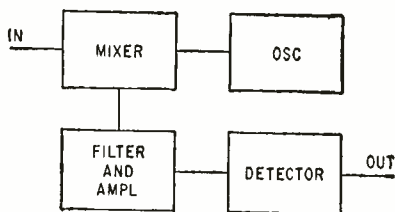

FIG. 1—Block diagram of heterodyne multiplex adapter. Unit is basically 455-kc superheterodyne whose input is subcarrier frequency and output is multiplexed audio

Adapter for Stereo

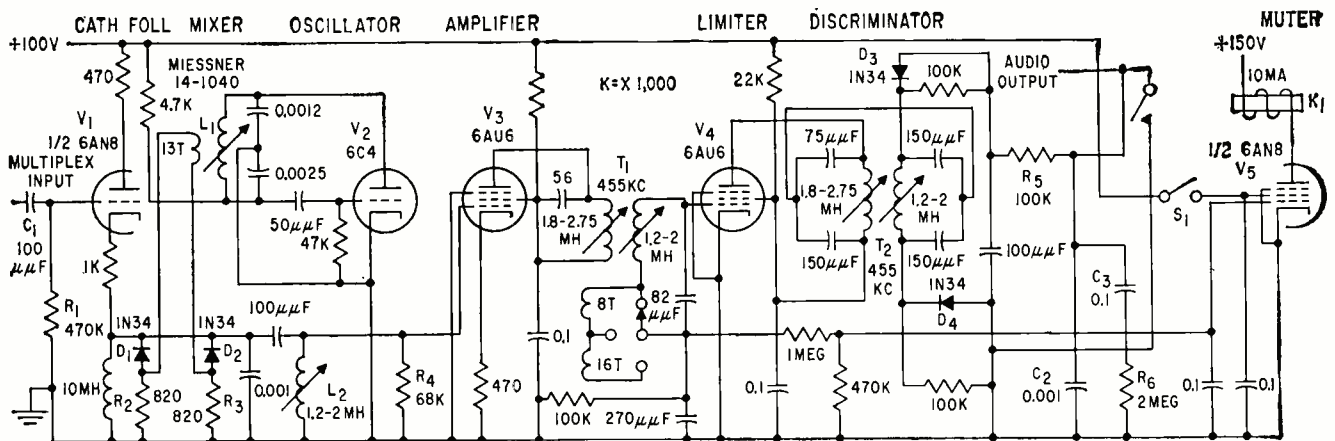

FIG. 2—Cathode follower matches input to balanced mixer. Conventional f-m circuits amplify, limit and demodulate i-f signals. Muting circuit grounds audio output with no subcarrier present

through cathode follower V_1 , through the simple high-pass network of C_1 and R_1 . This high-pass filter passes the subcarrier frequencies and attenuates the audio frequencies present.

A cathode follower is used for isolation between the input circuit and the balanced mixer D_1 and D_2 and to reduce the input impedance to that suitable for use by the balanced mixer.

Oscillator

The local oscillator V_2 is connected as a Colpitts-type oscillator. The secondary winding of oscillator coil L_1 develops approximately 2 volts across the two detector resistors R_2 and R_3 . These resistors balance the voltages to ground.

The output of the mixer is coupled to single-tuned circuit L_2 which selects the 455-kc component of the mixer output. This signal is coupled to amplifier V_3 . Tuned circuit L_2 is loaded by R_4 to obtain the proper Q and selectivity.

Amplifier

The amplifier output is supplied to limiter V_4 through variable selectivity double-tuned transformer T_1 . Transformer T_1 was made by winding 24 turns of No. 26 dcc wire, tapped at 8 turns, adjacent

to the transformer primary winding. Three steps of selectivity are available: 5 kc, 10 kc and 20 kc. The Q of the double-tuned circuit is such that the single-tuned circuit response fills in the valley of the double-tuned circuit response when it becomes overcoupled.

Limiter V_4 drives discriminator transformer T_2 and the signal is detected by discriminator D_3 and D_4 . The resulting audio signal is passed through the deemphasis network consisting of R_5 and C_2 and through the contacts of muting relay K_1 to the external audio system.

The muting circuit is so arranged that when there is no subcarrier signal present, the audio output of the adapter is shorted to ground.

Muting Circuit

Muting is accomplished by single-contact, normally-open relay K_1 whose coil is in the plate circuit of muting tube V_5 . Part of the rectified d-c voltage developed at the control grid of limiter V_4 is applied to the control grid of muter tube V_5 . When a subcarrier is present, the voltage at this grid will be negative cutting off muter V_5 , thus reducing the plate current and maintaining relay K_1 in the open condition. When the relay is open, audio signals are allowed to pass to

the external audio system.

When the subcarrier is not present at the limiter grid, the voltage at the control grid of muter V_5 approaches ground potential causing its plate current to rise high enough to energize relay K_1 shorting the audio signal to ground. Blocking capacitor C_3 and bleeder resistor or R_6 eliminate pops and clicks which might result from opening and closing of muting relay when there is a d-c output from the discriminator. Switch S_1 is in series with the screen voltage supply of the muter tube and may be used to disable the muting feature.

Performance

The heterodyne multiplex adapter can be tuned to accept many subcarrier frequencies by varying the oscillator frequency. As the subcarrier frequency becomes lower, it becomes necessary to use the narrower bandwidth settings. Full 20-kc bandwidth is available at the commonly used 43-kc subcarrier frequency. Experimentation has shown that bandwidths up to 50 kc may be obtained using the 455-kc center frequency.

Bandwidths down to approximately 2 kc may be obtained by employing 175 kc or 262 kc as center frequency.

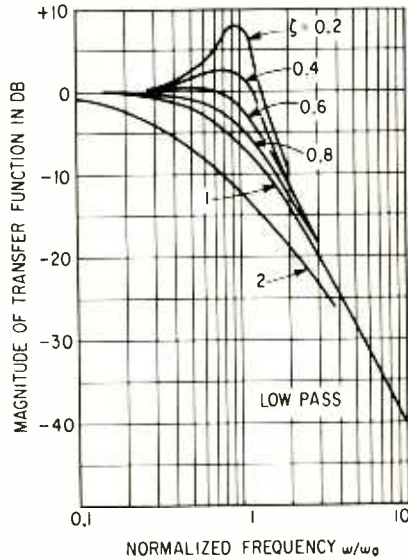
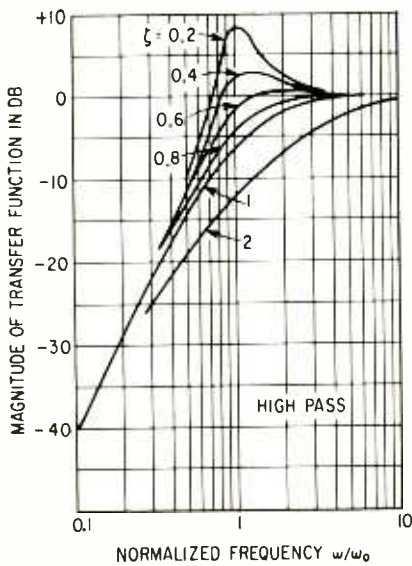

FIG. 1—Shapes of transfer function curves for various values of damping factor

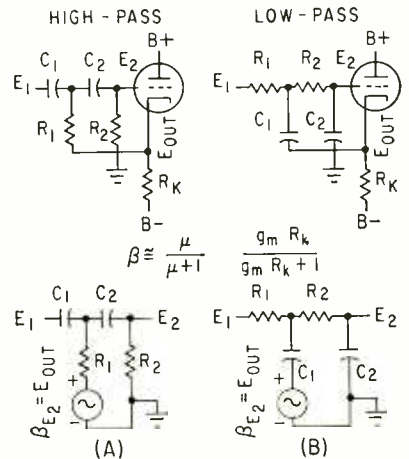

FIG. 2—High-pass (A) and low-pass (B) filter unit showing equivalent circuit with zero output impedance

How to Design

PASSIVE R-C filters are extremely useful in high-, low- and band-pass applications. Stringent requirements, however, often demand either more general passive circuits containing inductance or active networks containing tubes or transistors. At low frequencies, suitable high-quality inductors tend to be expensive, heavy and susceptible to hum pickup. For this reason, active R-C filters are extensively used. The circuit to be described has performance characteristics comparable to the two- or three-tube feedback circuits commonly used but is much simpler and cheaper to build.

These filters are applicable for frequencies from d-c to values so high that stray capacitance becomes a limiting factor. The useful range is through the audio spectrum to approximately 100 kc. With care, operation to a few mc may be possible.

The basic filter unit consists of a cathode follower plus two resistors and two capacitors which may be wired either as a high-pass or low-pass filter having in either case 12-db/octave attenuation slope. These units may be cascaded to give high-, low- or band-pass filtering with attenuation slopes that are

any desired multiple of 12-db/octave.

In the filter theory discussion, the variable s is the complex frequency variable. To obtain the complex number representation for the response to sinusoidal inputs set $s = j\omega$, where $j = \sqrt{-1}$ and ω is the frequency in rad/sec. To match published graphical data², results are put into standard forms for quadratic transfer functions $E_2/E_1 = N/(s^2 + 2\zeta\omega_n s + \omega_n^2)$ where $N = s^2$ for high-pass filters or ω_n^2 for low-pass filters, ζ (zeta) is a dimensionless parameter called damping factor and is a measure of the sharpness of transition from the passband to the rejection band and ω_n is the corner frequency with dimensions in rad/sec. The corner frequency locates the nominal transition point between pass and rejection bands. Figure 1 shows the magnitude plotted against frequency for several values of damping factor. If the damping factor is greater than 1, the system will be overdamped (as with all passive R-C filters). The transient response will be sluggish and the frequency response has a broad, gradual transition region. When the damping factor is 1, the system is critically damped. The transient re-

sponse is the fastest possible without overshoot or ringing and the frequency response has a moderately sharp transition. When the damping factor is less than 1, the system is underdamped. In this case, the transient response is rapid but has overshoot. With low values of damping factor, pronounced ringing will occur. The frequency response tends to have sharp transition possibly with a hump near the corner frequency. The exact choice of damping factor depends upon the application and upon what may be in cascade with the filter, but values in the range 0.5 to 1 are most commonly used.

Basic Filters

The basic form of the high-pass filter is shown in Fig. 2A, top. When a negative (B) supply is not available, other methods of establishing d-c level for the vacuum tube may be used. If it is assumed that the cathode follower has a zero output impedance, the equivalent circuit is as shown in Fig. 2A, bottom, and the transfer function, corner frequency and damping factor may be calculated from Table 1.

The basic form of the low-pass filter is shown in Fig. 2B, top, with the equivalent circuit below. As

Single triode plus three resistors and two capacitors comprise network that may be either high- or low-pass filter having 12-db/octave attenuation. Filters can be cascaded for high-, low- or band-pass filters with slope any desired multiple of 12-db/octave with insertion loss of less than 2 db. Once designed, filter can be changed to new frequency by simple scale changes

By **W. D. FRYER**, Research Physicist, Physics Div., Cornell Aeronautical Lab., Inc., Buffalo, N. Y.

Low Cost Audio Filters

for the high-pass filter, all calculations may be made from Table 1.

Designing a Symmetrical Circuit

For damping factors greater than 0.5, the symmetrical design procedure may be used. This method has three advantages: design formulas for C_1 , C_2 , R_1 and R_2 are the same for both high- and low-pass filters; a high-pass filter may be converted into a low-pass filter (and reverse) with the same corner frequency and damping factor merely by interchanging R_1 with C_1 and R_2 with C_2 ; and the circuit becomes insensitive to tube parameter variations.

Symmetry of design occurs when $R_1 C_1 = R_2 C_2 = 1/\omega_o$. See Table 1 for definitions.

The transfer function becomes:

$$\frac{E_2}{E_1} = \frac{s^2 \text{ (high-pass) or } \omega_o^2 \text{ (low-pass)}}{s^2 + (\alpha + \gamma)\omega_o s + \omega_o^2}$$

Choose a damping factor greater than 0.5 (damping factor = $(\alpha + \gamma)/2$), a corner frequency in rad/sec and determine the value of $\alpha = 1 - \beta$.

Determine γ from $\gamma = 2\zeta - \alpha$. This value must exceed unity. If it does not, a smaller α or a larger ζ must be chosen.

Choose C_1 arbitrarily. Calculate

$C_2 = (\gamma - 1)C_1$; $R_1 = 1/(\omega_o C_1)$; and $R_2 = 1/(\omega_o C_2)$.

As an example; suppose $\zeta = 0.6$, $\omega_o = 100$ and $\alpha = 0.1$. Then $\gamma = 1.1$, $C_1 = 0.01 \mu\text{f}$ (chosen arbitrarily), $C_2 = 0.001 \mu\text{f}$, $R_1 = 1 \text{ meg}$ and $R_2 = 10 \text{ meg}$.

If necessary, or desirable, a change in impedance level may now

less. For fixed α and γ , the smallest possible value of damping factor is $\zeta_{min} = \sqrt{\alpha\gamma}$. Design equations for obtaining this value are given in reference³. An infinite number of trial and error solutions also exist for any $\zeta > \zeta_{min}$.

Deviations from Idealized Theory

The output impedance of a cathode follower is not zero but typically several hundred to one thousand ohms. In a high-pass filter this deviation from the assumptions in the simple theory has never been found troublesome. In a low-pass filter however, a measurable effect often occurs at frequencies so high that the reactance of C_1 becomes comparable to the cathode follower output impedance. Typically, this effect shows in the gain against frequency curve as a rejection notch (at some frequency above corner frequency) after which the attenuation curve approaches -6 db/octave instead of -12 db/octave .

If this effect is large enough to be troublesome, one or more of three methods of reducing its magnitude may be used: a cathode follower may be used with a lower output impedance; the impedance level of the R-C network may be raised; or a bypass capacitor may be placed

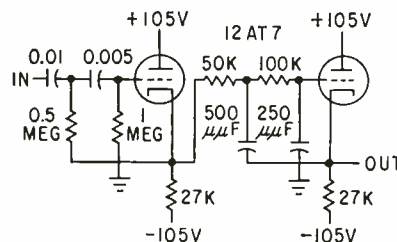

FIG. 3—Example of high- and low-pass filters cascaded to give band-pass action. Corner frequencies are 200 radians per sec (32 cps), and 40,000 radians per second (6,370 cps) respectively. Damping factor for each filter is 0.75

be made by multiplying the resistance values and dividing the capacitance values by the same factor. For practical reasons, the impedance level should be kept high.

Other Design Procedure

Symmetrical design cannot be used for damping factors of 0.5 or

across the cathode resistor.

An illustrative circuit of a high-pass and low-pass filter cascaded to give band-pass characteristics is shown in Fig. 3. Using handbook values of $\mu = 60$ and $g_m = 4,000 \mu\text{mhos}$ for the 12AT7, α was computed from

$$\beta \cong \frac{\mu}{\mu + 1} \frac{g_m R_K}{g_m R_K + 1} = 0.975$$

therefore

$$\alpha = 1 - \beta = 0.025$$

Figure 4 shows theoretical frequency response. Note the notch and leveling of the curve at high frequencies. This effect is a typical deviation from the theoretically anticipated curve for a low-pass filter.

Composite Filters

As a result of the low output impedance of these filter circuits, cascading of individual units is possible without the need for intermediate buffer stages. A small insertion loss (usually 0.5 to 1 db) means that multiple cascading does not cause the signal level to deteriorate significantly. As a result, composite filters with high-, low-, or band-pass characteristics with attenuation slopes of any desired multiple of 12-db per octave are easily obtained.

It is possible to cascade these filters with passive R-C filters. In this case, use of a fairly low damping factor for the active filter will

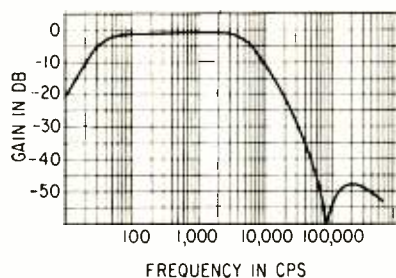

FIG. 4—Theoretical frequency response agreed with actual response

tend to compensate for the inherent droop of the passive filter response. In practice, the addition of passive units often necessitates the use of an additional buffer stage. In this case, another active filter may be as cheap as the passive one.

Variation of Corner Frequency

Any satisfactory filter circuit (Fig. 3 for example) can be changed to a new corner frequency by a simple scale change of C 's or R 's. The change in corner frequency does not affect the damping factor.

Continuous tuning of the corner frequency can be achieved by using ganged capacitors for C_1 and C_2 or ganged resistors for R_1 and R_2 . When capacitance or resistance variation is linear with shaft rotation, the corner frequency will vary inversely with shaft rotation.

The insertion loss of one active filter unit is the gain loss of the cathode follower and is typically

less than 1 or 2 db. Near the corner frequency it is possible to get greater voltage out than put in when values of damping factor corresponding to humps in the response curves near the corner frequency are used.

The output impedance in an exact sense undoubtedly is a function of frequency. For all practical purposes it is approximately several hundred to 1,000-ohms resistive.

The circuit is inherently stable. There is no possibility that an increase or decrease of the transconductance or amplification factor of the tube can cause instability.

Sensitivity

The sensitivity of the response characteristics to parameter changes is quite low. To an extremely good approximation, the corner frequency depends only on the passive components and not at all upon tube parameters. The damping factor depends upon the gain of the tube, but the gain of a cathode follower is quite insensitive to changes in tube parameters at least when the amplification factor is large.

Linearity is essentially as good as for an ordinary cathode follower circuit. Large signals may be handled by properly adjusting the d-c levels of voltage and current.

Applications

Many applications for these filter units exist. In audio, they may be used for rumble or hiss suppression, crossover networks and f-m multiplex circuit use; in industrial electronics, filtering transducer outputs, radio propagation signals, servo control signals and quantization of noise. In laboratory use, they can function as a universal high-, low-, and band-pass filter. With symmetrical design, any individual unit could be used either as high- or low-pass, the choice being made by simple switching. With continuously variable resistance or capacitance, variable tuning is possible.

Table I—Formulas and Parameters Used in Basic Filter Design

Transfer Function	Corner Frequency	Damping Factor
High-Pass $\frac{E_2}{E_1} = \frac{s^2}{s^2 + (\alpha\omega_1 + \gamma\omega_2)s + \omega_1\omega_2}$	$\omega_o = \sqrt{\omega_1\omega_2}$	$\zeta = \frac{\alpha\omega_1 + \gamma\omega_2}{2\omega_o}$
Low-Pass $\frac{E_2}{E_1} = \frac{\omega_1\omega_2}{s^2 + (\gamma'\omega_1 + \alpha\omega_2)s + \omega_1\omega_2}$	$\omega_o = \sqrt{\omega_1\omega_2}$	$\zeta = \frac{\gamma'\omega_1 + \alpha\omega_2}{2\omega_o}$

Definitions

$\alpha = 1 - \beta$	$\omega_o =$ corner freq. in rad/sec
$\gamma = \frac{C_1 + C_2}{C_1} = 1 + \frac{C_2}{C_1}$	$\zeta =$ damping factor
$\omega_1 = \frac{1}{R_1 C_1}$	$\beta =$ cathode follower gain
$\omega_2 = \frac{1}{R_2 C_2}$	$\gamma' = \frac{R_1 + R_2}{R_2} = 1 + \frac{R_1}{R_2}$
$s =$ complex frequency variable ($=j\omega$ for sinusoidal responses)	

REFERENCES

- (1) Patent Pending.
- (2) H. Chestnut and R. Mayer, "Servo-mechanisms and Regulating System Design," 1, John Wiley & Son, 1951.
- (3) W. D. Fryer, High-, Low-, and Band-Pass Filters for Audio and Sub-Audio Frequencies, Cornell Aeronautical Lab.

Silicon Power Rectifiers

Current carrying capacities of 200 ma to 140 amp at 150 C and peak inverse voltages of 50 to 600 v are obtained in military units

By **ROBERT F. EDWARDS**, President's Assistant for Planning, International Rectifier Corp., El Segundo, Calif.

DEVELOPED BY the military services to provide sufficient rectifier production in the event of industrial mobilization, silicon power rectifiers have reached mass production and standardization.

Table I lists the entire series of EIA and military standard silicon power diode mechanical configurations. There is still some variation in current ratings between the services for identical mechanical configurations. Lower ratings are in parenthesis.

The standard sizes are based on incremental changes in rectifying area of the silicon *p-n* junction, as well as current carrying capacity. Stud mounted units are rated at 135-150 C case tempera-

ture and pigtail mounted units are rated at 150 C ambient temperature. The 250-ma diodes are pigtail types and all others listed are stud mounted.

A rectifier can be selected from this list for nearly every application. Typical current-temperature curves, for the 35-, 70- and 140-amp diodes, are given in Fig. 1. These show the absolute maximum rectified diode current as a function of diode base current. Such curves are not part of the standard and may vary from manufacturer to manufacturer.

Use of standard parts by equipment designers eliminates delays. In addition, it assures parts approval by military buyers.

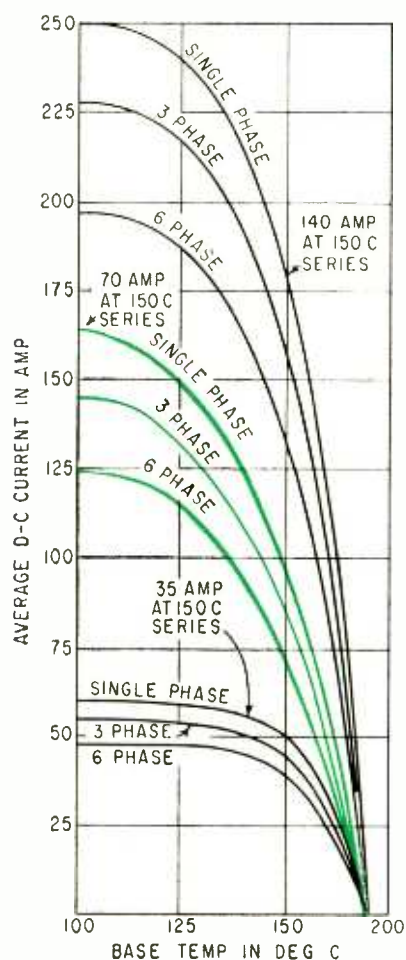

FIG. 1—Absolute maximum rectified diode current as a function temperature

Table I—Current Rating and Peak Inverse Voltage of EIA and Military Standard Silicon Power Diodes

Part Number	Specification Number	Approved as Standard by:	Current at 150 C	PIV (volts)
JAN 1N538	MIL-E-1/1084A	ASESA	250 ma	200
JAN 1N540	MIL-E-1/1085A	ASESA	250 ma	400
JAN 1N547	MIL-E-1/1083A	ASESA	250 ma	600
JAN 1N253	MIL-E-1/1024A	ASESA	1 amp	100
JAN 1N254	MIL-E-1/999b	ASESA	100 ma	200
JAN 1N255	MIL-E-1/999b	ASESA	100 ma	400
JAN 1N256	MIL-E-1/991b	ASESA	200 ma	600
USAF 1N1200	MIL-E-1/1108 (USAF)	USAF, USN (6A) USA (5A)	12A	100
USAF 1N1202	MIL-E-1/1108 (USAF)	USAF, USN (6A) USA (5A)	12 A	200
USAF 1N1204	MIL-E-1/1108 (USAF)	USAF, USN (6A) USA (5A)	12 A	400
USAF 1N1206	MIL-E-1/1108 (USAF)	USAF, USN (6A)	12 A	600
*USAF 1N1184	MIL-E-1/1135 (USAF)	USAF, USN (USA 20A)	35 A	100
*USAF 1N1186	MIL-E-1/1135 (USAF)	USAF, USN (USA 20A)	35 A	200
*USAF 1N1188	MIL-E-1/1135 (USAF)	USAF, USN (USA 20A)	35 A	400
USAF 1N1190	MIL-E-1/1135 (USAF)	USAF, USN	35 A	600
USAF 1N1202	MIL-E-1/1136 (USAF)	USAF, USN, USA (50A)	70 A	100
USAF 1N1234	MIL-E-1/1136 (USAF)	USAF, USN, USA (50A)	70 A	200
USAF 1N1236	MIL-E-1/1136 (USAF)	USAF, USN	70 A	400
USAF 1N1288	MIL-E-1/1136 (USAF)	USAF, USN	70 A	600
1N2054-	66-2435	USN	140	50
1N2056-	66-2435	USN	140	150
1N2059-	66-2435	USN	140	300
1N2064-	66-2435	USN	140	600

*Qualification will be attempted for the USA specifications (1N249a, 1N250a, 1N2135a)

Audio Amplifier Design

Plate dissipation in class-A and class-B audio amplifiers is substantially reduced by feeding a superaudible signal to the grid in addition to the desired signal. Maximum dissipation of class-A amplifier may be cut to 41 percent of that of a conventional class-A amplifier, and maximum dissipation may be halved in a class-B amplifier

By **ROBERT B. DOME**

Consulting Engineer, Television Receiver Department, General Electric Co., Syracuse, New York

PLATE DISSIPATION of class-A or class-B audio amplifiers can be reduced as much as 41 and 50 percent, respectively. The reduction is obtained by feeding an auxiliary signal to the amplifier grid.

The auxiliary signal at superaudible frequency is adjusted in amplitude so that its positive peaks never cause peak plate current to exceed maximum current peak of the desired signal. Similarly, amplitude is adjusted so as never to cause clipping of the auxiliary signal on the negative peaks.

Class-A Amplifier

In a class-A amplifier of conventional design, with no input signal all plate input power is dissipated on the plate. With an input signal, useful output is obtained in an external circuit and plate dissipation is reduced correspondingly. With the arrangement to be described, some input is provided to the tube on all occasions except when the tube is being driven to peak plate current. So that the additional input does not interfere with the desired low-frequency signal, a superaudible frequency was chosen.

Two cycles of audio frequency are shown in Fig. 1 for a conventional class-A amplifier following a no-signal region. Average d-c plate current is constant whether the audio is present or not. The same two cycles are shown in Fig. 2 with an auxiliary signal added to give the amplifier something to do at all times except when it is called upon to deliver maximum plate current. The auxiliary signal rides

evenly in a positive and negative direction about the low-frequency signal as an axis so as not to disturb average low-frequency current.

The plate circuit of the class-A amplifier has two load circuits, one for the auxiliary frequency and one for the low-frequency audio, as shown in Fig. 3. Load for the superaudible frequency is shown as resistor R bypassed for low frequencies by inductance L .

The wave shape of the auxiliary signal may be sinusoidal or it may be a square wave. The plate circuit for the auxiliary signal may be tuned for the sinusoidal wave or the fundamental component of the square wave. It may also have broad response, resembling a video amplifier and producing essentially square waves of the auxiliary signal from the square-wave grid excitation. Reduction of plate dissipation depends on the choice of these factors and in general improves with square waves.

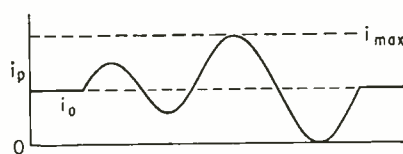

FIG. 1—Plate current in conventional class-A amplifier



FIG. 2—Class-A amplifier plate current with auxiliary signal added

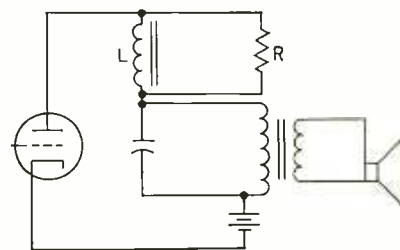

FIG. 3—Low-dissipation class-A amplifier has plate circuits for both desired and auxiliary signals

Performance

Expected performance of a class-A amplifier operated conventionally and in these three conditions is shown in Fig. 4. Data is presented as maximum watts dissipation/watt input as a function of k , where $k = (E_b - E_{b_{min}})/E_b$.

Plate dissipation can be reduced to as low as 40.5 percent of original. Even when $k = 0.91$, dissipation is only 46 percent of original. A k of 0.91 is quite easily achieved in commercially available tubes. For example, the 6V6GT attains a k of 0.91 when operated at its rated value of $E_b = 315$ v, $E_{sc} = 225$ v and $i_b = 34$ ma. Plate voltage $E_{b_{min}}$ is approximately 28 v at $E_{sc} = 0$ and $I_b = 68$ ma. Thus, $k = (315 - 28)/315 = 0.91$.

Plate input is 10.7 watts. If this is called rated dissipation, maximum dissipation may be reduced to 46 percent of this figure or 4.93 watts.

With a sinusoidal superaudible wave and the plate circuit tuned to the fundamental frequency, net plate dissipation as a function of

Cuts Plate Dissipation

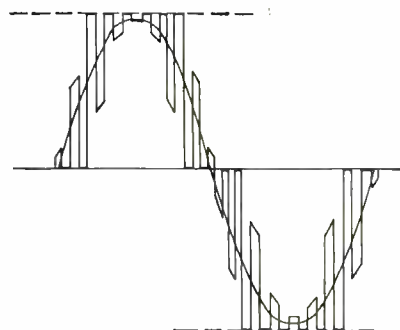
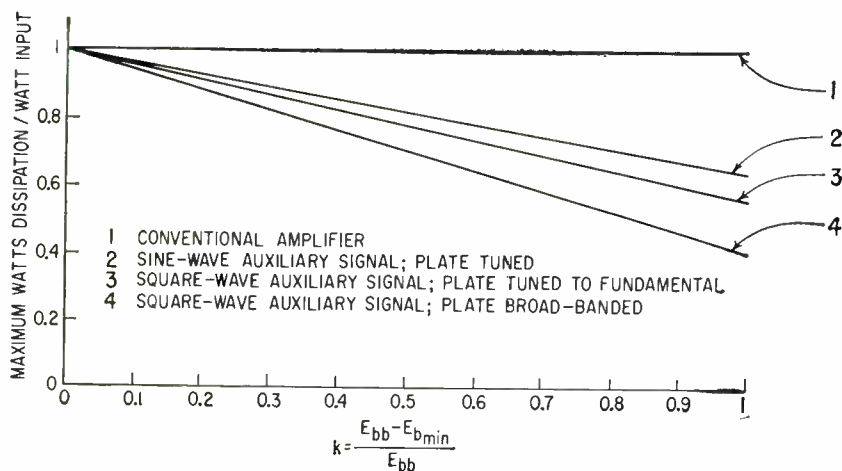

FIG. 5—Class-B amplifier plate voltage with auxiliary signal added

FIG. 4—Maximum dissipation against k for class-A amplifier with 1-watt input

amplitude, m , of the desired low-frequency wave (where m has a minimum value of 1) is

$$W_{diss} = E_{bb} I_b \left[1 - k \left(\frac{1}{2} + \frac{3m^2}{4} - \frac{2m}{\pi} \right) \right]$$

The value of m that yields maximum dissipation may be found by differentiating this equation with respect to m , setting the differential equal to zero and solving for m . Thus, $m = 4/3\pi = 0.425$ for maximum dissipation.

Similarly, the equation for dissipation as a function of m and k for a square superaudible signal but with the plate auxiliary circuit tuned to the fundamental of the square wave to produce essentially a sinusoidal plate voltage is

$$W_{diss} = E_{bb} I_b \left\{ 1 - k \left[\frac{2}{\pi} + \left(\frac{1}{2} + \frac{1}{\pi} \right) m^2 - \frac{8m}{\pi^2} \right] \right\}$$

By differentiation, $m = 8/(\pi^2 + 2\pi) = 0.495$.

The equation for dissipation as a function of m and k for a superaudible square wave but with the auxiliary plate circuit broad-banded to cause the plate voltage waveform to be essentially square is

$$W_{diss} = E_{bb} I_b \left[1 - k \left(1 + m^2 - \frac{4m}{\pi} \right) \right]$$

and by differentiation, $m = 2/\pi = 0.636$ for maximum dissipation.

The class-B amplifier is typified

by its zero-signal plate current being essentially zero and by the positive and negative half cycles of audio frequency plate currents being handled by separate tubes. Figure 5 shows how the plate voltages from one plate to the other appear when the auxiliary signal is added. This signal is different from the class-A case in that no auxiliary signal is present when the low-frequency is zero.

Again, the auxiliary signal may be sinusoidal or square at the grids and may be sinusoidal or square at the plates. Figure 6 shows how maximum dissipation is reduced when the auxiliary signal is added as a function of k . Conditions are

those of a conventional class-B amplifier, with a sinewave auxiliary signal and plate tuned to the fundamental, with a square wave auxiliary signal and the plate tuned to the fundamental of the square wave, and with a square wave auxiliary signal and the plate broadly tuned to accept all harmonics of the square wave.

Data of Fig. 6 is presented as maximum dissipation vs k for constant input of one watt under maximum signal conditions. Maximum dissipation may occur at a value less than maximum signal input.

At $k = 1$, maximum dissipation may be cut in half, and for $k = 0.9$ (a value usually attainable),

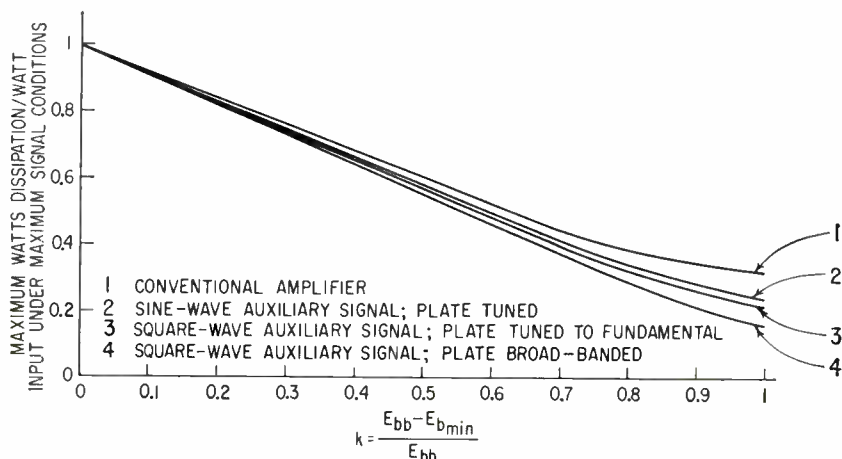

FIG. 6—Maximum dissipation against k for class-B amplifier operated under four conditions. Input is constant at 1 watt under maximum signal conditions

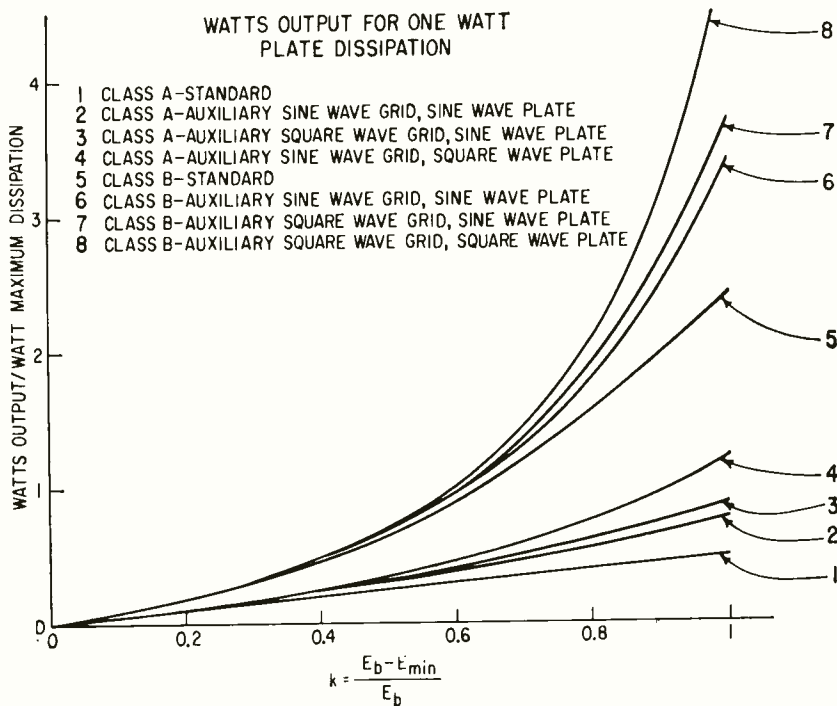

FIG. 7—Power output/watt maximum rated plate dissipation for class-A and class-B amplifiers operating under conventional and various auxiliary signal conditions

maximum dissipation may be cut to 63 percent of conventional.

Increased Output Power

The auxiliary signal immediately reduces plate dissipation without altering input power or useful output power. A possibility also exists of increasing input power and therefore obtaining more useful output power while operating tubes within rated dissipation. This possibility exists whenever d-c plate voltage or d-c plate current or both may be increased within the operating limits of the tube. Figure 7 shows these possibilities.

The curves show maximum power output obtainable per watt of rated maximum plate dissipation as a function of k . For example, if total rated dissipation of a pair of tubes operated class B is 250 watts and $k = 0.9$ in conventional class-B operation, curve 5 shows power output obtainable is twice dissipation rating or 500 watts.

If the auxiliary signal is added using square waves at the grid and broad-banding the plate, output available at $k = 0.9$ from curve 8 is 3.18 times dissipation rating or 797 watts. Whether increased input is permissible must be investigated for the particular tube.

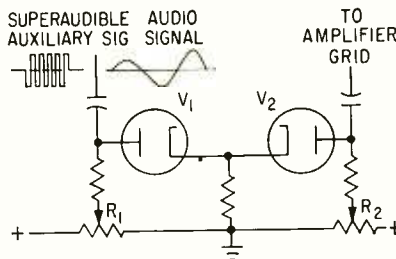

FIG. 8—Grid excitation circuit for class-A amplifier with auxiliary signal

Assume a pair of type 810 triodes operated class B. Each tube is rated at 125 watts plate dissipation under CCS operating conditions, with maximum d-c plate voltage 2,500 v and maximum plate d-c of 250 ma. Peak plate current is $0.25\pi = 0.785$ ampere, which may be attained with $E_{b, min}$ of 160 v. Thus, with $E_b = 2,500$ v, a k of 0.936 is attainable. Referring to Fig. 7, curve 5, output under conventional class-B operation is $W_o = 2.15(250) = 537$ watts.

Power input is $W_{in} = 4W_o/k\pi = 4(537)/0.936\pi = 730$ watts. Since $E_b/I_b = 2,500/0.25 = 10,000$ and $2E_b/I_b = 730$, $E_b = 1910$ v and $I_b = 191$ ma per tube. Both these values are permissible.

Suppose an auxiliary square wave is added and the plate circuit is

broad-banded. Curve 8, Fig. 7, shows that useful output may be 3.7 times rated dissipation of 925 watts.

Input has been increased by the ratio of curve 1 to curve 4 of Fig. 6, or by the ratio of 0.34 to 0.2. Therefore, $W_{in} = 730 (0.34/0.2) = 1,241$ watts.

Solving equations $E_b/I_b = 10,000$ and $2E_b/I_b = 1,241$ yields $E_b = 2,491$ volts and $I_b = 249.1$ ma per tube. Both are permissible values.

Similar calculations may be performed for the square wave grid input and plate circuit tuned to the fundamental. Under permissible limits, $E_b = 2,260$ volts and $I_b = 226$ ma per tube. $W_{in} = 1,020$ watts and $W_{oa} = 750$ watts.

The 750 watts should be obtainable with practical circuits; the 925-watt figure is theoretically obtainable if the super-audible plate circuit is truly broad-banded. However, if some higher harmonics are attenuated, less than 925 watts would be obtained, approaching the 750-watt figure when only the fundamental is left.

Amplifier Input Circuit

One of many possible circuits for producing the grid excitation is shown in Fig. 8. It is suitable for the class-A amplifier. Each plate is provided with a resistive impedance to ground, and is arranged to be biased into conduction by potentiometers connected to B plus.

Input signals consisting of a super-audible wave and the desired audio signal are fed through a blocking capacitor to one plate. Output is taken from the other plate through a suitable blocking capacitor. The circuit is adjusted so that with a constant amplitude super-audible frequency, potentiometer R_1 is set to just clip the negative-going half cycle of the auxiliary wave. Potentiometer R_2 is set to just clip the positive-going half cycle of the auxiliary wave.

When audio is applied, output will be as shown in Fig. 2. Maximum audio input will be that level which at its peaks just reduces the auxiliary signal to zero. The auxiliary signal should cause plate current to go through the excursion of zero plate current to the plate current at zero grid-bias voltage.

UNIVERSAL

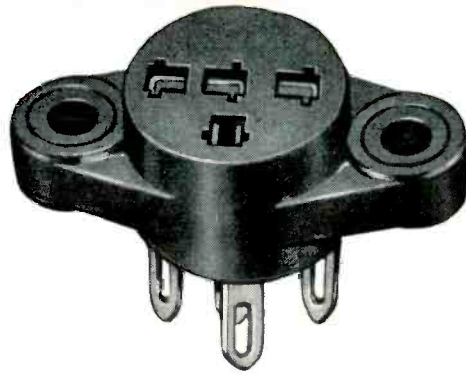

No. 24872

TRANSISTOR SOCKET FOR CONVENTIONAL WIRING

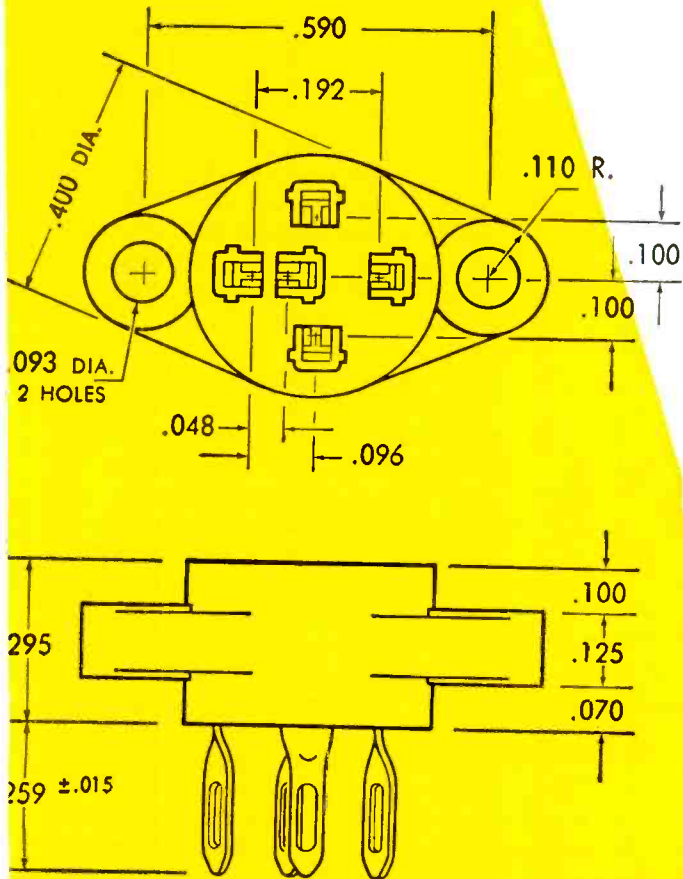

No. 24872



For use with transistors designed to the triangular base layout .2" x .1" (JETEC-30) contact centers, as well as the three contact in-line (.048 x .192 contact centers). This socket was originally designed for the all transistor TV set; however, its future applications are many; industrial communications, test equipment, bread board circuits, etc.

This design features an exceptional subminiature contact designed for the absolute minimum in intermittent failures, and an all molded monoblock construction with mounting holes provided as part of the casting. Assemblies are available in G. P. Black and low loss Mica-filled Phenolic.

The drawing shows five contacts but any number can be omitted to meet your particular contact layout.

Contacts are of Phosphor bronze,
Cadmium plated .0001 (P24).



Cinch
ELECTRONIC
COMPONENTS

Centrally located plants at Chicago, Illinois; Shelbyville, Indiana; LaPuente, California; St. Louis, Missouri.

CINCH MANUFACTURING COMPANY

1026 South Homan Ave., Chicago 24, Illinois

Division of United-Carr Fastener Corporation, Boston, Mass.

Clock Source for Electronic Counters

Small, stable, fixed frequency, 100-kc oscillator is a transistorized version of the Pierce oscillator. When the crystal is replaced with a high-Q inductor-capacitor tuner, it becomes a transistorized Clapp oscillator

By THOMAS F. MARKER, Manager, Automated Data Development Dept., Sandia Corp., Albuquerque, New Mexico

APPLICATIONS of transistors to computer and communication equipment today requires small transistorized oscillators with frequency stabilities better than ± 1 part in 10^6 . Limitations of space and available power often prevent the use of elaborate circuits to control frequency and output voltage from source oscillators.

The circuit shown in Fig. 1 has been used for applications where a small, stable, fixed-frequency oscillator is needed. The circuit consumes 1.5 percent of the power and can be packaged into less than 10 percent of the space required for an electron-tube equivalent.

The circuit is a transistorized version of the Pierce crystal oscillator. When an *E* cut crystal plate is employed, the circuit constants are suitable for operation at 100 kc. For stable operation at 60 kc, C_1 and C_2 are increased to 0.01 μ f. The tuned circuit consists of the mesh which includes the crystal and C_1 , C_2 . The capacitors produce an impedance transformation which aids in isolating transistor parameter variations from the crystal. The crystal oscillates in the positive reactance mode slightly above its natural series resonance frequency. To achieve maximum frequency stability, the oscillation frequency should approach the series resonant frequency of the crystal. As the two capacitors across the crystal are made larger, improvement in stability is achieved; however, this is at

the expense of requiring more current gain from the transistors. When larger current gains are employed by using more favorable transistor types, the effects of transistor characteristic variations

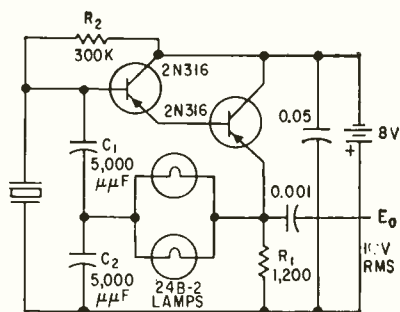

FIG. 1—Stabilized transistor oscillator circuit is used in computer equipment where the temperature is held close to room ambient

become more pronounced so that only moderate improvements in stability are achieved.

Gain Regulation

The circuit uses two 2N316 transistors connected in a composite common emitter configuration. Because of production variations in the current gain of transistors and crystal *Q*, the gain is automatically adjusted to the value which just sustains oscillation. The lamps, connected between C_1 and C_2 to the output emitter, are used for this function. Two type 24B-2 switchboard lamps connected in parallel

between C_1 and C_2 provide sufficient regulation to limit the amplitude of oscillations so that the output is essentially sinusoidal. Lamps are selected so that their cold resistances do not exceed 40 ohms.

Bias current for the transistors is provided by R_2 connected from the collectors to the input base and R_1 connected from output emitter to ground. Since the oscillator is used in computer equipment where the temperature is held close to room ambient, there is no requirement for elaborate temperature-compensating bias circuits.

Oscillator stability varied less than ± 1 part in 10^6 over periods of several hours in an environment where the temperature varied not more than ± 2 F from ambient, and the 8-volt collector supply was constant to ± 0.5 volt.

At room temperature, oscillator frequency closely follows the temperature characteristic of the crystal. With the *E* plate used, this amounts to a frequency shift of approximately 1 ppm/deg C about the crystal turnover temperature and becomes as large as 4 ppm/deg C at temperatures substantially above and below the turnover temperature. For applications with limited ambient variations, the crystal is enclosed in a small container lined with $\frac{3}{8}$ in. thick Dylite expanded polystyrene foam.

The circuit has been employed in electronic counters as a clock source.

Announcing CMC's New Model 400C

The most versatile DIGITAL PRINTER ever made!

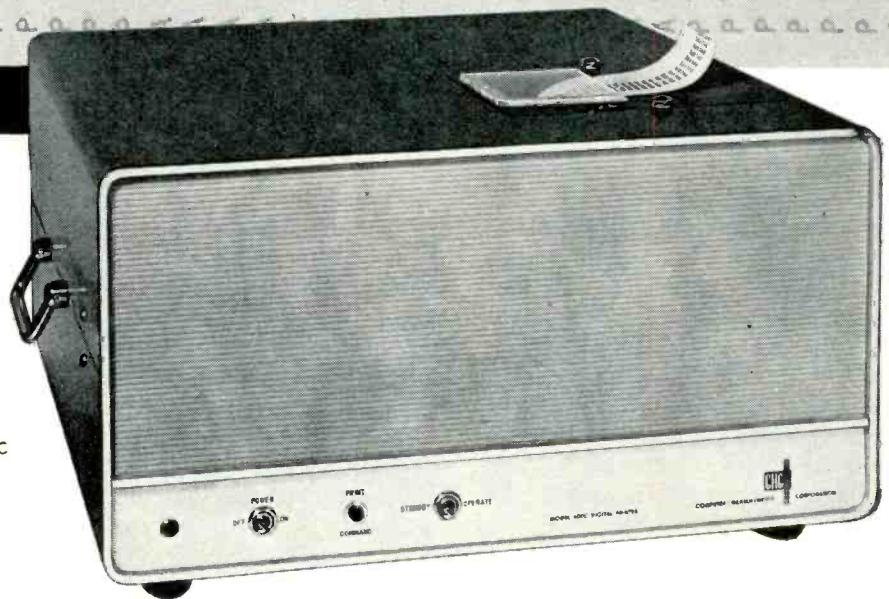

MODEL 400C

ALL NEW, the CMC Model 400C is a reliable, economical instrument for permanently recording digital data from counting, timing, frequency measuring, and data handling systems.

EIGHT OPTIONS OFFERED

Optional features which broaden the area of application for the CMC digital printer:

- 10 line output for operating punches and electric typewriters • analog output for driving strip chart and other pen type recorders
- built-in inline readout for visual monitoring at a distance • accumulator for totalizing • code converter to accept any digital code, Model 400C is compatible with any make of counting equipment
- transistorized drive which accepts low voltage input • an add-subtract solenoid which prints plus and minus numbers • print-line identification for coding printout.

CMC engineering representatives are located in principal cities. For more information on this versatile instrument, phone your nearby representative or write directly to Dept. 184.



Computer-Measurements Corporation

5528 Vineland Ave. • No. Hollywood, Calif.
Phone STanley 7-0401 • TWX: N HOL 8290

New Standard Features

Standard features designed to improve reliability and flexibility include elimination of stepping switches, 4 line per second printout, parallel entry, and rugged unitized construction.

Key Specifications

Print-out capacity 6 digits standard, up to 12 on special order • Accuracy determined by basic counting instrument • Display time 0.2 seconds minimum, maximum controlled by the counter • Weight 64 lbs. • Price \$950. Add \$10 for rack mount.

A-M Sidebands Transmit Stereo

CONVENTIONAL a-m transmitters can easily be converted for stereophonic broadcasting with adapters developed by Kahn Research Labs, Freeport, N. Y. News of the development was received after the article "Recent Developments in Stereo Broadcasting" had been prepared for the April 3, 1959, issue of ELECTRONICS.

Only one transmitter is required, and conventional a-m receivers are used. Monaural reception of stereo programs is also completely compatible on any standard receiver. When stereo broadcasts are not being programmed, the system may be switched to the compatible single-sideband mode.

The combined stereo/compatible single-sideband system is illustrated in the simplified block diagram of Fig. 1. During stereo operation, two sidebands are produced that are independently modulated by the two stereo channels. The resulting envelope wave has the same spectrum requirements as conventional a-m and is theoretically free from inherent distortion. In actual practice, however, the

adapter will add less than one percent total harmonic distortion to the overall system.

The envelope wave produced by the adapter permits independent upper and lower sidebands to be demodulated by standard a-m detectors. Therefore, stereophonic reception can be achieved by simply tuning two receivers to the respective upper and lower sidebands.

Compatible monaural reception of stereo programs is accomplished by tuning a standard a-m receiver to the carrier in the usual manner. Both stereo channels can then be received without loss of program balance.

Fidelity

Improved audio fidelity in each of the stereo channels is a function of receiver bandwidth. Design economy requires that most receivers employ narrow-band i-f amplifiers, and the great majority have a total passband of only 5 or 6 kc.

When conventional a-m transmissions are employed, receivers must be tuned so that the carrier is

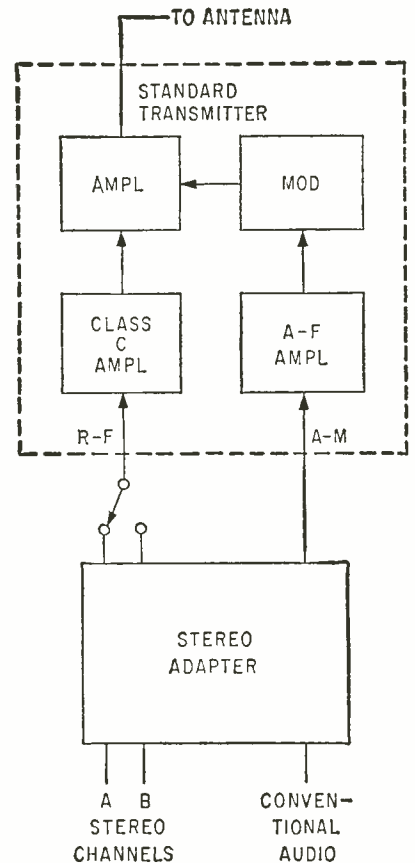

FIG. 1—Adapter is used with standard a-m transmitter

Electronics Tests Drug Reactions



Performance of animals after being given new drugs is graphically recorded at Schering Corp. behavior laboratory. Landis & Gyr impulse counters show statistical pattern of behavior for comparison with behavior of same animal without drug

centered in the i-f passband. Therefore, only one-half, or between 2.5 and 3 kc, constitutes the actual fidelity of these receivers. With a-m stereo reception, however, each set is tuned slightly off carrier so that the carrier appears on one side of the i-f passband, in the same manner as compatible single-sideband. Thus more of the i-f bandwidth of the receiver can be used, resulting in a marked improvement in audio fidelity, approaching that of f-m.

Instrument Makes Contour Maps

DRAWING contour lines showing ground elevations has been achieved in an instrument developed by the Photographic Survey Corp. Ltd. and other companies of Hunting Associates Ltd., Toronto.

Called Stereomat, the device re-

First family of power triodes made specifically for series regulation!

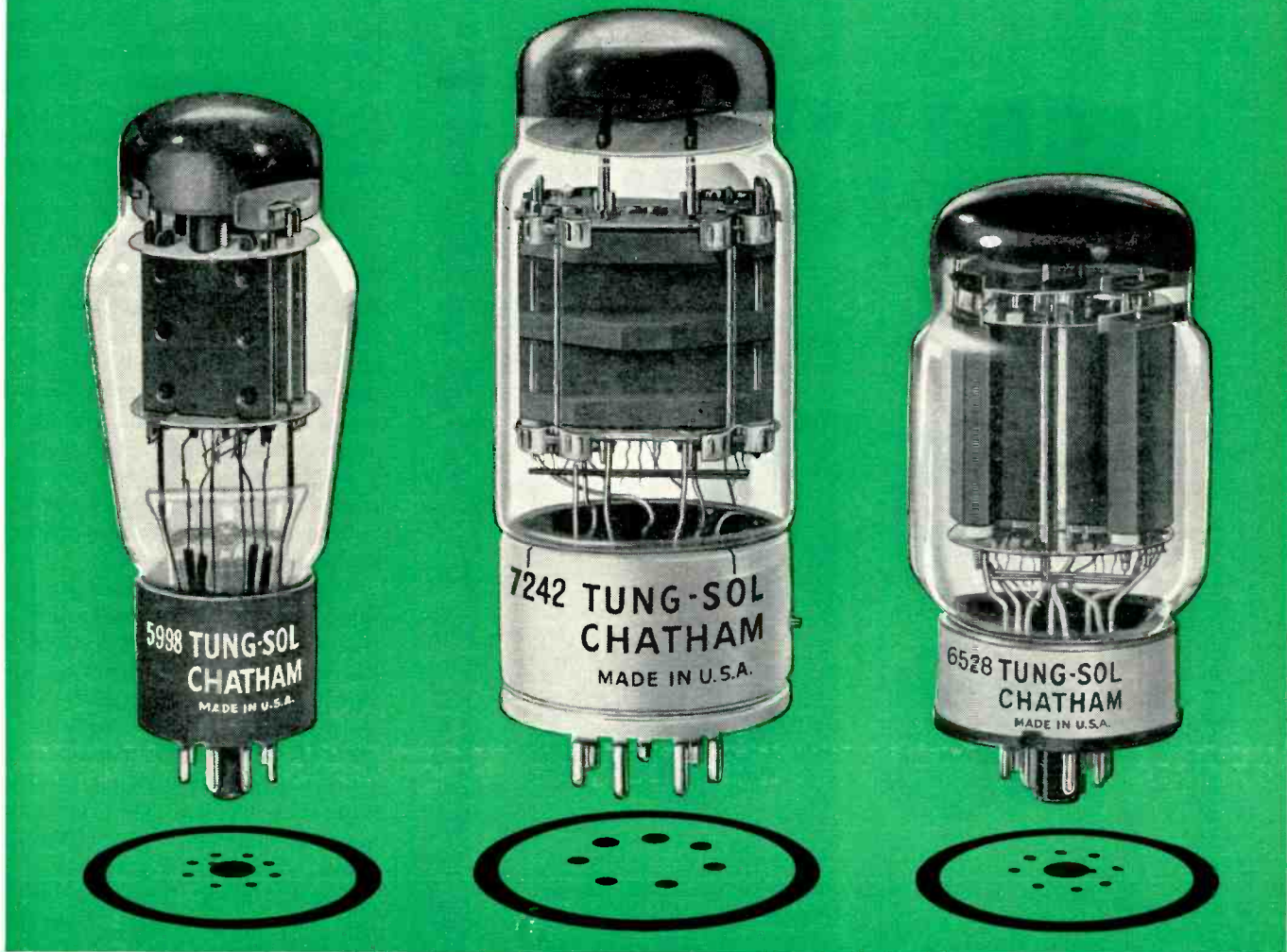

Tung-Sol/Chatham power triode family covers every series regulator need!

Now designers can specify a premium quality Tung-Sol/Chatham tube for all series regulator sockets. Tung-Sol/Chatham's family of power triodes—the first designed and produced specially for series regulator service—meets all design requirements and assures maximum reliability and life at all times.

Types include the new 100 Watters, 7241 and 7242, medium mu or low mu-high current, 12 or 26 Volt

heater versions available on most types. All embody sturdy construction features that contribute to overall ruggedness and long hours of heavy-duty operation.

Compare the ratings below against your particular application! If you desire complete data sheets . . . or you have a specific design problem, contact us today! We'll be glad to give whatever assistance we can. Just write: Tung-Sol Electric Inc., Newark 4, N. J., Commercial Engineering Offices: Bloomfield and Livingston, N. J., Culver City, Calif., Melrose Park, Ill.

TYPICAL VALUES				
	Total Plate Current	Range of Tube Voltage Drop	Minimum Tube Drop	Grid Voltage Swing
5998	200 ma	80 v	45 v	20 v
6528	400	65	70	10
7242	600	80	70	13

PERTINENT CHARACTERISTICS PER TUBE				
	Max. Plate Current	Max. Plate Voltage	MU	Gm
5998	280	275	5.5	28,000 umhos
6528	600	400	9.0	74,000 umhos
7242	900	400	9.0	111,000 umhos

TUBE TYPES BY PLATE DISSIPATION RATINGS				
Total Plate Dissipation	26 to 30 W	60 W	100 W	
Low Mu	6AS7G, 60B2 6080WA, 7105	6336A 6394A	7241	
Medium Mu	5998	6528	7242	







TUNG-SOL®

All the right connections for

CONTINUOUS PERFORMANCE



Continuous performance under extreme environmental conditions is yours with Deutsch 27-contact miniature connectors. These environmental performers exhibit thrilling qualities:

-  Available for immediate delivery
-  Durable for 500 cycles of engagement
-  Seal before and after contact
-  Unaffected by altitude pressure variations
-  Operate from -67°F. to 250°F.
-  Meet or exceed requirements of MIL-C-5015

Shimmy and shake these rugged connectors. They're vibration-dampened and withstand physical shocks up to 100 G's. The exclusive Deutsch ball-lock coupling ring ensures a positive lock without twisting or turning, without lock-wiring or coupling nut. Just push in to connect—pull back to disconnect.

To take a peek at the inside information on Deutsch 27-contact miniature connectors...as well as the 3, 7, 12, 19, 37 and 61 contact members of this environmental troupe...write for data file 4B.

The Deutsch Company

7000 Avalon Boulevard • Los Angeles 3, Calif.



places the human operator in establishing contours on photogrammetric maps made from aerial photography. In addition to civil and military mapmaking, it promises benefits for mining, heavy construction and other industries that require fast and accurate mapping service.

Other Applications

It is expected that some of the circuits developed for the system will find applications in communications, radar, submarine detection, missile guidance systems, and in geophysical instruments used for mining exploration.

Applications for defense purposes are being studied by Canadian and U. S. military research organizations.

The process of making accurate maps from aerial photographs involves determining elevations of ground points, so that contour lines showing the terrain relief can be drawn. Determination of relief is obtained on instruments called stereoplotters by viewing the common area between two overlapping aerial photographs taken from different positions in space.

Parallax along the base line between the two pictures (X parallax) is a measure of elevation. It is also necessary to remove components of parallax in a direction perpendicular to the base line (Y parallax).

Perceiving X parallax and removing Y parallax through relative orientation have been human functions. The operator of the stereoplottor instrument must be highly trained and have faultless depth perception. In addition, it is a slow and tedious task.

Operation

The stereomat attached to a conventional stereoplottor determines X and Y parallax at any point in the stereo model. It removes Y parallax during relative orientation automatically.

In the profiling mode, it corrects X parallax at all times by vertical movement of the projection platform, keeping an index mark on the terrain surface. This mark provides a continuous profile of the relief along any selected path in the stereo model as the index mark is

moved along the path in a horizontal plane.

In the contouring mode, elevation is held constant, and X parallax information is used to derive information for steering the index mark through the stereo model, producing contour lines.

The system identifies corresponding points in the two photographs of the same object taken from different positions. This is accomplished by scanning the area around each point with a spot of light. Varying light intensity resulting from boundary crossings in the photograph are converted to electrical signals by multiplier photo tubes.

Associated circuitry measures correlation of the electrical signals resulting from each photograph. The correlation is a measure of the common scanning area that is being searched. If the correlation is weak, the scanning pattern expands and vice versa. Thus points of image detail are identified by the context in which they appear.

After identifying the images, the new instrument determines the direction and magnitude of the parallax in both the X and Y directions separately.

The circuitry thus produces two d-c voltages, one for Y and one for X parallax. Polarity of the voltages depends on direction of the parallax and magnitude on amount of parallax.

Servos

The X parallax error voltage is fed to a servo that actuates the elevation of the projection table (index mark). When the error voltage becomes zero, the servo stops and the index mark is on the terrain surface.

The Y parallax error voltage is automatically switched to appropriate servo motors that in turn actuate the projection heads of the plotting instruments to remove Y parallax.

In the contouring mode, X parallax error voltage is combined with other information generated by the circuitry to actuate X and Y servos that move the index mark in the horizontal plane in the direction necessary to maintain the mark on a selected contour line.

NEW IDEAS IN PACKAGED POWER

for lab, production test,
test maintenance, or as a
component or subsystem
in your own products

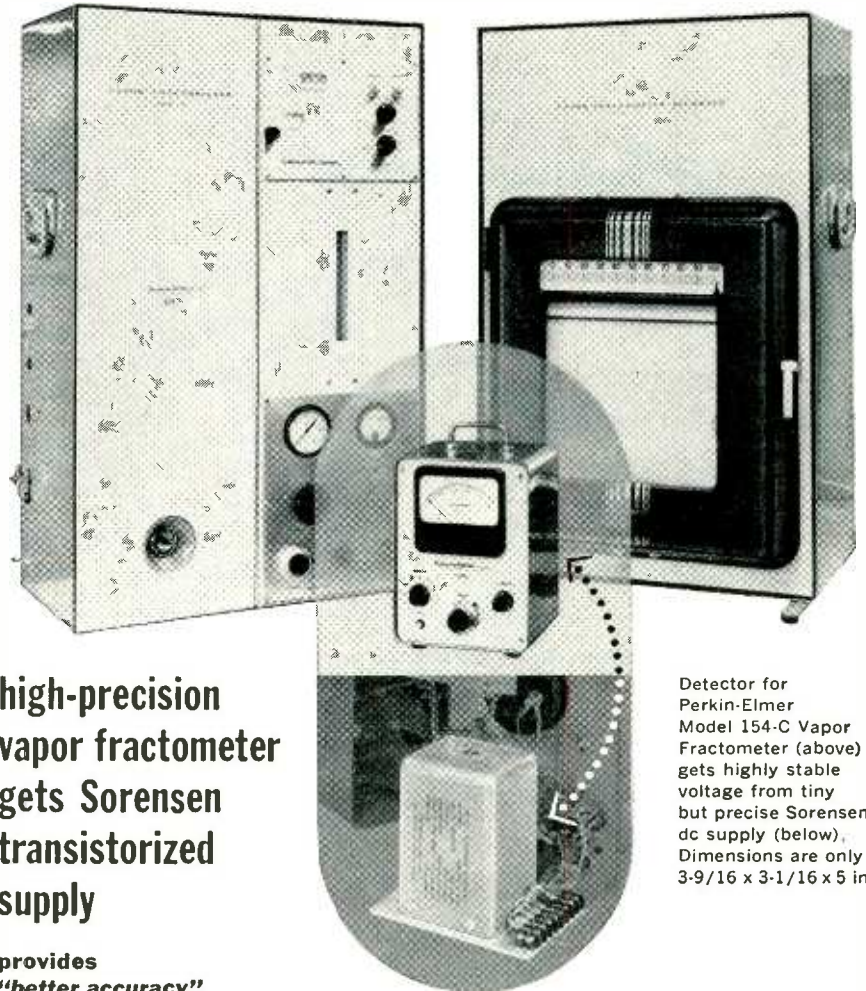

high-precision vapor fractometer gets Sorensen transistorized supply

provides
"better accuracy"
says Perkin-Elmer

Detector for Perkin-Elmer Model 154-C Vapor Fractometer (above) gets highly stable voltage from tiny but precise Sorensen dc supply (below). Dimensions are only 3-9/16 x 3-1/16 x 5 in.

Perkin-Elmer Corporation, Norwalk, Connecticut, selected a modified Sorensen miniature transistorized supply to build into the hot-wire detector unit for their new precision Model 154-C Vapor Fractometer.

They report they're pleased with the speed with which Sorensen modified their standard Model QM miniature voltage-regulated dc supply to fit their specialized requirements and they praised Sorensen's quick deliveries. But here's the statement we, at Sorensen, liked best:

The QM "... appears to afford even better regulation than Sorensen's specifications show (better than $\pm 0.05\%$ variation in output voltage for a 10% change in line voltage)." Need we say more?

Sorensen makes the widest line of transistorized power supply equipment on the market today—plus a complete line of electronic and magnetic-amplifier regulators for ac and dc, inverters, converters, and frequency changers, plus a complete line of extremely high-voltage equipment. Write for catalogs. And if you have a special problem or tough specifications to meet, ask the advice of your nearest Sorensen representative—he'll have the answer.

8.48



SORENSEN & COMPANY, INC.

Richards Avenue, South Norwalk, Connecticut

WIDEST LINE OF CONTROLLED-POWER
EQUIPMENT FOR RESEARCH AND INDUSTRY

IN EUROPE, contact Sorensen-Ardag, Zurich, Switzerland. IN WESTERN CANADA, ARVA. IN EASTERN CANADA, Bayly Engineering, Ltd. IN MEXICO, Electro Labs, S. A., Mexico City.

Semiconductor Solid Circuitry

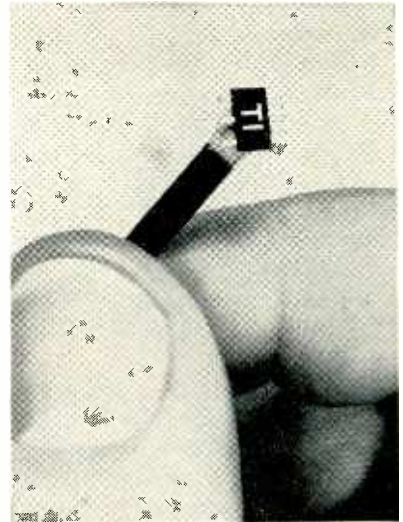
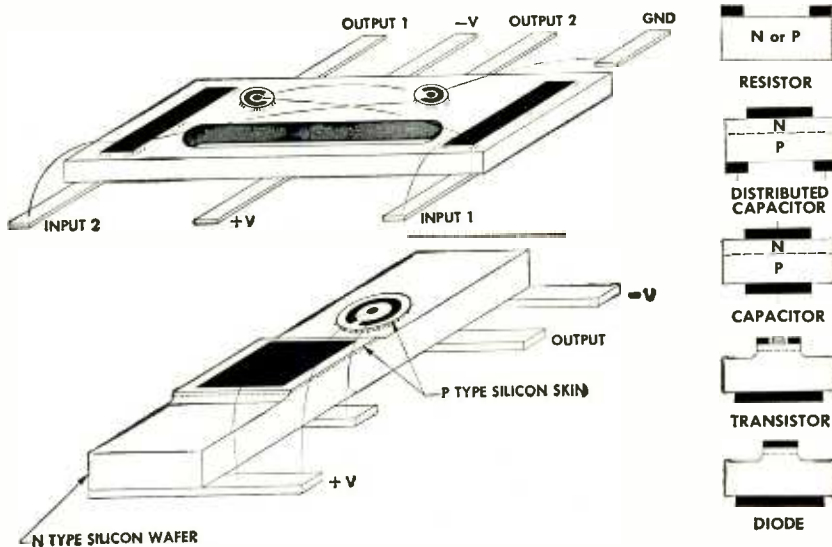

FIG. 1—All silicon, solid circuit multivibrator (top left). All silicon, solid circuit phase-shift oscillator (bottom left). Circuit elements (center). Resistor is formed by applying ohmic or nonrectifying contacts to a semiconductor wafer. Distributed capacitor is formed by combining the resistive and capacitive elements. Capacitor is formed by using capacitance of a relative large area of pn junction. Transistor uses diffused-base techniques as does diode. Solid circuit multivibrator shown on the head of match (right)

ONE OF THE MOST amazing assets of the electronics industry is its ability to avoid stagnation. This ability has been evidenced countless times through the years by originality, by doggedness and by patience. Just when a certain phase of the art seems to reach a plateau, a new path opens up for all to follow.

In recent months, there has been noticeable interest in what has been termed integrated molecular electronics—the combining of the passive functions of resistance, capacitance and inductance with the active function of amplification in a single, semiconductor solid circuit. Now, one manufacturer has announced publicly developmental models of such devices. The manufacturer is Texas Instruments.

Manufacturing Techniques

By using such semiconductor manufacturing techniques as controlled masking, etching and diffusion, Texas Instruments has formed diodes, transistors, resistors and capacitors as integral parts of single pieces of both silicon and germanium.

Two circuits, each less than $\frac{1}{8}$ by

$\frac{1}{8}$ by $\frac{3}{32}$ in., were demonstrated by the firm. The first is a multivibrator circuit, Fig. 1, containing the equivalent of 12 components—two diffused-base transistors, two capacitors and eight resistors. The second is an oscillator circuit, Fig. 1, containing the equivalent of nine components—five resistors, three capacitors and one transistor. By the usual measurements, these circuits represent a component density up to 34 million parts per cubic foot.

Application Areas

Solid circuits are expected to find ultimate usage mainly in applications where large numbers of repetitive circuits are required combined with low weight and size.

Figure 1 shows also how the different circuit elements are formed within the single semiconductor.

Reliability of solid circuits should be high for the following reasons: (1) Circuits, component equivalents and their connections are all integrated into the semiconductor material permitting predictable process controls. (2) Each circuit can be designed for a specific application and can be checked and tested

functionally during the manufacturing process. (3) Electronic characteristics of each component equivalent can be tailored for the particular application in which the solid circuit will be used. (4) compared with a conventional circuit, up to 75-percent fewer connections are required.

The circuits described are strictly developmental and are not available, at this time, in either sample or production quantities.

Electronic Sardines Save Space

CONVENTIONAL leads and wiring are eliminated by welding components directly together giving a packing density of more than 100 components per cubic inch in another miniaturization approach unveiled by Raytheon. The company has likened the resultant package to a sardine sandwich.

Four elements make up the sandwich. First is the stick which is the component welded assembly. Next is the logic wiring, the terminations and the potting. In building the stick, a number of



a continuing series on technical topics of specific interest to engineers

How important are the functions of various impregnants in paper capacitors?

Capacitors using impregnated kraft tissue paper dielectric are available with a variety of impregnating materials. These materials are generally waxes, oils, or thermo-setting plastics. The electrical "personality" and capabilities of the completed capacitor is, in part, determined by the characteristics of the impregnant. The components application engineer must be familiar with the available materials in order to judiciously prescribe the proper component for a given application.

MINERAL OIL is an excellent electrical insulating medium. It possesses low electrical loss factor, is quite stable in dielectric constant over operating temperatures ranging from -65°C to $+85^{\circ}\text{C}$ and from low audio to radio frequencies. It exhibits extremely high dielectric strength and comparatively good insulation resistance characteristics. It is used to provide the operating conditions described as "E" characteristic in Military Specification MIL-C-25A.

ANOTHER SPECIAL IMPREGNATING OIL is used which is similar to mineral oil in physical and electrical characteristics, but is stabilized and purified to further improve the electrical characteristics and extend the operating temperature range to 125°C . This is supplied for "K" characteristic paper capacitors of specification MIL-C-25A. At Sangamo, the designation for this special impregnating oil is "Ethern".

CHLORINATED BIPHENYL is a synthetic oil that is manufactured under carefully controlled conditions of purity. Paper capacitors using this impregnant are often chosen for applications where fire hazards are a consideration because it is virtually non-flammable. Chlorinated biphenyl possesses a higher dielectric constant and provides an effective mechanism for decreasing the comparative size and cost of large value capacitors. It is used almost exclusively for impregnating capacitors designed for power frequency applications including those used for power factor correction in alternating current circuitry. This material is used to provide the "D" and "F" characteristics of MIL-C-25A. At Sangamo, the designation for Chlorinated biphenyl is "Diaclor".

A POLYESTER RESIN impregnant is a non-melting solid which is used where physically rugged capacitor sections of good electrical characteristics over an operating temperature range from -55°C to $+85^{\circ}\text{C}$ are desired. Its dielectric constant falls between that of chlorinated biphenyl and mineral oils and its capacitance stability during operating life is excellent. At Sangamo, the designation for polyester resin is "Resinex".

STABILIZED CHLORINATED NAPHTHALENE is a wax which is often used in light weight capacitors of minimum size where some sacrifice in electrical characteristics, such as lower insulation resistance at all temperatures and somewhat higher power factors can be tolerated and where an operating temperature range from -40°C to $+85^{\circ}\text{C}$ is acceptable. Its high

dielectric constant results in light weight units of small size and provides the "H" characteristic operating requirements of MIL-C-25A. At Sangamo, the designation for stabilized chlorinated naphthalene is "Sangwax".

SILICONE IMPREGNANTS are chemically stable synthetic oils and are available over a wide viscosity range. They are used when extreme operating temperatures are specified and low dielectric losses are desirable. Silicone oils are liquid throughout their recommended operating temperature range.

Specification Guide Of The Various Impregnants Used in Sangamo Paper Capacitors

IMPREGNANT	SANGAMO CAPACITOR TYPE DESIGNATION
Mineral Oil	Type 50, 60, 70, 42 and 43
Ethern	Type SB, SD, SMB, SMD, 50K, 60K and 70K
Diaclor	Type 71, 50, 60, 40, 41, 75 and 80 (Referred to as can, oil paper, types)
Resinex	Type 33 (molded tubular)
Sangwax	Type 50, SA and SC

NOTE: With the exception of the Type 33 all of these capacitors are housed in hermetically sealed metallic containers. The Type 33 is molded in a thermo-setting non-hygroscopic plastic case. The "S" series types are housed in tin coated brass tubular containers with compressed glass solder seal ends. These units are most applicable where "High Reliability" is a necessity.

Engineering Catalogs Numbers 2421 and 2422 give full information and are available upon request for your files.

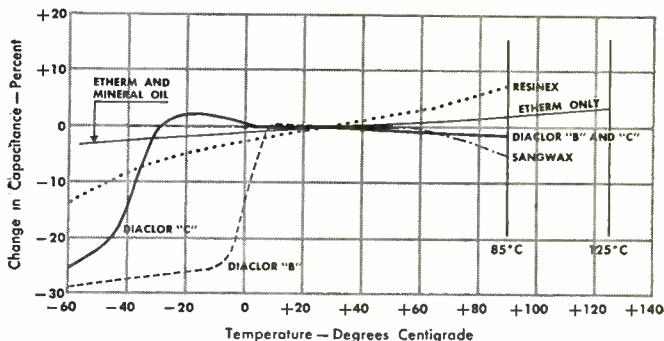

Composite curve of paper capacitors using five Sangamo impregnants for capacitance variations with temperature at 1000 cycles per second.

SC59-2

SANGAMO ELECTRIC COMPANY, Springfield, Illinois

--designing towards the promise of tomorrow



He's found the cable
he needs!

It's Hickory Brand intercommunicating and sound system cable!

- LONG SERVICE LIFE
- EXCELLENT MECHANICAL CHARACTERISTICS
- EXCELLENT ELECTRICAL PROPERTIES

Use Hickory Brand for balanced intercom systems, annunciators, telephones, control circuits, electronic computers and multiple speaker and signal systems.

Quality-engineered Hickory Brand Electronic Wires and Cables are precision manufactured and insulated and sheathed in modern plastics.



Write for complete information on
the full line of HICKORY BRAND
Electronic Wires and Cables

HICKORY BRAND Electronic Wires and Cables

Manufactured by
SUPERIOR CABLE CORPORATION, Hickory, North Carolina

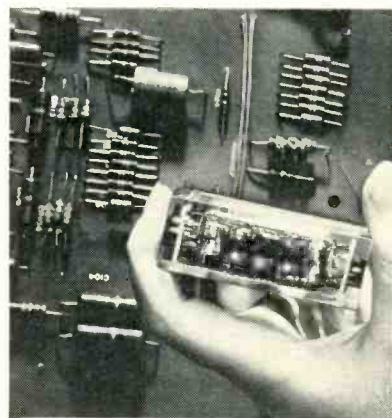

Electronic sandwich being held contains five times as many components as typical printed circuit in background

subassemblies are brought together with precision jigs and joined by a stored-energy welder. Layers of fine insulated wires form the interconnecting logic wiring. Molded terminal blocks with newly designed connectors are used and then the entire unit is potted.

Triple Triode Makes Debut

IN PRODUCTION at General Electric is a new idea in tubes—a triple triode. The 6EZ8 nine-pin miniature tube is capable of being used as a one-tube tuner for frequencies in the f-m band.

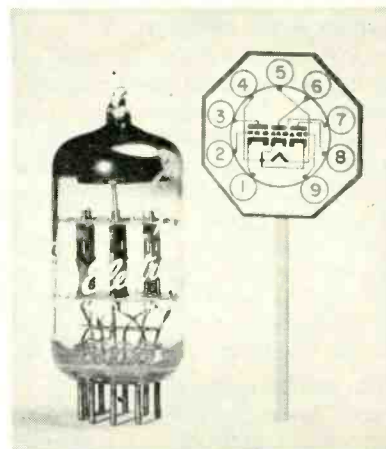

Cathodes of two of the three sections of the tube have a common connection with the cathode of the third section brought out to a separate pin. Each triode in the tube is rated as follows: plate volts, 330 max; negative d-c grid volts, 50; plate dissipation, two watts. In typical operation with

plate voltage of 125 and grid voltage of -1 , each section has an amplification factor of 57, transconductance of $4,200 \mu\text{mhos}$, and plate resistance of $13,500 \text{ ohms}$. Under these operating conditions, each section draws 4.2 ma.

One possible application for the new tube is its operation as a combined r-f amplifier, oscillator and mixer. Another might be used as a combined oscillator, mixer and afc tube.

Snap-In Connector Has Removable Contacts

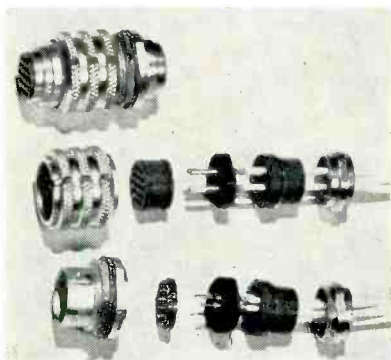

CRIMP-TYPE terminations used in a new miniature snap-in connector manufactured by The Deutsch Company completely eliminate soldering. The new DS series is available in seven, 19 and 37 pin and socket arrangements with other sizes available shortly.

The connector offers continuous dielectric separation with no voids; is completely environmental up to 30 psi; withstands temperatures from -100 to $+300$ F and has a contact retention of 25 lb.

Heat-Resistant Plastic Available

HIGH heat resistance, stiffness and toughness are combined in a new acrylic-type thermoplastic polymer.

Designated PL-12 by the J. T. Baker Chemical Co., the new plastic has a heat distortion point of 240 F, flexural modulus of 415,000 psi and fair transparency.

Injection molding and extrusion of the material can be done by conventional acrylic techniques.



... for Complete Reliability Under Severe Environmental Conditions

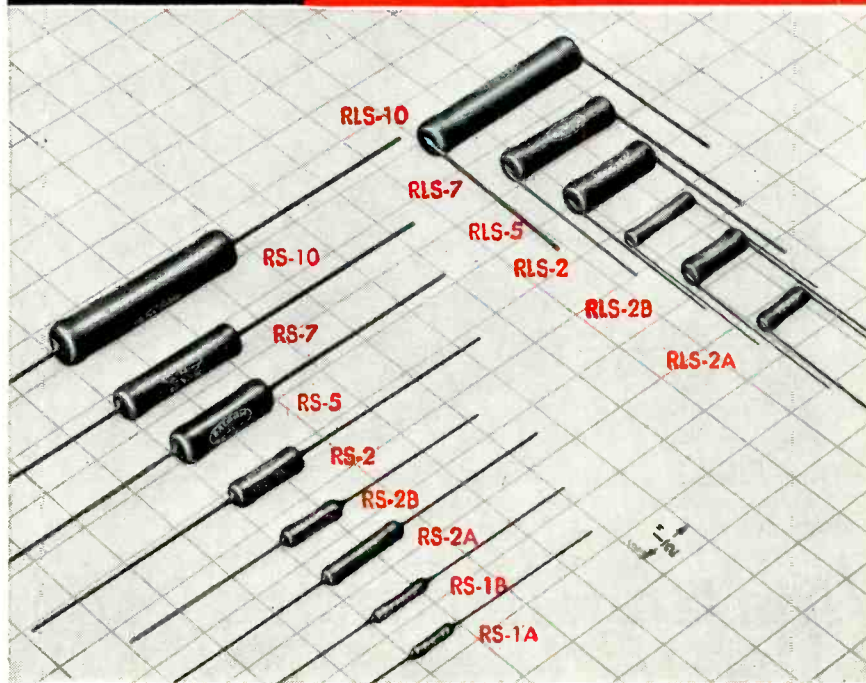

TYPE RS, RLS POWER RESISTORS

Wire Wound, Precision, Miniature, Ruggedized

RS-2A DERATING CURVE

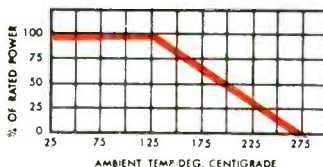

JUST ASK US

The DALOHM line includes precision resistors (wire wound and deposited carbon); trimmer potentiometers; resistor networks; collet fitting knobs and hysteresis motors designed specifically for advanced electronic circuitry.

If none of the DALOHM standard line meets your needs, our engineering department is ready to help solve your problem in the realm of development, engineering, design and production.

Just outline your specific situation.

**DALE
PRODUCTS
INC.**

1300 28th AVE.
COLUMBUS, NEBRASKA

Designed for the specific application of high power, coupled with precision tolerance requirements. Available with axial leads - RS TYPE; with radial leads - RLS TYPE (for printed circuitry).

Gives reliability under severe environmental conditions.

- Rated at 1, 2, 3, 5, 7 and 10 watts.
- Resistance range from 0.1 ohm to 175K ohms, depending on type.
- Tolerance: $\pm 0.05\%$, $\pm 0.1\%$, $\pm 0.25\%$, $\pm 0.5\%$, $\pm 1\%$, $\pm 3\%$.

TEMPERATURE COEFFICIENT: Within 0.0002/degree C.

OPERATING TEMPERATURE RANGE: -55° C. to 275° C.

SMALLEST IN SIZE: $3/32'' \times 13/32''$ to $3/8'' \times 1-25/32''$

COMPLETE PROTECTION: Impervious to moisture and salt spray.

WELDED CONSTRUCTION: Complete welded construction from terminal to terminal.

SILICONE SEALED: Offers maximum resistance to abrasion, and has high dielectric strength.

MILITARY SPECIFICATIONS: Surpasses applicable paragraphs of MIL-R-26C.

Write for Bulletins R-23, R-30



Thickness of radome at 23 points is read from position of metal floats positioned by air pressure. A total of 184 points is measured by rotating the radome



Radome is placed over retracted inner casting of fixture

Air Gage Measures Radome Walls

DIMENSIONAL INSPECTION of radomes for the Hawk missile is simplified with a precision air gage which measures radome wall thickness at 23 points in 1 step. The instrument was built for Raytheon Manufacturing Company's Hawk production plant, Andover, Mass., by The Sheffield Corp.

The gage consists of a gaging fixture and a columnar panel. To position the radome, or nose cone, a retractor is manually opened, the cone lowered over an inner casting and the retractor closed.

Both inner and outer castings of the fixture house a series of 23 small metal feelers which retract as the cone is positioned. Air pressure causes the feelers to gently hug the inner and outer surfaces of the cone.

The outer casting is mounted to the fixture's base. The inner casting is mounted on a swing arm pivoting from the base. The arm is moved to the right for loading and to the left, against a reference stop, for gaging.

Vertical glass columns are calibrated to show critical measurements on a flow graph. As each feeler assumes its position according to radome wall thickness, a small metal float actuated by air

pressure moves to a corresponding position within a column.

Color coding on the graph indicates acceptable radome thickness tolerances. All floats must be within marked limits. Amount and location of variances are read directly from the flow graph.

Increments from 1 to 47 inches can be checked. By manually rotating the radome around the base of the stand, a total of 184 different gaging points can be measured in 8 steps.

Radome Correction

The radomes are constructed of laminated glass fiber cloth and resin. Domes with undersized wall thicknesses are returned to production for layup of additional laminas and then remachined. Domes with oversized thicknesses are machined down on a 25-inch Axelson tracer lathe.

Air pressure in the gage ranges from 60 to 120 psi. Air flows upward through each internally-tapered glass column, actuating the metal floats. Air also flows out through plastic hosing to mating feelers. A filter cleans incoming air.

A proper relationship between radome wall thickness and dielectric constant is required for effective

rf transmission. According to Raytheon, gaging time per radome is a few minutes, compared with about 2 hours formerly required with dial indicator gages.

Parts Can Be Molded Into Epoxy Mirrors

PARABOLOIDS, hyperboloids, ellipsoids and other complex surfaces for reflective components of infrared and other optical systems are being made of vacuum-plated cast epoxies by Singer Military Products Division, New York, N. Y.

Electrical and mechanical com-

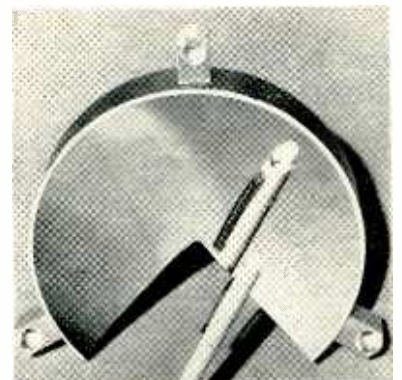

Cut has been made in mirror to demonstrate machinability

CUT COSTS OF TEST EQUIPMENT BY 20% WITH Technical Information Service

Case histories have shown that companies waste up to 20% of their annual expenditures for test equipment.

A prime cause is the failure to make the best buy obtainable because each company did not know the full range of available equipment. Collecting and maintaining complete, timely, and accurate product information is difficult—could cost as much as \$25,000 a year to service—and yet could be incomplete and inaccurate.

A prodigious number of crucial engineering and purchasing man-hours are squandered in test equipment procurement. Tracking down sources of supply takes days and, often, weeks. Key personnel are trapped by protracted correspondence and sales interviews while obtaining full specifications and prices. When modifications are involved, workloads increase geometrically. This costly routine must be repeated every time new purchases are made.

Now, for the first time, you can plug these hidden profit leaks through the use of a completely new concept in instrument evaluation for procurement.

Technical Information Service (TIS) provides you with complete, timely product information about all available electronic test equipment. In a matter of minutes you can possess detailed descriptions of equipment produced by every manufacturer in the business, from the largest to the smallest, without bias in favor of either. What's more, the descriptions include the full specifications, price, and the names and addresses of local sales representatives—all you need to initiate procurement.

Consider the benefits enjoyed by clients of Technical Information Service.

SINGLE SOURCE OF SUPPLY INFORMATION

Clients have the only central source of supply information designed specifically for their electronic test equipment requirements. Completely categorized, up-to-the-minute information makes the user a technical expert capable of quickly evaluating complete spec-by-spec comparisons of competitive equipment. Since TIS maintains accurate files by constant check of all sources for additions and changes in specifications and prices, clients may make inquiry by phone or letter on any test instrument problem at any time.

With such information at their fingertips, clients can make their purchases with total awareness of what the market has to offer. Procurement is made with minimal demands on key personnel and their time. Many clients find that this accelerated purchasing procedure has earned an extra bonus in expediting tight-schedule projects for which the test equipment is needed.

COMPLETE, ACCURATE INFORMATION

Clients receive detailed data on more than 4,500 separate instruments manufactured by some 400 different companies. Constant review of the entire instrument field by graduate engineers keeps data on specifications, prices, and models up to date at all times.

VOL. I—Sources • VOL. II—Modifiers • VOL. III—Scalars
VOL. IV—Index of Manufacturers and Representatives



Suppliers are queried on incomplete or dubious information, if necessary, before their products are included in any TIS release.

Since all products are described without charge and without advertising claims, small and large manufacturers are on equal footing. Their instruments speak for themselves with bald facts, free of slanted claims or persuasive case histories. Clients make their own evaluations from complete, factual information.

SUPPLIER RESEARCH SERVICE LOCATES "CUSTOM" INSTRUMENTS

Often, seemingly built-to-order requirements can be satisfied by minor modification to standard instruments. The complete listing of all large and small manufacturers of stock items provides a ready reference for such inquiry, either directly by the client or through the efforts of TIS.

In those cases where unique equipment is a necessity, TIS Supplier Research surveys the market for the client, collecting all the pertinent information he requires to initiate serious negotiations with suppliers.

COMPLETE PRIVACY

Whether TIS is locating sources for unique requirements or providing information on standard equipment, clients maintain a cloaked identity during all stages of inquiry. The Client conducts negotiations with the suppliers in whom he is interested.

FOUR-VOLUME DIRECTORY

Clients of the tax-deductible Technical Information Service receive a free, four-volume, handsomely bound encyclopedia of standard equipment and sources published twice a year and supplemented constantly. Three volumes are devoted to descriptions of equipment. The fourth volume is an extensive cross-index of manufacturers and their representatives. Completely free of advertising, the directories give clients a complete, factual picture of all standard electronic test instruments. Clients of Technical Information Service receive both the Directories and Supplier Research Service.

PROVEN IN USE

For the past two years TIS has served such clients as General Electric, M.I.T., Lincoln Labs., General Motors, NASA, Litton Industries, Naval Ordnance Lab., Hewlett-Packard, Lockheed Aircraft, Western Electric, RCA, Marconi Instruments, Eglin AFB, American Bosch Arma, and hundreds of others. The merit of TIS is proven by the fact that many clients have contracted additional service for other departments and projects.

FREE BROCHURE GIVES KEY TO SAVINGS

One subscriber saved more than three times the cost of TIS within a week! You will have the key to how it was done when you go through the TIS brochure which tells all . . . shows how TIS reduces even the hidden, seldom-counted costs of the old-fashioned way of instrument procurement. Send for your copy of this FREE brochure today. No obligation. Use the convenient coupon below.

Technical Information Corporation

41 Union Square, New York 3, New York, WAtkins 4-2111

Code 105:

I am interested in knowing more about Technical Information Service. Please send me your free brochure immediately, at no obligation.

NAME _____ TITLE _____

DEPARTMENT _____ COMPANY _____

ADDRESS _____

Lapp

ANTENNA STRAIN INSULATOR

The Lapp porcelain rod insulator shown at the top of the illustration develops 12,000 lb. strength, and is suitable for the most severe electrical and mechanical duty. It is available with rain shield and/or corona rings. All hardware is silicon aluminum alloy. Smaller insulators, in porcelain or steatite, are suited to lighter duty for strain or spreader use. Lapp engineering and production facilities are always ready for design and manufacture of units to almost any performance specification. Write for Bulletin 301, with complete description and specification data. Lapp Insulator Co., Inc., Radio Specialties Division, 150 Sumner Street, LeRoy, N. Y.

Lapp

ponents, mounting brackets and other parts can be molded into the mirror's epoxy backing. Other advantages reported by the firm include a high rate of production, machinability, controlled density and high resistance to thermal shock.

An epoxy negative, cast from a precision ground glass master mirror is used as a mold for the epoxy backing. An aluminum reflective coating is vacuum plated on the backing and overcoated with a protective film.

Standardized CRT Disk Cathode Measurement

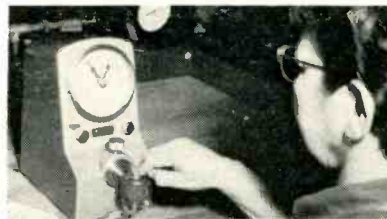

Method of using air gage to measure critical dimension of cathode

STANDARDIZED TECHNIQUES for measuring the distance from cap surface to ceramic on crt disk cathodes are proposed for industry adoption by Superior Tube Co., Norristown, Pa. Air and mechanical gages can be employed.

Objective of the proposal is to end producer-customer discrepancies in the measured distance, called the E dimension by the firm (Fig. 1). The dimension controls spacing between the cathode's emitting surface and the control grid, controlling in turn the amount of cutoff voltage.

All disk cathodes made by the firm are checked to a tolerance of 0.0005 inch in the E dimension. In addition, customers make quality control checks. Measurements are customarily made with identical types of mechanical gages.

An extensive investigation into E dimension measurements revealed that 2 identical mechanical dial gages, mounted side by side and calibrated with the same precision gage blocks, many times gave different results when measuring the same cathode.

The disk-shaped caps can be de-



MINIMUM SIZE Maximum Dependability LOW COST

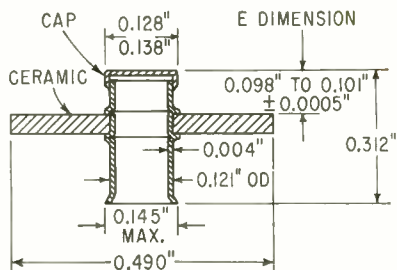

FIG. 1—Standard disk cathode showing E dimension. Tolerances of other dimensions vary from 0.0005 to 0.010 inch

pressed with a slight amount of pressure due to their lightness. Spring pressure found in dial gage mechanisms, according to the firm, is in most cases ample to depress the disk, giving an E reading less than the actual dimension when pressure is removed. Differences in spring pressure from gage to gage introduce false readings.

In the new system, cathode samples are air gaged and used as secondary standards for calibrating measuring instruments, correlating manufacturer's and customer's results. The readings for cathodes which are within tolerance are recorded and the cathodes are used as masters by both producer and customer.

With a master in place on a mechanical gage, the dial is set to read the exact E dimension previously determined by air gage. Whatever amount the cap is deflected is disregarded. Tests have shown that any mechanical dial gage can be accurately calibrated by this measurement.

This method is considered a secondary solution by the firm, intended to preserve the utility of the many existing mechanical gages used for this purpose.

Air gages are considered preferable since there is no mechanical contact with the disks and the air pressure is not sufficient to deflect the disk. If the disk is concave, an average dimension is recorded since the stream of air covers the entire surface of the cap rather than high or low spots.

Other advantages cited are faster readings, less mechanical maintenance, only 1 calibration per work day and air gages do not require different adapters for various sizes of cathodes.



ACTUAL SIZE

The new T-154 relay is now being manufactured by Allied Control at Plantsville, Conn.

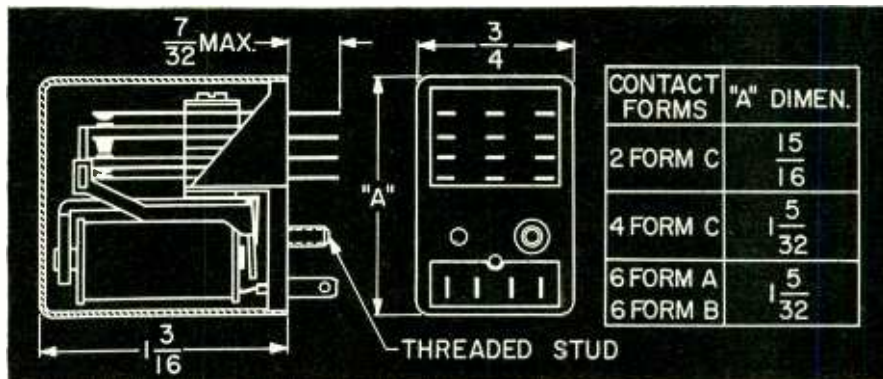

General Features:

Operate Sensitivity:

From 90 milliwatts for 1.3 ohm coil to 160 milliwatts for 15,000 ohm coil up to 2 Form C

From 200 milliwatts for 1.3 ohm coil to 400 milliwatts for 15,000 ohm coil up to 6 Form A

Coil Resistance: Up to 15,000 ohms

Coil Voltage: Up to 140 volts d-c

Contact Rating:

Low Level to 1 ampere 29 volts d-c or 115 volts a-c resistive. 5 ampere contacts are available

Contact Arrangement: Up to 6 Form A, B and 4 Form C

Operate and Release Time: 7 milliseconds max. at 1 watt

Shock: 10 g's

Vibration: 10 to 55 cps at .062" double amplitude

Enclosure: Dust proof and hermetically sealed

For complete information write for Bulletin T154



ALLIED CONTROL



ALLIED CONTROL COMPANY, INC., 2 EAST END AVENUE, NEW YORK 21, N. Y.

ON THE MARKET



Time Delay Relays subminiature

DIALTRON CORP., 203 Harrison Pl., Brooklyn 37, N. Y., announces a line of subminiature time delay relays designed for high-altitude, high-vibration, and high-temperature ap-

plications. Seated height is $1\frac{3}{32}$ in., and weight $\frac{3}{4}$ oz. They are offered in a time range from 1 to 300 sec and in heater voltages up to 150 v interchangeable on d-c or a-c of any frequency with a power drain of 4 w. Circle 200 on Reader Service Card.

Phase Generator 5-200,000 cps

DYTRONICS Co., 78 Sunnyside Lane, Columbus 14, Ohio. Model 410 is a new instrument offering both a phase shifter and a phase difference generator. It covers a frequency range from 5 cps to 200,000

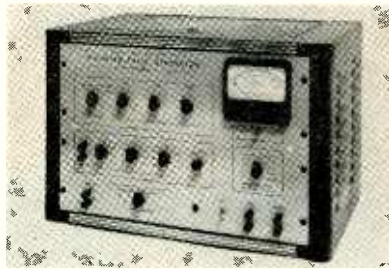

cps. By addition of an external capacitor the l-f limit can be extended below 0.1 cps thus giving an effective frequency range from 200,000 cps to below 0.1 cps. Accuracy over a-f spectrum is 0.1 deg with decreasing accuracy above and below the audio range. Circle 201 on Reader Service Card.

D-C Voltmeter four-and five-digit

CUBIC CORP., 5575 Kearny Villa Road, San Diego 11, Calif. Four- and five-digit d-c voltmeters are announced. They feature transistORIZATION; clear, bright readout

with edge-lighted numerals one inch high; controlled drive of stepping switches, in which the switches turn themselves off part way through their cycle, coasting to a stop and thus preventing over-drive and minimizing impact wear. Circle 202 on Reader Service Card.



Push Button Switch locking type

RICHARDS ELECTROCRRAFT, INC., 3743 N. Kedzie Ave., Chicago 18, Ill. A new line of locking type push button switches mount easily on $\frac{5}{8}$ in.

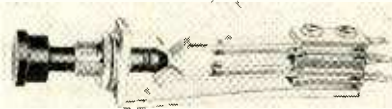

centers. They are ruggedly constructed with plated steel frames. Contact leafs are of nickel silver, contacts of fine silver. Switches are available in standard 3 ampere rating. Circle 203 on Reader Service Card.

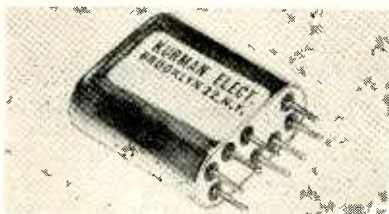

Relay microminiature

KURMAN ELECTRIC Co., 191 Newel St., Brooklyn 22, N. Y. Model KX relay measures 0.4 in. wide by 0.8 in. long by 0.875 in. high. Features

include: operating temperature range, -65 C to $+125$ C; sensitivity of 200-250 mw. Relay will withstand shock tests of 50 g's; vibration frequency of 20 to 2,000 cps, at 20 g's. Circle 204 on Reader Service Card.

Audio Transistors medium power

BENDIX AVIATION CORP., Long Branch, N. J. Designed for use as

a power transistor driver, the new 2N1008, A, B transistor series has many applications to Class A and B amplifiers, audio oscillators, relay drivers, servo controls and



How to make a Magnetic Core that's really SMALL?

use **AL**

PERMENDUR

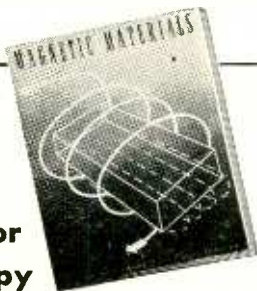
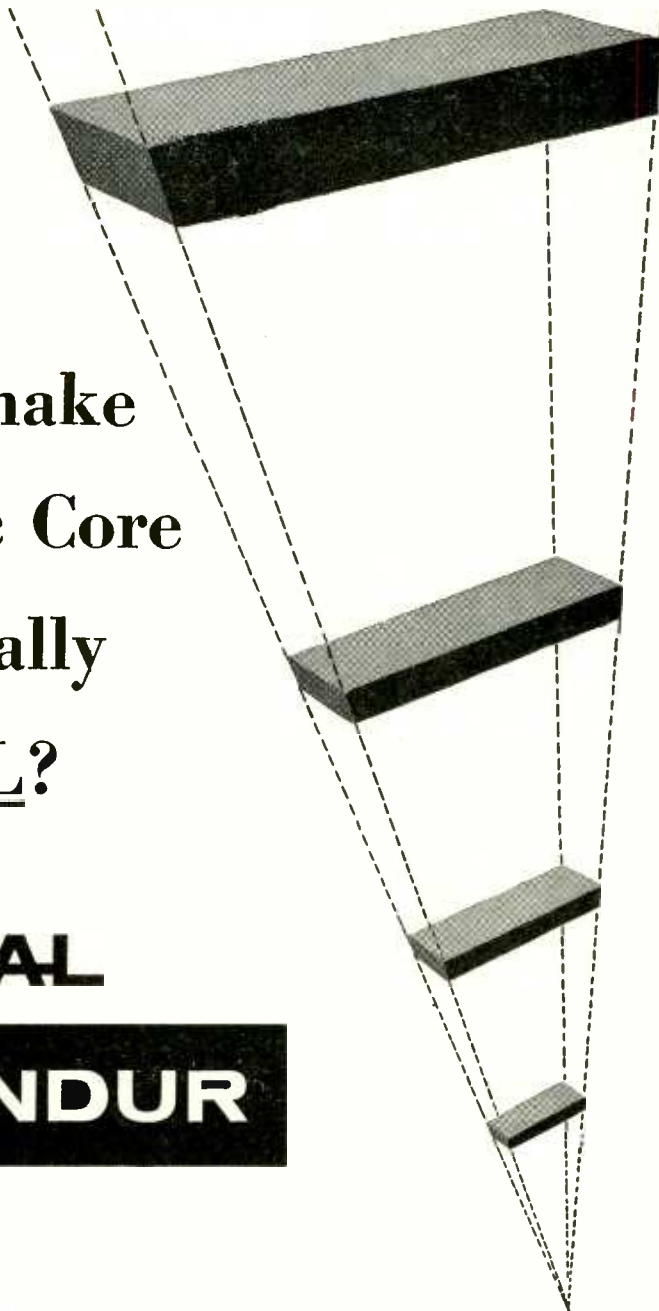

Write for
your copy

"MAGNETIC MATERIALS"

This 32-page book contains valuable data on all Allegheny Ludlum magnetic materials, silicon steels and special electrical alloys. Illustrated in full color, includes essential information on properties, characteristics, applications, etc. Your copy gladly sent free on request.

ADDRESS DEPT. E-16

When the conditions of service make it imperative for you to hold the size and weight of magnetic cores at an absolute minimum, that's the place to use Permendur. With it you can push the flux density up to 20 kilogausses, and practically eliminate weight as a consideration.

Along with its suitability for cores wherever the premium is laid on compactness, Permendur is just the thing for sonar magnetostriction applications, too. We maintain proper annealing facilities for this

alloy. Write for technical data on it, and let our engineers help you to cash in on its possibilities.

In addition to Permendur, we offer a range of high-permeability alloys, oriented silicon steels and other electrical alloys that is unmatched in its completeness. Our services also include the most modern facilities for lamination fabrication and heat treatment.

Let us supply your requirements. *Allegheny Ludlum Steel Corporation, Oliver Building, Pittsburgh 22, Pa.*

STEELMAKERS to the Electrical Industry

Allegheny Ludlum

WSW 6119



**RELIABILITY...
THE SOLUTION
TO YOUR
ELECTRONIC
COMPONENT
PROBLEMS**

Designing reliability into electronic components and instrumentation is Borg Equipment Division's business. Borg's reliable engineering, research and production facilities are at your service for commercial or military projects. Bring your component reliability problems to Borg. You'll enjoy working with our cooperative, creative engineering staff. The result will be a sound, practical and reliable solution at a considerable saving of time and money. Here are just a few of the products manufactured by Borg . . .

- FREQUENCY STANDARDS
- AIRCRAFT INSTRUMENTS
- POTENTIOMETERS
- MULTI-TURN COUNTING DIALS
- FRACTIONAL H. P. MOTORS
- SPECIAL DESIGNS

WRITE FOR COMPLETE ENGINEERING DATA



*Built
by Borg*

BORG EQUIPMENT DIVISION
Amphenol-Borg Electronics Corporation
JANESVILLE, WISCONSIN
CIRCLE 60 READERS SERVICE CARD

medium level audio amplification. Contained in the JEDEC TO-9 package, the transistor is capable of dissipating 400 mw at 25 C and 67 mw at 75 C. Circle 205 on Reader Service Card.

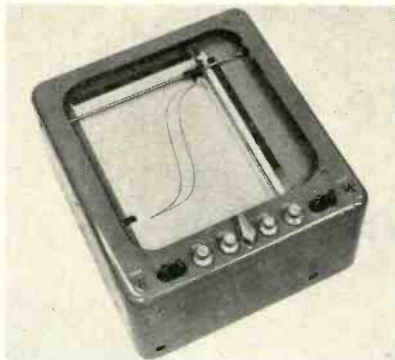

**X-Y Recorder
Rugged design**

HOUSTON INSTRUMENT CORP., 1717 Clay Ave., Houston 3, Texas. The HR-92 X-Y recorder is used for computer readout and for plotting stress vs strain, magnetic material, tube and semiconductor characteristics, pressure vs temperature, speed vs torque, or any other two related variables. Use of self-balancing potentiometer servos assures 0.5 percent accuracy and drift-free performance at available sensitivities of up to 1 mv per in. Pen speed is 1 sec full scale without overshoot. Circle 206 on Reader Service Card.

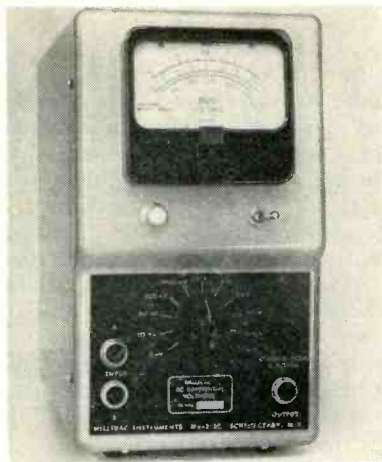

**Differential VTVM
3 percent accurate**

MILLIVAC INSTRUMENTS DIVISION of
Cohu Electronics, Inc., Box 997,

FROM THIS

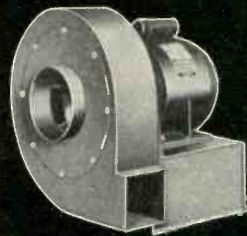

TO THIS

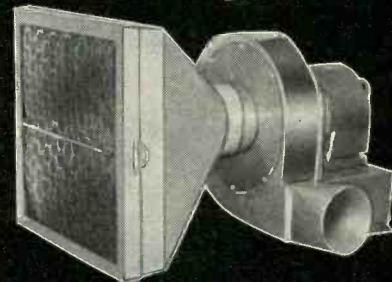

**... and Peerless Electric®
Solves Another Electronic
Gear Cooling Problem!**

• A large aircraft manufacturer needed to cool stationary and airborne electronic gear. Peerless PW-12 Pressure Blowers were selected. Square-to-round discharge adapters with intake filters were fabricated to provide dust-free air. We are working continuously with many of the nation's top producers and users of electronic equipment.

We design and build our own fans and blowers . . . motors and all. That's why we unconditionally guarantee their dependable performance. Our engineers work to your specifications to produce the fans and blowers that enable your equipment to operate at its best.

Contact us today!
We're interested in your inquiry!



FAN AND BLOWER DIVISION
THE Peerless Electric® CO.
FANS • BLOWERS • ELECTRIC MOTORS
1446 W. MARKET ST. WARREN, O.

CIRCLE 61 READERS SERVICE CARD
April 10, 1959 — ELECTRONICS

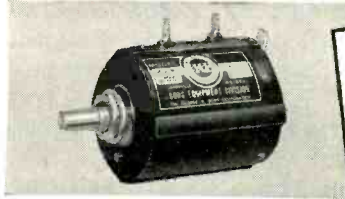

**205 SERIES, 10-TURN
MICROPOTS**

SIZE: 1 3/4" dia.; 2 1/8" long;
shaft extension 7/8" or special
to order.

LINEARITY ACCURACY:
±0.1% and 0.05% (independ-
ent or zero based).

RESISTANCES: 50 ohms to
100,000 ohms, tolerance ±5%.

POWER DISSIPATION: 5 watts
at 40° C.



**1100 SERIES, 10-TURN
MICROPOTS**

SIZE: 1 7/8" dia.; 2 1/8" long; shaft
extension 7/8" or special to order.

LINEARITY ACCURACY: 0.5%
to 0.1% (independent linearity).

RESISTANCES: 50 to 100,000 ohms,
tolerance ±5%.

POWER DISSIPATION: 3 watts at
40° C.

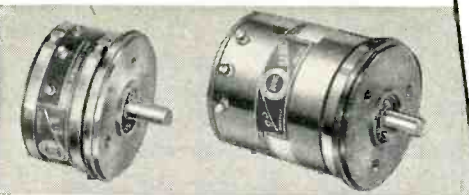

900 SERIES MICROPOTS

Borg 900 Series Micropots are available
in single-turn, 3-turn and 10-turn models.

SIZE: Single-turn — 2" dia.; 1 5/8" long
3-Turn — 2" dia.; 1 3/8" long
10-Turn — 2" dia.; 2 1/16" long
Shafts — 1/4" dia.
Bushing Mount — 7/8" long
Servo Mount — 5/8" long

LINEARITY ACCURACY: Single-turn — ±.5%
(independent)

3-Turn — ±0.1% (independent, zero based, or abso-
lute reference).

10-Turn — .05% (independent, zero based, or abso-
lute reference).

RESISTANCES: Single-Turn — 50 to 50,000 ohms

3-Turn — 15 to 60,000 ohms

10-Turn — 50 to 300,000 ohms

TEMPERATURE LIMITS: Tested to 350° F.

STANDARD COMPONENTS

*built
by*



**FIT MANY SPECIAL
DESIGN NEEDS**

Design flexibility of standard Borg components often eliminates the need for expensive, specially designed units. Borg offers a complete line of precision potentiometers, turn-counting dials and fractional horsepower motors. Many of these standard Borg components are currently on duty in missile launching platforms and firing control stations, radar and sonar equipment, computers and similar electronic apparatus. Production of standard Borg components assures quick delivery. A partial selection is shown on this page. Write for complete data on all Borg components. Ask for catalog BED-A90.



990 SERIES TRIMMING MICROPOTS

SIZE: 1 1/4" x 5/16" x 1 7/8"
RESISTANCES: 10 to 30,000 ohms
standard. Other values on special
order.

Tolerances — ±5% 100 ohms and
over
±10% below 100
ohms

ADJUSTMENT: Screw driver slot
provides adjustment of complete
range in 40 turns.

TERMINALS: Printed circuit,
soldered lug, insulated wire leads.

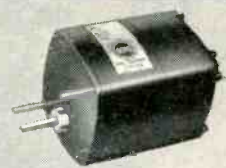

**PRECISION INSTRUMENT
MOTORS**

Borg-Motors offer you fractional horsepower motors in synchronous or induction models with or without gear-trains in 2-pole or 4-pole models for your precision equipment. Borg-Motors are totally enclosed, using precision machined die cast alloys for end bells and gear train cases. Die cast rotors, mounted on two ball bearings, assure long life, continued accuracy.



DIRECT READING MICRODIALS

Borg Direct-Reading Microdials provide the highest accuracy of perception when forced-fast-reading and setting is required because of their inline digital presentation. Borg Direct-Reading Microdials are available in 3-digit 10-turn models, 4-digit 100-turn models and 5-digit 1,000 turn models. Also available are Borg Concentric Scale Microdials which indicate the position of any multi-turn device of 10 turns or less.

WRITE FOR COMPLETE DATA ON ALL
BORG COMPONENTS — CATALOG BED A90



BORG EQUIPMENT DIVISION

Amphenol-Borg Electronics Corporation

JANESVILLE, WISCONSIN



- MICROPOTS
- MICRODIALS
- MOTORS



-and now the vibration test!

Shock — testing on the rocks? If vibration and shock are your headache, you *could* build your own pots to lick this problem! But look out for foul play in the shaft and bushings, under shock — you can lose your accuracy right *there!* And make sure your pet design includes a contact with no resonances, minimum mass, low wiper pressure — yet with excellent linearity! Oh, you'll be plenty busy!

But the easy way is to come to Ace! Our shockless pots incorporate, through exclusive precision production methods, fantastically close bearing fit. And our own specially balanced contacts place extremely low mass at the edge-wipe end, under low brush pressure, for steady contact under shock. Tempered precious metals and low contact resistance mean long, corrosion-free wear. Tested to 50 G's at 2000 cycles.

Our complete pot line incorporates all these anti-shock design features. Under extreme servo applications, this 1/2" servo-mount Series 500 Acepot delivers 0.3% linearity.



ACE ELECTRONICS ASSOCIATES, INC.
99 Dover Street, Somerville 44, Mass.
SOMerset 6-5130 TMX SMVL 181 West. Union WUX

Acepot® Acetrim® Aceset® Aceohm® *Reg. Appl. for

Schenectady, N. Y. The MV-212C a-c differential vtvm is designed for differential measurements from 0.7 mv to 300 v, in the frequency range from 20 cps to 500 kc. Dual range attenuators are provided. They are easily balanced by a common mode rejection control for common mode rejection ratios up to 100:1. Circle 207 on Reader Service Card.



Calibration Unit all-semiconductor

AMPEX CORP., 934 Charter St., Redwood City, Calif., has introduced a fully portable, all-semiconductor device intended for precision alignment and calibration of electronic equipment such as f-m record/reproduce systems. The TC-10 calibrator contains a voltage standard accurate to 0.01 percent. Nine precision oscillators and seven binary dividers provide 63 accurate calibration frequencies ranging from 1,012 cps to 151.2 kc. Circle 208 on Reader Service Card.

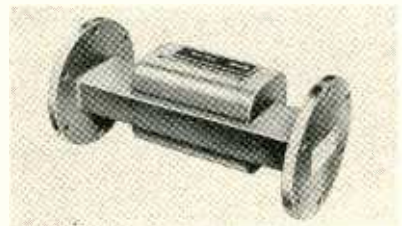

Ferrite Isolators three models

POLYTECHNIC RESEARCH & DEVELOPMENT Co., INC., 202 Tillary St., Brooklyn 1, N. Y., announces a new line of ferrite isolators. Covering the frequency range from 3.95 to 12.4 kmc in three broadband models, they have an insertion loss of

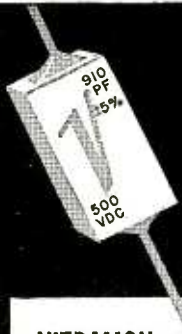

Vitramon[®] CAPACITORS

will help you build **LOW LOSS**
... into your circuit systems

Losses, inherent in EVERY capacitor, are held to a minimum in VITRAMON capacitors... the capacitors of purity. Pure silver electrodes... pure porcelain enamel... perfectly bonded.

LOW LOSS? YES! PLUS ...

RUGGED LOW NOISE STABLE
WIDE TEMPERATURE RANGE
VAPORPROOF MINIATURE

The biggest names in electronics use VITRAMON capacitors in guided missiles, jet ignition, proximity fuses and in radar, servo, guidance, fire control, telemetering and carrier telephone systems.

If substitutes are not good enough... if you need the best... write today!

Vitramon[®]
Incorporated

BOX 544L • BRIDGEPORT 1 • CONN.

VITRAMON capacitors have low dissipation over wide frequency ranges.

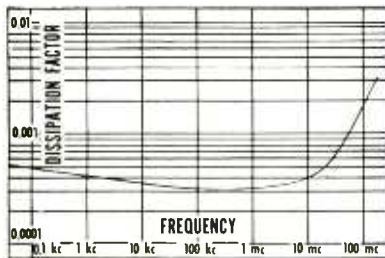

Two materials — a monolithic block of porcelain enamel and fine-silver electrodes — fused into one strong, stable, efficient and effectively homogeneous **RELIABLE** unit.

CIRCLE 64 READERS SERVICE CARD

Electrical Coil Windings

For 40 years... specializing in all types of coils to customers' specifications. Design or engineering assistance available on request.

COTO-COIL CO., INC.

SINCE 1917

65 Pavilion Avenue Providence 5, Rhode Island

CIRCLE 65 READERS SERVICE CARD

sending a bill?

It'll get there quicker if you give your postal delivery zone number with your address.

The Post Office has divided 106 cities into postal delivery zones to speed mail delivery. Be sure to include zone number when writing to these cities, be sure to include your zone number in your return address—after the city, before the state.

McGraw-Hill Book News



FIRE CONTROL PRINCIPLES

Just Published

Treats the basic physics and geometry applicable to any fire control problem. Describes the methods of solution of this problem applicable to any system, and discusses the fundamental instrumentation techniques applicable to all fire control systems. By Walter Wrigley, Professor of Aeronautical Engineering, and John Hovorka, Instrumentation Laboratory Staff Physicist, M. I. T. 152 pages, illus., \$10.00

NUCLEONICS FUNDAMENTALS

Just Published

Provides broad view of basic atomic and nuclear physics, radioactivity, particle accelerators, radiation protection, instrumentation, fission, reactor principles, research and power reactors, thermonuclear power, nuclear explosives, and isotope separation. Treatment is not highly mathematical. By D. B. Hoisington, Professor, U. S. Naval Post-graduate School. 400 pages, illus., \$9.50

LOGICAL DESIGN OF ELECTRICAL CIRCUITS

Thorough, systematic treatment of Boolean methods for analyzing relay, diode, and vacuum tube circuits—particularly as used in the design of automation systems, computers, telephone dialing systems, and similar applications. Uses only simple mathematics and basic electrical laws to explain Boolean algebra as a vital tool in circuit design. By Rene A. Higonnet, Eng'g., Photon, Inc., and Graphic Arts research Foundation, Inc., and Rene A. Grea, Technical Director, Lumitype-Photon Co., Paris. 194 pp., over 300 illus., \$10.00

TRANSFORM METHOD IN LINEAR SYSTEM ANALYSIS



Shows how to apply the transform method in effectively analyzing and solving problems for a wide range of linear systems. Gives many useful mathematical techniques, tying them together by means of the concept of system function. Properties and applications of the Laplace transform, Fourier transform, z-transform, and others are clearly explained in the book. By John A. Aseltine, Member, Technical Staff, Space Tech. Lab., Ramo-Wooldridge Corp., Lecturer, Univ. of Cal. 300 pp., 259 illus., \$8.50.

10 DAYS' FREE EXAMINATION

McGraw-Hill Book Co., Inc., Dept. L-4-10
327 W. 41st St., N. Y. C. 36

Send me book(s) checked below for 10 days' examination on approval. In 10 days I will remit for book(s) I keep, plus few cents for delivery costs, and return unwanted book(s) postpaid. (We pay delivery costs if you remit with this coupon—same return privilege.)

- Wrigley & Hovorka—Fire Control Prin., \$10.00
- Hoisington—Nucleonics Fund., \$9.50
- Higonnet & Grea—Log. Design Elec. Circ., \$10.00
- Aseltine—Transform Method Lin. Sys. Anal., \$8.50

(PRINT) Name

Address

City Zone.... State.....

Company

Position

For price and terms outside U. S. Write McGraw-Hill Int'l., N. Y. C. L-4-10

CIRCLE 66 READERS SERVICE CARD

F.M. Deviation Measurement

Wide Deviation —

High Carrier Frequency

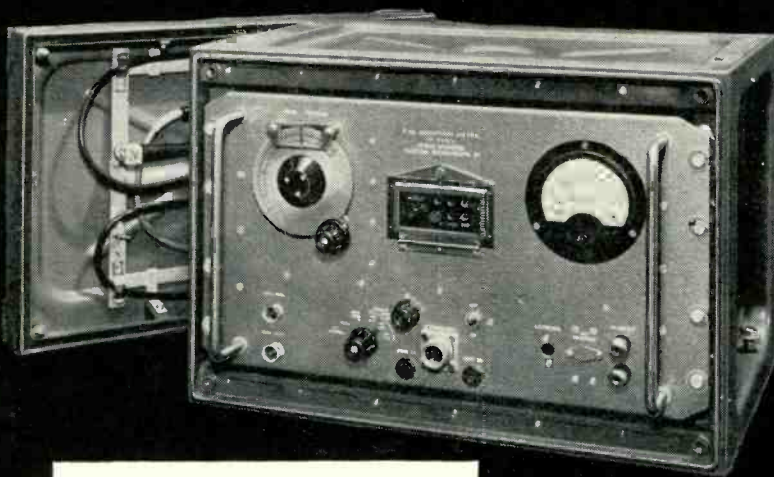

MARCONI DEVIATION METER MODEL 928 CAN BE USED AT CARRIER FREQUENCIES UP TO 500 mc FOR DIRECT MEASUREMENT OF DEVIATIONS UP TO 400 kc.

DEVIATION METER MODEL 928/2

is an alternative narrow-deviation model arranged for use at carrier frequencies between 215 and 265 mc.

Please send for leaflet B132/A

ABRIDGED SPECIFICATIONS 928: — CARRIER FREQUENCY: 20-100 mc (fundamental), up to 500 mc using harmonics. FREQUENCY DEVIATION: 0-100 kc, 0-200 kc; 0-400 kc in the mod. frequency range 50 cps—120 kc. ACCURACY: $\pm 3\%$ R.F. INPUT RANGE: 55 mv—10 v. **928/2:** — As above except for the following:—CARRIER FREQUENCY: 215—265 mc. FREQUENCY DEVIATION: 0-15 kc, 0-50 kc, 0-150 kc.

MARCONI INSTRUMENTS

*Marconi
for f m
test gear*

111 CEDAR LANE ENGLEWOOD NEW JERSEY Tel: LOwell 7-0607
Canada: Candian Marconi Co. Marconi Building, 2442 Trenton Ave. Montreal 16
MARCONI INSTRUMENTS LTD · ST. ALBANS · HERTS · ENGLAND

only 1.0 db and a vswr of only 1.2. Each covers an entire waveguide band. Conservatively rated at 5 w, these isolators can actually handle up to 25 w with only a temporary electrical degradation. Circle 209 on Reader Service Card.

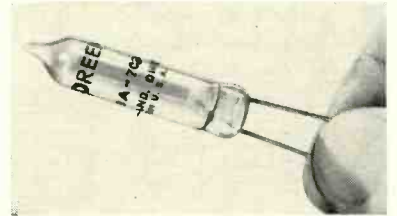

Corona Regulators low current

THE VICTOREEN INSTRUMENT Co., 5806 Hough Ave., Cleveland 3, Ohio. Type GV3A-700L corona type regulator tube, for operation at 700 v and for currents of 0.001 μ a or higher, provides an attractive form of voltage regulation for many applications requiring economy of current drain from the primary power source. Circle 210 on Reader Service Card.



Variable Scale for data reduction

THE GERBER SCIENTIFIC INSTRUMENT Co., 89 Spruce St., Hartford 1, Conn. Model TP007200B variable scale is a manually operated mechanical device. It saves much time in the reading of records such as oscillograms or telemeter data, because to a large extent it eliminates the drudgery involved in data reduction. It also saves time in the plotting of graphs and curves, especially in the direct multiplication and division of graphical functions and the reading thereof. Circle 211 on Reader Service Card.

VHF-UHF Calibrator wide frequency

CONTROL ELECTRONICS Co., INC., 10 Stepar Place, Huntington Station, L. I., N. Y., announces a vhf-uhf calibrator which covers the spectrum from 50 mc to 11,000 mc

TC132R

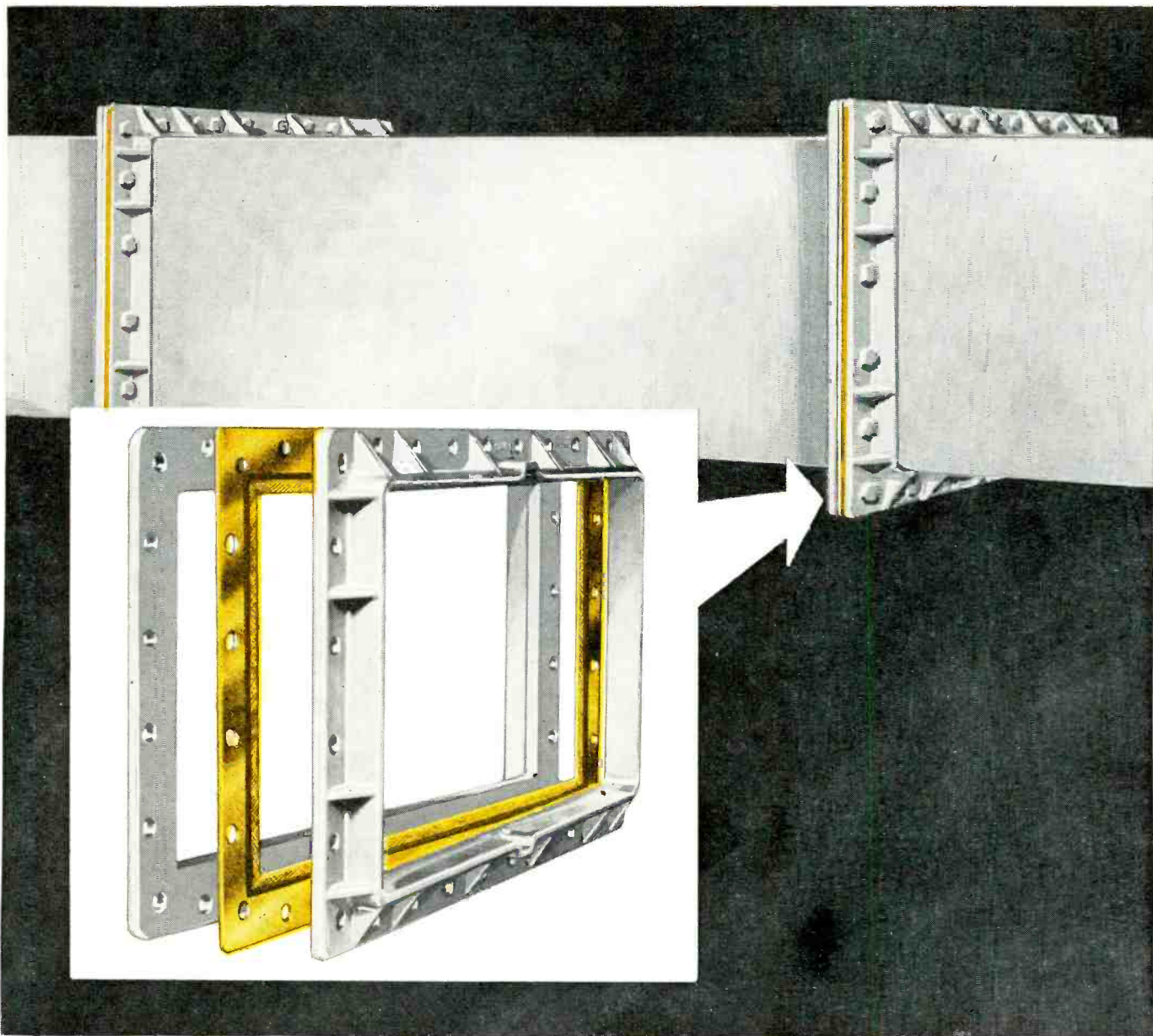

THESE WR WAVE GUIDE SEALS PROVIDE POSITIVE SEALING; PREVENT R/F LEAKAGE, ARCING & BURNING

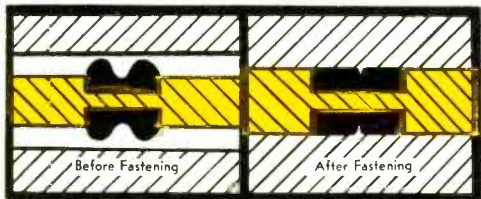

Electr-O-Seals are now available to fit all EIA (RETMA) standard WR series wave guide flanges, WR90 thru WR2300 as well as specials.

These seals not only provide near perfect sealing and complete electrical continuity, but offer many economical advantages — made by the makers of Parker O-rings, Stat-O-Seal®, and Gask-O-Seal®.

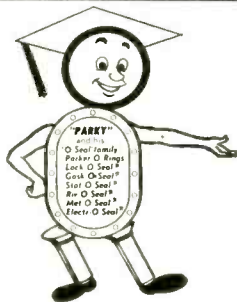

Parker SEAL COMPANY

CULVER CITY, CALIFORNIA and CLEVELAND, OHIO

A DIVISION OF PARKER-HANNIFIN CORPORATION

PRECISION

Geared To Your Product Needs

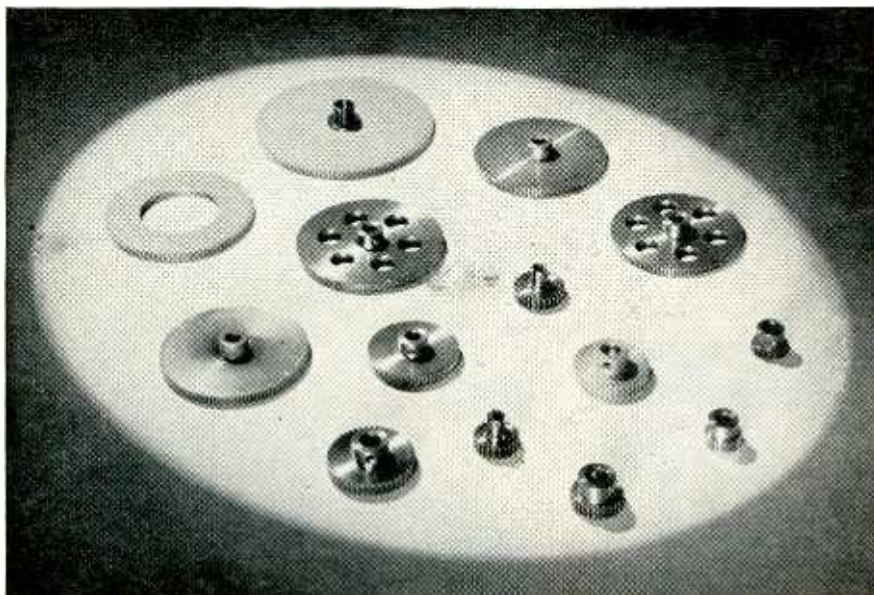

APPCO *Certified* STOCK GEARS

32 TO 120 PITCH . . . A.G.M.A. PRECISION #1, 2 & 3

Every tooth a masterpiece in finish and motion . . . every gear to the most exacting A. G. M. A. precision standards . . . all meet Government specifications—that's the quality of APPCO Certified Precision Stock Gears. The precision of every gear Certified to assure engineers and production men of their exact requirements for every precision product.

APPCO Certified Precision Stock Gears are available for quick deliveries in 32, 48, 64, 72, 96 and 120 diametral pitches of 14½° and 20° pressure angles. Each gear designed with dimensions proportional to their diametral pitch for minimum weights and space considerations.

The fine precision and certified testing permits the use of APPCO Gears in precision assemblies of all types—airborne, shipboard, missile or stationary. APPCO Gears are usable in the engineering prototypes or breadboard design . . . will qualify uniformly for use in actual model pre-production or production manufacturing areas. Each gear is completely sealed on a shipping tray with plastic cover . . . always "factory fresh" and free of dust, corrosion and scratches.

Put extra precision into your products. Write for APPCO catalog to Atlas Precision Products Co., Castor and Kensington Avenues, Philadelphia 24, Pennsylvania.



GET FREE
CATALOG

MEMBER



Division of
PRUDENTIAL INDUSTRIES INC.

without tuning controls. It has accuracies of ± 0.005 percent throughout the entire frequency range. Unit is an accurate secondary frequency standard for laboratory use in calibrating and testing of microwave receivers, radar systems, navigational aids, beacons, signal generators and r-f preselectors and filters. Circle 212 on Reader Service Card.

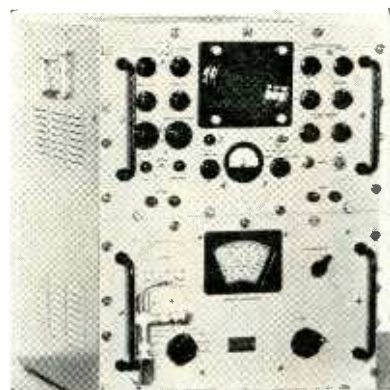

Spectrum Analyzers versatile units

LAVOIE LABORATORIES, INC., Morganville, N. J. The use of external detachable coaxial and waveguide mixers in two new spectrum analyzers, models LA-18M (illustrated) and LA-20M, provides greater sensitivity and more extensive range calibrated to 44 kmc. Frequency calibration is accurate to ± 0.1 percent at operating frequency of local oscillator, and the units have a sweep repetition rate of from 0.5 to 30 cps free running or synchronized. Circle 213 on Reader Service Card.



Tiny Capacitors 50-volt

GOOD-ALL ELECTRIC MFG. Co., Ogallala, Nebr. For transistorized circuits where space is critical, four new series of 50-v subminiature capacitors have been released. All are metal enclosed, hermetically sealed designs. They are available in tolerances to ± 1 percent. Types

NEW HIGH VOLTAGE NPN TRANSISTORS ALLOW TUBE REPLACEMENT AND CIRCUIT COMPATIBILITY



ACTUAL
SIZE

GT's new high voltage germanium alloyed junction transistors now allow the same optimization as formerly could be realized only with vacuum tubes. These characteristics plus conventional "transistor" advantages offer new design opportunities in computers, magnetic memory cores, data processing equipment, gas filled indicator tubes and other applications where reduction of space, weight and high reliability are prime requisites.

The GT 1200 is particularly suited to drive gas filled display tubes, such as the Burroughs Nixie® and Pixie®, without changing existing circuitry other than altering voltages so as not to exceed the rating of the transistor.

		GT 1200
Collector to Base Voltage (Emitter Open)	$I_C = 25 \mu A$	90 Volts Min.
Emitter to Base Voltage (Collector Open)	$I_E = 25 \mu A$	20 Volts Min.
Collector to Emitter Voltage (Punch Through)	$I_E = 25 \mu A$	90 Volts Min.
Supplied in TO-9 case		

GT 1201 — GT 1202, in addition to driving gas filled display tubes, are ideally suited for driving high inductance loads, driving transformer coupled loads and allow more nearly perfect impedance matching. These transistors are fast devices capable of handling high impedance loads and large signal swings.

	GT 1201	GT 1202
Collector to Base Voltage (Emitter Open)	$I_C = 25 \mu A$ 75 Volts Min.	45 Volts Min.
Emitter to Base Voltage (Collector Open)	$I_E = 25 \mu A$ 20 Volts Min.	20 Volts Min.
Collector to Emitter Voltage (Punch Through)	$I_E = 25 \mu A$ 75 Volts Min.	45 Volts Min.
Supplied in TO-9 case		

Write today for Bulletin GT 1200. Nixie® and Pixie® are registered trade marks of Burroughs Corporation



GENERAL TRANSISTOR

C O R P O R A T I O N

91-27 138TH PLACE

JAMAICA 35,

NEW YORK

IN CANADA: DESSER E-E LTD., 441 ST. FRANCIS XAVIER, MONTREAL 1, QUEBEC. FOR IMMEDIATE DELIVERY FROM STOCK, CONTACT YOUR NEAREST AUTHORIZED TRANSISTOR DISTRIBUTOR OR GENERAL TRANSISTOR DISTRIBUTING CORP., 91-27 138TH PLACE, JAMAICA 35 NEW YORK. FOR EXPORT: GENERAL TRANSISTOR INTERNATIONAL CORP., 91-27 138TH PLACE, JAMAICA 35, NEW YORK.

©N

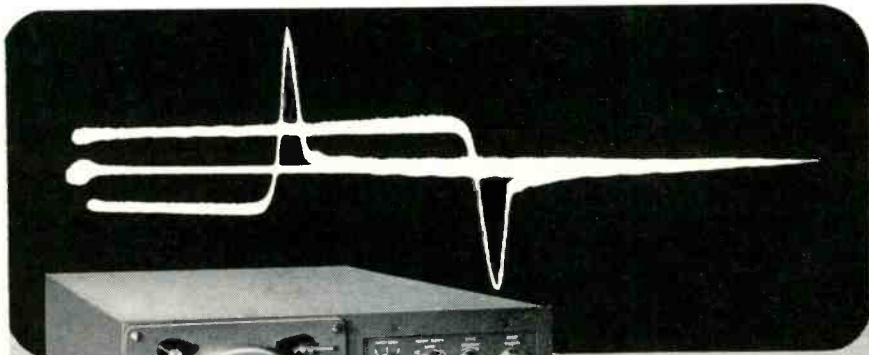

Typical display of recovery time of two diodes tested simultaneously.

2 FROM 1

GET DUAL POSITION OPERATION FOR QUALITY CONTROL TESTING OF FAST RECOVERY DIODES WITH THE **EG&G MILLI-MIKE OSCILLOSCOPE**

Now two operators can use the same EG&G Type 2236A Milli-Mike Oscilloscope at the same time. It's like getting **two** oscilloscopes—(EG&G Oscilloscopes)—for the price of **one!**

TYPE 2236A PERFORMANCE DATA

	Vertical (TW)	Horizontal
Sensibility	.054 v/trace width	0.30 v/trace width
Nominal Spot Size (trace width)	0.002 inch	
Deflection	27 v/inch (nominal)	150 v/inch
Frequency Response	DC to greater than 3,000 mc (-3db at approx. 2,000 mc)	
Input Impedance	50 or 100 ohms	
Writing Speed	3 x 10" trace widths/sec.	

The EG&G Milli-Mike Oscilloscope—one of a family of millimicrosecond instruments—is now being used to solve problems in measurement of high speed semiconductors, decay times of scintillators, discontinuities in transmission lines and as a synchroscope in high resolution radar systems. For information on this and other millimicrosecond pulse techniques, write to Application Engineering Group.



EDGERTON, GERMESHAUSEN & GRIER, INC.

160 BROOKLINE AVENUE, BOSTON 15, MASS. 1622 SOUTH "A" STREET, LAS VEGAS, NEV.

626 G and 627 G are of extended foil construction. Types 628 G and 629 G employ tab construction. All are designed for operation at 85 C without derating and to 125 C with 50 percent derating. Circle 214 on Reader Service Card.

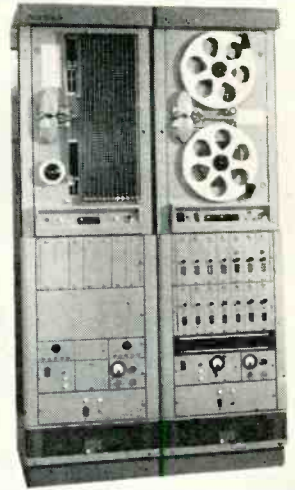

Recorder/Reproducer closed-loop

CONSOLIDATED ELECTRODYNAMICS CORP., 300 N. Sierra Madre Villa, Pasadena, Calif., has available a new magnetic tape continuous-loop recorder/reproducer designed for the repetitive study of highly transient data, random occurrences, and time-delay application. The type 5-781 (shown at left), a self-contained system containing amplifiers, precision-frequency power supplies, and blower, provides selective or simultaneous erase for its 14 analog, f-m or pdm record/reproduce channels. It is fully compatible with the type 5-752 reel recorder (right) and together they form an integrated magnetic-tape system. Circle 215 on Reader Service Card.



Power Supply transistorized

LAMBDA ELECTRONICS CORP., 11-11 131 St., College Point 56, N. Y. A new all-transistor power supply with

...and
the
tubes
are
RCA!"

One design engineer tells
another exactly how he
puts the "high" in "fidelity"

New design! Just demonstrated the model!
FM's superb...such quieting...rock-stable
tuning! Can't hear any hum in the wide-open
audio preamplifier...or noise in the treble!
And the power amplifier...*just feel that bass!*
He has good reason to be proud. From front
end to output stage, the design's a honey.
And, as he says: "...*the tubes are RCA!*"

RCA tubes for monophonic and stereo-
phonic high fidelity have been especially de-

signed to bring out the best in your equip-
ment. Among these are four special types—
RCA-6973 and 7027 beam power tubes, RCA-
7025, a high-mu twin triode controlled for
hum and noise and the 7199, a remarkable
triode-pentode combination.

Your RCA Field Representative will be glad
to help you select the right tube for your
circuit. Call him now. Or you can get techni-
cal data from RCA Commercial Engineering,
Section D-19-DE2, Harrison, N. J.

RCA Field Offices

EAST:
744 Broad Street
Newark 2, N. J.
HUmboldt 5-3900

MIDWEST:
Suite 1154
Merchandise Mart Plaza
Chicago 54, Ill.
WHitehall 4-2900

WEST:
6355 E. Washington Blvd.
Los Angeles 22, Calif.
RAYmond 3-8361



RADIO CORPORATION OF AMERICA
Electron Tube Division
Harrison, N. J.



NICAD HELPS MOSLER MAINTAIN LEADERSHIP IN BANK SECURITY



NICAD nickel cadmium sintered plate battery

With a reputation for providing top security, The Mosler Safe Company must be certain that its Century Bank Alarm system will perform reliably *under any conditions*.

A NICAD nickel cadmium battery makes such performance a certainty. Should the main power source fail, the NICAD battery provides vital stand by power.

NICAD sintered plate batteries were chosen by Mosler on the basis of proved dependability and long-term service—a combination through which NICAD offers long-range economy. Additionally, NICAD offers cycle life which far exceeds that of any other battery . . . peak operational efficiency under severe conditions . . . low internal resistance that creates high discharge rates . . . capacity range from 1/2 to over 150 ampere hours.

For more information on the adaptability of NICAD batteries to signal alarm systems, air and space craft, microwave and telemetering devices, and similar equipment, request Bulletins 501 and 501A from NICAD Division, Gould-National Batteries, Inc., Easthampton, Mass.

NICAD

TRADEMARK

NICKEL CADMIUM ALKALINE STORAGE BATTERIES

a range of 0-1 ampere is being produced. It is convection cooled with no moving parts, no internal blowers. Voltage range is 0-32 v d-c. Unit is priced at \$285 for the un-metered model (LT 1095) and \$315 with meters (LT 1095 M). Circle 216 on Reader Service Card.

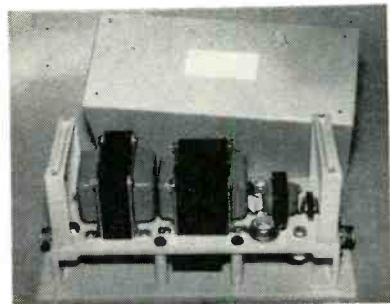

Servo Amplifier solid-state

DI-AN CONTROLS, INC., 40 Leon St., Boston 15, Mass. Model AS-20 servo amplifier is specifically designed for use in critical heavy-industry and automation applications, in which long life and ability to withstand abnormal input or output stresses are important. Using semiconductor circuitry throughout, the unit is mechanically and electrically ruggedized. For example, a unique input circuit will operate unharmed with continuous input overvoltage of 2,500 percent. Circle 217 on Reader Service Card.



Power Supplies plug-in type

CONSOLIDATED AVIONICS CORP., Westbury, L. I., N. Y. New a-c/d-c plug-in power supplies are available with regulated and unregulated outputs. Reliable performance under elevated temperature conditions is assured as a result of the larger heat sink provided through housing each unit in a finned aluminum case. Units are available to operate from

Over 9,500 hours ago, the successful Vanguard Satellite was launched. We salute the U. S. Navy and its cooperating agencies, as the Satellite, launched over a year ago, continues in orbit.

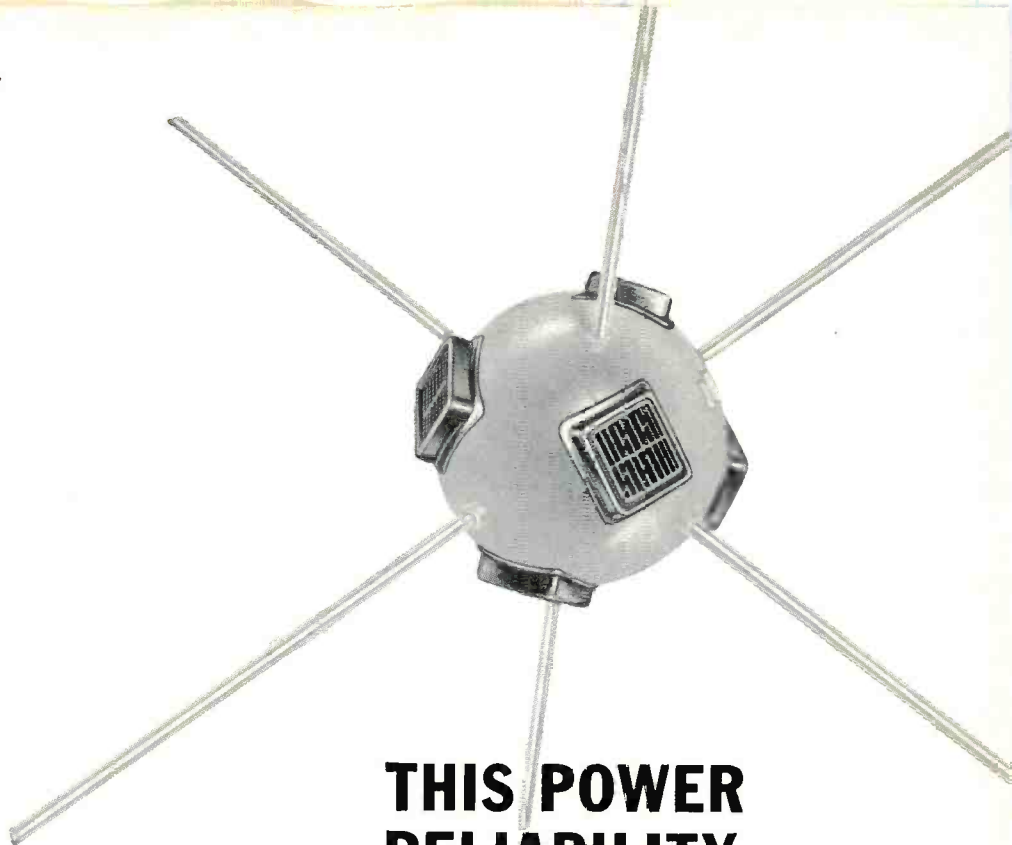

THIS POWER RELIABILITY PROBLEM HAD TO BE SOLVED

FOR SPACE VEHICLES

Hoffman Silicon Solar Cells were the solution



The transmitter of the U.S. Navy's Vanguard Satellite required an extremely reliable power source with the highest possible light energy conversion efficiency. Hoffman Silicon Solar Cells were chosen to do this exacting job. To date a new record has been set for continuous electrical power in outer space (with no "time-out" for refueling).

If you require a highly dependable electrical power supply, with a wide operating and storage temperature range of from -65°C to $+175^{\circ}\text{C}$, a higher light conversion efficiency (up to 10%), an extended spectral response range of from 4,000-11,500 angstroms, benefit from Hoffman's unequalled experience as the pioneer in the commercial development of Silicon Solar Cells and their uses.

For details consult the Hoffman Solar Cell applications specialist in your immediate area or write to Department SS.

If you need a job in electronics done quicker and better, contact

Hoffman Electronics

CORPORATION
SEMICONDUCTOR DIVISION
930 PITNER AVENUE EVANSTON ILLINOIS



GENERAL ELECTRIC VOLTAGE REGULATION IDEA FILE

By C. A. NEUMANN



FOR RADAR ENGINEERS

Using General Electric Inductrol^{*} Regulators in the high-voltage power supply of radar systems

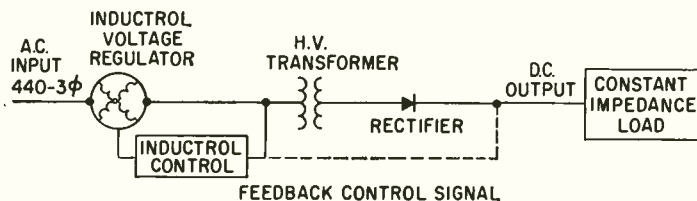

Because the high-voltage power supply is an inherent part of the transmitter portion of a radar system, there is much concern over keeping the system effectively and continuously operative despite voltage control problems.

The diagram above illustrates how General Electric Inductrol regulators help solve this problem.

With the regulator in the circuit, as shown, it is possible to regulate the power supply output voltage while combining both the run-up function and the precise voltage control function.

ANY DESIRED RANGE OF VOLTAGE CONTROL for the system can be incorporated into this single regulator. In addition, the Inductrol voltage regulator, through its associated controls, corrects for input voltage variations and fluctuations of the load, while compensating for regulation of the circuit and changing characteristics of the rectifier element.

For reliable operation of the high-voltage power supply, the Inductrol regulator must provide the desired range of d-c power required. Problems such as line voltage variation, load changes, infinite d-c level requirements, being able to withstand high fault currents, and system regulation must be accomplished reliably and automatically for continuous operation of the power supply.

AS AN EXAMPLE, here is a typical high-voltage power supply with the following requirements: d-c voltage—18 kv

max., d-c current—1.7 amps max. Line voltage variation $\pm 10\%$, d-c output voltage to be adjustable from 2 kv to 18 kv. System characteristics are: power factor—90%; efficiency—95%, system regulation—10%.

TO OBTAIN VOLTAGES OF 2-18 KV with your three-phase bridge rectifier, the Inductrol regulator will vary the 440 V, three-phase input on the transformer primary in direct proportion to the H.V. requirements. In addition, it will automatically compensate for line voltage variations, load changes, and system regulation while being able to withstand fault currents of 25 times normal (for 2 seconds) and giving infinite voltage adjustment from 2 to 18 kv. This is accomplished without having the control device introduce waveform distortion, is free from contact maintenance (no brushes or switch contacts) and maintains $\pm 1\%$ accuracy over the full range. Inherently, the Inductrol regulator, whether dry-type or liquid-filled design, is virtually free from maintenance requirements.

OTHER INDUCTROL REGULATOR USES: Line voltage correction (60 or 400 cycle) control of filament power supplies, focus coil control, and grid voltage control in radar systems, variable speed antenna drives, computers, and many other electronic equipments.

FOR MORE INFORMATION, write to Section 425-20, General Electric Company, Schenectady 5, New York.

*Registered Trademark of the General Electric Company for Induction Voltage Regulators.

Progress Is Our Most Important Product

GENERAL  ELECTRIC

110 v, 60 or 400 cps input with outputs of 6, 12, 24, 75, 150, 250, and 300 v d-c, and with currents up to 400 ma. Circle 218 on Reader Service Card.

Phototube ten-stage, head-on

RADIO CORP., OF AMERICA, Harrison, N. J., has introduced type 7326, a ten-stage, head-on type of multiplier phototube. It is designed for use in applications such as flying-spot scanning and photometry which require low dark current as well as high sensitivity over the entire visible spectrum. The tube is also very useful in scintillation counter applications. Circle 219 on Reader Service Card.



Ten-Turn Pots subminiature

DAYSTROM PACIFIC, 9320 Lincoln Blvd., Los Angeles 45, Calif., has available ten-turn pots only $\frac{1}{2}$ in. by 1 in. in size. They incorporate V guides and spring-loaded rods that eliminate backlash and insure stability. Double wipers, one on either side of the resistance element, eliminate intermittents caused by shock and vibration, and double the effective resolution. Circle 220 on Reader Service Card.

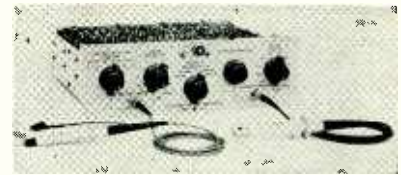

Amplifier voltage/current

HEWLETT-PACKARD Co., 275 Page Mill Road, Palo Alto, Calif. Designed for use with the model 150A oscilloscope, the model 154A voltage/current dual channel amplifier provides simultaneous measurement and observation of both

SICKLES
has its finger
on the pulse
of the
Delay Line
art

Sickles
DELAY LINES
engineered to your
specifications

The complexities of delay line design and manufacture hold no fears for Sickles. We've built up a 38 year record of success in precision coil winding – and *since 1938* have produced delay lines for a host of applications including color TV, commercial air controls, computers, missiles and military guidance systems.

No matter how complex the job, our engineering laboratory can contribute. If quantity production is required, of course Sickles as one of the world's largest coil producers can handle that too – bringing into play our complete (and in many instances, *unique*) facilities for volume manufacture.

We'll be glad to discuss your delay line problem – and have a qualified representative call on you. For information, write direct to Section SI-4.

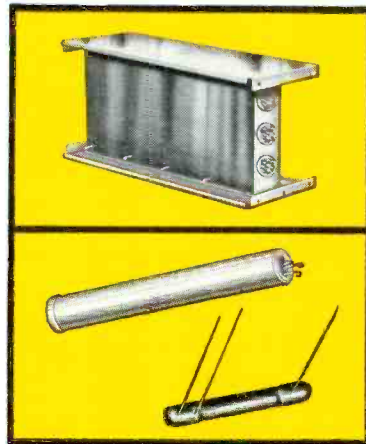

At upper left is a typical composite of 5 delay lines, hermetically sealed in a metal case which we have produced for ground-to-air traffic control. Its major lumped line has $T_d = 20.3$ usec tapped at each 1.45 usec with a rise time of 0.5 usec.

Distributed lines, at lower left, can be supplied with time delays up to 25 usec with impedances of 300 to 5000 ohms. They may be hermetically sealed, potted, resin dipped or encapsulated.

F. W. SICKLES DIVISION / *General Instrument Corporation*

Leaders in electronic coil winding and assembly since 1921

165 Front Street (P. O. Box 330) Chicopee, Mass.

Other plants in Joliet, Ill. and Waterloo, Ont., Canada



GENERAL INSTRUMENT CORPORATION INCLUDES F. W. SICKLES DIVISION, AUTOMATIC MANUFACTURING DIVISION, RADIO RECEPTOR COMPANY, INC. AND MICAMOLD ELECTRONICS MANUFACTURING CORPORATION (SUBSIDIARIES)



SPECIAL

TIMING and COUNTING

INSTRUMENTS

THE Series 70 System measures **CONTINUOUS** time intervals by means of an electronic memory or storage. Time increments as well as continuous time intervals are measured by the Series 70 System, and recorded on tape punch and printer readout.

ELECTRONIC time averaging of two inputs to this system averages out errors due to eccentricities.

THIS System was developed for testing inertial gyros — but the general approach may be the solution to your problems! Write today to the **SPECIALIST IN FREQUENCY COUNTERS.**

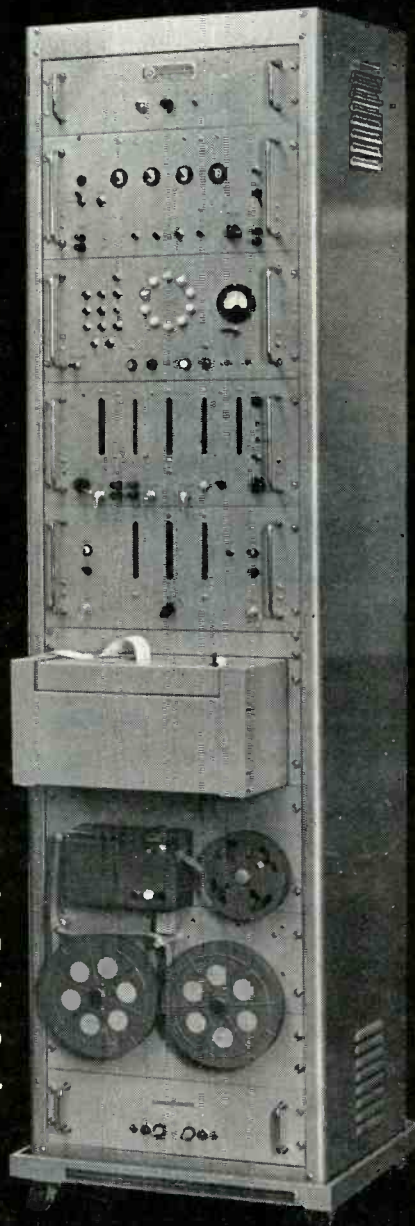

NORTHEASTERN ENGINEERING, INC.

MANCHESTER, N. H. • 25 So. Bedford St.

P. O. Box 150 • NATIONAL 2-6485

a-c voltage and a-c current waveforms. Electronic switching between channels, either by alternate sweeps or by 100 kc chopping, allows a direct comparison of voltage and current relationships within a circuit. The current channel, equipped with a current sensing probe, provides direct presentation of current waveforms by clamping the probe around a wire. **Circle 221 on Reader Service Card.**

VHF Preamplifier low noise

HALLER, RAYMOND, AND BROWN, INC., Science Park, State College, Pa. Model 53ONS broadband vhf preamplifier has a gain of 42 db from 50 to 300 mc. Average noise figure is less than 8 db. Packaged weight is 4 lb without power supply. Power input is 70 w. Other models have bandwidths from 50 to 250 mc and cover frequency range from 50 to 500 mc. **Circle 222 on Reader Service Card.**

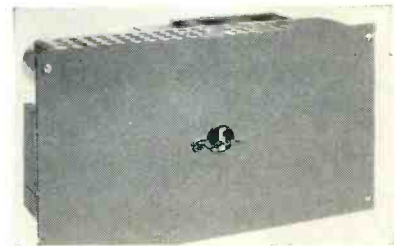

D-C Supplies extremely rugged

SORENSEN & Co., INC., Richards Ave., South Norwalk, Conn., has developed the model MD heavy duty d-c supplies. They consist of conservatively rated magnetic-type voltage regulators, full-wave silicon diode rectifiers, and capacitive input filters. Units can be supplied from stock with output voltages ranging from 2.5 to 1,000 v d-c, with power capacities of 25, 50, 100, 200, 400, 750, 1,500 and 3,000 w. **Circle 223 on Reader Service Card.**

Panoramic Receiver joystick control

CGS LABORATORIES, Route 7 at 35, Ridgefield, Conn., announces an

Meet Bill Bushor and Sam Weber

Associate Editors, electronics
FEATURE ARTICLE EXPERTS



Resumés:

Bushor, William E., Lawrence Institute of Technology, BSEE, I. R. E. member. 9 years experience: U.S. Army (communications chief), Bell Aircraft (air-to-air missile), G. M. Research Labs, Sperry Gyroscope, etc. Member Society Technical Writers.

Weber, Samuel, Virginia Polytechnic Institute, BSEE, I. R. E. member. 10 years diverse engineering experience: U. S. Navy, Barlow Electrical Mfg. Co., Curtiss-Wright, etc. Primarily in communications, uhf and microwave components and design, jet engine test instrumentation.

Present Occupations:

Bill Bushor is preparing a series to appear in 1959 on medical electronics comprising diagnostics, therapeutics, prosthetics, and clinical and operative aids.

Sam Weber is working on "Sophisticated Communications Methods" for the October 1959 issue. Report covers scatter systems, meteorburst transmission, satellite relays, carrier systems, etc.

References:

If you're not a subscriber, if your subscription is expiring, if you will miss exciting features "in-the-works" by electronics 26-man staff, fill in box on Reader Service Card. Easy to use. Postage free.



electronics

A McGraw-Hill Publication • 330 West 42nd Street, New York 36, N. Y.

NEW!

"SEE-THRU"

RED

PRINTED CIRCUIT TAPES & SHAPES

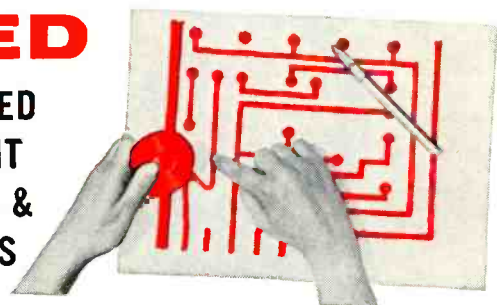

ELIMINATE MOST NEGATIVE RETOUCHING — CUT DRAFTING TIME. New Brady "See-Thru" Red self-sticking tapes and shapes speed production, increase accuracy in laying out printed circuit layouts. Translucent — easy to register on lines. Photographs opaque black. Thin plastic film (.002") assures sharp, clean outlines. Close tolerance pre-cut self-sticking shapes are non-smudging. Matching connector strips in rolls. Over 100 standard shapes and sizes in stock for immediate delivery. **Write for new Bulletin and FREE TEST SAMPLES.**

Manufacturers of Quality
Pressure-Sensitive
Tape Products — Est. 1914

W. H. **BRADY** CO.

735 W. Glendale Ave., Milwaukee 9, Wis.

80A

CIRCLE 78 READERS SERVICE CARD



POLARIZED RELAYS

**COMPACT
RUGGED
HIGH SPEED
LONG LIFE
TESTED and
PROVEN**

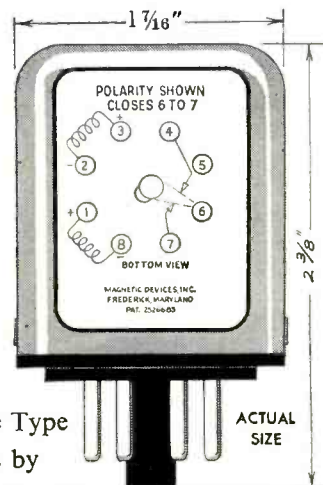

High speed, sensitive Type 300 Polarized Relays by MDI give long operating life—tested and proven by years of military use.

Coil Resistance
25 to 4,000 ohms

Operating Current
2 to 60 MA

Overall Dimensions
1-7/16" x 1-7/16" x 2-3/8"

For full details, write, wire or phone today

MAGNETIC DEVICES, MDI INC.

Dept. E, 712 East Street • Frederick, Md.

CIRCLE 125 READERS SERVICE CARD

LOOK TO TOBE FOR PROGRESS



600,000
amperes
help harness
H-power

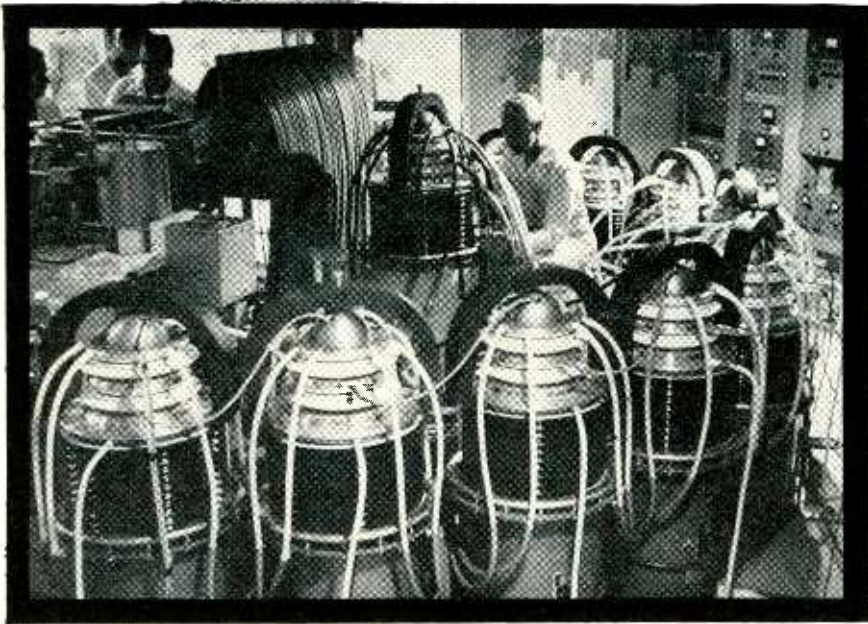

At the recent Geneva Atoms-For-Peace Conference, Los Alamos scientists unveiled *Scylla*—a fusion device used to heat a plasma of ionized heavy hydrogen particles millions of degrees by blasting it with a 600,000-ampere thunderbolt.

Surrounding the heart of this thermonuclear machine is a bank of Tobe low-inductance, energy-storage capacitors...each rated at 100,000 volts each capable of a 20,000 megawatt peak surge.

Why *Tobe* capacitors? Because only Tobe, with over 30 years of capacitor manufacturing experience, could meet the rigid design specifications set for the project. Tobe can meet yours too. So, whether you need a bank of thermonuclear energy-storage capacitors or a miniaturized tubular, talk to Tobe. Our engineers speak your language.

For further technical information or engineering aid, write Tobe-Deutschmann Corp. Norwood, Mass.

specify



PRODUCTS

TOBE DEUTSCHMANN • CAPACITOR PIONEERS SINCE 1922

electronically tuned panoramic receiver with new joystick control. Vertical motion of the joystick controls the amount of expansion of the crt display; horizontal, the centering of the display. This TRAK receiver operates over the 100 to 150 mc range. Bandwidth is 30 kc; noise figure, 9 db at the worst point. With a dynamic range in excess of 60 db, sensitivity is $0.5 \mu\text{v}$, and spurious responses are 60 db or more down. Circle 224 on Reader Service Card.



Photoelectric Control transistorized

AUTOTRON, INC., 3629 N. Vermilion, Danville, Ill. Conservative operating requirements of the new model BT1 transistorized photoelectric control are 10 ft-candles minimum light with 0.04 sec minimum dark time and 0.04 sec minimum light time. The control relay energizes when light is on the sensing element. Contacts are spdt, silver cadmium oxide, rated 8 amperes at 115 v a-c, noninductive load. Circle 225 on Reader Service Card.

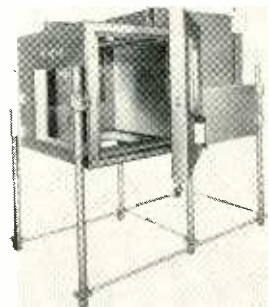

Test Chamber automatic operation

THE AMERICAN RESEARCH CORP., Farmington, Conn. A new vibration test chamber, which has a temperature range of -100 F to $+350 \text{ F}$ with mechanical refrigeration, is

How far can an engineer go at AC?

Your career can go up and up with missiles and space vehicles. For AC, new leader in the instrumentation business, is building more and more AChievers—one of the world's finest inertial guidance systems—plus a host of other remarkable electro-mechanical, optical and infra-red devices.

If you are a graduate engineer in the electronic, electrical or mechanical fields, you can go places at AC, because AC is going places.

Do you want new and different assignments?—Look to AC. Professional status?—AC assures it. Interesting location?—You can go across the country or around the world. A top management position?—The door is always open. Long-range security?—AC and General Motors are famous for it.

Investigate these opportunities now. Just write the Director of Scientific and Professional Employment: Mr. Robert Allen, Oak Creek Plant, Box 746, South Milwaukee, Wisconsin.

INERTIAL GUIDANCE SYSTEMS • AFTERBURNER FUEL CONTROLS • BOMBING NAVIGATIONAL COMPUTERS
GUN-BOMB-ROCKET SIGHTS • GYRO-ACCELEROMETERS • GYROSCOPES • SPEED SENSITIVE SWITCHES • SPEED SENSORS • TORQUEMETERS

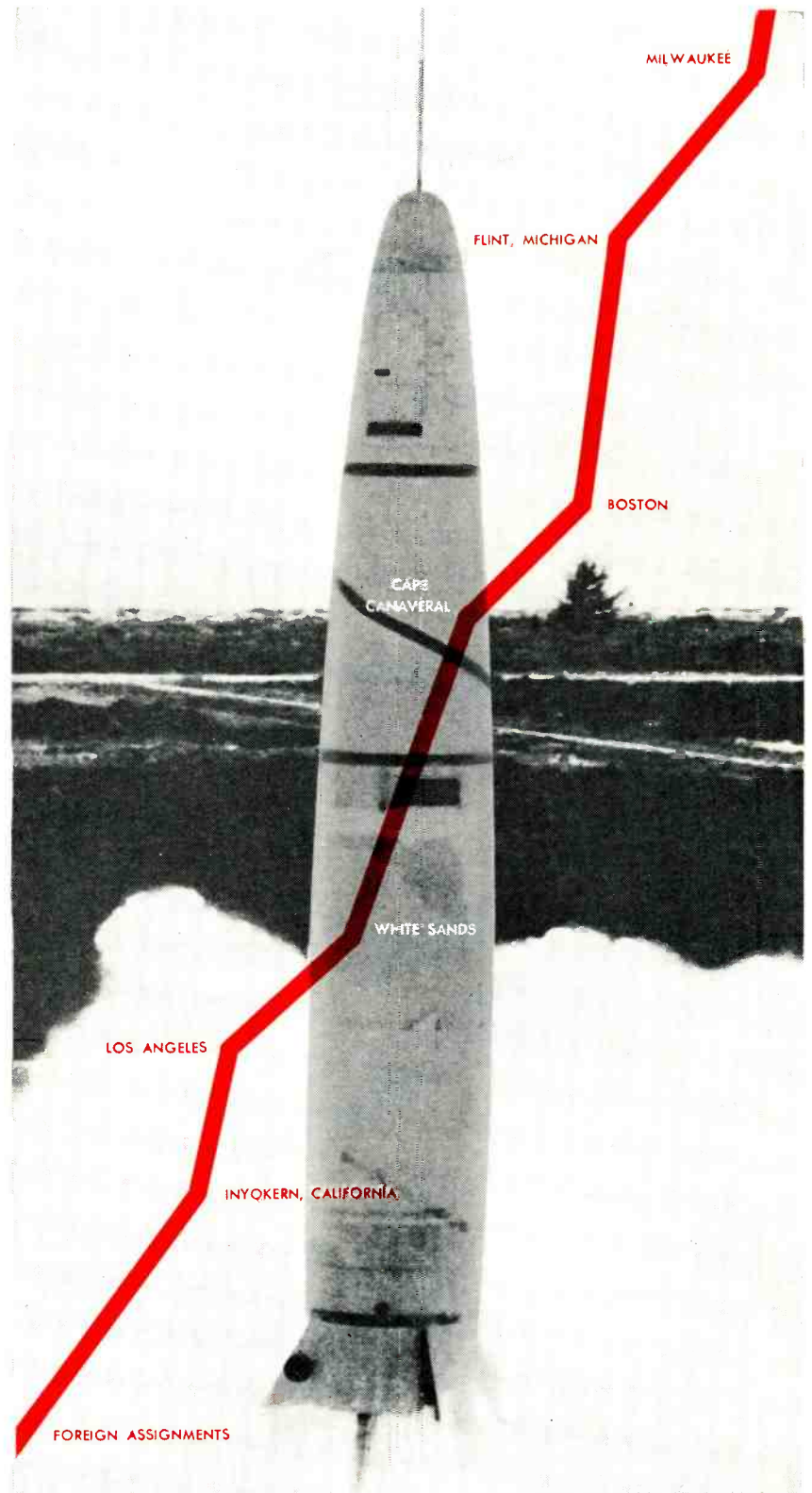

The Thor, launched on a cushion of flames, is guided by the AChiever. And the AChiever does its job so well that the demand for AC products is constantly increasing.



SPARK PLUG 

THE ELECTRONICS DIVISION OF GENERAL MOTORS

Wire and Cable Leaders depend on CHEMO PRODUCTS



TEFLON* TAPES AND COATED YARNS

For Quality
For Service



CHEMO TEFLON* TAPES

Tapes from .001" thicknesses to .125" thicknesses. Continuous lengths. Dielectric Strength: 2,000 volts per mil. Tensile strength: 4,000 p.s.i. Elongation 350%. Maximum whiteness at no premium cost.

CHEMO TEFLON-COATED YARNS

Yarns of uniform quality. Operating range 100°F to 620°F. Excellent tensile strength. Low flow under heat and pressure. Excellent electrical properties over a wide range of temperatures and frequencies. High degree of chemical inertness.

Wherever you find wires and cables insulated with TEFLON* . . . and there are more applications seen every day . . . you'll find a Chemo Products TEFLON tape or yarn ready to do the job.

Get all the unique performance advantages of TEFLON* insulation plus super-swift service and expert quality. Get the complete package from Chemo.

Save weight and space — Reduce assembly costs — Speed production — Cut maintenance and replacement costs — with:

CHEMO TEFLON* TAPES AND YARNS

Ask for new data sheets on CPI TEFLON* tapes and high temperature yarns . . . and on other TEFLON products.

*Teflon—Dupont registered trademark



CHEMO PRODUCTS INC.

PLANT: WEST WARWICK, RHODE ISLAND
NEW YORK OFFICE: 1071 AVENUE OF THE AMERICAS

62-9

furnished with a removable insulated plug and a flexible diaphragm. Testing may be done with the vibration table in a horizontal or vertical position. Chamber has a free test space of 4 by 4 by 4 ft. Circle 226 on Reader Service Card.

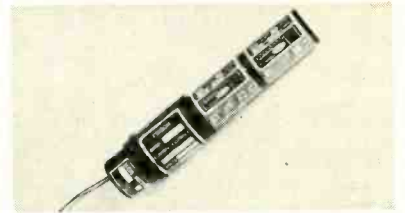

In-Line Sub-System space-saving

THOMAS A. EDISON INDUSTRIES, McGraw-Edison Co., 61 Alden St., West Orange, N. J., announces a new space-saving in-line sub-system consisting of a size 10 servo motor, a gear head containing a clutch, and two precision potentiometers. Many different in-line modular units are available to the systems engineer containing any component adaptable to rotary operation such as resolvers, potentiometers, synchros and tachometer-generators. Circle 227 on Reader Service Card.

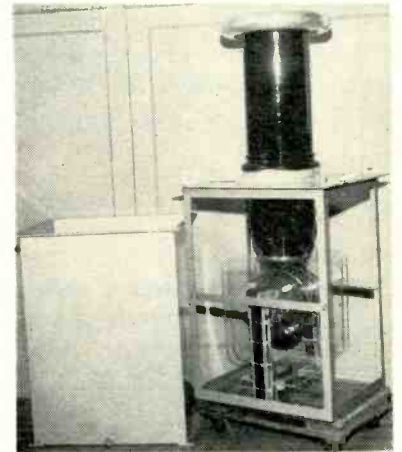

H-V Transformer corona-free

DEL ELECTRONICS CORP., 521 Homestead Ave., Mt. Vernon, N. Y. New corona-free h-v transformers intended for research purposes are rated at 200,000 peak volts at 10 ma. Their design and construction employ modern techniques and ma-

CABLE CLIPS
 ★
of all Nylon
 for severe conditions
 ★
of Ethyl Cellulose
 for maximum economy



WECKESSER



molded
Black Nylon
SCREWS
and NUTS
 ★
 Acid resistant
 ★
 Need no insulation
 ★
 Can't rust
 ★
 Can't corrode

WECKESSER COMPANY

5701 Northwest Highway • Chicago 46, Ill.

CIRCLE 82 READERS SERVICE CARD

here is the world's smallest and simplest
 strip chart recorder!



- **AMPLE STORAGE:** Contains 63-ft. chart roll, or 31 days' recording at one inch per hour. Useful chart width 2 3/16".
- **ACCURATE:** Galvanometer pointer swings free for maximum accuracy, being clamped briefly for marking.
- **INKLESS:** Recording process is completely dry, utilizing special pressure sensitive paper. Method provides remarkable definition.
- **RECTILINEAR:** Advanced design provides true rectilinear recording free from distortion.
- **RELIABLE:** Positive synchronous motor drive with sprocket engaging holes in paper for accurate time indication.
- **VERSATILE:** Portable or panel mounting models. Stocked in a variety of scales and chart speeds.

WRITE TODAY FOR LITERATURE

rust industrial co., inc.

130 Silver Street, Manchester, N. H.

CIRCLE 85 READERS SERVICE CARD

*Subject to change without notice.

*Your Inquiries
 to Advertisers
 Will Have
 Special Value . . .*

—for you— the advertiser—and the publisher, if you mention this publication. Advertisers value highly this evidence of the publication you read. Satisfied advertisers enable the publisher to secure more advertisers and—more advertisers mean more information on more products or better service—more value—to YOU.

FOREMOST
 in
ASW
SYSTEMS

EDO CORPORATION
 College Point, L.I., N.Y.
 Since 1925

CIRCLE 83 READERS SERVICE CARD

ELECTRONICS—April 10, 1959

marion
 advancement
 in instrument
 design



MM-1 MEDALIST* meter

Today's most readable, modern miniature meter. Shielded—no error from magnetic panels. Rugged Marion-Coaxial mechanism. Max. weight 1.6 oz. In all standard ranges, various colors. Single hole mounting. Data on request. Marion Instrument Division, Minneapolis-Honeywell Regulator Co., Manchester, New Hampshire, U.S.A.
 *T.M. Reg. U.S. Pat. Off. U.S. & Foreign Patents
 Copyright © 1959, Marion

marion
 "WHERE ELECTRONICS MEETS THE EYE"
meters



CIRCLE 86 READERS SERVICE CARD

materials including mylar and special epoxies for insulation purposes. Circle 228 on Reader Service Card.

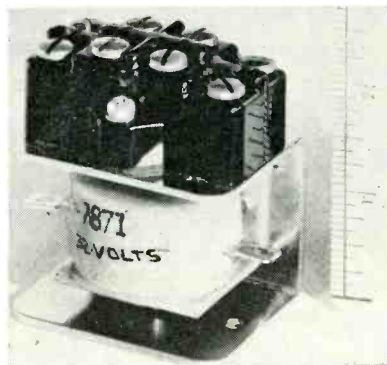

**Power Relay
 heavy duty**

ACRO DIVISION, Robertshaw-Fulton Controls Co., Columbus 16, Ohio. Outstanding feature of a new power relay is its ability to carry an extremely heavy load. The switch has UL approval for a rating of 20 amperes, 2 h-p at 230 v a-c. Largest dimension of the relay is less than 3 in.; length is 2 1/16 in., and width about 1 1/2 in. Circle 229 on Reader Service Card.

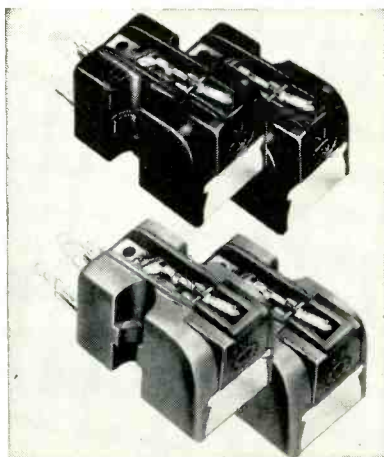

**Stereo Cartridge
 four versions**

CBS-HYTRON, Danvers, Mass., announces the Columbia constant displacement stereo cartridge in four versions. The basic twin-ceramic cartridge can be purchased with either a diamond or sapphire stylus and in either the in-phase or out-of-phase connection. In-phase cartridges provide conventional phasing of the output signals for each channel. This permits use of the

140 **KMC**

ULTRAMICROWAVE*

$E=mc^2$

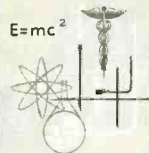

EQUIPMENT

BY

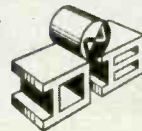

—it works

—it's accurate

—it's available

Complete data on request



DE MORNAY—BONARDI

780 SOUTH ARROYO PARKWAY • PASADENA, CALIF.

*TRADE MARK De Mornay-Bonardi for its millimeter wave equipment

CIRCLE 169 READERS SERVICE CARD

send for this

FREE

**EICO
 Electronics
 Catalog**



you save 50% on Top-Quality
 Test Instruments
 Hi-Fi • Ham Gear

KITS AND WIRED

for professional and home use

TEST INSTRUMENTS
 battery eliminators
 battery testers
 bridges
 decade boxes
 electronic switch
 flyback tester
 oscilloscopes
 probes
 signal and sweep generators
 tube testers
 transistor tester
 vacuum tube voltmeters
 volt-ohm-milliammeters

HI-FI
 stereo and monaural tuners
 preamplifiers
 power amplifiers
 integrated amplifiers
 speaker systems

HAM GEAR
 cw transmitter
 modulator-driver
 grid dip meter

OVER 1 1/2 MILLION EICO instruments in use throughout the world.

LIFETIME service and calibration guarantee. IN STOCK at your neighborhood EICO dealer. Send now for FREE catalog E-4



33-00 N. Blvd., L. I. C. 1, N. Y.

...praised by the experts as BEST BUYS IN ELECTRONICS

© 1958 ELECTRONIC INSTR. CO., INC.

CIRCLE 87 READERS SERVICE CARD

- NOW AVAILABLE
- OFF-THE-SHELF DELIVERY
- FACTORY PRICES



**WINCHESTER
 ELECTRONICS
 INCORPORATED**

- CONNECTORS
- TERMINALS
- ACCESSORIES

AUTHORIZED DISTRIBUTOR

**GREENE SHAW
 COMPANY, INC.**

341 WATERTOWN ST., NEWTON 58, MASS.

DEcatur 2-9300 — DEcatur 2-6500

CIRCLE 88 READERS SERVICE CARD

April 10, 1959 — ELECTRONICS

RONDO® "the pack with the built-in shock absorber"

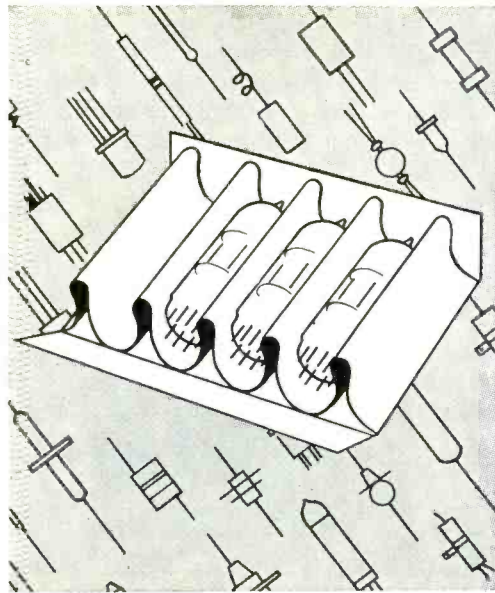

This Unique System

Holds Small Delicate Components by the spring-clip action of its fluted partitions and Offers:

PROTECTION in Handling and Shipping

FACILITY in Production, Storage, and Inventory

CONVENIENCE at Receivers End

ECONOMY in All Phases

RONDO IS A PAPER PRODUCT SOLD AT PAPER PRICES!

ANTI-TARNISH BOARD SUPPLIED

Holds objects from 5/16" to 1/4" in diameter. Further information on request.

Rondo Process and Designs Patented in All Major Countries



RECOGNIZED ALL OVER THE WORLD

RONDO of AMERICA, inc. 100 A SANFORD ST., HAMDEN 14, CONN.

Representatives: C. S. Shotwell, 527 S. Alexandria Ave., Los Angeles 5, Cal., Phone: DUNKIRK 8-8879
Brown & Scratch, 664 N. Michigan Ave., Chicago 11, Ill., Phone: SUPERIOR 7-2973

CIRCLE 89 READERS SERVICE CARD

COMPUTER ENGINEERS

Positions are open for computer engineers capable of making significant contributions to advanced computer technology. These positions are in our new Research Center at Newport Beach, California, overlooking the harbor and the Pacific Ocean—an ideal place to live. These are career opportunities for qualified engineers in an intellectual environment as stimulating as the physical surroundings are ideal. Qualified applicants are invited to send resumés, or inquiries, to Mr. L. R. Stapel, Aeronutronic Systems, Inc., Box NK-486, Newport Beach, California.

Positions Open:	:	Areas of Interest:
Systems Engineers	:	Computers &
Logical Designers	:	Data Processors
Magnetic Memory Engineers	:	Storage Units
Communications Engineers	:	Display Devices
Digital Computer Programmers	:	Computer Components
Circuit Engineers	:	Solid State Devices
Mechanical Engineers	:	Memory Systems
Optical Engineers	:	Flight Data Entry
	:	Digital Circuit Design
	:	Advanced High Speed Computer Systems

COMPUTER DIVISION
AERONUTRONIC

a subsidiary of FORD MOTOR COMPANY

NEWPORT BEACH • GLENDALE • SANTA ANA • MAYWOOD, CALIF.

NOW DENTAL QUALITY INSTRUMENTS Imported from GERMANY

WE ARE FEATURING HERE SOME OF THE QUALITY DENTAL TOOLS THAT ARE BEING USED BY LEADING ELECTRONIC AND OTHER INDUSTRIAL MANUFACTURERS. CUSTOM-MADE IN GERMANY TO OUR SPECIFICATIONS, THEY ARE THE FINEST AVAILABLE AT ANY PRICE.

PRECISION TWEEZERS

Ideal for research and production work. Fine, serrated points for sure grip of small items.

\$.95 each

12 for \$9.00

HAEMOSTATIC FORCEPS

Slender serrated beaks lock and hold any small item in position.

\$3.50 each

12 for \$39.00

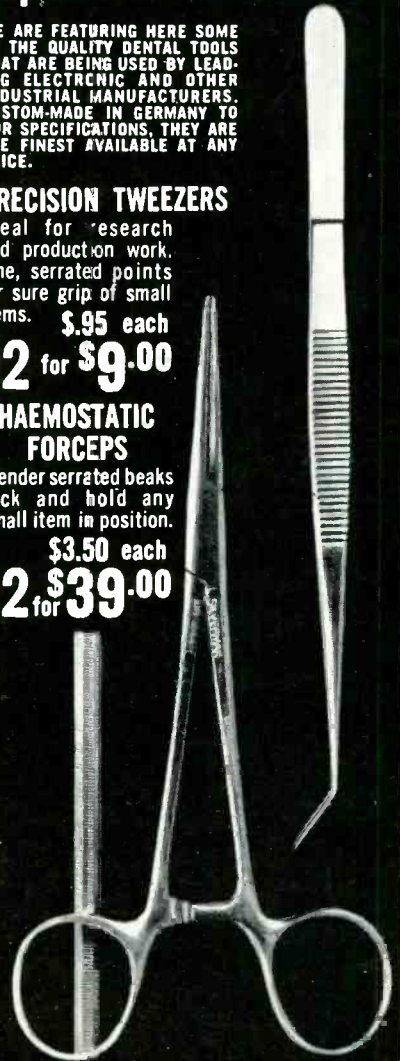

MIRROR HANDLES

6 for \$4.00

5/8"
3/4"
7/8"
15/16"
1"

MIRRORS

Available in plain or magnifying. Please specify size and type.

1 doz. for \$3.25

3 doz. \$8.95 for

SILVERMAN'S

THE DENTAL MAIL-ORDER HOUSE OF AMERICA SINCE 1896

1033 CHESTNUT ST., PHILA. 7, PA.

WRITE FOR COMPLETE CATALOG

CIRCLE 91 READERS SERVICE CARD

PLANT LOCATION QUIZ



Q Why did Ware Laboratories locate a plant in WESTern PENNSylvania?

A (1) *100% Financing at Low Interest*—3-acre site purchased, plant constructed by Connellsville Industrial Enterprises at less than \$5 a sq. ft. (2) *Skilled Labor*—Ware found an ample supply of skilled metalworkers to staff their new plant. (3) *Room to Grow*—Ample space for future expansion, and parking is never a problem. (4) *Accessibility*—Connellsville is close to transportation facilities, including the Pennsylvania Turnpike and major highways; near raw materials and markets—vital factors in establishing Ware's new plant for production of aluminum windows, doors, window walls.

WRITE TODAY

44 WESTern PENNSylvania communities are organized to do as much for you. For further information on these localities and the combination of advantages they offer, return the coupon below.

WEST PENN POWER
an operating unit of the WEST PENN ELECTRIC SYSTEM



WEST PENN POWER, Area Development Department
Cabin Hill, Greensburg, Pennsylvania

E-9

Yes, I'm interested in WESTern PENNSylvania:

- Please contact me in strict confidence. Phone _____
 Please send booklet, "Plant Location Services."

Name _____ Title _____
 Company _____ Street _____
 City _____ Zone _____ State _____

cartridge with either stereo or monaural records in any dual-amplifier or conventional stereo amplifier system—or it can be used in monaural systems by connecting the cartridge outputs in parallel. Circle 230 on Reader Service Card.

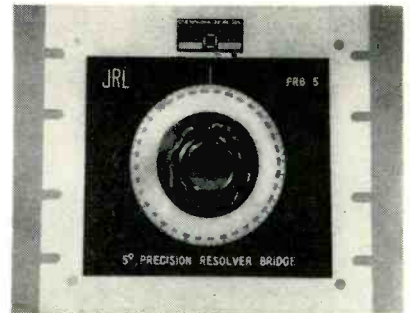

Resolver Bridge precision unit

JULIE RESEARCH LABORATORIES, INC., 556 W. 168th St., New York 32, N. Y., has available models PSB-5 and PRB ultraprecision bridges which permit checking synchros or resolvers to an accuracy of 0.002 percent every 5 deg of angular position. These precision standards feature symmetric construction and maintain rated accuracy over 0-4,000 cps, and have been used successfully at somewhat reduced accuracies up to 10 kc. Circle 231 on Reader Service Card.

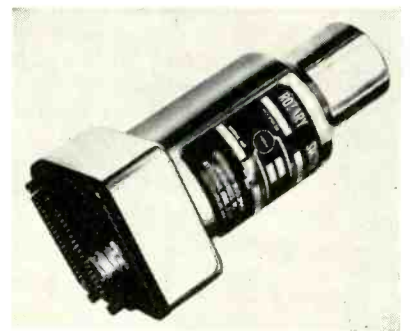

Rotary Switch for pam systems

INSTRUMENT DEVELOPMENT LABORATORIES, INC., 67 Mechanic St., Attleboro, Mass. A new 3 pole 28 v d-c ungoverned motor-driven telemetering commutator for use in pulse amplitude modulation systems with either airborne or ground gating has been developed. Each of the three poles contains a flexible mas-

an Epsco transistorized

TRANSICON DATRAC[®] ANALOG-DIGITAL CONVERTER

can solve your data
conversion problem . . .
economically!



designed FOR YOUR SYSTEM by system specialists who have pioneered the field of high-speed, reversible analog-to-digital conversion . . .

- **PRODUCTION ENGINEERED** to be the lowest-cost transistorized converters available anywhere.
 - **MODULARIZED**—plug-in building-blocks permit assembly of over 50 standard models.
 - **EASY TO USE**—no adjustments
 - **HIGH SPEED**—up to 25,000 conversions/sec analog-to-digital; up to 100,000 conversions/sec digital-to-analog
 - **HIGH POWER DIGITAL OUTPUTS**
 - **DIGITIZES BOTH CURRENTS AND VOLTAGES**
 - **PARALLEL AND SERIAL CODED OUTPUTS**
 - **BUILT-IN EXPANDABILITY**—8-bit converters to 10, 12 or 14 bits; changing codes from binary to binary-coded decimal; making an analog-to-digital converter from a digital-to-analog unit
- . . . and an Epsco Exclusive: **PROVEN RELIABILITY** One million hours of operation in hundreds of installations around the world have proven DATRAC reliability. Now an all solid state TRANSICON DATRAC assures even greater performance.

New 6-page, 2-color brochure available with complete description of TRANSICON DATRACS. Write, wire or phone your local Epsco representative or contact, in the East: Epsco, Inc., Equipment Division, 588 Commonwealth Avenue, Boston 15, Massachusetts; in the West: Epsco-West, 125 E. Orangethorpe Ave., Anaheim, California.

TRANSICON ANALOG-TO-DIGITAL CONVERTERS FOR . . .

Data Logging Systems
Telemetry Data Reduction
Digital Transmission over Telephone Lines
Analog Digital Computer Linkages
Wind Tunnel Instrumentation

TRANSICON DIGITAL-TO-ANALOG CONVERTERS FOR . . .

Driving Analog Plotters from Digital Sources
Analog Displays on Meters and Oscilloscopes from Digital Codes
Analog Computer Inputs
Radar Display Drivers
Fire Control Simulators

TRANSICON ALARM LIMIT MONITORS FOR . . .

Automatic Checkout Systems
High-speed Fault Analyzers
Power Plant Monitors
Industrial Process Controllers

Epsco
First in data control

when every second counts...

... count on **THERMAL** time delay **RELAYS**

by **DIALCO**



Hermetically Sealed

Rugged—built to meet conditions of **high altitude** **high vibration** **high temperature**

DIALCO RELAYS exhibit no resonance from 5 to 1,000 CPS at 10 G's; are not damaged by 50 G's shock; are fully compensated for temperatures from -65° C to +125° C.

Available in delays from 1 to 300 seconds; heater voltages up to 150 V. interchangeable on DC or AC of any frequency with a power drain of 4 watts. SPST normally open or normally closed contacts are rated at 6 amps at 115 V. AC or 3 amps at 28 V. DC resistive.

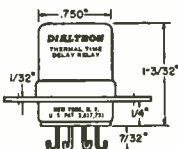

SUB-MINIATURE

Lightweight (3/4 oz.)
Standard 7-pin plug-in or solder terminals with mounting flange

Dialtron Corp., 203 Harrison Pl., Brooklyn 37, N. Y.

Send data on Thermal Time Delay Relays to:

Name _____

Position _____

Company _____

Address _____

DIALTRON

CORP.

203 Harrison Pl., Brooklyn 37, N. Y.

HYacinth 7-7600

CIRCLE 94 READERS SERVICE CARD

ter pulse which can be externally interconnected to provide either a pulse of 2 live segments and 3 dead segments or 3 live segments and 4 dead segments. Circle 232 on Reader Service Card.

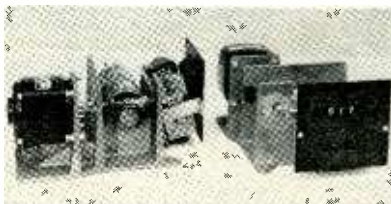

Servo Assembly aluminum casting

DATRON ELECTRONICS, 1836 Rosecrans Ave., Manhattan Beach, Calif., offers a new servo assembly for use by designers of automatic null balance systems. It includes a Holtzer-Cabot 4 pole 60 cycle servo motor, drive coupling, shaft, bearings and gear drive assembly, digital counters with automatic shutter action to indicate plus or minus digital output, and one or more balance or output potentiometers. Circle 233 on Reader Service Card.

Rack Cabinet easily modified

FALSTROM CO., 44 Falstrom Court, Passaic, N. J. The standardized FT-192 rack cabinet is designed for a wide variety of uses with or without accessories. It is designed and engineered to permit easy modifications at little additional cost. Unit is of formed construction, and designed to make possible the use of heavier loads and afford stable anchoring points for components and chassis. Circle 234 on Reader Service Card.

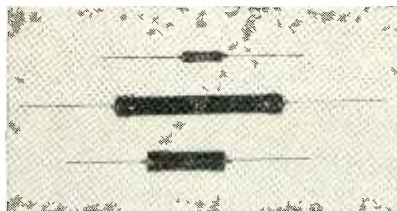

Carbon Film Resistor long load life

ELECTRA MFG. CO., 4051 Broadway, Kansas City, Mo. The Criterion carbon film resistor is claimed to have

★★★★★

IN EVERY FIELD, THERE IS ONE FOREMOST NAME... IN SONIC ENERGY, THAT NAME IS BENDIX

WHAT'S ALL THIS TALK ABOUT SONIC ENERGY CLEANING?

Sonic Energy Cleaning is a *practical production tool* that will reduce rejects on many parts and products, lower cleaning costs and improve product performance.

So there's plenty of good reason for all the talk about Bendix Sonic Energy Cleaning.

Bendix® pioneered and has led in development of Sonic Energy Cleaning for industrial applications and so has more Sonic Energy experience. Our Sonic Energy Applications Laboratory has no equal in its ability to provide the most efficient answer for cleaning applications that can use Sonic Energy to advantage. And our line of Sonic Energy Cleaning systems is most complete.

It makes real sense for any manufacturer to utilize the *Bendix* way of investigating his application and verifying any equipment requirements.

NEW, UP-TO-THE-MINUTE REPORT ON SONIC ENERGY CLEANING

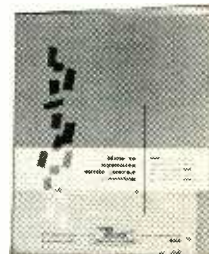

Explains in detail the principles and workings of this process. Illustrates, describes and analyzes typical results. Outlines five-step plan to help you determine feasibility of Sonic Energy Cleaning for you. To get your copy, write: PIONEER-CENTRAL DIVISION, BENDIX AVIATION CORPORATION, 2713 HICKORY GROVE ROAD, DAVENPORT, IOWA.



SONIC ENERGY CLEANING

CIRCLE 95 READERS SERVICE CARD

April 10, 1959 — ELECTRONICS

How To Get Things Done Better And Faster

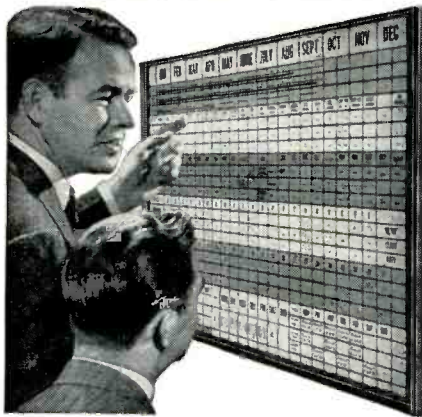

BOARDMASTER VISUAL CONTROL

- ☆ Gives Graphic Picture—Saves Time, Saves Money, Prevents Errors
- ☆ Simple to operate — Type or Write on Cards, Snap in Grooves
- ☆ Ideal for Production, Traffic, Inventory, Scheduling, Sales, Etc.
- ☆ Made of Metal Compact and Attractive. Over 350,000 in Use

Full price **\$49.50** with cards

FREE

24-PAGE BOOKLET NO. C-30
Without Obligation

Write for Your Copy Today
GRAPHIC SYSTEMS

55 West 42nd Street • New York 36, N. Y.
CIRCLE 96 READERS SERVICE CARD

PRECISION POWER OSCILLATORS



PRICE
\$119.00

MODEL 1040

SPECIFICATIONS

Frequencies.....400 or 1000 C.P.S. by selector switch
(other frequencies on request)
Distortion.....Less than 1 %
Hum Level..... Approximately .05 % of rated output
Output Power... 3 watts into matched resistive load
Power Supply... 115 volts, 60 C.P.S., 40 watts
Dimensions..... 5-11/16 x 9 x 6 1/8 inches

OTHER MODELS AVAILABLE

MODEL	DESCRIPTION	POWER OUTPUT
1040A	Sim. to Mod. 1040	8 watts

EXCELLENT ACCURACY AND STABILITY • TRANSFORMER ISOLATED OUTPUT • 3 OUTPUT IMPEDANCES • LOW INTERNAL IMPEDANCE • OUTPUT VARIABLE UP TO 120 VOLTS

MODEL 1500

SPECIFICATIONS

FREQUENCY.....400 CPS (Other freq avail.)
Distortion.....Less than 1/2 %
Hum Level.....Approximately .02 %
Output Power...20 watts
Power Supply...115 volts, 60 CP.S.
Dimension.....8 3/4" x 19" x 8" deep

OTHER MODELS AVAILABLE

MODEL	DESCRIPTION	POWER OUTPUT
150	Write for brochure	160 V.A.



PRICE
\$299.00

Representatives in Principal Cities



INDUSTRIAL TEST EQUIPMENT CO.
55 EAST 11th STREET • NEW YORK 3, N. Y.

CIRCLE 99 READERS SERVICE CARD

Artisan

ELECTRONIC

ORGAN
for your
HOME!

**BUILD-IT
YOURSELF
SAVE!**

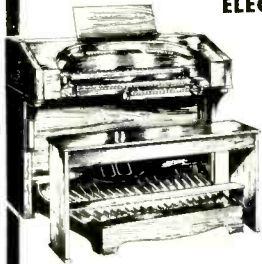

Now you can own a professional electronic organ and save up to 50% on an easy pay-as-you-build plan . . . The world famous ARTISAN ORGAN—in 14 models from the popular 2-manual Home entertainment style to the majestic 4-manual Theatre and Church style is now available in kit form. Simple step-by-step instructions, pictorial diagrams and schematics make this an ideal spare-time project for anyone.



SEND FOR THIS
FREE LITERATURE
TODAY!

Get ALL the facts on the magnificent 20th Century Successor To The Pipe Organ—The ARTISAN! Gives you information you should know before you purchase ANY organ—kit or commercial model.

**ELECTRONIC
ORGAN ARTS, INC.**

4878 Eagle Rock Blvd., Dept. E-4
Los Angeles 41, California

CIRCLE 97 READERS SERVICE CARD

RIBBONS • STRIPS

— of —

- ★ PURE TUNGSTEN
- ★ THORIATED TUNGSTEN
- ★ MOLYBDENUM
- ★ SPECIAL ALLOYS

and OTHER METALS

IN

ULTRA THIN SIZES

to

TOLERANCES CLOSER THAN COMMERCIAL STANDARDS

by

OUR SPECIAL ROLLING TECHNIQUE

Note: for highly engineered applications—strips of TUNGSTEN and some other metals can be supplied

ROLLED DOWN TO .0003 THICKNESS

- Finish: Roll Finish—Black or Cleaned
- Ribbons may be supplied in Mg. weights if required

For HIGHLY ENGINEERED APPLICATIONS

DEVELOPED AND MANUFACTURED BY

H. CROSS CO.

15 BEEKMAN ST., N. Y. 38, N. Y.
TELEPHONE WOrth 2-2044
COrtlandt 7-0470

CIRCLE 98 READERS SERVICE CARD

FIRST 920 Channel Single Conversion

VHF Mobile Receiver Uses

HYCON EASTERN CRYSTAL FILTER

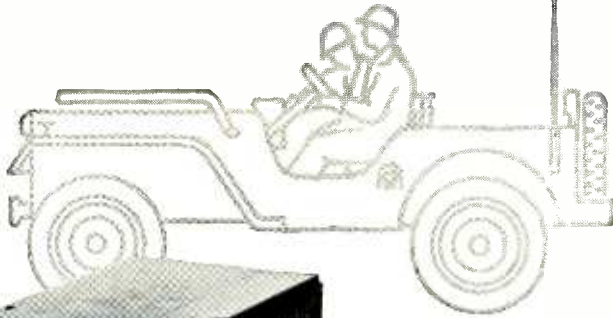

VHF, 920 Channels, fully transistorized Radio Receiver by Avco Mfg. Corp., Crosley Division

Hycon Eastern 11.5 Mc Crystal Filters Measure 2" x 1 1/2" x 3/4"



Bandwidth at 6 db attenuation: 33 Kc
Bandwidth at 60 db attenuation: 60 Kc
Insertion Loss: 4 db
Ultimate attenuation: 80 db

Mobile communications for today's fast moving military operations require equipment which is rugged, compact, highly accurate and dependable. Filling this need is the Avco-Crosley, fully transistorized, 920 channel, mobile VHF-FM Radio Receiver incorporating a Hycon Eastern 11.5 Mc Crystal Filter and matching Discriminator.

The use of only one frequency conversion provides excellent image rejection in combination with high adjacent channel selectivity. By eliminating multiple conversions, cross modulation and receiver desensitization are reduced even in the presence of strong interference from any of the other 920 channels.

High Frequency Crystal Filters for mobile applications offer the advantages of small size, freedom from microphonic behavior, and ability to maintain their characteristics throughout the entire temperature range of -60°C to $+90^{\circ}\text{C}$. Hermetically sealed, no realignment or readjustment is ever required.

There are Hycon Eastern Crystal Filters designed to solve selectivity problems in AM or FM receivers and SSB transmitters, whether fixed or mobile. Hycon Eastern engineers can assist you in choosing filter characteristics best suited to your needs. Write for Crystal Filter Bulletin.

far greater resistance to heat and moisture than a composition resistor. It is also available in much closer tolerances, has a longer load life and far better temperature coefficient. It was specifically designed for use in computers, commercial instruments and similar applications. Circle 235 on Reader Service Card.

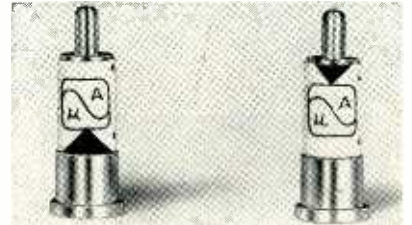

Silicon Diode as high as 60 kmc

MICROWAVE ASSOCIATES, INC., Burlington, Mass. The Varactor is a diffused silicon p-n junction diode designed to be a variable capacitance with low loss at high frequencies. Unit complies with MIL-E-1 outline 7-1 for cartridge type crystal rectifiers and will fit most standard crystal holders. In the standard MA-460 series, the pin end of the diode is connected to P-type material on the top of a small "mesa" and the N side of the silicon element is connected to the base. The reversed polarity unit denoted by the suffix R is also available. Circle 236 on Reader Service Card.



Power Inverter transistorized

ARNOLD MAGNETICS CORP., 4613 W. Jefferson Blvd., Los Angeles 16, Calif. A new transistorized power inverter supplies a-c sine-wave power from a battery line source. Unit is especially designed to insure maximum performance from a-c gyros and motors. No excess heat is created because the output wave-shape, being sinusoidal, avoids the



HYCON EASTERN, INC.

75 Cambridge Parkway

Dept. A

Cambridge 42, Mass.

HOW ABOUT YOU?

Do you know that many cancers can be cured if detected early? That an annual health checkup is your best protection against cancer?

Are you giving yourself this big advantage? Or are you taking chances with your life because of foolish attitudes about cancer like these?



DON'T EVEN MENTION THAT WORD!

Fear keeps some people from even *learning* cancer facts that can save their lives.

NEVER FELT BETTER!



Checkups help to detect cancer in its "silent" stage before you notice any symptom.



COSTS TOO MUCH!

Dollars you spend for the protection of your health can mean years of life.

Millions of Americans have made an annual checkup a habit... *for life*. How about you?

AMERICAN CANCER SOCIETY



If YOU are concerned with the designing and buying of DRAWN SHELLS, FORMED METAL PARTS and EYELETS, FERRULES, METAL STAMPINGS and ASSEMBLIES

CLY-DEL

can help you!



WRITE FOR your free copy of new, helpful, informative Cly-Del brochure

ENGINEERING Use the Cly-Del Engineers for development help.

TOOL ROOM Use the Cly-Del Tool Room for advantages of time, accuracy, economy.

MANUFACTURING Use Cly-Del to keep your profitable production UP!

INSPECTION Use Cly-Del for guaranteed quality ... on time.

CONSULTATION WITHOUT OBLIGATION We will appreciate the opportunity to advise you and estimate your present and future requirements.

CLY-DEL MANUFACTURING CO.

46 SHARON ROAD

WATERBURY

CONNECTICUT

CIRCLE 152 READERS SERVICE CARD

**FILTERS
DELAY LINES
TOROIDS
MAG-AMPS
RF COILS**

**FUGLE-MILLER
LABORATORIES • INC**

CLARK
NEW JERSEY



Tel. FULTON
1-2727



Bendix-Pacific
needs
**CIRCUIT
DESIGN
ENGINEERS**

**TELEMETERING... SONAR...
MISSILE GUIDANCE... AIRBORNE RADAR**

If you have had two or more years experience in Circuit Design in Telemetering, Sonar, Missile Guidance or Airborne Radar . . . and are interested in moving to a permanent, well paying position in Southern California—

Please write W. C. Walker your qualifications or fill in the coupon and mail today.

**W. C. Walker, Engineering Employment Manager
Bendix-Pacific, Bendix Aviation Corporation
11600 Sherman Way, North Hollywood, Calif.**

I am interested in _____ Engineering.
I am a graduate engineer with _____
degree and _____ years experience.

Name _____

Address _____

City _____ Zone _____ State _____

heat-producing harmonic currents which are characteristic of square-wave operation. There is no loss of efficiency due to sine-wave operation because the transistors are operated as saturated switching elements. Circle 237 on Reader Service Card.



**Servo Motor
size 8 unit**

INDUCTION MOTORS CORP., 570 Main St., Westbury, N. Y., announces a new size 8 servo motor designed for transistorized applications in aircraft and missiles. The BT705-1 features a high torque to inertia ratio over an unusually short length. The control phase is designed with a high-impedance center-tapped winding for transistor use. Circle 238 on Reader Service Card.

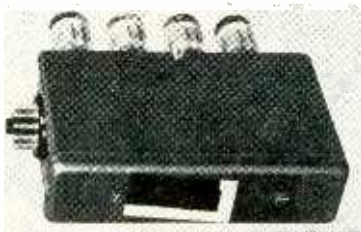

**Counting Unit
in-line display**

BECKMAN INSTRUMENTS, INC., 2200 Wright Ave., Richmond 3, Calif. A new type of decimal counting unit features a single-digit display, 1 1/2 in. high, packaged as an integral part of the plug-in counting module. A large in-line display can be created simply by mounting several units side-by-side. Digits are formed by selectively illuminating from 5 to 11 character segments. All digits lie in the same surface plane so that the display can be read throughout a 150 deg viewing angle. Maximum counting rates of 100 kc and 1 mc are available. Circle 239 on Reader Service Card.

**how to
CUT
COSTS
on small
components**

If the cost of metal stampings and wire forms figures in your profit picture, let us give you a quotation on your current components. Send us a sample or blueprint . . . and discover how big savings in time and production costs, big gains in precision and uniformity are possible on small components, when Art Wire tackles the job!

Our engineering staff, our production experience, and our modern high speed equipment are always at your disposal. If you wish to learn more about what a wide and versatile range of shapes and parts we can produce for you—at lower cost than you'd guess—just write for our illustrated folder.

**ART WIRE
AND STAMPING CO.**

18 Boyden Place, Newark 2, N. J.
CIRCLE 155 READERS SERVICE CARD

April 10, 1959 — ELECTRONICS

AMCITYPE **1108B**

NEW INSTRUMENT LOAD

for TYPE N

Provides excellent stability...
plus low reflection

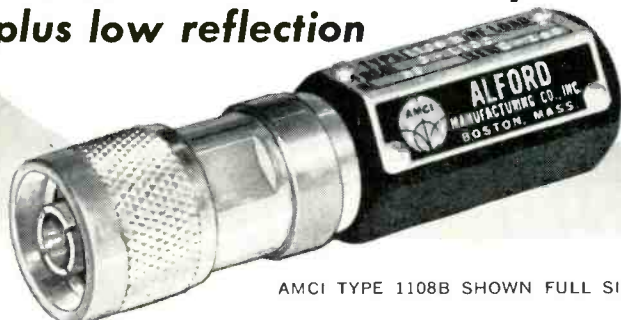

AMCI TYPE 1108B SHOWN FULL SIZE

- A nearly reflectionless termination for 50-ohm coaxial transmission lines over the frequency range of 0 to 1100mc.
- Suitable as a secondary standard.
- VSWR under 1.02.
- Rated maximum input power: 0.5 watt.
- Designed around a metal-film-on-glass type of resistor.
- Other connector types available on request.

Write for
complete information
on AMCI
Instrument Loads



CIRCLE 156 READERS SERVICE CARD

SOMETHING NEW IN SLOTTED SECTIONS



Actually, this is a new kind of Standing Wave Detector, which completely makes obsolete the 8-foot monsters for impedance and VSWR measurements from 100 to 1000 mc/s.

The PRD Type 219 is only 8 inches long and weighs a "pocketable" four and one-half pounds.

As if these facts were not startling enough, the 219 also features:

- Direct reading of VSWR
- Direct reading of angle of reflection coefficient
- Direct reading of reactive component sign
- Matched load for self-calibration supplied
- Adaptability to most coaxial lines, including the LT and new TNC series
- Low cost
- Rugged construction

Listed below are a few of the important specifications.

Frequency Range:	100 to 1000 mc/s
Residual VSWR:	Less than 1.03
Minimum Input Signal:	Approx. 1V at 100 mc/s; 0.1V at 1000 mc/s for measuring a matched load
Characteristic Impedance:	50 ohms
Detector:	Crystal included
RF Input Connector:	BNC jack
RF Output Connector:	Type N jack supplied. Connector types available include types C, BNC, LT, TNC, 7/8" coax.
Audio Output Connector:	BNC jack
Dimensions:	8" L x 5" W x 5 3/4" H
Weight:	4 1/2 pounds

f.o.b. Brooklyn, New York

Note to owners of the new PRD Catalog, E-8: Don't bother reading this ad. All these details and more can be found on page B-13. If you are unfortunate enough not to own a copy of this designers' workbook, send your request on your company letter-head please.

If all you want are specifications on the 219, fill out the inquiry card in this magazine.



POLYTECHNIC RESEARCH & DEVELOPMENT CO., INC.

Factory & General Office:
202 Tillary St., Brooklyn 1, N. Y.
ULster 2-6800

Western Sales Office:
2639 So. La Cienega Blvd., Los Angeles 34, Calif.
Texas 0-1940

CIRCLE 158 READERS SERVICE CARD

RUGGED and RELIABLE

New!

TRANSISTORIZED

The
A. W. HAYDON COMPANY'S
TRANSISTORIZED SUB-MINIATURE
ELECTRONIC TIME DELAY RELAYS!

SAVE SPACE AND WEIGHT!

	Miniature Series	Sub-Miniature Series
Cross Section	1 7/16" x 1 2/32"	3 1/32" x 1 3/16"
Length	2 1/4" long	2" long
Weight	6 ounces	3 ounces
WRITE FOR:	Bulletin AWH TD-503	Bulletin AWH TD-504

TEST-PROVED PERFORMANCE!

High Temperature: 125°C (250°F)
Vibration: 2000 CPS at 15 g.
Contact arrangements up to 4 pole double throw.
Unique transistorized R.C. time constant network.
Time Delays from 50 MS to 120 seconds. Longer Delays available.
Hermetically sealed housings.

MEET
REQUIREMENTS
OF MIL-E-5272A.



The
A. W. HAYDON Company

235 NORTH ELM STREET, WATERBURY 20, CONNECTICUT
Design and Manufacture of Electro-Mechanical Timing Devices



CIRCLE 157 READERS SERVICE CARD

HIGH SPEED,

Sensitive Polarized **RELAYS**



"DIAMOND H"



SERIES P Relays

**FOR ELECTRONIC AND
COMMUNICATIONS APPLICATIONS**

Engineered to provide extremely fast action with high sensitivity, freedom from bounce and excellent stability, "Diamond H" Series P Polarized Relays give consistent performance with low distortion. Under some conditions they will handle over 1,000 pulses per second.

Magnetically latched SPDT, with two independent coils, Series P Relays are available with various coil resistances from 10 to 4,000 ohms each coil. Contact ratings will vary with switching speeds desired, but range from 60 milliamperes to 2 amperes.

Extremely compact, to save space and weight, they fit standard octal sockets. Their impact and vibration resistance is excellent for relays of this type, thanks to extra-rugged construction.

"Diamond H" engineers are prepared to work out a variation to meet your specific requirements. Write or phone us your needs.

**THE
HART MANUFACTURING
COMPANY**

**202 Bartholomew Ave., Hartford, Conn.
Phone Jackson 5-3491**

Literature of

MATERIALS

Mica Isolators. Magnetic Shield Division Perfection Mica Co., 1322 No. Elston Ave., Chicago 22, Ill. An 8-page data sheet K-5 covers mica isolators for transistor heat sink applications. Circle 250 on Reader Service Card.

Kovar Alloy. The Carborundum Co., Perth Amboy, N. J. Those concerned with making pressure and vacuum-tight seals with hard glasses will find useful the information contained in a recent booklet on Kovar alloy. Circle 251 on Reader Service Card.

COMPONENTS

Lacing Cords. Alpha Wire Corp., 200 Varick St., New York 14, N. Y. An illustrated 4-page brochure covers the 76 synthetic lacing cords and tapes carried in inventory. Circle 252 on Reader Service Card.

Tantalum Capacitors. Fansteel Metallurgical Corp., North Chicago, Ill. A 16-page technical booklet on what to expect from tantalum capacitors of the wet electrolytic type has just been released. Circle 253 on Reader Service Card.

Potentiometers. Waters Mfg., Inc., Wayland, Mass. Folder PF1258 covers the complete line of standard precision pots and includes many pots for special applications. Circle 254 on Reader Service Card.

EQUIPMENT

Galvanometer. Leeds & Northrup Co., 4934 Stenton Ave., Philadelphia 44, Pa. A two-page data sheet ED2(1) describes the type E guarded d-c galvanometer. Circle 255 on Reader Service Card.

Laboratory Test Instruments. Freed Transformer Co., Inc., 1724 Weirfield St., Brooklyn 27, N. Y., has available the No. 558 fully il-

the Week

Illustrated catalog of precision laboratory test instruments. Circle 256 on Reader Service Card.

Function Generator. Navigation Computer Corp., 1621 Snyder Ave., Philadelphia 45, Pa., is offering a new 12-page report describing a digital controlled function generator. Circle 257 on Reader Service Card.

D-C Voltmeter. Hewlett-Packard Co., 275 Page Mill Road, Palo Alto, Calif. Vol. 10, No. 5 of the *Journal* covers a new digital d-c voltmeter with automatic range and polarity selection. Circle 258 on Reader Service Card.

Trace Blanker. Photographic Instrumentation Development Co., 19458 Ventura Blvd., Tarzana, Calif. A well-illustrated bulletin describes the features and operation of a trace blanker which adds greater versatility to recording oscillographs. Circle 259 on Reader Service Card.

Magnetic Shift Registers. C K Components, Inc., 101 Morse St., Watertown, Mass. An 8-page brochure deals with the theory of magnetic shift registers and contains detailed information on the company's standard line of units. Circle 260 on Reader Service Card.

UHR Standard Bridge. Mid-eastern Electronics, Inc., 32 Commerce St., Springfield, N. J. A catalog sheet completely describes model 801 uhr standard bridge for precise measurement of resistance from 1,000 ohms to 110 million megohms. Circle 261 on Reader Service Card.

FACILITIES

Electrical Contacts. Contacts Inc., 1100 Silas Deane Highway, Wethersfield, Conn., has available a catalog describing its products and the services it has to offer in the selection of the most effective contact material for any specific application. Circle 262 on Reader Service Card.



BUILD ON . . .

EASTERN

CLIMATE CONTROL EXPERIENCE:

PRESSURIZATION and DEHYDRATION

Look to Eastern Industries for the advanced pressurization/dehydration packs required by the avionic and ground support systems of tomorrow. Whenever a precisely controlled flow of dehydrated air is required, Eastern design and production experience team up to create compact, lightweight, reliable subsystems. Characteristics and performance range of existing units:

Characteristics and performance range of existing units:

capacities: up to 1.5 FT³/Min. free air
operating temperatures: from -67°F to +150°F, 100% R.H.

operating altitudes: from 10,000 ft. to 50,000 ft.

weights: from 8 lbs. to 115 lbs. complete

Smaller packs feature replaceable chemical dehydrator elements—the larger subsystems are available with automatic reactivating dehydrators.

Let us quote on your next pressurization/dehydration requirement. In the meantime, write for full information on the entire line of Eastern aviation products. Send for Bulletin 360.

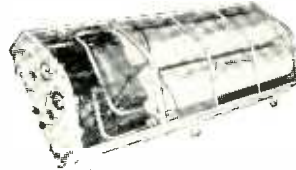

a wide range of units for specialized air control

**EASTERN
INDUSTRIES
INCORPORATED**
100 SKIFF STREET
HAMDEN 14, CONN.



NEW* WESTINGHOUSE PROXIMITY LIMIT SWITCH

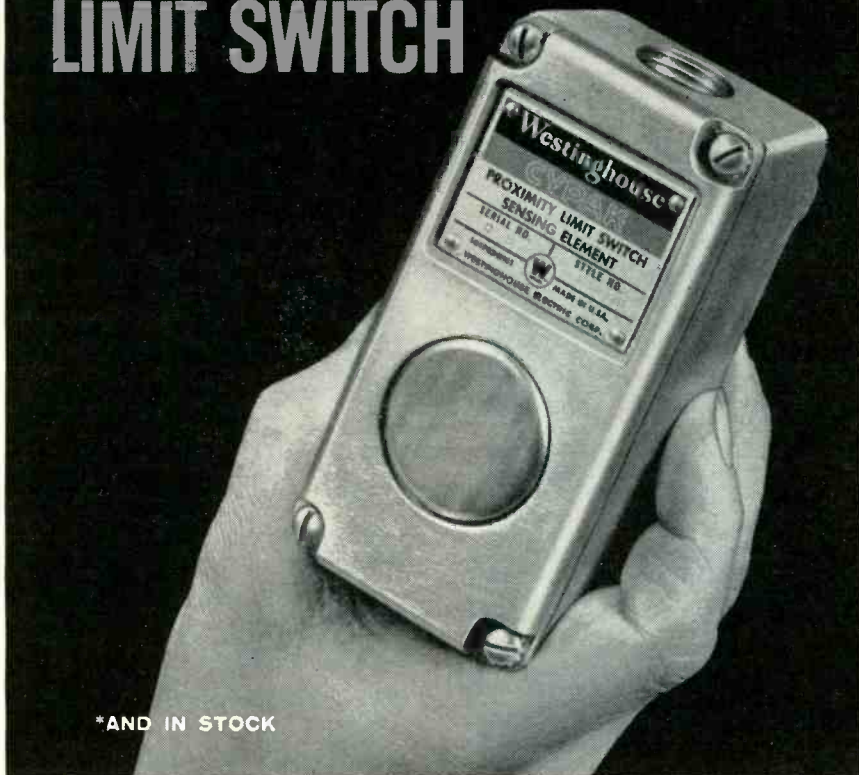

*AND IN STOCK

...WON'T WEAR OUT... NEVER NEEDS REPLACEMENT

No tubes . . . no moving parts to weaken and fail from wear . . . not affected by dust, dirt, oil mist or iron filings . . . will even operate under water . . . sensing heads available for distances of ½ inch and 2 inches . . . also for explosion-proof applications . . . corrosion and vibration resistant . . . won't spark, pit or wear, because there are no contacts.

Sure, they cost a little more initially. But we haven't seen the application yet where the new Westinghouse proximity limit switch can't pay for itself time and again through eliminated replacements and machine down time.

GET ALL THE FACTS about new Westinghouse proximity limit switches . . . see how and where they can benefit you. Write to Westinghouse Electric Corporation, Director Systems Department, 356 Collins Avenue, Pittsburgh 6, Pennsylvania. J-01011

YOU CAN BE SURE...IF IT'S **Westinghouse**

WATCH "WESTINGHOUSE LUCILLE BALL-DESI ARNAZ SHOWS" CBS TV MONDAYS

NEW BOOKS

Principles and Applications of Random Noise Theory

By JULIUS S. BENDAT

John Wiley & Sons, Inc., New York, 1958, 431 p, \$11.00.

UNTIL two years ago, the literature on Noise Theory was unfortunately confined to research papers published in the technical journals. There then appeared three texts: "Random Processes in Automatic Control" by Laning and Battin (McGraw-Hill 1956), "Principles of Noise" by Freeman (Wiley 1958) and "Random Signals and Noise" by Davenport and Root (McGraw-Hill 1958). With the addition of the book by Bendat to this list, the previous paucity of text material has now perhaps become a plethora. Bendat's book must be reviewed, accordingly, not in isolation, but vis-a-vis the aforementioned texts.

Comparative Merit—In general, Bendat's book suffers greatly by such a comparison. Where the material of this book overlaps directly that of its predecessors (and this is a nonnegligible fraction of the text), its exposition appears less lucid and its attention to important detail less meticulous.

There are many, many carelessly worded statements throughout the book (on p 5 one learns that every stationary process is nonstationary, to give but one example) that will surely serve as stumbling points for the neophyte. The treatment of numerous topics that are replete with subtleties is heuristic in nature; while this is not always in itself a fault in a book intended as an engineer's introduction to a sophisticated subject, one should give ample warning that all is not really as simple as it may seem.

The book can serve well for the novice wishing to get a quick physically motivated overall picture of what noise theory deals with. For the serious student planning to work in this field, however, the previously mentioned texts, though sometimes more difficult, have many advantages.—DAVID SLEPIAN, *University of California, Berkeley, Calif.*

THUMBNAIL REVIEWS

Insulation Engineering Fundamentals.

By G. L. Moses, R. Lee and R. Hillen, Lake Publishing Co., Lake Forest, Ill., 1958, 117 p., \$2.75 (paper). Based on a series of articles from *Insulation*, this book covers uses, importance, achievements, weaknesses and problems of insulation. In addition to the basic chapters, the chapters on special electronic insulation, high and power frequency electronic equipment insulation should be of particular interest.

Analog Simulation. By W. J. Karplus, McGraw-Hill Book Co., Inc., New York, 1958, 434 p., \$10.00. Devoted completely to solution of field problems by analog techniques, this book also presents the necessary mathematical tools.

Linear Programming. By R. O. Ferguson, McGraw-Hill Book Co., Inc., New York, 1958, 342 p., \$10.00. Intended for people at all levels of management, this book shows how to use linear programming for solving certain types of management problems.

Concise Guide to Plastics. By H. R. Simonds, Reinhold Pub. Corp., New York, 1957, 318 p., \$6.95. Basic practical data on strength properties, processes production and prices of almost all American commercial plastics are presented along with their selection, uses and forms. This guide should be of value to those who use plastics in any way in the electronics industry.

Introduction to the Design of Servomechanisms. By J. L. Bower and P. M. Schultheiss, John Wiley & Sons, Inc., New York, 1958, 510 p., \$13.00. This book intends to answer the question: "Given the basic components of a servo system and a set of performance specifications, what should be the form of the complete loop-gain function?" After an introduction to stability and single and multiple-loop feedback system design, consideration is given to such factors as harmonic response, time response, error coefficients and noise response.

Sampled Data Control Systems. By J. R. Ragazzini and G. F. Franklin, McGraw-Hill Book Co., New York, 1958, 331 p., \$9.50. Directed to practicing engineers and graduate students, this book presents a unified treatment of material found in papers, reports and recent research of the authors and their colleagues on the analysis and design of sampled-data feedback and control systems.



Where Do You Fit In...

Subscriber? / Pass-Along Reader? / Forget to Renew?

An engineer earns more money by knowing more—keeping pace with advances in his specialty—having knowledge at his fingertips ready to apply swiftly. In 1959 six issues of *ELECTRONICS* will be devoted to primary, important segments of electronic engineering, design and control. Each special issue an up-to-minute, definitive, comprehensive databook in one handy package—a reference text.

ELECTRONICS can't guarantee to supply back issues to start or re-start your subscription. To insure receiving these special issues your order must be received four weeks previous to publication date. We'll give full credit for the unexpired portion of your current subscription.

Be sure your subscription doesn't lapse. Fill out the card below and mail it to us.

*Partial listing of contents "Designing For Reliability" (May 29th Special Issue)

Part One—What is reliability?

I. Definition: The probability that a device will perform its objective adequately for the period of time intended under the operating conditions encountered.

A. Measures of Adequacy.
1. For consumer products.
2. For commercial and industrial products.
3. For military products.

B. Reliability Levels. 1. In components. 2. In circuits. 3. In systems.

II. Means of Measuring.
A. Classical Statistical Measures.
B. Life Testing.

III. Effects of Environment and Service Conditions.
A. Environmental Data.
1. How environment af-

fects performance. 2. Measuring environment. 3. Accumulation and interpretation of environmental data.

B. Servicing and Maintenance Conditions.

Part Two—How to achieve reliable designs.

I. Organization.

A. Planning. 1. Attitude and philosophy. 2. Working group.

B. Inspection procedures.

II. System Design.

A. Safety Margins. B. Monitoring, Metering and Warning Gear. C. Calculating System Reliability. D. Simplification of Systems. E. Package Design as Reliability Insurance.

III. Circuit Design.

A. Component Selection.

BE SURE to receive your personal copy of these SPECIALS

1. Electronics in Space—April 24th Special Issue
- *2. Designing for Reliability—May 29th Special Issue
3. Transistorizing Electronic Equipment—July 31st Special Issue
4. Electronic Instruments for Design and Production—September 11th Special Issue
5. Modern Communications Methods—October 23rd Special Issue
6. Materials for Environmental Extremes—December 4th Special Issue

OK Renew my subscription for 3 more years
 OK Enter my new subscription

U. S. subscription rates 3 years \$12 1 year \$6
 Canadian rates \$10 for 1 year Foreign rates \$20 for 1 year

Check enclosed
 Bill me later

Name _____ Position _____

Product Manufactured or Service _____

Company _____

Street _____

City _____ Zone _____ State _____

Mail reply to—Circulation Manager, *ELECTRONICS*, 330 West 42nd Street, New York 36, N. Y.



Tamar Accelerates Research

ACQUISITION of a 10,000-sq ft facility in Santa Monica, Calif., for expanded microwave-electronics research projects was recently announced by Tamar Electronics, Inc.

A microwave-electronic R&D and manufacturing corporation, Tamar is engaged in both military and commercial projects specializing in electronic countermeasure systems and components. Its chief hardware items include airborne transmission-line systems (scimitar antennas, adapters, connectors, umbilicals), transistorized radio remote control units, and microwave test equipment.

Tamar recently announced a 1958 gross military sales figure of \$4½ million. Its most recent contract awards were received from the USAF, Boeing, Douglas, and Ramo-Wooldridge.

This latest addition to Tamar's existing facilities in West Los Angeles and Gardena, Calif., marks the firm's third such expansion-move in the past year.



Garbarino Joins Magnaflux

HAROLD L. GARBARINO recently joined Magnaflux Corp., Chicago, Ill., to fill the position of chief engineer-electronics. In this capacity he directs the department responsible for the development and improvement of eddy current nondestructive testing instruments,

precision magnetic field measuring instruments, and ultrasonic thickness measuring equipment.

For the past seven years Garbarino has been with Armour Research Foundation, where he was assistant manager of electrical engineering research. Prior to that time he was development engineer for the General Electric Co.

Elect Officers for New Firm

THE board of directors of Silicon Transistor Corp., Carle Place, N. Y., recently elected Harold Sandler chairman of the board and appointed the following permanent officers: Robert L. Ashley, president; H. Sandler, treasurer; Donald Des Jardin, vice-president and secretary; and Randolph Bronson, vice-president.

The company, a newcomer in the

industry, has begun production on silicon glass diodes and silicon power transistors. Firm's products will be aimed at the military electronics market.

IRC Appoints Chief Engineer

INTERNATIONAL RESISTANCE Co., Philadelphia, Pa., has appointed Larry McFarren to chief engineer of its Burlington, Iowa, plant.

Prior to joining IRC, McFarren was manager, resistor and dielectric assemblies engineering at General Electric Co., specialty electronic components department, Syracuse and Auburn, N. Y. He was previously associated with P. R. Mallory & Co., Inc., Indianapolis, Ind., as chief engineer, resistor division.



Servo Hires Statsinger

JOSEPH STATSINGER has joined Servo Corp. of America, New Hyde Park, L. I., N. Y., as director of engineering.

Prior to joining Servo, Statsinger was with the Arma Division of American Bosch Arma Corp. for 14 years. There, most recently, he served as assistant chief engineer in charge of missile guidance.

Elco Pacific Expands

NEW, larger quarters in West Los Angeles, Calif., were recently taken by Elco Pacific.

The move will provide the com-

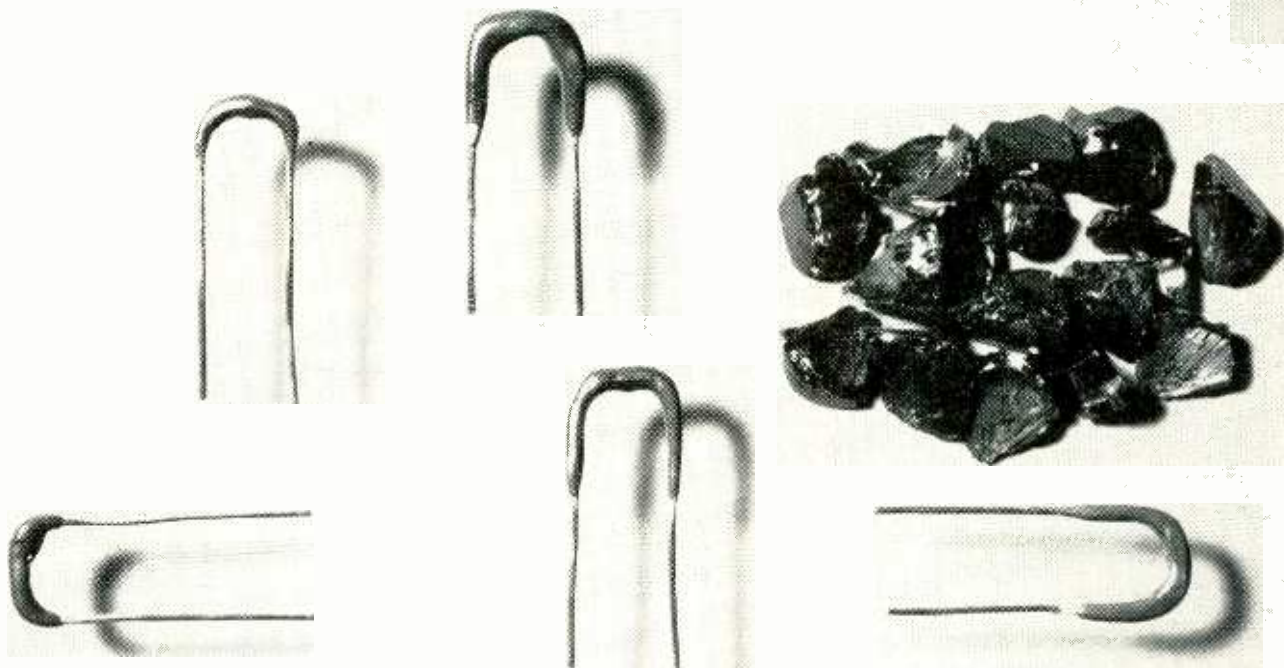

Now Available from **B&A**[®]
HIGH-PURITY LOW-MELTING GLASS
For Coating Electronic Devices

Here's good news for every producer of electronic devices. Low-melting glasses—a new research development reported before the Electrochemical Society by S. S. Flaschen and A. D. Pearson of Bell Telephone Laboratories* — may represent a major breakthrough in low cost and highly efficient protective coating of semiconductors, capacitors, diodes and other types of electronic devices.

These new, high-purity, low-melting glasses promise an ideal coating for protecting germanium and silicon transistors and diodes

from atmospheric oxidation, contamination and humidity. Coating may be accomplished by simply dipping the devices in a fluid bath of the glass, withdrawing and cooling; by vapor deposition; or through the use of a pre-form (compressed powder).

Research quantities now available from B&A!

We can now supply low-melting glasses to meet the needs of your development engineers. Write us today for further information or technical assistance.

Other B&A "Electronic Grade" Chemicals Available!

Baker & Adamson, the nation's foremost producer of laboratory and scientific chemicals, offers an extensive line of "Electronic Grade" chemicals—specially designed to meet the stringent quality requirements of the electronic industry. Other special high purity chemicals are also available or can be custom made to meet your needs. For more information, write for free folder, "Electronic Grade Chemicals."

*Abstract No. 116, Journal of The Electrochemical Society, August, 1958.

BAKER & ADAMSON[®]
 "Electronic Grade"
 Chemicals



GENERAL CHEMICAL DIVISION
 40 Rector Street, New York 6, N. Y.

RECORDERS WORK... WHILE YOU ARE BUSY ELSEWHERE

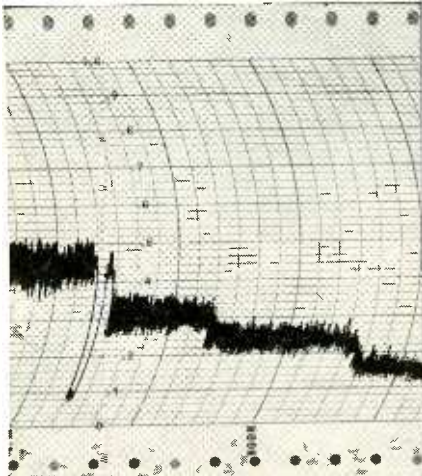

Courtesy Nuclear Measurements Corp., Indianapolis, Indiana

This record was made by a DC Milliammeter in a monitoring unit, measuring fall-out over Indianapolis after the explosion of an experimental bomb.

The recorder was on the job continuously for 1½ days before fall-out began to increase as shown here. Meanwhile the technicians and engineers were busy at other tasks.

Make recording instruments help you multiply your effectiveness. Ask for Catalog 657.

Product Representatives in Most Principal Cities

The ESTERLINE-ANGUS Company, Inc.

Pioneers in the Manufacture of Graphic Instruments

Dept. E, P. O. Box 596, INDIANAPOLIS 6, INDIANA

CIRCLE 164 READERS SERVICE CARD

This is not and is under no circumstances to be construed as an offer to sell, or as an offer to buy, or as a solicitation of an offer to buy, any of the securities herein mentioned. The offering is made only by the Prospectus.

New Issue

March 26, 1959

40,000 Shares General Transistor Corp.

Common Stock

Price \$66.50 per share

Copies of the Prospectus may be obtained in any state only from such dealers participating in this issue, including the undersigned, as may legally offer these Securities under the securities laws of such State.

Kidder, Peabody & Co.

Hayden, Stone & Co.

Carl M. Loeb, Rhoades & Co.

Paine, Webber, Jackson & Curtis

Shields & Company

Francis I. duPont & Co.

E. F. Hutton & Company

CIRCLE 165 READERS SERVICE CARD

pany with the needed space to manufacture several types of military connectors developed at Elco's Philadelphia plant; service West Coast manufacturers of printed circuitry; and to perform certain manufacturing operations to expedite delivery of the end product to region's users.



Mycalex Elects Board Member

DAVID R. HULL, vice president of Raytheon Mfg. Co., and currently serving as president of the Electronic Industries Association, has been elected to the board of directors of the Mycalex Corp. of America, Clifton, N. J.



Name Fredenburg Plant Manager

RAYMOND N. FREDENBURG was recently named plant manager for Mid-Eastern Electronics, Inc., Springfield, N. J., developers and manufacturers of electronic instruments and test equipment.

He was formerly with Weston

April 10, 1959 — ELECTRONICS

Electrical Instrument Corp. where he contributed to some of the early work in developing solid state electronic test equipment.

News of Reps

R. O. Whitesell & Associates is now the rep in the Kentucky-Indiana area for **Ungar Electric Tools, Inc.**, Los Angeles, soldering tool manufacturer.

Mid-Eastern Electronics, Inc., Springfield, N. J., appoints the **Kenneth W. Meyers Co.**, Park Ridge, Ill., for northern Illinois and southern Wisconsin; and the **J. L. Pierce Co.**, Detroit, Mich., for all of Michigan. Both of the sales organizations will handle Mid-Eastern's entire line of power supplies, special test equipment and ultra high resistance measuring instruments.

Deltron, Inc., Philadelphia, Pa., has named six additional reps to handle its power supply line. New reps and their territories are:

Lawrence F. Fuller, Jr., of Ardmore, Pa.—southern New Jersey, eastern Pennsylvania, Maryland, Virginia and District of Columbia.

Stanley K. Wallace Associates, Inc., of Lutz, Fla.—the southeast area.

Robert G. Moyer Co., of Alhambra, Calif.—southern California to Fresno, southern Nevada and Arizona.

Carduner-Bosworth Co., of Port Washington, N. Y.—the New York metropolitan area.

Leo Jacobson Co., Inc., of Buffalo, N. Y.—upper New York State.

Northwest Sales & Eng. Service Co., of Seattle, Wash.—Oregon, Washington, Idaho, Montana, British Columbia, northern California south to and including Fresno.

Hunter & Salsbury Inc., Hicksville, N. Y., announce their appointment as reps for **Industrial Transformer Co.**, Gouldsboro, Pa. They are covering the metropolitan New York-New Jersey territory for Industrial's line of commercial military and computer type transformers.

A PROBLEM OF UTMOST GRAVITY

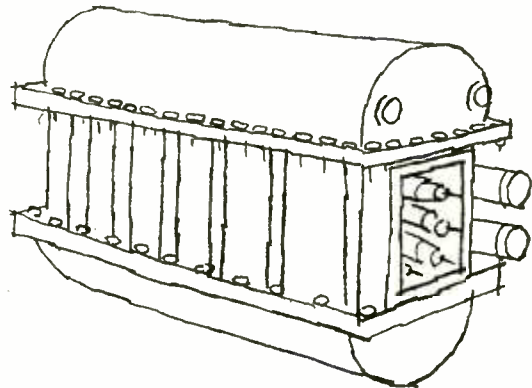

*RAYTHEON-DESIGNED, HIGH VOLTAGE
DC MAGNETRON POWER SUPPLY*

Weight, in one form or another, seems to be a concern of most of us today. While astronauts contend with the problem of "none at all", designers of electronic components continually face the problem of "too much".

An aircraft manufacturer recently called on Raytheon to design a 10,000-volt, 60-kva, 400-cycle, filtered DC magnetron power supply for high-temperature airborne-radar application. Several designs were available, but their weight -- more than 1,800 pounds -- put them in the lead balloon class.

Our engineers, thoroughly experienced in the field of fluorochemical transformer design, were able to get the "lead" out, about 1,300 pounds of it, and to come up with a unit (shown above) weighing less than 500 pounds.



Have any weighty problems?
We'll be glad to lighten
your load.

Simply write to:
Raytheon Manufacturing Company
Magnetic Components Product Dept.
Section 6120
Waltham 54, Massachusetts





what's happening in Tucson?

TUCSON IS FREE of the tensions and hustle of big cities. Tucson offers its residents a truly cultural atmosphere in a dry healthful climate with an average of 11 hours of sunshine every day.

The University of Arizona, with an enrollment over 15,000, functions as the center of cultural activities—offering a variety of orchestral, choral and dance programs. The fine Tucson Symphony plays regularly at the famed Temple of Music and Art.

The Fine Arts Show and Photo Workshop climax the year's activities in the visual arts with exhibitions and symposiums. Tucson's reputation is attracting many fine artists who make this their home. The Fashion Fiesta in February displays the latest work of the Southwest's top designers.

Spring Training activities of the Cleveland Indians...the Saturday Evening Forum (the nation's largest community forum)...the world famed rodeos and Spanish celebrations...these and more make Tucson a stimulating, rewarding place to live...and work. (For more details see opposite page.)

COMMENT

Soft Magnets

We observed with interest your article "Soft Magnets for Amplifiers" (p 55, Feb. 6). We checked the magnetic characteristics of the alloys listed in this article and would like to comment on those shown for Hymu 80.

Currently, Hymu 80 is produced to an initial permeability at 40 gaussers of 26,000 minimum. The average coercive force is 0.02-0.035 oersteds; residual flux density ranges from 2.5-5.0 kilogaussers. The balance of data is correct. These magnetic characteristics are obtained after annealing in a dry hydrogen atmosphere at 2,050 F for four hours and furnace cooled.

A large variety of magnetic characteristics can be obtained from the 49-percent nickel alloy, and these depend upon melting techniques and methods of processing to produce the specified characteristics.

W. S. EBERLY

CARPENTER STEEL Co.
READING, PA.

Reader Eberly sent along several technical data sheets on Hymu 80, 400 and 800, and on other magnetic materials. We had given Hymu 80 an initial permeability of 10-20,000, an average coercive force of 0.05-0.07, and a residual flux density of 2.5. We were pleased to note how rapidly advances are being made in magnetic materials.

Microwave Hazards

(Re: "Researching Microwave Health Hazards," p 49, Feb. 20) I think you have done a good job in pulling together a large and diverse collection of information into a very readable and interesting article.

THOMAS S. ELY, M.D.
ATOMIC ENERGY COMMISSION
WASHINGTON, D. C.

... As you can well understand, the field concerned with the bio-

STANPAT SOLVES THE GHOSTING PROBLEM

NEW resin-base STANPAT ELIMINATES GHOSTING, offers better adhesion qualities on specific drafting papers!

THE PROBLEM

Some of our longtime customers first called our attention to the "ghosting" problem. Certain tracing papers contain an oil which could be leached out by the STANPAT adhesive (green back) causing a ghost.

THE SOLUTION

A new STANPAT was developed (red back), utilizing a resin base which did not disturb the oils and eliminates the ghost. However, for many specific drafting papers where there is no ghosting problem, the original (green back) STANPAT is still preferred.

WHICH ONE IS BEST FOR YOU?

Send samples of your drawing paper and we will help you specify. Remember, STANPAT is the remarkable tri-acetate pre-printed with your standard and repetitive blueprint items—designed to save you hundreds of hours of expensive drafting time.

SO SIMPLE TO USE



1. PEEL
the tri-acetate adhesive from its backing.

2. PLACE
the tri-acetate in position on the tracing.

3. PRESS
into position, will not wrinkle or come off.

STANPAT CO.

WHITESTONE 57, N. Y. Dept. 102
Phone: Flushing 9-1693-1611

Enclosed are samples of the drafting paper(s) I use (identify manufacturer). Please specify whether Rubber Base or Resin Base STANPAT is most compatible with these samples.

Send literature and samples of STANPAT.

Please quote price on our enclosed sketches which we are considering to have pre-printed.

NAME _____

FIRM _____

ADDRESS _____

CITY _____

ZONE _____ STATE _____



CIRCLE 168 READERS SERVICE CARD

April 10, 1959 — ELECTRONICS

logical effects of microwaves is a sensitive subject, especially that phase regarding hazards. Yet any information in this realm needs judicious publicity. When any article appears, we workers in this rather small group are somewhat apprehensive that the picture will be distorted, either by magnification or depression of the accumulated knowledge and concepts. In my opinion, your article was excellent. The subject was well covered, organized, and judiciously presented. You accurately reported the prevailing majority opinions, although not in all cases my own opinion—but this is the way it should have been reported.

One technical criticism that I might suggest is that you did not clarify well the difference between quantitation and qualitation regarding the comparison of human problems and the smaller animal experimental results. A quantitative difference is widely agreed upon; few, if any, investigators have suggested that there is a qualitative difference.

Please do not misunderstand me; you did not say otherwise, but it seemed implied on p 49 regarding environmental temperature, and in the statement "not necessarily applicable." To repeat myself, the article was excellent, and the preceding remarks involve a minor point.

Your description of my dosimeter was an accurate summary of its characteristics, good and bad.

ALFRED W. RICHARDSON
ST. LOUIS UNIVERSITY
SCHOOL OF MEDICINE
ST. LOUIS, MO.

We are most interested in the idea that there is a qualitative difference between reactions of human beings and smaller furbearing animals to microwave radiation. Actually, our opinions lean toward agreement with researcher Richardson, but there was, at the time the article was prepared, no substantial documentation of the idea. It may be a minor point, but we feel strongly that all points of view in this matter of microwave health hazards deserve judicious hearing.

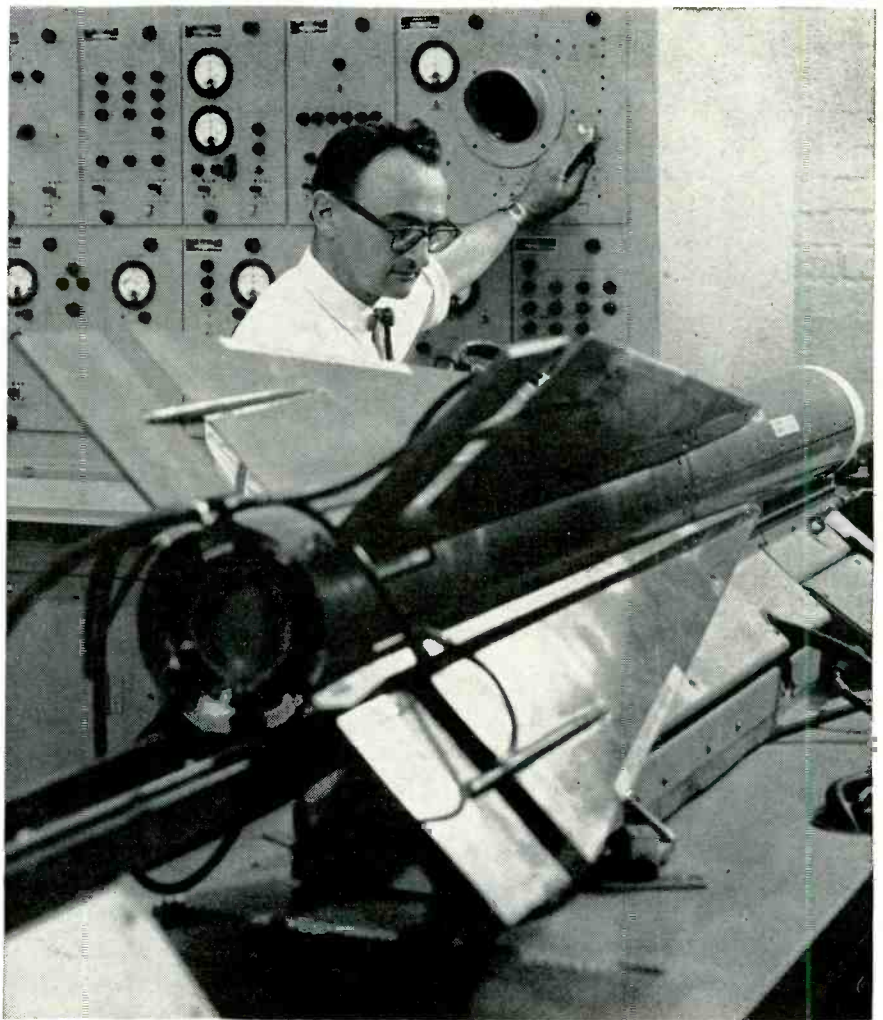

what's happening in Tucson? **GUIDED MISSILE DEVELOPMENT!**

A HUGHES-TUCSON ENGINEER puts a new GAR 3 Falcon missile through its paces on the roller conveyor rails of an EGSP console.

With projects underway on new and highly advanced types of guided missiles, Hughes in Tucson offers assignments throughout the entire spectrum of missile research and development.

Hughes-Tucson offers permanent positions to people with the ability and enthusiasm to make major contributions in these areas: missile systems analysis, infrared and radar guidance systems, electromechanical and hydraulic control systems, missile test and handling equipment.

These opportunities for professional advancement are matched by the unique qualities of Tucson as a place to enjoy a fuller life. (See the advertisement on opposite page.)

Investigate Hughes...and Tucson... today. Send resume to Mr. James W. Kirchoff at the address below.

Creating a new world with electronics

HUGHES

Tucson Engineering Laboratories
Hughes Aircraft Company
Emery Park Station, Tucson, Arizona

MISSILES YOUR GOAL?



Get into a key missile program at BENDIX —prime contractor for the Talos missile

Engineering can be a really satisfying career—and within engineering one branch stands out. That's Guided Missiles. If the missile field is the one you want—hear this. We need engineers with exceptional ability who can handle responsibility.

At Bendix you work with men who are outstanding in every phase of engineering. You use facilities second to none. You do work that's challenging and important—work that offers exceptional opportunities to build your professional standing.

You will enjoy Midwestern living at Bendix, too. Fine, four-season climate and excellent recreational facilities are close at hand. In addition, Bendix offers you a liberal personal benefit program.

If this interests you and you want additional information, mail the coupon below for your copy of "Opportunities Abound at Bendix Missiles". You can read it through in half an hour—and it may prove to be the best half hour you've ever spent in your life.

Bendix PRODUCTS DIVISION Missiles



Bendix Products Division—Missiles
403B So. Beiger St., Mishawaka, Ind.

Gentlemen: I would like more information concerning opportunities in guided missiles. Please send me the booklet "Opportunities Abound at Bendix Missiles".

NAME _____

ADDRESS _____

CITY _____ STATE _____

ELECTRONICS ENGINEERS

(Senior)

- Develop test equipment, methods and procedures for determining conformance of complex electronic equipment with Company and Air Force specifications.
- Contact various electronic manufacturers to determine requirements for purchase of equipment as required to test and simulate flight operations of radar, navigation, fire control & similar electronic systems.
- Also develop procedures for use of electronic test equipment. Conduct investigatory work and recommend corrective action and changes. EE degree required. Quality control experience desired.

Salary commensurate with ability.

In addition to other advantages, Republic offers a comprehensive benefit program among the finest in industry.

Send resume in confidence to

Mr. W. Walsh
Employment Office



REPUBLIC AVIATION

Farmingdale, Long Island, N. Y.

Engineers—INVEST your resume in LFE*

IMMEDIATE OPPORTUNITIES:

- *CIRCUIT DESIGN
- *QUALITY CONTROL
- *MICROWAVE
- *COMPUTERS
- *TRANSISTOR
- *SENIOR PHYSICIST
- *SENIOR PROJECT ENGINEERS
- *RELIABILITY
- *RADAR & SYSTEMS
- *FLIGHT TEST
- *FIELD ENGINEERS
- *ELECTRONIC ENGINEERS



Send resume to:

Professional Placement Director
75 Pitts Street
Boston 14, Mass.

**LABORATORY
FOR ELECTRONICS**

POSITIONS!

To satisfy your objectives and use your best talents! S.E.E. helps many distinguished companies and organizations to obtain able men at all levels. No placement fees to you. Send resume for appraisal & full information.

Scientists, Engineers & Executives, Inc.
1926-17th St., N. W. Washington 6, D. C.

WE'RE LOOKING
FOR A MAN
LIKE Torricelli

$$MGH = \frac{1}{2}MU^2$$

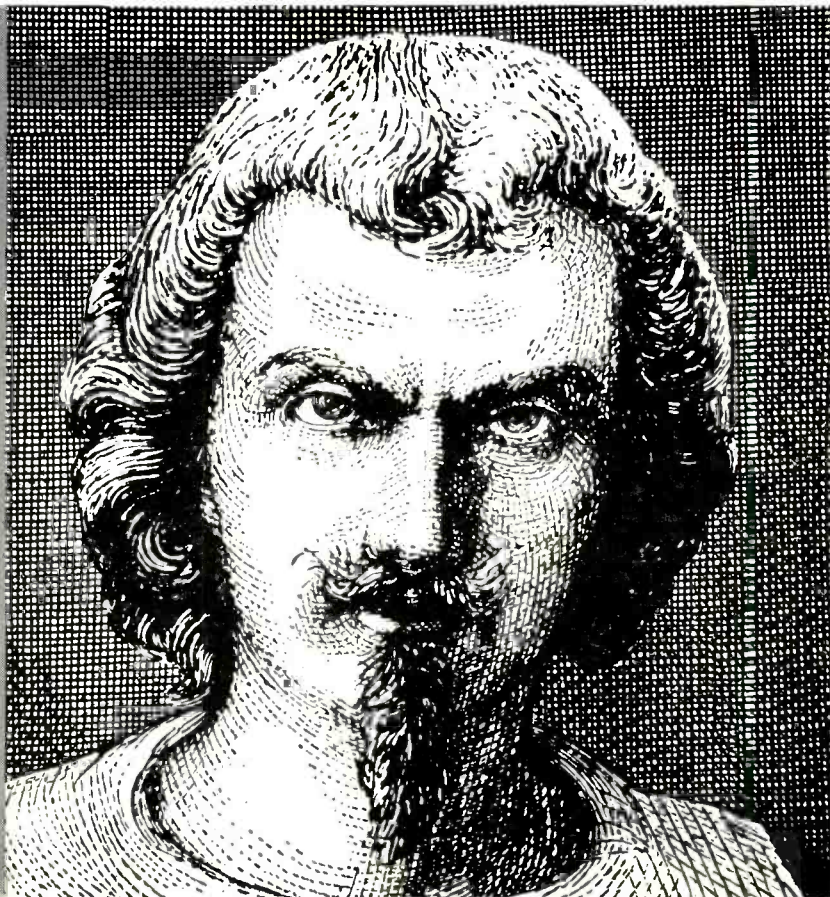

-WITH A MODERN TURN OF MIND

Air has weight— atmosphere has pressure.

This knowledge, centuries old, lies at the base of searching problems facing the exploration of space.

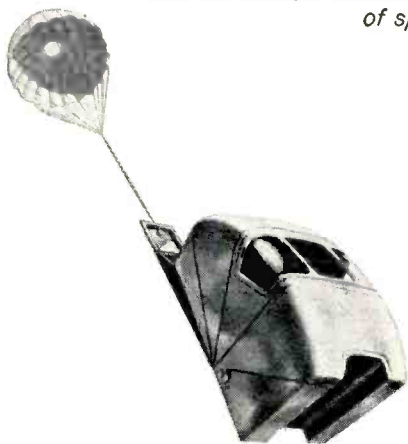

At Goodyear Aircraft, hand-picked men with a modern turn of Torricellian mind are finding rewarding stimulation of their talents in programs involving Crew-Escape Capsules—in the perfection of mass-production nose cones of optimum efficiency.*

New multimillion-dollar research and development facilities—in Akron and in Litchfield Park, Arizona—are manned by this good company of men who would welcome good company like you.

If you have a Torricellian talent and are seeking a challenge that has solid substance and long-range surety — then write direct: Mr. Charles Jones, Director of Technical & Scientific Personnel, Goodyear Aircraft Corporation, Akron 15, Ohio.

*Also programs in rocket propulsion, interplanetary guidance, ground support systems for missiles, nose cones, radar structures, advanced black boxes, radomes and structures engineering.

GOOD YEAR AIRCRAFT

ENGINEERS

**Why
2 Years at
Norden Labs
add up
to 4
...in your
Professional
Development**

...because GROWTH is the pattern here—healthy, vigorous, rapid—providing unusual opportunities for a good man to move ahead. Norden's professional staff has increased 40% in six months.

New long-range commitments give you accelerated opportunities to learn and grow, meet new challenges, experience individual achievements.

Acquisition by United Aircraft has added extensive research facilities (including the most advanced computation services) to Norden's fine R & D labs. You also enjoy the long-term career benefits and growth potential of association with one of the country's leaders in the development of advanced aircraft propulsion systems.

And the *diversity* of Norden's projects makes it easy to get the right assignment to utilize your skill and ingenuity. (Project range: communications, radar, infra-red, missile and aircraft guidance, TV circuitry, inertial and stellar navigation, data handling, navigation-stabilization systems, bomb director systems.)

Immediate openings at White Plains, N. Y. and Stamford, Connecticut locations for engineers at all levels of experience:

TELEVISION & PASSIVE DETECTION

- Transistor Circuit Development • High & Low Light Level TV Camera Design • Video Information Processing • TV Monitors & Contact Analog Displays • Military Transistorized TV Systems
- (Also openings for recent EE grads)*

RADAR & COMMUNICATIONS

- Design & Development of:*
- Antennas • Microwave Systems & Components • Receivers • Transmitter Modulators • Displays • Pulse Circuitry (VT & Transistors) • AMTI • Data Transmission • ECM

DIGITAL

- Digital (Senior) Design: Logical, Circuit, Magnetic Storage

PROJECT ENGINEERING

- Senior Engineers — Engineering Program Mgt.

SYSTEMS ENGINEERING

- Synthesis, analysis & integration of electronic & electro-mechanical systems

QUALITY ASSURANCE

- Systems Reliability Analyses • Component Reliability & Evaluation • Vibration, Shock & Environmental Test • Standards

ENGINEERING DESIGN

- Electronic Packaging

FUTURE PROGRAMS

- Systems Engineer (SR) — Broad creative background, ability to communicate—experience in radar, TV systems — supervise R&D proposals • Senior Engineer — Cost development for R&D proposals. Require broad technical experience in electro-mechanical and electronics systems

STABILIZATION & NAVIGATION

- Servo Loops for gyro stabilization, antenna stabilization, accelerometer force balance, antenna scanning • Repeater Servos • Transistorized Integrator, DC Amplifier, Servo Amplifier • Magnetic Amplifiers • Transistorized DC & AC power supplies • Gyros & Accelerometers

Descriptive Brochure Available Upon Request

TECHNICAL EMPLOYMENT MANAGER

NORDEN LABORATORIES

NORDEN DIVISION — UNITED AIRCRAFT CORPORATION
121 WESTMORELAND AVENUE • WHITE PLAINS, NEW YORK

I am interested in obtaining further information on opportunities at Norden Laboratories.

NAME _____

ADDRESS _____

CITY _____ ZONE _____ STATE _____

DEGREE _____ YEAR _____

(United States Citizenship Required)

PERSONNEL MANAGERS

**LOOKING FOR
Experienced Engineers . . .
Technical Personnel?**

Write for a free copy of:

**“How You Can Reach The
Experienced Engineer . . .”**



The top-flight engineers and technical personnel you want are at a premium . . . as this twelve page booklet points out. How you can reach and influence these men is the story told.

The booklet tells where to find the experienced engineer. It explains how you can make contact . . . channel and concentrate your employment advertising to just the men with the job qualifications you want. Included are testimonials from personnel men who use technical publications successfully . . . sample advertisements that got results . . . helpful hints to consider and pitfalls to avoid when you prepare your copy and layout for an Employment Opportunity advertisement.

Write for your free copy to:

Mr. Thomas Bender
Classified Advertising Division
McGraw-Hill Publishing Co., Inc.
P.O. Box 12
New York 36, New York

ENGINEERS

A FINER CLIMATE



TO WORK IN...



...TO LIVE IN

*At Sylvania's
Mountain View Operations
in California*

(SAN FRANCISCO BAY AREA)

*you'll discover
more than just one
kind of climate.*

PROFESSIONAL CLIMATE—Advanced programs will challenge your technical creativity. You'll make major contributions in the fields of electronic defense, radar, communications and data processing systems. Because Sylvania is one of the nation's fastest growing electronics organizations, there are an unusual number of growth opportunities.

LIVING CLIMATE—You and your family will enjoy the healthful atmosphere and sunny climate of the San Francisco Peninsula. You'll find plentiful housing, excellent shops, fine schools and year round recreation.

Openings in:

System Studies / Circuit Design / Computers & Data Handling / Electronic Packaging / Development Engineering / Concept & Planning / Advanced ECM Circuitry / Equipment Development / Product Engineering / Tube Engineering / Tube Application Engineering / Mechanical Engineering / Tube Production Engineering / Theoretical Physics / Experimental Physics / Mathematics / Microwave Engineering.

*You may communicate in confidence
to Wayne L. Pearson*

MOUNTAIN VIEW OPERATIONS

SYLVANIA

SYLVANIA ELECTRIC PRODUCTS INC.

P.O. Box 188
Mountain View, California



*You can explore
new areas of growth
at IBM in design
and development
of semi-conductors*

Many new designs in IBM circuits and systems require the latest advances in the semi-conductor field. IBM's program includes theoretical and experimental studies in the most advanced semi-conductor devices and technology. An example of original IBM development is the NPN high-speed drift transistor for logical switching and high-power core driving. These programs are opening up new opportunities for high-level professional people. Related areas where opportunities exist include: applied mathematics and statistics, circuit research, logic, cryogenics, optics, phosphors, magnetics, microwaves, theory of solid-state, transistor design.

A career with IBM offers advancement opportunities and rewards. You will enjoy professional freedom, participation in education programs, and the assistance of specialists of diverse disciplines. Working independently or as a respected member of a small team, your contributions are quickly recognized. This is a unique opportunity to ally your personal growth with a company that has an outstanding growth record.

QUALIFICATIONS: B.S., M.S. or Ph.D. in one of the physical sciences—and proven ability in the field of semi-conductors.

For details, write, outlining background and interests, to:
Mr. R. E. Rodgers, Dept. 554-D2
IBM Corporation
590 Madison Avenue
New York 22, N. Y.

IBM

INTERNATIONAL BUSINESS MACHINES CORPORATION

FROM CONCEPT

ENGINEERS

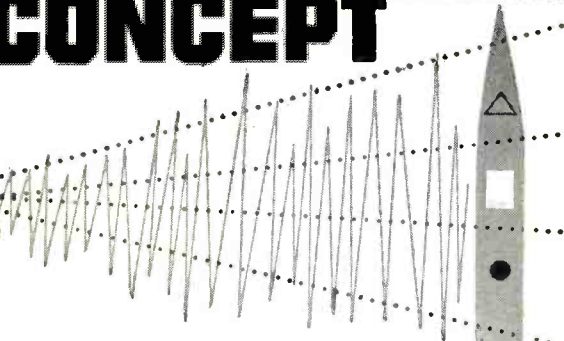
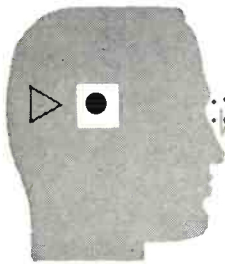

TO HARDWARE

*See your personal efforts
integrated into the total flight system
with a prime contractor...*

REPUBLIC AVIATION

It's an unnerving experience, in this era of systems engineering, for a man to work long and hard on a subsystem or component project and then see the product of his labor leave the plant in a packing case on its way to a prime contractor for systems installation. How different is the picture at Republic Aviation! Working for this prime systems contractor you will have the opportunity to see the total flight system take shape and the satisfaction of seeing your personal efforts become an important part of it. You'll broaden your experience and professional interests by working with capable men from varied disciplines on advanced electronics for every type of flight vehicle—from guided missiles to helicopters.

Decide NOW to join this Prime Contractor

Gain accelerated advancement by becoming a ground floor participant in Republic's \$35 million R&D program aimed at bringing about substantial breakthroughs in aeronautics and space technology. A new order of career progress is waiting for engineers and scientists at Republic Aviation.

Investigate these electronic opportunities with Republic

- Inertial Guidance & Navigation / Digital Computer Development / Systems Engineering / Information Theory
- Telemetry-SSB Technique / Doppler Radar / Countermeasures
- Radome & Antenna Design / Microwave Circuitry & Components
- Receiver & Transmitter Design / Airborne Navigational Systems
- Jamming & Anti-Jamming / Miniaturization-Transistorization
- Ranging Systems / Propagation Studies
- Ground Support Equipment

Among other advantages, Republic offers a comprehensive employee benefit program including company paid hospitalization, surgical, accident & life insurance, tuition (2/3), 2 fold pension plan, individual merit rated increases & many other benefits.

Please send resume in complete confidence to:

MR. GEORGE R. HICKMAN
Engineering Employment Manager Dept. 11D-2



REPUBLIC AVIATION

Farmingdale, Long Island, New York

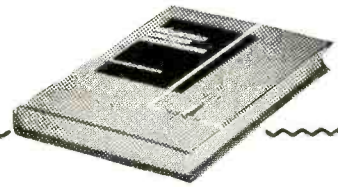

ELECTRONIC COMMUNICATION

Just Published—A wealth of practical electronics information for all major communication fields. Special emphasis placed on FCC license requirements. Covers such essentials as tubes, power supplies, amplifiers, transmitters, and receivers—including applications to radio, loran, radar, etc. Transistors, color TV, single-sideband transmission, and other developments are clearly treated. By R. L. Shrader, Oakland Jr. Coll. 937 pages, 771 illus., \$13.00

ELECTRICAL MEASUREMENT ANALYSIS

Just Published—Guide to analytical solution of electrical measurement problems. Fully treats methods, concepts, and techniques of analysis, including theory and operation of electromechanical instruments. Null and deflection methods of measurement; errors; compensation theorem; square-wave response of galvanometers from steady-state and transient points of view; and other topics are covered. By E. Frank, The George Washington Univ. 443 pages, 245 illus., \$8.75

GUIDED MISSILES

Operation, Design and Theory

A full, authoritative survey of guided missiles and their components—how they work, what goes into them, their theoretical foundations, how they are checked, and how they are used. Gives you a background of fundamentals that aids in the design of missile components. Offers a vast storehouse of theory, facts, formulas—with drawings, charts, and diagrams illustrating every point. Sponsored by the Dept. of the Air Force. 546 pp., over 500 illus., \$8.00



6 books in one!

Just Published ENGINEERING MANUAL

For quick answers to engineering problems, including fields outside your own—a practical reference of data and methods in architectural, chemical, civil, electrical, mechanical, and nuclear engineering. Covers most-needed essentials—everything from basic principles to applications. Prepared by a staff of specialists. Editor, R. H. Perry, U. of Oklahoma. 680 pp., 450 illus. and tables, \$9.50

FREE EXAMINATION

McGraw-Hill Book Co., Dept. FL-4-10
327 W. 41st St., N. Y. 36, N. Y.

Send me book(s) checked below for 10 days' examination on approval. In 10 days I will remit for book(s) I keep, plus few cents for delivery costs, and return unwanted book(s) postpaid. (We pay delivery costs if you remit with this coupon—same return privilege.)

- Shrader—Electronic Communication, \$13.00
- Frank—Elec. Measurement Anal., \$8.75
- Dept. Air Force—Guided Missiles, \$8.00
- Perry—Engineering Manual, \$9.50

(Print) Name

Address

City Zone..... State.....

Company

Position

For price and terms outside U. S. write McGraw-Hill Int'l., N.Y.C.

FL-4-10

advanced RADAR SYSTEMS ENGINEER

Starting Salary to
\$14,000

A position for a man with broad experience in radar systems development and systems design engineering.

Write in confidence to:

P-1199—ELECTRONICS

Class. Adv. Div., P.O. Box 12, N. Y. 36, N. Y.

ELECTRICAL ENGINEER

Challenging opportunity for experienced development engineer to work on new types

of

TANTALUM CAPACITORS

Expanding company offering excellent employee benefit programs, providing security and possibilities for future advancement.

Direct inquiries to:

Dr. J. S. Wagener

Kemet Company

Division of Union Carbide Corporation
P.O. Box 6087 Cleveland 1, Ohio

ADDRESS BOX NO. REPLIES TO: Box No.
Classified Adv. Div. of this publication.

Send to office nearest you.

NEW YORK 36: P. O. BOX 12

CHICAGO 11: 520 N. Michigan Ave.

SAN FRANCISCO 4: 68 Post St.

SELLING OPPORTUNITY WANTED

Importing firm Belgium introduced all European armies wants American manufacturers exclusive distributorship. RA-1247, Electronics.

SPECIAL SERVICE

Technical Libraries set up to service Engineers. Electronics a specialty. Write Michaels Library Service, SS-1343, Electronics.

THIS EMPLOYMENT OPPORTUNITIES SECTION offers a quick, effective solution to your manpower problems. Because its readership is confined to just the type of men you need, waste circulation is avoided.

ENGINEERS...PHYSICISTS

NEW opportunities at Motorola in Chicago

give yourself and your family
all the big city advantages at a
relaxed midwest pace, while you
ADVANCE YOUR CAREER



Outstanding career opportunities are waiting at the many Motorola research and development laboratories in the Chicago area. This is your opportunity to advance your career with a swiftly expanding company, working in the most modern and well instrumented laboratories . . . with liberal employee benefits, including an attractive profit sharing plan and association with men of the highest technical competence.

You'll like living in one of the beautiful suburbs of the playground of the midwest, where there are endless social, cultural, and educational activities to choose from the year-round. Exciting life or quiet life—Chicago offers either.

MILITARY POSITIONS OPEN

- Radar transmitters and receivers
- Radar circuit design
- Antenna design
- Electronic countermeasure systems
- Military communications equipment design
- Pulse circuit design
- IF strip design
- Device using kylstron, traveling wave tube and backward wave oscillator
- Display and storage devices

CIVILIAN POSITIONS OPEN

2-WAY RADIO COMMUNICATIONS

- VHF & UHF Receiver • Transmitter design & development • Power supply
- Systems Engineering • Selective Signaling • Transistor Applications • Crystal Engineering • Sales Engineers

PORTABLE COMMUNICATIONS

- Design of VHF & UHF FM Communications in portable or subminiature development.

MICROWAVE FIELD ENGINEERS

Write to:

Mr. L. B. Wrenn Dept. D
MOTOROLA, INC.

4501 Augusta Blvd., Chicago 51, Ill.



ALSO . . . there are excellent opportunities in
PHOENIX, ARIZONA • RIVERSIDE, CALIFORNIA



MOTOROLA

ENGINEERS

7 NUCLEAR SUBMARINES + ADVANCED RESEARCH & DEVELOPMENT

In a Variety of Fields Engaging Engineers at
GENERAL DYNAMICS—ELECTRIC BOAT DIVISION

Some of the most interesting work in advanced technologies is now in progress at Electric Boat Division—most highly trained engineering and design staff of any private shipyard in the United States.

Immediate openings in:

ELECTRICAL SYSTEMS—EE, ME or Physics degree required. Responsible for conceptual engineering and systems analysis of large complex devices employing a combination of electrical, electronic, electromechanical, hydraulic and pneumatic systems. Should be familiar with servomechanisms theory, experienced in use of analog or digital computers as a design tool, and have a good grasp of mathematics. Will work on proposal preparations, feasibility studies and execution of hardware contracts.

COMPUTERS—Responsible for conceptual engineering and programming of special purpose digital and

analog computers. Should be familiar with system engineering, experienced in programming and check systems for both analog and digital computers, with good grasp of simulation techniques. Requires EE, Physics or Mathematics degree.

SERVOMECHANISMS—For engineering design of servomechanisms in the instrument & multiple horsepower class. To interpret performance specifications, do system design, including stability studies, and calculate other performance criteria.

CIRCUITS—Responsible for conceptual and production engineering of electronic equipment. Familiar with servomechanisms and analog com-

puter theory. Experienced in use of semi-conductors, magnetic amplifiers and vacuum tube circuit elements; good grasp of mathematics, EE or Physics degree.

Circuit development & System Installation assignments concerning application of missile fire control and shipboard navigation systems. Requires EE degree and minimum of 2 years missile or navigation system experience.

Development of Circuits and equipment in conjunction with missile and navigation systems installations aboard submarines. Requires EE degree with advanced courses and experience in servomechanisms.

Electric Boat Division's location—just half way between New York and Boston on the Connecticut shore near New London—provides excellent living and working conditions. To arrange convenient interview appointment at General Dynamics headquarters in New York, or at Electric Boat Division in Groton, send your resume, in confidence, to James P. O'Brien, Technical Employment Supervisor.

GENERAL DYNAMICS ELECTRIC BOAT DIVISION

GROTON

CONNECTICUT

ENGINEERS

AIR DATA INSTRUMENTS

Expansion of air data engineering department has created vacancies for engineers and designers (EE & ME) at all levels including Senior positions for especially qualified men in 1. pressure switches, 2. altitude and mach controllers, 3. ground support equipment for air data instruments—for advanced programs in supersonic and other classified instrument and control projects, as well as civil jet programs.

Send resume,
in confidence, to
T. A. DeLuca.

ADVANCED CELESTIAL NAVIGATION SYSTEMS

Senior Project & Staff Positions. Qualifications should include previous responsible experience in analog and digital computers, advanced electronic techniques and navigation concepts.

FIELD SERVICE ENGINEERS & TECHNICAL REPRESENTATIVES

For field service work on flight instrumentation. Requires electronic background with knowledge of electro-mechanical systems. Must be able to travel and/or relocate.



kollsman INSTRUMENT CORPORATION

80-08 45th AVENUE, ELMHURST, NEW YORK • SUBSIDIARY OF *Standard* COIL PRODUCTS CO. INC.

PROFESSIONAL SERVICES

YARDNEY LABORATORIES, Inc.

"Pioneers in Compact Power" *
Electro-Chemical Generators of Energy
"from milliwatts to megawatts" *

40-48 Leonard Street Worth 6-3100
New York 13, N. Y. * T.M.

Technical Liaison in Great Britain & France

Graduate electronics engineer, ex naval officer who recently held succession of top communication posts abroad, possessing entree into management many industries these countries, fluent in French language, offers his professional services for effecting technical and business liaison including locating processes and ideas for utilization in U. S. industry. Highest references available. Write SS-1301, Electronics, Class. Adv. Div., P.O. Box 12, N.Y.C. 36, N.Y.

Consult these SPECIALISTS

Let them save your time by bringing their broad experience in their specialty to bear on your problems.

FOR ADDITIONAL INFORMATION

About Classified Advertising

Contact

The McGraw-Hill

Office Nearest You.

ATLANTA, 3
1301 Rhodes-Haverty Bldg.
JACKSON 3-6951
M. H. MILLER

BOSTON, 16
350 Park Square
HUBBARD 2-7160
D. J. CASSIDY

CHICAGO, 11
520 No. Michigan Ave.
MOHAWK 4-5800
W. J. HIGGINS D. C. JACKMAN

CLEVELAND, 13
1164 Illuminating Bldg.
SUPERIOR 1-7000
W. B. SULLIVAN T. H. HUNTER

DALLAS, 1
1712 Commerce St.,
Vaughn Bldg.
RIVERSIDE 7-5117
GORDON JONES F. E. HOLLAND

DETROIT, 26
856 Penobscot Bldg.
WOODWARD 2-1793
D. M. WATSON

LOS ANGELES, 17
1125 W. 6 St.
HUNTLEY 2-5450
P. M. BUTTS

NEW YORK, 36
500 Fifth Ave.
OXFORD 5-5959
H. T. BUCHANAN R. P. LAWLESS

PHILADELPHIA, 3
Six Penn Center Plaza
LOCUST 8-1330
T. W. McCLURE
H. W. BOZARTH

ST. LOUIS, 8
3615 Olive St.
JEFFERSON 5-4867

SAN FRANCISCO, 4
68 Post St.
DOUGLAS 2-4600
R. C. ALCORN



ANOTHER NEW ROSTER OF OPPORTUNITIES APLENTY AT BURROUGHS

Again we are stepping up our aggressive research and development programs. These have already made us a \$300-million-a-year force in *advanced electronic and electro-mechanical information processing* for both commerce and defense. Here are just a few of the many exceptional career opportunities open right now for exceptional men:

CALIFORNIA at our ElectroData Division in Pasadena

Electronic Engineers with experience in areas such as logical design, computer components, circuit design, electronic packaging, sub-miniaturization, manufacturing costs and processes.

Electronic Data Processing Specialists with experience in areas such as applied programming, applied mathematics and technical sales consultation, etc. Positions available throughout the country.

For Details, write to the district office nearest you or Mr. C. J. Blades, Manager, Professional Employment, Dept. 501A, Burroughs Corporation ElectroData Division, 460 Sierra Madre Villa, Pasadena, California.

For Details, write Mr. James Gilroy, Professional Placement Coordinator, Dept. 501B, Burroughs Corporation Research Center, Paoli, Pennsylvania.

PENNSYLVANIA at our Military Field Service Division in Phila.

Site Engineers for direct supervision of a field team of electronic technicians engaged in the installation and maintenance of data processing equipment. Requires minimum of 5 yrs. applied electronic experience at supervisory level.

Instructors to train technical personnel in the installation, maintenance and repair of electronic and/or electro-mechanical equipment. Requires knowledge of theory as well as its practical application.

For Details write Mr. A. J. Bellace, Employment Supervisor, Burroughs Corporation Military Field Service Division, Dept. 501C, Burroughs Drive, Radnor, Pennsylvania.

PENNSYLVANIA at our Research Center near Philadelphia

Systems Engineers with specific experience in systems analysis and design of digital data processors. Should be trained in engineering, physics or mathematics. Graduate training desirable.

Mathematicians, computer-oriented, with particular experience in problem formulation, numerical analysis, and applied mathematics—in connection with formulation and design of computational procedures. Procedures involved in problems of guidance and air defense, trajectory calculations, logical design, sampled data systems, circuit analysis and more. Advanced degree in mathematics preferred.

MICHIGAN at our Burroughs Division in the Detroit Area

Experienced Electronic, electrical and mechanical engineers to work in many areas of research, development and design for information processing equipment applicable to commercial and military use.

For Details, write Mr. A. L. Suzio, Administrator, Corporate Placement Services, Dept 501, Burroughs Corporation, Detroit 32, Michigan.



Burroughs Corporation

"NEW DIMENSIONS" / IN ELECTRONICS AND DATA PROCESSING SYSTEMS

dull routine driving



you

MAD?

You can't broaden your career horizons if you are isolated from challenging engineering assignments. GILFILLAN provides this opportunity plus a friendly, informal atmosphere that is conducive to scientific achievement. Diversified technical challenge is being offered to electronic engineers with

experience in the fields of Air Navigation, Missile Guidance and Support, Radar Systems, and Countermeasures.

you owe it to yourself to write to



DIR. SCIENTIFIC PERSONNEL DEPT. 56
1815 VENICE BLVD.
LOS ANGELES 6, CALIF.

SEARCHLIGHT SECTION

Hysteresis Synchronous Motors

For high fidelity recording and reproducing equipment. These units are brand new, not surplus at prices that cannot be duplicated anywhere. Price with capacitor.

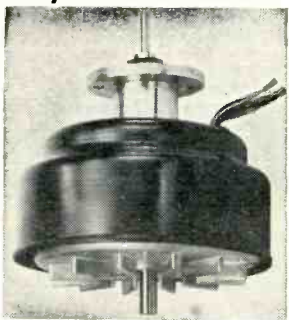

- 7 1/2 and 15" per second.....each \$27.75
- 7 1/2" per second.....each 24.25
- 15" per second.....each 21.25
- Pressure Wheels 1 1/2" diameter with 1/4" oilite bearings95 ea.
- Stereo Heads, Brush BK 1072, Hi-Imp Record or Playback..... \$25.00 ea. 2/45.00

J. H. GIBSON COMPANY

1202 W. Washington Blvd. L.A. 7, Calif.

Money saving prices on tubes. TV, Radio, Transmitting, and Industrial Types. New, 1st quality, guaranteed. Top name brands only. Government surplus and commercial test, lab, and communications equipment in stock. Sell us your excess tubes and equipment. Unused, clean tubes of all types wanted. Send specific details in first letter. Write for "Green Sheet" catalog 25e.

BARRY ELECTRONICS CORP.

512 Broadway WA 5-7000 New York 12, N. Y.

INDUSTRIAL SPACE For Rent

Exceptionally clean, light industrial four-story building—10,000 sq. ft. per floor, located in Paterson, New Jersey area—good labor—low tax area.

Would cooperate in working out desirable lease with interested company. Might even interest myself financially in established business

CHARLES H. READE, Owner

135 Hoboken Ave., Jersey City 2, N. J.
O1. 3-3012

R A D A R

From Stock Delivery
Skysweep Antenna Pedestal. SCR 581 & 784 Search-track Radars. MPN-1B GCA. APS-10. APS-31. APS-33 Airborne.
Navy Weather-Eye Radars
Microwave plumbing—over 1,000 items.
RADIO RESEARCH INSTRUMENT CO.
550 Fifth Avenue, N. Y. 36, N. Y. JUdson 6-4691

400 CYCLE GENERATORS also variable frequency

Large stock on hand

Write for catalogs

RELIABLE ELECTRIC MOTOR REPAIR CO.
19 California Ave. Paterson, N. J.

APR-TUNING UNITS

Each tuning unit has an accurately-calibrated manual vernier tuner continuous over its range, in addition to automatically-reversing motor-driven scanning of its spectrum.

TN-APR (38-95 MC) uses a 6AK5 RF amplifier stage, a 9002 mixer, and a 9002 oscillator. A 4-gang capacitor and adjustable iron core coils are used in conventional circuits. IF rejection is improved by a 30-MC wave trap in the antenna circuit. \$16.95.

TN/APR-(74-320 MC) uses butterfly units as RF and Osc. tanks. No RF tube is used. The Mixer and Osc. each use a 955. The antenna circuit contains an IF-rejection wave trap. \$24.95.

TN/APR-(300-1000 MC) RF and Osc. tanks are butterfly units. No RF tube is used. The 2nd harmonic of the 955 oscillator beats in the 1N21B crystal mixer with the RF signal to produce 30 MC IF. To reduce spurious response from beating of the oscillator fundamental in the 1N21B with lower RF signals, a high-pass filter is used in the antenna circuit. \$39.50.

TN-19/APR-4 (975-2200 MC) uses a tuned resonant cavity for RF preselection and a 703A tube in a butterfly circuit for local oscillator. Oscillator output is fed through four 1N21B crystals to produce a harmonic-rich voltage which is coupled into the RF cavity. A third loop in the cavity couples both RF and Osc. output into another 1N21B crystal which mixes the RF signal with the 3rd harmonic of the oscillator signal to produce 30 MC IF. \$89.50.

VHF UHF

AN/APR-4 38-4000 mc RECEIVER

—This is a precision receiver covering 38-4000 mc. The set utilizes 5 tuning units with direct reading dials in megacycles. The receiver has a wide and narrow band-width 30 mc I.F. strip which may be selected at will.

An output meter is provided to measure signal strength. Outputs are provided for a pulse analyzer and pan adaptor 110-v AC, 60-2600 cycle. With 3 tuning units 38 to 1000 mc. Excellent. \$159.50.

With 4 tuning units 38-2200 MC, \$239.50

LM Frequency meter heterodyne, crystal calibrated. Modulated covering frequencies from 125KC to 20,000KC continuously. This equipment provides accuracies of .02% in the 125 to 2000KC band and .01% in the 2000 to 20,000KC band. With original calib. book and crystal.
Brand New \$59.50
Excellent \$39.50

AN/APR5A—Airborne superhet radar search rec. Freq. range 1000 to 6100 MC. Rec. has a 10 MC IF band width operating from 80/115V AC, single phase 60 to 2600 cps. and one amp. at 26V DC—complete with tubes. \$89.50

Measurements Corp Pulse Generator Model 79B-60 to 100,000 pulses per second, which can be locked with a sine wave or other external source when frequency accuracy is needed. Pulse width 0.5 microseconds & delay time not more than 25% pulse width (at 70% peak). Output voltage is approx. 150 volts to 200 volts peak positive with respect to ground. Cathode follower output with 1000 ohm impedance. Sync. output is 35 volt displaced by 1/2 period from pulse output. Sync. input may be as little as 2 volts. 110 volts, 60 cycle, 115 watts. Excellent..... \$69.50
MD4 - RT - 15
3 cm radar modulator, rec. and trans. complete with all tubes, Magnetron 725 A, 2 ea. 723/AB, 829B, 715B, etc. Excellent..... \$39.50

R W ELECTRONICS

Dept. L

2430 S. Michigan Ave.
Chicago 16, Ill.

Electronic LABORATORY SUPPLY COMPANY

LITTON INDUSTRIES TYPE 4J52 MEGNETRONS

New, Original Factory-Sealed Boxes

SPECIAL PRICE \$120.00 ea. Net F.O.B. San Francisco. Absolutely Guaranteed.

Write for special price on quantity purchases.

2708 GERMANTOWN AVENUE • PHILADELPHIA 19, PENNSYLVANIA • CHEstnut Hill 8-2700

All Brand RESISTORS

Type J Potentiometers Single-Duals-Triples
Type G Miniature Potentiometers
By Return Mail . . . From Stock

LEGRI S COMPANY

391 Riverdale Ave. Yonkers 5, N. Y.

INDEX TO ADVERTISERS

● A C Electronics Division.....	111	● Hart Mfg. Co.	124
● Ace Electronics Associates, Inc.	94	● Haydon Company, A. W.	123
Aeronutronic	115	Haydon, Stone & Co.	130
● Airpax Electronics, Inc.	43	● Hewlett-Packard Company	46
● Alford Mfg. Co.	123	● Hoffman Electronics Corporation	105
● Allegheny Ludlum Steel Corporation..	91	● Hughes Aircraft Company	27, 28, 29, 30, 132, 133
Allied Chemical Corp.		● Hycon Eastern, Inc.	120
General Chemical Division	129		
● Allied Control Inc.	89	I-T-E Circuit Breaker Company	36
● American Super-Temperature Wires, Inc.	50	● Industrial Test Equipment Co.	119
● Ampex Corporation	22, 23	Inso Electronic Products, Inc.	12
● Amphel-Borg Electronics Corp.		● International Resistance Company....	7
Borg Equipment Division	92, 93		
● Art Wire and Stamping Co.	122	● Jerrold Electronics Corporation	44
● Atlas Precision Products Co.	100		
		Kleinschmidt Division of Smith-Corona Marchant, Inc.	48
● Bendix Aviation Corp.			
Pioneer Central Div.	118	● Lambda Electronics Corp.	3
● Bendix-Pacific	122	● Lapp Insulator Co., Inc.	88
● Boeing Aircraft Co.	42	Lockheed Missiles & Space Division..	8, 9
● Brady Co., W. H.	109		
● Bureau of Engraving, Inc.	47	● Marconi Instruments	98
		● Marion Instrument, Division of Minneapolis-Honeywell	114
● Carr Fastener Company Division of United Carr	45	● McGraw-Hill Book Co., Inc.	97
Chemo Products, Inc.	112	● McGraw-Hill Publishing Co., Inc.	52, 53
● Cinch Mfg. Co.	75	● Mullard Ltd.	6
● Clare & Co., C. P.	13		
● Clevite Corporation	15	Magnetic Devices, Inc.	109
● Cly-Del Mfg. Co.	121	● Mallory & Co., Inc., P. R.	54
Computer-Measurements Corporation..	77	● Marconi Instruments	98
● Coto-Coil Co., Inc.	97	Marion Instrument, Division of Minneapolis-Honeywell	114
● Cross Co., H.	119	● McGraw-Hill Book Co., Inc.	97
		● McGraw-Hill Publishing Co., Inc.	52, 53
● Dale Products, Inc.	85	● Mullard Ltd.	6
● DeMornay-Bonardi	114		
● Deutsch Company	80	Nical Division, Gould-National Batteries Inc.	104
● Dialtron Corp.	118	● Northeastern Engineering, Inc.	108
● du Pont de Nemours & Co., Inc., E. I. Polychemicals Dept.	17, 18, 19, 20		
● Durant Mfg. Co.	144	Parker Seal Company	99
		● Peerless Electric Co.	92
● Eastern Industries, Inc.	125	● Philadelphia Insulated Wire Co.	33
● Edgerton Germeshausen & Grier, Inc.	102	● Polarad Electronics Corporation....	37, 38
● Edo Corporation	113	Polytechnic Research & Development Co., Inc.	123
● Eitel-McCullough Inc.	10		
● Electronic Instrument Co. (Eico)....	114	● Radio Corporation of America	103, 4th Cover
● Electronic Organ Arts Inc.	119	● Raytheon Mfg. Co.	131, 2nd Cover
● Electronics	109	● Rex Corporation, The	21
● Epsco, Inc.	117	Rondo of America, Inc.	115
● Esterline-Angus Co., Inc.	130	● Rust Industrial Co., Inc.	113
● Fairchild Semiconductor Corp.	35	● Sanborn Company	21, 25
● Fugle-Miller Laboratories, Inc.	121	Sangamo Electric Company....	83
		Silverman's	115
● General Electric Co.		● Sorensen & Company, Inc.	81
Apparatus Div.	106	● Sprague Electric Company	5
General Instrument Corporation		● Stackpole Carbon Company	49
Semi Conductor Division	51		
F. W. Sickles Division	107		
● General Transistor Corporation	101		
● Graphic Systems	119		
● Greene-Shaw Company Inc.	114		



The Westinghouse hermetically sealed, Polyclad Hipermag core is the newest development in cores for magnetic amplifier applications. Applied over a new specially designed aluminum box housing the core, Polyclad insulation hermetically seals the core and allows encapsulating, casting or impregnating without altering magnetic properties. This special core:

- Stops magnetic amplifier rejects caused by changed magnetic values.
- Is suitable for all environmental conditions — high temperatures, humidity and high-voltage stress.
- Eliminates costly core taping.
- Is tested by Roberts constant-current, flux reset technique, or to your specification.

Available in production lots with normal delivery, these cores are supplied in special sizes or in standard AIEE sizes.

For more information about these or other Hipermag or Hipersil® cores, call your Westinghouse representative . . . or write Westinghouse Electric Corporation, P.O. Box 231, Greenville, Pennsylvania. J-70855

YOU CAN BE SURE...IF IT'S
Westinghouse

WATCH "WESTINGHOUSE LUCILLE BALL-DESI ARNAZ SHOWS"
CBS TV MONDAYS

CIRCLE 170 READERS SERVICE CARD

DURANT

DIGITAL READ-OUT COUNTERS

Model "Y" SERIES

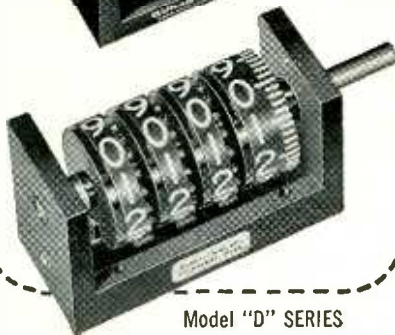

Model "D" SERIES

for MISSILE TRACKING,
RADAR CONTROLS, COMPUTERS,
NAVIGATION INSTRUMENTS,
GAUGING INSTRUMENTS, and
ANY other indicator applications.

- Meets military specifications.
- High speeds, lower torque, lower moment of inertia for long life.
- Nylon wheels with legible figures, nylatron pinions.
- Single, 1 1/2, or double width wheels.
- One-piece aluminum die cast frame.
- Base mounting. Threaded mounting holes may be in frame top or ends.
- Right or left hand drive, clockwise or anti-clockwise rotation.
- "Y" Series, single or dual bank types.
- Component parts can be purchased separately to meet design requirements.

Your answer to an infinite number
of variable demands
for PRECISION CONTROLS.

Send for Catalog No. 400

DURANT
MANUFACTURING COMPANY

1912 N. Buffum Street
Milwaukee 1, Wisconsin

12 Thurbers Avenue
Providence 5, R. I.

REPRESENTATIVES IN ALL PRINCIPAL CITIES
CIRCLE 171 READERS SERVICE CARD

• Standard Electric Time Co.	2
Stanpat Co.	132
Superior Cable Corp.	64

Technical Information Corporation...	87
• Tensolite Insulated Wire Co., Inc.	16
• Texas Instruments Incorporated, 3rd Cover Thermal American Fused Quartz Co., Inc.	26
• Tohe-Deutschmann Corp.	110
• Transatron Electronic Corporation	41
• Tung-Sol Electric Inc.	79

Veeder-Root, Inc.	34
• Vitramon Inc.	97

Weckesser Co.	113
• Weinschel Engineering	14
West Penn Power	116
Westinghouse Electric Corp.	126, 143
Weston Electrical Instrument Corp.	31

Professional Services	140
----------------------------	-----

CLASSIFIED ADVERTISING

F. J. Eberle, Business Mgr.

EMPLOYMENT OPPORTUNITIES	134-142
--------------------------	---------

SPECIAL SERVICES	139
------------------	-----

EQUIPMENT (Used or Surplus New) For Sale	142
--	-----

ADVERTISERS INDEX

Barry Electronics Corporation.....	142
Bendix Aviation Corporation, Bendix Products Div. Missiles Guided..	134
Burrhoughs Corporation	141
Electronic Laboratory Supply Co.....	142
General Dynamics Electric Boat Div....	140
Gibson Company, J. H.	142
Gilfillan Brothers, Inc.	142
Goodyear Aircraft Corporation	135
International Business Machines Corp....	137
Kemet Company, Div. of Union Carbide Corp.	139
Kollsman Instrument Corporation	140
Laboratory for Electronics	134
Legri S. Company	142
Motorola Incorporated	139
Norden Laboratories, Norden div. United Aircraft Corp.	136
Radio Research Instrument Company.....	142
Reade, Charles H.	142
Reliable Electric Motor Repair Co.....	142
Republic Aviation Corporation	134-138
R W Electronics	142
Scientists, Engineers & Executives Inc...	134
Sylvania Electric Products Inc.	137

• See advertisement in the June, 1958 Mid-Month
ELECTRONICS BUYERS' GUIDE for complete line
of products or services.

This index is published as a service. Every care is taken
to make it accurate, but ELECTRONICS assumes no
responsibilities for errors or omissions.

BETTER PRODUCTS



Businesspaper advertising brings you information on new and better products, alerts you to new processes and production methods by which you can improve your own products. That's why it pays to read the advertising in your businesspaper. Helps you keep an ear to the ground for new and important developments you can put to work — profitably.

Advertising works for you!

LOWER PRICES



Businesspaper advertising helps to lower prices of the products you buy and sell by broadening markets, building sales volume, bringing you cost-saving opportunities. When you're looking for ways to lower costs and prices . . . give better value . . . and improve profits, it's the editorial pages of your businesspapers that tell you *how*—and the advertising pages that tell you *with what*.

Advertising works for you!

MORE JOBS



Businesspaper advertising helps create demand, improve products, step-up production, distribution and sales. With new companies, new factories, new products, new services constantly being developed, you get a healthy, vigorous economy—a full-employment economy. Yes, sir! Advertising works. And it works for you.

Advertising works for you!



Advertising Federation of America
Advertising Association of the West



Prepared for AFA and AAW by the Associated Business Publications in the interest of better understanding of businesspaper advertising.

NEW TI HIGH FREQUENCY DIFFUSED-BASE GERMANIUM TRANSISTORS

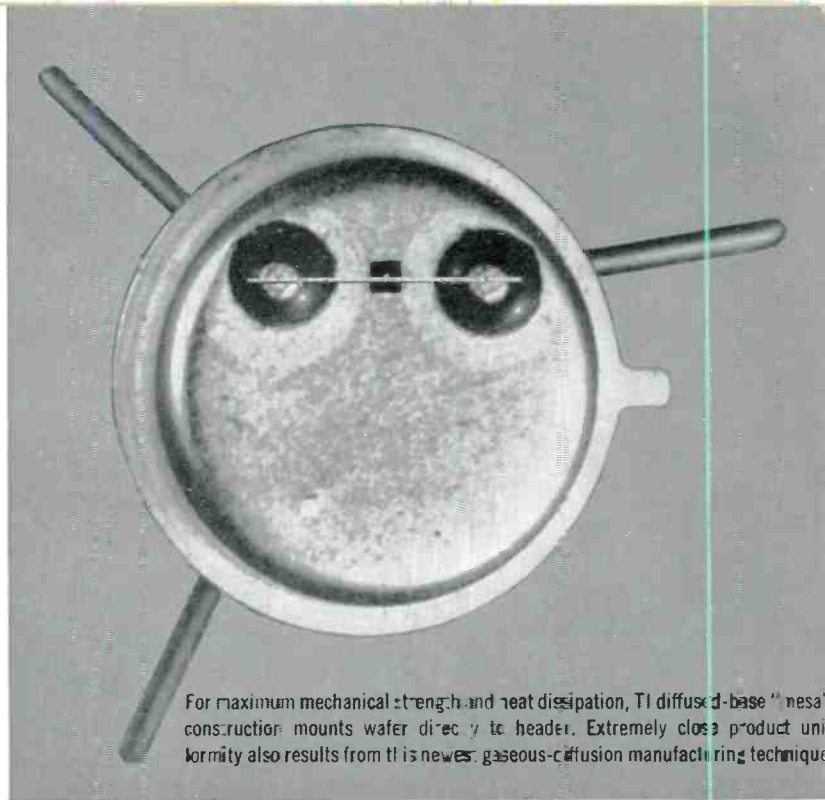

For maximum mechanical strength and heat dissipation, TI diffused-base "mesa" construction mounts wafer directly to header. Extremely close product uniformity also results from TI's newest, gaseous-diffusion manufacturing technique.

750 MC • 750 mW
ALPHA CUTOFF MAX DISSIPATION

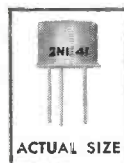

Guaranteed current gains of 12, 10 and 8 db minimum at 100 mc with new TI 2N1141, 2N1142 and 2N1143 diffused-base germanium transistors! Alpha cutoff ratings up to 750 mc coupled with 750 mW power dissipation at 25°C case temperature make these newest TI transistors ideal for military high frequency power oscillators and amplifiers where assured reliability and performance are of primary importance.

All units are 100% production stabilized at temperatures well above their 100°C rated junction operating point . . . exceed MIL-T-19500A specifications . . . and are *in stock now*.

Contact your nearest TI sales office or nearby TI distributor *today* . . . for immediate delivery.

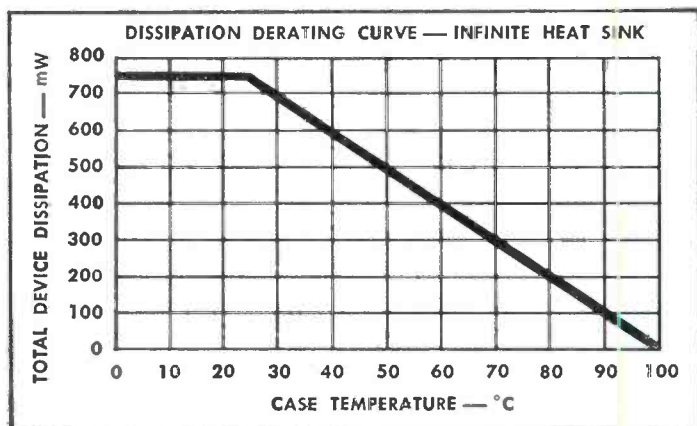

absolute maximum ratings @ 25°C case temperature

	2N1141	2N1142	2N1143
Collector Voltage Referred to Base	-35	-30	-25 V
Emitter Voltage Referred to Base	-1	-0.7	-0.5 V
Collector Current	-100	-100	-100 mA
Emitter Current	100	100	100 mA
Device Dissipation (infinite heat sink)	750	750	750 mW
Collector Junction Temperature	+100	+100	+100 °C
Storage Temperature Range	-65 to +100 °C		

typical characteristics @ 25°C case temperature

Frequency Cutoff (Common Base)	750	600	480 MC
Collector Reverse Current, $V_{CR} = -15V, I_E = 0$	1	1	1 μA
Saturation Voltage, $I_C = -70mA, I_B = 17.5mA$	2	2	2 V
Thermal Resistance Junction to Mounting Base	0.1	0.1	0.1 °C/mW
Small Signal Short Circuit Forward Current Transfer Ratio, $10 I_C$	10 I_C	50 I_C	100 I_C mA
$V_{CB} = -10V, f = 1000cps$	0.97	0.85	0.75



from THE WORLD'S LARGEST SEMICONDUCTOR PLANT



**TEXAS INSTRUMENTS
INCORPORATED**

SEMICONDUCTOR-COMPONENTS DIVISION
POST OFFICE BOX 312 • 13500 N. CENTRAL EXPRESSWAY
DALLAS, TEXAS

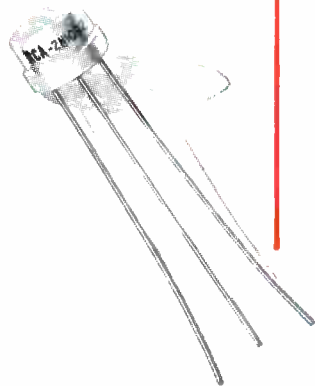
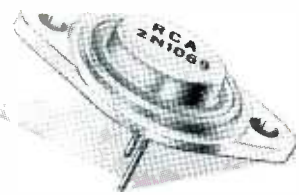

5 new

RCA

DIFFUSED-JUNCTION MESA

Silicon Transistors

...with excellent beta stability from -65°C to $+175^{\circ}\text{C}$ and exceptionally low saturation resistance!

- 2N1092—medium power
- 2N1067—intermediate power
- 2N1068—intermediate power
- 2N1069—high power
- 2N1070—high power

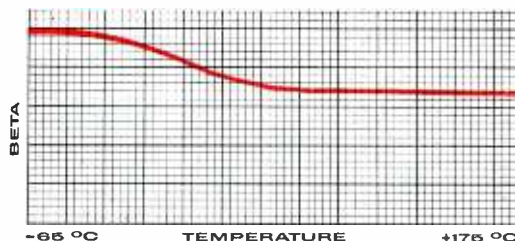

RCA's new n-p-n silicon transistors offer significant reductions in saturation resistance, and feature excellent beta stability over the entire operating temperature range. These features result from use of RCA's advanced diffused-junction mesa technique. These transistors are designed to meet stringent military environmental, mechanical, and life test requirements.

RCA silicon transistors offer the equipment designer a wide choice of power-switching capability in preferred industry

cases (JEDEC TO-3, TO-8, and TO-9).

RCA SILICON TRANSISTORS are commercially available in limited quantities. Your RCA Field Representative has complete information on these units and will be glad to discuss with you other silicon transistors now under development. For technical data on the 2N1092, 2N1067, 2N1068, 2N1069, and 2N1070, write RCA Commercial Engineering, Section D-19-NN2, Somerville, N. J.

EAST: 744 Broad St., Newark, N.J., HUboldt 5-3900

NORTHEAST: 64 "A" Street, Needham Heights 94, Mass. HILcrest 4-7200

EAST CENTRAL: 714 New Center Bldg., Detroit 2, Mich. TRinity 5-5600

CENTRAL: Suite 1154, Merchandise Mart Plaza Chicago, Ill. WHitehall 4-2900

WEST: 6355 E. Washington Blvd., Los Angeles, Calif. RAymond 3-8361

GOV'T: 224 N. Wilkinson St., Dayton, Ohio BALdwin 6-2366
1625 "K" Street, N.W., Washington, D.C., DIstrict 7-1260

Type	JEDEC Outline	ABSOLUTE-MAXIMUM RATINGS				CHARACTERISTICS											
		Vces [Ⓢ] (volts)	Vceo [Ⓢ] (volts)	Collector (amp.)	Transistor Dissip. \ddagger (watts)	At Case Temperature of 25°C						At Case Temperature of 175°C					
						Saturation Resistance			DC Current Gain (Beta)			DC Collector Cutoff Current (Icbo)			DC Collector Cutoff Current (Icbo)		
						Typical	Max.	Conditions	Typical	Min.	Conditions	Typical	Max.	Conditions	Typical	Max.	Conditions
2N1092	TO-9	60	30	0.5	1	3	10	Ic=200 ma.	20	10	Ic=200 ma.	75	1000	Vcbo=30 volts			
2N1067	TO-8 [Ⓢ]	60	30	0.5	2.5	3	10	Ic=200 ma.	35	15	Ic=200 ma.	75	1000	Vcbo=30 volts			
2N1068	TO-8 [Ⓢ]	60	30	1.5	5	1	2.67	Ic=750 ma.	38	15	Ic=750 ma.	75	1000	Vcbo=30 volts			
2N1069	TO-3	60	45	4	25	0.7	2	Ic=1.5 amp.	20	10	Ic=1.5 amp.	150	2000	Vcbo=30 volts			
2N1070	TO-3	60	45	4	25	0.4	0.67	Ic=1.5 amp.	20	10	Ic=1.5 amp.	150	2000	Vcbo=30 volts			

[Ⓢ] "Heat-Sink" mounting clamp supplied.
[Ⓢ] Collector-to-emitter breakdown voltage with base connected to emitter.

[Ⓢ] Collector-to-emitter breakdown voltage with base open.
[Ⓢ] At a case temperature of 100°C.



RADIO CORPORATION OF AMERICA
Semiconductor & Materials Division
Somerville, N. J.