

A MCGRAW-HILL PUBLICATION

PRICE ONE DOLLAR

OCTOBER 10, 1958

# electronics

engineering issue

**Sending Undersea  
Ordnance Data**

... p 86

**New Ferrite  
Plate Memory**

...p 100

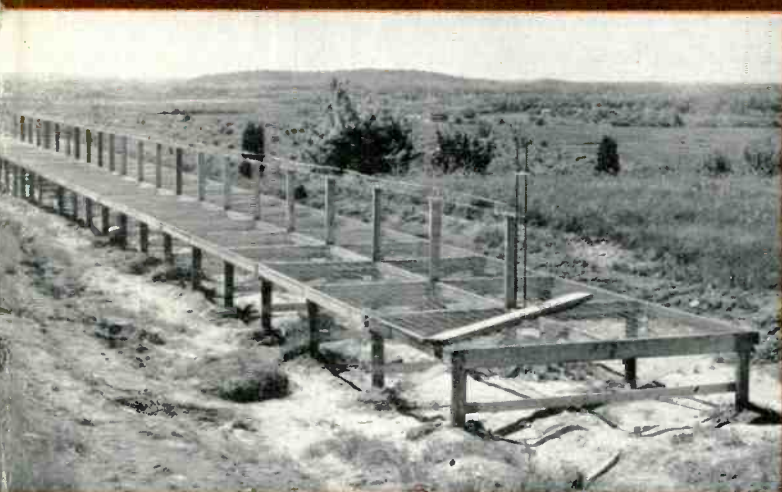

**Tracking Our**

**Satellite**

...page 81





# For Your Special Applications

The bulk of UTC production is on special units designed to specific customers' needs. Illustrated below are some typical units and some unusual units as manufactured for special applications. We would be pleased to advise and quote to your special requirements.

## FILTERS

All types for frequencies from .1 cycle to 400 MC.



400 — telemetering, 3 db at  $\pm 7.5\%$ , 40 db at 230 and 700 —,  $\frac{3}{8}$  x  $1\frac{1}{4}$  x 2"

15 — BP filter, 20 db at 30 —, 45 db at 10 —, phase angle at CF less than 3° from —40 to +100° C.

LP filter with 1 db to 49 KC, stable to 1 db from 0 to 85° C., 45 db at 55 KC.

LP filter less than .1 db 0 to 2.5 KC, 50 db beyond 3 KC.



Tuned DO-T servo amplifier transformer, 400 — .5% distortion.

Toroid for printed circuit, Q of 90 at 15 KC.

Dual toroid, Q of 75 at 10 KC, and Q of 120 at 5 KC.

HVC tapped variable inductor for 3 KC oscillator.

## HIGH Q COILS

Toroid, laminated, and cup structures from .1 cycle to 400 MC.

## SPECIALTIES

Saturable reactors, reference transformers, magnetic amplifiers, combined units.



RF saturable inductor for sweep from 17 MC to 21 MC.

Voltage reference transformer .05% accuracy.

Multi-control magnetic amplifier for airborne servo.

Input, output, two tuned interstages, peaking network, and BP filter, all in one case.



Wound core unit .01 micro-second rise time.

Pulse current transformer 100 Amp.

Pulse output of magnetron, bifilar filament.

Precise wave shape pulse output, 250V, 3 Amps.

## PULSE TRANSFORMERS

From miniature blocking oscillator to 10 megawatt.

## POWER COMPONENTS

Standard and high temperature . . . hermetic, molded, and encapsulated.



Multi-winding 140 VA, 6 KC power transformer  $1\frac{1}{4}$  x  $1\frac{1}{4}$  x 1"

200° C. power transformer, 400 —, 150 VA.

400 — scope transformer, 20 KV output.

60 — current limiting filament transformer, Sec. 25 Mmfd., 30 KV hipot.

# UNITED TRANSFORMER CORPORATION

150 Varick Street, New York 13, N. Y. • EXPORT DIVISION: 13 E. 40th St., New York 16, N. Y., CABLES: "ARLAB" PACIFIC MFG. DIVISION, 4008 W. Jefferson Blvd., Los Angeles, Cal.

# electronics engineering issue

A McGRAW-HILL PUBLICATION • VOL. 31, NO. 41 • OCTOBER 10, 1958

H. W. MATEER, *Publisher*

JAMES GIRDWOOD, *Associate Publisher*

W. W. MacDONALD, *Editor*

*Managing Editor*, John M. Carroll.

*Feature Editor*, John Markus.

*Associate Editors*: John M. Kinn, Jr., Frank Leary, Michael F. Tomaino, Howard K. Janis, Sylvester P. Carter, Haig A. Manoogian, Roland J. Charest, William P. O'Brien, George Sideris, Edward DeJongh, John F. Mason, William E. Bushor, Ronald K. Jurgen, Thomas Emma, Patrick J. Lahey, Samuel Weber.

*Pacific Coast Editor* (Los Angeles) Harold C. Hood; *Midwestern Editor* (Chicago) Harold Harris; *New England Editor* (Boston) Thomas Maguire.

*Art Director*, Harry Phillips, Roy Thompson.

*Production Editor*, John C. Wright, Jr., Bernice Duffy, Jean L. Matin.

*Research*, Charles B. Graham, Marilyn Koren.

*Editorial Assistants*: Gloria J. Filiopone, Arlene Schilp, Patricia Landers, Catherine McDermott.

JAMES GIRDWOOD, *Advertising Sales Manager*, R. S. Quint, *Assistant Advertising Sales Manager and Buyer's Guide Manager*. Fred Stewart, *Promotion Manager*. Frank H. Ward, *Business Manager*. George E. Pomeroy, *Classified Manager*. Hugh J. Quinn, *Acting Circulation Manager*.

*New York*: Donald H. Miller, Henry M. Shaw, Martin J. Gallay. *Boston*: Wm. S. Hodgkinson. *Philadelphia*: James T. Hauptli. *Chicago*: Bruce Winner. *Cleveland*: Warren H. Gardner. *San Francisco*: T. H. Carmody, R. C. Alcorn. *Los Angeles*: Carl D. Dysinger, D. A. McMillan. *Denver*: J. Patten. *Atlanta*: M. Miller. *Dallas*: Gordon L. Jones, Robert T. Wood. *London*: E. E. Schirmer. *Frankfurt*: Michael R. Zeynel.

## Issue at a Glance

**Tracking Satellites.** Meridian transits of orbiting earth satellites are detected with accuracy of less than one second by 22-element dual-terminal interferometer. See p 81. . . . . **COVER**

**Business Briefs** . . . . . **p 7**

Electronics Newsletter . . . . .	7	Military Electronics . . . . .	14
Figures of the Week . . . . .	7	Magnetics Control <i>Triton</i> . . . . .	14
Test 'Copter Systems . . . . .	8	17 Airlines Order New Jet Trainer . . . . .	16
NEC Offering Varied Program . . . . .	8	Financial Roundup . . . . .	16
X-Ray Amplifier Cuts Exposure . . . . .	12	EE Grads Soon Find Jobs . . . . .	16
Washington Outlook . . . . .	12	Television Saves Money for Bank . . . . .	20
Study Printed Cryotron Circuits . . . . .	14	Accelerating Radiography . . . . .	20
Meetings Ahead . . . . .	20		

**Keeping Track of Earth Satellites.** Twenty-two element proximity coupled array in conjunction with special receiver circuits records time of satellite meridian transit . . . . . **p 81**  
By C. J. Sletten, C. R. Forbes, Jr., and L. F. Shodin

**Telemeter System Relays Undersea Ordnance Data.** Test data for development and evaluation of underwater weapons are transmitted to shore by a four-channel telemetering system . . . . . **p 84**  
By M. J. Aucremanne and D. D. Woolston

**Electronics Determines Cement Setting Time.** Cement paste used as dielectric of test capacitor enables easy and accurate determination of admittance which is proportional to cement setting time . . . . . **p 88**  
By J. M. Tobio

**Universal Tape Amplifiers for Digital Data Systems.** Read and write amplifiers are specially designed for data processing application and to meet requirements of existing digital systems . . . . . **p 91**  
By Robert F. Shaw

**Discriminator Controls Aircraft Alternator.** At 400 cps, discriminator has 100 millivolt d-c output with a frequency deviation of  $\pm \frac{1}{2}$  cps . . . . . **p 94**  
By Roger Hill

**Mobile Radio System Provides 920 Channels.** Improved bandpass filter techniques, used in military transceiver, double the number of channels per megacycle of spectrum . . . . . **p 96**  
By Frank Brauer and Don Kammer

**DIGEST CONTINUED ON NEXT PAGE**



## DIGEST continued

**End-Fired Memory Uses Ferrite Plates.** Flux induced around holes in ferrite plates is used to store digital information..... p 100  
By V. L. Newhouse, N. R. Kornfield and M. M. Kaufman

**Low-Pass R-C Filter With Optimum Response.** Two-section R-C filter is easily designed for optimum response with formulas and graphs... p 104  
By Dudley D. Nye, Jr.

**Temperature Rise Chart.** Resistance-change figures in copper-wire component provide direct reading of temperature rise..... p 106  
By Donald Arany

**Electrons At Work**..... p 108

Control Regulates Iron Lung..... 108	Calibrator Plots ADF Errors..... 115
Neon Oscillator Rings..... 108	Selective Calling Tested..... 117

By Ronald L. Ives

**Component Design**..... p 118

The Hall-Effect Circulator..... 118	Crossed-Field T-W Tube..... 122
Preassembled Parts..... 120	Rotary Wafer Switch..... 124

**Production Techniques**..... p 128

Liquid Plastic Laminates Glass... 128	Machine Welds Part Pigtailed... 130
Wire Pails Cut Winding Costs... 128	Readout Tube Parts Are Stacked... 131

Bicarbonate Strips Insulation.... 134

**New Products**..... p 136

**Literature of the Week**..... p 178

**Plants and People**..... p 180

**News of Reps.**..... p 186

**New Books**..... p 187

**Comment**..... p 192

**Index to Advertisers**..... p 206

# electronics

Oct. 10, 1958 Vol. 31, No. 41

Published weekly, with alternating engineering and business issues and with a BUYERS' GUIDE issue in mid-June, by McGraw-Hill Publishing Company, Inc., James H. McGraw (1860-1948) Founder.

Executive, Editorial, Circulation and Advertising Offices: McGraw-Hill Building, 330 W. 42 St., New York 36, N. Y. Longacre 4-3000. Publication Office: 99-129 North Broadway, Albany 1, N. Y.

See panel below for directions regarding subscription or change of address. Donald C. McGraw, President; Joseph A. Gerardi, Executive Vice President; L. Keith Goodrich, Vice President and Treasurer; John J. Cooke, Secretary; Nelson Bond, Executive Vice President, Publications Division; Ralph B. Smith, Vice President and Editorial Director; Joseph H. Allen, Vice President and Director of Advertising Sales; A. R. Venezian, Vice President and Circulation Coordinator.

Single copies \$1.00 for Engineering Issue and 50¢ for Business Issue in United States and possessions, and Canada; \$2.00 and \$1.00 for all other foreign countries. Buyers' Guide \$3.00. Subscription rates—United States and possessions, \$6.00 a year; \$9.00 for two years; \$12.00 for three years. Canada, \$10.00 a year; \$16 for two years; \$20.00 for three years. All other countries, \$20.00 a year; \$30.00 for two years; \$40.00 for three years. Second class postage paid at Albany, N. Y. Printed in U.S.A. Copyright 1958 by McGraw-Hill Publishing Co., Inc.—All Rights Reserved. Title registered in U. S. Patent Office. BRANCH OFFICES: 520 North Michigan Avenue, Chicago 11; 68 Post Street, San Francisco 4; McGraw-Hill House, London E. C. 4; 15, Landgrat-Wilhelm, Frankfurt/Main; National Press Bldg., Washington 4, D. C.; Six Penn Center Plaza, Philadelphia 3; 1111 Henry W. Oliver Bldg., Pittsburgh 22; 55 Public Square, Cleveland 33; 856 Penobscot Bldg., Detroit 26; 3615 Olive St., St. Louis 8; 350 Park Square Bldg., Boston 16; 1321 Rhodes-Haverty Bldg., Atlanta 3; 1125 West Sixth St., Los Angeles 17; 1740 Broadway, Denver 2. ELECTRONICS is indexed regularly in The Engineering Index.

Subscriptions: Address correspondence to: Fulfillment Manager, Electronics, 330 W. 42nd St., New York 36, N. Y. Allow one month for changes of address, stating old as well as new address. Subscriptions are solicited only from persons engaged in theory, research, design, production, management, maintenance and use of electronics and industrial control components, parts and products. Position and company connection must be indicated on subscription orders.

Postmaster: please send form 3579 to Electronics, 330 W. 42nd St., New York 36, N. Y.



Member ABP and ABC



NEW

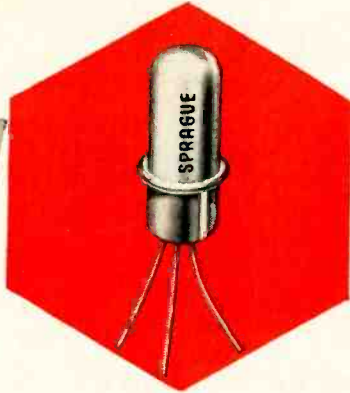

2N393		
	Min.	Typ.
$h_{fe}$	40	155
$f_{max}$	40	60

## HIGH-SPEED, HIGH-GAIN 2N393 TRANSISTORS for modern computer circuitry

Type 2N393 Micro-Alloy Transistors combine high gain with excellent high frequency response to meet demands of high-speed computer switching applications in the megacycle range. Low saturation resistance, low hole storage, and exceptionally good life characteristics make micro-alloy transistors top performers in general high frequency applications, as well as computer circuits.

D-C  $\beta$  is remarkably linear up to 50 milliamperes collector current. The design of the 2N393 is particularly well adapted to direct-coupled logic circuitry. The polarities of the emitter and collector voltages are similar to those of PNP junction-type transistors.

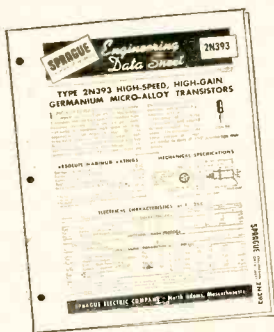

Both micro-alloy and surface barrier transistors are now being made in Sprague's completely new semiconductor facility. Quantity orders for the popular types shown here are shipped promptly. Or get fast delivery on small quantities from your local Sprague Industrial Distributor.

For complete engineering data sheets of the types in which you are interested, write Technical Literature Section, Sprague Electric Co., 35 Marshall St., North Adams, Massachusetts.

\* Sprague micro-alloy and surface barrier transistors are fully licensed under Philco patents. All Sprague and Philco transistors having the same type numbers are manufactured to the same specifications and are fully interchangeable. You have two sources of supply when you use micro-alloy and surface barrier transistors!

SPRAGUE COMPONENTS:  
TRANSISTORS • RESISTORS • MAGNETIC COMPONENTS  
CAPACITORS • INTERFERENCE FILTERS • PULSE NETWORKS  
HIGH TEMPERATURE MAGNET WIRE • PRINTED CIRCUITS

ELECTRONICS engineering issue — October 10, 1958

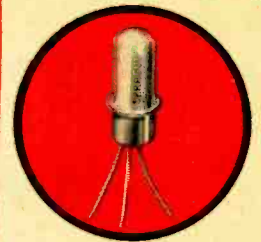

2N128  
MIL GENERAL PURPOSE  
(MIL-T-12679A)

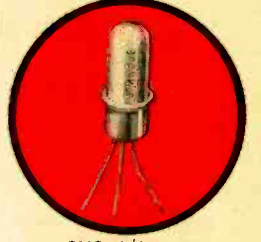

2N240/SB5122  
FOR COMPUTER  
SWITCHING

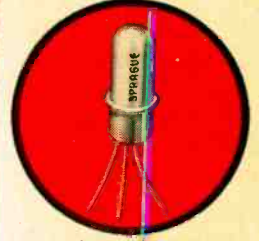

2N344/SB101  
FOR MEDIUM GAIN  
AMPLIFIERS

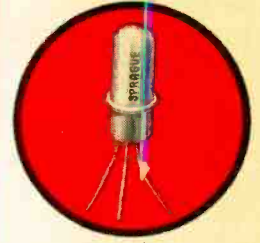

2N345/SB102  
FOR HIGH GAIN  
AMPLIFIERS



2N246/SB103  
FOR HIGH FREQUENCY  
OSCILLATORS

**SPRAGUE**®

the mark of reliability

# Need a Fastener that Hasn't Been Invented?

*Chances are you'll pay top price for it.*

*But by following these six rules you can*

*avoid the high cost of becoming an inventor!\**

**I**T'S natural to assume that, after designing a piece of equipment, you'll have no trouble finding standard fasteners to fit it. Usually such fasteners will be readily available. But what happens when you find yourself with a finished design that doesn't lend itself to any known fastening method?

The most expensive thing you can do at this point is to start inventing fasteners. Valuable man hours go into research, design, prototypes and testing. And unless you can make these fasteners in very large quantities the unit cost will be high, particularly if tooling is necessary.

*Now, here are six tips that can get you out of trouble—and keep you out:*

1. Remember—not all standard specialty fasteners are listed in fastener manufacturers' catalogs. The fastener company that serves you is probably tooled up for hundreds of non-standard devices, designed and produced to solve problems like yours for other customers. Maybe one would meet your requirements. You'd save the development and tooling charges.

2. There may be a stock fastener available for this job that hasn't come to your attention. Discuss the problem with the fastener manufacturer. If he has nothing in stock, he may be able to modify one of his standard devices at very nominal extra cost.

3. Don't overlook free professional help! Your fastener manufacturer will be glad to offer advice and design service—he does it for everyone else. Unload the problem on him, and let his experience work for you.

But you'll save money if you avoid specifying the fastener that hasn't been invented. By following the next three rules you can usually keep from reaching the point where a non-standard device might be necessary.

4. Go into the fastening problem during the early stages of design. Design your closures with standard fastenings in mind. You won't be left with the costly choice of inventing a fastener or redesigning your product.

5. Keep a complete file of fastener manufacturers' catalogs. Your product designers seldom are fastener specialists too, but they can have complete information available when they need it—at the design level.

6. Work closely with the Fastener Sales Engineer who calls on you. He's trained and paid to help solve your problems. Take full advantage of this service.

Whether you need a standard specialty fastener or the one that hasn't been invented, Southco is well qualified to invite your inquiries. There's no obligation on your part. It's part of our business to offer free consultation at the design or production levels, on items of your own product line, or on those involving military specifications.

Send today for our forty-four page Fastener Handbook No. 8, just printed. Write to Southco Division, South Chester Corporation, 233 Industrial Highway, Lester, Pa.

\* Reprints of this page are available on request.

**SOUTHCO**

© 1958

**FASTENERS**



new

Frequency

anger

RANGE of FREQUENCIES... EXCELLENT REGULATION

... LOW DISTORTION

This NEW FCR100—latest addition to the Sorensen line of Frequency Changers—supplies a frequency range from 45 to 2000 cycles with exceedingly good wave form, and matches the other Sorensen Frequency Changers in uniformly excellent performance.

The low output harmonic distortion, with consistently reliable regulation of frequency and voltage, makes each of these Frequency Changers ideal for critical applications. Let your Sorensen representative supply you with full details on these Frequency Changers—with or without filters. Or write directly to headquarters for technical data.



FCR100



FCR250

**FCR100**

Input Freq.: 45-65 cps  
Output Freq.: 45-2000 cps  
Out. Freq. Regulation:  $\pm 1\%$  or  $\pm 0.01\%$  with suitable external standard  
Load Range: 0 to 100 VA  
Input Voltage: 105 to 125 VAC  
Output Voltage: 115 nominal VAC  
Harmonic Distortion: 1% maximum  
\$530.— in cabinet.

**FCR250**

Input Freq.: 45-65 cps  
Output Freq.: 320-1000 cps  
Freq. Reg.:  $\pm 1.0\%$ ; or  $\pm 0.01\%$  with optional internal frequency standard  
Load Range: 0 to 250 VA (500 VA at 400 and 800 cps)  
Voltage Input & Output: 105 to 125 VAC  
Voltage Reg.:  $\pm 1\%$   
Harmonic Distortion: 5% typically  
\$990.— in cabinet.

**Note:** This distortion value can be reduced to 3% from 350 to 450 cps, and to 2% for specific tuned frequency, by inserting the NEW FCF 250 Filter in the output line.



CONTROLLED POWER FOR RESEARCH AND INDUSTRY

SORENSEN & COMPANY, INC.  
Richards Avenue, South Norwalk, Connecticut

In Europe, contact Sorensen-Ardag, Eichstrasse 29, Zurich, Switzerland, for all products including 50 cycle, 220 volt equipment

# ride herd on transistor circuits

## standardize on



### CK1050



### LIGHT INDICATOR TUBES

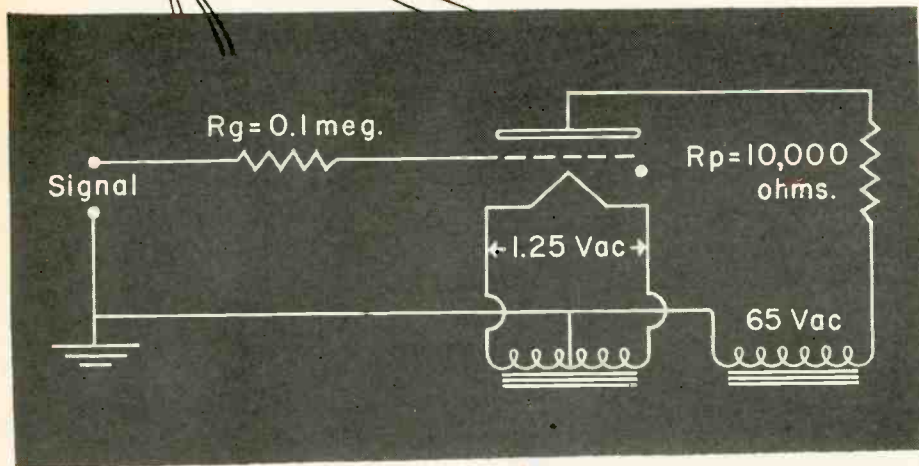

1. Low signal requirement
2. High light output — 5 times that of NE-2
3. Negligible loading of transistor circuits
4. Many thousand hours of life with little loss of light intensity
5. Subminiature size
6. AC operation — low drain
7. Simple and dependable

With above Circuit Conditions

Average anode current	2.0 mA <sub>dc</sub>
Grid bias for conduction	0 to -3.1 V <sub>dc</sub>
Grid bias for conduction (R <sub>g</sub> = 2.0 meg)	0 to -4.1 V <sub>dc</sub>
Average tube voltage drop at I <sub>p</sub> = 5 mA <sub>dc</sub>	18 V <sub>dc</sub>



### INDUSTRIAL TUBE DIVISION

Reliable Miniature and Subminiature Tubes • Filamentary Tubes  
VR Tubes • Rectifiers • Thyratrons • Cathode Ray Tubes

Newton, Mass.: . . . . . 55 Chapel St., Bldg 4-7500  
New York: . . . . . 589 Fifth Ave., Plaza 9-3900  
Chicago: 9501 Grand Ave., Franklin Park, National 5-6130  
Los Angeles: 5236 Santa Monica Blvd., NOrmandy 5-4221



# ELECTRONICS NEWSLETTER

**CIVIL AVIATION ELECTRONICS** battle may occur between U.S. and British representatives when the International Civil Aviation Organization meets in Montreal in February to discuss short-range navigation aids and their relationship to an international system. The British, whose long-range Decca (Decca Navigator Co.) navigation system spans the Atlantic from Newfoundland to Scotland, are expected to push for a world air navigation standard embracing both VOR and Decca, the medium-range system of Decca Navigator. U.S. policy has been to support the VORTAC/DME system.

- In the New York area, helicopter navigation system evaluation for the Airways Modernization Board has seen the participation of Bendix Aviation, which produces the British gear and sells it in North America under the name Bendix-Decca, as a licensee of Decca Navigator.
- In Washington and then in Indianapolis last week, 23 nations sent representatives to a symposium on VORTAC and its relationship to an international air navigation system. Air Coordinating Committee was sponsor.

**SEISMOLOGISTS** of Columbia University have announced the detection of surface waves from nuclear explosions more than 7,000 miles away. Announcement was possible because the Atomic Energy Commission recently declassified precise

times and locations of 10 nuclear explosions in the Marshall Islands in 1954 and 1956. Seismographs at Columbia's Lamont Geological Observatory, Palisades, N. Y., recorded surface waves from the Marshalls blasts. University scientists said such waves "presumably may be detected by long-period seismographs throughout the world." East-West delegates at Geneva recently reached an understanding on methods for detecting and identifying nuclear explosions which included seismic wave recording.

**CIVIL AERONAUTICS ADMINISTRATION** has just announced award of a \$1,632,638 contract for scan conversion systems equipment to Intercontinental Electronics Corp., Mineola, N. Y., an affiliate of Cutler-Hammer. Intec says gear is capable of transforming radar, video map and beacon information into television information and displaying it on indicators that operate in normal ambient light. First installation is slated for New York's International Airport by late December. Each installation consists of two systems: System A, which has five scan conversion units, one control rack assembly, five horizontal consoles, four sector monitors and five maintenance monitors; and System B, which has two scan conversion units, one control rack, three horizontal consoles, four sector monitors and two maintenance monitors.

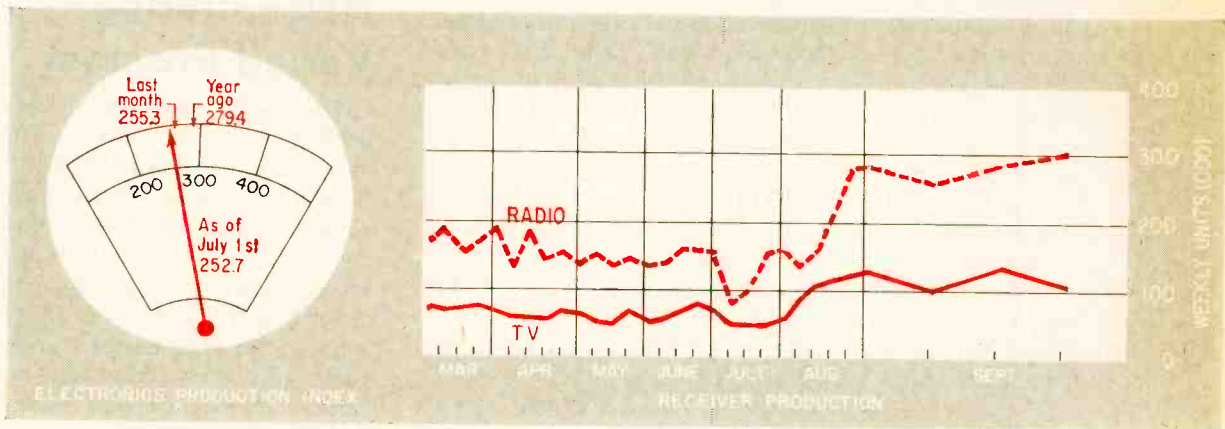

## FIGURES OF THE WEEK

### RECEIVER PRODUCTION

(Source: EIA)	Sept. 19, '58	Sept. 12, '58	Sept. 20, '57
Television sets, total	118,811	145,289	155,751
Radio sets, total	309,962	295,249	356,290
Auto sets	109,901	89,210	105,965

### STOCK PRICE AVERAGES

(Source: Standard & Poor's)	Sept. 24, '58	Sept. 17, '58	Sept. 25, '57
Radio-tv & electronics	59.48	59.10	44.99
Radio broadcasters	69.12	69.22	56.43

## FIGURES OF THE YEAR

Totals for first seven months

	1958	1957	Percent Change
Receiving tube sales	221,201,000	254,252,000	-13.0
Transistor sales	21,084,218	12,902,300	+63.4
Cathode-ray tube sales	4,239,404	5,306,594	-20.1
Television set production	2,442,929	3,082,799	-20.8
Radio set production	5,582,834	7,799,882	-28.4
TV set sales	2,456,662	3,236,697	-24.1
Radio set sales (excl. auto)	3,452,833	4,236,453	-18.5



Airways Modernization Board officials get ready to

## Test 'Copter Systems

Keeping track of helicopters presents problems. Here are a few possible answers

OPERATIONAL TESTING of the Bendix-Decca low-frequency navigation system aboard five New York Airways helicopters began last month under Airways Modernization Board sponsorship.

The tests are an attempt to loosen one more knot in the tangled skein of civil air navigation and traffic control. Right now, installation and pilot familiarization have been completed. Six months of data-taking will follow. No firm results are expected before 1961.

Medium-range navigation by the VORTAC system, ideal for fixed-wing aircraft, isn't good for the whirlybirds. The system's vhf and uhf signals are interrupted by obstacles in the line-of-sight to a low flying helicopter. Also, the 'copter's rotor can introduce spurious modulation.

Helicopters also present special traffic control problems. Bobbing up and down behind obstacles, they are hard to spot on airport surveillance radars. One answer is to keep them on precisely defined aerial highways and keep fixed-wing aircraft out of their way.

AMB has contracted with four firms to check out the Decca system as a medium-range navigation

aid for helicopters: Pacific Division of Bendix has installed a four-station Decca chain of transmitters and seven of the 108-lb mobile units. Five are in NYA commercially scheduled helicopters. Bendix got \$175,000 in fiscal 1958, will get \$175,000 in fiscal '59.

Bell Helicopter has supplied AMB with a specially instrumented helicopter. Bell's share of the contract was \$50,000 in fiscal 1958, will be \$52,000 in fiscal 1959. Airborne Instruments Lab will evaluate the test results. AIL's share was \$163,000 in the last fiscal year and is \$90,000 in the present one. N. Y. Airways came in for \$82,000 for running tests in fiscal '58, will get \$82,000 for fiscal '59.

Decca operates on harmonics of a 14-kc reference frequency between 70 and 130 kc. A typical chain uses four stations: a master and three slaves. Each slave is about 70 miles from the master. Phase comparisons of incoming signals fix position on a hyperbolic grid. A flight plotter on the airplane's instrument panel has a stylus that traces out the flight path on a special area map. Aircraft position always corresponds to the spot directly under the stylus. Use of

Decca system for helicopter navigation is also under study by the Army at Fort Huachuca, Ariz., and in Western Germany.

Medium-range navigation is not the only helicopter requirement now receiving attention. AMB's Bell H-131I helicopter is equipped with a pictorial crossed-pointer instrument landing aid. The device, known as RAILS (Remote Area Instrument Landing System) includes Sylvania's APN-117 radar altimeter, a computer to convert Decca's hyperbolic position coordinates into crossed-pointer indication, a drift indicator and a sensitive air-speed indicator. An additional helicopter landing aid, a 65-lb X-band radar set with 360-deg scan, has been used experimentally by the Marines. Radar was developed by Bendix.

A sonic altimeter, also designed by Bendix, has been tried out in helicopters. The device operates on 14 kc. It requires 25 w from a transistor power supply and delivers 10 w audio power into a microphone with 10 to 12 percent efficiency. The altimeter is reportedly accurate to 3 in. at an altitude of 250 ft. Major developmental problem has been interference from ambient sonic noise.

## NEC Offering Varied Program

CHICAGO—LAST-MINUTE developments on space stations, satellites and their instrumentation, a tutorial session on automatic navigation, talks on network theory and a report on experiments with speech using digital computer simulation will be among top features at the 14th annual National Electronics Conference here next week. The meeting runs Monday through Wednesday.

Featured speakers include Gen. John B. Medaris of Redstone Arsenal, Deputy Secy. of Defense Donald A. Quarles, and Simon Ramo of the Ramo-Wooldridge Corp.

The special IGY technical session has as speakers Allen M. Peterson, Stanford University;

(Continued on p 12)



# STANDARD MISSILE GROUND CHECKOUT AND LAUNCHING "DC POWER SUPPLIES"

BY

# PERKIN

PROVEN in production use in the Nation's Major Missile Programs

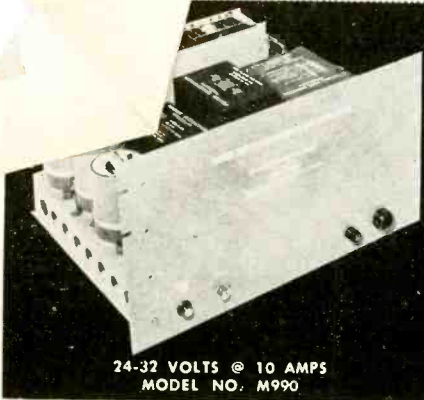

24-32 VOLTS @ 10 AMPS  
MODEL NO. M990

Transistor—Mag amp power supply  
D.C. Output: 24-32V @ 10 amps  
A.C. Input: 105-125V, 1 phase, 60 cps.  
Static Regulation:  $\pm 0.1\%$  line & load  
Dynamic Regulation:  $\pm 0.1\%$  line;  $\pm 1\%$  load  
Ripple: 1 MV R.M.S. maximum  
Output Impedance: 0.05 ohms, 0-20 KC  
Protection: Short circuit proof; unit has automatic current limiting at 125% of rated load  
Dimensions: 19"W x 10 1/2"H x 15"D  
rack panel mount  
Meets Spec. MIL-T-4860

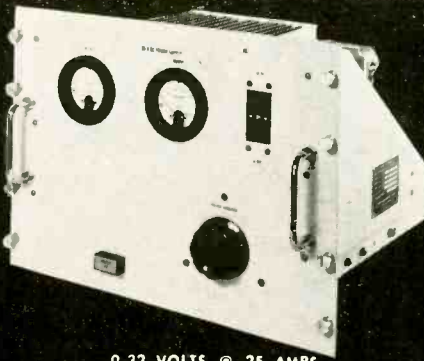

0-32 VOLTS @ 25 AMPS  
MODEL NO. M1071

Mag-amp power supply  
D.C. Output: 0-32V @ 25 amps  
(Surge loads to 35A for 30 min. or less)  
A.C. Input: 115V, 1 phase, 60 cps.  
Regulation:  $\pm 1\%$  28 volts—  
Not stabilized for A.C. line voltage changes.  
Ripple: 1% RMS @ 32V and full load  
Response Time: 0.1 to 0.2 seconds  
Dimensions: 19"W x 14" H x 15"D  
Rock panel mount  
Meets Spec. MIL-E-4158A

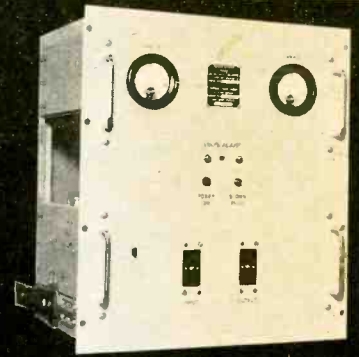

24-32 VOLTS @ 30 AMPS  
MODEL NO. MTR28-30-2

Transistor—Mag amp power supply.  
D.C. Output: 24-32V @ 30 amps  
A.C. Input: 105-125V, 1 phase, 60 cps  
Static Regulation:  $\pm 0.1\%$  line and load  
Dynamic Regulation:  $\pm 0.1\%$  line  
 $\pm 1\%$  for full load changes  
Ripple: 7 MV RMS max.  
Output Impedance: 0.05 ohms 0 to 20 KC  
Protection: Short circuit proof; unit has automatic current limiting at 125% rated load  
Dimensions: 19"W x 21 1/4"H x 14"D  
Rock panel mount  
Meets Spec. MIL-E-4970

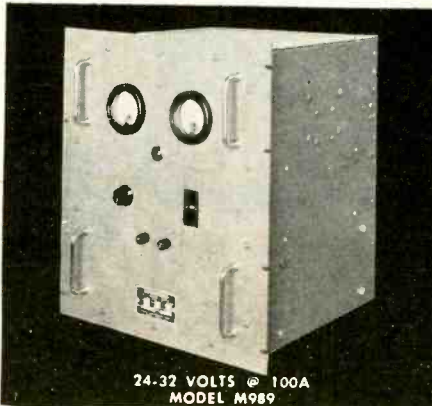

24-32 VOLTS @ 100A  
MODEL M989

Mag-amp power supply  
D.C. Output: 24-32V @ 100 amps  
A.C. Input: 208/230 or 460V  $\pm 10\%$   
3 phase, 60 cps  
Regulation:  $\pm 1/2\%$  for line & load  
Ripple: 1% RMS  
Response Time: 100 milliseconds  
Dimensions: 19"W x 21"H x 16"D  
Rock panel mount  
Unit incorporates remote sensing.  
Meets Spec. MIL-E-4970

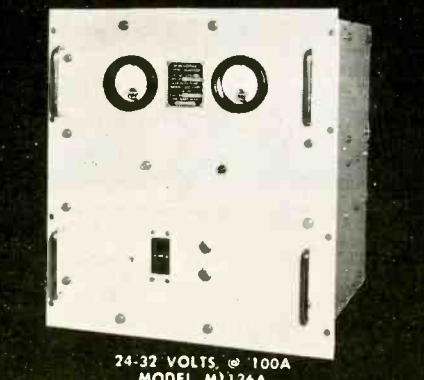

24-32 VOLTS @ 100A  
MODEL M1136A

Transistor—Mag amp power supply.  
D.C. Output: 24-32V @ 100 amps  
A.C. Input: 208V  $\pm 10\%$ , 3 phase, 60 cps.  
Static Regulation:  $\pm 0.1\%$  line,  $\pm 0.2\%$  for load  
Dynamic Regulation:  $\pm 0.5\%$  line,  $\pm 2V$ . for full load changes  
Ripple: 10 MV RMS max.  
Dimensions: 19"W x 21"H x 18"D  
Rock panel mount  
Meets Spec. MIL-E-4970

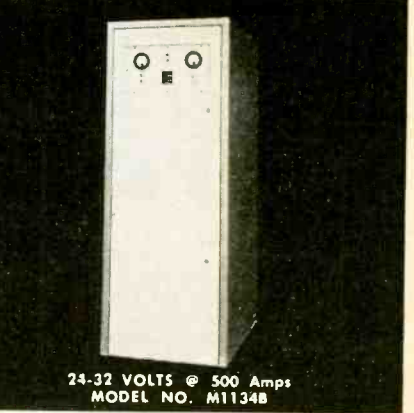

24-32 VOLTS @ 500 Amps  
MODEL NO. M1134B

Transistor—Mag amp power supply  
D.C. Output: 24-32V @ 500 amps  
A.C. Input: 208/230/460 V  $\pm 10\%$   
3 phase, 60 cps  
Static Regulation: 0.1% line; 0.1% load  
Dynamic Load Regulation:  $\pm 15\%$  for full load changes  
Ripple: 1/2% RMS max.  
Response Time: Adjustable 20-200 MS  
Dimensions: 26"W x 68"H x 32"D  
Meets Spec. MIL-P-6457A

For further data, contact Perkin Factory or Sales Offices.

Denver,  
Alpine 5-1196  
Detroit,  
HO 8-2461  
San Francisco,  
Emerson 9-3354

Atlanta,  
Cedar 7-7801  
Orlando,  
CH 1-2128  
Syracuse,  
Gibson 6-0220



# PERKIN

PERKIN ENGINEERING CORPORATION

345 KANSAS STREET, EL SEGUNDO CALIFORNIA • OREGON 87215

New York area office: Sales & Warehousing: 25 Great Neck Road, Great Neck, L. I., New York, HUinter 2-8606  
New England area office: 46 Amesbury, Lawrence, Mass., MUrdock 3-3252. Representatives in principal cities.



Design better products

parts with

# SILICONE-GLASS LAMINATE

...resist arcing under high voltage

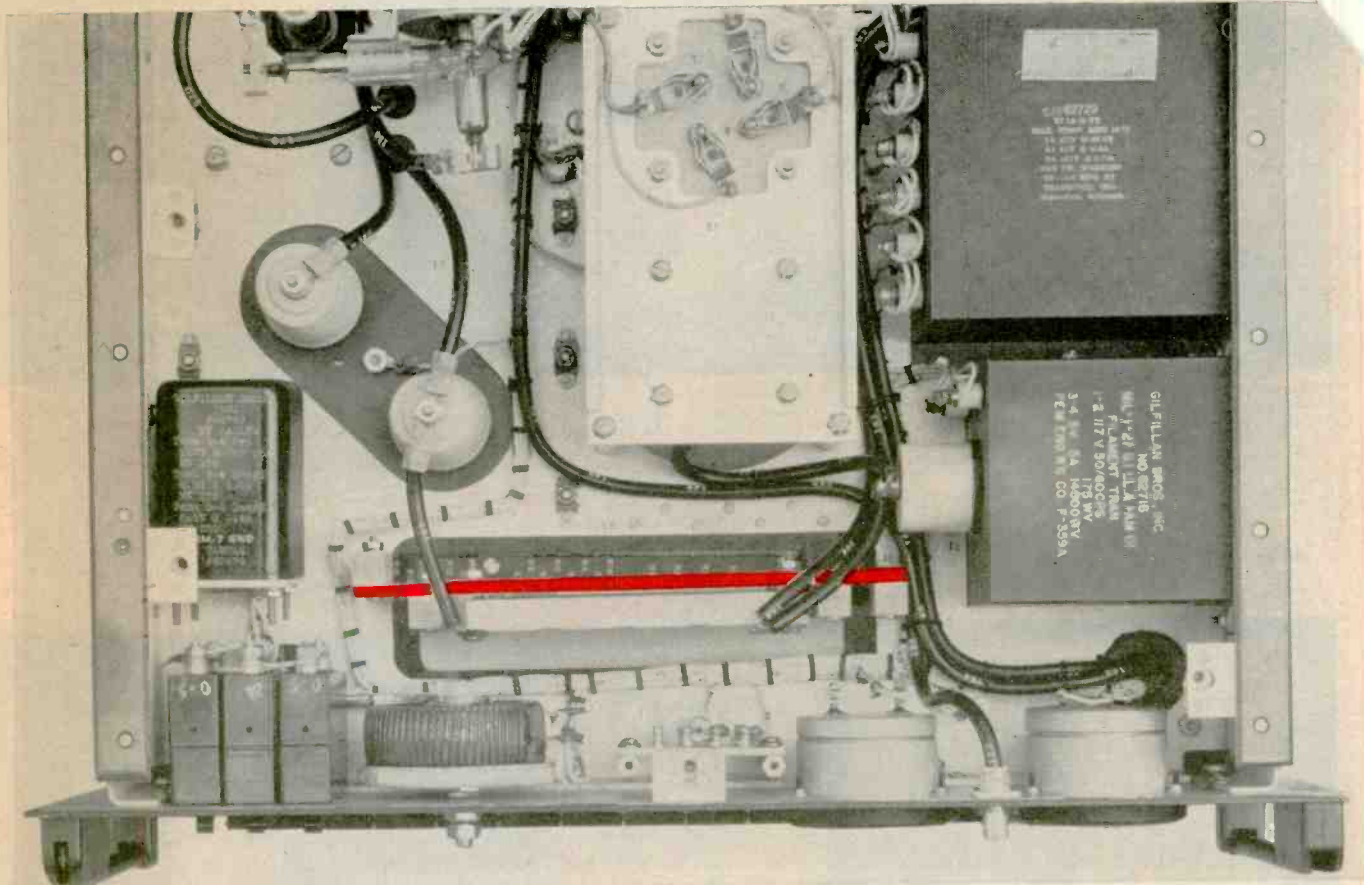

This AN/FPN-33 Quadradar Transmitter of Gilfillan Bros., Inc., of Los Angeles, employs silicone-glass laminates to prevent recurrent arcing under high voltage and high humidity conditions. Gilfillan Bros. also use silicone laminates in their Ground Control Approach equipment.

### TYPICAL PROPERTIES OF SILICONE-GLASS LAMINATES\*

Flexural Strength, psi	
at 25C	24,000
at 260C after 100 hr at 260C	4,600
Water Absorption, percent	0.05
Electrical Strength, volts/mil	
initial	310
after 200 hr at 260C	327
after 5000 hr at 260C	180
Dielectric Constant at 10 <sup>6</sup> cycles	
Condition A <sup>1</sup>	3.67
Condition D <sup>2</sup>	3.68
Dissipation Factor at 10 <sup>6</sup> cycles	
Condition A <sup>1</sup>	.002
Condition D <sup>2</sup>	.004

\* As measured on samples 1/8 inch thick.

<sup>1</sup> As received.

<sup>2</sup> After 24 hr immersion in water at 23C.

Silicone-glass laminates are ideal dielectrics for high voltage electronic devices operating under extreme humidity conditions. Made of glass cloth bonded with Dow Corning silicone resins, these laminates have high arc resistance, low moisture absorption, low loss factor. At temperatures as high as 250 C, they retain excellent physical and dielectric properties. Lightweight yet strong, silicone-glass laminates are easy to fabricate and machine. Supplied as tubes, sheets, and punched or molded parts by leading laminators. Write for FREE BOOKLET.



**Dow Corning CORPORATION**  
MIDLAND, MICHIGAN



# Dow Corning Silicone Dielectrics

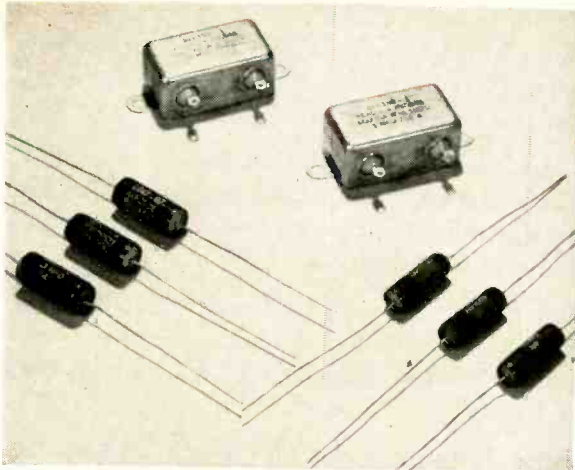

Aerovox capacitors impregnated with silicone dielectric fluid.

## SILICONE DIELECTRIC FLUIDS IMPROVE COMPONENT CHARACTERISTICS

A liquid dielectric, Dow Corning 200 Fluid makes higher operating temperatures possible, increases stability, aids miniaturization and improves characteristics of electronic assemblies and components. Silicone fluid impregnated capacitors, for example, maintain near-constant capacitance at high and low temperatures, show little change in properties over a wide range of frequencies and environmental conditions.

CIRCLE 104 READERS SERVICE CARD

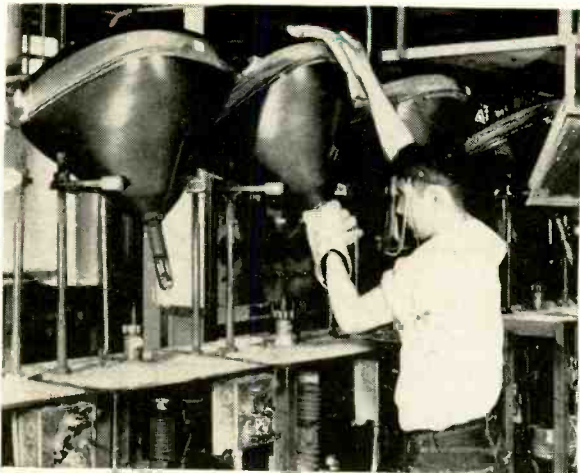

TV tube evacuation with Dow Corning diffusion pump fluid.

## SILICONE DIFFUSION PUMP FLUIDS OFFER GREATER STABILITY, ECONOMY

Because of their great stability, Dow Corning silicone fluids make diffusion pump operation more efficient and economical. They develop vacua in the range of  $10^{-5}$  to  $10^{-7}$  mm of Hg; resist oxidation even when exposed to air at operating temperatures. Dow Corning diffusion pump fluids do not decompose into gums or tars . . . save replacement costs and production time. In addition, they offer rapid recovery and quick pumpdown.

CIRCLE 105 READERS SERVICE CARD

## SILASTIC COVERED WIRE RESISTS CORONA, OZONE

Wire and cable insulated with Silastic®, the Dow Corning silicone rubber, is easy to strip and solder — flexible for quick and convenient hookup of electronic components. Unaffected by moisture, weathering and temperature extremes from  $-90$  to  $250$  C, Silastic insulation remains flexible and retains its dielectric properties despite long exposure to corona and ozone. Wire insulated with Silastic is readily available from leading cable manufacturers.

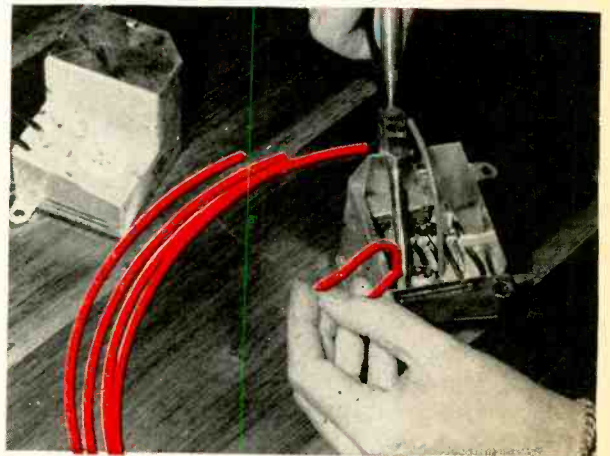

High voltage transformer for RCA TV receiver.

W. H. Pickering, Cal. Tech.; and Alan H. Shapley, Bureau of Standards, Colo.

In addition, panel discussions on "The Role of The Laboratory Program in Engineering Education" and "Engineering Writing and Speech" will be held. About 100 scientific papers in 24 different areas of electronics will be given by engineers and scientists from 16 states and three foreign countries.

Lawrence W. von Tersch, program chairman, tells *ELECTRONICS* that the "quality of the papers is extremely high, and the sessions concerning automatic navigation, network theory and speech using digital computer simulation are outstanding in their scope and interest."

A record number of more than 250 commercial exhibits, highlighted by displays of new electronic developments and devices, are scheduled. NEC officials expect more than 10,000 registrants, principally scientists, engineers, educators, manufacturers and government officials, will attend.

## X-Ray Amplifier Cuts Exposure



New image amplifier (A) for x-ray equipment is readied for operating demonstration with closed-circuit tv camera (B)

NEW X-RAY image amplifier device being studied this week by medical men in the Chicago area is reported to produce projections 350 times brighter than conventional fluoroscope equipment.

Further advantage claimed for the amplifier is a substantial reduction in the total amount of radi-

## WASHINGTON OUTLOOK

IN THE YEAR since Russia's launching of the first earth satellite, the defense budget has gone from a tight ceiling on spending, to a removal of expenditure restrictions and now back to economizing.

Defense spending has been boosted almost \$3 billion since Sputnik I, with the biggest increases for electronics and related programs. Now the Pentagon is trying to hold expenditures next year to about \$42 billion—a rise of roughly \$1 billion over fiscal 1959.

This has generated some talk in industry of impending cancellations of contracts. Among the projects involved in the speculation have been Martin's Titan ICBM and Seamaster jet seaplane and Convair's B-58 supersonic medium-range bomber.

You can disregard talk of Titan's cancellation. Says a high-ranking Pentagon official: "Titan is a remarkably unlikely candidate for discontinuance. The very considerations which led us not to make Titan a crash project and thus indistinguishable from Atlas, now assure the continuance of the project."

However, in terms of scope, speed and direction, Titan project will still be under what program officers and contractors would like.

Odds are that the Seamaster project, which now lags about two years behind schedule, will be cancelled. Production of the B-58 will likely go beyond the 77 aircraft already ordered or planned, but output will be severely limited.

- The Pentagon's return to serious budget-economizing in the face of growing Russian military capabilities is a tremendously risky decision. There is no belief in Washington that the cold war threat has abated materially in the past year. Indeed, the crises in Lebanon and the Formosa Straits have caused renewed concern.

But the Eisenhower administration is confident that great strides have been taken in the U.S. missile program and other key defense projects since Sputnik and that substantially increased expenditures would not necessarily bolster U.S. military power.

This is how one top-level Defense Dept. official puts it: "We're tremendously stronger than we were a year ago. Whether our position vis a vis the Russians has improved, we don't know. But we certainly haven't fallen back any."

"Our basic policy is still to deter an enemy from taking aggressive action. We believe we've got the power to do this now. That's why we haven't got into an all-out arms race with Russia."

- Air Force contractors will soon be getting the final version of the so-called "make-or-buy" regulations. These rules, as originally proposed, would have required prime contractors to stick by an initial "make-or-buy" list submitted to the Air Force. The list enumerated what items the prime contractor would make himself and what items he would buy from subcontractors.

However, when the final version comes out, it won't be so rigid; primes will be allowed to change from make to buy or conversely by giving the Air Force prior notice. Air Force officials will have the last word. The new regulation applies to all contracts of \$350,000 or more.



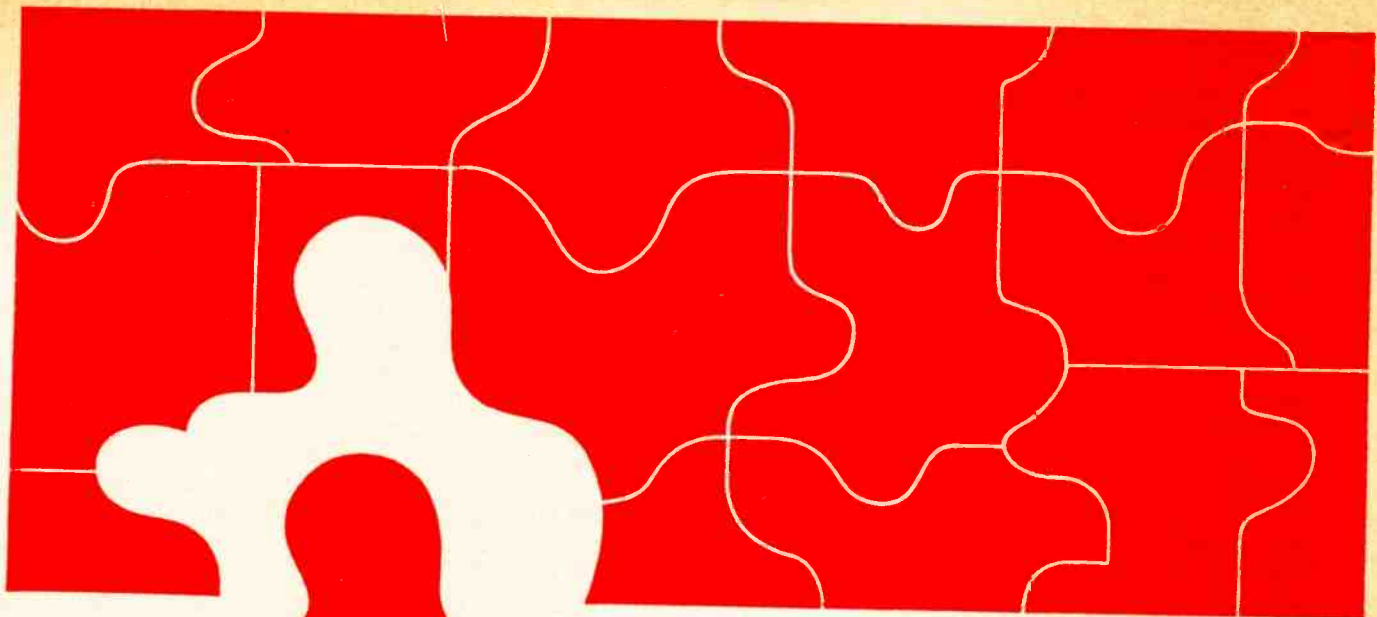

*Puzzled by ground loop problems? How to rescue microvolt signals from volts of noise?*

## HERE'S WHY KIN TEL'S DIFFERENTIAL DC AMPLIFIERS FIT IN INSTRUMENTATION SYSTEMS

**160 db DC, 120 db 60 cycle common mode rejection with balanced or unbalanced input ■ Input completely isolated from output ■ Input and output differential and floating ■ 5 microvolt stability for thousands of hours ■ .05% linearity, 0.1% gain stability ■ Gain of 10 to 1000 in five steps ■ >5 megohms input, <2 ohms output impedance ■ 120 cycle bandwidth ■ Integral power supply**

These are just a few of the many outstanding features of the Model 114A differential DC amplifier... features that make this amplifier *really work* in instrumentation systems... features that will help solve *your* instrumentation problems today.

Ideal for thermocouple amplification, the 114A eliminates ground loop problems; allows the use of a common transducer power supply; permits longer cable runs; drives grounded, ungrounded or balanced loads, and can be used inverting or non-inverting.

For additional information and technical literature on this exceptional instrument, write or call KIN TEL - the world's largest manufacturer of precision, chopper-stabilized DC instruments.

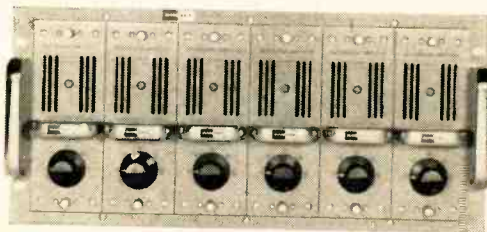

**KIN TEL 114A**  
differential DC amplifiers  
...convenient, interchangeable plug-in mounting in either 6-amplifier 19" rack mount modules or single-amplifier cabinets.

5725 Kearny Villa Road, San Diego 11, Calif.  
Phone: BRowning 7-6700  
Representatives in all major cities

**KIN TEL**  
A Division of Cohu Electronics Inc.

tion to which physician and patient are exposed during examination.

The new unit, produced by Rauland Corp., subsidiary of Zenith Radio, has a 41-sq in. screen.

Aimed primarily at cardiological use, the bright image and large screen area permit a good view of the entire human heart and surrounding area. Also possible are examinations of the complete stomach or colon while radio-opaque barium salts are moving through.

Higher image brightness suggests the possibility of viewing x-ray patients by closed-circuit tv from another room where radiation exposure is eliminated and consultations are possible, say researchers.

## Study Printed Cryotron Circuits

OF SPECIAL INTEREST to electronics engineers is a progress report on the cryotron, presented recently by Dudley A. Buck of MIT. Cryotron, a superconducting electronic switch for digital computers, operates on principle of magnetic destruction of superconductivity.

Cryotron, developed by Buck and now undergoing further work at MIT and at A. D. Little, Inc., is used in circuits refrigerated by liquid helium.

Subminiature device comprises a single straight wire around which a wire coil is wrapped. Straight wire conducts current with zero resistance. Current in control winding can quench superconductivity in straight wire and resistance returns. Interconnection of cryotrons provides basic computer switching circuits.

Buck reported 23 elements are known to have superconductive properties at low temperatures. Work at MIT is concentrating on tantalum and tin, with niobium used for control windings.

Slow switching speed is cryotron's drawback. Since speed increases as size decreases, MIT group is attempting further miniaturization by techniques analogous to printed circuits, with elements as well as wires printed. A new type of electron-beam photography is under study for printing cryotron circuits.

## MILITARY ELECTRONICS

• Navy has four Vanguards left to shoot and says it will fire them between now and the end of the IGY this Dec. 31. Although Vanguard has been successful in putting only one grapefruit-sized satellite into orbit after eight attempts, the system, technically speaking, is considered to be one of the nation's most sophisticated missiles.

• First of twin 90-ft, 150-ton radio astronomy antennas, recently hoisted into place in the Owens Valley, Calif., desert, will be ready for listening this month. The second will be operational by Dec. They will be hooked up for use together by Spring.

The \$1.5-million installation is being financed by the Office of Naval Research and will be operated by the California Institute of Technology.

To lower wind resistance and let the rain through, the 6,000 sq ft of steel mesh sheeting is perforated by

$\frac{3}{8}$ -in. holes. The reflecting skin of the dish can be adjusted on its tubular steel frame at 324 different points.

Mounted on wheels that ride tracks 35 ft apart, and 1-hp electric motor is used to aim the antennas. Operating on only a fraction of its power, the same motor is used to track the stars.

Research objectives include attempts to identify several hundred radio sources with visible stars. "So far," scientific director John G. Bolton says, "only about 50 of some 2,000 known radio stars have been identified."

Some benefits to be derived from the work, Navy says, are: advances in electronic techniques such as low-noise receivers and antennas, and better knowledge of the propagation of radio waves through the ionosphere and the troposphere. Wavelengths ranging from about two inches to near 40 in. will be studied.



One portion of solid-state system is built and wrapped up as . . . .

## Magnetics Control Triton

MAGNETIC AMPLIFIERS form the active elements of the \$1-million powerplant instrumentation system going into the Triton nuclear submarine. System will provide more than 75 continuous measurements

of pressure, temperature, flow and level of coolants and feedwater.

The primary coolant loop contains 44 sensing elements linked to 78 measurement and control magnetic amplifiers. The ampli-



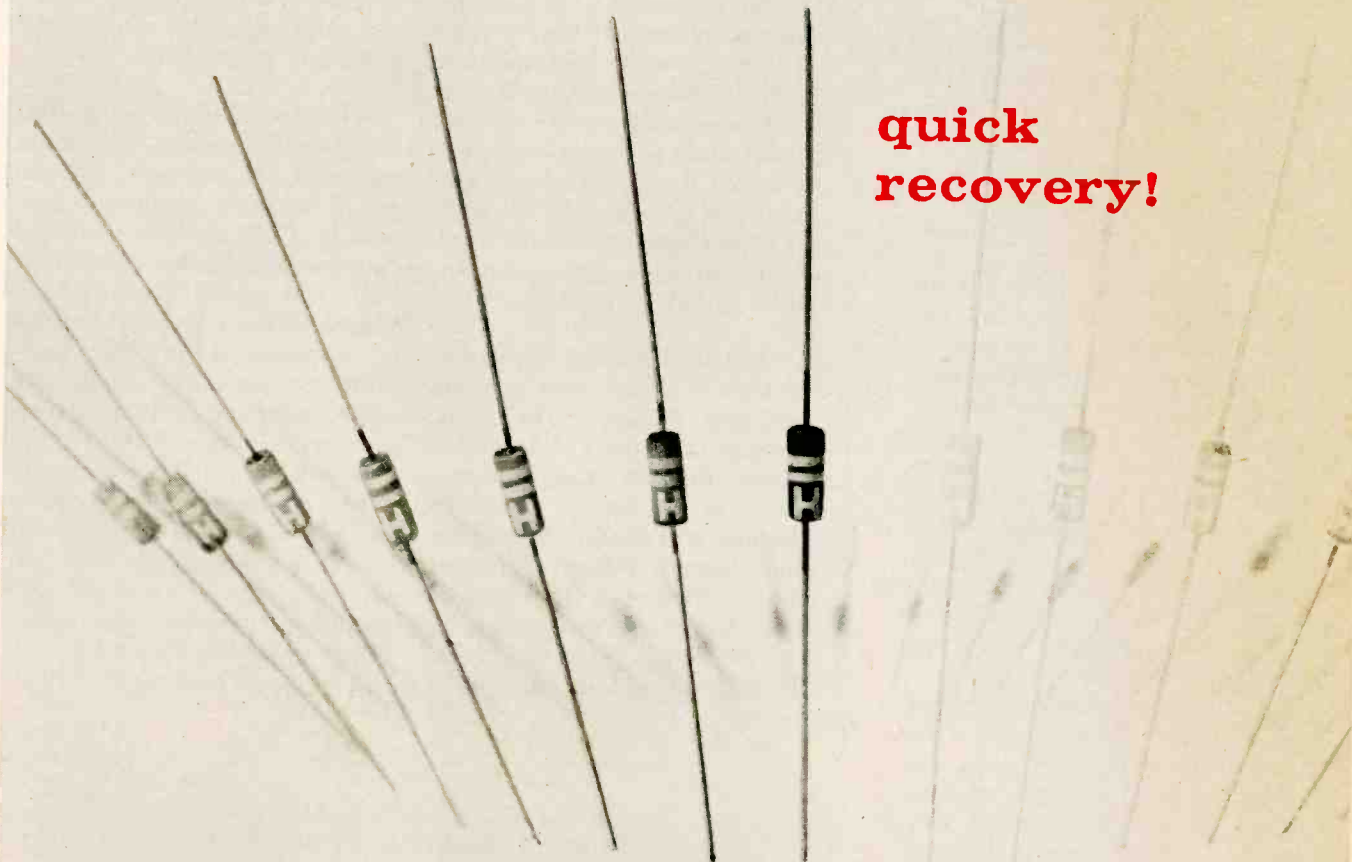

**quick  
recovery!**

## **Reliable Hughes Silicon Junction Diodes**

With recovery to 400 K ohms (minimum) in 1 microsecond... Hughes high-speed silicon diodes reliably meet the quick recovery requirements of most germanium types, and in addition, stand up under high voltages at high temperatures. In fact, the breakdown voltages increase with temperature... thereby providing maximum protection when temperatures reach unexpected levels. With this order of reliability, Hughes quick recovery silicon diodes assure dependability under the most severe operating temperatures.

### Typical performance levels:

Breakdown voltages at current of 0.1 mA from 30-200 volts.

Ambient operating temp.  $-80^{\circ}\text{C}$  to  $+150^{\circ}\text{C}$

Reverse current—as low as  $1\ \mu\text{A}$  at  $-175$  volts and  $25^{\circ}\text{C}$

—as low as  $30\ \mu\text{A}$  at  $-175$  volts and  $100^{\circ}\text{C}$

Special high conductance types in the quick recovery series are available in all voltage classes. No matter what your problem, chances are that there is a Hughes diode to meet your need. Write today for a complete data sheet on the Hughes quick recovery silicon diode—or any other Hughes semiconductor device.

Address: HUGHES PRODUCTS, Marketing Department, International Airport Station, Los Angeles 45, Calif.

Creating a new world with ELECTRONICS

**HUGHES PRODUCTS**

© 1958. Hughes Aircraft Company

fiers, housed in six cabinets, transmit signals to 41 indicators and to control initiation and alarm circuits. The feedwater systems contain 32 sensing elements, 66 measurement and control amplifiers and 32 indicators.

The system, designed by General Electric's instrument department in West Lynn, Mass., contains several new sensing elements.

One is a resistance temperature detector with a range of 0 to 700 F. Another is a scaled pressure detector able to withstand one ton per square inch. Sensing and measuring elements are sealed within the nuclear reactor compartment.

In the feedwater system, an all-magnetic computer matches the steam demand of the turbine to reactor power according to a predetermined program and controls the feedwater valve.

Instrumentation which monitors and limits the nuclear activity in the Triton's twin reactors was recently completed by Allen B. Du Mont labs. It is a special-purpose computer with three channels covering low, intermediate and power ranges of neutron flux.

The first two channels are built in duplicate. The third has triple circuitry for added safety and is also equipped to slow down or shut down the reactors if power rises too high. The system is packaged in two 1,000-lb cabinets.

## 17 Airlines Order New Jet Trainer

TWENTY-SIX-TON electronic flight simulator ordered by 17 airlines began teaching pilots to fly commercial jet transports this week.

The flight simulator (ELECTRONICS, p 16, Feb. 14) duplicates all flying conditions from takeoff to landing in a flight deck replica of the new Douglas DC-8. It provides instrument simulation, aircraft motion, and sound. It also provides a visual representation by closed-circuit tv of airport runways and surrounding terrain during approaches and takeoffs.

A 300:1 scale model of an airport is projected on a screen.

## FINANCIAL ROUNDUP

• Chemical industry, one of electronics' major customers, should enjoy a 10 percent sales increase in 1959, a chemical industry spokesman predicted at a National Industrial Conference Board marketing meeting last month. Chemical industry accounts for 10 to 11 percent of electronic equipment spending by manufacturers. Spokesmen for other industries which are important electronics customers look for a 4 to 5 percent hike in petroleum sales, 25 percent for steel, and 20 to 30 percent in autos, 6 percent for machinery and equipment, and 5 percent for textiles.

• Marquardt Aircraft joins growing ranks of aircraft firms acquiring electronics divisions. The L. A. firm purchased assets of Associated Missile Products Co., Pomona, Calif., a division of American Machine & Foundry, for slightly more than \$1 million. Associated Missile Products Co. employs about 300 people in development and production of missile check-out and test gear, data transmission systems and simulators used in

training aircraft personnel in radar operation. American Machine & Foundry will remain active in the electronics field. Firm's Defense Products Group still has three electronics engineering centers—in Greenwich and Stamford, Conn., and Alexandria, Va.—an AM&F spokesman points out.

• Thiokol Chemical offers 106,669 shares of capital stock to stockholders at \$42 per share. Thiokol got in electronic equipment business in 1957 when it purchased National Electronics Laboratory. NEL, now part of Thiokol's Specialties Division, is presently engaged in development of vhf transmitter-receiver equipment, remote control units and electronic recording devices. Proceeds from stock issue will be used for general corporate purposes. Firm also plans to raise \$7 million of additional new money through sale of 5½ percent long-term unsecured notes to institutional investors next Spring. Company intends to spend \$6 million on capital equipment in 1958-1959.

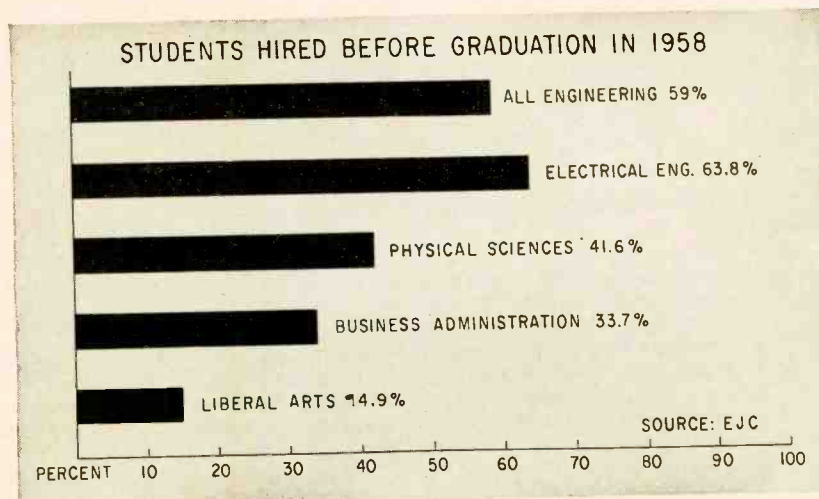

Electrical engineering led in pregraduation hiring in 1958. Survey shows . . .

## EE Grads Soon Find Jobs

PLACEMENT SURVEY of 1958 engineering school graduates indicates that members of the 1959 class,

now back at school, will have no difficulty finding jobs next spring.

(Continued on p 20)



# NO PARALLEL RESONANCE

(UP TO 1000 MEGACYCLES)

WITH ALLEN-BRADLEY DISCOIDAL  
FEED-THRU AND STAND-OFF CAPACITORS



Type SOB  
Screw mounting



Type SOS  
With solder tabs



Type FTS  
With shield



Type FTB  
Screw mounting



Type FTU  
Without shield

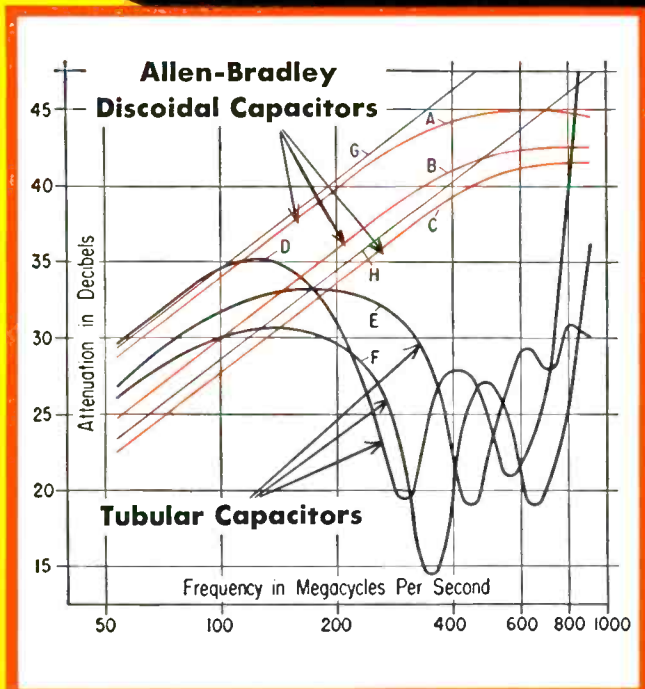

## AVOID RADIATION INTERFERENCE FOR VHF AND UHF RECEIVERS

Their unique discoidal design eliminates ALL parallel resonance effects which are normally encountered with tubular type capacitors in the VHF and UHF frequency ranges. With this complete absence of self-resonance, as shown in the graph at left, you can use far greater nominal capacitance values to obtain lower coupling impedances . . . and superior filtering.

The rugged construction of Allen-Bradley discoidal capacitors minimizes breakage during assembly or from thermal shock incurred during soldering. And, these capacitors have *gold plated* terminals to insure faultless soldering every time . . . even after long periods in storage.

Both feed-thru and stand-off capacitors are available in standard nominal capacitance values from 5 mmf to 1,000 mmf.

For suppression of stray radiation at frequencies to 1,000 megacycles, you cannot equal Allen-Bradley discoidal capacitors. Send for Technical Bulletin 5409.

### Discoidal vs. Tubular Feed-Thru Ceramic Capacitors

Allen-Bradley Discoidal Type . . . . .	} Curve A—1800 MMF at 1 KC Actual Curve B—1150 MMF at 1 KC Actual Curve C— 800 MMF at 1 KC Actual
Representative Tubular Type . . . . .	
The "Ideal" Capacitor . . . . .	} Curve G—2000 MMF Curve H—1000 MMF



5-58-E

ALLEN-BRADLEY PRESENTS...

# NEW METAL GRID

1/4, 1/2, and 1-WATT

PRECISION RESISTORS



*Far exceed MIL Specs  
for film and wire-wound resistors*

Allen-Bradley's new, truly accurate, metal grid resistors are now available in 1/4, 1/2, and 1-watt ratings, producing test results that are a substantial improvement over the MIL Specifications for wire-wound and film type precision resistors. They combine remarkable stability, under load and on the shelf, with an exceptionally low temperature coefficient. The metal alloy grid is noninductive, providing excellent high frequency characteristics. They also have an exceptionally low noise level... comparable to that of wire-wound units. Each unit is individually calibrated and marked with nominal resistance value, tolerance ( $\pm 0.1$  to 1%), and temperature coefficient. Provided with gold plated leads for flawless soldering. Considering their superior characteristics, these new resistors justly qualify under the Allen-Bradley trademark of *Quality*.

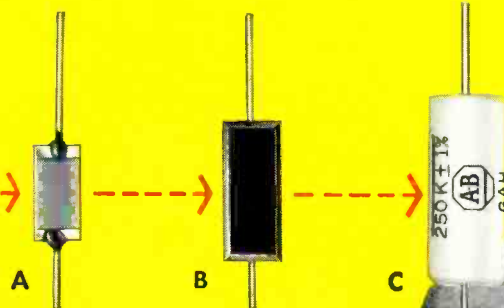

Type GAH  
1 Watt at 100°C  
 $\pm 0.1$  to 1%



The construction of the 1/4, 1/2, and 1-watt resistors is identical. At the upper left is an enlarged view of the metal alloy grid, mounted on glass, which forms the resistance element. (A) Actual size of 1-watt element, (B) encapsulating epoxy resin body, (C) finished unit hermetically sealed in ceramic tube,

Allen-Bradley Co.  
222 W. Greenfield Ave., Milwaukee 4, Wis.  
In Canada: Allen-Bradley Canada Ltd., Galt, Ont.

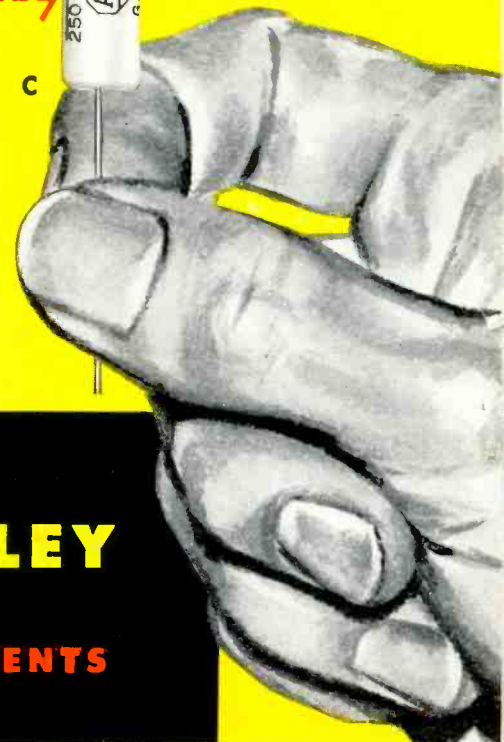

**ALLEN-BRADLEY**

QUALITY

**ELECTRONIC COMPONENTS**



At AnSCO, America's prime contractors can make use of a vast supply of technological talent to help solve precision gear assembly problems quickly and easily.

AnSCO has been manufacturing precision assemblies designed to do specialized jobs in the mechanical-optical fields and, of course, has research and development facilities to place at the disposal of anyone needing specialized talent.

AnSCO won an Army-Navy E for efficiency in the production of radar instruments, sextants, precision gear trains and computer units during the last war.

Why not consult AnSCO on your next project? AnSCO can certainly be of help whether you want original designs and models or you have your own specifications.

YOU may get the complete AnSCO picture by writing for AnSCO's illustrated brochure: *AnSCO Contract Manufacturing Service*.

# AnSCO's

## Precision assemblies are mass produced at competitive prices

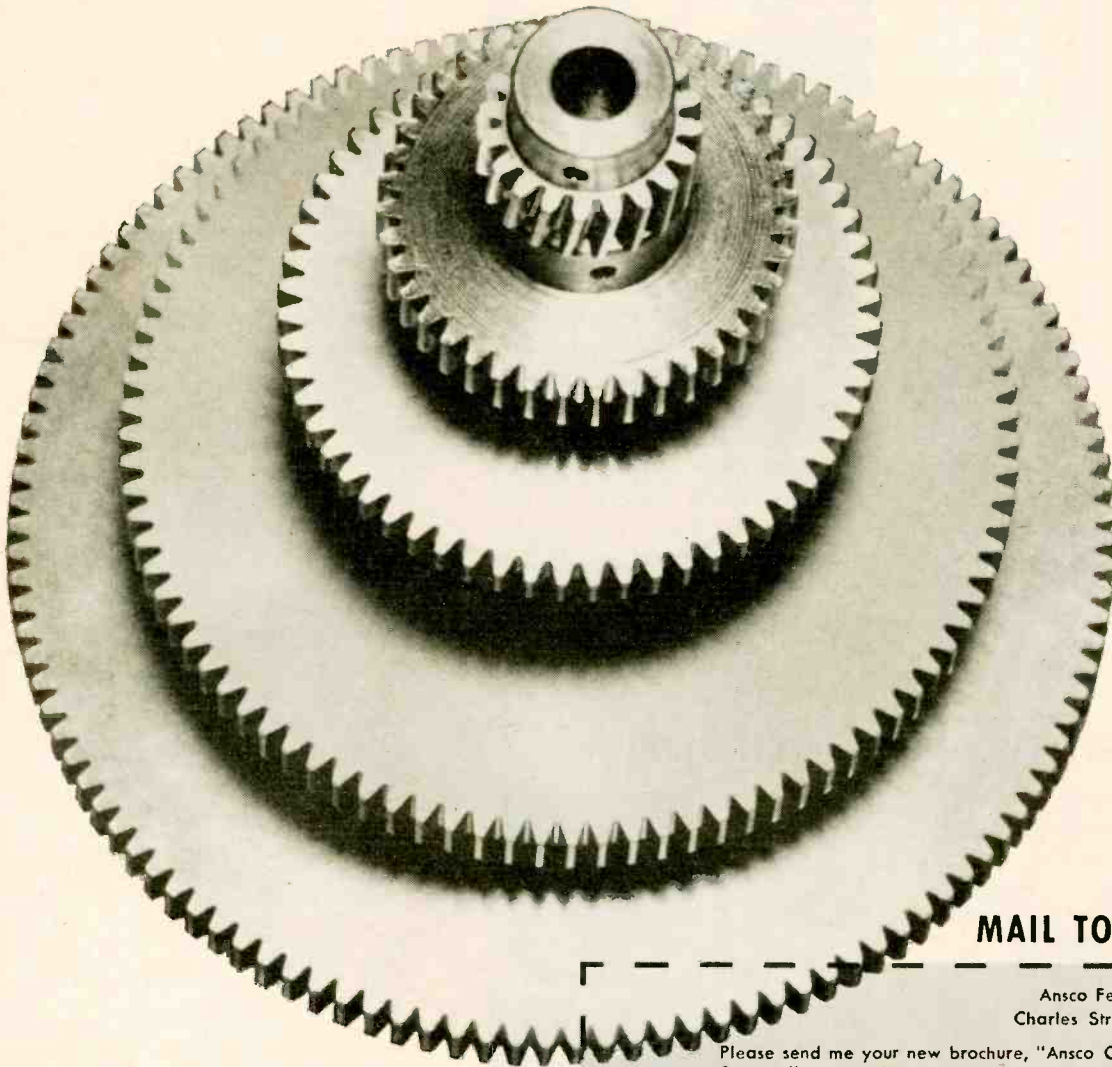

**MAIL TODAY**

AnSCO Federal Sales Dept. (E6)  
Charles Street, Binghamton, N. Y.

Please send me your new brochure, "AnSCO Contract Manufacturing Service," at no obligation.

Name \_\_\_\_\_

Title \_\_\_\_\_

Company \_\_\_\_\_

Address \_\_\_\_\_

City \_\_\_\_\_ Zone \_\_\_\_\_ State \_\_\_\_\_

# AnSCO

Binghamton, N. Y. A Div. of General Aniline & Film Corp.

Despite unfavorable economic conditions last spring, none of the 1958 graduates surveyed failed to find employment, according to the Engineers Joint Council. The survey, recently released by EJC's Engineering Manpower Commission, covered more than 45 percent of the estimated 33,000 engineers graduating in 1958.

A month before graduation last June, the placement situation for 14,541 prospective graduates was: 59 percent with jobs, 9.8 percent entering graduate studies, 8.8 percent entering military service, 11.6 percent considering jobs and 10.8 percent uncommitted.

Graduates with electrical engineering degrees outnumbered graduates in other engineering fields and also got the highest percentage of job commitments before graduation.

Of 4,193 EE's, 63.8 percent were hired before graduation, 9.6 percent were entering graduate studies, 6.8 percent entering military service, 12.3 percent considering job offers and 7.5 percent were uncommitted.

By comparison, only 41.6 percent of physical science majors, 33.7 percent of business administration students and 14.9 percent of liberal arts majors were hired a month before graduation.

Survey returns received after June 20 showed that 83.5 percent of engineering graduates were hired, eight percent were entering graduate studies, 7.5 percent were enter-

ing military service and one percent were considering job offers. None of the graduates were reported to be without job offers or other firm plans upon graduation.

## Television Saves Money for Bank



CLOSED-CIRCUIT tv began working recently for a savings bank in Waterbury, Conn., to reduce paperwork and duplicate records, and to speed up customer service.

The installation allows the bank to maintain its central files two floors above the main banking floor and still have them available for teller reference.

Four special pickup consoles on the third floor contain vertically mounted vidicon cameras. A card holder on the top of each console permits simultaneous insertion of three sets of cards containing signature specimens, bank balances or other information.

## MEETINGS AHEAD

Oct. 13-15: National Electronics Conf., 14th Annual, Hotel Sherman, Chicago.

Oct. 14-15: Institute of Printed Circuits, Fall Meeting, Chicago.

Oct. 20-21: Aero Communications Symposium, Fourth National, PGCS, Hotel Utica, Utica, N. Y.

Oct. 20-21: USA National Committee, URSI Fall Meeting, Penn State Univ., University Park, Pa.

Oct. 20-24: Society of Motion Picture and Television Engineers, 84th Convention, Sheraton-Cadillac Hotel, Detroit.

Oct. 26-31: American Institute of Electrical Engineers, Fall Meeting, Penn-Sheraton Hotel, Pittsburgh, Pa.

Oct. 27-28: Aeronautical and Navigational Electronics, East Coast Conf., Lord Baltimore Hotel, Baltimore.

Oct. 27-28: Electronic Industries Assoc., Radio Fall Meeting, Sheraton Hotel, Rochester, N. Y.

Oct. 29-30: Fifth Annual Computer Applications Symposium, sponsored by Armour Research Foundation, Morrison Hotel, Chicago.

Oct. 30-31: Aircraft Electrical Society, Pan Pacific Auditorium, Los Angeles.

Oct. 30-31; Nov. 1: Electron Devices Meeting, PGED, IRE, Shoreham Hotel, Wash., D. C.

Nov. 6-7: Prof. Group on Nuclear Science, IRE, Fifth Annual Meeting, Villa Hotel, San Mateo, Calif.

Nov. 17-20: Magnetism and Magnetic Materials, Fourth Annual Conf., AIEE, APS, IRE, AIME, OIIR, Sheraton Hotel, Philadelphia.

Nov. 17-20: Radar Conference, Seventh Annual, Univ. of Miami, Miami Beach, Fla.

Nov. 19-20: Northeast Electronics Research and Eng. Mtg., NEREM, Mechanics Bldg., Boston.

Nov. 19-21: Electrical Techniques in Medicine and Biology, ISA, IRE, AIEE, Nicollet Hotel, Minneapolis.

Dec. 3-5: Global Communications, Second National Symposium, AIEE, IRE, Colonial Inn-Desert Ranch, St. Petersburg, Fla.

Dec. 9-11: Mid-America Electronics Conf., Municipal Auditorium, Kansas City, Mo.

Jan. 29-30: Long-Distance Transmission by Waveguides, IRE, London, England.

Feb. 12-13: Solid-State Circuit Conf., IRE, AIEE, U. of Penn., Philadelphia.

## Accelerating Radiography

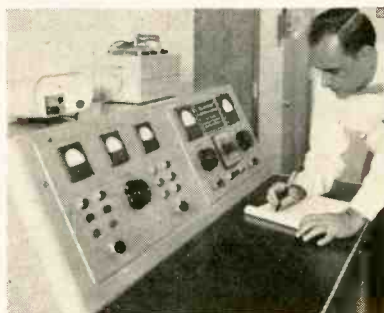
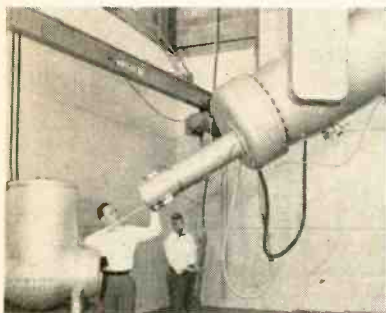

Crane-mounted two-million-electron-volt accelerator is positioned to x-ray massive casting at American Chain & Cable Co. Rays penetrate 10 inches of steel in 15 minutes. A slower-acting radioisotope source is used on smaller castings. Van de Graaff machine, built by High Voltage Engineering Co., has new sealed tube design which does not require auxiliary vacuum equipment. Barium-getter ion pump built into tube picks up outgassed molecules. At right, operator logs readings on control console. Accelerator is housed in chamber with four-foot concrete walls





## Union Relays meet all requirements of Talos guidance system

The **Talos**, the Navy's long-range guided missile, is very important to the nation's defense. And Bendix Aviation Corporation, builder of the Talos, depends on a relay manufactured by Union Switch & Signal. The relay meets all the requirements of the missile's guidance control system.

That relay is the UNION miniature 6PDT (also used in the Navy's Vanguard missile). The chief reason for choosing the Union 6PDT is its extreme reliability. The probability of flight failure of a contact pair is only once in 600,000 operations. Part of the relay reliability can be attributed to its clean, simple, *rotary* design which gives it fewer inherent problems than other relays. In vibration tests, it is absolutely solid to 2,000 C.P.S. at 15 G. And in temperature tests, it has performed satisfactorily for six minutes at temperatures up to 177° C.

This 6PDT is one of a complete line of *dependable* miniature relays made by Union Switch & Signal. These ac and dc relays are manufactured to MIL-R-25018, MIL-R-6106C, and MIL-R-5757C requirements. All of these relays are distinguished by the advanced design and quality control which have made Union Switch & Signal a leading manufacturer of relays. Send the coupon for complete information.

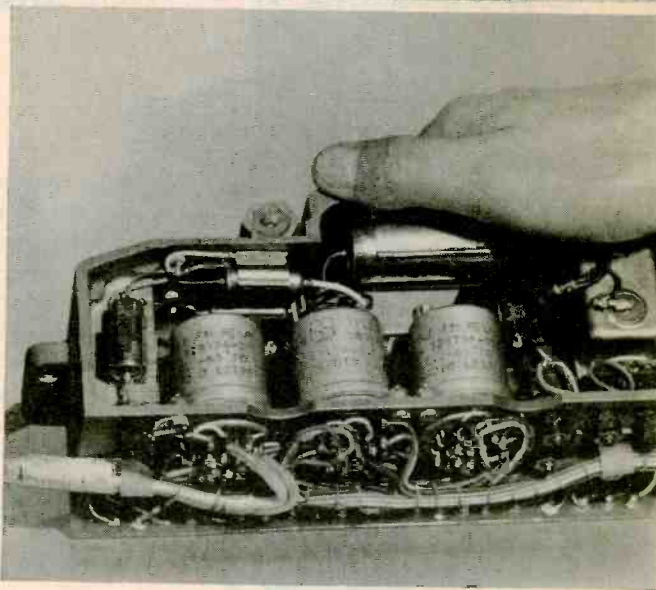

### COMPLETE FACTS

Union Switch & Signal, Advertising Dept.  
Pittsburgh 18, Pennsylvania

Please send information on the following:

- 6PDT miniature dc and ac relays.
- New 4PDT relay which meets every requirement of MIL-R-25018.
- Digital and Alpha-Numerical Indicators for data display.

Name \_\_\_\_\_ Position \_\_\_\_\_

Firm \_\_\_\_\_

Address \_\_\_\_\_

City \_\_\_\_\_ State \_\_\_\_\_

*"Pioneers in Push-Button Science"*



# UNION SWITCH & SIGNAL

DIVISION OF WESTINGHOUSE AIR BRAKE COMPANY

PITTSBURGH 18, PENNSYLVANIA



**your**

**two**

**best**

**friends...**

**"the man ahead"**

**and**

**"the man behind"**

That man just ahead of you hopes you'll take his job away from him. He's plain selfish about it . . . that way you push him up the ladder, too.

The fellow right behind you, what about him? He's another good friend. Just help make him more capable of capturing your present spot . . . see, now he's pushing you!

How can you serve yourself better than you ever have before? By upgrading your own job performance. By learning all you can about other functions of your company's business. By putting today's problems together with tomorrow's promises . . . and becoming more and more knowing about both, right here in the high-utility pages of this one specialized publication.

This, don't ever forget, is your own magazine — for you and men like yourself to work things out together — to find new and better ways to make progress and profits. McGraw-Hill editors, who live on your street, unceasingly strive to make it the single greatest community of interest for your industry. And the more effort they put into it, the easier it is for you to get more out of it for every reading minute invested.

Look ahead, read ahead, get ahead. Live this secret. Share it. After you've read this issue so satisfyingly, hand it over to that man one step below. Show him how much there's in it for him, too. A few issues from now, we'll bet he looks you in the eye and says, "Thanks, friend. I just got my own subscription."

## **McGRAW-HILL SPECIALIZED PUBLICATIONS**

*The most interesting reading for the man*

*most interested in moving ahead*





# Guaranteed, long-term accuracy 1%

AvoMeter 8 is unlike any test meter you have ever used. Compare it only with a laboratory standard . . . for both are hand-calibrated, with long-term accuracy conservatively specified . . . and guaranteed.

In ruggedness, portability, ease of operation, and, most important, in versatility, the AvoMeter 8 is superior even to the most costly standards.

Wherever you require an accurate, dependable multi-range meter, use the AvoMeter 8, moderately priced at \$89.01.

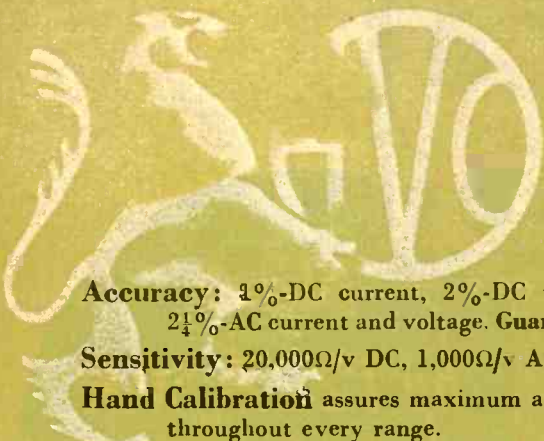

**Accuracy:** 1%-DC current, 2%-DC voltage, 2 1/4%-AC current and voltage. **Guaranteed.**

**Sensitivity:** 20,000Ω/v DC, 1,000Ω/v AC.

**Hand Calibration** assures maximum accuracy throughout every range.

**Mirrored Scale** and knife edged pointer prevent parallax errors.

**Overload Protection** by automatic cutout.

**AC Current Ranges** from 100 ma to 10 amps, full-scale.

**Reversing Switch** ends lead changing on signals of slowly varying polarity.

**Zeroing Controls** for each resistance range permit changeover without resetting.

**Accessories** extend ranges to 25,000 volts DC, 400 amperes AC, .025 ohms to 200 megohms resistance.

**Price \$89.01**

# AVOMETER 8

U.S.A. inquiries: For complete literature and ordering information, call or write Dept. ZR168

**BRITISH INDUSTRIES CORPORATION**

Scientific Instruments Division, Port Washington, New York

Other inquiries: AVO Limited, Avocet House, 92-96 Vauxhall Bridge Road, London, S.W.1, England

# At last! A PRECISION DUAL

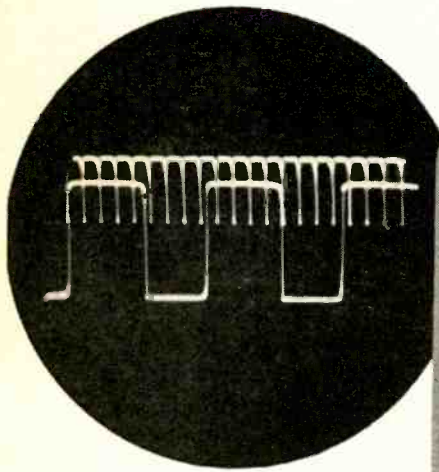

New 122A uses alternate sweep or 40 KC chopper for dual trace display



New  
**hp 122A/AR**  
rugged cabinet  
or 7" high  
rack mount

Other high performance, direct reading,

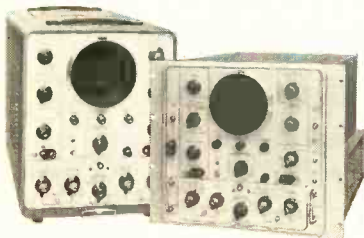

**-hp- 150A/AR, DC to 10 MC.** 2+ sweep times, 0.02 sec/cm to 15 sec/cm. Plug-ins for high gain or dual channel use. Rack mount, \$1,200; cabinet model, \$1,100.



**-hp- 130B/BR, DC to 300 KC.** Similar X, Y amplifiers, 21 sweep times, 1  $\mu$ sec/cm to 12.5 sec/cm. Balanced input 5 most sensitive ranges. Includes times-5 magnifier. \$650.

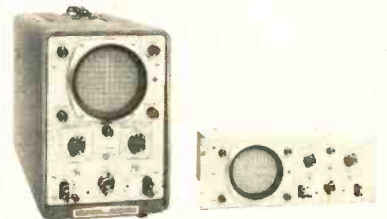

**-hp- 120A/AR, DC to 200 KC.** 15 sweep times, 1  $\mu$ sec/cm to 0.5 sec/cm. Times-5 magnifier, automatic trigger. Simple to use, rugged, outstanding value. \$435.



# 200 KC SCOPE WITH TRACE PRESENTATION!

**Big-scope versatility at moderate cost!**

Here at last is a 200 KC oscilloscope — priced at just \$625 — giving you “big-scope” versatility and the time-saving convenience of simultaneous two-phenomena presentation.

Engineered to speed industrial, mechanical, medical and geophysical measurements in the 200 KC range, the new *-hp-122A* has two identical vertical amplifiers and a vertical function selector.

*The amplifiers may be operated independently, differentially on all ranges, alternately on successive sweeps, or chopped at a 40 KC rate.*

Other significant features include universal optimum automatic triggering, high maximum sensitivity of 10 mv/cm, 15 calibrated sweeps with vernier, sweep accuracy of  $\pm 5\%$  and a “times-5” expansion giving maximum speed of 1  $\mu\text{sec}/\text{cm}$  on the 5  $\mu\text{sec}/\text{cm}$  range. Trace normally runs free, syncing automatically on 0.5 cm vertical deflection, but a knob adjustment eliminates free-run and sets trigger level as desired between  $-10$  and  $+10$  volts. Rack or cabinet mount; *rack mount model only 7" high.*

For complete details, write or call your *-hp-* representative, or write direct.

## BRIEF SPECIFICATIONS

**Sweep:** 15 calibrated sweeps, 1-2-5 sequence, 5  $\mu\text{sec}/\text{cm}$  to 0.2 sec/cm, accuracy  $\pm 5\%$ . “Times-5” expander, all ranges. Vernier extends 0.2 sec/cm range to 0.5 sec/cm.

**Trigger selector:** Internal + or —, external or line. Triggers automatically on 0.5 cm internal or 2.5 v peak external. Displays base line in absence of signal. Trigger level selection  $-10$  to  $+10$  v available when automatic trigger defeated.

**Vertical Amplifiers:** Identical A and B amplifiers, 4 calibrated sensitivities of 10 mv/cm, 100 mv/cm, 1 v/cm and 10 v/cm;  $\pm 5\%$  accuracy. Vernier 10 to 1.

Balanced (differential) input available on all input ranges. With dual trace, balanced input on 10

mv/cm range. Input impedance 1 megohm with less than 60  $\mu\text{mf}$  shunt. Bandwidth DC to 200 KC or 2 cps to 200 KC when AC coupled. Internal amplitude calibrator provided.

**Function Selector:** A only, B only, B-A, Alternate and Chopped (at approx. 40 KC).

**Horizontal Amplifier:** 3 calibrated sensitivities, 0.1 v/cm, 1 v/cm, 10 v/cm. Accuracy  $\pm 5\%$ . Vernier 10 to 1.

Bandwidth DC to 200 KC or 2 cps to 200 KC, AC coupled.

**General:** 5AQPI CRT, intensity modulation terminals at rear, power input approximately 150 watts, all DC power supplies regulated.

**Price:** (Cabinet or rack mount) \$625.00.

Data subject to change without notice. Prices f.o.b. factory.

automatic trigger  oscilloscopes



**-hp- AC-21C Voltage Divider Probe.** 50:1 divider with 10 megohm input impedance and 2.5  $\mu\text{mf}$  capacitance. For *-hp-* 150A but usable with most scopes, VTVM's, preamps. \$25.

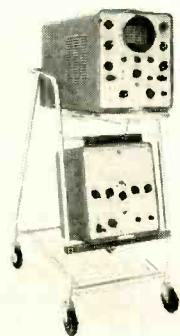

**-hp- 115A Testmobile** for 150A, other scopes. Tilts scope to  $30^\circ$  in  $7\frac{1}{2}^\circ$  stages. Heavy chrome tube construction, 4" rubber tired wheels, rolls easily, folds compactly for storage. \$80.

**-hp- 116A Storage Unit** (\$22.50) hangs on 115A, holds three 150A plug-ins or *-hp-* 117A Accessory Drawers, \$10 each.

## HEWLETT-PACKARD COMPANY

5027A PAGE MILL ROAD • PALO ALTO, CALIFORNIA, U.S.A.  
CABLE "HEWPACK" • DAVENPORT 5-4451  
FIELD REPRESENTATIVES IN ALL PRINCIPAL AREAS

CIRCLE 17 READERS SERVICE CARD

CIRCLE 18 READERS SERVICE CARD →

# ANACONDA ANATHERM





# First polyester high-temperature magnet wire in full range of sizes

-- ROUND



-- SQUARE



-- RECTANGULAR



Anatherm, Anaconda's Class 155°C polyester film-coated magnet wire is now available in single, heavy, triple and quadruple grades of round wires (sizes 8 through 46) and in a full range of sizes of squares and rectangles. This is the first time a complete range of sizes and shapes has been offered in this type wire.

Fully tested for use at temperatures up to 155°C, Anatherm was also the first film-coated wire to meet the newly adopted AIEE 155°C (Class F) rating.

Anatherm gives you greater thermal stability—plus excellent abrasion-resistance, chemical stability and dielectric strength. Thus Anatherm is ideally suited for manufacturers seeking maximum per-

formance and reliability from smaller and smaller equipment operating at higher and higher temperatures.

As a polyester magnet wire, Anatherm can be used equally successfully at any "hottest-spot" temperatures over the range of 105°C to 155°C. If you're on the spot about high-temperature magnet wire, ask the Man from Anaconda about Anatherm.



Write for free Anatherm technical bulletin: Anaconda Wire & Cable Co., 25 Broadway, New York 4, New York.

58364



SEE THE MAN FROM **ANACONDA**<sup>®</sup>  
FOR **ANATHERM MAGNET WIRE**

FROM ANACONDA... THIS WIDE VARIETY OF TOP-QUALITY MAGNET WIRES—

**ANALAC** (Class A-105 C)  
solderable magnet wire

**VITROTEX** (Class B-130 C)  
glass-insulated, high heat resistance

**PLAIN ENAMEL** (Class A-105 C)  
low-cost enameled magnet wire

**NYFORM** (Class A-105 C)  
high resistance to winding hazards

**EPOXY** (Class B-130 C)  
all-round compatibility

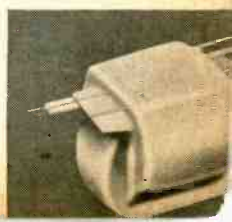

# YOUR FUTURE IS GREAT IN A GROWING AMERICA



## ELECTRONICS

Electronics is one of our fastest growing industries. By 1965 there will be thousands of new needs and new jobs.

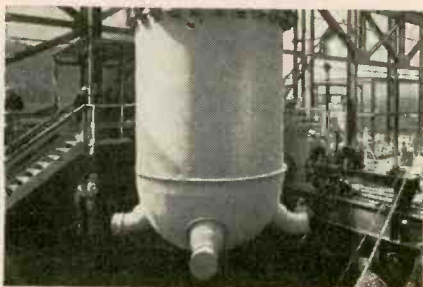

## NUCLEAR ENERGY

Nuclear energy is now supplying power for ships and electric plants. Future possibilities are virtually unlimited.



## HEALTH

Ever-increasing opportunities in research, development and production. In the field of antibiotics 50% more workers will be required.

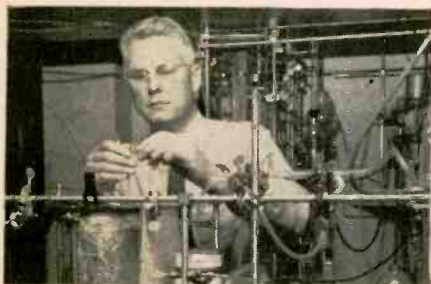

## CHEMICALS

Today there are more than 800,000 workers in chemicals and related industries. By 1970, there will be *twice* as many!



## COMMUNICATIONS

As our nation grows, the demands made upon communications grow proportionately. Thousands more needs, more jobs.



## EDUCATION

The giant school-building program now beginning will offer new jobs to many thousands of construction workers.



## TRANSPORTATION

Our growing population demands constantly increasing mobility. Result: thousands of new opportunities, new jobs in the coming Jet Age.



## FOODS

The trend is to labor-saving, ready-to-eat packaged foods. This new phase of an old industry will need thousands more workers.

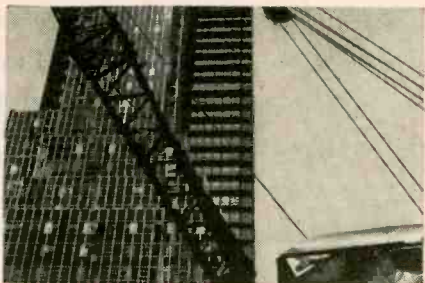

## CONSTRUCTION

3 million workers will benefit from new highway and construction programs—and even more workers will be needed soon.

## 7 BIG REASONS FOR CONFIDENCE IN AMERICA'S FUTURE

**1. MORE PEOPLE**—Four million babies yearly. U. S. population has *doubled* in last 50 years! And our prosperity curve has always followed our population curve.

**2. MORE JOBS**—Though employment in some areas has fallen off, there are *15 million* more jobs than in 1939—and there will be *22 million more* in 1975 than today.

**3. MORE INCOME**—Family income after taxes is at an all-time high of \$5300—is expected to pass \$7000 by 1975.

**4. MORE PRODUCTION**—U. S. production *doubles* every 20 years. We will require millions more people to make, sell and distribute our products.

**5. MORE SAVINGS**—Individual savings are at highest level ever—*\$340 billion*—a record amount that is now available for spending.

**6. MORE RESEARCH**—*\$10 billion* spent each year will pay off in more jobs, better living, whole new industries.

**7. MORE NEEDS**—In the next few years we will need more than *\$500 billion* worth of schools, highways, homes, durable equipment. Meeting these needs will create new opportunities for everyone.

\* \* \*

**Add them up and you have the makings of another big upswing. Wise planners, builders and buyers will act now to get ready for it.**

**FREE!** Send for this new illustrated booklet, "Your Great Future in a Growing America." Drop a postcard to: ADVERTISING COUNCIL, Box 10, Midtown Station, New York 18, N.Y.



## MARKETING

Marketing includes sales, consumer research, product and package design, advertising and public relations. *All* need new skills every year—and *many thousands* of new workers!





WESTON INSTRUMENTS: STANDARDS OF STABILITY IN SCIENCE AND INDUSTRY

# TOP ACCURACY IS AT YOUR FINGER-TIPS

... with Weston Portable Instruments

Easy portability, exceptional readability, sustained high accuracy . . . these features have been painstakingly engineered into every Weston Portable. Each is hand calibrated by direct comparison with precise reference standards. All are shielded against the effects of external magnetic fields . . . far in excess of ASA requirements. Weston Portables are equipped with long mirror scales and knife-edge pointers to eliminate parallax errors. All are well compensated for temperature changes.

Models 931, 901 and 622 make up a graduated series of Weston Portables. They cover a broad range of applications — from general testing in field, plant or laboratory to the exacting demands of electronics, telephony and temperature measurement. The 931 group and the 901 group have scale lengths of 4.0" and 5.5" respectively. The unusually sensitive '622' instruments have 6.1" scales, with proportionately greater accuracies and readability.

You'll find complete information in the Weston bulletins covering these instruments. Call your local Weston representative . . . or write to Weston Instruments, Division of Daystrom, Inc., Newark 12, N. J. *In Canada: Daystrom Ltd., 840 Caledonia Rd., Toronto 10, Ont. Export: Daystrom Int'l., 100 Empire St., Newark 12, N. J.*

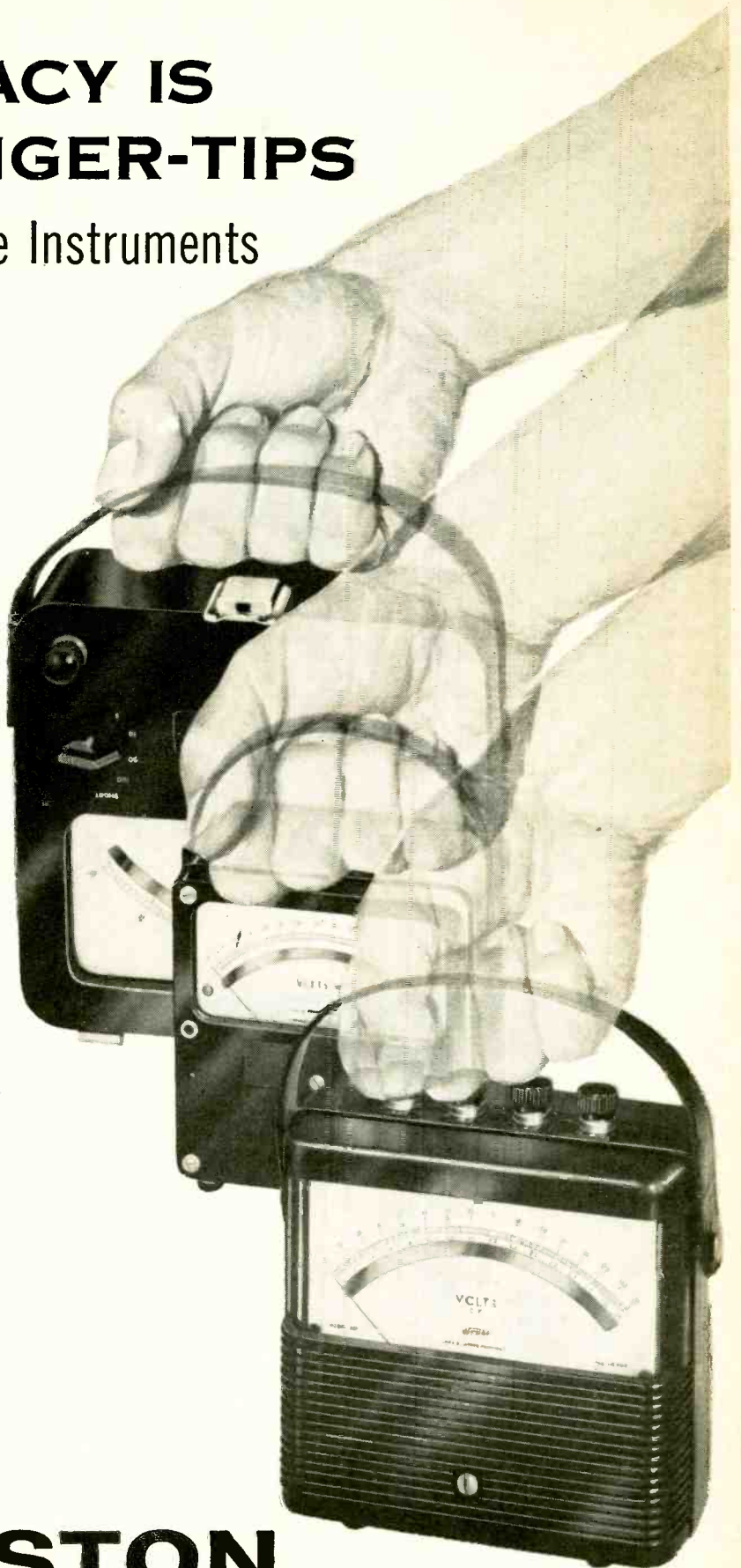

## WESTON

*Instruments*



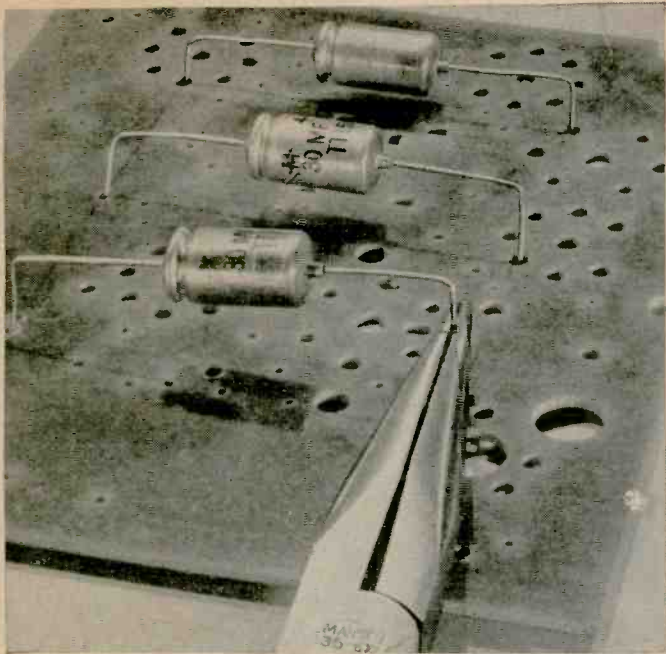

Leader in electrolytic capacitors, Mallory introduced the first dry electrolytics . . . the first 85° C capacitor, the Mallory FP . . . and the first high-temperature tantalum capacitor. In recent years, Mallory has led in progress in miniature capacitors, including those shown here . . . the first miniature electrolytics economically priced for commercial use; plus a complete line of subminiature tantalum models.

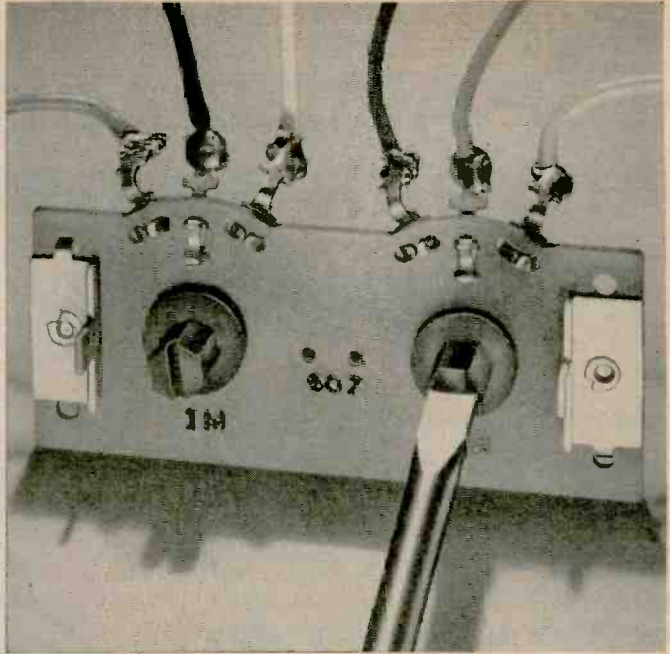

Economical strip-type controls cut manufacturing costs . . . are just one of many special Mallory designs of carbon volume controls including models for use with printed circuits, with low hop-off resistance for transistor circuits, with convenient push-pull switch. Mallory precision made wire-wound resistors include a full line of controls and vitreous enamel, cement-coated and axial lead fixed resistors.

# Get More From Mallory..



Ideal power for transistors is the mercury battery, pioneered by Mallory. High energy in small volume, long life and constant discharge characteristics make this battery valuable in miniaturized, self-powered equipment. Another Mallory development is the Solidion® solid state battery, capable of storage for over 15 years. It is ideal for stockpiled systems.

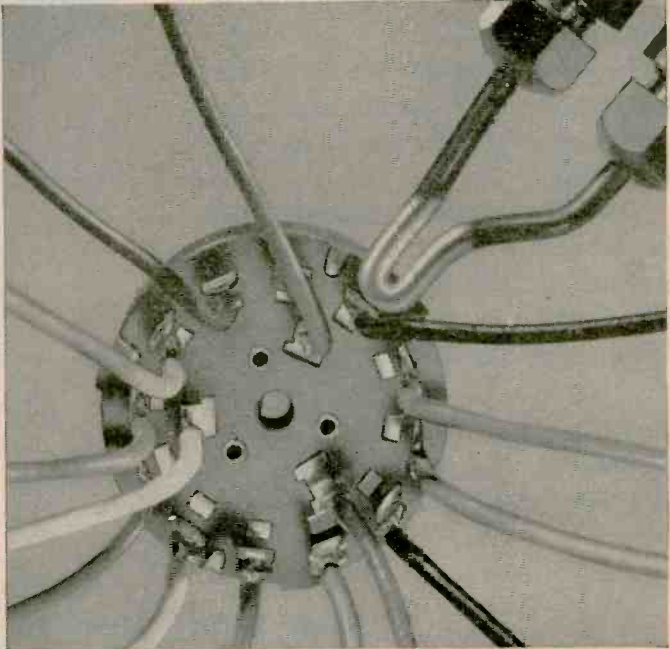

Special electronic components include a wide selection of wafer and push-button switches, and a series of jacks and plugs including types for communications and military uses. The famous Mallory Inductuner, a high precision variable inductance tuning element, gives superior front-end performance in VHF and UHF bands.



**Big news in silicon rectifiers** is the new Mallory Type T . . . first to offer radio and TV manufacturers high reliability at low cost. It has low reverse current and low forward drop. Unique Mallo-Seal\* encapsulating compound enables it to exceed military humidity test requirements, stand 250 hours boiling water test. In addition, a new line of Mallory military types includes "top-hat" and stud-mounted styles.

\*TRADE MARK

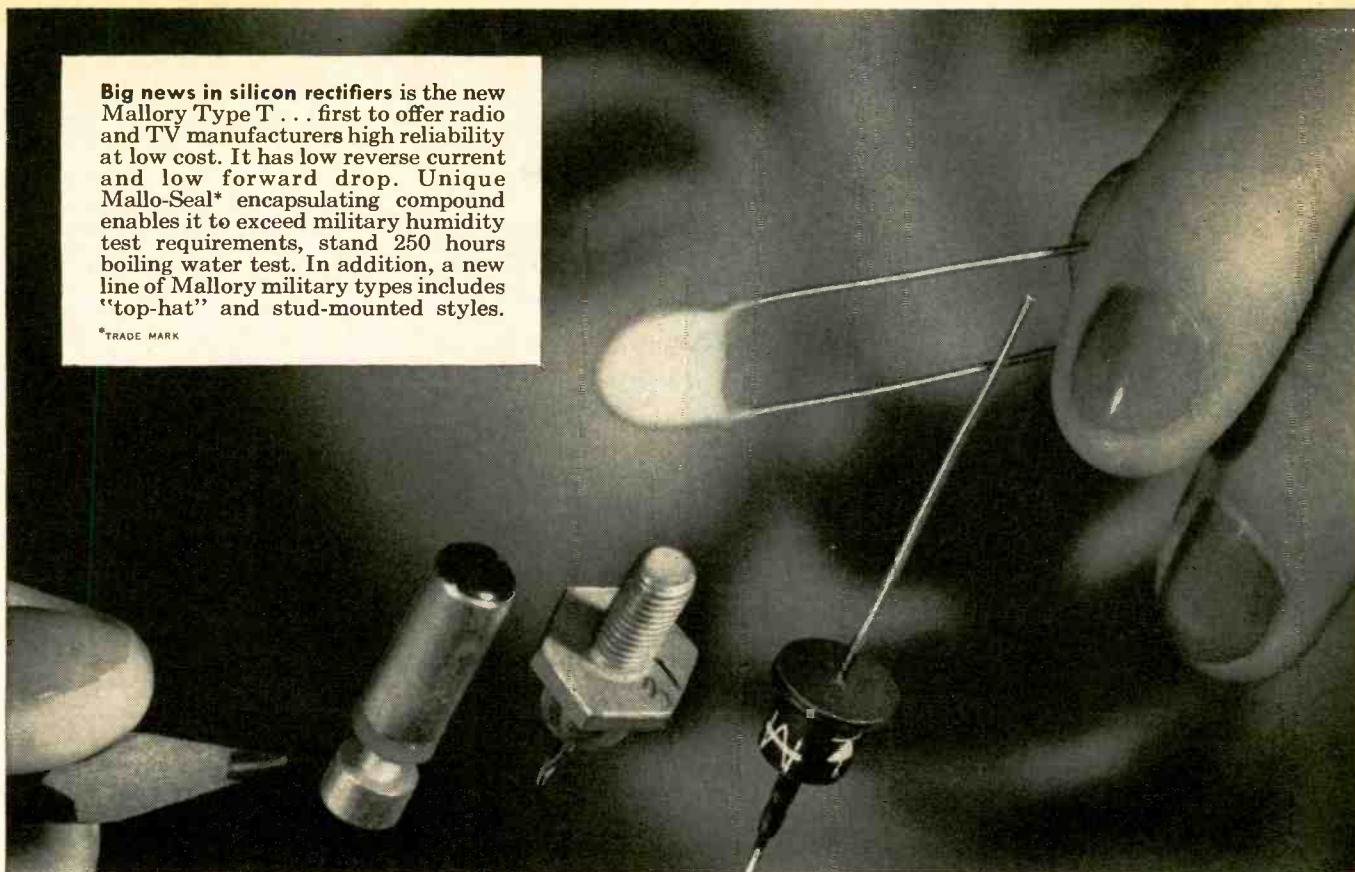

## *... More Precision Products . . . More Engineering Assistance* In the Radio and Television Industry, for example . . .

**F**ROM the r-f "front end" to the power supply, Mallory offers radio and television manufacturers a broad line of precision-made components . . . and skilled engineering assistance in their applications.

Batteries, capacitors, controls, resistors, switches, vibrators and tuning devices—all these products of Mallory represent the knowledge of more than thirty years of creating and manufacturing special components that have contributed greatly to electronic progress.

We at Mallory are privileged to have been among the pioneers of the radio and television industry, and to have had a part in its spectacular growth. Among our contributions have been some notable "firsts"—the first commercial vibrator, the first 85° C electrolytic capacitor,

the first mercury battery, and the first silicon rectifier to provide highest quality and dependability at low commercial prices. Today, you can get from Mallory the most diversified line of components, made under a tradition of precision design and workmanship that is unequalled in the electronics industry.

Because the Mallory line is so varied and inclusive, you can depend on Mallory for engineering assistance that extends across the application of many related components in your specific radio or television circuit. Not merely specialists in a few components, but well experienced in many, our staff can lend valuable help to your designers in achieving peak over-all performance and economy. We'll welcome the opportunity for a consultation—just call or write Mallory today.

#### Serving Industry with These Products:

**Electromechanical**—Resistors • Switches • Tuning Devices • Vibrators  
**Electrochemical**—Capacitors • Mercury and Zinc-Carbon Batteries  
**Metallurgical**—Contacts • Special Metals • Welding Materials



# for DEPENDABILITY use HICKORY BRAND



## ELECTRONIC WIRES and CABLES

- QUALITY-ENGINEERED
- PRECISION-MANUFACTURED
- PLASTIC INSULATED AND SHEATHED

### MW HOOKUP WIRE

Use for electronic devices, aircraft instruments, radio and radar transmitters, receivers, lighting and power rectifiers. Thirty color combinations. Features high dielectric strength, resistance to acids, alkalis, oil, flame and moisture. Fungus-proof. Temperature rating minus 40° C to 80° C.

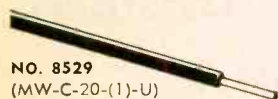

NO. 8529  
(MW-C-20-(1)-U)

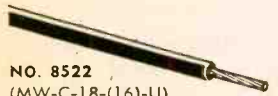

NO. 8522  
(MW-C-18-(16)-U)

#### SIZE 20 AWG

**Specifications:** Solid tinned copper conductor .016 vinyl insulation .066 diam. Length: 25' coil, 100' spool, 1000' spool.

#### SIZE 18 AWG

**Specifications:** 16 x 30 stranded tinned copper conductor .016 vinyl insulation .081 diam. Length: 25' coil, 100' spool, 1000' spool.

### COAXIAL CABLES

Maximum operating efficiency in applications requiring high, very high and ultra-high frequencies.

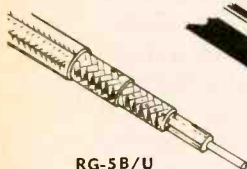

RG-5B/U



RG-59A/U



RG-17A/U

Army Navy Type No.	Inner Conductor In.	Diameter of Dielectr. In.	Nominal Impedance Ohms	Attenuation DB/100 Ft. 10%		Nominal Overall Diameter In.
				400 MC	3000 MC	
RG-5B/U	0.051" 16 AWG	0.185"	50	6.5	24	0.332"
RG-17A/U	0.195"	0.680"	50	2.5	11	0.870"
RG-59A/U	0.023"	0.146"	75	9	30	0.242"

### HOOKUP and LEAD WIRES

Use for high voltage leads to cathode ray tubes. Features high dielectric strength, corona resistance and minimum surface leakage.

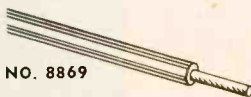

NO. 8869

**20 AWG 7 x 28** stranded copper tinned .108" nom. dia. **Specifications:** .035 flame retardant polyethylene insulation, color white. Puncture voltage 32,000 volts. Temp. rating 100° C. Suggested working voltage 10,000. Length: 25' coil, 100' spool.



NO. 8868

**20 AWG 7 x 28** stranded copper tinned .168" nom. dia. **Specifications:** .065 flame retardant polyethylene insulation, color white with red strip. Puncture voltage 54,000 volts. Temp. rating 100° C. Suggested working voltage 20,000. Length: 25' coil, 100' spool.

### INTERCOMMUNICATING and SOUND SYSTEM CABLES

Shielded and unshielded cables available, also composite types. Designed for long service life, excellent mechanical and electrical characteristics. Use for balanced intercom systems, annunciators, telephones, control circuit cable, electronic computer cable and multiple speaker and signal systems.

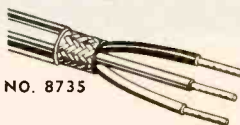

NO. 8735

**3 conductors 22 AWG 7 x 30 Cu.** tinned .015" ins. .189" nom. dia. **Specifications:** 3 cond. vinyl plastic insulation cabled black, red and white tinned copper braid shield, vinyl jacket. Length: 15' coil, 50' coil, 100' spool, 500' spool, 1000' spool.

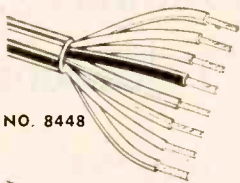

NO. 8448

**8 conductors 22 AWG 7 x 30 strand** .015" ins. .235" nom. dia. **Specifications:** Cabled, .020" vinyl jacket over all. Colors: Black, blue, brown, green, orange, red, white and yellow. Length: 100' spool, 500' spool.

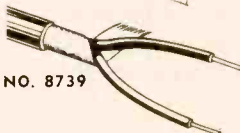

NO. 8739

**2 conductors 22 AWG solid .015" ins.** .015" nom. dia. **Specifications:** 2 Cond. vinyl plastic insulation cabled black and red, tinned copper spiral shield, vinyl jacket. Length: 100' spool, 500' spool, 1000' spool.

Write for complete information on the complete line of  
Hickory Brand Electronic Wires and Cables



# HICKORY BRAND Electronic Wires and Cables

Manufactured by  
SUPERIOR CABLE CORPORATION, Hickory, North Carolina



# The New Brush Mark II opens up whole new world of direct writing applications



#### Sensitivity

10mv/line (mm). Full scale deflection from chart center  $\pm 200$  mv.

#### Measurement Range

.010v. to 100v.

#### Input Impedance

5 megohm single-ended, 10 megohm balanced.

#### Frequency Response

D.C. to 100 cps.

#### Recording Channels

Four, 2 event channels and 2 analog.

#### Chart Speeds

1, 5, 25, 125 mm/sec.

#### Power Requirements

105-125v., 60 cps, 135 watts at 115v.

The portability and remarkable simplicity of the Brush Mark II make it practical to use *anywhere*.

Wherever you work—in research, design and development, production, field testing—you get an immediate *ultralinear* record of performance . . . for quick analysis and corrective action on the spot . . . for study at a later date . . . for reproduction by conventional low-cost copy methods.

As foolproof as you'd hoped for, this recorder has built-in amplifiers, permanent calibration, instant paper loading and a "white glove" writing system. Use it as a recording voltmeter . . . as a supplement to your "scopes".

CALL-WRITE-WIRE for immediate shipment from stock — \$1350 F.O.B. Cleveland.

**brush** INSTRUMENTS

DIVISION OF

3405 PERKINS AVENUE

**CLEVITE**  
CORPORATION

CLEVELAND 14, OHIO



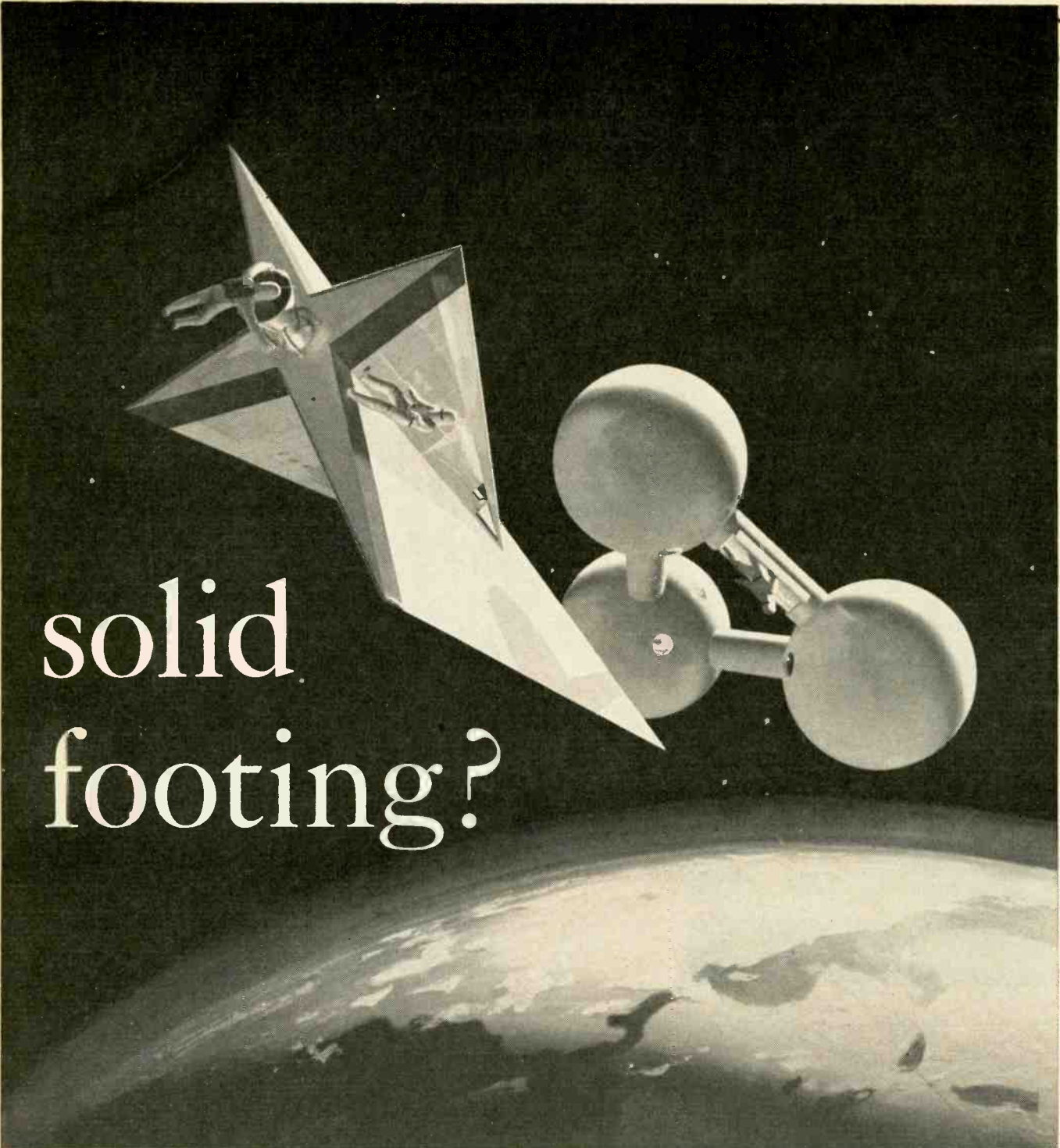

# solid footing?

To a man floating weightless around Space Station C, these are perhaps meaningless words—but *solid footing* is highly important to most of us who live and work on the surface of the earth.

Autonetics has established a solid footing in inertial guidance through 12 years of successful development and production of airborne and ocean-going systems, as well as systems for space applications.

The healthy growth of the Autonetics Guidance Engineering department—based on a number of highly diversified contracts—has created new senior-

level positions in the fields of electro-mechanical component development and system analysis.

Well qualified, experienced men will find solid footing in this permanent, progressive, and successful organization—plus the chance to create and to grow in one of today's most challenging fields.

But time's a-wasting. *Now* is the time to find out what the future holds for *you* at Autonetics.

Please send your resume to Mr. B. K. Benning, Manager, Employment Services, 9150 E. Imperial Highway, Downey, California.

NERVE CENTER OF THE NEW INDUSTRIAL ERA

**Autonetics**

A DIVISION OF NORTH AMERICAN AVIATION, INC.







For better looking equipment,  
use the best looking resistors

NEW IRC **GBT** 

New attractive appearance— $\frac{1}{2}$  watt and 1 watt  
New smaller size—1 watt

*Ask your IRC salesman about NEW GBT Carbon Composition Resistors*

**INTERNATIONAL RESISTANCE COMPANY** • 401 N. Broad Street, Philadelphia 8, Penna. In Canada: International Resistance Co., Ltd., Toronto, Licensee

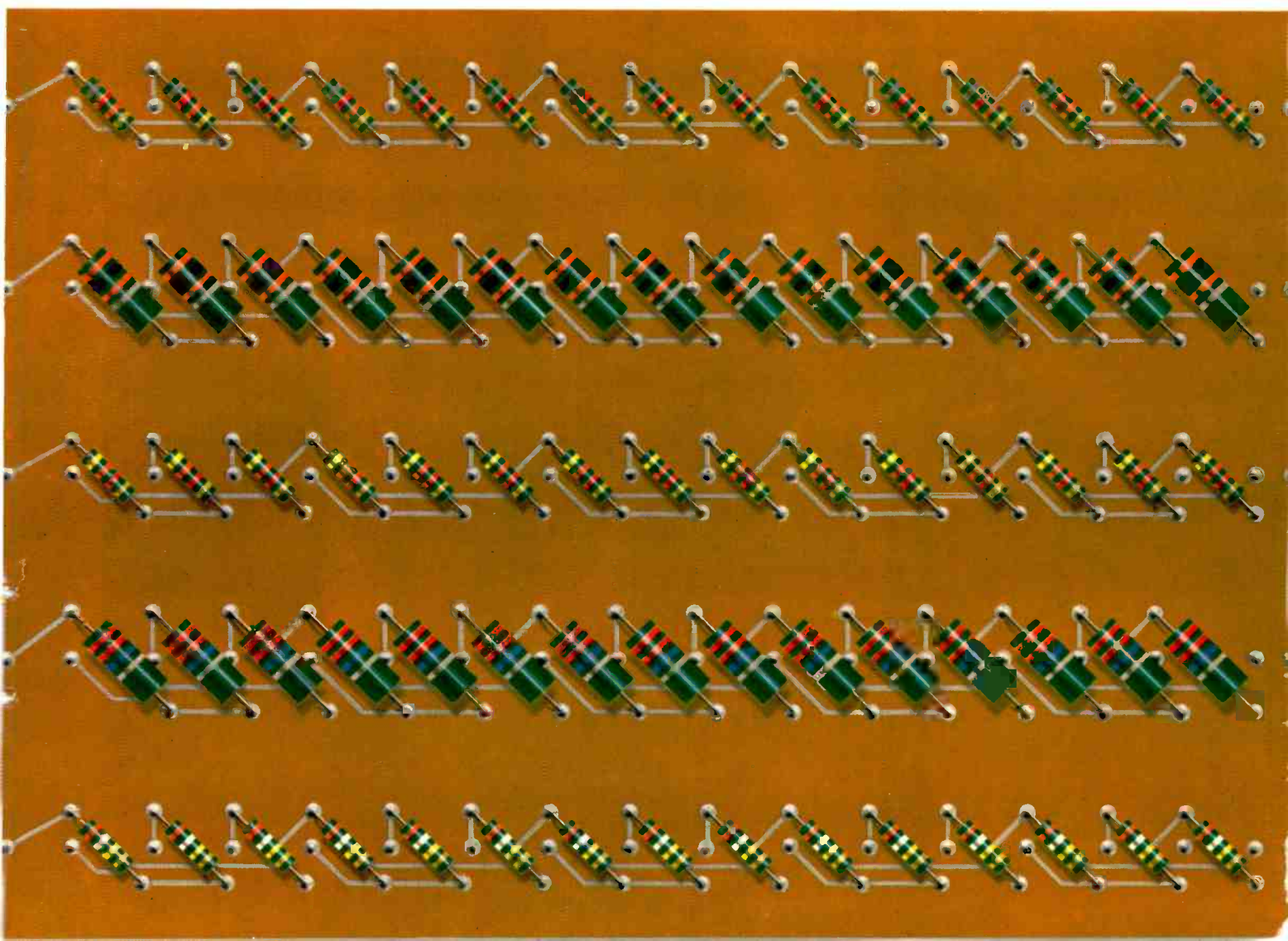

# Temco

AIRCRAFT  
DALLAS

## Making major breakthroughs in brazing stainless sandwich

Two radically new process developments by Temco Engineering may well revolutionize the entire concept of fabricating stainless steel honeycomb structures. One is "Temcombing," Temco's *continuous process* of stainless sandwich fabrication. The other is a simplified "Two-Phase" method for brazing stainless honeycomb structures. Patents now are being applied for on both of these processes.

Conventional, time-consuming batch brazing methods seem primitive compared with Temcombing. Panels of virtually unlimited size now are feasible in place of small, batch-made panels, thus reducing weight and critical tolerance errors. After lay-up, finished Temcomb panels can be turned out at rates up to 18 inches per minute, and at considerably *lower costs than by batch methods*.

Temco's exclusive Two-Phase resistance brazing method eliminates the need for furnace operations. For complex shapes, the Two-Phase process is the fastest and most advanced developed to date.

Advanced weapons systems, probing beyond Mach 3, demand whole new domains of materials and reliability. Temco engineering capabilities are meeting these demands with new developments and fabrication techniques in stainless steel, titanium, and other high-temperature materials. Pioneering in design, tooling and production for tomorrow's spacecraft industry is part of Temco's complete systems capabilities — all ready to meet *your* challenge.

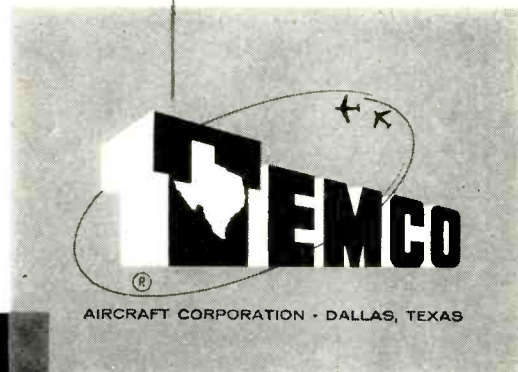

TOMORROW'S NEED IS TODAY'S CHALLENGE AT..



Only Merck makes  
all three forms of ultra-pure

# SILICON

for semiconductor applications

**Merck Polycrystalline Billets**—have not been previously melted in quartz, so that no contamination from this source is possible. Merck guarantees that single crystals drawn from these billets will yield minimum resistivities over 50 ohm cm. for n type material, and over 100 ohm cm. for p type material. Merck Silicon Billets give clean melts with no dross.

**Merck Polycrystalline Rods**—are ready for zone melting as received . . . are ideal for users with floating-zone melting equipment. Merck Polycrystalline Rods (8½ to 10½ inches long and 18 to 20 mm. diameter—smaller diameters on special order) yield more usable material. In float-zone refining one can obtain minimum resistivities of 1000 ohm cm. p type with minimum lifetime of 200 microseconds.

**Merck Single Crystal Silicon**—offers manufacturers without floating-zone equipment semiconductor Silicon of a quality unobtainable elsewhere. No crucible-drawn crystals can match the reliability of Merck single crystal material in semiconductor devices. Merck Single Crystal Silicon is available with min. resistivity of 1000 ohm cm. p type. Other resistivities ranging from 1.0 ohm cm. p or n type up to 1000 ohm cm. will soon be available.

© Merck & Co., Inc.



*For additional information on specific applications and processes, write Merck & Co., Inc., Electronic Chemicals Division, Dept. ES-8, Rahway, N.J.*

**ULTRA-PURE  
SILICON** —a product of **MERCK**

**BASE BORON CONTENT BELOW ONE ATOM  
OF BORON PER SIX BILLION SILICON ATOMS**

**Better Prints . . .**

---

**Easier  
Printmaking . . .**

---

**Big, new  
operating  
features**



# The Printmaster 810

Here's the advanced Printmaster 810—with features that outdate every other whiteprinter in its price class. Now you can assure yourself of better whiteprints, more easily, in less time.

- 1. More compact—lower in height . . .** saves valuable floor space, allows easier lamp replacement, better control . . . means less fatigue.
- 2. New design of brush feed assembly . . .** to automatically control curled edges, folded corners.
- 3. New print pick-off . . .** prevents tearing, sticking or scratching.
- 4. Improved tracing release . . .** convenient release pedal means immediate control of tracing and print—no loss of time and material.
- 5. Cool cylinder design . . .** means practically no sticking in processing plastic-coated materials and foils.
- 6. New filtered air system . . .** Fiberglas® filter delivers filtered air—for cleaner machine, cleaner prints—means less shut-down time for cleaning.

And Ozalid offers other great *proven* features such as new steel frame support . . . double paper rods . . . both rear and front delivery . . . and U/L approved safety devices.

Why not test-run your own tracings through the new "810"? Simply call your local Ozalid representative or write: Ozalid, Dept. L-10-10, Johnson City, N. Y.



A Division of General Aniline & Film Corporation  
In Canada: Hughes Owens Company Ltd., Montreal





Eimac Announces...

## Six New Ceramic Reflex Klystrons

1K20 Series X and K Band Klystron (left)  
1K125C Series C Band Klystron (right)

Two important frequency ranges in the C, X and K bands are now covered by Eimac ceramic reflex klystrons. Eimac's advanced stacked ceramic design gives these tubes exceptional ruggedness and frequency stability.

The four new tubes of the 1K20 series cover 8500 to 11,700 Mc. at power levels to 50 milliwatts. These tubes are specifically designed for use in the severe vibration and temperature environment of air-borne and missile radar systems. They will withstand vibration levels of 15G in any reference plane with less than 100 kilocycle frequency deviation. Rated for use at any altitude, the 1K20 series tubes are conservatively rated at +250°C seal temperature. A new non-contacting, non-microphonic tuner permits noise-free tuning of the tubes through their complete ranges. Low beam voltage requirement and simple

radiation cooling minimize the weight and complexity of associated equipment.

Two new C-band tubes comprising the 1K125 series cover 3700 to 5000 Mc. Power levels up to 2 watts make these tubes ideal for reliable broadband point-to-point communication. Tuning by dielectric slug rather than variable RF gap avoids sensitivity to shock and vibration. Integral-finned cooler and higher operating temperature ratings minimize cooling requirements.

Eimac know-how in the field of ceramic-metal tube design now brings compactness, ruggedness, high performance and reliability to these important microwave frequencies.

For further information request a copy of the brochure  
"A New Line of Eimac Reflex Klystrons"

**EITEL-McCULLOUGH, INC.**  
SAN CARLOS, CALIFORNIA

Cable Address: EIMAC, SAN CARLOS

*Eimac First for ceramic reflex klystrons*



### GENERAL CHARACTERISTICS

Type	Freq. Range Mc.	Beam Voltage	Power Output Range	Reflector Voltage
1K125CA . . . . .	3700-4400	1000 Vdc	1.5 to 2.0 W	0 to -500 Vdc
1K125CB . . . . .	4400-5000	1000 Vdc	2.0 to 2.3 W	0 to -500 Vdc
1K20XS . . . . .	8500-9300	300 Vdc	25 to 50 mW	0 to -250 Vdc
1K20XK . . . . .	9200-10,000	300 Vdc	25 to 50 mW	0 to -250 Vdc
1K20XD . . . . .	10,000-10,800	300 Vdc	25 to 50 mW	0 to -250 Vdc
1K20KA . . . . .	10,700-11,700	300 Vdc	25 to 50 mW	0 to -250 Vdc



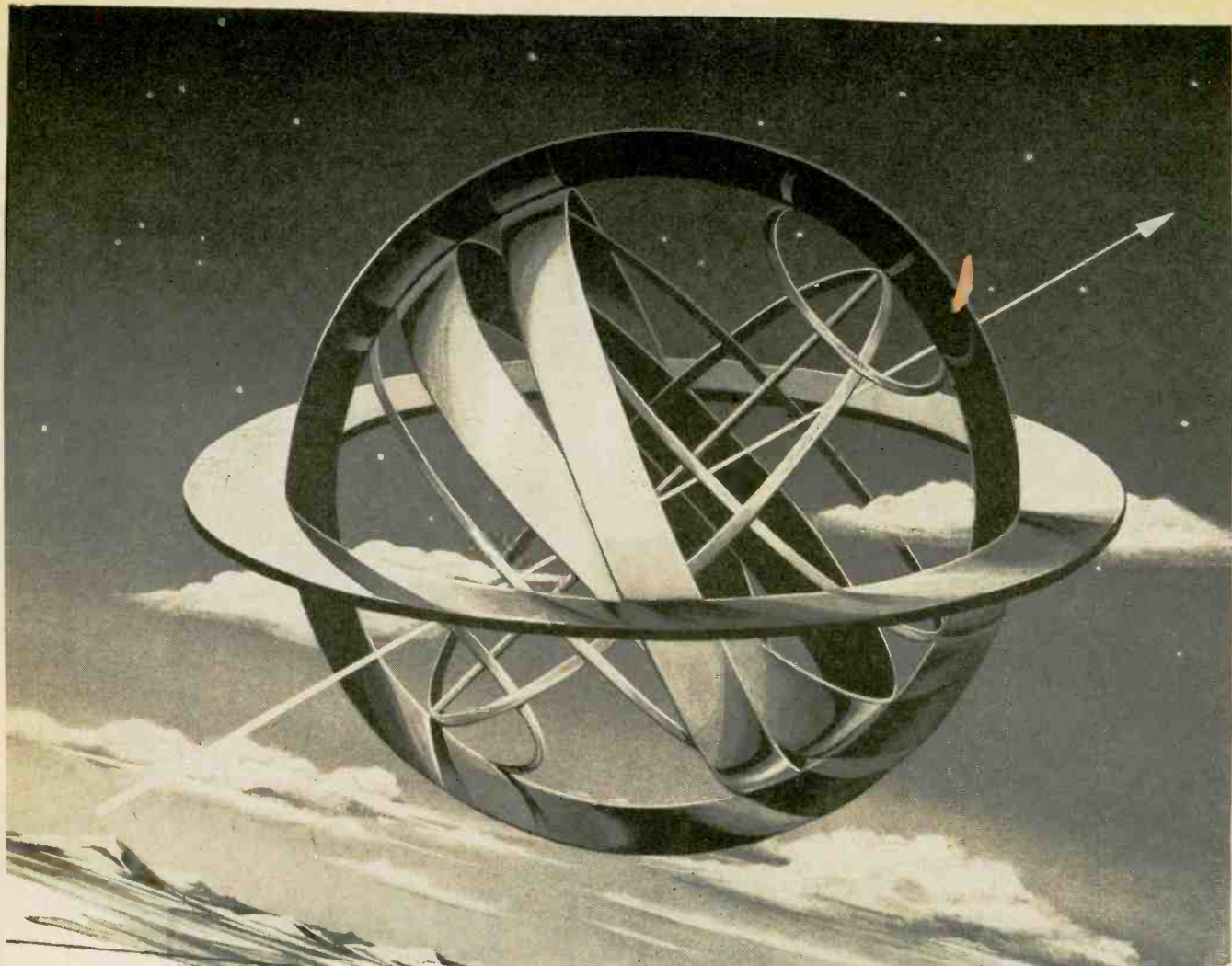

## HIPERNAS II

### A new concept in advanced INERTIAL NAVIGATION SYSTEMS

Bell has outstanding opportunities for experienced engineers and scientists in the following areas:

- Inertial navigation system analysis and design
- Design and evaluation of gyros and accelerometers
- Airborne digital computer application
- Inertial test equipment development and design
- Transistorizing of analogue and pulse circuitry
- Advanced design and packaging

Assignments embrace a high level of design and development problems. Learn about the personal opportunities and unexcelled benefits now available to you on this challenging program. Send resume of your qualifications to: Supervisor of Engineering Employment, Dept. H-51, BELL AIRCRAFT CORPORATION, P. O. Box One, Buffalo 5, New York.

*Niagara Frontier Division*





# Announcing A NEW MEMBER OF THE **Tarzian** SILICON RECTIFIER LOW CURRENT FAMILY...

## The H Series

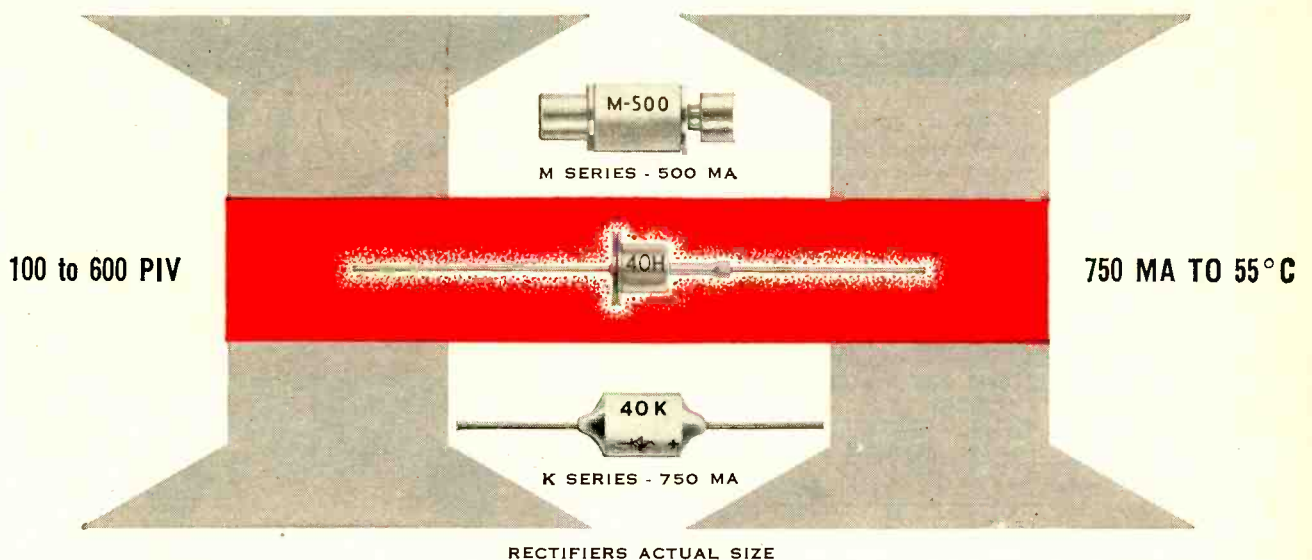

### ELECTRICAL RATINGS CAPACITIVE LOAD

S. T. Type	Max. Peak Inverse Volts	Max. RMS Volts	CURRENT RATINGS—AMPERES											
			Max. D. C. Load			Max. RMS			Max. Recurrent Peak			Surge 4MS Max.		
			55°C	100°C	150°C	55°C	100°C	150°C	55°C	100°C	150°C	55°C	100°C	150°C
10H	100	70	.75	.5	.25	1.875	1.25	.625	7.5	5.	2.5	30	30	15
20H	200	140	.75	.5	.25	1.875	1.25	.625	7.5	5.	2.5	30	30	15
30H	300	210	.75	.5	.25	1.875	1.25	.625	7.5	5.	2.5	30	30	15
40H	400	280	.75	.5	.25	1.875	1.25	.625	7.5	5.	2.5	30	30	15
50H	500	350	.75	.5	.25	1.875	1.25	.625	7.5	5.	2.5	03	30	15
60H	600	420	.75	.5	.25	1.875	1.25	.625	7.5	5.	2.5	30	30	15

### Features

- High Reliability—  
Extra Heavy Duty Junction
- Hermetically Sealed  
Welded Case
- Small Size
- Low Price
- Mass Production
- Available from Stock in  
Many Ratings



**RECTIFIER DIVISION**  
DEPT. D-4, 415 N. COLLEGE AVE., BLOOMINGTON, IND.

IN CANADA: 700 WESTON RD., TORONTO 9, TEL. ROGERS 2-7535 • EXPORT: AD AURIEMA, INC., NEW YORK CITY

# NUCLEAR ENERGY BALLISTICS RADAR RESEARCH

## RIBET DESJARDINS

### SYNCHROSCOPE 204 A

The synchroscope 204 A, an apparatus of very high performance, is unique in making it possible to record ultra-rapid phenomena reaching several thousand kilometers-second. It offers the same characteristics of precision and safe operation that have secured the universal reputation of the Electronic Department of the Ribet-Desjardins Company.

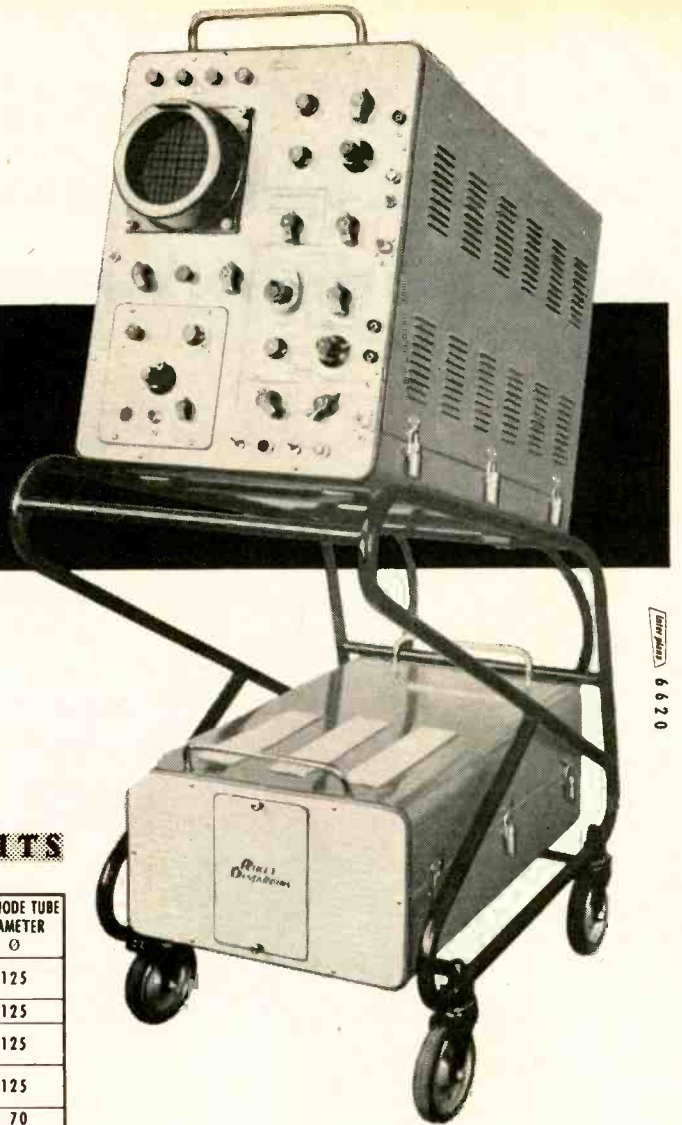

6620

#### MEASURE AND CONTROL UNITS

##### I - OSCILLOSCOPES AND SYNCHROSCOPES

MODELS	CHANNELS	RANGE	AMPLI V		RESPONSE LAG $\mu$ s	MARKER	CATHODE TUBE DIAMETER $\phi$
			Passing Band cps - m c	Sensitivity mV/p to p/cm			
204 A	1	0.01 $\mu$ s/cm - 4 s/cm	0 - 50	50	0.007	Calibrated + 100 $\mu$ s	125
251 A	2	0.02 $\mu$ s/cm - 10 s/cm	0 - 30	50	0.02	Calibrated	125
252 BL	1	0.1 $\mu$ s/cm - 4 ms/cm	0 - 10 10 - 10	80 50	0.04	0.05 $\mu$ s - 1000 $\mu$ s	125
254 A	2	0.1 $\mu$ s/cm - 1 s/cm	0 - 4	20	0.12	Calibrated	125
255 A	1	0.1 $\mu$ s/cm - 1 s/cm	0 - 10	50	0.045	Calibrated	125
255 A	1	0.3 $\mu$ s/cm - 0.01 s/cm	0 - 4	150	0.12	0.4 $\mu$ s - 4 ms	70
256 A	2	1 $\mu$ s/cm - 1 s/cm	0 - 1	15	—	Calibrated	90
256 A	1	1 $\mu$ s/cm - 1 s/cm	0 - 0.8	50	—	Calibrated	90
258 A	1	2 $\mu$ s/cm - 20 ms/cm	50 - 1	50	—	—	70
264 B	2	1 $\mu$ s/cm - 0.05 s/cm	10 - 2	6	—	—	90
267 B	1	1 $\mu$ s/cm - 0.1 s/cm	0 - 1 20 - 0.8	250 8	—	—	90
268 A	1	10 cps - 30 kc	50 - 1	45	—	—	70

##### II - GENERATORS AND WOBBLERS

MODELS	FREQUENCY RANGE	SIGNAL	PRECISION	MODULATION	VOLTAGE	PRECISION
406 B	20 cps - 200 kc		+/- 1.5 %	—	20 or 2 x 10 V	3 %
409 A	10 - 300 mcs		>0.1 % min. quartz marker	FM	0.1 V	—
410 A	0 - 250 mcs		>0.1 % min. quartz marker	FM	0.1 V	—
411 A	0 - 320 mcs		>0.1 % min. quartz marker	FM	0.2 V and 0.1 V	—
428 A	100 kcs - 30 mc		>1 % min.	AM	0.1 V constant level	—
476 A	100 kcs - 26 mc		>1 % min. and >2 % min.	FM	0.1 V	—
457 B	5 cps - 50 kc K = A/a : 2-20		2 %	—	10V z int. 100V z ext.	+/- 5 %
458 A	5 cps - 50 kc (repeat) 0.5 $\mu$ s - 10.000 $\mu$ s		5 %	—	2 x 50 V z int.	+/- 5 %

##### III - SUPPLY - MEGOHMMETERS - SUNDRY UNITS

MODELS	DESCRIPTION AND GENERAL FEATURES
111 C	100 <sup>3</sup> - 400 <sup>3</sup> : 200 mA 108 <sup>3</sup> - 15 mA. Heating 1 <sup>3</sup> .3 - 25 V up to 6 amps.
114 A	100 <sup>3</sup> - 250 <sup>3</sup> : 150 mA 150 <sup>3</sup> - 10 mA. Heating 6.3 V, 3 amps.
674 B	5 Mohm - 100 kMohm in 4 measuring ranges at 280 V. cont. controlled
803 B	Pressure and Vibration Detector for fluids and solids.
804 B	Static and Dynamic Extensometric Units
805 A	Magnetic detection of faults in composition and treatment in large components
806 A	Magnetic detection of faults in composition and treatment in small parts
713 A	Cathodic Oscilloscope with 5 or 6 curves for all industrial investigations

*Ribet-Desjardins are, among others, suppliers for :*

The French Atomic Energy Authority, National French Center for Scientific Research, the Marcel Dassault Aircraft Works, the Bretigny Flight Test Center, the French National Defence, SNCF (the French Railways), Oerlikon (Switzerland), Transmission Services for the Belgian and Netherlands Armies, the Universities of Liege and Brussels, Polish and Yugoslav Central Purchasing Authorities, Brandt Company, French Public Health (neuro-biologic services for hospitals).

*In order to receive technical particulars on the equipment of interest to you please write to*

## RIBET DESJARDINS

MEASURE - CONTROL DEPARTMENT  
13-17, Rue Périer, Montrouge (Seine), France  
Tel. ALE. 24-40 - CODE WORD : PILACELECT, MONTRouGE



# NEW Idea Obsoletes Old Switches

For Telemetry . . Missiles . . Computers . . Communications



## Tabet ROTARY WAFER SWITCH

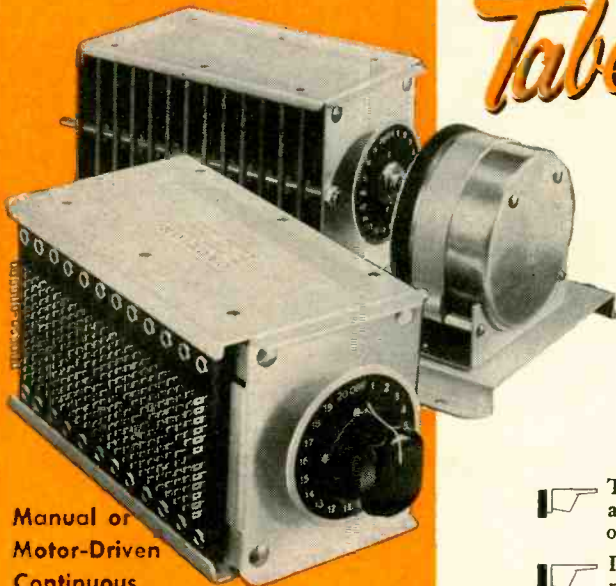

Manual or  
Motor-Driven  
Continuous  
or Stepping

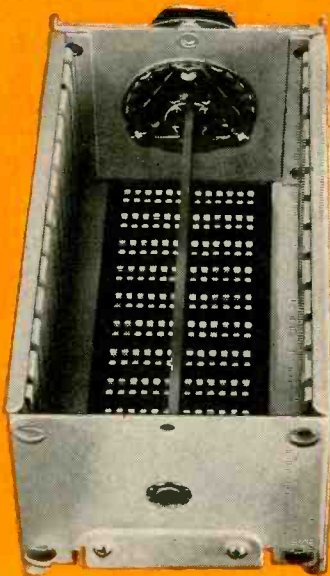

Wafer Housing Assembly

TABET Rotary, Wafer Switches can be supplied with one to twenty-four wafers.

- Saves time and money on operating and repairs.
- Has definitely longer life.
- Now being supplied, under U. S. Gov't specifications, for use by the Navy in communications equipment both aboard ship and in shore installations.

- ▢ TABET Rotary, Wafer Switches have been proved by extensive tests on all types of time sequence switching for both manual and motor driven operation. Easily adaptable for stepping switch service.
- ▢ Individual TABET switch wafers (including rotary sections) are instantly removable without unsoldering or disassembling.
- ▢ TABET printed circuit wafers permit unlimited choice of switch circuit configurations.
- ▢ TABET wafers plug into rugged, semi-floating, printed circuit receptacles—which can be designed to match any wafer-circuit terminating patterns.
- ▢ TABET wafer contact surfaces are heavily silver-plated for maximum life and low-resistance contact. Rhodium plating is used for motor-driven, high speed switching.

An outstanding feature of the TABET Rotary Switch is the *ease* with which repairs and alterations can be made.

- It never is necessary to remove wires from the TABET Switch.
- Both the TABET wafers and their receptacles are easily removed.
- It is impossible to make errors in replacements on the TABET Switch.

TABET Rotary, Wafer Switches are manufactured under U. S. Patent Nos. 2,832,901 and 2,841,660. Other U. S. and Foreign patents presently are pending.

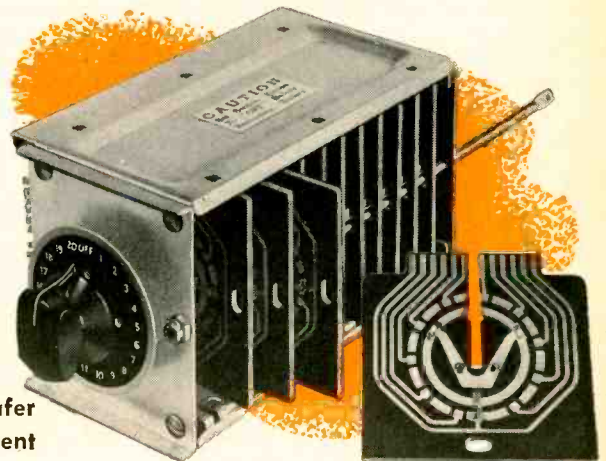

Switch Showing Wafer Mounting Arrangement

For full information on the adaptability of TABET Switches to needs of your business, address:



# Tabet MANUFACTURING CO., INC.

1336 BALLENTINE BOULEVARD

NORFOLK, VIRGINIA



# New Sizes! OHMITE®

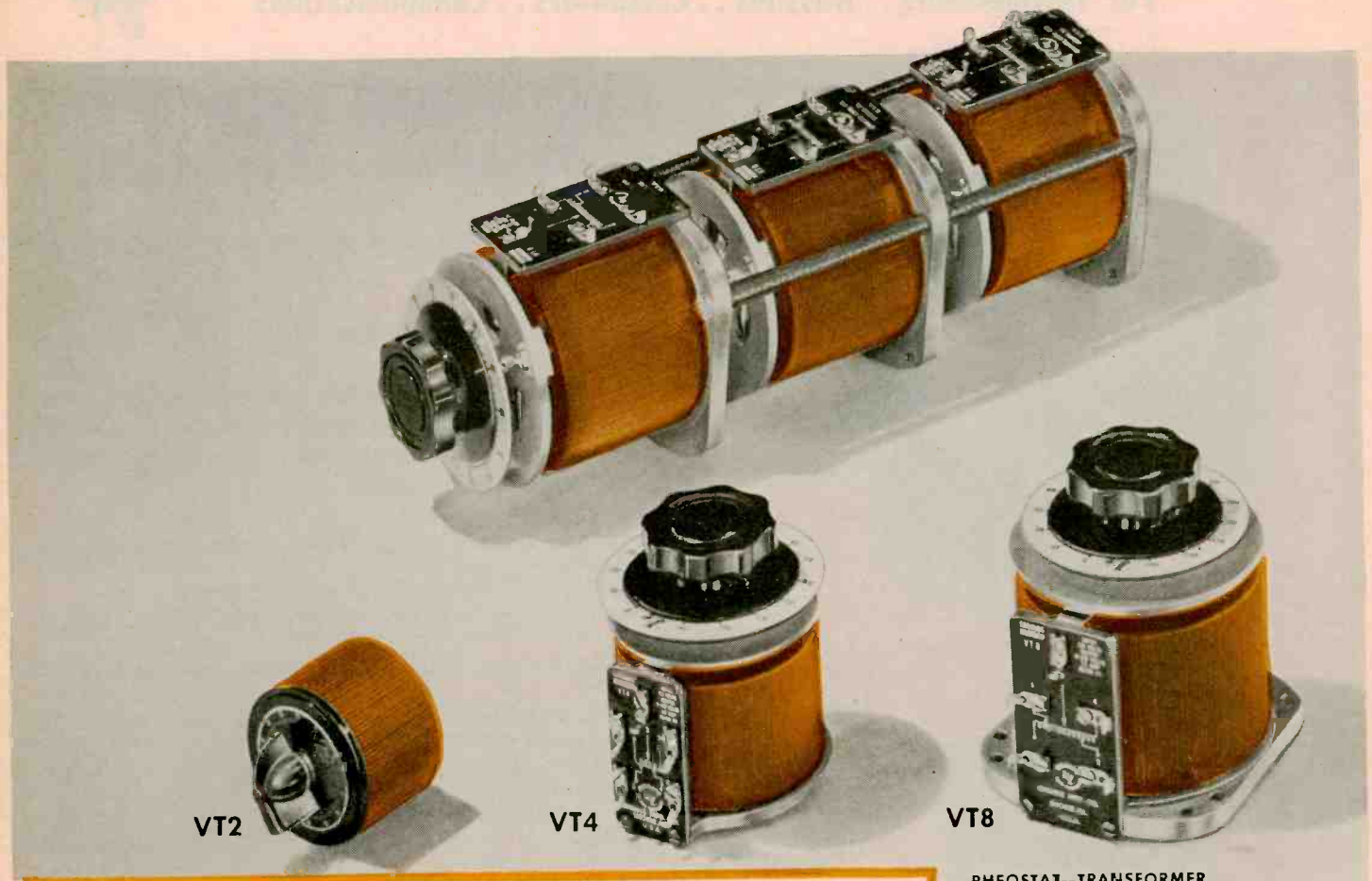

## EXPANDED LINE! EXCLUSIVE FEATURES!

OHMITE, universally recognized manufacturer of high quality electrical components, now offers industry an expanded line of variable transformers. The three basic models listed below provide current ratings sufficient to meet a large percentage of industrial applications. The new line is available in enclosures, tandem assemblies, and other modifications. Ohmite, the only manufacturer in the industry producing both power rheostats and variable transformers, offers rheostat-transformer tandem combinations.

## UNSURPASSED OHMITE CONSTRUCTION!

Note all these advanced Ohmite "v.t." features: *greater capacity for equal size*—Models VT2 and VT4 offer a "bonus" in current at no increase in cost over comparable competitive units; *positive current transfer*, achieved in all "v.t." models—a pigtail from the brush to a large slip-ring contacts a large area of the terminal; *table or panel mounting*—on Models VT4 and VT8, shaft can be positioned for panel or table use; *interchangeable with other popular types of variable transformers*—Model VT2 has single-hole mounting, Models VT4 and VT8 match popular 3- or 4-hole mountings; *reversible direct reading dial*—calibrated on one side for normal line connection and on the other side for overvoltage connection; heavily plated rhodium brush track guarantees longer, trouble-free performance.

## BASIC MODELS

### MODEL VT2

Input voltage: 120v, 60 cycle.  
Output voltage: 0-132, 0-120.  
Max output at any brush setting: 1.5 amp.

### MODEL VT4

Input voltage: 120v, 60 cycle.  
Output voltage: 0-140, 0-120.  
Max output at any brush setting: 3.5 amp.

### MODEL VT8

Input voltage: 120v, 50/60 cycle.  
Output voltage: 0-140, 0-120.  
Max output at any brush setting: 7.5 amp.

## RHEOSTAT—TRANSFORMER TANDEM ASSEMBLIES

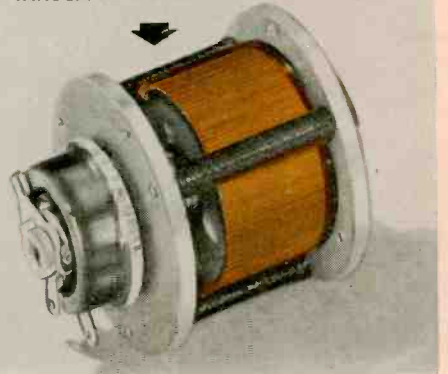

## MANY VARIATIONS

Transformers can be provided with many variations to meet different requirements such as special shafts, mountings for varying panel thicknesses, auxiliary switches, taps on transformer winding for fixed intermediate voltages, and motor drives for remote control or servo-operation.

AVAILABLE FROM OHMITE DISTRIBUTORS OR DIRECT FROM FACTORY



# "V.t." Variable Transformers

INDUSTRY'S MOST ADVANCED DESIGN!



## ENCLOSURES

Ohmite Variable Transformers are available in enclosures for portable or fixed use (back-of-panel or surface mounting). Units feature modern styling, rugged construction, and are designed for convenience.

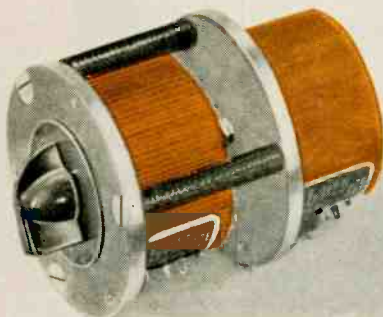

## TANDEM ASSEMBLIES

Ohmite Tandem Assemblies can be furnished in all three sizes of Ohmite Variable Transformers. Exclusive! Ohmite can also provide tandem assemblies combining famous Ohmite Power Rheostats, and Ohmite Variable Transformers.

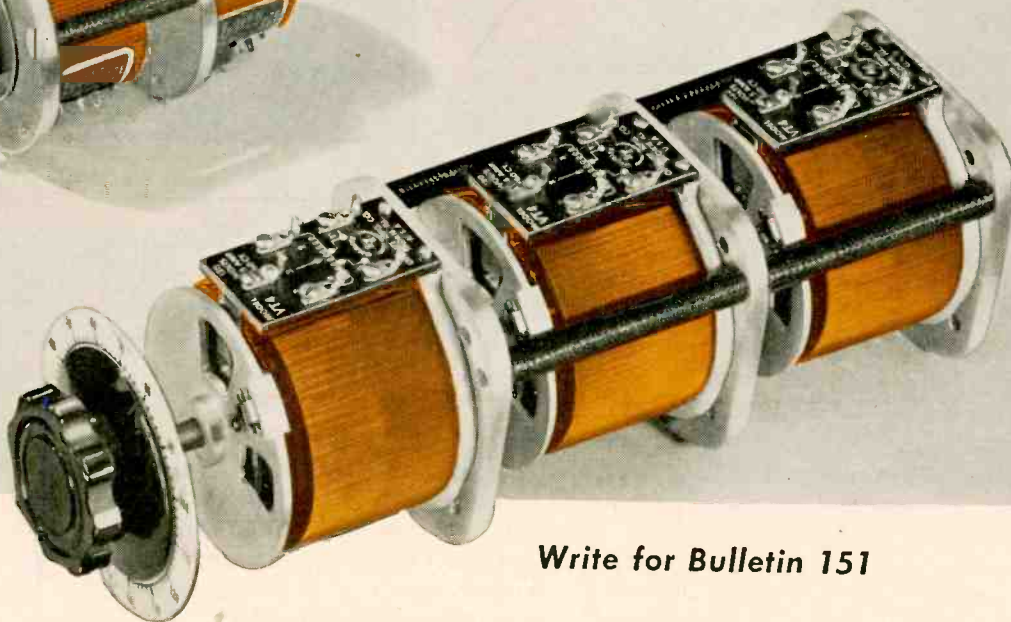

Write for Bulletin 151

# OHMITE®

RHEOSTATS RESISTORS RELAYS  
TAP SWITCHES R.F. CHOKES  
VARIABLE TRANSFORMERS  
TANTALUM CAPACITORS

MANUFACTURING COMPANY

3610 HOWARD STREET • SKOKIE, ILLINOIS

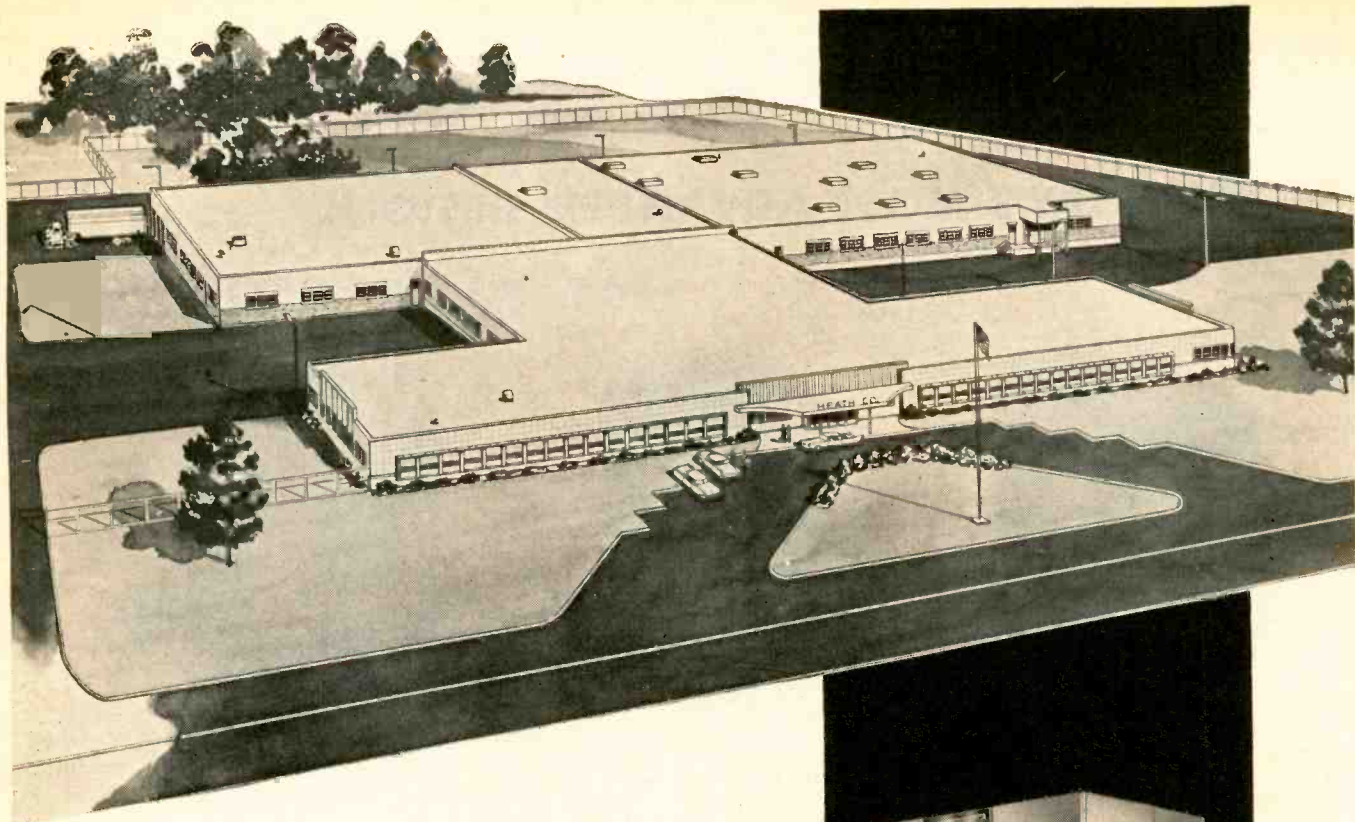

**New Heath plant  
equipped with  
ACE shielded enclosures**

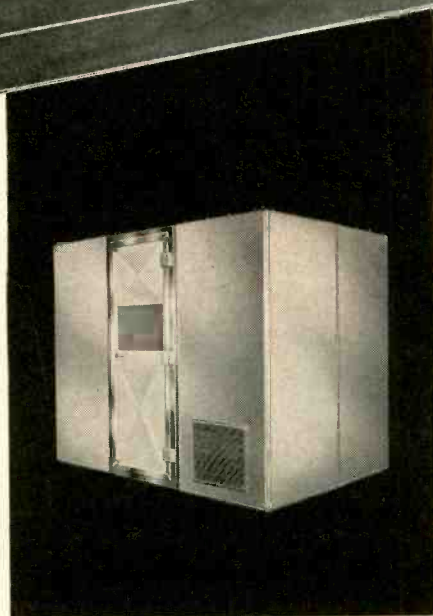

Heath Company — manufacturer of the famous Heathkit line of Amateur Radio Kits, Hi-Fi Equipment and Electronic Instruments—believes in positive r-f interference protection. The company's new plant at Benton Harbor, Michigan, has ACE shielded enclosures for its design and development work . . . for repairs and alignment. All critical measurements are completely shielded from r-f interference.

ACE's patented RFI\* and Cell-Type Designs guarantee high attenuation with dependable

r-f interference protection at all frequencies. Modular construction permits quick-and-easy size changes. Enclosures are designed and constructed to ensure permanent r-f leak-proof performance.

Let an ACE Engineer help you work out an effective and economical solution to *your* shielding problem. Whether your problem involves one unit or many, you'll find that ACE has the experience and the facilities to handle the complete job. Write for free catalog on standard ACE enclosures.

\*Lindsay Structure



**First and Finest in Shielded Enclosures**  
**ACE ENGINEERING & MACHINE CO., INC.**  
 Tomlinson Road • Huntingdon Valley • Pennsylvania



*designed for dependability!*

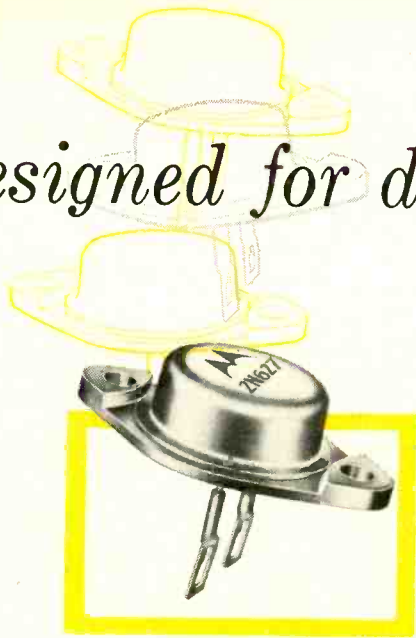

# MOTOROLA

*high power / high current*

# Transistors

The unique internal design of these high power transistors enables Motorola to achieve volume production while maintaining a laboratory standard of quality.

**A** ● Motorola's unusual "clip technique" eliminates internal wiring . . . greatly improving device dependability. Self-jigging, automatic assembly prevents human error . . . enables Motorola to specify exact limits.

**B** ● Miracle-Ring Emitter provides greater effective area permitting higher current operation.

**C** ● Industry standard TO-3 package with solder terminals and welded hermetic seal is designed to meet or exceed the mechanical and environmental requirements of military specification MIL-T-19500A.

Because of Motorola's advanced design and carefully controlled production techniques, you can incorporate these Motorola transistors in your circuits with complete confidence that they will provide highest efficiency . . . maximum reliability.

*...write for complete technical data, TODAY!*

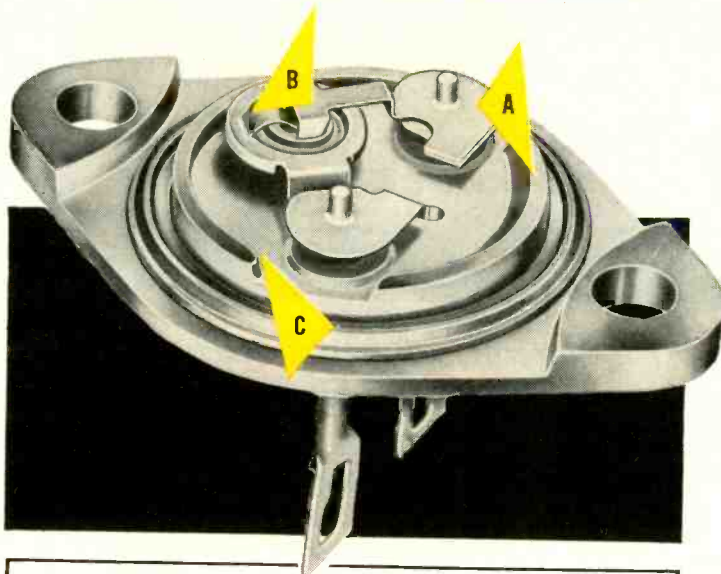

### GENERAL SPECIFICATIONS

TYPE NUMBER	BV <sub>CEO</sub> max volts	BV <sub>CEB</sub> max volts	h <sub>FE</sub>		V <sub>CE(sat)</sub> I <sub>C</sub> =10A I <sub>B</sub> =1A max volts
			min	max	
2N627	40	30	10	30	1.0
2N628	60	45	10	30	1.0
2N629	80	60	10	30	1.0
2N630	100	75	10	30	1.0

**FOR COMPLETE TECHNICAL INFORMATION** concerning these high power/high current transistors, write, wire or phone **MOTOROLA, INC.**, 5005 East McDowell Road, Phoenix, Arizona BRidge 5-4411 Teletype Px 80

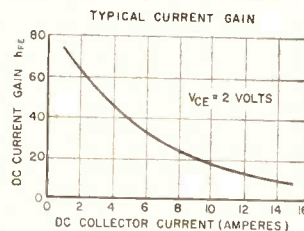

MOTOROLA, INC., 5005 E. McDOWELL, PHOENIX, ARIZONA

**REGIONAL OFFICES**

**RIDGEFIELD, NEW JERSEY**  
540 Bergen Boulevard  
Whitney 5-7500

**CHICAGO 44, ILLINOIS**  
4900 West Flourney Street  
Esterbrook 9-5200

**HOLLYWOOD 28, CALIFORNIA**  
6555 Sunset Boulevard  
Hollywood 5-3250



# MICRO SWITCH Precision

## These Lighted Pushbutton Switches Versatility . . . Flexibility

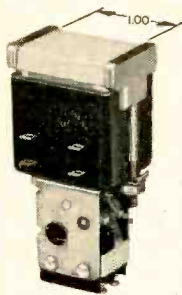
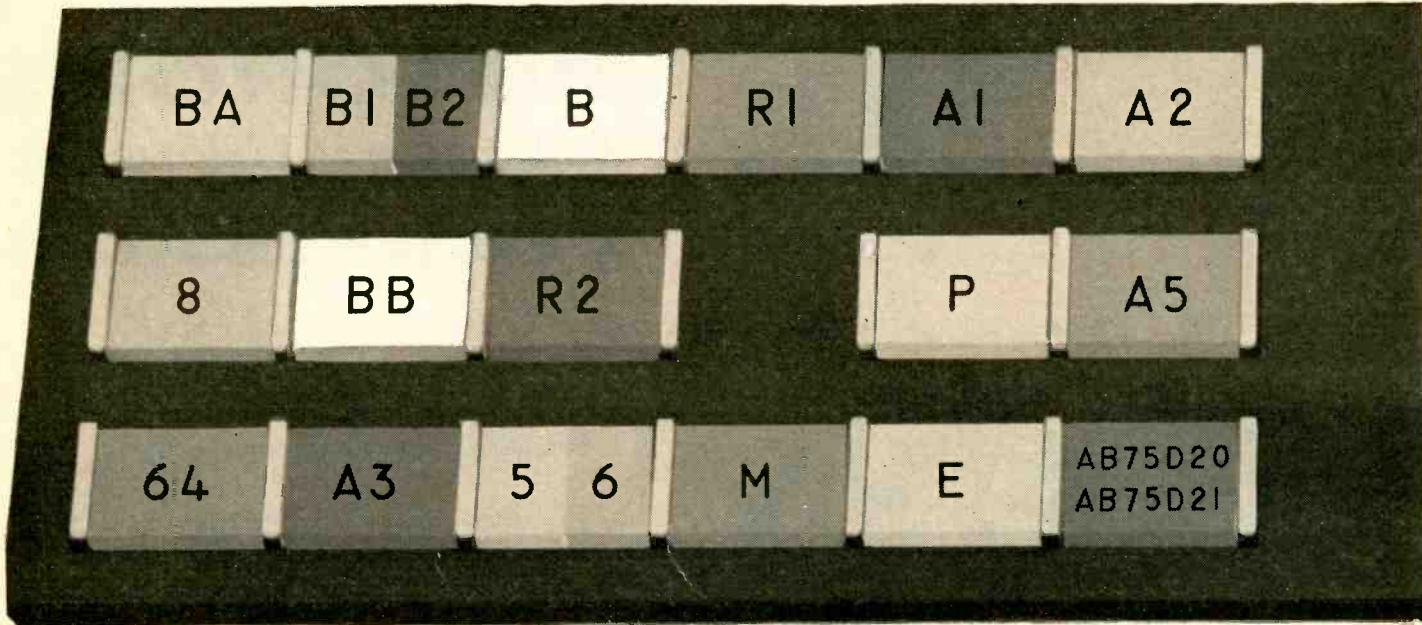

### "100PB3" Series

Maintained contact, alternate action operation. Each push of the button alternately transfers and restores the contacts of the two switches. The switches in this and other "100-PB" series assemblies are the "SM" subminiature.

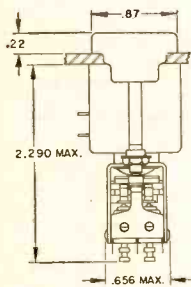

2-Pole Unit

*Designed For Computers, Business Machines, Electronic Data Processing Equipment, Scientific Instruments and Communication Systems*

The above panel illustrates how the "100PB" series lighted pushbutton switches can be mounted in openings to accommodate one or more units, each button separated by assembly barriers.

The 1.00" x 0.75" translucent plastic buttons are available in red, yellow, blue, green or white—easily replaced or interchanged. Pushbutton, lamp, and switch are combined into a single assembly, thus reducing panel area to an absolute minimum. Lamp and switch terminals are isolated.

These switch assemblies and indicator lights simplify construction of panels, combine good appearance in minimum space. Each switch assembly contains two lamps for choice of lamp circuitry.

Switch assemblies, except "100PB3" series, are available with two, three, or four SPDT subminiature switches, rated at 5 amps 125

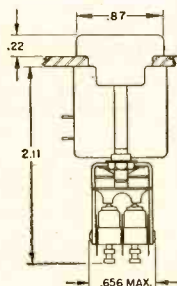
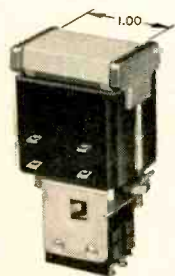

2-Pole Unit

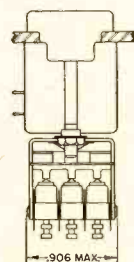

3-Pole Unit

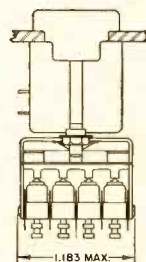

4-Pole Unit

### "100PB1" Series

Momentary action—contact transfer only while button is depressed. Provides positive "touch feedback" or "feel" which reduces the chance of false operation. 2, 3, or 4-pole units are available.



# Switches have uses unlimited



have -- Eye Appeal ...

... Require Less Panel Area

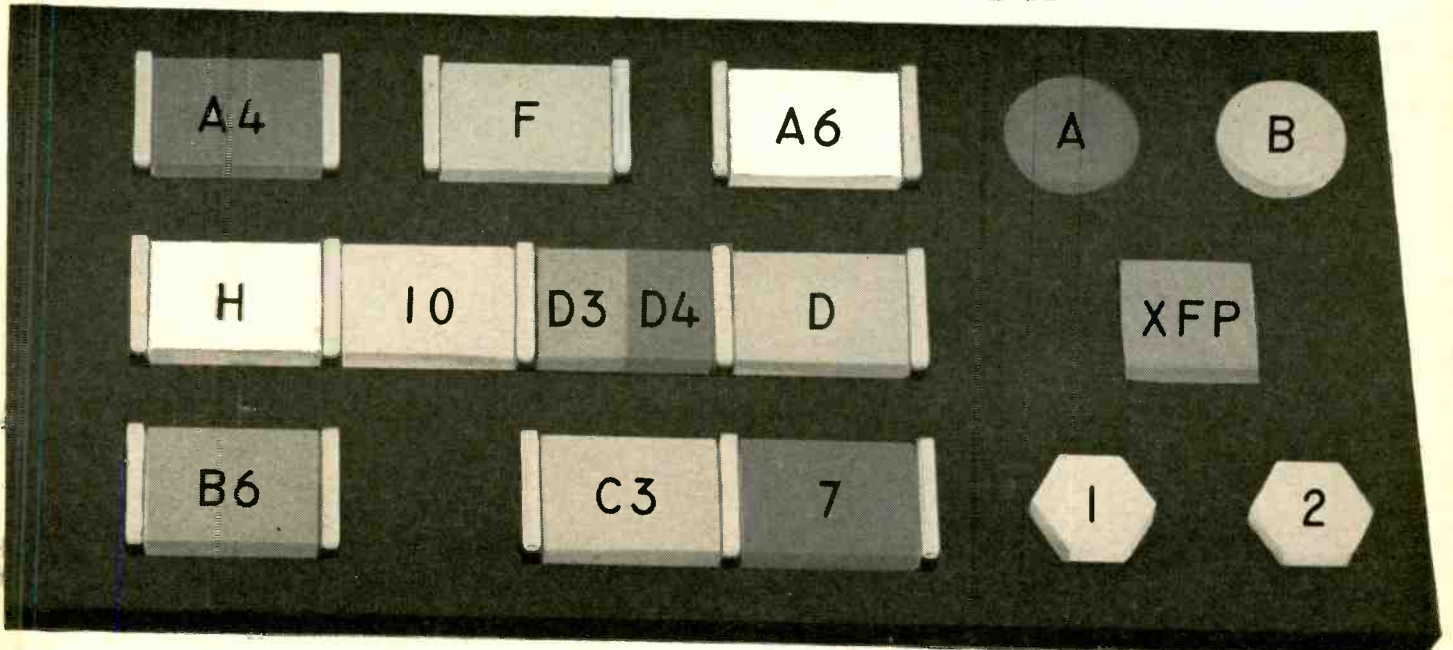

or 250 vac; or 3 amps inductive, 5 amps resistive, 30 vdc. Send for Data Sheet 143.

The five buttons at the right of the main illustration are of the "50PB" series. Buttons of four shapes, in red, yellow, blue, green and white are available. Send for Data Sheet 133.

## MICRO SWITCH ... FREEPORT, ILLINOIS

A division of Honeywell

In Canada: Honeywell Controls, Ltd., Toronto 17, Ontario

Consult with a MICRO SWITCH Sales Engineer.

Look in the Yellow Pages for location of Branch Office



# Honeywell

MICRO SWITCH PRECISION SWITCHES

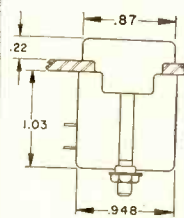
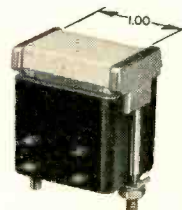

### "10OLT1" Series

Matching indicating light assembly, without switch mechanism. Provides panel harmony. Has same button and lamp combinations, and same means of mounting as the complete switch assembly.

LT1 Indicating Light Assembly

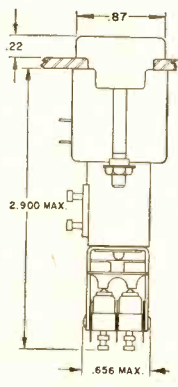
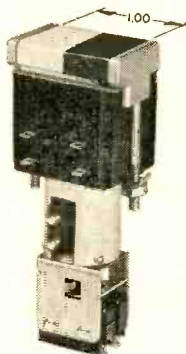

2-Pole Unit

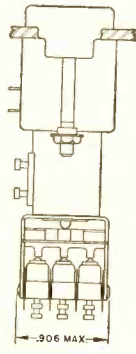

3-Pole Unit

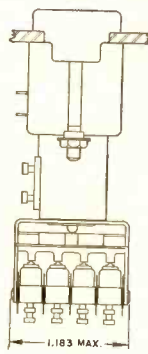

4-Pole Unit

### "100PB4" Series

Magnetically held "MAGSWITCH" contains a d-c solenoid whose terminals are electrically isolated from the lamp and switch terminals. With solenoid not energized switch action is momentary; with solenoid energized switch contacts remain transferred until electrically released. 2, 3, or 4-pole units are available.

## NEWS ABOUT SILICON DEVICES

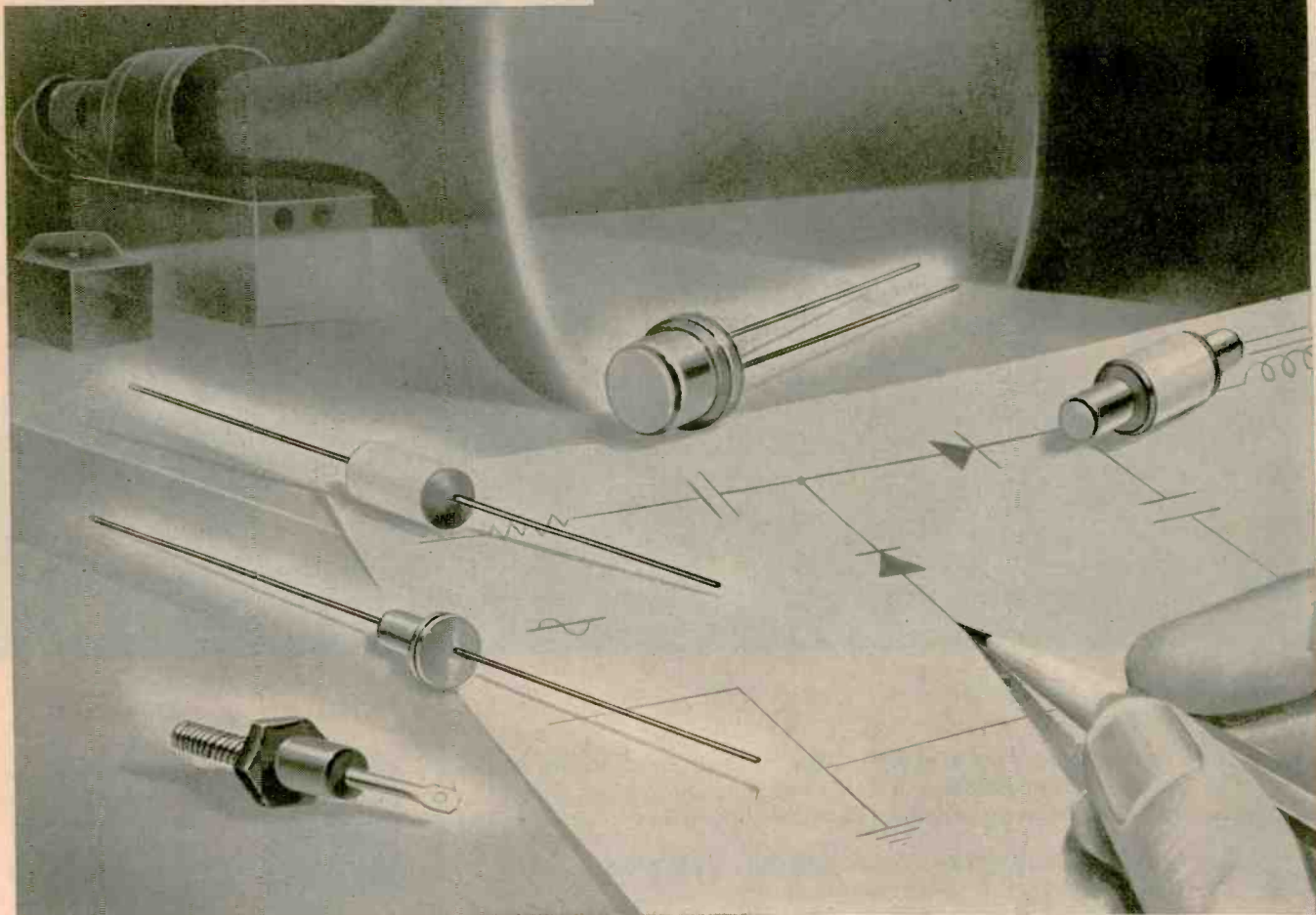

Reverse current:  $10^{-7}$  amp. Rectification ratio: 10,000,000:1

## Now... new efficiency for TV power supplies with dependable diodes of Du Pont Hyperpure Silicon

More efficient power supplies . . . savings in space and weight . . . important reasons why TV manufacturers are replacing conventional rectifying systems with silicon diodes. Today, several types of silicon diodes and rectifiers are readily available for TV circuits. TV manufacturers have tested silicon rectifiers and report no noticeable change in output voltage under continuous load conditions over long periods of time. Sil-

icon components can operate in ambients from  $-65^{\circ}$  to  $150^{\circ}$  C. They maintain excellent electrical stability and resist aging.

**Silicon components** have high shock and vibration limits. They are up to 99% efficient in units operated at 60 cps. and require little maintenance. Silicon cells permit a rectification ratio as high as 10 million to 1—almost negligible reverse conductance. Silicon bridges are

available with ratings from 1 to 1,000 amperes and more than 600 volts rms.

**Note to device manufacturers:** You can produce silicon transistors, rectifiers and diodes of the highest quality with Du Pont Hyperpure Silicon. It's now available in three grades for maximum efficiency and ease of use . . . with a purity range of 3 to 11 atoms of boron per billion. Technical information on crystal growing is available from Du Pont . . . pioneer producer of semiconductor-grade silicon.



### NEW BOOKLET ON DU PONT HYPERPURE SILICON

You'll find our new, illustrated booklet about Hyperpure Silicon helpful and interesting—it describes the manufacture, properties and uses of Du Pont Hyperpure Silicon. Just drop us a card for your copy. E. I. du Pont de Nemours & Co. (Inc.), Pigments Department, Silicon Development Group, Wilmington 98, Delaware. (This offer limited to United States and Canada.)

PIGMENTS DEPARTMENT

**DU PONT** HYPERPURE SILICON  
REG. U.S. PAT. OFF.

BETTER THINGS FOR BETTER LIVING  
... THROUGH CHEMISTRY



Type 11

Type 20

Type 26

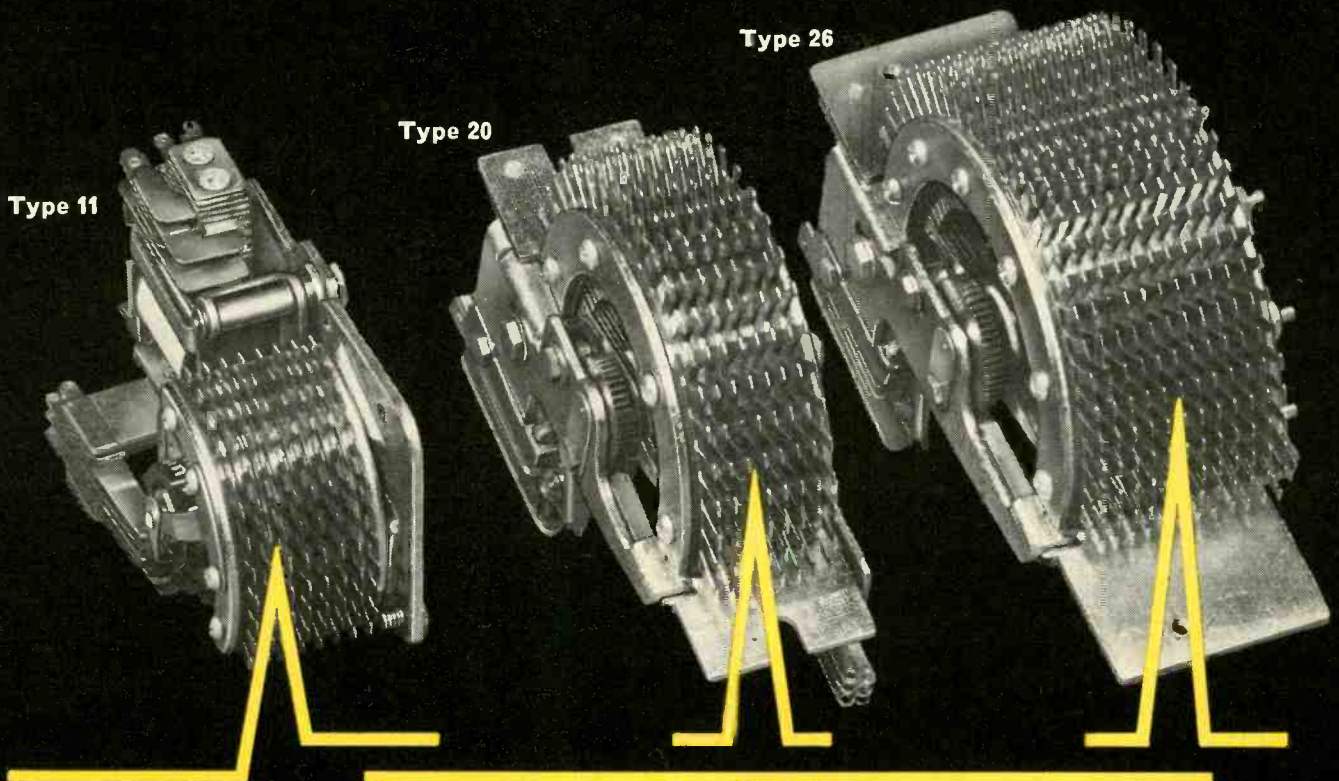

# NEW BLUE INSULATION

adds another refinement to CLARE Springdriven Stepping Switches

STANDARD AT NO EXTRA COST

## CONSIDER

*what these Superior Features will do for YOU !*

### • HIGH INSULATION RESISTANCE

100,000 megohms minimum between switch points and between each point and frame.

### • STABLE INSULATION RESISTANCE

Maintains 100,000 megohms minimum resistance over temperature range from  $-55^{\circ}\text{C}$  to  $+85^{\circ}\text{C}$ .

### • LOW MOISTURE ABSORPTION

Maintains low leakage characteristics in humid environment. Water absorption: 48 hours at  $50^{\circ}\text{C}$ , 0.5% (ASTM Test D570).

### • GOOD ARC RESISTANCE

Endures arcing from wiper contacts, maintaining high resistance to dielectric breakdown. Arc resistance: 140 seconds (ASTM Test D495).

### • MECHANICAL STRENGTH & STABILITY

High tensile and compression strengths. Holds mechanical dimensions throughout age and temperature variations (vital to retention of stack tightness.) Lifetime shrinkage: approximately .001 in./in.

### • MEETS MIL SPECIFICATIONS

MIL—P—14D (Type MDG)  
MIL—P—4389 (USAF)

*This new Blue Insulation supplied as standard on all CLARE Springdriven Stepping Switches as soon as present stocks of Bakelite insulators are used up. No extra cost.*

*Find out the many other superior qualities of CLARE Springdriven Stepping Switches. Call or write: C. P. Clare & Co., 3101 Pratt Blvd., Chicago 45, Illinois. In Canada: C. P. Clare Canada Ltd., 2700 Jane Street, Toronto 15. Cable Address: CLARELAY.*

**Send for CLARE Engineering Bulletin #101**

# CLARE RELAYS

FIRST in the industrial field



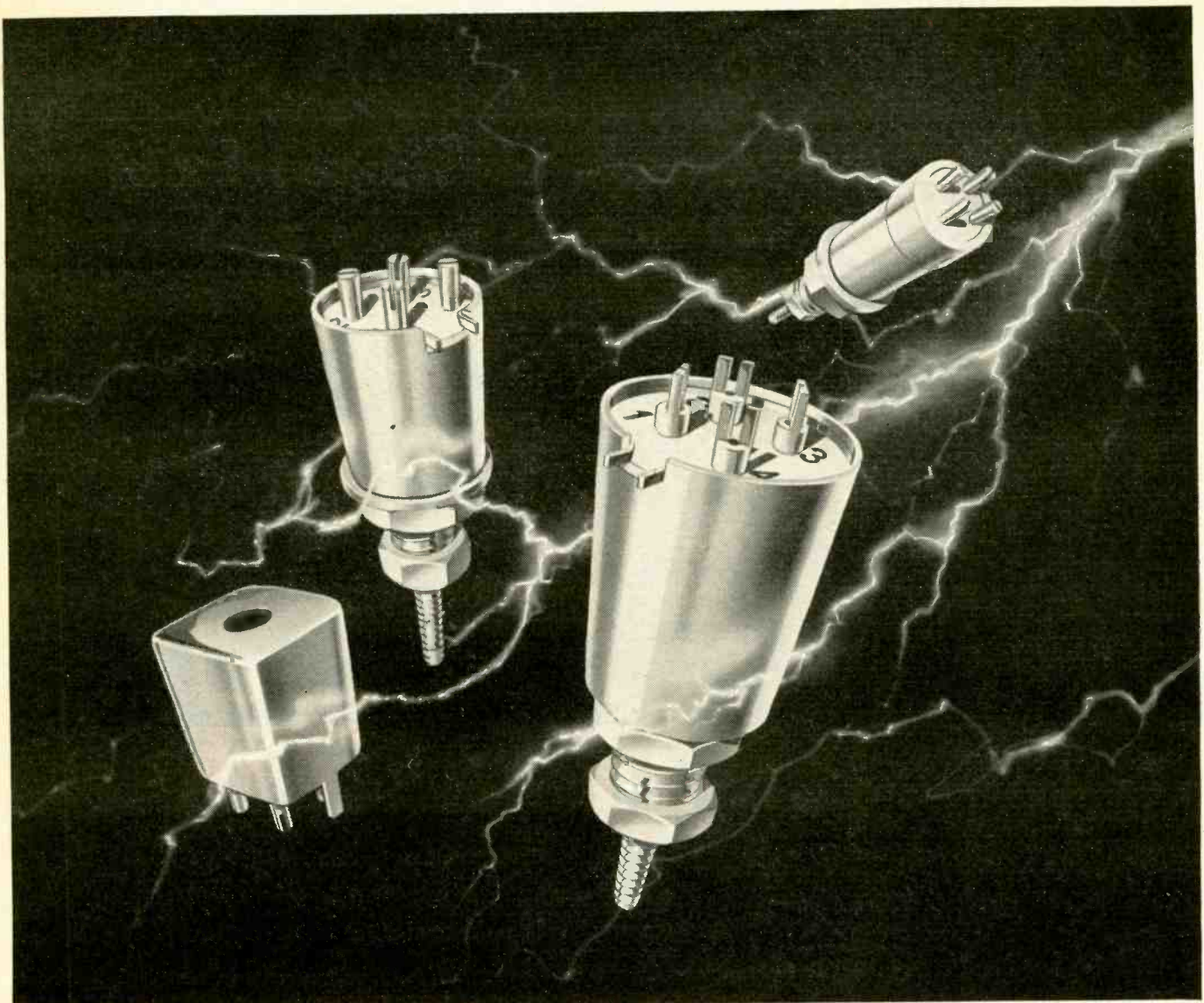

These shielded coil forms offer the utmost in reliability due to their unique design and construction. Dimensions when mounted, including terminals, are: LS-9,  $\frac{1}{16}$ " diameter x  $\frac{1}{2}$ " high; LS-10,  $\frac{3}{8}$ " x  $\frac{1}{16}$ "; LS-11,  $\frac{1}{16}$ " x  $\frac{1}{32}$ ". Each form mounts by a single stud. Single layer or pie-type windings to

your specifications. LS-14 is double-ended for primary and secondary windings with separate tuning slugs for independent tuning of each section; its overall length excluding tuning slugs is  $1\frac{1}{4}$ "; OD is  $\frac{1}{2}$ ". See photograph below for new aluminum housing shielded coil forms.

## Reliability – under any condition!

Cambion® miniaturized shielded coil forms are highly shock resistant. With mechanically enclosed, completely shielded coil winding, they bring all the ruggedness and dependable performance you require for your "tight spot" applications — IF strips, RF coils, oscillator coils, etc.

Cambridge Thermionic Corporation combines *quality control* with *quantity production* to supply exactly the components you need, in any amount. Our *quality control* includes material certification, checking each step of production, and finished product. And *Cambridge quantity production* means we can fill your orders for any volume, from smallest to largest.

Any Cambion coil form may be wound to your specifications in any desired quantity. For samples, specifications and prices, write to Sales Engineering Dept., Cambridge Thermionic Corpo-

ration, 437 Concord Ave., Cambridge 39, Mass. On the West Coast contact E. V. Roberts and Associates, Inc., 5068 West Washington Blvd., Los Angeles 16 and 1560 Laurel St., San Carlos, Cal.

New aluminum housing shielded coil forms with anodized finish. Available in three sizes, as variable tamper-proof units with positive locking mechanism and more precise tuning, or as fixed shielded coil forms. Flange mounted by means of two number 2-56 screws. Mounted heights above chassis are  $\frac{1}{4}$ ",  $\frac{3}{8}$ ", and  $\frac{1}{2}$ " (in variable units exclusive of tuning element).

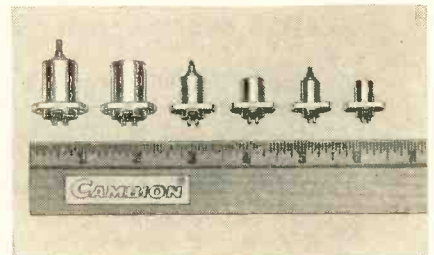

# CAMBRIDGE THERMIONIC CORPORATION

# CAMBION®

Makers of guaranteed electronic components, custom or standard





**6528** medium  $\mu$ ,  
high current, twin power triode  
for series regulator service!

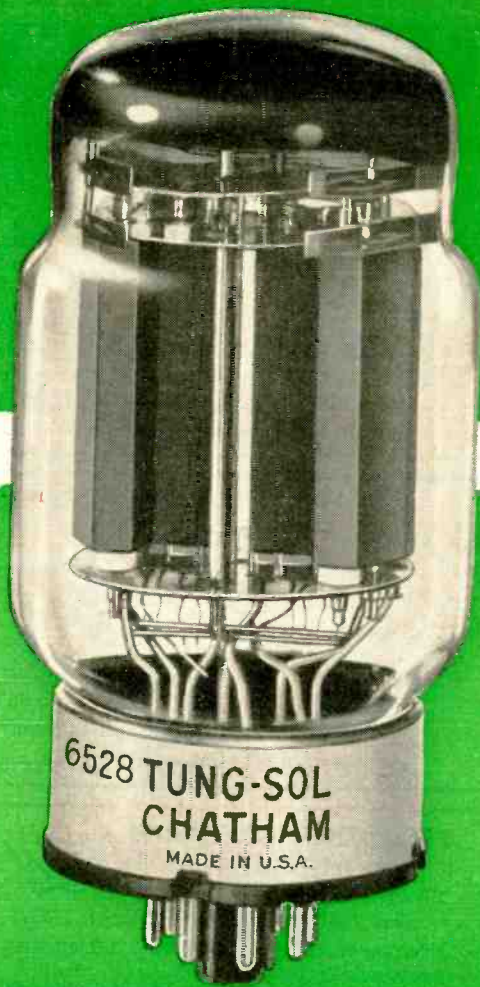

## Volume output makes Tung-Sol/Chatham 6528 available for widespread use!

Enthusiastic acceptance of the 6528 Twin Power Triode forced rapid expansion of production quotas, in turn resulting in lower manufacturing costs. These savings are reflected in lower prices to the user making Type 6528 economically practical for a vast number of new industrial and military applications.

Type 6528 requires fewer passing tube sections . . . permits lower range control circuits . . . and combines low internal tube drop with top control sensitivity — a definite advantage over previous series regulators. Also, 6528 triodes may be used in parallel or separately. This simplifies circuitry . . . saves space.

### DESIGN FEATURES OF TUNG-SOL/CHATHAM TYPE 6528!

- 1 Hard glass envelope permits full out-gassing . . . takes higher temperatures without gas evolution . . . increases thermal shock resistance.
- 2 Zirconium-coated graphite anodes assure excellent gettering. Graphite virtually unaffected by heat.
- 3 Oversize cathodes provide adequate emission reserve . . . eliminate standby deterioration.
- 4 Extra-rugged grids. Sturdy chrome-copper side rods support gold-plated molybdenum lateral wires.
- 5 Overall ruggedness. Metal snubbers and ceramic insulators support mount. Heavy button-stem has rigid support leads.

Tung-Sol Electric Inc. specializes in special-purpose tube development . . . can match any design requirement you have. For full data on Type 6528 . . . to fill any power tube socket . . . contact: Tung-Sol Electric Inc., Newark 4, N. J. Commercial Engineering Offices: Bloomfield and Livingston, N. J.; Culver City, Calif.; Melrose Park, Ill.

### TYPE 6528 RATINGS

Max. plate dissipation per tube . . . . .	60 watts
Max. plate dissipation per section . . . . .	30 watts
Max. steady plate current per section . . . . .	300 ma.
Max. plate voltage . . . . .	400 volts
Max. heater cathode voltage . . . . .	300 volts
Amplification factor* . . . . .	9
Transconductance per section* . . . . .	37,000 $\mu$ mhos

\*Average characteristics at  $E_b = 100v$ ,  $E_c = -4v$ ,  $I_b = 185 ma.$

 **TUNG-SOL**<sup>®</sup>



# FREQUENCY STANDARDS

## PRECISION FORK UNIT TYPE 50



Size 1" dia. x 3 3/4" H.\* Wght., 4 oz.

Frequencies: 240 to 1000 cycles

Accuracies:—

Type 50 ( $\pm 0.02\%$  at  $-65^{\circ}$  to  $85^{\circ}\text{C}$ )

Type R50 ( $\pm 0.002\%$  at  $15^{\circ}$  to  $35^{\circ}\text{C}$ )

Double triode and 5 pigtail parts required

Input, Tube heater voltage and B voltage

Output, approx. 5V into 200,000 ohms

\*3 1/2" high  
400 - 1000 cy.

## FREQUENCY STANDARD TYPE 50L



Size 3 3/4" x 4 1/2" x 5 1/2" High  
Weight, 2 lbs.

Frequencies: 50, 60, 75 or 100 cycles

Accuracies:—

Type 50L ( $\pm 0.02\%$  at  $-65^{\circ}$  to  $85^{\circ}\text{C}$ )

Type R50L ( $\pm 0.002\%$  at  $15^{\circ}$  to  $35^{\circ}\text{C}$ )

Output, 3V into 200,000 ohms

Input, 150 to 300V, B (6V at .6 amps.)

## PRECISION FORK UNIT TYPE 2003



Size 1 1/2" dia. x 4 1/2" H.\* Wght. 8 oz.

Frequencies: 200 to 4000 cycles

Accuracies:—

Type 2003 ( $\pm 0.02\%$  at  $-65^{\circ}$  to  $85^{\circ}\text{C}$ )

Type R2003 ( $\pm 0.002\%$  at  $15^{\circ}$  to  $35^{\circ}\text{C}$ )

Type W2003 ( $\pm 0.005\%$  at  $-65^{\circ}$  to  $85^{\circ}\text{C}$ )

Double triode and 5 pigtail parts required

Input and output same as Type 50, above

\*3 1/2" high  
400 to 500 cy.  
optional

## FREQUENCY STANDARD TYPE 2005



Size, 8" x 8" x 7 1/4" High  
Weight, 14 lbs.

Frequencies: 50 to 400 cycles  
(Specify)

Accuracy:  $\pm 0.001\%$  from  $20^{\circ}$  to  $30^{\circ}\text{C}$

Output, 10 Watts at 115 Volts

Input, 115V. (50 to 400 cycles)

## FREQUENCY STANDARD TYPE 2007-6 **NEW**



TRANSISTORIZED, Silicon Type  
Size 1 1/2" dia. x 3 1/2" H. Wght. 7 ozs.

Frequencies: 400 — 500 or 1000 cycles

Accuracies:

2007-6 ( $\pm .02\%$  at  $-50^{\circ}$  to  $+85^{\circ}\text{C}$ )

R2007-6 ( $\pm 0.002\%$  at  $+15^{\circ}$  to  $+35^{\circ}\text{C}$ )

W2007-6 ( $\pm 0.005\%$  at  $-65^{\circ}$  to  $+125^{\circ}\text{C}$ )

Input: 10 to 30 Volts, D. C., at 6 ma.

Output: Multitap, 75 to 100,000 ohms

## FREQUENCY STANDARD TYPE 2121A



Size  
8 3/4" x 19" panel  
Weight, 25 lbs.

Output: 115V  
60 cycles, 10 Watt

Accuracy:  
 $\pm 0.001\%$  from  $20^{\circ}$  to  $30^{\circ}\text{C}$

Input, 115V (50 to 400 cycles)

## FREQUENCY STANDARD TYPE 2001-2



Size 3 3/4" x 4 1/2" x 6" H., Wght. 26 oz.

Frequencies: 200 to 3000 cycles

Accuracy:  $\pm 0.001\%$  at  $20^{\circ}$  to  $30^{\circ}\text{C}$

Output: 5V. at 250,000 ohms

Input: Heater voltage, 6.3 - 12 - 28

B voltage, 100 to 300 V., at 5 to 10 ma.

## FREQUENCY STANDARD TYPE 2111C

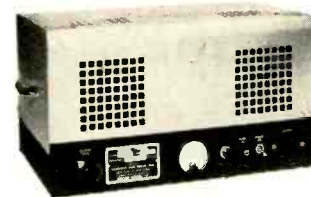

Size, with cover  
10" x 17" x 9" H.

Panel model  
10" x 19" x 8 3/4" H.

Weight, 25 lbs.

Frequencies: 50 to 1000 cycles

Accuracy: ( $\pm 0.002\%$  at  $15^{\circ}$  to  $35^{\circ}\text{C}$ )

Output: 115V, 75W. Input: 115V, 50 to 75 cycles.

## ACCESSORY UNITS for TYPE 2001-2



L—For low frequencies  
multi-vibrator type, 40-200 cy.

D—For low frequencies  
counter type, 40-200 cy.

H—For high freqs, up to 20 KC.

M—Power Amplifier, 2W output.

P—Power supply.

This organization makes frequency standards within a range of 30 to 30,000 cycles. They are used extensively by aviation, industry, government departments, armed forces—where maximum accuracy and durability are required.

WHEN REQUESTING INFORMATION  
PLEASE SPECIFY TYPE NUMBER

# American Time Products, Inc.

Watch  Master  
Timing Systems

Telephone: PLaza 7-1430

580 Fifth Ave., New York 36, N. Y.





**FIT  
TO  
FLY**

**AMP**

*THE NEW  
LIGHTWEIGHT  
A-MP "240"  
PATCHCORD  
PROGRAMMING  
SYSTEM*

. . . means lightning fast in-flight reprogramming of airborne electrical/electronic circuitry . . . obsoletes fixed circuit connectors and other systems requiring hours or days to rewire . . . and offers these unusual features:

- removable patchboards to permit complete reprogramming in seconds
- 3 ¼ pounds to minimize weight . . . miniaturized to conserve space
- rugged shock and vibration-resistant construction with high strength aluminum alloy
- shock-resistant seating of patchcord plugs in removable board
- AMP's patented wiping action that pre-cleans contacts for top electrical performance
- 240 contacts for greatest versatility in circuit combinations or program arrangements

*For more information on this new airborne wiring technique, AMP's Patchcord System Catalog is available on request.*

**AMP INCORPORATED**

**GENERAL OFFICES: HARRISBURG, PENNSYLVANIA**

A-MP products and engineering assistance are available through wholly-owned subsidiaries in: Canada • England • France • Holland • Japan

# THE LONG ARM OF

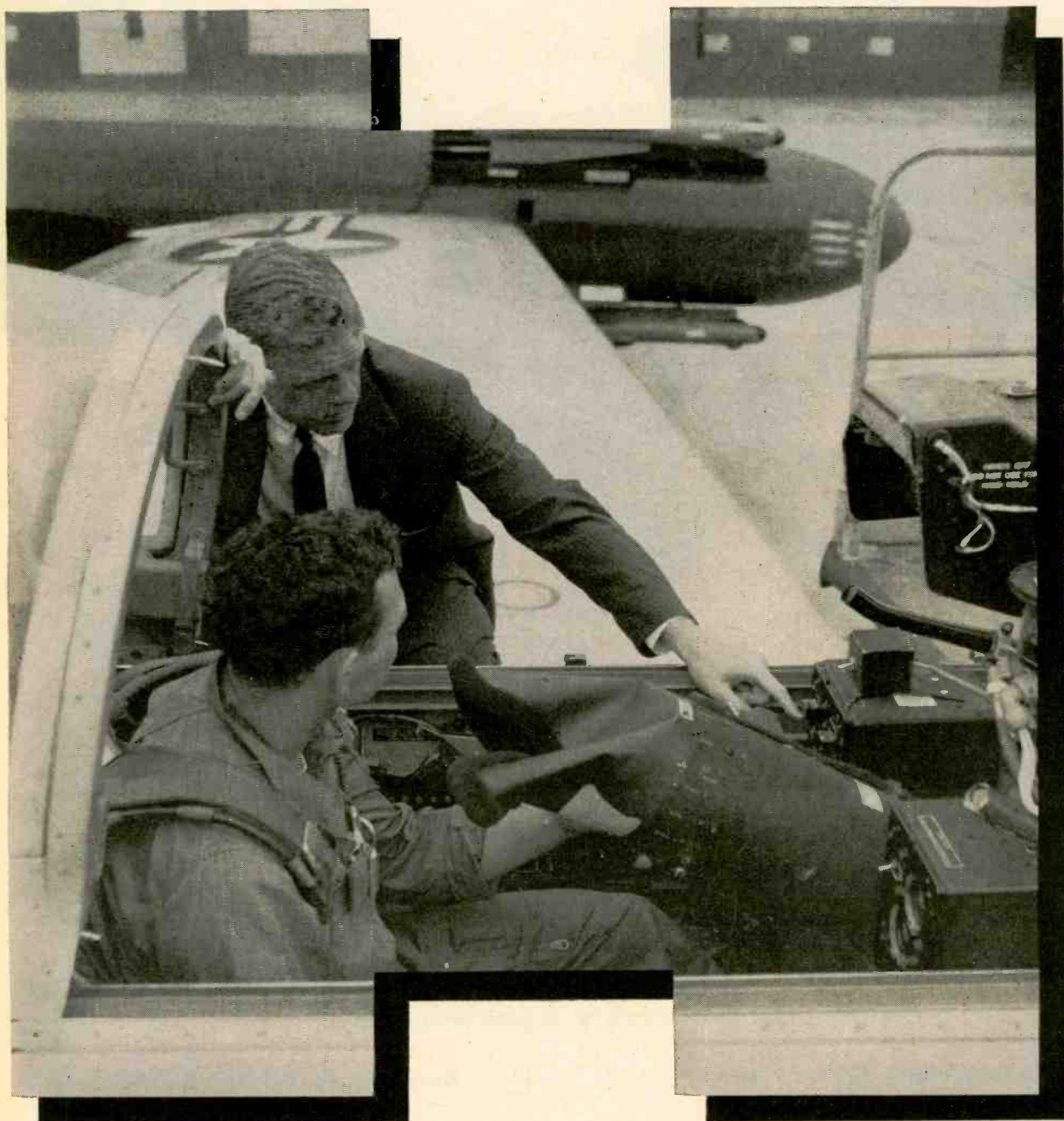



# THE LABORATORY

He takes Laboratory designed electronic systems and evaluates them where they actually prove themselves. He makes this equipment produce everything that was designed into it. His title: Hughes Field Engineer.

Responsible for the modification and maintenance of complex Electronics Armament Systems and Guided Missiles, he keeps in the forefront of the newest electronics developments. Working with complete integrated systems, the Hughes Field Engineer learns how each component works toward the working, fighting total.

This highly respected professional engineer forms a critical link in a strong engineering chain. As an extension of the Hughes Research & Development Laboratories, it is his job to recommend modifications in the basic designs. At the same time, he maintains liaison with the manufacturing

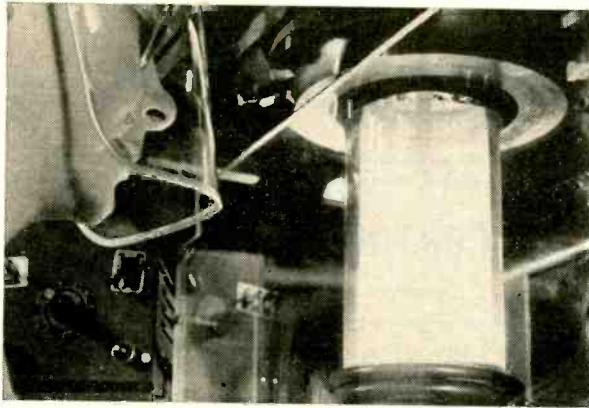

**Molten Ladle** of silicon is watched during first step in the precise manufacture of Hughes semiconductors. Constant innovations in Research, Development and Manufacture have positioned Hughes Products as a commercial electronics leader.

**Electronic Scanning Radar** systems, a radically new concept in radar beam positioning, is currently being developed and manufactured by the Hughes Ground Systems Division.

*the West's leader in advanced electronics*

**HUGHES**

© 1958. HUGHES AIRCRAFT COMPANY

groups, making sure that the highest standards of reliability have been built into the system.

The chain of Research, Development, Manufacturing and Field Evaluation is also evident in other Hughes activities. The commercial products activity performs all these functions in the areas of electron tubes, semiconductor devices, and industrial systems and controls. The Ground Systems Division performs all phases on protective radar systems.

This attention to the highest standards of engineering, combined with the diversity and wide scope of activity, makes Hughes an ideal firm for the engineer or physicist interested in career advancement.

*An immediate need now exists for engineers in the following areas:*

Microwave Tubes	Radar
Engineering Writing	Communications
Semiconductors	Circuit Design
Field Engineering	Microwaves
Computer Engineering	Systems Analysis

*Write, briefly outlining your experience, to Mr. Phil N. Scheid, Hughes General Offices, Bldg. 6-O-1, Culver City, California.*

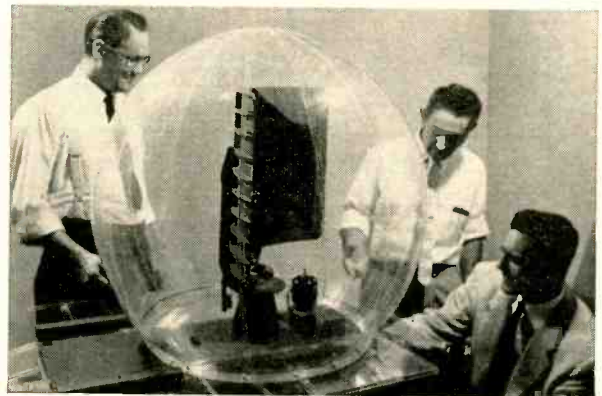

HUGHES AIRCRAFT COMPANY  
Culver City, El Segundo,  
Fullerton and Los Angeles, California  
Tucson, Arizona

# CDF Dilecto<sup>®</sup> paper-base laminates for the workhorse insulation jobs

For everyday mechanical-electrical parts that receive tough punishment and must have excellent physical and dielectric properties at low cost, the CDF phenolic paper-base line is outstanding.

**Economy.** CDF paper-base grades machine readily into intricate parts. Some are flame-retardant. Others are especially adaptable for punching. All are economical for the value delivered.

**Fabrication Facilities.** CDF has excellent and extensive plastics-fabrication facilities for turning out finished Dilecto parts to your specifications—better and more economically than you can do it yourself. Save the time and trouble of intricate fabrication by using CDF's specialized facilities.

See Sweet's, Electronics Buyers' Guide, and the other directories for the phone number of the CDF sales engineer nearest you. Or send us your print or problem direct, and we'll return a recommendation of the right Dilecto grade for your need.

CDF makes Di-Clad<sup>®</sup> printed-circuit laminates, Diamond<sup>®</sup> Vulcanized Fibre, CDF products of Teflon<sup>®</sup>, flexible insulating tapes, Dilecto<sup>®</sup> laminated plastics, Celoron<sup>®</sup> molded products, Micabond<sup>®</sup> mica products, Spiral Tubing, Vulcoid<sup>®</sup>.

\*Trademark of Continental-Diamond Fibre Corporation  
†Du Pont trademark for its TFE-fluorocarbon resin



## CONTINENTAL-DIAMOND FIBRE

A SUBSIDIARY OF THE **Bull** COMPANY • NEWARK 16, DEL.

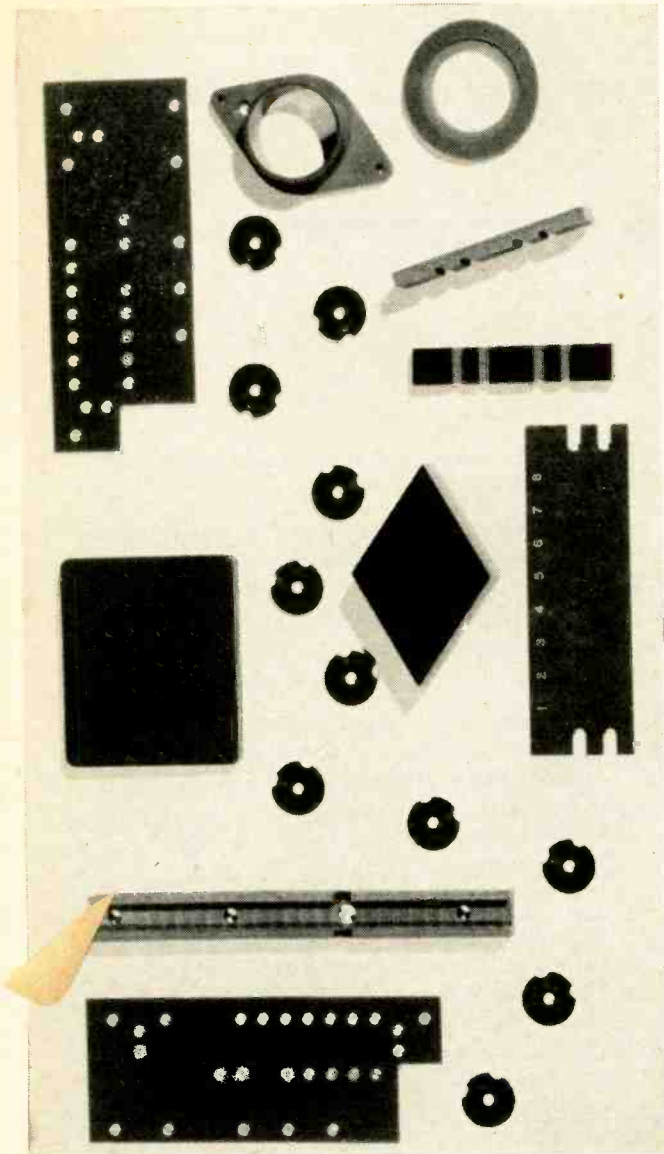

Fabricated by CDF. Near the presses that produced the Dilecto laminates, these paper-base parts were machined to close tolerances by CDF specialists . . . quickly, accurately, economically for the purchasers. This is a random selection from the five grades described in the table below.

Typical Property Values—Dilecto Paper-Base Laminates in Sheet Form

	X-13 (NEMA X)	XP-13 (NEMA P)	XX-13 (NEMA XX)	XX-13 FR (Fire-retardant) (NEMA XX)	XXXXP-28 (NEMA XXXP)
ROCKWELL HARDNESS (M SCALE)	100	95	110	108	90
TENSILE STRENGTH 1w (1000 psi.)	20	12	16	17	12
FLEXURAL STRENGTH 1w (1000 psi.)	27	16	17	20	18
COMPRESSIVE STRENGTH (1000 psi.)	40	25	35	41	22
WATER ABSORPTION (% in 24 hrs.) 1/16" thickness	3.5	3.0	1.4	1.2	0.6
MAXIMUM CONTINUOUS OPERATING TEMPERATURE (°C.)	120	120	120	120	120
DIELECTRIC STRENGTH perp. to lam. (VPM)	800	800	650	700	800
DIELECTRIC STRENGTH parallel to lam. (Kv.)	50	50	60	70	75
DISSIPATION FACTOR at 1 mc, Cond. A	0.042	0.038	0.034	0.038	0.027
DIELECTRIC CONSTANT at 1 mc, Cond. A	5.5	4.6	4.7	4.8	3.6
ARC-RESISTANCE (seconds)	8	4	4	10	10
INSULATION RESISTANCE (megohms) ASTM D-257, Fig. 3	100	100	1,000	1,000	600,000
AIEE insulation class	A	A	A	A	A





MODEL

**LEADING**  
"THE  
ADVANCEMENT  
OF THE ART"

**707**

**Telemetry Ground Station  
Instrumentation Tape**

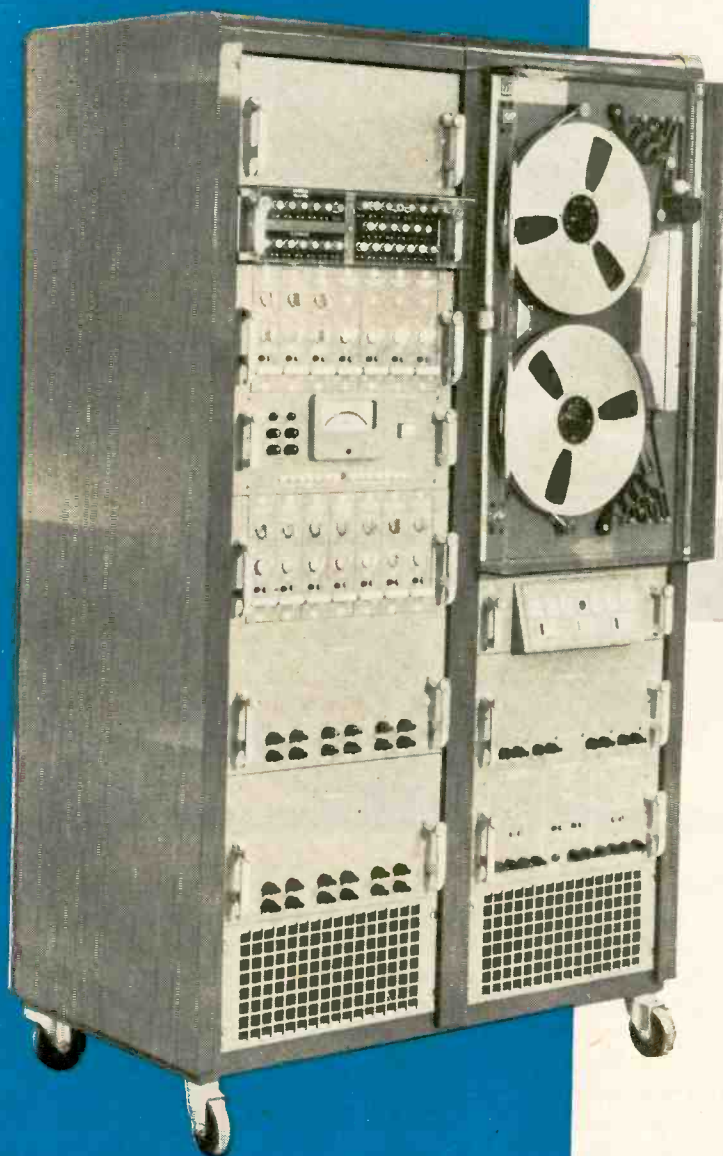

**START TIME**

Less Than 30 Milliseconds

**STOP TIME**

Less Than 30 Milliseconds

**FREQUENCY RESPONSE**

To 130,000 cps

**OUTPUT**

4 volts rms into 180 ohms

**RECORDER MODEL 707**

New high standards of instrumentation tape recording are set by this Midwestern-Magnecorder which offers many tape widths and speeds.

Plug-in modules provide direct analog, PDM and FM recording. Simultaneous recording and reproduction of two tracks may be had on quarter-inch tape. Half-inch tape models provide seven tracks and one-inch models have fourteen tracks. Other configurations are available on special order.

Ultra-precise all metal surface magnetic heads are of an exclusive design produced by Midwestern's Data Storage Devices Division.

COMPLETE SPECIFICATIONS  
ON REQUEST



**M I D W E S T E R N  
I N S T R U M E N T S**

41st AND SHERIDAN / TULSA, OKLAHOMA



# General Plate Nifer<sup>®</sup>

Helps Wilbur B. Driver Company Provide Customers with Improved Radio Tube Material at Lower Cost

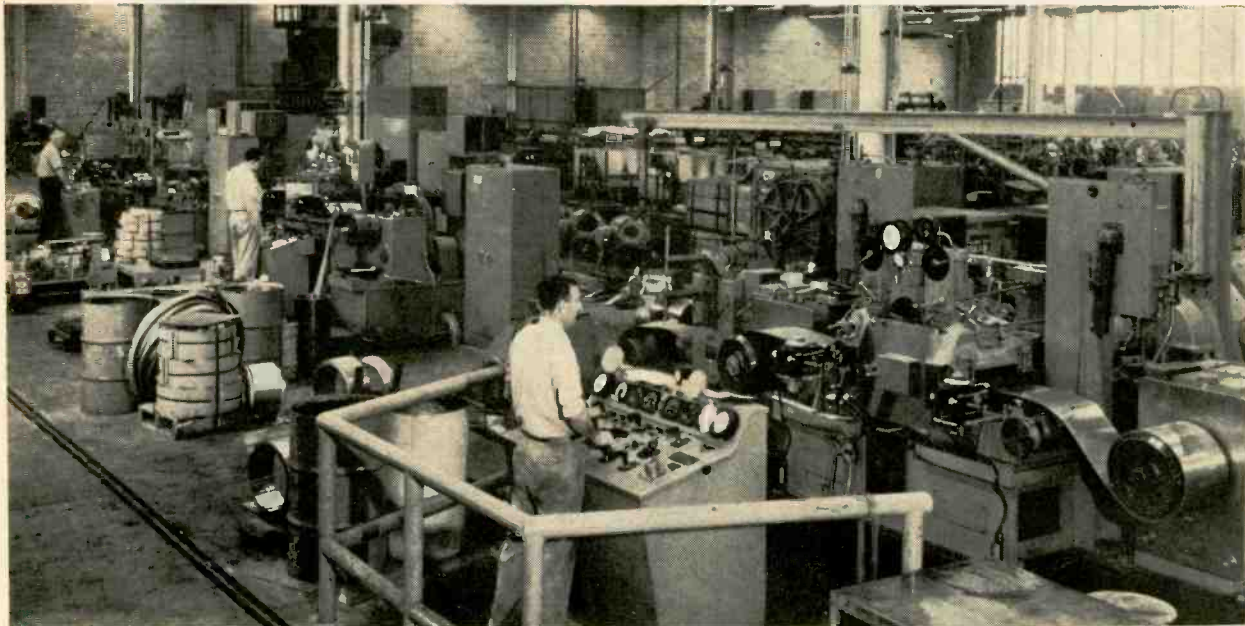

Sendzimer Mills at Wilbur B. Driver Company used for precision rolling G. P. NIFER

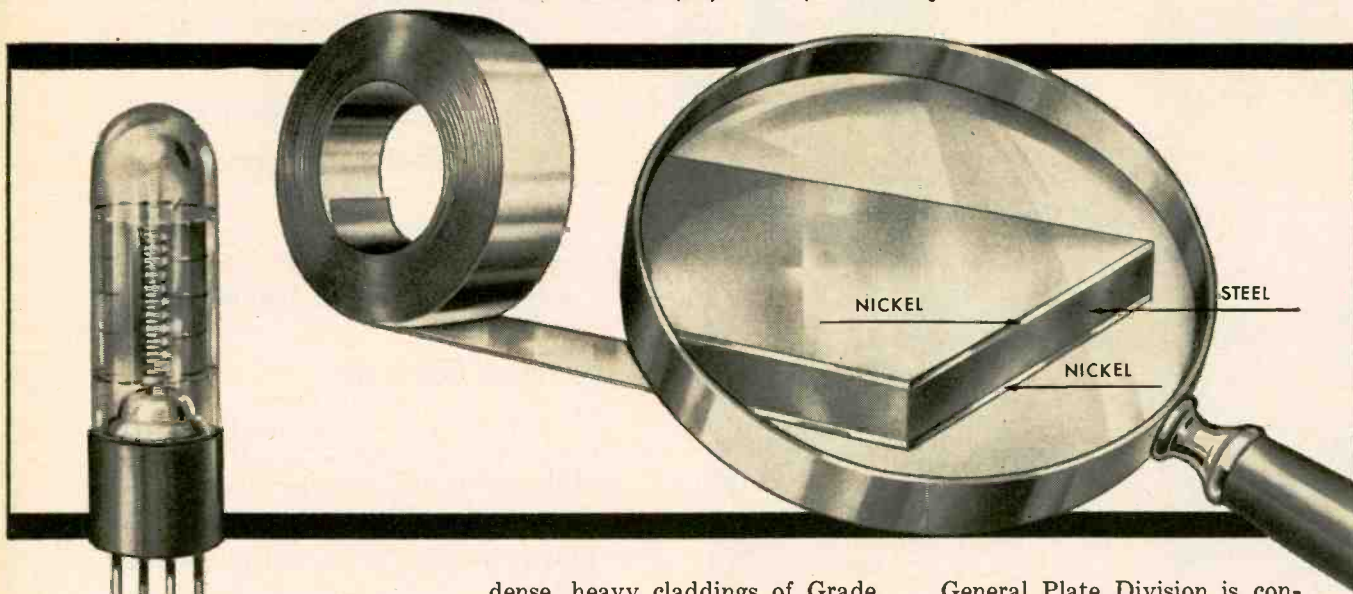

The well-known Wilbur B. Driver Company serves the electronic industry by supplying top quality tube materials such as filament and grid alloys, carbonized pure nickel strip and carbonized G. P. NIFER strip.

G. P. NIFER strip is low carbon steel faced on both sides with

dense, heavy claddings of Grade 330 Nickel. Wilbur B. Driver Company cold rolls G. P. NIFER in Sendzimer Mills to precise thicknesses for customers who fabricate radio tube parts. And, reports Wilbur B. Driver Company, NIFER not only saves on material cost, but produces better carbonization, resulting in superior radio tube performance.

General Plate Division is constantly developing new clad metals which save weight, cut costs, increase strength, conserve materials in critical supply, improve performance and offer other advantages not found in single metals. Why not write today for catalog GP-1 and get acquainted with the potentials of G.P. Clad Metals in your products?

*You can profit by using  
General Plate Clad  
Metals.*

**METALS & CONTROLS CORPORATION**

*General Plate Division*

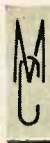

1310 Forest Street, Attleboro, Mass.

FIELD OFFICES: NEW YORK • CHICAGO • DETROIT • INDIANAPOLIS • MILWAUKEE • PASADENA



**NEW!**



**Tung-Sol-developed miniature damper**

**tubes cut costs of TV manufacture!**

*New 6AF3 and 12AF3 permit TV set-makers to profit more fully from economies of automated production.*

Two new Tung-Sol damper diodes—6AF3 and 12AF3—bring TV manufacturers substantial dollar-savings through increased efficiency. Modern automatic assembly equipment is better able to process the miniature, button-stem dampers than prior octal-base types. Also, the new types allow standardization of tube and socket size—a big plus in printed circuit usage.

In addition to these cost-cutters, 6AF3 and 12AF3 offer premium performance. They approach the high ratings of the 6AU4GTA and 19AU4GTA . . . have the same heater power as the 6AX4GT and 12AX4GTA. Set-testing under actual overload conditions indicates the new tubes carry a greater "safety factor" than any previous damper.

The economy and top-flight quality of the 6AF3 and 12AF3 characterize the entire Tung-Sol tube line. For complete data on the new miniature dampers . . . to fill any entertainment socket, contact: *Tung-Sol Electric Inc., Newark 4, New Jersey.*

New Tung-Sol miniature dampers compared with types they replace			
	BASING	LOAD-RATING	HEATER-RATING
<b>6AF3</b> <b>12AF3</b>	<b>Miniature</b>	<b>185ma*</b>	<b>6.3v, 1.2a</b> <b>12.6v, 0.6a</b>
<b>6AX4GT</b> <b>12AX4GTA</b>	<b>Octal</b>	<b>125ma†</b>	<b>6.3v, 1.2a</b> <b>12.6v, 0.6a</b>
<b>6AU4GTA</b> <b>19AU4GTA</b>	<b>Octal</b>	<b>190ma†</b>	<b>6.3v, 1.8a</b> <b>18.9v, 0.6a</b>
<b>12D4</b>	<b>Octal</b>	<b>145ma†</b>	<b>12.6v, 0.6a</b>

\*According to Design Maximum System of Ratings  
†According to Design Center System of Ratings



Announcing

# Honeywell AccuData I d-c Amplifiers

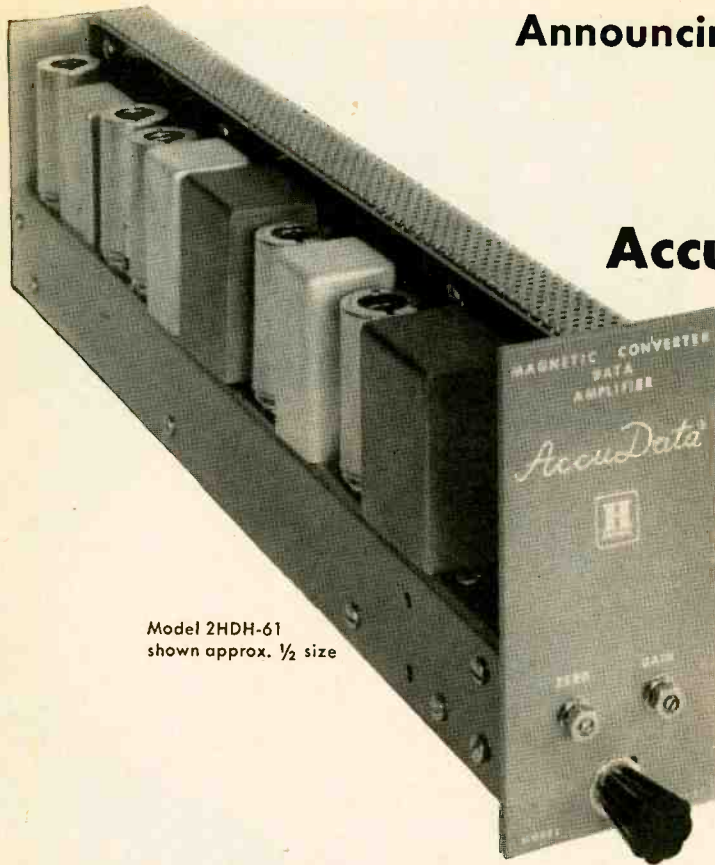

Model 2HDDH-61  
shown approx. 1/2 size

isolated differential input  
for strain gage,  
thermocouple and resistance  
bridge measurements

frequency response to 100 cps

100,000 ohm input resistance

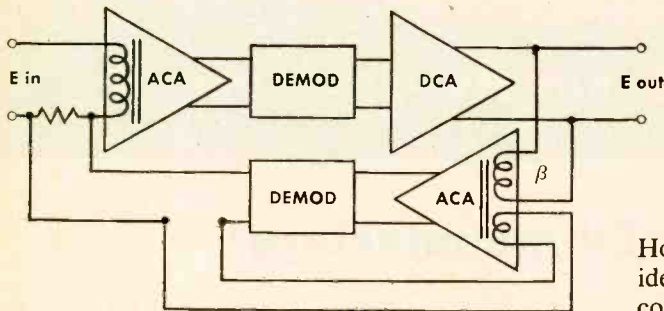

The principal feature of this new development is a completely closed loop wideband feedback circuit which provides a highly accurate isolated signal connected in series opposition to the input emf.

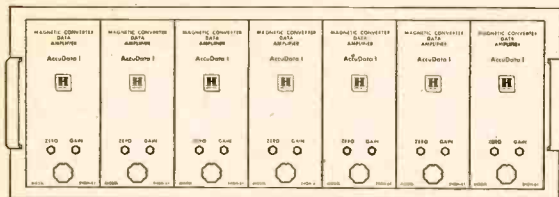

The AccuData I d-c Amplifier is 5 1/4" high and is designed to mount seven to a 19" relay width. A frame assembly is available for this purpose. Separate power supplies (not shown) are used, having 2, 7, 14, or 49 channel capabilities.

Honeywell's new AccuData I d-c Amplifiers combine two Honeywell Second Harmonic Magnetic Converters to provide ideal d-c transducer preamplifier characteristics. Thermocouples, grounded or ungrounded; resistive strain gages operated from common power supplies; and other low-source impedance d-c devices are perfectly suited as inputs to this highly accurate d-c amplifier. The input circuit, with input impedance of greater than 100,000 ohms, is completely isolated from the output circuit and from ground.

The output is single-ended to match emf-input analog-to-digital converters. Overall non-linearity is 0.01%; gain instability, drift, and noise are less than 0.1%.

Other specifications: Response down 3 db at 100 cps; Rise time to 99.9% = 30 milliseconds; Input: 0 to 5 mv; Output: 0 to 1.0 volt; Output impedance: 0.01 ohms; Common Mode Rejection: at d-c virtually infinite; at 60 cps: 130 db (3,000,000 to 1).

Write for technical bulletin on the AccuData I, Model 2HDDH-61, to Minneapolis-Honeywell, Boston Division, Department 7, 40 Life Street, Boston 35, Massachusetts.

# Honeywell



*First in Control*



# SILICON ZENER DIODES!

for every  
circuit!

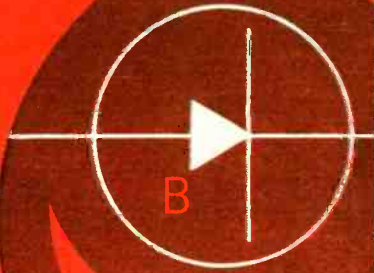

# International





# Rectifier Corp.



**XY Plot of Reverse Breakdown Characteristics Supplied with Each Diode!**

Here's the *versatile* zener line—a type for every application—coupled with a new service conceived to conserve engineering time! Excellent characteristics, especially in terms of low impedance values, hermetic sealing, all-welded construction and a high thermal capacity package qualify these diodes for your consideration. Receiving a plot of characteristics *with each diode* eliminates guesswork and tedious testing on your part—means more time for creative engineering. Inquire further about these diodes... and the special application services we are prepared to offer you.

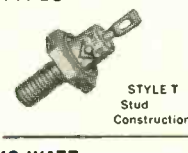
## VOLTAGE REGULATOR TYPES

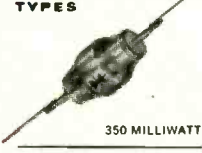
	INT.L DIODE TYPE	ZENER VOLTAGE RANGE	I <sub>Z</sub> MAX. ma	DYNAMIC IMPEDANCE		NOMINAL TEMP. COEFFICIENT %/°C
				Z <sub>Z</sub> (OHMS)	@ I <sub>Z</sub> ma	
<b>500 MILLIWATT TYPES</b>						
 MINIATURE STYLE M	MZ 3.9	3.6-4.3	125	1.5	25	-0.1
	MZ 4.7	4.3-5.1	100	1.5	20	0
	MZ 5.6	5.1-6.2	90	2.3	17.5	+0.3
	MZ 6.8	6.2-7.5	75	3	15	+0.5
	MZ 8.2	7.5-9.1	60	4.5	12.5	+0.6
	MZ 10	9.1-11	50	6.8	10	+0.7
	MZ 12	11-13	40	12	7.5	+0.75
	MZ 15	13-16	33	23	6	+0.8
	MZ 18	16-20	27	45	5	+0.85
	MZ 22	20-24	23	70	4.5	+0.9
MZ 27	24-30	18	90	3.5	+0.95	
<b>1 WATT TYPES</b>						
 STYLE S Pigtail Construction	1Z 3.9	3.6-4.3	250	1	50	-0.4
	1Z 4.7	4.3-5.1	200	1	40	0
	1Z 5.6	5.1-6.2	175	1.5	35	+0.3
	1Z 6.8	6.2-7.5	150	2	30	+0.5
	1Z 8.2	7.5-9.1	120	3	25	+0.6
	1Z 10	9.1-11	100	4.5	20	+0.7
	1Z 12	11-13	80	7.5	15	+0.75
	1Z 15	13-16	65	15	13	+0.8
	1Z 18	16-20	55	30	10	+0.85
	1Z 22	20-24	45	45	9	+0.9
1Z 27	24-30	35	60	7	+0.95	
<b>3.5 WATT TYPES</b>						
 STYLE T Stud Construction	3Z 3.9	3.6-4.3	850	.5	150	-0.4
	3Z 4.7	4.3-5.1	700	.5	125	0
	3Z 5.6	5.1-6.2	625	.75	110	+0.3
	3Z 6.8	6.2-7.5	525	1	100	+0.5
	3Z 8.2	7.5-9.1	425	1.5	80	+0.6
	3Z 10	9.1-11	350	2.5	70	+0.7
	3Z 12	11-13	275	4	50	+0.75
	3Z 15	13-16	225	7.5	40	+0.8
	3Z 18	16-20	200	15	35	+0.85
	3Z 22	20-24	160	22.5	30	+0.9
3Z 27	24-30	125	30	25	+0.95	
<b>10 WATT TYPES</b>						
 STYLE T Stud Construction	10Z 3.9	3.6-4.3	2500	.25	500	-0.4
	10Z 4.7	4.3-5.1	2000	.25	400	0
	10Z 5.6	5.1-6.2	1750	.4	350	+0.3
	10Z 6.8	6.2-7.5	1500	.5	300	+0.5
	10Z 8.2	7.5-9.1	1200	.75	250	+0.6
	10Z 10	9.1-11	1000	1.25	200	+0.7
	10Z 12	11-13	850	2	170	+0.75
	10Z 15	13-16	650	4	140	+0.8
	10Z 18	16-20	550	7.5	110	+0.85
	10Z 22	20-24	450	12	90	+0.9
10Z 27	24-30	350	15	70	+0.95	
<b>DOUBLE ANODE TYPES</b>						
 350 MILLIWATT	ZZ 3.9	3.6-4.3	110	3	22	-0.45
	ZZ 4.7	4.3-5.1	90	4	18	-0.1
	ZZ 5.6	5.1-6.2	70	5	14	0
	ZZ 6.8	6.2-7.5	60	10	12	+0.25
	ZZ 8.2	7.5-9.1	50	15	10	+0.35
	ZZ 10	9.1-11	40	25	8	+0.8
	ZZ 12	11-13	30	40	7.5	+0.6
	ZZ 15	13-16	25	60	5	+0.7
	ZZ 18	16-20	20	80	4	+0.8
	ZZ 22	20-24	16	125	3.5	+0.9
ZZ 27	24-30	13	200	3	+0.95	
<b>MULTIPLE JUNCTION TYPES</b>						
<b>HIGH VOLTAGE 5 WATT</b>	HZ 27	24-30	200	7	40	0
	HZ 33	30-36	150	10	30	+0.3
	HZ 47	43-51	110	20	22	+0.6
	HZ 68	62-75	75	60	14	+0.75
	HZ 100	91-110	50	180	10	+0.85
HZ 150	130-160	35	370	7	+0.95	

## REFERENCE ELEMENT TYPES

	IN430	8.0-8.8	50	15	10	±.002 -55° to +100°C
	IN430A	8.0-8.8	50	15	10	±.001 -55° to +100°C
	IN430B	8.0-8.8	50	15	10	±.001 -55° to +150°C



EXECUTIVE OFFICES: EL SEGUNDO, CALIFORNIA • PHONE OREGON 8-6281 • CABLE RECTUSA

NEW YORK AREA OFFICE: 132 EAST 70TH ST., PHONE TRAFALGAR 9-333D • CHICAGO AREA OFFICE: 205 W. WACKER DR., PHONE FRANKLIN 2-3888 • NEW ENGLAND AREA OFFICE: 17 DUNSTER STREET, CAMBRIDGE, MASS., PHONE UNIVERSITY 4-6520 • PENNSYLVANIA AREA OFFICE: SUBURBAN SQUARE BUILDING, ARDMORE, PENNA., PHONE MIDWAY 9-1428

WORLD'S LARGEST SUPPLIER OF INDUSTRIAL METALLIC RECTIFIERS • SELENIUM • GERMANIUM • SILICON

CIRCLE 55 READERS SERVICE CARD





## Teleprinted Communications... on the double!

The Kleinschmidt teletypewriter set sends teleprinted messages from tape at speeds up to 100 words per minute.

**AT THE SAME TIME**, on the same unit, the operator perforates and prints other messages for transmission.

Day after day, Kleinschmidt teletypewriters and related equipment at U. S. Army Communication Centers receive and transmit thousands of teleprinted messages. This tremendous communications traffic, accelerated by multiple-function Kleinschmidt equipment, developed in cooperation with the U. S. Army Signal Corps, flows smoothly and precisely. Both sender and recipient receive

a teleprinted original, identical in every respect.

Since the century began, the Kleinschmidt name has been associated with every major development in teleprinted communications. Now a member of the Smith-Corona family, Kleinschmidt looks ahead to new attainments in broadening the field of electronic communications for business and industry.



# KLEINSCHMIDT

DIVISION OF SMITH-CORONA MERCHANT INC., DEERFIELD, ILL.  
Pioneer in teleprinted communications systems and equipment since 1911



## When to use magnetic tape in automatic control

Iron dust and a magnifying glass provide a revealing visual comparison

You are seeing iron dust clinging to signals recorded on magnetic tape. There can be 3200 extremely reliable binary bits on one square inch—or analog control information similarly compact. In the compacting of automatic control data, magnetic tape is supreme—second only to nature's remarkable chromosome. Nature makes people, dogs, cats and monkeys. Magnetic tape recorders make, for example, machined parts—their shapes the most complex and precise that have ever been produced in quantity. It is done by numerical control. The principles involved are very widely applicable to all kinds of control applications. Three main criteria determine where magnetic tape is your best choice.

### Criteria No. 1: QUANTITY OF CONTROL DATA

Any automatic control operation that can benefit from very large numbers of time-synchronized commands is a natural candidate for magnetic tape. For example, continuous-path control of a milling cutter may require X, Y and Z coordinates at several hundred points per inch of tool movement. The more points, the greater the accuracy. A reel of magnetic tape can define millions of points at extremely low unit cost.

Continuous real-time control of variables is applicable to process programming, simulation devices, automatic inspection and electronic-system checkout—provided there is need for great accuracy in a complex situation. The program tapes may incorporate the work of giant computers and intricate interpolating devices. A great advantage of magnetic tape is that the computer and interpolator are used only during tape preparation, hence may be shared with many other needs.

### Criteria No. 2: HIGH TRANSFER RATE

The Ampex FR-300 digital tape handler can spew out alpha-numeric characters at rates as high as 30,000 to 90,000 per second. A short burst of digital information equivalent to a standard punched card can be extracted from magnetic tape under 4 milliseconds—including start and stop.

On analog position-control data, magnetic tape can provide many hundreds of complete commands per second—200 per second in one example and up to eight times this many if needed.

On control-system monitoring, a recording of as much as two hours duration can be played back in one minute for review by high-speed computers. Ampex tape recorders with overall speed ratios as high as 120-to-1 are available.

### Criteria No. 3: ERASURE AND RE-RECORDING

Magnetic tape can be erased to accept new data an endless number of times. Hence tape-loop recorders can operate on a repetitive cycle of recording, reproduction, erasure and re-recording to serve as time-delay devices or endless monitors. Such a loop can be the analog equivalent of a production line, conveyor belt or process flow. The loop keeps in step, accepts sensing information at one place and then triggers commands at some fixed time downstream. Or as a calamity monitoring device, the tape loop stores information briefly and erases it to make way for new data if nothing has occurred.

*Can we advise you on a specific application of magnetic-tape control or send further literature on magnetic-tape recorder principles and applications? Write Dept. E-19.*



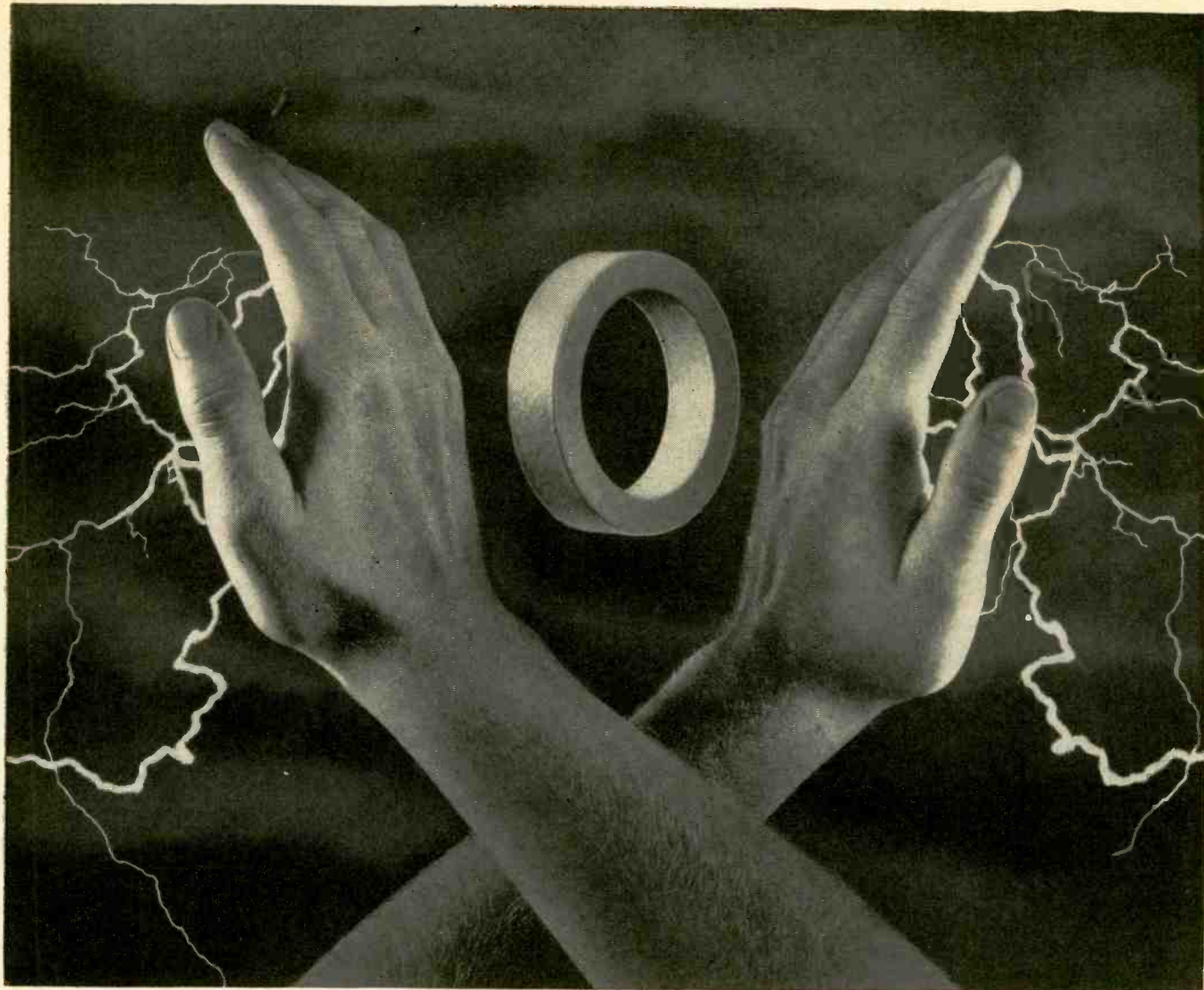

## **GUARANTEED TO WITHSTAND 1,000 VOLTS!**

### **GVB-finished tape wound core boxes drop your production costs**

We have developed a radical new finish for aluminum boxes for tape wound cores. Your production department will glow with delight, for we guarantee this finish to withstand 1,000 volts (at 60 cycles) without taping!

GVB, for Guaranteed Voltage Breakdown (limits), is what we call this new finish. It is perfectly matched to our aluminum core boxes, for it will withstand temperatures from  $-70^{\circ}\text{F}$  to  $450^{\circ}\text{F}$ . Potting techniques need not change, for GVB-finish lives happily with standard potting compounds.

By eliminating the need for taping the core box, you also eliminate a time consuming production step. By combining GVB-finish with our aluminum core box, we assure you a core capable of being vacuum impregnated down to 20 mm. of mercury.

And they are Performance-Guaranteed! Like all tape wound cores from Magnetics, Inc., aluminum-boxed or phenolic-boxed, you buy them with performance guaranteed to

published limits. The maximum and minimum limits are for  $B_m$ ,  $B_r/B_m$ ,  $H_l$  and gain. This data is published for one, two, four and six mil Orthonol® and Hy Mu 80 tape cores.

GVB-finished cores are ready for you now. So are the published limits for all Magnetics, Inc. tape wound cores. Write today for more GVB details, and for your copy of the guaranteed performance limits: Dept. E-51, Magnetics, Inc., Butler, Pennsylvania.

**MAGNETICS inc.**



# SYLVANIA-NPN SWITCHING TRANSISTORS

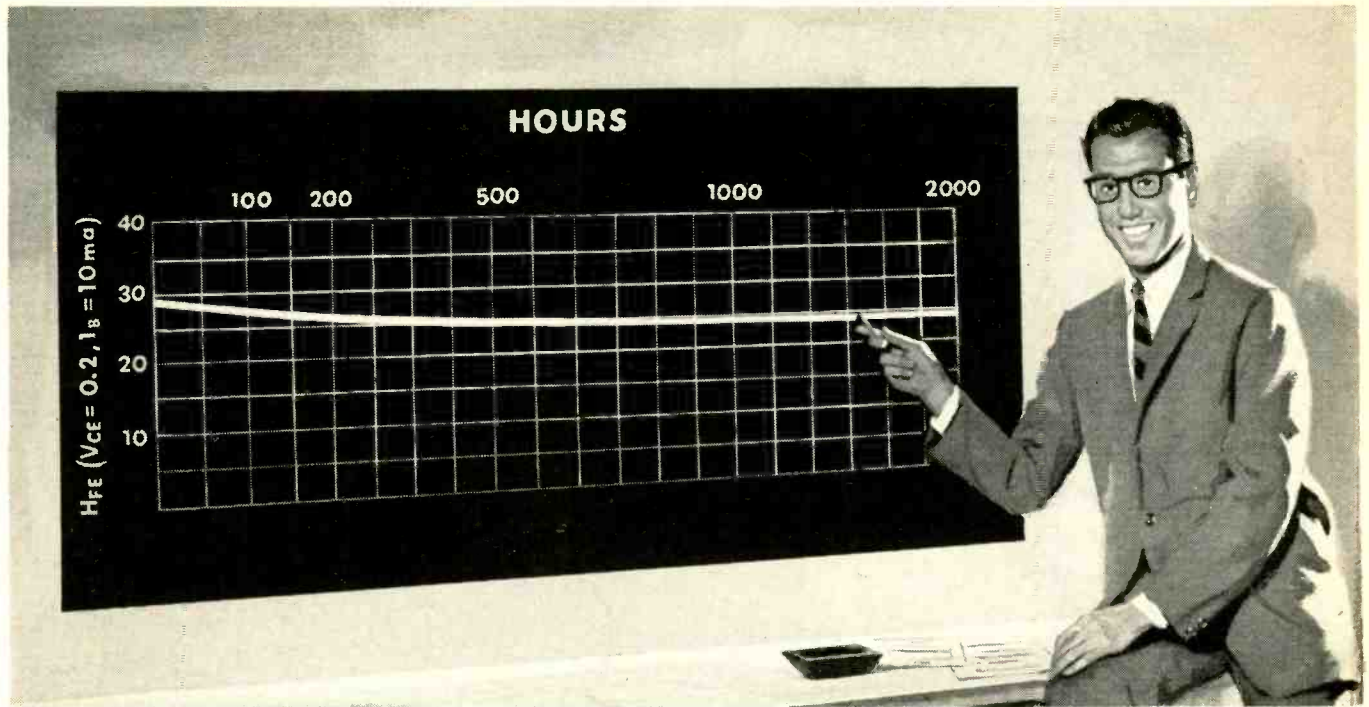

...still holding the line at **2000 hours**

Eight new high stability NPN switching transistors designed for wide application in low and medium power switching circuits, are now available from Sylvania. They increase to 15, the total number of NPN switching types in the Sylvania line. Most of the units now have passed 2,000-hour evaluations and are continuing to maintain the high Beta stability and fast rise time so important in switching applications.

The fifteen NPN germanium transistors include both *base-on-the-can* types with 150 mw and 200 mw dissipation and *base-off-the-can* types with 100 mw dissipation.

Each of the types features the Sylvania welded hermetic seal for full protection against humidity and other environmental conditions and meets JETEC TO-5 and TO-9 dimensions. For further particulars on the entire line, contact your Sylvania representative or write Sylvania direct.

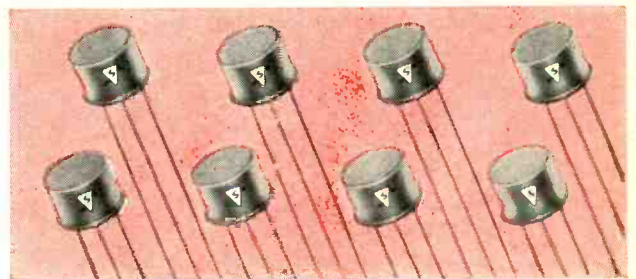

Type	Max. Dissipation at 25° Ambient	Max. Junction Temp. (°C)	Max. $I_c$ (ma)	Current Gain $h_{FE}$	Max. Rise Time, $t_r$
2N439	100 Mw	85	100	40	2.5 usec
2N556	100 Mw	85	200	50	3.5
2N557	100 Mw	85	200	30	6.5
2N558	100 Mw	75	200	75	3.5
2N576*	200 Mw	100	400	40	2.0
2N576A*	200 Mw	100	400	80	2.0
2N587*	150 Mw	85	200	30	2.0
2N679*	150 Mw	85	100	20	3.0
2N312	100 Mw	85	200	20	1.5
2N356	100 Mw	85	500	30	2.0
2N357	100 Mw	85	500	30	1.2
2N358	100 Mw	85	500	30	0.8
2N377*	150 Mw	100	200	40	2.5
2N385*	150 Mw	100	200	70	-
2N388*	150 Mw	100	200	110	1.0

\*Base internally connected to the case



# SYLVANIA

SYLVANIA ELECTRIC PRODUCTS INC.  
1740 Broadway, New York 19, N. Y.  
In Canada: Sylvania Electric (Canada) Ltd.,  
P. O. Box 1190, Station "O," Montreal 9

LIGHTING • TELEVISION • RADIO • ELECTRONICS • PHOTOGRAPHY • ATOMIC ENERGY • CHEMISTRY-METALLURGY

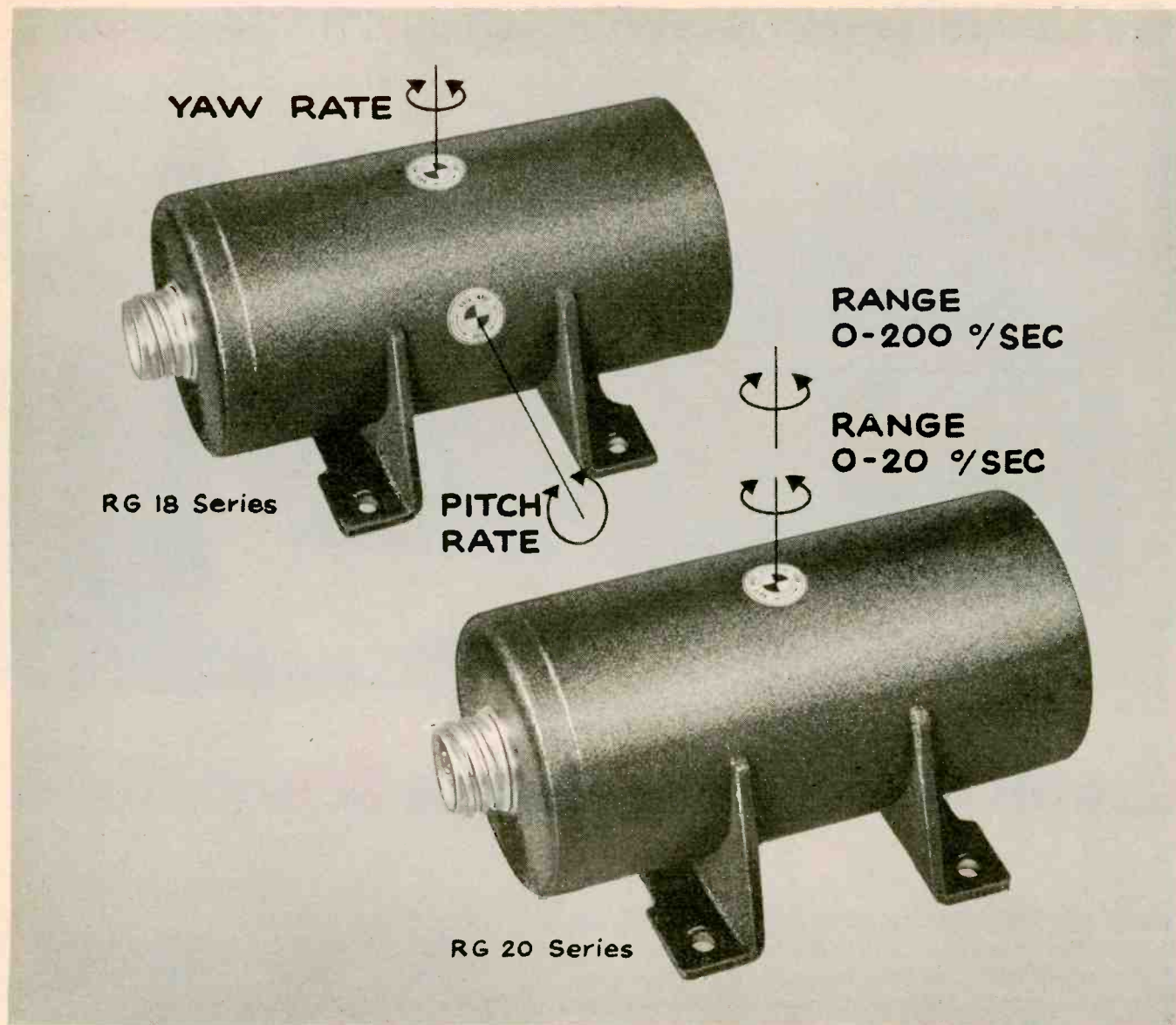

## New Humphrey dual-rate gyros do the work of two units

Now important reductions in the space required for instrument and control packages can be made with the introduction of a new Humphrey rate gyro that replaces two ordinary gyros. The new design utilizes a single motor to drive two separate wheels in one unit. With this new development, it is possible to measure rates about two different axes with an RG-18 Series Gyro or cover two different rate ranges about the same axis with a single RG-20 Series instrument.

RG-18 gyros should find widespread use for applications now requiring two instruments. For example, one unit could be used to measure both pitch and yaw. The RG-20 Series, with its two different rate ranges, may be applied to instrumentation systems where greater accuracy is required. For example, a single unit can be furnished to cover the rate ranges from 0-20 degrees/second and from 0-200 degrees/second. In effect, you expand the dynamic range of your instrumentation system from 100 to 1 to 500 to 1. This expanded scale gives you far greater accuracy.

The new rate gyros are built with two independent pick-offs—one for each axis or one for each range. They meet tough environmental conditions, such as temperature from  $-65^{\circ}\text{F}$  to  $180^{\circ}\text{F}$  while operating, relative humidity 100%, unlimited altitude and excellent resistance to acceleration, vibration and shock. Phone or write today and let the kind of engineering that developed these new dual-rate gyros go to work for you.

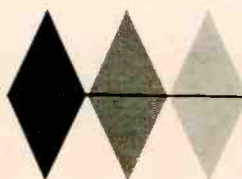

**Humphrey Inc.**

ELECTRO-MECHANICAL INSTRUMENTS

DEPT. E-108, 2805 CANON STREET  
SAN DIEGO, CALIFORNIA

FOR COMPLETE SYSTEMS, SPECIFY HUMPHREY  
GYROSCOPES, ACCELEROMETERS, POTENTIOMETERS



# NOW-

## RAPID ACCURATE TESTING OF

**SILICON  
GERMANIUM  
SELENIUM**

**RECTIFIERS and DIODES**



MODEL S-101

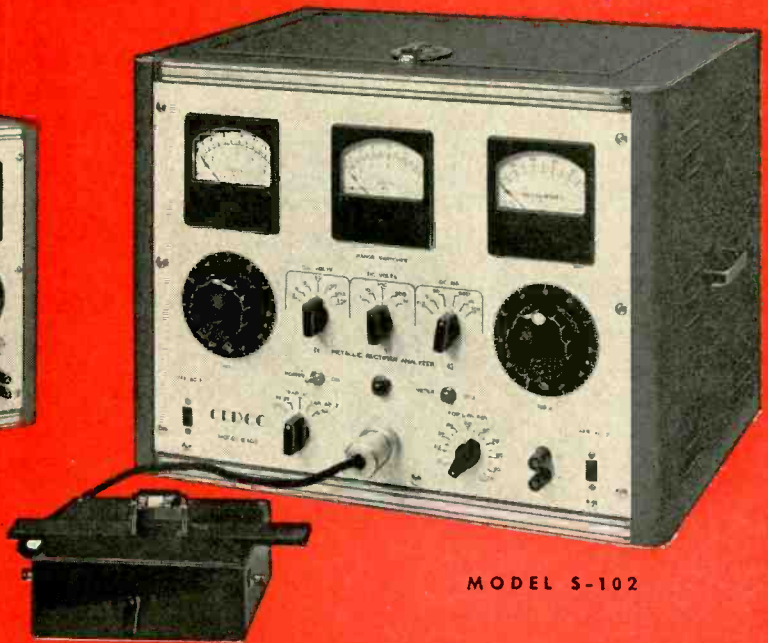

MODEL S-102

## WITH THE NEW *Cedco* METALLIC RECTIFIER ANALYZERS

### FEATURING

### 5 STANDARD CIRCUIT TESTS

1. Visual dynamic voltage-current characteristic.
2. Dynamic reverse-current leakage.
3. Dynamic forward-voltage drop.
4. Static reverse-current leakage.
5. Static forward-voltage drop.

NOW . . . for the first time, production and laboratory users of power rectifiers and signal diodes may perform *five* standard circuit tests with *one* precision instrument . . . the CEDCO Metallic Rectifier Analyzer.

Versatile, accurate and rapid, the new CEDCO Analyzer exceeds the highest standards of engineering quality. Three Weston meters, accurate within 1%, AC Voltmeter (0 to 1500 V.), DC Voltmeter (0 to 1000 V.) and DC Milliammeter (0 to 10 AMP.) assure dependable performance.

**Model S-101**—Self-contained featuring complete set of plug-in adapters, accepting wide range of sizes.

**Model S-102**—Ideal for laboratory use. Adjustable test fixture for remote testing permits shelf mounting away from the working area.

Illustrated brochure, Bulletin R-250, is available upon request.

Eastern Regional Sales Office:  
Wilson Building  
Camden, New Jersey



**Cedco** ELECTRONICS  
ERIE, PENNSYLVANIA

DESIGNERS AND MANUFACTURERS OF PRECISION ELECTRONIC TEST EQUIPMENT



# INDUSTRY'S BROADEST LINE OF

TYPICAL SWITCHING CIRCUIT AT 25°C

$V_{CC}$	$V_{BE}$	$I_C$	$I_{B1}$	$I_{B2}$	$t_{ON}$	$t_{OFF}$	$t_{R}$	$t_{F}$
-24	+24	-1	-30	+50	0.25	0.4	2.0	0.6
V	V	A	mA	mA	$\mu$ sec	$\mu$ sec	$\mu$ sec	$\mu$ sec

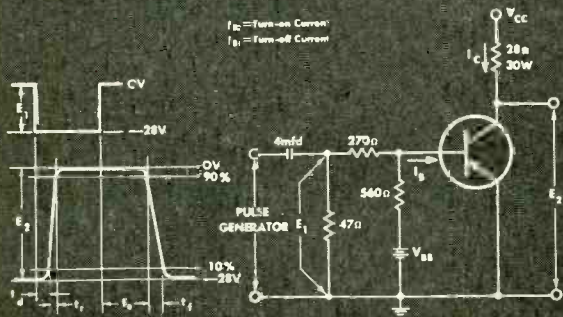

## NEW POWER SWITCHING TRANSISTORS



(ACTUAL SIZE)

NEW P-N-P germanium power switching transistors *guarantee* 5.5 W dissipation at 25°C with voltage ratings of 40, 60, 80, and 100 volts for optimum design flexibility. The functional design of the heat sink assures rapid installation requiring only one mounting hole through the chassis.

You get *guaranteed* 20-to-60 beta spread and a low 0.16 ohm saturation resistance at the 3A maximum collector rating. In addition, a maximum 125  $\mu$ A collector reverse current is *guaranteed* at one-half rated breakdown voltage with TI 2N1042, 2N1043, 2N1044, and 2N1045 alloy junction transistors.

These new devices are well suited for your switching circuits . . . relay drivers . . . audio and pulse amplifiers.

TYPICAL SOLENOID RELAY DRIVER

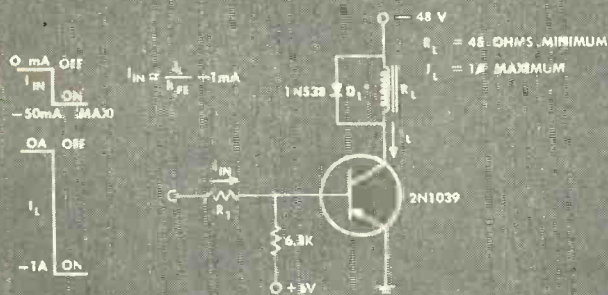

\* Diode D<sub>1</sub> is used to clip reverse voltage spikes across solenoid when transistor is turned off.

## NEW MEDIUM POWER SWITCHING TRANSISTORS



(ACTUAL SIZE)

NEW P-N-P germanium medium power transistors give you switching times as low as 1.1  $\mu$ sec. TI 2N1038, 2N1039, 2N1040, and 2N1041 alloy junction transistors provide 800 mW dissipation in free air at 25°C, 450 mW at 55°C . . . with voltage ratings of 40, 60, 80, and 100 volts.

In addition, *guaranteed* 20-to-60 beta spread and low 0.2 ohm saturation resistance assure reliable performance for your high speed switching circuits . . . relay drivers . . . low power audio and pulse amplifiers.

	Type	Dissipation at 25°C	Collector Voltage-V max	Collector Current A max	Beta		Collector Reverse Current I <sub>CO</sub> max		Saturation Resistance Ohm	
					min	max	$\mu$ A	V		
computer power	prnp	2N1046	15W	-80	-3	40	70 (Avg)	-1mA	-40	0.75
medium power	prnp	2N1038	800mW	-40	-1	20	60	-125	-20	0.2
		2N1039	800mW	-60	-1	20	60	-125	-30	0.2
		2N1040	800mW	-80	-1	20	60	-125	-40	0.2
		2N1041	800mW	-100	-1	20	60	-125	-50	0.2
power	prnp	2N456	50W	-40	-5	30@5A avg.		-2mA	-40	0.048
		2N457	50W	-60	-5	30@5A avg.		-2mA	-60	0.048
		2N458	50W	-80	-5	30@5A avg.		-2mA	-80	0.048
		2N1021	50W	-100	-5	23@5A avg.		-2mA	-100	0.08
		2N1022	50W	-120	-5	23@5A avg.		-2mA	-120	0.08
		2N1042	5.5W	-40	-3	20	60	-125	-20	0.16
		2N1043	5.5W	-60	-3	20	60	-125	-30	0.16
		2N1044	5.5W	-80	-3	20	60	-125	-40	0.16
		2N1045	5.5W	-100	-3	20	60	-125	-50	0.16

IMMEDIATELY AVAILABLE IN PRODUCTION QUANTITIES OR . . .

# TEXAS



WORLD'S LARGEST SEMICONDUCTOR PLANT





# GERMANIUM POWER TRANSISTORS!

## TYPICAL SWITCHING CHARACTERISTICS

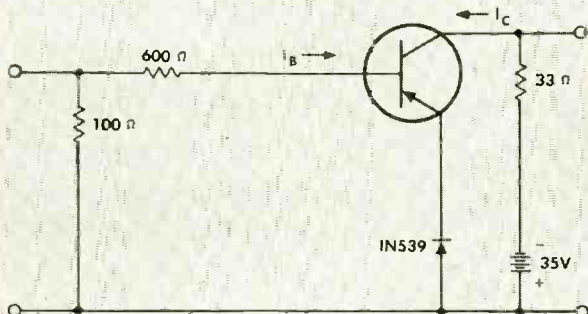

### TYPICAL SWITCHING TIMES

$T_d$	Delay Time	0.3 $\mu$ sec
$T_r$	Rise Time	0.7 $\mu$ sec
$T_s$	Storage Time	1.2 $\mu$ sec
$T_f$	Fall Time	0.5 $\mu$ sec

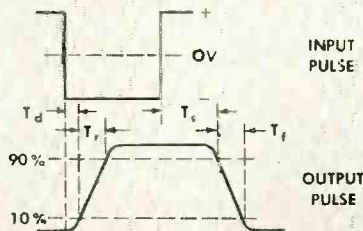

### TEST CURRENTS

- $I_{B1}$  (Turn-on Current) = -30mA
- $I_{B2}$  (Turn-off Current) = +30mA
- $I_C$  (Collector Current) = -1A

## NEW HIGHEST FREQUENCY COMPUTER POWER TRANSISTOR



(ACTUAL SIZE)

NEW TI 2N1046 combines *high power, high frequency* and *high voltage* performance in a single transistor package! This P-N-P diffused base germanium transistor has *guaranteed* dissipation to 15 watts and collector breakdown voltage to 80 volts with 12 mc typical alpha cutoff. Extremely low collector reverse current averaging 0.2 ma at 40 volts and a low 0.75 ohm saturation resistance assure reliable operating characteristics.

Designed for your deflection circuits and computer core driving applications, the 2N1046 has a typical 10mc internal cutoff frequency,  $f_T$  (point at which forward current transfer ratio equals unity).

## NEW HIGHEST VOLTAGE TRANSISTORS



(ACTUAL SIZE)

NEW TI 2N1021 and 2N1022 germanium transistors, with *maximum operating voltages of 100 V and 120 V respectively*, provide typical betas of 70 at 1A... 23 at 5A!

You get *guaranteed 700  $\mu$ A* maximum collector reverse current at one-half rated voltage and 2mA maximum at full rated voltage in addition to extremely low saturation resistance... 0.08 ohm  $R_{CS}$ .

For your audio, servo and power applications, consider these outstanding performance characteristics and specify TI germanium transistors.

## TYPICAL 20 WATT AMPLIFIER POWER GAIN = 23 db

TRANSISTOR	$V_{CC}$ V	$R_L$ $\Omega$	EFFICIENCY	DISTORTION 20 WATT	$R_s$ $\Omega$
2N1021	-80	30	66%	2%	3
2N1022	-100	50	66%	2%	5

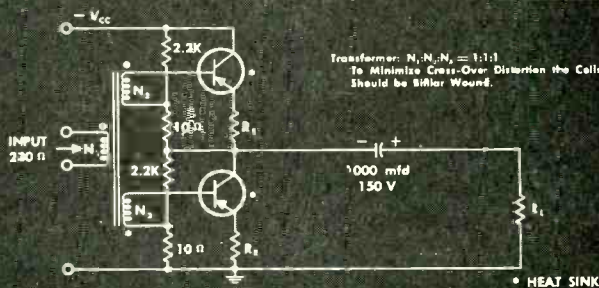

OFF THE SHELF IN 1-99 QUANTITIES FROM YOUR NEARBY TI DISTRIBUTOR

# INSTRUMENTS

**INCORPORATED**  
SEMICONDUCTOR - COMPONENTS DIVISION  
13500 N. CENTRAL EXPRESSWAY  
POST OFFICE BOX 312 • DALLAS, TEXAS

## TEXAS INSTRUMENTS SALES OFFICES

DALLAS • NEW YORK • CHICAGO • LOS ANGELES  
CAMDEN • DAYTON • DENVER  
DETROIT • OTTAWA • PALO ALTO • SYRACUSE  
SAN DIEGO • WALTHAM • WASHINGTON D. C.

Now . . . from Phelps Dodge . . .

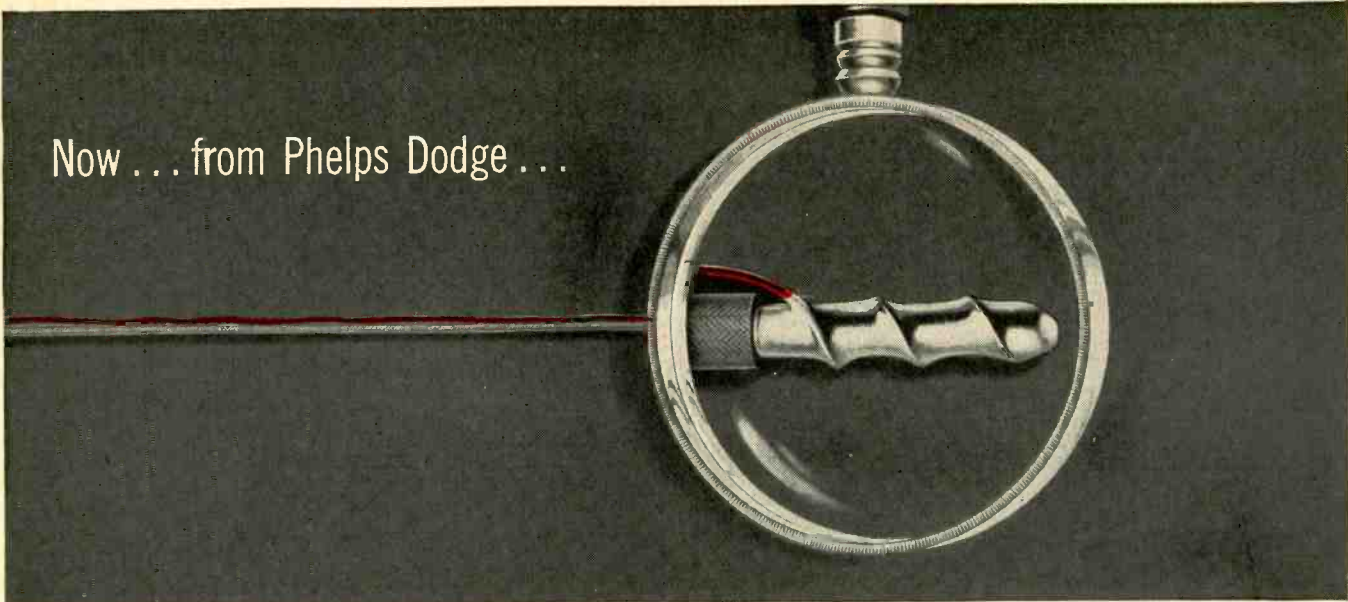

## First complete line of Solderable Magnet Wires for the Electronics Industry!

S-Y BONDEZE®

answers the long-awaited need for a self-bonding wire that is solderable at low temperatures. The high temperature cut-thru resistance of the underlying film will reduce the number of shorts in your coils.

NYLEZE®

a tough, all-purpose, solderable wire for your most severe applications. Especially suited for use in high speed automatic winding equipment or wherever extreme varnish or compound treatment is involved.

SODEREZE®

the magnet wire that is solderable at low temperature, proven over the years in thousands of customer applications.

GRIP-EZE®

a solderable film wire with controlled surface friction for use in lattice-wound coils. A special surface treatment provides mechanical gripping between turns and keeps the wire in place.

All Phelps Dodge solderable magnet wires are red in color.

*Any time your problem is magnet wire, consult Phelps Dodge for the quickest, easiest answer!*

FIRST FOR  
LASTING QUALITY  
—FROM MINE  
TO MARKET!



**PHELPS DODGE COPPER PRODUCTS  
CORPORATION**

**INCA MANUFACTURING DIVISION**  
FORT WAYNE, INDIANA



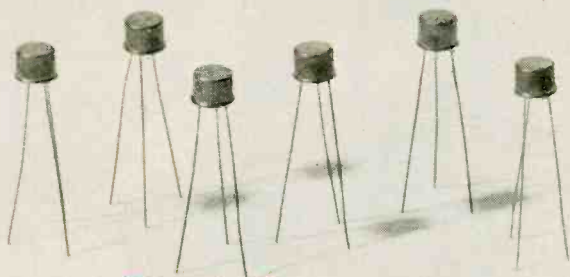

# Fairchild silicon transistors

## Milli-micro-second switching speeds and high current too

Where applications require transistor performance beyond previously accepted high limits, Fairchild Silicon Transistors offer an exceptional three-way combination:

1) 50 milli-micro-second typical rise time — permits faster switching rates in computing devices. Total switching time is typically 0.2 microseconds.

2) 1 watt dissipation at 100° C. — Saturation resistance is 10 ohms maximum. Resulting high-current capability provides opportunities to increase equipment performance while reducing circuit complexity.

3) Silicon temperature performance — Maximum junction temperature of 175° C. gives low leakage and more safety factor at any lower temperature.

These characteristics are the outcome of the solid-state diffusion technique used at Fairchild. Other important accomplishments of this process are excellent reliability and a high order of electrical uniformity throughout large production runs.

The accomplishment of a research-production team Singleness of purpose did it. Fairchild assembled a uniquely experienced team of research scientists and production engineers whose objective was to bring the advanced solid-state diffusion process under close control. They succeeded in putting laboratory-quality silicon transistors into quantity manufacture with firm product specifications exceeding anything previously offered.

### 2N696 and 2N697 SILICON TRANSISTORS

Symbol	Specification	Rating	Characteristics	Test Conditions
$V_{CE}$	Collector to Emitter voltage (25° C.)	40v		
$P_C$	Total dissipation Case temp. 25° C. Case temp. 100° C.	2 watts 1 watt		
$h_{FE}$	D.C. current gain		2N696 — 15 to 30 2N697 — 30 min.	$I_C = 150\text{ma}$ $V_C = 10\text{v}$
$R_{CS}$	Collector saturation resistance		6 $\Omega$ typical, 10 $\Omega$ max.	$I_C = 150\text{ma}$ $I_B = 15\text{ma}$

For full information and specifications,  
write Dept. A-10



844 CHARLESTON ROAD • PALO ALTO, CALIFORNIA

The unretouched scope face below shows the time comparison of input (positive) and output (negative) pulses in a non-saturating mode. Time base is 20 $\mu$ sec. per large division on the scope face. Maximum collector current is 50 ma.

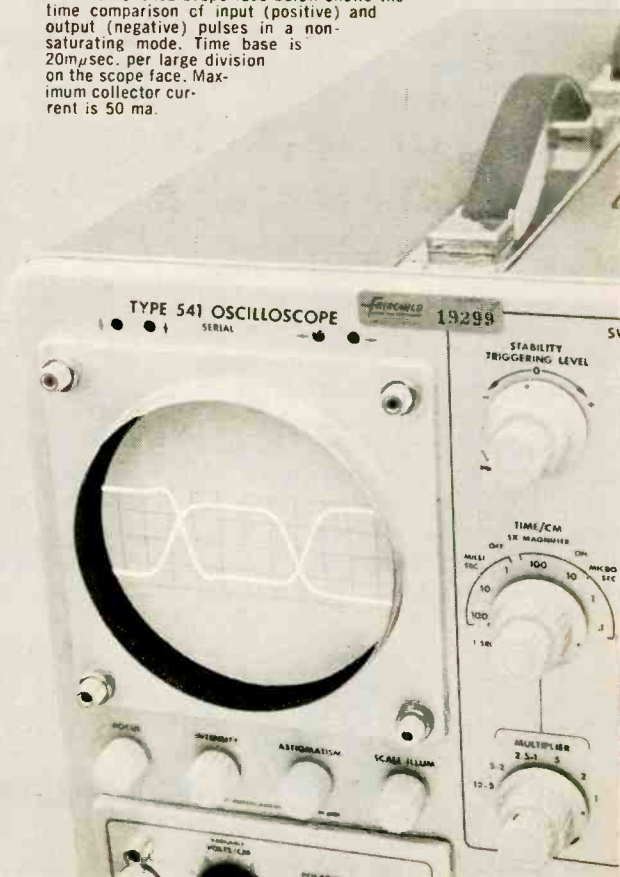

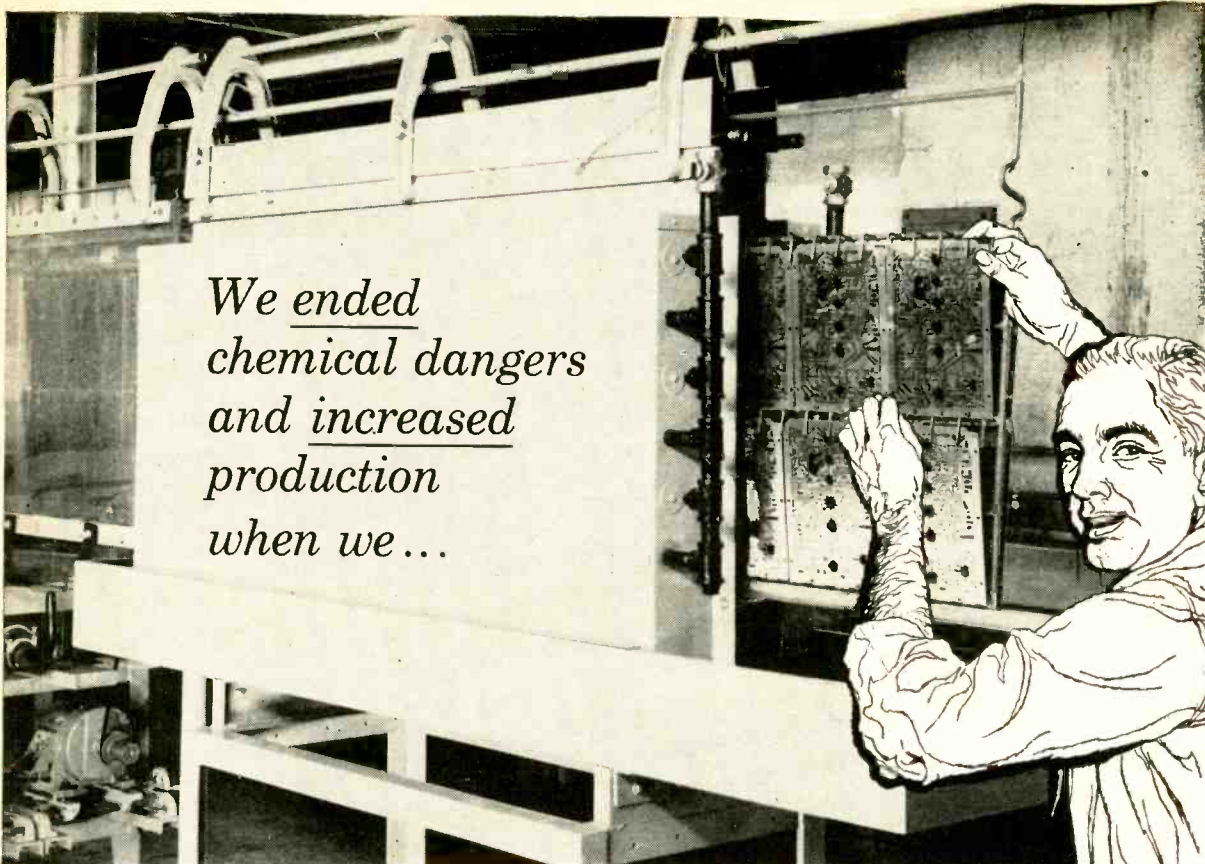

*We ended  
chemical dangers  
and increased  
production  
when we...*

## **STOPPED** *making our own etchant* **STARTED** *using* **HUNT S.C.E.**

"We used to make our own etchant for solder plated circuit boards until we heard of HUNT S.C.E. Solution.

"To mix our own etchant we used to stock large quantities of chromic and sulphuric acid. It took time to make up the solutions which filled the air with noxious fumes and was always dangerous to handle. Besides the time it took to make up the solutions we ended up with variations from batch to batch. And in order to get the solution working right, we had to heat it up to 140° F and over.

"So we did the wise thing... stopped making our own and started to use HUNT S.C.E. which works at room temperature. Now we have no more chemical dangers. We are really saving money — etching time is standardized

and we maintain a uniform production rate around the clock."

HUNT S.C.E. (Solder Circuit Etch) is superior to plant mixed etchants because it:

1. Etches rapidly at room temperature.
2. Is a ready, prepared product designed specifically for this one purpose.
3. Has a high capacity for copper.
4. Never attacks the solder plated circuit.
5. Has guaranteed uniformity and is the highest quality because of rigid laboratory control.
6. Gives fast, odorless etching of the copper.
7. Produces boards that pass all corrosion and stability tests.

For detailed information about HUNT S.C.E. and valuable production handling information, write for Technical Bulletin No. 3 — "The Etching of Solder Plated Circuit Boards by Hunt S.C.E. Solution." Hunt S.C.E. Solution is available in 125 pound (12 gallon) carboys and 530 pound (55 gallon) drums.

*Manufacturing  
Chemists*



*Established  
1909*

### **PHILIP A. HUNT COMPANY**

PALISADES PARK, N. J.

*Chicago • Cleveland • Cambridge • Brooklyn • Atlanta • Dallas • Los Angeles • San Francisco*



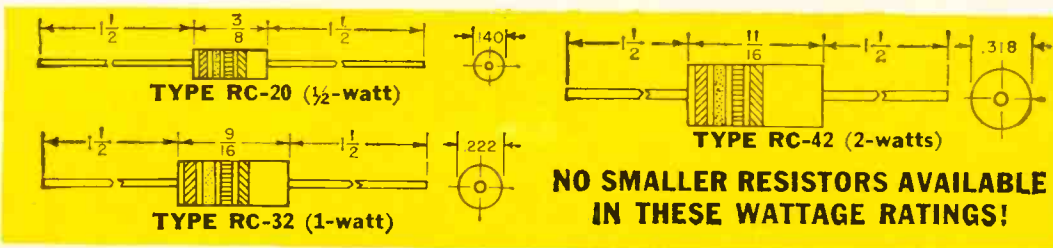

This is the kind of

# PLUS PERFORMANCE

You get when you specify **COLDITE 70+** resistors

This performance table for the RC-32 (short) 1-watt Coldite 70+ Resistors speaks for itself. Similar test data proving equally good performance for the RC-20 (1/2-watt) and RC-42 (2-watt) units will gladly be sent on request to: Electronic Components Division, Stackpole Carbon Company, St. Marys, Pennsylvania.

**NO SOLDERING PROBLEMS!** You'll get faster, better production—either manual or automatic—with Coldite 70+ than with any other resistors of their type! Hot tin dipping of leads assures real "solderability." What's more, the resistors can be supplied oriented and aligned on reel packs.

RESISTANCE-TEMPERATURE CHARACTERISTICS @ -15°C @ -55°C @ +65°C @ +105°C	Average Percent Resistance Change					
	10 ohms		270,000 ohms		22 megohms	
	COLDITE 70+	MIL-R-11B	COLDITE 70+	MIL-R-11B	COLDITE 70+	MIL-R-11B
<b>VOLTAGE COEFFICIENT per volt</b>	Not applicable		0.0068	0.0200	0.0160	0.0200
<b>LOW-TEMPERATURE STORAGE</b>	0.1	2.0	0.1	2.0	1.0	2.0
<b>LOW-TEMPERATURE OPERATION</b>	0.1	3.0	0.2	3.0	0.5	3.0
<b>TEMPERATURE CYCLING</b>	0.1	4.0	1.1	4.0	0.2	4.0
<b>MOISTURE RESISTANCE</b>	3.7	10.0	7.4	10.0	3.2	10.0
<b>SHORT TIME OVERLOAD</b>	0.2	2.5	0.13	2.5	0.2	2.5
<b>LOAD LIFE at 70°C</b>						
after 50 hours	0.2	6.0	3.0	6.0	0.25	6.0
after 250 hours	0.4	6.0	1.9	6.0	0.9	6.0
after 500 hours	0.5	6.0	1.9	6.0	1.9	6.0
after 1000 hours	0.5	6.0	1.5	6.0	2.3	6.0
<b>LEAD TWIST TEST</b>	0.04	1.0	0.0	1.0	0.1	1.0
<b>EFFECT OF SOLDERING</b>	0.2	3.0	0.6	3.0	0.4	3.0

**DIELECTRIC STRENGTH** All Stackpole Type RC-32 Coldite 70+ Resistors withstand 1000 volts r.m.s. at atmospheric pressure for 5 seconds as well as 625 volts r.m.s. at 3.4 inches of mercury for 5 seconds without damage, arcing or breakdown.

**TERMINAL SECURITY** All Stackpole Coldite 70+ Resistors withstand the standard 5-pound pull test.

**STACKPOLE**  
*Coldite 70+*  
fixed composition resistors

*Setting the standards by which other resistors will be judged.*

FIXED AND VARIABLE COMPOSITION RESISTORS • SNAP AND SLIDE SWITCHES • CERAMAG® FERROMAGNETIC CORES • FIXED COMPOSITION CAPACITORS • IRON CORES • CERAMAGNET® CERAMIC MAGNETS BRUSHES FOR ALL ROTATING ELECTRICAL EQUIPMENT • ELECTRICAL CONTACTS • AND HUNDREDS OF RELATED CARBON, GRAPHITE AND METAL POWDER PRODUCTS



# Ucinite Magnetron Connectors

Ucinite manufactures a variety of special connectors for the heater and heater-cathode terminals of magnetrons. Many of these have been adapted for special applications as to size and function to meet the sealing and mounting requirements of high temperature and high altitude operation and other special conditions.

Connectors are coaxial in construction and can be supplied with built-in capaci-

tors for added protection. Connecting leads of any length can be furnished to customer's specifications.

With an experienced staff of design engineers, plus complete facilities for volume production, Ucinite is capable of supplying practically any need for metal or metal-and-plastics assemblies. Call your nearest Ucinite or United-Carr representative for full information or write directly to us.



**The**  
**UCINITE CO.**  
*Newtonville 60, Mass.*  
Division of United-Carr Fastener Corp.

*Specialists in*  
**ELECTRICAL ASSEMBLIES,  
RADIO AND AUTOMOTIVE**



# PRD

## PACEMAKER LINE

# BROADBAND

## Direct Reading Frequency Meters

### MOST COMPLETE LINE... FOR EVERY PURPOSE, EVERY BUDGET

#### HIGH PRECISION, DIRECT READING METERS (0.015%)



Series 555 to 579 consists of 30 different types covering from 0.925 to 39.0 KMC/S. Representing highest state of the art, these frequency meters fully qualify as transfer or secondary standards for exacting laboratory or production service. Features include: hermetically sealed invar cavity, temperature-compensation, high Q, optimum cavity geometry, high conductivity plating.

#### PRECISION HETERODYNE FREQUENCY METER (0.002%)

Type 504, for 100 to 10,000 MC/S with accuracy of 0.002% at crystal check points every 5 MC/S and 0.03% or better between check points. Automatic interpolation by unique patented spiral-scale dial. Beat indication by both external earphones and built-in CRT. Meter is self-contained and portable.



#### INEXPENSIVE, DIRECT READING METERS (0.08%)

Series 585-A to 590-A affords excellent accuracy at lowest cost from 5.1 to 10.0 KMC/S. Ideally suited for panel mounting.



### COAXIAL FREQUENCY METERS:

#### LINE TERMINATING, HIGH PRECISION METER ( $\pm 0.3$ MC/S)

Type 560, ranges 2.4 to 3.4 and 2.7 to 3.7 KMC/S. Extremely wide range of pulse average power as well as CW can be handled. Hermetically sealed cavity and temperature-compensation permit operation under conditions of adverse humidity or large temperature variations.



#### CALIBRATED, PRECISION METER ( $\pm 0.3$ MC/S)

Type 583-D, for 2.4 to 3.7 KMC/S. Temperature-compensation and hermetical sealing insure optimum performance under all atmospheric conditions.



#### DIRECT READING UHF METER ( $\pm 0.2\%$ )

Type 587-A, covers range 250 to 1000 MC/S. Spiral drum scale 60 inches long enables precision direct reading. May also be used as a tunable narrow band filter.

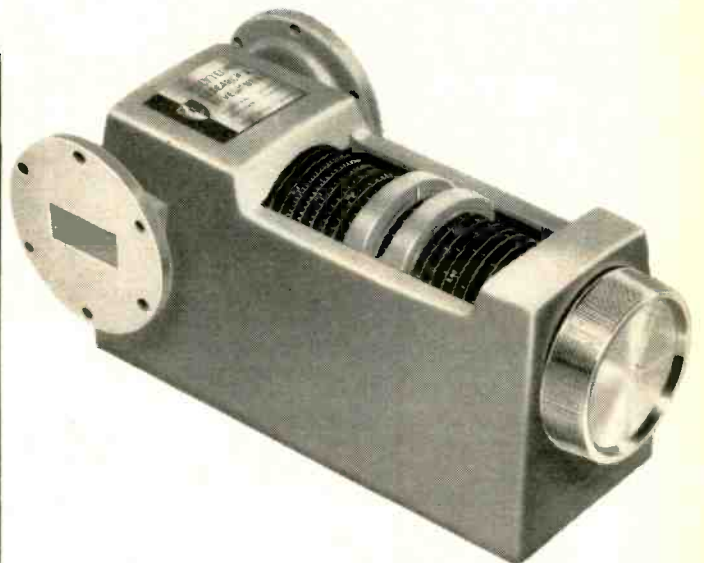

Seven full waveguide bandwidths are each covered by a separate meter in this 532 series of nine reaction-coupled frequency meters, extending over the complete range from 3.95 to 40.0 KMC/S.

These frequency meters consist of a TE<sub>111</sub> mode cavity resonator tuned by a non-contacting plunger. Ruggedness for long trouble-free life is assured by all-metal construction. Maximum readability, resolution and accuracy to  $\pm 0.08\%$  are the result of an optimized design distinguished by a drum type spiral scale more than 8 feet long.

Full details of PRD FREQUENCY METERS and the complete PRD PACEMAKER LINE are contained in this new 160 page PRD Microwave Catalog, largest and most informative ever published. It is available without cost or obligation to those engaged in microwave work. Write for your copy today.



**POLYTECHNIC RESEARCH & DEVELOPMENT CO., INC.**  
202 Tillary Street • Brooklyn 1, N. Y.

# New! Miniaturized!

## Kellogg Type "L" Relay

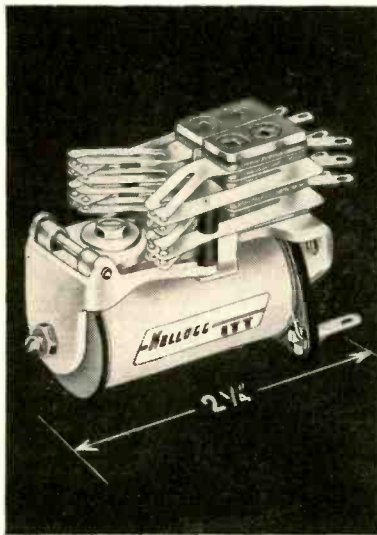

### TYPE "L" RELAY FACTS

CONTACT FORMS	FORM A	FORM B	FORM C	FORM D	REMARKS 13 SPRINGS MAX. PER STACK, ONE FORM D MAX. PER STACK.		
	(MAKE)	(BREAK)	(BREAK-MAKE)	(MAKE BEFORE BREAK)			
CONTACT RATING (NON-INDUCTIVE)	TWIN CONTACTS			SINGLE CONTACTS			RATINGS PERTAIN TO CURRENT CARRYING CAPACITY UNDER NORMAL CONDITIONS. SPECIAL APPLICATIONS USUALLY REQUIRE ENVIRONMENTAL TESTING.
	PALLADIUM .062" x .020" 4 Amps 150 Watts	GOLD .062" x .020" 1 Amp 150 Watts	SILVER .062" x .020" 2 Amps 100 Watts	PALLADIUM .093" x .031" 4 Amps 450 Watts	TUNGSTEN .125" x .050" 3 Amps 450 Watts	SILVER .125" x .050" 4 Amps 450 Watts	
TIMING (IN MILLI-SECONDS)	STANDARD COILS			SLUG COILS			TIMING VALUES ARE SUBJECT TO FURTHER LIMITATIONS DEPENDING UPON CONTACT ARRANGEMENT AND APPLIED VOLTAGE.
	OPERATE RANGE 3-30		RELEASE RANGE 4-20	OPERATE RANGE 20-60		RELEASE RANGE 30-100	
MISC.	COIL RESISTANCE			WEIGHT	RESIDUALS		
	SINGLE WOUND UP TO 20,000 OHMS		DOUBLE WOUND UP TO 6500 OHMS EACH WINDING	APPROX. 2 1/4 OZ.	AVAILABLE WITH SCREW OR FIXED TYPE RESIDUALS		

"Compact, lightweight, extremely versatile, reliable" . . . these are some of the comments of engineers who have tested Kellogg's new type "L" relay. It is a sturdy re-engineered version of the model used for years in telephone offices around the world. Now, its many new features make it particularly adaptable to industrial applications including computer systems, two-way radio and automation devices.

Efficient design gives the Kellogg type "L" more operating force than relays of comparable size. This means greater sensitivity, gram pressure and more springs per pileup. In addition, the new relay features:

- rear mounting, for ease of wiring
- wide variety of coils for any circuit requirements; single or double wound
- bifurcated stationary springs for independent contact action and high reliability; (single contacts also available)
- heavy duty bronze yoke and stainless steel bearing pin insure long life and stable adjustment
- single or double arm type armatures available
- hermetically sealed models, if desired
- operating speed: minimum of 1 to 2 milliseconds

- contact points: gold, silver, palladium, tungsten; other materials available
- residual: adjustable
- time delay: heel-end slugs and armature-end slugs for release time delay and operate time delay, respectively
- terminals: slotted
- weight: Net, 2 1/4 oz.
- dimensions: 2-1/4" L x 1-1/8" W, ranging in height from 17/32" to 1-1/16" (max.)
- operating voltages: up to 220 V.D.C.

Behind the superior reliability and design of Kellogg's type "L" relay are more than 60 years of experience as a leading producer of telephone equipment. And as the communications division of International Telephone and Telegraph Corporation, Kellogg has the research talent of 3500 engineers and technicians at its disposal.

Inquiries are invited. Send for a free catalog on relays and other components manufactured by Kellogg.

Kellogg Switchboard and Supply Company, 6650 South Cicero Avenue, Chicago 38, Illinois. Division of International Telephone and Telegraph Corporation.



Manufacturers of: Relays • Hermetically sealed relays • Switches • Solenoids



another  
**RADIO RECEPTOR**  
 semiconductor  
 achievement

# 3\* AMP / IN<sup>2</sup>

with the revolutionary new

## **Tri-AMP** **SELENIUM RECTIFIER**

**300% higher current density**

- life expectancy of 100,000 hours.
- 26 volt cells — lower forward voltage drop.
- no parallel devices for voltage division.
- no series devices for load sharing.

<b>THE DIFFERENCE AT A GLANCE!</b>			
<b>New Tri-AMP</b> 3-phase Bridge		<b>Standard Type</b> 3-phase Bridge	
Dimensions	Amp.	Dimensions	Amp.
4" x 4" *Fan Cooled	54	4" x 4" Fan Cooled	16.8
4" x 4" Convection Cooled	18	4" x 4" Convection Cooled	6.7

*Now you'll understand why conventional selenium rectifiers are now obsolete!*

Not just a variation of standard selenium rectifiers — TRI-AMP is a *new* selenium semiconductor with far greater reliability, operating at *three times* the current density of standard stacks. It has the overvoltage and overcurrent advantages of selenium, which means there is no need for the expensive and elaborate protective

devices so necessary when using other semiconductors.

Our Radio Receptor plant, working with unique equipment developed by Siemens of West Germany, is now producing TRI-AMP selenium semiconductors for immediate delivery. Please request full information from Section E-10R.

General Instrument Corporation  
 also includes Automatic Manufacturing  
 Division, F. W. Sickles Division,  
 Micamold Electronics Manufacturing  
 Corporation (subsidiary)



semiconductor division  
**RADIO RECEPTOR COMPANY, INC.**  
*Subsidiary of General Instrument Corporation*  
 240 Wythe Avenue, Brooklyn 11, N. Y.

GENERAL INSTRUMENT DISTRIBUTORS: Baltimore: D & H Distributing Co. • Chicago: Merquip Co. • Cleveland: Pioneer Electronic Supply • Los Angeles: Valley Electronics Supply Co., Burbank • Milwaukee: Radio Parts Co., Inc. • New York City: Hudson Radio & Television Corp., Sun Radio & Electronic Co. Philadelphia: Herbach & Rademan, Inc. • San Francisco: Pacific Wholesale Co. • Seattle: Seattle Radio Supply • Tulsa: Oil Capital Electronics

# for highest accuracy . . .



## PRECISION RESOLVERS

by **Reeves**  
INSTRUMENT CORPORATION

the **MOST ACCURATE** production models available

Reeve's complete line of precision resolvers has long led the field in reliability and accuracy. Functional accuracy of 0.05% in the Size 23 and 0.1% in the Size 15 and Size 11 is achieved in standard production without culling. Even higher accuracies can be obtained on special order.

Both compensated and uncompensated units can be supplied in any frame size. Special units are also available for use as phase shifters or for high frequency use. For the best in resolvers, bring your requirements to Reeves!

Write for resolver catalog RICO 57.

### REEVES CONTINUOUS RESOLVER CHECKER

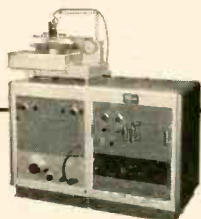

Provides continuous 360° check on resolver functional accuracy, and yields permanent record of results.



7RV57R

## REEVES INSTRUMENT CORPORATION

A SUBSIDIARY OF DYNAMICS CORP. OF AMERICA, ROOSEVELT FIELD, GARDEN CITY, NEW YORK



# PERFECT SURFACE... EXTREME HARDNESS... LOW COST

—all this and more, with LINDE Sapphire!

To assure dependability under the most severe conditions, tiny valve poppets and seats of pilot relief valves for space vehicle tanks built by Whittaker Controls are made from LINDE Sapphire. LINDE Sapphire was selected over other materials for this critical use because of its perfectly smooth surface, extreme hardness, and relatively low cost. Other advantages are resistance to corrosion and fast deliveries from LINDE.

Among other properties of LINDE Sapphire are zero porosity, great strength at elevated temperatures, and a high melting point of 2040° C. LINDE Sapphire is transparent, may be clear or red. It is easily sealed to metals or ceramics and has excellent IR transmission characteristics.

LINDE Sapphire is supplied in the form of balls, rods, tubes, domes, and special shapes to order. For more information, write Crystals Department, LINDE COMPANY, Division of Union Carbide Corporation, 30 East 42nd Street, New York 17, N. Y. In Canada: Linde Company, Division of Union Carbide Canada Limited.

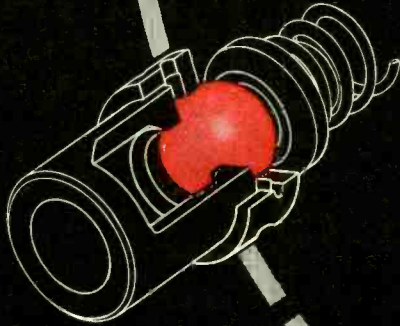

Pilot section of this pressure relief valve has poppet ball (red) and seat of LINDE Sapphire. Valve was designed and manufactured by Whittaker Controls Division of Telecomputing Corporation.

"Linde" and "Union Carbide" are registered trade-marks of Union Carbide Corporation.

*Linde*  
TRADE-MARK





Still More News from VEEDER-ROOT

# NEW *Quick-Reset, High Speed* Geared **REVOLUTION COUNTER**



Here's a new geared revolution counter designed for general purpose work where high speed and quick reset geared revolution counters are required. It will accept speeds up to 6000 rpm or 8000 cpm.

One flick of the lever (through 60° arc) will reset the counter to all zeros. A new modern case design and extra big numbers (.227 in. high) provide excellent visibility at extremely wide angles. The counter is ideal for in-line reading.

Where dependability is desired together with the added feature of positive subtraction, the new Model 1523 revolution counter offers exceptional possibilities. Write now for prices and specifications.

Length — 5"  
Width — 2 5/8"  
Height — 2 1/16"

*Everyone  
Can Count On*

## Veeder-Root



**INCORPORATED**  
Hartford 2, Connecticut

Hartford, Conn. • Greenville, S. C. • Altoona, Pa.  
Chicago • New York • Los Angeles  
San Francisco • Montreal

Offices and Agents in Principal Cities



Rx Prescribed for  
your system!

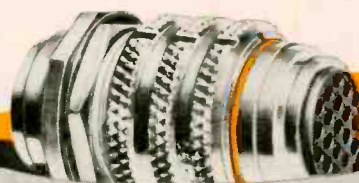

**NEW! NEW! NEW!**

*Deutsch Miniature  
Connectors with  
"Snap-In" Contacts*

**300° F**

**NO SOLDERING**

**ENVIRONMENTAL**

**SILICONE INSERTS**

**QUICK DISCONNECT**

Available in a wide range of shell-sizes with either pin or socket arrangements — all of them interchangeable with existing Deutsch DM5000 and DM9000 series miniature connectors. "DS" series plugs have the exclusive Deutsch designed and developed ball-lock coupling-ring . . . just push-in to connect; pull-back to disconnect.

For complete information, see your Deutsch representative or write for data file 10B.

**The Deutsch Company**

7000 Avalon Blvd., Los Angeles 3, Calif.



©1958 THE DEUTSCH COMPANY

# First from PHILCO

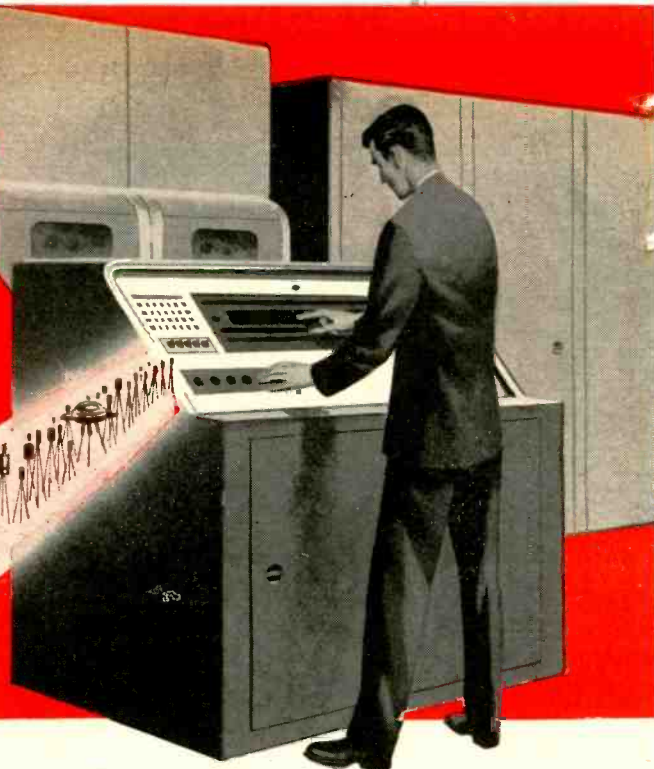

## A Complete Line of COMPUTER TRANSISTORS

Only Philco offers a complete line of specially designed computer transistors. Here are the best transistors for all phases of logic circuitry, read-in and read-out equipment, core-drivers, storage and switching devices.

Philco transistors are being used by all leading computer manufacturers, especially where millimicrosecond speeds are needed. A leading University has proven Philco transistor reliability in actual computer circuits

over tens of millions of transistor service hours.

All Philco transistors are hermetically sealed to insure maximum service life. Available in production quantities from the factory. Also available "off the shelf" in quantities 1 to 99 from your local Philco transistor distributor. When you think of TRANSISTORS . . . think of PHILCO FIRST.

### MEDIUM FREQUENCY, MEDIUM POWER ALLOY JUNCTION TRANSISTORS (250 mw) (in TO-9 package)

- 2N597 . . . . . for use in 200-300 kc computers,  $f_{\alpha_b}$  over 3 mc
- 2N598 . . . . . for use in 300-400 kc computers,  $f_{\alpha_b}$  over 5 mc
- 2N599 . . . . . for use in switching circuits faster than 400 kc,  $f_{\alpha_b}$  over 12 mc

### MICRO-MINIATURE TRANSISTOR

- 2N536 . . . . . high gain switching transistor, 20v maximum  $V_{CB}$ , DC beta typically 150

### HIGH FREQUENCY, HIGH GAIN (MICRO ALLOY) TRANSISTOR (MAT)

- 2N393 . . . . . combines high frequency response with high gain for general purpose, high frequency applications and switching circuits, typical  $f_{max}$  60 mc

### HIGH FREQUENCY SILICON TRANSISTOR (SAT)

- 2N496 . . . . . high speed silicon switch for speeds up to 5 mc characterized by extremely low saturation resistance.

### HIGH FREQUENCY SURFACE BARRIER TRANSISTOR (SBT)

- 2N240 . . . . . switching transistor, typical  $f = 60$  mc

### MICRO ALLOY DIFFUSED-BASE TRANSISTOR (MADT)

- 2N501 . . . . . extremely high speed switch; typical rise time 12  $\mu$  sec, fall time 4  $\mu$  sec

### BILATERAL ALLOY JUNCTION TRANSISTOR

- 2N462 . . . . . high gain ( $h_{FE} = 45$  in both directions), high voltage (40v) unit for applications where current reversal is desired

### POWER TRANSISTORS

- 2N353 . . . . . 40 volt, 30 watt power transistor
- 2N386 . . . . . 60 volt, 37.5 watt power transistor
- 2N387 . . . . . 80 volt, 37.5 watt power transistor
- 2N589 . . . . . 100 volt, 37.5 watt power transistor

### PHILCO'S NEWEST FAMILY OF MEDIUM- AND HIGH-POWER SWITCHING TRANSISTORS

- 2N670 . . . . . 300 mw, 2 amp pulse amplifier, in TO-9 type package
- 2N671 . . . . . 40 volt, 1 watt pulse amplifier in case with mounting stud and JETEC E3-51 base
- 2N672 . . . . . 40 volt, 0.75 microsecond high frequency switching transistor
- 2N673 . . . . . 40 volt, 1 watt, stud mounted switching transistor
- 2N600 . . . . . stud mounted 3/4 watt high speed power switch ( $f_{\alpha_c}$  and 5 MC)
- 2N601 . . . . . stud mounted 3/4 watt high speed power switch ( $f_{\alpha_c}$  and 12 MC)

Make Philco Your Prime Source For All Transistor Information And Prices. Write Dept. E-1058

# PHILCO CORPORATION

## LANSDALE TUBE COMPANY DIVISION

### LANSDALE, PENNSYLVANIA





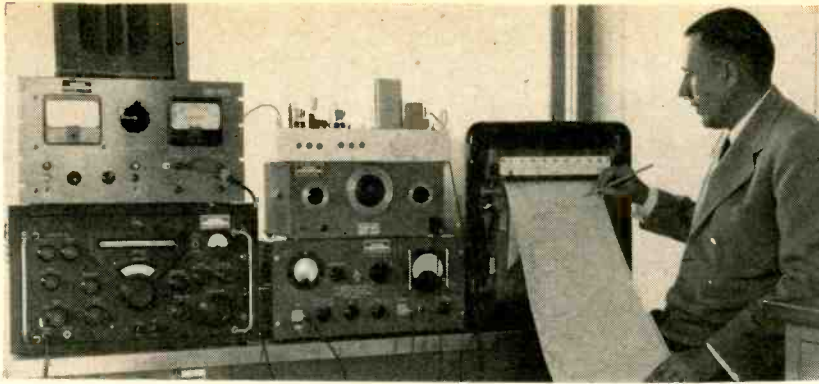

Satellite transit log being scanned shortly after Explorer I passage. Analysis of data yields information on orbital period and its rate of decrease

# Keeping Track of Earth Satellites

Interferometer system consists of a dual-terminal array of 22 dipoles proximity coupled to a 2-wire line. Antenna works into a receiver which converts 108-mc satellite transmissions to a 1-kc signal. Recorder logs transit time within 1 second as satellite crosses antenna beam null

By C. J. SLETTEN, G. R. FORBES, Jr., and L. F. SHODIN,

Headquarters, Air Force Cambridge Research Center, Laurence G. Hanscom Field, Bedford, Mass.

**A** RADIO DIRECTION-FINDING antenna system using a 108-mc dual-terminal linear array obtains accurate single coordinate position data at one instant in each orbital cycle of an earth satellite. In conjunction with the antenna system, a specially designed receiver allows the antenna to be calibrated using the sun and radio stars as sources. Time-integrating circuits in the receiver make possible the detection of low levels of satellite signals. Meridian transit times to accuracies of about one second have been obtained from Explorer I and II and Vanguard with this system.

To make a dual-terminal linear-array system practical for cheap installation, a method for simple but accurate control of radiation is essential. This is achieved by using electric dipoles proximity coupled to a two-wire feeding transmission line. A matching balun connects the

two-array terminals to coaxial lines.

In operation, the antenna array is located in the plane of the earth and oriented along a true east-west line. When the energy received at the two terminals of the antenna is combined in a hybrid network, a

pattern with a broadside fan beam is obtained at one hybrid network output and simultaneously a pattern with a deep broadside null is obtained at the other.

The time at which the satellite transmits the null in the broadside null

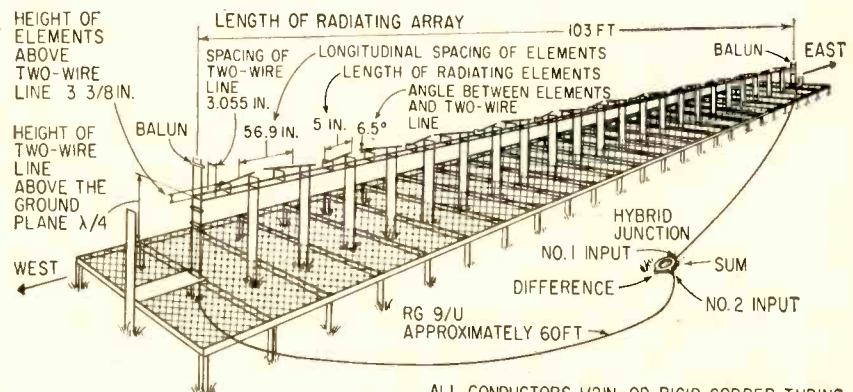

ALL CONDUCTORS 1/2 IN. OD RIGID COPPER TUBING

FIG. 1—Sketch of complete antenna assembly. Dimensions given are for a 22-dipole array at 108 mc. This configuration gives an antenna gain of 20 db over an isotropic radiator and a beamwidth of 5 deg calculated from the single terminal pattern

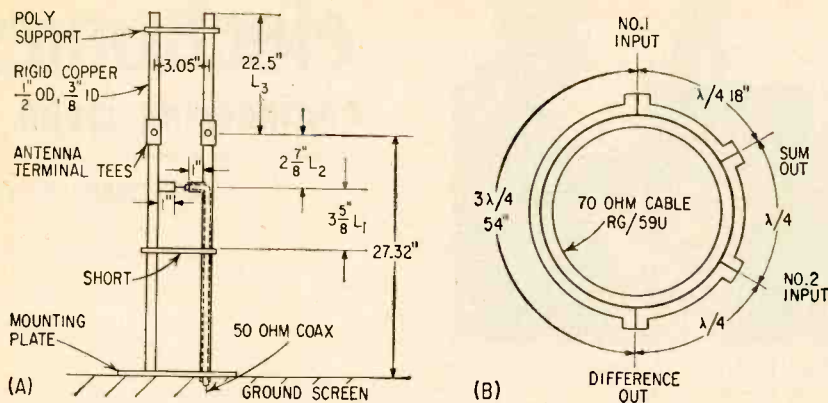

FIG. 2—Construction details of (A) matching balun and (B) coaxial hybrid junction

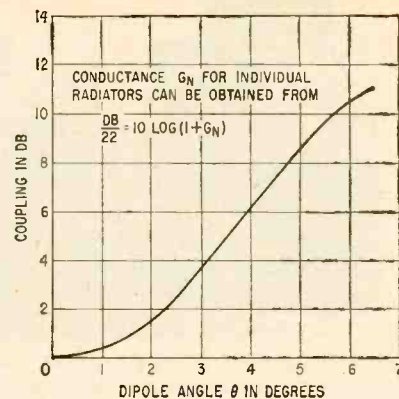

FIG. 3—Total array coupling

pattern gives an accurate single-coordinate fix. The broadside fan beam acts as a monitor during the detection time interval.

### Balun Design

The balun, shown in Fig. 2, is designed for coupling coaxial cable to the two-wire line of the antenna. Unlike bazooka type baluns, the balance is independent of the matching parameters. The load of about 300 ohms is placed at a calculated point above the 50-ohm coaxial input and matching is achieved by adjusting the position of the shorting bar and open stub lengths. Two shorting bars keep all the energy off the coaxial line.

Line lengths  $L_1$ ,  $L_2$ , and  $L_3$  on the balun are readily found on a Smith chart and final adjustments made empirically. Actual dimensions for the balun and hybrid are shown for matching to one end of the 22-element 108-mc array when the other end is terminated in a matched load.

The incremental conductance of each element of the array and total array coupling are obtained from Fig. 3. The data were obtained by measuring the power drop through

the array under single terminal transmitting conditions as the angle of the elements relative to the two-wire line was varied. The resonant length of the radiators was found in earlier experiments to vary little for the light couplings involved in such arrays. When all 22 of the radiating elements are set at 6.5 deg relative to the two-wire line a total of 90 percent of the applied power is coupled out. Heavier coupling can be obtained by reducing height of elements above the two-wire line. Coupling data for rotation less than 6.5 deg (Table I) are useful for building longer arrays.

### Receiver System

The receiver system works on signals obtained by switching between the sum and difference terminals of the hybrid or between one of the outputs and a reference matched load. Switching is done at the rate of 100 cps by a mechanical chopper. This mode of operation makes it possible to detect signals below the ambient noise level of the receiver.

After amplification by a 108-mc converter and receiver, the output

from the receiver phone jack is fed to a two-stage 100-cps filter  $V_1$  and  $V_2$ , as shown in the schematic of Fig. 4. Before the signal reaches the filter, most of the high-frequency noise is removed by the R-C low-pass network consisting of resistor  $R_1$  and capacitor  $C_1$ . Stage  $V_{1A}$  is a conventional amplifier whose output is fed through a parallel-T network tuned to 100 cps by variable resistors  $R_2$ ,  $R_3$  and  $R_4$ . Stage  $V_{1B}$  attenuates all frequencies except 100 cps and  $V_2$  repeats the same process; however, gain control  $R_5$  is inserted between  $V_1$  and  $V_2$  so that the receiver can be operated at a normal level without saturation. Tube  $V_3$  is a cathode follower isolating the high impedance circuits of  $V_2$ .

Diode detector  $D_1$  converts the 100-cps signal to d-c which is then integrated by resistor  $R_6$  and paper capacitor  $C_2$ , selected for low leakage. This integrating network serves to smooth out interference and sudden transients.

Conversion of the d-c signal appearing across  $C_2$  is accomplished by a balanced modulator consisting of stages  $V_4$  and  $V_5$ . A 1-kc signal is taken from an audio oscillator and fed to the grid of  $V_4$ . This tube serves as a phase inverter and by adjusting the balance control  $R_7$ , two signals of equal amplitude but 180 deg out of phase appear on the plate and cathode of  $V_4$ . These signals are coupled to the grids of  $V_{4A}$  and  $V_{4B}$  and also appear across the two 1,000-ohm cathode resistors  $R_8$  and  $R_9$ . If no voltage is present across capacitor  $C_2$ ,  $V_{4A}$  and  $V_{4B}$  act as grounded-grid amplifiers. Since their plates are in parallel, the out-of-phase 1-kc signals cancel. How-

Table I—System VSWR and Power Loss at 108 Mc

Dipole Angle, Degrees	Input VSWR With Matched Load at One End	VSWR Looking Into Hybrid Ring Sum Arm	Total Radiated Power, Db
2	1.26	3.67	1.50
3	1.61	2.61	3.95
4	1.41	2.14	6.00
5	1.06	1.73	8.60
6	1.11	1.52	10.5
6.5	1.14	1.53	11.0

Cable loss is 2.3 db; loss in baluns and two wire line is 1.5 db



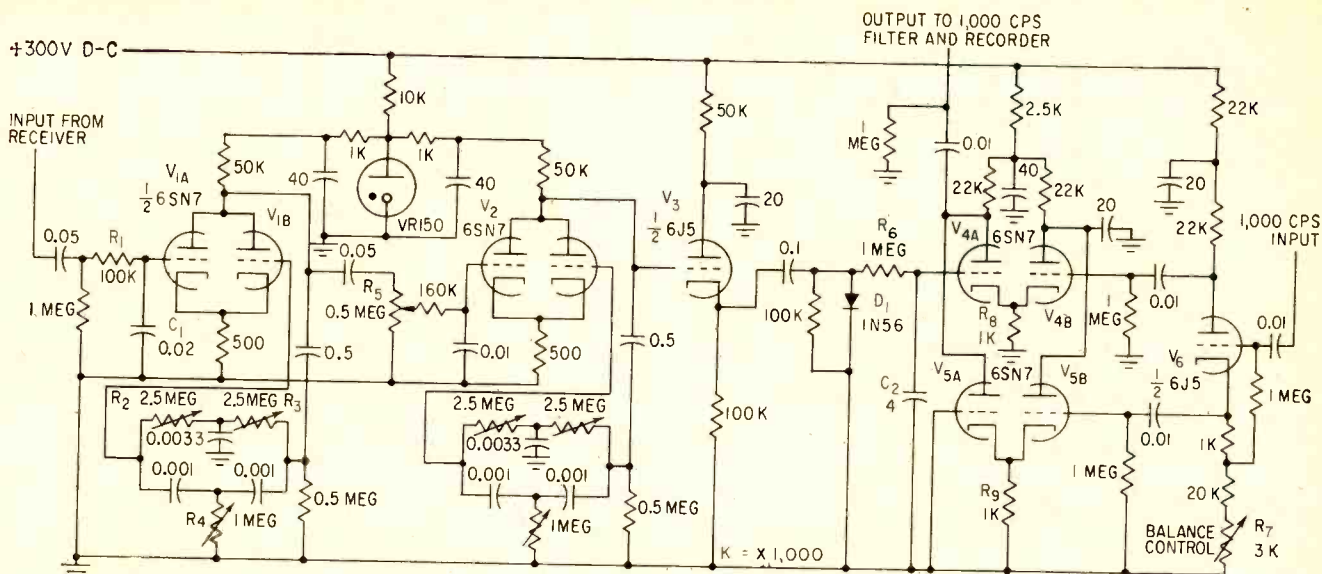

FIG. 4—Schematic diagram of auxiliary circuits. Input from receiver is a 108-mc signal chopped at a 100-cps rate. Use of filters and balanced modulator reduces noise and enables detection of low-level satellite transmissions

ever, harmonics are always present and a 1-kc filter must be used between the output terminal and the recorder for effective action of the balanced modulator. A bolometer-amplifier is employed as the 1-kc filter.

If a d-c component appears across  $C_2$ , the balance is upset and a 1-kc signal related in amplitude to the magnitude of the received signal appears at the recorder output terminal.

### Calibration

For satellite tracking the location of the null plane must be known

accurately. The sun, moon, and radio stars were all tried as calibrating sources. None of these sources proved to be wholly satisfactory. Sun signals fluctuate rapidly at 108 mc and average output varies widely from day to day making precise measurements difficult. Also, the sun is over 0.5-deg wide which is a poor approximation of a point source.

Most of the results reported here were achieved with the sun and satellites as sources because the weak output of radio stars was obscured by man-made noise in the Bedford, Massachusetts area.

After Explorer I was launched on January 31, 1958, strong signals were detected on the interferometer from the satellite's 108.035-mc and 107.995-mc transmitters. Three or four transits of our meridian (71 deg 16 min) were recorded each day.

Figure 5A shows a transit passage recorded using the difference (null) pattern. By watching the motion of the pen it is possible to estimate null crossing within one second of time. Unfortunately, the chart speed on the recorder was then too slow to show much detail about the Explorer's rapid signal variations with time. By analysis of these data, Smithsonian Astrophysical Laboratories were able to calculate the period of the orbit and estimate its rate of decrease.

When received on the sum minus difference connection, satellite signals produce a sharp signal as shown in Fig. 5B. Note that the signal from the satellite arises from a point source. There is a regular fading of the signal about every 10 seconds which is not exactly periodic but apparently always present. In addition to the regular 10 second fading more rapid variations are noticed when the signal is recorded without the 6-sec integrating time constant. These variations are deep fades occurring at 1-3 sec intervals. Slow variations in signal strength cause the two main lobes to be slightly unequal.

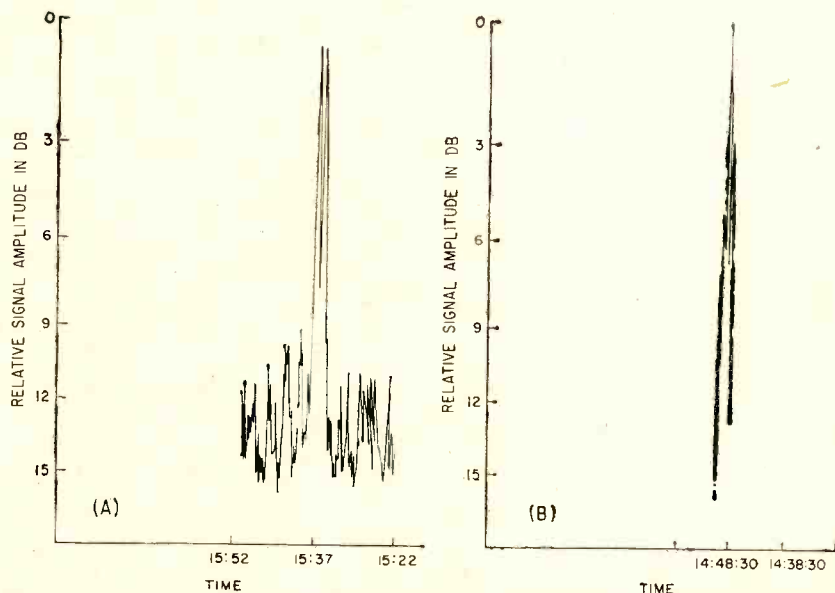

FIG. 5—Explorer I transit passage (A) recorded using difference output of hybrid junction. Sum minus difference connection (B) shows transit recorded as sharp pulse

# Telemeter System Relays

Test data during development and evaluation of underwater weapons such as mines, are transmitted to shore by a telemetering system capable of monitoring the performance of four weapons simultaneously. Transistorized transmitters, operating on separately assigned frequencies, convert the data to acoustic signals which are relayed to a shore-based receiver by cable after detection by a hydrophone in the underwater test area

By M. J. AUCREMANNE and D. D. WOOLSTON,

Underwater Evaluation Department, U. S. Naval Ordnance Laboratory, White Oak, Silver Spring, Md.

**N**AVAL UNDERWATER ordnance must be monitored during the development stage by methods that provide reliable test information. This article describes a transistorized underwater telemetering system, referred to as uts, that is capable of monitoring four underwater weapons simultaneously. Each weapon contains a transistorized transmitter with a separately assigned frequency band.

Data are converted by the transmitter from electrical to acoustical signals and projected into the water. The underwater signals are received by a hydrophone located in the test area and fed to the shore station by an underwater cable. At

the receiver on shore, the signal is demodulated and recorded on a graphic recorder. These data are analyzed and the results are used in the development and evaluation of underwater ordnance.

## Operation

The operation of the uts can be explained by referring to Fig. 1. Under field test conditions, underwater weapons such as mines are dropped from aircraft or planted by boats at the field test station. Usually the receiving hydrophone is placed in the area before the mines are planted, but the reverse procedure is possible. Normally, the four mines are located at distances

of 200 to 600 ft from the receiving hydrophone.

As the target vessel approaches the mines, the mine firing mechanism senses the vessel and the telemetering transmitter is turned on. Subsequent mine information modulates the transmitter and is transmitted through the water as an f-m acoustical signal. This signal is detected by the receiving hydrophone and relayed by cable to the receiver on shore and recorded. When the mine no longer senses the vessel, the transmitter is turned off. This conserves the transmitter power supply by requiring maximum power only during transmission periods. A block diagram

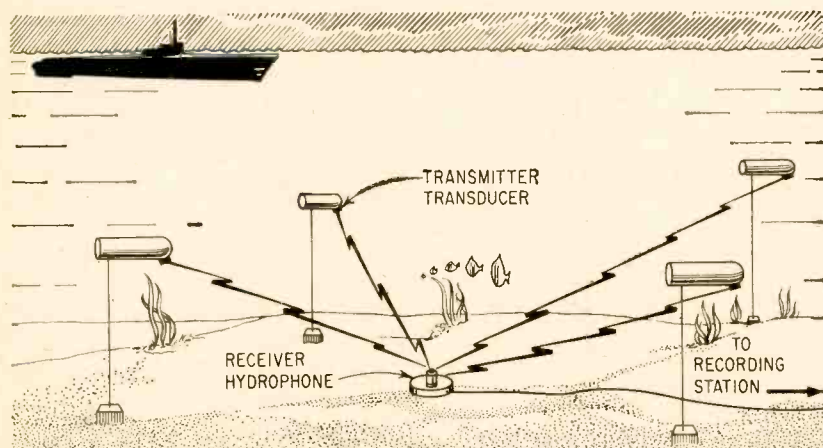
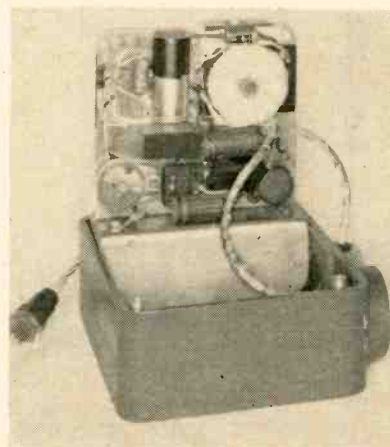

FIG. 1—Pictorial diagram illustrates how underwater telemetering system is set up to monitor performance of mines. The transmitters are activated by the mine firing mechanism, which senses the approach of the vessel at left



Interior of transmitter mounted in ordnance component. Unit withstands water-entry shock if dopped by aircraft



# Undersea Ordnance Data

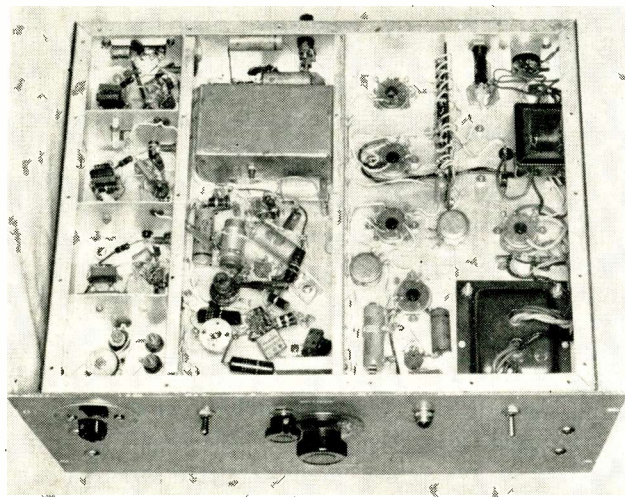

Bottom of this receiver shows wiring layout. Note shielding techniques used in the amplifier and local oscillator sections

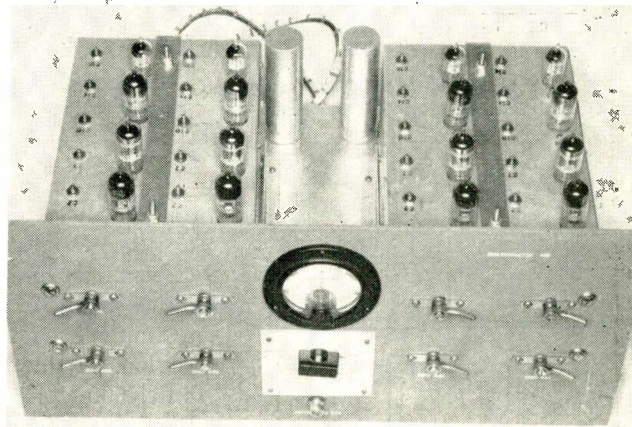

Four-channel discriminator is a compact, rack-mounted unit. It drives the direct-writing recorder which completes the system

of the telemetering system appears in Fig. 2.

Since mine operational data must be correlated in time with the position of the target vessel, the telemetering system is used in conjunction with field station tracking equipment. Thus mines are evaluated under operational conditions.

## Transducers

The transducers are barium titanate types with the active element having a hemispherical shape. The operating region for the transducers is 50 to 65 kc with average sensitivities of  $15 \mu\text{V}/\mu\text{bar}$ . Transducers having a bandwidth of approximately 20 kc are used as receiving hydrophones, while those used as projectors are selected on the basis of sensitivity for a particular frequency band.

The Q of the transducers is low, usually 2 to 4. A typical circle diagram of the transducer admittance is shown in Fig. 3. Since the telemetering transmitter must work efficiently, such a diagram is used in choosing the best operating region of each transducer. The frequency shift of the transmitter is small compared to the carrier frequency, consequently the region of

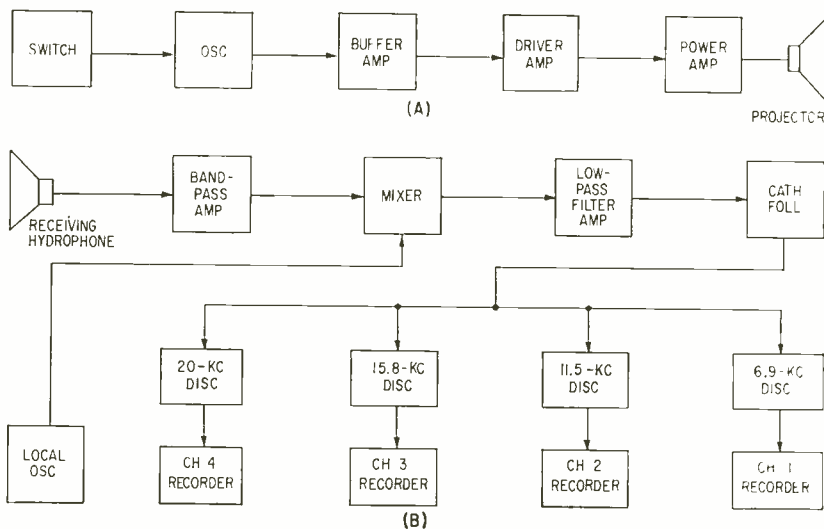

FIG. 2—Block diagram of complete underwater telemetering system. A major advantage of this system is its ability to provide ordnance data under operating conditions.

the circle diagram showing the least change in the resistive component is selected.

The impedance of the transducer appears as a series RLC circuit in parallel with the clamped capacitance. An equivalent circuit for the transducer is shown in Fig. 4A, where  $C_o$  is the clamped capacitance,  $C_m$  represents the motional capacitance,  $L_m$  represents the motional inductance and quantity  $R_m$  rep-

resents the motional resistance.

When the motional impedance branch is in series resonance, that is, when

$$\omega L_m - \frac{1}{\omega C_m} = 0 \text{ or if } \omega = \omega_m = \frac{1}{\sqrt{C_m L_m}}$$

the total admittance

$$Y_T = \frac{1}{R_m} + j\omega C_o$$

To make the transducer appear as a resistive load, an inductance  $L_a$  is

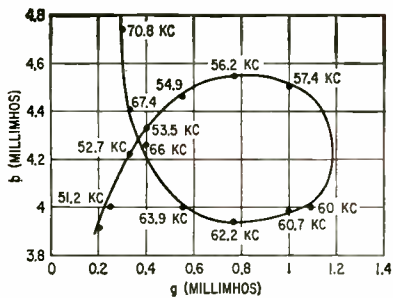

FIG. 3—Total admittance diagram for a typical barium titanate transducer

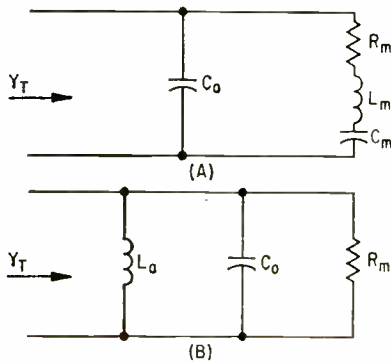

FIG. 4—Equivalent circuit diagrams of the transducer. Uncompensated case is shown in (A). In (B),  $L_a$  is added to tune out the clamped capacitance  $C_0$

added in parallel across the transducer as shown in Fig. 4B. If

$$\omega C_0 - \frac{1}{\omega L_a} = 0$$

and the Q of the coil is high, then

$$Y_T = \frac{1}{R_m} \text{ or } Z_T = R_m$$

when 
$$\omega_m = \frac{1}{\sqrt{C_m L_m}}$$

This condition is possible only at one frequency. Since the frequencies representing ordnance information are less than 600 cps apart, the impedance seen by the transmitter power amplifier remains nearly constant.

The directivity patterns of the transducer, as shown in Fig. 5, are made to determine compatibility between the transducers and the hydrophone, to provide complete underwater acoustic coverage.

### Transmitter

The transistorized transmitter weighs 3 lbs and is housed in a container 2-1/16 in. by 6 in. by 4-7/16 in. The transmitter consists of an oscillator, buffer stage, driver stage

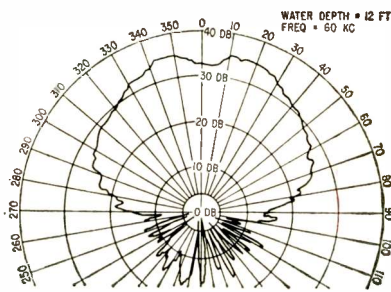

FIG. 5—Directivity pattern for a typical hemispherical transducer

and a power amplifier that drives the barium titanate projector. The transmitter in each of the four mines being monitored is assigned a bandwidth of 1 kc in the 60-kc region. Of this 1-kc band, generally only 500 to 600 cps is used to monitor mine operation. The remaining portion of each band allows for temperature drift and power-supply effects. A schematic diagram of the transmitter is shown in Fig. 6.

The oscillator  $Q_1$  is a temperature-compensated Clapp circuit. Additional temperature compensation may be obtained using a thermistor in the base circuit. The underwater ordnance mechanism modulates the transmitter by varying the current through saturable reactor  $T_1$  in the tank circuit of the oscillator.

The buffer stage  $Q_2$  is used for isolation and impedance matching between the oscillator and driver stages. This stage has a voltage gain of 0.95. Driver stage  $Q_3$  is a grounded-emitter circuit. It has a voltage gain of 26 db when its out-

put transformer circuit is tuned.

The power amplifier  $Q_4$  is operated class C with an efficiency of approximately 70 percent. The 470-ohm resistor  $R_1$  shunted by 0.15- $\mu$ f capacitor  $C_1$  provides the bias for this stage.

A powdered molybdenum permalloy toroidal core is used in the output transformer  $T_2$  in the emitter circuit. The secondary of this transformer is tuned by capacitor  $C_2$ . The power amplifier has a gain of 25 db, using a 24-v d-c supply, and an output power of 1.2 w.

The impedance of the projector appears as approximately a 1,000-ohm resistive load with the clamped capacitance tuned out.

### Switching Circuit

An npn silicon transistor  $Q_5$  has its base and emitter in series with the underwater ordnance. When the ordnance is in a quiescent state, the transmitter is cut off and is turned on when the ordnance becomes active. The transmitter then transmits a specific frequency indicative of the type of response of the ordnance. The quiescent transmitter power dissipation is less than 25 mw as compared to 1.2 w when a signal is being transmitted. Capacitor  $C_3$  in parallel with the base-to-emitter circuit protects the switching transistor from the initial surge current.

### Receiving System

The receiving hydrophone was selected from among the available transducers on the basis of bandwidth. It has a bandwidth of approximately 20 kc to accept in-

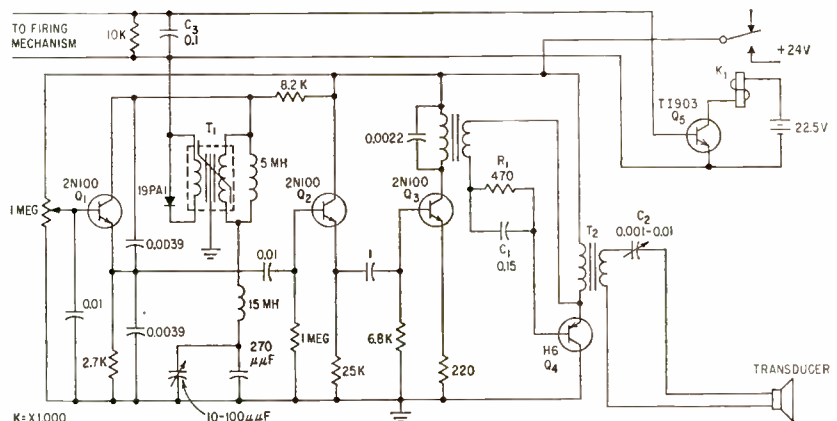

FIG. 6—Schematic diagram of the transistorized transmitter. When the mine senses the approach of a target, relay  $K_1$  is activated, turning on the transmitter





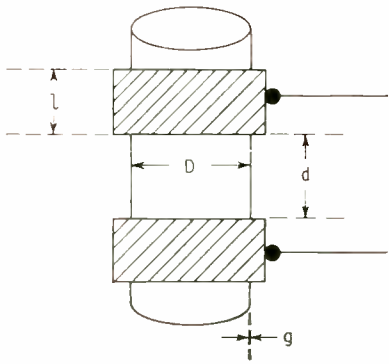

FIG. 1—Cell-tube capacitor. Sizes of various dimensions are: *D*, adjustable between 15 and 17 mm; *d*, adjustable between 5 and 36 mm; *l*, 20 mm and *g*, 0.4 to 0.5 mm

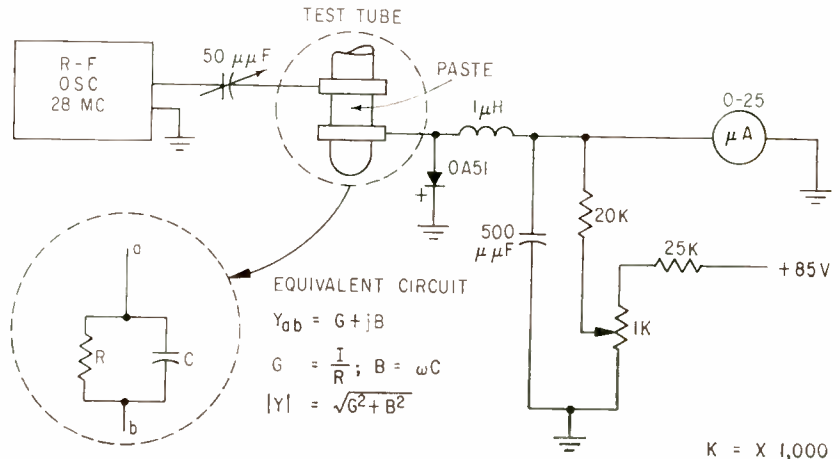

FIG. 2—Block diagram of setup for determining setting time of cement. Equivalent circuit of cell-tube capacitor is shown in dashed circle

Sample of cement is inserted as dielectric material in a test-tube capacitor and admittance readings made every 15 minutes. Maximum admittance signifies end of setting process. Comparison with mechanical test procedure proves that admittance technique is just as accurate and less complex

# Electronics Determines

By J. M. TOBIO, Lab. de Ensayos Fisicos,

Instituto Tecnico de la Construcción y del Cemento, Costillares, Madrid, Spain

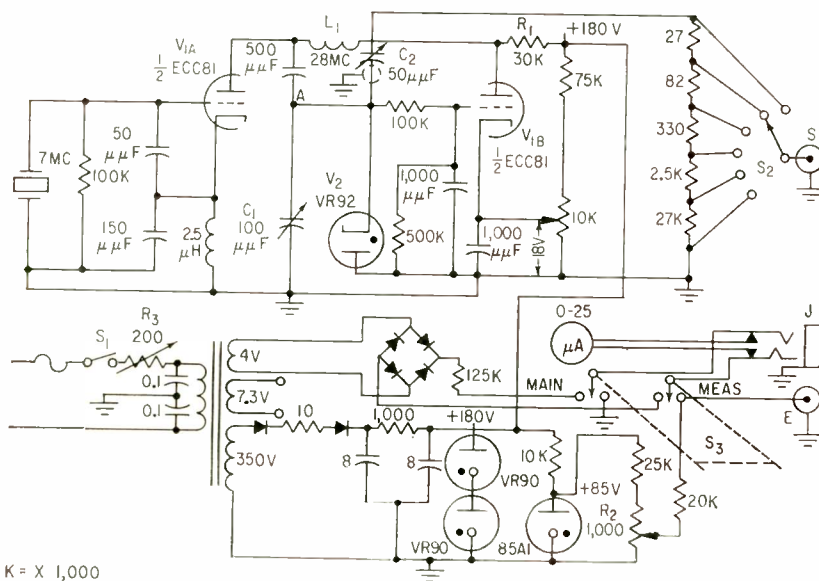

FIG. 3—Schematic diagram of the oscillator portion of the equipment

**A**PLICATION of dielectric techniques to the problem of determining the setting time of cement is not a new concept.<sup>1, 2, 3</sup> The system to be described, although basically similar in approach to the measurement is much less complex.

In its simplest version, the measurement consists of determining the variations in admittance of a cement paste during the process of setting. Once the paste is mixed, it is placed in a cylindrical capacitor where it functions as the dielectric material. The capacitor consists of two coaxial copper rings encircling a test tube as shown in Fig. 1.

Measurement fundamentals are indicated in the block diagram of Fig. 2. A stabilized 28-mc oscillator



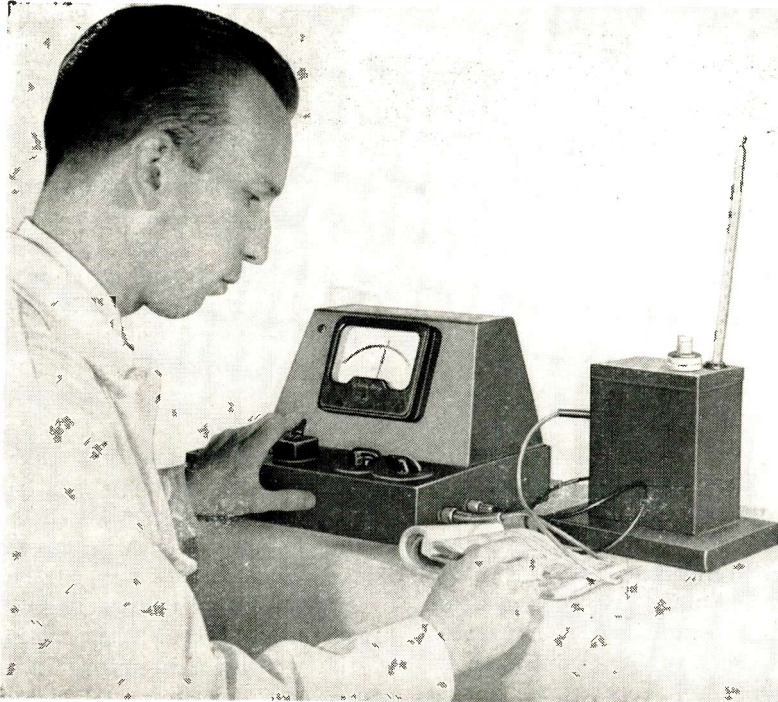

Simplicity of the test equipment is shown in this in-use illustration

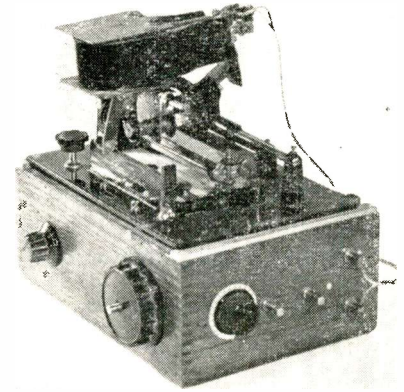

Mechanical comparison test requires use of this apparatus

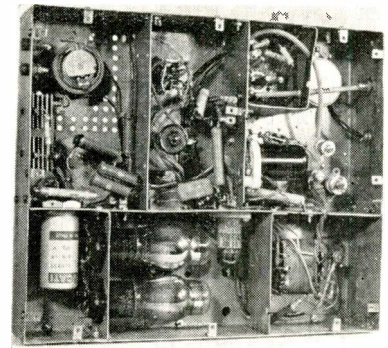

Internal construction of r-f oscillator portion of equipment

# Cement Setting Time

supplies a signal to the top plate of the capacitor cell. Resulting current, rectified by a germanium diode, is measured with a microammeter. Meter readings are proportional to the absolute value of the admittance obtained from the equivalent circuit also shown in Fig. 2.

## Oscillator

Circuit of the oscillator is shown in Fig. 3. It is a harmonic oscillator modified from a constant-amplitude oscillator developed at the National Bureau of Standards.<sup>4</sup> In Fig. 3,  $V_{1A}$  functions as a crystal oscillator at 7 mc. The anode circuit containing  $L_1$  and  $C_1$  is tuned to 28 mc.

The r-f potential existing at point A, Fig. 3, is fed through an adjustable capacitor  $C_2$  to an output attenuator. This same potential is rectified by  $V_2$  and applied to the

control grid of  $V_{1B}$ , which operates as a regulator.

Initial negative bias on the cath-

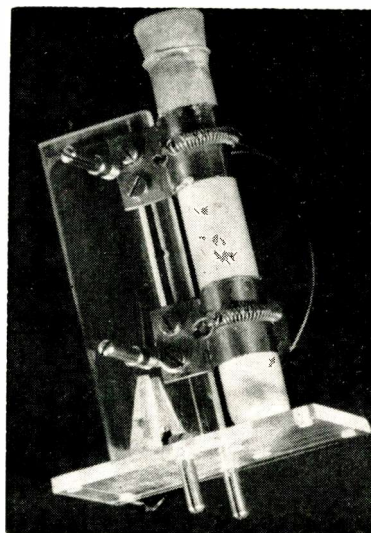

Test capacitor has this configuration

ode of  $V_{1B}$  is about 18 v. This amplitude is sufficient to hold the tube cut off. When the rectified output of  $V_2$  is applied as positive voltage to the control grid of  $V_{1B}$ , it causes conduction. When, for any reason, the potential at point A drops,  $V_2$  rectifies less and the control-grid voltage of  $V_{1B}$  becomes less positive. As a result, the triode draws less current; the drop in voltage across  $R_1$  is less; the plate of  $V_{1A}$  becomes more positive and oscillation increases in amplitude.

## Final Stabilization

When r-f potential at point A increases, the process is reversed. After a few trials and adjustments, the potential at point A can be made independent of both supply fluctuations and load across the attenuator.

The microammeter shown in Fig.

3 has a double purpose. It serves both as a main voltage control and also provides a reading of admittance values. Jack *J* disconnects the microammeter and connects an external recording device, if desired.

To emphasize admittance variations, an opposite voltage is applied to the measuring circuit<sup>5</sup>. This voltage is stabilized with the 85A1 tube and is adjusted by potentiometer *R*<sub>2</sub>.

### Equipment Operation

Once the instrument is turned on by switch *S*<sub>1</sub>, Fig. 3, switch *S*<sub>2</sub> is placed in the MAIN position. Next, *R*<sub>2</sub> is adjusted so that a predetermined reading is obtained on the meter. This reading serves as a reference for all measurements.

After the test progresses for about three or four minutes, *S*<sub>2</sub> is changed to MEASUREMENT and the resulting value is read on the meter. Simultaneous use of attenuator *S*<sub>2</sub> and potentiometer *R*<sub>2</sub> accomplishes required calibration of the instru-

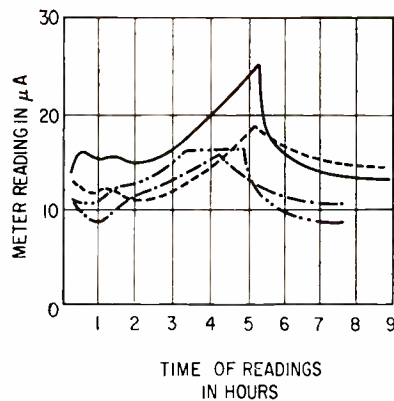

FIG. 4—Typical admittance curves for several Portland cements

ment. The meter should read at about its center-scale point.

For a cement of average setting, a measurement should be made every 15 minutes. If use is made of recording equipment, the apparatus should be kept on continuously. Relative admittance values should be plotted against time.

Curves of admittance against

time such as shown in Fig. 4 are then obtained. The maximum points of these curves correspond to the end of the setting process for various Portland cements.

### Experimental Checking

In earlier experimental work<sup>2,3</sup>, a close correlation between setting times obtained from admittance curves and those resulting from use of the Vicat needle method was observed. To carry out a more precise check, a provisional experimental arrangement was prepared as shown in Fig. 5.

A steel-toothed wheel 26.5 mm in diameter is driven by an eight-rpm motor. The wheel is mounted on a sliding frame driven at a constant linear velocity of 13 mm per hour by a synchronous motor. The combined rotational and linear motions of the wheel cut a groove in the concrete test specimen of 1 to 3 mm in depth. The specimen is attached firmly to the framework of the apparatus.

To determine mechanical resistance of the paste—to measure the work required to cut the groove—the amount of current drawn by the eight-rpm motor is recorded by a ballistic galvanometer and a photographic device.

### Test Results

If a simultaneous test is made with the mechanical apparatus and the admittance recorder, the graphs shown in Fig. 6 are obtained for the same cement. Curve *A* corresponds to the admittance measurements and curve *B* to the mechanical system. Note how point *P* of curve *A* (end of setting) corresponds to the sudden increase *CD* in curve *B* caused by a rapid increase in mechanical strength.

### REFERENCES

- (1) J. M. Tobio, Dielectric Modifications of the Cement Paste During Setting, Inf. Constr. No. 43, p 611, Aug.-Sept. 1952. Bul. Doc. No. 10, Centre d'Etudes et de Recherches de l'Industrie des Liants Hydrauliques, First Semester, 1953.
- (2) J. M. Tobio, Contribution to the Study of the Setting Process: Dielectric Behavior of Some Spanish Cements, Doctoral Theses, Madrid, 1955.
- (3) J. M. Tobio, A Study of the Setting Process, Monograph No. 153, Technical Inst. of Const. and Cement, Madrid, June 1955.
- (4) N. C. Hekimian, *Radio-Electric Eng.* p 36, Feb. 1954.
- (5) G. G. Blake, "Conductimetric Analysis at Radio Frequency," Chapman and Hall, London, 1950.

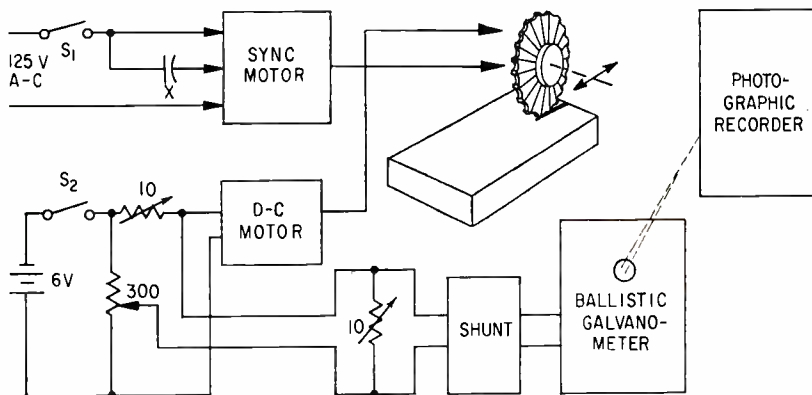

FIG. 5—Mechanical system used for comparison experiment. Work required to cut groove in cement is indicated by d-c motor current

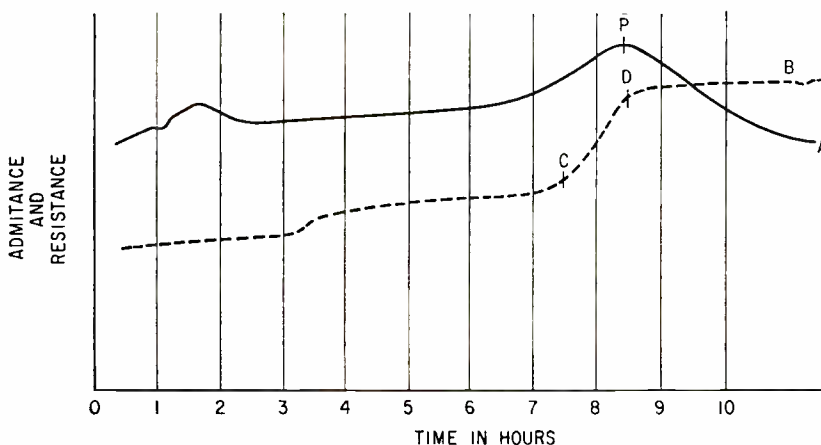
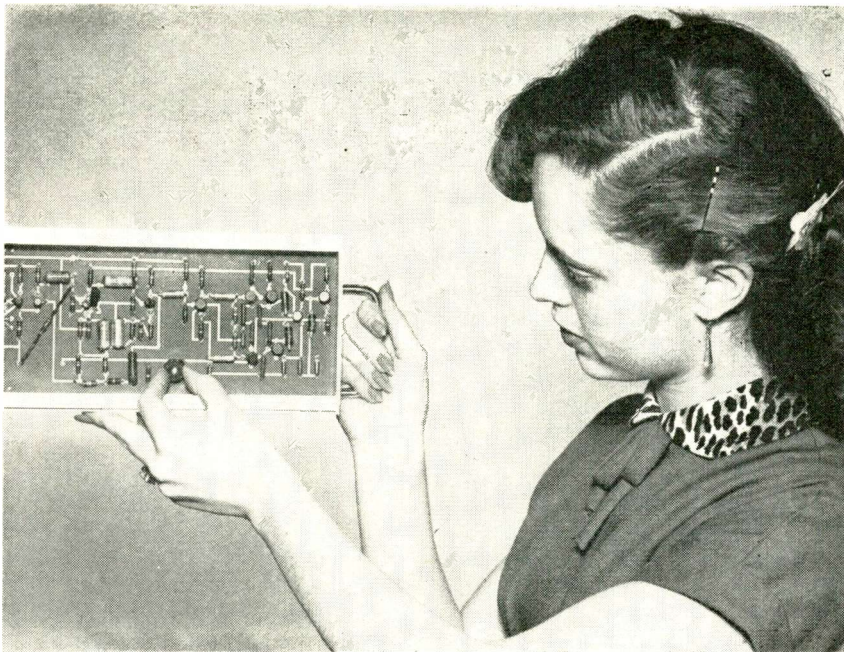

FIG. 6—Comparison of curves for admittance (*A*) and mechanical-resistance (*B*) methods of determining cement setting time





Operator adjusts clipping level on read amplifier. Signal-to-noise ratio of three to one will give reliable operation in digital data system

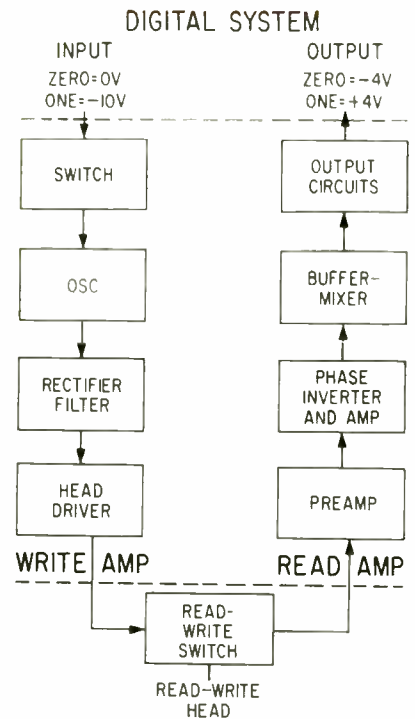

FIG. 1—Digital tape system

# Universal Tape Amplifiers for Digital Data Systems

Transistorized read and write amplifiers have wide-range input characteristics which accommodate most digital tape systems. Both return-to-zero and nonreturn-to-zero pulsing techniques can be used at repetition rates up to 22 kc. Adjustable clipping circuit in read amplifier permits insertion of 0 to 2.5 mv input noise discrimination

By **ROBERT F. SHAW**, Digitronics Corp., Albertson, New York

**M**AGNETIC TAPE record and playback amplifiers used in sound reproduction equipment do not have all the characteristics needed for processing digital data. To fill this void, the read and write amplifiers discussed here have been designed specifically to meet requirements of most digital tape handling systems.

A block diagram of a read-write

system is shown in Fig. 1. The read and write amplifiers are intended to be used with relay-type read-write switching. Although electronic switching is more desirable, few magnetic tape applications justify the extra cost involved.

During read operation, signals from the read-write head are applied through the read amplifier to logic circuits in the digital system.

Functionally, the read amplifier consists of four sections: a preamplifier to provide necessary initial signal gain; a phase inverter and amplifier circuit to separate and amplify negative and positive signals; a buffer-mixer to pass positive signals for rz (return-to-zero) operation or to combine positive and negative signals for nrz (non-return-to-zero) operation; and an

output to provide sufficient current to drive digital system logic circuits.

During write operation, signals from the digital system are applied through the write amplifier to the read-write head. Functionally, the write amplifier consists of four sections: a transistor switch to control application of input voltage; an oscillator to generate a carrier frequency; a rectifier-filter to convert carrier to d-c and discriminate against residual a-c; and a head driver to amplify the recorded signal by an amount sufficient to drive the read-write head.

### Read Amplifier

A tape read amplifier must deliver an output swing of  $-4$  to  $+4$  volts to satisfactorily drive the logic circuits of transistorized digital data handling equipment. Commonly available digital read heads provide an input signal of approximately 6 millivolts peak-to-peak from tapes magnetized to saturation during recording of ones and zeros and played back at the usual 60 to 75 ips speeds.

In practice, reliability is assured by designing the amplifier to perform satisfactorily with appreciably weaker input signals and to handle stronger signals without overloading. The amplifier shown in Fig. 2 gives full output with inputs as low as 1.35 millivolts zero-to-peak and will not overload with inputs up to 5 millivolts zero-to-peak. Good discrimination is obtained by using an input threshold of 0.4 millivolts, below which no output is produced.

Tests show the amplifier gives satisfactory reading at pulse repetition rates up to 22 kc. Major limitation on repetition rate is the high inductance of the head in use. A lower inductance head will allow operation at repetition rates up to 30 kc.

### Preamplifier

Signal level requirements indicate that overall gain of the read amplifier must be about 10,000 after allowances have been made for noise clipping and overdrive of high level stages. To obtain this gain with good stability, a feedback-stabilized preamplifier is used. This

circuit amplifies the signal until a point is reached where further stabilization can be accomplished by simple emitter degeneration and clamping circuits. Feedback of 60 db is introduced to give a voltage gain of 1,000 within  $\pm 10$  percent even when gain of individual stages varies as much as  $\pm 25$  percent.

Transistor  $Q_1$  is connected as an emitter follower and is used to drive the emitter of mixer  $Q_2$ . The feedback line from the last amplification stage is connected to the base of  $Q_2$  and is loaded by a 1,000-ohm resistor.

Following the mixer is a conventional two-stage amplifier employing capacitively coupled grounded-emitter stages. Bias stabilization is used to compensate for temperature changes up to 125 F.

Low-frequency response of the amplifier is down 3 db at 200 cps. Since the other coupling circuits have a much lower cutoff frequency, this characteristic is primarily determined by the coupling network made up of  $C_1$  and the input resistance of  $Q_3$ . High-frequency response of 3 db down at 65 kc is primarily determined by capacitor  $C_2$  and the input impedance of  $Q_4$ .

### Phase Inverter and Amplifier

Usefulness of a tape reading amplifier is increased if the same unit can be used for reading either rz

going pulses to two grounded-emitter amplifier stages made up of transistors  $Q_6$  and  $Q_7$ . One amplifier stage is used for each polarity. These stages have a gain of two and are stabilized by use of precision resistors and degeneration.

### Buffer-Mixer

Outputs from amplifiers  $Q_6$  and  $Q_7$  drive emitter followers  $Q_8$  and  $Q_9$ , respectively, in the buffer-mixer. Diodes  $D_1$  and  $D_2$  associated with  $Q_8$  and  $Q_9$  serve to isolate the output circuits from the rest of the preamplifier.

If it is required to operate in the rz mode, the output of  $Q_8$  is coupled through  $D_1$  to  $Q_{10}$  permitting the use of only one loop of the tape signal. If nrz operation is required, the outputs of  $Q_8$  and  $Q_9$  are connected together applying an output signal to  $Q_{10}$  whenever a flux change in either direction is sensed by the read head.

Noise clipping is accomplished by biasing buffer diodes  $D_1$  and  $D_2$ . Clipping level is controlled by manually adjusting potentiometer  $R_1$  to change the base voltage level of  $Q_8$  and  $Q_9$ . Although up to 5 volts of clipping is possible with circuit parameters shown in Fig. 2, under normal circumstances the level is set to about 0.8 volt. This level actually corresponds to 0.4 millivolt of noise since the preamplifier has a gain of 1,000 and the amplifier stages have an overall gain of 2.

### Output Circuits

A driving signal totaling 2.75 volts is required at the emitter of  $Q_8$  or  $Q_9$  to produce output with a 1.35-millivolt input signal. Magnitude of the driving signal is determined by five voltage requirements: 0.25 volt to drive current through diodes  $D_1$  and  $D_2$ ; 0.2 volt to cut off  $Q_{10}$ ; 0.6 volt to compensate for variations imposed by emitter supply impedance of  $Q_{10}$ ; 0.8 volt necessary to overcome clipping threshold as discussed previously; and 0.9 volt which must be allowed for gain variations and level shifts resulting from supply voltage and impedance variations.

Emitter supply voltage of  $Q_{10}$  and its collector clamping voltage are  $-4$  and  $+4$  volts, respectively; therefore, these voltages represent

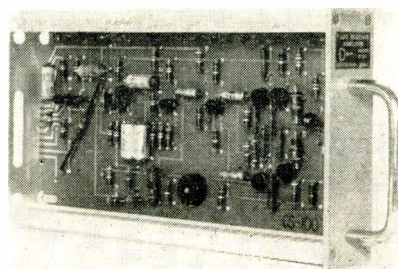

Read amplifier shown on plug-in package with covers removed

or nrz recordings. This facility is provided in the read amplifier through use of a phase inverter and optional buffer-mixer circuit for mixing positive and negative signals.

A conventional phase inverter circuit is used. Transistor  $Q_5$  applies both positive and negative



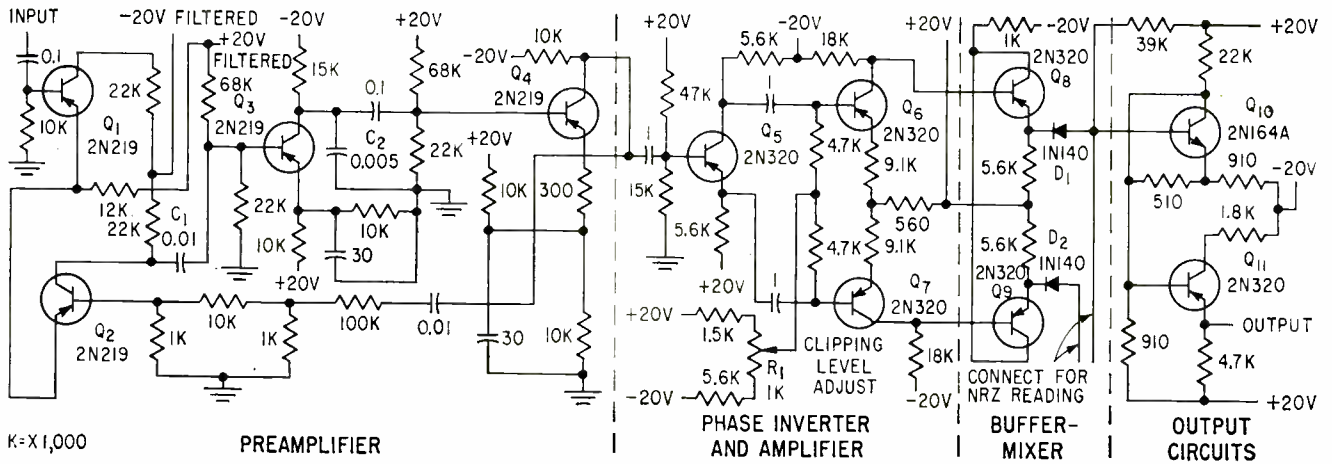

FIG. 2—Read amplifier circuit presents 10,000-ohm input impedance to read head. No-signal input produces a -4 volt output; peak input produces a +4 volt output

the end points of the output voltage swing. An output current of 8 ma at the positive end of the swing is provided by emitter follower  $Q_{11}$ .

Output waveforms are clean square waves for rz operation. For nrz operation, there are variations in the d-c operating points of  $Q_6$  and  $Q_7$ , which result in slight width variation between the output pulses derived from positive and negative going signal loops. This difficulty could be avoided by phase inverting at a higher amplitude level; however, such a circuit involves a more complex coupling arrangement since a simple phase inverter cannot handle greater signal swing without distortion at the existing supply voltages.

A write amplifier must provide enough driving current through the

write head to saturate the tape in either direction. Since most digital systems do not use a separate erase head, failure to saturate results in incomplete erasure of previous data. Desired magnetizing current must be produced in response to a signal at the amplifier input comparable with that produced by average digital logic circuits. In the write amplifier design described here, a negative signal having a 10-volt amplitude with respect to ground is required across the 10,000-ohm input resistance to give sufficient output current.

**Write Amplifier Design**

This amplifier has been designed to produce an output swing of  $\pm 8$  ma which is the tape saturation current required for a typical digital recording head. In addition to saturating the tape, the output current through the head must have a rise time sufficient to record at the 10-kc to 20-kc rates currently used for digital data recording. Rise time is 15 millisecc using a head with 50-millihenry inductance, but this can be brought down to 10 millisecc with the same circuit using a lower impedance head. Higher impedance heads give correspondingly longer rise time.

Since the write amplifier is used for nrz recording, direct coupling is used. This arrangement presents the usual stability and level problems associated with d-c amplifiers. These problems are solved using the carrier-type amplifier circuit shown in Fig. 3.

When turned on by a negative 10-

volt input signal, switching transistor  $Q_1$  applies voltage to the oscillator circuit consisting of  $Q_2$  and associated parts. A frequency of approximately 300 kc is generated by the oscillator and fed by way of a centertapped winding on the oscillator transformer to a full-wave rectifier made up of diodes  $D_1$  and  $D_2$ , and a simple R-C filter network. The rectified signal is then delivered to output amplifier  $Q_3$ , but only while a negative input voltage remains on the base of  $Q_1$ .

High-voltage transistor  $Q_3$  is used to drive the head circuit. In the absence of an output signal,  $Q_3$  conducts and its 16-ma collector current is divided equally between the head and  $R_1$ . Application of an input signal causes the rectified oscillator output to bias  $Q_3$ , cutting it off and permitting an 8-ma current flow through the head and  $R_1$  in a direction opposite to that produced with no signal. Diode  $D_3$  protects  $Q_3$  against overvoltage whenever the head is disconnected.

Appropriate change of output resistors permits higher current without a corresponding change in the output driver; however, rise times will be increased unless lower inductance heads are used. Output current can be maintained indefinitely in either direction through the head without overload.

The author acknowledges the help of Robert MacKenzie, E. Wolf and Milton Schwartz in developing of these amplifiers, and of Eugene Leonard who was responsible for the general direction of the program.

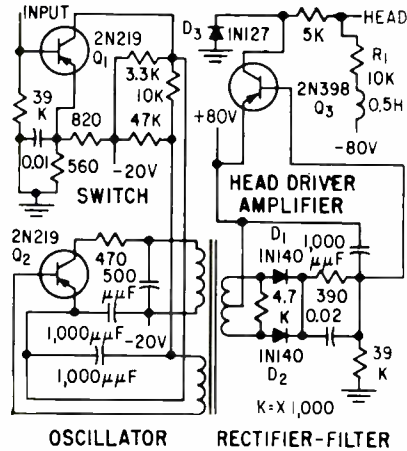
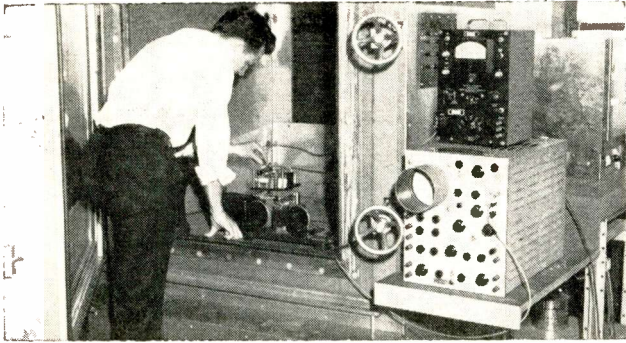
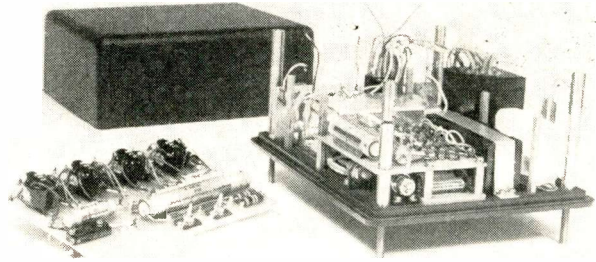

FIG. 3—Write amplifier circuit delivers a  $\pm 8$  ma swing to record head. Rise time in sec equals 0.04 times product of head inductance in mh and zero-to-peak current in ma



Discriminator is balanced before test run in altitude chamber



Closeup shows discriminator (right) and servo amplifier (left)

By **ROGER HILL**, Development Engineer, Avionic Division, John Oster Mfg. Co., Racine, Wisconsin

# Discriminator Controls

Servo discriminator measures phase with respect to preadjusted components and thereby makes accuracy a function of initial setting. At 400 cps, circuit has 100-millivolt d-c output for a frequency deviation of  $\pm 1/2$  cps. Absolute accuracy remains  $\pm 0.125$  percent between  $-55$  and  $+100$  C ambient

**A**IRCRAFT ALTERNATORS with tight frequency tolerances are often driven through a constant-speed transmission that is part of a feedback control loop with an error sensing device and a servo drive.

The inexpensive discriminator to be described is a fast-acting substitute for a standard error detector. With an input of 400 cps it has 100 millivolts d-c output at as high a power level as practical for a frequency deviation of  $\pm 1/2$  cps. Absolute accuracy remains within  $\pm 1/2$  cps in an ambient temperature range of  $-55$  to  $+100$  C. The output of the discriminator is fed into a silicon-diode modulator. The 100 millivolt figure is arbitrarily chosen to give an adequate signal to noise ratio at the output of the modulator.

## Basic Circuit

The output  $E_{00}$  in Fig. 1 is a function of the difference between the changes in  $E_{01}$  and  $E_{02}$ . The change in  $E_{01}$  due to a change in

frequency is a function of quantity  $T_1$ . A value of  $T_1 = R_1 C_1$  equal to  $1/\sqrt{2}\omega$  results in maximum sensitivity for the upper portion of the discriminator; while the lower half has its greatest sensitivity when  $T_2 = R_2 C_2$  equals  $\sqrt{2}/\omega$ .

For a 100-millivolt output during a half-cycle deviation from 400 cps with  $C_F = 0$ ,  $E_{11}$  and  $E_{12}$  must equal 116 volts rms. Now, if  $C_F$  is increased until peak rectifier action is approached, the 100-millivolt output is raised to approximately 150 millivolts. With a load  $R_L$  equal to twice the source impedance of the discriminator the output drops back to 100 millivolts. When  $R_s$  is neglected and the source impedance of  $E_{11}$  and  $E_{12}$  is considered negligible with respect to  $1/\omega C_1$  and  $R_2$  respectively, then the source impedance of  $E_{01}$ ,  $Z_{01}$ , equals  $R_1/(1 + j\omega R_1 C_1)$  and  $Z_{02}$  is  $R_2/(1 + j\omega R_2 C_2)$ . With values for  $T_1$  and  $T_2$  substituted the absolute values of  $Z_{01}$  and  $Z_{02}$  at 400 cps are  $R_1/\sqrt{1.5}$  and  $R_2/\sqrt{3}$ .

Lower values of  $R_1$  and  $R_2$  increase output power. However, input power requirements rise proportionately, as does the power that must be dissipated by  $R_1$  and  $R_2$ . Furthermore, as the resistor values are reduced, the capacitor must increase.

With  $R_1 = 4,260$  ohms,  $R_2 = 8,520$  ohms and  $C_1 = C_2 = 0.066 \mu\text{f}$ , each resistor dissipates only one watt. Because of the low-power dissipation the temperature of each resistor rises little above ambient. Absolute values of respective source impedance  $Z_{01}$  and  $Z_{02}$  are 3,480 ohms and 4,910 ohms.

Since the source impedance of the discriminator with  $C_F = 0$  is the sum of the absolute values, it totals 8,390 ohms. Capacitor  $C_F$  raises the output voltage by a factor of 1.5 without providing any additional power. Consequently, the discriminator output impedance, raised by a factor of  $(1.5)^2$ , equals 19,000 ohms. Therefore, the re-



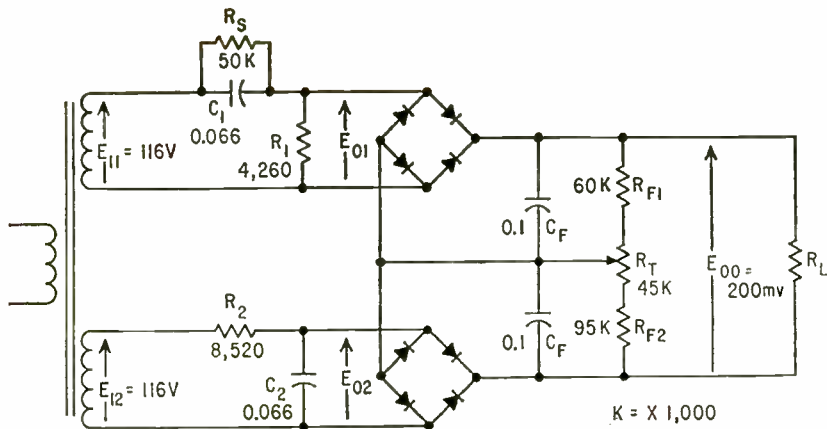
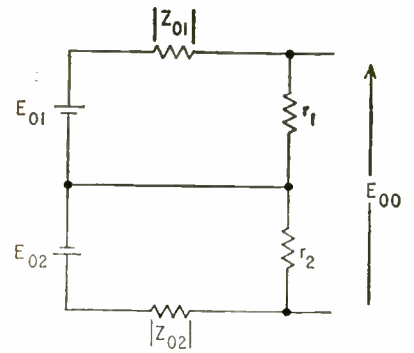

FIG. 1—Output voltage of full-wave discriminator is a function of difference in outputs across two bridges



$$|Z_{01}| = \frac{R_1}{\sqrt{1 + R_1^2 C_1^2 \omega^2}} = \frac{R_1}{\sqrt{1.5}}$$

$$|Z_{02}| = \frac{R_2}{\sqrt{1 + R_2^2 C_2^2 \omega^2}} = \frac{R_2}{\sqrt{3}}$$

FIG. 2—A d-c equivalent of the fullwave discriminator

# Aircraft Alternator

quired output sensitivity is obtained across a load of 38,000 ohms.

## Accuracy

Since the absolute value of  $\omega$  is defined by the relation  $T\omega = \text{a constant}$ , a percentage change in  $T$  effects an equal percentage change in  $\omega$ . For absolute accuracy complementary temperature coefficients for  $T_1$  and  $T_2$  are selected to maintain stability over the  $-55$  to  $+100$  C temperature range.

If the device is to be calibrated at 20 C, an ambient temperature increase of 80 C should produce an apparent change in  $\omega$  no greater than  $2\pi (1/2) = \pi$  radians, or  $\Delta f/f = 0.5/400 = \Delta T/T = 1,250$  ppm.

Hence, the maximum tolerable temperature coefficient for  $T$  is 15.6 ppm/C. If temperature coefficients of opposite sign are chosen for  $R$  and  $C$ , then only the difference of the two coefficients need be less than 15.6 ppm/C. Resistors were chosen with a positive temperature coefficient of  $23 \pm 5$  ppm/C. The capacitors have a temperature coefficient of  $-23 \pm 5$  ppm/C. If warmup time cannot be provided, the temperature of the components should remain as nearly identical as possible. Therefore, the resistors are elaborately heatsunk and held within 3 C of ambient temperature.

Potentiometer  $R_T$  provides the

initial discriminator calibration necessitated by the initial unbalance between  $E_{01}$  and  $E_{02}$ .

A d-c equivalent to the circuit in Fig. 1 is shown in Fig. 2 with  $r_1$  equal to  $R_{F1}$  plus the upper portion of  $R_T$  and  $r_2$  equal to  $R_{F2}$  plus the remainder of  $R_T$ . If all the constants are without error, zero output corresponds to  $r_1/r_2 = |Z_{01}|/|Z_{02}| = 348/491 = 1/\sqrt{2}$ . The percentage variation in  $r_1/r_2$ , required to balance out initial errors, is less than the 5-percent sum of the percentage

branch of the discriminator. If it is chosen 10 times  $R_1$ , its temperature coefficient is 1/10 as critical.

Ideally, the null point is independent of the amplitude of the input voltage. However, the off-null signal is a function of the input amplitude as well as frequency. An additional resistance in series with the upper-branch source impedance offsets the unbalance caused by distortion in the input signal.

## Rejecting Harmonics

If the harmonic content varies with the amplitude of the input signal, a change in input amplitude appears as a shift in frequency. Harmonics are rejected by designing the transformer so its primary inductance and the R-C combination reflected from the secondary resonate at 400 cps and by driving the device with a high-impedance source.

The output of a typical discriminator versus temperature is given in Fig. 3. The input to the discriminator is held at 400 cps while  $R_T$  adjusts the output to zero at 25 C. Ideally, the curve should be linear, but the temperature coefficient of the capacitors is slightly curved at 100 C and severely curved at higher temperatures. A similar departure from linearity is apparent at the low end.

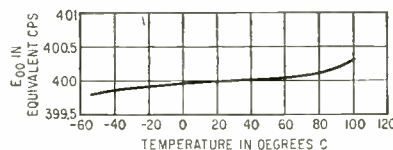

FIG. 3—Absolute accuracy of discriminator against ambient temperature

errors in  $E_{11}/E_{12}$ ,  $R_1$ ,  $R_2$ ,  $C_1$  and  $C_2$ . The sum of  $r_1$  and  $r_2$  is large with respect to  $Z_{01}$  or  $Z_{02}$  to insure peak rectifier action. Specifically, the sum of the two is set equal to 200,000 ohms, and other values are:  $R_{F1}$  equal to 60,000 ohms,  $R_{F2}$  equal to 95,000 ohms,  $R_T$  equal to 45,000 ohms and  $C_F$  equal to 0.1  $\mu$ f.

The d-c shunt resistance across  $C_1$  should be large with respect to  $R_1$  so that it does not disturb the frequency characteristic of the upper

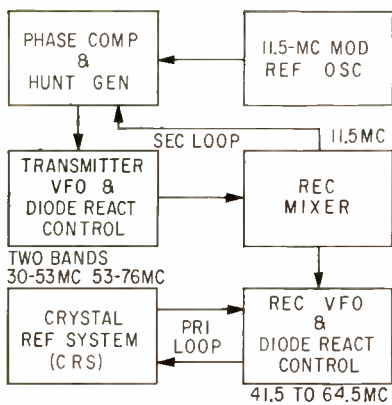

FIG. 1—Receiver-transmitter frequency control system, showing major frequency determining components

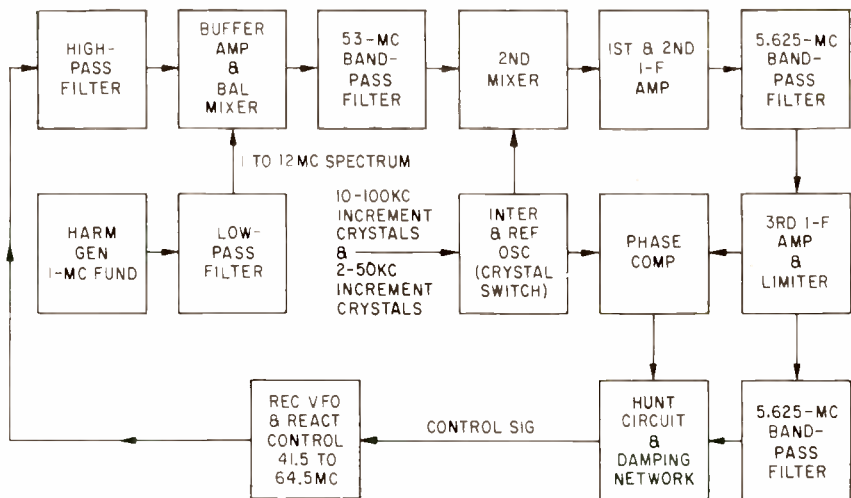

FIG. 2—Crystal reference system is used for channel derivation and controls the local oscillator frequency within 3 kc of nominal channel

Controlled-frequency transceiver, operating in two bands, uses improved bandpass filter techniques that double the number of channels per megacycle of spectrum. Oscillator-stabilized system, used in military vehicular communications, is designed for 50-kc channel spacing and selects any of 920 channels between 30 to 76 mc

# Mobile Radio System

By FRANK BRAUER and DON KAMMER

Communications Equipment Group, Avco Manufacturing Corp., Crosley Division, Cincinnati, Ohio

SINCE THE FREQUENCY spectrum cannot be enlarged, the present urgent need for more reliable communications channels can be satisfied by decreasing channel spacing, thereby stretching the usable radio spectrum. To accomplish this, the frequency-determining devices in a communications system must be designed for increased stability.

This article explains an approach used to stabilize the receiver and transmitter oscillators in a transistorized vehicular communications system (AN/VRC-12) developed for the U. S. Army Signal Corps.

## 50-Kc Channel Spacing

The system furnishes 920 channels of communication between 30 to 76 mc and operates from a 24-v vehicular battery. This equipment

is a transistorized military vehicular system designed completely for 50-kc channel spacing. It shows certain advantages over present military 100-kc channel-spacing equipment that now uses three different receivers to cover the 20- to 54-mc range.

The receiver has a sensitivity of  $0.3 \mu\text{v}$  for a 10-db signal-plus-noise/noise ratio and spurious responses are down 85 db. Transmitter output is 30 watts and all transmitted spurious frequencies are also down 85 db. The transceiver has ten preset channels and can be tuned manually or automatically. For automatic tuning, a servo system provides 3-second tuning between any two preset channels. The system operates over an ambient temperature range of  $-40$  to  $+65$  C.

Stable frequencies are derived by free running oscillators regulated by special control systems. A frequency control system implies a reference or standard, along with conventional regulation, direction, or error correction. Figure 1 shows the major frequency determining components.

Two frequency control loops are shown. The primary loop, the crystal reference system (crs), is used for channel derivation and controls the frequency of the receiver local oscillator within 3 kc of nominal channel frequency over the temperature range of  $-55$  to  $+85$  C. Since reception and transmission occur on the same channel, the stabilized receiver local oscillator is used as one of the references in the transmitter frequency control loop.



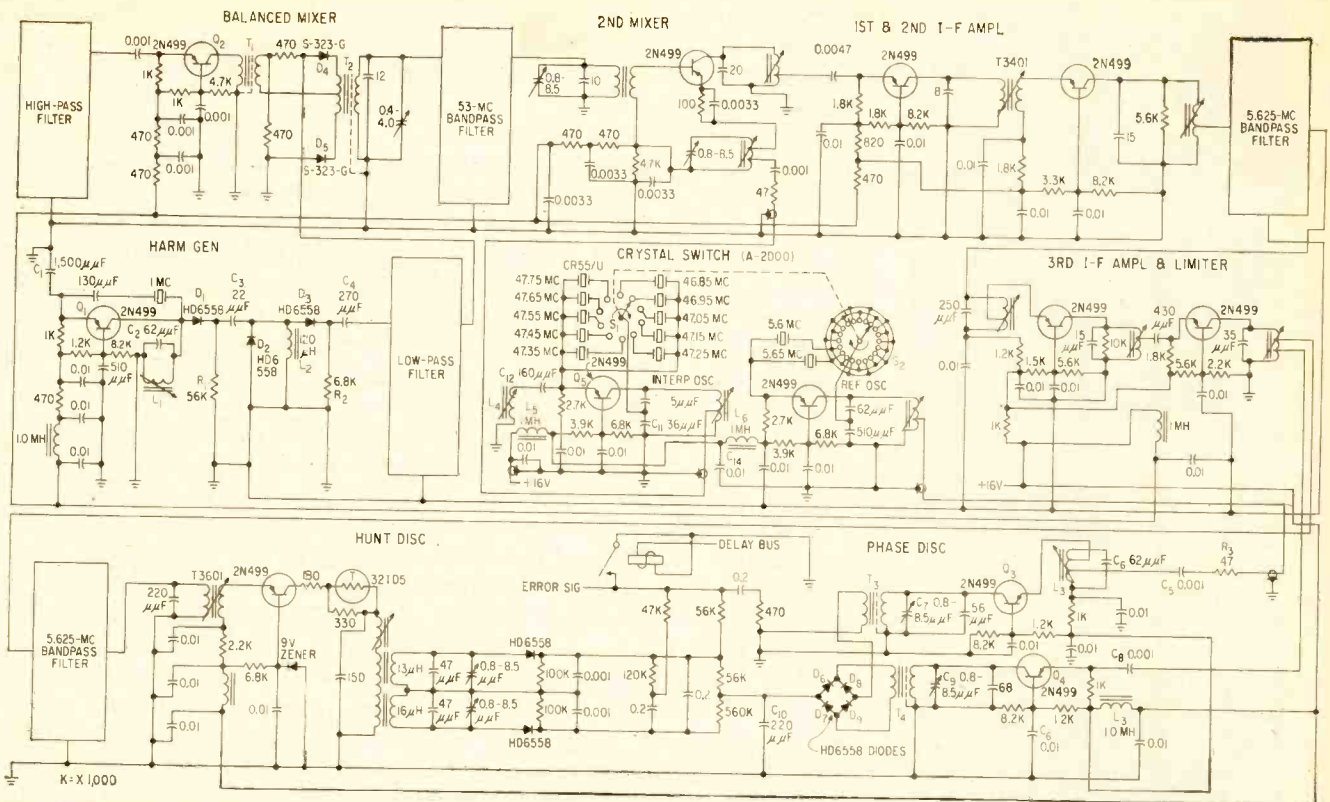

FIG. 3—Crystal reference system schematic. Hunting is achieved through instability, by phase splitting the output of a Travis discriminator, direct coupling one output and capacitance-coupling the other output to the reactance control circuit of the oscillator

# Provides 920 Channels

The 11.5-mc modulated oscillator, controlled by a crystal discriminator afc loop, performs the sidestep function since it operates at the receiver intermediate frequency. The error signal in both controlled loops is derived by phase comparison of the controlled frequencies with crystal-controlled references. Frequency correction is obtained by using semiconductor reactance devices in the vfo circuits. Electronic hunting circuits in both loops bring the vfo within holding range of the phase comparators.

Two bands cover the 30 to 76-mc operating range of the receiver: 30 to 53 mc, and 53 to 76 mc. An 11.5-mc i-f was selected to obtain high- and low-side mixing of the receiver local oscillator. Operational range of the local oscillator is thus restricted to 41.5 to 64.5 mc.

## Crystal Reference

A sampling of the local oscillator is fed to the crs (see Fig. 2). The

50-kc spacing is achieved by three successive interpolations.

The first interpolation occurs in the first or balanced mixer and divides the 23-mc band coverage into 1-mc increments. Since high and low mixing are employed in the balanced mixer, only the first 12 harmonics of a 1-mc crystal-controlled oscillator are required.

The second interpolation, which divides the 1-mc increments into 100-kc increments, takes place in the second mixer and is accomplished by a mechanically switched and synchronized crystal interpolation oscillator that employs 10 crystals in 100-kc steps between 46.85 and 47.75 mc.

Final interpolation is carried out in the phase comparator by synchronized selection of one of two crystals in the reference oscillator at 5.6 and 5.65 mc.

The switching frequency is the receiver local oscillator signal in the first or balanced mixer. Since this

signal level is 25-db higher than the outputs of the harmonic generator, balancing of the first mixer provides nearly constant output at all receiver local oscillator frequencies. A buffer amplifier is used for isolation, since mixed products of the harmonic generator, present in the first mixer, fed back to the receiver would lead to spurious responses.

The crystal reference system filter complement keeps spurious responses down at least 85 db. The high-pass filter at the input of the crs further attenuates undesirable frequencies below 41.5 mc. The low-pass filter cuts off at 12 mc and attenuates undesirable frequencies, particularly those around the 53-mc first i-f of the crs. The 53-mc bandpass filter attenuates the image and half i-f responses. A bandwidth of 1,750 kc accommodates the 400-kc control range of the receiver local oscillator, the 900-kc range of the ten 100-kc increment crystals in the second crs oscillator, and the 50-kc



Design engineer checks crystal reference system for the 920 channel vhf f-m receiver-transmitter

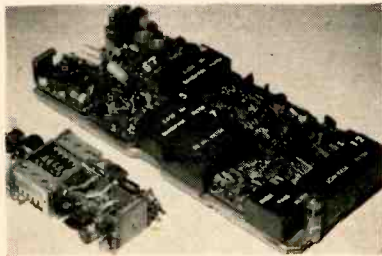

Crystal reference system, covers removed, shows packaging techniques employed. Individually packaged, pre-aligned, plug-in assemblies facilitate field maintenance

displacement between the crs reference oscillator crystals.

The 5.625-mc bandpass filters limit action to the desired frequency signal in the crs second i-f. These filters prevent undesired signals, 1-mc either side of the desired frequency, from disturbing discriminator response necessary for automatic hunting.

Action of the harmonic generator causes first and second i-f responses every 1 mc. This desired interval response is predetermined by the receiver local oscillator, positioned within 400-kc of the required frequency. The nearest spurious signal is then 600-kc away.

The proper crystals in the interpolation reference oscillators are selected automatically by gear-coupling the crystal switches to the main tuning system. The three second tuning on the overall system has a switching speed of 460 revolutions per minute for the inter-

polation and reference oscillators. Each revolution of the switch shaft switches the control system over a 20-channel range.

An automatic hunting system brings the frequency within the holding range of the phase comparator. Hunting is accomplished by phase splitting the output of a Travis discriminator, direct coupling one output, and capacitance coupling the other output to the reactance control circuit of the oscillator. Hunting action is achieved through instability and automatically stops during phase lock.

Phase comparator output is applied directly to the reactance control circuit of the receiver local oscillator. The output overrides the hunting voltage and compensates for the frequency error of the receiver local oscillator. A damping network reduces control loop gain below unity at the critical frequency and prevents loop instability. The critical frequency is the error frequency at which the loop phase shift is 360 deg. And here instability occurs if the loop gain is greater than unity.

The maximum frequency error of the controlled oscillator is determined solely by the additive errors of the various crystal oscillators. A total of 13 crystals, used with 12 transistors, in the crs provides the 920 crystal controlled channels.

#### Harmonic Generator

As seen in Fig. 3, transistor  $Q_1$  is connected in a common-base circuit. Oscillation is achieved with 100-percent feedback from the collector tank to the input circuit through the 1-mc series-mode crystal. Capacitor  $C_1$  corrects the oscillator frequency to within plus or minus five cycles of the nominal 1-mc. The transistor is driven into saturation, and the waveshape across  $C_2$  and  $L_1$  is clipped on half the cycle.

This waveshape passes through a clipper network  $D_1$  and  $R_1$ . This square wave is differentiated in network  $C_3$  and  $D_2$ . Coil  $L_2$  suppresses the lower order harmonics, and evens amplitude spread. Diode  $D_3$  and  $R_2$  act as a second clipper. Capacitor  $C_4$  and input resistance of the low-pass filter form a second differentiating network. Thus the

output is a pulse train with a 1-mc repetition rate and a pulse rise of 0.03  $\mu$ sec.

#### Balanced Mixer

Buffer amplifier transistor  $Q_2$  develops only 6-db gain and is broadbanded to accommodate the 41.5- to 64.5-mc input signals from the receiver local oscillator. It isolates the receiver tuner from balanced-mixer cross products which would cause spurious responses in the receiver mixer.

The receiver local oscillator signal, used to drive the mixer, is 30-db higher than the individual harmonics of the harmonic generator. Careful circuit layout, and shielding of  $T_1$  and  $T_2$ , provide a 30-db rejection while permitting a small variation of mixer output amplitude and meeting the 85-db spurious-signal rejection demands of the receiver. Diodes  $D_4$  and  $D_5$  achieve mixer saturation at a low driving signal level and permit a reasonable variation in driving level without upsetting the balance. The tuned output is essentially an end section of the 53-mc filter. Net loss of the balanced mixer, referred to the power level of the harmonic generator individual harmonics, is 10 db.

#### Phase Discriminator

Capacitor  $C_5$  couples the fixed input of either 5.6 or 5.65 mc to an input tank,  $C_6$  and  $L_3$ , which is tuned to 5.625 mc. Resistor  $R_3$  minimizes

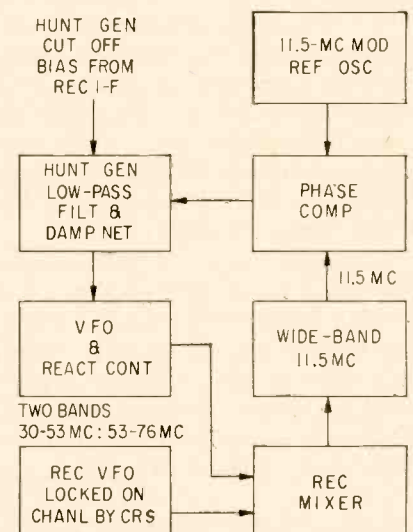

FIG. 4—Transmitter frequency control (secondary control loop) block diagram



effects of the wide impedance swing of the buffer input on the reference oscillator. Buffer amplifier  $Q_3$  is a common base transistor whose collector output is applied to the tuned circuit of  $C_7$  and the primary of  $T_3$  which is tuned to 5.625 mc. Transformer  $T_3$  secondary output is applied to the ring modulator  $D_4$ ,  $D_7$ ,  $D_8$  and  $D_9$ . Capacitor  $C_8$  couples an input from the crs limiter to driver amplifier  $Q_4$ , a common-base transistor.

The tank, primary of  $T_1$  and  $C_9$ , is tuned to 5.625 mc. The secondary of  $T_1$  couples the driver section output to the ring modulator. The diodes are matched impedance, low conductance pairs. They are matched to hold residual d-c output voltage as low as possible. A d-c voltage, resulting from a phase difference between the output of the buffer and driver sections of the phase discriminator when they are on the same frequency, is developed across  $C_{10}$ .

#### Crystal Switch

The crystal switch interpolation oscillator,  $Q_5$ , is a high-frequency transistor, connected in a Colpitts oscillator circuit. Oscillation is sustained by feeding back a portion of the energy from the collector tank circuit into the emitter circuit, through switch  $S_1$  and its properly selected crystal. Feedback is controlled by the ratio of the 5- $\mu\mu\text{f}$  capacitor and  $C_{11}$ . The  $C_{12}$  and  $L_1$  network compensates for stray capacitance due to switch leads and operates on the crystal frequency.

The crystals themselves are series-mode third-overtone crystals (CR55/U) having a frequency stability of 50 ppm. Oscillator output is tapped off the collector tank circuit and fed through a 50-ohm coaxial cable into the crs second mixer through a connector. Decoupling network  $L_5$  and the 0.01- $\mu\text{f}$  capacitor prevent the oscillator output from getting back into the 16-v regulated bus.

The reference oscillator is basically the same circuit as the interpolation oscillator, operating at either 5.6 or 5.65 mc. Each reference-oscillator crystal, used once with each interpolation-oscillator crystal, achieves the final 50-ke spacing. Decoupling network  $L_6$

and  $C_{14}$  keeps the 5.6 and 5.65-mc signal from leaking into the 5.625-mc i-f via the interpolation oscillator, as well as into the i-f itself.

High-speed operating ganged switches  $S_1$  and  $S_2$  are mechanically linked to the main tuning capacitor. These make-before-break switches always present two inputs at ring modulator  $D_6$  thru  $D_9$  of the phase detector and prevent a large undesired residual d-c output. One revolution of the switch for each megacycle represents a speed of nearly 500 rpm when a tuning requirement of three seconds is imposed on the servo operated receiver transmitter. A cam-operated switch withstands this speed.

Close tolerances achieve proper crystal selection with 20 different reference oscillator positions and 10 interpolation oscillator positions for each revolution of the shaft. Molding the cams maintains these close tolerances from unit to unit. The reference oscillator is well shielded from the interpolation oscillator by heavy metal housing.

#### Transmit Frequency

Transmit channels are derived from the receiver local oscillator, controlled by the crs (See Fig. 4). The transmit frequency is sampled by the receiver, and the receiver mixer output frequency of 11.5 mc is compared in a phase comparator with the output from a 11.5 mc modulated afc reference oscillator.

The error signal from this phase comparator is applied to a semiconductor reactance control device on the transmitter vfo to maintain channel frequency. Modulation is accomplished at a single frequency thus affording constant modulator sensitivity. Also, the modulator circuit parameters are easier to control at the single lower frequency.

The transmit frequency is fed directly into the receiver mixer from the transmitter vfo with the B+ removed from the receiver r-f amplifier.

A low-pass filter, inserted into the control line, attenuates the 11.5-mc signal leaking into the control from the phase comparator. The 75 db attenuation is obtained near i-f harmonic crossovers of 34.5, 46.0, 57.5 and 69.0 mc.

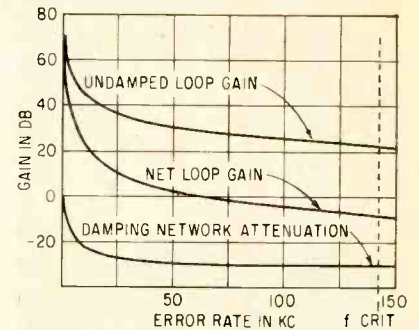

FIG. 5—Frequency-control-loop gain

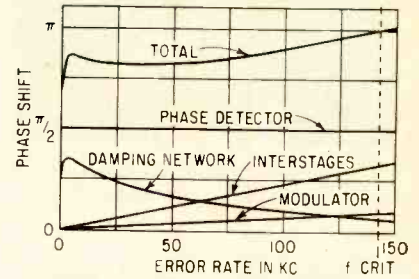

FIG. 6—Frequency-control-loop phase shift characteristics

Hunting is accomplished by a multivibrator operating into the reactance control circuit of the vfo. The multivibrator is biased with the rectified 11.5-mc signal derived from the receiver i-f after crystal frequency selection.

Figure 5 indicates gain characteristic of the transmitter frequency control loop vs sinusoidal error rate or modulation. Loop gain at the critical frequency is -10 db or less and the critical frequency occurs above 100 kc.

Frequency-control-loop phase shift is shown in Fig. 6.

The speech limiter in the transmitter prevents deviation in excess of 15-ke.

The control loop also overcomes the hunting voltage, compensates for vfo frequency error, and achieves maximum audio modulation because of the use of a voice-operated r-t relay.

The authors acknowledge assistance of engineers at the Signal Corps Engineering Labs., in particular A. C. Colaguori, A. Sills, and E. Jacobowies who formulated many concepts used in the crystal reference system. J. J. Lamplot, R. Midkiff and E. Wilson of the Communications Equipment Group of AVCO Crosley Division contributed significantly to the design of the frequency-control systems.



Memory rack—Apertured ferrite plate is used as memory or switch

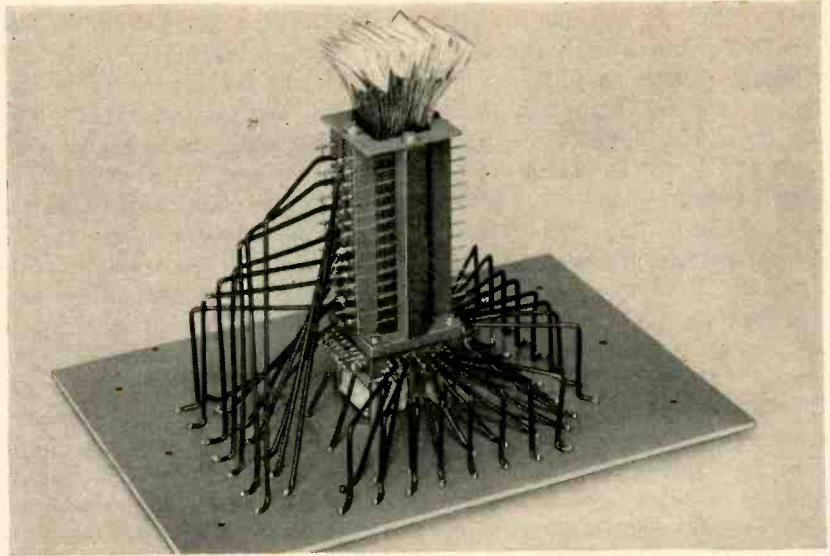

Plate assembly for a 256 by 7 bit memory. Seven pairs of printed storage plates are visible but stack of switch plates is hidden by supporting framework

# End-Fired Memory Uses

Magnetic flux is induced around holes in ferrite plates to store and switch digital information. Plate properties can vary considerably from hole to hole without affecting memory accuracy. End-fired ferrite plate memory operation is explained and transistor drive and regeneration circuits are described

**M**AGNETIC CORE memory elements become impractical in million-bit memories. Cost of the magnetic core and the hand wiring techniques are a direct cause for the high cost of memories in digital data processing systems. With present memory cores used in a coincident-current system, noise output increases as memory size increases and tends to place a maximum practical upper limit. Ferrite-plate memory and switch elements can reduce cost and size.

## Ferrite Plate

The developmental plate shown in Fig. 1 contains 256 holes in a 16 by 16 matrix. The outside dimensions of the plate are approximately 0.83 by 0.83 in. and the 256 holes are 25 mils in diameter, on 50-mil centers. It is fabricated from ferrite powder in a single pressing operation. Heat treatment of the plate produces the square hysteresis loop characteristics necessary for memory application. Because the ferrite material

is nonconducting, at least one of the windings necessary for memory application may be printed on the surfaces of the plate.

Ninety percent of the total flux change which occurs around an aperture driven by alternate set and reset pulses plotted against the pulse amplitude is shown in Fig. 2. The set and reset pulses are of equal amplitude. The curves represent the limits and the mean of corresponding holes in a small sample of plates of the type used in the experimental memory.

One of the significant parameters which can be abstracted from the plot is the starting field. Below the starting field value, which in this case is approximately 175 milliamperere-turns, no appreciable switching occurs.

Above the starting field the flux-current relationship is almost linear. Since application of more intense fields to a hole in a plate will continually increase the reversal flux, switching time remains ap-

proximately constant at 1.7  $\mu$ sec for excitations greater than 250 ma-turns.

To insure that flux penetration about an aperture does not extend beyond the midpoint between apertures, net switching current must not exceed 500 ma-turns.

## Memory System

Irregularities in the ferrite material from hole to hole is overcome by using two corresponding holes in adjacent plates to store each bit of information.<sup>1</sup> This reduces the tolerance requirements of the system. Using two holes for each bit of information also allows the information content to affect the polarity rather than the amplitude of the output signal.

The direction of flux used to define a stored ONE, a stored ZERO, and the cleared state is shown in Fig. 3. Information content of a location is sensed by determining which one of the two apertures containing the information must be switched to bring



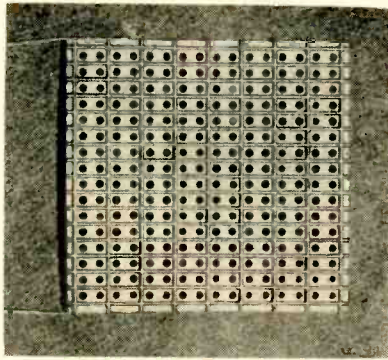

FIG. 1—Outside dimensions of ferrite plate are 0.83 by 0.83 in.

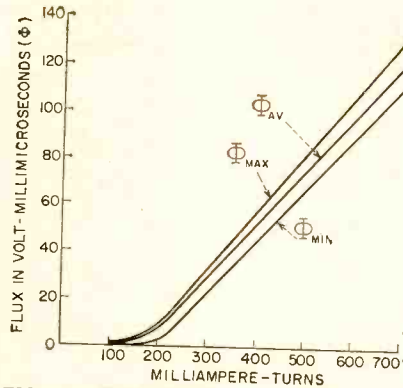

FIG. 2—Characteristics of ferrite plate driven by equal set and reset pulses

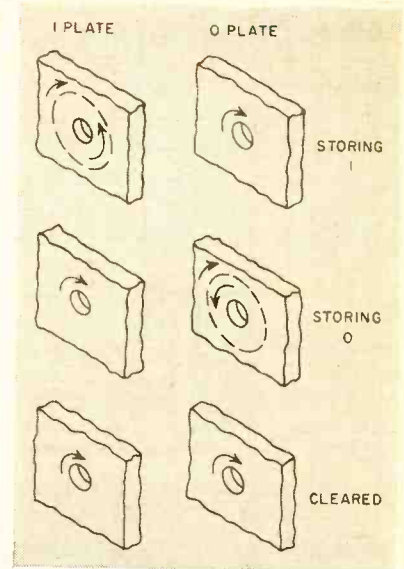

FIG. 3—A stored one, a stored zero and the cleared state in two-hole per bit system are defined by flux direction

By V. L. NEWHOUSE\*, N. R. KORNFIELD and M. M. KAUFMAN

BIZMAC Engineering, Industrial Electronic Products, Radio Corporation of America, Camden, New Jersey

# Ferrite Plates

the location to a cleared state. The wiring between a switch plate and one pair of storage plates is shown in Fig. 4. Wiring for the 256-word memory is shown in Fig. 5.

To read from a specific location, a clear pulse is sent through the address wire which links the switch with its storage location. This current causes a flux change around one of the storage aperture pairs which induces a positive or negative voltage pulse across the terminals of the digit rewrite winding. Polarity of the pulse depends on which of the two apertures was switched by the clear pulse; that is, on whether the interrogated location held a ONE or a ZERO.

To write information into a location, currents are sent along both the address line and the digit rewrite winding. The location must first be cleared. A current opposite in polarity to the one used to read is then sent along the corresponding address line at the same time a smaller current is sent along the digit rewrite line. Amplitude of the currents is adjusted so that flux switching can occur only where the digit rewrite line and the address

line intersect. Switching takes place only in one of the two apertures since the digit rewrite current adds to the address current in one aperture and subtracts in the other. The sum of the currents exceeds the starting field while the difference is generally less than this field. If the digit rewrite current is reversed, the sum and difference of the currents will appear in opposite apertures.

The number of plates used for storage is twice the number of bits per word, with all the bits of each word lying along the same address line. Each of the 256 address wires shown pass through corresponding apertures in the magnetic switch and each pair of storage plates. The bits of each word are read out of and written into the memory in parallel, with one sense amplifier and one digit rewrite driver per pair of memory planes.

## Magnetic Switch

The magnetic switch stack contains one plate for every pair of storage plates, and is threaded with sixteen row windings, sixteen column windings, and one d-c bias winding.<sup>2</sup> The d-c bias winding can be seen in Fig. 4. The column and

row windings are shown in Fig. 5.

For read operation, the bias is counteracted in a selected column of holes by sending a current pulse approximately equal to the steady bias current through the column winding. The current rise and fall times should be controlled to limit the amplitude of noise currents induced in the address wires passing through the selected column. At the same time, a current of similar amplitude and rise time is applied to the selected row winding. The currents flowing through the selected row and column switch the flux around the aperture where they intersect. A current of about half the magnitude of the row current is induced in the address wire passing through the aperture. The current flowing in the address wire clears the memory locations. Polarity of the voltages induced in the digit rewrite windings at the cleared locations determines the information content of the interrogated location.

For write operation, an interval of time is allowed for flux switching in the cleared memory location to be completed before the digit rewrite current drivers are turned on. Each driver sends a positive or

\* Now with General Electric Research Laboratories.

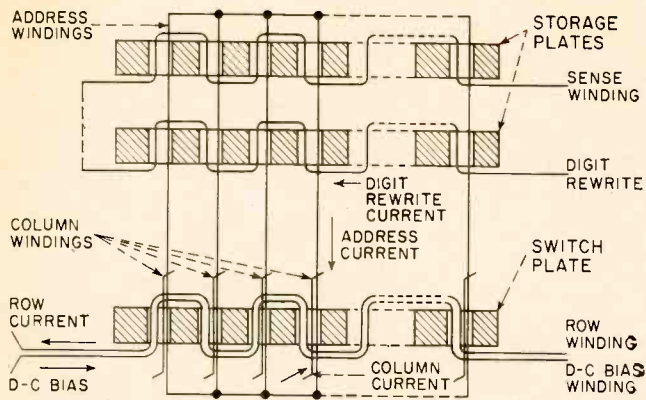

FIG. 4—Wiring between a switch plate and storage plates

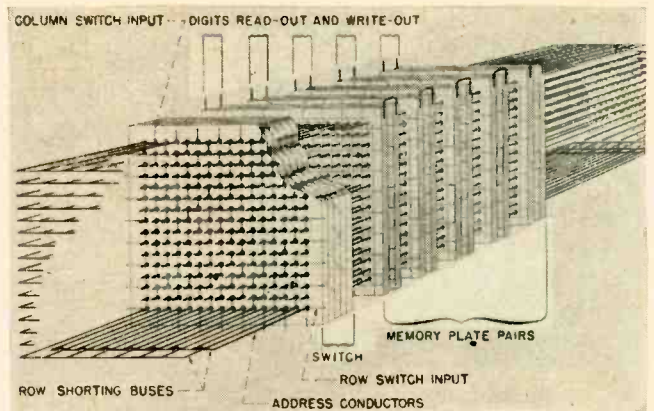

FIG. 5—Wiring for a 256-word memory with 4 bits per word

negative current pulse through the corresponding digit rewrite winding, depending on the information to be written into the memory. As soon as digit rewrite currents are established, the row and column currents flowing through the switch are turned off. This permits d-c bias to return the selected switch location to its original state, which in turn induces a set current pulse in the corresponding address winding. The pulse, together with already existing digit rewrite currents, switches the flux in the selected memory location and completes reentry of information into the memory.

### Magnetic Switch Driving

The selection system by which the desired magnetic switch row and column windings are pulsed is shown in Fig. 6. Row and column pulses are generated by current drivers and steered through the selected row and column windings by transformer-coupled transistor switches. The transistor switch is selected by a diode decoder with inputs from the flip-flop register which may also be used as a binary counter.

The switch circuit uses an alloy-junction transistor with good saturation properties. A 2N140 is a good example. The decoding network selects one of sixteen switches by injecting a current into the base of the switch transistor to lower collector resistance. A total of two microseconds is sufficient to set the flip-flop register, decode and saturate the transistor switch. The current pulse to the switches is supplied by the current driver. In the experimental system, this pulse was

approximately 50 ma in amplitude, 5  $\mu$ sec wide at the base and had a rise and fall time of about 1  $\mu$ sec. This current is steered through the selected transformer and switch winding. Since the transformer turns ratio is 10:1, secondary currents to the row and column windings of the magnetic switch are about 500 ma.

Using a transistor as a saturating switch has two advantages. Power dissipation for a given current is a minimum and transistor response time does not limit the rise and fall times of the applied current pulse. The time required to bring a transistor in and out of saturation is the only limit set by transistor frequency response.

### Regeneration Network

A block diagram of the regeneration loop for each of the seven pairs of storage plates is also shown in Fig. 6. One end of the digit rewrite winding linking the 512 apertures in a pair of ferrite plates is grounded. The other end is connected to both the sense amplifier and the digit rewrite amplifier. During the read portion of a memory cycle, voltage at the input of the sense amplifier is about 20 mv, while during the rewrite portion the sum of 511 disturb voltages may be as high as 1 v. Since it is polarity rather than amplitude of the output signal which determines the contents of a location, the first stage of the sense amplifier can be d-c coupled, without special precautions against drift. The discriminator in the sense amplifier senses the polarity difference between the output voltage of the first stage at the time of sensing and the output

one microsecond earlier.

A circuit diagram of the sense amplifier is shown in Fig. 7. It was designed to recover its sensitivity within 2  $\mu$ sec after the end of the disturbance due to the digit rewrite pulse.

The first stage  $Q_1$  is a linear amplifier for memory output signals and is cut off during the digit rewrite signal. Transistor  $Q_1$  is cut off to avoid saturation and long turn-on times by a -6-v pulse. The pulse, which is transmitted directly to the emitter of  $Q_1$  through  $D_2$ , is sufficient to overcome the digit rewrite voltage. Emitter resistor  $R_1$  controls the mean current through  $Q_1$  and therefore the level of the mean collector voltage when amplification takes place. Capacitor  $C_1$  acts as a bypass to prevent degeneration. If plate  $b$  of  $C_1$  were returned to ground, the antiparalysis pulse would cause the capacitor to charge and the amplifier would require an appreciable time to recover its initial state. Instead, plate  $b$  of  $C_1$  is returned to diode  $D_1$ , which passes current during the sensitive period of the amplifier and presents a low impedance to small a-c signals. The antiparalysis pulse which applies a negative voltage to plate  $a$  of  $C_1$ , applies a slightly greater negative voltage pulse to plate  $b$ . Plate  $a$  of  $C_1$  charges to approximately -3 v and plate  $b$  to approximately -5 v during the application of the antiparalysis pulse. When the pulse terminates,  $C_1$  is polarized so that it will be rapidly discharged by  $Q_1$ , whose base, at this time, is at ground potential.

The output of  $Q_1$  feeds emitter follower  $Q_2$ . Diode  $D_1$  passes current before the application of the



strobe pulse. This allows  $C_2$  to store the output level of  $Q_2$  prior to read for comparison with the signal during read. It is this feature which allows the output voltage of  $Q_2$  to drift without affecting circuit operation.

### Network Operation

A typical operation with a negative sense signal input produces an excursion of 2 v at the emitter of  $Q_3$ , cutting off  $D_1$ . Capacitor  $C_2$  still stores the output voltage of  $Q_2$  before the start of the positive voltage excursion of 2 v, and  $Q_3$  and  $D_1$  remain cut off. The strobe pulse is now applied allowing  $D_5$  to conduct and clamping the emitter of  $Q_3$  to the voltage stored by  $C_2$ . Since the emitter of  $Q_2$  is 2 v positive with respect to the emitter of  $Q_3$ ,  $Q_3$  conducts producing a negative output pulse. If the amplifier receives a positive signal input, the output of  $Q_2$  goes negative and  $Q_3$  remains cut off during the strobe period.

The digit rewrite driver uses complementary symmetry to either push or pull current through the

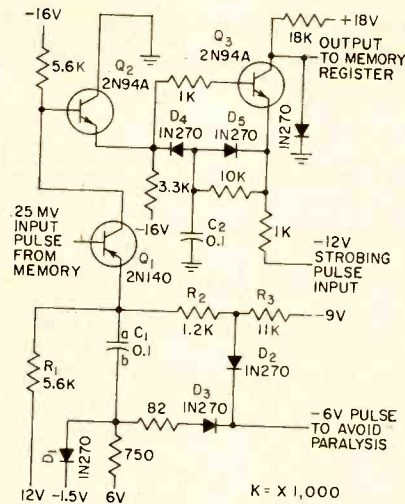

FIG. 7—Sense amplifier recovers within 2  $\mu$ sec after a digit rewrite pulse

digit rewrite winding. The circuit consists of 2 pnp and 2 npn transistors which supply current pulses of approximately 100 ma at 1 v with leading and trailing edges of approximately 1  $\mu$ sec. The current drivers, used to excite the magnetic switch, use two transistors each. They are required to supply 50 ma pulses at 16 v, with rise and fall

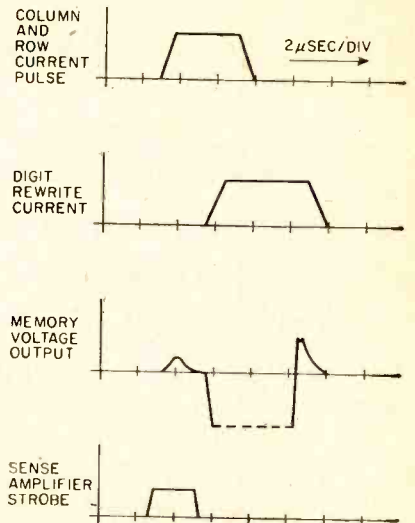

FIG. 8—Total access time for experimental memory is 10  $\mu$ sec

times of approximately 1  $\mu$ sec. Rise and fall times are controlled by limiting the maximum positive and negative excursions at the current driver output. The remaining circuits associated with the experimental memory are conventional.

Timing of the memory cycle is shown in Fig. 8. The row and column currents are approximately 5  $\mu$ sec wide at the base. The 5  $\mu$ sec time interval is distributed as follows. Approximately 1  $\mu$ sec is required for the leading edge. The slow rise time prevents generation of noise currents in partially selected switch locations. Flux switching in the selected memory location starts just before the row and column pulses reach their peak, and continues for approximately 2  $\mu$ sec. Two  $\mu$ sec are allowed for propagation time through the regeneration loop before the pulse terminates.

Flux switching which occurs during write takes approximately 2  $\mu$ sec with another  $\mu$ sec allowed for decay of the digit rewrite current. Total cycle time is approximately 8  $\mu$ sec. Total access time for the experimental memory allowing 2  $\mu$ sec for address selection is 10  $\mu$ sec.

This material was first presented at the 13th Annual NEC. The authors acknowledge the work of T. E. Gilligan.

### REFERENCES

- (1) J. A. Rajchman, Ferrite Apertured Plate for Random Access Memory, *Proc IRE*, 45, p 325, March, 1957.
- (2) J. A. Rajchman, A Myriabit Core Matrix Memory, *Proc IRE*, 41, p 1407, Oct., 1953.

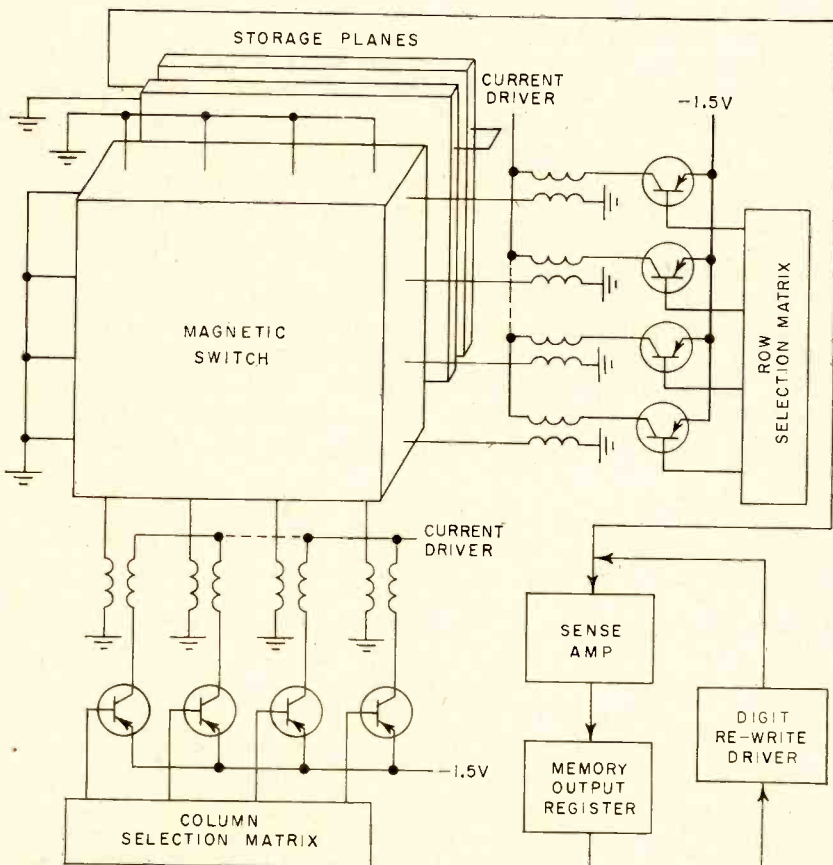

FIG. 6—Selection system for magnetic switch row and column windings and block diagram of regeneration loop for storage plates

# Low-Pass R-C Filter

Design formulas and graphs for one- and two-section low-pass R-C filters are presented. Two-section filter with optimum response effectively falls off at 12 db/octave beyond the constant low-frequency attenuation. When the ratio of shunt capacitors of the two-section network is selected within prescribed limits, an optimum filter is easily designed

By **DUDLEY D. NYE, JR.**

Staff Specialist, Analysis, Eastern Research Center, Robertshaw-Fulton Controls Co., Phila., Pa.

**A**LTHOUGH SINGLE R-C networks are widely used as low-pass filters, an optimum design for the two-section circuit is often overlooked. Low-pass filters seldom need any attenuation before the first breakpoint in the output response. But for a sharp, steep decrease in signal transmission beyond the breakpoint, the output R-C section in the two section filter should have little loading effect on the input section and a time constant equal to that of the first section.

The transfer function of the two-section filter shown in Fig. 1 is

$$M = \frac{1}{S^2 R_1 C_1 R_2 C_2 + S(R_1 C_1 + R_2 C_2 + R_1 C_2) + 1} \quad (1)$$

where  $S$  is the Laplace form for  $j\omega$ . The two roots of Eq. 1 determine the breakpoints of the frequency response shown in Fig. 2. When the roots are equal and consequently the breakpoints co-

incide, the maximum fall-off of 12 db/octave is reached at the single resulting breakpoint. When the roots differ, the response fall-off is 6 db/octave after the first breakpoint and then 12 db/octave beyond the second breakpoint.

### Optimized R-C Circuit

Because straight-line responses are only approximations of the actual response and rounding of the response curve occurs, a constant maximum fall-off of 12 db/octave beyond the flat low-frequency response exists when the roots differ by a minimum amount, or  $R_2/R_1 = (C_1/C_2 + 1)$ . Therefore, an optimum circuit can be designed in which

$$R_2 = (A + 1)R_1 \quad (2)$$

where  $A = C_1/C_2$ . Thus, when  $A$  and  $R_1$  are determined,  $R_2$  can be computed for maximum sharpness<sup>1</sup>.

Values of  $A$  are restricted for

optimum sharpness. The fall-off rate of an optimized filter with  $A = 1$  is not materially greater than that of the equal-component filter, but constant fall-off sharpness is approached as  $A$  is increased. However, the approach to constant fall-off reaches a practical limit as  $A$  is increased beyond 5. A capacitance ratio of 5 is consequently a good value for obtaining constant sharpness.

The roots of the transfer function for the two-section optimized filter are equal to  $(1/R_1 C_1)(1 \pm 1/\sqrt{A + 1})$ . When  $A$  equals infinity, the ratio of the roots is unity. And when  $A$  equals 5, the ratio of 2.38 gives a practical fall-off of 12 db/octave.

The value of  $\omega R_1 C_1$  as a function of the transfer function or transmission ratio  $M$  can be computed for R-C filters from the formulas given with the corresponding circuits in Fig. 1.

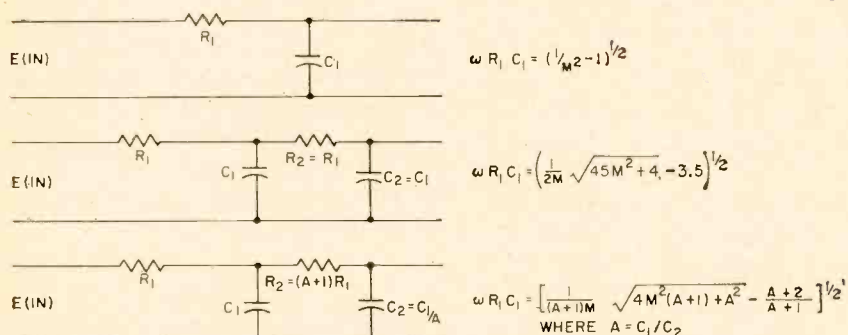

FIG. 1—Three R-C filters with respective design formulas are, from top to bottom, single-section R-C, two-section equal-component and two-section optimized networks

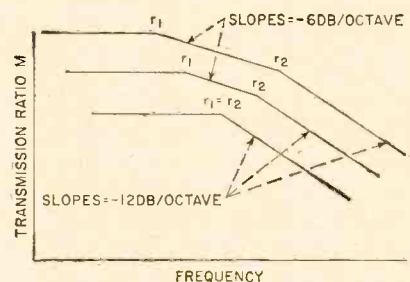

FIG. 2—Frequency-response curves for low-pass R-C networks indicate that equal roots of circuit transfer function gives single constant maximum fall-off. Both scales are logarithmic



# With Optimum Response

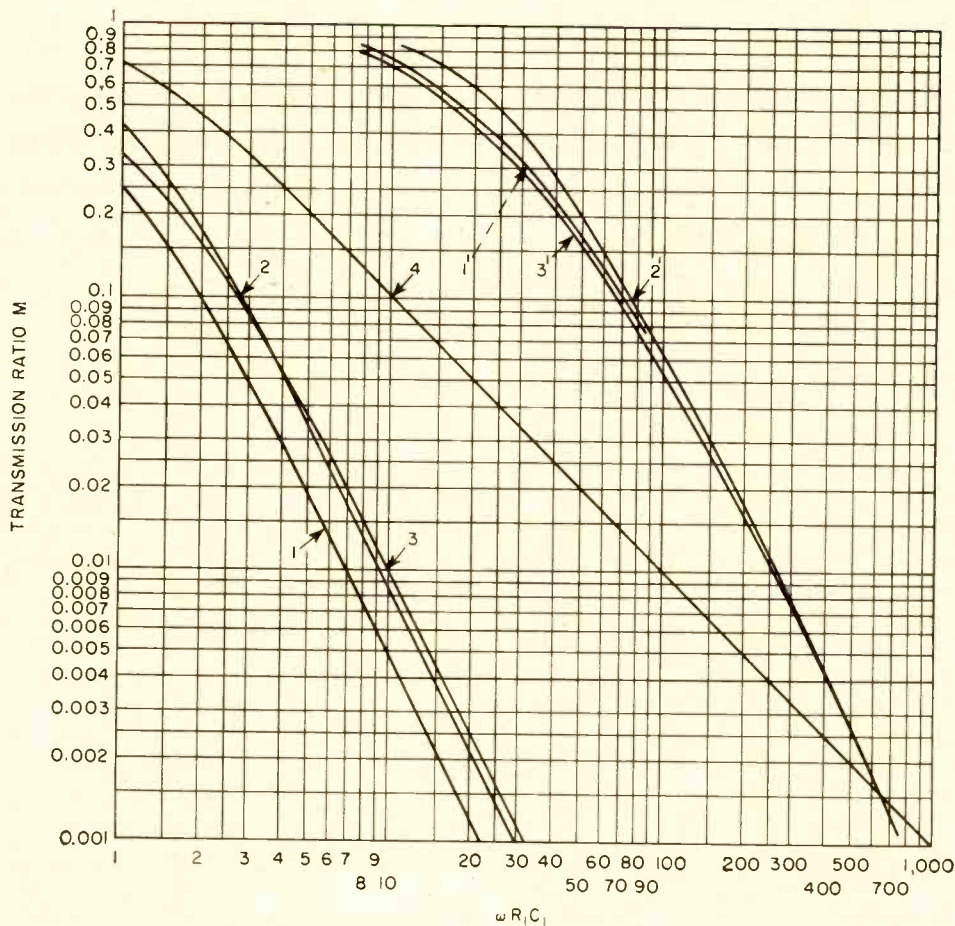

FIG. 3—Filters are designed with frequency-response curves 1, 2, 3 and 4 and then compared to the single-section filter with curves 1', 2' and 3'

Quantity  $\omega R_1 C_1$  can also be determined from the graphical form of the formulas shown by the transmission —  $\omega R_1 C_1$  curves of Fig. 3. Curves 1 and 2 give the responses of the optimized filters with  $A = 1$  and  $A = 5$ . Curve 3 is for an equal component network, and curve 4 is for a single R-C section.

### Design Procedure

First step in designing a one or two-section R-C filter is to select  $C_1$  and  $A$  in the optimized circuit by considering component sizes, available values and prices. Then determine  $\omega R_1 C_1$  as a function of the required  $M$  from curves 1, 2, 3 or 4 in Fig. 3, or by the appropriate formula of Fig. 1. Divide  $\omega R_1 C_1$  by  $\omega C_1$  to determine  $R_1$ . Finally, find  $R_2$  for the

two-section networks from the formulas in Fig. 1 or from Eq. 2.

As a design example, suppose that a transmission ratio of 0.0015 at 60 cps is to be obtained with the optimized two-section filter and a capacitor ratio  $A$  equal to unity. Capacitors  $C_1$  and  $C_2$  are chosen as  $0.5 \mu\text{f}$  from size considerations. Curve 1 of Fig. 3 indicates that  $\omega R_1 C_1$  is 18. Then  $R_1 = 18 / (2 \pi 60 \times 0.5 \times 10^{-6}) = 95,500$  ohms. From Fig. 1 or Eq. 2,  $R_2 = 2R_1 = 191,000$  ohms. Thus all parameters are determined.

The transmission responses for the four filters, adjusted for any desired transmission at a particular frequency, may be compared by shifting curves 1, 2 and 3 horizontally to intersect with curve 4 at the desired transmission ratio  $M$ .

When the curves are shifted to intersect curve 4 at the transmission ratio of 0.0015 they appear as curves 1', 2' and 3' in Fig. 3. Now the frequency responses of the two-section filters can be compared to a single section filter at any level. For example at a 3-db loss, which corresponds to a transmission ratio of 0.7, the frequency of the equal-component circuit is 9.8 times the frequency of the single-section. Frequencies of optimized circuits with  $A = 1$  and  $A = 5$  are 10.6 and 14.9 times the frequency of the single-section filter.

### REFERENCE

- (1) C. E. Mason, Some Basic Studies in Proportional Control, progress report ASME Special Research Committee on Automatic Regulation Theory, p 30. Oct. 1949.

# Temperature Rise Chart

Heat-rise evaluation of equipment is possible through measurement of resistance change in a copper-wire component. Transformers, inductors, relays, motors and generators are among the devices which may be checked by this technique. Temperature change is shown directly in deg C when resistance change during operational warmup is known

By DONALD ARANY, Supervisory Engineer, Hazeltine Corp., Little Neck, N. Y.

**E**QUIPMENT OPERATIONAL specifications often require electronic components to operate over an ambient temperature range of as much as  $-55$  to  $+65$  C.

The graph of Fig. 1 is based on the technique of determining internal temperature of a component by measuring the variation in resistance of a winding. It is

applicable to any unit using copper wire. Similar graphs might be made for other conductor materials and temperatures.

By definition the temperature coefficient of resistance  $\alpha$  is  $(1/R) (dR/dT)$ . Since  $\alpha$  varies in a known manner over the temperature range 0-100 C, for copper of 100 percent conductivity,  $\alpha$  equals  $R/(234.5 + T)$ .

Equating the two formulas and integrating, we obtain  $\Delta T = [(R/R_c) - 1] (234.5 + T_c)$ , where  $\Delta T$  is the winding temperature rise in deg C,  $R$  is the hot resistance in ohms,  $R_c$  is the cold resistance in ohms and  $T_c$  is the final winding temperature.

## Using the Chart

Suppose we are measuring the temperature rise of a transformer where  $R_c = 100$  ohms at 20 C. The resistance measurement is typically accomplished with a Wheatstone bridge. Selection of the highest resistance winding will generally result in greatest accuracy.

Several hours later, after thermal equilibrium has been reached, the hot resistance  $R$  is found to be 108 ohms at 25 C. The ratio  $R/R_c$  is thus 1.08. Finding the intersection of the right-hand scale and line  $T = 20$ , we read 20 deg on the top scale. Since the ambient temperature variation during the test was +5 deg, the final transformer temperature rise  $\Delta T$  is 15 C.

To demonstrate use of the expanded scale, suppose  $R_c$  measures 50 ohms at 55 C. Sometime later a hot resistance  $R$  of 60 ohms is measured at an external ambient temperature of 55 C. The ratio  $R/R_c$  thus equals 1.2. Passing from the left-hand ordinate over to the  $T = 55$  line, and then directly down, we read  $\Delta T = 58$  C.

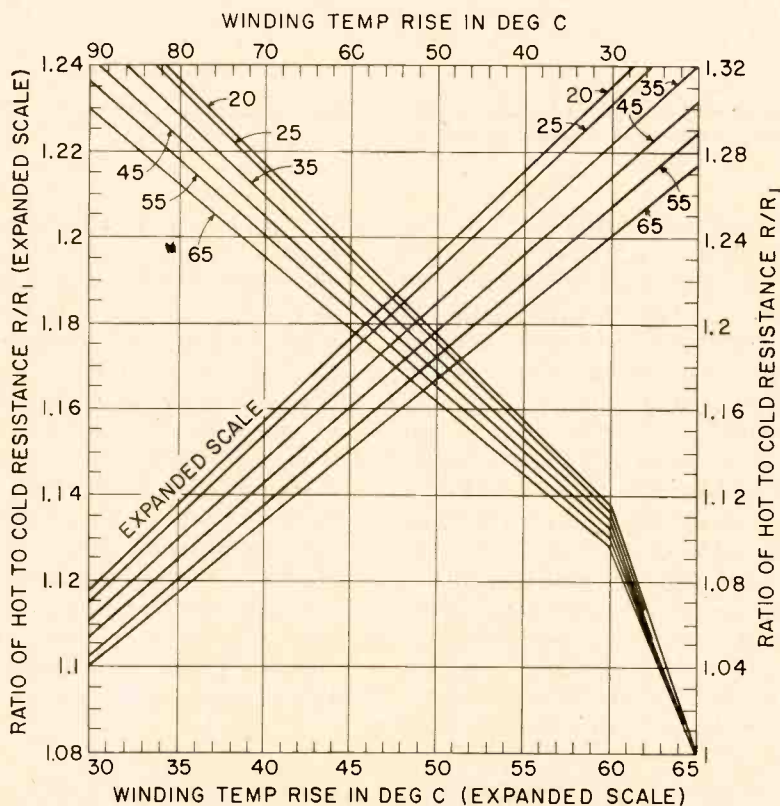

FIG. 1—Two scales are presented on chart for greater convenience. Numbers on curves refer to initial winding temperature in deg C





# Control Regulates Iron Lung

MECHANICAL respirators such as the iron lung have been sustaining the life of patients with respiratory paralysis for a long time. However, they do not regulate air intake automatically according to need.

A feedback control system to overcome this problem was designed and constructed by G. H. Meyers of Bell Labs and G. A. Saxton, Jr., of the University of Ill. School of Medicine. It regulates oxygen intake according to needs by incorporating the patient in the control loop.

The system is shown in Fig. 1. Air exhaled by the patient is analyzed for carbon-dioxide concentration. A narrow plastic tube is fixed under one nostril with a small piece of adhesive tape; the other end is attached to the analyzer. Less than ten percent of the patient's expired

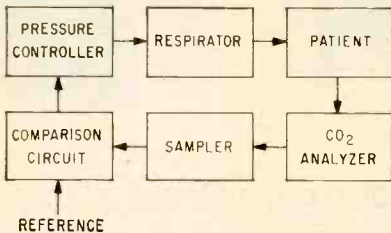

FIG. 1—Feedback control system includes patient in loop to regulate depth of breathing according to body needs

air is drawn through the analyzer by a small pump. This technique permits analysis of the patient's breath without discomfort to him.

The carbon-dioxide analyzer is a commercial instrument that detects CO<sub>2</sub> concentration by infrared absorption and provides an electrical output proportional to the amount of carbon dioxide in a gas passed through it.

The analyzer output is compared with a reference. If a difference exists, the error signal actuates a bleeder valve on the iron lung, causing it to readjust the depth of breathing.

The sampler circuit is shown in Fig. 2. Input is amplified by V<sub>1</sub> and applied through cathode follower V<sub>2</sub>. The signal taken from the junction of R<sub>1</sub> and C<sub>1</sub> is applied to a Schmitt trigger circuit, V<sub>3</sub>. Tube V<sub>4</sub>,

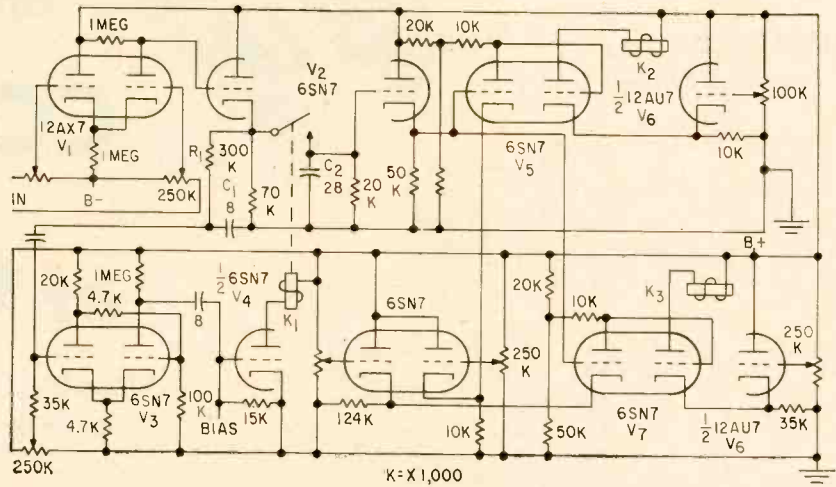

FIG. 2—Sampler circuit charges C<sub>2</sub> to level dependent on carbon-dioxide concentration. Comparison circuit controls relays K<sub>2</sub> and K<sub>3</sub> so that iron lung bleeder valve compensates errors

closes relay K<sub>1</sub> for a short time during exhalation. Sampling capacitor C<sub>2</sub> charges to a value depending on expired carbon-dioxide concentration.

Maximum and minimum limits are set for carbon-dioxide concentration. Tubes V<sub>5</sub> and V<sub>6</sub> and relay K<sub>2</sub> establish the upper limit; V<sub>7</sub>, the other half of V<sub>6</sub> and relay K<sub>3</sub> establish the lower limit.

Biases are adjusted so that relay

K<sub>2</sub> is energized and relay K<sub>3</sub> is deenergized when carbon-dioxide level is within limits. When carbon-dioxide concentration is low, relay K<sub>3</sub> is also energized. When it is high, both relays are deenergized.

If concentration exceeds either limit, power is applied by the relays to a motor that is geared to the bleeder valve on the iron lung. The motor drives the valve in a direction that will correct the error.

## Neon Oscillator Rings

By RONALD L. IVES Palo Alto, Calif.

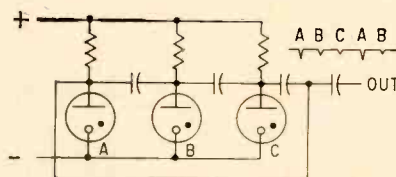

FIG. 1—Deliberate mismatching of components is required to make the neon lamps in this ring-of-three oscillator fire in sequence

NEON RING oscillators may be applied to a variety of sequential switching operations. Rings of three, four and five lamps can be constructed using available components with reasonable assurance of consistent behavior during the useful life of the neon lamps.

These oscillators require limited power and offer operating cycles of

various lengths in the audio and subaudio frequencies.

One form of a two-lamp oscillator, which provides sequential output pulses of alternating polarity, was described in *ELECTRONICS*, pp 110-112, May 23, 1958. The ring of three shown in Fig. 1 has a consistent direction of rotation only if

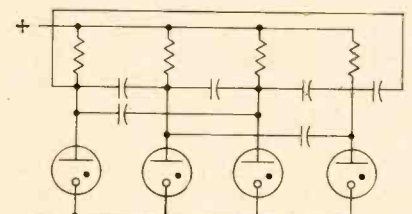

FIG. 2—Although ring-of-four cross-connected oscillator will fire in sequence, order of firing is difficult to establish



# CLIFTON PRECISION SIZE 8 ROTARY COMPONENTS UNCHANGED AND PROVEN

MORE THAN 30,000 SHIPPED TO CUSTOMERS OVER THE PAST THREE YEARS

ACTUAL SIZE

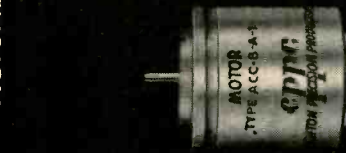

**SERVO MOTOR**

Input Power (total) 3.8 watts  
Stall Torque .15 oz in min.  
.20 oz in nom.  
Max. Weight 29 gms.



**SERVO MOTOR**

Input Power (total) 5.6 watts  
Stall Torque .3 oz in min.  
No Load Speed 6500 rpm min.



**MOTOR GENERATOR**

Generator:  
Input Voltage 10 v  
Output Voltage 0.13 v / 1000 rpm max.



**DC MOTOR**

Output Power 4.0 watts  
No Load Speed 20,000 rpm  
Input Voltage 28 v DC



**LINEAR TRANSFORMER**

Linearity .5%  
Null E at EZ .015 v  
Phase Shift 15 deg. lead



**TRANSMITTER**

Accuracy 7' error max.  
Null 30 mv max.  
Phase Shift 8.5 deg. lead



**RECEIVER**

Accuracy 30' max.  
error spread  
Torque Gradient 2200 mg-mm/deg.  
Input Power .54 watts



**CONTROL TRANSFORMER**

Accuracy 7' error max.  
Null 30 mv max.  
Phase Shift 8.5 deg. lead



**DIFFERENTIAL**

Accuracy 7' error max.  
Null 30 mv max.  
Phase Shift 9 deg. lead



**RESOLVER**

Accuracy 7' error max.  
Null 30 mv max.  
Phase Shift 11 deg. lead

LOOK TO CPPE FOR SYNCHRO PROGRESS

**CLIFTON PRECISION PRODUCTS CO. INC.**

Clifton Heights, Pennsylvania

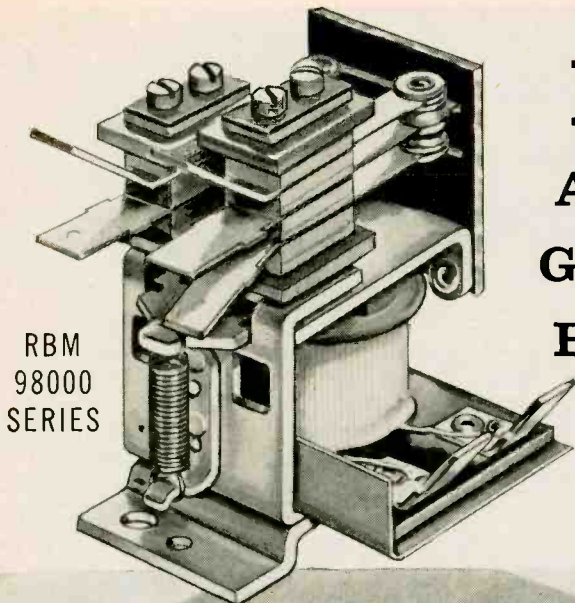

RBM  
98000  
SERIES

# RBM

## AC OR DC

## GENERAL

## PURPOSE

## RELAY

Since the basic relay and its many contact forms, ratings, and terminal variations are regular production items at RBM, design bottlenecks can be shattered. RBM has "CUSTOMER-ized" these relays to fulfill almost every conceivable requirement. This vast background of application engineering can serve you with design shortcuts... lower your "finished product" cost. Ask your RBM product application engineer.

**RBM'S VERSATILITY PERMITS ENGINEERING SHORT-CUTS  
THAT LOWER YOUR "FINISHED PRODUCT" COST!**

MANY ARE LISTED BY U/L  
FILE NOS. E 12139 OR E 22381



PRESSFIT PILE-UP  
ELIMINATES DRIFT,  
ASSURES CONTACT  
STABILITY

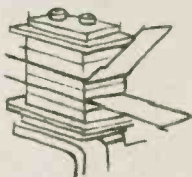

DEPENDABLE CROSS-BAR  
CONTACTS AVAILABLE  
FOR LOW VOLTAGE AND/OR  
LOW CURRENT CIRCUITS

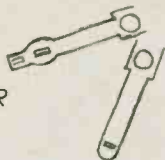

SIMPLIFIED MAGNET  
FRAME AND ARMATURE  
ASSEMBLY PROVIDES  
EFFICIENT, POSITIVE  
ACTION

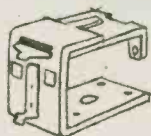

VARIETY OF  
MOUNTINGS AVAILABLE

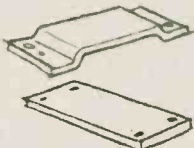

### OTHER FEATURES

	A.C. 98700 TYPE	D.C. 98600 TYPE
• MAX. COIL VOLTAGE	230 AC	115 DC
• MAX. COIL RES. IN OHMS	—	20000
• MAX. COIL WATTS OR VOLT AMPS.	9.0 VA. INRUSH 6.5 VA. SEALED	4.0 W.
• MAX. CONTACT FORM WITH RATED CURRENT AT 32 V. DC OR 115 V. AC (NON-INDUCTIVE LOAD)	2 PDT 15 AMPS. 4 PDT 6 AMPS. 6 PDT 3 AMPS	2 PDT 15 AMPS. 4 PDT 6 AMPS. 6 PDT 3 AMPS.
• APPROX. WEIGHT	4.1 OZ.	4.1 OZ.

ALSO AVAILABLE IN 97000 SERIES  
PROVIDING ADDITIONAL COIL  
POWER... GREATER SENSITIVITY

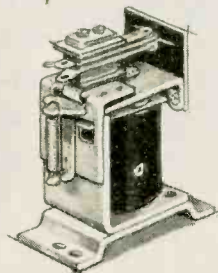

# RBM Controls Division

ESSEX WIRE CORPORATION, LOGANSPORT, INDIANA

Consult Your Local RBM Product Application Engineer or Write For Bulletin 1060



the components are mismatched.

The cross-coupled ring of four in Fig. 2 will perform consistently for some thousands of cycles with deliberately mismatched components. However, it performs erratically with matched components and is always hard to adjust for a specific firing order.

A group of neon rings was developed that maintains a fixed sequence of firing. The most flexible and also the simplest is shown in Fig. 3.

When first turned on, one of the lamps fires because of inherent inequalities in lamp properties, components or other factors. Firing causes about a 15-volt drop in anode potential of the conducting tube. This initial drop is coupled to all other anodes by capacitors, preventing the other lamps from firing.

As conduction continues, voltage on the other anodes rises as the anode capacitors are charged positively. However, the capacitors in the anode circuit of the conducting lamp are charged negatively because of conduction. When anode voltage of the conducting lamp falls below extinction value, conduction stops. The resulting rise in anode voltage is coupled to all other lamps in the ring by the anode capacitors.

Diodes are used in the cathode circuits to ensure that the next lamp

in the sequence fires with the rise in anode voltage. When the original lamp was conducting, bias voltage was produced on its cathode. Part of this bias was applied through a diode to the lamp at the left. In turn, part of this was coupled to the lamp to the left of that. Finally, the smallest part of the bias was coupled to the cathode of the lamp to the right of the originally conducting lamp.

The rise in anode voltage that occurred when the originally conducting lamp was extinguished causes the lamp at the right to conduct because this lamp has the most favorable cathode bias for conduction.

Cathode-to-ground capacitors keep cathode biases substantially constant during switching. Actual bias voltages, measured in a ring of five in operation, are shown in Fig. 4. These voltages are considerably higher than those indicated by purely resistive computation because of storage in the cathode-to-ground capacitors. Accordingly, these bias voltages can be modified somewhat by changing capacitor values. In this circuit, they can be varied from about 0.5 to 0.05  $C$  without impairing performance. However, all capacitors must have the same value.

A somewhat empirical formula

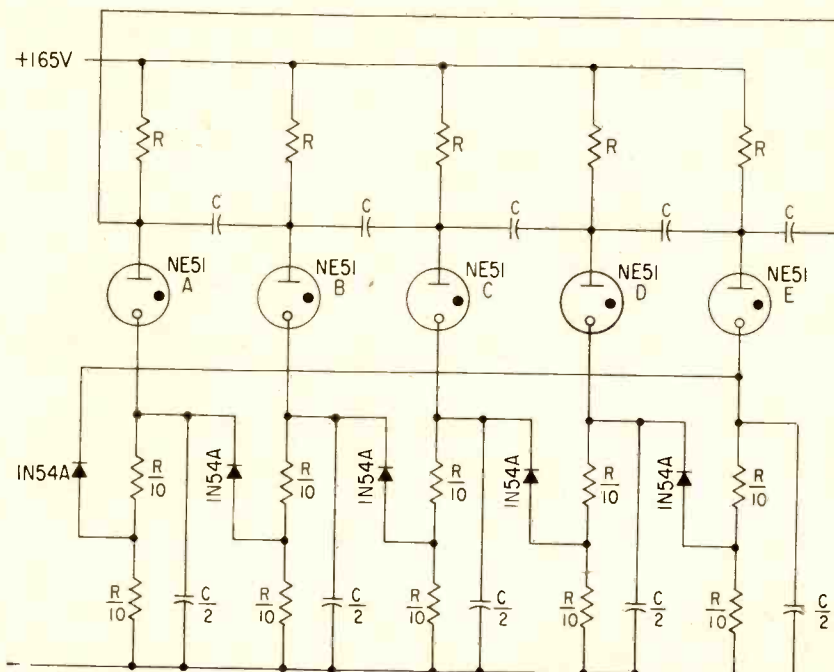
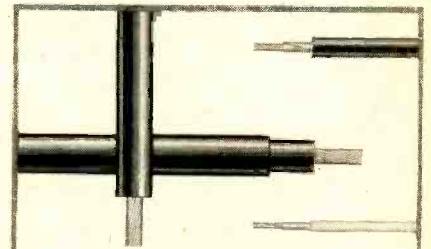

FIG. 3—By coupling different portions of bias from conducting lamp to other lamps, lamp with most favorable bias will be next to conduct



They can be your design assistants on other Essex Engineered Products.



### WIRE AND CABLE

A complete line of appliance wiring material, radio, television and electronic hook-up wire, 200°C high temperature Sil-X wire, automotive wires and cables, and flexible cards.

Wire and Cable Div., Ft. Wayne, Ind.

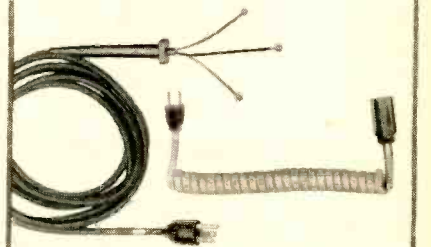

### COILED CORDS-CORD SETS

Prime source for plastic and rubber power supply cords. Terminations of all types (molded plastic and rubber) with infinite design possibilities. Complete line of Coiled Cards including HPN.

Write for Coiled Cords Literature Cords Limited Division, DeKalb, Ill.



### TYPE MS RELAY

A low cost, space saving single pole or common multiple contact D.C. unit. Highly reliable. Can be built to withstand extreme environmental conditions.

Write for Bulletin MS-3 R-B-M Control Div., Logansport, Ind.



**ESSEX**  
WIRE CORPORATION

CIRCLE 76 READERS SERVICE CARD



## ... now wind 19,000 times!

If you're dedicated to the cause of high resolution, you could wind your *own* pots and be sure. Allow yourself plenty of time, though — because the secret's in the number of turns per inch, and the spacing between 'em. Pack those turns right in there *closely* and *accurately*, and you *might* have a pot you'll be proud of!

But if you want to eliminate all bother, but not the high resolution, call on Ace! We've designed and built our own special winding equipment; we use premium, close tolerance resistance wire — and really leave no winding unturned to produce pots with the highest resolution in the industry. All AIA sizes, all mounting styles, specials and standards. So get your resolution the easy way — get Acepots! See your ACErep at once!

Here's highest resolution in a standard sub-miniature pot: The 500 Acepot® ½" size, ±0.3% independent linearity. Special prototype section insures prompt delivery on the Acepot® — ½" to 6". AIA sizes.



**ACE** ELECTRONICS ASSOCIATES, INC.  
 99 Dover Street, Somerville 44, Mass.  
 Somerset 6-5130 TMX SMVL 181 West. Union WUX  
 Acepot® Acetrim® Acesel® Aceohm® \*Reg. Appl. for

for performance of this neon ring oscillator is

$$T = 2.303 RC \log_{10} \frac{E_s - E_e}{E_s - E_f}$$

where  $T$  is time of one cycle in sec (from first to second firing of same lamp),  $R$  is resistance in meg,  $C$  is capacitance in  $\mu\text{f}$ ,  $E_s$  is supply voltage,  $E_f$  is firing voltage and  $E_e$  is extinction voltage.

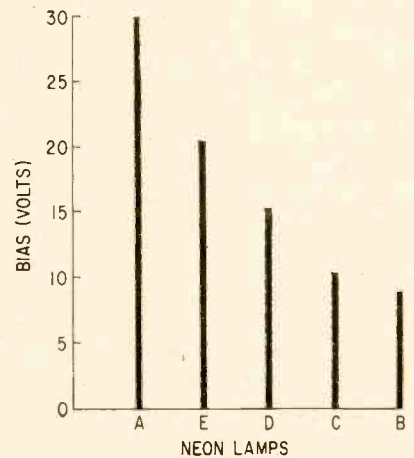

FIG. 4—Bias voltages on lamp cathodes are higher than might be expected because cathode capacitors store charge

If  $R$  in megohms is very much larger than  $C$  in microfarads, the formula holds within about 10 percent for cycles from 0.01 to 5 sec. Under these conditions, the neon lamps operate almost as independent oscillators. The triggering pulse from a lamp just extinguished comes nearly at the time anode voltage has risen to the firing level.

As the  $R$ - $C$  ratio falls below about 10,  $T$  decreases because triggering takes place before anode voltage has reached normal firing voltage.

With  $C = 0.5 \mu\text{f}$  and  $R = 10$  meg,  $T$  was found to be one second with a measurement accuracy of  $\pm 0.01$  sec. Computed time for  $T$  is 0.98 sec. Doubling  $R$  to 20 meg increases time to 2.02 sec, as might be expected from the formula. However, quadrupling  $C$  to  $2 \mu\text{f}$  only increases  $T$  to 2.8 sec.

At higher frequencies, the formula does not hold regardless of  $R$ - $C$  ratio. This is largely because it does not take into account times of deionization, reionization and switching transient. Bias variations during conduction are also not taken into account by the formula.

As with other gas-tube oscil-



IMMEDIATE DELIVERY

# 15kw S-Band Amplifier Klystron has no heavy magnets

Exclusive Space-Charge Focus cuts weight to only 6½ lbs.

### SAS-61 SPECIFICATIONS

Frequency Range . . . . . 2700 to 2900 mc  
 Heating Time . . . . . 90 sec.  
 Peak Power Output . . . . . 15 kw  
 Maximum Drive Power . . . . . 30w  
 Power Gain . . . . . 30 db

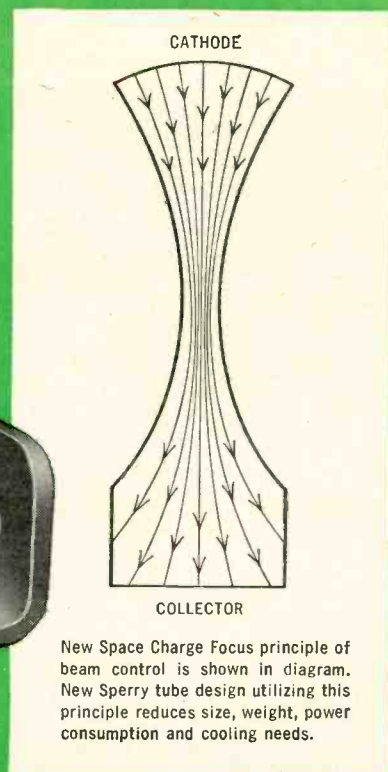

New Space Charge Focus principle of beam control is shown in diagram. New Sperry tube design utilizing this principle reduces size, weight, power consumption and cooling needs.

Available for immediate delivery, Sperry's new S-band transmitting tube is a 3-cavity pulse amplifier of high gain and extra-long service life.

Exclusive Sperry Space-Charge Focusing design eliminates heavy, cumbersome magnetic structures—a feature of prime importance in equipment design. Although the SAS-61 weighs only 6½ lbs., its sturdy construction withstands extreme vibration and environmental conditions.

Main applications for the SAS-61 are as an output tube in low-power radars, or as a driver for higher-powered klystrons in radar and linear accelerator systems. Its unusually long service life, however, makes it highly desirable for any application requiring 15 kw in the S-band. The SAS-61

with its internal tunable cavities is a complete microwave unit. No external equipment is required.

Sperry can deliver SAS-61 tubes in quantity at once. Write or phone your nearest Sperry district office.

**ELECTRONIC TUBE DIVISION**  
**SPERRY GYROSCOPE COMPANY**  
 Great Neck, New York

DIVISION OF SPERRY RAND CORPORATION  
 CLEVELAND • NEW ORLEANS • BROOKLYN • LOS ANGELES •  
 SAN FRANCISCO • SEATTLE • IN CANADA: SPERRY GYROSCOPE  
 COMPANY OF CANADA, LIMITED, MONTREAL, QUEBEC

# For Highest Dependability



## SELENIUM RECTIFIERS

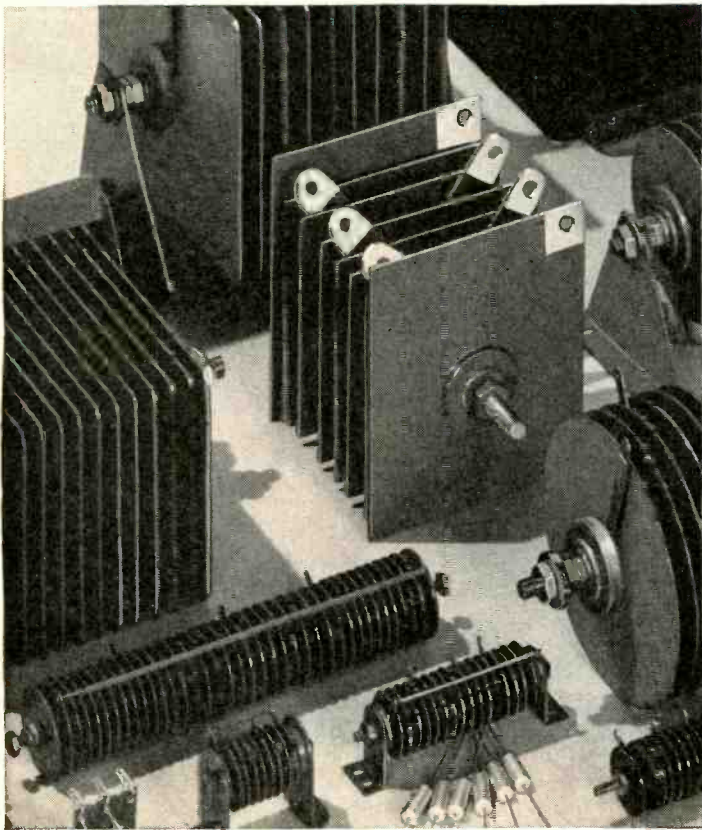

**First in Preference, because of**

- High Reliability
- Wide Range of Sizes, Ratings, Circuits
- Quick Delivery

(Many stack sizes available from stock)

**Write for Bulletins**

**FANSTEEL METALLURGICAL CORPORATION**

North Chicago, Illinois, U.S.A.

E586A

DEPENDABLE RECTIFIERS SINCE 1924

lators, great changes in illumination cause small changes in period. Changes of period are of the order of one percent when illumination is raised from 30 to 1,000 foot-candles. These changes are consistent.

Placing a ring of five in an environment where beta-gamma is 50,000 counts/minute causes both rate and sequence to become erratic. Removal restores rate and sequence promptly.

Control signals can be tapped from a neon ring in a number of places, the most suitable being the cathodes. With a capacitive tap on a lamp cathode in Fig. 3, output is a positive-going wave of about 3 volts amplitude with  $R = 10$  meg and  $C = 0.5 \mu f$ . Amplitude can be increased to about 12 volts by reducing cathode-to-ground capacitance.

A tap may be taken from any lamp cathode to the grid of a tube. With suitable cathode bias on the tube, it can be biased on by the neon ring for 1, 2, 3, 4 or 5 fifths of a complete cycle. The 4/5 position requires close differential operation in that the bias change is much smaller.

Characteristics of available components place a definite limit on the number of lamps in a neon ring. Using 10-percent components and neon lamps with firing and extinction voltages within  $\pm 1$  volt of each other, rings of three can be made on a production basis. Rings of five require 5-percent components and lamp characteristics within  $\pm 0.5$  volt.

Good system grounding and protection from line surges and static discharges are essential for consistent operation.

A ring of eight requires the same circuit precautions, one-percent components, lamps matched within 0.25 volt and uniform illumination (level not critical). Because lamp characteristics change with use, no ring of eight tested would operate for as many as 100,000 cycles. Aging of lamps did not result in much improvement.

In practice, rings of more than five lamps can be made to work, but their usefulness is limited by instability of neon lamps now commercially available and their sensitivity



to extraneous influences. Although great extension of these ring oscillators is theoretically possible, cost of construction and maintenance increase as approximately the factorial of the number of lamps.

Experiments were made with cross connection of anode capacitors such as shown in Fig. 2. For rings of four and more neon lamps, there was a slight improvement in consistency (perhaps 10 percent). But the cross connection becomes inordinately bulky and costly as the number of lamps increases. For example, in a ring of 10 lamps using cross connection, 45 capacitors are required.

### Calibrator Plots ADF Errors

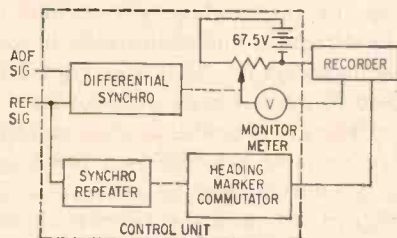

FIG. 1—Continuous plot of radio compass errors is made by comparing direction finder antenna position to gyro compass reference

FASTER and less costly determination of errors in aircraft radio direction finders may be possible with a new portable calibrator. The instrument, undergoing flight evaluation, provides a continuous record for all azimuth angles.

The calibrator was designed by Airborne Instruments, a division of Cutler-Hammer, in cooperation with Navy Bureau of Aeronautics.

Aircraft radio direction finders do not always point directly to the radio source. Existence and magnitude of errors depend on radio frequency, aircraft design, type of antenna installation and other factors not under the control of the designer or user of the radio compass.

These errors can be compensated, but first their direction and magnitude must be measured. The ADF calibrator is designed to provide an accurate, continuous record of the error of a direction finder.

The instrument comprises a con-

**2½ Times**  
**More Amperage**  
 at  
**NO INCREASE** in size

## New **FANSTEEL**<sup>®</sup> SILICON RECTIFIERS

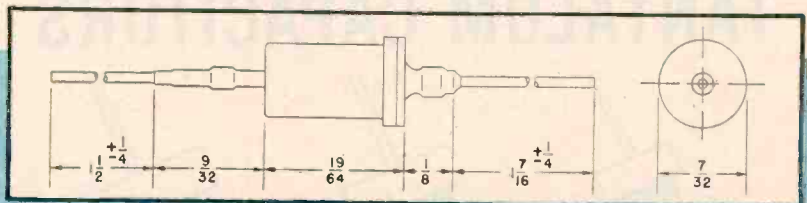

Catalog Nos.

1N1644  
 1N1645  
 1N1646  
 1N1647  
 1N1648  
 1N1649  
 1N1650  
 1N1651  
 1N1652  
 1N1653

- Rated at **750** milliamperes yet so small in size.
- Peak reverse voltage range **50-600** volts
- Reliable performance in temperatures up to **165°C**

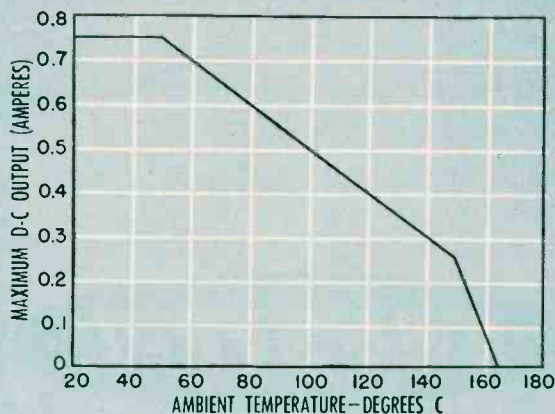

Write for New Bulletin 6.302

**FANSTEEL METALLURGICAL CORPORATION**

North Chicago, Illinois, U. S. A.

E535A

**DEPENDABLE RECTIFIERS SINCE 1924**

# Now for the *FIRST TIME*

## NEW

### FANSTEEL

# BLU-CAP\*

## TANTALUM CAPACITORS

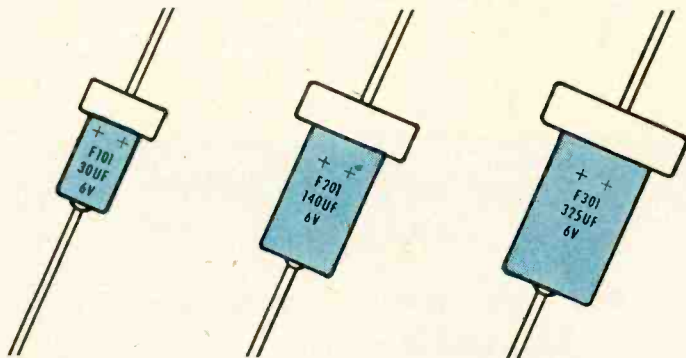

Developed by Fansteel to meet the current demand for a dependable, utility tantalum capacitor at prices that will fit it into almost any product where capacitor reliability in small sizes is desired.

Fansteel BLU-CAP Capacitors are made in ratings from 1.75 to 325 mfd., 6 to 125 wvdc.

Engineering samples are available. Full details in Bulletin 6.120.

\*Trademark



**FANSTEEL METALLURGICAL CORPORATION**

North Chicago, Illinois, U. S. A.

C588A

RELIABLE TANTALUM CAPACITORS SINCE 1930

ventional chart recorder and a data converter control unit. Because of limited cockpit panel space in many aircraft, the control unit is mounted on the pilot's knee during the calibration flight. However, it can be mounted on the panel. The recorder may be placed at any available spot.

A block diagram of the calibrator is shown in Fig. 1. Synchro signals from the ADF antenna and from a stable directional reference such as a gyro-stabilized compass are compared by a differential synchro. As the aircraft flies a circular pattern over the ground radio station, the differential synchro shaft rotates in a direction and to a position determined by the error.

The differential shaft positions a potentiometer that picks off an analog of the error from a 67.5-volt battery. The polarity and magnitude of this voltage correspond to the direction and magnitude of the compass error. This d-c signal is used to drive the chart recorder.

Present procedures for making error charts are based on point-by-point measurements. One method requires turning the aircraft slowly on the ground and using a compass rose and optical sighting. Another requires flying clover-leaf patterns over a fixed point.

For low and medium-frequency compasses, point-by-point methods may be adequate. Errors usually change slowly over large angular regions. However, local reflections from power lines, proximity of the ground and other factors can affect accuracy.

With uhf direction finders, the problem has become more serious. The error curve is much less predictable with large changes occurring over a few degrees. In addition, error is often seriously affected by external aircraft equipment such as fuel tanks and armament racks. For these reasons, almost continuous sampling is required.

The photopanel method of making error charts provides greater accuracy than point-by-point methods. It involves making a photographic record of gyro and radio compass readings in one-degree increments. However, processing results is a formidable task.

The calibrator was compared



with the point-by-point and photopanel methods. The calibrator was claimed to be faster and to have better repeatability. Accuracy was said to be better than the point-by-point methods and about equal to the photopanel method. And, with the calibrator, results are available immediately.

## Selective Calling Tested for Aircraft

TRANSISTORIZED circuits and modular construction are featured in a new aircraft selective calling system design now under test by Motorola. The new design uses computer pulse techniques to signal aircraft singly or in groups.

Operation is similar to that of Motorola's Selcal systems, but new techniques are employed in the design. These systems relieve pilots of continually monitoring radio channels, thereby increasing safety.

An in-flight alerting device—a bell, light or other signal—is activated whenever a radio message is intended for the particular aircraft. Activation of these devices in the aircraft selected is accomplished through a code transmitted along with the message and decoded by the airborne decoder units.

"Capabilities of the new system surpass existing equipment," Motorola engineers report, "in that all digits from 00000 to 99999 are acceptable." It is claimed that selected planes can be called in a fraction of a second with extreme reliability.

A newly developed group-calling feature permits alerting of all decoders in transmitter range, or of selected subgroups as determined by the operator. Code signals can be transmitted over single sideband, a-m or f-m radio and relayed to remote transmitter sites over carrier telephone links.

The decoder can be switched to respond to over 100,000 possible calls with equal reliability. Codes are easily set up, checked and switched by means of five rotary switches controlled from the front panel. For operation on more than one channel, decoders can be stacked within the aircraft.

# Now for the FIRST TIME

# NEW

## FANSTEEL SOLID TANTALUM S-T-A CAPACITORS AT 60 VOLTS (wvdc)

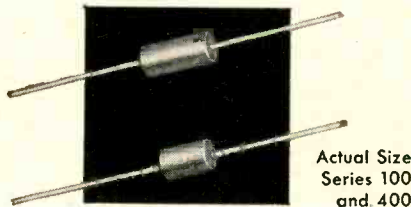

Actual Size Series 100 and 400

Unsurpassed reliability, sub-miniature sizes, extremely low leakage (less than 3 micro-amperes) temperature stability from  $-55^{\circ}\text{C}$  to  $+85^{\circ}\text{C}$ , excellent frequency stability. Hermetically sealed with long shelf and operating life. Delivery from stock (see table).

Write for Bulletin 6.112

### SPECIFICATIONS AND ORDERING REFERENCES

	Catalog Number	Capacity In MFD*	Working Voltage D-C	Maximum Peak Voltage
100 SERIES	STA 152	5.5	6	8
	STA 157	3.5	10	12
	STA 162	2.0	15	18
	STA 167	1.5	20	24
	STA 172	1.2	30	36
	STA 177	1.0	35	42
	STA 179	0.7	50	60
	STA 181	0.6	60	72
400 SERIES	STA 452	11	6	8
	STA 457	7	10	12
	STA 462	4	15	18
	STA 467	3	20	24
	STA 472	2.4	30	36
STA 477	2	35	42	
STA 479	1.4	50	60	
STA 481	1.2	60	72	
200 SERIES	STA 252	28	6	8
	STA 257	17	10	12
	STA 262	11	15	18
300 SERIES	STA 267	8	20	24
	STA 272	6	30	36
	STA 277	5	35	42
500 SERIES	STA 352	115	6	8
	STA 357	70	10	12
	STA 362	45	15	18
	STA 367	35	20	24
	STA 372	23	30	36
	STA 377	20	35	42

\*Standard Capacity Tolerances are minus 15%, plus 25%



**FANSTEEL METALLURGICAL CORPORATION**

North Chicago, Illinois, U. S. A.

C589A

RELIABLE TANTALUM CAPACITORS SINCE 1930

# The Semiconductor Hall-Effect Circulator

MOST PASSIVE transmission devices are reciprocal in nature. But with others, the nature of the transfer characteristic depends on whether the signal goes from some point A to another point B or from B to A. Gytrators, isolators and circulators are in the latter category of non-reciprocal devices. In a paper presented at WESCON by W. J. Grubbs of Bell Telephone Laboratories, the Hall-effect circulator was described.

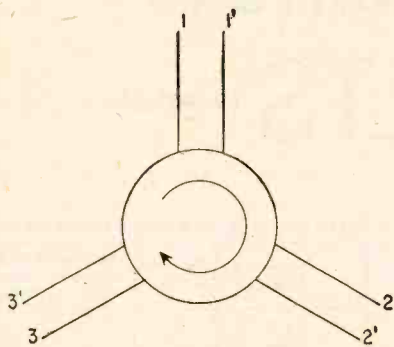

FIG. 1—Simple form of circulator

A circulator is a three-port, six-terminal, nonreciprocal passive device which circulates signals essentially in one direction only. The circulator shown in Fig. 1, for example, circulates signals in the clockwise direction only. An input signal on terminals 1-1' is transmitted to terminals 2-2'. No signal appears at 3-3'. The same clockwise circulation occurs when a signal is applied to any one of the three terminal pairs.

Suppose now that a magnetic field is applied perpendicular to a current flow, as shown in Fig. 2. Current carriers are deflected sideways. A transverse electric field, perpendicular to both the magnetic field and the longitudinal current flow, is built up between the sides of the conductor. The net electric field makes some angle  $\theta$  with the direction of current flow. This angle is known as the Hall angle. To a first approximation, its tangent is given by the product of the magnetic field and the Hall mobility of the major carriers in the sample. This approximation holds if the product of the majority car-

rier density and mobility is much greater than the same product for minority carriers. Hall-effect devices use semiconductors rather than metals since most metals have much lower mobilities.

If six equally spaced contacts are made to the edge of a slice of semiconductor as shown in Fig. 3 and a constant magnetic field is applied perpendicularly to the plane of the slice, the slice becomes a Hall-effect circulator for the proper value of magnetic field. In other words, the angle  $\theta$  must be such that the net electric field produces no voltage between terminals 3 and 3'.

When a load is connected to terminals 2-2' so that a current can flow, an additional Hall field is produced. It has the effect of decreasing the effective Hall angle in the sample. As a result, a stronger magnetic field is required to balance the circulator. The circulator can

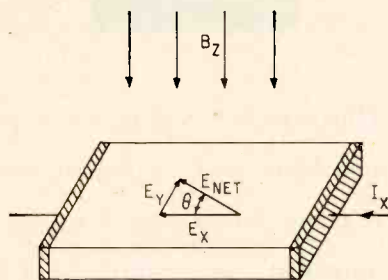

FIG. 2—Circulator with magnetic-field applied perpendicularly to current flow

be made to operate properly with a range of load resistances by adjusting the magnetic flux density.

### Parallel Networks

Hall-effect circulators have been made which are quite symmetrical. To date, the best circulator made has an average reverse loss of 61 db and an average forward loss of 17 db resulting in an average transmission ratio of 44 db. Any two pairs of terminals act as an isolator with 17-db loss in one direction and 61-db loss in the opposite direction. But symmetry depends primarily on having a regular 60-degree angular spacing between the six edge contacts. This spacing is difficult to achieve. Also, it is almost

impossible to obtain a specific input admittance or operating impedance level since this characteristic is almost directly proportional to the material's conductivity and the reciprocal of the sample thickness.

When a resistance network is connected in parallel with the circulator, imperfections can be removed effectively. And other interesting features are made available. For example, the forward loss can be decreased by using a larger magnetic field. Conversely, if a greater forward loss can be tolerated, a smaller magnet can be used.

With any fixed magnetic field, circulation is obtainable with any load admittance from about ten times the normal admittance down to zero or open circuit. Since the admittance of the circulator with the network changes only slightly over this range, the forward loss becomes high when a widely different load admittance is used because of admittance mismatch. Also, resistance networks can provide circulation when an essentially symmetrical circulator is used with a different load conductance on each of the three terminal pairs.

By using negative resistances in the network, the forward loss can be eliminated without decreasing the maximum reverse loss in the balanced condition. In fact, one can obtain negative loss or gain.

### Method of Construction

Degree of balance of a circulator is dependent almost completely

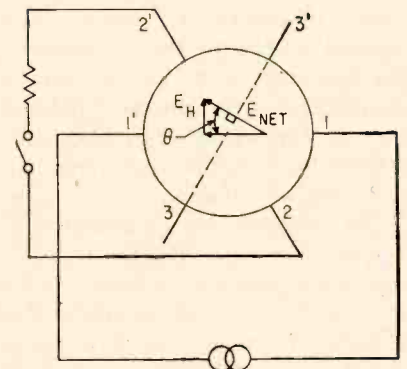

FIG. 3—Hall-effect circulator made by placing six contacts equally around the edge of a slice of semiconductor material





"We are sold on Kester '44' Resin-Core Solder, Jim. It's the fastest acting solder we have ever seen."



"Been using Kester Flux-Core Solder for almost half a century, Tom; nothing like it."



"Kester Solder spools are always marked with the exact alloy, Joe; no code markings."

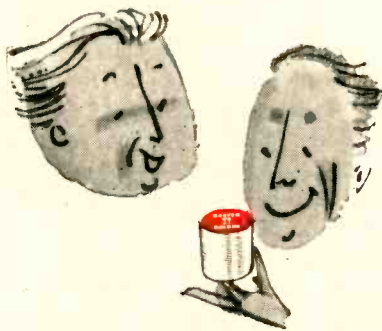

"Nothing like Kester Solder, Fred, for keeping costs in line."

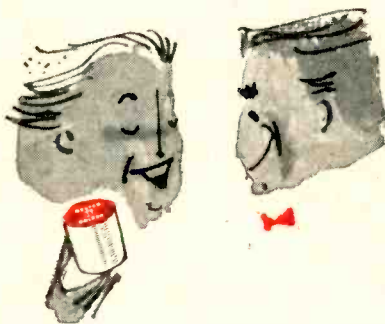

"Our girls swear by Kester, Bert; they claim soldering is much easier."

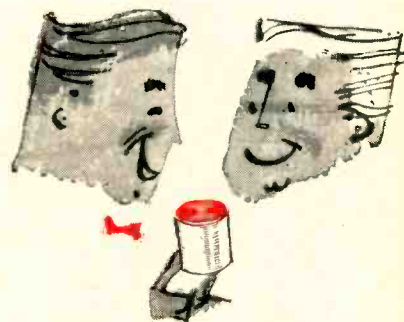

"Kester 'Resin-Five' Core Solder is the choice for our production, Paul."



"Our work goes much faster now, Bill, since we switched to Kester Solder."

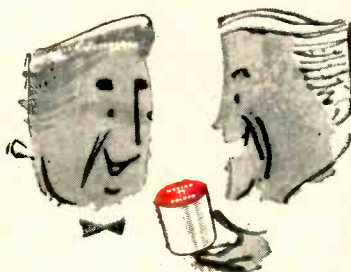

"We had a tough soldering job, Harry, but Kester engineers licked it in a hurry."



SEND TODAY for your free copy of the Kester book, "Solder . . . Its Fundamentals and Usage" . . . 78 pages of technical information.



### HOW THE WORD GETS AROUND

You hear comments like these everywhere informed people in the electronics industry get together to "talk shop." It's a fact . . . there is nothing quite like Kester Solder. And that's why it's so universally popular.

# KESTER SOLDER

*Company*

4204 Wrightwood Avenue • Chicago 39, Illinois  
Newark 5, New Jersey • Brantford, Canada

5 watt capacity -  
2 watt size

# Centralab **MODEL 4**

Miniature Wirewound Radiohms®

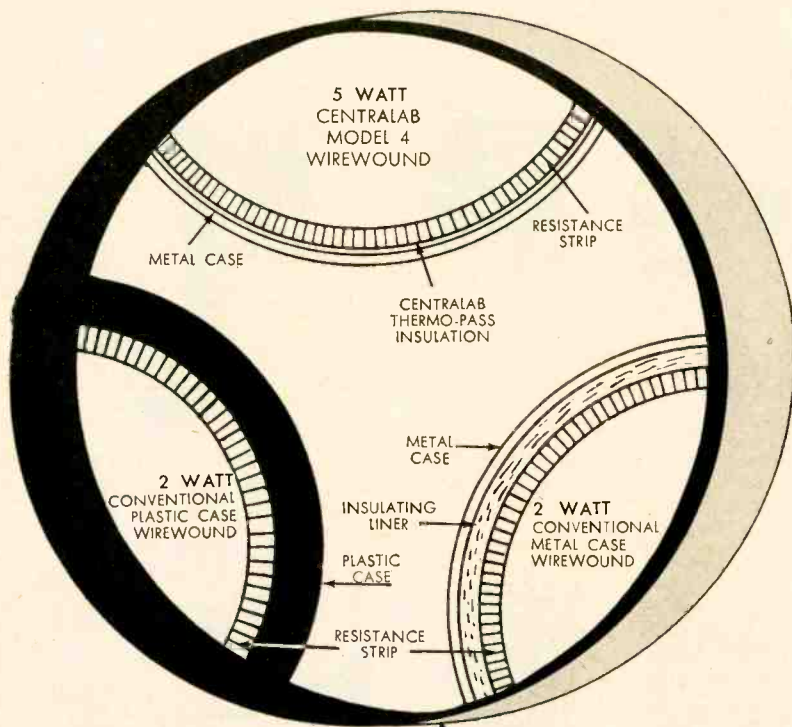

As you know, the rating and size of a variable resistor depends upon the speed with which heat can be transferred from the resistance element to the atmosphere. Centralab "thermo-pass" insulation combines exceptional heat transfer with a dielectric strength of 4500 volts per mil at 25° C. Result: Model 4 Radiohm, a conservatively rated 5 watt wirewound variable resistor smaller than a conventional 2 watt unit.

- Only 1 3/32" diameter by 9/16" deep.
- Resistance range, 1 ohm to 15K ohms; linear taper.
- 295° rotation, stop strength 15 inch pounds.
- Minimum life, 25,000 complete cycles.
- Totally enclosed elements.

For detailed information write for Centralab Engineering Bulletin EP-493 or contact your Centralab sales representative. Ask your local distributor about the many values he carries in stock in the WW and WN series (listed in Catalog 30).

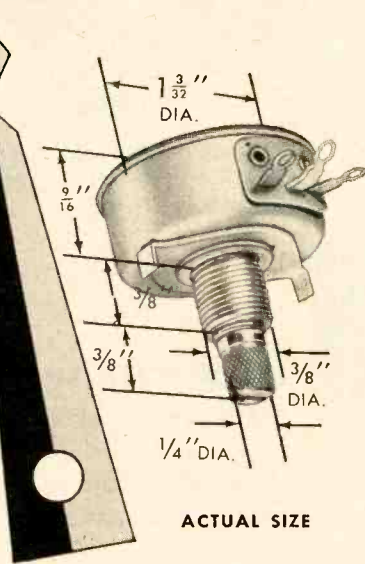

upon geometric placement of the six terminals. Circulators made to date have been made from a single ingot of *n*-type germanium with resistivity of six to seven ohm-cm. Sample thicknesses have been 20 to 40 mils with diameters of about 0.125 in.

A first sample was made by thermo-compression bonding a gold wire to each of the six faces of an approximately hexagonal slab. Spacing of the terminals was so irregular that the results were very poor with no parallel network.

Subsequent circulators were made from samples cut with an ultrasonic cutter. These samples have six projections which can be electroplated with antimony-doped gold. This plating was then alloyed into the pips and small balled gold wires were thermo-compression bonded to the centers of the plated surfaces.

### Practical Limitations

Assuming that external stray reactances can be made negligible by proper design and use of the circulator, speed of response will be limited only by the properties of the semiconductor material. All the circulator admittances are pure conductances and the loads should be pure conductances. Theoretically, the circulator should function properly over the entire frequency range from d-c up to the dielectric relaxation frequency of the material. This

### Preassembled Parts

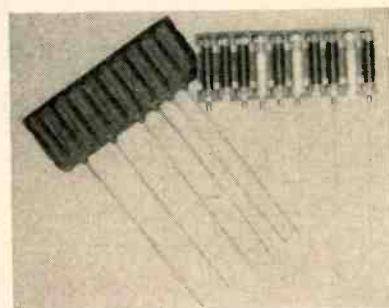

Manufacturers using point-to-point wiring methods can employ this new PAC (Pre-Assembled Components). Wire leads are mechanically crimped to individual component clips and then soldered. A variety of resistor-capacitor networks are available from the manufacturer—Erie Resistor Corp., Erie, Pa.

# Centralab

B-5810

A DIVISION OF GLOBE-UNION, INC  
914K E. KEEFE AVE. • MILWAUKEE 1, WIS.  
In Canada: 804 Mt. Pleasant Rd. • Toronto, Ontario

VARIABLE RESISTORS • PACKAGED ELECTRONIC CIRCUITS • ELECTRONIC SWITCHES  
CERAMIC CAPACITORS • ENGINEERED CERAMICS • SEMI-CONDUCTOR PRODUCTS



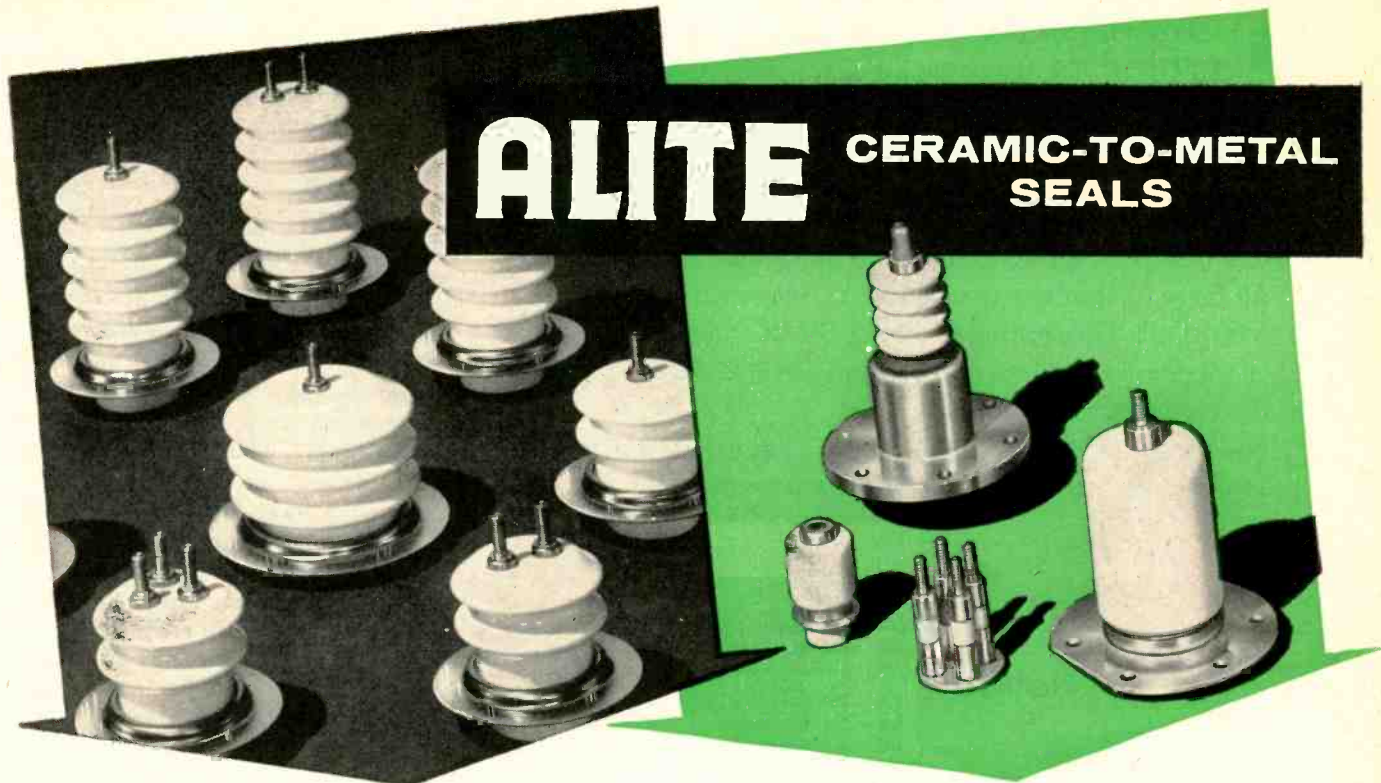

# ALITE CERAMIC-TO-METAL SEALS

## Standard Items or Custom Designs

FROM ONE COMPLETELY INTEGRATED SOURCE

Whether specifications call for standard types of ceramic-metal bushings or specially designed assemblies for unusual applications, designers and electronics equipment manufacturers can rely on the uniform high quality and dependability of Alite ceramic-to-metal seals.

Vacuum-tight seals and bushings made of high alumina Alite are ideal for use in electronic applications where service conditions are extremely severe or critical. Alite has superior mechanical strength and thermal shock resistance. It maintains low-loss characteristics through a wide range of temperatures and frequencies. It resists corrosion, abrasion, and nuclear radiation. The extra-smooth, hard, high temperature glaze on Alite seals assures continuing high surface resistivity and dependable operation.

Another important reason for outstanding reliability of Alite components is our ability to perform and carefully supervise, in our own

plant, every manufacturing step. From design to finished assembly—including formulating, forming, firing and testing—Alite is equipped to develop and produce high precision hermetic seals and bushings at one location. This permits an exceptionally high level of quality control, and results in what we sincerely believe to be the finest ceramic-to-metal seals available.

Our ceramics specialists are anxious to assist you on problems involving ceramic-to-metal seals. Tell us about your specific requirements today.

### New FREE Bulletins

Bulletin A-20 gives performance data and "inside look" at Alite facilities. Bulletin A-35 describes standard line of Alite High Voltage Bushings.

Write for them today.



ALITE DIVISION  
Orrville, Ohio



U. S. STONEWARE

New York Office  
60 East 42nd St.

68F-1

**H**ELIPOT's newest potentiometer... the single-turn, 1-1/16" A.I.A. diameter, all-metal series 5200... fends off 2,000 cps at 30G's, repels 10 cycles NAS 710, procedure III humidity, rides out 50G's shock and 100G's acceleration.

We're tough, too... on the 5200's mechanical tolerances. Register face, diameter and shaft runouts are all held to 0.001" max... spring-loaded shaft eliminates endplay.

All this with linearity to  $\pm 0.15\%$ ... power rating of 3 watts at 100°C (derating to zero at 150°)... 250 to 100,000 ohms standard resistance range... *and certified test data to prove our every claim.*

What a pot for airborne applications... at a down-to-earth price! *Write for data file A 102 for the proven facts.*

Beckman® Helipot®

Helipot Division of Beckman Instruments, Inc.  
Fullerton, California  
Engineering representatives in 27 cities.  
potentiometers... dials... delay lines...  
expanded scale meters...  
rotating components... breadboard parts

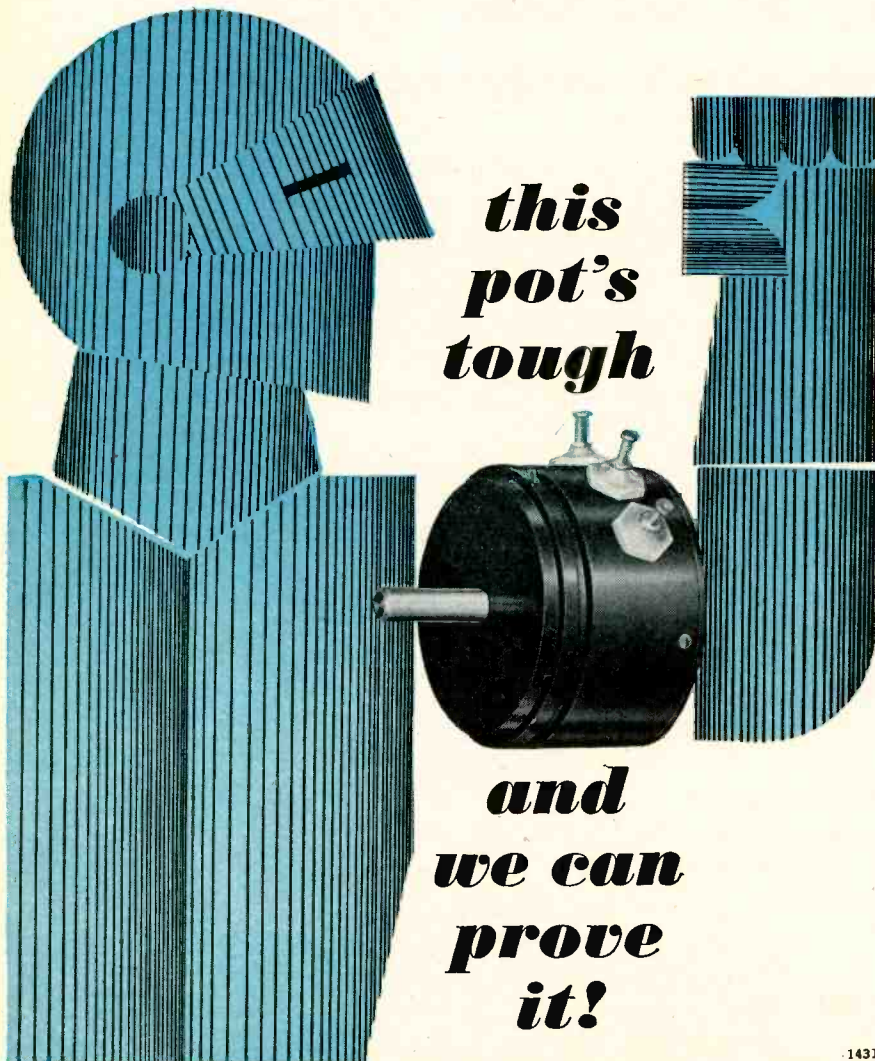

**this  
pot's  
tough**

**and  
we can  
prove  
it!**

1431

frequency is about a few kmc for the germanium used in the samples. Since sample geometry requires that all leads be fairly close to one another, radiation and pickup place a lower practical limit on the usable frequency range. Skin effect also becomes important at high frequencies.

Impedance levels from 200 to 600 ohms have been attained and this range should be extendable to 10 to 5,000 ohms still using only *n*-type germanium. With InAs and InSb, the low end of the range can be decreased to about 0.05 ohm, with the necessity for use of extremely low-resistance contacts.

Use of high-mobility materials such as InSb, InAs and HgSe permit use of smaller permanent magnets. But circulators made from these materials have extremely low impedance levels, on the order of one ohm, and are not useful in most circuits.

The semiconductor circulator has no junctions. Therefore, its lifetime depends only on the stability of the permanent magnet used. No special atmosphere is required for good operation. Contacts must be ohmic so that resistance will not vary with current level.

## Crossed-Field Traveling-Wave Tube

HIGH POWER and high-frequency performance are characteristics of a new type of traveling-wave tube described by C. C. Johnson and C. K. Birdsall of General Electric at WESCON this year. The new tube, designated the M-J, is a crossed-field device in which the electron stream is not toward the slow-wave circuit, as in a M type, but parallel to the circuit.

### Collector Electrode

The M-J circuit is placed in the plane of the usual end-hat of a linear or circular magnetron. A collector electrode is substituted for the usual circuit. During operation, the electron stream flows near the circuit and gives up energy to the circuit waves. But the electron stream is not collected on the circuit. Instead, it drifts toward a col-



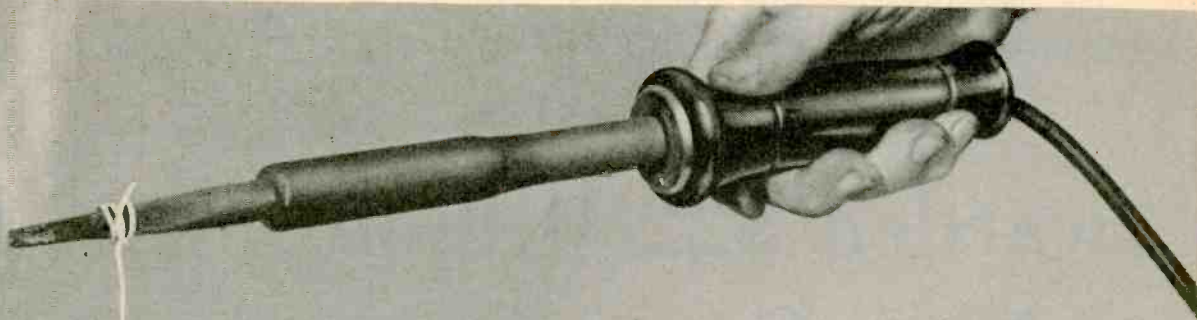

# Silicone rubber wire insulation withstands soldering heat without damage

**T**hanks to silicone rubber's remarkable heat resistance, no damage occurs when you lay a hot soldering iron on silicone-rubber-insulated wire. And silicone insulation strips cleanly and easily, saving hours of assembly time in the plant. Right-angle bends are no problem. Colors are bright for easy identification.

**Long service life at 500°F** Withstands 600°F and above for shorter periods. General Electric silicone rubber insulation meets military specifications MIL-W8777A, MIL-W16878B and others. When exposed to a direct flame, it forms a non-conducting ash of silicon-dioxide, releasing no toxic fumes, as do higher-priced insulating materials.

**Will not cold flow** Because silicone rubber is a *true* elastomer, it will not cold flow and subject wire to vibration, as will higher-priced insulating material. Newly developed stocks make possible thin-wall construction, have unusual abrasion resistance and physical strength. G-E silicone rubber stays flexible down to -75°F, special grades down to -150°F.

**Greater reliability** G-E silicone rubber exhibits excellent electrical properties and maintains them at both high and low temperatures, keeping its original dielectric strength for years. Moisture absorption is extremely low; ozone resistance approaches that of mica.

General Electric silicone rubber insulation matches or exceeds the vital properties of insulation costing three times as much. Find out what it can do for you. Mail coupon for technical data.

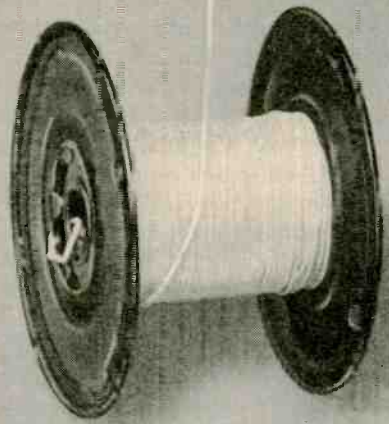

# GENERAL ELECTRIC

Silicone Products Department

Waterford, New York

Section R8CC10, Silicone Products Dept.  
General Electric Company, Waterford, N. Y.

Please send me more information on wire insulated with G-E silicone rubber.

Name \_\_\_\_\_ Position \_\_\_\_\_

Company \_\_\_\_\_

Address \_\_\_\_\_

City \_\_\_\_\_ Zone \_\_\_\_\_ State \_\_\_\_\_

# Westinghouse Awarded \$22 Million Navy Contract

The company's Friendship Airport plant will produce shipboard radio transmitters and radar equipment which it designed.

The radar particularly is considered a revolutionary breakthrough in electronics, permitting results identical to that achieved by conventional radar with 30 times the power.

R. E. KIRBY, manager of the electronic division, said there are actually three contracts involved.

One worth more than \$8 million is for production of the advanced air-search radar. It is to be used on carriers, cruisers and other ships.

The second contract is for \$1 million worth of conventional design radar.

The largest contract, more than \$12 million, is for production of medium and high frequency communications transmitters. These would be used on surface ships and submarines.

"The new radar equipment," Kirby said, "employs a revolutionary electronic circuit technique considered a technological breakthrough in the evolution of shipboard air-search radar." It was designed and tested here.

The transmitter is the product of Westinghouse research begun in 1951.

This Navy contract is the result of another major technological breakthrough by our outstanding team of engineers at Westinghouse-Baltimore. An exciting opportunity exists for qualified engineers to join this team. You will be a part of our wide range new development program which will result in a continuing pattern of major breakthroughs in the future.

#### PARTIAL LIST OF CURRENT OPENINGS:

Digital-Analogue Computer Design  
Transistor Circuitry  
UHF Communications  
Servo Control Loops  
Electronics Circuitry  
Intermediate Frequency Amplifiers  
Microwave Components  
Network Synthesis

TO APPLY: Send a resume of your education and experience to Dr. J. A. Medwin, Dept. 823, Westinghouse Electric Corporation, P. O. Box 746, Baltimore 3, Maryland.

Reprinted from the BALTIMORE NEWS POST

## Westinghouse - BALTIMORE



YOU CAN BE SURE...IF IT'S Westinghouse

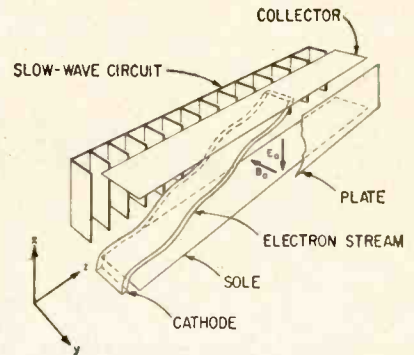

FIG. 1—Basic M-J configuration. The electron stream in flowing parallel to a slow-wave circuit in a region of crossed electric and magnetic fields gives up energy and drifts toward the collector electrode at upper right

lector which can be made to dissipate considerable power.

Figure 1 shows a linear M-J tube with an injected stream. The electron stream interacts with the circuit waves and is deflected as shown. The transverse r-f electric field, along  $B_0$ , causes the beam to snake along  $B_0$ . The stream moves closest to the circuit in a retarding electric field if the average stream velocity  $E_0/B_0$  is made larger than that of the wave. In this case, there is a net loss of energy from the stream and a consequent gain of energy by the circuit waves. Those electrons giving up energy move to a region of higher potential and maintain their longitudinal velocity.

Two main advantages of the tube are the use of a separate collector to dissipate larger quantities of heat than the circuit itself can and a uniform rate of gain over the tube length. A limiting factor for the tube is that it is necessary to obtain a uniform beam velocity. This requirement necessitates a constant  $E_0$  in the beam region.

Two experimental tubes have been built. The first was a demountable device which used a flattened helix slow-wave circuit. It produced about seven db net forward gain at 700 mc. The second was constructed as an M-J backward-wave oscillator. It produced about 10 mw output power at 4.5 kmc.

### Rotary Wafer Switch Maintains Easily

INDIVIDUAL SWITCH WAFERS, including rotary sections, are instantly



# New Product Announcement

## STEMCO TYPE MX\* THERMOSTATS

especially designed for missile, avionic and electronic applications

New Stemco Type MX Thermostats are miniature snap-acting units designed to *open* on a temperature rise. Being compact, lightweight units able to withstand high G's under wide ambient temperature ranges, Type MX thermostats are ideal for missile, avionic and other electronic applications where close temperature control is mandatory.

Basic design flexibility of the Stemco Type MX Series means the units can be supplied from regular production runs in a wide variety of models, both semi-enclosed or hermetically sealed. Ceramic or metal bases for semi-enclosed units, round enclosures or CR-7 crystal cans for hermetically sealed units. Several types of terminal arrangements, mounting provisions, brackets, etc., are available.

Stemco Type MX thermostats give you performance . . . small cubage . . . rugged reliability . . . *at a production price.*

\* 2° to 6°F differentials available



TYPE MX *Hermetically Sealed* — Electrically independent bimetal disc. Rated at 2 amps at 115 VAC and 28 VDC, based on 250,000 operations.

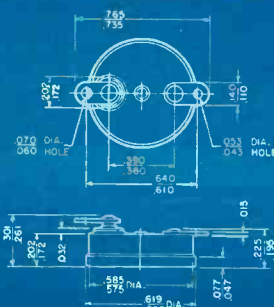

TYPE MX *Semi-Enclosed* — Metal base shown; also ceramic base types. Bulletin 6100 for data on hermetically sealed and semi-enclosed types.

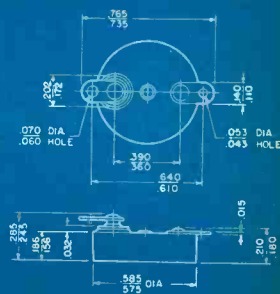

AA-7286

STEVENS manufacturing company, inc.  
Mansfield, Ohio



**THERMOSTATS**

CIRCLE 29 READERS SERVICE CARD



# Telephone Coils

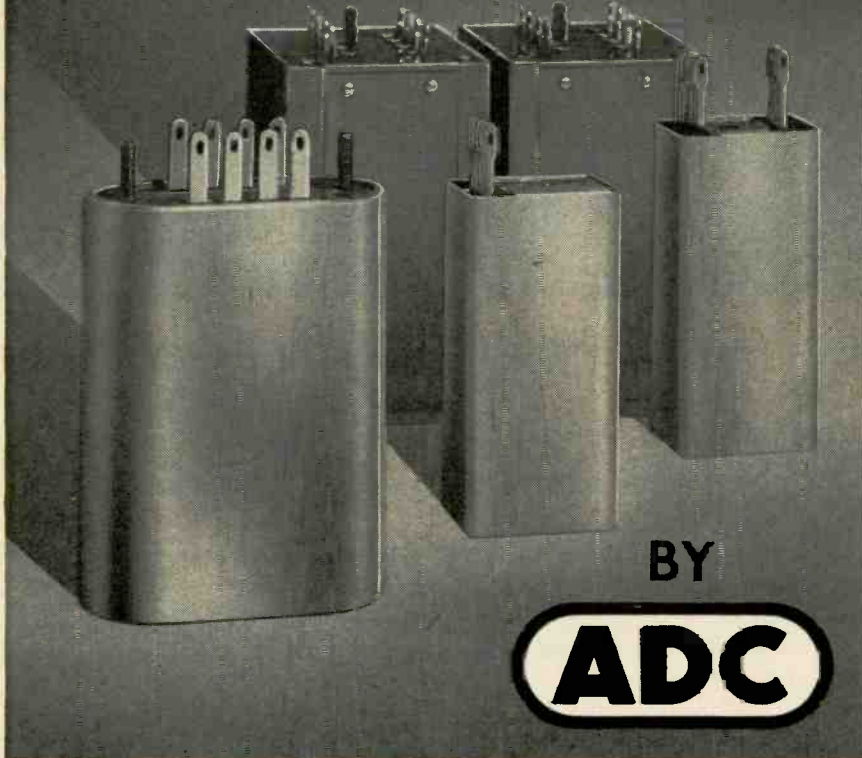

BY

**ADC**

**ADC** has completed design and tooling on a line of transformers which are electrically and physically interchangeable with components made by the Western Electric Company. This provides a quality source for those affected by Western Electric's announcement that they would no longer supply these items to manufacturers. Included in the ADC line are the oval can types popular in the 120 repeat coil series.

In addition to their regular stock, and custom transformers for the electronic industry, ADC has long been a dependable source of telephone-type transformers and coils. If you need iron core components which are interchangeable with Western Electric, check ADC. You'll be pleased with both price and delivery.

WRITE TODAY FOR TELEPHONE COIL LITERATURE



removable without unsoldering or disassembling from a new rotary wafer switch. The switch, developed by Tabet Manufacturing Co., Inc., of Norfolk, Va., incorporates printed-circuit wafers which plug into semi-floating printed-circuit receptacles. Silver-plated contact surfaces are used for manual versions of the switch and rhodium plating for motor-driven high-speed models.



Typical communications switch illustrates simple method for inserting rotary-switch wafers. Removed wafer is at right

Contacts are arranged radially on both sides of phenolic wafers. The contacts are positioned so that an active contact segment on one side is directly opposite an inactive segment on the reverse side. Active and inactive segments are symmetrical in relation to the off position. This design technique allows wafers to be inserted into the switch assembly without regard to which face of the wafer is right-hand or left-hand.

### Double Rotary Arm

Circuits through the contact segments are made by a double rotary arm. Contacts of the arm are staggered by the width of a wafer segment. The operator can make and break a single circuit alternately on one side of the switch wafer and then on the opposite side.

When the switch is in the off position, a slot in the rotary mechanism is aligned with a slot in the wafer. As a result, any wafer can be withdrawn without otherwise disconnecting or dismantling the switch assembly. Framework of the switch holds the wafers in proper alignment by slots or grooves into which the wafers are inserted and locked into place.

**ADC**

**AUDIO DEVELOPMENT COMPANY**

2838-13th Avenue South

Minneapolis 7, Minnesota

TRANSFORMERS • REACTORS • FILTERS • JACKS & PLUGS • JACK PANELS



# **NEW** HIGH VOLTAGE NPN

## TRANSISTORS ALLOW TUBE REPLACEMENT AND CIRCUIT COMPATIBILITY

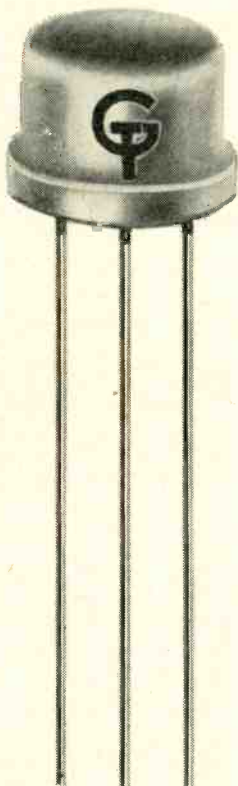

ACTUAL  
SIZE

GT's new high voltage germanium alloyed junction transistors now allow the same optimization as formerly could be realized only with vacuum tubes. These characteristics plus conventional "transistor" advantages offer new design opportunities in computers, magnetic memory cores, data processing equipment, gas filled indicator tubes and other applications where reduction of space, weight and high reliability are prime requisites.

The GT 1200 is particularly suited to drive gas filled display tubes, such as the Burroughs Nixie® and Pixie®, without changing existing circuitry other than altering voltages so as not to exceed the rating of the transistor.

		GT 1200
Collector to Base Voltage (Emitter Open)	$I_C = 25 \mu A$	90 Volts Min.
Emitter to Base Voltage (Collector Open)	$I_E = 25 \mu A$	20 Volts Min.
Collector to Emitter Voltage (Punch Through)	$I_E = 25 \mu A$	90 Volts Min.

Supplied in TO-9 case

GT 1201 — GT 1202, in addition to driving gas filled display tubes, are ideally suited for driving high inductance loads, driving transformer coupled loads and allow more nearly perfect impedance matching. These transistors are fast devices capable of handling high impedance loads and large signal swings.

	GT 1201	GT 1202
Collector to Base Voltage (Emitter Open)	$I_C = 25 \mu A$ 75 Volts Min.	45 Volts Min.
Emitter to Base Voltage (Collector Open)	$I_E = 25 \mu A$ 20 Volts Min.	20 Volts Min.
Collector to Emitter Voltage (Punch Through)	$I_E = 25 \mu A$ 75 Volts Min.	20 Volts Min..

Supplied in TO-9 case

Write today for Bulletin GT 1200



### GENERAL TRANSISTOR

C O R P O R A T I O N

91-27 138TH PLACE

JAMAICA 35,

NEW YORK

IN CANADA: BESSER E-E LTD., 441 ST. FRANCIS XAVIER, MONTREAL 1, QUEBEC. FOR IMMEDIATE DELIVERY FROM STOCK, CONTACT YOUR NEAREST AUTHORIZED TRANSISTOR DISTRIBUTOR OR GENERAL TRANSISTOR DISTRIBUTING CORP., 91-27 138TH PLACE, JAMAICA 35 NEW YORK. FOR EXPORT: GENERAL TRANSISTOR INTERNATIONAL CORP., 91-27 138TH PLACE, JAMAICA 35, NEW YORK.

©N

## Wire Pails Cut Winding Costs



Inner and outer pail extensions guide wire into cone of dereeler



This setup supplies 300 feet of wire per minute to 2-pole motor winder

PAIL PACKAGES of magnet wire reduce costs of manufacturing fractional horsepower motor field windings, according to Fasco Industries, Inc., Rochester, N. Y. The company uses 5-gallon pails containing 100 pounds of 25 to 31-gage wire insulated with Formvar, Nylon and other materials.

The pails are reported to hold 10 times more wire than spools. This reduces downtime required to change winding machine supplies. Rejects of stators wound from 2, 4 or 6 supplies is also reduced, since the supplies last longer. Normally

when a supply runs out while a stator is being wound, the stator must be rejected and the wire left in other supplies discarded.

Pails are made of 26-gage steel by Jones & Laughlin Steel Corp. Container Division. The wire is layered around a vertical cylindrical fiberboard core as the pail is filled. Empty pails are discarded or used as waste buckets or tote cans. The pails are used with dereelers which can take out the wire at speeds up to 2,700 feet a minute. Damage to insulation is prevented by a smooth finish in the pails.

tion of sulphuric acid and dried with filtered air. Any other good degreasing, oxidizing wash may be used.

The twin panel is placed face down on a table. Four flexible

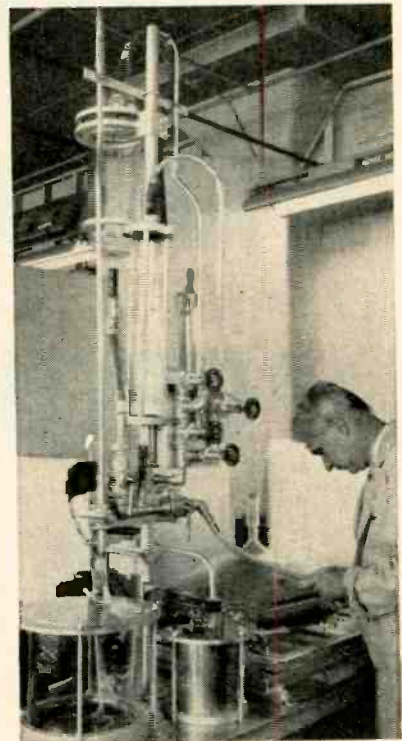

Pilot plant setup at Rohm & Haas for preparing plastic and filling space between twin panel and tv tube

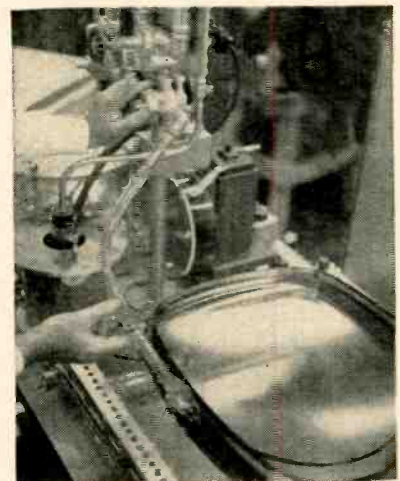

Tube has been cut away to show filling procedure

## Liquid Plastic Laminates Glass Parts

GLASS LAMINATING method devised by Corning Glass Works for its twin panel for tv picture tubes may also be used to create shock-absorbing designs for other glass-housed components.

Pieces to be laminated need not be perfectly matched so long as there is a closure around the space between the two parts. The laminating material will cure without pressure and high temperature.

Purpose of the twin panel design is to eliminate protective glass plates on tv sets. The skirt of the contoured panel fits around the regular 90 or 110-degree tube envelope. The panel is 0.225 inches thick and

is made of glass identical to the tube face.

Laminating material is a liquid plastic which can be tinted to desired transmission levels. It is non-toxic, noncontaminating and will withstand temperature fluctuations of -40 F to 160 F. Plastics in use are an acrylic resin, Duraplex TV-10, developed by Rohm & Haas Co., and an epoxy resin, DER 741 with DEH 61, developed by Dow Chemical Co. Both have a refractive index identical to glass used.

Before assembly, the twin-panel and tube face are washed with a 5 percent solution of trisodium phosphate, rinsed with a 5 percent solu-

tion of sulphuric acid and dried with filtered air. Any other good degreasing, oxidizing wash may be used. The twin panel is placed face down on a table. Four flexible spacers 0.70 inches thick are placed at the twin panel corners. The tube is placed face down on the spacers. The spacers are invisible in the plastic since index of refraction is identical.

The casting resin is mixed with



**Relay Sales**

Telephone Relays

Midget Relays

Keying Relays

Rotary Relays

Sealed Relays

Sensitive Relays

Latching Relays

Stepping Relays

Delay Relays

Timers

Contactors

Motor Starting Relays

Differential Relays

Polarized Relays

AN Approved Relays

Write for Catalog  
1957-C9

**Relay Sales**

*why wait for*

# RELAYS

**LEADING MAKES  
LATEST TYPES  
IN STOCK!**

## Crystal Can Relay

Hermetically sealed, fast and sensitive. Withstands extreme temperatures, shock and vibrations. Plug-in, solder-hook and 3-in lead type available. Meets military specification MIL-R-25018, MIL-R-5707C except as to contact overloads

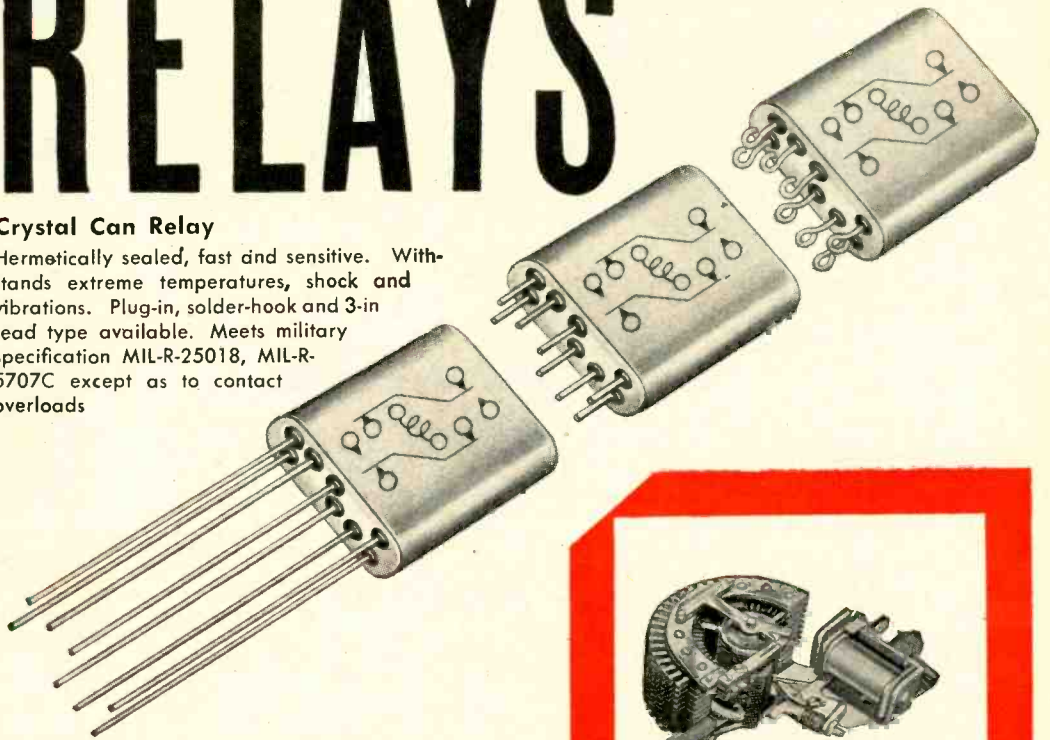

We maintain complete distributor stocks of the following makes:

Advance Relays	Phillips Controls
Automatic Electric	Struthers-Dunn
Clare	Leach Relays
Neomite-Elgin	Terado and Others

## Potter & Brumfield

### We Anticipate Your Relay Needs

Relay Sales cannot get better delivery from manufacturers than you. Relays now in stock were ordered as long as 10 months ago and selected by men who have specialized in supplying relays to the industry for many years. The items illustrated are typical of hundreds of thousands in stock. They are available in all popular coil ratings and contact arrangements. Why wait for relays? Call us today!

Write or Phone for Same Day Shipment

Phone: West Chicago 1100  
TWX West Chicago 3464

**RELAY SALES, INC.**

P.O. BOX 186-A TWX West Chicago, Ill., 3464

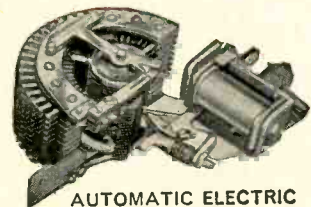

**AUTOMATIC ELECTRIC**  
Type 45 Stepper  
Wide Selection

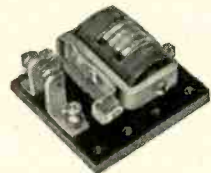

**STRUTHERS DUNN**  
Keying Relay  
Many Types in Stock

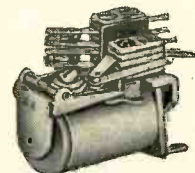

**PHILLIPS CONTROL**  
9QA Midget for Sub Chassis  
Mounting. Many Others  
in Stock



(Actual Size)  
**NEOMITE-ELGIN**  
Sub Miniature Hermetically Sealed  
Relay. All Advance Types in Stock.



... for Complete Reliability Under Severe Environmental Conditions

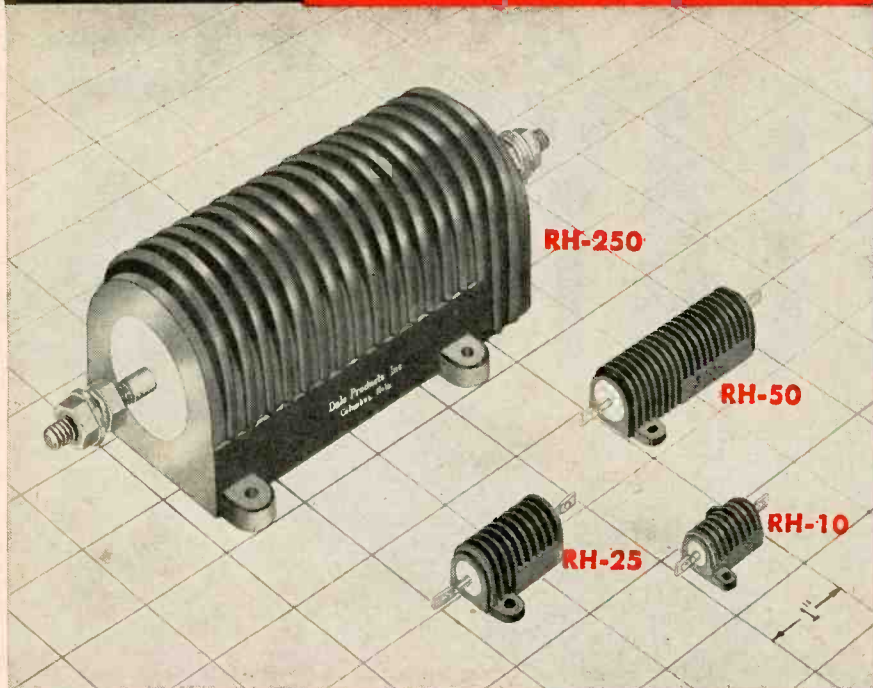

## TYPE RH POWER RESISTORS

Wire Wound, Precision, Miniature, Ruggedized

### TYPICAL DERATING CURVE

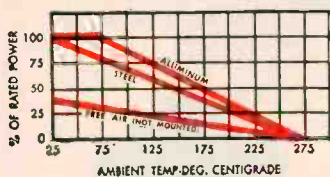

### JUST ASK US

The DALOHM line includes precision resistors and trimmer potentiometers (wire wound and deposited carbon); resistor networks; collet fitting knobs and hysteresis motors designed specifically for advanced electronic circuitry.

If none of the DALOHM standard line meets your need, our engineering department is ready to help solve your problem in the realm of development, engineering, design and production.

Just outline your specific situation.

**DALE PRODUCTS INC.**

1300 28th AVE.  
COLUMBUS, NEBRASKA

Designed for the specific application of high power requirements, coupled with precision tolerance. Mounts on chassis for maximum heat dissipation. Operates under severe environmental conditions as outlined in specifications below.

- Rated at 10, 25, 50 and 250 watts.
- Resistance range from 0.1 ohm to 175K ohms, depending on type.
- Tolerance 0.05%, 0.1%, 0.25%, 0.5%, 1%, 3%.

**TEMPERATURE COEFFICIENT:** Within  $\pm 0.00002/\text{degree C.}$

**COMPLETE PROTECTION:** 100% impervious to moisture and salt spray.

**WELDED CONSTRUCTION:** Complete welded construction from terminal to terminal.

**RUGGED HOUSING:** Sealed in silicone, inserted in radiator finned aluminum housing.

**MINIATURE SIZE:**  $7/16 \times 3/4$  to  $3 \times 4\frac{1}{2}$  inches.

**MILITARY SPECIFICATIONS:** Surpasses applicable paragraphs.



Picture tube is fitted inside panel



After cure, plastic has formed permanent seal between tube and panel

its catalyst and degassed. Degassed resin is fed into the space between the tube and panel by a delivery nozzle until the space is completely filled. The plastic is given a brief cure. The spacers yield to allow for plastic shrinkage.

The method, according to Corning, results in a tube face that is permanently clean. It cannot be imploded by a normal breakage source and is shatterproof should an implosion be caused by high impact.

## Machine Welds Part Pigtails

ASSEMBLY and welding machine produces pigtail assemblies for conventional resistors, capacitors, diodes and rectifiers. Production rate, according to Raytheon Mfg. Co., Waltham, Mass., is 3,000 an hour.

Lead wire is fed from a reel to welding position, straightened, and cut to length by a guillotine cut-off. Cups are fed from a vibratory hopper to welding position. Welding is controlled by a heat program timer. Assemblies are ejected into a box.

The machine will handle cups of



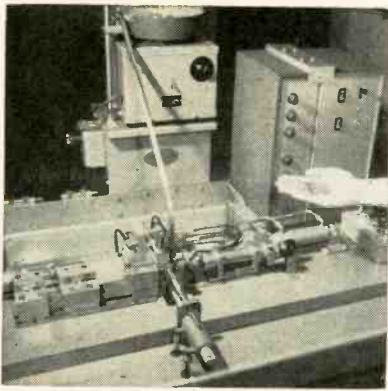

Wire fed from left, cups from hopper meet at welding station in center

different sizes and wire in sizes from 0.025 to 0.050 inch. Operation can be one-shot or repetitive. Fail safe devices can be added to halt operation when materials run out.

## Readout Tube's Parts Are Stacked Vertically

CATHODES AND ANODES etched from foil and stacked on support posts make up the active elements of gas-filled, cold-cathode Nixie readout tubes manufactured by Burroughs Corp. Electronic Tube Division, Plainfield, N. J.

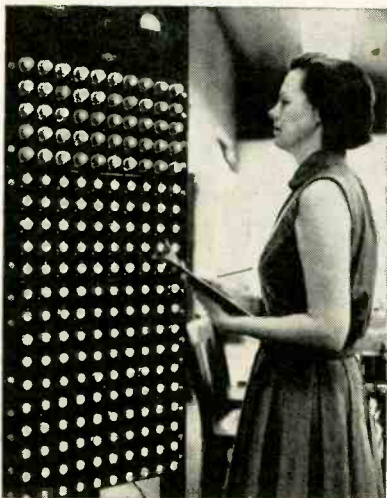

Tubes count some 10,000 times in aging

Each tube contains 10 characters (cathodes) and a common anode screen grid. These are etched by vendors in foil 3 to 5 mils thick. Stroke width of miniature tube numbers is about 5 mils. Gas glow makes them appear larger.

Before being cut apart with snippers, frames of cathodes and anodes are chemically and ultrasonically



...for Complete Reliability Under Severe Environmental Conditions

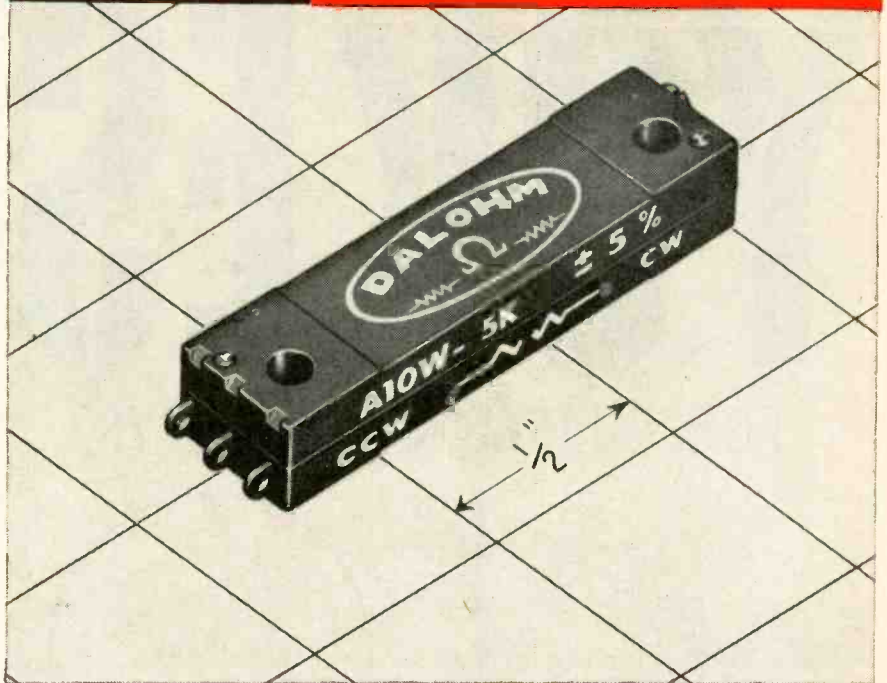

## TYPE A10-W TRIMMER POTENTIOMETERS

Wire Wound, Precision, Sub-Miniature, Ruggedized

A10-W Trimmer Potentiometers are completely sealed for high temperature operation; with ruggedized construction, they provide reliability under the most severe operating conditions. Four designs available for the demanding space requirements of precision circuitry.

- Rated at 1 watt up to 70° C. ambient temp.
- Resistance range from 1 ohm to 30K ohms.
- Standard tolerance:  $\pm 5\%$ , closer tolerance available.

**RESOLUTION:** .1% to 1%, depending on resistance.

**OPERATING TEMPERATURE RANGE:** -55° C. to 150° C.

**INSULATION RESISTANCE:** 1000 megohm minimum at 500 VDC at room temp.

**END RESISTANCE:** Not greater than 4%.

**TEMPERATURE COEFFICIENT OF TRIMMER UNIT:** Within  $\pm 100$  parts per million.

**SUB-MINIATURE SIZE:** .220 X .312 X 1.250 inches.

**SCREW ADJUSTMENT:** Fully adjustable throughout 25 turn range.

**SHAFT TORQUE:** 7 inch/ounce maximum.

**SAFETY CLUTCH:** Clutch arrangement on movable wiper contact prevents breakage due to over-excursion.

**SELF-LOCKING ADJUSTMENT:** Wiper will not shift under severe vibration or shock.

**MILITARY SPECIFICATIONS:** Surpasses applicable paragraphs.

### TYPICAL DERATING CURVE

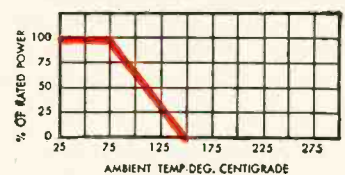

### JUST ASK US

The DALOHM line includes precision resistors and trimmer potentiometers (wire wound and deposited carbon); resistor networks; collet fitting knobs and hysteresis motors designed specifically for advanced electronic circuitry.

If none of the DALOHM standard line meets your need, our engineering department is ready to help solve your problem in the realm of development, engineering, design and production.

Just outline your specific situation.

**DALE  
PRODUCTS  
INC.**

1300 28th AVE.  
COLUMBUS, NEBRASKA

**CELCO** *Specialized*

# YOKES

FOR CHARACTER DISPLAYS

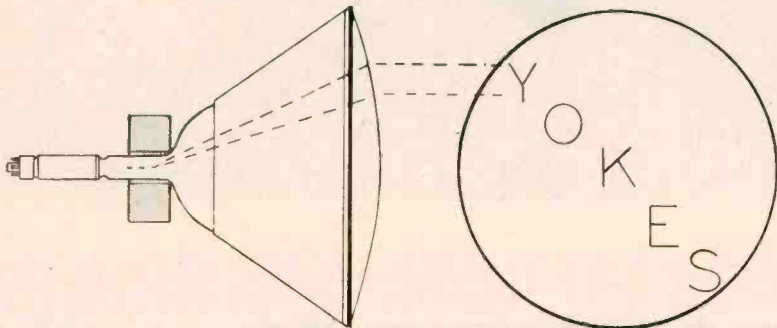

## YEARS AHEAD IN DESIGN PERFORMANCE

For critical applications, many of our customers have saved years of trial and error in YOKE selection by specifying Celco YOKES.

The construction of our yokes makes it possible to achieve **sensitivities, linearities, responses and distortion-free deflecting fields** not possible with the usual types of yoke.

For precision military and commercial displays, Celco also offers standard yokes in 7/8", 1", 1 1/8", 2", & 2 1/2" CRT neck diameters.

Write for CELCO DEFLECTION YOKE Catalogue & Design Sheets or for immediate engineering assistance Call your nearest CELCO Plant:

**Celco**

*Constantine Engineering Laboratories Co.*

Mahwah, N. J.  
Davis 7-1123

Miami, Fla.  
Plaza 1-9083

Cucamonga, Calif.  
Yukon 2-2688



cleaned. Ultrasonic cleaning was found to assist in removing surface gases from the metal.



Photo-etched characters are cut from protective frames

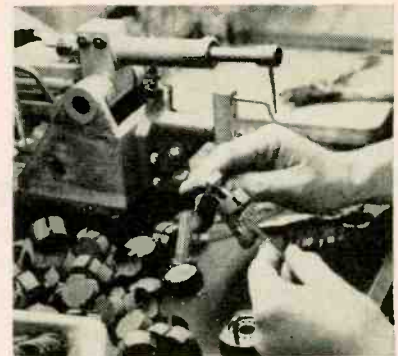

Support posts and cups are assembled on 13-pin stem



After characters are stacked projecting tabs are bent to pins and welded

Support posts and anode cups are welded together on a 13-pin stem to form the assembly base. In a prior operation, the posts are glazed for insulation. Posts are inserted in glass tubing which is flame-fused.

Cathodes are assembled on the posts alternately with glass ring spacers. Cathode tabs are bent to stem pins and welded. Tops of posts are crimped off and the anode screen welded in place.

After sealing, exhaust and gas filling, tubes are stabilized in aging racks, where they are stepped through a counting sequence to





**More materials:** Rugged, versatile compositions to resist impact, stress, vibration, pressure, heat, thermal shock, wear, chemical reactions. Superior electrical characteristics for higher temperatures and frequencies.

**More equipment:** Complete and separate production facilities devoted exclusively to finer quality AlSiMag Aluminas.

**More "know how":** Years of experience in formulating and fabricating Aluminas. The wider range of exacting designs produced have led to new, improved techniques. Precision tolerances. Dependable uniformity. Constant research.

Bring your problem to the source most apt to supply the right answer! Send blueprint with details of operating procedure for complete information.

**ALSiMAG<sup>®</sup>**

**best source for  
ALUMINA CERAMICS**

A Subsidiary of  
Minnesota Mining and  
Manufacturing Company



**AMERICAN LAVA  
CORPORATION**

**CHATTANOOGA 5, TENN.**  
56TH YEAR OF CERAMIC LEADERSHIP

For service, contact Minnesota Mining & Manufacturing Co. Offices in these cities (see your local telephone directory): Atlanta, Ga. • Boston: Newton Center, Mass. • Buffalo, N. Y. • Chicago, Ill. • Cincinnati, O. • Cleveland, O. • Dallas, Texas • Detroit, Mich. • High Point, N. C. • Los Angeles, Calif. • New York: Ridgefield, N. J. • Philadelphia, Pa. • Pittsburgh, Pa. • St. Louis, Mo. • St. Paul, Minn. • So. San Francisco, Calif. • Seattle, Wash. Canada: Minnesota Mining & Manufacturing of Canada, Ltd., P. O. Box 757, London, Ont. All other export: Minnesota Mining & Manufacturing Co., International Division, 99 Park Ave., New York, N. Y.





IT'S  
ALL  
FAN



# SAUCER FAN

The Saucer Fan represents an entirely new design concept whereby the driving motor is built within the propeller hub limiting its axial length to the minimum measurement required by a highly efficient motor. Ideally suited for tightly packed electronic packages, where space is critical, the Saucer Fan will provide cooling air to the amount of 280 cfm. Power requirement is 115 vac. 50-60 cps, 1 0.

The fan's pressure performance is tailored to the requirements of a modern, washable dustfilter. "Servo type" mounting flanges at each end of the venturi ring permit simplicity of mounting without loss of space. Direction of airflow may be easily reversed by turning the fan end for end. Electrical connections are made to a compact terminal block.

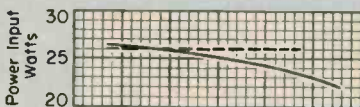
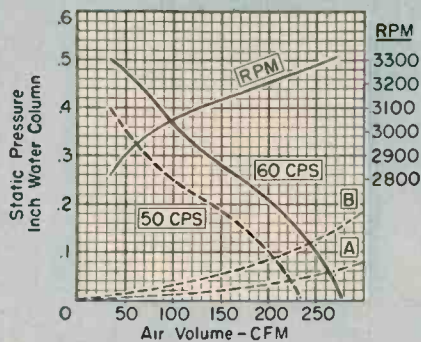

For complete technical details write to . . .



# ROTRON

MANUFACTURING COMPANY, INC.

WOODSTOCK, NEW YORK In Canada: The Hoover Co., Ltd., Hamilton, Ont.



Placing anode screen on top of stack completes mount assembly

count some 10,000 times. A beam switching tube drives the circuit. Inspections are made after mount assembly and before and after aging. Characteristics of the glow produced by application of a Tesla coil indicate whether the tube has been properly filled with gas.

## Bicarbonate Strips Winding Insulation

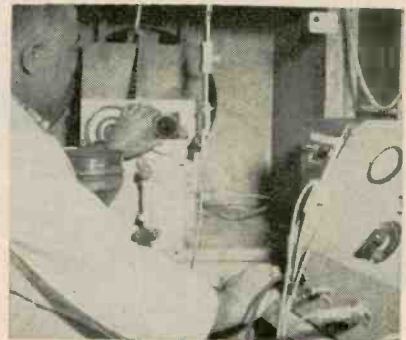

CONTROLLED STRIPPING of organic potentiometer winding coatings is accomplished at the Gamewell Co., Newton Upper Falls, Mass., by a machine which propels abrasive dust in an inert gas stream.

The abrasive is sodium bicarbonate, which removes the coating without damage to the wire contact wiping surface. The particles hit the coating at a speed of 1,100 feet a second. Stripping time averages 30 seconds compared with 1 to 1.5 minutes by hand buffing, the company says.

Photo shows setup used to strip contact areas on sine-cosine potentiometer winding. Card is held in fixture which revolves before dust nozzle. Machine is manufactured by S. S. White Industrial Division, New York, N. Y.



# YOUR FUTURE IS GREAT IN A GROWING AMERICA



## THE CITY THAT DIDN'T EXIST A MONTH AGO

Every 30 days the U. S. adds as many new Americans as live in Norfolk, Va.—creating brand-new wants and needs which must be satisfied.

What does this mean to you? It means greater opportunities than ever before—in all fields. Home construction is expected to double by 1975. Power companies plan to increase output 250% in the next 20 years to provide the power for scores of new labor-saving devices. Clothing suppliers predict a one-third increase in 7 years.

With 11,000 new citizen-consumers born every day, there's a new wave of opportunity coming.

### 7 BIG REASONS FOR CONFIDENCE IN AMERICA'S FUTURE

- 1. More people . . .** Four million babies yearly. U. S. population has *doubled* in last 50 years! And our prosperity curve has always followed our population curve.
- 2. More jobs . . .** Though employment in some areas has fallen off, there are *15 million* more jobs than in 1939—and there will be *22 million* more in 1975 than today.
- 3. More income . . .** Family income after taxes is at an all-time high of \$5300—is expected to pass \$7000 by 1975.

- 4. More production . . .** U. S. production *doubles* every 20 years. We will require millions more people to make, sell and distribute our products.
- 5. More savings . . .** Individual savings are at highest level ever—*\$340 billion*—a record amount available for spending.
- 6. More research . . .** *\$10 billion* spent each year will pay off in more jobs, better living, whole new industries.
- 7. More needs . . .** In the next few years we will need *\$500 billion* worth of schools, highways, homes, durable equipment. Meeting these needs will create new opportunities for everyone.

Add them up and you have the makings of another big upswing. Wise planners, builders and buyers will act *now* to get ready for it.

**FREE!** Send for this new 24-page illustrated booklet, "Your Great Future in a Growing America." Every American should know these facts. Drop a card today to: ADVERTISING COUNCIL, Box 10, Midtown Station, New York 18, N. Y.



(This space contributed as a public service by this magazine.)



# NEW PRODUCTS

## Servo Motor 400 cycle

MECHATROL, a division of Servomechanisms, Inc., 1200 Prospect Ave., Westbury, L. I., N. Y., announces a 400 cycle servo motor in BuOrd size 5, weighing only 0.85 oz and said to be shorter than those presently available in this



diameter. The 5S1-3 operates at 26 v, fixed phase and 40 v center-tapped control phase, power input

2 w per phase, with a nominal no load speed of 11,000 rpm, and 42,000 radians per sec<sup>2</sup> theoretical acceleration. Starting voltage is only 0.6 v maximum. Stall torque is 0.1 oz-in. minimum. Maximum power output is 0.3 w at a speed of 6,000 rpm. Operating temperature is -55 C to +85 C. **Circle 300 on Reader Service Card.**

## Remote Amplifier versatile unit

GATES RADIO CO., Quincy, Ill., announces the Unimote, a single channel remote amplifier. It will perform equally well as a microphone preamplifier, program am-

plifier up to  $\pm 18$  dbm output, repeater amplifier, isolation amplifier and as a standby amplifier for quick connection to an emergency circuit. Printed wiring is employed throughout. Size is 11 in. wide, 5 $\frac{1}{4}$  in. high and 5 in. deep. **Circle 301 on Reader Service Card.**

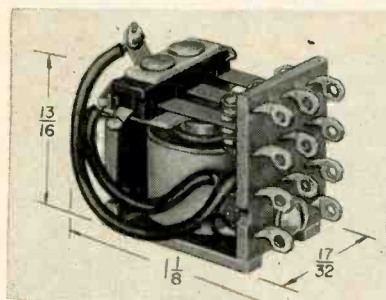
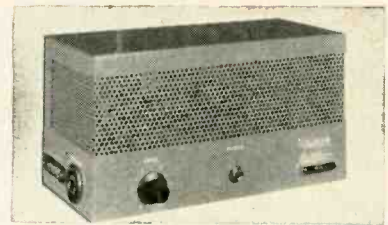

## Subminiature Relay weighs 5/8 oz

POTTER & BRUMFIELD, INC., Princeton, Ind., announces a subminiature armature type relay for commercial and industrial applications. The KM relay operates on as little as 750 mw. It provides switching arrangements up to 3

pdt; it switches up to 2 amperes at 115 v 60 cycle, resistive loads, and provides over a million operations at rated load. A d-c operated relay, it can be furnished for voltages up to 48 v. Some present applications include automatic traffic control systems and automatic weather stations. **Circle 302 on Reader Service Card.**

## Snap Action Switch low cost device

CHERRY ELECTRICAL PRODUCTS CORP., 1650 Deerfield Rd., Highland Park, Ill. The S75-00A switch features a low, flat actuator ideally suited for pushbutton, cam or interlock applications. Built-in posi-

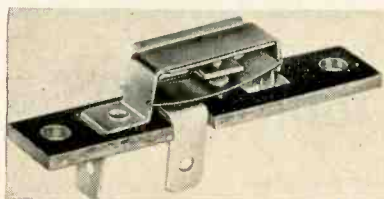

tive stop limits overtravel and prevents damage to the switch mech-

anism. The over center "bowed" blade provides high contact pressures and fast contact transfer with a life expectancy in the hundreds of thousands. Normally open version of the switch is priced at 17.2 cents each in 10,000 piece quantities. **Circle 303 on Reader Service Card.**

## D-C Amplifier rack-mounted

SOUTHWESTERN INDUSTRIAL ELECTRONICS Co., 2831 Post Oak Road, Houston 19, Texas. Model B-1 rack-mounted d-c amplifier delivers

up to 6 w at an output impedance of less than 0.1 ohm over the frequency range from d-c to 20,000 cps. Transistorized, direct-coupled circuitry not only makes it compact, but eliminates warmup time to provide instant, full-power sta-



bility. **Circle 304 on Reader Service Card.**



## Converter rms to d-c

SYSTRON CORP., 2000 Concord Blvd., Concord, Calif., announces a precision rms to d-c converter for

industrial or lab measurement of a-c voltages. Model 1240 features a true rms conversion accuracy of  $\pm 0.1$  percent, with high input impedance, 0.5 sec time response, 50 cps to 10,000 cps frequency re-





# WESTINGHOUSE TAKES A GIANT STEP IN SILICON POWER TRANSISTORS

Through major improvements in silicon purification and transistor fabrication, Westinghouse has broken down the previous limitations of Silicon Power Transistors. The result is a new series of Westinghouse Power Transistors which can operate at high efficiencies in the "true power range."

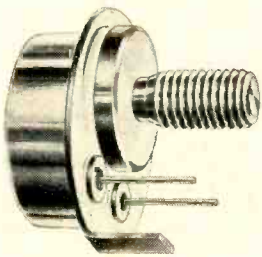

**LIFE-SIZE DRAWING** shows how Westinghouse Silicon Power Transistor is designed for attachment to heat sink with a screw stud. All leads are in the base.

	CURRENT RATING	V <sub>CB0</sub>	V <sub>CE</sub> (V <sub>EB</sub> =0)	R <sub>S</sub>
WX1015	2 AMPERES	30-300V	30-300V	0.5 OHMS TYPICAL
WX1016	5 AMPERES	30-300V	30-300V	0.4 OHMS TYPICAL

Thermal resistance—Junction to case, 0.7°C/watt typical. Current ratings based on the current at which current gain is equal to or greater than 10. It is possible to switch higher collector currents with some sacrifice in gain.

These are the first members of an entirely new family of Westinghouse Silicon Power Transistors, which have the advantages associated with silicon (high voltages and high operating temperature) without the disadvantages (high losses). As you can see from the chart below, these units possess exceptionally low saturation resistance—less than one half ohm. This low saturation resistance results in low internal dissipation. Coupled with high power handling capacity, it makes possible silicon transistors which can efficiently handle 1000 or 1500 watts. For example, as a DC switch, handling 1.5 kw (300 volts at 5 amperes) the internal dissipation of the units is about 12.5 watts with a resulting efficiency of better than 99%.

Like other silicon devices, these transistors can operate in ambient temperatures up to and exceeding 150°C while germanium units are limited to 85°C. Thus, where the higher power rating is not required these units may be used for their high temperature capabilities. It also follows that wherever germanium power units are presently employed, a switch to silicon transistors will result in higher reliability of operation, because of the greater margin of safety with respect to operating temperature.

There are a great many circuits for which this new type of silicon power transistor is made to order. It will

find use in inverters or converters (AC to AC, AC to DC, DC to AC, DC to DC), to control frequencies for data processing, servo output, and other aircraft information applications. It will serve as a low frequency switch, as mentioned above; it will operate efficiently with low power supply voltages; and it will find a number of uses in class A amplifiers. There are also many additional applications—too numerous to list here.

These Westinghouse Silicon Power Transistors are available in sample quantities for your testing and immediate application. Call your Westinghouse representative or write directly to Westinghouse Electric Corporation, Semiconductor Dept., Youngwood, Penna.

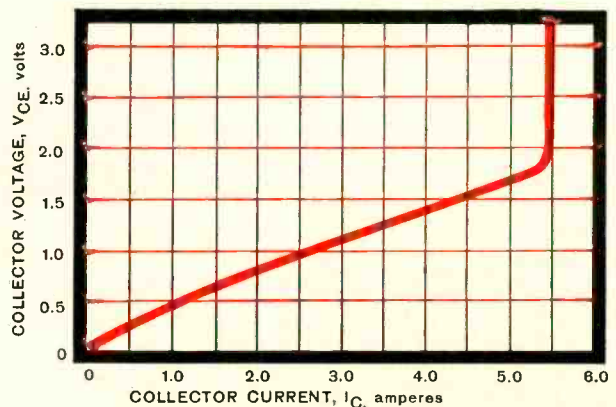

**LOW SATURATION RESISTANCE** is exhibited in this graph showing values for a typical Westinghouse Silicon Power Transistor driven to 5 amperes. The values are fractions of those observed in other silicon transistors.

**YOU CAN BE SURE... IF IT'S**

# Westinghouse

# Looking for the right resistor?

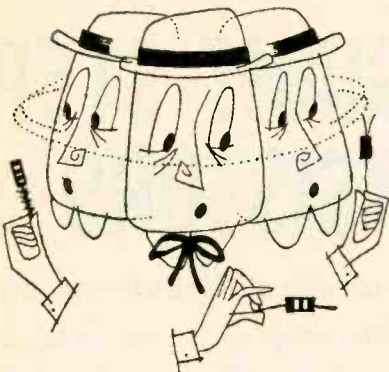

*you can find it in this catalog...*



... along with everything you'll want to know about the complete standard line of Speer Resistor Products — specifications, characteristics and applications:

- Fixed Composition Resistors
- Phenolic Coil Forms
- Iron Coil Forms

Be sure to send for your copy today.

### Other Speer Products for the Electronics Industry

anodes • contacts • fixed carbon resistors  
coil forms • discs • brushes • battery carbon • graphite plates and rods  
also R. F. coils • fixed composition capacitors • chokes made by Jeffers Electronics



**SPEER RESISTOR DIVISION**  
**SPEER CARBON COMPANY**  
Bradford, Pennsylvania

Send copy of the Speer Resistor Catalog.

Name \_\_\_\_\_  
Title \_\_\_\_\_  
Company \_\_\_\_\_  
Address \_\_\_\_\_  
City \_\_\_\_\_ State \_\_\_\_\_

CIRCLE 206 READERS SERVICE CARD

sponse, and long term stability for a-c inputs regardless of wave form. It is available for production testing with full scale ranges of 0.1, 0.3, 1, 3, 10, 30, 100, and 300 selected by one control. Output for each full scale is either 3 or 10 v d-c with less than 10 ohms output impedance. Circle 305 on Reader Service Card.

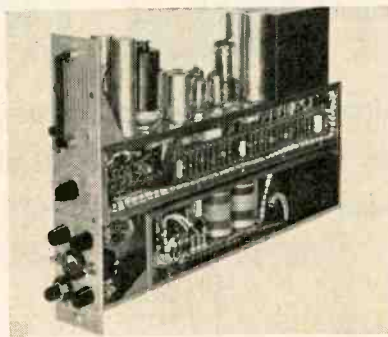

## D-C Amplifier high current output

DYNAMICS INSTRUMENTATION Co., 1118 Mission St., South Pasadena, Calif. Model 1411 d-c amplifier for driving recording galvanometers features high-current output ( $\pm 100$  ma) up to 30 kc, electrical offset control, output metering, damping resistance selector, dummy loads with substitution by relay, and continuously variable voltage gains from 1.0 to 3,000. Standard specifications include 100 K input impedance,  $\pm 2 \mu\text{v}$  drift limits, and less than 0.1 percent nonlinearity for the usual galvanometer frequency range. Circle 306 on Reader Service Card.



## Voltage Limiter instantaneous

ELECTRONIC MEASUREMENTS Co., Inc., Eatontown, N. J., has developed an instantaneous, all electronic voltage limiter for use with power supplies. It is used to protect transistors, and other voltage

# Why do it Yourself?



## It Pays to Standardize on Jeffers R.F. Choke Coils

You can save time, labor, and money by stocking the wide range of Jeffers R.F. choke coils just as you do resistors, capacitors, and other similar components. You can forget tedious, expensive hand assembly from miscellaneous forms, wires, and coatings by using standardized Jeffers coils, completely assembled for use.

Jeffers coils are well made, using insulated copper wire windings... husky molded jackets. All windings are soldered to leads... shorted end turns are completely eliminated.

Put these advantages to work in your circuits! Jeffers Electronics offers you... ready for delivery... a complete line of R.F. choke coils with a complete range of inductance values. Write today for our specification sheets.

Other Jeffers Products  
fixed composition capacitors

Other Speer Products  
for the Electronics Industry

anodes • contacts • resistors  
discs • brushes • molded notched coil forms  
battery carbon • graphite plates and rods

\*Patented



**JEFFERS ELECTRONICS**  
**DIVISION**  
**SPEER CARBON COMPANY**  
Du Bois, Pennsylvania

Other Speer Divisions:  
Speer Resistor, Speer Carbon Products,  
International Graphite & Electrode

CIRCLE 207 READERS SERVICE CARD



sensitive devices, from damage due to both low- and high-speed voltage excursions. The limiter is adjustable to provide protection at any voltage between 0 and 50 v, and it will handle power supplies with ratings up to 3 amperes. Circle 307 on Reader Service Card.



### V-R Power Supply transistorized

KEPCO LABORATORIES, INC., 131-38 Sanford Ave., Flushing 55, N. Y. Model SC-150-1 transistorized v-r power supply delivers 0-150 v, 0-1 ampere. Regulation for line or load is less than 0.01 percent or 0.002 v, whichever is greater. Ripple is less than 1 mv rms. Recovery time is less than 50  $\mu$ sec. Stability for 8 hours is less than 0.01 percent, or 0.002 v, whichever is greater. Operating ambient temperature is 50 C maximum. Temperature coefficient is less than 0.01 percent per deg C. Output impedance is less than 0.05 ohm. Circle 308 on Reader Service Card.



### Voltmeter 10 cps-1,000 kc

THE DAVEN CO., Livingston, N. J. Model 21A electronic voltmeter measures a-c voltages over a range of 10 cps to 1,000 kc. It will also serve as a null indicator, as a power



## SINE-COSINE Precision POTENTIOMETER-RESISTORS

For resolution of voltage into sine and cosine components in accordance with positions of shaft rotation.

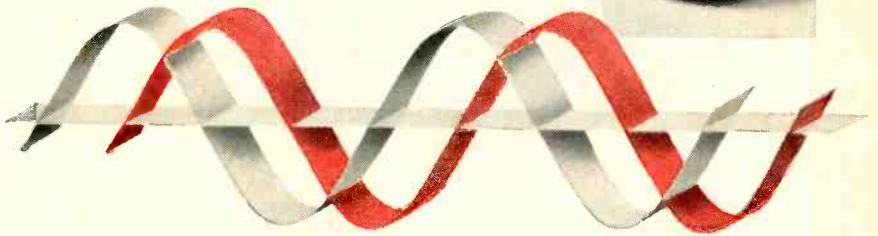

### TYPICAL APPLICATIONS:

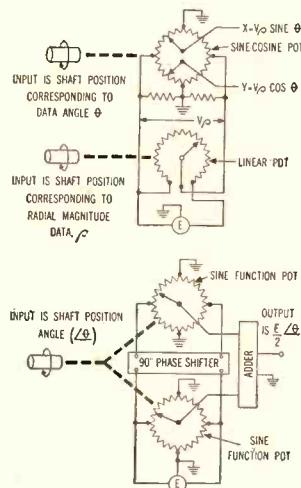

**ANGLE DATA TRANSMISSION** as used in automatic controls, directional and ranging systems, analog computers, and telemetry.

**PHASE DIVISION** as used in investigation of phase sensitive systems, delay measurements, and timing applications.

**DATA CONVERSION** as used in rotation of coordinates, or conversion from polar to rectangular coordinate form, for computers or data display applications.

Potentiometers having sinusoid functions are available in 3", 2", 1 7/8", 1 1/2", 1 1/4", and 7/8" diameters. These potentiometers are available with two sliders giving independent outputs, one proportional to the sine and the other to the cosine of the shaft angle. Multiple units may be ganged and phased for cosine function or for other applications such as rotation of coordinates.

Precision in potentiometer-resistors feature wide temperature range, excellent environmental stability, highly precise mechanical construction and electrical performance.

Technical reports on the use of these units, and complete data are available on request.



### TECHNOLOGY INSTRUMENT CORP

569 Main St., Acton, Mass. COLonial 3-7711  
P.O. Box 3941, No. Hollywood, Calif. POplar 5-8620

# NOW! stocked for immediate delivery

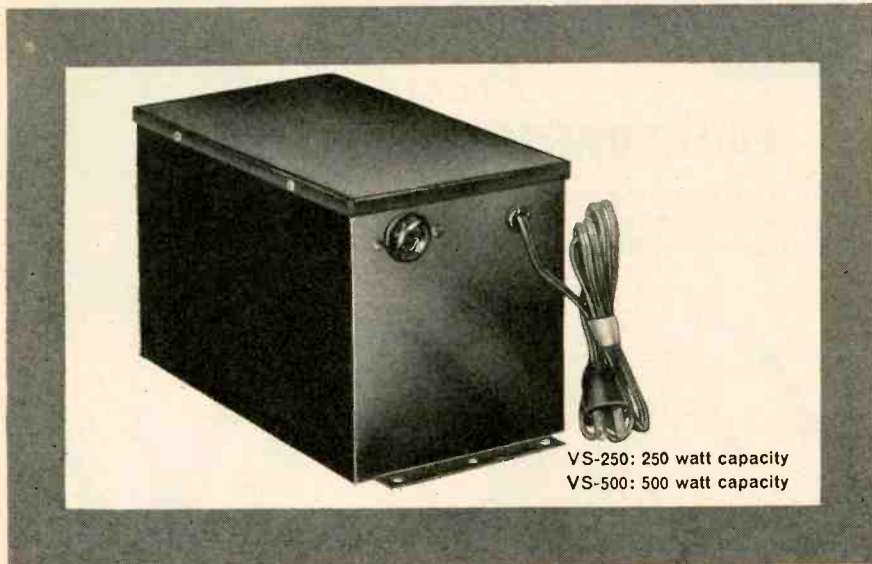

VS-250: 250 watt capacity  
VS-500: 500 watt capacity

## CHICAGO<sup>®</sup>

## VOLTAGE STABILIZING TRANSFORMERS

provide instantaneous, automatic stabilization to within  $\pm 1/2\%$  for voltages from 95 to 130 V. A.C.

These CHICAGO units, of static-magnetic design, are now stocked for immediate delivery through electronic parts distributors. CHICAGO voltage stabilizing transformers offer you many important advantages:

- \* **EXTREMELY CONSTANT OUTPUT:**  $\pm 1/2\%$  for input fluctuations from 95 to 130 volts A.C. with rated output of 117 volts, A.C., 60 cycle
- \* **RAPID STABILIZING ACTION**—usually a few cycles or less
- \* **UNAFFECTED BY POWER FACTOR**—or changes in load
- \* **ISOLATION TYPE**—provide complete isolation between input and output circuits
- \* **BUILT-IN CURRENT LIMITING CHARACTERISTICS**—protect load equipment from excessive fault currents
- \* **NO MOVING PARTS**—eliminates maintenance problems

**CUSTOM DESIGN SERVICE:** Units of other capacities, voltages and frequencies, or units to be built into your equipment, can be designed and produced in production quantities.

For complete details on these units write for Chicago Standard Bulletin CT-44 or see your Chicago Standard distributor.

### CHICAGO STANDARD TRANSFORMER CORPORATION

3502 Addison Street • Chicago 18, Illinois

Export Sales: Roburn Agencies, Inc. • 431 Greenwich Street • New York 13, N. Y.



level meter and as a wide band amplifier. Specifications on full scale accuracy are:  $\pm 2$  percent from 15 cps to 200 kc at 25 C and  $\pm 4$  percent from 10 cps to 1 mc at  $-10$  C to  $+55$  C. Stability is  $\pm 1$  percent over line voltage variations of 105 v to 125 v. Circle 309 on Reader Service Card.



### Subminiature Pot high resolution

G. M. GIANNINI & Co., Inc., 918 E. Green St., Pasadena 1, Calif. Model 875T precision pot provides high power dissipation at temperatures to 200 C. Weighing  $\frac{1}{8}$  oz, and with a diameter of only 0.875, it offers resolution as high as 0.06 percent with a standard linearity of 0.5 percent or better. Available resistances range from 200 ohms to 100,000 ohms per section, and up to 4 sections can be ganged on a common shaft. Torque is 0.1 oz-in. Circle 310 on Reader Service Card.



### Test Set for microwave tubes

BRIGGS ASSOCIATES, INC., 10 DeKalb St., Norristown, Pa., has announced the model CD-3 current division tester for microwave tubes. Used in conjunction with an oscilloscope, the unit is capable of detecting actual and potential electrical or mechanical failure of 2C39 and similar tubes. The company



claims that use of the unit will result in major savings on tube procurement and even greater savings by the shortened down-time of inoperative stations. Circle 311 on Reader Service Card.

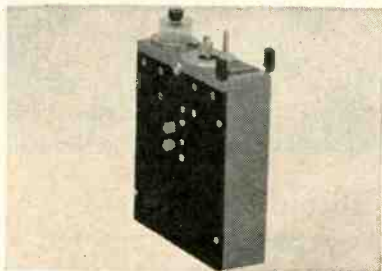

### Galvanometer four writing media

PHOTRON INSTRUMENT Co., 6516 Detroit Ave., Cleveland 2, Ohio. Model G2 galvanometer employs four writing media, recording curvilinear and rectangular coordinates. Ink-writing pen, electric stylus and hot stylus elements are all easily interchangeable for quick conversion from one type of record to another. Response with ink-writing pen or electric stylus, with no compensation is flat to 40 cps, with hot stylus flat to 30 cps. Rise time is 0.015 sec. Linearity is 2 percent for the hot stylus and  $\pm 1.5$  percent of full scale for ink-writing pen or electric stylus. Circle 312 on Reader Service Card.

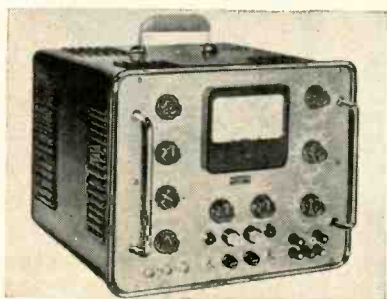

### Power Supply for klystron tubes

F-R MACHINE WORKS INC., 26-12 Borough Place, Woodside 77, N. Y. The Z819A klystron power supply is a compact versatile unit designed for low and medium power klystron tubes. Beam voltages up to 1,000 v at 85 mils, reflector voltages up to

# Announcing

A new, highly accurate, yet inexpensive, method of speed measurement . . . monitoring . . . control. Applicable to machines, engines and transportation equipment.



## TACH-PAK

accepts a signal from a magnetic proximity pickup and conditions this signal for application to a meter calibrated directly in RPM . . . a control system . . . or a chart recorder. Installation is simple and there is NO maintenance problem.

L4

AIRPAX  
Control Specialists Since 1948



SEMINOLE DIVISION  
THE AIRPAX PRODUCTS COMPANY — FORT LAUDERDALE, FLA.



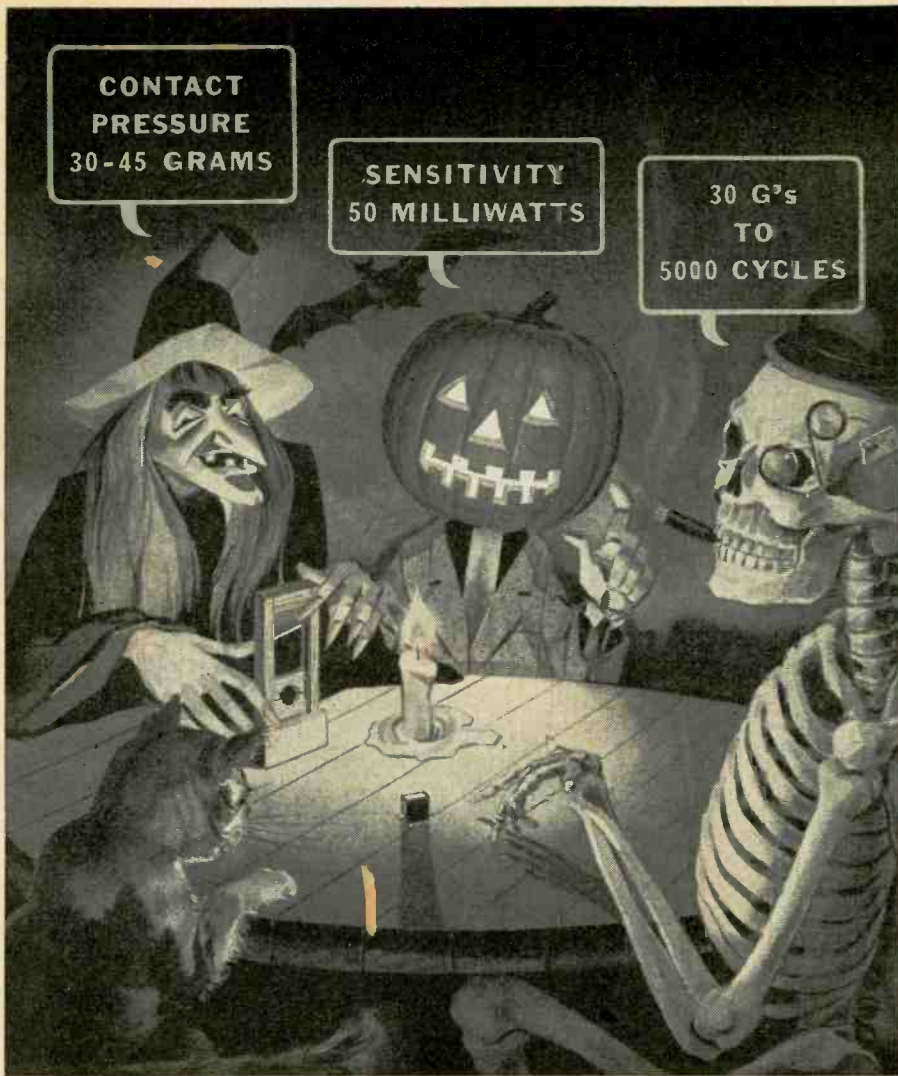

## High level engineers conduct spirited discussion

The nearly fiendish delight of these specifying engineers comes from their discovery of a new relay which can meet the requirements of even the most horrible application.

It is the new Sigma Series 32, a DPDT magnetic latching relay which needs neither standby power nor a size reference. (Such spring-less, catch-less, trigger-less and power-less latching of the 32 solves all sorts of problems in wear, tear, heat and disturbances from power interruptions, all in one swoop.) Besides the distinguishing specs being discussed by the characters above, the 32 also has all the usual features you'd expect in this type of relay: e. g., hermetic seal; all standard mounting styles (eight grid-spaced pins, eight "J" hook solder terminals, plug-in types) for either flange or stud mounting; size 0.800" x 0.400" x 0.900" high; weight 18 grams.

Whether your circuit is wet or dry, you might find a 32 is just what it needs. Preliminary descriptive sheets give a fairly complete rundown on the Series 32, or you could even buy a sample 32 to try.

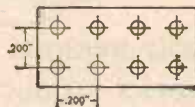
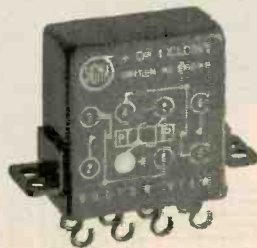

# SIGMA

SIGMA INSTRUMENTS, INC.,  
62 Pearl Street, So. Braintree 85, Mass.

900 v and a -300 to +150 v grid supply are available. All voltages may be accurately pre-set. In addition, important voltages and currents are front-panel metered. Circle 313 on Reader Service Card.



## Silicon Rectifiers low priced

GENERAL ELECTRIC Co., Syracuse, N. Y., announces two new families of economy-priced low current silicon rectifiers. Four 100 C rectifiers have piv ratings of 100, 200, 300 and 400 v. They are all capable of 250 ma d-c rectified current output at 100 C ambient temperature. Six 125 C rectifiers have piv ratings of 100, 200, 300, 400, 500 and 600 v. Circle 314 on Reader Service Card.



## Preamplifier d-c coupling type

SANBORN Co., 175 Wyman St., Waltham 54, Mass. Model 450-1300 d-c coupling preamplifier is designed for use with optical oscillographs, tape recorders, oscilloscopes and other indicating devices. It features high performance on single-ended or balanced signals. A three-stage circuit features cathode follower input and output, with overall gain provided by the second



stage push-pull transistor amplifier. Input is single-ended or push-pull, impedance 5 megohms each input side to ground; 50 mv input produces 1 v at output jack under maximum output load conditions. Circle 315 on Reader Service Card.

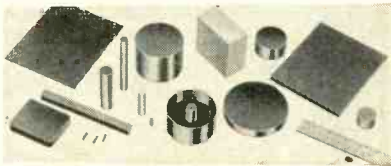

### Diallyl Phthalate in machinable stock

MESA PLASTICS CO., 11751 Mississippi Ave., Los Angeles 25, Calif., has available blanks of diallyl phthalate plastic for machining prototypes. Blanks are furnished as machinable stock in a wide variety of shapes and sizes. Diallyl phthalate is the plastic which maintains insulation resistance, dielectric strength, and dimensions throughout exposure to high humidity and elevated temperature. Company states that the blanks are guaranteed free of voids, cracks, and porosities, thus insuring complete machinability to any configuration. Circle 316 on Reader Service Card.



### Transistors switching type

TEXAS INSTRUMENTS INC., P. O. Box 312, Dallas, Texas, announces two silicon switching transistors with switching times as low as 500 millimicroseconds in saturating circuitry. They are expected to have wide use in high speed computers and other switching applications requiring high reliability over wide temperature ranges. Packaged in the military and industry accepted round-welded JETEC TO-5 package, the 2N1005 and 2N1006 fea-

look what **\$24<sup>50</sup>** buys  
in test equipment!



**HEATHKITS  
GIVE YOU  
TWICE AS MUCH  
equipment for  
every dollar  
invested**

The famous model V-7A Vacuum-Tube-Voltmeter is a perfect example of the high-quality instruments available from Heath at 1/2 the price you would expect to pay! Complete, only **\$24<sup>50</sup>**

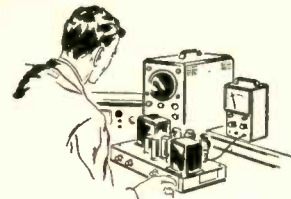

Get the most out of your test equipment budget by utilizing HEATHKIT instruments in your laboratory or on your production line. Get high quality equipment, without paying the usual premium price, by dealing directly with the manufacturer, and by letting engineers or technicians assemble Heathkits between rush periods. Comprehensive instructions insure minimum construction time. You'll get more equipment for the same investment, and be able to fill your needs by choosing from the more than 100 different electronic kits by Heath. These are the most popular "do-it-yourself" kits in the world, so why not investigate their possibilities in your particular area of activity! Write for the free Heathkit catalog now!



Contains detailed descriptions of Heathkit models available, including VTVM's, scopes, generators, testers, bridges, power supplies, etc.

**FREE catalog**

Mail coupon below for  
your copy—Now!



Also describes Heathkit ham gear and hi-fi equipment in kit form. 100 interesting and profitable "do-it-yourself" projects!

**HEATH COMPANY**  
A SUBSIDIARY OF DAYSTROM, INC.,  
BENTON HARBOR 14, MICHIGAN

Name \_\_\_\_\_

Address \_\_\_\_\_

City & Zone \_\_\_\_\_

State \_\_\_\_\_

# BALLANTINE

## SENSITIVE WIDE BAND ELECTRONIC VOLTMETER

measures 1 millivolt to 1000 volts  
from 15 cycles to 6 megacycles

Accuracy 3% to 3 mc; 5% above  
Input impedance 7.5 mmfds shunted by 11 meg

When used without probe, sensitivity  
is increased to 100 MICROVOLTS but  
impedance is reduced to 25 mmfds  
and 1 megohm



MODEL 314  
Price \$285

- Same accuracy at ALL points on a logarithmic voltage scale and a uniform DB scale.
- Only ONE voltage scale to read with decade range switching.
- No "turnover" discrepancy on unsymmetrical waves.
- Easy-to-use probe with self-holding connector tip and unique supporting clamp.
- Low impedance ground return provided by supporting clamp.
- Stabilized by generous use of negative feedback.
- Can be used as 60 DB high fidelity video pre-amplifier.

All Ballantine instruments are SENSITIVE - ACCURATE - DEPENDABLE

Write for catalog for complete information.

### BALLANTINE LABORATORIES, INC.

100 FANNY ROAD, BOONTON, NEW JERSEY



ture d-c betas of 20-to-55 and 45-to-150, respectively. Both also have a collector dissipation of 125 mw at 25 C, 60 ohms saturation resistance, and 0.1  $\mu$ a collector cut-off current. Circle 317 on Reader Service Card.

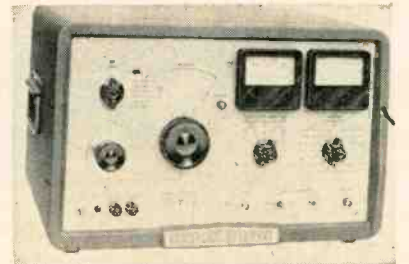

### Signal Generator covers 50 kc-65 mc

HEWLETT-PACKARD Co., 275 Page Mill Road, Palo Alto, Calif. The 606A signal generator covers the frequency range 50 kc to 65 mc. Output is 3 v full range, and may be continuously attenuated to 0.1  $\mu$ v. Unit employs the master oscillator power amplifier circuit with a full feedback loop, insuring constant output over the full frequency range. It has extremely low distortion even at high modulation levels. Circle 318 on Reader Service Card.



### Servo Multiplier two channels

ELECTRO PRECISION CORP., Arkadelphia, Ark. Providing a static nulling area of 0.02 percent, the DLI-101 dual servo multiplier consists of two complete servo multiplier channels. Each channel provides for accurate, reliable multiplication of three variables by a fourth. Its age feature maintains constant loop gain for reference voltage variation in the range between 2 and 100 v. The 0.6 sec



full scale slow speed, the open loop gain in excess of 10,000, and the 0.1 percent linearity single turn pots combine to provide high dynamic and static accuracy. Composed of Digitrol plug-in building blocks, the DLI-101 offers maximum flexibility and ease of maintenance. Circle 319 on Reader Service Card.

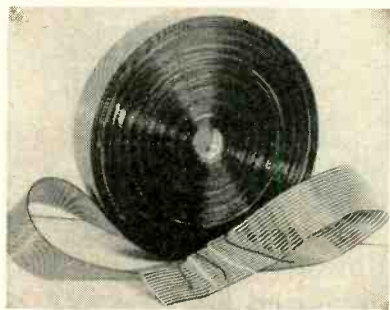

### Flat Cable multiconductor

SPECTRA-STRIP WIRE AND CABLE CORP., 10052 Larson Ave., Garden Grove, Calif. Spectra-Strip is a multi-colored, multiconductor flat cable where interwire capacitance is stabilized. Using it, the design engineer has a choice of where he will place certain circuits in relation to others, and still stay within the same cable. By grounding the wire on each side of any particular lead, the need for a shielded wire or coaxial cable can be avoided in many cases. Circle 320 on Reader Service Card.



### Load Isolator low insertion loss

LITTON INDUSTRIES, 5873 Rodeo Rd., Los Angeles 16, Calif. Model R 307/S142 ferrite load isolator, particularly suited to electronic countermeasure application, gives a minimum of 10 db isolation over an 1,800 mc bandwidth. It is de-

# NEW ANOTHER NEW DEKATRAN RATIO TRANSFORMER

*Now*

*in this  
actual small size*



## model DT-35

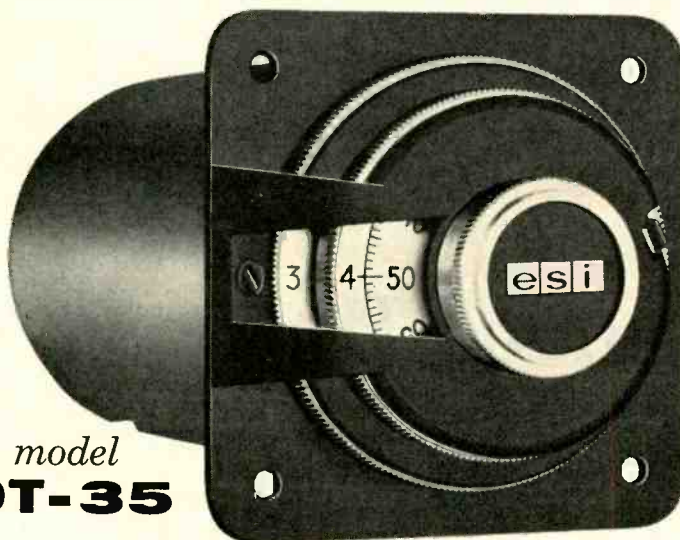

A miniaturized concentric dial precision decade ratio transformer voltage divider for panel mounting. A two decade ratio transformer and an interpolating potentiometer provide 4 place readings of voltage ratio in one convenient straight line.

## FEATURES

- **RUGGED CONSTRUCTION:** Designed to meet wide range of environmental conditions.
- **SMALL SIZE:** 6 units mount on 3x19-inch rack panel.
- **TRANSIENT SUPPRESSION:** Switching transients have been minimized.
- **EASE OF READING:** 4 place in-line window readout.
- **DIAL LOCK:** Interpolating dial can be locked without affecting outer dials.
- **ACCURACY:**  $\pm 0.01\%$  at full scale; 50—10,000 cps.
- **OUTPUT CURRENT:** High current switches and low output impedance allow current rating of 1 ampere.

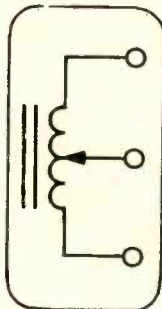

**WEIGHT:** 1 1/4 pounds net.  
**PRICE:** \$160.00.

*Manufactured to meet applicable military specifications*

**esi**

**ELECTRO-MEASUREMENTS, INC.**  
7524 S. W. MACADAM AVENUE • PORTLAND 19, OREGON

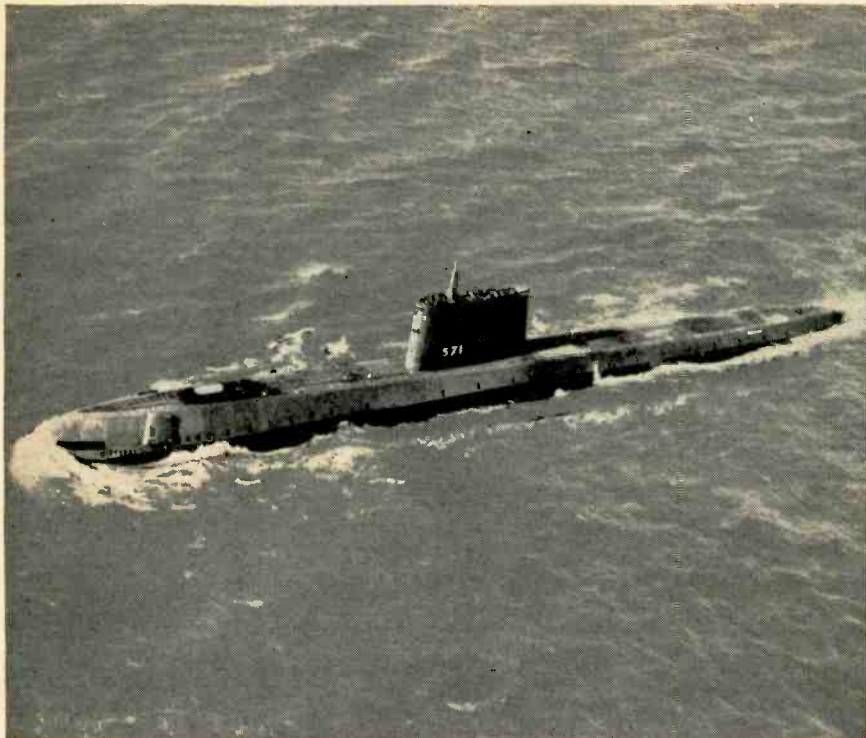

Official U. S. Navy Photograph

## 'Diamond H' Aircraft-type Relays Go to Sea in the Nautilus

Their reliability proven in such critical land and air applications as guided missiles, jet engine controls and fire control systems, "Diamond H" miniature, hermetically-sealed, aircraft-type relays were chosen by Westinghouse for an important role in the world's first atomic-powered submarine. They're used in the reactor control system of the Nautilus.

Possible performance characteristics of "Diamond H" Series R 4 PDT relays span such broad ranges that the modifications which can be arranged to meet particular sets of requirements are almost endless. They're fully described in Bulletin R250, a copy of which is yours for the asking. Our engineers will gladly work with you to develop a variation for your specific need.



### THE HART MANUFACTURING COMPANY

202 Bartholomew Avenue, Hartford 1, Conn.

signed for 1 db maximum insertion loss, but production isolators are showing only 0.5 to 0.8 db loss over most of the bandwidth. Operating power is 300 w c-w. Its length is 5.0 in. but this can be shortened to 3.5 in. without harming electrical characteristics. Circle 321 on Reader Service Card.

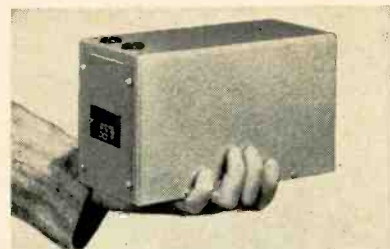

### Voltage Regulators small and light

BRITISH INDUSTRIES CORP., 80 Shore Road, Port Washington, N. Y. The new Claude Lyons automatic line voltage regulators are completely independent of load from 0 to 100 percent of rated value, and are unaffected by input frequency variations over at least the range from 45 to 65 cps. Output waveform is a perfect reproduction of the input, with no harmonics added. Correction generally occurs within 3 cycles. Units are available for single phase or 3-phase inputs of 115 or 230 v nominally, with outputs from 575 va to 2,300 va. A typical regulator delivering 1,150 va, measures 5½ in. high by 9 in. long by 4¾ in. wide, and weighs 11½ lb. Circle 322 on Reader Service Card.

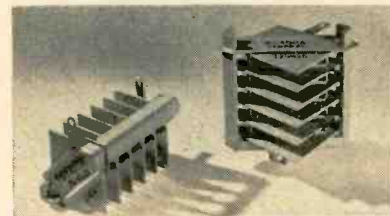

### Selenium Rectifiers cover 150 to 450 ma

INTERNATIONAL TELEPHONE AND TELEGRAPH CORP., Clifton, N. J., announces the Federal Slim-Line of selenium rectifiers. The line presently consists of two sizes which



cover the range from 150 to 450 ma for half-wave rectifier applications and for B-plus supplies in voltage doubler circuits. Designed to meet the most rigid requirements of radio and tv receiver manufacturers, they feature a sturdy yoke-type construction which engages the corners of the selenium cells eliminating center holes and permitting the full area of the plate to be utilized. Circle 323 on Reader Service Card.

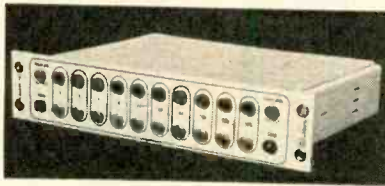

### Converter digital-to-analog

NAVIGATION COMPUTER CORP., 1621 Snyder Ave., Philadelphia 45, Pa., has added a new, fully-transistorized digital-to-analog converter to its extensive line of pulse handling equipment. It is intended for the conversion of binary-coded data up to ten bits in length, into proportional d-c voltage of both polarities. Accepting inputs from a ten flip-flop storage register, the unit presents an output of  $\pm 15$  ma into 10 ohms within  $0.4 \mu\text{sec}$  after application of all input signals, and is linear within at least  $\pm 1$  percent. Circle 324 on Reader Service Card.



### Ceramic Capacitors layer-built

SPRAGUE ELECTRIC CO., North Adams, Mass., announces new layer-built Monolithic ceramic capacitors for transistorized circuitry. Into a small rectangular block  $\frac{1}{2}$  in. by  $\frac{1}{2}$  in. by  $\frac{1}{8}$  in. thick, it is possible to pack a capacitance of as much as  $0.75 \mu\text{f}$  at 24 v d-c. The new capaci-

*Now...*

**ERIE "PAC"**  
*with*  
**WIRE LEADS**  
*for Point-to-Point Wiring*

### ERIE WIRE LEAD PAC FEATURES

- Applicable for universal wiring
- Dual protection — leads mechanically wrapped and soldered
- High solderability wire leads to base terminals

Erie "PAC" is now available with wire leads in addition to printed board terminals. Manufacturers using point-to-point wiring can now gain the many advantages of the "PAC" Modular System.

The wire leads are mechanically crimped, then soldered to the respective component terminations.

### SPECIFICATIONS

Wire Leads .....	Standard, 22 AWG Special, 20 AWG
Capacitance Range—ceramic dielectric .....	10 mfd — .01 mfd
—mylar dielectric .....	.01 mfd — .1 mfd
Capacitance Tolerance* .....	+100%, -0%, $\pm 20\%$ , $\pm 10\%$ , $\pm 5\%$
Capacitance VDCW*—ceramic dielectric .....	500 VDC, 1 KVDC
—mylar dielectric .....	100 VDC, 200 VDC, 400 VDC
Resistance Range .....	10 $\Omega$ — 50 meg $\Omega$
Resistance Tolerance .....	$\pm 5\%$ , $\pm 10\%$ , $\pm 20\%$
Resistor Rating .....	$\frac{1}{2}$ watt @ 350 VDCW

\*Dependent upon capacity

Write for samples of ERIE Wire Lead PAC to fit your requirements and for detailed specifications contained in ERIE Engineering Bulletin 450-2.

**ERIE Electronics Division**  
**ERIE RESISTOR CORPORATION**  
MAIN OFFICES: ERIE, PA., U. S. A.  
FACTORIES: ERIE, PA. • HOLLY SPRINGS, MISS. • TRENTON, ONTARIO, CANADA

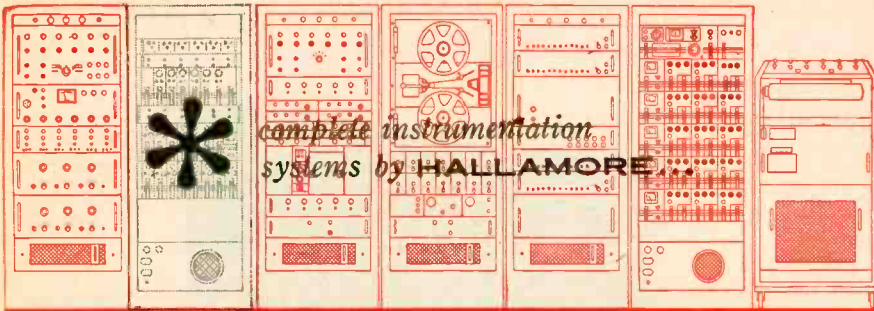

complete instrumentation systems by HALLAMORE...

## A NEW CONCEPT IN VOLTAGE CONTROLLED OSCILLATORS

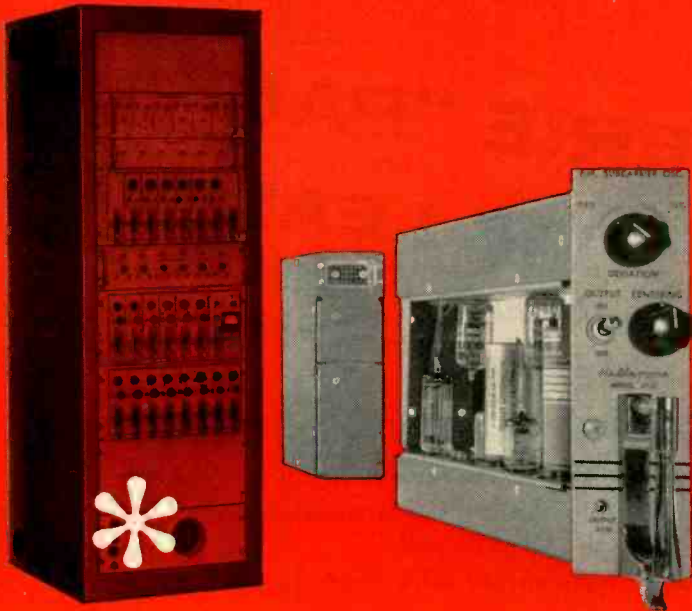

module size 2" x 7 $\frac{3}{4}$ "...adjustable internal bias...all standard IRIG channels...The voltage controlled subcarrier oscillator, shown in this building block type FM instrumentation system, is the latest in a series of building-block components developed by Hallamore Electronics Company for the instrumentation field. Engineered for stability and flexibility, the unit designated HEC-0161 is entirely compatible with existing systems and offers unusual advantages in improved accuracy, operational simplicity, and the saving of space. A standard module case will accommodate up to six oscillators and a summing amplifier, HEC-0166. A common supply, HEC-0144, integral to the module case, provides the power in this configuration, while an individual supply, HEC-0143, is available to provide complete isolation for each transducer input.

The basic Hallamore voltage controlled subcarrier oscillator unit, HEC-0161, can be instantly converted to any IRIG telemetering channel by plug-in channel selectors, HEC-0164, and output filters, HEC-0165. Plug-in units for non-standard channels and bandwidths can be supplied. For complete specifications and operational data, write Hallamore Electronics Company, Dept. 88, 8352 Brookhurst Avenue, Anaheim, Calif.



**HALLAMORE ELECTRONICS COMPANY** a division of the SIEGLER CORPORATION

Engineers... for ideal working conditions with a dynamic, creative organization address resume to Chief Engineer.

TWX Code: AH 9079

tors are built by spraying alternate layers of ceramic dielectric material and silver electrodes until the desired capacitance is achieved, using automatic machinery especially made for the purpose. Resultant capacitors are solid homogeneous blocks. Circle 325 on Reader Service Card.

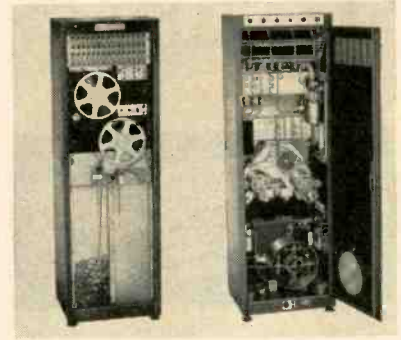

### Data Recorder all-transistorized

D. G. C. HARE Co., 30 Burtis Ave., New Canaan, Conn., announces model 424 fully-transistorized tape transport system; a new type of data recording system to record, store and reproduce analog or digital data. Two independent capstan drives, with high speed start-stop times of less than 2 millisecc, permit tape to operate in either direction at speeds from 7 $\frac{1}{2}$  to 60 ips. A high speed of 150 ips is also available for special applications. Circle 326 on Reader Service Card.

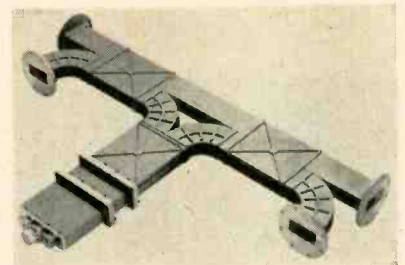

### Diplexer for S-band

BOMAC LABORATORIES, INC., Salem Road, Beverly, Mass. The BL-584 S-band diplexer is used primarily for connecting two transmitters operating at different frequencies to a common antenna feed, with very low crosstalk between them. It also separates the



two echo signals at the two frequencies into the approximate receiver channels. A pair of ganged plungers provides continuous variation of the two diplexing frequencies. A replaceable section makes it possible to diplex many combinations of frequencies. The unit can also be used as a continuously variable directional coupler. Circle 327 on Reader Service Card.



### D-C Power Supply for lab and line

WESTINGHOUSE ELECTRIC CORP., 356 Collins Ave., Pittsburgh 6, Pa. Model 646 Volt-Pak is a general-purpose d-c power supply for industrial laboratory and production line use. Rated output is 0-450 v d-c, 250-ma continuous, or 500-ma intermittent load. A-c output is rated 6.3 v, 3.0 amperes. Selenium rectifiers are used to provide instant operation and reduce maintenance problems. Smooth voltage control from zero to full output is obtained from a variable autotransformer. Circle 328 on Reader Service Card.



### Reference Element reduced size

U. S. SEMICONDUCTOR PRODUCTS, INC., Phoenix, Arizona. A new diffused silicon voltage reference ele-

# REVERE Thermocouple Wires



bought **FIRST**  
because they  
**LAST**

Day in, day out . . . in aircraft, refinery vessels, fire protection systems, furnaces, molding presses . . . under extremes of heat and cold, moisture, chemicals and abrasion, Revere thermocouple wires stand up because they're tailor-made for each application.

Solid or stranded chromel-alumel, iron-constantan and copper-constantan conductors available in various gauge sizes. Wrapped, carded or extruded insulations include polyethylene, vinyl, nylon, Revcothene\*, Teflon†, fiber glass, asbestos and pure silica glass fiber. Outer braids treated with flame and abrasion resistant saturants. Metallic braids for severe service. L & N, SAMA or NBS calibration. Wires constructed to Military Specifications MIL-W-5845, MIL-W-5846 and MIL-W-5908.

Whether your application requires extreme flexibility, chemical inertness or resistance to temperature, flame, abrasion, moisture, acids or solvents, a standard or special Revere thermocouple wire will meet your specific need.

\*Revere trade name

†E. I. DuPont trademark

Send for Engineering Bulletin No. 1701 describing Revere Thermocouple Wires and Extension Leads.

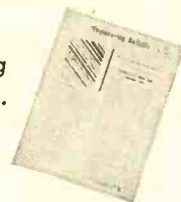

## REVERE CORPORATION OF AMERICA

Wallingford, Connecticut

A SUBSIDIARY OF NEPTUNE METER COMPANY

neptune

21

# for **SSB** transmissions: a new rapid test instrument

- incredibly simple to operate
- compact complete unit occupies only 19 1/4" of panel height
- exceptionally low-priced



## PANORAMIC'S SSB-3

### a sensitive spectrum analyzer

Panoramic's Model SB-12a Analyzer

### a stable tuning head

### a two-tone generator

### internal calibrating circuitry

Now, Panoramic has incorporated in one convenient package the equipment you need to set up . . . adjust . . . monitor . . . trouble-shoot SSB and AM transmissions.

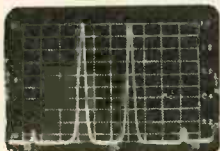

#### TWO TONE TEST\*

Fixed sweep width 2000 cps. Full scale log sideband tones 1.5 kc and 2.1 kc from carrier (not shown). Odd order I.M. distortion products down 37 db.

#### HUM TEST\*

Indication of one sideband in above photo increased 20 db. Sweep width set to 150 cps reveals hum sidebands down 54 db and 60 db.

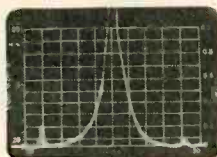

- pre-set sweep widths of 150, 500, 2000, 10,000 and 30,000 cps with automatic optimum resolution for fast, easy operation
- continuously variable sweep width up to 100 kc for additional flexibility
- 60 db dynamic range
- 60 cps hum sidebands measurable to -60 db
- high order sweep stability thru AFC net work
- precisely calibrated lin and log amplitude scales
- standard 5" CRT with camera mount bezel
- two auxiliary outputs for chart recorder or large screen CRT

- 2 mc to 39 mc range with direct reading dial free of hum modulation

- two separate audio oscillators with independent frequency and amplitude controls
- output 2 volts max. per tone into 600 ohm load, combined in linear mixer
- I.M. of two tones less than -60 db

- two RF signal sources simulate two-tone test and check internal distortion and hum of analyzer
- center frequency marker with external AM provisions for sweep width calibrations

\* See Panoramic Analyzer No. 3 describing testing techniques, etc., for single sidebands. A copy is yours for the asking.

Write, wire, phone RIGHT NOW for technical bulletin and prices on the new SSB-3. Panoramic instruments are PROVED PERFORMERS in laboratories, plants and military installations all over the world. Send for our new CATALOG DIGEST and ask to be put on our regular mailing list for The PANORAMIC ANALYZER featuring application data.

ment measures only 1 in. long by 3/8 in. o-d with axial leads. Reduced package size results from a unique silicon wafer sandwiching technique. Units are now available with 0.0005 percent per deg C temperature coefficient, with an operating temperature range from -65 C to +200 C. They may be had in both axial lead and lug terminal styles, to fill any requirements for a reference voltage, such as used in computers, measuring instruments and controls. Circle 329 on Reader Service Card.



### Rectifier Control magnetic type

FAIRFIELD ENGINEERING CORP., 934 Hope St., Springdale, Conn. Driving GE's silicon controlled rectifiers, type ZJ-39A, in power control systems and servo drives is greatly simplified by the use of a new magnetic rectifier control (MRC). The unit operates from low-level a-c or d-c control signals to develop a steep wavefront (current) to trigger the GE rectifiers. Circle 330 on Reader Service Card.



### Filters for narrow bandwidth

WHITE INSTRUMENT LABORATORIES, Box 9006, Allandale Station, Austin 17, Texas. Type FP2 filters



530 So. Fulton Ave., Mount Vernon, N. Y. • Phone: OWens 9-4600  
Cables: Panoramic, Mount Vernon, N. Y. State



are two-resonator networks designed as vacuum tube coupling circuits where relatively narrow bandwidth is desirable. FP2A filters operate from a typical triode amplifier or any other source of approximately 10 K ohms into a grid. FP2B filters operate from a typical cathode follower or other 500 to 600 ohm source into a grid. The  $-3$  db pass band is  $\pm 5$  percent, skirt attenuation is 40 db one octave from the center frequency, phase shift is approximately zero at the center frequency, and voltage ratio is 2. **Circle 331 on Reader Service Card.**

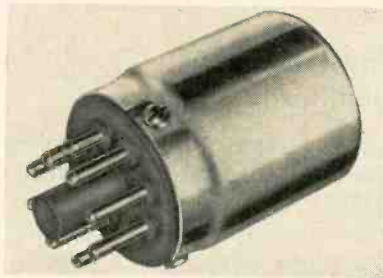

### Crystal Oven high stability

BLILEY ELECTRIC Co., Union Station Bldg., Erie, Pa., announces a new high stability crystal and components oven series. The TCO-14 series will accommodate two Bliley BH6A crystals or transistors, coils and other circuit elements requiring temperature stabilization. Stability is  $\pm 2$  C. Operating voltages are 6.3 v, 12.6 v or 26.5 v. **Circle 332 on Reader Service Card.**

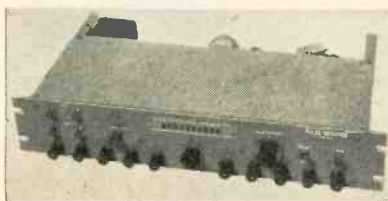

### Pulse Counter variable scale

BURROUGHS CORP., Plainfield, N. J., announces type 1791 variable scale megacycle counter. It features the shielded type BD300 beam switching tube—a decimal counting device, which enables the

**TUBE PRODUCTION IS A SCIENCE AT VARIAN**



### *Air washed assembly*

Varian Microwave tubes must be particle-free if they are to meet rigid performance standards. Varian Factory Engineers met this challenge by developing air-washed production areas in which vital tube components are assembled in a continuous flow of clean filtered air.

This is typical of the attention to detail and production skill that have made Varian Tubes the Standard for "out-ahead" microwave equipment. Over 100 of these tubes are described and pictured in our latest catalog. Write for your copy today.



VA-97

THE  
MARK OF  
LEADERSHIP



**VARIAN associates**

PALO ALTO 1, CALIFORNIA

Representatives throughout the world

KLYSTRONS TRAVELING WAVE TUBES, BACKWARD WAVE OSCILLATORS, LINEAR ACCELERATORS, MICROWAVE SYSTEM COMPONENTS, R.F. SPECTROMETERS, MAGNETS, MAGNETOMETERS, STALOS, POWER AMPLIFIERS, GRAPHIC RECORDERS, RESEARCH AND DEVELOPMENT SERVICES.





## 6 Taylor-Fabricated Laminated Plastic Insulators Protect Control Elements of GE Automatic Toaster

These insulators for the pop-up mechanism, color control unit, and heating element in the General Electric Automatic Toaster are made of continuous filament woven glass fabric with melamine resin bond. This Taylor Fibre Co. material was selected for its ability to withstand the temperatures encountered in the toasting operation, its excellent arc resistance and mechanical strength, and its cost, which is lower than that of the mica insulators formerly used.

Another factor in the decision was the capacity of Taylor Fibre Co. to produce the fabricated parts to specification, and in the large quantities required, at reasonable cost.

You, too, may have applications which can utilize the combination of physical, mechanical and electrical properties found only in lami-

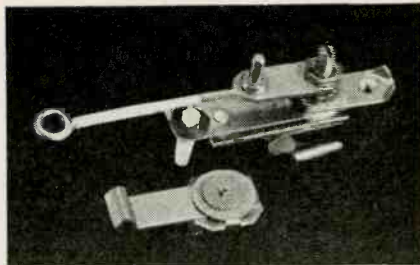

nated plastics. Our application engineers will be glad to discuss them with you, offer engineering assistance, and recommend a Taylor grade that will fit your specific requirements. Our plants at Norristown, Pa., and La Verne, Calif., are both fully equipped for fast supply of basic materials and finished parts. Write us for detailed information or to arrange for a Taylor Fibre man to call on you. TAYLOR FIBRE CO., Norristown 40, Pa.

**Taylor**  
LAMINATED PLASTICS VULCANIZED FIBRE

unit to count and reset to frequencies of 1 mc. Additional features include reset time of less than 1  $\mu$ sec, directly cascadable units, and the availability of two types of outputs. Circle 333 on Reader Service Card.

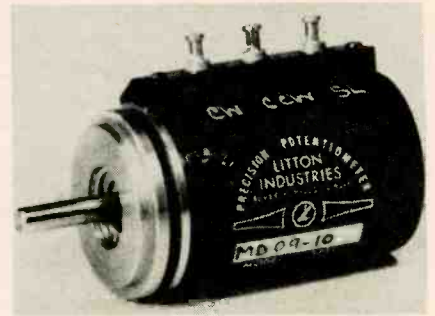

## Miniature Pot multiturn

LITTON INDUSTRIES, 5873 Rodeo Road, Los Angeles 16, Calif. Model MD09-10 is a  $\frac{3}{8}$  in. diameter multiturn potentiometer. Company guarantees independent linearity to  $\pm 0.015$  percent and resolution to 0.0085 percent. Unit is manufactured with a ceramic core, a drawn metal case with O-ring seal, welded tap leads, stainless steel ball bearings protected with a Teflon seal and a balanced cylindrical rotor and slider assembly. Circle 334 on Reader Service Card.



## Epoxy Adhesive for preforms

EMERSON & CUMING, INC., 869 Washington St., Canton, Mass. Eccobond SBC is a single part epoxy adhesive which can be molded readily into a preform. The material is supplied in powder form, heated slightly, molded under moderate pressure, and then allowed to cool. The resultant preforms are



then usable as a quick setting adhesive for numerous jobs such as bonding anode caps to vacuum tubes, cementing tube bases, or any job where an easy to handle, rigid preform simplifies the operation. Complete cure of the preform is completed in a few minutes at temperatures from 350 to 500 F. Circle 335 on Reader Service Card.

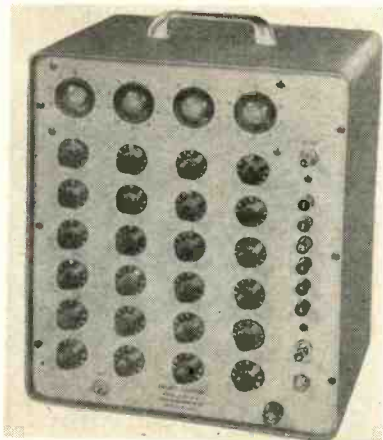

### Preset Counters multiple type

FREED TRANSFORMER CO., INC., 1788 Weirfield St., Brooklyn 27, N. Y. The 2020 preset counters can be supplied with multiple groups of presetting controls for use in all vital industrial operations for accurate, high speed sequential predetermining counting and control. With the new counters a complete program can be preset for winding multiple tapped coils or for any event which requires a machine controlled at different predetermined counts. Circle 336 on Reader Service Card.



### Synchronous Motor weighs only 0.9 oz

MECHATROL, a division of Servomechanisms, Inc., 1200 Prospect Ave., Westbury, L. I., N. Y. A

# DU PONT REPORTS ON FREON<sup>®</sup> SOLVENTS

for precision-parts cleaning

## New solvents by Du Pont clean with minimum effects to elastomer and plastic parts

Now you can protect delicate, costly parts during cleaning operations by using "Freon" solvents. For safe cleaning of precision parts and instruments, Du Pont's new "Freon" solvents remove oil and grease, yet show minimum effects on elastomeric and plastic materials.

Chart below compares linear swell of some commonly used plastics and elastomers due to "Freon" with that caused by other solvents. "Freon" cleans effectively, yet is noncorrosive without inhibitors, nonflammable, and much less toxic than ordinary solvents.

PERCENT LINEAR SWELL IN VARIOUS SOLVENTS (100 HRS. @ 130°F.)

ELASTOMERS	NEOPRENE WRT		GR-S		BUNA-N	
"Freon"-TF	0%	0%	0%	0%	0%	0%
"Freon"-MF	0%	0%	0%	0%	0%	0%
Carbon Tetrachloride	20%	40%	20%	40%	20%	40%
Trichlorethylene	20%	40%	20%	40%	20%	40%
Inhibited Methyl Chloroform	20%	40%	20%	40%	20%	40%
*DISSOLVED	20%	40%	20%	40%	20%	40%
PLASTICS	LINEAR POLYETHYLENE		NYLON 101		EPOXY RESIN	
"Freon"-TF	0%	0%	NIL	NIL	NIL	NIL
"Freon"-MF	0%	0%	NIL	NIL	NIL	NIL
Carbon Tetrachloride	4%	8%	4%	8%	4%	8%
Trichlorethylene	4%	8%	4%	8%	4%	8%
Inhibited Methyl Chloroform	4%	8%	4%	8%	4%	8%

NOTE: Swelling would be approximately nil in all cases with "Freon" solvents at their boiling points. Swelling would be considerably greater with all other solvents at their boiling points.

**Freon<sup>†</sup> solvents minimize cleaning hazards.** These new solvents by Du Pont offer outstanding safety for men and equipment. "Freon" is much less toxic than ordinary solvents—will not burn or explode. "Freon" is noncorrosive without inhibitors—is exceptionally stable even in the presence of oils and water. "Freon" solvents are suitable for a wide range of uses where ordinary solvents create problems of corrosion or damage to plastics, paint and elastomers.

For your free copy of Du Pont's booklet describing the unique properties of "Freon" solvents, mail the coupon or write: E. I. du Pont de Nemours & Co. (Inc.), "Freon" Products Division 5210, Wilmington 98, Del.



BETTER THINGS FOR BETTER LIVING...THROUGH CHEMISTRY

<sup>†</sup>Freon is Du Pont's registered trademark for its fluorinated hydrocarbon solvents.



### FREE BOOKLET

Mail coupon for your free copy of booklet describing properties of "Freon" solvents... there's no obligation.

E. I. du Pont de Nemours & Co. (Inc.)  
"Freon" Products Division 5210, Wilmington 98, Del.

Please send me your free booklet describing the unique properties of "Freon" solvents for precision-parts cleaning.

Name \_\_\_\_\_ Position \_\_\_\_\_  
Company \_\_\_\_\_  
Address \_\_\_\_\_  
City \_\_\_\_\_ Zone \_\_\_\_\_ State \_\_\_\_\_



# BIRD

## "Termaline" 50 ohm Coaxial Line LOAD RESISTORS



### MODEL 888

1200  
Watts  
Continuous  
Duty  
1500 Watts  
Intermittent Duty  
2 to 3 KW  
Continuous Duty with  
forced air cooling  
Input connections are  
available to terminate  
most coaxial lines.

BIRD "Termaline" Load Resistors are designed to provide a constant impedance of 50 ohm from DC through the useful coaxial frequency range. Each Resistor is intended to simulate an infinite length of 50-ohm line, thus providing an almost reflectionless termination. Low VSWR and freedom from radiation makes the Bird Loads extremely useful during adjustment and testing. Measurements of power are also possible when these Resistors are used as terminations for the appropriate Bird "ThruLine" Directional Wattmeters. Accuracy in RF resistance, rugged ability to absorb power and absence of any need for adjustments has long characterized the Bird "Termaline" Load Resistors. For specifications on standard models see chart below. For other requirements please phone or write. Our long experience in this field may assist you in the solution of your problem.

synchronous motor in BuOrd size 5, weighs only 0.9 oz. The standard motor, 5H1-1, operates from a single phase power supply at 26 v. However, units can be supplied to operate from 2 or 3 phase supplies at speeds of 12,000 or 8,000 rpm. Power output is 5 w total; pull-out torque, 0.07 oz-in.; pull-in torque, 0.04 oz-in.; starting time, 30 milli-sec; operating temperature range, -55 C to +85 C. Circle 337 on Reader Service Card.

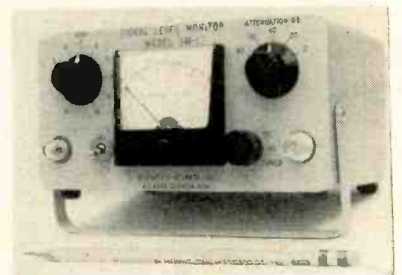

### Signal Level Monitor portable unit

SCIENTIFIC-ATLANTA, INC., 2162 Piedmont Road, N.E., Atlanta 9, Ga. Model SM-1 signal level monitor is a portable, light weight instrument designed primarily as a versatile and time saving accessory for antenna and r-f laboratories. It features high sensitivity, operation with either c-w or modulated r-f signals, tuned or untuned selective amplifier, no d-c drift, precision attenuators and small size. Circle 338 on Reader Service Card.

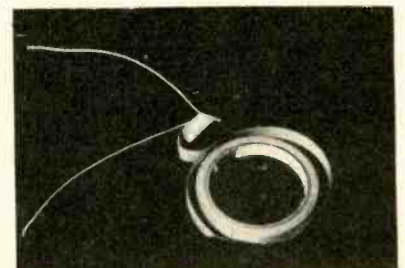

### Electrical Tape of cast Teflon

DIELECTRIX CORP., Allen Blvd. & Grand Ave., Farmingdale, L. I., N. Y. A new cast Teflon film for various electrical-tape applications possesses such advantages as unusually strong dielectric characteristics, performance over a wide thermal range, negligible water absorp-

Model	Max. Power	Freq. Range	Max. VSWR*	Input Connector
80-M	5 W	0-4 KMC	1.2	Type "N" male
80-F	5 W	0-4 KMC	1.2	Type "N" female
80-CM	5 W	0-4 KMC	1.2	Type "C" male
80-CF	5 W	0-4 KMC	1.2	Type "C" female
80-BNCM	5 W	0-4 KMC	1.2	Type BNC male
80-BNCF	5 W	0-4 KMC	1.2	Type BNC female
80-A	20 W	0-1000 MC	1.1	Type "N" female
81	50 W	0-4 KMC	1.2	Type "N" female
81-B	80 W	0-4 KMC	1.2	Type "N" female
82-A	500 W	0-3.3 KMC	1.2	Coplanar. Adapter to UG-21B/U supplied
82-AU	500 W	0-3.3 KMC	1.2	"LC" Jack mates with UG-154/U plug on RG-17/U cable
82-C	2500 W**	0-3.3 KMC	1.2	Coplanar. Fittings and cable assemblies for flexible and rigid coax lines available

\*VSWR on all models is 1.1 max. from DC to 1000 MC.  
\*\*Water cooled

### Other Bird Instruments



"ThruLine"  
Directional  
RF Wattmeters



"Termaline"  
RF Absorption  
Wattmeters



Coaxial  
RF Filters



Coaxial  
RF Switches



**BIRD ELECTRONIC CORP.**  
Express 1-3535  
1800 E. 38 St., Cleveland 14, Ohio  
Western Representative:  
VAN GROOS COMPANY, Woodland Hills, Calif.



tion, low rate of moisture vapor permeability, and inertness to chemicals and solvents. Cast Teflon films are available in continuous roll lengths of 100 and 500 ft and in widths from  $\frac{1}{4}$  in. to 12 in. in increments of  $\frac{3}{32}$  in. **Circle 339 on Reader Service Card.**

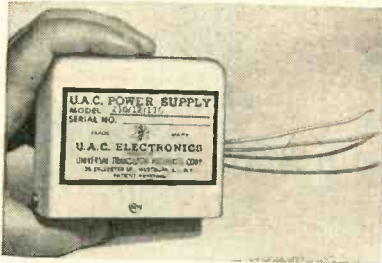

### Power Supplies transistorized

UNIVERSAL TRANSISTOR PRODUCTS CORP., 17 Brooklyn Ave., Westbury, L. I., N. Y., announces a series of fully transistorized power supplies that provide the output required to operate receiver installations. The rectified, filtered units wire directly to battery and mobile equipment. Features include operating life in excess of 10,000 hr; efficiency to 85 percent; elimination of high current starting surges, moving parts, and vibrator hash; and extremely low ripple. **Circle 340 on Reader Service Card.**



### Crystals small and stable

BULOVA WATCH CO., Woodside 77, N. Y. The ST-7ONXS miniature crystal series are hermetically sealed and mounted in the HC-6/U military type holder. They cover a frequency range of 100 kc to 250 kc, with a frequency tolerance of  $\pm 0.015$  percent over a  $-55$  C to  $+90$  C temperature range. Overall size is  $\frac{3}{4}$  in. wide by  $\frac{1}{2}$  in. deep by  $1\frac{1}{2}$  in. high, with weight about 1

## THE NEW BLACK & WEBSTER ELECTROSET

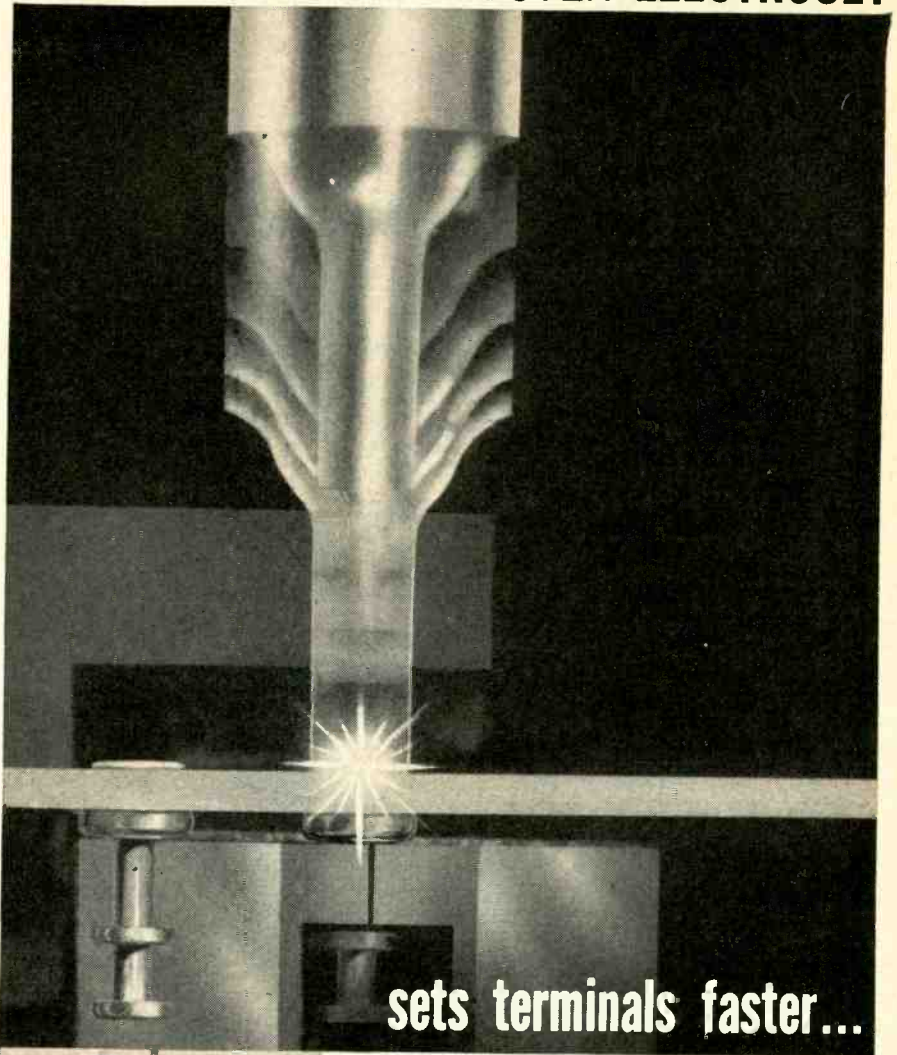

sets terminals faster...

with fewer rejects...

*than any production tool you have ever used*



The new Black & Webster ELECTROSET is an all electric solenoid-operated high production tool for setting standard turret type or seamed terminals. It speeds up production, reduces costs because it is automatic, accurate — and lightning fast. Here's how:

**OPERATION**—Terminals are fed to staking nest automatically from 8" vibrator feeder. Operator simply places board over terminal and triggers Electropunch, staking terminal in the board. As operator withdraws board, feed automatically advances new terminal to nest.

**FASTER PRODUCTION**—limited only by operator speed in feeding board. ELECTROSET has achieved rates to 3600 per hour.

**CONTROLLED IMPACT**—careful control through variable voltage transformer, capable of varying impact from feather touch to 3500 lbs. Accurate, positive "punch" eliminates rejects from too-light or too-heavy blows.

**EASY POSITIONING**—light beam under punch head indicates exact terminal location, when terminal is hidden by board.

**VERSATILE**—adaptable to feeding and setting contacts, pins, shoulder studs and plug nuts.

SEND SAMPLE TERMINAL FOR EVALUATION.

**BLACK & WEBSTER, INC.**

DEPT. E, 445 WATERTOWN STREET, NEWTON 58, MASSACHUSETTS



# SEND FOR DATA ON THESE NEW RELAYS

## TYPE TJV VIDEO SWITCHING RELAY

Specially engineered for carrying video and other high frequency currents. Unusual flexibility of design permits a wide range of contact spring assemblies and combinations to be used. Fast operate, release and transfer time.

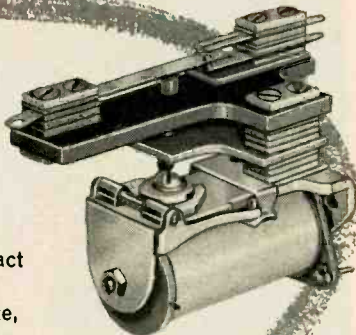

## TYPE TJC VERSATILE COMPACT RELAY

Incorporates the best characteristics of the standard telephone type and the small lightweight relay. Features include rugged construction, sensitivity, large contact spring capacity, compact size. Independent-action twin contacts.

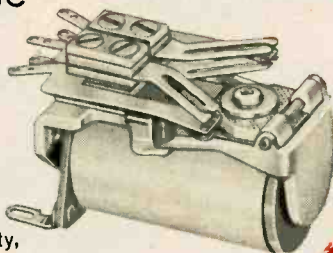

## TYPE TQ SENSITIVE MINIATURE RELAY

Operates on DC coil signals at sensitivities from 20 to 100 milliwatts. Contact rating with resistive load at 28 VDC. or 115 VAC; silver contacts, 3 amperes. Shock, up to 50 G. Vibration up to 10 G, from 10 to 500 cps.

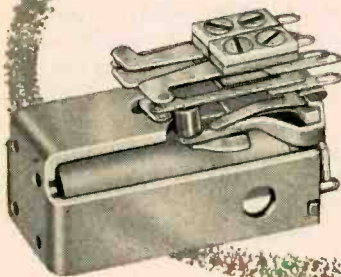

# COMAR

ELECTRIC COMPANY  
3349 ADDISON ST., CHICAGO 18, ILL.

RELAYS • SOLENOIDS • COILS • SWITCHES • HERMETIC SEALING

oz. Crystals meet all environmental conditions of MIL-E-5272, MIL-E-5400 and MIL Std. 202. Circle 341 on Reader Service Card.



## Terminal Setter automatic machine

BLACK & WEBSTER, INC., 445 Watertown St., Newton 58, Mass., has developed an automatic machine for setting standard turret-type and "bead chain" terminals in terminal boards. The new automatic Electroset, model FST, is built around an Electropunch and a vibratory feeder. A feeding mechanism is capable of presenting terminals in a staking nest at the rate of 100 per min. Ultimate production rates will depend on the arrangement of holes in the board, and operator skill. The vibratory feeder will hold approximately 2,000 terminals. On the standard Electroset, boards up to 10 in. in width can be handled. Circle 342 on Reader Service Card.

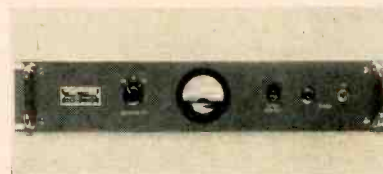

## Deviation Meter readings in kc

NEMS-CLARKE Co., 919 Jesup-Blair Drive, Silver Spring, Md., announces a deviation meter for use with many models of their receivers



in telemetry applications. The DM-100, its associated circuitry and power supply are mounted on a 3½ in. by 19 in. panel for rack mounting. In operation it is bridged across the video output of the receiver. Unit permits a direct reading of the deviation in kc of the subcarrier oscillators used in a telemetry system. A three-position switch permits full scale readings of 25, 50 and 75 kc. Circle 343 on Reader Service Card.

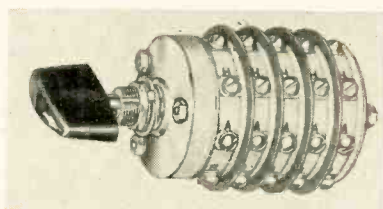

### Rotary Switch multipole

ELECTRO SWITCH CORP., Weymouth 88, Mass. The new, compact type JL rotary multipole switch has a maximum of eight contact positions and up to ten sections, controlled by a single knob. It is furnished to meet BuShips Drawing 9000-S6 202-74422, with 3, 5 or 10 sections; the modified type JL can be furnished with any number of sections, up to ten. Electrical rating is 5 amperes 125 v a-c. Circle 344 on Reader Service Card.

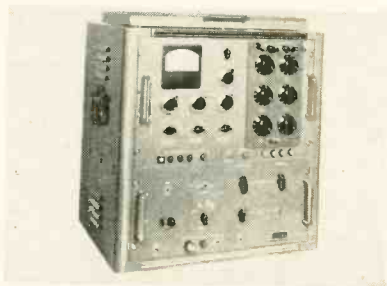

### Diode Test Set automatic unit

MEASUREMENTS RESEARCH CO., 3801 Castor Ave., Philadelphia 24, Pa., has introduced a new automatic diode test set. Model 5002AB automatically compares the d-c forward and reverse characteristics of semiconductor diodes against preset limits and presents

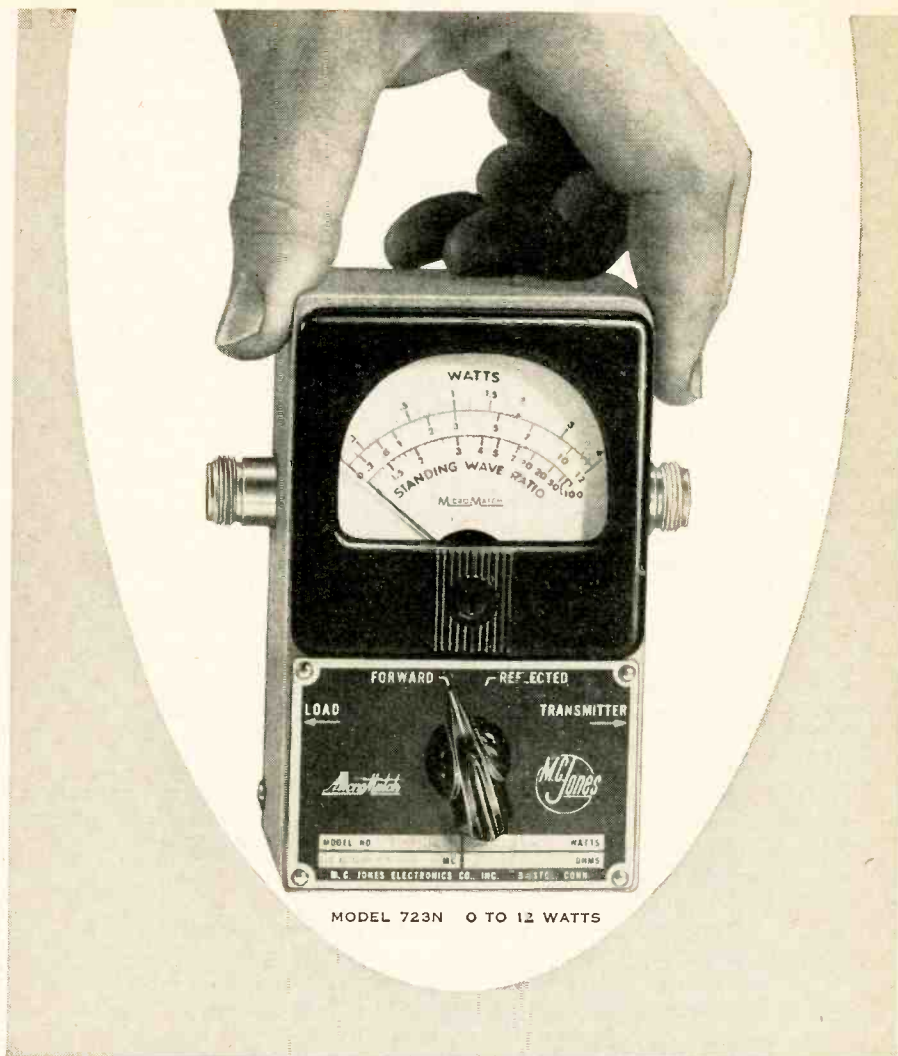

## VSWR and RF WATTMETERS

### 25 MCS TO 3000 MCS

These rugged, compact units accurately measure and indicate the RF power and VSWR of coaxial transmission lines. Each type combines a frequency insensitive bidirectional coupler and complete indicator circuit in one small case. Accuracy of power measurement is  $\pm 5\%$  of full scale.

Model No.	Frequency Range (Mcs)	Power Range (Watts)	RF Connectors
712N	25—1000	0-2.5; 5; 10 in 3 scales	N*
723N	1000—3000	0-12 in one scale	N†

\* Also available with UHF, BNC and Type C connectors  
 † Also available with BNC and Type C connectors

For more information please write for 68-page catalog No. 12 or see *Electronics Buyers' Guide* or *Electronic Engineers Master*.

U.S. Letters Patent No. 2,588,390



**M. C. JONES ELECTRONICS CO., Inc.**  
**BRISTOL, CONNECTICUT**

**ENGINEERS & SCIENTISTS:**

# Why opportunities are *better* at Melpar

IN BOSTON AND WASHINGTON, D.C. AREAS

**Growth and Diversification:** Since 1945 Melpar has experienced a steady growth, and today we are engaged in a number of highly advanced weapon systems programs as well as 110 different electronic research, development, and production projects. Our continuous expansion coupled with our emphasis on diversification assure uninterrupted career advancement for staff members.

**Professional Gratification:** At Melpar you can choose to grow in a specialized sphere of activity or, as a member of a project team, you can broaden your experience by participating in all phases of a project from initial concept on through to prototype completion.

**Environment:** Our modern and well-equipped laboratories are located in choice suburban areas near Washington, D. C. and Boston, Massachusetts. These locales were selected because of their proximity to superior educational, cultural and recreational facilities. Fine housing in all price ranges is readily available.

**Positions are available for men with experience in the following fields:** Systems evaluation • Digital computer circuitry • Analog computer instrumentation • Data processing • Microwave design • Pulse circuitry Operations analysis • Advanced mathematics • Electromechanical design • Receiver design • Subminiaturization • Electronic production engineering.

For detailed information about openings, write to:  
Technical Personnel Representative



**MELPAR** *Incorporated*

A Subsidiary of Westinghouse Air Brake Company

3159 Arlington Boulevard, Falls Church, Virginia

10 miles from Washington, D.C.

the results in a go-no-go form. The diode may be tested at one voltage for compliance to forward low and high limit current specifications and at another voltage for reverse high limit specifications. A wide variety of test fixtures are available to accommodate various configurations of diodes. Circle 345 on Reader Service Card.

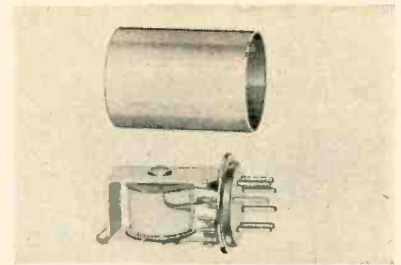

## Plug-In Relay subminiature

LINE ELECTRIC Co., 271 So. 6th St., Newark 3, N. J. The DF series relay features 7-pin miniature tube base, dust cover, light weight and low cost. Precision designed for extremely long life, it is ideal for computers and radiosonde. Contacts are spdt 2 amperes, 115 v a-c, 60 cps or 26.5 v d-c noninductive. Size is 1 in. above chassis,  $\frac{3}{4}$  in. diameter. Circle 346 on Reader Service Card.

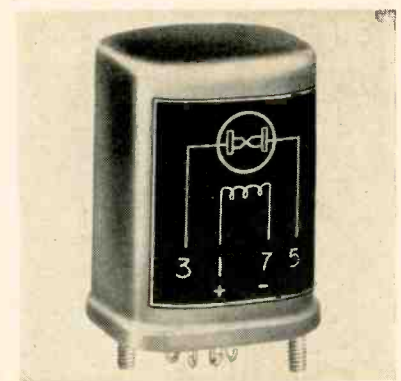

## Relay no moving parts

PENDAR, INC., 2664 So. La Cienega Blvd., Los Angeles 34, Calif., has developed an all electronic relay with no moving parts. The electronic coil circuit operates on 28 v d-c, pulls in at 18 v and drops out at 7 v or less with a positive





## digital volt-ohmmeter

—for quick, easy  
measurements with  
consistent accuracy



MODEL 615

Easy to read—the digits are  $\frac{1}{2}$ " high, white against jet black, and displayed in line for fast, repetitive reading with minimum fatigue.

1% accuracy on DC and Ohms... 2% on AC. The illuminated decimal point and negative polarity indicator insure readout accuracy. And since the display is direct reading, all interpolation and parallax errors are eliminated. Readings are repeated within one digit.

Complete data in Bulletin 615

Model 615.....\$300.00

Order from your  
Hycon representative,  
or from:



**ELECTRONICS, INC.**, 370 So. Fair Oaks, Pasadena, Calif.  
A SUBSIDIARY OF HYCON MFG. CO.

CIRCLE 228 READERS SERVICE CARD

### 3 DIGITAL INSTRUMENTS IN 1

The Hycon reads DC volts in 4 decimal ranges from .001V to 999V . . . AC volts in 3 decimal ranges from 1.0V to 999VRMS . . . ohms in 5 decimal ranges from 1 ohm to 9.99 megohms.

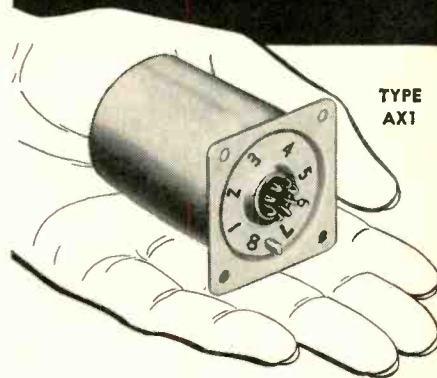

TYPE  
AXI

**WITH COMPACTNESS — PLUS  
"MIL-SPEC" 2000 cps  
VIBRATION TESTS**

### SPECIFICATIONS (General)

- a. Operates during 5 to 2000 cps, 10G vibration.
- b. Operates  $-55^{\circ}$  to  $+125^{\circ}$  C.
- c. Withstands 30G 11ms shock.
- d. Weight 9 oz.
- e. Hermetically sealed.
- f. D.C. operating coil.
- g. Timing not affected by voltage variations.
- h. 3% accuracy under normal test conditions.

This relay employs a new type escapement principle. It offers utmost reliability under severe environmental conditions through its rugged design and self-starting characteristics.

Write for complete descriptive Bulletin 820. Address Dept. E-1058.



**SIGNAL CORPORATION**  
INDUSTRIAL TIMERS DIVISION  
MOLINE, ILLINOIS

CIRCLE 230 READERS SERVICE CARD

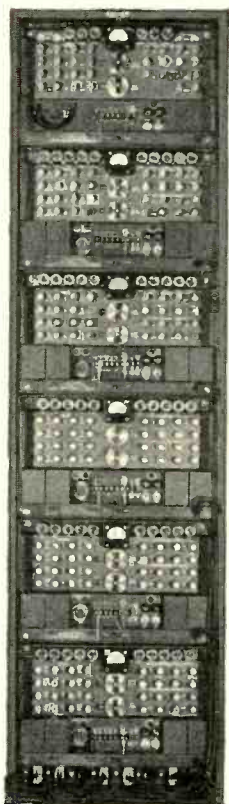

## MINIATURIZED CARRIER TELEPHONE SYSTEMS FOR RADIO AND 4-WIRE CABLE

### FOUR OR 24 CHANNELS

Two miniaturized voice-multiplex systems providing four or 24 voice channels over radio or 4-wire cable are available. They have many advantages over earlier designs: high performance, small size, light weight, low cost, circuit simplicity, low power requirements, small number of tubes of a single type only, low operating cost, low maintenance and high reliability.

These systems provide a voice-channel flat within 1 db from 300 to 3500 cycles, for each 4 kc of bandwidth occupied. Each channel is equipped with hybrid, signaling, and dialling circuits for all the standard 2-wire and 4-wire loop options.

The basic unit provides an order-wire and 4 carrier-derived channels. These units can be stacked in groups of 2, 3, 4 or 5 by means of a group modem to provide 9, 14, 19 or 24 channels. Full flexibility is provided for dropping and inserting channel groups at repeater and terminal points. Moderate lengths of 4-wire cable or open-wire line may be inserted between the multiplex equipment and the radio terminals.

24-channel carrier-telephone terminal complete with hybrids, ringing and dialling circuits, and test facilities. Dimensions are 58" high, 16" wide and 8" deep. Power input 250 watts. Weight 326 lbs.

## RADIO ENGINEERING PRODUCTS

1080 UNIVERSITY ST., MONTREAL 3, CANADA

TELEPHONE  
UNiversity 6-6867

CABLES  
RADENPRO, MONTREAL

CIRCLE 229 READERS SERVICE CARD

ELECTRONICS engineering issue — October 10, 1958

are  
you



using  
only  
**HALF**  
your  
potential

**In your present job?**

Because of the diversity and rapidly increasing demands for our products, you have the challenging opportunity here at Bendix-Pacific to constructively apply all your talents.

There are important career positions open NOW at all levels in our small, independent engineering groups in these fields —

**MISSILE GUIDANCE • TELEMETERING  
AIRBORNE RADAR • MISSILE HYDRAULICS & MARINE HYDRAULICS  
SONAR & ANTI-SUBMARINE WARFARE**

Please write W. C. Walker your qualifications or fill in the coupon and mail it today.

W. C. Walker, Engineering Employ'mt Mgr.  
Bendix-Pacific, Bendix Aviation Corp.  
11604 Sherman Way, No. Hollywood, Calif.

I am interested in (check one)  
 Electrical  Mechanical Engineering  
I am a graduate engineer with

\_\_\_\_\_ degree.  
I am not a graduate engineer but have  
\_\_\_\_\_ years experience.

Name \_\_\_\_\_  
Address \_\_\_\_\_  
City \_\_\_\_\_  
Zone \_\_\_\_\_ State \_\_\_\_\_

snap action operation. Relay is completely potted and will withstand present day shock or vibration problems. Unit will switch either a-c or d-c, has a transfer time of less than 50  $\mu$ sec and no contact bounce. Circle 347 on Reader Service Card.

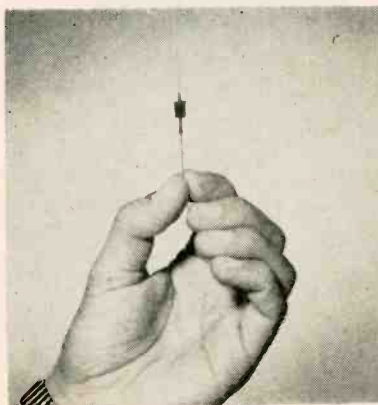

**Silicon Rectifiers  
series of ten**

FANSTEEL METALLURGICAL CORP., North Chicago, Ill., has a series of ten new silicon rectifiers rated at a maximum d-c output current (at 50 C ambient) of 750 ma. Known as type 1N, they are  $\frac{3}{16}$  in. diameter by  $\frac{1}{8}$  in. long, exclusive of leads. The ten rectifiers are rated in steps from maximum peak reverse voltage of 50 v to 600 v inclusive. Maximum full load forward voltage drop (full cycle average at 150 C) is only  $\frac{1}{2}$  v. Circle 348 on Reader Service Card.

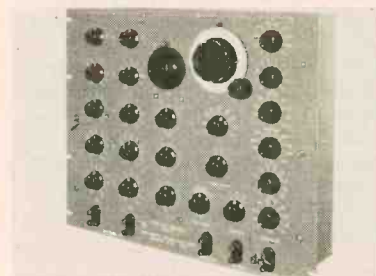

**Vector Bridge  
direct reading**

THE HARRIS TRANSDUCER CORP., Woodbury, Conn. Precise direct reading of magnitude and phase angle components of impedance or

at last! **AC  
Microamperes**  
can be measured  
**quickly**  
**accurately!**



with the **NEW  
QUAN-TECH  
AC MICROAMMETER  
MODEL 301**

Saves you time and headaches in making measurements that previously were slow, inaccurate, cumbersome... Measures currents in transistors, magnetic amplifiers, resonant circuits, filters, servo systems, recording heads, etc. Using an oscilloscope, observe current waveforms and transient currents.

**CLAMP-ON PROBE** gives you fast, one-hand operation. Speeds laboratory and production testing.

**INSERTION PROBE** gives you greater accuracy, increased sensitivity and wider frequency range.

**SPECIFICATIONS**

**SENSITIVITY:** 3  $\mu$ a to 100 ma full scale with Insertion Probe (300  $\mu$ a to 100 ma with Clamp-On-Probe).

**ACCURACY:**  $\pm 2\%$  of full scale at 1 KC ( $\pm 5\%$  clamp-on).

**FREQUENCY:** Flat within  $\pm 2\%$  50~ to 100 KC, -3 db at 10~ and 1 MC (clamp-on  $\pm 5\%$  100~ to 100 KC, -3 db at 50~ and 1 MC).

**INPUT IMPEDANCE:** 2 ohms plus 8  $\mu$ h, 60 mmf to ground from 3  $\mu$ a to 1 MA. Negligible impedance and capacitance 300  $\mu$ a to 100 MA.

**OSCILLOSCOPE CONNECTION:** 0.1 volt into 10 K ohms.

**PRICE:** \$290.00 including both probes.

**OTHER INSTRUMENTS AVAILABLE:**  
Miniature DC Coupled Decade Amplifier  
Isolation Amplifier  
Regulated Power Supplies

Write for complete information  
NEC — Booth 39

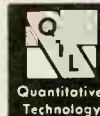

**QUAN-TECH  
LABORATORIES**  
MORRISTOWN, NEW JERSEY

CIRCLE 232 READERS SERVICE CARD



# 4027

## THE NEW ACME 3-PART MIXTURE FOR IMPREGNATING AND MOLDING ALL ELECTRICAL WINDINGS

Now—an epoxy mixture that comes complete ready to mix and use. Nothing else to buy. Yet the cost is less than what is usually charged elsewhere for the resin alone! That's Acme Star Compound #4027.

This remarkable mixture is immediately self-extinguishing, even after repeated exposures to open flame. Cures hard and tough. Has excellent mechanical and thermal shock resistance. Viscosity low enough for thorough impregnation at process temperatures. Very good adhesion to metals and other materials used in coil construction. For data sheets, address your inquiry attention of G. F. Garrity, Divisional Sales Manager.



**THE ACME WIRE COMPANY**  
NEW HAVEN, CONN.

MAGNET WIRE • COILS • VARNISHED INSULATIONS  
INSULATING VARNISHES AND COMPOUNDS



CIRCLE 234 READERS SERVICE CARD

Fully tested from 2 to 2,000 CPS vibration. Acceleration of 15 to 30 G's. Frequency range 16 to 100 kc — typical tolerance  $\pm .012\%$  from  $-40^{\circ}\text{C}$  to  $+70^{\circ}\text{C}$ . Lower frequencies down to 400 cycles available in other Monitor types with less rigid requirements.

**NEW  
at  
Monitor!**

Low Frequency crystals to meet high vibration requirements



Small size  
MC-13/U

Monitor's modern facilities and techniques insures the quality of all units.



*If you have a special crystal problem, call, wire or write.*  
**SEND FOR NEW CATALOG!**  
**MONITOR PRODUCTS COMPANY**  
815 Fremont Ave., South Pasadena, Calif.  
RYan 1-1174

CIRCLE 235 READERS SERVICE CARD



## “SNIP OR CLIP” TAB TERMINALS

Snip the lead, or clip the tab . . . get the exact terminal type you need! Save space and eliminate the need to stock two types of resistors. This unique feature is on General Electric 5-, 10-, and 20-watt resistors. For your vitreous-enameled resistor catalog, follow reader service instructions below. General Electric Co., Roanoke, Va.

784-12

*Progress Is Our Most Important Product*

**GENERAL  ELECTRIC**

CIRCLE 236 READERS SERVICE CARD



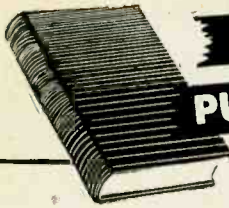

**JUST  
PUBLISHED**

## New Working Aids from McGraw-Hill

### FOUNDATIONS OF INFORMATION THEORY

This authoritative book fills the need for a concise and thorough explanation of the mathematical theory of information. It is designed specifically to help you more effectively meet today's requirements in electronics, electrical engineering, and other technical fields. The book assumes no prior knowledge of information theory—it starts with basic concepts and takes you in logical fashion through discrete channels, semi-continuous channels, and the binary symmetric channel. By AMIEL FEINSTEIN, Acting Asst. Prof., Depts. of Statistics and Electr. Engg., Stanford U. 137 pp., \$6.50.

### CONTROL SYSTEM COMPONENTS

An analytic treatment of a number of the most commonly used components in servo-mechanisms and other feedback control systems. Methods of analysis and basic engineering principles are presented from the point of view of the systems engineer, rather than specific discussions of commercial devices. Main emphasis is placed on the calculation of transfer functions. Recent advances in magnetic amplifiers, transistors, and hydraulic and pneumatic systems are covered. By JOHN E. GIBSON, Assoc. Prof. of Electr. Engg., Purdue U., and FRANZ B. TUTEUR, Assoc. Prof. of Electr. Engg., Yale University. 480 pp., illus., \$12.00.

### LOGIC MACHINES AND DIAGRAMS

Gives you a complete survey of mechanical and electrical machines designed to solve problems in formal logic, and of geometrical methods for solving these problems. Covers logic diagrams, network diagrams for the propositional calculus, the Stanhope demonstrator, Jevons' logic machine, the Marquand machine, and other topics. Applications to such fields as operations research, information storing and processing, and efficient circuit designing are outlined and discussed. By MARTIN GARDNER. 259 pp., 96 illus., \$5.00.

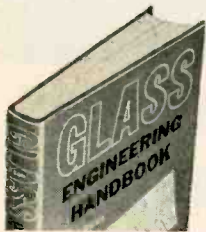

### GLASS ENGINEERING HANDBOOK

Here is a highly informative volume on the composition, manufacture, properties, and applications of glass as an engineering material. It gives practical data on the use of glass and glass products in engineering, research, and various fields of manufacture including electron-tube manufacture, the nuclear field, guided missiles, and the automotive field. In addition to coverage on the more commonly known glasses, there is information on special topics such as photosensitive glass, glass ceramics, electrically conducting glass, glass in electronic circuit components, glass-reinforced plastics, and others. By E. B. SHAND, Technical Consultant, formerly Research Staff Engineer, Corning Glass Works. Second Edition, 488 pp., 222 illus., \$10.00.

### MAGNETIC RECORDING TECHNIQUES

Here is a practical guide to the technology of magnetic recording methods and devices for engineers and technicians concerned with their application in audio, video, communications, automation, computing, and other fields. Emphasizing the basic knowledge needed to attain top performance, it gives a fundamental coverage of the principles of the recording and reproducing processes; recording materials, including the theory of ferromagnetism; recording mechanisms; and established design standards. Provides a clear development of design methods. By W. EARL STEWART, Chief Product Engineer, The Standard Register Co. 268 pp., 150 illus., \$8.50.

### ENGINEERING ELECTROMAGNETICS

Gives ready access to the data, principles, and equations of electromagnetics. Steady magnetic field, electrostatics, time-varying fields, relaxation and iteration methods of experimental mapping . . . these and other topics are explained in detail. The book devotes special attention to Maxwell's equations and their application to such areas as circuit theory, wave motion, and radiation. Vector analysis is used throughout. Many clear illustrations and examples help make this volume especially useful in solving specific problems. By WILLIAM H. HAYT, JR., Assoc. Prof. of Electr. Engg., Purdue U. 328 pp., 89 illus., \$8.50.

### SAMPLED-DATA CONTROL SYSTEMS

Provides a clear, unified treatment of sampled data systems. Essential theory is developed in a way which helps you apply it not only to synthesis of control systems, but also to communications, data processing, filtering, and other areas. A helpful feature is the extensive use of the z-transform, particularly in developing time-domain synthesis methods. Many illustrative examples demonstrate practical applications. By JOHN R. RAGAZZINI, Dean College of Engineering, N.Y.U., and GENE F. FRANKLIN, Asst. Prof. of Electr. Engg., Stanford U. 331 pp., 186 illus., \$9.50.

admittance are provided by a new vector bridge useful from 60 cps to low radio frequencies. True bridge circuits insure accuracy dependent only on precision resistors, use no tubes or transistors. Dials displaying ohms impedance and degrees phase angle require no calculations or frequency correction. Range is -90 to +90 deg, impedance up to 100,000 ohms. Accuracies are to a fraction of a percent impedance or fraction of a deg phase angle. Circle 349 on Reader Service Card.

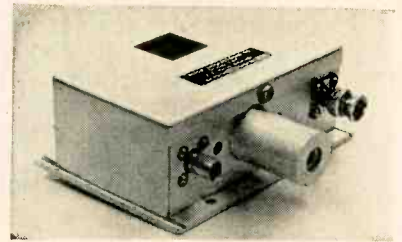

### Power Amplifier miniaturized

RHEEM MFG. Co., 7777 Industry Ave., Rivera, Calif. A ruggedized, miniature r-f power amplifier measures approximately 5 in. by 3½ in. by 2 in. and weighs only 1 lb. Operating in the 235 mc to the 260 mc telemetering band, the model REL-09 HF delivers an 8-w output to a 52-ohm load with a 1.4-w input drive. Grid and plate tuning controls are accessible from the front plate, and automatic protection is provided against damage resulting from loss of drive or plate power. Circle 350 on Reader Service Card.

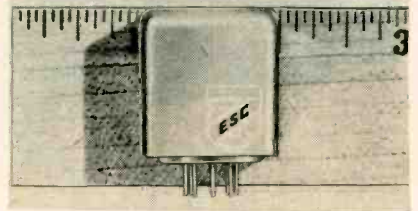

### Pulse Generator one-in. square

ESC CORP., 534 Bergen Blvd., Palisades Park, N. J., has developed a new, low cost, portable 1 in. sq pulse generator, the Modupulser. Specified pulse rate is factory-set to

## MAIL COUPON FOR 10-DAY FREE EXAMINATION

McGraw-Hill Book Co., Dept. L-10-10, 327 W. 41st St., N.Y.C. 36

Send me book(s) checked below for 10 days' examination on approval. In 10 days I will remit for book(s) I keep plus few cents for delivery costs, and return unwanted book(s) postpaid. (We pay delivery costs if you remit with this coupon—same return privilege.)

- Feinstein—Found. of Information Theory, \$6.50
- Gibson & Tuteur—Control Syst. Comp., \$12.00
- Gardner—Logic Machines & Diagrams, \$5.00
- Stewart—Magnetic Recording Techniques, \$8.50
- Hayt—Engineering Electromagnetics, \$8.50
- Ragazzini & Franklin—Sampled-Data Control Systems, \$9.50
- Shand—Glass Engineering Handbook, \$10.00

(PRINT)  
Name .....

Address .....

City ..... Zone ..... State .....

Company .....

Position .....

For price and terms outside U. S., write McGraw-Hill Int'l., N.Y.C.

L-10-10



allow for quick, simple plug-in operation. Unit can be supplied with a variable repetition rate. It is also available with external triggering. Circle 351 on Reader Service Card.



### Megohmmeter self-contained

RADIOMETER, 72 Endrupvej, Copenhagen NV, Denmark, has announced a new self-contained, line-operated megohmmeter, type IM5, which provides for accurate resistance measurements from 1 megohm to  $10^9$  megohms in seven ranges. It features 5 fixed d-c test voltages of 50, 100, 200, 500, and 1,000 v that can be used on all resistance ranges. Circle 352 on Reader Service Card.

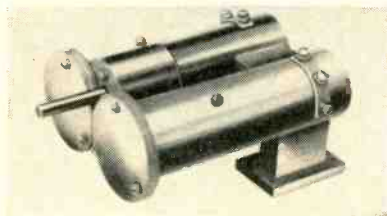

### Preselector Filter wide range

AIRTRON, Inc., 1096 W. Elizabeth Ave., Linden, N. J., announces a filter especially adapted to broadband image rejection or front-end selectivity applications requiring minimum size and weight. Its two sections provide characteristics simi-

# MARCONI

## TEST SETS FOR MOBILE RADIO TESTING

Designed for precision performance in

- \* Receiver alignment
- \* Signal-to-noise measurement
- \* Discriminator testing
- \* Checking rf and audio outputs
- \* Deviation measurement

... All you need for fast field testing of fm transmitters and receivers is here in these two complementary instruments, tailored for mobile radio measurements.

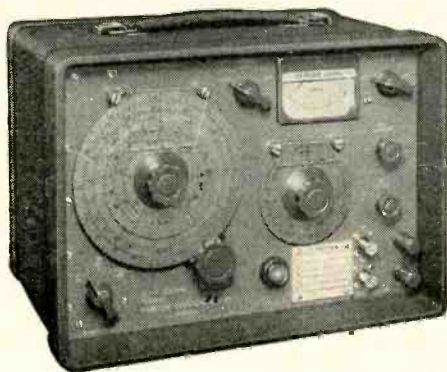

The 1064/2 provides high-grade fm outputs in the ranges 30 to 50, 118 to 185, and 450 to 470 mc; crystal-controlled i-f outputs at five spot frequencies; and a 1 kc af output.



The 1065 has an rf power meter and 0-15 kc deviation indicator for use up to 500 mc; a dual-impedance af power meter; and a multi-range volt/ammeter.

*Each is lightweight, portable, and quality-engineered throughout. Tubes and crystals are all American types. Send for leaflet B117/B.*

## MARCONI INSTRUMENTS

*Marconi  
for f.m.  
test gear*

111 CEDAR LANE • ENGLEWOOD • NEW JERSEY • Tel: LOwell 7-0607  
CANADA: CANADIAN MARCONI CO • 6035 COTE DE LIESSE • MONTREAL 9  
MARCONI INSTRUMENTS LTD • ST. ALBANS • HERTS • ENGLAND



# Modernize\* your Counters



with the  
**MODEL 1520**  
**Digiverter**  
PAT. PENDING

*Reduces  
eyestrain*  
*Eliminates  
ambiguity*  
*Speeds  
reading*

**DIRECT** reading digital converter fits all vertical DCU system counters — no wiring changes, no plug-in connections or mechanical modifications required.

**DIGIVERTER** clamps on front panel of counter over vertical windows; has self-contained power supply with line cord for 115-volt, 50-2400 cycle outlet; uses less than one watt per DCU. Its photoelectronic system transmits directly whatever the counter reads without interference; no relays, vacuum tubes, thyatrons, or transistors are used. Utmost simplicity results in greatest reliability.

**DIGIVERTERS** are available with Nixies® mounted on converter case for integral readout (as illustrated above) or with Nixies® in a separate housing or on a standard relay rack panel for remote reading (as shown at left).

**DIGITAL** converters for individual DCU's are also available for OEM installation, customizing or installation in special purpose test equipment and computers where "in-line" display is desirable. These are called DIGIDECS and can be supplied for either integral or remote reading.

\* **WHY TRAIN PERSONNEL . . .**  
to random display when "in-line" reading  
is the natural way.



REMOTE CABINET



REMOTE PANEL

**SEND FOR TECH. DATA**  
For additional information, including application data, write or phone DE 4-3100. Demonstrations available by local representatives.



**Radio Frequency**  
**LABORATORIES, INC.**  
Boonton, New Jersey, U. S. A.

lar to those of a standard four-section filter. Use of two TE<sub>111</sub> modes in each section has the further advantage of a broad tuning range free from crossing or interfering modes. Unit shown on p 163 tunes from 7,500 to 8,500 mc, with insertion loss not exceeding 2.0 db for a 25 mc bandwidth. Rejection obtained from these characteristics is at least 50 db at frequencies 60 mc removed from F<sub>o</sub>. Circle 353 on Reader Service Card.

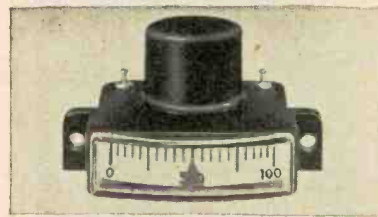

## Edgewise Meter compact, rugged

**MARION ELECTRICAL INSTRUMENT CO.**, Grenier Field, Manchester, N. H. The MCE-1 edgewise meter is designed for control panel applications where space is limited but large display is required. It features a clear Plexiglas front and large triangular pointer that is easily seen on a scale 1 1/8 in. long. They are available in standard current and voltage ranges (100 ma to 1 ampere and 1 to 300 v.) Circle 354 on Reader Service Card.



## Voltmeter panel mount type

**WAVEFORMS, INC.**, 331 Sixth Ave., New York 14, N. Y. Model 520A-P AC amplifier/voltmeter mounts interchangeably with the 510B-P panel mount audio oscillator. It is assembled on an oversize panel which serves as mounting plate and escutcheon. It bolts to any panel



# IT'S A MUST!

If you sell to the \$7 billion electronics industry, you'll want a *free* copy of *electronics* MARKET MEDIA FILE.

What are the prospects for:

MILITARY ELECTRONICS?  
REPLACEMENT  
ELECTRONICS?  
HOME ELECTRONICS?  
INDUSTRIAL  
ELECTRONICS?

Who are the  
BUYING INFLUENCES?

Why are more than 9,000 men who make the buying decisions for 30 giant companies subscribers to *electronics*? . . . and what does that mean to your advertising dollar?

The 1958 *electronics* MARKET MEDIA FILE gives the answers in 12 fact-packed pages that you will refer to time and again throughout the year.

Send for your *free* copy today.

**ABC electronics ABP**  
**A MCGRAW-HILL PUBLICATION**  
**330 W. 42nd St., New York 36, N. Y.**

## NEW miniature rotary switch

TYPE **MA-12**

12 POSITIONS  
5 SECTIONS  
3 AMP.  
115 V.  
A-C

TYPE **MA-12**

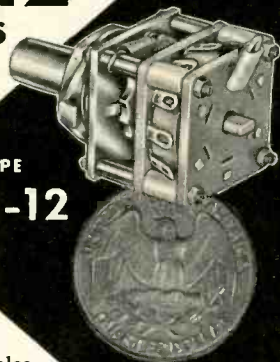

### FEATURES:

- Small —  $\frac{3}{4}$ " square
- Versatile — up to 6 poles per section; up to 5 sections
- Current-carrying capacity — 3 amp.
- Interrupting rating —  $\frac{1}{2}$  amp. 115 v. a-c.
- Voltage breakdown — 1000 volts RMS
- Rotation — unlimited, or limited 2 to 12 pos.
- Electrical life — 10,000 cycles at rated load
- Designed to meet MIL-S-3786

ACTUAL SIZE

Write for complete information today.

**R-F ELECTRONICS, inc.**

DIVISION OF ELECTRO SWITCH CORPORATION

167 King Ave., Weymouth 88, Massachusetts

CIRCLE 240 READERS SERVICE CARD

## COMPACT!

**GRAYHILL**

Miniature Rotary Tap Switches

Series 24

Positive detent action for precision requirements. Designed and built for long life and dependable service.

Available with up to 10 positions per deck and from 1 to 10 decks. Shorting or non-shorting version.

Spring Return

With up to 4 detent positions plus a momentary spring return position. Available 1 to 3 decks.

Shown  
Actual Size

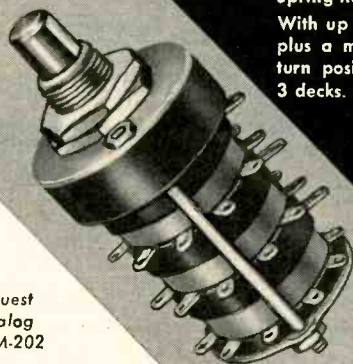

Request  
Catalog  
No. M-202

**Grayhill**  
INC.

Telephone Fleetwood 4-1040

523 Hillgrove Avenue • La Grange, Illinois

CIRCLE 241 READERS SERVICE CARD

# GREEN Pantograph Engravers

**ELIMINATE DELAYS!**

*Keep the work  
in your own plant.*

**PORTABLE  
40-POUND  
BENCH-  
MODEL  
106**



Famous 2 or 3-dimensional engraver, successfully used by thousands, features 5 positive, accurate pantograph ratios. Versatile ball bearing spindle has three speeds up to 14,000 rpm; height of pantograph and position of cutter are continuously adjustable; one copy carrier (supplied) accepts all standard master type sizes.

The Model 106 has proven incomparable for speed and accuracy... yet reasonably priced.

Cutter grinders, rotary tables, master letters, compound slides, name plates and all required accessories. For complete information, write to



**GREEN  
INSTRUMENT  
COMPANY, INC.**

363 PUTNAM AVENUE, CAMBRIDGE 39, MASS.

CIRCLE 242 READERS SERVICE CARD

## MODEL D2 HEAVY-DUTY 2-DIMENSIONAL

- 575 pounds — rigid, sturdy, precise
- Vertical adjustment of copy table automatic with Pantograph
- Unobstructed on three sides to take large work
- Micrometer adjustment for depth of cut
- Ball-bearing construction throughout — super-precision ball bearing spindle
- Spindle speeds up to 26,000 rpm for engraving or machining modern materials
- Ratios 2 to 1 to infinity — master copy area 26" x 10"
- Vertical range over 10"

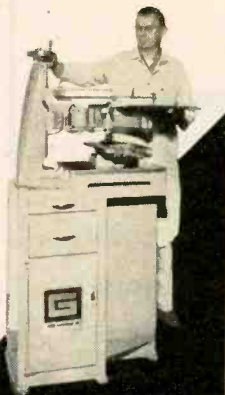

with a 6 $\frac{1}{8}$  in. by 4 $\frac{1}{8}$  in. cutout. Unit has 12 ranges in 1-3 sequence from 0.001 v to 300 v full scale. Input impedance is 10 megohms and band-pass is 10 cps to 2 mc. Circle 355 on Reader Service Card.

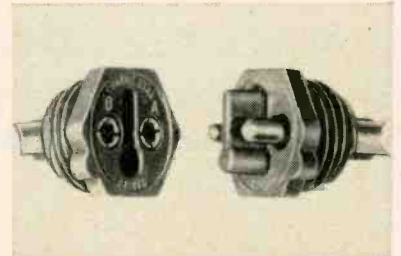

## Connector hexagonal type

DEJUR-AMSCO CORP., 45-01 Northern Blvd., Long Island City 1, N. Y. A new miniature, hexagonal, two-contact connector is suitable for high altitude applications requiring high breakdown voltages under critical environmental conditions. A polarizing barrier between the two pin contact is an integral part of the low arc resistance Melamine molding MIL-M-14E, type MME mineral filled. The barrier provides a long leakage path and permits use of high voltage (4,000 v rms) and current (30 amperes) without breakdown. Circle 356 on Reader Service Card.

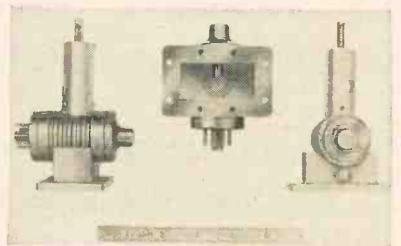

## Reflex Klystrons for C-band

EITEL-McCULLOUGH, INC., San Bruno, Calif., has introduced two new C-band reflex klystrons, the 1K125 series. These ceramic-metal tubes cover the frequency range of 3,700 to 5,000 mc. Capable of output powers to 2.3 w, they are ideal for reliable broadband point-to-point communications use. They are tuned by an adjustable dielec-

**AMCI**

**TYPE 1026**

# SLOTTED LINES

for  
accurate  
measurement of  
impedance in rigid  
and flexible coaxial  
transmission lines.

### FEATURES:

- Rated residual VSWR under 1.01
- Rated error in detected signal under 1.005
- Available in 20, 40, 60, 80, and 130 inch lengths.

Write for  
Bulletin E-958

The outer conductor of the Type 1026 Slotted Lines is made of two substantial aluminum castings, carefully machined and dowelled together, with the important surfaces finished by a hand scraping operation. The inner conductor is ground to a close tolerance, supported by compensated dielectric pins, and longitudinally positioned by a compensated dielectric anchor at the feed end.

AMCI Tapered Reducers, Instrument Loads, and Impedance Standard Lines are available for use with the Type 1026 Slotted Lines in making measurements of a wide range of rigid and flexible coaxial lines.



ANTENNA SYSTEMS—COMPONENTS—AIR NAVIGATION AIDS—INSTRUMENTS

**ALFORD** Manufacturing Co., Inc.

799 ATLANTIC AVE., BOSTON, MASS.



tric slug rather than a variable r-f gap, thus minimizing sensitivity to shock and vibration. Higher temperature ratings made possible by the use of ceramics, and an integral-finned cooler, keep cooling requirements at a minimum. Circle 357 on Reader Service Card.

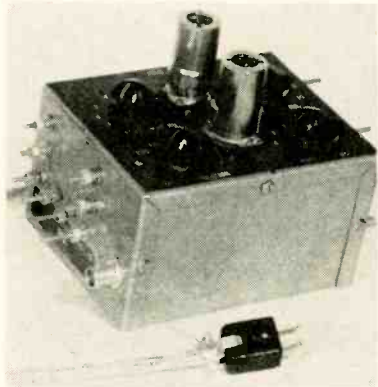

### Preamplifier general purpose

ARENBERG ULTRASONIC LABORATORY, INC., 94 Green St., Jamaica Plain 30, Mass., announces the PA-620 preamplifier which makes available at the ultrasonic transducer output a tuning coil that will resonate at all frequencies from 6-70 mc with the fixed capacity of the crystals which may reach 100  $\mu\text{f}$  in ultrasonic work. A second objective is to narrow the pass band and improve the signal to noise ratio. A third is to provide a light weight pickup head which may be placed more conveniently close to the object being tested. A fourth objective is to provide means for varying the bandwidth. Circle 358 on Reader Service Card.

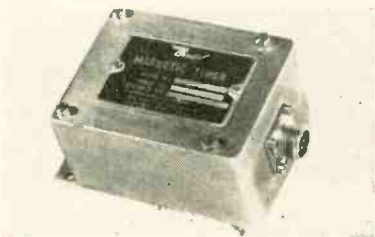

### Magnetic Timer no moving parts

BENDIX AVIATION CORP., South Bend 20, Ind. Solid-state compo-

## FREE - - - Revised IERC Heat-Dissipating Tube Shield Guide!

MORE THAN 1,200 ELECTRON TUBE AND SHIELD COMBINATIONS FOR IMPROVED ELECTRON TUBE RELIABILITY ADDED TO REVISED EDITION. Thousands of original IERC Guides are in daily use everywhere! Newest edition is sent FREE on request. Over 25 pages of easy, thoughtfully referenced listings and fold-out spread of photos designed for fast familiarization and accurate use of the IERC Guide. Latest IERC Heat-dissipating Tube Shields are included—help you select proper shields for new design and retrofitting applications. You won't want to be without this valuable information package if you're designing for maximum equipment reliability—so easy to achieve with IERC Heat-dissipating Electron Tube Shields for effective electron tube cooling and retention under severest shock and vibration environments!

For a free copy, write on company letterhead to:  
Dept. TSG,



**International Electronic Research Corporation**

145 West Magnolia Boulevard, Burbank, California

PATENTED OR PATS. PEND.



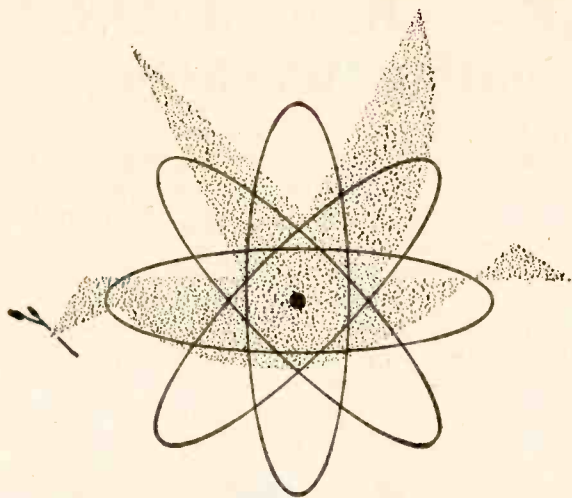

# performance for PEACE

More than sixty Los Alamos scientists were invited to Switzerland by the United Nations to participate in the 1958 International Conference on Peaceful Uses of Atomic Energy. Five major experimental devices, designed at Los Alamos, were set up at Geneva and exhibited in operation.

This international prestige of the Los Alamos Scientific Laboratory has been well earned by the members of its staff, an informal and creative community of scientists and engineers.

A limited number of vacancies exist for highly qualified applicants in the fields of physics, chemistry, mathematics, electronics, and engineering. Further information may be obtained by writing to

**Personnel Director  
Division 58-3**

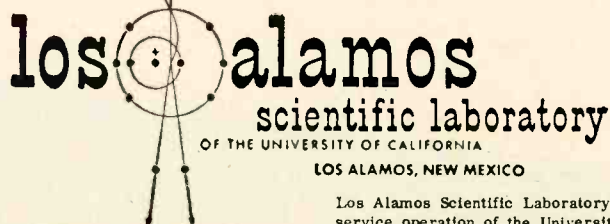

Los Alamos Scientific Laboratory is a non-civil service operation of the University of California for the U. S. Atomic Energy Commission.

ents such as transistors, diodes and special magnetic amplifiers have been combined to develop a magnetic timer with no moving parts. The design, which is suitable for use on most rocket engines, will provide an accurate timed interval of a few millisecc to several seconds. Small in size, the timer is claimed to be rugged, accurate, versatile and reliable. **Circle 359 on Reader Service Card.**



## Tiny Servomotor simplified design

DYNAMIC INSTRUMENT CORP., 59 New York Ave., Westbury, L. I., N. Y., announces the model M-100 60-cycle BuOrd Size 11 frame miniature servo motor. Its simplified coil and stator assembly permit manufacture of practical miniature motors as small as 3/10 in. diameter. The M-100 can be provided with a variety of shaft extensions, power and voltage ratings. **Circle 360 on Reader Service Card.**



## P-C Disks save time, money

SPRAGUE ELECTRIC CO., North Adams, Mass. Time and money can be saved by use of the new Multi-Comp p-c disks in many applica-



*New Exclusive*  
**IRON CORE  
Development**

*Saves: Production  
Costs*

*Reduces: Breakage  
Loss*

*Corrects: for  
Non-uniformity  
of torque in phenolic  
impregnated coil forms*

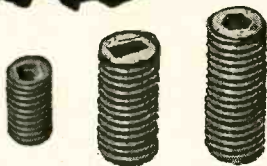

®Trademark

# EQUI-TORQUE\*

## Process #25

...Developed by  
**RADIO CORES, INC.**  
Originators of

## ENGINEERED ECONOMY IRON CORES

Get even, smooth-running, satisfactory torque control in application of threaded cores to coil forms with **EQUI-TORQUE PROCESS #25!**

- ★ Specially processed tacky wax
- ★ Lubricates to ease torque
- ★ Impregnated in cores
- ★ Compensates for low torque
- ★ Covers all thread form
- ★ Uniform running torque
- ★ Wax withstands 200°F.
- ★ Equalizes initial and running torque
- ★ Recycling excellent
- ★ No deterrent in function with aging

Operational tested and now being used by leading television, radio and coil manufacturers.

Write for samples and further information today!

# Radio Cores, Inc.

Phone: **GArden 2-3353**



9540 SOUTH TULLY AVENUE • OAK LAWN, ILLINOIS

Copyright 1958

CIRCLE 245 READERS SERVICE CARD

# VITREOSIL®

**FUSED QUARTZ  
MEETS YOUR  
CRITICAL  
REQUIREMENTS**



**CHECK WHAT VITREOSIL OFFERS:**

- ✓ Absolute Chemical Purity
- ✓ Extreme Heat Resistance
- ✓ Thermal Shock Resistance
- ✓ Chemical Inertness
- ✓ Outstanding Electrical Properties
- ✓ Full-Range Radiant Energy Transmission

VITREOSIL fused quartz products can be supplied in an unusually large variety of types and sizes. Also fabricated to specification to meet semi-conductor requirements.

### TRANSPARENT VITREOSIL

For ultra-violet applications, metallurgical investigations and processes, chemical research and analysis, photochemistry, spectroscopy and physical, optical and electrical research and production operations. Send specifications for your requirements. Please use coupon below.

See our ad in

Chemical Engineering Catalog

**THERMAL AMERICAN  
FUSED QUARTZ CO., INC.**  
18-20 Salem Street, Dover, New Jersey

Please send technical data on

Company \_\_\_\_\_  
Name & Title \_\_\_\_\_  
Street \_\_\_\_\_  
City \_\_\_\_\_ Zone \_\_\_\_\_ State \_\_\_\_\_

CIRCLE 247 READERS SERVICE CARD

# PULSE DELAY GENERATOR • MODEL 10 K



*NEW*  
with  
**Extended  
Range  
Delay**

THE MODEL 10K IS A PRECISION INSTRUMENT WHICH PRODUCES A PULSE VARIABLE IN DELAY FROM AN EXTERNAL OR INTERNAL TRIGGER. THE DELAY RANGE IS 1.0 TO 9999.9 USEC IN .1 USEC STEPS. THE UNIT MAY BE TRIGGERED OVER A RANGE OF 0 - 2000 PPS., THE PRF BEING INDICATED ON A METER. THE METER ALSO FUNCTIONS AS A NULL INDICATOR FOR A BUILT-IN CRYSTAL CALIBRATOR. THE OUTPUT IS A .5 USEC WIDE POSITIVE PULSE WITH A RISE TIME OF .03 USEC, AND AMPLITUDE OF 0-40 V. INTO 100 OHMS.

**ACCURACY** ±0.01% or 0.05 usec.

**STABILITY** less than 0.005 usec. jitter & 0.005% change in delay with change in prf.

**VERSATILITY** single or paired pulse output & delayed scope trigger in advance of delayed pulse.

**EXTERNALLY TRIGGERED**

**ORBITRAN COMPANY**

LAKESIDE

CALIFORNIA

CIRCLE 246 READERS SERVICE CARD



## The new NORTHERN RADIO catalog is your buyers guide to **FREQUENCY SHIFT COMMUNICATION EQUIPMENT**



Complete descriptions and specifications... the only book of its kind in the field!

- 68 Pages • 34 Items
  - 34 Photographs • 20 Block Diagrams
- the Industry's FOREMOST and COMPLETE line of Quality Communication Equipment!

Write on your letterhead for your copy today  
**NORTHERN RADIO COMPANY, INC.**  
 149 W. 22nd St., New York 11, N. Y.  
IN CANADA: NORTHERN RADIO MFG. CO. LTD., OTTAWA, ONT.

CIRCLE 248 READERS SERVICE CARD

## For HIGHEST ELECTRICAL & MECHANICAL EFFICIENCY! *New* **JONES**

### SERIES 2400 PLUGS & SOCKETS

- Improved Socket Contacts — 4 individual flexing surfaces. Positive contact over practically their entire length.

- Cadmium plated Plug and Socket, Contacts mounted in recessed pockets, greatly increasing leakage distance, INCREASING VOLTAGE RATING.

- Interchangeable with 400 Series.

Send for complete Catalog No. 22, Plugs, Sockets, Terminal Strips.



P-2406-CCT



S-2406-SB

**Jones** **HOWARD B. JONES DIVISION**  
CINCINNATI MANUFACTURING CORPORATION  
 CHICAGO 24, ILLINOIS  
 SUBSIDIARY OF UNITED-CARR FASTENER CORP.

CIRCLE 249 READERS SERVICE CARD

tions where previously rectangular plates had to be used. The small printed circuits can be handled, inspected, inserted and soldered in your plant using exactly the same techniques that were employed for disk ceramic capacitors. The company has solved the problem of screening resistors on the same disks previously used for single and multiple capacitors without the necessity of notching or perforating the disks in order to maintain alignment of screen patterns during manufacture. Circle 361 on Reader Service Card.



### Silicon Rectifier for power uses

WESTINGHOUSE ELECTRIC CORP., P.O. Box 2099, Pittsburgh 30, Pa. Type 329 silicon power rectifier can provide average forward currents up to 160 amperes per cell in single-phase circuits or 150 amperes per cell in three-phase circuits with maximum peak inverse ratings up to 500 v. Features include: high ambient temperature operation—up to 190 C junction temperature; long life; high efficiency; low regulation; rugged construction and small size. Circle 362 on Reader Service Card.

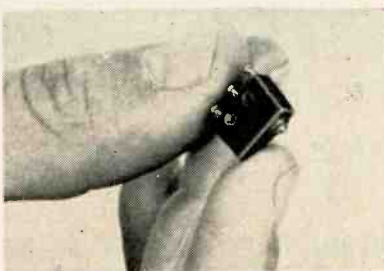

### Precision Switch sub-subminiature

MICROSWITCH, Freeport, Ill. The type SX sub-subminiature precision snap-action switch measures only 0.5 by 0.35 by 0.2 in. (on the case)

## AN INVITATION TO JOIN ORO

### Pioneer In Operations Research

Operations Research is a young science, earning recognition rapidly as a significant aid to decision-making. It employs the services of mathematicians, physicists, economists, engineers, political scientists, psychologists, and others working on teams to synthesize all phases of a problem.

At ORO, a civilian and non-governmental organization, you will become one of a team assigned to vital military problems in the area of tactics, strategy, logistics, weapons systems analysis and communications.

No other Operations Research organization has the broad experience of ORO. Founded in 1948 by Dr. Ellis A. Johnson, pioneer of U. S. Opsearch, ORO's research findings have influenced decision-making on the highest military levels.

ORO's professional atmosphere encourages those with initiative and imagination to broaden their scientific capabilities. For example, staff members are taught to "program" their own material for the Univac computer so that they can use its services at any time they so desire.

ORO starting salaries are competitive with those of industry and other private research organizations. Promotions are based solely on merit. The "fringe" benefits offered are ahead of those given by many companies.

The cultural and historical features which attract visitors to Washington, D. C. are but a short drive from the pleasant Bethesda suburb in which ORO is located. Attractive homes and apartments are within walking distance and readily available in all price ranges. Schools are excellent.

For further information write:  
 Professional Appointments

## OPERATIONS RESEARCH OFFICE **ORO**

The Johns Hopkins University

8935 ARLINGTON ROAD  
 BETHESDA 14, MARYLAND



and weighs but  $\frac{1}{8}$  oz. Electrical rating is 5 amperes at 250 v a-c and 30 v d-c. An important space-saving feature is the small stacking area which it requires when ganged on common mounting pins. Ten switches can be mounted in every sq in. of space. Contact arrangement of the SX is spdt. Operating force is 6 oz maximum, release force 1 oz minimum. Circle 363 on Reader Service Card.



### TWT Amplifier low noise

LEL, Inc., 380 Oak St., Copiague, L. I., N. Y. Model TWT-10 CM traveling wave amplifier features helix protection through incorporation of a high sensitivity relay circuit. Noise figures of less than 7 db over a wide band of frequencies, combined with protection against crystal burnout are some of the advantages obtained by the use of these amplifiers in radar systems. Circle 364 on Reader Service Card.

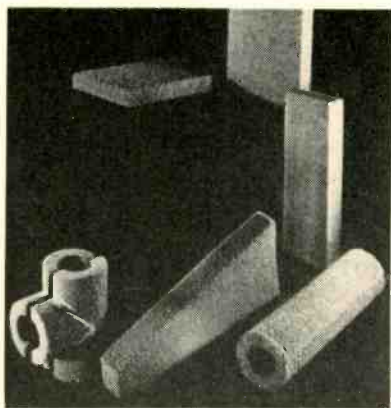

### Insulating Material wide range of uses

PITTSBURGH CORNING CORP., One Gateway Center, Pittsburgh 22, Pa., has developed an acid-resistant insulating and refractory material

## Double-throw contacts, fast reset THERMAL TIME DELAY RELAYS "MR" and "CR" Series..no chatter

- Time delays — 3 to 60 seconds
- "MR" for military use — withstands 5-500 cps. Form C contacts — input voltage, 28, DC, ambient —65°C. to +125°C.
- "CR" for machine tool requirements — withstands 5-55 cps. Two Form C contacts — input voltages, 28 and 117, AC or DC, ambient temperature —55°C. to +85°C.

The "MR" and "CR" relays are part of the new Curtiss-Wright Thermal Time Delay Relay line which includes:

- H-Series**  
— vibration resistant, for missiles, aircraft
- S-Snapper**  
— double-throw, snap-action contacts
- IR and STR**  
— instant reset, voltage compensated
- K, G and W**  
— economical, low-cost, stocked

For our new catalog, write or phone Electronics Division, Components Dept., Carlstadt, New Jersey, GENEVA 8-4000.

ELECTRONICS DIVISION

# CURTISS-WRIGHT

CORPORATION • CARLSTADT, N. J.  
CIRCLE 250 READERS SERVICE CARD

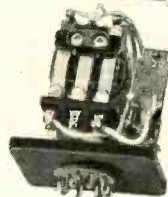

## make the acid test!

**GUARANTEED  
LEAKPROOF  
WITH NEW  
SUPERIOR  
SEALING\***

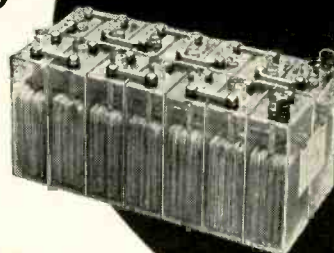
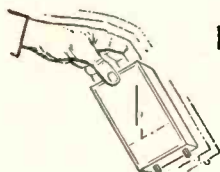

### Sturges Storage Battery

the answer to any portable power problem

- new method used for completely sealing all binding and terminal posts, prevents any leaking or creeping of electrolyte
- can be encased with any electronic units without damage from corrosion
- non-spill in any position
- redesign of "H" type cells increases output capacity a full 20% over catalogued rating
- no liquified gas or vapor is discharged from cells on charge or discharge
- lightweight transparent molded plastic case

Write for **FREE literature** on various types of storage batteries.

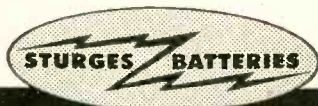

\*Patents Pending  
CONSULT US ON ANY SPECIAL  
BATTERY APPLICATION PROBLEMS

manufactured by **ELECTRONIC BATTERIES, INC.**

Bush Terminal Building No. 4 • 28-34 35th Street, Brooklyn 32, New York

CO-AX



**★ ULTRA LOW capacitance & attenuation**

WE ARE SPECIALLY ORGANIZED TO HANDLE DIRECT ORDERS OR ENQUIRIES FROM OVERSEAS

SPOT DELIVERIES FOR U.S.

BILLED IN DOLLARS—  
SETTLEMENT BY YOUR CHECK  
CABLE OR AIRMAIL TODAY



TYPE	μμ F/ft	IMPED.Ω	O.D.
C1	7.3	150	.36'
C11	6.3	173	.36'
C2	6.3	171	.44'
C22	5.5	184	.44'
C3	5.4	197	.64'
C33	4.8	220	.64'
C4	4.6	229	1.03'
C44	4.1	252	1.03'

**NEW 'MX and SM' SUBMINIATURE CONNECTORS**  
Constant 50Ω-63Ω-70Ω impedances

TRANSRADIO LTD, 138A Cromwell Rd, London SW7 ENGLAND CABLES: TRANSRAD, LONDON

CIRCLE 252 READERS SERVICE CARD

known as Foamsil. It is 99 percent pure fused silica and can neither oxidize nor absorb moisture. Material offers continuous insulating protection and withstands thermal shock within the range of -450 F to 2,200 F. It is available in blocks up to 3 in. in thickness and in pre-fabricated curved segments, wedge-shapes and other designs, or may be cut to size in the field. Circle 365 on Reader Service Card.

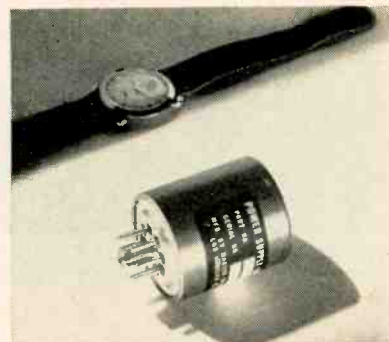

**Power Supply tiny, versatile**

MASTER SPECIALTIES Co., 956 E. 108th St., Los Angeles 59, Calif., announces a 5½ oz power supply which occupies 5 cu in. It will supply 60 ma or more current at 300 v d-c, from a 115 v 400 cps a-c input source. Unit is qualified per Mil-T-5422C, and has a variety of airborne or ground applications. High operating efficiency results in almost no internal heat dissipation. Output voltage ripple is less than 5 percent at full output rating. Circle 366 on Reader Service Card.

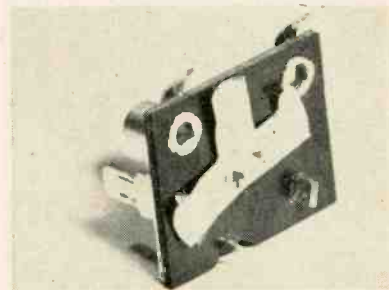

**Grounding Switch twist-tab mounting**

P. R. MALLORY & Co., Inc., Indianapolis 6, Ind. A new type of rotary switch is designed for use as a "local-distance" reception switch

**INSULATED WIRE**

that will withstand 2000°F



- Available in sheath diameters of .04 to .32.
- One or more wires in Ceramic insulation compressed in a metal sheath.
- Can be bent to shapes.
- Sheath can be welded without loss of insulation.
- Available in many sheath-wire and insulation materials.
- Complete thermocouple probes available using this material made to your requirements. Send for Bulletin 3.8A.

For AEROPAK ceramic insulated wire—Bulletin 4

**AEROPAK**

Insulated Wire long lasting eliminating costly replacements



**Aero Research**

**INSTRUMENT COMPANY, INC.**

315 NO. ABERDEEN STREET, CHICAGO 7, ILLINOIS

Sales Representatives throughout the United States and Canada



Here's information you'll want  
on

**STANDARD**  
TRADEMARK

**precision  
timers**



Accurate, reliable, versatile Elapsed Time Indicators. Synchronous motor drive, manual or electric zero reset. Electric clutch controlled by manual or automatic switch or output of electronic tubes. Units available for flush panel mounting or portable use.

Model	Scale Divisions	Totalizes	Accuracy
S-100	1/5 sec.	6000 sec.	±.1 sec.
S-60	1/5 sec.	60 min.	±.1 sec.
SM-60	1/100 min.	60 min.	±.002 min.
S-10	1/10 sec.	1000 sec.	±.02 sec.
S-6	1/1000 min.	10 min.	±.0002 min.
S-1	1/100 sec.	60 sec.	±.01 sec.
MST	1/1000 sec.	.360 sec.	±.001 sec.
MST-500	1/1000 sec.	30 sec.	±.002 sec.

REQUEST BULLETIN NO. 198

**THE STANDARD ELECTRIC TIME COMPANY**

89 LOGAN STREET • SPRINGFIELD, MASSACHUSETTS

CIRCLE 254 READERS SERVICE CARD

**New CANNON XLR plugs  
for audio and electronic uses**



**CANNON  
PLUGS**

**GREATER VALUE AT NO INCREASE IN PRICE**

Improved features illustrated above give you more for your money than any similar plug on the market.

These deluxe audio plugs, in handsome satin nickel finish, give protection against disagreeable interference and mechanical noises. Positive latch holds firmly, yet allows for quick disconnect. Improved strain relief bushings and cable clamps accommodate full range of microphone cables. Series includes wide variety of shell types, with three and four contacts. Mates with Cannon former XL series.

Like all the plugs in the complete Cannon line the XLR series is manufactured of finest quality materials for reliable, long-lasting service. See the distributor nearest you or write for Bulletin XLR-3.

27,000 kinds to choose from! Call on Cannon for all your plug needs. If we don't have what you want, we'll make it for you. We're ready to help you at any stage—from basic design to volume production—with the largest facilities in the world for plug research, development and manufacturing. Write us today about your problem. Please refer to Dept. 120

**CANNON ELECTRIC COMPANY**  
3208 Humboldt St., L.A. 31, California

Where Reliability for Your Product  
is Our Constant Goal 346

CIRCLE 255 READERS SERVICE CARD

**NEW**

**WILEY**

**BOOKS**

**1. SWITCHING CIRCUITS  
AND LOGICAL DESIGN**

By SAMUEL H. CALDWELL, Massachusetts Institute of Technology

Deals with the methods of handling problems of circuit synthesis. Presents principles of switching circuit design necessary for a knowledge of the complex applications of switching theory.

1958 685 pages Illus. \$14.00

**2. NOTES ON ANALOG-DIGITAL  
CONVERSION TECHNIQUES**

Prepared by Staff Members of the M.I.T. Servomechanisms Laboratory; edited by ALFRED K. SUSSKIND, M.I.T.

Includes: the theory of sampling, quantizing, and coding; analysis and evaluation of basic coding and decoding methods for electrical and mechanical analog quantities; etc. A Technology Press Book, M.I.T.

1958 410 pages \$10.00

**3. AUTOMATIC PROCESS CONTROL**

By DONALD P. ECKMAN, Case Institute of Technology

A comprehensive treatment of the important principles of process control, using the modern approach with block diagrams and frequency techniques.

1958 368 pages Illus. \$9.00

**4. PRINCIPLES AND APPLICATIONS  
OF RAMDON NOISE THEORY**

By JULIUS S. BENDAT, Ramo-Wooldridge Corp.

A thorough explanation of the fundamental ideas in random noise theory. Includes full treatment of Rice's representation of random noise, and development of the important Zero crossing problem.

1958 431 pages Illus. \$11.00

**5. An Introduction to  
THE DESIGN OF SERVOMECHANISMS**

By JOHN L. BOWER, North American Aviation; and PETER M. SCHULTHEISS, Yale University

Stresses the importance of finding a systematic approach to design, with emphasis on the basic feedback phenomena and feedback systems design rather than specific components.

1958 510 pages \$13.00

**6. ZONE MELTING**

By WILLIAM G. PFANN, Bell Telephone Laboratories

Covers all phases of this technique for controlling the purity and composition of solids.

1958 236 pages Illus. \$7.50

Mail this coupon for your ON-APPROVAL copies!

**JOHN WILEY & SONS, Inc.** E-98  
440 Fourth Ave., New York 16, N. Y.

Please send me a copy of the book(s) circled below to read and examine ON APPROVAL. Within 10 days I will return the book(s) and owe nothing, or I will remit the full purchase price(s), plus postage.

Name .....

Address .....

City ..... Zone ..... State .....

SAVE POSTAGE! Check here if you ENCLOSE payment, in which case we will pay postage. Same return privilege, of course.

CIRCLE 256 READERS SERVICE CARD



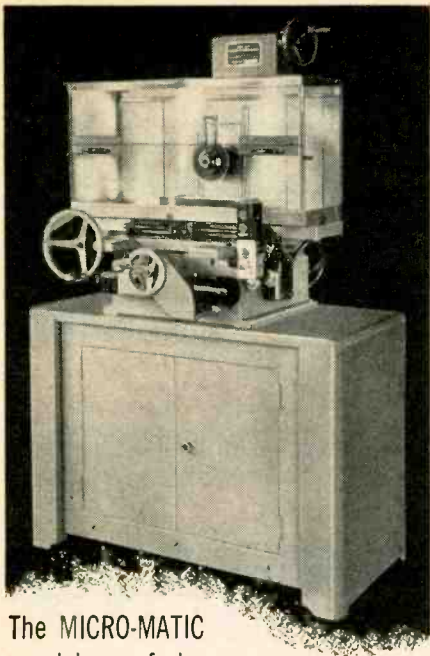

The MICRO-MATIC precision wafering machine—fully automatic model-WMA

# SLICES

*to extremely close tolerances*

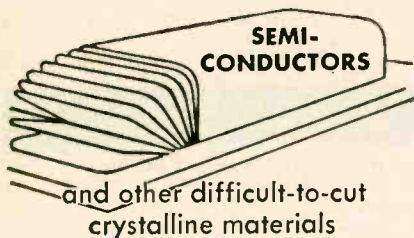

## AUTOMATIC INDEXING ON FULLY AUTOMATIC PRODUCTION MODELS

Write for descriptive literature

**MICROMECH  
MANUFACTURING CO.**  
1020 Commerce Ave. • Union, N. J.

CIRCLE 257 READERS SERVICE CARD

for tv receivers, for sensitivity control, tone control or other uses where one or two circuits are occasionally connected to ground. The GS-1 grounding switch features twist-tab type mounting which eliminates the time and cost of assembling onto a chassis by means of threaded bushings or lugs. It is simple and rugged in design, has been tested for 5,000 rotational cycles or better. Circle 367 on Reader Service Card.

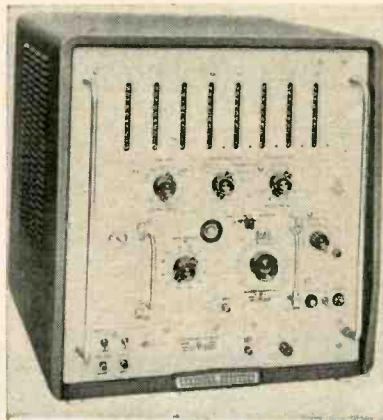

### Electronic Counter 8 readout units

HEWLETT-PACKARD Co., 275 Page Mill Road, Palo Alto, Calif. The 524D electronic counter provides for full frequency measurements from 0 cps to 10 mc automatically and directly in one self-contained unit, without calculation or interpolation. It has a new crystal oscillator stability of 5 parts in  $10^8$  per week and is equipped with 8 vertical neon readout units. Circle 368 on Reader Service Card.



### Pulse Source adjustable unit

AUTOMATION DYNAMICS CORP., 255 County Road, Tenafly, N. J., announces a new nuclear counter simulator. It provides recurrent,

# NOW! 3 STAGE PROGRESSIVE ECONOMY DIES

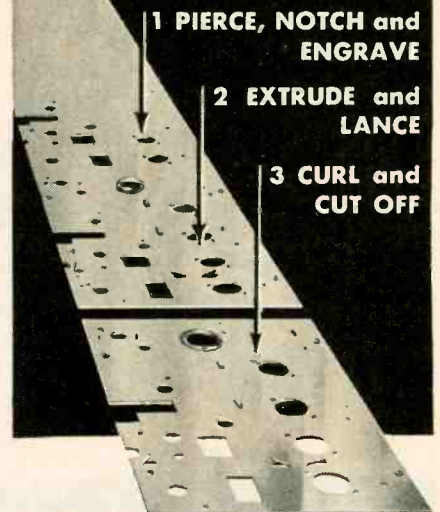

## Savings

### — YOU CAN SEE —

die material cost .... \$63  
tooling time ..... 45 hours!  
set-up time ..... 10 minutes!  
over 5000 pieces per day!  
(hand feed, 8x6", 20 ga. CRS)

Now you can benefit from economy tooling for compound, progressive and other types of tool designs.

Parts are produced in any gauge or material by means of Templet tooling processes — at substantial savings.

*Submit prints  
for quotations*

**TEMPLET**  
INDUSTRIES INCORPORATED  
or authorized licensees  
701 Atkins Ave., Brooklyn, N. Y.

The Templet Process (Pat. Nos. 2,495,221 and 2,850,096) is also available for use in your own shop. Now licensed to more than 150 major U.S. manufacturers. Write for details.

CIRCLE 258 READERS SERVICE CARD



You can reduce  
**GERMANIUM WASTE**

with these new paper-thin  
**Felker Diamond Blades!**

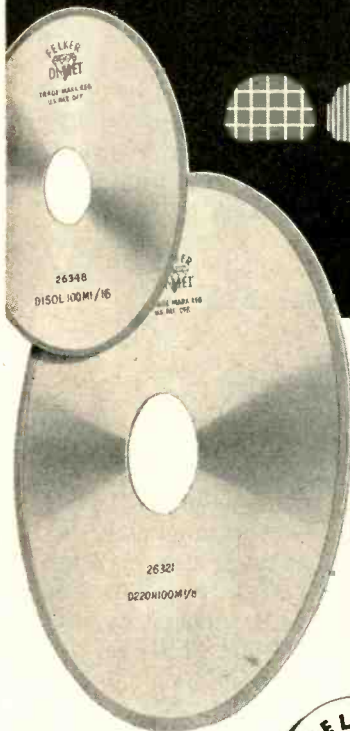

Here's good news to all crystal cutters, germanium, quartz, silicon, barium titanate, etc.! Felker DI-MET metal bonded diamond blades are exceedingly thin, greatly reducing amount of expensive crystal lost in the cut! Special blades are supplied for either wafering or dicing insuring maximum efficiency and savings of material!

Fast cutting, smooth finishes, long blade life, utmost reliability... you get them all in Felker DI-MET... originators of the first commercial diamond abrasive cut-off blades!

Available from your Felker  
Distributor... or write direct.



**FELKER MANUFACTURING CO.**  
Torrance, California

*First in Diamond Cut-Off Blades!*

CIRCLE 259 READERS SERVICE CARD

Above:  
FOR DICING  
TYPE DIT  
Available as  
thin as .006"

Below:  
FOR WAFERING  
TYPE DITR  
Available as  
thin as .015"

## sending a bill?

It'll get there quicker if you give your postal delivery zone number with your address.

The Post Office has divided 106 cities into postal delivery zones to speed mail delivery. Be sure to include zone number when writing to these cities; be sure to include your zone number in your return address —after the city, before the state.

the specs are the proof...  
the BEST BUYS are **TEICO**<sup>®</sup>  
for COLOR & Monochrome TV servicing



**COLOR**  
and Monochrome  
dc to 5 mc lab & tv  
5" OSCILLOSCOPE  
#460  
Factory-wired \$129<sup>95</sup>  
Kit \$79<sup>95</sup>

• Features DC Amplifiers!

Flat from DC-4.5 mc, usable to 10 mc. VERT. AMPL.: sens. 25 rms mv/in; Input Z 3 megs; direct-coupled & push-pull thruout; K-follower coupling bet. stages; 4-step freq-compensated attenuator up to 1000:1. SWEEP: perfectly linear 10 cps-100 kc (ext. cap. for range to 1 cps); pre-set TV V & H positions (30 & 7875 cps); auto. sync. ampli. & lim. PLUS: direct or cap. coupling; bal. or unbal. inputs; edge-lit engraved lucite graph screen; dimmer; filter; bezel fits std photo equipmt. High intensity trace CRT. 0.06 usec rise time. Push-pull hor. ampli., flat to 400 kc, sens. 0.6 rms mv/in. Built-in volt. calib. Z-axis mod. Sawtooth & 60 cps outputs. Astig. control. Retrace blanking. Phasing control.



**TV-FM SWEEP**  
GENERATOR  
& MARKER #368  
Factory-wired \$119<sup>95</sup>  
Kit \$69<sup>95</sup>

Entirely electronic sweep circuit (no mechanical devices) with accurately-biased inductor for excellent linearity. Extremely flat RF output: new AGC circuit automatically adjusts osc. for max output on each band with min. ampl. variations. Exceptional tuning accuracy: edge-lit hair-lines, 6:1 vernier. Swept Osc. Range 3-216 mc in 5 fund. bands. Variable Marker Range 2-75 mc in 3 fund. bands; 60-225 mc on harmonic band. 4.5 mc Xtal Marker Osc., xtal supplied. Ext. Marker provision. Sweep Width 0-3 mc lowest max. deviation to 0-30 mc highest max. dev. 2-way blanking. Narrow range phasing. Attenuators: Marker Size, RF Fine, RF Coarse (4-step decade). Cables: output, 'scope horiz., 'scope vertical.

**DYNAMIC CONDUCTANCE**



Tube &  
Transistor  
Tester  
#666  
Factory-wired \$109<sup>95</sup>  
Kit \$69<sup>95</sup>

COMPLETE with steel cover and handle. SPEED, ease, unexcelled accuracy & thoroughness. Tests all receiving tubes (& Color & Monochrome pic tubes with adapter). Composite indication of Gm., Gp & peak emission. Simultaneous sel of any 1 of 4 combinations of 3 plate voltages, 3 screen voltages, 3 ranges of continuously variable grid voltage (with 5% accurate pot). New series-string voltages: for 600, 450, 300 ma types. Sensitive 200 ua meter. 5 ranges meter sensitivity (1% shunts & 5% pot). 10 SIX-position lever switches: free-point connection of each tube pin. 10 pushbuttons: rapid insert of any tube element in leakage test circuit & speedy sel. of individual sections of multi-section tubes in merit tests. Direct-reading of inter-element leakage in ohms. New gear-driven rollchart. Checks n-p-n & p-n-p transistors: separate meter readings of collector leakage current & Beta using internal dc power supply.

See the 50 EICO models  
IN STOCK at your neighborhood distributor.  
Write for  
**FREE Catalog E-10**  
33-00 Northern Boulevard, L. I. C. 1, N. Y.

Prices 5% higher in West.

CIRCLE 262 READERS SERVICE CARD



# WELCH TWO-STAGE DUO-SEAL

## High Vacuum PUMP®

Run-in to Perfection

- DEPENDABLE PERFORMANCE
- QUIET OPERATION
- LONG LIFE

### Choice of Two Speeds

Revolutions per minute	300	525
Vacuum, microns	0.05	0.1
	(0.00005 mm)	(0.0001 mm)
Capacity, liters/min.	33.4	58
Motor Horsepower	1/3	1/2

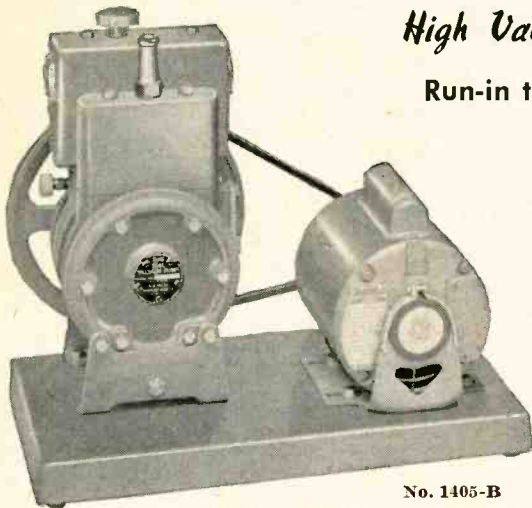

No. 1405-B

Pat. No. 2,337,849

WRITE FOR OUR PUMP CATALOG

No. 1405B. DUO-SEAL VACUUM PUMP, Motor Driven, 525-RPM. For 115 volts 60 cycles, A.C. Each .....\$255.00

No. 1405H. DUO-SEAL VACUUM PUMP, Motor Driven, 300-RPM. For 115 volts 60 cycles, A.C. Each .....\$230.00

For attached Belt Guard add \$17.50 to the above prices.

See our Pump Catalog for complete listing of this series high vacuum pumps.

**W. M. WELCH SCIENTIFIC COMPANY**  
DIVISION OF W. M. WELCH MANUFACTURING COMPANY  
ESTABLISHED 1880

1515 Sedgwick Street, Dept H, CHICAGO 10, Illinois, U.S.A.

Manufacturers of Scientific Instruments and Laboratory Apparatus

CIRCLE 263 READERS SERVICE CARD

exponentially shaped voltage pulses simulating the output of a gas filled nuclear particle counter tube. Pulse rate is adjustable over a range of 1 to 15 pps, and voltage from 0 to 100 mv. Instrument may be applied in development and test of electronic counters, and permits an accurate determination of counter performance not ordinarily possible with random pulses. Circle 369 on Reader Service Card.

## Titanium Wire nickel coated

LITTLE FALLS ALLOYS, INC., 189 Caldwell Ave., Paterson, N. J., has available a new special purpose wire for use primarily as a material for ceramic to metal brazing. The wire is nickel coated titanium and its primary application is its use as a sealing material for ceramic base vacuum tubes. The alloy will melt to bond with the ceramic, forming a perfect air-tight seal. Wire is presently available in sizes from 0.062 to 0.004. Circle 370 on Reader Service Card.

Hermetically-Sealed so that ...  
**WATER • DUST • HUMIDITY**  
**GRIT • FUMES • IMPURITIES**

## DURANT MODEL YE ELECTRIC COUNTER

meets RIGID MILITARY requirements  
in MISSILES and INSTRUMENTATION



only ELECTRICAL IMPULSES (for counting  
and reset) enter this PROTECTIVE CASE

only 3-1/2" wide x 1-7/8"  
deep x 3-7/16" high

...and FAST\*

Designed for use on military and industrial applications where adverse operating conditions exist. Compact and sturdy with Winchester hermetic seal connector on bottom for quick electrical connections. Large, easily-read figures — white on black background. Operates on 28 V. DC — other voltages available on special order. Finished gray or standard military.

### DURANT MANUFACTURING COMPANY

1912 N. Buffum St.  
Milwaukee 1, Wis.

12 Thurbers Ave.  
Providence 5, R.I.

Representatives in Principal Cities

\* Speeds up to 1500 CPM  
with maximum resetting  
time of 105 milliseconds

Send  
for  
Bulletin

**DURANT** MANUFACTURING CO.  
OF Milwaukee

## LEGAL NOTICE

STATEMENT REQUIRED BY THE ACT OF AUGUST 24, 1912, AS AMENDED BY THE ACTS OF MARCH 3, 1933, AND JULY 2, 1946 (Title 39, United States Code, Section 233) SHOWING THE OWNERSHIP, MANAGEMENT, AND CIRCULATION

Of Electronics published weekly at Albany, New York for October 1, 1958.

1. The names and addresses of the publisher, editor, managing editor and business manager are: Published by McGraw-Hill Publishing Company, Inc., 330 West 42nd Street, New York 36, N. Y.; Editor, W. W. MacDonald, 330 West 42nd Street, New York 36, N. Y.; Managing editor, John M. Carroll, 330 West 42nd Street, New York 36, N. Y.; Business manager, Frank H. Ward, 330 West 42nd Street, New York 36, N. Y.

2. The owner is McGraw-Hill Publishing Company, Inc., 330 West 42nd St., New York 36, N. Y. Stockholders holding 1% or more of stock are Donald C. McGraw & Willard T. Chevalier, Trustees under Indenture of Trust m/b James H. McGraw, dated 1/14/21 as modified; Donald C. McGraw & Harold W. McGraw, Trustees under an indenture of Trust m/b James H. McGraw, dated 7/1/37 as amended; Donald C. McGraw, individually; Harold W. McGraw, individually; Elizabeth M. Webster, c/o Donald C. McGraw (all of 330 West 42nd St., New York 36, N. Y.); Mildred W. McGraw, Madison, New Jersey; Grace W. Mehren, 538 Arenas St., La Jolla, Calif.; Affiliated Fund, Inc., 63 Wall St., New York, N. Y.; Genoy & Co., P. O. Box 491, Church St. Station, New York, N. Y.; Touchstone & Co., c/o Wellington Fund, Inc., Claymont, Delaware.

3. The known bondholders, mortgages, and other security holders owning or holding 1 percent or more of total amount of bonds, mortgages, or other securities are: None.

4. Paragraphs 2 and 3 include, in cases where the stockholder or security holder appears upon the books of the company as trustee or in any other fiduciary relation, the name of the person or corporation for whom such trustee is acting; also the statements in the two paragraphs show the affiant's full knowledge and belief as to the circumstances and conditions under which stockholders and security holders who do not appear upon the books of the company as trustees, hold stock and securities in a capacity other than that of a bona fide owner.

5. The average number of copies of each issue of this publication sold or distributed, through the mails or otherwise, to paid subscribers during the 12 months preceding the date shown was: 49,649.

McGraw-Hill Publishing Company, Inc.  
By JOHN J. COOKE, Secretary.

Sworn to and subscribed before me this 8th day of September, 1958.

[SEAL] JANET A. HARTWICK.  
(My Commission expires March 30, 1959)



## expecting a check?

You'll get it quicker if you gave your postal delivery zone number with your address.

The Post Office has divided 106 cities into postal delivery zones to speed mail delivery.

Be sure to include zone number when writing to these cities; be sure to include **your** zone number in **your** return address—after the city, before the state.



DE MORNAY-BONARDI

## first in ultramicrowave equipment

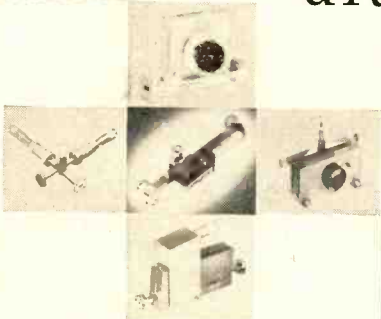

A complete line of research instruments covering frequencies up to 90,000 mc... proved in laboratories the country over.



DE MORNAY-BONARDI • 780 SOUTH ARROYO PARKWAY • PASADENA, CALIFORNIA

## NEW MOLDED CORONA BARRIER

insures minimum and uniform loss



**BIWAX**  
CORPORATION

3446 Howard Street

• Skokie, Illinois

• Phone: Ambassador 2-3339

Precision molding provides the proper thickness of deposit each and every time on the transformer winding. Resulting uniformity assures minimum and uniform corona loss. Ideal for high voltage flyback transformers.

Process is applicable to many other compounds for applications where uniformity is required for variable thickness of deposit. Can be set up in your plant or handled by Biwax. Write for details.

Send for Biwax brochure which shows complete line of compounds with specifications.

INSULATION

# NEWS

FROM ALPHA  WIRE

**NEW DESIGN FREEDOM FOR  
YOU WITH COMPLETE LINE OF  
ALPHLEX® TUBING AND SLEEVING**  
all cut and marked to your specifications

### PLASTIC TUBING

**PVC-105:** the universal insulating tubing for all electronic needs — conforms to spec MIL-I-631C, approved by Underwriters' Laboratories for 105°C. Displays high resistance to heat, oil, chemicals, corrosion, fungi, abrasion— with no loss in tensile strength, non-flammability or flexibility.

**PVC-80:** withstands temperatures to 80°C. Slightly more flexible than PVC-105.

**PVC-60:** low temperature flexibility to -50°C.

**PLE-70:** for UHF and extra high dielectric uses; also excellent for channeling chemical solutions.

**PVC-744:** meets Spec MIL-I-7444A. For aircraft applications to -67°C.

**PLASTIC ZIPPER TUBING:** Versatility unlimited. Zip to close or open. Or permanent seal. Choose from 5 types, any sizes.

**SILICONE RUBBER FIBERGLASS TUBING, SRF-200:** the finest class H insulation. Excellent shock & fungus resistance, flexibility, freedom from cracking and crazing, from -90°F to +400°F. Conforms to Spec MIL-I-3190.

**SILICONE IMPREGNATED FIBERGLASS SLEEVING, SFS-400:** a quality class H insulation retaining its flexibility and dielectric properties to +400°F. Meets Spec MIL-I-3190.

**PLASTIC IMPREGNATED FIBERGLASS SLEEVING, PIF-130:** excellent class B insulation sleeving for continuous operation to 130°C. Meets Spec MIL-I-3190.

**VARNISH IMPREGNATED TUBING & SLEEVING, VTS-135:** general-application insulation. 4 grades, all meet Spec MIL-I-3190.

**HIGH TEMPERATURE FIBERGLASS SLEEVING, HTF-100:** tightly braided class H 100% fiberglass sleeving for applications as high as 1200°F.

**TEFLON TUBING, TFT-250:** tough & flexible, -90°C to +250°C. Chemically inert. No moisture absorption. Non-flammable. Fungus-resistant.

**SPECIAL PROBLEM?** Consult with us at no obligation.

**ALPHLEX**  **TUBING**

Write for free catalog to ALPHLEX® TUBING  
Division Alpha Wire Corporation,  
200 Varick Street, New York 14, N. Y.

## A RADICAL APPROACH

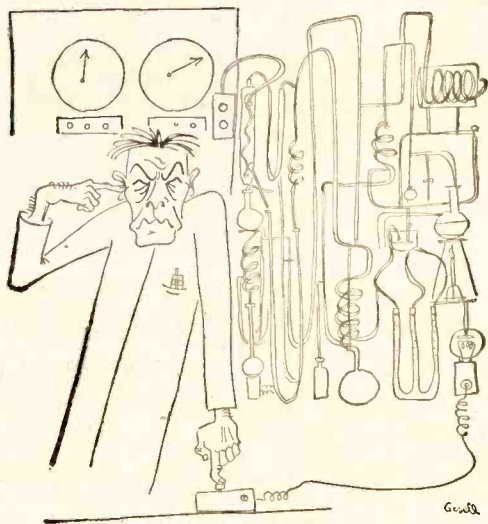

Cooling heat-producing components of a high-temperature, high-voltage transformer with a boiling liquid hermetically sealed in its case may seem a bit radical to the uninitiated. But if the liquid is a high-dielectric fluorochemical, like that used in air conditioning systems, the idea begins to make sense.

As the vapor comes in contact with the fan-cooled surface of the transformer case it condenses to a liquid, and gets rid of its heat to the surrounding atmosphere.

In a recent project completed by Raytheon engineers, six ounces of fluorochemical vapor and a one-pound fan did a better cooling job than 20 pounds of transformer oil. Operating temperatures were reduced as much as 75° C.



Our engineers will be glad to initiate you in the miniaturization techniques made possible by these versatile coolant-dielectrics. Simply contact:

Raytheon Manufacturing Company  
Magnetic Components Department  
Section 6120  
Waltham 54, Massachusetts

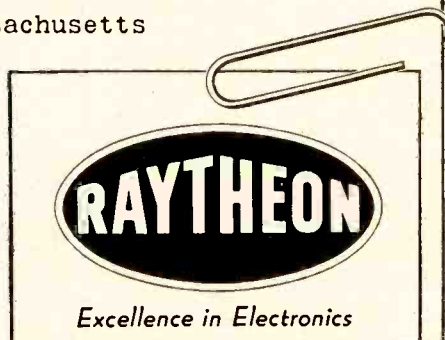

## Literature of

### MATERIALS

**Epoxy Casting System.** Isochem Resins Corp., 221 Oak St., Providence 9, R. I. Technical data bulletin DB-405-8167 covers Isocast 405, a general purpose 100 percent solids, filled epoxy resin casting system which may be used over a wide temperature range. **Circle 375 on Reader Service Card.**

**Wire Markers.** North Shore Nameplate, Inc., 214-27 Northern Blvd., Bayside 61, N. Y. An 8-page catalog illustrates and describes a wide variety of standard Speedy-Marx wire markers available on instant-release dispensing cards. **Circle 376 on Reader Service Card.**

### COMPONENTS

**High Temperature Switch.** Micro Switch, Freeport, Ill. Data sheet 140 describes a new switch, said to have the highest available electrical rating for its size of any switch designed for use at 600 F. Case, cover and plunger of the device discussed are molded of a special type of glass-bonded synthetic mica. Operating characteristics, electrical data and prices are covered. **Circle 377 on Reader Service Card.**

**P-C Connectors.** H. H. Buggie, Inc., P.O. Box 817, Toledo 1, Ohio. A 24-page catalog describes and illustrates a standard series of printed circuit connectors, and lists many variables that have been designed and produced for specific applications. **Circle 378 on Reader Service Card.**

**R-F Filters.** Microphase Corp., Box 1166, Greenwich, Conn. Catalog C3-58 lists a number of standard low-pass and high-pass filters of the block, tubular and shell types operating in ranges from 10 mc to 12,000 mc. **Circle 379 on Reader Service Card.**

**Silicon Semiconductors.** Hoffman Electronics Corp., 930 Pitner Ave., Evanston, Ill. A 6-page folder



## the Week

contains technical data on general purpose diodes, glass diodes, zener diodes, rectifiers, zener reference units, zener power regulators and solar cells. Circle 380 on Reader Service Card.

### EQUIPMENT

**Diode Tester.** Technitrol Engineering Co., 1951 E. Allegheny Ave., Philadelphia 34, Pa. A two-page folder covers the operating principles of the model 1001 dynamic diode tester and explains the type of diode characteristics which can be analyzed, such as forward and back resistance, hysteresis and stability. Circle 381 on Reader Service Card.

**Magnetic Voltage Regulators.** Sorensen & Co., Inc., Richards Ave., South Norwalk, Conn. A 4-page illustrated brochure furnishes complete technical data on the MVR magnetic voltage regulators. It covers detailed product description, principles of operation, operating instructions and maintenance. Circle 382 on Reader Service Card.

**Multichannel Sampling.** General Devices, Inc., P. O. Box 253, Princeton, N. J., announces a 16-page booklet on electronic and electromechanical sampling devices for multichannel instrumentation. It contains more than 35 illustrations on the subject of selection and application of sampling devices. Booklet may be obtained by a request on company letterhead.

### FACILITIES

**Facilities Brochure.** Automation Dynamics Corp., 255 County Road, Tenafly, N. J. A four-page brochure describes services offered for development and construction of electronic equipment for measurement, communication, computing and control. A brief outline of the facilities and thumbnail sketches of the technical leaders are presented. Circle 383 on Reader Service Card.

## REDUCE BREAKDOWN FAILURES

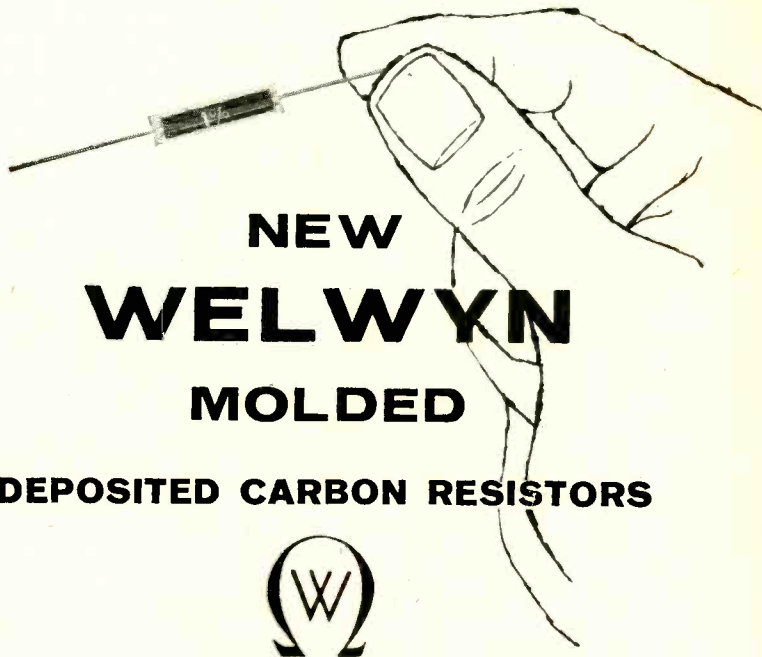

## NEW WELWYN MOLDED DEPOSITED CARBON RESISTORS



The use of a thermo-plastic insulation material has resulted in an economically priced molded carbon resistor of markedly improved endurance and long term stability.

Type N resistors subjected to several one-hour cycles of immersion in boiling water — while DC polarized — have revealed only negligible changes in resistance. Continuous operations at 150°C caused no damage to the component.

The new Type N resistor, a deposited carbon film fired onto a porcelain rod, is first tropicalized with multiple coatings of pancratic lacquers to give it long term moisture resistance, and is then molded in a thermo-plastic material.

This molded insulation has an effective resistance in the order of  $10^{13}$  ohms. Its inherent thermal conductivity is approximately ten times that of air, resulting in substantially improved load life under conditions involving excessive or high wattage dissipation. Similarly, Type N resistors may be soldered as close to the insulation as desired without fear of melting or deforming the cover.

One added advantage of the Type N is that the original markings on the resistor body remain visible and legible through the transparent molded material.

Welwyn Type N carbon resistors meet the requirements specified by MIL-R-10509B, and are available in all values, ranging from 10 ohms through 1 megohm. For complete data and specifications write to Welwyn International, Inc., 3355 Edgecliff Terrace, Cleveland 11, Ohio.



**SAMPLES AVAILABLE ON REQUEST.**



## IEC Expands Facilities

GROUND-BREAKING ceremonies were recently held to initiate work on a 15,000-sq ft engineering office for Interstate Electronics Corp. of Anaheim, Calif.

This new addition will increase the company's total floor area from 56,000 to 71,000 sq ft of engineering, manufacturing and office space. It supplements the existing facilities, which include an electronic engineering laboratory, a technical library and an instrument calibration laboratory.

Headed by Paul H. Reedy, president (shown at left with, l to r, Frank E. Booth, vice chairman of board; L. Delford Fedderman, chairman of board; Charles A. Pearson, Anaheim mayor; John E. Koster, board member), the firm

has enjoyed a rapid growth.

Inaugurated with three people in January 1956, the company now employs more than 270, and has a current backlog of over \$4 million.

Interstate Electronics is engaged in the field of advanced communications and missile test range instrumentation, and is a prime contractor for Polaris fleet ballistic missile instrumentation.

Augmenting the firm's electronic engineering endeavors are two new departments: Acronautics, directed by Frank G. Denison, and Television, directed by James J. Reeves. An intensive R&D program has been initiated in the field of specialized closed-circuit tv with unique medical adaptations.

Pasadena, Calif., were recently announced by Joseph H. Lancor, Jr., vice president in charge of development.

Francis T. Greenup, formerly chief product engineer, is named manager of engineering services and manager of the Alectra Department, which designs and manufactures CEC's Alectra line of portable test instruments.

George M. Slocomb is promoted from supervisory principal engineer to assistant chief development engineer.

E. James Penrose is named administrative manager. He was formerly assistant to Lancor.



## Nolan Takes New Position

THE Pacific Division of Bendix Aviation Corp., N. Hollywood, Calif., has appointed Edward L. Nolan as radar applications engineer with responsibility for sales promotion of the company's line of airborne radar for the military. With the company since 1951, Nolan has headed the applications and field engineering group in radar engineering for the past two years.

## Burton Moves To Avco's RAD

APPOINTMENT of Charles J. Burton as vice president is announced by Avco Research and Advanced Development Division. He moves to Avco RAD from Barnes Engineer-

## Honor British Scientists

THREE British scientists will receive John Price Wetherill Medals from The Franklin Institute of Philadelphia at Institute ceremonies next Wednesday.

Slated for the awards are John T. Randall, Wheatstone professor of physics at the University of London, King's College; Henry A. H. Boot, a senior principal scientific officer at the Services Electronics Research Laboratory, Baldock; and James Sayers, professor of electron physics at the University of Birmingham.

Medal citations to the three

scientists read: "For their basic developments which provided the first useful highpower pulsed microwave magnetron, and which established the fundamental principles upon which all later developments in this field were based."

## CEC Fills Three Major Posts

THREE major appointments in the Central Engineering Division, Consolidated Electrodynamics Corp.,





**S**implify design  
**S**peed production  
**\$**ave money

You can save many expensive engineering hours because designers no longer need to plow through thousands of eyelet specifications. Over 20 years' experience has shown that a very high percentage of all eyelet work can be done with the 7 United Standard diameters.

**Use UNITED Standardized Sizes**

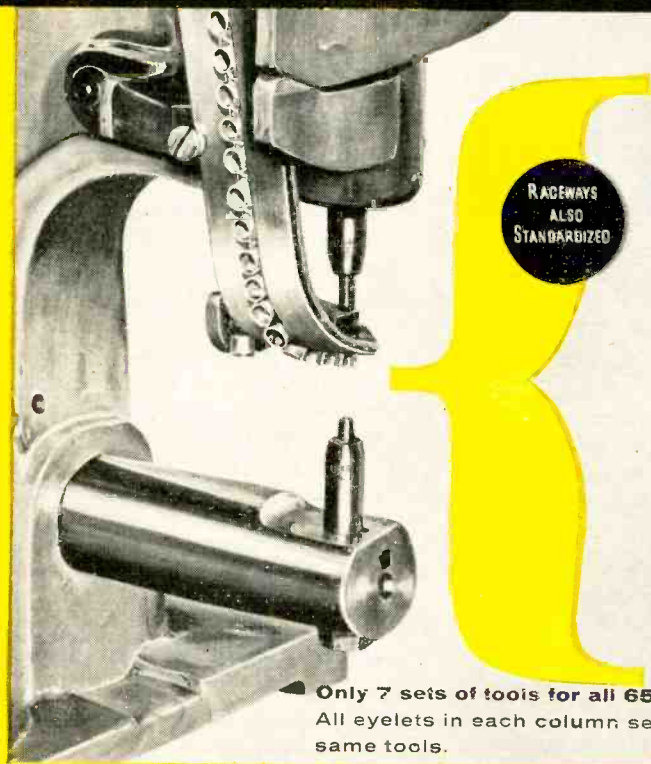

Length Length Head	DIAMETER OF BARREL						
	2/32" 082	3/32" 093	4/32" 125	5/32" 156	6/32" 187	7/32" 218	8/32" 250
2/32" 082	SE-22	SE-33	SE-43	SE-53	SE-63	SE-73	SE-83
3/32" 093	SE-23	SE-34	SE-44	SE-54	SE-64	SE-74	SE-84
4/32" 125	SE-24	SE-35	SE-45	SE-55	SE-65	SE-75	SE-85
5/32" 156	SE-25	SE-36	SE-46	SE-56	SE-66	SE-76	SE-86
6/32" 187	SE-26	SE-37	SE-47	SE-57	SE-67	SE-77	SE-87
7/32" 218	SE-27	SE-38	SE-48	SE-58	SE-68	SE-78	SE-88
8/32" 250	SE-28	SE-39	SE-49	SE-59	SE-69	SE-79	SE-89
10/32" 312	SE-30	SE-40	SE-50	SE-60	SE-70	SE-80	
11/32" 344	SE-31	SE-41	SE-51	SE-61	SE-71	SE-81	
12/32" 376	SE-32	SE-42	SE-52	SE-62	SE-72	SE-82	
15/32" 408	SE-33	SE-43	SE-53	SE-63	SE-73	SE-83	
16/32" 437	SE-34	SE-44	SE-54	SE-64	SE-74	SE-84	

\*The diameter given indicates the size hole for the eyelet.  
 These eyelet numbers are descriptive. For example in SE-611, the SE means Standardized Eyelet. The first number (6) indicates Barrel Diameter (6/32"). The number or numbers which follow indicate Barrel Length (11/32").

Only 7 sets of tools for all 65 sizes  
 All eyelets in each column set by same tools.

Only SEVEN sets of tools needed for all 65 sizes! This means that tooling is reduced as much as 90%. With United's closely co-ordinated system of Standardized Eyelets and Eyeletting machines, eyelet grip can be increased as much as 1000% (for instance, from .093" to .437") without a single change in drill, punch, or setting tool. Result: greatly reduced installed costs and true fastener economy.

Purchasing problems are eliminated. United Standardized Eyelets are carried in stock at key points: United's Shelton Eyelet Division plant near New York and branch offices in Chicago and Los Angeles. Low eyelet costs for you are ensured by United's constant high volume production on a relatively small number of sizes.

Inventory is greatly simplified. Fewer sizes do more jobs. Actual experience of thousands of users for over two decades has shown that United Standardized Eyelets and co-ordinated Eyeletting machines can

reduce the number of eyelet sizes carried in stock an average of 66 2/3%.

Precision made in standard increments of 1/32" in both barrel O.D. and length, each one of the 65 United Standardized Eyelet sizes has a standard relationship in dimension and proportion to every other eyelet in the series. They are designed to save you money. Start to-day to enjoy the advantages of United's Standardized Eyelets. Write or call us for complete information.

**New Eyelet Catalog** Complete specifications of all phases of United's co-ordinated system of eyelets, eyeletting machines, setting tools. Also includes data on special eyelets and metal stampings.



**SHOE MACHINERY CORPORATION**  
 BOSTON 7, MASSACHUSETTS

Branches: ATLANTA, GA. • CHICAGO, ILL. • CINCINNATI, CLEVELAND and COLUMBUS, OHIO • DALLAS, TEXAS • HARRISBURG, PA. • JOHNSON CITY, N. Y. • LOS ANGELES, CALIF. • LYNCHBURG, VA. • MILWAUKEE, WISC. • NASHVILLE, TENN. • NEW YORK, N. Y. • PHILADELPHIA, PA. • ROCHESTER, N. Y. • ST. LOUIS, MO.

# EISLER VERTICAL SPOT WELDERS

MADE IN SIZES 1/2-1-2-3-5 KVA

WITH OR WITHOUT TRANSFORMER OR TIMER

Sent to Any Radio Tube Manufacturer in U.S.A. on a 30 Day Free Trial Basis.

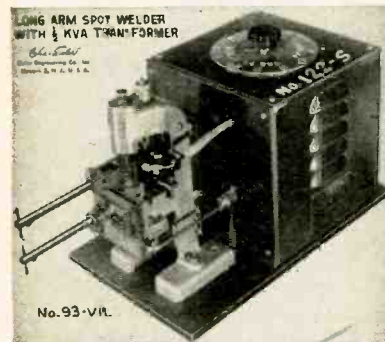
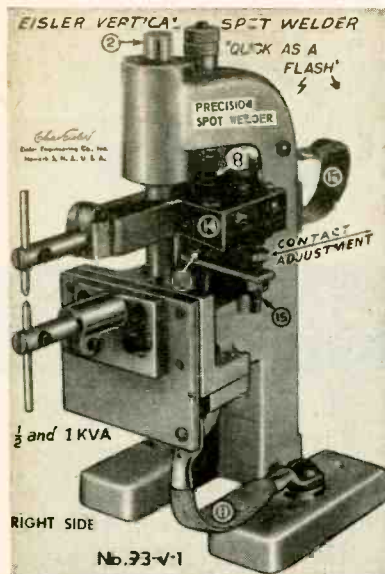

## TRANSISTOR MAKING EQUIPMENT

### DIODE MACHINERY AUTOMATIC OR SEMI-AUTOMATIC

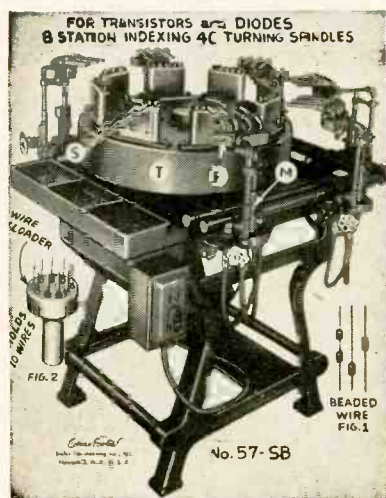

Send for Catalog Dr. Chas. Eisler, M. E. Founder  
CHAS. EISLER, JR., PRES.

**EISLER ENGINEERING CO., INC.**  
751 So. 13th St. NEWARK 3, N. J.  
CIRCLE 269 READERS SERVICE CARD

ing Co., where he was vice president since 1952. Previously, he had been with American Optical and American Cyanamid.

Burton specializes in electron microscopy and ultrasonics, is working at Avco RAD's new center in Wilmington, Mass.



## Feirn Takes New Post

APPOINTMENT of Fred C. Feirn as applications engineer for proximity transducer systems has been announced by Electro Products Laboratories, Chicago, Ill. In this capacity he will develop special applications of proximity transducers for uses in which standard systems do not apply.

Before taking this position, Feirn had been associated with Magnaflux in the development of magnetic circuitry for determining flaws in metals.

## IRE's PGME Names Two

E. A. SPEAKMAN, manager of planning, RCA Defense Electronic Products, Camden, N. J., has been named chairman of the administrative committee, Professional Group on Military Electronics, IRE.

R. R. Welsh, manager of the Camden office of RCA's West Coast Electronic Products Department, becomes committee secretary.

Speakman and Welsh succeed, respectively, Willis E. Cleaves of



## Transistorized FREQUENCY STANDARDS

- ★ Provide stable frequency source for missile requirements
- ★ Light weight—small size
- ★ Ruggedized for missile service

Compact, rugged, completely transistorized units . . . consisting of crystal controlled oscillator, six binary counter stages and tuned power output stage. Provides precision time and frequency reference. Proved out in current missile projects by all three armed services. Various frequencies and accuracies are available as required.

### TYPICAL SPECIFICATIONS

Type TFS-400-28D

Output Frequency . . .	400 CPS
Frequency Accuracy . . .	± 0.002%
Under the following conditions:	
temperature . . . . .	0 to +60°C
voltage variation . . . . .	25 to 30 VDC
vibration . . . . .	0 to 2000 CPS @ 10G
Output Power . . . . .	50 Milliwatts
Output Impedance . . . . .	80 Ohms
Input Voltage . . . . .	28 Volts DC
Input Power . . . . .	1 Watt
Heater Voltage . . . . .	28 Volts DC
Heater Power . . . . .	3 Watts DC
Size . . . . .	4 1/2" long x 1 3/4" diameter
Weight . . . . .	11 Ounces

Write for data sheet or information on your specific requirements.

*Designers for Industry*  
Incorporated 1935

4241 Fulton Parkway • Cleveland 9, O.

CIRCLE 270 READERS SERVICE CARD



Bendix Aviation, Towson, Md., and Carl R. Busch, Aeronautical Radio, Inc., Washington, D. C.

The professional group on military electronics reports periodically to the general IRE membership on conditions within the military electronics industry.

Both Speakman and Welsh were appointed for one-year terms.

## Microsonics, Inc., Hires Federico

NEW ADDITION to the engineering staff of Microsonics, Inc., Hingham, Mass., is Gennaro S. Federico. He will work on ultrasonic solid delay line design and development.

Federico was formerly a senior engineer on prototype research for the Corning Glass Works.



## Jordan Joins Gulton Industries

APPOINTMENT of J. Paul Jordan as assistant to the president of Gulton Industries, Inc., Metuchen, N. J., is announced. He joins the company in the capacity of a scientific coordinator, responsible for technical planning on government and company sponsored programs.

During his employment with General Electric Co., over the past 20 years, Jordan specialized in electronics and physics and served as

A NEW FASTENER... A NEW TYPE OF FASTENER

## DIE CAST ROUND-HEAD THUMB NUTS & SCREWS

with GRC's exclusive

**WIDE GRIP** feature



Head Diameters  
1/2" thru 1-1/8"

Thread Sizes  
#4 thru 7/16"

Mass produced in rust-proof zinc alloy at low cost, with eye appeal to help sell your product

... generous width tops have deep fluted edges for firm, comfortable grip. Closed or open end nuts. 1-pc. die cast or 2-pc. assembled screws with and without shoulders.

Other GRC Fasteners

Die Cast Zinc Alloy  
Wing Nuts, Cap Nuts,  
Wing Screws, Rivets

Molded Nylon  
Screws, Washers,  
Screw Insulators

Write NOW for prices and  
GRC's New Fastener Catalog.

See GRC at the  
METAL SHOW  
Booth 550



**GRIES**

World's Foremost  
Producer of Small  
Die Castings

**GRIES REPRODUCER CORP.**

151 Beechwood Ave., New Rochelle, N. Y. • NEw Rochelle 3-8600

CIRCLE 271 READERS SERVICE CARD

**ELECTRONIC  
ASSOCIATES**  
*Incorporated*

LONG BRANCH, NEW JERSEY • CAPITOL 9-1100

SUSTAINING EAI'S LEADERSHIP IN THE FIELD OF ANALOG COMPUTING

EAI's new series Application Bulletins and Simulation Bulletins provide dramatic evidence of the growing success of EAGE Analog Computing equipment in solving design engineering problems. See why two-thirds of all Analog Computers in use today bear EAI's PACE emblem. For 231R Analog Computer Bulletin No. AC-802 or for literature describing successful applications in your industry, write Dept. EL-10

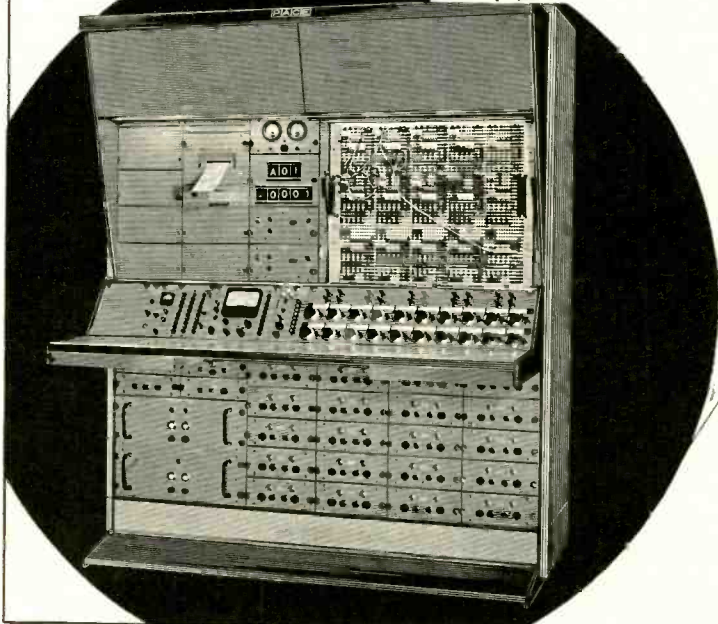



# STODDART

## COAXIAL ATTENUATORS AND TERMINATIONS

made with exclusive Stoddart Filmistors for highly accurate and stable resistive values from dc to 3000 mc.

2, 6 and 10-position  
**TURRET ATTENUATORS**  
with simple "PULL-TURN-PUSH"  
operation, small and rugged.

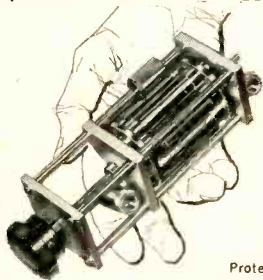

Protected under  
Stoddart Patents

## ATTENUATOR PADS



Available in any conceivable combination of male and female Type C and Type N connectors. Maximum length of 3" for any attenuation value.

### GENERAL SPECIFICATIONS

VSWR: Less than 1.2 to 3000 mc.  
Characteristic Impedance: 50 ohms.  
Attenuation Value: Any value from 0 db to 60 db including fractional values.  
Accuracy:  $\pm 0.5$  db; values above 50 db have rated accuracy of attenuation through 1000 mc only.  
Power Rating: 1.0 watt sine wave.

## COAXIAL TERMINATIONS



Small-stable-50 or 70 ohms

1/2-Watt: 50 ohms impedance, TNC or BNC connectors, dc to 1000 mc, VSWR less than 1.2.

1-Watt: 50 ohms impedance, dc to 3000 mc or dc to 7000 mc, Type N or Type C connectors, male or female; VSWR less than 1.2, 70 ohm, Type N, male or female terminations available.

Fast delivery on all items.  
Send for complete literature.

# STODDART

AIRCRAFT RADIO CO., INC.  
6644 Santa Monica Blvd., Hollywood 38, Calif.  
HOLLYWOOD 4-9292

CIRCLE 273 READERS SERVICE CARD

a consulting engineer; manager, Physical Electronics Section; section engineer and special assignments engineer.



## Garcelon Joins El-Tronics, Inc.

CONTINUING its management building program, made necessary by acquiring three companies in the past 18 months, El-Tronics, Inc. has appointed Fred H. Garcelon to the position of executive vice president.

Garcelon comes to El-Tronics after 9 years with CBS-Hytron where he was general sales manager of transistor operations.

Located in El-Tronics' executive offices in Philadelphia, his duties will embrace all company divisions: Alvac Computer Division, Los Angeles, Calif.; Warren Component Division, Warren, Pa.; and the Parkchester Machine Division, Mayfield, Pa.

## RCA Appoints New Managers

THE ENGINEERING department of the RCA Semiconductor and Materials Division has announced three appointments.

B.V. Dale, who was chief engineer of the former RCA Components Division, has been named manager, Modules Engineering.

F.E. Vinal, previously manager, RCA Materials Advanced Development Laboratory, was appointed manager, Materials Engineering.

D.H. Wansley, former manager,

## There's a *Bird* JEWEL BEARING to fit Your Need!

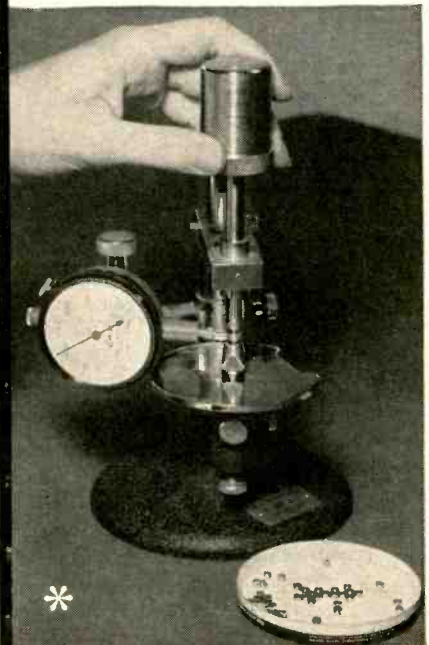

Bird can supply you with sapphire and borrosilicate glass precision jewel bearings in a wide range of standard types, sizes, and complete assemblies — or, custom-built to your specifications. Special mounting techniques provide exact tolerance jewel assemblies, mounted or set in bushings or screws, ready for assembling into your product without further inspection. Jewels mounted with resilient silicone rubber or spring cushions provide additional protection to shock and vibration.

Because of the exact tolerances, maintained through the most rigid quality-control methods, Bird jewels are used by the foremost manufacturers of electrical, aircraft, and timing instruments — and recorders.

Typical products include:

*Aircraft Instruments*  
*Weather Recorders*  
*Ammeters*  
*Voltmeters*  
*Wattmeters*  
*Compasses*  
*Dial Gages*  
*Timers*  
*Test & Recording Instruments*  
*Marine Instruments*

\*Illustrated — Concentricity check of mounted ring jewels — one of the inspection processes in Bird's quality control program.

Our engineering staff is at your service for all small bearing problems. A request on your letterhead for Bulletin 100-6 will receive our prompt attention.

*Richard H. Bird & CO., INC.*

1 SPRUCE ST., WALTHAM 54, MASS.

SAPPHIRE & GLASS JEWELS  
PRECISION GLASS GRINDING  
JEWEL MOUNTING & ASSEMBLY

CIRCLE 274 READERS SERVICE CARD



# It's a MUST!

If you sell to the \$7 billion electronics industry, you'll want a free copy of *electronics MARKET MEDIA FILE*.

What are the prospects for:

MILITARY ELECTRONICS?  
REPLACEMENT ELECTRONICS?  
HOME ELECTRONICS?  
INDUSTRIAL ELECTRONICS?

Who are the

BUYING INFLUENCES?

Why are more than 9,000 men who make the buying decisions for 30 giant companies subscribers to *electronics*? . . . and what does that mean to your advertising dollar?

The 1958 *electronics MARKET MEDIA FILE* gives the answers in 12 fact-packed pages that you will refer to time and again throughout the year.

Send for your free copy today.

ABC **electronics** ABP  
A MCGRAW-HILL PUBLICATION, 330 W. 42nd St., New York 36, N. Y.

For Those Who Demand Service!

# COSMIC

ELECTROLYTIC  
& PAPER  
TUBULAR

"35 YEARS OF PROVEN  
DEPENDABILITY"

## Condensers

COSMIC CONDENSER CO.  
853 Whittier St., Bronx, N. Y.  
PHONE  
LUDlow 9-3360

CIRCLE 276 READERS SERVICE CARD

## Your Inquiries to Advertisers Will Have Special Value . . .

—for you—the advertiser—and the publisher, if you mention this publication. Advertisers value highly this evidence of the publication you read. Satisfied advertisers enable the publisher to secure more advertisers and—more advertisers mean more information on more products or better service—more value—to YOU.

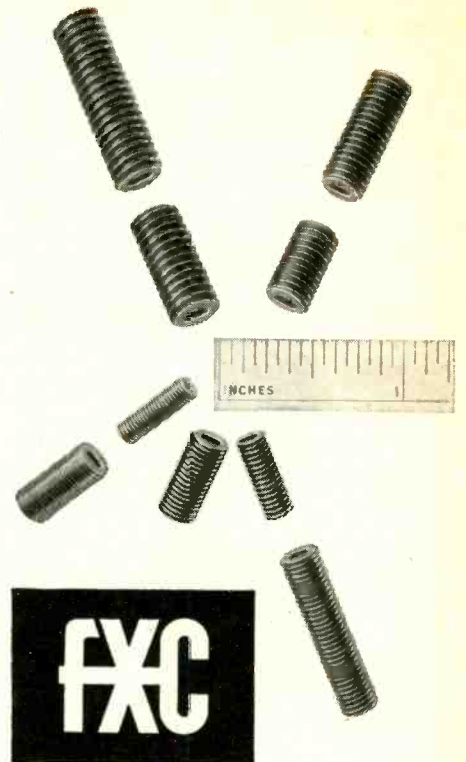

presents a  
comprehensive line of

# threaded ferrite slugs

for  
permeability tuning

Ferrites are the finest material for tuning slugs wherever a high-Q, high-permeability core is required and space is at a premium. These Ferroxcube tuning slugs have been specifically developed for the permeability tuning of inductors, filters and transformers in the 1 kc to 4 Mc frequency range. They come in a large variety of sizes and threads, and have been found particularly useful for final inductance adjustments on filters with ferrite pot cores. The screwdriver slot in the slugs runs all the way through the core for simpler coil assembly and easy adjustability at either end. All Ferroxcube threaded slugs are furnished complete with self-threading coil forms of phenolic-impregnated tubing.

For complete data, as well as information on the availability of specific types and sizes, write to:

**FERROXCUBE CORP. OF AMERICA**  
60G East Bridge Street, Saugerties, New York  
CIRCLE 278 READERS SERVICE CARD

Make a **GM** PORTABLE D'ARSONVAL

# GALVANOMETER

*the Heart  
of Your  
Instrument*

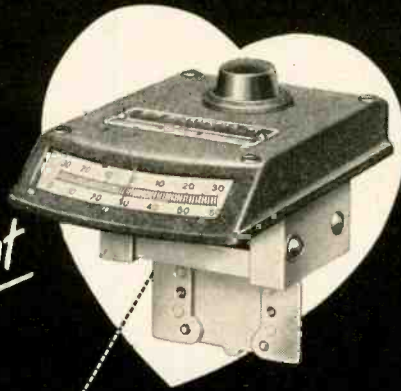

FOR MEASURING LIGHT reflectance and color, the Photovolt Corporation of New York uses a Model 600 G-M Galvanometer for its popular Reflection Meter (left). Whatever your own particular instrument field, you can achieve this same self-contained portability, ruggedness and high sensitivity with G-M Galvanometers. Complete catalog on request.

**GM LABORATORIES INC.**

4336 NORTH KNOX AVE., CHICAGO 41

CIRCLE 204 READERS SERVICE CARD

## Announcing...

### *Modine* transistor coolers



**Standardized for immediate shipment  
in module and strip form**

These compact, lightweight aluminum units prevent thermal runaway in electronic circuits... hold transistor junction temperature safely within design limits. Heat is conducted through the base mounting plate and is dissipated by cooling air passing through the fins.

Modine Bulletin ID-158 contains performance data and application information on these efficient coolers. For full details on standard and custom-built models, write Electronic Cooling Dept., Modine Manufacturing Co., 1602 DeKoven Avenue, Racine, Wisconsin.



T-1373

Engineering Department, becomes manager, Semiconductor Engineering.

Dale and Wamsley will have their headquarters at the Somerville, N.J., plant. Vinal will remain at the RCA facility in Needham Heights, Mass.

## News of Reps

GPL closed-circuit tv equipment is now being handled in Colorado, Utah and Wyoming by the Paul R. Posakony Co.

DeJur-Amsco Corp. has appointed the following sales reps:

Logan and Stone Co. to cover the northern California territory; Jerry Deere Associates for the states of Utah, Colorado, New Mexico and Arizona.

Gene French Co. is named to carry the electronic instrument line of Belleville-Hexam Corp., Los Gatos, Calif., in New Mexico, Colorado, Utah and parts of southern Nevada and northwest Texas.

Appointment of the Merrill Franklin Co. as sales reps in Minnesota, North Dakota, South Dakota, and the western part of Wisconsin, is announced by Deltime, Inc., Mamaroneck, N. Y.

Electro Tec Corp., South Hackensack, N. J., has two new reps:

Northport Engineering, Inc., will handle sales in Minnesota, North Dakota, South Dakota, Wisconsin, counties of Bayfield, Sawyer, Rusk, Chippewa, Eau Claire, Trempealeau and La Crosse and all west of these.

The Hilker Co. will cover North Carolina, South Carolina, Georgia, Kentucky, Tennessee, Alabama and Mississippi.

Computer Engineering Associates, Inc., Pasadena, Calif., appoints Landfear Enterprises as reps for New York State, south of Kingston, and for northern New Jersey.

Seezak components of U. M. & F. Mfg. Co., North Hollywood, Calif., will be sold in southern California and Arizona by Pacific Electro-Sales, Inc.



# Reliable Micro-Miniature Rotary Relay Design

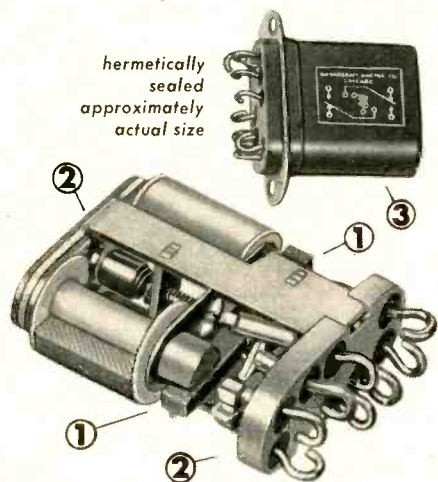

hermetically  
sealed  
approximately  
actual size

1. Balanced rotary element with radial thrust bearings at both ends of shaft, operated by the balanced pull of twin coils — minimizes effect of gravity, shock and vibration, permitting reliable operation where other relays fail.
2. Rugged frame and header assembly of bridge type construction—minimizes distortion and permits reliable operation under vibration, shock and temperature extremes.
3. Permanently adjusted and hermetically sealed under ideal conditions—safe from contamination.

Many other refinements advance reliability to meet critical demands.

Available to meet applicable military specifications.

Literature mailed promptly on request. Inquiries for relays to meet specified conditions given special attention.

## MAGNECRAFT Electric Company

3350 B W. Grand, Chicago 51, Ill.

CIRCLE 279 READERS SERVICE CARD

ELECTRONICS engineering issue — October 10, 1958

## NEW BOOKS

### Network Synthesis

By D. F. TUTTLE, JR.

John Wiley and Sons Inc., New York. 1958, 1,175 p., \$23.50.

The most significant single fact about this huge volume on network synthesis is the care taken by the author in providing an impressive treatment of concepts relating to the synthesis of two-terminal networks. His able and straightforward discussions of many topics are neatly integrated into a provocative account of the evolution of modern network theory.

Although this initial volume stresses only the two-terminal network, many fundamental ideas are presented germane to the synthesis of four-terminal networks which the author plans to develop as a second volume later on.

**Background**—The book is admirably suited for the designer of low-frequency electrical networks of the linear passive bilateral variety. Before the middle twenties, the designer relied solely upon the laws of Kirchhoff to yield important information on the behavior of linear networks. These laws, first published in 1845, provided a basic mathematical approach to the problem of network analysis and led to the concept of complex impedance. In the middle twenties, synthesis ideas began to emerge through the early efforts of G. A. Campbell, R. M. Foster, and W. Cauer. The added stimulus came from Otto Brune who in 1930 supplied the concept of physical realizability and sparked the development of network synthesis as a direct approach to the design of networks to meet prescribed conditions.

Basically, the book is intended as reference material for a first-year graduate course. In a nicely balanced arrangement, the 15 chapters fall into three general areas of consideration; analysis and mathematical formulations, introducing the reader to the complex-frequency variable and positive-real functions; properties of driving-point impedances and procedures for synthesizing R-L, L-C, R-C and RLC structures; the approximation problem with emphasis on the potential



## Amperex®

### 866AX

MERCURY VAPOR RECTIFIER

with  
these

Amperex

## EXTRAS:

- threaded removable plate cap
- improved heat dissipation
- compact bulb size
- no loose base problems
- direct interchangeability with the 866

MAXIMUM OUTPUTS IN TYPICAL CIRCUITS			
	AC Input Volts RMS	DC Output Volts to Filter	Max. DC Load Current Amps.
Single-Phase Full Wave (2 Tubes)	3535*	3180	.5
Single-Phase Full Wave Bridge (4 Tubes)	7070†	6360	.5
Three-Phase Half Wave (3 Tubes)	4710‡	4780	.75
Three-Phase Double Y-Parallel (6 Tubes)	4080‡	4780	1.5
Three-Phase Full Wave (6 Tubes)	4080‡	9570	.75

\*per tube †total ‡per leg

Other Amperex replacement favorites:

- 5894 High-sensitivity VHF/UHF twin tetode; 40 W anode dissipation
- 6360 High-sensitivity VHF/UHF twin tetode; 14 W anode dissipation
- 6939 Miniature UHF twin tetode; 5 W anode dissipation
- 6146 High-sensitivity beam power tube



ask your distributor  
about extra-quality  
**Amperex**  
replacement tubes

**Amperex ELECTRONIC CORP.**  
230 Duffy Avenue, Hicksville, L. I., N. Y.

CIRCLE 280 READERS SERVICE CARD



# PRECISION DEFLECTION WITH COSSOR YOKES



Slip Ring Yoke

Two-Axis Fixed Yoke

## Component Development Engineering at its BEST!

- ADVANCED ELECTRICAL DESIGN
- PRECISION MECHANICAL DESIGN
- ACCURATE PRODUCTION METHODS

Custom Built to the most  
Exacting Specifications  
by Cossor Engineers

In Mumetal Cores for Optimum Geometry  
In Ferrite Cores for Speed and Sensitivity  
In Non-magnetic Cores for Perfection of Response

Any of Cossor's Three Core Types can be made in single or double axis with single or push-pull windings, and encapsulated for fixed or slip ring (rotating) use.

Normal characteristics of yokes for 1-1/2 in. neck tubes are:

**Positional accuracy** - the spot position will conform to the yoke current co-ordinates within 0.25% of tube diameter. For deflection angles less than 25° better accuracy can easily be achieved.

**Memory** - 0.5% max. without over-swing;  
0.1% or less with controlled over-swing.

Complete encapsulation in epoxy (stycast) or silicone resins is standard for all Cossor deflection yokes, and is done with special moulding tools ensuring accurate alignment of the yoke axis. When slip rings are added, solid silver rings are mounted in encapsulating resin. The finished slip ring yoke is precision turned to centre bore, and can include bearing mounting surfaces with dimensional tolerances approaching those associated with high quality metal parts.

Settling Time (Micro sec.) =  $\frac{120 \sqrt{\text{Inductance in Henries}}}{\text{Accelerator Voltage - kV}}$

Sensitivity degrees/ milliamperes =  $\frac{0.095 \sqrt{\text{Inductance - millihenries}}}{\text{Accelerator Voltage - kV}}$



COMPONENTS DIVISION

# COSSOR CANADA LIMITED

301 Windsor St., Halifax, N. S.  
8230 Mayrand St., Montreal, Que.  
648A Yonge St., Toronto, Ont.  
Corporation House, 160 Laurier West, Ottawa, Ont.

CIRCLE 281 READERS SERVICE CARD

analogy. Each chapter is thoroughly documented and meticulously detailed with a wealth of illustrative examples and problems.

Range of topics—The first chapter is an engaging introduction to basic network philosophies. It is followed by a chapter on analysis techniques involving the loop and node methods, concepts of duality and circuit theorems. In the third chapter, mathematical representations of the independent variable are described which lead to a generalized approach involving frequency as a complex variable. The rest of the chapter is devoted to a practical treatment of function theory. The next chapter on energy consideration utilizes the complex frequency variable to derive broad properties of two-terminal networks and develops the concept of positive-real functions.

Since driving-point immittance functions of passive structures are necessarily rational and positive-real, the fifth chapter concentrates on necessary properties for physical reality. In the sixth chapter, the synthesis of L-C functions is developed from the separation property of poles and zeros along the imaginary axis of the complex frequency plane. By means of partial fraction and continued fraction expansions, canonic networks are evaluated. The technique is extended to R-C and R-L functions in the seventh chapter.

Three extensive chapters follow on additional properties of RLC functions and on a general synthesis procedure which relies upon the removal of reactance, susceptance, resistance and conductance along the real frequency axis of the complex frequency plane as preliminary steps in achieving a final synthesis. These steps are accomplished by a procedure which assures that the reduced function remains positive-real throughout the process. A special point is made of the fact that the real part and the imaginary part of a reduced driving-point immittance are interrelated. Various methods are then presented which yield a final synthesis. These are based upon contributions by Brune and Darlington involving perfectly coupled coils and contributions by Bott and Duffin which lead to a

## You Get Things Done With Boardmaster Visual Control

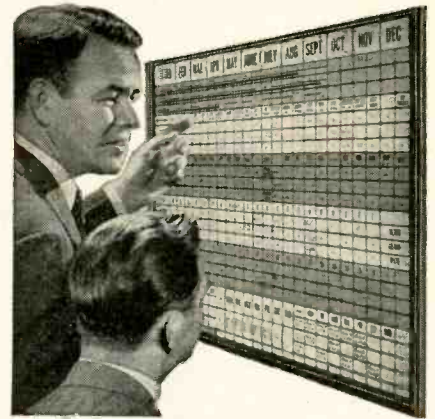

- ☆ Gives Graphic Picture of Your Operations—Spotlighted by Color
- ☆ Facts at a glance — Saves Time, Saves Money, Prevents Errors
- ☆ Simple to operate — Type or Write on Cards, Snap in Grooves
- ☆ Ideal for Production, Traffic, Inventory, Scheduling, Sales, Etc.
- ☆ Made of Metal. Compact and Attractive. Over 300,000 in Use

Complete price \$4950 including cards

**FREE** 24-PAGE BOOKLET NO. C-50  
Without Obligation

Write for Your Copy Today

**GRAPHIC SYSTEMS**

55 West 42nd Street • New York 36, N. Y.  
CIRCLE 282 READERS SERVICE CARD

# CABLE CLIPS

of all Nylon  
for severe conditions

of Ethyl Cellulose  
for maximum economy



# WECKESSER



molded  
Black Nylon  
**SCREWS  
and NUTS**

- ★ Acid resistant
- ★ Need no insulation
- ★ Can't rust
- ★ Can't corrode

**WECKESSER COMPANY**  
5701 Northwest Highway • Chicago 46, Ill.

CIRCLE 283 READERS SERVICE CARD



realization without mutual inductance but requiring a larger number of elements.

Certain esoteric considerations relating to applications and network construction are dealt with in chapters 11 and 12.

**Approximation Techniques**—The remaining chapters are concerned with approximation techniques for evolving realizable functions whose frequency behaviors are acceptably close to requirements. The author explores a variety of techniques, such as, trial and error attacks, method of least squares, the Taylor approximation, Padé procedure, Chebyshev polynomials, the use of weighting functions and practical difficulties which may arise in selecting an optimum approximation.

The analogy between complex-variable theory and two-dimensional potential theory is fully exploited from basic considerations of potential functions. Usable results are derived and applied to approximating a constant. Further extensions will be covered in Volume II.

The last chapter presents a review of developed principles and applies them to a few unifying examples. It is followed by three appendices. The last contains a bibliography which is very much up to date.

Throughout the book, the author makes a very strong attempt to hold the reader's attention by interjecting challenging remarks and by providing concise summaries, conclusions, discussions, reviews, recapitulations, and retrospects at strategic locations. The treatment is rather lucid and revealing. However, there is no pretense of completeness even though the book is quite large. As a whole, it will prove to be an excellent addition to the literature and should enjoy wide acceptance. —ANTHONY B. GIORDANO, *Polytechnic Institute of Brooklyn, Brooklyn, N. Y.*

## THUMBNAIL REVIEWS

**Vorschaltgeraete und Schaltungen fur Leuchtstofflampen.** By C. Sturm; Brown Boveri & Cie AG., Mannheim, Germany, 1957, 372 p. This worthy pocket-size handbook covers almost every aspect of fluorescent lamp characteristics and applications

## ATTRACT AND HOLD TECHNICAL PERSONNEL

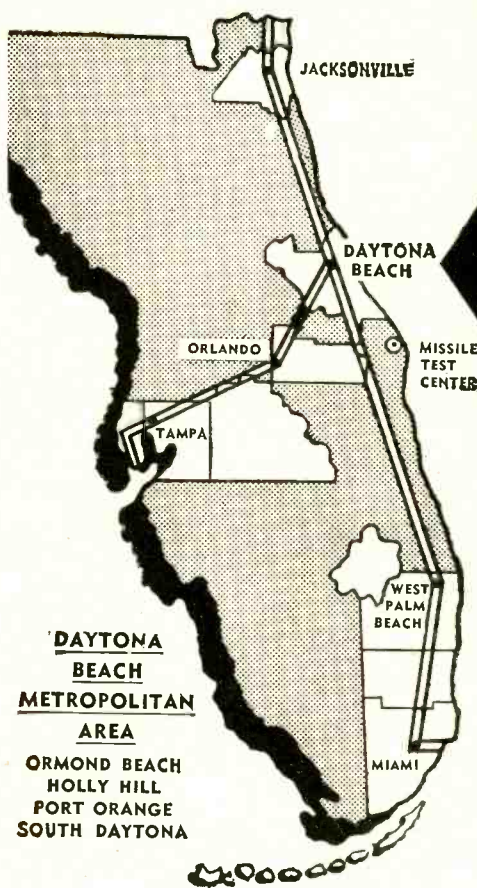

**STRATEGIC  
LOCATION FOR  
GROWTH INDUSTRIES**  
**DAYTONA BEACH  
FLORIDA**  
**Metropolitan Area  
Industrial Sites**

Daytona Beach, the east-to-west terminal on the north-to-south route of the projected Federal Limited Access Freeway System, gives industry a plus for the future.

Write for new 90 page Industrial Brochure

**R. H. MILES, MGR.  
INDUSTRIAL DEPARTMENT  
CHAMBER OF COMMERCE  
DAYTONA BEACH, FLORIDA**

CIRCLE 284 READERS SERVICE CARD

## IF THIS IS YOUR PROBLEM

If you need effective, highly readable, smartly illustrated company literature (booklets, pamphlets, manuals) to display your products, inform the public of your operations, attract key personnel to your plant, train employees, and perform any of the other communicative functions that are vital to your business . . .

## THIS IS YOUR ANSWER

The McGraw-Hill TECHNICAL WRITING SERVICE has a staff of more than 150 highly-trained writers, editors, and illustration specialists whose job it is to create technical and general literature for industry. We write, illustrate, design, and print Equipment Manuals, Product Bulletins, Handbooks, Company Histories, Annual Reports, and other specialized material. Save money and time. Let our staff be your staff for Technical and Business publications.

*This service is available through ad agencies.*

Write • Phone

**TECHNICAL WRITING SERVICE**  
McGraw-Hill Book Co., Inc.  
330 W. 42nd St., N. Y. 36, N. Y.  
LOngacre 4-3000

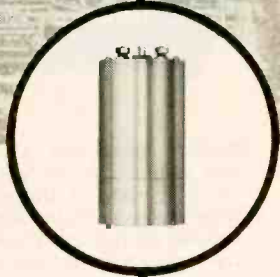
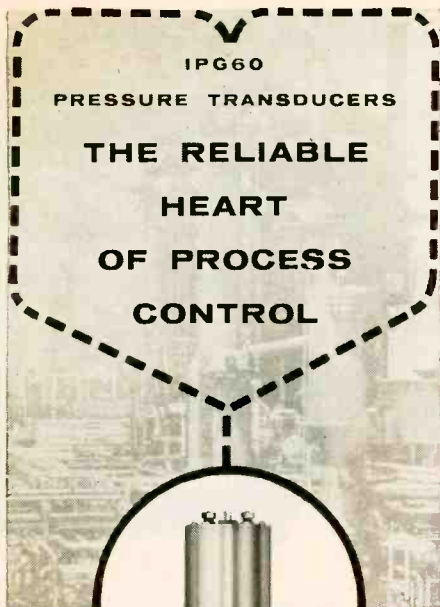

Model IPG60 pressure transducers are specified for the Beckman 112 Data Processing Computer.

Model IPG60 pressure transducers are suitable for a variety of applications.

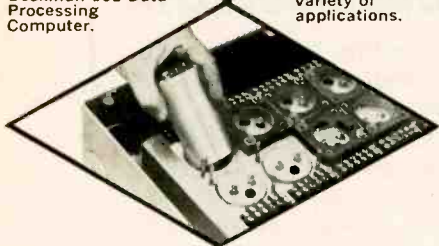

The evolution of industry toward automation has created a demand for precision data handling systems such as the Beckman 112 Data Processing Computer. Statham Model IPG60 pressure transducers are specified in this system, providing basic information signals which are accurate within  $\pm 1/4\%$ . Complete data on the Model IPG60, or information on other Statham instruments, are available upon request.

RANGE: 0 to +15 psig.  
 PRESSURE MEDIA: Non-corrosive fluids  
 OUTPUT: Approximately 35 mv. full scale at 14 V. excitation  
 NON-LINEARITY & HYSTERESIS: Not more than  $\pm 0.25\%$  of full scale

*Statham*

STATHAM INSTRUMENTS, INC. of Puerto Rico  
 254 Carpenter Rd., Hato Rey, Puerto Rico  
 Cable Address: STATRICO  
 A SUBSIDIARY OF STATHAM INSTRUMENTS, INC.  
 12401 W. Olympic Blvd., Los Angeles, California  
 CIRCLE 285 READERS SERVICE CARD

including starting arrangements, stabilization, brightness control, economic considerations, fading of dyed materials from ultraviolet radiation and health hazards from fluorescent sources. References are included to Swiss, German and American trade and technical literature.

Oral Communication of Technical Information. By R. S. Casey, Reinhold Pub. Corp., New York, 1958, 199 p. \$4.50. This handbook on effective speaking for technical men covers such situations as presiding at meetings, giving technical legal testimony and talking science to laymen. Organization of material, composition, delivery and use of mechanical aids such as recordings and slides are treated.

Proceedings of the Third National Conference on Tube Techniques. New York, 1958, 128 p., \$5.00. Collection of 29 papers on tube types, parts, materials, production techniques and test methods presented at conference sponsored by Advisory Group on Tube Techniques of the Dept. of Defense.

V.H.F. Radio Manual. By P. R. Keller, George Newnes, Ltd., Tower House, Southampton St., London, W.C. 2, England, 1957, 216 p., 30s. Theory, practice and operation of commercial and amateur vhf two-way radio systems, fm broadcasting transmitters and receivers, and tv tuners operating in the 30 to 450-mc range. Information available in basic radio textbooks is not repeated except where it is necessary to maintain the self-contained nature of the book. Physical significance of mathematical expressions is explained by diagrams or graphs.

Television in Science and Industry. By V. K. Zworykin, E. G. Ramberg and L. E. Flory, John Wiley & Sons, Inc., New York, 1958, 300 p., \$10.00. This book is devoted mainly to achievements in the applications of closed-circuit television systems. Individual chapters cover the history of the medium and the equipment developed for it.

Methods of Testing Thermocouples and Thermocouple Materials—NBS Circular 590. By Wm. Roeser and S. T. Lonberger, Superintendent of Documents, U.S. Printing Office, Washington 25, D.C., 1958, 21 p., \$2.00. Calibration of platinum vs platinum-rhodium, copper-constantan, Chromel-Alumel and iron-constantan thermocouples is covered along with guidance on selection of best test method for particular circumstances. Accuracies obtained in calibrating various thermocouples by different methods, along with the uncertainty in the interpolated values by various methods, are presented in a table.

## announcing NEY MOLDED CONTACT ASSEMBLIES

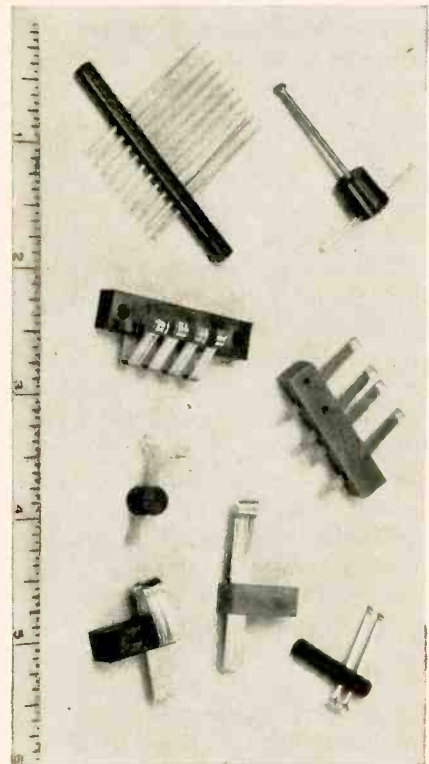

Impressive cost savings and greater reliability are inherent in the use of the new Ney molded contact assemblies. For use with printed commutators, potentiometer windings, slip ring assemblies and printed rotary switches, these assemblies are available in a standard line now being manufactured by Ney, or can be designed to customer specifications.

Seven prime advantages are (1) a complete single or multiple brush assembly ready to use, (2) no welding or soldering, (3) reduction of adjustment during assembly into unit, (4) insured uniformity of desired gram pressure, (5) reduced inspection costs, (6) time tested Ney alloys for reliability, (7) will withstand extremes in operating environments.

SEND FOR LITERATURE



**The J. M. Ney Company**

P.O. Box 990, Dept. E, Hartford 1, Conn.  
 CIRCLE 286 READERS SERVICE CARD



# electronics

## READER SERVICE CARDS

... have increased the flow of product and service information between buyers and sellers.

... have helped increase manufacturers' sales.

Reader Service Cards have been provided to get quick and easy information on products.

Avail yourself of this Service to get all the information you need.

Manufacturers are cooperating wholeheartedly with the Service to supply information promptly.



**WEINSCHEL**  
*offers highest stability!*



### MODULATED RF SOURCES

- Output independent of load.
- Excellent amplitude stability.
- Excellent frequency stability.
- Highly stable internal modulation.



Model No.	Frequency Range MCS	Max. Average Power Output 100% Sq. Wave Mod.
MS-1	50-250	40 Milliwatts
MS-2	250-920	100 Milliwatts
MS-3	900-2000	50 Milliwatts

**Weinschel Engineering**  
KENSINGTON, MARYLAND

CIRCLE 296 READERS SERVICE CARD

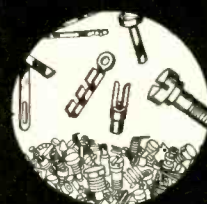

## Precious Metals Plated

**ON ANY PART —  
TO ALL SPECS**

**GOLD, SILVER, PLATINUM, RHODIUM, PALLADIUM...** the precious metals generally cost the same, no matter where you buy them. But you *do* get more for your money when you buy precious metal plating from Harper-Leader. You get the full benefits of the engineering, metallurgical, and other highly specialized services of Harper-Leader's technical staff.

*Send for Bulletin E-58*

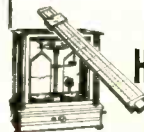

**HARPER-LEADER, INC.**

Waterbury 20, Conn.

CIRCLE 297 READERS SERVICE CARD

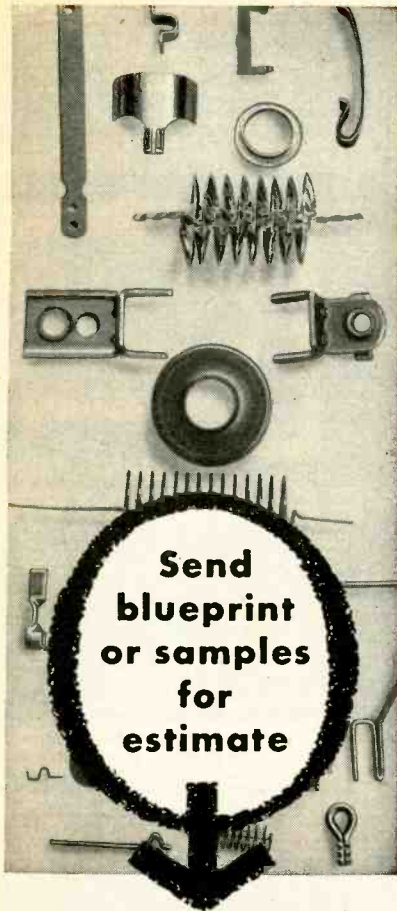

Send  
blueprint  
or samples  
for  
estimate

# WIRE FORMS and METAL STAMPINGS

We'll prove that our high speed production means lower unit costs for you!

You'll save two ways — (1) the initial low unit cost made possible by high speed machines; (2) precision and quality control guarantees accurate parts and performance.

**STRAIGHTENING AND CUTTING**  
Perfect straight lengths to 12 feet.  
.0015 to .125 diameter.

**WIRE FORMS**  
.0015 to .125 diameter.

**SMALL METAL STAMPINGS**  
.0025 to .035 thickness.  
.062 to 3 inches wide.

*Specializing in production of parts for electronic, cathode ray tubes and transistors.*

Write for illustrated folder.  
**ART WIRE AND STAMPING  
COMPANY**

18 Boyden Place, Newark 2, New Jersey  
CIRCLE 287 READERS SERVICE CARD

## COMMENT

### Radar Power

... "Radar Power Nomograph" (July 4, p 72) ... gives relationships for computing the power per square centimeter close to radar antennas. I wish to point out that these relationships are valid only in the Fraunhofer region (far field). Accordingly, for radars in current use the distances from the antenna in the nomograph would lead to incorrect results since the Fresnel zone (near field) can be considered to end at a distance from the aperture equal to the square of the diameter of the reflector divided by twice the wavelength.

Thus the end of the near field for a 3-cm set with a 3-ft antenna would be 45 ft, and a 10-ft antenna, 511 ft; for a 10-cm set with an 8-ft antenna, 100 ft, and a 32-ft antenna, 1,600 ft; for a 30-cm set with a 50-ft antenna, 454 ft.

From the above we see that the nomograph cannot be used for most practical ... radar installations. In the near field, a good approximation is to divide the average power by the cross-sectional area of the antenna in centimeters, since there is no beam-spreading in the Fresnel zone.

JOSEPH H. VOGELMAN  
ROME AIR DEVELOPMENT CENTER  
ROME, N. Y.

... I have measured greater field strengths at the fundamental frequency in front of a hangar when the main beam was directed between two hangars than I did in the center of the beam at a distance of 2,500 ft from the antenna. This effect was caused by multiple reflections from the hangar wall ...

HARRY R. MEAILL  
GENERAL ELECTRIC CO.  
SCHENECTADY, N. Y.

Author Allen agreed that Reader Vogelmann's observation was correct, adding:

However, the intended use of the nomograph was as a quick method of determining density levels by nontechnical persons such as safety or laboratory supervisors. Appropriate to this purpose, the nomograph gives conservative an-

## MEASUREMENTS' New STANDARD PULSE GENERATOR



MODEL 179

The Model 179 is uniquely suited for production and laboratory work where pulses of known repetition rate and width are required. It is extensively used in TV, radar, computer and nuclear fields.

- Wide, calibrated frequency range — 60 cps to 100 Kc
- Continuously variable calibrated pulse width
- Triggered and free-running operation
- High-amplitude positive and negative pulses ... +200 v to -150 v

Laboratory Standards  WRITE FOR BULLETIN  
**MEASUREMENTS**  
A McGraw-Edison Division  
BOONTON, NEW JERSEY  
CIRCLE 288 READERS SERVICE CARD

## Count on SYSTRON RDB COUNTER with in-line readout



MODEL 1043

- ★ RDB Channels 1-18
- ★ RPM

### MEASURES

- ★ Mass Flow Rate
- ★ Frequencies
- ★ 1 to 100,000 Periods

FREQUENCY RANGE ... 5 CPS to 100 KC  
ACCURACY ... ± 1 count, ± 1 part in 10<sup>5</sup>  
READOUT ... Nixie, to 99,999  
SENSITIVITY ... 5 Millivolts rms  
TIME BASES:

RDB ... 1/5 second  
CPS ... 1 & 10 seconds  
RATE ... Selectable 0.1ms increments  
to 10 secs.

PERIOD 1 to 100,000 cycles of input  
PRICE ... \$1,550

F.O.B. Concord



950 GALINDO STREET • CONCORD, CALIFORNIA  
REPRESENTATIVES IN PRINCIPAL CITIES

CIRCLE 289 READERS SERVICE CARD



## Raytheon Missile Projects

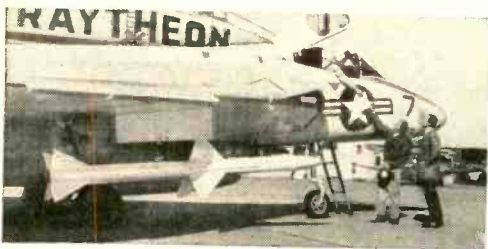

**SPARROW III**—the Navy's tenacious, lightning-fast, air-to-air missile—is intended for extensive use by Navy fighter aircraft in fleet air defense. Sparrow III is a Raytheon prime contract.

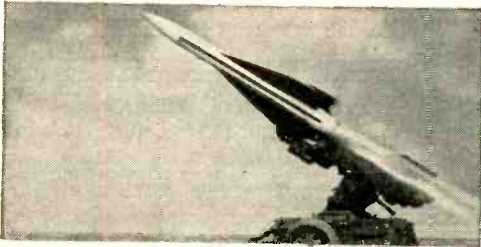

**HAWK**—the Army's defense against low-altitude attackers—carries out its destruction in the blind zone of conventional radars. Hawk development and production is under Raytheon prime contract.



**TARTAR**—A substantial contract for vital electronic controls for this Navy destroyer-launched missile is held by Raytheon. This equipment—a tracking radar and associated units—enables it to "lock on", cling to target's path, despite evasive tactics.



**ADVANCED PROJECTS** in aeronautical structures as well as missile guidance and control are now underway in Raytheon laboratories. New facilities are continually being added for this work.



**PRELIMINARY NEW DESIGNS** of tomorrow's missiles will result from the advanced work being done by today's missile engineers. Raytheon plays an important role in this area.

Raytheon diversification offers

# JOB STABILITY FOR CREATIVE MISSILEMEN

Here is an opportunity to free yourself of worry about a job that's here today, gone tomorrow.

**Diversified assignments**—only possible in a company with Raytheon's wide range of missile activities—means security not found in one- or two-project companies. You apply your creative energies to the many projects you work on, and they in turn are your "insurance" against falling into a rut.

**Individual recognition** comes quickly from Raytheon's young, engineer-management—men who are keenly aware of the engineer's needs and contributions to missile progress.

**Dynamic Raytheon growth**—the fruit of this management's progressive policies—is best illustrated by the fact that Raytheon is already the only electronics company with two prime missile contracts—Navy Sparrow III and Army Hawk.

**The next step is up to you.** Why not get frank answers and helpful information on the type of job suited to your background and talents, its location, salary and other important details. Write, wire or telephone collect: The number is CRestview 4-7100 in Bedford, Massachusetts. Please ask for J. Clive Enos.

### **RAYTHEON OPPORTUNITIES NOW OPEN IN:**

**WEAPONS SYSTEM ANALYSIS • CONTROL SYSTEMS  
• PACKAGING • MICROWAVE • RADAR • SPECIFICATIONS • MISSILE AERODYNAMICS • WIND TUNNEL TESTING • AERODYNAMIC HEATING • ROCKET ENGINEERING • VIBRATION MEASUREMENT and DATA REDUCTION**

### **RAYTHEON MANUFACTURING COMPANY**

**Missile Systems Division, Bedford, Mass.**



**DIRECT READING OF  
FM DEVIATION . . .  
25 to 500 mc. At Low Cost!**



**LAMPKIN 205-A  
FM MODULATION METER**

- Indicates instantaneous peak modulation, plus or minus, on 0-12.5 or 0-25.0 KC scales.
- Accuracy 10% of full scale.
- Tunable 25 to 500 MC- in one band, with fast and slow controls.
- Sensitivity 20 millivolts or better throughout range.
- Speaker for aural monitoring, oscilloscope output for visual monitoring.
- Meets FCC specs for mobile-radio maintenance.
- Size only 7" x 12" x 7/4". Weight 13 lbs.
- Price \$240.00 net. Satisfaction guaranteed or money refunded.

To measure transmitter center frequencies, from 0.1 to 175 MC (to 3,000 MC by checking multipliers), with an accuracy better than 0.0025%, use the LAMPKIN 105-B MICROMETER FREQUENCY METER.

Write today for technical data on both instruments.

**LAMPKIN LABORATORIES, INC.**  
Instruments Div., Bradenton, Florida  
CIRCLE 290 READERS SERVICE CARD



**DANO**



puts  
**PERFORMANCE  
into every coil!**



Regardless of type or quantity, every coil is quality manufactured to your exact specifications.

- Encapsulated
- Paper Interleave
- Bobbin
- Cotton Interweave
- Form Wound
- Vacuum Impregnated
- High Temperature Application

Also, Transformers Made To Order

WRITE TODAY! Your inquiries are invited. Dano will analyze your coil problems. No obligation.

**THE DANO ELECTRIC CO.**  
MAIN ST., WINSTED, CONN.

CIRCLE 291 READERS SERVICE CARD

swers insofar as safety is concerned over a range from the antenna to about  $1\frac{1}{2}$  times the extension of the near field as determined from  $D^2/2\lambda$ .

The nomograph was developed for use at Air Arm division (of Westinghouse Electric) where we are primarily concerned with airborne X-band antennas. If it is applied to ground or shipboard radars having very high power or very large antennas, or both, the indicated densities in the near field may be so conservatively estimated that shielding for personnel would appear impractical. In such circumstances, use of the near-field equation would be more suitable.

In reply to Reader Meahl's comment, Author Allen wrote:

... We have experienced phenomena similar to that which you described in making measurements in the vicinity of radar antennas. My original manuscript had several cautions in it concerning sidelobes, noncircular main beams, reflections and multiple installations, but these were (subsequently) edited out of the article . . .

J. E. ALLEN

WESTINGHOUSE ELECTRIC  
BALTIMORE, MD.

**Intermetallics**

In regard to our article on indium antimonide detectors ("New Intermetallics Offer Wide Infrared Response," July 4, p 48) . . . because of uncorrected editorial changes, the article as published contains typographical errors, redundancies, meaningless statements and incorrect organization . . .

We feel that you should remedy the situation insofar as it now can be remedied by publishing (these facts): a) The article was published without benefit of the authors' corrections. b) Reprints of the original manuscript may be obtained (from) Chicago Midway Laboratories . . . c) The authors of the article are:

W. S. STARKEY  
L. H. DEVAUX

CHICAGO MIDWAY LABORATORIES  
CHICAGO, ILL.

**PROFESSIONAL  
SERVICES**

**CROSBY LABORATORIES, INC.**  
*Murray G. Crosby & Staff*

Radio - Electronics  
Research Development & Manufacturing  
Communications, FM & TV  
299 Robbins Lane, Syosset, New York  
WE11s 1-3191

**ELECTRONIC RESEARCH  
ASSOCIATES, INC.**

"TRANSISTORIZE" YOUR PRODUCT!  
Complete Service in consulting, research, development, and production on Transistor circuitry, products and instrumentation.  
67 Factory Place Cedar Grove, N. J.  
CEnter 9-3000

**ERCO RADIO  
LABORATORIES, INC.**

*Radio Communications Equipment*  
Engineering - Design - Development - Production  
Our 30th Year in Air to Ground  
Communication and Radio Beacons  
Garden City • Long Island • New York

**MEASUREMENTS**

*Research & Manufacturing Engineers*

Harry W. Houck  
Specialist in the Design and  
Development of Electronic Test Instruments  
Hoonton, New Jersey

**ALBERT PREISMAN**

*Consulting Engineer*  
Television, Pulse Techniques, Video  
Amplifiers, Patent technical consultation.  
616 St. Andrews Lane, Silver Spring, Maryland

**TELECHROME MFG. CORP.**

*Electronic Design Specialists*  
COLOR TELEVISION EQUIPMENT  
Flying Spot Scanners, Color Synthesizers, Keyers,  
Monitors, Oscilloscopes and Related Apparatus  
Telemetering for Guided Missiles.  
J. R. Popkin-Churman, Pres. & Dir. of Eng.  
28 Ranick Dr. Amityville, L. I., N. Y.

**YARDNEY LABORATORIES, Inc.**

*Research-Design-Development*  
Electro-Chemical Generators of Energy  
40-48 Leonard Street WOrth 6-3100  
New York 13, N. Y.

**Professional Assistance . . .**

*in solving your most difficult problems in the specialized field of electronic devices is offered by these consultants.*



Circuit Development Group Leader Ralph Wolcott (left) considers future changes in computer output unit for bombing—navigational systems.

*Ground-floor opportunities in*

# INTEGRATED BOMBING-RADAR-NAVIGATIONAL SYSTEMS at **IBM**

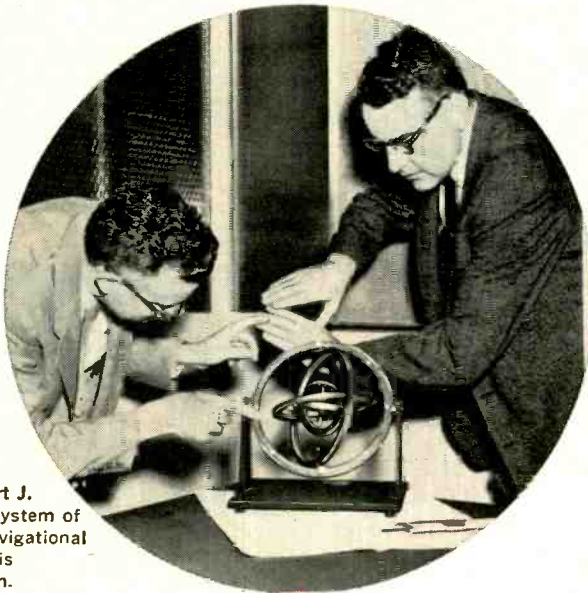

Project Engineer Robert J. Cantwell (left) uses a system of gimbals to describe navigational problems in the analysis of a new system design.

The design and development of advanced airborne computers at IBM Owego offer an unusual professional opportunity to engineers and scientists today. At this IBM Military Products facility you now have a chance to work on completely integrated bombing-radar-navigational systems. And it's just like joining a new company — the ground-floor opportunities you will find at IBM Owego. In addition, you have all the advantages . . . all the security . . . of IBM.

### Challenging assignments now open

- Airborne analog and digital computer systems
- Test equipment development
- Radar circuits and systems
- Inertial Guidance
- Transistor circuit design

### Qualifications

**B.S. or M.S. degree** in electrical or mechanical engineering, physics, or mathematics, and  
**Proven ability** to assume a high degree of technical responsibility in your sphere of interest.

**FOR DETAILS**, just write, outlining background and interests, to:

Mr. P. E. Strohm, Dept. 554W  
 Military Products Division  
 International Business Machines Corp.  
 Owego, New York

**IBM is a recognized leader** in the rapidly expanding electronic computer field. Its products are used for both commercial and military applications. Continuous growth affords excellent advancement opportunities. The "small-group" approach assures recognition of individual merit. Company benefits set standards for industry, and salaries are commensurate with your abilities and experience.

**IBM**

**MILITARY PRODUCTS**

DATA PROCESSING  
 ELECTRIC TYPEWRITERS  
 MILITARY PRODUCTS  
 SPECIAL ENG'G. PRODUCTS  
 SUPPLIES  
 TIME EQUIPMENT

Plants and laboratories: Endicott, Kingston, Owego, Poughkeepsie, Yorktown, N. Y.; Lexington, Ky.; Rochester, Minn.; San Jose, Calif.



Staff Engineer William Howard (center) reviews gearing accuracy requirements of test equipment with electronic circuit designers.





**BOLD**

New approaches — new horizons — new ideas . . . all are a part of the bold thinking being expressed by CROSLEY engineers in exciting electronics' programs. Here is your chance to expand your own concepts when you and CROSLEY join as "Partners in Opportunity".

**HERE ARE FIELDS OF CURRENT ACTIVITY:**

- |  |  |
|--|--|
| 1. Ground Radar  | 5. Communications<br>(AIRBORNE TRANSMITTERS AND RECEIVERS) |
| 2. Airborne Defense Systems  | 6. Airborne Fire Control                                   |
| 3. Antenna and Micro-Wave Equipment  | 7. Servo-Mechanisms  |
| 4. Computer and Analytical Services<br>(DESIGN AND DEVELOPMENT)<br>(PROGRAMMING & APPLICATION) | 8. Transistorized Equipment                                |
|  | 9. Guided Missiles   |
|  | 10. Infrared Research                                      |

Write us for complete details. We'll send you literature and we'll tell you about the advantages of family living in Cincinnati—"Queen City of the West, Closest to the Heart of America". There are numerous company benefits and you will be paid generous relocation expenses.

Send your resume to:

FRANK PLASHA, PERSONNEL MANAGER,  
DIVISION HEADQUARTERS, DEPT. 35

**AVCO**  
**Crosley**

AVCO MANUFACTURING CORPORATION  
CROSLEY DIVISION

1329 ARLINGTON STREET

CINCINNATI 25, OHIO

MARQUARDT

Professional Personnel  
Requisition

**ELECTRICAL TEST  
FACILITIES DESIGN  
ENGINEER**

To design electrical equipment and installations for Marquardt Jet laboratory, the West's largest jet engine testing facility. Will plan and design equipment and facilities for testing of fuel systems, hydraulic-pneumatic controls, rotating accessories, and assist in design of test equipment controls and installation of electronic instrumentation.

Definite growth potential for advancement to project supervisor.

Requires BS-EE degree, plus three to five years experience.

Contact: Jim Dale, Manager  
Professional Personnel  
16549 Satcoy Street  
Van Nuys, California

marquardt AIRCRAFT CO.

VAN NUYS, CALIFORNIA      OGDEN, UTAH

**HRB** work  
and study

HRB, a Division of The Singer Manufacturing Company, offers the graduate engineer and physicist challenging work in the electronics field. While working in research and development, you may join many others of the HRB staff in doing graduate work in your specialized field at neighboring Pennsylvania State University. Employees may take as many as six credits per semester. Encouraging education and initiative are part of the basic philosophy at HRB.

For more information write:  
Personnel Officer  
Haller, Raymond & Brown, Inc.  
Science Park  
State College, Pennsylvania

POSITION WANTED

Manufacturing and Development Engineer.  
10 years experience development of metal joining materials and methods includes soldering, brazing, and organic bonding. Thoroughly familiar with manufacturing methods. Experience in Radar and Electronic industry. PW-9006, Electronics, Class. Adv. Div.; P.O. Box 12, N. Y. 36, N. Y.



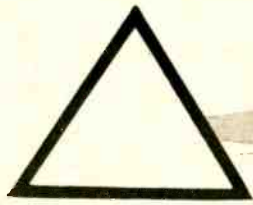

# BROAD SPECTRUM

## OF ADVANCED PROJECTS AT STROMBERG-CARLSON

*Electronics Arm of General Dynamics Corporation  
in Rochester, New York*

The many areas in which research, development and design groups work include radar, navigation, microwave communications, air traffic control, sonar, automatic test equipment, guided missile electronics, nuclear instrumentation, telecommunications, electro-acoustics, and Hi-fi equipment.

Recently Stromberg-Carlson was appointed Systems Manager and Prime Contractor for an important new USAF passive reconnaissance system.

You join two professional communities when you come to Stromberg-Carlson—the company, and the City of Rochester, which has the largest percentage of professional people for a city of its size (500,000) in the nation. And in many other ways Rochester is an ideal spot for an engineer or scientist to live and raise a family... noted for its cultural advantages; advanced study opportunities at U. of Rochester with its famed Eastman School of Music and Symphony; unrivaled park and school systems; modern hospitals. And Rochester, gateway to the Finger Lakes, is in New York's famous upstate vacationland, near Niagara Falls, Thousand Islands and Adirondack Mountains.

*Immediate openings for:*

### RESEARCH & ADVANCED DEVELOPMENT

**LABORATORY MANAGER**—Radio Communications. To direct R&D involving information theory, modulation techniques, propagation phenomenon, microwave techniques etc.

**SENIOR MATHEMATICIAN**—PhD or outstanding MS in Math, Physics or EE. Specialist in information theory applied to communications and data systems.

**PHYSICISTS or EE's**—experienced in communications research involving microwave technology, solid state circuitry and mathematical investigations.

### ELECTRONICS ENGINEERING

**SENIOR STAFF ENGINEERS**—heavy experience in one of the following areas, to become a recognized authority:

1. Automatic test equipment
2. Undersea warfare (airborne and submarine sonar systems)
3. Digital computer systems (airborne navigation and missile guidance)
4. Advanced communications systems.

**PRINCIPAL ENGINEER**—to develop and investigate new ideas in automatic control, including digital computer problems.

**SECTION HEAD**—broad experience in electronic circuit design and development, data handling, automatic test equipment, communications or navigation.

**SENIOR EE's, PHYSICISTS or EE's**—for major phases in development of such projects as:

1. transistorized nuclear reactor instrumentation.
2. transistorized industrial process control equipment.
3. advanced navigation techniques including TACAN and NAVTAC.
4. advanced automatic test equipment.
5. airborne and underwater Sonar.
6. countermeasures.
7. advanced communications systems
8. transistorized digital machine tool controls.

### ELECTRONIC SYSTEMS

**SECTION HEAD**—PhD or MS in EE or Physics. To supervise and act as consultant and liaison specialist in systems design work—both theoretical and equipment—in broad communications projects.

**SECTION HEAD**—to supervise integration of antennas (emphasis on broadband ECM receiver types) into an ECM reconnaissance system.

**SENIOR ENGINEERS**—experience in systems theoretical design and/or equipment design. Requires knowledge of entire electromagnetic spectrum, working knowledge of propagation methods.

### TELECOMMUNICATIONS

**PRINCIPAL SCIENTIST**—to consult on semi-conductor problems. Requires knowledge of application of solid state devices in electronics engineering; theory of semi-conductors etc.

### SENIOR ENGINEERS

1. for telephone network design including modern synthesis filters, delay equalizers, discriminator networks, loss and phase equalizers, transistor switching circuitry etc.
2. for R&D of electronic switching systems involving solid state devices and new relay switching circuits.

### EE's or Equivalent

1. experienced in carrier engineering, knowledge of dial and manual telephone systems.
2. for systems engineering work required by telephone central office equipment.

*If you qualify for one of the positions listed above,  
write immediately to Fred E. Lee, Manager of Technical Personnel.*



# STROMBERG-CARLSON

A DIVISION OF GENERAL DYNAMICS CORPORATION  
1447 N. GOODMAN STREET • ROCHESTER 3, N. Y.



# Follow the sun TO PHOENIX!

*...where Motorola offers rewarding opportunities!*

Work where it's fun to live. Advance your career—both in recognition and financial gain—at Motorola in Phoenix.

Your family will share your opportunity when you settle down in sunny, dry, healthful Phoenix! Tourists spend millions of dollars every year just to visit Phoenix. The attractions of this fabulous vacationland can be yours to enjoy year-round with Motorola!



If you are qualified for any of the positions below, write, wire or phone today.

**ELECTRONIC ENGINEERS,  
MECHANICAL ENGINEERS, PHYSICISTS**

System Analysis, Design and Test  
 Radar Communications  
 Navigation Missile Guidance  
 Data Processing and Display

**Circuit Design, Development and Packaging**

Microwave Pulse and Video  
 Antenna Digital and Analog  
 R-F and I-F Transistor  
 Servos

Technical and Specification Writing  
 Printed and Etched Circuitry

Write:

Mr. Kel Rowan  
 Western Military Electronics Center  
 Motorola, Inc., Dept. A-10  
 8201 E. McDowell Road  
 Phoenix, Arizona

Engineering positions also available at Motorola, Inc. in Chicago, Illinois, and Riverside, California.

**MOTOROLA, INC.**

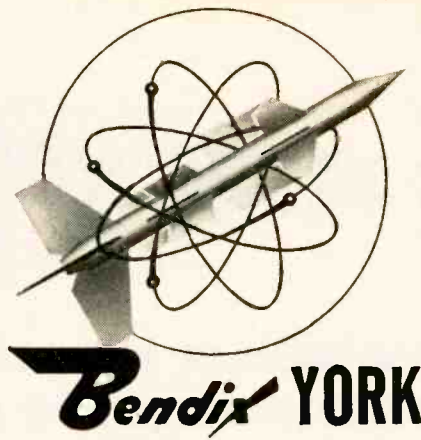

**Bendix YORK**

*offers the opportunity  
and the challenge of  
key assignments in...*

**GUIDED MISSILE  
ELECTRONICS**

**ELECTRONIC ENG.  
MECHANICAL ENG.**

**DESIGNERS—DRAFTSMEN**

Here is your chance to prove your ability doing *important* work on missile fuzing, guidance, packaging and related test equipment. We have key openings that offer you the opportunity to move ahead rapidly in your profession. At Bendix York, you benefit from the advantages of a small company atmosphere in a growing division of one of the nation's largest engineering and manufacturing corporations. Also, you'll enjoy the "good life" in our beautiful suburban community. Good salaries, all employee benefits.

Drop us a card, briefly stating your education & experience. We'll act immediately to get together with you and talk it over.

ADDRESS:  
PROFESSIONAL  
PLACEMENT  
DEPT. E

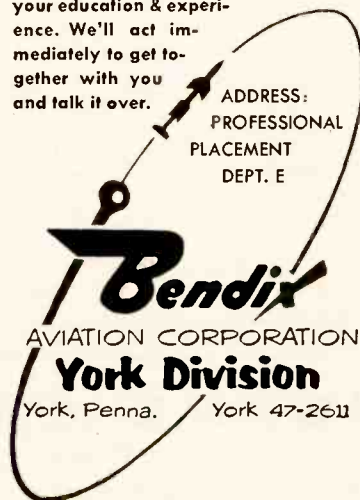

AVIATION CORPORATION

**York Division**

York, Penna. York 47-2611

**CHALLENGING OPPORTUNITIES  
IN RESEARCH  
AND DEVELOPMENT**

**ELECTRONIC  
ENGINEERS**

**SYSTEMS  
ENGINEERS**

Design of electronic instrumentation for underwater ordnance. Analytical and experimental treatment of scientific research problems in the fields of hydrodynamics, acoustics, electronics, network theory, servomechanisms, mechanics, information theory and noise analysis including analogue and digital computations.

**THE  
PENNSYLVANIA STATE UNIVERSITY  
ORDNANCE RESEARCH LABORATORY**

P. O. Box 30

University Park, Pennsylvania

- Opportunities for Graduate Study
- Faculty Appointments for Qualified Applicants
- Excellent Working and Living Conditions

Send Resume To:

**ARNOLD ADDISON**  
Personnel Director

**HRB tangible  
benefits**

To the electronic engineer and physicist with demonstrated creativity and sound technical background, HRB, a Division of The Singer Manufacturing Company, offers an abundance of benefits. You will share in such company policies as paid vacations, company-paid group life insurance, retirement plan and hospitalization and medical programs. Salaries are excellent and location is ideal.

For more information write:  
 Personnel Officer  
 Haller, Raymond & Brown, Inc.  
 Science Park  
 State College, Pennsylvania

**NEW ADVERTISEMENTS**

received by October 3rd will appear in the October 24th issue subject to space limitations.

Classified Advertising Division

**ELECTRONICS**

P. O. Box 12

New York 36, N. Y.



## ADVANCED WEAPONS

Top openings for electronics engineers experienced in the design of weapon systems and components.

### Advanced Weapons Engineer-Scientist.

M.S. or B.S. in E.E., with 6 to 8 years in advanced guidance and communications systems. To provide electronic systems solutions for missiles and space vehicles used tactically and in scientific research. Involves planning and carrying out electronic system programs from conception to specification stage for design and procurement.

### Lead Development Engineer. (Electronics).

M.S. or B.S. in E.E., with 6 or more years experience in digital or analog computation for aircraft and missile electronic systems. To be responsible for computer applications from engineering to advanced airborne electronic systems. Involves supplying performance predictions; analyzing physical data information; systems planning; preparing preliminary type specifications; contacting military agencies and computer suppliers.

A. L. Jarrett, Manager  
Advanced Weapons Engineering,  
Dept. R-11

CHANCE  
**BOUGHT AIRCRAFT**  
INCORPORATED • DALLAS, TEXAS

## HRB e.e.'s and physicists

A rewarding future is waiting for you at HRB, a Division of The Singer Manufacturing Company. HRB is one of the country's fastest growing research and development companies. You will live in State College, home of Pennsylvania State University. Located among the scenic mountains of central Pennsylvania, State College offers the congenial atmosphere of a small town for young family growth. Hunting, fishing and recreation areas are within minutes' drive.

For more information write:  
Personnel Officer  
Haller, Raymond & Brown, Inc.  
Science Park  
State College, Pennsylvania

## EMPLOYMENT PROBLEM?

When you are in need of specialized men for specialized jobs, contact them through an employment ad in this publication.

## ENGINEERS

# Why 2 years with Norden Labs are worth 4 to your professional development

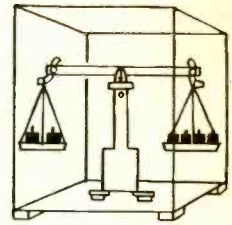

Whether you are aiming at *specialization* in an advanced phase of electronics—or wish to obtain a broad background essential for creative *systems engineering*—you will find an exceptional combination of factors leading to rapid professional growth at Norden Labs.

### Flexibility of Assignment

enables you to cross lines and work on related aspects on a diversity of sophisticated projects.

### Small R & D Groups

working in unusually close contact with technically-minded management, provides *high visibility* for your individual achievements.

### Unusual "university-climate"

promotes interdisciplinary communications...encourages flow of original thinking.

Current opportunities exist at both White Plains, NY and Stamford, Connecticut locations for work on a number of advanced projects —

### RADAR & COMMUNICATIONS

Design & Development openings in the following areas:

• ANTENNAS • MICROWAVE SYSTEMS • MICROWAVE COMPONENTS • RECEIVERS • TRANSMITTER MODULATORS • PULSE CIRCUITRY (VT & TRANSISTORS) • DISPLAYS • AMTI • DATA TRANSMISSION • ECM

### TELEVISION & PASSIVE DETECTION

• TV DISPLAY CIRCUITRY • TV CAMERA CIRCUIT DESIGN  
• TV TRANSISTOR CIRCUITRY

### QUALITY ASSURANCE

• RELIABILITY ANALYSIS • STANDARDS • ENVIRONMENTAL TEST

### SYSTEMS

• RADAR SYSTEMS

### ENGINEERING DESIGN

• ELECTRONIC PACKAGING • MATERIALS—CHEMICAL ENGINEERING: Non-Metallic Experience; Mil Specs

### DIGITAL

• DIGITAL (SENIOR) — DESIGN: Logical, circuit, magnetic storage

### STABILIZATION & NAVIGATION

TECHNICAL EMPLOYMENT MANAGER

# NORDEN LABORATORIES

Norden Division — United Aircraft Corporation

121 Westmoreland Avenue

White Plains, New York

I am interested in obtaining further information on opportunities at Norden Laboratories.

Name \_\_\_\_\_

Address \_\_\_\_\_

City \_\_\_\_\_ Zone \_\_\_\_\_ State \_\_\_\_\_

Degree \_\_\_\_\_ Year \_\_\_\_\_

# ENGINEERS

# STEP UP TO LEAR

• SENIOR

• PROJECT

Engineers with communications and/or circuit design experience are invited to join up with the fast-moving, forward-thinking team of Lear, Inc.

Unlimited opportunities for advancement and greater responsibilities at project-director levels are available to creative minded, experienced electronic engineers.

Lear, for twenty eight years pioneer in aircraft radio communications and navigation equipment, automatic flight controls and flight indicators, is now forging ahead in the Missile-Space field. If you would like to work close by the shores of the blue Pacific on diversified electronic projects, write

Mr. LEW PECK, Manager  
Industrial Relations

**LEAR, INC.**  
3171 SOUTH BUNDY DRIVE  
Santa Monica, California

## ELECTRONIC CIRCUIT ENGINEERS

Design and development of amplifier and signal circuitry for aircraft, missile, and industrial servo systems.

Requires E.E. degree and two or more years of experience with hi-fi, communications, or servo electronics.

Write or phone collect: Mr. John Taylor,

**CADILLAC GAGE COMPANY**

Box 3806

Detroit 5, Michigan

PRescott 7-7100

## RADAR SIMULATION

Challenging position with pioneer producer of 3-D Maps for ultrasonic and light optical Flight and Radar Simulation Systems.

Diversified functions will include simulation systems analysis, electromechanical design, some basic research, and extensive gadgeteering for military and commercial products.

Alert engineers with simulator system experience are invited to forward a resume for immediate consideration and further details.

### AERO SERVICE CORP.

210 E. Courtland St.  
Philadelphia 20, Pa.

## HRB smaller company?

HRB, a Division of The Singer Manufacturing Company, is a small company. It has remained small by choice. Electronics engineers and physicists will find country quiet and metropolitan opportunity at HRB. Individual recognition for creative initiative is only one of the many advantages offered. A sincere interest in the progress of each engineer is standard policy in this internationally recognized "small" research company.

For more information write:  
Personnel Officer  
Haller, Raymond & Brown, Inc.  
Science Park  
State College, Pennsylvania

## DISENCHANTED ENGINEERS

If your present employer has failed to utilize your full potential, why not permit us to explore the parameters for your personal qualifications with the many dynamic young companies in aviation, electronics, missiles and rockets. We now have in excess of 4,000 openings in the \$8,000 to \$10,000 bracket, all of which are fee paid. Why wait? Send resume in duplicate at once to:—

FIDELITY PERSONNEL  
1218 Chestnut Street, Philadelphia 7, Pa.

## ENGINEERS—EE's RADAR FLIGHT SIMULATORS

XMTR-RECVR-PWR SUPPLY  
IMMEDIATE OPENINGS  
LOCAL NEW YORK CITY ASSIGNMENTS  
TOP RATES + PER DIEM

Call or Write—BERT GRAHAM  
PARAMOUNT DESIGNS  
408 Jay St., Bklyn. UL 5-6161

## SEARCHLIGHT SECTION

(Continued on pages 202-205)

## Hysteresis Synchronous Motors

For high fidelity recording and reproducing equipment. These units are brand new, not surplus at prices that cannot be duplicated anywhere. Price with capacitor.

7 1/2" and 15" per second . . . each \$27.75  
7 1/2" per second . . . . . each 24.25  
15" per second . . . . . each 24.25  
Pressure Wheels 1 1/2" diameter with 1/4" oilite bearings . . . . . .95 ea.

**J. H. GIBSON COMPANY**  
1202 W. Washington Blvd. L.A. 7, Calif.  
Telephone RI-9-9976

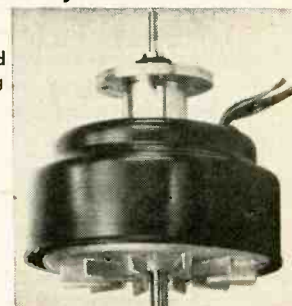



# HRB more responsibility!

HRB, a Division of The Singer Manufacturing Company, is offering a challenge to electronic engineers and physicists who are able to accept mature responsibility on research and development projects. The creative mind will find academic freedom, complete management encouragement and full responsibility on a task. Excellent salary and generous company benefits.

For more information write:  
 Personnel Officer  
 Haller, Raymond & Brown, Inc.  
 Science Park  
 State College, Pennsylvania

### IDEAL LOCATION

Growing concern located in large college town in Southwest needs engineers with one to four years experience in electronics, servo-mechanisms, computers and data handling. Profit sharing possibilities. Work on advanced degrees.

**DORSETT LABORATORIES, INC.**  
 401 East Boyd Street Norman, Oklahoma

**ENGINEERS** / for development of

## ADVANCED CELESTIAL NAVIGATION SYSTEMS

Project and Staff positions available to those interested and qualified for serious development work in

- AIRBORNE NAVIGATION SYSTEMS**
- RELATED ELECTRONICS**
- ANALOG & DIGITAL COMPUTERS**
- ASSOCIATED TEST EQUIPMENT**

Minimum 4 years experience in military navigation-type servos, computers, electronics, photoelectric tracking or other related equipment desired.

### FIELD ENGINEERS

For development & flight evaluation work.

For further information about positions available with Kollsman, designers of America's finest aircraft instruments, send resume to T. A. DeLuca.



**kollsman** INSTRUMENT CORPORATION

80-08 45th AVENUE, ELMHURST, NEW YORK • SUBSIDIARY OF Standard COIL PRODUCTS CO. INC.

### SCIENTISTS • ENGINEERS

**FIT YOUR PROFESSIONAL GROWTH CURVE TO ELECTRONIC PROGRESS WITH GENERAL ELECTRIC**

An index of the professional opportunities at General Electric is this one fact...

*G.E. spends more than 6% of its revenue for research in advanced fields — 3 times the percentage allocated by the average industrial company*

For electronics the significance of this is clear when you consider the rise of the industry's sales from \$2.5 billion in 1947 to a projected \$14 billion in 1958 — spurred largely by products unknown 10 years ago.

Electronics Park is one of the centers where G-E scientists and engineers are developing new concepts, techniques, equipment — from which come whole new G-E product lines... whole new G-E departments. As nuclei of these new departments our Development Personnel may follow their creations into production phases — or they may remain to initiate other lines of advance.

Below are listed some of the areas of technical progress at Electronics Park. Why not check your particular interest and mail the coupon to us today. A Bachelor's or Advanced Degree in Electrical or Mechanical Engineering or Physics and/or experience in electronics is required for our current openings.

Clip Here ▼

**TO:** General Electric Company  
 Electronics Park, Div. 27-WN  
 Syracuse, New York  
 Att: Technical Personnel Dept.

- I AM INTERESTED IN**
- Advanced Development
  - Design
  - Field Service
  - Technical Writing
  - Research

- IN THE FIELD OF**
- Military Radio & Radar
  - Multiplex Microwave
  - Mobile Communications
  - Semiconductors
  - Electronic Components
  - Computers
  - Missile Guidance
  - Television Receivers
  - Industrial Television
  - Antennae
  - Early Warning Systems

Name \_\_\_\_\_  
 Address \_\_\_\_\_  
 \_\_\_\_\_ Degree \_\_\_\_\_





**THAT'S A BUY!**

TOROID & HIPERSIL® "C" CORES AT GREAT SAVINGS TO YOU!



**"C" CORES ARNOLD TYPE "SILECTRON"®**

Mfg No.	Mil Thk	Strip Width	Build Up	Window	Let's	Price
A22	1	3/8"	3/16"	1/4"	3 5/8"	\$1.56
A414	2	3/8"	0.5"	1/4"	3 5/8"	2.40
AJTH66	4	7/8"	5/8"	11/16"	1-11/16"	2.75
AJTH35	4	7/8"	5/8"	11/16"	1-11/16"	2.75
AJ1076	4	3/8"	1/4"	9/16"	1 1/8"	1.39
AA15	12	2"	1 1/16"	1"	3"	2.05
AJH79	4	1 1/8"	9/16"	1 1/8"	2-7/8"	3.00
AJH84	4	1 3/4"	9/16"	1 1/8"	2-7/8"	4.40
AJH11	4	1 1/4"	9/16"	5/8"	1-9/16"	2.25

**"C" CORES MOLONEY "HIPERCORE"®**

MH26	4	1 1/4"	1 1/2"	5/16"	2 1/2"	2.79
MH19	4	1 1/8"	3/4"	3/4"	2 1/16"	3.90

**"C" CORES THOMAS & SKINNER "ORTHOISIL"®**

4C795	4	1 3/8"	3/4"	3/4"	2-5/16"	3.60
4C592	4	1 1/4"	3/8"	1/2"	1-9/16"	1.73
4C59	4	1 1/4"	1/2"	15/16"	2-1/2"	2.61
4C58	4	1 1/4"	3/8"	1/2"	7-3/16"	2.96

**"C" CORES WESTINGHOUSE "HIPERSIL"®**

Z15	4	1 3/8"	3/16"	3/16"	1 3/4"	4.14
H231	4	1 1/8"	3/8"	1 1/8"	6 1/16"	1.62
H467	4	1 1/8"	5/8"	1 1/8"	2-1/2"	2.07
Z	4	1 3/8"	3/16"	1 1/8"	1"	2.16
H26	4	1 1/4"	1 1/2"	1 3/8"	7 1/2"	3.24
H37	4	1 3/4"	1 1/2"	1 3/8"	3"	4.23
A13	4	1 1/2"	1 1/2"	1 1/4"	4 1/4"	2.34
H475	12	2"	1 1/2"	1 1/4"	3"	3.39

**TOROIDS—#60000-2A2/MAGNETICS INC. 3283304 "MAG. METALS"**

Mfg No.	O.D.	I.D.	Width	Core Sil.	Price
3283304	1.07"	0.555"	.445"	.004-0.01	\$1.25
60000-2A2	.810"	.440"	.195"	.002-0.018	1.35 ea.

**HI-VOLTAGE SELENIUM RECTIFIER!!!**

"INTERNATIONAL RECTIFIER" CARTRIDGE HI-VOLTAGE SELENIUM ONE-HALF WAVE RATED 6300 VAC/piv & 4500V/CAP. Inset 2725VDC @ Five Ma; 5" Lxth, 9/16" Dia. SIMILAR TO V125HF WHICH SELLS FOR \$16.07 EACH. JAN. 1957. "TAB" SPECIAL! \$4.00 EACH. 2 for \$7.8 for \$25 POSTPAID 48 STATES U.S.A.

**TEK-AP TABPAK® HIGH CURRENT POWER SUPPLIES**

One Year Guarantee

Variable 0-28 VDC. Completely built. Ready to go. Full Wave Selenium Rectifier. Transformer. Various Meters. Pilot Light. 4" Volt & Amp Meters. Switch. Terminals & Fuse. Heavy Duty Steel Cabinet. Input or 220V (3 phase) to order. Std. 115V/60cy

**CONTINUOUS RATING**

Stock Number	With Meters
T6000F	\$1250
T2V5A	57
T2V5ACC	79
T2V12A	135
T2V12ACC	169
T2V24A	174
T2V24ACC	245
T2V50A	310
T2V50ACC	400
T130V5A	234
T130V5ACC	275

**"TEKSEL" SELENIUM BRIDGE RECTIFIERS FULL WAVE • WRITE FOR CATALOG #858**

CURR. CONT.	18VDC	36VDC	54VDC	72VDC	144VDC
1AMP	\$1.40	\$2.30	\$3.45	\$4.90	\$10.65
2AMP	2.30	3.20	5.25	7.25	14.00
3AMP	2.90	4.15	6.40	8.60	17.25
6AMP	4.40	6.75	12.75	18.75	36.00
10AMP	6.35	12.20	18.50	26.30	48.75
15AMP	10.30	20.90	29.30	40.00	64.45
24AMP	16.00	32.00	41.60	57.50	95.50
36AMP	24.75	47.90	61.90	89.90	188.00
50AMP	33.45	63.75	121.50	132.75	227.00

**"TABTRAN" Rectifier Xfms**

Sec'd Volts DUAL 0-15-18 & 0-9-15-18 Series  
Sec'ds 0-3-6-9-12-15-18-21-24-27-30-33-36 Volts

TR4001	1 Amp/0.1 sec/w.	\$5.15
TR4002	2 Amp/0.1 sec/w.	7.15
TR4003	5 Amp/0.1 sec/w.	9.80
TR4005	12 Amp/0.1 sec/w.	17.60
TR4006	24 Amp/0.1 sec/w.	35.60
TR4007	50 Amp/0.1 sec/w.	58.45
TR4008	100 Amp/0.1 sec/w.	117.00

**"TABTRAN" Rectifier Chokes**

CR6001	1 Amp/0.1 HY/1.4 Ohm	\$3.90
CR6002	2 Amp/0.1 HY/0.87 Ohm	5.75
CR6003	5 Amp/0.07 HY/0.6 Ohm	9.99
CR6004	12 Amp/0.04 HY/0.4 Ohm	15.75
CR6005	24 Amp/0.04 HY/0.23 Ohm	25.60
CR6006	50 Amp/0.01 HY/0.01 Ohm	47.00

**FILTER CAPACITORS**

CE156M	6000 MFD 15V	\$2.00
CE502M	2000 MFD 50V	\$4.00
CE2005M	500 MFD @ 200V	\$5.00

Brackets for Capacitors @ 25c each

**New Variable Voltage X-frms**

**SUPERIOR-GR-STACO**

0-132V-1.25A	\$7.23
0-135V/3A	10.63
Cased 0-135V/7.5A	19.55
Uncased 0-135V/7.5A	15.30
Cased 0-270V/3A	22.50
Uncased 0-270V/3A	17.00
Cased 0-135V/15A	39.10
Uncased 0-270V/9A	25.10
Uncased 0-135V/30A	44.10
Uncased 0-270V/12A	44.10
Uncased 0-135V/60A	89.10
Uncased 0-270V/30A	113.00
Uncased 0-270V/60A	189.00

**LARGEST STOCK USA! IMMEDIATE DELIVERY WRITE FOR QTY. PRICES & CATALOG!**

**"TAB" TERMS:** Money Back Guarantee Our 14th year. \$2 min. order. F.O.B. N.Y.C. Add shpg. charges or for C.O.D. 25c Dep. Prices shown subject to change.

111EX LIBERTY ST., N. Y. 6, N. Y.

Write for Catalog

PHONE: RECTOR 2-6245

**-CAPACITORS-**

**10 mfd-600 V. . . . \$1.25**

Dual 2.5 & 5 mid sections. Four bakelite terms. Case 5 3/4" x 3 3/4" x 1" complete with 2 mntg. lhts. Qua. disc.

**6 mfd-150 V. . . . \$ .70**

Metallized paper bathtub capacitor. Standard dims. & mount.

**HIGH KVA MICA CAPS  
TRANS. MICA CAPS  
SUBMINIATURE CAPS  
VACUUM CAPS. Prices quoted.**

**TYPE "J" POTS**

"JU" Linear Taper . . . . . \$ .75  
"JL" Linear Taper . . . . . \$ .85  
"JJ" Linear Taper . . . . . \$2.50

Mfd	Volts	Price	Mfd	Volts	Price	Mfd	Volts	Price
.001	10KV	4.95	.5	3000	1.25	1	10KV	74.50
.001	50KV	24.95	.5	4000	3.25	1	15KV	PUR
.0025	10KV	5.25	.5	5000	3.05	5	220VAC	.98
.0025	15KV	5.95	.5	7500	4.95	5	330VAC	1.19
.005	25KV	21.95	.5	25KV	38.50	5	600	6.95
.01	1500	.55	1	5-5 9000	5.95	5	1000	1.69
.012	25KV	10.95	1	5-1 2000	.32	5-5	400	.89
.015	16KV	12.95	1	115 VAC		6	330VAC	1.29
.02	8000	4.50	1	10KV	.44	6	1000	1.95
.02	10KV	5.25	1	20KV	.69	6	1500	2.95
.02	20KV	8.25	1	1500	.99	7	600	1.15
.025	15KV	7.25	1	2000	1.55	7	800	1.25
.025	50KV	32.95	1	3000	2.55	8	330VAC	1.50
.03	7500	4.25	1	4000	4.95	8	600	1.29
.04	17KV	6.50	1	5000	8.95	8	660VAC	2.40
.05	2500	.65	1	6000	8.95	8	1000	2.15
.05	7500	4.50	1	7500	7.50	8	1500	3.65
.05	16KV	7.95	1	7500	7.50	8	9500	19.50
.05-.05	12KV	8.95	1	7500	7.50	8	2000	6.95
.05-.05	40KV	60.00	1	7500	14.75	8	8-8 600	1.89
.075	7000	3.25	1	10KV	22.95	8	8-8 600	2.25
.1	1500	.65	1	12.5KV	32.95	8	8-8 600	2.98
.1	2500	.69	1	15KV	38.50	8	10KV	PUR
.1	3000	.50	1	20KV	37.50	10	400	.65
.1	4000	1.20	1	25KV	59.50	10	600	1.10
.1	5000	1.35	1.25	25KV	69.50	10	600	1.45
.1	7500	.89	1.5	15KV	45.00	10	1000	3.45
.1	7500	3.25	1.5	25KV	PUR	10	1000	2.25
.1	7500	.89	2	600	.55	10	1500	4.35
.1	7500	3.95	2	1000	.79	10	2000	6.50
.1	15KV	2.95	2	1000TTLA	1.29	10	2500	10.95
.1	15KV	8.95	2	1500	1.15	10	2500	6.25
.1	20KV	9.95	2	2000	2.75	10	2000	20.95
.1	25KV	24.95	2	2500	3.25	10	5000	PUR
.1	25KV	21.95	2	3000	4.95	10	6000	52.50
.1	125 100KV	PUR	2	4000	7.75	12	660VAC	4.25
.1	1	1000	2	5000	11.90	12	660VAC	4.25
.2	10KV	8.50	2	6000	21.95	12	1000	2.95
.2	13KV	9.50	2	7500	23.50	12	2000	7.75
.2	15KV	10.75	2	10KV	55.00	13.5	1000	21.25
.2	50KV	69.50	2	12.5	53.50	14	660VAC	4.25
.25	2000	.89	3	1000	9.95	15	1400VAC	3.25
.25	3000	1.25	3	2000	1.95	15	600	2.95
.25	4000	1.75	3	1000	8.50	15	1000	4.10
.25	6000	.89	3	8000	30.50	15	1500	6.35
.25	15KV	15.95	4	500	.65	20	330VAC	3.25
.25	20KV	19.95	4	600	.75	20	4000	35.25
.25	25KV	49.50	4	600TTLA	.89	25	600	4.25
.25	50KV	69.50	4	330VAC	1.25	25	2500	10.95
.25	2000	.25	4	1000	1.10	28	1000	5.50
.4	10KV	10.95	4	1000	1.60	30	2500	13.50
.4	4-4 7500	3.75	4	1500	2.65	32	600	2.98
.5	10VAC	.49	4	2000	3.75	32	600	2.98
.5	600	.45	4	3000	4.95	40	600	5.85
.5	1500	.59	4	4000	6.99	50	100	4.10
.5	2000	1.19	4	4000	18.50	100	4000	49.50
.5	2500	1.21	4	5000	19.95	120	3000	49.25
			4	7500	59.50			Photo Flash

**BATHTUB CONDENSERS**

Mfd	Volts	Price	Mfd	Volts	Price	Mfd	Volts	Price
.01	600	.19	3x.1	400	.15	3x.5	400	.40
2x.01	600	.15	3x.1	600	.31	1	300	.29
2x.02	600	.15	2	1000	.19	1	400	.35
2x.025	600	.15	25	400	.25	1	600	.45
2x.04	600	.15	25	600	.29	1	1000	.55
.05	1000	.24	25	1000	.39	2x.1	600	.69
2x.08	600	.12	25	600	.25	2	50	.30
1	600	.25	2x.25	100	.34	2	400	.49
2x.1	600	.19	2x.25	600	.24	2	600	.59
1								



# ELECTRONIC

WAR TERMINATION INVENTORIES

WRITE OR WIRE FOR INFORMATION ON OUR COMPLETE LINE OF SURPLUS ELECTRONIC COMPONENTS. ALL PRICES NET F.O.B. PASADENA, CALIFORNIA

# C&H

## SALES CO.

2176-E East Colorado St.  
Pasadena 8, California  
RYan 1-7393

### INVERTERS

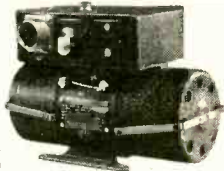

- DMF2506M Continental Electric 24-30 volts input; 5.5-45 amps; cont. duty. Output: 115 volts; .44 amps; 400 cyc; 1 phase; pf 1.0; 50 watts **\$39.50**
- 12116-2-A Bendix Output: 115 VAC; 400 cyc; single phase; .45 amp. Input: 24 VDC, 5 amps **\$25.00**
- 12117 Bendix Output: 6 volts; 400 cycles, 6 volt ampers; 1 phase. Input: 24 VDC; 1 amp. **\$15.00**
- 12121 Bendix Input: 24 volt D.C. 18 amp. 12000 r.p.m. Output: 115 volts, 400 cycle, 3-phase. 250 volt amp, 7 pf. **\$49.50**
- 12123 Bendix Output: 115 V; 3 phase; 400 cycle; amps. .5; Input: 24 VDC; 12 amp. **\$49.50**
- 12126-2-A Bendix Output: 26 volts; 3 phase; 400 cycle; 10 VA; 6 PF. Input: 27.5 volts DC; 1.25 amps. **\$24.50**
- 12142-1-A Bendix Output: 115 volts, 3 phase, 400 cycle, 250 VA. Input: 27.5 VDC, 22 amps. Voltage and frequency regulated. **\$99.50**
- 12147-1 Pioneer Output: 115 VAC, 400 cycles; single phase. Input: 24-30 VDC; 8 amps. **\$19.95 each**
- 10285 Leland Output: 115 volts AC; 750 VA, 3 phase, 400 cycle, .90 pf and 26 volts. 50 VA single phase, 400 cycle, .40 pf. Input: 27.5 VDC, 60 amps. cont. duty, 6000 rpm, Voltage and frequency regulated. **\$59.50**
- 10563 Leland Output: 115 VAC; 400 cycle; 3-phase; 115 VA; 75 pf. Input: 28.5 VDC; 12 amps. **\$25.00**
- PE109 Leland Output: 115 VAC, 400 cyc.; single phase; 1.53 amp.; 8000 rpm. Input: 13.5 VDC; 29 amp. **\$50.00**
- PE218 Leland Output: 115 VAC; single phase pf. 90; 380/500 cycle; 1500 VA. Input: 25-28 VDC; 92 amps.; 8000 rpm.; Exc. Volts 27.5 **\$30.00**
- AN 3499 Eicor, Class "A" Input: 27.5 volts at 9.2 amps. AC. Output: 115 volts, 400 cycles; 3 phase, 100 voltamp; continuous duty. **Price \$39.50 each**

### MG54D BENDIX INVERTER FREQUENCY & VOLTAGE REG.

Output: 200/115 volts; 400 cycle, single or 3 phase; .80 pf, 250 VA. Input: 28 VDC, 22 amps. **\$99.50**



### DIFFERENTIAL

Size 2 1/8" long, 1 1/8" dia. 1-1 reverse ratio. 1/4" shaft on each end; one shaft 25/32" long, one shaft 15/32" long. Input and output gear 1-23.32" dia. 53 teeth. Stock No. 150 **\$3.50 ea.**

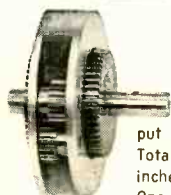

### SIMPLE DIFFERENTIAL

1 to 1 reverse ratio; 48 teeth on input and output gear, 1-1/32 inch diameter. Total outside diameter 1-25/32 inches. Shaft size is 1/4 inch. One shaft is 9/16" long; other shaft is 3/16" long. **\$5.00**

Stock No. 151

### ONAN MOTOR GENERATOR SET

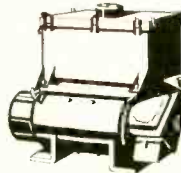

#### MG 075-G-1

Generator 115 VAC; 480 cycle; 5.3 amps; .6KW; PF 1.0; Also 26 VDC; 100 watt; 3.8 Amps; Driven by 115-230 VAC —2hp motor; 60 cycle; single phase; 3450 rpm; 10.5 amps.

Price **\$135.00**

### SELSYNS-SYNCHROS



- ICT cont. Trans 90/55V 60 cy. **\$34.50**  
 1DG Diff. Gen. 90/90V 60 cy. **34.50**  
 1F Syn. Mtr. 115/90V 60 cy. **34.50**  
 1G Gen. 115V 60 cy. **34.50**  
 1HDC **37.50**  
 1HCT **37.50**  
 1HG **37.50**  
 1SF Syn. Mtr. 115/90V 400 cy. **12.50**  
 23TR6 torque receiver, 115/90 VAC, 60 cycle **37.50**  
 23CT6 control transformer, 90/1V per degree, 60 cycle **37.50**  
 23CX6 control transmitter, 115/90 VAC, 60 cycle **37.50**  
 7DG differential generator, 90/90 volts, 60 cycle **37.50**  
 2J1F1 Gen. 115/57.5V 400 cy. **7.50**  
 2J1F3 Gen. 115/57.5V 400 cy. **10.00**  
 2J1FA1 Gen. 115/57.5V 400 cy. **7.50**  
 2J1G1 57.5/57.5V 400 cy. **5.00**  
 2J1H1 Diff. Gen. 57.5V 400 cy. **7.50**  
 2J5D1 Cont. Trans. 105/55V 60 cy. **17.50**  
 2J5F1 Cont. Trans. 105/55V 60 cy. **17.50**  
 2J5H1 Gen. 115/105V 60 cy. **17.50**  
 2J15M1 Gen. 115/57.5V 400 cy. **17.50**  
 5CT Cont. Trans. 90/55V 60 cy. **34.50**  
 5D Diff. Mtr. 90/90V 60 cy. **34.50**  
 5DG Diff. Gen. 90/90V 60 cy. **34.50**  
 5F Syn. Mtr. 115/90VAC 60 cy. **34.50**  
 5G Syn. Gen. 115/90VAC 60 cy. **34.50**  
 5HCT Cont. Trans. 90/55V 60 cy. **37.50**  
 5SDG Diff. Gen. 90/90V 60 cy. **12.50**  
 6DG Diff. Gen. 90/90V 60 cy. **25.00**  
 6G Syn. Gen. 115/90VAC 60 cy. **34.50**  
 7G Syn. Gen. 115/90VAC 60 cy. **42.50**  
 C56701 Type 11-4 Rep. 115V 60 cy. **20.00**  
 C69405-2 Type 1-1 Transm. 115V 60 cy. **20.00**  
 C69406 Syn. Transm. 115V 60 cy. **20.00**  
 C69406-1 Type 11-2 Rep. 115V 60 cy. **20.00**  
 C76166 Volt. Rec. 115V 60 cy. **10.00**  
 C78248 Syn. Transm. 115V 60 cy. **12.50**  
 C78249 Syn. Diff. 115V 60 cy. **5.00**  
 C78410 Repeater 115V 60 cy. **20.00**  
 C78863 Repeater 115V 60 cy. **7.50**  
 C79331 Transm. Type 1-4 115V 60 cy. **20.00**  
 851 Bendix Autosyn Mtr. 22V 60 cy. **7.50**  
 403 Kollman Autosyn. Mtr. 32V 60 cy. **7.50**  
 FPE-25-11 Diehl Servo Mtr. 75/115V 60 cy. **15.00**  
 FPE-43-1 Resolver 400 cy. **19.50**  
 FJE-43-9 Resolver 115V 400 cy. **15.00**

### HONEYWELL VERTICAL GYRO MODEL JG7003A-1



115 volts, 400 cycles, single phase, 35 watts. Pitch and roll potentiometer pickoffs 890 ohms, 40 volts max. AC or DC. Speed 20,000 rpm, ang. momentum 12,500,000 gm-cm<sup>2</sup>/sec. Erection system 27 VAC, 400 cycles, time 5 min. to 1/2". Weight 5.5 lbs. **Price \$35.00 each**

### HIGH-QUALITY OPTICAL PARTS

5" Schmidt Ultra Hi-Speed Objective Lens System



Eastman Kodak infra-red receiver, formerly known as U.S. Navy Metascope, Type B, 7" long with 5" SCHMIDT ultra-high speed Objective Lens (approx. f 0.5). Elaborate optical system, many coated lenses. Uses 2 penlight batteries. Govt. cost approx. \$300. Factory-new. Shipping wt. 9 lbs. **Price \$19.95**  
 Waterproof Carrying Case, extra. Shipping wt. 3 lbs. **Price \$3.00**  
 Dual purpose U.S.N. floodlight throws strong beam of invisible infra-red rays. With infra-red lens, spare sealed beam lamp, batteries. Shipping wt. 23 lbs. **Price \$14.95**

### MICROFLEX RESET TIMER TYPE HXS141



A synchronous motor-driven device which trips its contacts closed or open after an adjustable time interval. Starting and resetting electrically controlled. Contacts: 15 amps., 12 volt D.C. Max. Cycles: 60 sec., Min: 0.1 sec.

Clutch Coil: 12 VDC—Motor: 110V, 60 cy. Mfg. Eagle Signal Corp. **Price \$15.00**

### GENERAL ELECTRIC AUTO PILOT DIRECTIONAL GYRO INDICATOR and CONTROL UNIT

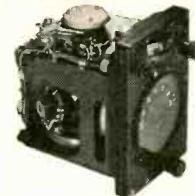

Mod. 8K63AC. 115 volts, 400 cps, 3 phase, 40 watts. Has settable induction pick-off.

**Price \$10.00**

### VARIABLE SPEED BALL DISC INTEGRATORS

#### No. 145

Forward & Reverse 2 1/4-0-2 1/4. Input shaft spline gear 12 teeth 9/32" dia. 3/8" long. Output shaft 15/64" dia. x 15/32" long. Control shaft 11/32" x 3/8" long. Cast aluminum construction. Approx. size 3" x 3" x 2 3/4".

#### No. 146

Forward & Reverse 4-0-4. Input shaft 5/16" dia. x 3/4" long. Output shaft 15/64" dia. x 9/16" long. Control shaft 11/64" dia. x 11/16" long. Cast aluminum construction. Approx. size 4 1/2" x 4 1/2" x 4". **\$17.50 ea.**



(All Shafts Ball Bearing Supported)

### SMALL DC MOTORS



- (approx. size overall 3/4" x 1 1/4" dia.):  
 5067126 Delco PM, 27 VDC, 125 RPM, Governor Controlled **\$15.00 ea.**  
 5069600 Delco PM 27.5 VDC 250 rpm **12.50**  
 5069230 Delco PM 27.5 VDC 145 rpm **15.00**  
 5068750 Delco 27.5 VDC 160 rpm w. brake 6.50  
 5068571 Delco PM 27.5 VDC 10,000 rpm (1x1x2") **5.00**  
 5069790 Delco PM, 27 VDC, 100 RPM, Governor Controlled **15.00 ea.**  
 5BA10A118 GE 24 VDC 110 rpm **10.00**  
 5BA10AJ37 GE 27 VDC 250 rpm reversible **10.00**  
 5BA10AJ52 27 VDC 145 rpm reversible **12.50**  
 5BA10AJ50, G.E., 12 VDC, 140 rpm **15.00**  
 5BA10FJ401B, G.E. 28 VDC, 215 rpm, 10 oz. in., .7 amp, contains brake **15.00**  
 5BA10FJ421, G.E. 26 VDC, 4 rpm, reversible, 6 oz. in., .65 amp **15.00**  
 206-1001 PM Planetary Gear Reduced Motor with Magnetic Brake. Mfgd. by Air Equipment 26 volts 600 ma 145 rpm **17.50**  
 5BA10FJ33, G.E., 12 VDC, 56 rpm reversible **15.00**  
 806069 Oster series reversible 1/50 h.p. 10,000 rpm. 27.5 VDC 1 5/8" x 3 1/2" **5.00**  
 C-28P-1A 27 VDC 1/100 h.p. 7,000 rpm **3.00**



# DEAL WITH SPECIALISTS AND SAVE

LARGEST INVENTORY

RECEIVING • TRANSMITTING

ONLY 1ST QUALITY

MINIATURE • SUBMINIATURE  
KRYSTRONS • MAGNETRONS ETC.

OUR OWN EXPORT DIV.

DIODES & TRANSISTORS



# Jsh

ELECTRONICS CO.

Dept. E-10

1108 Venice Boulevard • P.O. Box 15654  
Los Angeles 15, California • Richmond 9-7644

Cable Address: JASHELEC

Telegraph: FAX

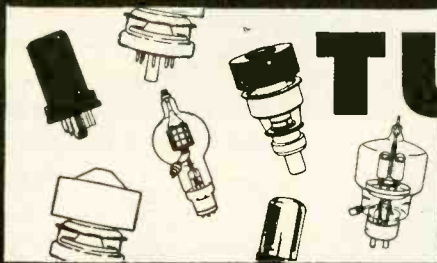

# TUBES

- ★ NEW ★ NAME BRANDS
- ★ IMMEDIATE DELIVERY
- ★ LOW PRICES
- ★ UNCONDITIONAL GUARANTEE

WRITE • WIRE • CALL

FOR QUOTATIONS

## SCR 584 ANTENNA PEDESTALS

Complete 360° azimuth & full elevation sky sweep (210°). Fully equipped with azimuth & elevation motors, potentiometers, selsyns, and amplidydes. The ideal antenna system for sky sweeping, tracking, telemetering.

In Excellent Condition. Delivery from Stock. An outstanding buy at our special price. Control consoles also in stock. Complete details in McGraw-Hill MIT Radiation Lab Series, Vol 1 Radar System Engineering & Vol 26 Radar Scanners & Radomes.

See our ad in the September 26, issue.

**RADIO RESEARCH INSTRUMENT CO.**

550 FIFTH AVE.  
NEW YORK  
JUDSON  
6-4691

NEW USED REBUILT

SOLD RENTED BOUGHT

## instruments

immediate delivery

Many Temperature Controllers, Precision Indicators, Continuous Line & Multiple Point Recorders. Leeds & Northrup Speedomax, Micromax; M.-H. Brown ElectroniKs; Brown-Beckman Electronic Pneumatic pH Controllers. Similar instruments.

Complete Control Panels Engineered & Built to fit your needs

Sold on Trial Basis

**Instrument Service Engineering Labs.**

1205 LAMAR ST • DAYTON 4, OHIO • ADams 2241

WE BUY . . . ANY VALUES

## ALLEN-BRADLEY

RESISTORS and POTENTIOMETERS

at highest prices.  
Submit your offerings directly to:

LEGRI S COMPANY  
391 Riverdale Ave.  
YONKERS 5, NEW YORK

ADDITIONAL SEARCHLIGHT SECTION ADVERTISING on page 200

## Electronic LABORATORY SUPPLY COMPANY

Premium quality NEW components at below factory prices

OCTOBER SPECIAL: W-E 35-A—Grasshopper Fuses 1 1/3 amp. \$96.00 per M.

★ Write for our 16 page CATALOG and SPECIAL mailings

7208 GERMANTOWN AVENUE • PHILADELPHIA 19, PENNSYLVANIA • Chestnut Hill 8-2700

### HARRY KRANTZ CO.

the largest RESISTOR stock in the Country

Tremendous Quantities—1/2, 1 & 2 W. 40 to 70% off mig. prices

89 Chambers St., N. Y. C. 13 WO 2-5727

### lab grade TEST EQUIPMENT for sale

standard brands—military surplus (new or professionally reconditioned) experienced problem solvers and budget-cutters

ENGINEERING ASSOCIATES  
434 Patterson Road Dayton 19, Ohio

### ALL BRAND RESISTORS

Type J Potentiometers Single-Duals-Triples Type G Miniature Potentiometers From Stock—By Return Mail

LEGRI S COMPANY  
391 Riverdale Ave. Yonkers 5, N. Y.



# V&H

RADIO-ELECTRONICS



U.S.A. center for

# TUBES

and

# ELECTRONICS

Suppliers of:  
MAGNETRONS KLYSTRONS  
IGNITRONS THYRATRONS  
TRANSMITTING RECTIFIERS  
TR. • A&R RECEIVING, ETC. CATHODE, RAY

### IT'S YOUR FREE COMPLETE CATALOG, DESCRIBING TUBE CHARACTERISTICS

Ready to be mailed. Call REpublic 5-0215 or write . . .

### V & H RADIO-ELECTRONICS

We Give Prompt Service on Request for Quotation.

2029-2047 W. Venice Blvd., Los Angeles 6, Calif. TWX LA 1460 Cable: VHRAELECT



**SPECIAL VALUES!!**

CV-12/APR-6. Mixer Assy. for APR-6 receiver, 4000 mc. 6000 mc. Tunable C Band waveguide. \$24.50  
 CV-13 Mixer Assembly for APR-6 receiver. The mixer is designed to cover the range 2000 to 4000 mc. \$22.50  
 SPR-2 front end. Consists of a dual butterfly detector assembly covering 80 to 1,000 mc. Means are provided for automatically scanning the spectrum, and for recording the signals on 2-inch paper tape. Brand new, complete with 1N27 crystal and amphenol fittings. \$35.00  
 Klystron mount for 726A klystron (10 cm). Complete with tuning plunger and all fittings. \$7.95  
 BC 911. dual coax. switch. With British connectors. Useful up to 400 mc. \$22.50  
 90 deg. elbows "L" Band with flanges "H" Plane \$18.55  
 Armatures for BD86 dynamotors. \$2.50  
 Antenna Strain Insulators: Johnson #136-151. \$2.00  
 Sawtooth potentiometer. W.E. #KS15138LO-1. 100 ohms. 5.76 Watt. Delivers sawtooth current waveform 360 deg. contin. rotation. Brushes 180 deg. apart. \$2.50  
 Capacitor Pyranol #14F103. 0.25 mfd/25,000 vdc. \$18.35  
 Receiver front end cavity resonator: Tunes 2700 to 3400 mc with a loaded Q of 3000. 50-ohm, type N input. Video output from 1N27 crystal. May be used at quarter wave (1.1 to 1.4 kmc). \$22.50



**CROSS GUIDE** directional coupler UG40 output flange. Main guide is 6" long with 90° "E" plane bend at one end, and is fitted with std. UG39/UG40 flanges. Coupling figure 20DB. \$15

APT-4 Jamming transmitter. Uses 5J30 or 5J31 magnetron. Power output: 130 watts, 350-780 mc. Used, less tubes, ex. cond. \$32.50  
 FILTER, Artificial Line: WECO D163169. 650 ohms imp. insertion loss: 5 db. \$32.50  
 Barry shock mounts: nos. 2045, C-2060, C-2070, C-2090 \$45.00 ea.  
 Trihedral radar reflector, MK-1, aluminum. \$3.50  
 SPLICER, for 11/16 perforator tape, WECO #X-61859 list 20 SCS #47W 61859-20. Complete set with number tape dispenser. \$8.50  
 MN 28Y Control box, unit of MN 26 compass. New. \$3.75  
 Noise filter, Malloy NF1-1. 100 amp/35vdc. \$1.00  
 Power supply unit, navy type—EL-2. Input: 115 vac. 50 cy. Output: 135 vdc/10 ma. 90vdc/5ma 3 vdc/350 ma. New, complete with spare parts box. To be used with model TRX radio gear. \$9.50  
 Pulse analyzer, type APA-6. With 3 in. scope. \$235  
 Phase-shifter, Heinholz type 0-360 deg. \$2.50  
 Capacitor, oil-filled, 0.25 mfd/25,000 volts dc. \$15  
 Hydrophone, MODEL M-2. A lattice of 3 crystals in a disk-like structure. 17-37 Kc. \$27.50  
 F.T.&R. 101-A. Two-wire applique, contains equalizing devices, and balancing circuits. Used for adapting 2-wire military circuits to 4-wire systems. \$47.50

**I. F. AMPLIFIER STRIPS**

Model 15: 30 mc center freq. B.W., 2.5mc. Gain: 65db. Uses 5 stages of 6AK7. Has DC restorer and video detector. Input impedance: 50 ohms. Less tubes \$15.00  
 30 Mc. IF strip. Uses 6-6AC7. Bandwidth is 2mc. Gain: 120 db. New, complete with all tubes and schematic. \$24.50  
 60 MC. Miniature IF strip, using 6AK5's 80 Mc center Freq. Gain: 95 db at Bandwidth of 2.7 Mc. New. Complete with tubes. \$15.00

**COMMUNICATIONS EQUIPMENT CO.**

343 Canal St.  
 New York 13, N. Y.  
**CHAS. ROSEN**

Phone: CA nAl 6-4882

DIRECT ALL INQUIRIES TO DEPT. E-10

**MICROWAVE ANTENNAS**

AT49/APR—Broadband Conical, 300-3300 MC. \$8.95  
 3 CM ANTENNA ASSEMBLY: Uses 17" paraboloid dish, operating from 24 vdc motor. Beam pattern: 5 deg. in both Azimuth and elevation. Sector Scan, over 160 deg. at 35 scans per minute. Elevation Scan, over 2 deg. Tilt. Over 24 deg. \$35.00  
 3 cm Horn, 1" x 3/4", with twist and 180 deg. bend. With dielectric window. \$22.50  
 Discone Antenna, AS 125 APR, 1000-3200 mc. Stub supported with type "N" Connector. \$14.50  
 AS14/AP, 10 CM pick up dipole assy. complete w/ length of coax and "N" connectors. \$4.50  
 30" Parabolic Reflector Spun Aluminum dish 10 1/2" Focus \$4.85  
 AN/APA-12—Sector Scan adaptor for APS-2 radar—Complete Kit \$15.00  
 10 CM. ANTENNA ASSY (Airborne), 30" dish with coax. dipole feed. Focal length is 10 1/2" Horiz polarization, 350 deg. azimuth. Tilt: plus and minus 20 deg. 28 vdc drive motor, selsyn takeoff. \$65.00

**MICROWAVE TEST GEAR**

T-85/APT-5 Transmitter, 30 watts, noise modulated. 300-1400 mc. Requires 3C22 lightbulb tube. Units in excellent condition, less tubes. \$45.00  
 AT48/IF Pickup horn antenna for 3 cm. Silver plated. 3 1/2" long, with type N fitting. \$12.50  
 TS33/AP frequency meter. For measuring pulsed or CW signals of Itard sets in the frequency range of \$8700-9500 mc. \$55.00  
 TS14/AP Signal Generator. Freq. range 3200-3370 mc. Pulse width 1-2.8 usec. continuously variable. Rep. rate 300-2500 cps. Complete with power monitor system. \$97.50  
 TS69/AP cavity wavemeter, 340-1000 mc. Used, excellent with veeder root counter and calibration charts. \$35.00  
 P4E-Synchroscope: 4 mc. bandwidth with a gain of 100. 5-inch display, includes 2-stage video amplifier. Writing speeds 0.04/0.166/0.572 in per microsec. \$65.00  
 TS/28/UPM Synchroscope. Uses 5CP1 tube and may be used as a regular scope with repetitive sweeps. Signal gain is 100 with a bandwidth of 5mc. Triggered sweeps range from 1 to 6 microsec per inch. \$85.00  
 CW TEST SET, TS45/APM-3. Complete with 10 cm. consisting of a single generator covering 9300-9400 mc, plus a built-in power monitor and wavemeter. Power output is 10 mw, and the power meter/monitor can measure power up to 40 db above 1 mw. The wavemeter has a "Q" of 1,000 and an absolute accuracy of 2 mc. Operates from 115/50-2400 cy/1 phase. Ideal for testing radar receivers and transmitters, telemetering equipment, microwave links, and for microwave laboratory work. New. \$69.00

**10 CM.—RG48/U Waveguide**

10CM ECHO BOX: Tunable from 3200-3333 Mc. For checking out radar transmitters, for spectrum analysis, etc. Complete with pickup antenna and coupling devices. \$17.50  
 POWER SPLITTER for use with type 726 or any 10 CM Shepherd Klystron. Energy is fed from Klystron antenna through dual pick-up system to 2 type "N" connectors. \$12.50  
 LTR, LIGHTHOUSE ASSEMBLY. Parts of RT39 APG 5 & APG 15. Receiver and Trans. Cavities w/ assoc. Tr. Cavity and Type N CPLG. To Recv. Uses 2C40, 2C43, 1B27, Tunable APX 2400-2700 MCS. Silver Plated. \$15.00  
 BEACON LIGHTHOUSE cavity p/o UPN-2 Beacon 10 cm. Mr. Bernard, Rice, each. \$27.50  
 MAGNETRON TO WAVEGUIDE Coupler with 721-A Duplexer Cavity, gold plated. \$15.00  
 721A TR BOX complete with tube and tuning plungers. \$12.50  
 AS14A AP-10 CM Pick up Dipole with "N" Cables \$4.50  
 HOLMDELL-TO-TYPE "N" Male Adapters. W. E. #D167284. \$2.75  
 ANTENNA, AT49A/APR: Broadband Conical, 300-3300 MC Type "N" Feed. \$12.50  
 "E" PLANE BENDS, 90 deg. less flanges. \$7.50

**VHF UHF**  
**AN/APR-4 38-4000 mc RECEIVER**

—This is a precision receiver covering 38-1000 mc. The set utilizes 5 tuning units with direct reading dials in megacycles. The receiver has a wide and narrow band-width 30 mc I.F. strip which may be selected at will. An output meter is provided to measure signal strength. Outputs are provided for a pulse analyzer and pan adaptor. 110V AC, 60-2600 cycle. With 3 tuning units, excellent. \$159.50

**HI-FI HEADSET** — Uses annular grooved plastic fibre comes with voice coils as in speakers, and brand new Rubber Ear pads to obtain spacing for correct acoustical load. GIVES FINEST MUSIC REPRODUCTIONS! Imp.: 300 Ohms per unit or 600 ohms when wire series. Brand New \$9.95  
 Less Head band. \$6.95

**3 CM Radar Installation in Brand New original boxes.** This is a complete self-contained radar receiver and transmitting unit with parabolic antenna complete with 76 tubes. Indicators and control boxes. Tube complement consists of:  
 2 ea.—723AB 30 ea.—6J6 1 ea.—725A  
 2 ea.—1B22 9 ea.—6VGGT 1 ea.—807  
 4 ea.—3B21 11 ea.—6AK5 1 ea.—VR105  
 2 ea.—3FP7 4 ea.—6SL7GT 4 ea.—VR150  
 3 ea.—5U4 2 ea.—724A  
 (govt. acquis. cost over \$4,000.00). Ship. wt. 331 lbs. W/operating instructions. Your special price \$69.50  
 Write for flyer.

**R. W. ELECTRONICS**  
 2430 S. Michigan Ave. Dept. L Chicago 16, Ill.

**Radalab INC.**

87-17 124th St., Richmond Hill 18, N. Y.  
 Phone Virginia 9-8181-2-3

OVERSEAS CUSTOMERS CALL US DIRECTLY BY  
 TELEX OVERSEAS TELETYPE TWX N.Y. 4-4361

**COMPLETE INSTALLATIONS**

ARC-12	APS-10	GRC-3-8	PRC-6
ARC-21	APS-15	GRC-9	PRC-8-9-10
ARC-27	APS-20	GRC-26	PRC-14
ARC-34	APS-33	GRC-27	SCR-399
ARC-49	APS-34	GRC-32	CRD-6

**AN/APR-4 38-4000 MC RECEIVER**  
 This is a precision receiver covering 38-4000 mc. The set utilizes 5 tuning units with direct reading dials in megacycles. The receiver has a wide and narrow band-width 30 mc I.F. strip which may be selected at will. An output meter is provided to measure signal strength. Outputs are provided for a pulse analyzer and pan adaptor. Each tuning unit has an automatic sweeping mechanism which enables any portion of the tuning range to be scanned automatically. Input 110v 60 cyc. POR

**APA-17**  
 This is a direction finder that is used with the APR-1 and APR-4 receivers. This unit provides a visual indication as to the relative bearing of the radio or radar signal that is received on the receiver unit. Power input 110v 100 cycle and 24v DC APA-17B units cover frequencies up to 10,000 mc. POR

**GROUND INSTRUMENT LANDING SYSTEM**  
 This set consists of an AN/CRN-10 localizer and a AN/CRN-2 glide path ground station. This equipment can be set up at an airport to provide a complete I.L.S. that will operate with the AN/ARN-5 and RC-103 airborne I.L.S. system to provide blind approach facilities. This system can be installed permanently or transported. Each station has complete monitoring facility. Input power is 110V 60 cyc.

**ANTENNA PEDESTALS**  
 We have a large inventory of radar type antennas and associated pedestals, such as SCR-584, MPG-2, SCR-545, SA, SK, SC, SCR-682, APG, APS, APQ, and many others. Please send your requirements. Other data on request.

**TRANSMITTERS • RECEIVERS • RADAR**  
 FREQUENCY SHIFT KEYING and PHOTO TRANSMISSION

SEND FOR OUR NEW CATALOG



Operate your...

- tape recorder
- P. A. system
- portable TV set
- hand tools

FROM YOUR CAR, Boat or Plane!

with



## INVERTERS

FOR CHANGING YOUR STORAGE BATTERY CURRENT TO

A.C. HOUSEHOLD ELECTRICITY ANYWHERE... in your own CAR, Boat or Plane!



**OPERATES**  
PORTABLE TV SET  
directly from your car!

### OPERATES

- TAPE RECORDERS
- DICTATING MACHINES
- PUBLIC ADDRESS SYSTEMS
- ELECTRIC SHAVERS



MAKE YOUR CAR, BOAT OR PLANE  
"A ROLLING OFFICE!"



**OPERATES**  
• RADIOS  
• RECORD PLAYERS  
• MIXMASTERS, ETC.  
directly from your car!

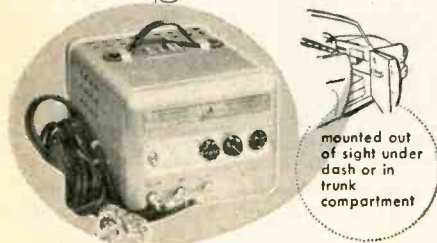

mounted out of sight under dash or in trunk compartment

## ATR UNIVERSAL INVERTERS

Especially designed to change 6 or 12 volt D.C. to 110 volt A.C. 60 cycles. for...

- EXECUTIVES
- SALESMEN
- OUTDOOR MEN
- PUBLIC OFFICIALS
- POLICEMEN
- REPORTERS
- FIREMEN

MODELS 6U-RHG (6 volts) 125 to 150 watts. Shipping weight 27 lbs. List price... \$89.95

DEALER NET PRICE... \$59.97

12U-RHG (12 volts) 150 to 175 watts. Shipping weight 27 lbs. List price... \$89.95

DEALER NET PRICE... \$59.97

Write for literature on other Sizes and Models of ATR INVERTERS, priced as low as \$9.95 list.

SEE YOUR JOBBER OR WRITE FACTORY

- ✓ NEW MODELS
- ✓ NEW DESIGNS
- ✓ NEW LITERATURE
- "A" Battery Eliminators
- DC-AC Inverters
- Auto Radio Vibrators



AMERICAN TELEVISION & RADIO Co.  
Quality Products Since 1931

SAINT PAUL 1, MINNESOTA, U. S. A.

CIRCLE 292 READERS SERVICE CARD

# INDEX TO ADVERTISERS

AMP, Incorporated	55	Cosmic Condenser Co.	185
Ace Electronics Associates, Inc.	112	Cossor (Canada) Limited	188
Ace Engineering & Machine Co.	46	Curtiss-Wright Corp.	171
Acme Wire Co.	161		
Aero Research Instrument Company, Inc.	172	Dale Products, Inc.	130, 131
Airpax Products Co.	141	Dano Electric Co.	194
Alford Mfg. Co., Inc.	166	Daven Company	3rd Cover
Allen-Bradley	17, 18	Daytona Beach Chamber of Commerce	189
Alpha Wire Corp.	177	DeMornay-Bonardi	177
American Lava Corporation	133	Designers for Industry Inc.	182
American Television & Radio Co.	206	Deutscher Co.	79
American Time Products Inc.	54	Dow Corning Corp.	10, 11
Amperex Electronic Corp.	187	du Pont de Nemours & Co. (Inc.) E. I.	
Ampex Corporation	65	Freon Products Division	153
Anaconda Wire & Cable Co.	26, 27	Pigments Dept.	50
Anso, Div. of General Aniline & Film Corp.	19	Durant Manufacturing Co.	176
Art Wire & Stamping Co.	192		
Audio Development Co.	126	Eagle Signal Corp., Industrial Timer Division	159
Autonetics, A Division of North American Aviation, Inc.	34	Eisler Engineering Co., Inc.	182
		Eitel-McCullough, Inc.	39
		Electro-Measurements, Inc.	145
		Electronic Associates Inc.	183
		Electronic Batteries, Inc.	171
		Electronic Instrument Co., Inc. (EICO)	175
		Erie Electronics Division, Erie Resistor Corp.	147
Ballantine Laboratories, Inc.	344	Fairchild Semiconductor Corp.	69
Bell Aircraft Corp.	40	Fansteel Metallurgical Corp.	114, 115, 116, 117
Bendix-Pacific, Division of Bendix Aviation	160	Felker Manufacturing Co.	175
Bird & Co., Inc., Richard H.	184	Ferroxcube Corp. of America	185
Bird Electronic Corp.	154	Freed Transformer Co., Inc.	208
Biwax Corporation	177		
Black & Webster, Inc.	155		
Booker & Wallestad, Inc.	207	G M Laboratories, Inc.	186
British Industries Corporation	23	General Electric Co.	
Brush Instruments Division of Clevite Corp.	33	Apparatus	161
		Silicone Products Department	123
		General Transistor Corp.	127
		Graphic Systems	188
		Grayhill, Inc.	165
		Green Instrument Co., Inc.	166
		Gries Reproducer Corp.	183
Cambridge Thermionic Corp.	52	Hallamore Electronics Company	148
Cannon Electric Co.	173	Harper-Leader Inc.	191
Cedco Electronics	68A	Hart Manufacturing Co.	146
Celco-Constantine Engineering Laboratories Co.	132	Heath Company	143
Centralab, A Division of Globe-Union, Inc.	120	Helipot Corp., Div. of Beckman Instruments	122
Chicago Standard Transformer Corp.	140	Hewlett-Packard Company	24, 25
Cinch Mfg. Corp.	107	Hughes Products, a Div. of Hughes Aircraft Co.	15, 56, 57
Clare & Co., C. P.	51	Humphrey, Inc.	68
Clifton Precision Products Co., Inc.	109	Hunt Company, Phillip A.	70
Comar Electric Company	156	Hycon Electronics Inc.	159
Constantine Engineering Laboratories Co.	132		
Continental-Diamond Fibre Div. of the Budd Company, Inc.	58		



# booker & wallestad

is a plastics molder  
of miniature parts  
with answers to

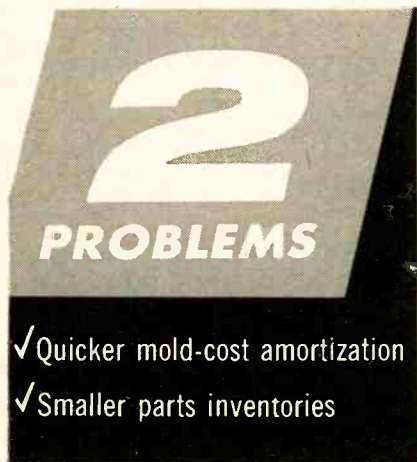

Carry minimum inventories of custom-molded miniature plastics parts without excessive cost penalties.

Write off the cost of molds much more quickly because your original investment is much less.

Booker & Wallestad have developed unique processes for producing precision quality parts in any quantity, using any compound. There are very substantial savings in mold costs. Set-up time is saved. Production time is saved at every step, even when specifications are exacting.

These advantages make possible very short runs of controlled quality. They avoid inventory losses where model changes are frequent. Ask Booker & Wallestad to prove these claims on the basis of your requirements.

# booker & wallestad, inc.

*Unusual SKILL and ECONOMY  
in custom plastics molding...*

3332 Gorham Ave. • Minneapolis 26, Minn.

International Electronic Research Corp.	167
International Rectifier Corp.	63
International Resistance Co.	36

Jones Electronics Co., Inc., M. C.	157
Jones Div., Howard B., Cinch Mfg. Co.	170

Kellogg Switchboard & Supply Co.	74
Kester Solder Co.	119
Kintel, A Division Colu Electronics Inc.	13
Kleinschmidt Div., of Smith-Corona Marchant Inc.	64

Lampkin Laboratories, Inc.	194
Linde Company	77
Los Alamos Scientific Laboratory	168

Magnecraft Electric Co.	187
Magnetics, Inc.	66
Mallory and Co., Inc., P. R.	30, 31
Marconi Instruments, Ltd.	163
McGraw-Hill Book Company	162
Measurements Corp.	192
Melpar Inc.	158
Merck & Co., Inc.	37
Metals & Controls Corp., General Plate Div.	60
Micromech Manufacturing Co.	174
Micro-Switch a Div. of Minneapolis- Honeywell	48, 49
Midwestern Instruments	59
Minneapolis-Honeywell	62
Modine Mfg. Co.	186
Monitor Product Co.	161
Motorola, Inc.	47

Ney Company, J. M.	190
Northern Radio Co., Inc.	170

Ohmite Mfg. Co.	41, 45
Operations Research Office (ORO) John Hopkins University, The	170
Orbitran Company	169
Ozalid, A Division of General Aniline & Film Corp.	38

Panoramic Radio Products, Inc.	150
Pefkins Engineering Corp.	9
Phelps-Dodge Copper Products Corp., Inca Mfg. Div.	68D
Phileo Corporation	80
Polytechnic Research & Development Co., Inc.	73

Quan-Tech Laboratories	160
------------------------	-----

## New ROHN SELF SUPPORTING COMMUNICATION TOWER

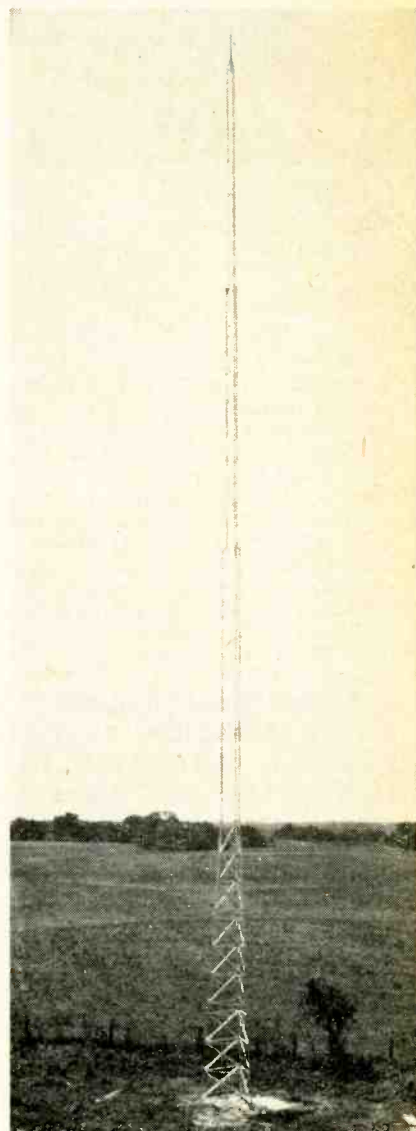

- ★ 120 ft. in height, fully self-supporting!
- ★ Rated a true HEAVY-DUTY steel tower, suitable for communication purposes, such as radio, telephone, broadcasting, etc.
- ★ Complete hot-dipped galvanizing after fabrication.
- ★ Low in cost—does your job with BIG savings—yet has excellent construction and unexcelled design! Easily shipped and quickly installed.

**FREE** details gladly sent on request.  
*Representatives coast-to-coast.*

### ROHN Manufacturing Co.

116 Limestone, Bellevue,  
Peoria, Illinois

"Pioneer Manufacturers of  
Towers of All Kinds"

CIRCLE 294 READERS SERVICE CARD

CIRCLE 293 READERS SERVICE CARD

# FREED

## A.C. DIFFERENTIAL VOLTMETER



TYPE 1560

- Measures the ratio of 2 A.C. Voltages with a resolution of 0.1%
- Independent of voltage phase relation
- Accuracy unaffected by reference voltage stability
- Ideal instrument for measurements of response and gain characteristics of passive and active networks: filters, precision transformers, attenuators, amplifiers, transformer ratios
- Achieves laboratory accuracy in production measurements.

### SPECIFICATIONS

Percent Difference: -10% to +5% in .01% increments on multiturn potentiometer dial. Input Voltage (each channel): .3 volt to 100 volts rms in 5 ranges.

Input Impedance: 470 K ohms shunted by approximately 20 mmf capacitance on 1 volt range; 400 K ohms shunted by 40 mmf.

Frequency Range: 20 to 20,000 cps (MODEL 1560); 20 to 200,000 cps (MODEL 1560E).

Calibration Linearity:  $\pm 0.25\%$  difference, 20 to 20kc;  $\pm 0.5\%$  difference, 20 to 200kc. Power Supply: Electronically regulated; 115 volts, 60 cps input.

### FOR PRECISION LABORATORY OR PRODUCTION TESTING 1110-AB INCREMENTAL INDUCTANCE BRIDGE AND ACCESSORIES



Accurate inductance measurement with or without superimposed D.C., for all types of iron core components.

- INDUCTANCE — 1 Millihenry to 1000 Henry
- FREQUENCY — 20 to 10,000 Cycles
- ACCURACY — 1% to 1000 Cycle, 2% to 10KC
- CONDUCTANCE — 1 Micromho to 1 MHO
- "Q" — 0.5 to 100
- SUPERIMPOSED D.C. — Up to 1 Ampere
- DIRECT READING — For use by unskilled operators.

#### ACCESSORIES AVAILABLE:

- 1140-A Null Detector
- 1210-A Null Detector - V.T.V.M.
- 1170 D.C. Supply and 1180 A.C. Supply.

## FREED TRANSFORMER CO., INC.

1722 Weirfield St., Brooklyn (Ridgewood) 27, N.Y.

CIRCLE 295 READERS SERVICE CARD

RBM Controls Division, Essex Wire Corp. ....	110, 111
R-F Electronics, Inc., Div. of Electro Switch Corp. ....	165
Radio Cores, Inc. ....	169
Radio Corporation of America ....	4th Cover
Radio Engineering Products ....	159
Radio Frequency Laboratories, Inc. ....	164
Radio Receptor Co., Inc. ....	75
Raytheon Mfg. Company ....	6, 178, 192
Reeves Instrument Corp. ....	76
Relay Sales, Inc. ....	129
Revere Corporation of America ....	119
Ribet Desjardins ....	42
Rohn Mfg. Co. ....	207
Rotron Manufacturing Co., Inc. ....	134
Sarkes Tarzian Inc. ....	41
Sigma Instruments, Inc. ....	142
Sorensen & Co. ....	5
Southeo Div., South Chester Corp. ....	4
Speer Carbon Company ....	138
Sperry Electronic Tube, Division of Sperry Rand Corp. ....	113
Sprague Electric Co. ....	3
Stackpole Carbon Co. ....	71
Standard Electric Time Co. ....	173
Statham Instruments, Inc. ....	190
Stevens Mfg. Co., Inc. ....	125
Stoddart Aircraft Radio Co., Inc. ....	184
Superior Cable Corp. ....	32
Sylvania Electric Products, Inc. ....	67
Systron Corporation ....	192
Tabet Mfg. Co., Inc. ....	43
Taylor Fibre Co. ....	152
Technology Instrument Corp. ....	139
Temco Aircraft Co. ....	36
Templet Industries Incorporated ....	174
Texas Instruments Incorporated ....	68B, 68C
Thermal American Fused Quartz Co., Inc. ....	169
Transradio, Ltd. ....	172
Tung-Sol Electric, Inc. ....	53, 61
Ucinite Co. ....	72
Union Switch & Signal Div. of Westinghouse Air Brake Company ....	21
United Shoe Machinery Corp. ....	181
U. S. Stoneware ....	121
United Transformer Co. ....	2nd Cover
Varian Associates ....	151
Veeder-Root, Inc. ....	78
Weckesser Co. ....	188
Weinschel Engr. & Mfg. Corp. ....	191
Welch Scientific Co., W. M. ....	176

Welwyn International Inc. ....	179
Westinghouse Electric Corp. ....	124, 137
Weston Instruments a Division of Daystrom, Inc. ....	29
Wiley & Sons, Inc., John ....	173

Professional Services ....	194
----------------------------	-----

### CLASSIFIED ADVERTISING

F. J. Eberle, Business Mgr.

### EMPLOYMENT OPPORTUNITIES 195-201

EQUIPMENT (Used or Surplus New) For Sale ....	202-205
---	---------

WANTED Equipment ....	202, 204
--------------------------	----------

### ADVERTISERS INDEX

A & M Instrument Service ....	202
Aero Service Corporation ....	200
Avco Manufacturing Corp., Crosley Division ....	196
Barry Electronics Company ....	202
Bendix Aviation Corp., York Division ....	198
C & H Sales Company ....	203
Cadillac Gage Company ....	200
Chance Vought Aircraft Inc. ....	199
Communications Equipment Co. ....	205
Dorsett Laboratories, Inc. ....	201
Electronics Laboratory Supply Co. ....	204
Engineering Associates ....	204
Fair Radio Sales ....	202
Fidelity Personnel Service ....	200
Finnegan, H. ....	202
General Electric Company ....	201
Gibson Company, J. H. ....	200
Haller, Raymond & Brown, Inc. ....	196-198-199 200-201
Instrument Service Engineering Labs ....	204
International Business Machines ....	195
JSH Electronics Company ....	204
Kollsman Instrument Corp. ....	201
Krantz Company, Harry ....	204
Lear, Incorporated ....	200
Legri S. Company ....	204
Marquardt Aircraft Company ....	196
Monmouth Radio Labs ....	202
Motorola Inc. ....	198
Norden Laboratories, Norden Div. of United Aircraft Corp. ....	199
Paramount Designs ....	200
Pennsylvania State University ....	198
Radalab Inc. ....	205
Radio Research Instrument Co. ....	204
R. W. Electronics ....	205
Stromberg-Carlson, Div. of General Dynamics Corp. ....	197
TAB ....	202
V. & H. Radio-Electronics ....	204

This index is published as a service. Every care is taken to make it accurate, but ELECTRONICS assumes no responsibilities for errors or omissions.





**Top reliability in miniature size...**

**Daven wire wound resistors**

For printed circuit boards, miniature plug-in packages... any tight place in which you must have a really small wire wound resistor, check Daven for the Super Davohm Miniatures that can solve your problem. For example...

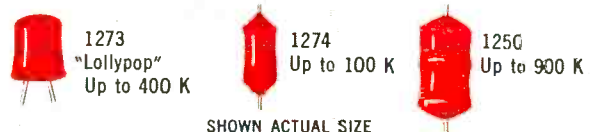

SHOWN ACTUAL SIZE

These resistors meet and exceed all requirements, except physical size, of MIL-R-93-B, and MIL-R-9444.

The overall stability of Daven Miniature Resistors is possible because of an entirely new approach to subminiature production techniques. A unique spool design permits low-stress winding of fine resistance wire... obtaining 2 to 3 times the resistance value previously supplied on a miniature bobbin. This is done under the most stringent quality control and inspection.

The industry's widest range of sizes, temperature coefficients, and tolerances is available for your requirements. Write today for further information and a complete resistor catalog.

THE **DAVEN** CO.  LIVINGSTON, NEW JERSEY

TODAY, MORE THAN EVER, THE DAVEN © STANDS FOR DEPENDABILITY



# Over 1,000,000 Hours

of trouble-free service from 100

RCA-6198 Vidicons

...in Pennsylvania Station, N. Y.



Every one of the 100 Dage cameras in Pennsylvania Station, New York, is equipped with an RCA-6198 Vidicon.



This is what James L. Lahey, General Manager of Dage Television Division of Thompson Products, Inc. says about the performance of RCA-6198 Vidicons:

*"...all the RCA-6198 vidicon tubes performed satisfactorily in excess of 10,000 hours and, although a few have been replaced in the last few weeks, it appears that 80% will pass the 15,000 hour mark."*

**T**HE REMARKABLE 100-camera system placed in operation by Dage in February 1957 is substantially increasing the efficiency of ticket sales and reservations at New York's famed Pennsylvania Rail-

road Station. And noteworthy is this fact: *Every camera in this system is equipped with an RCA-6198 Vidicon.*

RCA anticipated the need for reliable high-quality TV-camera tubes in industrial and military TV applications, and is providing equipment designers with quality-built industrial-type Vidicons for a variety of applications.

If your TV-system designs call for camera-tube reliability backed by both design and field experience, then by all means look into the advantages of RCA Vidicons. Your RCA Field Representative will be glad to discuss the use of RCA Vidicons in your applications.

#### Industrial Products Sales

744 Broad St., Newark 2, N. J.  
HUmboldt 5-3900

Suite 1154, Merchandise Mart Plaza  
Chicago 54, Ill.  
WHitehall 4-2900

6355 E. Washington Blvd.  
Los Angeles 22, Calif.  
RAYmond 3-8361

#### Government Sales

415 S. Fifth St., Harrison, N. J.  
HUmboldt 5-3900

224 N. Wilkinson St., Dayton, Ohio  
BALdwin 6-2300

1625 "K" St., N. W.,  
Washington 6, D. C.  
DIstrict 7-1260



**RADIO CORPORATION OF AMERICA**

® Electron Tube Division

Harrison, N. J.