

MAY • 1956

electronics

A MCGRAW-HILL PUBLICATION • PRICE 75 CENTS

ELECTRONICS IN THE PROCESS INDUSTRIES

page 138

Irradiated Wire
Insulation146

Video
Transformers150



Automatic
Circuit-Plating
Machine



for the HIGHEST in RELIABILITY

UTC products are the most copied in the world. This is only natural, since we maintain the largest laboratories and engineering staff in our field. However, copying alone cannot provide the measure of uniformity and reliability inherent in UTC units. To provide for the maximum in quality and reliability, continuing programs of quality control and quality improvement are constantly maintained in our laboratories.

WHAT MAKES A TRANSFORMER FAIL?
 Illustrated are a few views of the UTC Reliability Laboratory in action... finding the answers.



Qualitative micro analysis.



Vibration stress analysis.



Torque testing of standard assemblies.



Checking uniformity of thermoplastic compounds.

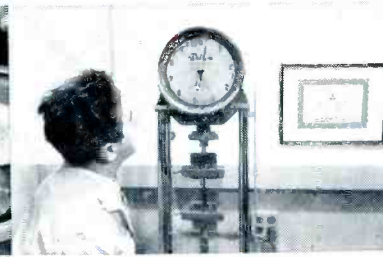

Quantitative checking of weld strength.



Hermetic terminals on microscope check.



Chemical section analyzing new materials.



Microscope analysis of dissection units.

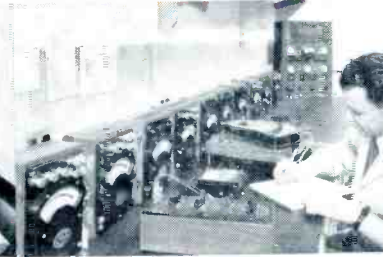

Calibration to primary standards.



Pilot plant hydrogen annealing.



Seal tests under extremes of cold, heat, and altitude.



Abrasion and mercury tests on magnet wire.



Pilot plant run on encapsulating material.



Corrosion testing on insulating materials.

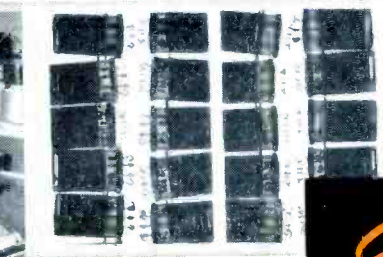

Non-destructive quality control by x-ray.

IS THIS PROVEN RELIABILITY AND UNIFORMITY IN THE COMPONENTS OF YOUR EQUIPMENT?

A large aircraft company... "Our vendor analysis for past year (thousands of tests) shows zero rejects."

A large electric company... "Consistent quality has placed you as our #1 source...are grateful for the aid you have given our own quality control staff."

A large military electronics company... "Switching from former vendor to UTC has saved us 18% of transformer and filter cost by reducing manufacturing costs."

A large instrumentation company... "We haven't had one field failure in fifteen years' use of UTC parts*."

*Over 100,000 units.

United Transformer Co.
 150 VARICK STREET • NEW YORK 13, N. Y.
 EXPORT DIVISION: 13 EAST 40th STREET, NEW YORK 16, N. Y. CABLES: "ARL"

A MCGRAW-HILL PUBLICATION

H. W. MATEER, *Publisher*

W. W. MacDONALD, *Editor*

VIN ZELUFF, *Managing Editor*

JOHN MARKUS, *Associate Editor*

ALEXANDER A. MCKENZIE, *Associate Editor*

JOHN M. CARROLL, *Associate Editor*

JOHN M. KINN, JR., *Associate Editor*

WILLIAM P. O'BRIEN, *Assistant Editor*

WILLIAM G. ARNOLD, *Assistant Editor*

DAVID A. FINDLAY, *Assistant Editor*

HAIG A. MANOOGIAN, *Assistant Editor*

GLORIA J. FILIPPONE, *Editorial Assistant*

ARLENE SCHILP, *Editorial Assistant*

CAROLE A. MORRIS, *Editorial Assistant*

GLADYS T. MONTGOMERY, *Washington Editor*

HARRY PHILLIPS, *Art Director*

WALLACE B. BLOOD, *Manager*

R. S. QUINT, *Buyers' Guide Manager*

FRANK H. WARD, *Business Manager*

GEORGE E. POMEROY, *Classified Manager*

DONALD H. MILLER, *New York*

JAMES GIRDWOOD, *New York*

THOMAS B. VOUGHT, *New York*

WM. S. HODGKINSON, *New England*

JAMES T. HAUPTLI, *Philadelphia*

CHARLES WARDNER, *Chicago*

BRUCE WINNER, *Chicago*

WALTER M. LUCE, *Chicago*

HENRY M. SHAW, *Cleveland*

T. H. CARMODY, *San Francisco*

R. C. ALCORN, *San Francisco*

CARL W. DYSINGER, *Los Angeles*

WILLIAM KEARNS, *Atlanta*

GORDON L. JONES, *Dallas*

DOUGLAS BILLIAN, *Dallas*

HERBERT LAGLER, *London*

KEITH HENNEY, *Consultant*

AUTOMATIC CIRCUIT-PLATING MACHINE—Unloading XXP laminate strips on which tv circuits have been produced, by 75-foot-long automatic Thru-Con plater in Auburn, N. Y. plant of GE's Electronic Components Department (see p 234).....COVER

SHOPTALK 2

FIGURES OF THE MONTH 6

INDUSTRY REPORT 7

TV Tape Recording	7	Hi-Fi Gets Transistors	16
Engineers Get Top Pay	7	Electronics: San Francisco	16
Announce New Transistors	8	Electronics In Bowling	20
Companies Size Up Profits	8	How Industrial TV Stands	20
Canadian Radar Expanding	9	Senate Gets UHF-TV Data	22
President Hails de Forest	9	Transistor Activity Abroad	22
Flat TV Tube Picture	12	Rising Copper Prices Halt	24
Computer Firm Mergers	12	Fire Fails To Upset Output	24
Insulation Sales Rise	14	Output Up In West Germany	24
British Demonstrate Color	14	Future Meetings	26
		Industry Shorts	26

CROSSTALK 137

FEATURES

Electronics in the Process Industries 138

By John M. Carroll

Electrons Produce High-Temperature Dielectric 146

By James B. Meikle and Bruce Graham

Toroidal Transformers Pass Video Bandwidths 150

By G. W. Gray

VHF Transhorizon Communication Techniques 154

By R. M. Ringoen and J. W. Smith

Transistor Circuits for Digital Computers 160

By D. E. Deutch

Techniques for Measuring Noise—Part III 162

By W. R. Bennett

Beam Deflection Tube Simplifies Radio Compass 166

By J. M. Tewksbury

CONTINUED ON NEXT PAGE

contents

continued

Radar PRI Display Uses Precision Interlace 168
By A. Shulman

TV Modulation Indicator Uses Electronic Chopper 172
By Edward M. Tink

Telemetry Receiver Conserves Bandwidth 174
By M. S. Redden, Jr. and H. W. Zancanato

Transistor Generator Simulates Radar Target 179
By William Eckess, Joe Davenport and Kenneth Sherman

Bevatron Frequency Measurement System 182
By William Brobeck and W. C. Struven

Radar Second Detector Filter Nomograph (Reference Sheet)... 188
By Chester W. Young

ELECTRONS AT WORK 192

Thermocouple Effect for Metals...192	Cycle Counting Welder.....206
Lemons Sorted Into Five Groups...192	Fusion Heat Stabilizes Crystal...208
Remote Broadcast Amplifier.....192	Atomic Reactor Camera.....212
By Ken Maxwell	British Scatter Terminal.....214
Equipment Coordinates Nike....194	TV Monitors Nuclear Separation...214
Robot Telemeters Weather.....196	Quick Microwave.....216
Early Microwave Anniversary.....198	One-Way Waveguide Correspondence 218
Warehouse Guarded With ITV...200	Pertinent Patents.....226
Meter Adapter for Blind.....202	By Norman L. Chalfin
By J. Atkin, H. Bickel and V. Proscia	

PRODUCTION TECHNIQUES 234

Automatic Circuit-Plating.....234	Air-Leak Gages Check Pots.....256
Tuner Life-Testing Machines.....236	Production-Floor Cable Rack.....260
Grinder Tins Ceramics.....238	Jumper-Inserting Head.....262
Grommet-Inserting Tool.....240	Sandblasting Rotors.....266
Fixture Aids Varnishing.....243	Etched-Wiring Connections.....268
Socket-Holding Tool.....252	Stapling Cup on TV Back Cover...276
Shaft-Spinning Setup.....254	Assembling Image Orthicons.....278
Hole Sizes for Wiring Boards....282	

NEW PRODUCTS 284

LITERATURE 358

PLANTS AND PEOPLE 368

NEW BOOKS 399

THUMBNAIL REVIEWS 404

BACKTALK 406

INDEX TO ADVERTISERS 463

SHOP

► **HOME, SWEET HOME** . . . In mid-March (p 121, April issue) we left our Editor hanging over a hot typewriter in Los Angeles and wondering about the weather ahead.

It was spring in Phoenix (ah!), the temperature in Dallas was 85 one night and 43 the next (??) and, back in New York, Mac arrived just in time to enjoy (x&%#!) the heaviest snowstorm of the entire winter.

He tells us that even if he had not planned to return east after a month and nearly 7,000 miles in the field it would have been necessary, since most manufacturers were packing their products and personal belongings and heading for the IRE convention in the last week anyway.

► **NEXT ISSUE** . . . The engineers who taught the electron tube to think right after World War II uncorked a two-headed djinni. After we took a close look at digital computers (Electronic Computers for the Businessman, p 122, June 1955), the next step was to look into the analog field.

While digital machines have trespassed into areas as diverse as insurance and retail merchandising, the analog machine has stayed with the engineer. Hence the title of the article, **ANALOG COMPUTERS FOR THE ENGINEER**, in next month's issue.

electronics

MAY, 1956

Vol. 29, No. 5



Member ABC and ABP

TALK

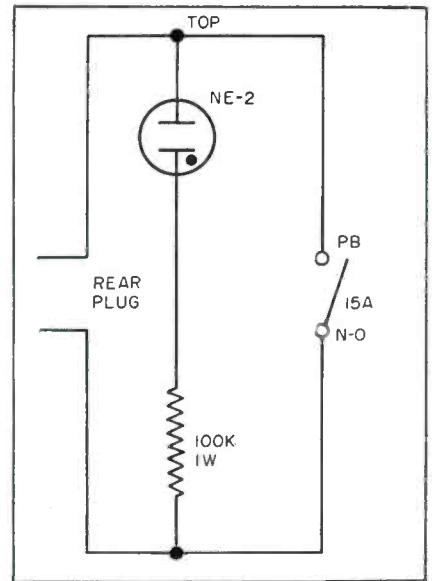
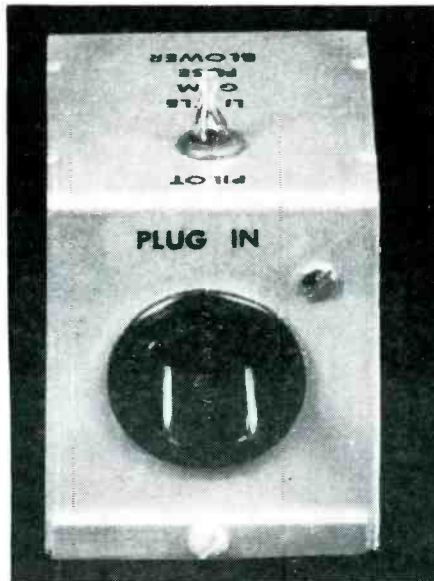

Front and rear views of apparatus for conducting research on human frailty. We included the circuit so that there could be no doubt of the positive action of the low-impedance shunt

► **PSYCHO-ELECTRONICS** . . . A new field of research is suggested in the following short paper received from one who calls himself Juan Carlos Mente-Borracho, PhD. He says his assistant, who has better English, calls it electro-psychotics:

The human proclivity for performing certain operations in an almost compulsive manner regardless of printed or spoken instructions to the contrary is well known, and is best evidenced by the border of fingerprints to be found about almost any WET PAINT sign.

To determine just how prevalent this human failing actually is, various experimental devices have

been tested in west coast laboratories, nameless by their own request.

Simplest, and most successful, of these devices is the Little Gem Fuse Blower. This consists of a small aluminum box, shown in the photographs. On the top surface is a neon bulb mounted in a grommet. At top front is the name of the device applied as a decal. The plug, switch and bulb shown in the diagram are appropriately labelled.

In operation, the fuse blower is found on an engineer's desk when he returns from the water cooler. It is picked up by the recipient.

The apparatus is then plugged into the nearest a-c outlet, the engineer noting with approval that

the pilot lights immediately. He then pushes the button.

A loud noise is heard from the direction of the fuse box and the lights in that engineering bay go out. A snickering noise is heard from middle distance, dull grumblings from the engineer, and all is darkness in that vicinity until the janitor puts in new fuses.

After a short interval, the first recipient of the apparatus leaves his office, taking the device with him. When he returns, without the device, he sits expectantly at his desk until the lights in some other engineering bay go out. Approximately 60 percent of the recipients of this device act in this manner.

Published monthly with an additional issue in June by McGraw-Hill Publishing Company, Inc., James H. McGraw (1860-1948), Founder, Executive Editorial and Advertising Offices; McGraw-Hill Building, 330 W. 42 St., New York 36, N. Y. Longacre 4-3000. Publication Office, 99-129 North Broadway, Albany 1, N. Y. Donald C. McGraw, President; Paul Montgomery, Executive Vice-President; Joseph A. Gerardi, Vice-President and Treasurer; John J. Cooke, Secretary; Nelson Bond, Executive Vice-President, Publications Division; Ralph B. Smith, Vice-President and Editorial Director; Joseph H. Allen, Vice-President and Director of Advertising Sales; J. E. Blackburn, Jr., Vice-President and Circulation Director.

Subscriptions: Address correspondence to Electronics—Subscription Service, 330 W. 42nd St., New York 36, N. Y. Allow one month for change of address. Subscriptions are solicited only from persons engaged in theory, research, design, production, maintenance and use of electronic and industrial control components, parts and products. Position and company connection must be indicated on subscription orders.

Single copies 75¢ for United States and possessions, and Canada; \$1.50 for Latin America; \$2.00 for all other foreign countries. Buyers' Guide \$3.00. Subscription rates—United States and possessions, \$6.00 a year; \$9.00 for two years. Canada: \$10.00 a year; \$16.00 for two years. Other western hemisphere countries and the Philippines, \$15.00 a year; \$25 for two years. All other countries \$20.00 a year; \$30.00 for two years. Three-year rates, accepted on renewals only, are double the one-year rate. Entered as second-class matter August 29, 1936, at the Post Office at Albany, N. Y., under act of Mar. 3, 1879. Printed in U.S.A. Copyright 1956 by McGraw-Hill Publishing Co., Inc.—All Rights Reserved.

BRANCH OFFICES: 520 North Michigan Avenue, Chicago 11, Ill.; 68 Post Street, San Francisco 4; McGraw-Hill House, London, E. C. 4; Washington, D. C. 4; Philadelphia 3; Cleveland 15; Detroit 26; St. Louis 8; Boston 16; 1321 Rhodes-Haverty Bldg., Atlanta 3, Ga.; 1125 West Sixth St., Los Angeles 17; 919 Oliver Building, Pittsburgh 23. ELECTRONICS is indexed regularly in The Engineering Index.

SORENSEN

ENGINEERS STANDARD MODELS TO MEET SPECIAL REQUIREMENTS

*to illustrate this flexibility, engineers can
now choose from five 1000VA regulators!*

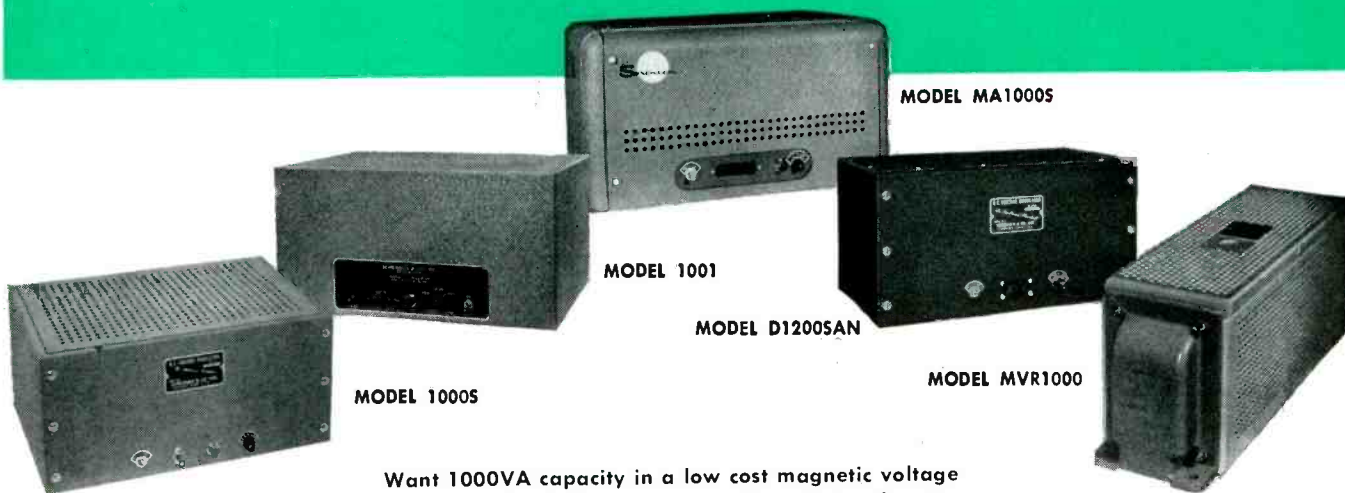

MODEL 1000S — Automatic wide-range electronic regulation with the original Sorensen frequency insensitive circuit incorporating the safety diode. Regulation $\pm 0.1\%$.

MODEL MA1000S — For unattended installations requiring extremely dependable automatic line regulation. This tubeless unit offers stable long-life performance with minimum maintenance. Regulation $\pm 0.5\%$ over wide frequency range.

Want 1000VA capacity in a low cost magnetic voltage regulator with 0.5% regulation? Then choose the new Sorensen MVR1000; compact, economical. Need 1000VA, but with 0.01% regulation? Then choose Model 1001. For any requirement, any application, there's a Sorensen 1000VA unit engineered with you in mind.

And the same thing is true for practically any specified requirement in the field of regulated power — whatever you need, Sorensen makes it now or will make it to do exactly the job you want done, within the limits of your particular application. Sorensen offers you the widest possible range of characteristics. For research or industry, call on Sorensen — *the world's authority on regulated power.*

SEND FOR 1956 CONDENSED CATALOG
New and more complete — gives condensed specifications on a wide range of units for a variety of applications. Be sure you have all available information when you specify — send for your copy today!

MODEL 1001 — Developed from unique, dependable Sorensen regulating circuit, refined for ultra-precise $\pm 0.01\%$ regulation.

MODEL D1200SAN — $\pm 0.25\%$ regulation for 400 cycle industrial and aircraft requirements up to 1200VA.

MODEL MVR1000 — New low cost compact magnetic voltage regulator for less exacting applications. Fully automatic $\pm 0.5\%$ regulation with fast response time.



SORENSEN & COMPANY, 375 FAIRFIELD AVENUE, STAMFORD, CONN.

TECHNIQUE

MUIRHEAD

A JOURNAL OF INSTRUMENT ENGINEERING

A FREE
QUARTERLY

FOR THE
ENGINEER
TECHNICIAN
SCIENTIST
RESEARCH WORKER
and all others interested in
SCIENTIFIC INSTRUMENTS
and their applications

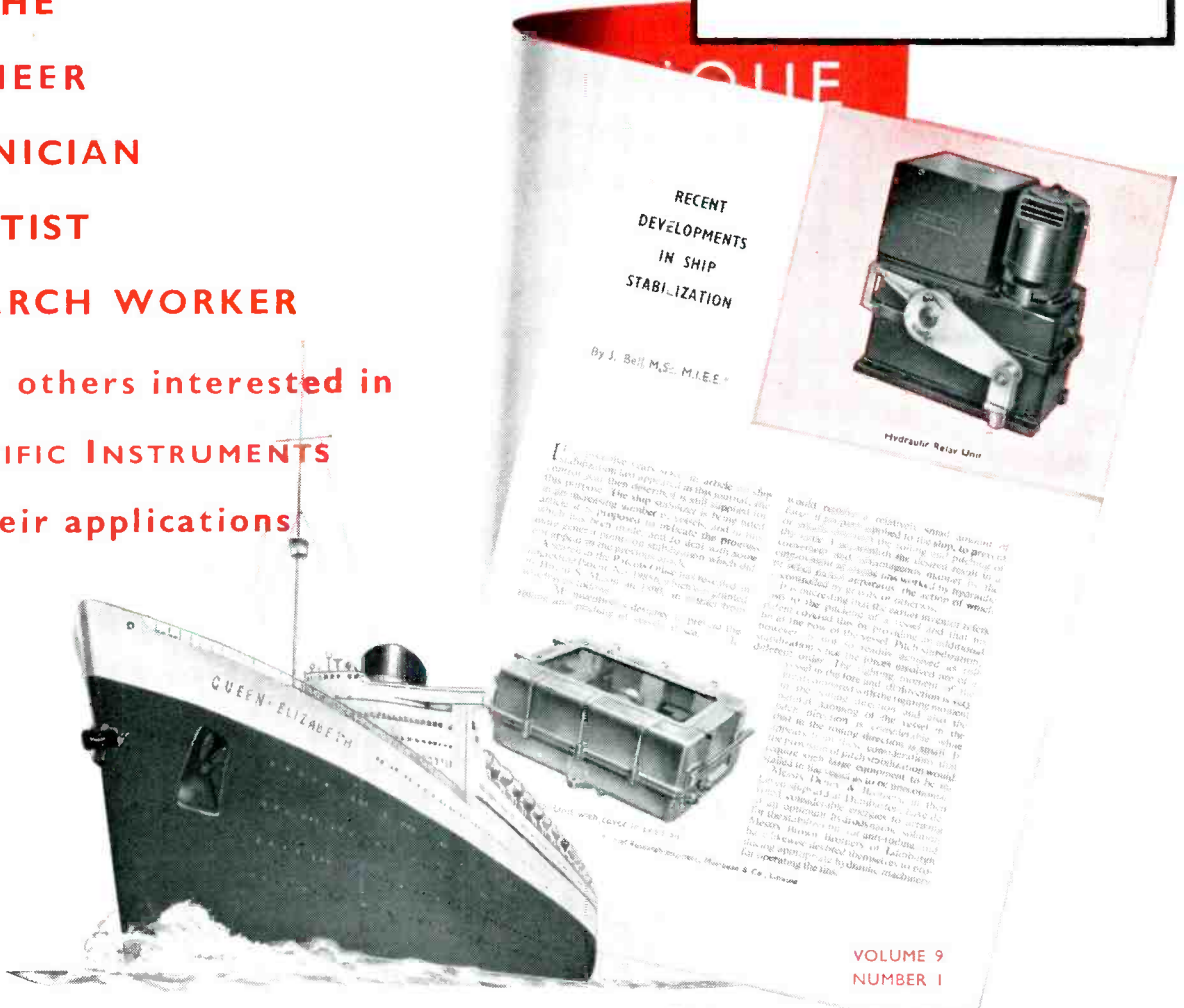

With Technique coming to you quarterly, you will be kept informed of the latest Muirhead instruments and learn about their applications in industry, research and education. Join the ever increasing number of regular readers by mailing the adjacent coupon, or write under your business letterhead to the address below.

MAIL THIS COUPON

MUIRHEAD INSTRUMENTS INC.
677 Fifth Ave., New York 22, N.Y.

NAME _____
STREET _____
CITY _____ ZONE _____
STATE _____
COMPANY _____
POSITION _____

TECHNIQUE

MUIRHEAD

MUIRHEAD INSTRUMENTS Inc. 677 Fifth Ave., New York 22, N.Y.

United States Sales and Service for MUIRHEAD & CO. LIMITED · Beckenham · Kent · England

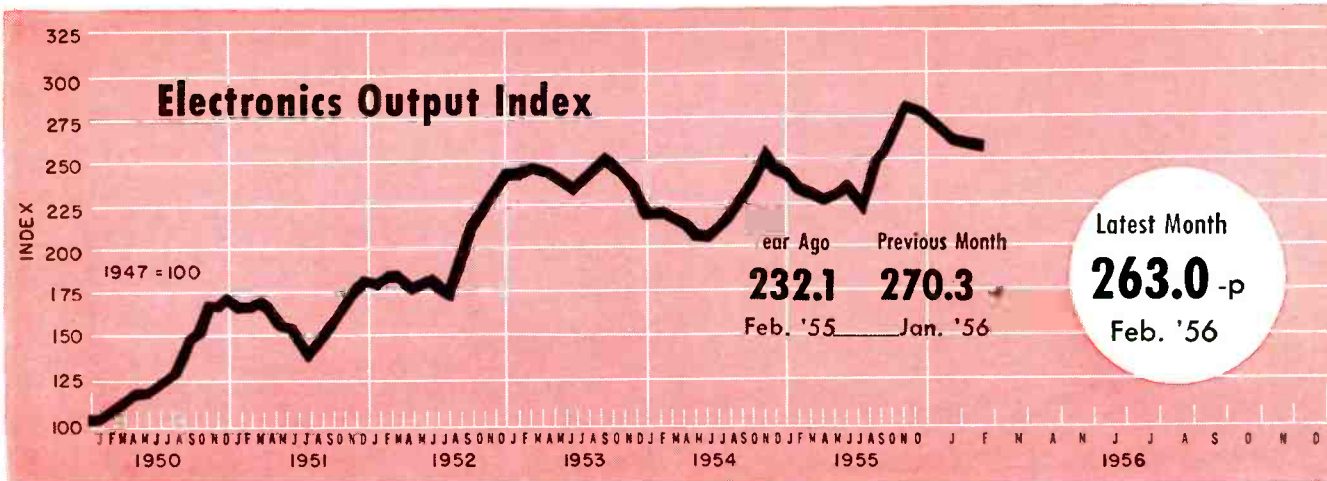

FIGURES OF THE MONTH

	Latest Month	Previous Month	Year Ago
RECEIVER PRODUCTION			
(Source: RETMA)	Feb. '56	Jan. '56	Feb. '55
Television sets, total	576,282	588,347	702,514
With UHF	78,956	82,107	101,217
Color sets	nr	nr	nr
Radio sets, total	1,093,506	1,078,624	1,089,724
With F-M	2,660	nr	17,751
Auto sets	437,611	519,648	597,742

	Latest Month	Previous Month	Year Ago
RECEIVER SALES			
(Source: RETMA)	Feb. '56	Jan. '56	Feb. '55
Television sets, units	530,554	614,213	626,613
Radio sets (except auto)	454,867	531,206	320,042

	Latest Month	Previous Month	Year Ago
RECEIVING TUBE SALES			
(Source: RETMA)	Feb. '56	Jan. '56	Feb. '55
Receiv. tubes, total units . . .	37,754,000	40,141,000	38,526,000
Receiv. tubes, value	\$30,756,000	\$31,314,000	\$28,108,000
Picture tubes, total units . . .	898,063	892,385	859,529
Picture tubes, value	\$17,136,695	\$17,016,391	\$17,119,568

	Quarterly Figures		
	Latest Quarter	Previous Quarter	Year Ago
(Source: NEMA)	4th '55	3rd '55	4th '54
Vacuum (non-receiving)	\$9,967,411	\$9,027,845	\$9,338,181
Gas or vapor	\$3,251,621	\$3,438,835	\$3,498,123
Magnetrons and velocity modulation tubes	\$13,726,323	\$10,998,967	\$15,249,651
Gaps and T/R boxes	\$1,578,767	\$1,421,138	\$1,788,780

	4th '55	3rd '55	4th '54
MILITARY PROCUREMENT			
(Source: Defense Dept.)	4th '55	3rd '55	4th '54
Army	\$48,477,000	\$19,477,000	\$44,599,000
Navy	\$20,378,000	\$20,054,000	\$37,328,000
Air Force	\$131,938,000	\$128,023,000	\$92,069,000
Total—Electronics	\$200,793,000	\$167,554,000	\$173,996,000

	Latest Month	Previous Month	Year Ago
BROADCAST STATIONS			
(Source: FCC)	Mar. '56	Feb. '56	Mar. '55
TV stations on air	488	485	451
TV stations CPs—not on air . . .	109	106	122
TV stations—new requests	24	22	20
A-M stations on air	2,858	2,841	2,703
A-M stations CPs—not on air . . .	115	123	103
A-M stations—new requests	262	247	194
F-M stations on air	536	539	538
F-M stations CPs—not on air . . .	12	13	10
F-M stations—new requests	4	4	6

	Feb. '56	Jan. '56	Feb. '55
COMMUNICATION AUTHORIZATIONS			
(Source: FCC)	Feb. '56	Jan. '56	Feb. '55
Aeronautical	44,570	44,331	42,048
Marine	54,637	54,276	48,977
Police, fire, etc.	19,971	19,757	17,289
Industrial	28,054	27,599	23,405
Land transportation	8,726	8,576	7,318
Amateur	145,427	143,841	130,642
Citizens radio	15,563	14,920	9,916
Disaster	327	326	312
Experimental	652	644	597
Common carrier	2,176	2,137	1,822

	Jan. '56	Dec. '55	Jan. '55
EMPLOYMENT AND PAYROLLS			
(Source: Bur. Labor Statistics)	Jan. '56	Dec. '55	Jan. '55
Prod. workers, comm. equip. . . .	393,000-p	403,500-r	358,300
Av. wkly. earnings, comm.	\$74.30 -p	\$75.17 -r	\$70.53
Av. wkly. earnings, radio	\$70.40 -p	\$71.46 -r	\$69.32
Av. wkly. hours, comm.	40.6 -p	41.3 -r	40.3
Av. wkly. hours, radio	40.0 -p	40.6 -r	40.3

	Jan. '56	Dec. '55	Jan. '55
SEMICONDUCTOR SALES ESTIMATES			
Germanium diodes, units	3,300,000	2,690,000	1,700,000
Silicon diodes, units			

	Mar. '56	Feb. '56	Mar. '55
STOCK PRICE AVERAGES			
(Source: Standard and Poor's)	Mar. '56	Feb. '56	Mar. '55
Radio-tv & electronics	465.5	426.8	438.0
Radio broadcasters	543.2	489.8	502.9

p—provisional r—revised nr—not reported

FIGURES OF THE YEAR

Television set production	1,164,629	1,357,096	-14.2	7,756,521
Radio set production	2,172,130	2,157,870	+ 0.7	14,894,695
Television set sales	1,144,767	1,274,198	-10.2	7,421,084
Radio set sales (except auto)	986,073	794,989	+ 24.0	6,921,384
Receiving tube sales	77,895,000	76,477,000	+ 1.8	479,802,000
Cathode-ray tube sales	1,790,448	1,726,485	+ 3.7	10,874,234

TOTALS FOR FIRST TWO MONTHS

	1956	1955	Percent Change	1955 Total
Television set production	1,164,629	1,357,096	-14.2	7,756,521
Radio set production	2,172,130	2,157,870	+ 0.7	14,894,695
Television set sales	1,144,767	1,274,198	-10.2	7,421,084
Radio set sales (except auto)	986,073	794,989	+ 24.0	6,921,384
Receiving tube sales	77,895,000	76,477,000	+ 1.8	479,802,000
Cathode-ray tube sales	1,790,448	1,726,485	+ 3.7	10,874,234

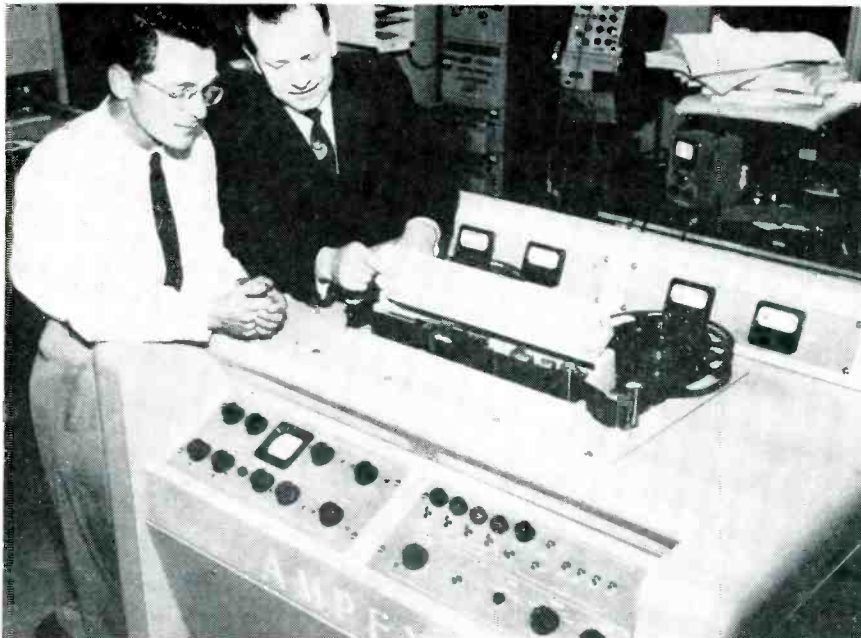

NEW magnetic head assembly adds impetus as . . .

TV Tape Recording Progresses

Ampex delivering three black-and-white units to CBS. Full commercial production in '57

TIMETABLE for the commercial introduction of television tape recording equipment was stepped up when Ampex Corp. announced that it plans to deliver three prototype units to CBS by August. The west coast company plans to build eight prototype units this year and then begin commercial production next February.

Prototype recorders will sell for \$75,000 each but the price is expected to drop eventually to between \$45,000 and \$50,000.

► **Speed**—The Ampex device records

both video and audio signals on magnetic tape two inches wide. The tape moves at a speed of 15 inches a second. Sixty-five minutes of tv programming can be recorded on a 14-inch reel. Frequencies as high as 4 mc can be recorded, according to the company.

The relatively slow tape speed is permitted by use of a magnetic head assembly (four heads on a drum) that rotates at high speed. As one head leaves the tape another touches it, so that one head is always on the tape. The video signals are recorded from side to side, slanting downward across the tape. The audio signals are recorded along one edge in the conventional manner.

The unit demonstrated handled

monochrome tv signals only. The company is working on adapting the device for color tv use.

► **Prospects**—In addition to the CBS order, Ampex reports that research laboratories have indicated interest in the machine to explore its information-recording potential. Several tv stations have placed orders for the units and government and military agencies have expressed interest in the development.

Industry Engineers Get Top Pay

Electrical and mechanical engineering salaries top chemical and industrial pay

DESPITE higher salary offers to attract more engineers, major employers are keeping internal salary relationships in line, according to a recent salary survey covering 33 firms in 19 industries. Precedence given to internal salary structures has tended to have a leveling effect on the market for engineers, according to the study, even though the present supply and demand ratio is two applicants for each 3½ job openings.

► **Median**—The survey, which covers chemical, electrical, mechanical and industrial engineering positions with limited management responsibility, shows that for the entire group, about 66 percent of the salaries fall between \$5,000 and \$8,900. The range, median range and me-

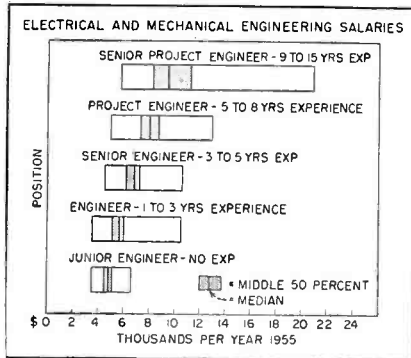

dian for electrical and mechanical engineering salaries is shown in the chart. The median for the group is about \$7,000. This compares to a median salary for chemical engineering positions of about \$6,500 and a median of \$6,000 for industrial engineering positions.

► **Distribution**—The following table shows the percentage distribution of salaries for the three fields surveyed

Salary	Chemical	Electrical and Mechanical	Industrial
Under \$5,000	21.4	12.9	23.1
5-6,900	37.5	36.0	55.0
7-8,900	23.8	32.4	18.9
9-10,900	13.7	12.2	2.9
11-12,900	1.8	6.5	—
13-14,900	1.8	—	—

► **Range**—The survey shows the pay range for mechanical and electrical positions that cover more than 66 percent of the salaries in each position. Approximately 66 percent of senior project engineers earned between \$8,500 and \$12,600; 86 percent of project engineers' salaries were between \$6,550 and \$9,600; 93 percent of senior engineers earned between \$5,600 and \$8,400; and 83 percent of engineers earned between \$4,750 and \$6,800 a year.

► **Future**—A picture of what the future may hold in salary for workers in the electronics-electrical field was given by Ralph J. Cordiner, president of GE. He stated that a greatly expanded national economy, in which the ratio of skilled to unskilled jobs is certain to increase, may make average earnings of \$8,000 to \$9,000 a year entirely possible for General Electric employees by 1966. Average annual earnings of GE employees, including benefits paid by the firm have increased from slightly more than \$2,000 in 1939 to \$5,600 in 1955.

Announce New Transistors . . .

Subminiature triode and vhf tetrodes are introduced as techniques advance

USE of a grown-diffused technique has produced germanium and silicon transistors that operate at usable power levels in the vhf region. Commercial availability of the units has been announced by Texas Instruments.

► **High frequency**—The transistors are tetrodes. A *pnp* germanium unit is rated at 25-mw collector dissipation at 75 C, 200-mc frequency cutoff and maximum oscillation frequency in excess of 250 mc. Units reportedly have oscillated at 450 mc in coaxial circuits.

Two *npn* silicon units have been announced. Both have 125-mw rated total dissipation at 25 C, derated to 25 mw at 125 C. The units are recommended for operation at 12.5

and 30 mc respectively.

Diffusion of donor and acceptor impurities occurs in the liquid phase as the crystal is being grown. A thin base region results which imparts desirable high-frequency characteristics to the transistor. Precise control of temperature and other variables is required. Diffusion of impurities can be controlled by taking into account the different diffusion rates of group 3 donor and group 5 acceptor materials.

► **Subminiatures**—A *pnp* alloy-junction triode transistor small enough so that more than 20 can be placed on a dime has been developed by Philco. The unit withstands 20,000 g acceleration because its excess mass has been eliminated.

An experimental amplifier using the subminiature transistor is about the size of a pencil eraser. It utilizes direct-coupled circuitry and provides 70-db gain.

. . . And New Applications

► **Carrier Current**—A completely transistorized power-line carrier unit built by Westinghouse for Potomac Edison uses only 18 w compared with 250 w for an electron-tube unit. Power output is 1 w. Nevertheless, the set works through a channel attenuation of 40 db instead of 33 db for previous equipment.

Transistors are utilized in a Minneapolis-Honeywell instrument that indicates the temperature of exhaust gas of jet aircraft engines.

► **Telephone**—A transistorized all-electronic dial telephone switchboard has been delivered to the Navy by Stromberg-Carlson division of General Dynamics. The unit uses transistors and diodes to perform line-finding, switching, tone-signaling and other functions.

Stromberg is at work on a 100-line 15-link electronic switching system for installation aboard naval vessels. The unit will require about 4,500 transistors and approximately 5,000 diodes.

► **Telegraph**—A high-speed telegraph transmitter-receiver, also for the Navy, has been built by Teletype. The set handles four land-line or radiotelegraph channels which handle 100 words a minute.

The transmitter-receiver uses 572 transistors instead of the 357 electron tubes used in an earlier model.

Companies Size Up Net Profits After Taxes

Two surveys with varying results indicate the spotiness of 1955 gains

APPRAISAL of the 1955 net profit picture for firms in the electronics field compared to the 1954 record, depends largely on the sample of firms that is taken. One analysis, covering 17 electronics companies with net profits ranging from \$500,000 to \$200 million shows that the

(Continued on page 10)

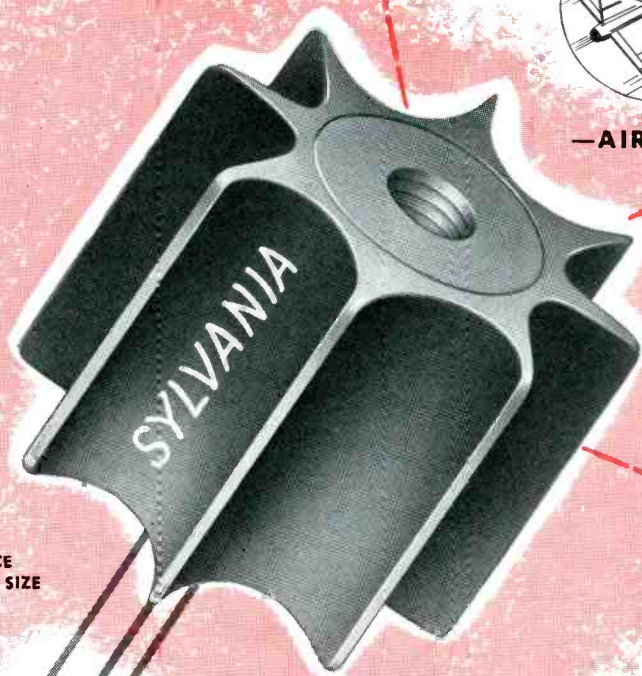

TWICE
ACTUAL SIZE



—AIRCRAFT



—COMPUTERS



—COMMUNICATIONS

NEW

60-VOLT power transistors

For circuits and systems where you
need higher voltage ratings

—offers all the important advantages which made its 30-volt counterpart so popular

- high current gain • low thermal resistance
- 4 watts average dissipation with heat sink
- hermetic seal • low relative cost

Here is an exclusive Sylvania Transistor development designed to broaden power transistor applications in circuits operating from power supplies up to 60 volts.

Sylvania's new 60-volt power transistor can also introduce improvements in the design of inductance coupled circuits operating from power supplies up to 30 volts.

Like its 30-volt counterpart, the new 60-volt power

transistor provides high current gain over a wide range of operating conditions and high current switching for computer applications.

Write for complete details on these new 60-volt power transistors as well as the popular 30-volt series

**60-volt
power transistors**
*Type 2N141 (PNP)
Type 2N143 (PNP)

*with cooling fins

**30-volt
power transistors**
*Type 2N68 (PNP)
*Type 2N95 (NPN)
Type 2N101 (PNP)
Type 2N102 (NPN)

"another reason why it pays to specify Sylvania"



SYLVANIA®

SYLVANIA ELECTRIC PRODUCTS INC.
1740 Broadway, New York 19, N. Y.
In Canada: Sylvania Electric (Canada) Ltd.,
University Tower Bldg., Montreal

LIGHTING • RADIO • ELECTRONICS • TELEVISION • ATOMIC ENERGY

total net profit for the firms was some \$26 million more in 1955 than in 1954, an 8-percent increase. Net profits were \$330 million in 1955 compared to \$304 million in 1954.

Another survey by the First National City Bank of New York covering eighty-seven companies in the radio, tv and electrical equipment field showed that 1955 total net income after taxes was 1 percent below that in 1954. The totals were \$503.6 million in 1955 compared to \$510.7 million in 1954, a decline of \$6.9 million.

► **Trend**—Although most firms in the field showed higher nets in 1955, large losses by relatively few firms canceled many gains. For example, two major firms in the field had net profits that together were \$40 million lower in 1955 than in 1954.

This indicates why percentage changes in income for firms in the industry are not the best measures of industry earnings trends. The ratios of net income to book net assets or to sales are considered better measures.

► **Return**—For the 87 radio, tv, and electrical equipment firms, net assets totaled \$3.6 million in 1954 and \$3.9 billion in 1955. The percent return on these assets equalled 13 percent in 1954 and 12.8 percent in 1955. The percent margin on sales was 5 percent in 1954 and 4.4 percent in 1955. The lower 1955 percentages represent a return to the downward trend in both return on net assets and profit margin on sales that has continued in the industry since 1950 and was arrested only in 1954 due to contemplated changes in the excess profits law.

For manufacturing companies as a whole, the survey shows that the average net profit margin per dollar of sales rose from 5.9 cents in 1954 to 6.7 cents in 1955. The average rate of return on net assets for the companies rose from 12.3 percent to 15 percent during the period.

Therefore, by both measures, the radio, tv and electrical equipment industry is below industry in general.

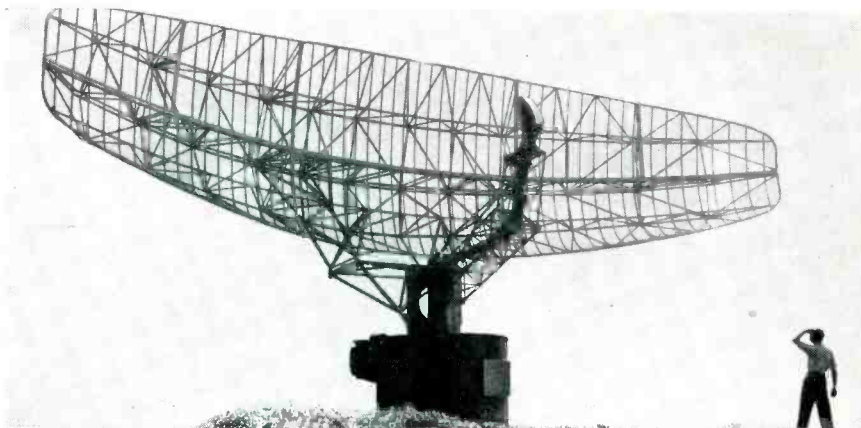

SURVEILLANCE antenna with 40-foot span will track aircraft up to 200 miles and 70,000 feet altitude to keep . . .

Canadian Radar Expanding

DOT awards \$5 million contract for continent-wide surveillance

FIFTEEN major airports from Moncton, N. B. to Vancouver, B. C. are being readied for the jet age. Canada's Department of Transport will start equipping key installations early in 1958 with Raytheon surveillance radar. Although specifications call for 120-mile range, it is expected the systems will overlap patterns every 200 miles or less.

Airports (besides Moncton and Vancouver) to add equipment include Seven Islands, Quebec, Montreal, Ottawa, Toronto, London, North Bay, Fort William, Winnipeg, Regina, Sasgatoon, Edmonton and Calgary.

► **The Twist**—Because rain and other bad weather frequently make it difficult or impossible to track aircraft, airport operators will be able to put a twist on the beam that will gimlet through the normal radar clutter. Although generally employing linear polarization, the radars are equipped to switch to circular polarization.

Raindrops will reflect a reverse spiral beam that can be filtered out at the receiver, whereas aircraft generally return enough of the original signal to show up on the screen clearly.

► **Rejecting Dummies** — Another feature of the surveillance equip-

ment is the moving target indicator that picks up only moving objects. Anything as immovable as a cigar-store Indian is rejected and does not show up as clutter.

A major portion of the development and production of the installations will be carried out in Canada by Raytheon Canada, Ltd., in which Raytheon Manufacturing has part ownership. When completed, the installation will bring DOT radar coverage up to 400,000 square miles.

President Eisenhower Hails de Forest

MAGNITUDE of American contribution to worldwide better living was illustrated in a recent letter from President Eisenhower to Dr. Lee de Forest.

The letter said, "In this fiftieth anniversary year of a great invention, I congratulate you on your many contributions to scientific progress. Through your long and distinguished career you must have experienced many moments of pride that your imagination and talent furthered the development of modern radio, television and radar."

The President's letter added "You must also feel great satisfaction in remembering your past decades of service and in anticipating future achievements that your han-

(Continued on page 12)

Sprague on request will provide you with complete application engineering service for optimum results in the use of electrolytic capacitors.



Sprague

LITTL-LYTICS*

for

transistor circuitry

HERE ARE THE SMALLEST *aluminum electrolytic capacitors ever made to Sprague's rigid quality standards.* Add to that their low leakage current, high reliability, and moderate price, and you have a new series of *miniature* electrolytic capacitors ideal for use in transistorized pocket radio receivers, wireless microphones, personal-style wire recorders, and similar equipment.

Their ultra-low leakage current is particularly important for it means minimum drain and long battery life when used in filtering applications across a battery, and excellent circuit performance when used in coupling applications.

Sprague Littl-Lytics are available in a full range of capacitance ratings from 1 to 110 mf, and in standard working d-c voltages of 1, 3, 6, 10, 12, and 15. Sizes range from $\frac{3}{16}$ "D x $\frac{1}{2}$ "L to $\frac{3}{8}$ "D x $\frac{3}{4}$ "L. Maximum operating temperature of the new Type 30D capacitors is 65°C.

Performance and size data on metal encased, hermetically sealed Littl-Lytics, in more ratings than ever before, are all provided in NEW Engineering Bulletin 320A, available on letterhead request to the Technical Literature Section, Sprague Electric Company, 35 Marshall Street, North Adams, Massachusetts.

typical ratings

Cat. No.	30D6	30D16	
WVDC	6	6	
μ F	3	60	
Leakage Current (μ A Max.)	2.0	3.0	
Can Size	D"	$\frac{3}{16}$	$\frac{3}{8}$
	L"	$\frac{1}{2}$	$\frac{3}{4}$

★Trademark

world's largest capacitor manufacturer

SPRAGUE

Export for the Americas: Sprague Electric International Ltd., North Adams, Massachusetts. CABLE: SPREXINT.



Dr. Lee de Forest

diwork has made possible." The great scientist, with over 300 patents granted to him, is approaching his 83rd birthday.

Flat TV Tube Picture Shows Promise

Air Force to use tube as cockpit display. British announce their version of flat tube for tv use

INSTRUMENT panel simplification program undertaken by the U. S. Air Force centers about the flat and transparent picture tube developed by Kaiser Aircraft and Electronics (ELECTRONICS, p 7, Feb. 1955) and has as one of its goals the replacement of instrument panel meters by one or two picture tubes.

► **Navy Version**—A similar simplification program, using the Kaiser tube, has been under way for the U. S. Navy by Douglas Aircraft. Approximately 20 airframe companies are actively participating.

Development has reached an advanced stage and the Navy expects to fly a Lockheed T2V jet trainer with the new instrumentation by the end of this year. The Army Transportation Corps has recently joined the effort.

Bell Aircraft is coordinating a program to simplify helicopter instrumentation in a similar way.

► **British tube**—It is reported that

D. Gabor of the Imperial College of Science and Technology at London University has developed a flat picture tube which differs from the Kaiser tube in many ways. Further work will be supported by the British National Research Development

Corporation in England.

► **Other Tubes**—At least two large companies in the United States are known to have laboratory models of flat picture tubes in various stages of development.

Computer Firm Mergers Continue

Burroughs-Electrodata linkup provides full computer line. Still another merger rumored

PATTERN of merger activity continues to concentrate the electronic data processing machine business in the hands of established office equipment firms.

Electrodata, a Pasadena, Calif., computer manufacturer spun off from Consolidated Electrodynamics (ex Consolidated Engineering), will combine with Burroughs. The merger is subject to stockholders approval at a May meeting.

CEC, which holds 36 percent of Electrodata stock, receives \$6 million of Burroughs stock, increasing CEC earnings 17¢ a share on the basis of current Burroughs dividends.

► **Products**—The Electrodata computer, which sells for \$140,000 to \$300,000, provides a medium-sized machine for the Burroughs line that already includes a small unit. A large Burroughs computer will be announced this year.

Small machine is the E101 priced at \$32,500. Sixteen have been sold and several are on order. Electrodata has 25 machines installed—about 3 of them on lease. The large Burroughs machine BEAM (Burroughs Electronic Accounting Machine) will use the Series G 900-line a minute printed and card handler for data input and output functions.

Other Burroughs products include a 5,000-character a second electrostatic matrix printer and an electronic character reading device.

► **Rumors**—Conversations are going on about an association of Underwood and International Telephone and Telegraph interests in the com-

puter industry.

Underwood makes the small Elecom 50 computer and recently moved into the medium-sized field with the Elecom 125 computer and file processor. The computer sells for \$350,000 while the file processor sells for \$125,000. The file processor uses magnetic tape and processes 30 items a second.

IT & T indicates that it will go into the computer business whether or not association with Underwood is consummated. Its Belgian affiliate, Bell Telephone Manufacturing Co. of Antwerp is manufacturing a computer.

► **Abroad**—Reports from Russia tell of a large electronic digital computer called BESM. These are initial letters of the Russian words for high-speed electronic computing machine. Built around 1951 by the USSR Academy of Sciences, it does 7,000 to 8,000 operations a second, reportedly compares favorably with commercially available U. S. computers.

Another Russian computer, Ural, will go into production this spring and is expected to provide advantages over BESM.

A computer called Pegasus was recently demonstrated at the Ferranti Computing Center, London. It does 1,000 additions, 500 multiplications or 200 divisions a second working with 11-digit numbers. Computer consists of a console and two readily transportable cabinet enclosures.

Installed at the computing center at English Electric headquarters in London is a computer named Deuce. The machine was developed in 1952 at the National Physical Laboratories in Teddington. It is available to engineers and businessmen on a rental basis.

(Continued on page 14)

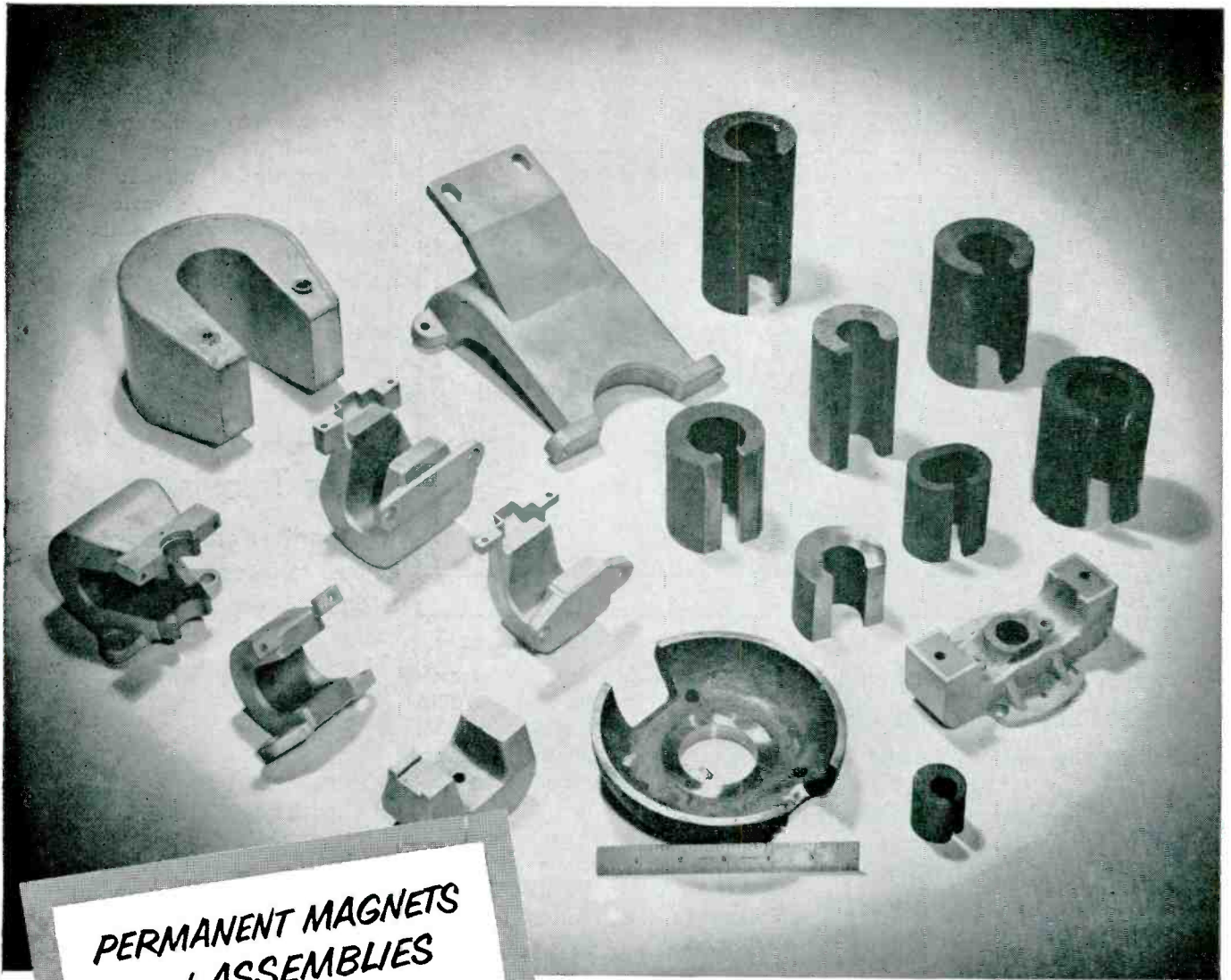

**PERMANENT MAGNETS
and ASSEMBLIES**
*for Wave Guides, Traveling
Wave Tubes and Magnetrons*

**We can handle
ANY requirements you have**

- ★ Made to your specifications
- ★ Any size, shape or coating required
- ★ Send us your drawings for quotation

The group of magnets illustrated above are indicative of the great scope of Arnold production in this field. We can supply these permanent magnets in any size or shape you may need; in weights ranging from a few ounces to 75 pounds or more; and with die-cast or sand-cast aluminum jackets, Celastic covers, etc., as required. Complete assemblies may be supplied with Permendur, steel or aluminum bases, inserts and keepers as specified—magnetized and stabilized as desired. ● Let us handle your magnetron, traveling wave tube and wave guide permanent magnet requirements, or any other magnetic material specification you may have.

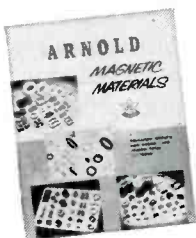

Write for your
copy of
Bulletin GC-106A
on all
Arnold Products

ADDRESS DEPT. E65

THE ARNOLD ENGINEERING COMPANY

SUBSIDIARY OF ALLEGHENY LUDLUM STEEL CORPORATION

General Office & Plant: Marengo, Illinois

DISTRICT SALES OFFICES . . . New York: 350 Fifth Ave

Los Angeles: 3450 Wilshire Blvd.

Boston: 200 Berkeley St.



Insulation Sales Increase

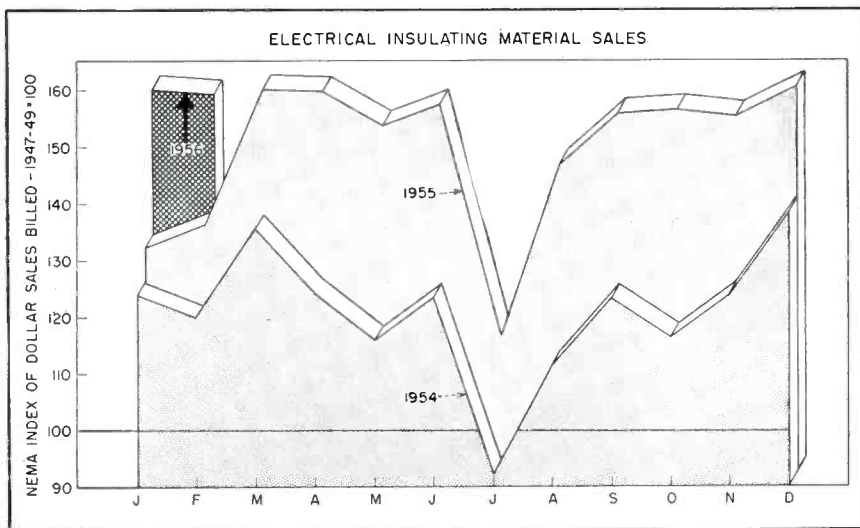

Monthly sales volume throughout 1955 exceeds that of 1954, but remains below '51 and '53

ELECTRICAL insulating materials sales maintained a healthy volume throughout 1955 registering a 23 percent increase over 1954 business, and coming within 8 percent of the record high business of 1951 and 1953.

► **Materials**—NEMA index of electrical insulating materials domestic dollar sales billed is made up of laminated products, manufactured electrical mica, special dry process electrical porcelain, varnished fabric and paper, varnished tubing and saturated sleeving, and vulcanized fiber. Total sales of the materials in the index reached \$369.2 million in 1955 compared to \$286.8 million in 1954. Not all insulation material firms submit sales figures for use in the index so that overall volume is much higher.

► **Breakdown**—Relative importance of the various materials in the index is indicated by sales billed by participating companies. Varnished tubing and saturated sleeving ranked first in sales, both in 1955 and 1954, with totals of \$184.9 million in 1955, and \$148.7 million in 1954 for the six firms reporting figures.

Laminated products volume for

20 firms accounted for \$135.1 million in sales in 1955 compared to \$110.2 million for 19 firms in 1954. The figure for laminates, however, includes products unrelated to electronic uses.

Vulcanized fiber ranks next in dollar sales. The material racked up sales of \$22.9 million in 1955 for 6 firms in the field compared to \$17.2 million in 1954.

Manufactured electrical mica sales for 7 companies totaled \$12.6 million in 1955 compared to \$9.5 million in 1954.

Varnished fabric and paper sales for eight companies totaled \$10.1 million in 1955 compared to \$8.1 million in 1954. Last on the list in terms of sales were special dry process electrical porcelain and dry process electrical porcelain. Total for both types was about \$3,000,000 in 1955 compared to \$2.4 million in 1954 for 13 firms reporting.

► **New**—With insulation materials for electronics being called upon to withstand higher and higher temperatures, companies in the field are continually striving to perfect new and better insulations. Sequoia Process Corp. and Stanford Research Institute recently announced a jointly developed new technique for irradiating special polyethylenes. (See p 146).

It produces a new electrical insulation with greater tolerance for heat. Irradiation of the coated wire

entails passing the strands on pulleys over a set of rollers and under a beam of high-energy electrons. Each segment of wire follows the same path through various beam intensities and receives the same amount of radiation. Source of the process radiation is a GE electron-beam generator at Sequoia's Redwood City, California plant.

British Demonstrate Color Television

Transmitter and receivers are shown to international color standards group

LIVE-COLOR was demonstrated with a low-power television transmitter at Alexander Palace, London, by the BBC recently.

► **CCIR**—The event, organized by the British Radio Equipment Manufacturers' Association, was timed to coincide with the arrival in London of 100 electrical engineers from nineteen countries on both sides of the Iron Curtain. They are members of the television study group of the Comité Consultatif International des Radiocommunications.

The engineers are empowered by their respective governments to recommend the technical system to be adopted as the international standard for color television. Their recommendations will be put forward when the International Telecommunications Union meets in plenary session in August at Warsaw.

If complete agreement is reached, it is possible that a single standard system for color television will be accepted by all European countries, including Russia and her satellites. This would mean that programs could be picked up by viewers on either side of the Iron Curtain, on color receivers or in standard black and white, and that links could be set up connecting every European capital from London to Moscow.

As far as Britain is concerned, if any one of the other systems is chosen, it will have to decide

(Continued on page 16)

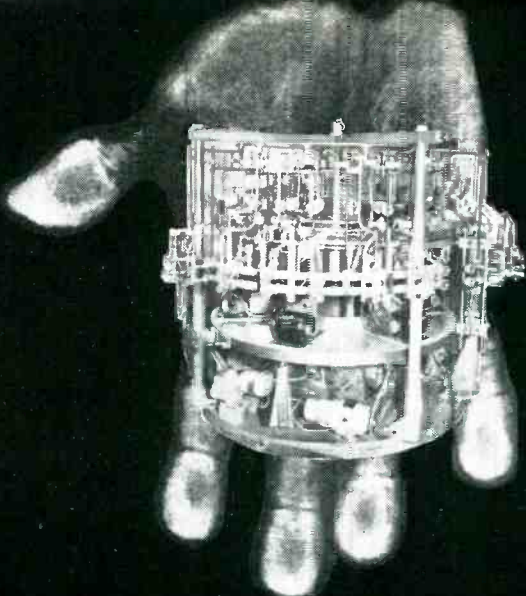

VERSATILE KAHLE AUTOMATIC MACHINES FOR ELECTRONIC GLASS-WORKING

The old adage about "many hands" is still true! The productive capacity of Kahle's Glass-working Machines represents thousands of untiring "mechanical hands" who can quickly and skillfully complete a wide variety of electronic tube production operations . . . from the stem-forming to the final tip-off . . .

HELPING HANDS

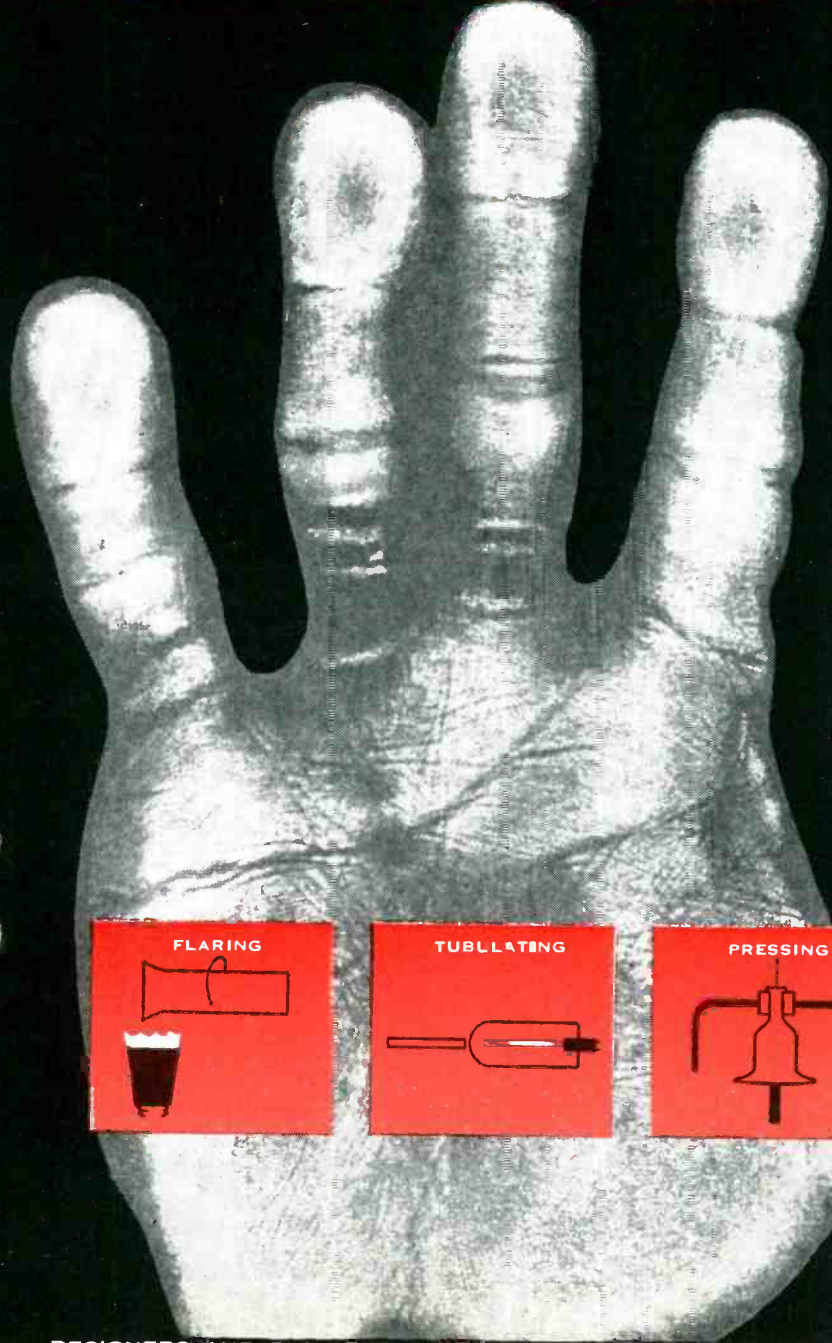

. . . the World's Leading Tube Manufacturers have continuously depended on Kahle Electronic Tube Equipment for over 25 years.

Kahle's highly specialized engineering staff and extensive facilities can better answer all your glass-working requirements . . . many standard Machine types are available . . . when unique conditions exist, Kahle will custom-engineer the properly modified type for your particular production. Thinking of buying production equipment? Call-on-Kahle . . . today!

SEND FOR KAHLE'S VALUABLE REFERENCE FILE OF GLASS-WORKING EQUIPMENT—TODAY!



FLARING



TUBULATING

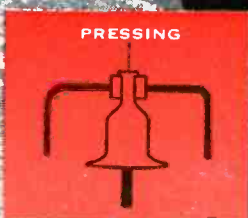

PRESSING



SEALING

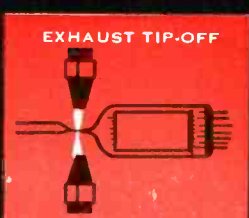

EXHAUST TIP-OFF

Kahle ENGINEERING COMPANY
1310 SEVENTH STREET NORTH BERGEN, N. J.

DESIGNERS AND BUILDERS OF AUTOMATIC AND SEMI-AUTOMATIC EQUIPMENT FOR ALL INDUSTRIAL OPERATIONS

www.americanradiohistory.com

whether or not to set up a whole duplicate string of transmitters and land links at considerable cost, while monochrome programs would continue to go out over the existing stations. Despite the enormous capital expenditure involved, some British manufacturers think this would be worth while since Britain would then be producing color television sets which could be exported.

► **Sets**—At the demonstration the sets, operating on 405 lines, were alongside standard black and white units receiving the same signal and giving black and white pictures. The sets used were made by E. K. Cole; Cossor; Electric and Musical industries; General Electric Company; Marconi; Murphy; and Pye. Murphy Radio has now supplied the B.B.C. with eight of the twelve color sets ordered by the Corporation for its present series of tests. One further set has gone to the

Post Office. These 21-inch receivers are bulkier than the 21-inch black and white units. They are British-made except for the tube and associated components which are of American origin. The tube is of the shadow mask type.

► **Price**—Cost of the imported tube is about six times the equivalent 21-inch black and white tube made in Britain.

A normal monochrome set usually has eight controls which the owner can adjust. The Murphy color set has eleven in this category, plus a tone control for sound. The three extra controls are a "color killer," which turns the set into an ordinary black and white receiver, a "hue" to line up the colors, and a "saturation" control which in effect is color brightness.

Sets of this type could be produced in quantity at a retail price of between \$840 to \$980.

Hi-Fi Gets Transistors, P-C Units

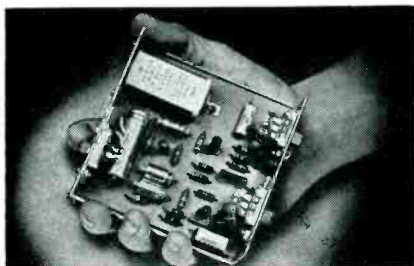

Preamp, left, uses transistors on etched-wiring board. Amplifier kit on right uses wiring board to eliminate wiring errors

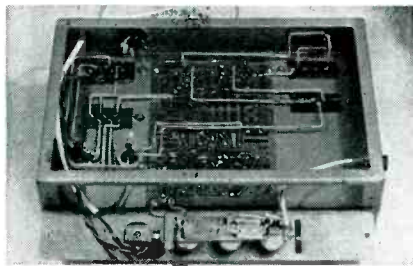

TRANSISTORS have made their appearance in accessory high-fidelity sound equipment as a humless pre-amplifier-equalizer. Mounted on a printed circuit board, three transistors boost a low-level input to a level sufficient to drive a conventional amplifier system. The preamplifier, made by Fisher Radio Corp., provides controls for volume and matching of phono-cartridge impedance. Use of transistors permits matching the input to low-impedance magnetic cartridges without use of transformers.

► **Printed Circuits**—Manufacturers of home-construction kits for sound equipment have adopted printed-circuit boards as a means of simpli-

fying wiring and eliminating the chance of errors and poor lead placement. In the Mullard 10-watt amplifier shown in the photograph, all circuit wiring other than for the power supply and tone controls are part of an etched board. A recently introduced 25-watt Williamson-type amplifier kit made by Allied Radio Corp. uses printed-circuit wiring for the low-level stages.

► **Organs**—In Electronic Organ Arts home-construction kit for an organ, an etched-wiring board printed on both sides eliminates all wiring on the tone generator chassis. Construction time has been reduced to about one-quarter of that with conventional wiring.

Electronics:

San Francisco Picture

Area moving ahead fast as electronics research and production center

GROWTH of electronics in the San Francisco Bay area is reaching large proportions as more electronics firms settle and expand there. Present size of the industry was pointed up in a handbook of the scientific resources of the area recently published by the International Science Foundation and other sponsors. It outlines the Bay area's research facilities in electronics. The industrial labs and applied research facilities in the electronics field were listed as follows

Aircraft Engineering & Maintenance; Alto Scientific; Ampex; Applied Electronics; Applied Radiation; Beckman Instruments; Cascade Research; Chromatic TV Labs.; Color Television; Dalmo Victor; Detroit Controls; Fischer Research Laboratory; Friden Calculating Machine; Gilliland Instrument; Hansen Laboratories; Hewlett-Packard; Huggins Laboratories; IBM; Jennings Radio; Kaiser Aircraft & Electronics; Land-Air; Levinthal Electronic Products; Marchant Calculators; Relaxisor; Remler; Stanford Research Institute; Sylvania Electric Products; Varian Associates.

► **Size**—The electronic facilities in the area were among the largest in number of any of the scientific fields surveyed, ranking at the top with chemical and mechanical engineering facilities. The 28 electronics organizations in the listing employ nearly 15,000 people. The four largest in employees are Beckman Instruments with 3,000; Friden Calculating Machine with 2,400; Marchant Calculators with 1,400; and Stanford Research Institute with 1,150; Lenkurt Electric, though not listed, presently employs 1,600.

► **Future**—Since the beginning of 1956, expansion of electronics firms in the San Francisco area has stepped up substantially. About a dozen companies have announced expansion plans in the San Francisco Bay area in the past four months that will add approximately 1 million sq ft of space. Largest expansions to be made are those by IBM with a multimillion-dollar plant covering 400,000 sq ft of space, and

(Continued on page 20)

NEW Impedance Comparator

Measures and Reads Directly...

Phase-Angle Differences
to 0.0001 Radians

Differences in Magnitude
to 0.01% Accuracy

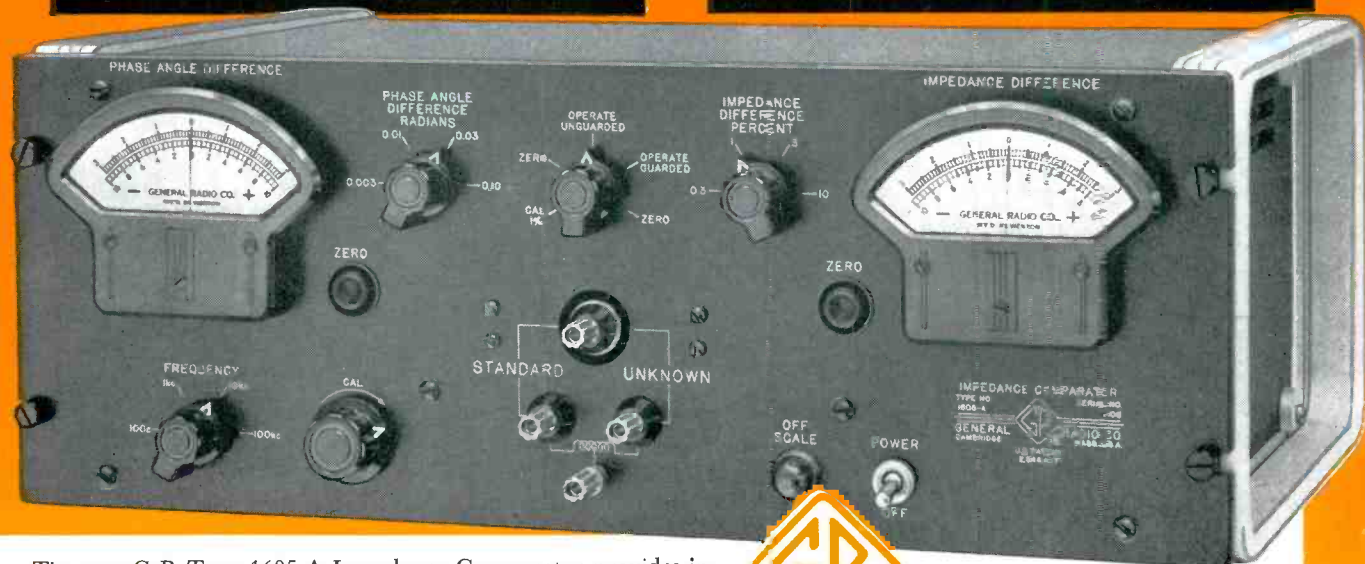

**Type 1605-A
Impedance Comparator . . . \$790**

The new G-R Type 1605-A Impedance Comparator provides in one completely self-contained package features and advantages which are not available in any other measuring equipment. This instrument performs rapid go/no-go impedance measurements by indicating directly the difference in both magnitude and phase angle between an unknown and standard impedance. No bridge balance is required — the two panel meters supply the answers simultaneously. Because this instrument compares two impedances which are nearly alike, it can perform measurements over very wide ranges of frequency and impedance level with an accuracy not easily obtainable otherwise.

The unusual combination of *precision* and *speed* in one instrument adapts the Impedance Comparator to a wide variety of applications in the laboratory or production-test line. Impedances of any phase angle and with a wide range of magnitudes can be measured. The two meter voltages, proportional to impedance-magnitude difference and phase-angle difference respectively, are available at the rear of the instrument to operate recorders or remote indicators of many types. Finally, an internal guard circuit is provided to make negligible the effects of stray capacitance when measuring remote unknown impedances.

Typical Uses Include:

- ★ *Rapid, yet precise testing, sorting and matching of components.*
- ★ *Drift investigations on precision components such as deposited carbon resistors where changes are typically small and high precision of measurement is needed.*
- ★ *Ganged potentiometers and capacitors can be checked for proper tracking and phase alignment.*
- ★ *In production testing of precision inductors, turns may be removed until the Impedance Comparator indicates the desired value has been reached.*
- ★ *Measurement of loss in capacitors of all types.*
- ★ *Dissipation-factor measurements of dielectric materials are considerably simplified and speeded.*
- ★ *The Impedance Comparator has already been incorporated in several automatic sorting machines. The ability to measure amplitude and phase angle independently, and to provide signals for accepting or rejecting a component or subassembly makes this instrument an extremely valuable part of any automatic sorting machine. Because no change in calibration is required for measuring different impedance levels, components of all types can be tested in rapid sequence. Automatic switching may be used with no adverse effects on operation because the guard circuit negates the capacitance of such switching.*

Wide Range of Internal-Test Frequencies

100, 1000, 10,000 and 100,000 cps.

Impedance Range

Resistance: 2 ohms to 20 megohms

Capacitance: 40 $\mu\mu\text{f}$ to 500 μf

Inductance: 10 μh to 10,000 h

Direct-Reading Meter Ranges

Impedance-Magnitude Differences:
0.3%, 1%, 3% and 10% of full scale.

Phase-Angle Differences:
.003, .01, .03, 0.1 radians full scale.

Over-All Accuracy

3% of full scale (.01% over-all accuracy
on 0.3% impedance magnitude range).

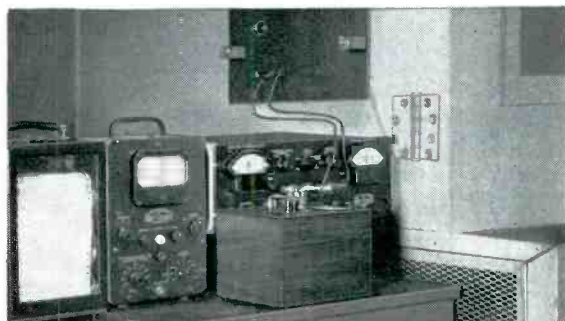

A Written Record of Your Environmental Tests—The Impedance Comparator's built-in guard circuit permits accurate measurements of high- as well as low-impedance components in remote locations. Impedance changes caused by controlled temperature and humidity alterations in a test chamber can be automatically recorded. The photo shows the G-R Type 1230-A D-C Amplifier and Electrometer and an Esterline-Angus Recorder performing a typical environmental test; other commercially available recording instruments of 100 mv full scale sensitivity are suitable.

GENERAL RADIO Company

275 Massachusetts Avenue, Cambridge 39, Massachusetts, U.S.A.



90 West Street NEW YORK 6
8055 13th St., Silver Spring, Md. WASHINGTON, D. C.
1150 York Road, Abington, Pa. PHILADELPHIA
920 S. Michigan Ave. CHICAGO 5
1000 N. Seward St. LOS ANGELES 38



RELIABLE

Cathode Type SUBMINIATURE TUBES

with reliability based on dynamic quality control — utmost assurance against catastrophic failure — the result of:

RAYTHEON PIONEERED

X-ray analysis — for constant guidance in the maintenance of tube quality and reliability

environment control — for years Raytheon has manufactured these tubes under conditions minimizing lint and dust contamination

controlled welding — with new equipment and new techniques developed under Bureau of Ships sponsorship for the ultimate in welding quality and reliability

microscopic inspection — designed for continuous corrective feedback during production



X-rayed for reliability



SPECIAL TUBE DIVISION
RAYTHEON MANUFACTURING CO.

HOME OFFICE:
Boston: 55 Chapel St., Newton 58, Mass. • B1gelow 4-7500
For application information write or call the Home Office or:
New York: 589 Fifth Ave., PLaza 9-3900
Chicago: 9501 Grand Ave., Franklin Park, TUXedo 9-5400
Los Angeles: 622 S. La Brea Ave., WEbster 8-2851

RAYTHEON RELIABLE SUBMINIATURE TUBES for Guided Missile, Military and All Other Critical Applications

TYPE	DESCRIPTION	Vibration Output* (maximum) mVac	TYPICAL CHARACTERISTICS								
			Heater		Plate		Grid Volts or R _k	Screen		Amplification Factor	Mutual Conductance μmhos
			Volts	mA.	Volts	mA.		Volts	mA.		
5639 5639A	Video Amplifier, Pentode	100	6.3	450	150	21	100 ohms	100	4	—	9000
5702WA	RF Amplifier Pentode	50	6.3	200	120	7.5	200 ohms	120	2.6	—	5000
5703WA	High Frequency Triode	10	6.3	200	120	9.4	220 ohms	—	—	25.5	5000
5744WA	High Mu Triode	25	6.3	200	250	4.2	500 ohms	—	—	70	4000
5783WA 5783WB	Voltage Reference	50	Operating voltage approximately 86 volts between 1.5 and 3.5 mA.								
5784WA	RF Mixer Pentode	100	6.3	200	120	5.5	-2.0	120	3.5	—	3200
5787WA 5787WB	Voltage Regulator	50	Operating voltage approximately 98 volts between 5 and 25 mA.								
5829WA	Dual Diode	—	6.3	150	Max. I _o = 5.5 mA. per plate						
5995	Half-Wave Rectifier	—	6.3	300	Max. I _o = 50 mA.						
6021 6021A	Medium Mu Dual Triode	50	6.3	300	100	6.5	150 ohms	—	—	35	5400
6110	Dual Diode	—	6.3	150	Max. I _o = 4.4 mA. per plate						
6111 6111A	Medium Mu Dual Triode	50	6.3	300	100	8.5	220 ohms	—	—	20	5000
6112 6112A	High Mu Dual Triode	25	6.3	300	100	0.8	1500 ohms	—	—	70	1800
6152	Low Mu Triode	25	6.3	200	100	1.0	270 ohms	—	—	17.5	5100
6245	RF Amplifier Pentode	50	6.3	200	20	2.5	0	30	0.8	—	3275
6247	Low Microphonic Triode	2.5	6.3	200	250	4.2	500 ohms	—	—	60	2650
6533	Low Microphonic Triode	1.0	6.3	200	120	0.9	1500 ohms	—	—	54	1750
6542	Voltage Regulator	—	Operating voltage approximately 150 volts between 5 and 25 mA.								

*At 40 cycles, 15 g.

Note: All dual section tube ratings (except heater) are for each section.



"bantamweight"



SILICON POWER DIODES



for **HIGH**

EFFICIENCY—to over 99%
TEMPERATURE—to 170°C
CURRENT—to 15 amps
VOLTAGE—to 200 volts

R FORWARD
R REVERSE \gg 100,000

HERE ARE THE CHARACTERISTICS

Type	25° C Max. Rating			Reverse Current at PIV mA
	Forward Voltage at 5A volts	Peak Inverse Volts	RMS volts at PIV volts	
CK774	1.5	25	17.5	25
CK775	1.5	60	42.5	25
CK775-1	1.5	125	88.5	25
CK776	1.5	200	141.5	25

Raytheon Silicon Power Diodes are *hermetically sealed*. Cooling requirements are drastically reduced. Frequency range is better than 100 kc.

Write for new Power Diode Application Notes.

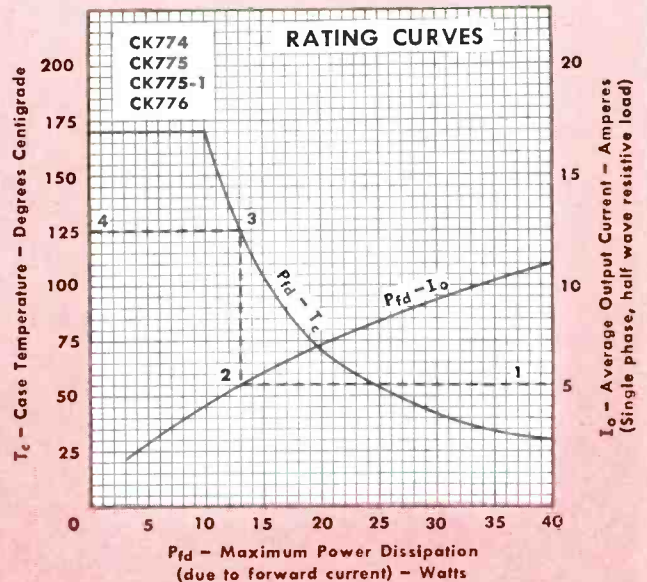

To use this chart: (see dotted line example)

- Find desired current on right ordinate(1)
- Read corresponding P_{fd} on average current curve(2)
- Project vertically to limiting dissipation — case temperature curve(3)
- Read limiting case temperature on left ordinate(4)



mtg. co.

SEMICONDUCTOR DIVISION

Silicon and Germanium Diodes and Transistors • Silicon Power Diodes

Home Office, Boston: 150 California St. Newton, Mass. • DEcatur 2-7177

For application information write or call the Home Office or:

New York: 589 Fifth Ave., PLaza 9-3900
 Chicago: 9501 Grand Ave., Franklin Park, TUxedo 9-5400
 Los Angeles: 622 S. La Brea Ave., WEBster 8-2851

Lockheed with a 200,000-sq ft facility and plans to spend \$20 million in the area in the next three years.

Electronics Strikes Gold In Bowling

Pinspotters sales move into high gear. Another company enters the field

ONE of America's most popular indoor sports, bowling, is accounting for a sizable amount of electronics business through increasing use of the automatic pinspotter, (ELECTRONICS, p. 148, June, 1953). American Machine & Foundry, which first developed the device, reports that 4,000 of them were installed last year, bringing the total number of machines operating in the U. S. and Hawaii to 8,455 at the end of 1955. At the end of 1953, only about 1,000 machines were in use.

► **Rate**—Business is continuing at a high pace this year. New leases for the device were being received by AMF at the end of 1955 at a rate of 850 per month. Contracts received during February were almost double the December rate. The company expects to install between 6,000 and 7,500 additional machines in 1956.

► **Firms**—Now Brunswick has entered the field, and is just beginning to install the machines. The firm will manufacture and lease the devices.

AMF leases the machines to bowling alley operators, and receives a minimum guarantee of \$800 per machine per year. Present installations are producing at least \$8 million in annual rentals for the firm.

► **Market** — With about 60,000 bowling alleys in the U. S., the present market for automatic pinspotters is still large. In addition, new bowling alleys are currently being established at an estimated rate of 3,000 a year.



CLERK and Dage industrial tv system ride scooter to view filed bank records. Other new applications indicate . . .

How Industrial TV Stands Today

Increasing sales and applications spur growth trend of closed-circuit systems

STEADY growth of industrial tv business has led companies in and outside of the field, to appraise its present and future prospects.

► **Progress**—Despite a lack of verified statistics on sales volume or installation rates, all estimates indicate that industrial tv has grown steadily.

Total sales volume for 1955 was about \$4 million, a fourfold increase over 1952 sales. For 1956, estimates ranging between \$6 million to \$10 million have been made. Projections through 1960 are even more optimistic. Some put total annual volume as high as \$40 million, but most peg the total at between \$10 million and \$20 million.

► **Price**—Main spur to the growth of industrial tv has been a steady reduction in price. Whereas the cost of an installation used to run as high as \$10,000, today the average cost, including camera and monitor, may range between \$1,000

to \$5,000. One company estimates that average costs now run between \$2,000 and \$3,000, and it expects the average price to drop to around \$1,500 by 1960.

► **Applications**—Two fields that hold large potentials for the equipment are education and telecommunications. It is estimated that more than 100 institutions now have closed-circuit installations, and that the number may triple in the near future.

The potential in the telephone field is even more promising. Pennsylvania Bell Telephone demonstrated closed-circuit equipment developed by Dage Television Division of Thompson Products that uses a low-speed scanning system to transmit business data over 25 miles of conventional telephone circuits. Bell plans to offer the service in metropolitan areas with distance between transmitter and receiver limited to 25 miles. (ELECTRONICS, p 10, Jan. 1956.) It is reported that the slow-scan system will incorporate the Skiatron dark-trace tube which allows retention of material on the receiving tube for long

(Continued on page 22)

HOW to CHOOSE VIBRATION MOUNTS

For Jet and Missile Applications

Use our free engineering data sheets on ALL-ANGL Barrymount® Isolators. They describe and illustrate the operating principle of the ALL-ANGL Barry Mount, telling how it works to control shock and high-frequency vibration. They give

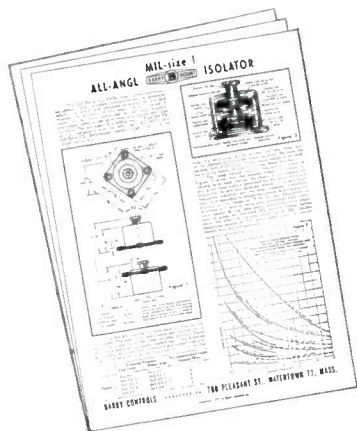

you load-deflection curves, transmissibility curves, and load-versus-natural-frequency curves that show how these isolators perform under various loads and vibration inputs and for different directions of applied acceleration. They explain how these curves can be used to evaluate isolator performance. And they contain detailed drawings that show all necessary dimensions and clearances.

Because of their proved efficacy in protecting delicate electronic apparatus through every flight attitude, ALL-ANGL Barry Mounts give the designer valuable aid in cramming the most instrumentation into the least space. They make it practicable to mount equipment on any available surface — upright on a deck or shelf, hung from above, attached to a bulkhead, or at any angle necessary to fit a unit into limited space. Regardless of mounting position, ALL-ANGL Barry Mounts give protection against high-frequency vibration through every operational maneuver of the most modern aircraft.

Barry engineering data sheets are free on request. Write for your copies today.

WILL MIL-SPEC MOUNTS WORK

when you need protection most
— at steep-angle attitudes?



ALL-ANGL ISOLATORS give vital in-flight reliability protection

Sure, you can meet the *specification* with a mount that only has to work at a 10-degree tilt. But what happens when the aircraft climbs at steep angles or goes into a 90-degree turn or dive?

That's where you need ALL-ANGL Barrymount® Isolators. You can mount 'em and *fly 'em* at any cock-eyed angle you choose. And they give the same sure protection to vital instruments and controls from take-off through every twist, turn, and dive of the aircraft's most violent maneuvers. These curves show why.

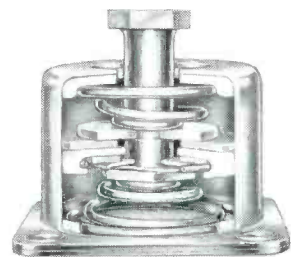
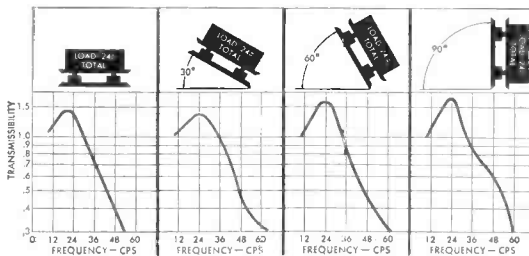

Write now for data sheets AA-0-1 containing detailed performance data. And remember — when your problem is protection thru every flight attitude, your answer is ALL-ANGL Barry Mounts. For recommendations, call your nearest Barry Sales Representative.

**BARRY
CONTROLS**
INCORPORATED

BARRY  MOUNT

SALES REPRESENTATIVES
IN ALL PRINCIPAL CITIES

707 PLEASANT STREET, WATERTOWN 72, MASSACHUSETTS

periods. It is reported that almost one-half million dollars worth of the tubes have been ordered, for use in the telephone-line system.

► **Applications**—One manufacturer lists the following breakdown as the major fields in which industrial tv applications have been, and will be

made: test equipment, materials-handling control, handling of explosives, radiation and nuclear research and control, underwater applications, visual training in industry, security and law enforcement, commerce and banking applications, motion-picture studio, and tv studio applications.

Senate Group Gets UHF-TV Date

RETMA shows the present status of the service and indicates future trends

TELEVISION set manufacturers have produced 4.5 million all-channel tv receivers since uhf-tv production began in 1952, representing 15.8 percent of the 28.2 million tv sets manufactured in that time. In addition, approximately 4 million tv sets, both new and old, have been converted outside the factory, either in the home or by distributors or dealers bringing the total number of sets equipped for uhf since the first station was licensed in 1952 to 8.5 million, about 22 percent of total tv in use. These are some of the major statistics presented by RETMA to the Senate Interstate and Foreign Commerce Committee in explaining its position on uhf and vhf-tv problems.

► **Stations**—There are 108 vhf stations now on the air that were approved by the FCC before uhf tv entered the picture. Since that time, 264 vhf stations and 156 uhf stations have gone on the air. However, 58 uhf stations have discontinued operations as against 8 vhf stations.

The uhf stations are estimated to reach a maximum of 21 percent of U. S. households. The figures indicate that the percentage of uhf equipped tv sets in use slightly exceeds the estimated maximum number of U. S. households within the range of all uhf-tv stations.

► **Inventory**—RETMA statistics on uhf-tv factory sales and factory inventories indicate that set manufacturers have maintained a more

than adequate supply of uhf-equipped sets. For example, in January, 1956, 16.4 percent of total tv sets on hand were equipped for uhf reception. However, only 13.4 percent of total tv sets sold were uhf equipped.

► **Color**—To answer the committee's questions as to whether set manufacturers are now producing or planning to produce color tv receivers with uhf reception facilities, RETMA polled set manufacturers representing an estimated 95 percent of color tv production in 1956. The results showed that 66.5 percent of the color receivers manufactured in January and February of 1956 were factory-equipped for uhf signals.

However, the same companies stated that only 10.6 percent of the color sets they plan to produce during the remainder of 1956, will be equipped to receive uhf telecasts. The companies indicated that the percentage would be higher if the 10-percent excise tax is removed from all-channel color television receivers.

Transistor Activity Expands Abroad

Number of firms licensed to manufacture and sell the devices has doubled since 1953

ALTHOUGH production of transistors abroad is still far behind growing U. S. production, which may reach 12,000,000 units this year, foreign electronics manufacturers are pushing activities in the field.

► **Companies**—In little more than two years, the number of foreign companies licensed by Western Electric under Bell System patents to manufacture and sell transistors has more than doubled. In 1953 there were about 14 manufacturers in foreign countries listed as Bell licensees. Today, there are 30. They are:

Company	Country
Allmanna Svenska Elektriska	Sweden
Ateliers de Constructions Electriques de Charleroi	Belgium
Automatic Telephone & Electric	England
British Thomson-Houston	England
Compagnie Generale de Telegraphie Sans Fil	France
Ebauches	Switzerland
English Electric	England
Marconi's Wireless Telegraph	England
L. M. Ericsson	Sweden
Felten & Guillaume	Germany
Carlswerk	W. Germany
Ferranti	England
Foundation Hasler Works	W. Germany
General Electric Co., Ltd.	England
Hitachi	Japan
Kobe Kogyo	Japan
*Le Material Telephonique	France
Mitsubishi Electric Mfg.	Japan
Northern Electric	Canada
N. V. Philips	Netherlands
Pye	England
Siemens & Halske	W. Germany
Societe Anonyme de Telecommunications	France
Societe Alsacienne de Constructions Mecaniques	France
Societe Industrielle de Liaisons Electriques	France
*Standard Telephones & Cables	England
*Suddeutsche Apparatefabrik	W. Germany
Telefunken	Germany
Telefunken	W. Germany
Telettra	Italy
Tokyo Shibaura Electric	Japan
Tokyo Tsushin Kogyo	Japan

*Subsidiaries of IT&T

► **Countries** — Japan has moved ahead fast in transistors. In 1953, none of its electronics firms were licensees; today there are five. France also has made gains. In 1953, only one French company was licensed.

► **Applications**—As has been the case in the U. S., the hearing aid field is the main foreign market for transistors. However, use of the devices in portable radios is gaining.

(Continued on page 24)

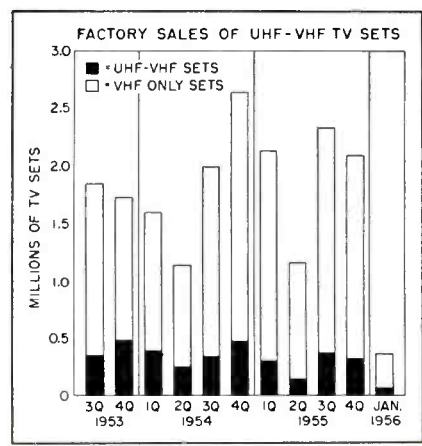

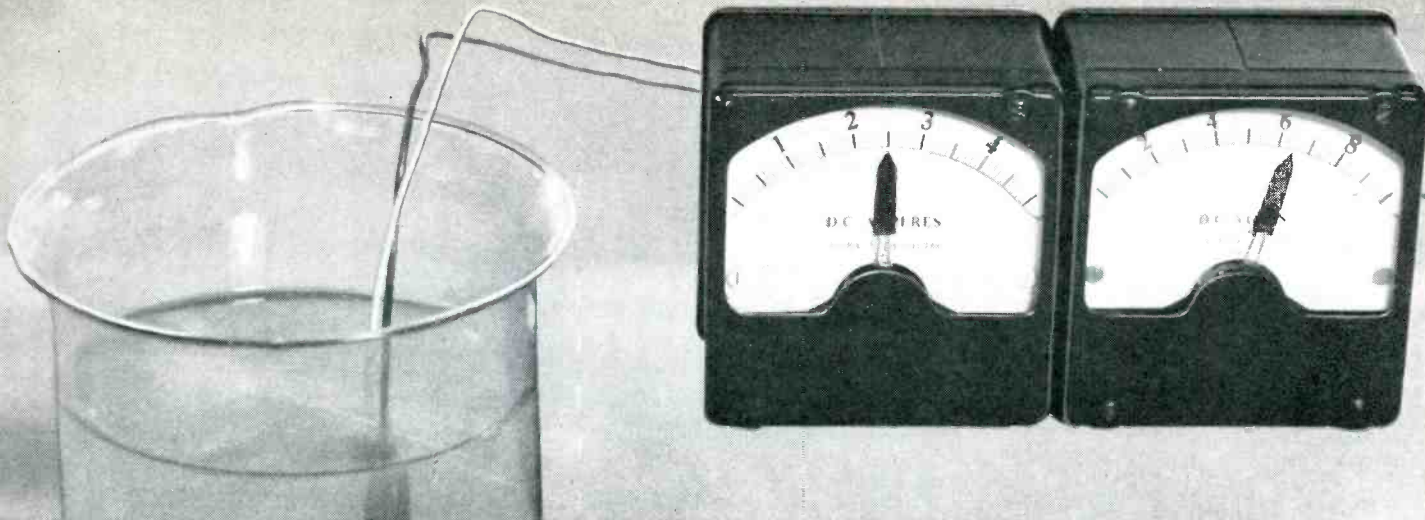

Nearly any combination of sizes, weights, and ratings is available.



80 volts
10.5 amp min.
15 cz., 22 cu. in.



1.5 volts
5 amp min.
.8 oz., 1.7 cu. in.



6.3 volts
158 amp min.
6 oz., 5.7 cu. in.

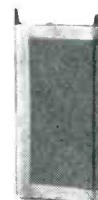

1.3 volts
375 amp min.
3 oz., 3.6 cu. in.



3 volts
10 amp min.
.43 oz., .6 cu. in.

SHOWING TREMENDOUS POWER FOR RELATIVE WEIGHT, THIS 3-OZ. BATTERY DELIVERS 2.5 AMPS AT 6.3 VOLTS FOR 16 MINUTES.

WHERE CAN YOU USE . . .

G.E.'s New Water-activated Batteries with High Power-to-weight Ratio

G.E.'s new water-activated batteries are designed to give maximum power for the least possible weight and volume per unit. In many applications, these silver-chloride/magnesium batteries will furnish up to TWICE the output of silver-oxide/zinc batteries and up to FOUR TIMES that of lead-acid batteries of corresponding size and weight.

FOR USE NEARLY ANYWHERE, G-E water-activated batteries are activated by immersion in water. In land or airborne applications, activation is accomplished by other saturation methods. This versatility makes them an ideal power source for many specialized applications.

THE COMPLETELY DRY CONSTRUCTION of G-E water-activated batteries simplifies many storage problems. Since they contain no water during storage, danger of freezing and power loss is eliminated. With normal precaution against moisture, length of storage will not alter their come-up time—They still reach operating voltage within two seconds after activation!

THE WIDE VARIETY OF DESIGNS possible with G-E water-activated batteries, ideally suits them to the power requirements and space limitations of certain equipment now using bulky, heavier power supplies. If your power needs can be satisfied with a water-activated bat-

tery, investigate G.E.'s line today. And remember, though a wide range of ratings and sizes is available, G-E water-activated batteries can be designed to your specific needs. For detailed information, contact your G-E Apparatus Sales Office, or send coupon below for free descriptive bulletin.

General Electric Co., Section C223-3
Schenectady 5, N. Y.

Please send me Bulletin GEA-6238A on
Water-activated Batteries

I am requesting this information

- For immediate project
 For reference only

Name

Position

Company

City Zone State

Progress Is Our Most Important Product

GENERAL  ELECTRIC

Japan has been among the leaders in this application, but other countries are moving into the field.

For example, Pam Radio and Television in England recently announced that it is in production on a transistorized portable radio that will sell for about \$65. Transistors for the set are supplied by Pye of Great Britain.

Rising Copper Prices Finally Halt

Market in primary metal begins to ease. Economic pressure on electronics industry lessens

RECENT increases and fluctuations of copper prices have been of grave concern to the electronics industry as well as other major users.

► **Price**—Copper prices have more than tripled in the past ten years, with the greatest increases occurring in the past year. Average price per pound in 1946 was 14¢ compared to 36¢ last year and 46¢ so far this year.

► **Market**—Copper output (refined plus that recovered from scrap) totaled about 2.3 million tons last year. This year's first quarter output was about 600,000 tons. The electronic and electrical industry is the largest consumer of copper, taking upwards of 60 percent of this output.

► **Damper**—Recently copper prices declined from a high of about 54¢. One of the reasons given for the decline is the infiltration of competitive metals in the market tending to tone down the headlong rise in price and balance supply with demand.

Huge copper users such as the Bell System have been emphasizing use of substitutes for copper wherever and whenever it becomes practical. Reducing the size of aluminum wire and splicing it as easily as copper are some of the problems to be worked out. When these are licked it may well be that copper may have lost an estimated 20 percent of the lucrative electronic market.



NEW plant is built up within five days after old one burns down as . . .

Fire Fails To Upset Defense Output

Minimum of time is lost as electronics firm moves fast to keep production rolling

FIRE struck Sunday, April 1, completely leveling the 40,000-sq ft plant of Varo Manufacturing in Garland, Texas which was engaged 100 percent in defense electronics production. Fifteen hours later the company had leased a new 15,000-sq ft building and was moving into it. At about the same time, as the FBI was still examining the smoldering ashes for evidence of possible sabotage, construction of a new plant was started a few feet away from the ruin.

Five days later, on Friday, 8,000 sq ft of the new plant was ready for

occupancy. With additional 8,000-sq ft increments being completed approximately every 10 days, Varo will have a new plant and a leased one with more total space than that lost only 30 days after the fire.

► **Output**—Engineering prototype design and construction was in partial operation two days after the fire, and production schedules will be effected but slightly, according to the firm. All equipment will be 90 percent replaced by April 30 and production rates will be back to normal and quantity shipments on existing contracts will begin less than 60 days after the disaster, the company stated. New contracts will suffer no delay since recovery will be complete within the normal delay of material procurement.

Output Expands In West Germany

Production of radio and tv sets hit new high. Export volume keeps growing

WITHOUT defense work or substantial foreign aid the electronics industry in West Germany has literally pulled itself up by its own bootstraps to become one of the world's leaders in electronics.

► **Rank**—Today, West Germany is

in third place, after England and France, as a leading producer of electronics equipment in Europe. According to Dr. Lothar Rohde, codirector of Rohde & Schwarz in Germany, the nation accounts for about 25 percent of the estimated \$100 million annual electronics volume of all of Europe.

► **Radio-Tv**—West Germany has returned to her position as one of

(Continued on page 26)

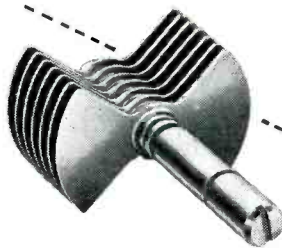

Rotor. Assembled in precision fixture, rigidly soldered. Nickel-plated brass. Precision-grooved rotor to control thrust washer compression.

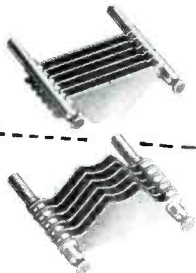

Stators. Assembled in precision fixtures, rigidly soldered. Nickel-plated brass. Jig located in final assembly to maintain exact plate spacing.

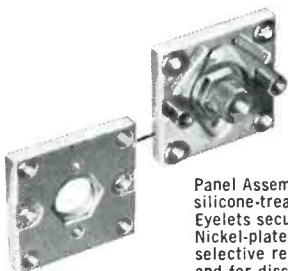

Panel Assembly. Low-loss silicone-treated steatite panel. Eyelets securely spun into panel. Nickel-plated brass bearing, selective reamed for shaft fit and for dissimilar bearing metals for long life.



Contact Spring. Beryllium copper heat-treated for long life. Silver-plated for positive contact.

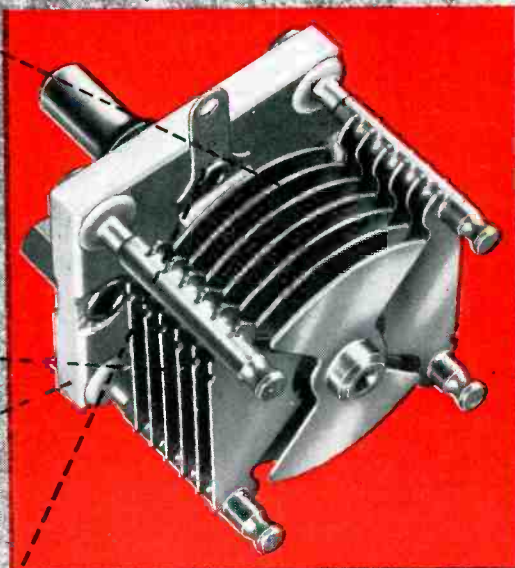

Precision built from every angle.

HAMMARLUND

Means precision in detail

The finest materials, design and workmanship are inherent in every Hammarlund variable capacitor, assuring quality you can depend upon for the most critical applications.

Hammarlund offers a complete line of standard precision-built capacitor designs to fill most requirements. In addition, Hammarlund maintains a large stock of tools and excellent short-order facilities to meet any "special" needs.

When you need standard or special variable capacitors, come to the **expert** first — come to Hammarlund!

Write For Bulletin E-556

THE HAMMARLUND MANUFACTURING COMPANY, INC.
460 West 34th Street, New York 1, N. Y.
International Division: 13 East 40th Street, New York 16, N. Y.



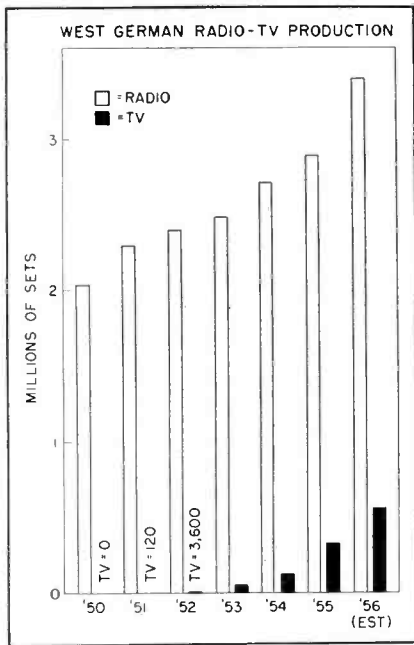

the world's leading exporters of radio receivers. The industry exported some 43 percent of the 1955 production of about 3 million sets compared to 20 percent in 1953. Radio production totaled 2.8 million sets in 1954 of which 867,000 were sold abroad.

Over 300,000 tv sets were manufactured in the country last year compared to 147,000 in 1954. Production in 1956 is expected to increase to between 500,000 and 600,000. About 30,000 tv sets were exported in 1955 compared to 19,000 in 1954.

► **Dollars** — West Germany exported about \$60 million worth of radio and tv sets last year. The main export markets were the Netherlands which accounted for \$10.5 million; Switzerland, \$5.5 million; Belgium, \$4 million; Great Britain and Italy \$3.5 million each and U.S., \$3.5 million.

► **Imports** — West Germany is a substantial market for other countries as well as a competitor. In 1955 about 54,000 radio and tv sets worth \$3.5 million were imported. The U.S. and the Netherlands were the main suppliers accounting for about \$1.2 million each. Great Britain accounted for about \$1 million so that the three countries accounted for 90 percent of total West German radio-tv set imports.

FUTURE MEETINGS

- APRIL 29-MAY 3: Fourth Annual Semiconductor Symposium, Electrochemical Society, Mark Hopkins Hotel, San Francisco.
- APRIL 30-MAY 3: URSI Spring Meeting, NBS, Wash., D. C.
- APRIL 30-MAY 4: SMPTE 79th semiannual convention and exhibit, Hotel Statler, New York, N. Y.
- MAY 1-3: The 1956 Electronic Components Symposium, U.S. Department of Interior Auditorium, Washington, D. C.
- MAY 2-4: Northeastern District Meeting, AIEE, Sheraton Hotel, Rochester, N. Y.
- MAY 14-16: National Aeronautical & Navigational Conference, PGANE, Biltmore Hotel, Dayton, Ohio.
- MAY 14-17: The Design Engineering Show and Conference, Philadelphia, Pa.
- MAY 15-16: Industrial Nuclear Technology Conference, NUCLEONICS, Armour Research, Museum of Science and Industry, Chicago, Ill.
- MAY 17-19: Thirtieth Engineering Industries Exposition and Annual Convention, New York State Society of Professional Engineers, Statler Hotel, New York, N. Y.
- MAY 21-24: Electronics Parts Distributors Show, Conrad Hilton Hotel, Chicago, Ill.
- MAY 21-22: RETMA Symposium on Reliable Applications of Electron Tubes, Irvine Auditorium, University of Penna., Philadelphia, Pa.
- MAY 22-24: Thirty-Second Annual Session of the Communications Section of the Association of American Railroads, Hotel Netherlands Plaza, Cincinnati, Ohio.
- MAY 23-26: Annual meeting, National Society of Professional Engineers, Ambassador Hotel, Atlantic City, N. J.
- MAY 24-26: Tenth Annual Armed Forces Communications and Electronics Association Convention and Exhibit, Hotel Statler, Boston.
- JUNE 4-6: Second Annual Radome Symposium, Ohio Union, Ohio State University, Columbus, Ohio.
- JUNE 5-6: Radio Technical Commission for Aeronautics, Spring meeting of Assembly, with Boston sections of IRE and IAS, Statler, Boston.
- JUNE 6-8: Tenth Annual Convention, American Society for Quality Control, Montreal.
- JUNE 18-24: International Congress on Automation, Conservatoire National des Arts et Metiers, Paris, France.
- AUG. 20-21: National Telemetering Conference, IRE, AIEE, IAS, ISA, Biltmore Hotel, Los Angeles, Calif.
- AUG. 21-24: 1956 Western Electronic Show and Convention, Pan-Pacific Auditorium, Los Angeles, Calif.
- SEPT. 10-12: Information Theory Symposium, IRE, MIT, Cambridge, Mass.
- SEPT. 11-12: Second RETMA Conference on Reliable Electrical Connections, University of Pennsylvania, Philadelphia.
- SEPT. 17-21: Eleventh Annual International Instrument-Automation Conference and Exhibit, ISA, New York Coliseum, New York, N. Y.
- SEPT. 24-25: Industrial Electronics Conference, IRE, AIEE, Hotel Manger, Cleveland, Ohio.

Industry Shorts

- **Few thousand** RCA-type 21-inch color picture tubes have been ordered by GE for a new line of color sets to be introduced next fall.
- **Forty** noncommercial educational tv grants have now been made by FCC. Only one station has surrendered its authorization.
- **Steady** replacement demand for tv picture tubes at a volume of around

10 million tubes a year, is predicted by E. B. Hinck of Du Mont.

► **Manufacture** of tv receivers has been suspended by Stromberg-Carlson but the firm will continue to produce radio-phonographs and hi-fi equipment.

► **Artificial** ionosphere has been produced by the Air Force Cambridge Research Center by releasing nitric oxide gas under high pressure into the atmosphere at an altitude of more than 316,000 feet.

HIGH Output (1.0 v. RMS into 70 ohms)
WIDE Range (2-220 Megacycles. All At Fundamental)
 and
CONSTANT OUTPUT
 (Fast Acting AGC)

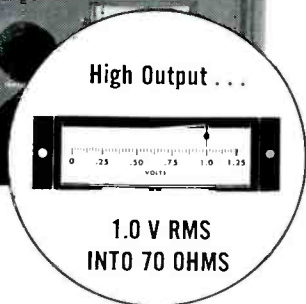
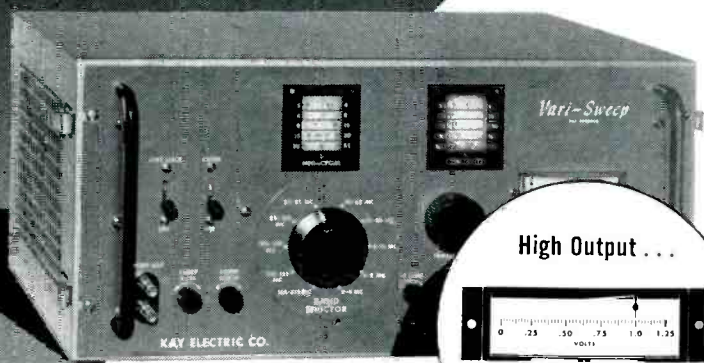

SPECIFICATIONS

- Range:** Fundamental frequency 2 to 220 mc., continuously variable in 10 switched overlapping bands. Direct reading frequency dial calibrated to $\pm 2.0\%$.
- RF Output:** 1.0 v. RMS into 70 ohms, metered. Flat within ± 0.5 db over widest sweep and frequency band.
- Sweep Width:** Continuously variable to $\pm 30\%$ of center frequency to maximum of at least 30mc.
- Sweep Rate:** Continuously variable 10 to 40 cps.; also locks at line frequency.
- Attenuator:** Switched 20, 20, 10, 6, and 3 db plus continuously variable 6 db.
- Power Supply:** Electronically regulated 105 to 125 v. A. C. 50 - 60 cycles

**NEW
KAY**

Vari-Sweep

ALL-ELECTRONIC HIGH LEVEL SWEEPING OSCILLATOR OR, (with sweep off) CONTINUOUSLY TUNED CW SIGNAL SOURCE

- Operates On Fundamental Frequency, Therefore Stable Narrow-Band Sweeps
- 1.0 v. RMS (into 70 ohms) Output Flat to ± 0.5 db Over Widest Sweep
- Output Automatically Held Constant (AGC) Over Complete Range
- Variable Sweep Width (to 30 mc. PLUS) — Variable Center Frequency
- Direct Reading Frequency Dial Accurate To $\pm 2.0\%$
- Sweep Repetition Rates Down to 10 cps

Price: **\$695.** FOB Plant



KAY *Ligna-Sweep* MODEL C

ALL-ELECTRONIC SWEEPING OSCILLATOR FOR TV-FM APPLICATIONS

Variable center frequency and sweep with high output automatically held constant over frequency sweep and frequency band. Ranges are covered by six switched bands with direct reading frequency dial.

VHF: Range 30 to 220 mc. continuous, with fundamental frequency output of

1.0 v. RMS into 75 ohms. Sweep width variable to at least 15 mc.; 20 mc. over VHF TV bands. Separate low IF band.

Also Video Range 100 kc. to 12 mc. with beat frequency output of 0.25 v. RMS into 75 ohms. Sweep width variable 100 kc. to 12 mc.

Price: **\$350.** FOB Plant

write for new
1956 Kay catalog

KAY ELECTRIC COMPANY Dept. E-5
 14 MAPLE AVENUE PINE BROOK, N. J. CAldwell 6-4000

NEW SOLUTIONS

From RAYTHEON—a quality

TEST JACKS FOR PRINTED CIRCUITS

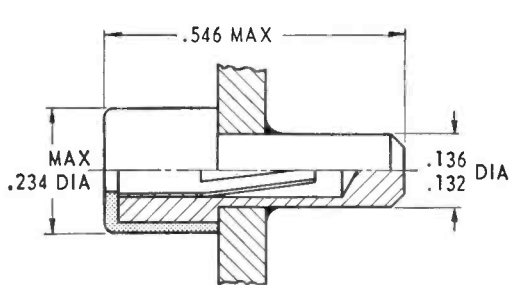

PROBLEM—Convenient test points are needed on printed circuit panels. Jacks must lend themselves to easy assembly and automatic dip soldering.

SOLUTION—Raytheon's new printed circuit test jacks. No mounting hardware—for panels 1/32 to 1/4" thick. Can be dip soldered. Unique beryllium copper spring-pin contact. Accommodates standard .080 diameter test prod. 8 colors. (Also available—Raytheon subminiature and standard test jacks.)

CAPTIVE HARDWARE

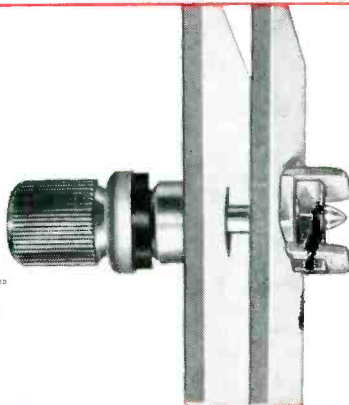
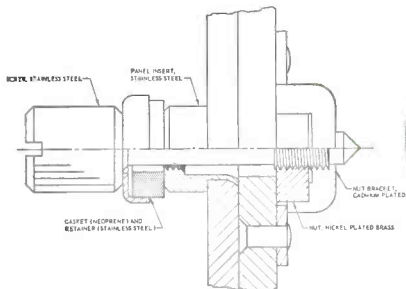

PROBLEM—To meet military specifications for captive hardware.

SOLUTION—Raytheon supplies the complete assembly at the lowest cost available. Consists of a stainless steel captive screw (variety of lengths) and panel insert; nickel plated brass floating nut; cadmium plated nut bracket; Neoprene gasket and stainless steel gasket retainer. Thread sizes: 10-24, 1/4-20, 5/16-18.

5-WAY BINDING POSTS

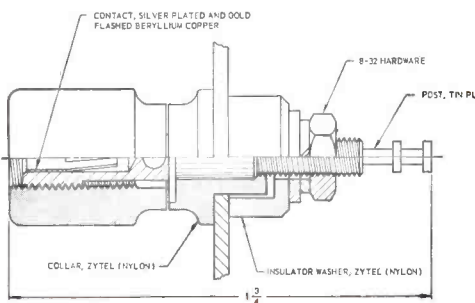

PROBLEM—A compact, high-strength binding post incorporating a test jack is required.

SOLUTION—Raytheon binding posts are made of nylon and brass and include a beryllium-copper spring pin contact for plug in of .080" diameter prods. Other connections: prod or wire clamped thru center hole; wire coiled around post and clamped. Turret Terminal for solder connection. Available in black or red.

SHAFT LOCKS

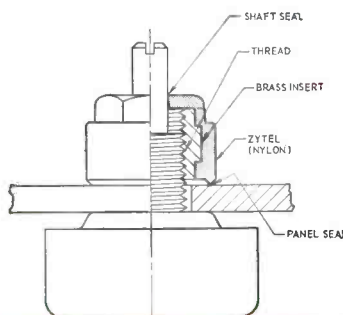

PROBLEM—To retain adjustment of slotted shaft potentiometers under conditions of vibration and shock.

SOLUTION—Raytheon shaft locks provide constant drag on potentiometer shafts. Permit smooth adjustment without unlocking, but prevent vibration or shock from moving shaft. Also provide water and dust proof seal of shaft and panel. Made of nylon and brass. Replaces potentiometer mounting nut. For 1/4" and 1/8" shafts.

TO OLD PROBLEMS

line of panel components

KNOB LOCKS

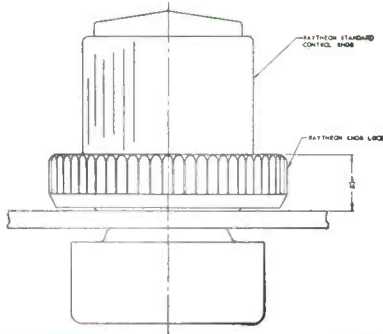

PROBLEM—To retain control settings under conditions of vibration, shock or accidental manual contact, yet permit easy adjustment.

SOLUTION—Raytheon knob locks are rotated one eighth turn clockwise to hold setting securely under all conditions. Reversing lock permits easy re-setting of control. Simple rugged construction. Design matches Raytheon Standard Control Knobs.

PULL HANDLES

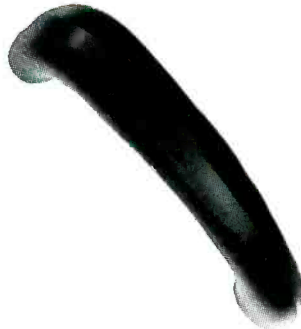
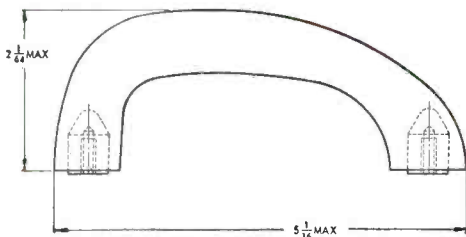

PROBLEM—Functional design, high strength and attractive appearance are needed for pull handles.

SOLUTION—Integrated in design and appearance with Raytheon Standard Control Knobs, Raytheon pull handles have a unique "contour grip" shape. Molded of "Tenite II" with anodized aluminum inserts for maximum strength and impact resistance. Mirror or matte finish available.

TERMINAL BOARD MOUNTING BRACKETS

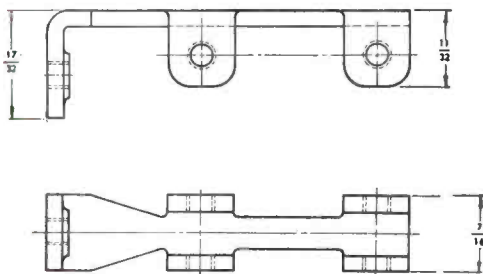

PROBLEM—Brackets which meet military specifications for vibration and shock are required for mounting terminal boards or printed circuit panels.

SOLUTION—Made of cadmium plated steel, Raytheon mounting brackets meet mil specs for withstanding rugged conditions. Brackets may be used for mounting one or two boards. Available in four sizes—2-1/16" to 3-9/16" overall length for panels ranging from 1-3/8" to 3-7/16" wide.



Available from Raytheon—A complete line of Standard Control Knobs designed to meet rigid mil specs.

Now available for the first time, all the components shown here—designed to meet your specific needs. These components, in conjunction with Raytheon's Standard Control Knobs series, form a *complete, integrated line from one source*—to satisfy virtually all your requirements.

For full information and prices, please write Dept. 6120A.

Excellence in Electronics

RAYTHEON MANUFACTURING COMPANY

Equipment Marketing Department, Waltham 54, Mass.



A-4006

EASY TO MACHINE!

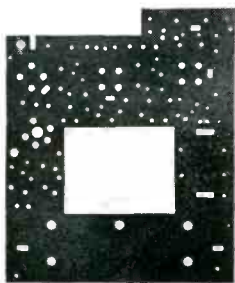

As manufactured by
INSULATED CIRCUITS, INC., WEST CALDWELL, N. J.

Your printed circuitry is off to a good start when you specify one of C-D-F's Metal-Clad Dilecto grades. Base materials are uniform, almost homogeneous—therefore easier to punch, drill, form...with less waste of expensive time and materials.

EASY TO ETCH!

The closely bonded foil can be etched cleanly and dipped in hot solder to 220°C. (428°F.) for ten seconds with a guarantee of no blistering or separating. HIGH BOND STRENGTH is an all-important virtue of C-D-F Metal-Clads.

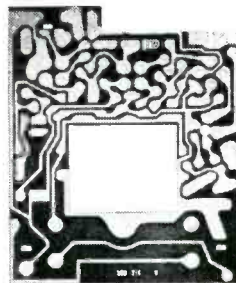

As manufactured by
INSULATED CIRCUITS, INC.
WEST CALDWELL, N. J.

FOUR FEATURES YOU GET WITH

C-D-F METAL-CLAD LAMINATES

EASY TO ASSEMBLE!

Automatic or hand assembly is speeded when printed circuits are on dimensionally stable C-D-F Dilecto. Minimum warp and twist. Unlike many materials, Dilecto can be dropped, jammed into tight chassis, treated roughly in assembly and service.

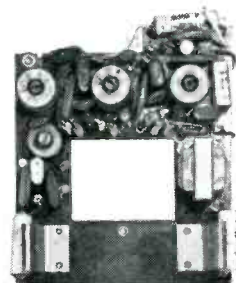

As manufactured by
INSULATED CIRCUITS, INC.
WEST CALDWELL, N. J.

EASY TO SELL!



As manufactured by
Regency Division, I.D.E.A., Inc.
Indianapolis 26, Ind.

Manufacturers, like I.D.E.A., Inc., whose Regency transistor radio is pictured, find C-D-F a big, reliable source of supply. C-D-F delivers high-quality laminates on time, to meet exacting production schedules. Result: better products, made and sold at lower costs!

C-D-F Metal-Clad Dilecto

A laminated plastic with copper or aluminum sheet bonded tightly to one or both surfaces. Base materials: paper or woven glass fabric. Resins: phenolic, epoxy, or Teflon*. Good deliveries; expert engineering and fabricating service.

Write for *new* Metal-Clad Technical Bulletin, samples of all grades. The name and address of C-D-F sales engineer nearest you are listed in both Electronics Buyers Guide and Product Design File (Sweet's). *DUPONT TRADEMARK

improves design... simplifies purchasing... speeds production!



CONTINENTAL DIAMOND FIBRE

CONTINENTAL DIAMOND FIBRE DIVISION OF THE BUDD COMPANY, INC.

NEWARK 16, DELAWARE



**IMMEDIATE DELIVERY
on a NEW TUBELESS!**

MAGNETIC AMPLIFIER

AC LINE VOLTAGE REGULATOR

MODEL MLR - 1000

1 KVA

- ☆ NO TUBES TO REPLACE
- ☆ NO MOVING PARTS
- ☆ NO VIBRATING CONTACTS
- ☆ REGULATES RMS VALUE
- ☆ IDEAL FOR UNATTENDED INSTALLATIONS

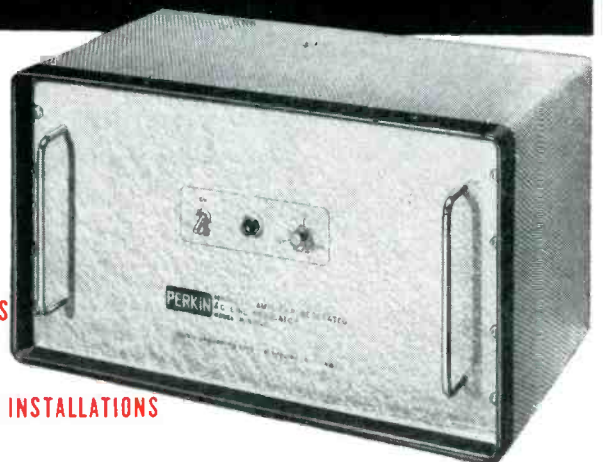

Specifications...

- Input Voltage Range: 95 to 135 volts
- Output Voltage: Nominal 115 volts, can be adjusted from 110 to 120 volts.
- Output Current: 8.5 amperes
- Regulation Accuracy: $\pm 0.25\%$ for any combination of line or load
- Frequency Range: 60 cycles $\pm 10\%$
- Wave Form Distortion: 3% maximum
- Power Factor Range: 0.5 lagging to 0.9 leading
- Response Time: 0.2 sec.
- Maximum Load: 1.0 KVA
- Ambient Temperature Range: Up to 45° C.
- Dimensions: 19½" wide x 11" high x 11½" deep (cabinet)
19" wide x 10½" high x 11½" deep (rack panel)
- Mounting: Cabinet or 19" Rack Panel
- Finish: Gray Hammertone
- Weight: 85 lbs.



Write for Bulletin MLR 1000

PERKIN ENGINEERING CORP.
345 KANSAS ST., EL SEGUNDO, CALIF. PHONE: OREGON 8-7215

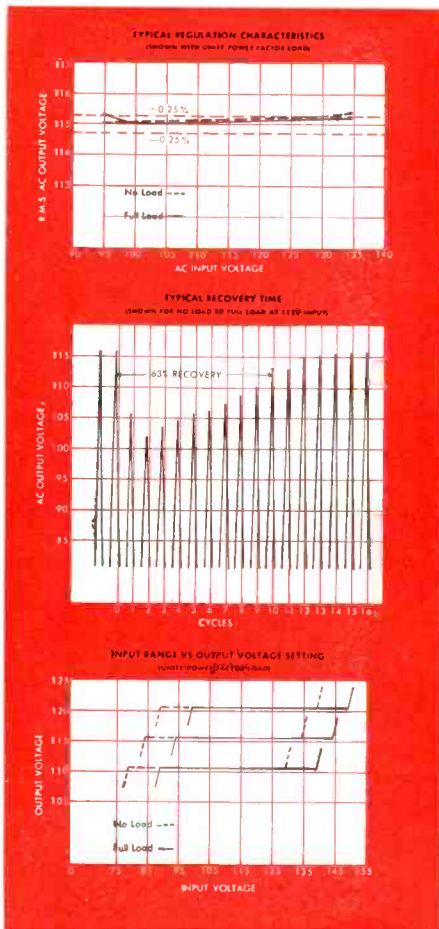

For PROMPT REPLY, wire the factory collect or phone our nearest sales office.

New York City: HUnter 2-7784
Philadelphia: NOrristown 5-2600
Chicago: DIversey 8-6885
St. Louis: DElmar 7701
Kansas City, Mo.: JEfferson 7221
Dallas: FOrrest 8-8306
Denver: MAIn 3-0343
San Francisco: ULmar 1-7129
Syracuse: 2-1167
Pittsburgh: WAInut 1-2959
Minneapolis: MIdway 4-7884
Seattle: MOhawk 4895
Albuquerque: 5-9632
Los Angeles: SYcamore 8-5790

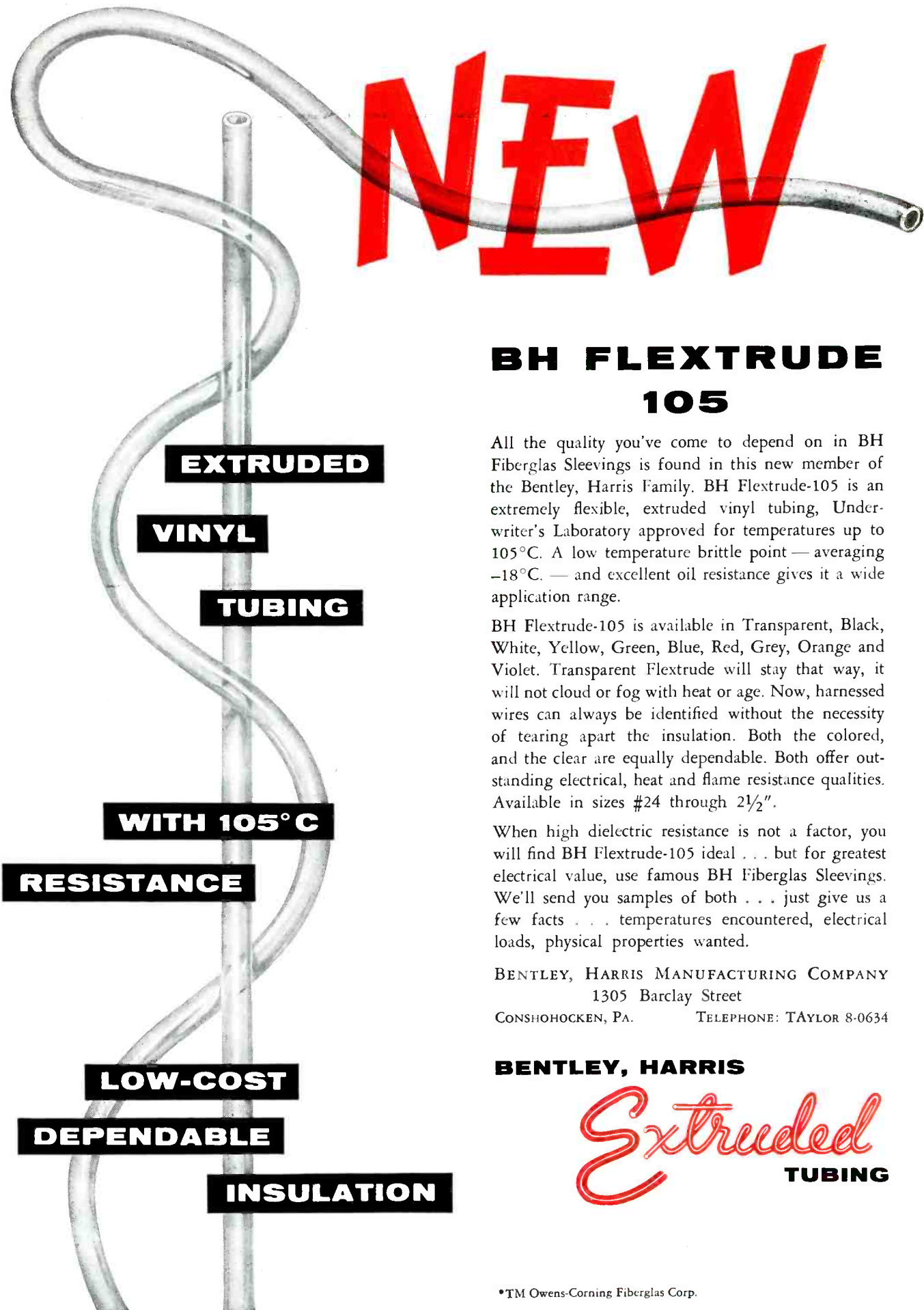

NEW

BH FLEXTRUDE 105

All the quality you've come to depend on in BH Fiberglas Sleeveings is found in this new member of the Bentley, Harris Family. BH Flextrude-105 is an extremely flexible, extruded vinyl tubing, Underwriter's Laboratory approved for temperatures up to 105°C. A low temperature brittle point — averaging -18°C. — and excellent oil resistance gives it a wide application range.

BH Flextrude-105 is available in Transparent, Black, White, Yellow, Green, Blue, Red, Grey, Orange and Violet. Transparent Flextrude will stay that way, it will not cloud or fog with heat or age. Now, harnessed wires can always be identified without the necessity of tearing apart the insulation. Both the colored, and the clear are equally dependable. Both offer outstanding electrical, heat and flame resistance qualities. Available in sizes #24 through 2½".

When high dielectric resistance is not a factor, you will find BH Flextrude-105 ideal . . . but for greatest electrical value, use famous BH Fiberglas Sleeveings. We'll send you samples of both . . . just give us a few facts . . . temperatures encountered, electrical loads, physical properties wanted.

BENTLEY, HARRIS MANUFACTURING COMPANY
1305 Barclay Street
CONSHOHOCKEN, PA. TELEPHONE: TAYLOR 8-0634

BENTLEY, HARRIS

Extruded
TUBING

*TM Owens-Corning Fiberglas Corp.

let **OHMITE**
engineers
"TEAM UP"
with your
engineers

IN SOLVING YOUR
RESISTANCE PROBLEMS

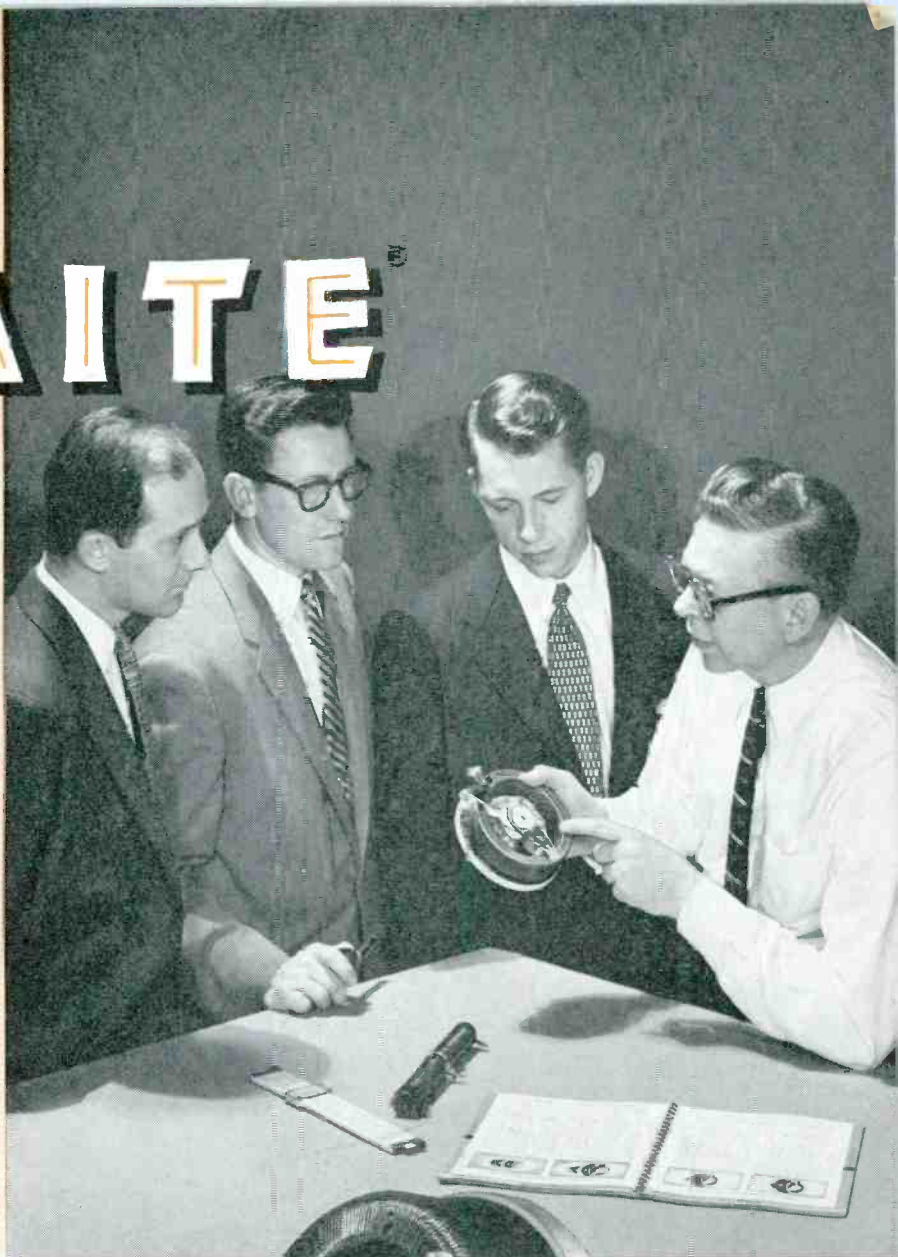

Save valuable engineering time . . . team up with Ohmite to solve your resistance problems. Ohmite engineers are resistance specialists . . . they can quickly analyze your requirements and recommend the correct rheostats and resistors to fit your application. Years of experience in building dependable resistance units . . . complete design, development and production facilities . . . plus a long record of helping others to economically solve their resistance problems . . . are your assurance that Ohmite can help you. We invite you to submit your resistance problems to us.

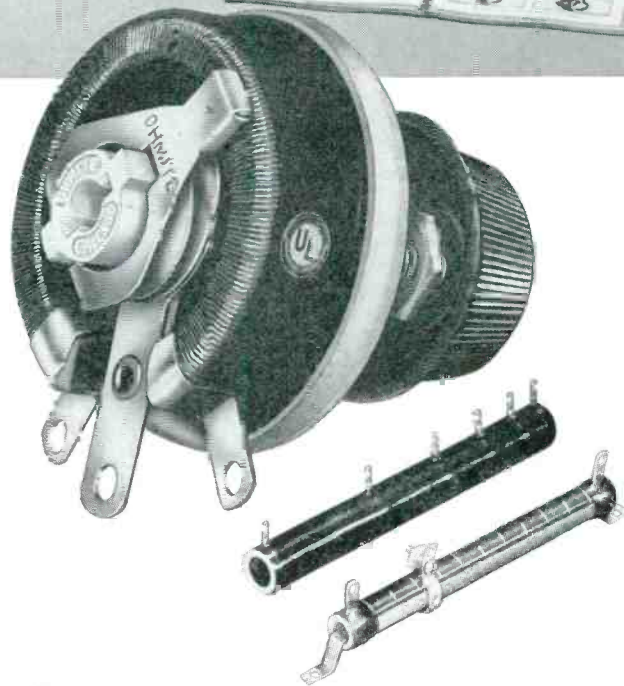

OHMITE MANUFACTURING COMPANY, 3610 Howard Street, Skokie, Illinois (Suburb of Chicago)

Be Right with - **OHMITE**

RHEOSTATS • RESISTORS • RELAYS • TAP SWITCHES • TANTALUM CAPACITORS

OHMITE®

AMRECON®

Relays

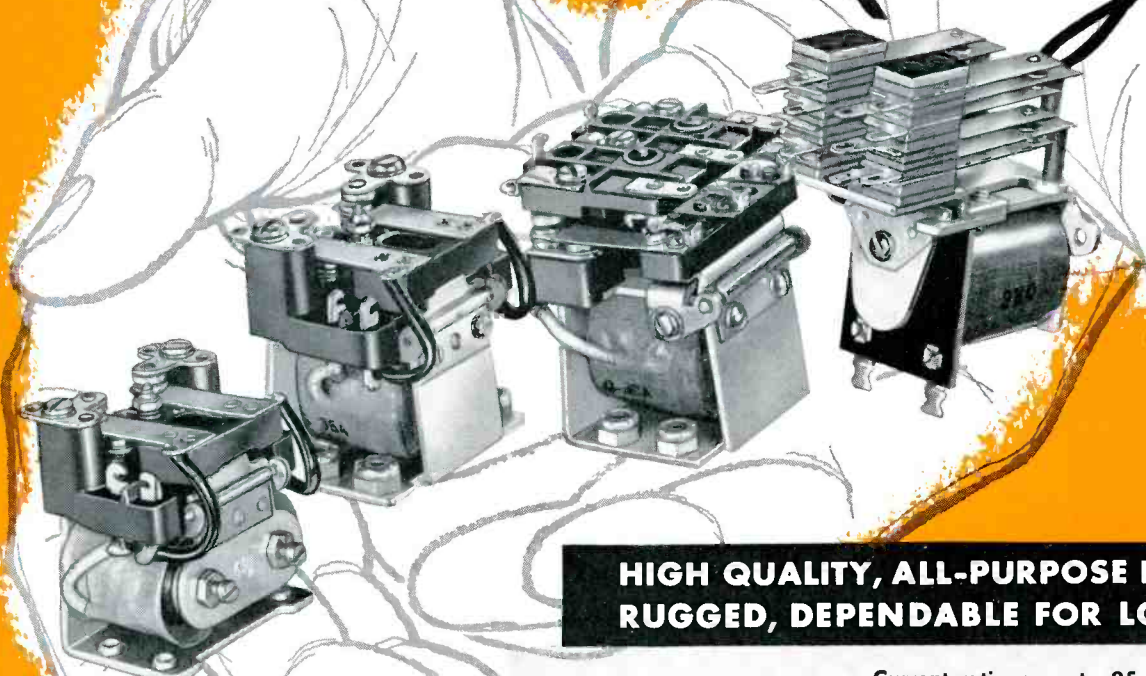

**HIGH QUALITY, ALL-PURPOSE RELAYS...
RUGGED, DEPENDABLE FOR LONG LIFE!**

65 types in four stock models

Ohmite Amrecon relays have proven their exceptional ruggedness and long life in years of service. Now, four popular stock models—DOS, DOSY, DO, and CRU, in 65 different types—are available from stock.

Models DO and DOS fill many industrial needs for a compact, lightweight relay that handles power loads usually requiring much larger, heavier units. They are particularly adaptable to aircraft and mobile equipment where severe shock and vibration are encountered. The increased operating sensitivity of Model DOSY relay, equipped with twin coils, makes the DOSY adaptable to a wide range of electronic control circuits, such as plate circuit controls. At 115 VAC or 32 VDC, noninductive load, Models DOS and DOSY have contact ratings of 15-amp; Model DO, 10 amp; and Model CRU, 5 amp. Available in a wide range of coil operating voltages and contact combinations.

Current ratings up to 25 amp, AC or DC.
Also made-to-order models in many contact combinations and coil voltages.

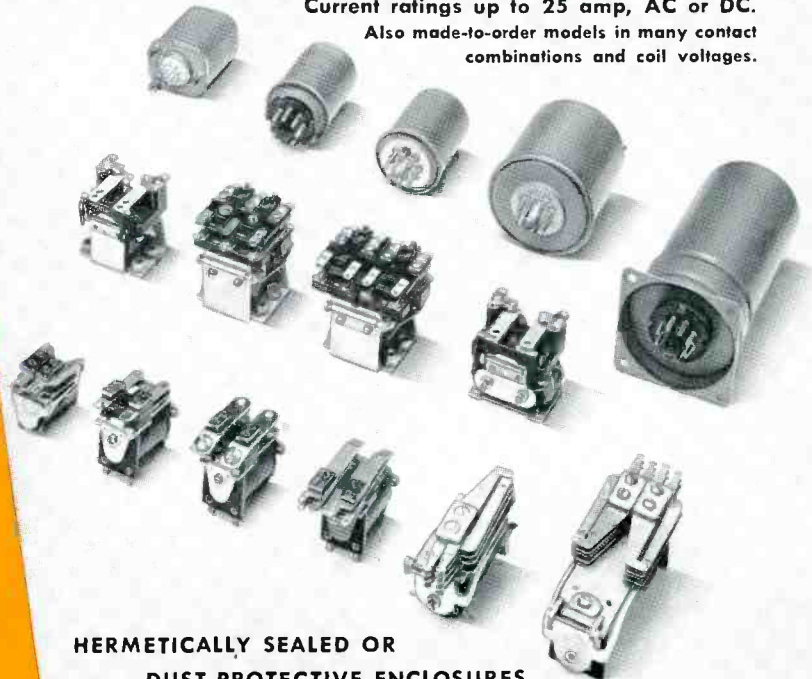

**HERMETICALLY SEALED OR
DUST-PROTECTIVE ENCLOSURES**

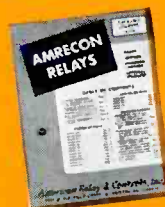

**SEND FOR
CATALOG R-10**

OHMITE MANUFACTURING COMPANY
3610 Howard Street, Skokie, Illinois
(Suburb of Chicago)

Be Right with
OHMITE®
RHEOSTATS • RESISTORS • RELAYS • TAP SWITCHES

Only the Big

NATIONAL MOLDITE COMPANY

Double check the Core Manufacturer with the low price and quick delivery promises, which do not permit intelligent engineering and careful production.

Long established firms like MOLDITE, with their vast contributions to research and development of new cores and core materials, with their advanced production and testing techniques, are greatly responsible for raising the worlds standards for quality cores, molded coil forms, and ferrites. Every business has its Johnny-come-lately's without the background and goodwill that we at MOLDITE cherish and protect every day.

When you want cores you can trust, that will guarantee the high quality of your equipment,
MOLDITE
is ready to serve you.

ALWAYS DELIVERS A HIGH QUALITY PRODUCT



Send for our Catalog 120

IRON CORES • FERRITES • MOLDED COIL FORMS • E E CORES

Robert T. Murray Co.
604 Central Avenue
East Orange, N. J.

Jerry Gollen Co.
2750 W. North Ave.
Chicago 22, Ill.

William A. Franklin
3 Holly Road
North Syracuse, N. Y.

Jose Luis Ponte
Cordoba 1472
Buenos Aires

NATIONAL MOLDITE COMPANY

1410 Chestnut Avenue
Hillside 5, New Jersey

Perlmuth-Colman & Assoc.
2419 South Grand Ave.
Los Angeles Cal.

John S. Plewes Co.
52 Humbercrest Blvd.
Toronto 9, Ontario

How will the tube function in your circuit?

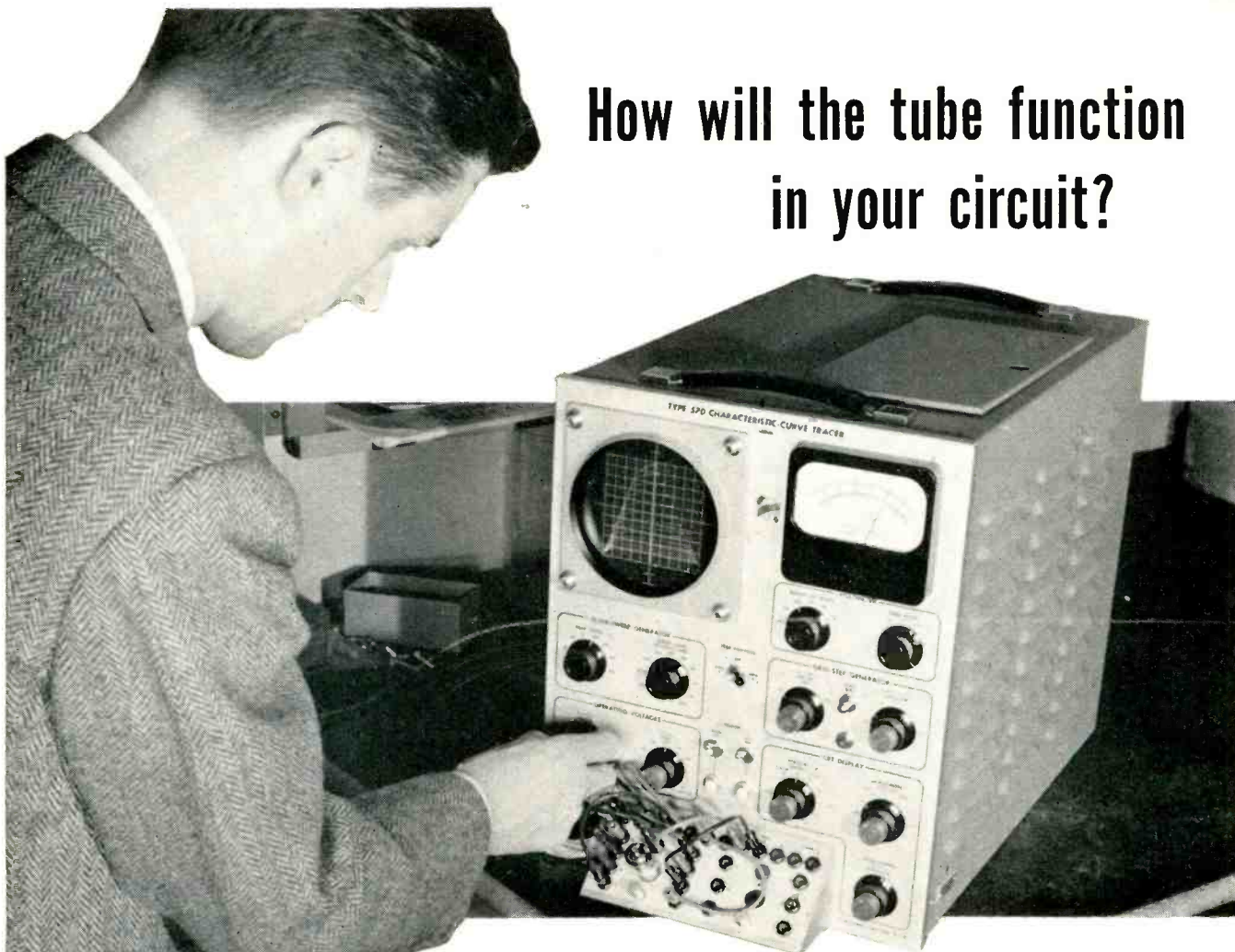

With the aid of the Tektronix Type 570 Characteristic-Curve Tracer you can see exactly how a vacuum tube will function under almost any set of circuit values. You can read voltages and currents accurately from the family of characteristic curves presented on the screen. These accurate pictures of grid, plate, and screen-grid characteristics under your own design conditions can save many hours of valuable engineering time.



TYPE 570 BASIC SPECIFICATIONS

Displays Families of Curves on CRT Screen

Choice of four to twelve characteristic curves per family — with as many as 8 positive-bias curves per family. Low-impedance grid-step supply has high current capability for accurately displaying positive-bias curves.

Plots All Important Characteristics

- Plate current against plate voltage.
- Plate current against grid voltage.
- Screen current against plate voltage.
- Screen current against grid voltage.
- Grid current against plate voltage.
- Grid current against grid voltage.

Calibrated Controls

Accurate current and voltage readings directly from the crt screen.

Wide Display Range

- 11 current ranges from 0.02 ma/div to 50 ma/div.
- 9 voltage ranges from 0.1 v/div to 50 v/div.
- 11 series-load resistors from 300 ohms to 1 megohm.
- 7 grid-step values from 0.1 v/step to 10 v/step.

Price — \$925

f.o.b. Portland (Beaverton), Oregon

Tektronix, Inc.

P. O. Box 831, Portland 7, Oregon

Phone Cypress 2-2611 • TWX-PD 265 • Cable: TEKTRONIX

Want complete specifications? Please call your Tektronix Field Engineer or Representative, or write direct for Type 570 Technical Description.

Raytheon — World's Largest Manufacturer of Magnetrons and Klystrons



ONE MAN? NO, TWELVE!

ADD THEIR SKILLS TO YOUR STAFF — AT NO COST

You see only one man on the button. But he is representative of twelve—12 Raytheon Application Engineers. They all work in the division of Raytheon that designs and produces magnetrons, klystrons and special purpose tubes.

Teamed together, your engineers and ours can determine the tube requirements of your microwave system: Which klystron is best suited? Which magnetron? Should an existing tube be modified, or is an entirely new one called for?

This teamwork lightens the burden on your systems engineers. It lets them concentrate on equipment designs while our engineers assist you in selecting the right tubes for the best service.

Consult the leading maker of magnetrons and klystrons right from the start. Raytheon is ready to help you wherever you are, whatever your project—military or commercial. Write for details on our Application Engineering Service. Ask also for valuable Tube Data Booklets.

Excellence in Electronics



RAYTHEON MANUFACTURING COMPANY

Microwave and Power Tube Operations, Section PT- 47, Waltham 54, Massachusetts

Raytheon makes: Magnetrons and Klystrons, Backward Wave Oscillators, Traveling Wave Tubes, Storage Tubes, Power Tubes, Receiving Tubes, Picture Tubes, Transistors

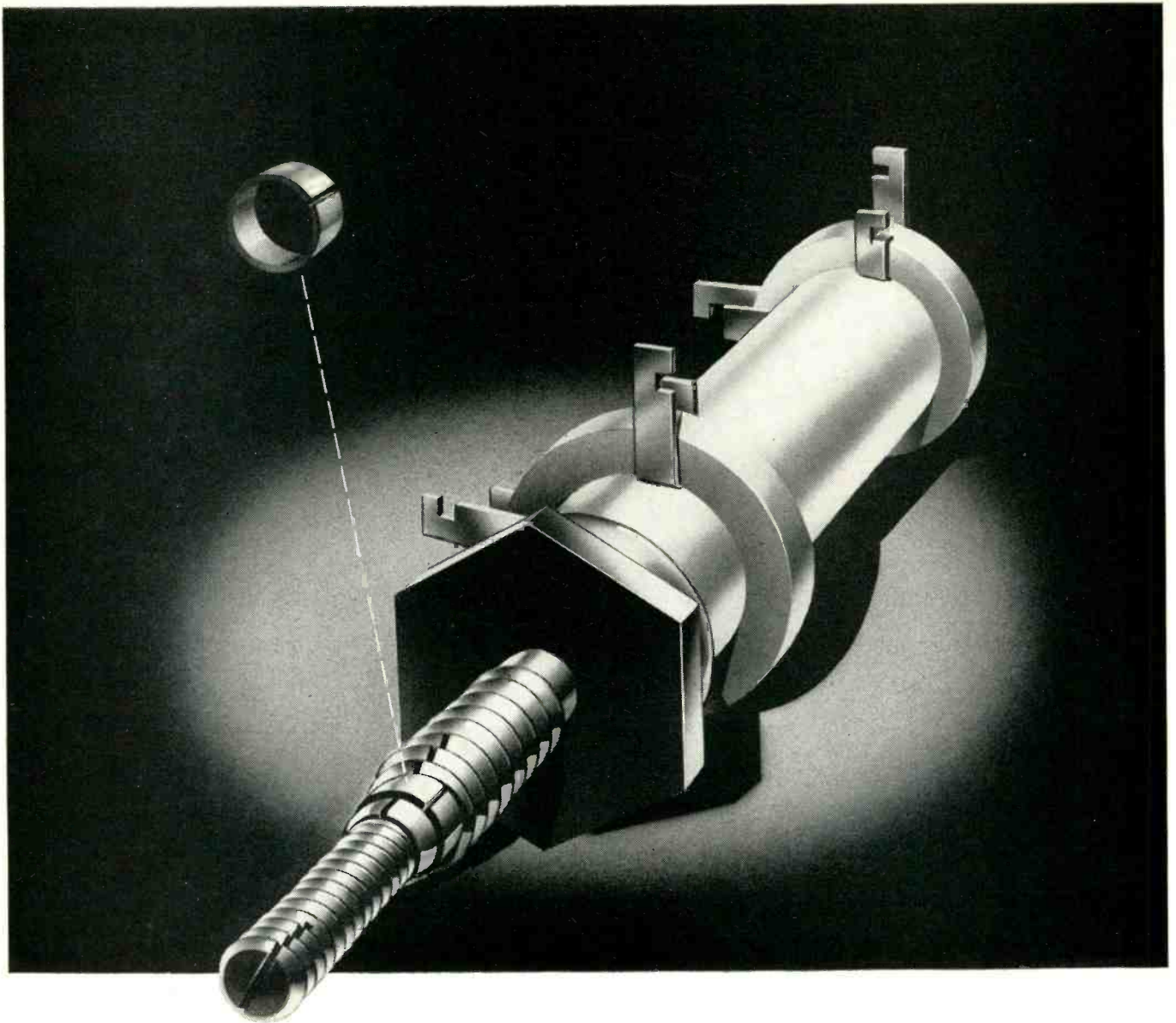

Always tense but never tired

Again CTC comes up with an advancement for more secure, more effective electronic assemblies. It's the new Perma-Torq* constant tensioning device for tuning cores of standard CTC ceramic coil forms.

CTC's Perma-Torq, a compression spring of heat treated beryllium copper, has very high resistance to fatigue and keeps coils tuned as set, under extreme shock and vibration. It allows for immediate readjustment without removal or loosening of any mounting nut or locking spring. But most important of all — Perma-Torq like all CTC components is *quality controlled*.

CTC's *quality-control* means you get consistent top quality components. Each step of production is checked, each component part — even though already certified — is checked again. And finally CTC's finished product is checked. That's why CTC can offer you a guaranteed electronic component — standard or custom — whose performance you can depend upon.

CTC researchers and practical experts are always available to help solve

your components problems. For samples, specifications and prices write to Sales Engineering Dept., Cambridge Thermionic Corporation, 437 Concord Ave., Cambridge 38, Mass. On the West Coast contact E. V. Roberts, 5068 West Washington Blvd., Los Angeles 16 or 988 Market St., San Francisco, Cal.

NEW PERMA-TORQ UNITS come completely factory assembled to mounting studs, eliminating the bother of assembling and adjusting separate locking springs. CTC coil forms with Perma-Torq Tensioning Device are designated PLST, PLS5, PLS6 and PLS7, are completely interchangeable with the LST, LS5, LS6 and LS7 series, and are available at no increase in price.

*Patent pending

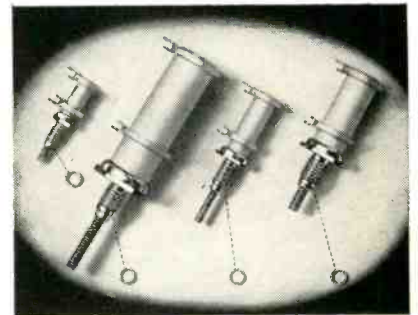

CTC

CAMBRIDGE THERMIONIC CORPORATION

*makers of guaranteed electronic components
custom or standard*



MAXIMUM MICROWAVE POWER

Broadband 650 to 10,750 mc

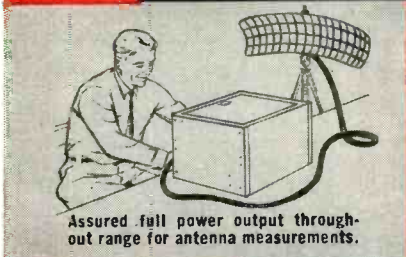
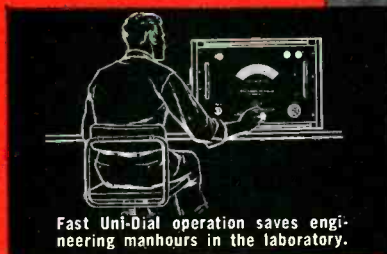

MICROWAVE SIGNAL SOURCES

When you need power — and frequency accuracy — Polarad Microwave Signal Sources provide a maximum power output 10 to 20 db greater than comparable signal generators. They are excellent for standing wave determinations, antenna and transmission loss measurements, and testing microwave components on the production line.

These units are direct reading and continuously tuned with Polarad's UNI-DIAL control that automatically tracks the reflector voltage as the klystron cavity is being tuned. There are no slide rule interpolations, no mode charts needed. The frequency range of these signal sources is approximately 2:1 except for the X band unit.

Maximum power output is assured throughout the entire range of each instrument by means of a power set control. For improved stability a temperature compensated klystron tube is utilized in an external precision cavity. All Polarad Signal Sources can be externally modulated with either Square wave or FM signals.

Contact the Polarad representative in your locality for complete information.

Polarad Model KX, Klystron Power Supply is especially designed to work with all 5 models of the Polarad Signal Sources. Has special 1000 cps square wave output for modulating purposes.

MINIMUM POWER AVAILABLE FROM POLARAD SIGNAL SOURCES IN THE RANGE OF 650 TO 11,500 MC

	MODEL SSR	MODEL SSL	MODEL SSS	MODEL SSM	MODEL SSX*	
FREQUENCY RANGE	650-1300MC	1050-2250MC	1740-4600MC	4450-8000MC	7850-10,750MC	
MINIMUM POWER AVAILABLE (mw)	100	80	50	15	15	
	Low Range	400	150	100	45	25
	Middle Range	400	150	60	15	20

*SSXA available on special order 7850-11,500 MC

AVAILABLE ON EQUIPMENT LEASE PLAN

FIELD MAINTENANCE SERVICE AVAILABLE THROUGHOUT THE COUNTRY

A complete line of Extremely High Frequency Microwave Signal Sources also available in a range of 12.4 to 50.0 KMC.



ELECTRONICS CORPORATION

43-20 34th STREET, LONG ISLAND 1, N. Y.

REPRESENTATIVES • Albuquerque • Atlanta • Baltimore • Boston • Buffalo • Chicago • Dayton • Englewood • Fort Worth • Los Angeles • New York • Philadelphia • San Francisco • Syracuse • Washington, D.C. • Westbury • Winston-Salem • Canada, Arnprior, Toronto.

Superior

MARINE ELECTRONIC EQUIPMENT

by

EDO

EDO

DEEP DEPTH SOUNDER

Sonar unit in wide Navy use, now available commercially. Gives clear indication of depth on CRT in two scales: 0-100 feet; 0-100 fathoms. Records continuously in three scales: 0-600 feet; 0-600 fathoms; 0-6,000 fathoms.



EDO

FISHSCOPE

Most advanced fish finding device on the market, available in three versions for deep and shallow fishing. Spots fish on CRT at depths to 400 fathoms, then magnifies any 10-fathom sector 20 to 40 times for clearer view. Compact design, single transducer.

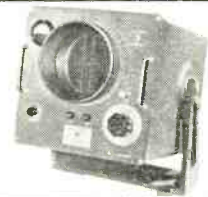

EDO

LORAN

Compact, direct-reading aid to long-range navigation. No special training required to operate. Fix obtained from single, 28-tube unit in matter of seconds, regardless of weather or sea conditions. Absolutely accurate though relatively low in cost.

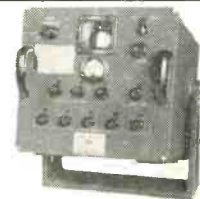

EDO

RADAR

For long and short-range navigation in any weather. CRT display gives clear picture on 1, 2, 5, 10 and 20-mile range. Patented slotted waveguide antenna, mounted on transmitter, assures superior definition. Ideal where space and generator capacity are limited.

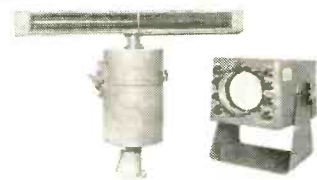

EDO

SURVEY DEPTH RECORDER

Extremely accurate equipment for measuring depth of water for survey purposes. Legible, permanent record of depth, 0 to 250 fathoms, is made within eight overlapping range scales. For permanent or temporary installation.

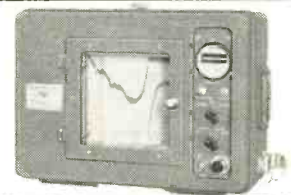

EDO

CORPORATION • COLLEGE POINT, L. I., N. Y.



Since 1925

For high conductance

get on the **GOLD** standard with



RADIO RECEPTOR

GOLD BONDED GERMANIUM

GLASS DIODES

Available in Production Quantities

Thanks to Radio Receptor's recently developed controlled gold bonding process, there's a new standard of excellence in glass diodes. Now you can have dependable, high conductance without sacrifice of desirable low leakage in reverse current. These diodes are tested in excess of military requirements and include every desired feature you've sought, including utmost stability, durability and precise size.

CODE NO.	MINIMUM FORWARD CURRENT AT +1V (MA)	PEAK INVERSE VOLTAGE	MAXIMUM REVERSE CURRENT (UA)
DR309	400	100	10 @ 10V 50 @ 50V
DR301	400	125	100 @ 50V
DR308	200	100	10 @ 10V 50 @ 50V
DR310	100	150	50 @ 100V

Glance at the specs of these four representative types . . . You'll see why RRco. gold bonded diodes will give you outstanding performance.

If you're working on . . .

Computers • Receiving equipment • Transistor biasing • Magnetic amplifiers • Modulators • Demodulators • Pulse circuitry • Logic circuitry • Metering • Varistors

. . . The new RRco. gold bonded diodes offer a golden opportunity for design and development in these and many other applications. For the full list of types available, write today to Dept. E-16



*Really
Reliable*

Semiconductor Division

RADIO RECEPTOR COMPANY, INC.

Radio and Electronic Products Since 1922

240 Wythe Avenue, Brooklyn 11, N. Y. • EVergreen 8-6000

Radio Receptor Products for Industry and Government: Selenium Rectifiers • Germanium Diodes
Thermatron Dielectric Heating Generators & Presses • Communications, Radar & Navigation Equipment



**Protects
Safety Record
and Reduces
Operating Costs
with . . .**



3-D

Micro-Vision

At the world's largest commercial aircraft maintenance base, in South San Francisco, Bausch & Lomb Stereomicroscopes play an important part in insuring the safety and efficiency of United Air Lines planes. For 15 years inspectors have been using these optical aids for quick, sure identification of defects in cams, bearings, gear teeth, plating, connecting rods, and many other

engine parts. Cracks, plating inclusions, rough surfaces which might cause wear—they all show up vividly in natural 3-dimensional detail. These critical inspections, made during regularly scheduled engine overhauls, catch failures *before* they happen. The result: dependable safety . . . lower operating cost.

FREE! GET THIS EXCLUSIVE 3-D MICRO-VISION BOOK

- See actual stereo views!
- Know *how* and *where* to use Stereomicroscopes!
- Fit exact model to job needs with unique Selector-Chart!

Write

today for Manual D-15.

Bausch & Lomb Optical Co.,
61405 St. Paul St., Rochester 2, N. Y.



BAUSCH & LOMB



America's only complete optical source
. . . from glass to finished product

STEREOMICROSCOPES

Good-ALL capacitors

Good-All capacitors with **MYLAR*** dielectric combine **SPACE SAVING SIZE** with remarkably **HIGH INSULATION RESISTANCE**

Other outstanding characteristics include **STABILITY WITH LIFE**, **LOW POWER FACTOR** and **HIGH HUMIDITY RESISTANCE**. Good-All MYLAR dielectric capacitors are widely used in tolerances of 1%, 2% and 5% because of the assurance that later shifts will not wipe out the advantage of initial precision. Shelf life is inherently superior to that of paper dielectric capacitors.

MARBELITE TYPES 620M & 621M



MYLAR Dielectric. Cased in plastic impregnated tubes and end-filled with tough, durable thermosetting plastic. 620M—extended foil const. 621M is tab.

SERAMELITE TYPES 620S & 621S



MYLAR Dielectric. Housed in glazed ceramic tubes for use under extremely severe humidity conditions. 620S—extended foil construction. 621S is tab.

*DuPont's trademark for polyester film.

Insulation resistance.....Greater than 20,000 Megohm Mfds. at 25°C. High IR is retained at elevated temp.
 Power factor.....Less than 0.5% from +25°C. to +85°C. Less than 1.5% from +25°C to +150°C.
 Temperature range.....May be operated at rated voltage—65°C to +85°C and to +125°C without derating.
 Tolerances available.....1%, 2%, 5%, 10% and 20%.
 Humidity resistance.....These types easily meet the humidity requirements of RETMA specification REC-118-A, Section 2.38.
 Physical size.....The miniature size of these types is illustrated in the table below.

DIMENSIONS OF SELECTED VALUES

Cap. (mfd.)	620M		621M		620S		621S	
	200V	600V	200V	600V	200V	600V	200V	600V
.01	.223 x 27/32	.223 x 27/32	.223 x 11/16	.223 x 11/16	.215 x 27/32	.215 x 27/32	.215 x 27/32	.215 x 27/32
.022	.243 x 27/32	.243 x 27/32	.243 x 11/16	.243 x 11/16	.312 x 1	.312 x 1	.312 x 1	.312 x 1
.047	.363 x 27/32	.450 x 31/32	.283 x 27/32	.363 x 31/32	.312 x 1	.360 x 1	.312 x 1	.360 x 1
.1	.363 x 31/32	.450 x 1 1/4	.363 x 27/32	.450 x 1 1/8	.360 x 1	.438 x 1 1/4	.360 x 1	.438 x 1 1/4
.22	.450 x 1 3/16	.610 x 1 1/2	.450 x 1 1/16	.610 x 1 3/8	.438 x 1 1/4	.531 x 1 13/16	.438 x 1 1/4	.531 x 1 13/16
.47	.450 x 1 5/8	.798 x 1 1/2	.450 x 1 1/2	.718 x 1 3/4	.531 x 1 9/16	.625 x 1 7/8	.531 x 1 9/16	.625 x 1 7/8

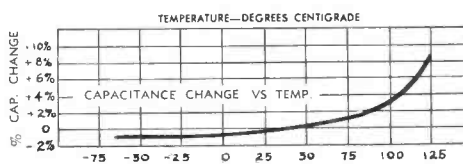
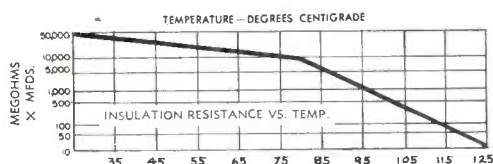

Our engineers are ready to work with you on special applications.
 Write or wire for specifications and quotations.



GOOD-ALL ELECTRIC MFG. CO. OMAHA, NEBRASKA

Grant INDUSTRIAL SLIDES FOR

the key factors in design

**ACCESSIBILITY
COMPACTNESS
PROVISION FOR EASY,
SPEEDY MAINTENANCE
AND COMPONENT
REPLACEMENT**

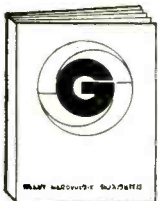
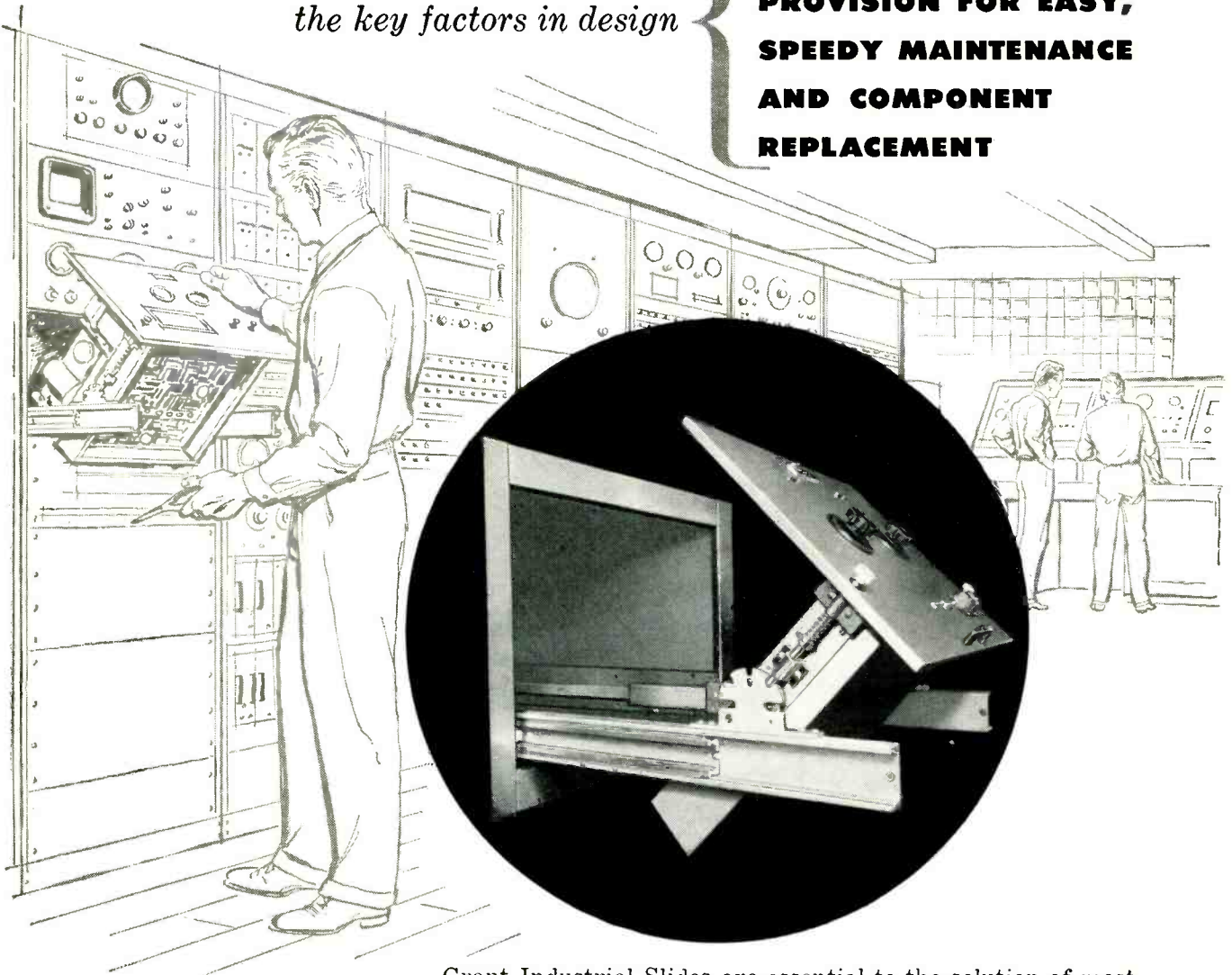

**More
Than
100
Pages
of
Important
Working
Data**

The Grant Industrial Slide Catalogue—on the press—outlines principles, details, of more than 100 standard and custom-made slides. A working manual on built-in accessibility. Ask us to reserve your free copy.

Grant Industrial Slides are essential to the solution of most problems centering on these design factors—so highly emphasized in this automation era. Grant Slides provide skillfully developed, competently engineered sliding, pivoting mountings for nearly all types of assemblies—electronic, hydraulic, pneumatic, mechanical.

Grant engineers and representatives are located in all important industrial centers—their valuable store of specialized experience is yours for the asking.

Grant INDUSTRIAL SLIDES

Grant Pulley and Hardware Corporation
31-85 Whitestone Parkway, Flushing 54, N. Y.
944 Long Beach Avenue, Los Angeles 21, California

NEW

from face to terminal block

Cramer

type 412

TIME DELAY RELAY

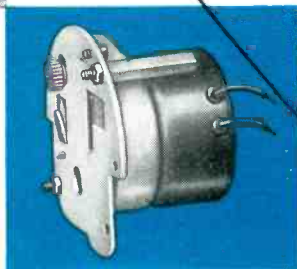
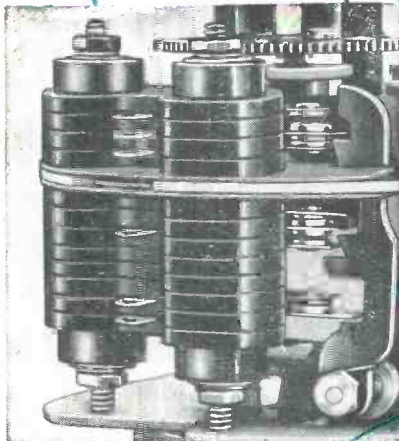
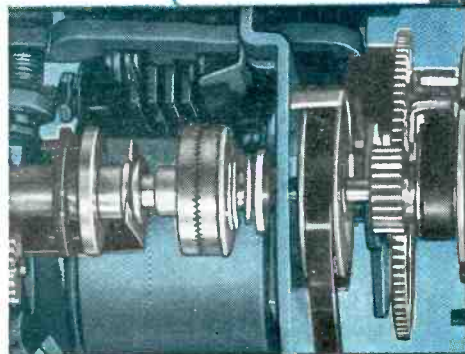
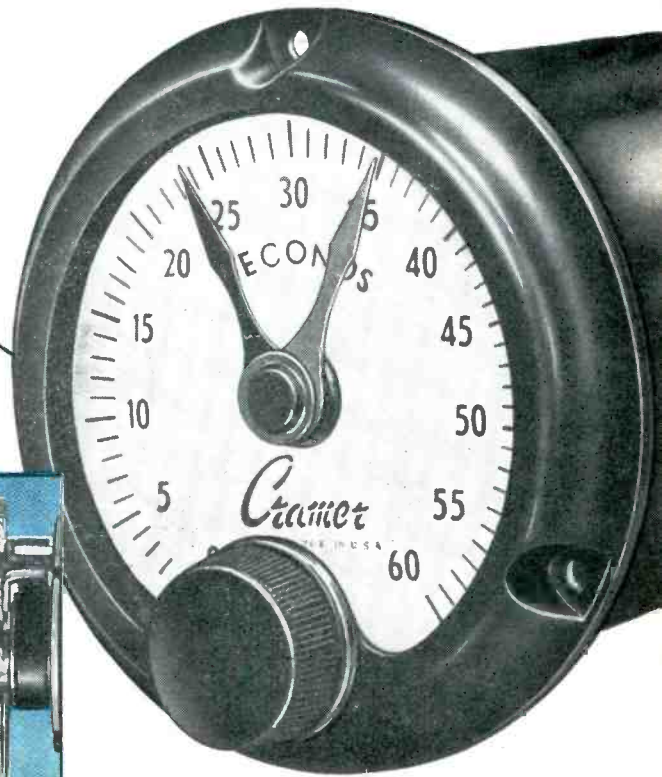

NEW—Repeat Accuracy within $\pm \frac{1}{4}$ of 1% of full scale (30 sec. and longer ranges); $\pm \frac{1}{2}$ of 1% on faster timers.

NEW—Full Vision Dial. 300 degree scale assures precise settings and fast, accurate readings. Dial and pointers protected by transparent cover.

NEW Contacts, rated 15 amps., give positive quick-make, quick-break operation. Contacts are of silver cadmium oxide with ability to handle high inrush currents.

NEW Flexibility in wiring. Nine-position terminal block offers side or rear connection, presents a variety of wiring possibilities.

NEW Reset Shock Spring Design laboratory tested for more than a million operations.

NEW Friction Setting Mechanism allows adjustment even while timer is operating.

NEW—Ratchet Clutch operated by powerful relay, provides instant action, no slip.

NEW O-Ring Retainer permits quick removal of bakelite housing, exposing entire timer mechanism.

Timer driven by high torque (30 in. oz. at 1 r.p.m.) Cramer Type 112 Synchronous Motor.



The **R. W. CRAMER CO., Inc.**

SPECIALISTS IN TIME CONTROL
BOX 3, CENTERBROOK, CONNECTICUT

TAYLOR

Laminated Plastics
Vulcanized Fibre

Shop Talk

TAYLOR FIBRE CO.

Plants in Norristown, Pa. and La Verne, Calif.

PHENOL—MELAMINE—SILICONE—EPOXY LAMINATES • COMBINATION LAMINATES • VULCANIZED FIBRE • POLYESTER GLASS ROD

Tips for designers

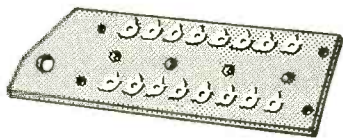

Terminal board for a complex circuit in an electronic spectrophotometer instrument is made of Taylor Grade LE laminate . . . selected for its insulating and mechanical properties.

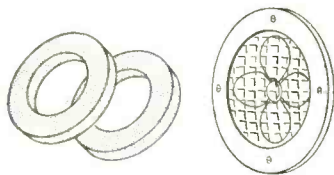

Large exhaust fans use Taylor paper base phenolic washers to help absorb thrust . . . an inexpensive arrangement, with long life.

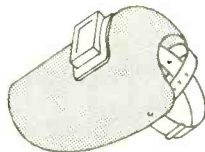

Welders' helmets are fabricated from tough, durable Taylor vulcanized fibre . . . readily formed to many desired contours.

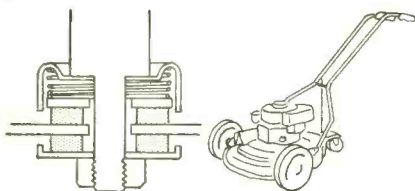

Rotary lawn mower utilizes abrasion resistance of Taylor phenolic laminate washer in slip-clutch attachment of drive shaft to cutting blade.

TAYLOR FABRICATING FACILITIES

Your production problems can often be simplified . . . schedules safeguarded . . . inventory headaches cured . . . and overall costs reduced by having Taylor fabricate finished parts of vulcanized fibre and laminates to your specifications. Efficient, modern facilities are ready to serve you. Write to Taylor about your specific requirements.

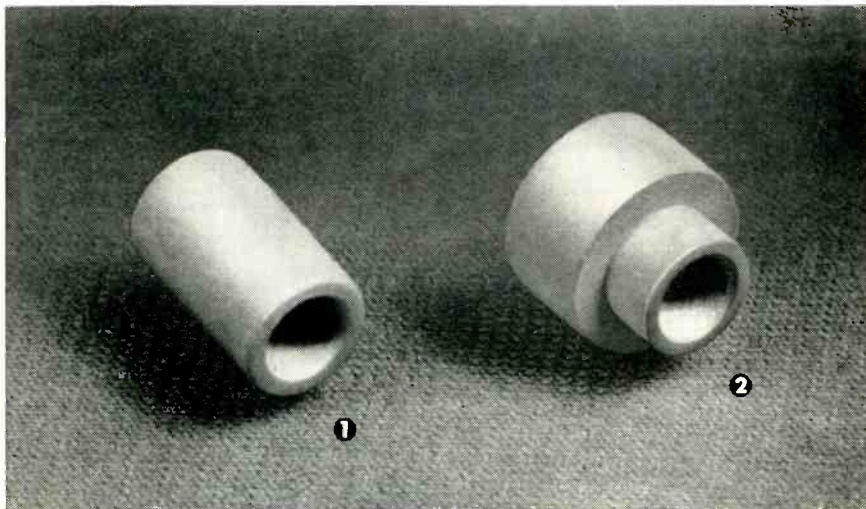

Chosen for its mechanical strength and electrical insulation, this Taylor laminated tubing provides an economical means for making (1) an ignition breaker arm bushing and (2) a distributor terminal bushing.

Strength plus electrical insulation, available in Taylor laminated tubing

Among the most versatile basic materials available to the designer, Taylor laminated plastics are constantly finding new applications . . . in new products for future markets and as replacements for parts in current production.

Widely used in flat sheets for the fabrication of parts for electrical components, Taylor laminates are also available in tube form. This makes them applicable to an even greater number of parts . . . such as bushings, guides, shafts, and housings for resistors, thermistors and fuses. The tubes are supplied with inside diameters as small as $\frac{3}{32}$ ". Standard lengths are 36" or 49", depending on grade, inside diameter and wall thicknesses.

Included in the broad selection of Taylor laminated tubing are a great variety of different grades

. . . paper, fabric and glass bases combined with special formulations of phenol, melamine, silicone and epoxy resins. Each grade offers electrical and physical properties which qualify it for a specific application at a reasonable price.

Of particular interest to economy-minded designers and production managers is the fact that this laminated tubing permits the use of a part for a mechanical application without the need for extra electrical insulation.

Plan to take greater advantage of Taylor laminates . . . in tube, sheet and rod form . . . either in your present products or in those which you are now designing. Call or write for a discussion of your specific requirements.

Save Money, Maintenance and Man-hours!

GET YOUR **DC** FROM AC

with dependable, long-life

Federal

SELENIUM RECTIFIER

Power-Converting EQUIPMENTS

NO costly, bulky, moving equipment to buy ... no expendable parts to replace frequently ... virtually no maintenance! No wonder Federal's compact, rugged, always-dependable Selenium Rectifier Equipments are the growing answer to DC output requirements ... for industrial power, battery charging and hundreds of other DC applications.

Federal Equipments are ready to connect to your AC source ... ready to deliver uninterrupted DC power wherever you need it and whenever you need it!

Powered by Federal's completely inert selenium rectifiers, the life of Federal Equipments is practically *unlimited*. All are conservatively rated ... with a wide margin of safety to withstand momentary heavy overloads.

If the DC output you need is not in Federal's line of standard power supply equipments, Federal will design and build to meet your specific requirements. Tell us the rating you need ... write today to Power Equipment Department—E-213

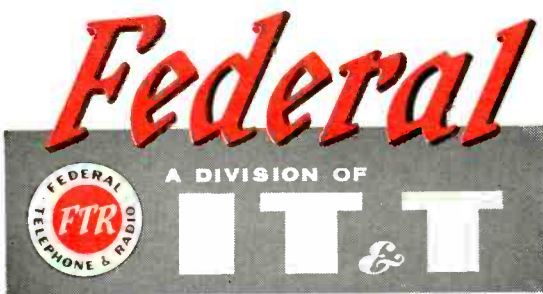

Federal Telephone and Radio Company
A Division of INTERNATIONAL TELEPHONE AND TELEGRAPH CORPORATION
COMPONENTS DIVISION • 100 KINGSLAND ROAD • CLIFTON, N. J.

In Canada: Standard Telephones and Cables Mfg. Co. (Canada) Ltd., Montreal, P. Q.
Export Distributors: International Standard Electric Corp., 67 Broad St., New York

ELECTRONICS — May, 1956

POWER SUPPLIES— Industrial, Military, Laboratory

Chucks, brakes, clutches, screens, separators, drums, pulleys, lifting magnets, relays, circuit-breakers, solenoids, DC motors—these are only a few of the wide variety of applications now being successfully served by Federal Power Supplies.

Federal's FTR-3152-AS
Typical of the many standard types ready for shipment

Rated:
115/230 volts, 4.4/2.2 amps.
AC Input: 220/440 volts
3-phase, 50/60 cycles



REGULATED POWER SUPPLY

The FTR-3128-BS is designed to meet the exacting requirements of the aviation industry for a regulated and filtered DC power supply useful for laboratory and testing purposes. Front panel control knob enables continuous selection of an DC output voltage between 22 and 30 volts.

Federal's FTR-3128-BS
Typical of the many standard types ready for shipment

Rated:
22/30 volts, 0/10 amps.
AC Input: 105/125 volts
1 phase, 58/62 cycles



MAGNETIC AMPLIFIERS

Presently used in a wide range of successful applications for industry and the Armed Forces, such as:

- Voltage Control
- Current Control
- Speed Control
- Position Control
- Temperature Control
- Photoelectric Control
- Counting
- Automatic Regulation

Federal Selenium Rectifiers, in partnership with the right magnetic components, provide Magnetic Amplifiers outstanding for:

Stability • Accuracy • Long Life
High Gain • Fast Response • Low-cost Operation



**DON'T GIVE UP
WITHOUT TRYING AN
R/M Teflon*
PRODUCT**

What are you striving for—product improvement?—better equipment performance?—a more economical process? A product made of “Teflon” by R/M could well be the missing link you’re seeking. For R/M has been working with this wonder plastic ever since it was produced and, with it, has solved some of the very toughest problems encountered in recent years by electrical and electronics engineers.

It is quite conceivable that R/M has already faced your particular problem and come up with a solution to it. So take advantage of the skill, experience and unmatched help that R/M can offer you. The many different products pictured indicate R/M’s versatility in “Teflon” manufacture. We can fabricate to your own specifications or supply you with “Teflon” in the form of rods, sheets, tubes or tape (in 13 colors conforming to military standard color code). For further information, write today.

Properties of “Teflon”: High dielectric strength • Moisture absorption zero • Unaffected by weather • Excellent heat stability up to 500° F. in continuous operation • As tape, leaves no carbon residue along the discharge path • High impact resistance • Nonadhesive • Stretches easily • Tensile strength 1500-2500 psi.

**Du Pont trademark*



RAYBESTOS-MANHATTAN, INC.
PLASTIC PRODUCTS DIVISION, Manheim, Pa.

FACTORIES: Manheim, Pa. • Bridgeport, Conn. • Ne. Charleston, S.C. • Passaic, N.J. • Neenah, Wis. • Crawfordsville, Ind. • Peterborough, Ontario, Canada

RAYBESTOS-MANHATTAN, INC., Asbestos Textiles • Laundry Pads and Covers • Packings • Brake Linings • Brake Blocks • Clutch Facings • Fan Belts • Radiator Hose
Rubber Covered Equipment • Industrial Rubber, Engineered Plastic, and Sintered Metal Products • Abrasive and Diamond Wheels • Bowling Balls

NEW
from
Transitron

2N200



military
type

transistors

Features

- DESIGNED TO MIL-T-25380/5
- RELIABLE OPERATION UP TO 75°C
- WELDED HERMETIC SEAL
- RIGID PRINTED BOARD MOUNTING
- UNIFORM CHARACTERISTICS
- SMALL SIZE

MAXIMUM RATINGS	
Collector Voltage, V_{ce} at 75°C	30 volts
Power Dissipation	100 m.w
Collector Current	100 ma
TYPICAL CHARACTERISTICS	
Common Emitter Current Gain, B	45
Common Emitter Power Gain	40 db
Input Resistance, h_i	32 ohms
Collector Cut-off Current, I_{co}	4 μ a

Transitron's military type 2N200 germanium transistor is designed for use in electronic equipment where high ambient temperatures and severe environmental conditions require an extremely reliable transistor.

The 2N200 meets all of the requirements of MIL-T-25380/5, and due to its improved case design, is the preferred type for all transistor applications. It is the recommended replacement for the 2N43A.

Send for Bulletin TE-1320.

Transitron electronic corporation • melrose 76, massachusetts



Germanium Diodes

Transistors

Silicon Diodes

Silicon Rectifiers



Speaking of Cutting Costs

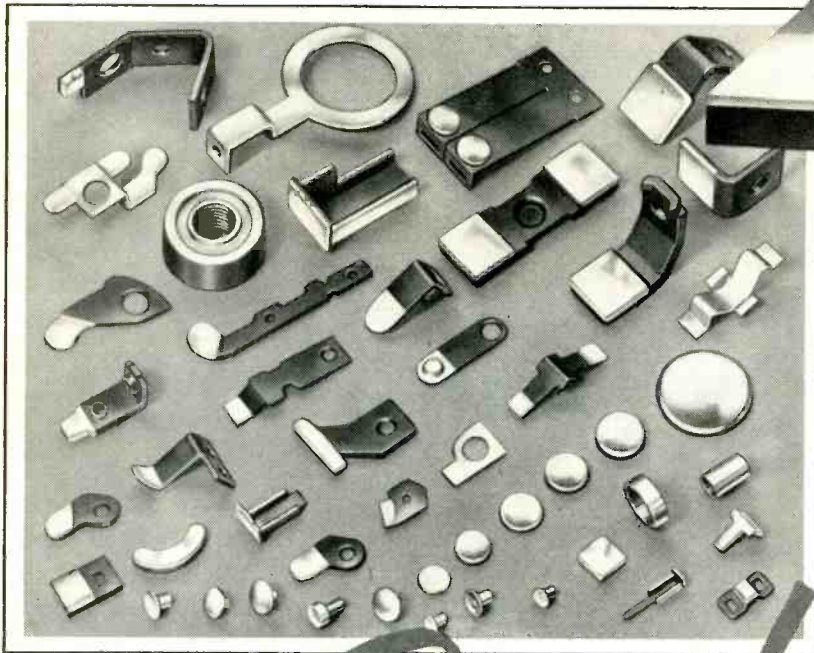
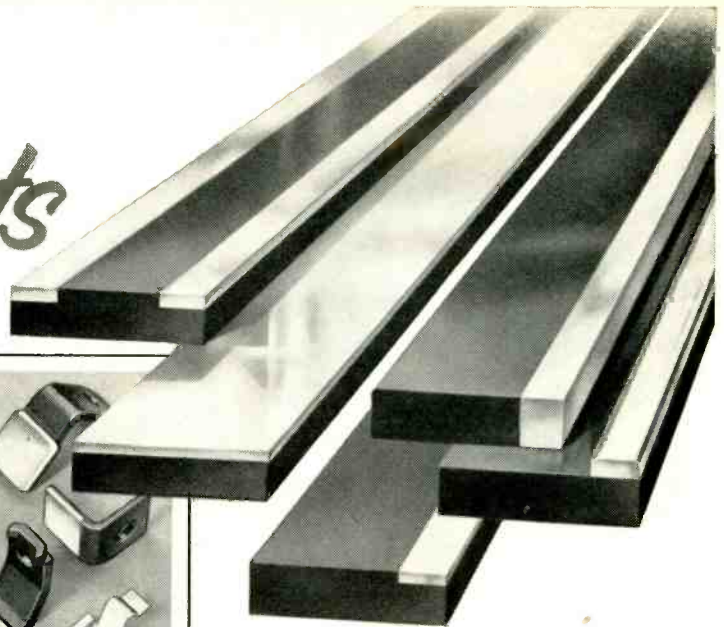

General Plate

COMPOSITE METAL CONTACTS

Save Money and Improve Performance, too!

That's right — time and time again General Plate Division has been able to cut electrical contact costs for customers — while improving product performance.

At General Plate Division customers with contact questions deal directly with a top notch team of Engineers, Production people, and Cost Analysts who specialize in contact activities.

Result? Savings — savings by design for alert customers — with improved performance in the bargain.

Here's what's behind it —

Drawing on forty years of metal cladding experience, General Plate Engineers have developed superior bonded metals which combine the best electrical and mechanical properties of two or more separate metals for greatest contact efficiency and economy.

General Plate Production people have developed the finest facilities available for the manufacture of all kinds of contacts from these materials.

General Plate Application Engineers and Cost Analysts have worked out contact design details which assure you contacts you can count on — at real savings.

You too can earn this double dividend at General Plate Division — why not investigate — today.

**METALS & CONTROLS CORPORATION
GENERAL PLATE DIVISION
35 FOREST STREET, ATTLEBORO, MASS.**



**GENERAL PLATE ELECTRICAL
CONTACT KIT FOR LABORATORY
AND DEVELOPMENT USE**

Kit K11 contains a wide assortment of silver rivet contacts; Kit K12 has representative standard button contacts. Also included are metal strips for fabrication of contact parts. These kits are available at nominal cost. Bulletin available.

*You can profit by using
General Plate Composite Metals*

from **Transitron**

SILICON RECTIFIER STACKS

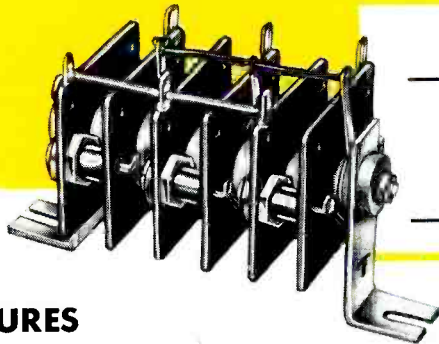

Circuit	D.C. Output		Stack Type No.
	Voltage (volts)	Current (amps)	
3 ϕ Bridge	1132	.6	TD12A60F2A1
3 ϕ Bridge	62	2.4	TD12C10F1A3
3 ϕ Half Wave	1124	.6	TD12A60Y4A1
3 ϕ Half Wave	46.5	4.8	TD12C10Y1A4
1 ϕ Bridge	1128	.4	TD12A60B3A1
1 ϕ Bridge	250	2.4	TD12C40B1A3
1 ϕ Bridge	62.5	2.4	TD12C10B1A3

RATINGS AT 125°C AMBIENT TEMPERATURE

FEATURES

- RELIABLE OPERATION UP TO 150°C
- VOLTAGE RATINGS UP TO 2580 RMS
- CURRENT RATINGS UP TO 50 AMPERES
- EXCELLENT REGULATION
- NEGLIGIBLE LEAKAGE CURRENT

The recognized superiority of silicon rectifiers has now been combined with the versatility of stack mounting in two new series of silicon rectifier stacks. These rectifiers overcome the basic limitations of germanium, selenium and copper oxide to provide trouble-free operation under the most severe environmental conditions.

Transitron silicon rectifier cells have established a record of dependability in such critical applications as missiles and jet aircraft. They are designed to meet the requirements of MIL-E-1C. Four JAN types, the 1N253, 1N254, 1N255 and 1N256, may be optionally incorporated into these stacks. Write for Bulletin TE-1342.

Circuit	D.C. Output		Stack Type No.
	Voltage (volts)	Current (amps)	
3 ϕ Bridge	188	6	TL6J20F1A1
3 ϕ Bridge	46	6	TL6J05F1A1
3 ϕ Half Wave	93	12	TL6J20Y1A2
3 ϕ Half Wave	186	6	TL6J20Y2A1
1 ϕ Bridge	125	4	TL4J20B1A1
1 ϕ Bridge*	125	12	(2)TL6J20D1A3
1 ϕ Bridge*	375	4	(2)TL6J20D3A1

RATINGS AT 125°C AMBIENT TEMPERATURE

* 2 Stacks Required

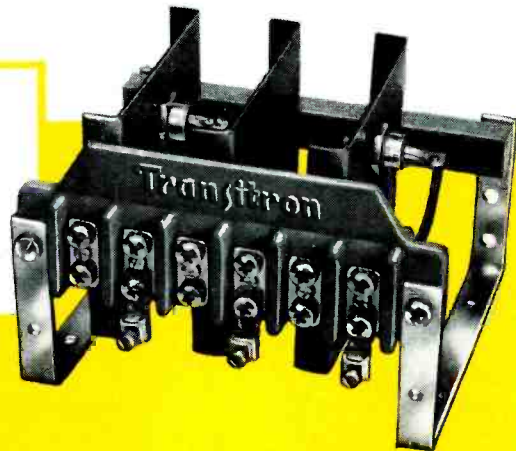

Transitron electronic corporation • melrose 76, massachusetts



Germanium Diodes



Transistors



Silicon Diodes



Silicon Rectifiers.



PICTURES OF

Airpax has recently expanded its line of choppers and introduced a miniature circuit breaker, a wide-band audio-frequency detector, and a magnetic amplifier.

Miniature Circuit Breaker

Types 401 and 410 Circuit Breakers make possible a new flexibility in equipment protection. This miniature breaker illustrated to the left fits in the same space on your front panel as a conventional toggle on-off switch—yet it protects your equipment as well as controls the power to it. With an Airpax breaker, the same protection heretofore available only at power distribution centers and large power supplies is now entirely feasible on individual chassis; breakers are available rated up to 10 amperes at 120 volts rms.

The magnetic inverse time delay of the Airpax breaker allows normal transients to pass without tripping the breaker. Trip level is independent of ambient temperature. The single-phase series circuit breaker is wired into an equipment exactly as is a spot on-off switch. The toggle is used exactly as an on-off switch and in addition it snaps to the off position if the breaker trips to show the operator which chassis is out. Action is trip free; the equipment cannot be forced on while the fault persists.

Time delay and trip level of each breaker are tested before the unit is shipped to assure you of the utmost in reliable equipment protection.

Frequency Detector

Another new Airpax product is the Magmeter. This wide-band frequency detector is designed to simplify your equipment. Type F-948 operates from 0 to 500 cps; other types are available with ranges from 0-50 to 0-2000 cps. Wherever frequency is to be indicated instantaneously over a wide band, the Magmeter offers a means for improving the performance of your equipment.

The signal whose frequency is to be measured is fed through a current limiting resistor to an Airpax Magmeter. The output from the Magmeter is connected through a calibrating rheostat to a d'Arsonval meter. A 500 microampere movement is used with Type F-948. Meter deflection is then directly proportional to frequency over the full frequency range. No regulated reference voltages are needed; the Magmeter is relatively insensitive to signal waveform and tolerates wide fluctuations in signal voltage.

Once calibrated, a Magmeter retains an accuracy of 2 per cent of full scale despite changes in service conditions. Operated within its ratings, it has a life of many years without being recalibrated.

Each Magmeter is standardized before leaving the factory. So stable is this magnetic component that it can be used with the data on its individual calibration card as a secondary frequency reference.

Coaxial Chopper

Toward the opposite end of the spectrum is the Airpax Type 199 Coaxial Chopper. This unit is driven at 100 cps (other drive frequencies can be provided on special order) and switches coaxial 50-ohm lines. One 50-ohm line (moving line) is alternately connected to

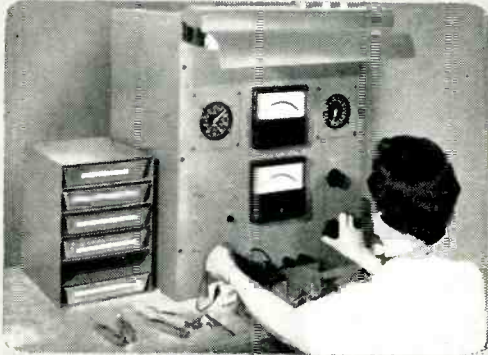
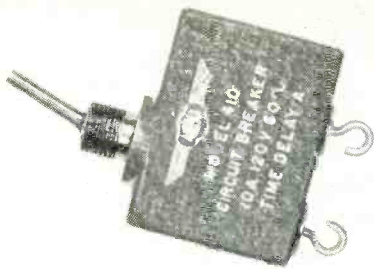

PROGRESS

either of two other 50-ohm lines (fixed lines). During intervening intervals, the fixed lines are terminated in their characteristic impedances. From 200 Mc to 400 Mc the SWR looking into any of the three lines does not exceed 1.3. The unit is 2-1/8 by 1-9/16 by 13/16 inches.

Chopper Driver

Operating characteristics of some control equipments could be improved by the use of a 400-cps chopper such as Airpax Type 300. To provide the necessary 400-cps drive, Airpax has developed the compact vacuum-tube plug-in oscillator shown here. Type 202 Chopper Driver operates from voltages usually available in electronic equipment and provides a sinusoidal output of 6.3 volts at 400 cps. Thus, where only dc power is available or where, to avoid possible interference from 60-cps pickup, you prefer to use a 400-cps chopper, Type 202 Chopper Driver provides a convenient inverter. The transformer output is balanced to ground for minimum interference from the drive power.

Magnetic Amplifier

The right-hand film strip tells the newest Airpax story: development and production of an instrument magnetic amplifier. Ferrac is a ferromagnetic analog computer amplifier of exceptional stability. Airpax engineers have decreased the initial standoff and null errors of this magnetic amplifier to such an extent that you can use this reliable component in the low-level computing portions of your automatic controls and guidance equipment.

Type M-943 Ferrac has two independent control (input) windings and separate output and power supply windings. Characteristics are tabulated below.

Characteristic	Rating
Input	dc, polarity reversible
Output	unfiltered dc, polarity reversible
Power Requirement	less than 3 watts at 115 volts and 400 cps
Linear Output	at least 7.5 volts of output under all operating conditions into 1000-ohm load
Nominal Gain	100 microamperes into either control winding produces 2.5 volts of output, gain is stable within 2 db with operating conditions
Frequency Response	approximately 8 cps for each 1000-ohms in one control loop under standard conditions
Initial Standoff Error	5 microamperes or less, which corresponds to about 2 parts in 10,000 of full power output
Null Error	5 microamperes or less with changes in environmental and operating conditions

The Ferrac is hermetically sealed to withstand humidity and is potted to withstand vibrations of 10 G at 10-55 cps and 11-millisecond shocks of 30 G. It can be stored at -65 to +100 C and operated at -55 to +85 C. It weighs only about 8 ounces.

Because the Ferrac operates at low internal voltages and impedances and requires so little operating power, it can be expected to outlive many other types of electronic components. As with all Airpax components, the Ferrac is the outcome of thoughtful engineering and is produced and inspected with conscientious care to assure you of a uniformly reliable product in which we can be proud and of which you can be fully satisfied.

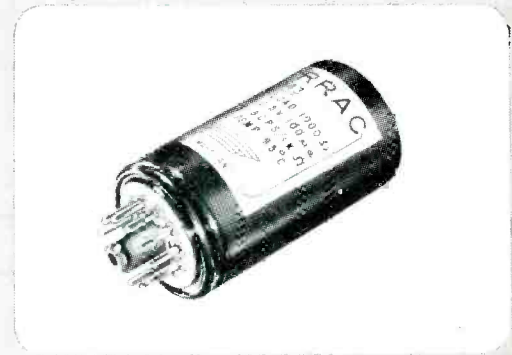
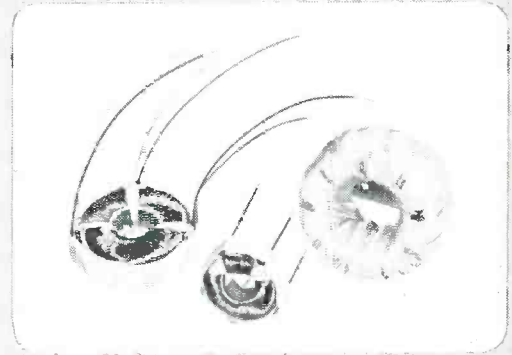
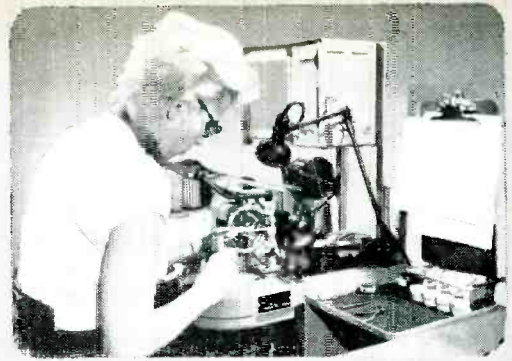



RELIABILITY

Dependable performance is a quarter-century tradition at Motorola—the world's largest exclusive manufacturer of electronic equipment. Under subcontract to Convair, Motorola *engineered for reliability*, and is now producing the guidance equipment for the Navy's new all-weather anti-aircraft missile, the "Terrier".

Positions open to qualified Engineers and Physicists



MOTOROLA

COMMUNICATIONS & ELECTRONICS DIVISION
National Defense Department

2710 N. CLYBOURN AVE. • CHICAGO, ILL. • Laboratories: Phoenix, Arizona and Riverside, California

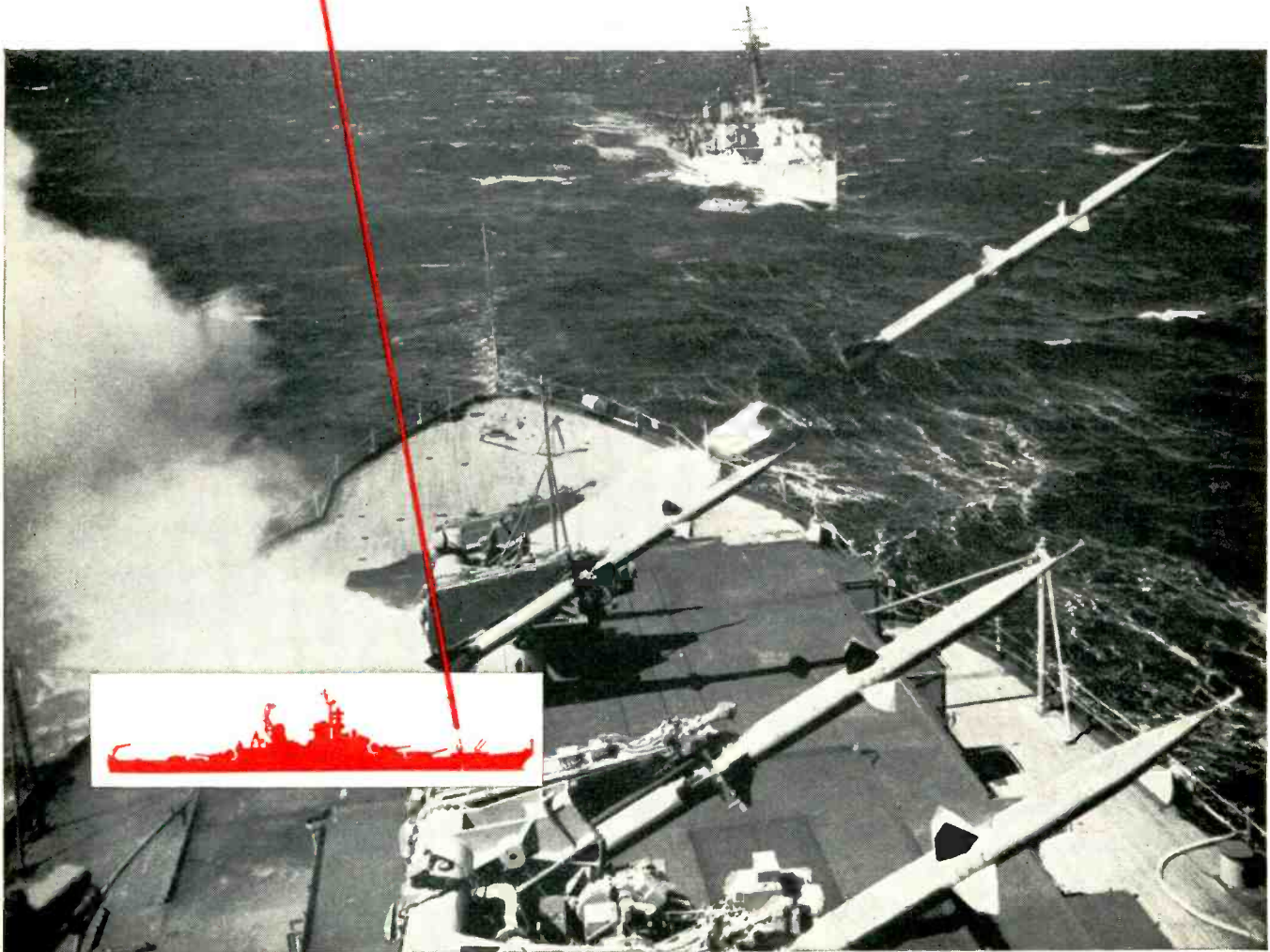

NEW GERMANIUM POWER RECTIFIERS REDUCE VOLUME AND WEIGHT 75%

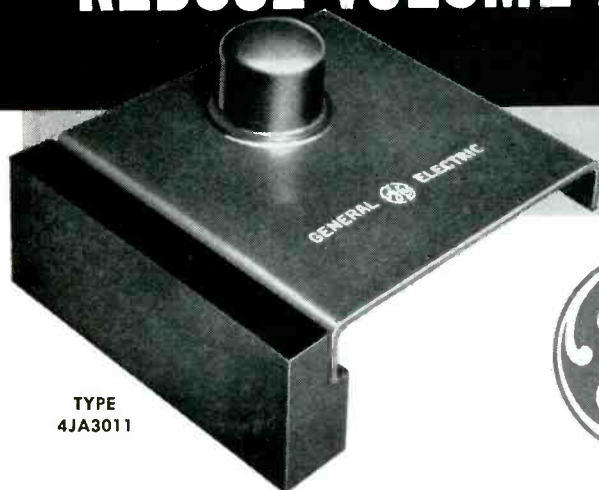

TYPE
4JA3011



...and actually cost less!

GERMANIUM POWER RECTIFIERS

Ratings to
85°C

Because of the higher efficiency of germanium, these new G-E rectifiers achieve a full 75% saving in size and weight—and yet actually cost less than any conventional type dry rectifier in use today. This sharply-reduced weight and volume is a result of greatly-increased power per cell in the unique G-E low-loss rectifier.

Compare and see! For new efficiency in your 1956 designs go the limit with new G-E Germanium Power Rectifiers. Tell your rectification problem to the G-E application engineer—write today to: *General Electric Company, Semiconductor Products, Section X456, Electronics Park, Syracuse, New York.*

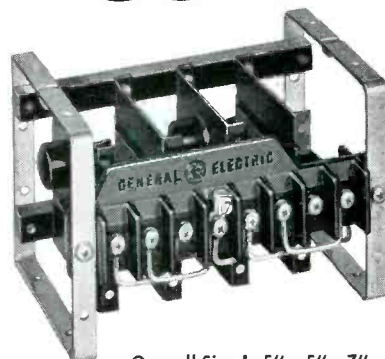

Overall Size Is 5" x 5" x 7"

NOW AVAILABLE IN PRODUCTION QUANTITIES

These rectifiers are available in standard combinations consisting of one or more rectifying elements. A few of the typical ratings are listed below.

CIRCUIT	D-C OUTPUT AT 55° C (Resistive Load) (Natural Convection Cooling)*
Half Wave	24 amps @ 62 V
	12 amps @ 125 V
	8 amps @ 210 V
Full Wave Center Tap	24 amps @ 62 V
	10 amps @ 125 V
Full Wave Bridge	10 amps @ 125 V
Three-Phase Half Wave	17.8 amps @ 93 V
	11.2 amps @ 186 V
Three-Phase Bridge	11.2 amps @ 188 V

*Up to double DC output currents for forced air cooling.

Be "money-wise" and
"pound-wise" too, with these
stand-out design features:

- Weight and volume reduced 75%
- Rectifier losses have been reduced to 1/3 or less
- No forward aging effects... no need for age-compensating devices

Progress Is Our Most Important Product

GENERAL  ELECTRIC

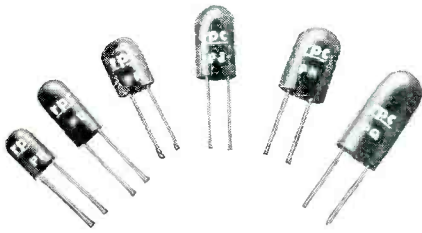

NEW Printed Circuit Precision Resistors

To meet the requirements for printed circuitry, RPC has developed Type P Encapsulated Wire Wound Precision Resistors. Miniature, single ended units designed for easy rapid mounting on printed circuit panels with no support other than the wire leads. Many newly developed techniques are employed in the manufacture of Type P Resistors. These units can be operated in ambient temperatures up to 125°C. and will withstand all applicable tests of MIL-R-93A, Amdt. 3. Available in 6 sizes, rated from 1/10 watt to .4 watt. 1/4" diameter by 3/8" long to 3/8" diameter by 3/4" long. Resistance values to 3 megohms. Tolerances from 1% to 0.05%.

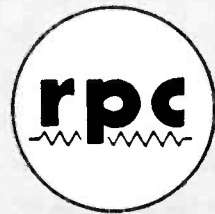

HIGH QUALITY RESISTORS FOR ELECTRONICS



Wire Wound Precision Meter Multiplier Resistors

Type MFA and MFB High Voltage Wire Wound Resistors are Hermetically Sealed in glazed steatite tubes with ferrule ends for maximum protection against all adverse environmental conditions. Fully meet all requirements of JAN-R-29. Special multi-section winding insures greatest safety factor due to low voltage gradient between sections. Standard resistors up to 6 megohms, 6 KV, 0.5% tolerance. Higher resistance and closer tolerances available. MFA 9-25/32 inches long x 1 1/2 inches diameter. MFB 5 5/32 inches long x 1 1/2 inches diameter.

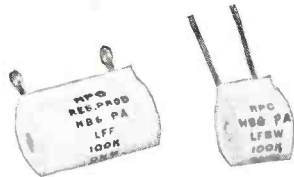

Encapsulated Precision Wire Wound Resistors

RPC Type L Encapsulated Resistors will withstand temperature and humidity cycling, salt water immersion and extremes of altitude, humidity, corrosion and shock without electrical or mechanical deterioration. Type L resistors are available in many sizes and styles ranging from sub-miniature to standard with lug terminals, axial or radial wire leads. Available for operation at 105° C. or 125° C. ambient temperatures. These resistors will meet all applicable requirements of MIL-R-93A, Amdt. 3. Type L can be furnished with all resistance alloys and resistance tolerances from 1% to .02%.



High Voltage Resistors

Type B Resistors are stable compact units for use up to 40 KV. These resistors are used for VT voltmeter multipliers, high resistance voltage dividers, bleeders, high resistance standards and in radiation equipment. They can be furnished in resistance to 100,000 megohms. Available as tapped resistors and matched pairs. Sizes range from a 1 watt resistor 1 inch long x 3/8 inch diameter rated at 3500 volts, to a 10 watt resistor 6 1/2 inches long x 3/8 inch diameter rated at 40 KV. Low temperature and voltage coefficients. Standard resistance tolerance 15%. Tolerances of 10%, 5% and 3% available. Tolerance of 2% available in matched pairs.

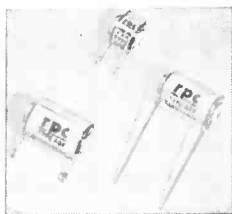

Wire Wound Precision Resistors

Type A Precision Resistors are widely used for all general requirements. They are available in a wide variety of sizes, styles and terminal types. They can be furnished with all resistance alloys in tolerances from 1% to .02%. Type A will meet the requirements of MIL-R-93A, Amdt. 2, Characteristic B. Special winding techniques, impregnation and thermal aging result in resistors of exceptional stability. Matched resistors, networks and special assemblies can be supplied.

RPC is a widely recognized supplier of high quality resistors to industry, Government Agencies and the Armed Forces. Advanced production methods, modern equipment and scientific skill enables RPC to manufacture resistors of *highest quality in large quantities at reasonable cost.* Modern manufacturing plant is completely air conditioned and equipped with electronic dust precipitators to insure highest production accuracy. RPC resistors are specified for use in instruments, electronic computers, radiation equipment, aircraft equipment and scientific instruments.

Test equipment and standards for checking and calibrating are equalled by only a few of this country's outstanding laboratories. Our ability to produce resistors of highest quality coupled with prompt delivery have established RPC as a leading manufacturer of resistors. Small or large orders are promptly filled.

Representatives in principal cities. For full information send for latest catalog.



High Megohm Resistors

Type H Resistors are used in electrometer circuits, radiation equipment and as high resistance standards. Resistance available to 100 million megohms, (10¹⁴ ohms). For utmost stability under adverse conditions Type HSD and HSK Hermetically Sealed are recommended. Eight sizes from 3/8 inch to 3 inches long are available. Voltage rating to 15,000 volts. Low temperature and voltage coefficients. Standard resistance tolerance 10%. Tolerance of 5% and 3% available. Also matched pairs 2% tolerance.

RESISTANCE PRODUCTS CO.

914 S. 13th Street
HARRISBURG, PA.



NEW SWITCH NEWS

FOR CIRCUIT DESIGNERS

New subminiature sealed switch is environment-free; mounts interchangeably with MS25085

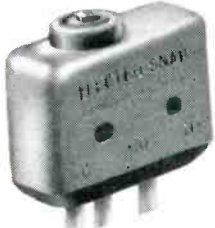

MODEL EF-3

Single Pole, Double Throw
 Move. Differential, .004 Max.
 Overtravel, .003 Min.
 Oper. Force, 5 to 17 oz.
 Release Force, 60 gram
 Elec. Life Ratings:
 150,000 ops. @ 125/250 V. A.C.,
 2.5 AMP.
 100,000 ops. @ 125/250 V. A.C.,
 5.0 AMP.
 50,000 ops. @ 30 V. D.C.,
 (2.5 AMP., IND.; 4.0 AMP., RES.)
 Amb. Temp., -65° to +180° F.

Sealed in a corrosion-resistant, treated aluminum enclosure, this tiny switch is environment-free; highly vibration and shock resistant. It carries 5 amps. at 125/250 V.A.C. with an electrical life rating of 100,000 operations. Low operating force and small movement differential make it ideal for bi-metal temperature, diaphragm operated and other "feather-touch" devices, while small size permits mounting singly or ganged in restricted space. Rugged and dependable, it has positive snap action.

Tiny, new 40 amp. basic switch has high capacity, longer life and constant stability of tolerances

Measuring only 1 3/4" x 43/64" x 43/64", the new Electro-Snap G3-8 Basic Switch handles current ratings up to 40 amps. A new method of combining Electro-Snap's double-break action with a heavy-duty switching element assures electrical and mechanical life of 100,000 cycles at large capacities; also provides constant stability of tolerances and accurate repeatability. New plastic compound case gives the switch an ambient temperature rating of -65° to +300° F. with extreme shock resistance. Small size makes it ideal for motor controls and compact automation set-ups. A wide range of actuators is available.



MODEL G3-8

OPERATING CHARACTERISTICS

Single Pole, Double Throw
 40 AMPS @ 125/250 V. A.C.
 @ 30 V. D.C. Res.

Oper. Force, 30 ozs.
 Overtravel, .025" Min.
 Move. Differ., .055 ± .010

New simultaneous triple-pole switch interrupts 3-phase ac. circuits; 6-circuit control in a small package

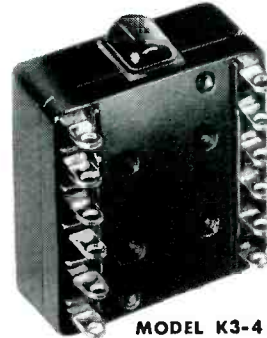

MODEL K3-4

Triple-Pole, Double Throw
 15 AMP., 125/250 V. A.C.
 30 V., D.C. Res.
 10 AMP., 30 V., D.C., Ind.
 Overtravel, .015 Min.
 Move. Diff., .028 ± .007
 Mech. Life, 1,000,000 ops.
 Elec. Life, 500,000 ops.

This completely new Electro-Snap triple-pole switch simultaneously reverses current flow through three windings of a 3-phase motor up to 1 H.P. and interrupts other types of multi-switching installations. Instantaneous "make" and "break" snap-action of the three poles is independent of the speed of actuation—even extremely slow moving cams can be used.

The K3-4 Series offers designers a wide variety of 3-phase circuit hookups for servo-controls, to limit movement of machine members and as a start-and-stop switch which formerly were possible only with complicated relays or a number of separate switches. A large selection of standard actuators is available.

New small basic switch is low cost; directly interchangeable with AN3234 Specs

The new Electro-Snap F2 Series snap action switches are extra-compact with extremely high electrical capacity for their size. Mechanical and electrical life at 1/32" overtravel is 150,000 operations, minimum, with accurate repeatability and constant stability of tolerances. Self-aligning springs provide contact wiping action rare in a switch of this size.

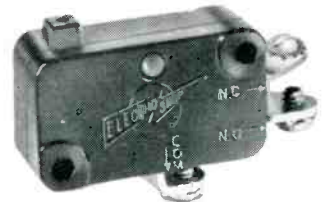

F2 SERIES

Durable case of special plastic gives the switch an ambient temperature rating of -100° to +275° F. or +375° F. Available, at low cost, in three basic models with a wide selection of actuators.

SERIES F2 BASIC SWITCH: F2-3: Single Pole, Double Throw
 F2-2: Single Pole, Normally Open; F2-1: Single Pole, Normally Closed

OPERATING CHARACTERISTICS

Electrical Rating: 10 AMP. 125/250 V. A.C. 60 cycles
 30 V. D.C. inductive and resistive (6 AMP, 30 V. D.C. for Airborne Application)
 Operating Force, 7 to 12 oz. Movement Differential, .011 ± .005
 Reset Force, 4 oz. Min. Overtravel, 1/32 Min.
 Pretravel, 3/64 Max.

SEND COUPON FOR MORE DATA

ELECTRO-SNAP SWITCH & MFG. COMPANY
 4236 W. Lake St., Chicago 24, Ill.

Please send data sheets on switches checked:

- EF-3 — subminiature sealed
- G3 — 40 Amp. basic
- K3 — Triple-pole
- F2 — Extra-small basic

NAME _____

COMPANY _____

ADDRESS _____

CITY _____ ZONE _____ STATE _____



PRECISION SWITCHES



BASIC SWITCHES

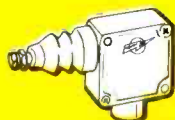

DIECAST ENCLOSED SWITCHES



HERMETICALLY SEALED LIMIT SWITCHES

CONFORM TO MIL & AM SPECIFICATIONS

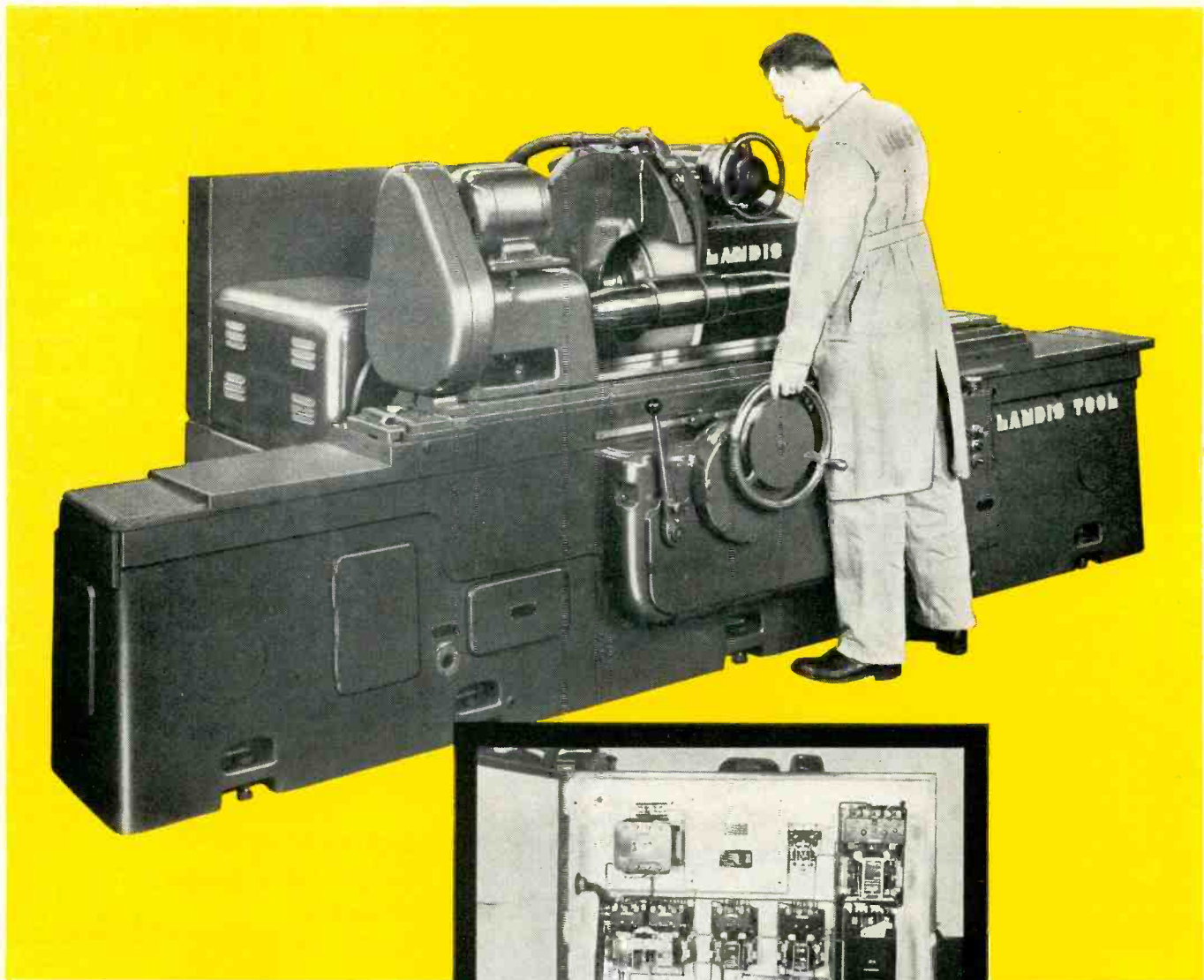

This Landis 10" x 48" Type CH plain hydraulic grinding machine depends on Rome Synthinol Machine Tool Wire for dependable service throughout the electrical system.

How Landis Tool builds long life into the electrical circuits of these large precision grinders

Oils and coolants—two liquids necessary in the operation of these large Landis grinders—can be pretty rough on ordinary insulated wires.

That's one of the reasons why the Landis Tool Company in Waynesboro, Pennsylvania, specifies Rome Synthinol® Machine Tool Wire for their line of precision cylindrical grinders. Other reasons: Rome's fast service and expert assistance to help solve wiring problems.

Synthinol, the thermoplastic insulation used in these Rome Machine Tool Wires, is specially compounded to resist moisture, heat, flame, acids, oils, and cutting solutions.

Uniformly small diameters and bright colors for easy identification make Rome Synthinol Machine Tool Wire a good choice for multiple circuit wiring like that on the Landis Type CH plain hydraulic grinding machine shown above.

Next time you're ordering machine tool wire, specify Rome for long life and trouble-free service in your product. Further information will be given promptly on request.

It Costs Less to Buy the Best



ROME CABLE
Corporation
 ROME • NEW YORK
 and
 TORRANCE • CALIFORNIA

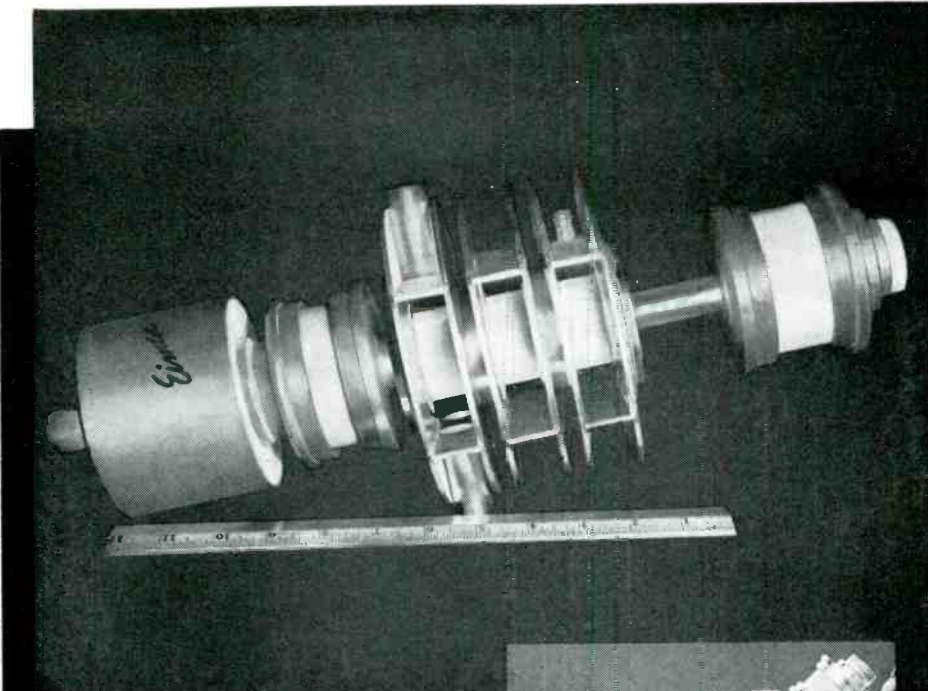

A single EIMAC one kilowatt CW Klystron covers the entire 1700-2400 megacycle range

TYPICAL CW OPERATION

Eimac 3K2500SG
amplifier klystron
1700-2400 mc

D-C Beam Voltage 6kv
D-C Beam Current .472 amps
Power Output 1.0 kw
Driving Power 1.0 watt
Efficiency 35 to 40%
Power Gain 30db

One kilowatt CW power output is now commercially available with the new Eimac 3K2500SG amplifier klystron, specifically developed for reliable forward-scatter microwave systems. This three-cavity klystron operates at power gains of 1000 times and an efficiency of 35 to 40 percent.

Eimac's exclusive external resonant cavities and ceramic windows permit all critical RF tuning circuits to be placed outside the vacuum system. Two easily adjusted tuning knobs for each cavity assure the most positive and simple tuning possible.

Ceramic and metal construction, a high efficiency oxide cathode, and forced air cooling give the rugged 3K2500SG the reliable, efficient, long-life service typical of all Eimac tubes.

The 3K2500SG klystron is available with resonant cavities, magnetic framework, magnetic beam control coils, output load coupler, and air system socket providing equipment manufacturers with a complete klystron amplifier circuit system.

For detailed information
about Eimac tubes and their applications
write our Technical Services Dept.

EITEL-McCULLOUGH, INC.
SAN BRUNO • CALIFORNIA
The world's largest manufacturer of transmitting tubes

New Stokes

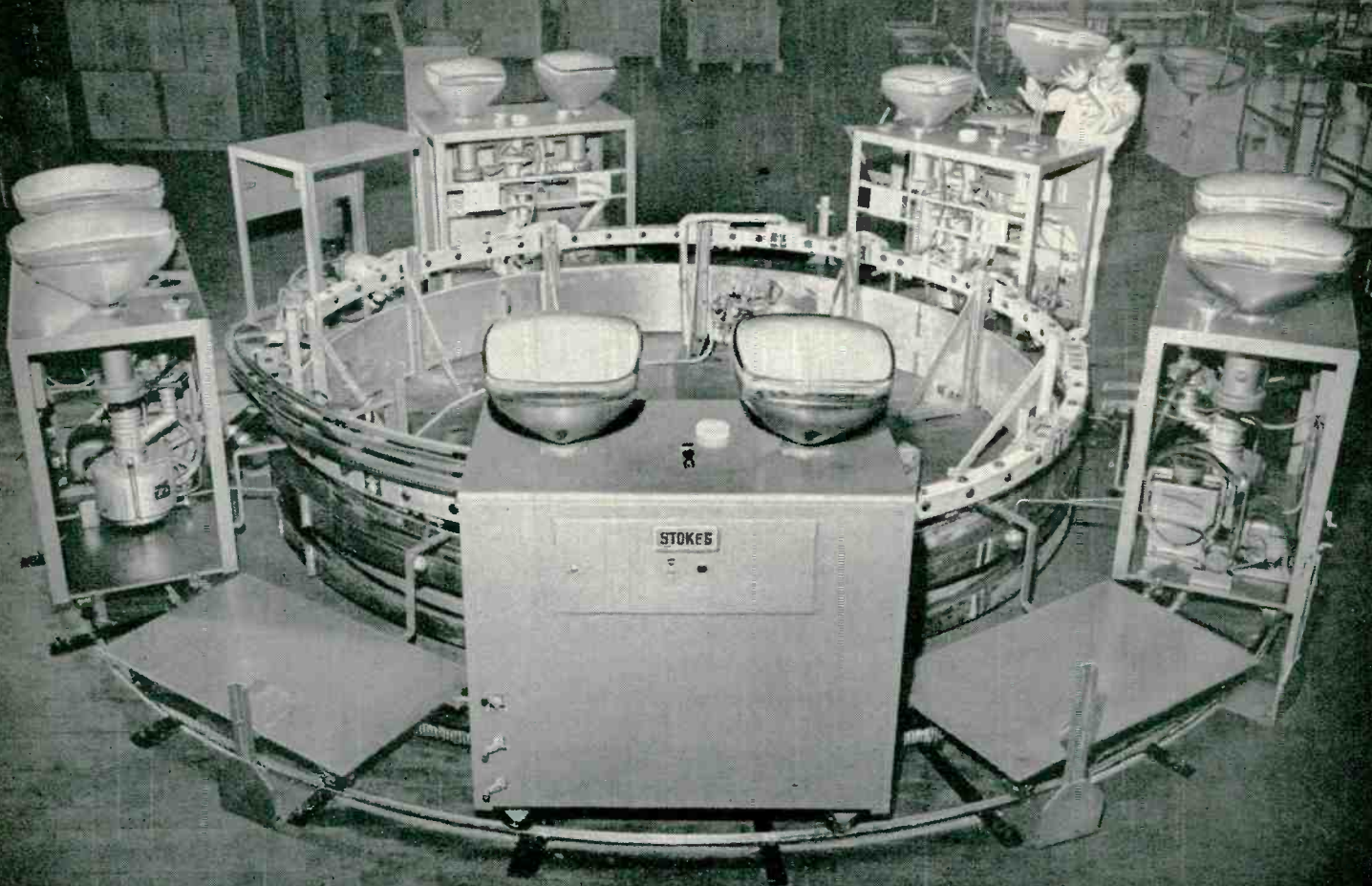

New Stokes dual-tube in-line aluminizing system is setting high standards of economy and productivity at Thomas Electronics, Inc., Passaic, New Jersey.

Electronic equipment manufacturers are profiting from other STOKES Vacuum Equipment...

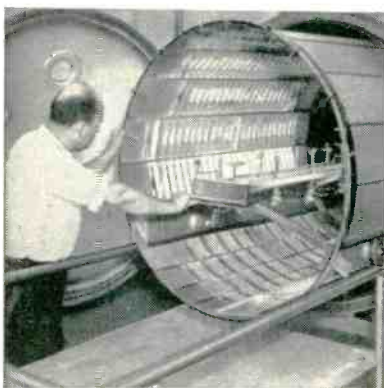

Vacuum Metallizers. Stokes manufactures a complete line of vacuum metallizing equipment to plate selenium rectifiers, printed circuits and other conductive coatings on non-conductive materials.

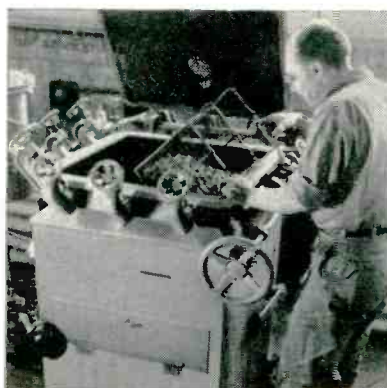

Vacuum Impregnators. Manufacturers of electronic equipment use Stokes vacuum impregnation systems to obtain improved characteristics of coils, condensers, capacitors and other components.

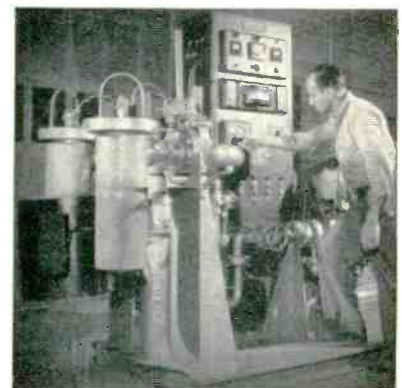

Vacuum Furnaces. Stokes melting and heat-treating furnaces permit electronic manufacturers to pre-process raw and semi-finished materials with less contamination, for increased life and performance.

5 Cart In-line TV Dolly System Aluminizes 96 Tubes Per Hour

New system at Thomas Electronics, Inc.—largest independent manufacturer of cathode ray tubes — affords increased production . . . reduces initial cost . . . requires less floor space and maintenance

TODAY's big news in TV picture tube production is the new Stokes aluminizing system. This high-production equipment evacuates and aluminizes *two tubes per cart* with one pumping system. The new design affords several cost-cutting and production-boosting advantages:

Greater production. Using a mechanical pump and 4-inch high speed "Ring-Jet" booster, overall cycle time is 6½ minutes with 21-inch tubes—96 per hour with the standard five cart system.

Lower first cost. Fewer carts are needed . . . the basic unit, consisting of five carts with ten dollies, costs less than comparable single-tube systems.

Lower maintenance. There is only *one* pumping system for every *two* tubes.

Less floor space. Circular track is only 17 feet in diameter.

Flexibility. Five additional carts can be added to the standard dollies to produce 21-inch tubes at a rate of 192 per hour. Tubes up to 27-inch can be accommodated.

The system is fully automatic. Operator loads . . . and then unloads completely aluminized tubes. Filament replacement is simplified by removable holders. Internal cooling coils provide for rapid cooling of oil in the booster pump before vacuum is released.

A Stokes engineer will be glad to discuss how this new system for black and white or color tubes can be integrated into your production line. He'll also welcome the opportunity to talk over your specialized requirements . . . to apply Stokes' extensive experience in high vacuum engineering and automatic production technology. F. J. STOKES MACHINE COMPANY, 5503 Tabor Road, Philadelphia 20, Pa.

Reference Data:

Microvac Pumps—Catalog 750
Diffusion and Booster Pumps
Specification and performance data
Story of the Ring-Jet Pump
How to Care for Your Vacuum Pump—
Booklet 755
Vacuum Impregnation—Catalog 760
Vacuum Furnaces—Catalog 790
Vacuum Metallizing—Catalog 780
Vacuum Calculator Slide Rule

The logo consists of the word "STOKES" in a bold, white, sans-serif font, centered within a solid black rectangular background.

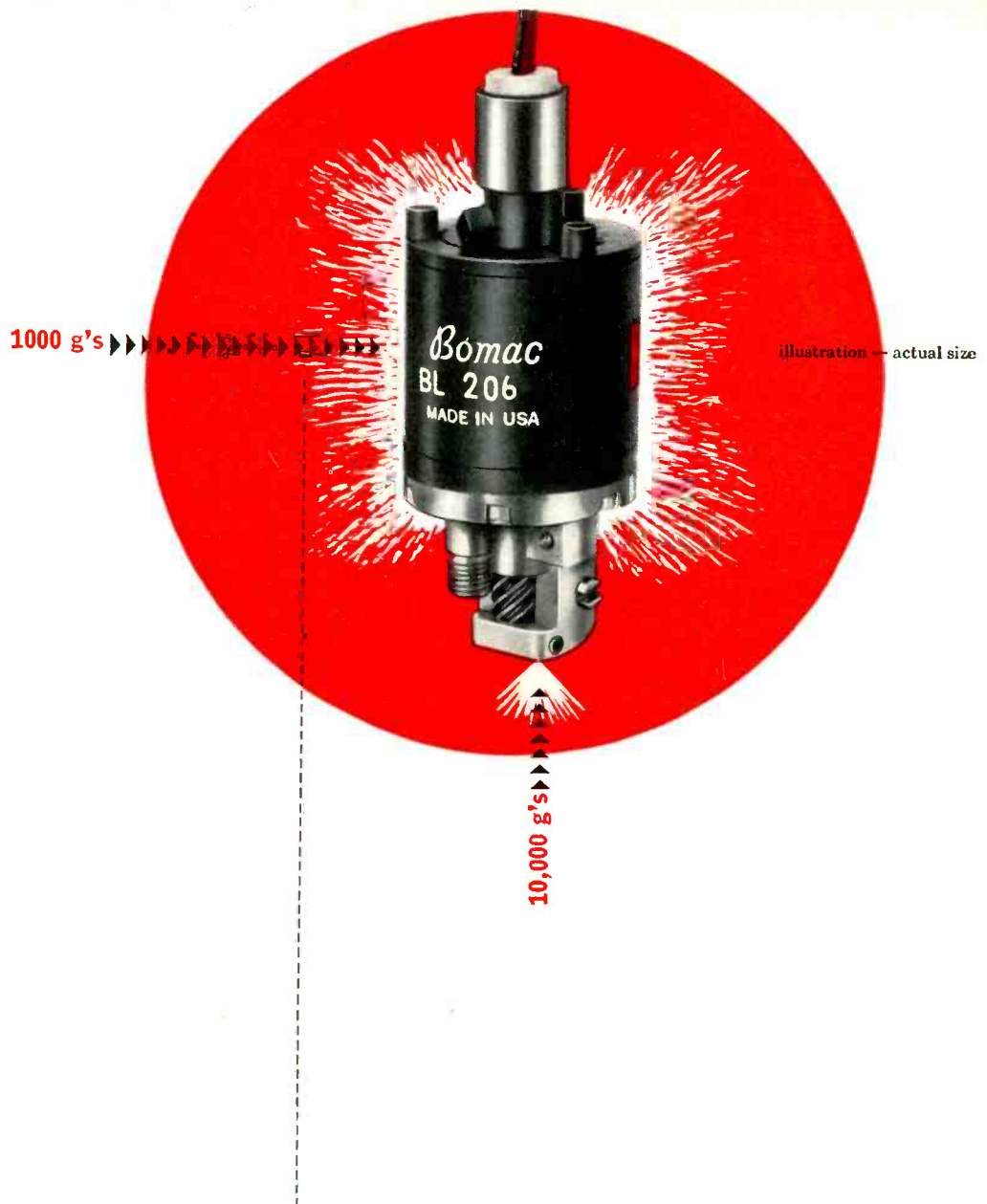

ANOTHER BOMAC FIRST! miniature C band magnetron...

UNERRING RELIABILITY in performance under severe stress — 10,000 g's longitudinally, 1,000 g's laterally
 HIGH PRECISION, ADJUSTABLE TUNING from 5400 to 5900 mc by worm drive with set screw lock on tuner
 FREQUENCY DRIFT — less than 0.05 mc/C
 COMPLETE PACKAGE UNIT — no accessories, equipment or accessory fittings are required
 OPERATING TIME — 2 seconds
 WEIGHT — 6.5 oz
 DIMENSIONS — 3 1/4" high, 1 1/16" diameter

For complete specifications, write (on your company letterhead) to Dept. E-5

Bomac Laboratories, Inc.

Other miniature magnetrons for higher shock applications are available.

BEVERLY, MASSACHUSETTS

Offices in major cities:—Chicago • Kansas City • Los Angeles • Dallas • Dayton • Washington • Seattle • San Francisco • Toronto

Export:—Maurice I. Parisier, 1860 Broadway, N.Y.C.

UNITED—with DC-6A Cargoliners—gives you “EXTRAS” no other cargo carrier can match!

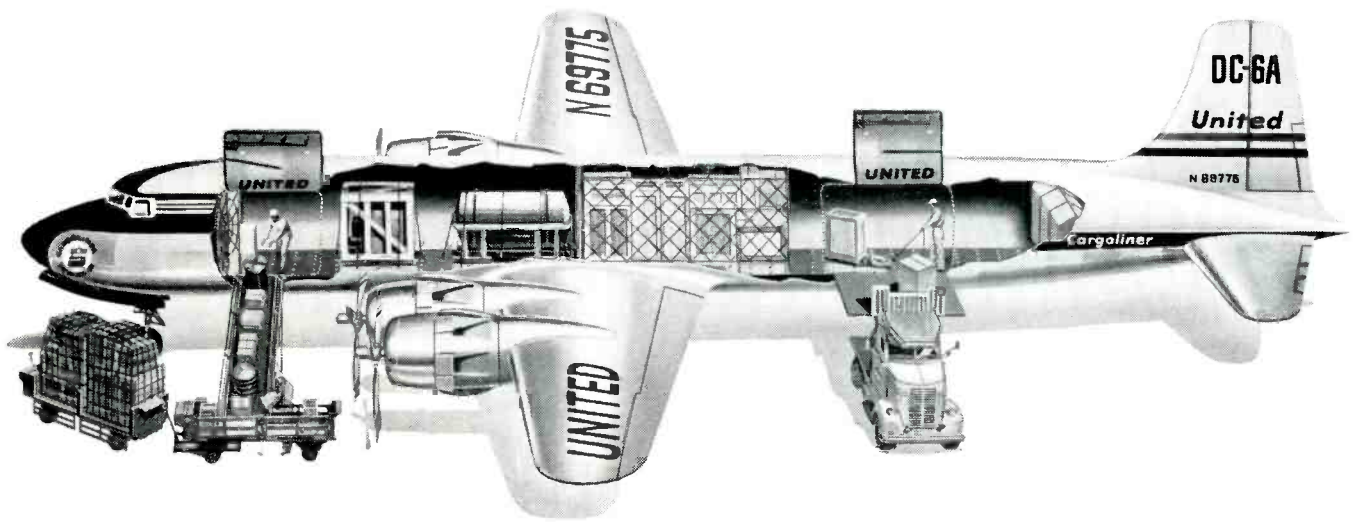

EXTRA Air Freight Capacity—each new DC-6A carries up to 30,000 pounds of cargo at 300 mph. Single pieces up to 76" x 81" x 115" and up to 8000 pounds can be shipped by DC-6A Cargoliner.

EXTRA Dependability—all of United's new DC-6A Cargoliners* are equipped with radar for smoother flights and better on-time performance. No other airline offers radar-equipped cargo planes.

PLUS these “EXTRAS” in schedules and service:

- *Telemeter Airbill*—the complete airbill arrives *in advance* of your shipment.
- *Reserved Air Freight Space* aboard all Mainliners, Cargoliners, and connecting world-wide carriers.
- *Every United flight*—both passenger and cargo planes—carries freight between the 80 cities on United's Main Line Airway.

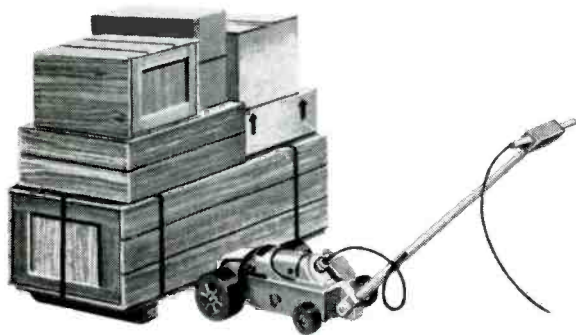

EXTRA DC-6A Heavy-cargo Features—including motorized tug bar for precision handling of heavy pieces... tie-down strength greater than any other airline's cargo planes... pre-loaded mobile pallets.

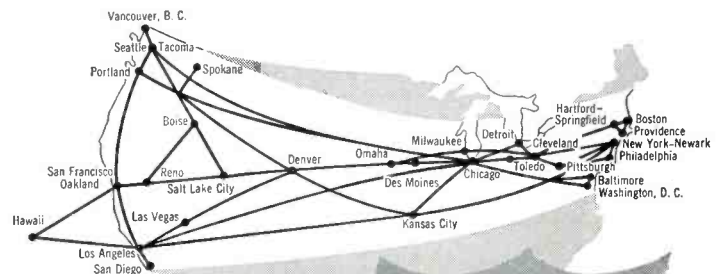

For service or information, call the nearest United Air Lines Representative. Write for free Air Freight booklet. Cargo Sales Division, Dept. V-5, United Air Lines, 5959 S. Cicero Ave., Chicago 38.





As a Direct-Reading Instrument The extreme sensitivity of the d-c amplifier is utilized to check plasticizer insulation resistance values in the megamegohm range.

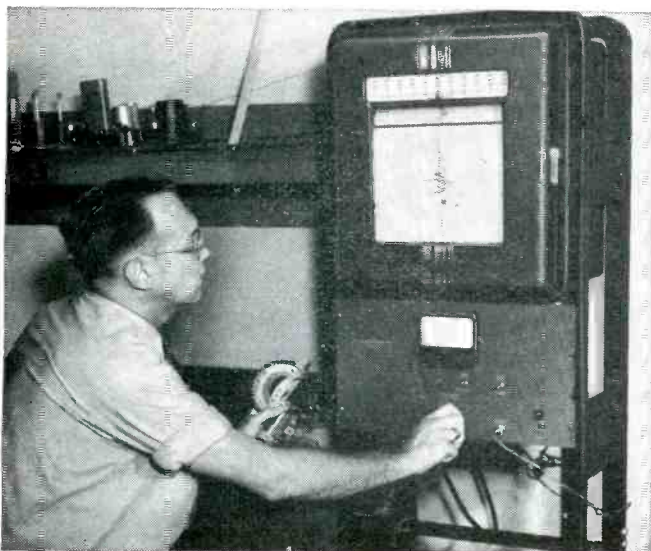

As a Recorder Preamplifier The rack-mounted amplifier above is being used to increase the sensitivity of a recorder in running special tests of switches.



As a Null Detector The d-c Amplifier is being used above for factory checking and calibration of instruments.

L&N Low Level d-c Amplifiers are

Triple Purpose... for Triple Service

● In response to the constant demand for versatility in precision instruments, these d-c Indicating Amplifiers combine the functions of three useful instruments in one:

1. A Direct-Reading Instrument that is always ready to use . . . never any readjusting of zero, either initially or during a series of readings. Simply select the range in which you want to work by turning scale-multiplier knob.

2. A Recorder Preamplifier — Values measured by Stabilized d-c Amplifiers can be recorded directly on Speedomax recorders.

3. A Null Detector more sensitive than most reflecting galvanometers, yet with full scale response time of only 2 to 3 seconds. These instruments are unaffected by vibration; leveling is not necessary. At the turn of a range knob, a wide choice of sensitivities can be obtained without external shunts. A non-linear response characteristic is also available for easy balancing.

These amplifiers are suitable for handling low level measurements with thermocouples, strain gages, bolometers—bridge and potentiometer circuits—ionization, leakage and phototube currents—almost any measurement of extremely small direct current or voltage.

Self-contained, the unit can either be used "as is" or removed from case and mounted on a 19" relay rack.

For details, including complete specifications, send for Folder EM9-51 (1). Write our nearest office, or 4979 Stenton Ave., Phila. 44, Penna.

LEEDS  **NORTHROP**
instruments automatic controls • furnaces

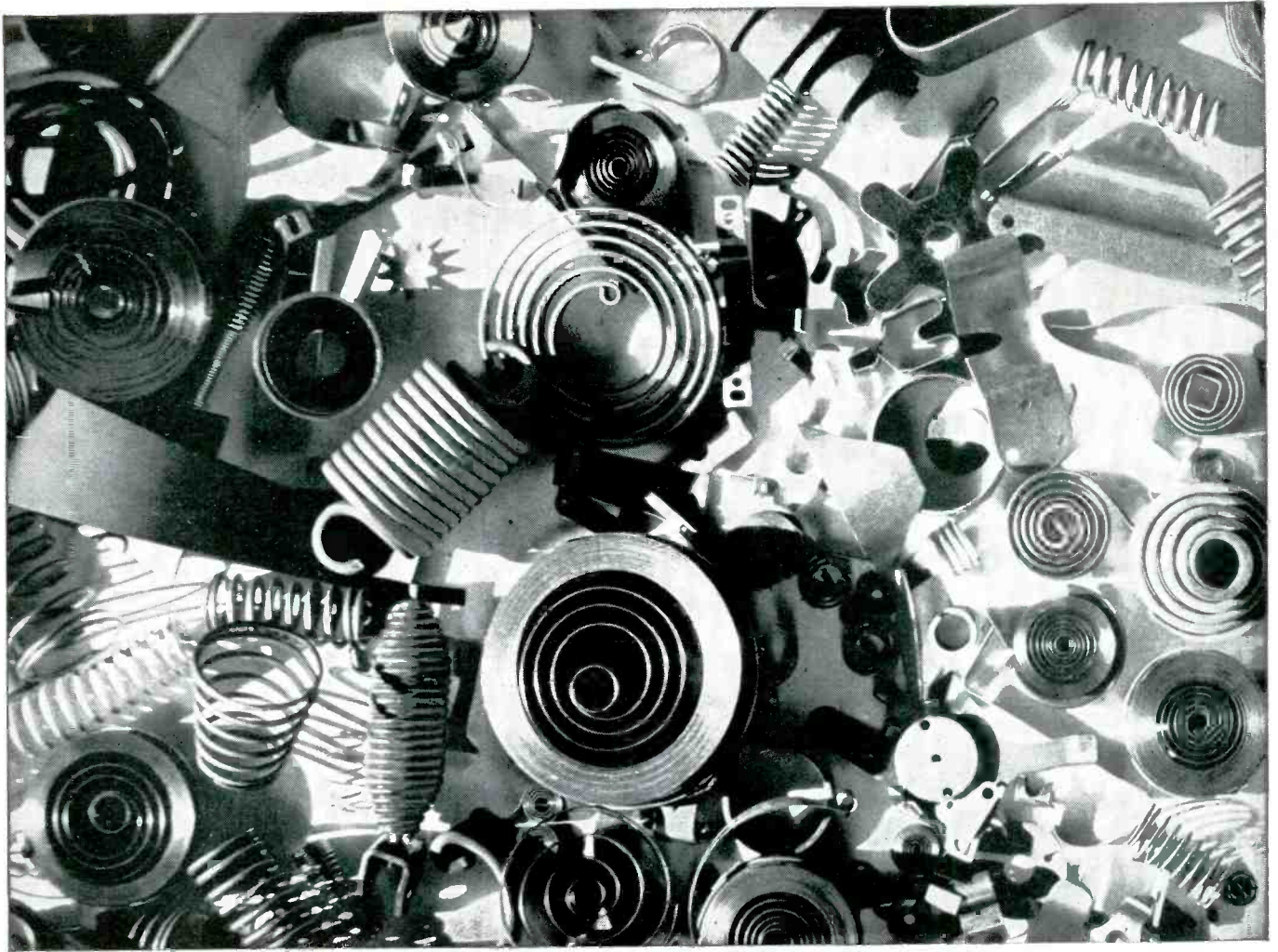

Photo courtesy of Associated Spring Corp.

Need a spring for service above 500° F.?

When it is a question of strength and resistance to fatigue and relaxation under corrosive conditions —

Particularly when temperatures range over 500° F. and other materials do not perform satisfactorily —

That is the time to see how INCO Nickel Alloys may solve the problem for you.

Inconel and Duranickel, for example, are widely used for springs that must resist relaxation at stresses up to 70,000 psi and temperatures up to 650° F.

Inconel "X" goes even further. It maintains 90 per cent of its room-temperature mechanical properties up to 900° F., 80 per cent up to 1100° F. Combines excellent resistance to heat, corrosion, and *relaxation* at stresses up to 100,000 psi. (Maximum recommended design stress,

corrected, decreases as heat exceeds 700° F.)

Other Inco Nickel Alloys—Monel, "K" Monel, Perma-nickel® — help solve special spring problems. Perma-nickel, for example, combines good electrical conductivity with excellent heat and fatigue resistance.

Why don't you let Inco engineers help you find the right spring for severe service.



Nickel Alloys

MONEL® • "R"® MONEL • "K"® MONEL • "KR"® MONEL
 "S"® MONEL • INCONEL® • INCONEL "X"®
 INCONEL "W"® • INCOLOY® • NIMONIC® Alloys
 NICKEL • LOW CARBON NICKEL • DURANICKEL®

THE INTERNATIONAL NICKEL COMPANY, INC.

Electrical and Electronic Section
 67 Wall Street, New York 5, N. Y.

E-5-56

I need springs that will last longer in corrosive conditions
 high temperatures. Please send me your new booklet on
 "Inco Nickel Alloy Helical Springs".

Name _____ Title _____

Company _____

Company Address _____



AIR-TO-GROUND TV SYSTEM

Transmits Combat Pictures on FM

Airborne military television crams a self-contained transmitting station into a small reconnaissance plane, then flies this ever-moving station over unpredictable terrain. Taking these adverse conditions into account, Admiral developed an extremely compact television system which uses FM transmission for the picture. It is now in production for the U.S. Army Signal Corps. Even under difficult conditions, this equipment provides excellent definition.

The transmitting plane, flying at approximately 1,000 feet, would have a line-of-sight range of 25 or 30 miles. This would enable a battle commander aided by a panel of TV screens, each screen showing a different sector, to coordinate military operations over a wide area.

In addition, a mobile ground-to-ground TV system is under development. Inquire about Admiral's exceptional capabilities in the field of military electronics. Address inquiries to:

Admiral®

CORPORATION

Government Laboratories Division, Chicago 47

LOOK TO **Admiral** FOR
RESEARCH • DEVELOPMENT • PRODUCTION
IN THE FIELDS OF:

COMMUNICATIONS UHF AND VHF • MILITARY TELEVISION
RADAR • RADAR BEACONS AND IFF • RADIAC
TELEMETERING • DISTANCE MEASURING
MISSILE GUIDANCE • CODERS AND DECODERS
CONSTANT DELAY LINES • TEST EQUIPMENT

Facilities Brochure describing
Admiral plants, equipment and ex-
perience sent on request.

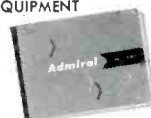

ENGINEERS: The wide scope of work in progress at Admiral creates challenging opportunities in the field of your choice. Write Director of Engineering and Research, Admiral Corporation, Chicago 47, Illinois.

Note: NEW COLOR SOUND FILM on Admiral Automation available for showing to technical or business groups. Address Public Relations Director, Admiral Corporation, Chicago 47.

ALL-NEW, ALL-PURPOSE COPY MAKER...



**the right way
to copy anything**

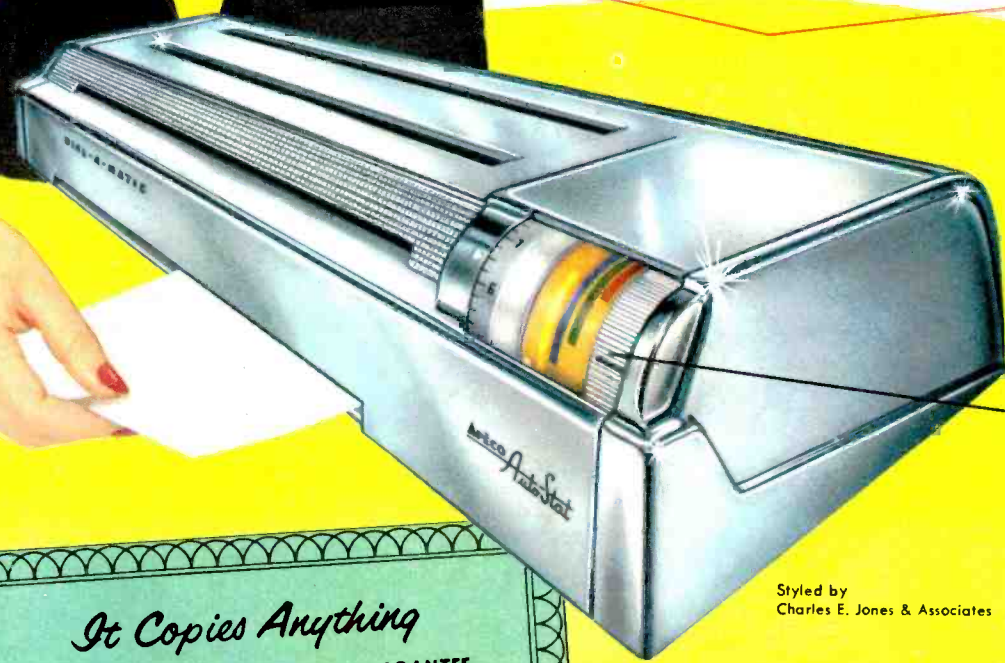

The Brand New

APĒCO *Auto-Stat*

DIAL-A-MATIC

Now get copies of anything written, printed, typed, drawn, photographed or blueprinted. All copies made the same easy way, right in your own office.

**Simplest copy control ever . . .
it's the DIAL THAT DOES IT**

It is the one copy maker that fulfills all copy requirements for all businesses, large or small. It offers hundreds of money and time saving uses and is so low cost it pays for itself in less than a year . . . even when less than 5 copies a day are needed. It's light weight . . . compact, and styled in gleaming mirror-finish stainless steel.

Styled by
Charles E. Jones & Associates

It Copies Anything

EXCLUSIVE JOB-PERFORMANCE GUARANTEE

The APECO Dial-A-Matic Auto-Stat is guaranteed in writing to copy any originals on which your purchase decision is based.

***And Here's Why it's RIGHT**

- It's Right Because it's All-Purpose . . .** It copies anything without limitations!
- It's Right Because it's Fast** Copies are ready in less than 30 seconds!
- It's Right Because it's Economical** Copies cost less than a phone call!
- It's Right Because it's Error Proof . . .** Copies are photo-exact . . . legally acceptable!
- It's Right Because it's Confidential . . .** Copies are made right in your own office!



Have you read this
NEW BOOKLET?
Mail this air mail postage
paid card for your
FREE BOOK

**American Photocopy Equipment Co.
1920 W. Peterson Avenue
Chicago 26, Ill.**

(Dept. E-56)

Rush me, without obligation, your free booklet on new Apeco Dial-A-Matic Auto-Stat copying. I understand this factual report will show me how I can improve the efficiency of my business as well as increase work output.

Name _____

Title _____

Firm _____

Address _____

City _____ Zone _____ State _____

In Canada: Apeca of Canada, Ltd.
134 Park Lawn Rd., Toronto, Ont.

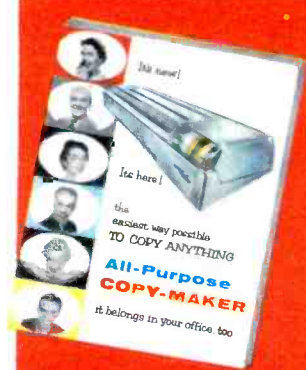

**THIS CARD
TEARS OUT
use it to get your
FREE BOOK**

**AMERICAN PHOTOCOPY EQUIPMENT CO.
Chicago 26, Ill.**

Copies!

Copies!

Copies!

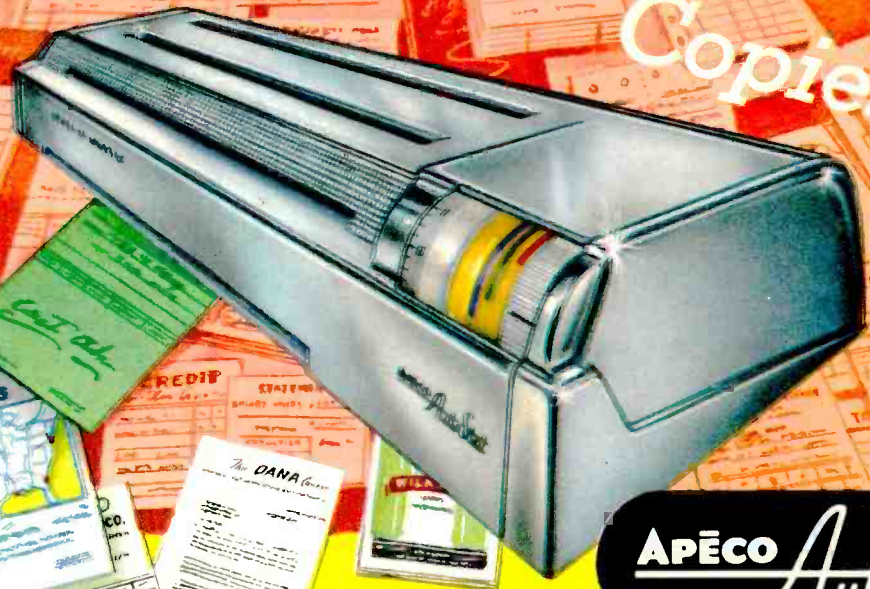

APECO *Auto-Stat*
DIAL-A-MATIC

all-purpose copy maker

There isn't an office form or record used by businesses —large or small— that can stump this versatile new copy maker. Hard to believe? Well...it's true! Thousands of business executives now using the Apeco Dial-A-Matic Auto-Stat know:

"IT'S THE RIGHT WAY TO COPY ANYTHING."



Now...new **FREE BOOKLET** tells you how!

Your free copy of this new booklet pictures and describes the revolutionary, new APECO Dial-a-matic Auto-Stat; tells how this new copying method can be used in your business to cut office paper work, save time, labor, and money. This informative, factual report should be must reading for you, as well as every executive member of your staff. Send for your free booklet today!



FIRST CLASS
Permit No. 26670
(Sec. 34.9 P.L. & R.)
Chicago 26, Ill.

Via Air Mail

BUSINESS REPLY CARD
No postage stamp necessary if mailed in the United States

5c—Postage will be paid by—

AMERICAN PHOTOCOPY EQUIPMENT CO.

1920 W. Peterson Ave.
Chicago 26, Ill.



TEAR-OUT POSTAGE PAID AIR MAIL CARD!

**SEND FOR YOUR
FREE BOOKLET TODAY!**

Now...shakers for random motion vibration testing

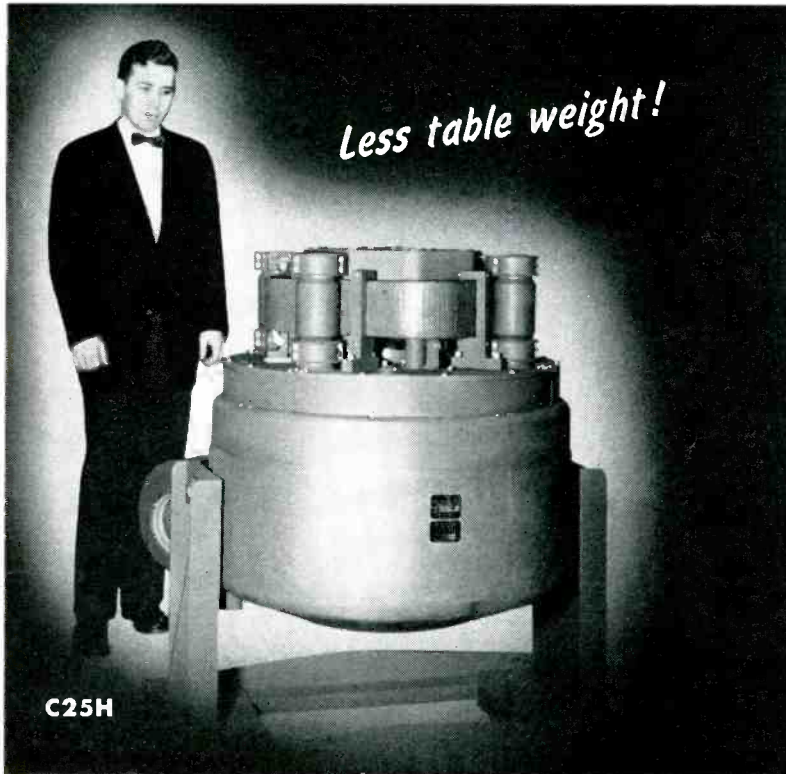

Three new high performers which are particularly adapted to random motion vibration testing join the unique line of MB Vibration Exciters. With them, virtually every modern test requirement for sinusoidal or random motion can be met with increased data-reliability.

Model C6 extends testing range to 5000 cps without axial resonance . . . has a moving element weighing only 3½ pounds . . . delivers 200 pounds of force.

Model C10 develops 1200 pounds force . . . and up to 67.5 "g". Usable to 3000 cps, it has a suspension system that assures true rectilinear motion, with first resonance of unloaded 17½-pound moving element over 3000 cps.

Model C25H rated at 3500 pounds force, now has a newly designed moving table assembly weighing

only 75 pounds . . . yet the axial resonance remains well above operating limit of 2000 cps.

These shakers put into practice the advanced vibration engineering for which MB's specialists are known, and which is always ready to assist you.

GOOD VIBRATION EXCITER INSURANCE

Remember, MB maintains a service department second to none in scope of service and size. It does installation checkouts, instructs operating personnel, and "trouble-shoots". Such service assures that you'll get the most from your equipment.

Ask for recommendations on your specific needs, or look over the MB line by sending for Bulletin 420-B-5





manufacturing company

A division of Textron American, Inc.

1060 State Street
New Haven 11, Conn.

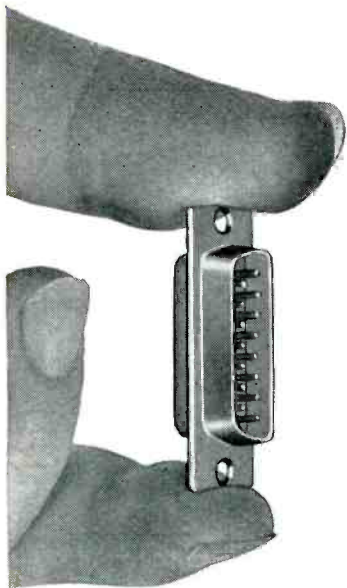
HEADQUARTERS FOR PRODUCTS TO CONTROL VIBRATION . . . TO EXCITE IT . . . TO MEASURE IT.



TINY like a beetle 
 RUGGED like a turtle
 ..because they both
 have a SHELL

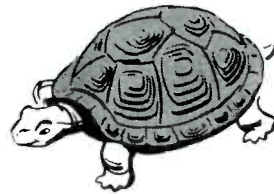

TYPE **D** SUBMINIATURES

...light, but strong steel shells give maximum support to Cannon "D" Sub-Miniature Plugs. And... *mounting depth is actually less than on conventional shell-less connectors.*

Zytel 101 insulators allow a greater number of contacts within a smaller area in standard units. Four DH Connectors are now made for hermetic seal applications. And, junction shells specially adaptable for potting. The DF Sub-Miniature Series feature new floating mounting holes for ease of alignment; screw locking assemblies, miniature coaxial contact combinations, and straight and angle 90° junction shells with cable clamps.

Four shell sizes. 15, 25, 37, and 50 five ampere contact insert arrangements; gold plated brass contacts in plastic inserts; cadmium plated steel contacts in fused glass insulators.

Keystone polarization. And... most important of all... Cannon Electric assured quality.

NOW ... Available in Diall plastic.

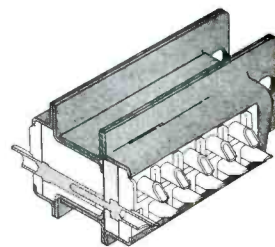

Cutaway of standard "D" sub-miniature connector



Standard D available in Zytel or Diall. DH hermetic seal units have vitreous insulators; solderpot shown; eyelet also available.

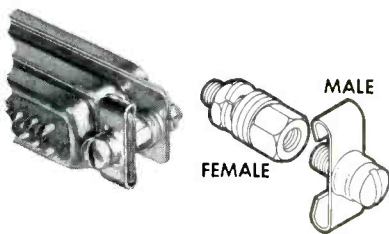

Screw locking mechanism is simple, positive.



Each miniature coaxial replaces five 5-amp. contacts in "D" layout.



Floating mounting holes aid alignment in multiple mount rack-and-panel applications.

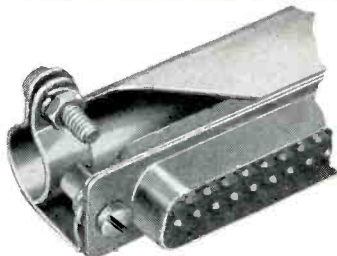

Junction shell with 90° cable clamp.



Look for this Display Box of Cannon "D" Sub-Miniatures



Write for 8-page Bulletin D-6.
 "D" Connectors Are Stocked by
 More than 200 Jobbers, Coast-to-Coast—and by Cannon Service Stores.

Please refer to Dept. 120



CANNON PLUGS

CANNON ELECTRIC CO., 3208 Humboldt St., Los Angeles 31, Calif.



Better Things for Better Living
... through Chemistry

ELECTRONIC DESIGN

PROPERTY AND APPLICATION DATA
ON THESE VERSATILE ENGINEERING MATERIALS:
"ZYTEL," "ALATHON," "TEFLON," "LUCITE."

NEWS

No. 5, 1956

Thin-walled tubing of Du Pont TEFLON® withstands soldering temperature, simplifies component-part assembly

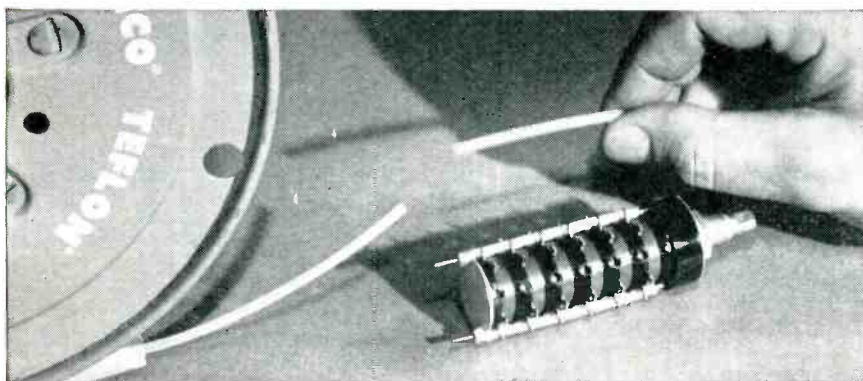

Tubing of "Teflon" serves as an insulator around two stainless-steel studs in miniature rotary tap switches designed for use in military aircraft. (Manufactured by Grayhill Co.,

La Grange, Illinois. Tubing supplied by The Polymer Corporation of Pennsylvania, Reading, Pennsylvania, under trademark "Polypenco" spaghetti tubing of "Teflon".)

Moisture resistance, excellent dielectric strength utilized in miniaturization

"Teflon" tetrafluoroethylene resin maintains high dielectric strength at elevated temperatures. It also has high surface resistivity, dropping only to 10^{13} ohms at 100% relative humidity. It maintains full electrical insulating characteristics, even when flexed or bent during assembly and installation. This combination makes it possible to miniaturize an electrical assembly without fear of dielectric failure.

For example, thin-wall tubing of "Teflon" simplifies assembly of component parts in a series of miniature rotary tap switches. Since "Teflon" will not burn, melt or decompose when connections next to it are soldered, assembly of switch parts is easier, faster, and the possibility of accidental grounding is minimized. The thermal stability of "Teflon", even in thin sections, is demonstrated in this tubing where the wall thickness is only .014". The nominal inside diameter is .075". "Teflon" meets Class H, AIEE standards for maximum insulating temperatures.

"Teflon" is non-flammable, has good mechanical strength and is completely unaffected by sunlight or outdoor weathering. It has zero water absorption by ASTM test D570-42, resists corrosion and growth of fungus, is chemically inert.

"Teflon" is applicable to a variety of uses in the electronic field. You can profitably use this versatile Du Pont engineering material in applications involving miniaturization; high-frequency, high-voltage, and high-temperature requirements; exposure to corrosive action. Send coupon below for complete properties and case history applications as a guide to proven applications of "Teflon".



TV shield of "Alathon" pictured above is used in the new RCA Victor color-TV receiver. In addition to providing the needed insulation, the shield of "Alathon" gives mechanical protection to the tube when it is shipped or handled. Can you employ "Alathon" to help solve your electronic problems?

Strength, flexibility, chemical resistance and dielectric characteristics of articles molded of "Alathon" polyethylene resin offer many possibilities for application in the electrical field.

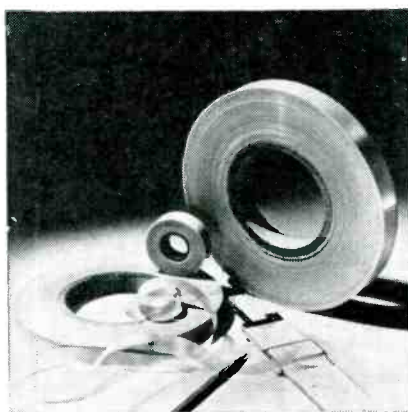

Insulation tape of "Teflon" is outstanding in television and FM transmission lines where the material must have low power loss and be able to withstand the high temperatures built up within a transmission installation. Now available in N.E.M.A. coding colors, "Teflon" is used as conductor insulation for armature or field, coil wrappers, slot liners, taping of coils, lead insulation and coil separators within slots. (Manufactured by Raybestos-Manhattan, Inc., Manheim, Pennsylvania.)

NEED MORE INFORMATION?

CLIP THE COUPON for additional data on the properties and applications of these Du Pont engineering materials.

E. I. du Pont de Nemours & Co. (Inc.), Polychemicals Department
Room 225 Du Pont Building, Wilmington 98, Delaware.

In Canada: Du Pont Company of Canada Limited, P.O. Box 660, Montreal, Quebec

Please send me complete property and application data on Du Pont "Teflon" , "Alathon" .

I am interested in evaluating these materials for _____

Name _____
Firm Name _____
Position _____
Type of Business _____
Street Address _____
City _____ State _____

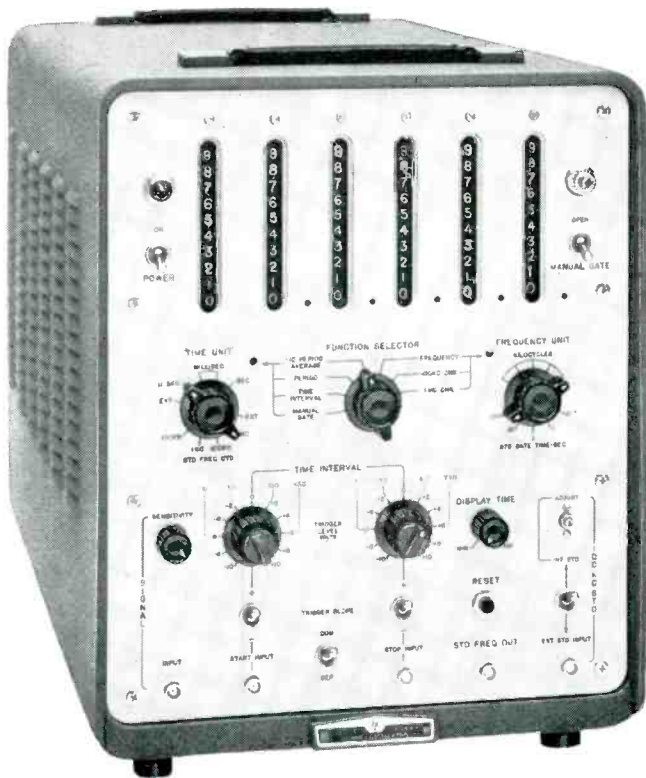

This one new Counter gives

Time or 10 cps to

 **523B ELECTRONIC COUNTER**

- ▲ Etched circuits, extreme reliability
- ▲ Rugged unitized construction
- ▲ Permits visual identification on oscilloscope of exact time interval measured
- ▲ High accuracy crystal oscillator circuit
- ▲ Trouble-localizer lights—plug-in circuit sections
- ▲ Counts pulses of selected levels for nuclear measurement

Check the exclusive features of the new *-hp-* 523B and see if you don't agree this is the most useful, convenient, and value-packed counter of its type ever offered commercially. Construction throughout is of highest quality. Etched circuits are rugged and ultra-dependable. Circuits are arranged for complete accessibility and visibility. Trouble-localizer lights and plugs disconnecting circuit elements further simplify maintenance.

An exclusive feature of the *-hp-* 523B is the pulse output for oscilloscope Z-axis modulation making possible visible indication of exact time interval being measured. Other important features include a pulse count discriminator counting only pulses of voltage above a pre-determined level, and a high accuracy crystal oscillator circuit for maximum stability. Con-

trols are color-coded and concentric, arranged by function. Readings are direct in clear, bright numerals visible under all light conditions. The automatic decimal point is also brightly illuminated.

FREQUENCY, PERIOD, TIME

In frequency counting, Model 523B covers 10 cps to 1.1 MC with accuracy of ± 1 count \pm crystal stability of $2/1,000,000$ per week. Time base crystals are pre-aged. For ultimate accuracy, a front panel connector permits application of a 100 KC external standard. Gate times are 0.001, 0.01, 0.1, 1 and 10 seconds. The gate also may be operated manually.

In period measurement, the unknown controls gate opening and closing, while the 523B's high-dependability *-hp-* AC-4A Decade Counters record cycles of an internal standard frequency. The result is a 10-period average measurement which reduces ten-fold effects of any triggering uncertainty. Period may be measured from 0.00001 cps to 10 KC in seconds, milliseconds or microseconds.

-hp- 523B also measures time from 3 μ sec to 100,000 seconds (27.8 hours.) Results are presented directly in seconds, milliseconds and microseconds. A threshold feature permits measurements to be started and stopped only by signals of pre-determined amplitude, polarity and slope. Separate adjustable stop and start channels are provided for maximum flexibility. Measurements may be started or stopped at any level from -300 to $+300$ volts on positive or negative slopes.

BROADEST USEFULNESS

In addition to industrial use as a precision counter of production quantities, *-hp-* 523B is ideal for measuring nuclear pulses, power line frequencies, rps and rpm, very low frequencies, oscillator stability and repetition rates. With suit-

 **provides complete coverage in quality**

Direct Frequency Period Readings

1.1 MC!

able transducers, local or remote measurements of weight, temperature, pressure, acceleration and other phenomena may be made.

-hp- 523B also quickly and conveniently measures time between impulses, pulse lengths, shutter speeds, projectile velocity, relay operating times, precise event timing, interval stability, frequency ratios, phase delay, etc.

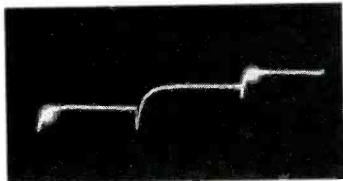

Fig. 1. Visual presentation is extremely helpful when studying complex waveforms. Exclusive -hp- 523B pulse output for 'scope Z-axis modulation permits viewing time-interval start and stop points on waveform being measured.

Specifications

FREQUENCY MEASUREMENT:

Range: 10 cps to 1.1 MC.
Accuracy: ± 1 count \pm stability (see General).
Input Requirements: 0.2 volt rms minimum.
Input Impedance: Approx. 1 megohm, 30 μ f shunt.
Gate Time: 0.001, 0.01, 0.1, 1, 10 seconds.
Reads In: KC; decimal point automatically positioned.

PERIOD MEASUREMENT:

Range: 0.00001 cps to 10 KC.
Accuracy: $\pm 0.3\%$ (for measurements of one period), $\pm 0.03\%$ (10 period average) at 1 volt rms. Improved by greater input voltage.
Input Requirements: 1 volt rms minimum. Direct coupled.
Input Impedance: Approx. 1 megohm, 40 μ f shunt.
Gate Time: 1 or 10 cycles of unknown.
Standard Frequency Counted: 10 cps, 1 KC, 100 KC, 1 MC, or external applied frequency.
Reads In: Seconds, milliseconds, microseconds; decimal point automatically positioned.

TIME INTERVAL MEASUREMENT:

Range 3 μ sec to 100,000 sec. (27.8 hours).
Accuracy: ± 1 /std. freq. counted \pm stability (see General).

Input Requirements: 1 v peak minimum. Dc coupled.
Input Impedance: Approx. 1 megohm, 25 μ f shunt.
Start and Stop: Independent or common channels.
Trigger Slope: Positive or negative on start and/or stop channels.
Trigger Amplitude: Continuously adjustable on both channels from -300 to +300 volts.
Std. Freq. Counted: 10 cps, 1 KC, 100 KC, 1 MC; External.
Reads In: Seconds, milliseconds, microseconds; decimal point automatically positioned.

GENERAL:

Registration: Six places on neon lamp decade units.
Stability: 2/1,000,000 per week. May be standardized against WWV.
Display Time: Variable approx. 0.1 to 5 seconds; display held indefinitely if desired.
Output Frequencies: Secondary standard frequencies available at front panel: 10 cps, 1 KC rectangular, 100 KC and 1 MC sine-wave (stability as above).
Trigger Output: Start and Stop pulse output (width approx. 0.5 μ sec). Available for:

1. Voltage level selection of input signal for frequency measurements.
2. Z-axis modulation of oscilloscope for time interval measurements.

Self Check: Panel control provides automatic count of internal 100 KC and 1 MC frequencies to assure accuracy of gate and proper operation of counters.

External Standard: 100 KC from external primary standard can be applied to unit for highest accuracy.

Power: 115/230 volts $\pm 10\%$, 50/60 cps. approx. 285 watts.

Dimensions: Cabinet Mount: 13 $\frac{3}{4}$ " wide x 16 $\frac{1}{4}$ " high x 21" deep. Rack Mount: 19" wide x 14" high x 21" deep.

Weight: Net: 48 lbs. Shipping: 85 lbs. (cabinet mount).

Accessories Furnished: 2 AC-16D Cable Assemblies.

Price: \$1175.00.

Data subject to change without notice. Prices f.o.b. factory.



**SEE YOUR -hp- REPRESENTATIVE OR
WRITE DIRECT FOR DATA SHEETS**

HEWLETT-PACKARD COMPANY

3637A PAGE MILL ROAD, PALO ALTO, CALIFORNIA, U.S.A.

Cable "HEWPACK"

DAvenport 5-4451

FIELD ENGINEERS IN ALL PRINCIPAL AREAS

electronic counters. Request details.

THE SHORTAGE OF SCIENTISTS AND ENGINEERS: How Critical Is It?

The United States is running into a serious shortage of scientists and engineers. There is no novelty in this observation. It has often been made in the last few years. And there has been mounting alarm about what this shortage may mean for both our national security and our prosperity.

There would be great novelty, however, if general agreement were attained on such important matters as the size of the shortage, the extent of the damage it threatens to inflict, and the best ways to eliminate it. The purpose of these editorials is not to provide this novelty, but to ventilate some of the key aspects of the shortage of scientists and engineers.

This first editorial in the series is designed to throw light on the over-all dimensions of the shortage. Others to follow will be addressed to such questions as:

- How serious is the threat to our economic well-being and to our national security?
- What needs to be done to prevent the shortage from becoming critical?

Rise Has Been Rapid

The problem is *not* that we have been producing a small number of engineers and scientists. Indeed, the number has risen sharply. We now have a working force of more than 600,000 engineers, over twice as many as the 286,000 there were in 1940. And we have about 250,000 scientists (chemists, physicists, biologists, geol-

ogists, mathematicians, etc.), compared to only 92,000 in 1940. About one in 148 persons in the labor force of 1940 was a scientist or engineer; today the ratio is about one in every 80.

In research and development work, where highly creative scientific minds are required, there has been fully as rapid a rise in employment of scientists and engineers. Fewer than 90,000 were employed in research and development fifteen years ago; the total now exceeds 200,000.

— But Not Rapid Enough

Despite this rapid increase in the number of scientists and engineers — at a rate much faster than the increase in the labor force as a whole — the needs of industry, government and education for technically trained people have risen even more sharply.

The principal reason for this mounting demand is the prodigious growth of research in the last 15 years. From a total of only about \$900 million spent on all types of research in 1941, the annual expenditure rose to over \$5 billion by 1953 (the latest estimate available). Over two-thirds of the research is done by private industry, mostly to develop new and better products and to find new and better methods of production. Most of the rest is performed by the government, largely to develop improved and inevitably more complex scientific weapons.

One aircraft company has found from its own experience that it required 17,000 engineering manhours to develop a typical fighter plane in 1940. The requirement is now about 1.4 million engineering manhours. Development of the typical fighter plane of 1960 will require well over 2 million engineering manhours.

In this dramatic example, the need for engineering services for a basic piece of military equipment soared 80 times in 15 years. It is an indication of why the demand for more and more technically trained men and women has outstripped even the imposing increase in scientific and engineering manpower of the last decade and a half.

Size of the Gap

Exactly how great the gap is between the available supply of scientists and engineers and the number required, it is impossible to say. In some instances technical talent undoubtedly could be better used than it is now. And part of the shortage might "disappear" if higher salaries had to be paid. (These questions will be discussed in later editorials.) But informed estimates of the approximate size of the gap can be given.

- According to the best available information, from estimates by the Engineers' Joint Council and the U. S. Bureau of Labor Statistics, **the minimum need for engineers from graduating classes is 40,000 each year for the next ten years.** Last year we graduated only 23,000 engineers, just about enough to cover replacement needs without allowing for any expansion of the number of active engineers. Projections made by the U. S. Office of Education indicate that we shall probably not have a class of 40,000—the *current* annual requirement—until 1963.

- According to Dr. Howard Meyerhoff, executive director of the Scientific Manpower Commission, **there is now a shortage of about 20,000 scientists.** Last year the number of doctoral degrees in the natural sciences, almost a prerequisite for research work, was only 5,000. Dr. Meyerhoff estimates that the shortage of scientists will rise another 30,000 by 1960.

More Needed As Teachers

Not all of the graduates with scientific and engineering training, furthermore, will work as scientists and engineers—that is, by performing research and giving it practical application. Such training is now necessary in many sales and management positions. And more of our technically trained men and women must remain in educational institutions as teachers if the quality of engineering and scientific education is to be maintained. A survey in 1954-55 by the National Education Association showed that, out of 277 universities, state colleges and large private colleges, nearly one-third *already* had unfilled vacancies in engineering and three-fourths had vacancies in physical sciences.

The dimensions of the shortage of scientists and engineers can be summarized as follows: **Despite a substantial rise in the trained manpower available, the needs of industry, the government and education have risen still faster. The best information indicates that, on the basis of current and anticipated needs, our recent yearly rates of production of slightly over 20,000 engineers and about 5,000 PhD's in natural sciences could be doubled without closing the gap entirely.**

The disturbing implications of this shortage for our national security and our prosperity and some practical suggestions for eliminating it will be the subjects of subsequent editorials in this series.

This is one of a series of editorials prepared by the McGraw-Hill Department of Economics to help increase public knowledge and understanding of important nationwide developments of particular concern to the business and professional community served by our industrial and technical publications.

Permission is freely extended to newspapers, groups or individuals to quote or reprint all or parts of the text.

Donald C. McGraw
PRESIDENT

McGRAW-HILL PUBLISHING COMPANY, INC.

a 3 cent investment



*Remington Rand Univac
Professional Employment Dept.*

(INSERT ONE OF THE PLANT LOCATIONS LISTED BELOW)

SEND COMPLETE RESUME TO ANY ONE OF THESE THREE PLANT LOCATIONS

MR. D. A. BOWDOIN
Dept. MP-2
2300 W. Allegheny Ave.
Philadelphia, Pa.

MR. R. K. PATTERSON
Dept. MS-2
1902 W. Minnehaha Ave.
St. Paul W4, Minn.

MR. FRANK KING
Dept. MN-2
Wilson Avenue
South Norwalk, Conn.

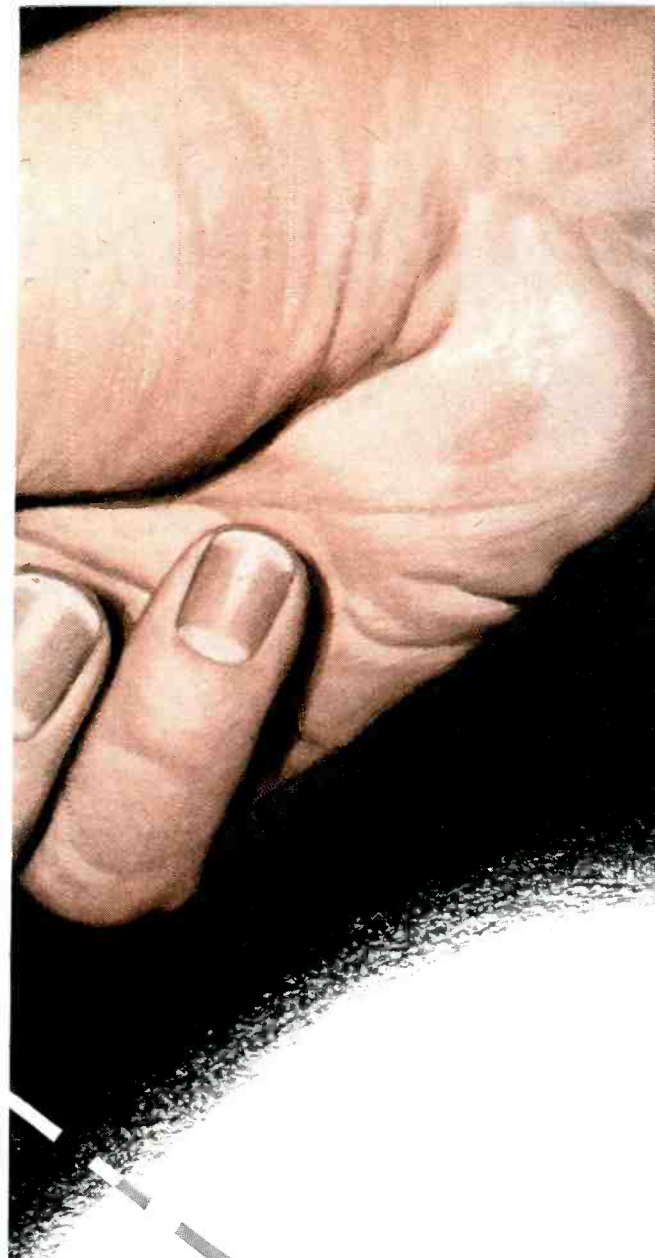

THREE CENTS

. . . that's all it takes to introduce you to the most advanced program in the fast-growing Electronic Computer field. A *complete program* of national importance offering limitless opportunities is going on now at Remington Rand Univac® where the advancements of tomorrow are being made today!

Take the first step toward a career—not a job—sharing in the responsibilities and obligations of the recognized leader in Electronic Computer Systems. Work with the men who developed much of the basic knowledge of computers . . . *men who set the standards for others to follow.* Excellent salaries, benefits and educational programs guarantee a future limited only by the individual.

**There is no finer future . . .
immediate openings for:**

ELECTRONIC ENGINEERS—Must have degree and be experienced in pulse circuitry, digital computers, or data processing equipment.

SALES ENGINEERS—Must have scientific, engineering or mathematical degree and be qualified to combine systems analysis, application and sales function.

PRODUCTION CONTROL PLANNING—Engineering degree preferred with 5 years' experience in Production Control. To develop product program schedules and long range production plans.

ALSO OPENINGS FOR—Physicists . . . Programmers . . . Mathematicians . . . Contract Administrators . . . and many others.

in your future

Univac offers unmatched opportunities for advancement and professional growth through its unequalled expansion program . . . brought about by government and industrial demands for the finest in Computers, File Computers, Data Handling and Control Systems. Components too, are being developed and manufactured by Univac for other leading manufacturers in the field. Join and grow with this fabulous new industry . . . at Remington Rand Univac.

©Registered in U.S. Patent Office

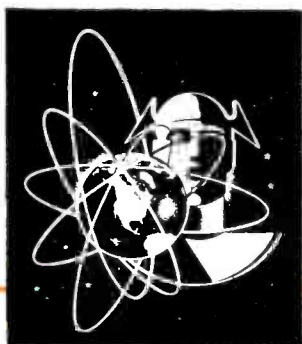

Remington Rand Univac

DIVISION OF SPERRY RAND CORPORATION

FIRST IN ELECTRONIC COMPUTING SYSTEMS

Special Amplifiers by Honeywell

for nuclear reactor control



AIA Preamplifier—wide-band pulse amplifier of moderate gain. Low output impedance for feeding long coaxial cables. Small size; can be mounted near neutron detector, or adapted to proportional counter. Similar to Oak Ridge Model Q-541.



AID Linear Pulse Amplifier—for amplifying pulse output of AIA Preamplifier. Feedback design gives high linearity, stability, accurate reproduction of input pulse. Similar to Oak Ridge Model Q-1326.

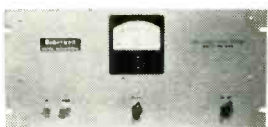

Log Count Rate Amplifier—measures average rate of a series of pulses . . . derives a usable signal from pulse output of the linear amplifier. Two d-c stages produce large signal easily differentiated to obtain period time.



Low Level Period Amplifier—differentiates log count rate meter output to give a period signal for safety during startup. Inverse time delay gives quick shutdown for excessively short period . . . waits longer for longer periods.



Log N and Period Amplifier—combines two functions in a single unit. Used with ion chamber to produce signal proportional to log of neutron flux, to feed log power level recorder. This signal is differentiated to obtain period signal, which is then amplified to actuate a recorder.

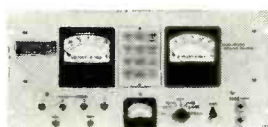

Safety Amplifier—inputs for two ion chambers supply controlled power to four magnets or clutches, to actuate emergency shutdown of a reactor. Can be interconnected to increase capacity or to provide operation on coincidence of high-level flux signals. Engineered for utmost reliability and stability.

CALL ON Honeywell for consultation in applying these components and related indicating, recording and controlling instruments to specific reactor installations. A specialized staff of nuclear instrumentation engineers is well qualified to work on your problems.

MINNEAPOLIS-HONEYWELL REGULATOR Co., *Industrial Division*, Wayne and Windrim Avenues, Philadelphia 44, Pa.—in Canada, Toronto 17, Ontario.

REFERENCE DATA:

Write for the Booklet,
"Honeywell Nuclear Reactor Control."



MINNEAPOLIS
Honeywell
BROWN INSTRUMENTS

First in Controls



TELEVISION

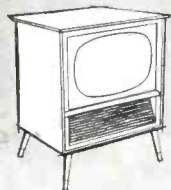

HEARING AIDS



GUIDED MISSILES



RADIO



your equipment?

... how **LONG** is the **LIFE** line of

El-Menco
Capacitors

DM-15

DM-20

ACTUAL SIZES



COMPUTER

If it depends on El-Menco Dur-Mica capacitors, it can run from 12 to 15 years with average use! Not 1,000—but 6,000 or more hours of accelerated testing!

In rigid life tests in which the applied voltage was 1½ times rated voltage and the ambient temperature was 125° centigrade, El-Menco DM-15, DM-20 and DM-30 capacitors out-distanced all normal ratings with each lasting over 6,000 hours at 125° centigrade. Because of the acceleration of these tests the life of these capacitors may be equivalent to 12 to 15 years or more under normal operating conditions.

For television, guided missiles, hearing aids, computers, miniaturized printed circuitry, electronic brains, and other civilian or military applications . . . test the life-long potentialities of long-life El-Menco capacitors.

El-Menco Dur-Mica DM-15, DM-20 and DM-30 Dipped Mica Capacitors offer:

- | | |
|--------------------------------------|---------------------|
| 1. LONGER LIFE | 3. POTENT POWER |
| 2. EXCELLENT STABILITY—SILVERED MICA | 4. SMALLER SIZE |
| | 5. PEAK PERFORMANCE |

Made To Meet Government and Civilian Requirements



For your special requirements — we are pleased to offer information and assistance. Write for free samples and catalog on your firm's letterhead.

El-Menco
Capacitors

THE ELECTRO-MOTIVE MFG. CO., INC.
WILLIMANTIC, CONNECTICUT

- molded mica • mica trimmer
- tubular paper • ceramic

Arco Electronics, Inc., 103 Lafayette St., New York, N. Y.
Exclusive Supplier To Jobbers and Dealers in the U.S. and Canada

Simpson panel instruments...

VOLTMETERS,
AMMETERS, MILLIAMMETERS,
MICROAMMETERS, WATTMETERS, GALVANOMETERS, VOLUME
LEVEL INDICATORS,
SEALED & RUGGEDIZED
METERS, METER
RELAYS

800 STOCK TYPES

... plus *HUNDREDS MORE*, custom-built
from standing tools *

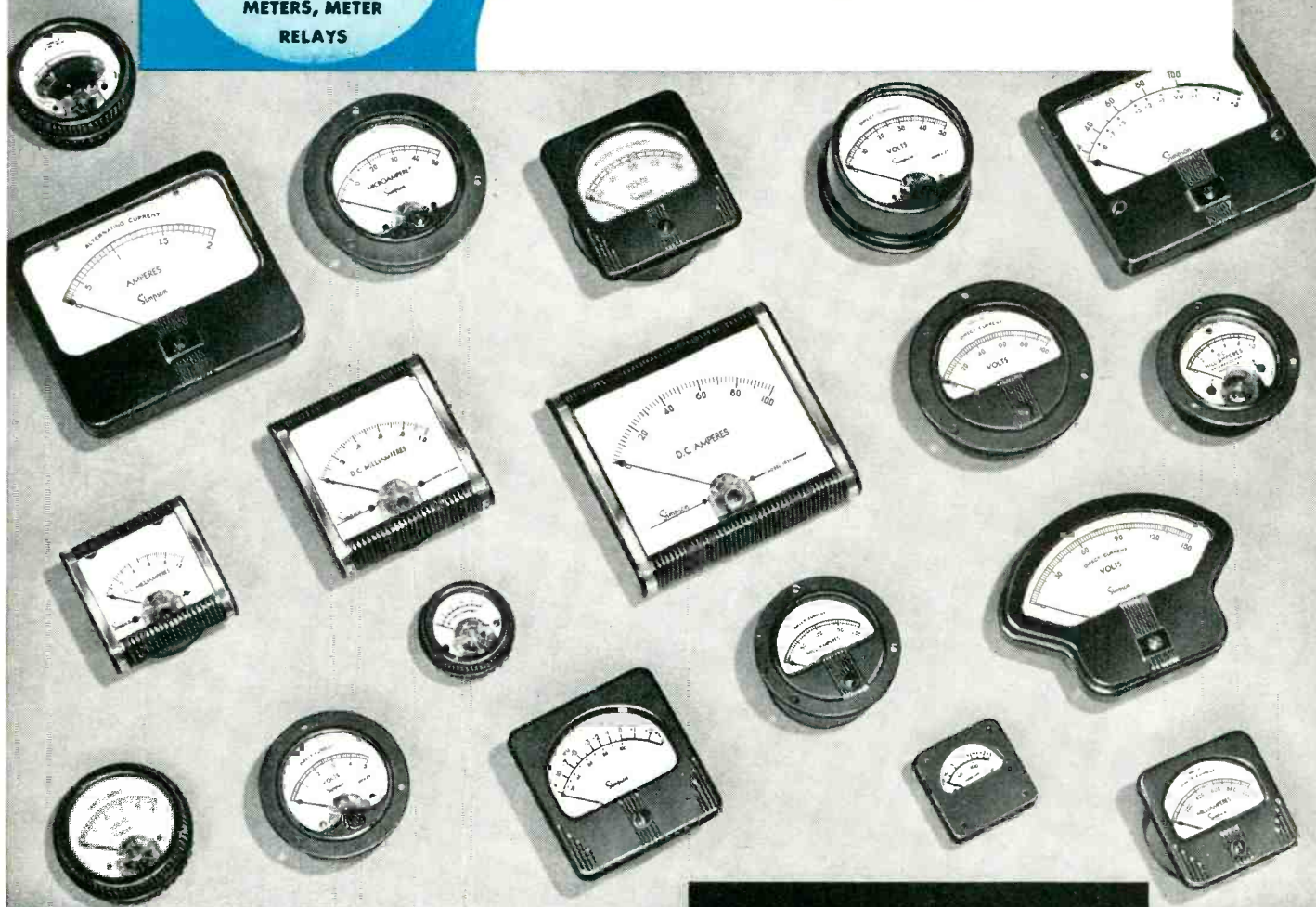

YOUR ELECTRONIC PARTS DISTRIBUTOR
HAS HUNDREDS IN STOCK!

* Send us your special meter requirements today. Let our top-flight engineers work out solutions or make recommendations best suited to your needs.

Simpson

INSTRUMENTS THAT STAY ACCURATE

.. sizes and types to meet your exact requirements!

5 ACCURATE METER MOVEMENT TYPES

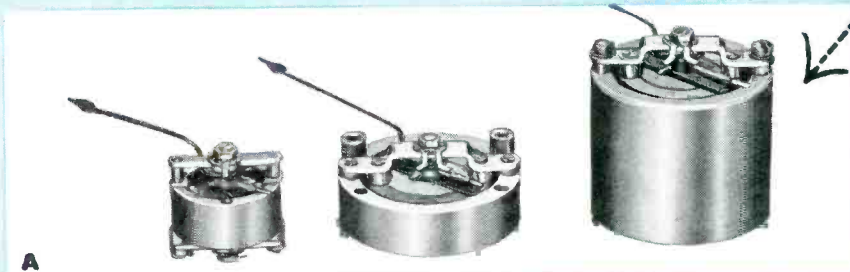

(A) NEW CORE TYPE—A superb new movement that is *self shielded*, remarkably small and lightweight. Instruments now equipped with it meet the various Military Specifications for Sealed and Ruggedized Meters. Shallow, medium, and deep sizes.



(B) EXTERNAL MAGNET TYPE—The magnet structure of this time-proven movement is an independent part, permitting a choice of magnet material to match specific requirements.



(C) DYNAMOMETER TYPE—This fine movement features a high torque to weight ratio. With it, Simpson is the only manufacturer producing a two-inch wattmeter. Movement is air damped, sturdily built.

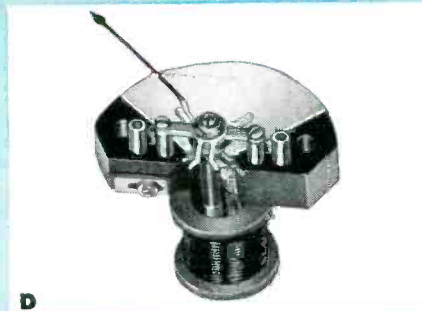

(D) MOVING VANE TYPE—The preferred movement for A-C measurement. Consumes remarkably little power. Features Simpson three-way balancing and patented balance weight locking clips.

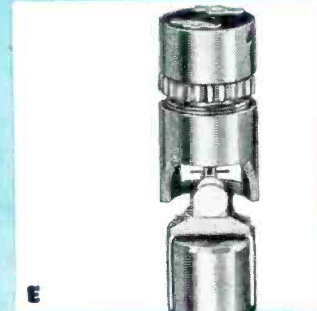

(E) NEW BIFILAR SUSPENSION TYPE*—Represents a brilliant, new adaptation of the D'Arsonval principle with bifilar suspensions that *eliminates all friction due to pivots and jewels*.
*Simpson-Greibach Movement

Shunts and Current Transformers available to your specifications.

Send for Technical Manual 17



Simpson ELECTRIC COMPANY

5200 West Kinzie St., Chicago 44, Ill. Phone: EStebrook 9-1121
In Canada: Bach-Simpson, Ltd., London, Ontario

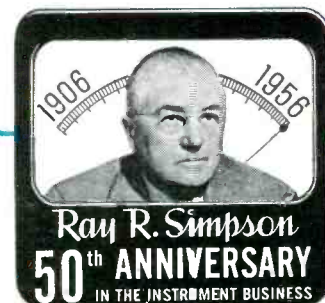

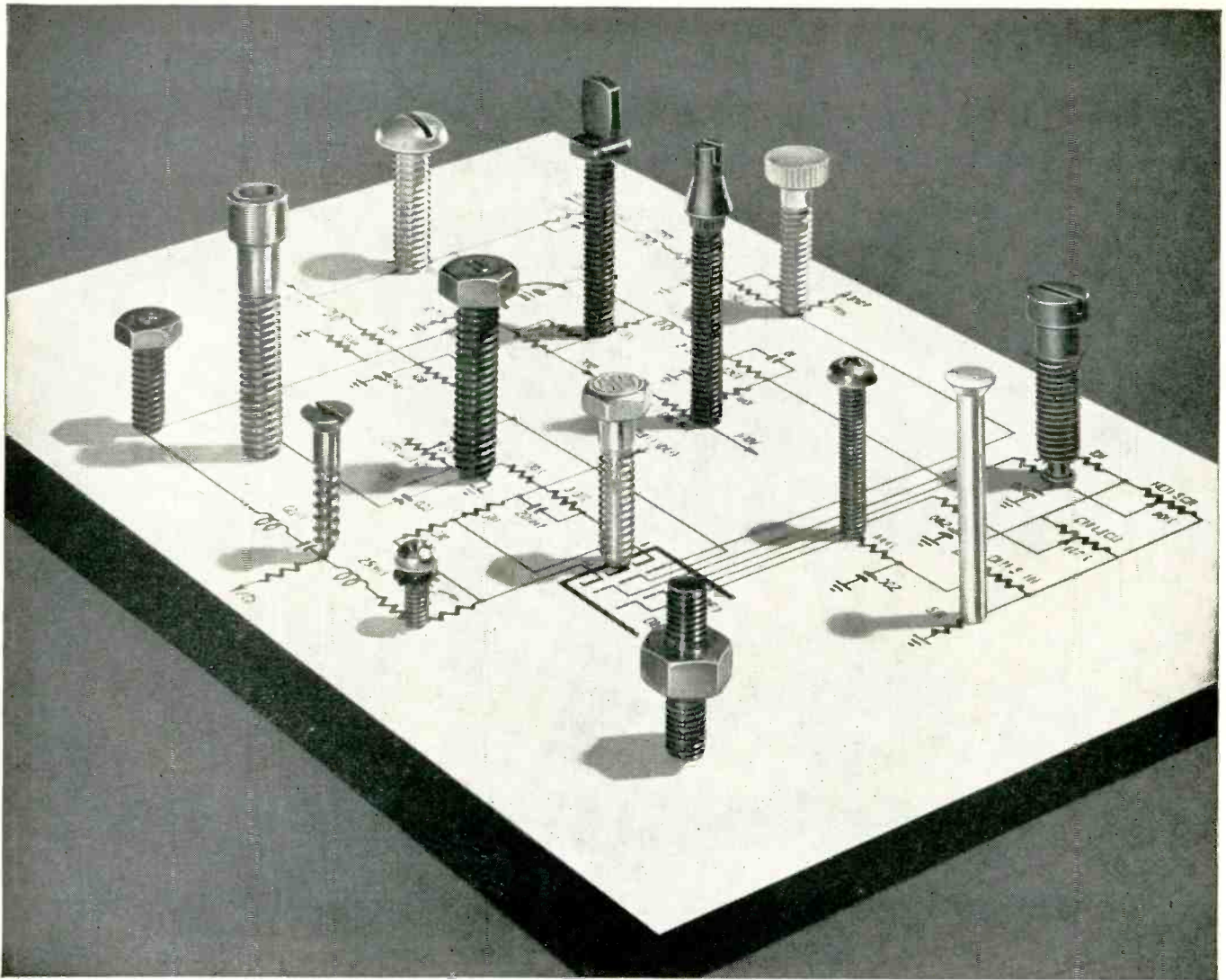

QUALITY PERFORMANCE *depends on small things*

Manufacturers of electronic equipment recognize that such small things as fastenings are vitally important to the operation of that equipment...to the service that it gives...to the length of life that it serves.

Harper Everlasting Fastenings cost no more and you benefit by:

- The speed of assembly due to the clean threads and precision manufacture.
- The assurance of quality performance due to corrosion resistance and superior strength.
- The improvement in appearance due to the fact that Harper fastenings never rust.

More than 7000 different Harper fastening items are carried in stock in both non-ferrous and stainless steels. See your nearest Harper distributor or write for the Harper catalog.

THE H. M. HARPER COMPANY
8244 Lehigh Avenue, Morton Grove, Ill.

If you have a beaded part that you are now milling from bar, it will pay you to investigate the Harper Flo-Form® method of producing such parts in quantities economically. Savings range up to 50%. Information on request from a Harper Field Engineer.

Specialists in all corrosion-resistant fastenings

Bolts • Nuts • Screws • Rivets • Washers
of Brass • Bronze • Monel • Aluminum • Stainless

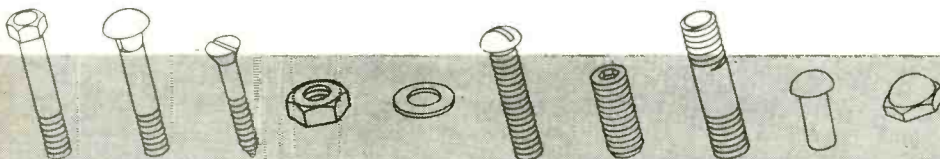

OVER 7000 ITEMS IN STOCK...HARPER DISTRIBUTORS EVERYWHERE



Everlasting Fastenings

NOW!

designed specifically for PRINTED CIRCUITS

SNAPS INSTANTLY INTO PLACE—REMAINS FIRMLY LOCKED

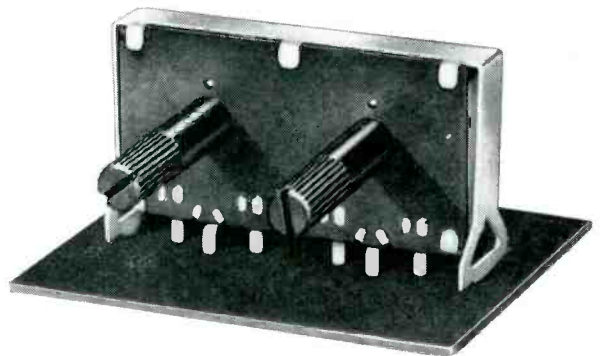
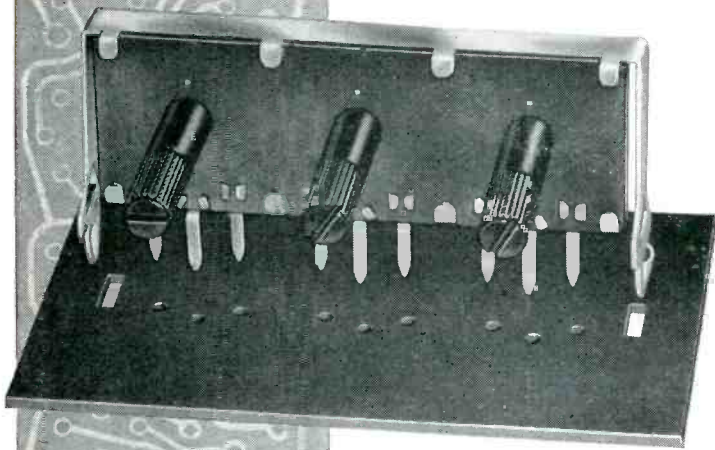

Illustrations are actual size—note compact multiple units

CONSERVES PANEL SPACE—REDUCES HANDLING COSTS

EAST COAST OFFICE
130 N. Broadway
Camden 2, New Jersey
Phone: Woodlawn 6-1668
TWX No. Camden NJ 383
Phila. Phone: Market 7-3129

WEST COAST OFFICE
928 S. Robertson Blvd.
Los Angeles 35, Cal.f.
Phone: Crestview 4-5931
TWX No. BEV H 7666

SOUTHWESTERN U.S.A.
John A. Green Company
6815 Oriole Drive
P.O. Box 7224
Dallas 9, Texas
Phone: Dixon 9918

CANADIAN DIVISION
C. C. Meredith & Co., Ltd
Streetsville, Ontario
Phone: 310

SOUTH AMERICA
Jose Luis Pontet
Buenos Aires, Argentina
Montevideo, Uruguay
Rio de Janeiro, Brazil
Sao Paulo, Brazil

OTHER EXPORT
Sylvan Ginsbury
8 West 40th Street
New York 18, New York
Phone: Pennsylvania 6-8239

A NEW TOTALLY FUNCTIONAL DESIGN CONCEPT

1. Snaps instantly into place with full length sturdy spring supports that lock control rigidly to printed panel.
Wide shoulders provide rugged support.
No mounting hardware, no separate support needed.
2. Compact multiple units conserve panel space, reduce handling costs and number of automatic assembly stations.
3. The only variable resistor with external contour designed specifically for mechanized handling and feeding into a printed panel.
4. Exclusive clip-off mounting supports and terminals for easy removal by service man without a solder pot.
5. Mounts upright with shafts parallel to printed panel, eliminating need for shaft protection during panel solder immersion.
6. Available in 2-control units (Series X52) or 3-control units (Series X53) as illustrated.

Many other types of controls available for your printed circuit and automation needs.

A CTS control can be tailored to your specific requirement. Let CTS SPECIALISTS help solve your current control problems. Write or phone today.



CHICAGO TELEPHONE SUPPLY
Corporation

ELKHART • INDIANA

The Exclusive Specialists in Precision Mass Production of Variable Resistors

VERSATILE 2 ϕ SERVOS

SIZES 10, 11, 15, 18 • ONLY SIZE 10 IS ILLUSTRATED



**SERVO
MOTORS**

MOTOR

- Can be wound for high or low impedances.
- Designed for use with transistorized or vacuum tube servo amplifiers.
- Control phase can be center tapped.
- Maximum torque-to-inertia ratio provided by minimum air gap construction.
- .43 gm.-cm.² rotor inertia. (For illustrated unit only.)

- -65°C to +150°C ambient temperature range. No warm-up required at low temperature.
- Sizes 10 and 11 available with 2 or 6 pole windings.
- Sizes 15 and 18 available with 2, 4 or 8 pole windings.
- Servo can be wound to operate on any specified voltage between 18 and 300 volts.
- Most sizes available in 400 or 60 cycle input voltage.

SERVO with Exclusive INSTANT-STOPPING DC BRAKE



DC BRAKE MOTOR

- .02 sec. stopping time without external loading.
- 12,000 radians per sec.² theoretical acceleration.
- 1.8 gm.-cm.² rotor inertia. (For illustrated unit only.)

- 1000 hours life at 75°C; 100 hours at 125°C.
- 27 volt DC brake excitation.

SERVO-GEAR-TRAIN

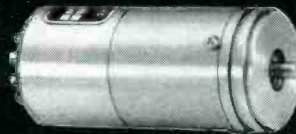

MOTOR GEAR-TRAIN

- Precision gear train, 30 min. max. backlash.
- 1:1 to 4000:1 gear ratios. Higher ratios on special order.
- *Exclusive* DC brake may be added.

- 25 in.-oz. max. operating load torque. 75 in.-oz. max. momentary load torque will not damage gear-train.

SERVO-TACH-GENERATOR

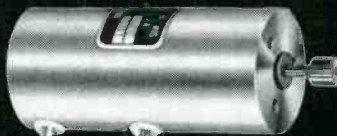

TACH-GENERATOR MOTOR

- Drag cup or squirrel cage type generator.
- Minimum null voltages as low as 12 millivolts.

- 2 gm.-cm.² min. rotor inertia of *smallest* units.
- *Exclusive* DC brake may be added.

SERVO-TACH-GENERATOR- GEAR-TRAIN



TACH-GENERATOR MOTOR GEAR-TRAIN

Combination of servo, gear train and tach. generator to your specific requirement. *Exclusive* DC brake may be added.

Units can be built to meet 15 day humidity test of MIL-E-5272A. Flange, face or synchro type mount-

ings to your specifications. Write today for further information, stating requirements.

Burton Browne Advertising

Other products include actuators, synchros, AC drive motors, servo mechanism assemblies, DC motors, motor-gear-trains, fast response resolvers, servo torque units, reference and tachometer generators, synchro indicators and motor driven blower and fan assemblies.

John Oster

MANUFACTURING CO.
Your Rotating Equipment Specialist
Avionic Division
Racine, Wisconsin

HUGHES MEMOTRON

A NEW TYPE OF
CATHODE RAY TUBE



MAINTAINS brilliant traces indefinitely.

Now you can examine nonrecurrent phenomena without resorting to photography. The Memotron, a direct display cathode ray storage tube, retains transients—permits leisurely examination on the tube face itself.

There is no blooming or fading. And the high tube brilliance permits its use without a hood, even in well-lighted surroundings.

DISPLAYS successive transient writings.

Even the most complex patterns can be superimposed or shifted in position. The Memotron tube thereby enables you to make convenient comparisons and analyses.

INSURES superior file records.

When a file record is needed, photography is greatly simplified because all displays occur at a constant, uniform brightness regardless of differences in writing speeds. Therefore, a single camera exposure setting is sufficient.

FUNCTIONS as curve plotter.

An oscillograph equipped with a Memotron combines, into one instrument, pen-recorder performance at low frequencies and oscillograph performance at high frequencies. Successive writings may be stored to produce a family of curves.

TYPICAL APPLICATIONS: As a read-out device for the display of solutions produced by an analog computer . . . for recording shock transients during shock testing . . . in medicine for electro-cardiography and vector-cardiography. Illustrated: a technique for plotting a family of curves, representing a coupled circuit with varied parameters.

GENERAL SPECIFICATIONS

RESOLUTION . . . 50 to 60 written lines per inch.
 WRITING SPEED . . . 0 to at least 100,000 inches/second (selected tubes in excess of 100,000 ips).
 BRIGHTNESS . . . 50 foot-lamberts.
 USABLE SCREEN DIAMETER . . . 4 inches, maximum.
 DIMENSIONS . . .
 Over-all length: 18 1/2 inches, ± 1/2-inch.
 Bulb diameter: 5 5/8 inches, maximum.
 Neck diameter: 2 1/4 inches, ± 3/32-inch.

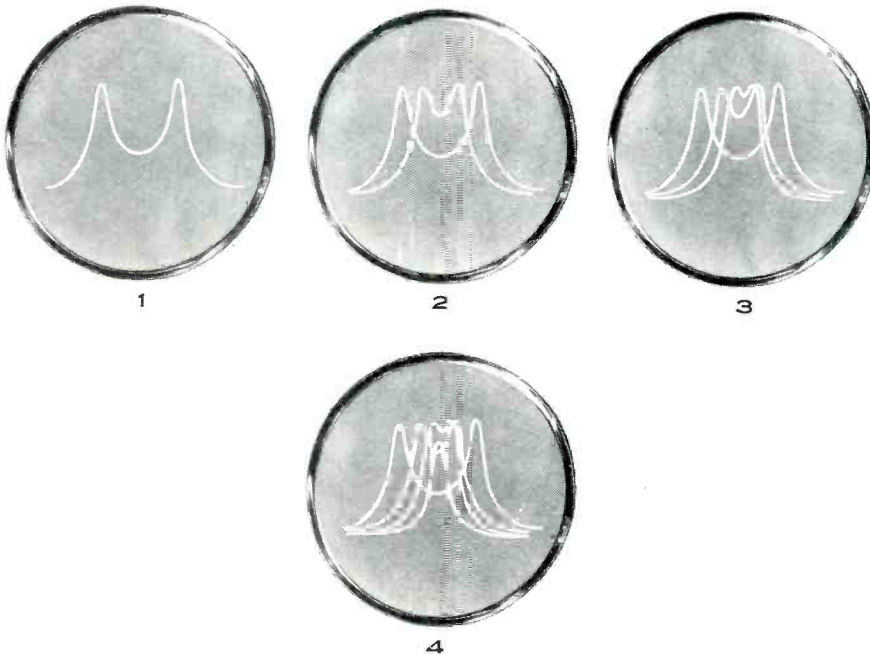

HUGHES PRODUCTS

A DIVISION OF THE HUGHES AIRCRAFT COMPANY

For descriptive literature, please write:

HUGHES PRODUCTS
 ELECTRON TUBES
 11220 South Hindry Street
 Los Angeles 45, California

© 1956, H. A. C.

Ucinite EQUIFLEX vibration isolators

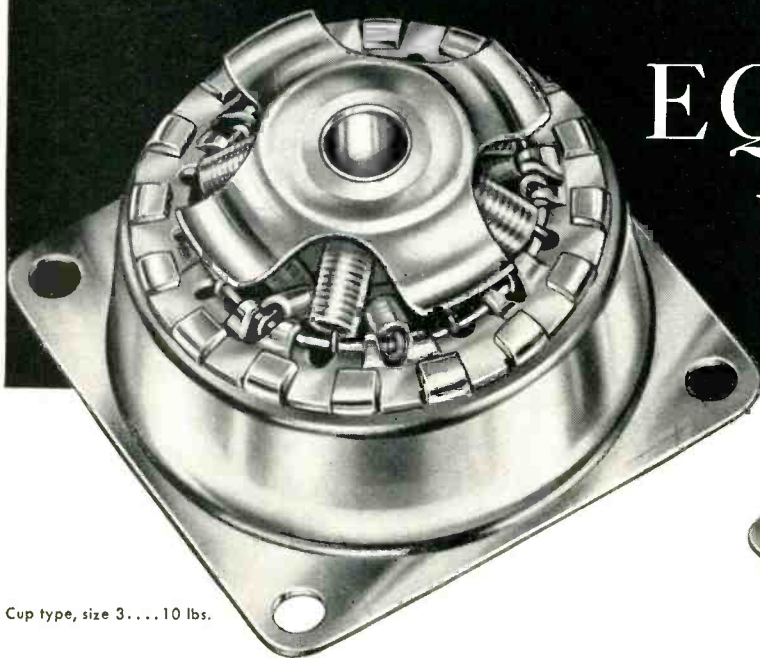

Cup type, size 3 . . . 10 lbs.

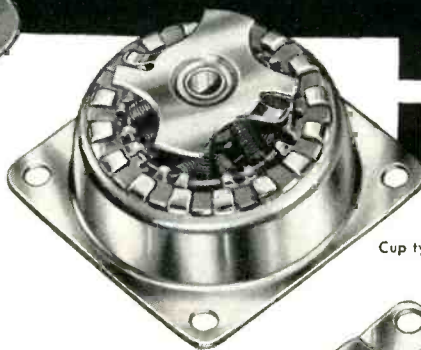

Cup type, size 1 . . . 1/2 lb.



Square plate type,
Size 1 . . . 1/4 lb.

Standard Equiflex mountings come in two basic types . . . the Square Plate and the Circular Cup. Both types are available in three different sizes . . . size 1 for light loads or small equipment, size 2 for medium loads or medium duty equipment, size 3 for heavy loads or heavy duty equipment.

Equiflex mountings withstand 100 hour salt spray tests, take 15G shocks without damage and will keep equipment captive up to 30Gs. Extra-damped mountings are available in which each multiple coil spring is shrouded with polyethylene or Teflon tubing.

Equiflex vibration isolators can be supplied to cover load ranges from 1/4 to 35 lbs.

- Greatly prolonged service life.
- Wide temperature range.
- Controlled damping.
- Can be loaded in any direction or position.
- Absence of drift or permanent set.
- Equiflex action or 1:1 ratio of radial and axial spring rates.
- Integral single unit assembly with safety washers included and attached.



The
UCINITE CO.

Newtonville 60, Mass.

Division of United-Carr Fastener Corp.

Specialists in
**ELECTRICAL ASSEMBLIES,
RADIO AND AUTOMOTIVE**

How many ways can you use

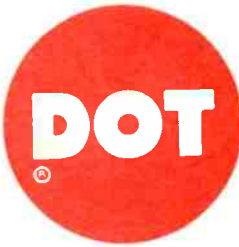
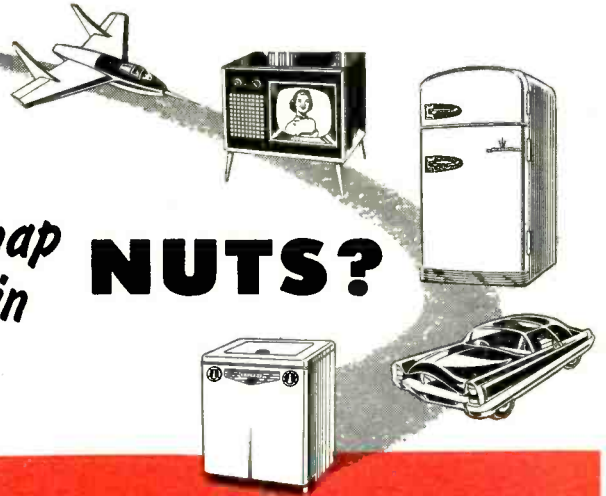

PLASTIC *snap in* NUTS?

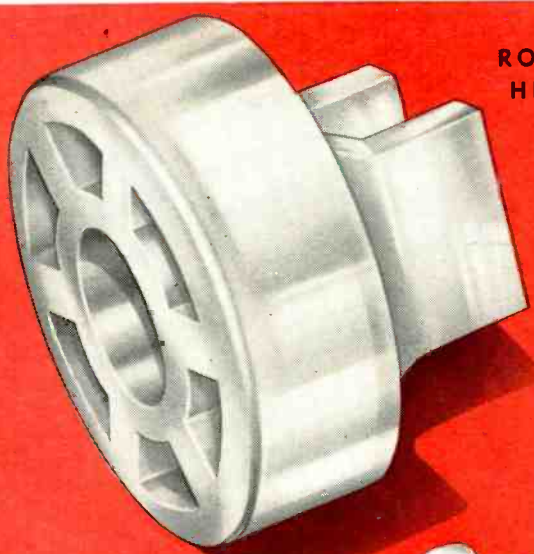

ROUND HEAD



SQUARE HEAD

QUICK, EASY ASSEMBLY

Nut is pressed into square hole punched in sheet metal.

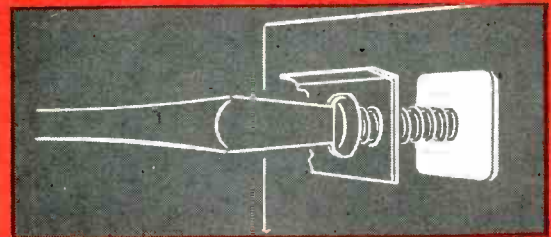
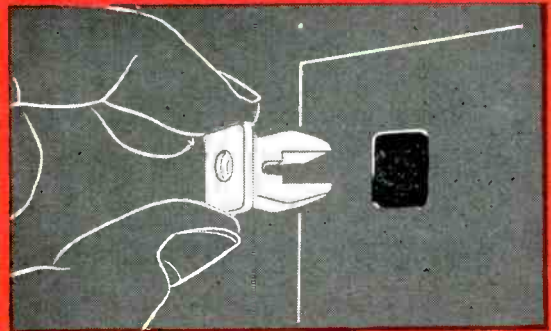

Ordinary sheet metal screw cuts its own threads as it is driven into the nut, expands fingers, locks nut and screw securely.

United-Carr's new self-locking, plastic nut is designed for blind application and can be used with all types of metal finishes without scratching or chipping the surface. Its plastic fingers provide rigid anchorage yet will not mar paint, polished metals or even porcelain.

Inexpensive sheet metal screws cut their own threads and expand the nut's fingers as they are driven, locking both nut and screw tightly in

place. Screws can be removed and replaced several times without damage to the nut.

DOT plastic snap-in nuts are electrically non-conductive and provide a high degree of insulation against heat transfer. For all practical purposes, they also provide an effective vapor seal.

Available in several styles and sizes. Write for full information and samples or contact your nearest United-Carr representative.

UNITED-CARR FASTENER CORP.

CAMBRIDGE 42, MASSACHUSETTS

MAKERS OF  FASTENERS

solving logical problems
with Burroughs
pulse control systems

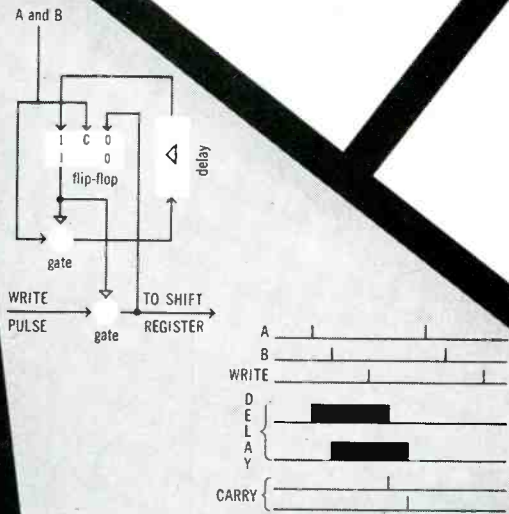

a one flip-flop serial binary adder

... conceived and proved in the same day

This new and unique serial binary adder will find many uses in digital work. But it might never have been developed without Burroughs Pulse Control Equipment to act as a catalyst for the engineer's imagination.

The engineer who developed the adder, like all others in logical design, is constantly faced with the problem of finding new components which require a certain amount of experiment and imagination. He is most efficient when using equipment that is as flexible as the problem and capable of keeping pace with his thinking. In this case, for example, his problem was reduced to: (1) setting down the idea in block diagram form, (2) interconnecting his Burroughs units accordingly, and (3) checking results.

His original idea was quickly brought to working reality, because a Burroughs System eliminates many of the usual steps in between. And while setting down the diagram for the system hook-up, he was automatically specifying not only the equipment he would ultimately need to build the unit, but also how to assemble it. Thus, he did away with breadboard hardware entirely.

You can give yourself the same creative edge by letting a Burroughs Pulse Control System give your imagination a chance to work. Just send us your pulse problem, and we'll gladly work out a Burroughs Pulse Control solution . . . at no cost. Or, write for Bulletin 236.

tools for engineers



BURROUGHS CORP. • ELECTRONIC INSTRUMENTS DIV.
Department C • 1209 Vine Street • Philadelphia 7, Penna.

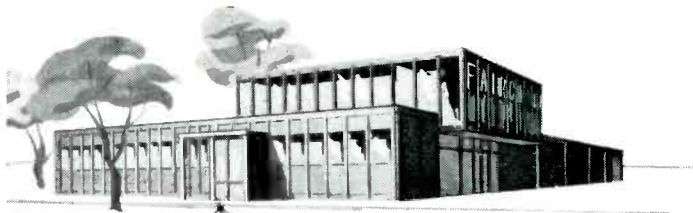

Los Angeles, Cal.

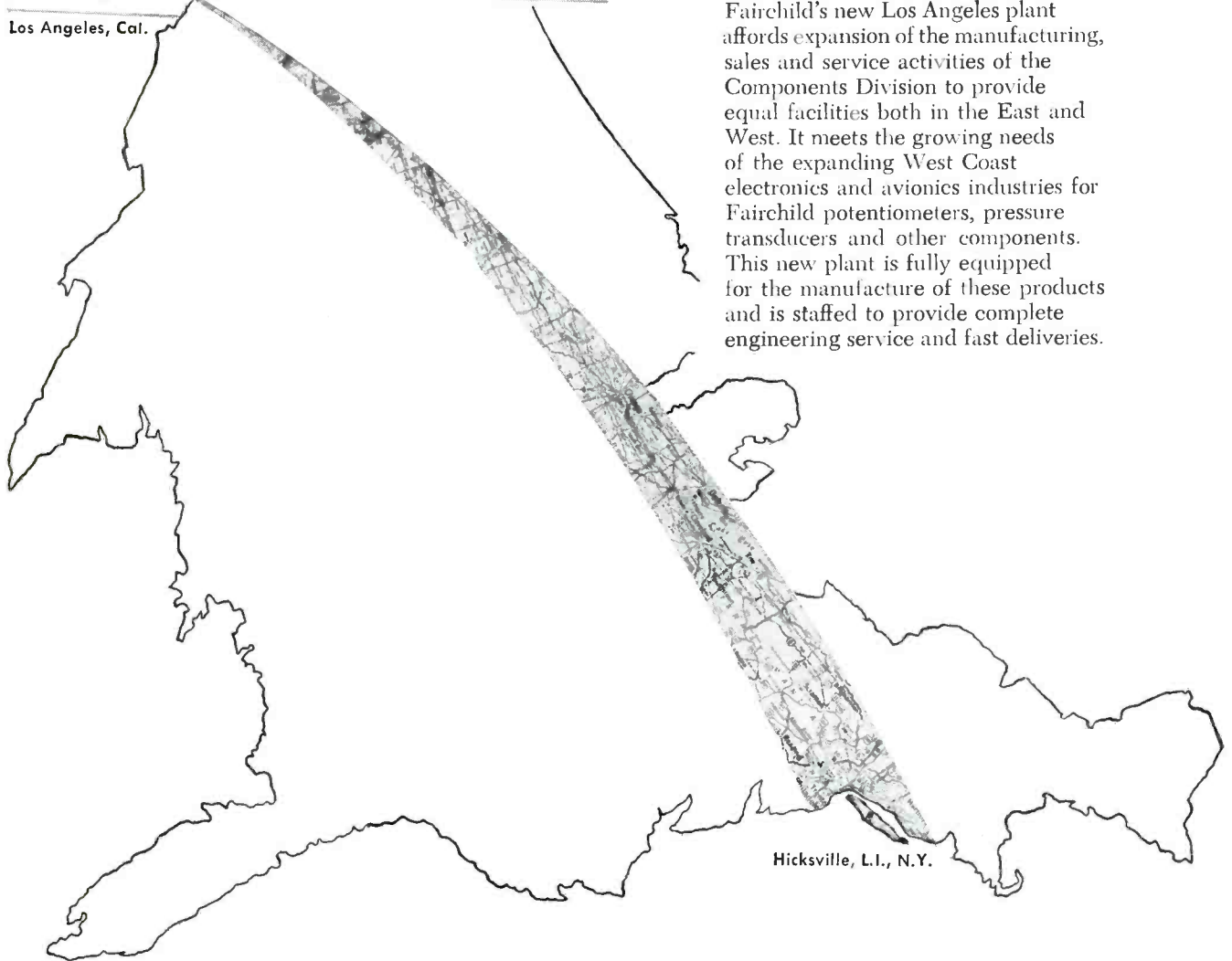

Hicksville, L.I., N.Y.

Fairchild's new Los Angeles plant affords expansion of the manufacturing, sales and service activities of the Components Division to provide equal facilities both in the East and West. It meets the growing needs of the expanding West Coast electronics and avionics industries for Fairchild potentiometers, pressure transducers and other components. This new plant is fully equipped for the manufacture of these products and is staffed to provide complete engineering service and fast deliveries.

AVAILABILITY AND SERVICE

from L.I. to L.A.

The name "Fairchild" means the finest in precision components, and now — through the facilities of the West Coast plant — it means faster deliveries and better service, too. Now you are able to get complete engineering service, quotations, order handling, delivery and other customer services from either plant, whichever is more convenient to you. This is another example of the way Fairchild strives to be of maximum service to you no matter what factors govern your choice of precision components. Write to Fairchild Controls Corporation, Components Division, Dept. 140-76A.

EAST COAST
225 Park Avenue
Hicksville, L. I., N. Y.

WEST COAST
6111 E. Washington Blvd.
Los Angeles, Cal.

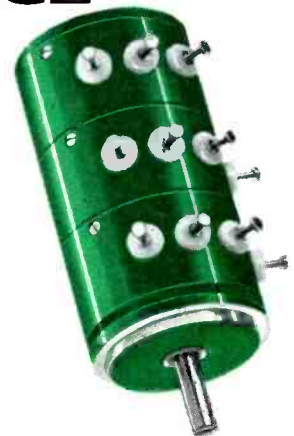

FAIRCHILD
PRECISION POTENTIOMETERS
and COMPONENTS

growing in
NEBRASKA
 in the Heart of America

Work-willing labor keeps our standards high, costs low.

Organized just five years ago, Dale Products, Inc., has enjoyed a phenomenal growth due to the high standards we have demanded and received from our production department, plus the fine cooperation of our representatives and distributors, and the confidence of our hundreds of customers.

Our line now includes 12 ELECTRONIC COMPONENTS; the factory floor space at our main plant at Columbus, Nebraska, has grown from less than 2,000 square feet to more than 20,000 square feet; and the number of our employees at Columbus is now more than 275 people.

There are many factors in Nebraska favorable to the growth of an industry such as ours, but, personally, I cannot give too much credit to our production people—loyal, intelligent, adaptable, work-willing men and women upon whom you can depend for the highest standards of production at the lowest unit cost.



George Risk, President

for complete information, write to
DALE PRODUCTS, Inc.
 1300 28th Ave., Columbus, Nebraska
 In Canada: Charles W. Pointon, Ltd.,
 6 Alcina Ave., Toronto
 Export Dept.: Pan-Mar Corp.

DALOHM

America's foremost
 line of **MINIATURE
 POWER RESISTORS**



you can depend on the
DALOHM line

TYPE RH
WIRE WOUND
RESISTORS

Three wattages—three sizes



TYPE RS
WIRE WOUND RESISTORS

Four wattages—six sizes



RUGGEDIZED TYPE RSE
WIRE WOUND RESISTORS

Three wattages—
 three sizes



TYPES WWA & WWL

Precision Encapsulated

WIRE WOUND

RESISTORS Three wattages—five sizes



TYPE DC
DEPOSITED
CARBON RESISTORS

Five wattages—seven sizes



TYPE DC-5 **DEPOSITED CARBON**
RESISTORS High Voltage



TYPE DCH Hermetic Seal-Ruggedized

DEPOSITED
CARBON RESISTORS

Five wattages—seven sizes



DALOHM Collet-
 Fitting **KNOBS**



DALOHM
ALUMINUM DIALS



MANUFACTURERS you'll do better ELECTRONICALLY in NEBRASKA

here's why:

With no state debt and operated on the pay-as-you-go principle, Nebraska is one of the last remaining strongholds of early American thinking.

It has a fine, healthful climate and happy, hard-working, clear-thinking people, many of whom find it necessary, due to farm mechanization, to seek other than agricultural employment.

Smart, resourceful, and dependable, these farm-bred men and women will show higher man-hour production than is believed possible to obtain anywhere else. **This is a matter of record.**

While it is this labor factor that is usually given major credit for the success of every precision manufacturer now operating in the state, all the other factors which make for lower-cost, trouble-free operation also are here. They include:

- Fast, main line transportation in all directions
- Low cost electric power ● Abundant natural gas
- Practically unlimited constant-temperature water
- No franchise, state income, or other crippling taxes
- Progressive communities organized and ready to build plants for sale or lease.



An Invitation from Governor Victor E. Anderson

"Nebraska's official attitude toward industry provides a healthy climate in which to work and live. We will welcome the opportunity to help you."

For complete and specific details about Nebraska locations, write to C. V. Price, Chief of Division—or call collect, 2-3669 (Lincoln). Your inquiry will be held in strict confidence.

DIVISION OF NEBRASKA RESOURCES
State Capitol Lincoln, Nebraska

in the Heart



of America

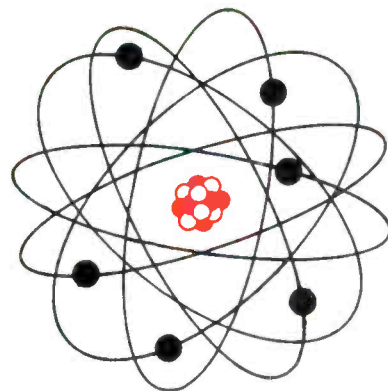

NEBRASKA LEADS IN ATOMIC DEVELOPMENT

Consumer Public Power District of Nebraska is one of the few utilities in the nation granted preliminary approval by the Atomic Energy Commission for the construction of a nuclear-fueled power plant.

"By-products" from the plant will open untold opportunities for industries located within the environs of the plant. Now is the time to investigate and discover what advantages could accrue to you from such a location.

About a Sawtooth, Clamping and your Efficiency...

Let's look at it this way—What features should an instrument incorporate to make your job easier, help prevent costly mistakes? Take the case of the new PRD Klystron Power Supply. Should we incorporate a sawtooth rather than a sine wave modulation? It's easier to put in a sine wave. However, a sawtooth has the definite advantage of eliminating phasing and blanking problems when the frequency response of a transmission device is to be studied. So, in goes the sawtooth. It's easy enough to get hold of some sine wave modulation which can be applied through the external modulation input.

As for preventing mistakes—consider switching from cw to square wave modulation. Suppose you forget to readjust the reflector voltage . . . Sure, you'll catch the mistake later, but time is lost. The new PRD Klystron Power Supply has an electronic clamping circuit which locks the top of the square wave to the previously chosen reflector voltage. No readjustments to think about, no mistakes.

Want to modulate with pulses—use the external input. The rise time degradation of your pulses will be less than .1 microsecond!

Another point, good regulation! Here's an example: a $\pm 10\%$ line change or *any* load change will cause a reflector voltage change of only $\pm 0.1\%$.

Compare . . . chances are that you'll send in your order for the PRD Type 809, too.

**PolYTECHNIC RESEARCH
& DEVELOPMENT CO., INC.**
202 TILLARY STREET, BROOKLYN 1, NEW YORK
Telephone: ULster 2-6800



The New PRD KLYSTRON POWER SUPPLY



HERE'S WHAT THE TYPE 809
CAN DO FOR YOU —

- Powers most low and medium voltage klystrons—up to 600 V. beam supply
- Has electronic readjustment of reflector voltage when changing from cw to square wave modulation—no errors due to forgetfulness
- Has square wave, sawtooth and provision for external modulation for pulses
- Affords exceptional stability and regulation at modest cost
- Price \$350.00 F.O.B. New York

(Available from stock. Call or write for new Bulletin.)

Midwest Sales Office:
1 SOUTH NORTHWEST HIGHWAY,
PARK RIDGE, ILL. — TAlcot 3-3174
Western Sales Office:
737-41, SUITE 7, NO. SEWARD ST.
HOLLYWOOD 38, CAL. — HO-5-5287



A. A. HABERBERGER
General Works Manager



E. J. HAMMER
Dir. Industrial Relations
& Asst. Work Mgr.



R. A. SCHOLES
Asst. Treasurer



H. A. WILLIAMS
Manager Electronic
Components Division



A. K. NEFF
Sales Mgr., Electronics



V. E. GERBER
Asst. to Sales Mgr.,
Electronics



H. S. CONRAD
Vice President and
General Manager



H. C. STACKPOLE
Secretary



LYLE G. HALL
President and Treasurer



D. L. ALMQUIST
Asst. to Mgr., Electronics



MRS. V. G. DINSMORE
Sales Office Supervisor



T. J. ECKL
Customer Sales Service,
Electronics



E. F. FEILE
Customer Sales Service,
Electronics



R. W. JOHNSON
Customer Sales Service,
Electronics



H. J. YEAGER
Customer Sales Service
Electronics



N. J. SCHABERL
Production Manager



J. H. STACKPOLE
Chairman of the Board



F. S. LAMBERT
Production Supt.,
Electronics



C. S. ARNOLD
Supt. Kane, Pa. Plants



H. M. DRESSEL
Director Electronic
Research and Eng.



L. D. ANDREWS
Director Ferrites & Metal
Powders Research & Eng.



F. X. SORG
Director Fixed Resistor
Research and Eng.



S. H. LINWOOD
Research Engr., Ferrites



D. N. KIRKPATRICK
Engineer, Electronics



A. J. BUERK, JR.
Supt., Johnsbury, Pa.
Plant, Electronics

Electronic Components Division
STACKPOLE CARBON COMPANY
St. Marys, Pa.



● VARIABLE AND FIXED COMPOSITION RESISTORS ● IRON CORES ● CERAMAG[®] FERRO-MAGNETIC CORES ● LOW VALUE COMPOSITION CAPACITORS ● LINE AND SLIDE SWITCHES ● PRINTED COMPONENTS ● MOLDED COIL FORMS ● CERAMAG-NET[®] CERAMIC PERMANENT MAGNETS ● BRUSHES FOR ALL ROTATING ELECTRICAL EQUIPMENT ● ELECTRICAL CONTACTS ● POWER TUBE ANODES . . . and dozens of carbon, graphite and metal powder specialties.

NEW NEW NEW
QUALITY STYLING RELIABILITY

CMC

9
8
7
6
5
4
3
2
1
0



Model 201A Frequency and Period Counter—\$700.00

setting the pace for modern industry...

America's Finest Instruments



Model 200A Frequency Counter \$425.00

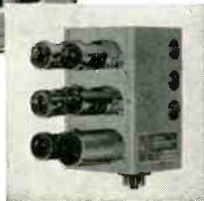

Model XD-100A Crystal Time Base \$100.00

frequency and period counters

Compact, streamlined, easily portable—used for precise frequency and period measurements, production line testing, telemetering, calibration, etc. Direct digital read-out.

Exclusive features of the Model 201A are the inclusion of a crystal oven to bring the accuracy to .0001%... *plus* .1 sec., 1 sec., 10 sec., and 1 cycle time bases *at no extra cost*.

The *economy* Model 200A is designed to permit the use of a *plug-in* Crystal Time Base *at any time in the field* to increase accuracy from .1% to .0001%. It is also available with five decade display at \$75.00 additional.

The all-new CMC line of electronic counting instruments has been designed and engineered to meet the rigid requirements of science and industry and, at the same time, offer functional layout to simplify operation, reduce eye fatigue and enhance equipment appearance. Years ahead engineering utilizing proven developments make it possible to include features usually available only as optional accessories. Exacting test and laboratory requirements make the CMC line...the standard in excellence for the industrial world.

- Improved Readability**
—new, wide-angle display minimizes parallax
- Improved Sensitivity**
—more than 500% over the usual operating range
- Greater Stability**
—crystal oven as standard equipment at no extra cost increases stability to .0001%
- Quick Time Base Alignment**
—without auxiliary equipment
- Completely Regulated Power Supply**

preset controllers



Model 314A Preset Controller (4 digit) \$495.00

High speed counters used to automatically control any operation after a pre-selected count has been reached. Batching and packaging of pills, bottles, caps, machine parts, etc., are a few of the many applications. Sweeping design changes offer many new features...

- COINCIDENT TYPE**
- ABSOLUTE ACCURACY**
- DIRECT SETTING**
- DIRECT READ-OUT**
- EXCEPTIONAL VERSATILITY**

Pulse Output • Relay Contact Closure • Variable Contact Closure Time • Automatic or Manual Relay Hold • Totalizing Count

OPTIONAL FEATURE: Mechanical register to indicate batches (gross, dozen, etc.) or total count.

Model 101A Preset Decade Counting Unit—\$75.00

CMC
 CC-8
 9
8
7
6
5
4
3
2
1
0

Complete catalog data available from factory or nearest representative
 Nationwide engineering representation including Canada and export markets

Computer-Measurements Corporation
 5457 Cleon Avenue • North Hollywood, California • Dept. 78E

Now Available...

FIRST HF TRANSISTORS
now in production, meeting
Army Signal Corps Standards

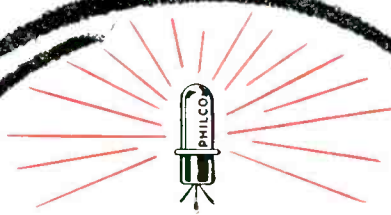

A wide variety of military equipment, once impossible to transistorize due to frequency limitations of available transistors, is now being developed with Philco Surface Barrier Transistors.

PHILCO SBT

SURFACE BARRIER TRANSISTORS

(Type 2N128 and 2N129)

Meet MIL-T-12679A Military requirements

Check These Features

- High frequency performance
- Extreme reliability
- Uniformity of characteristics
- Rigid quality control
- Minimum battery drain
- Low leakage currents
- Low operating voltage
- Absolute hermetic seal
- Meet MIL-T-12679A Military requirements

Now available for large volume military and industrial applications . . . the high frequency Philco Surface Barrier Transistors that were developed for the Army Signal Corps to meet the stringent requirements of field use in military electronics equipment. Advanced precision techniques used in fabricating the Philco Surface Barrier Transistors make possible rigidly controlled automatic manufacture with its resultant uniformity, reliability and high volume production. These reliable transistors point the way to new fields in transistorization. Make these reliable high frequency Philco Surface Barrier Transistors part of your forward looking plans.

For complete technical information on these High Frequency transistors write
Dept. E-3, LANSDALE TUBE CO., Lansdale, Pa. A DIVISION OF PHILCO CORP.

PHILCO CORPORATION
LANSDALE TUBE COMPANY DIVISION
LANSDALE, PENNSYLVANIA

Doelcam Selective Range

D-C PROPORTIONAL AMPLIFIER



MODEL 2HLA-4
Shown with Cabinet off
for Rack Mounting

**SPECIFY AN INTERCHANGEABLE
PLUG-IN UNIT THAT MEETS YOUR RANGE
REQUIREMENT . . . EXACTLY**

The Doelcam Selective Range D-C Amplifier Model 2HLA-4 is designed for use in the laboratory or production line as a component part of a control or linear measuring system. It will accept any one of a number of interchangeable Range Plug-In Units for the combination of input voltage range, input resistance and frequency response that meets your application requirements. . . . *exactly*. One Plug-In Unit is provided with each instrument. No need to pay for built-in voltage ranges which may never be used. The exclusive Doelcam Second Harmonic Magnetic Converter is used in the input stage in place of a mechanical chopper for all around improved performance. *Write for Bulletin SRA-7.*



INTERCHANGEABLE
RANGE PLUG-IN UNIT

**Available in any range
between
0 to 0.1 MILLIVOLT
and
0 to 100 MILLIVOLTS**



MODEL 2HLA-4
Shown with Cabinet on
for Bench Mounting.

PERFORMANCE CHARACTERISTICS

ISOLATED INPUT: Input Terminals are isolated from amplifier circuitry and chassis ground.

HIGH CONVERTER FREQUENCY: 2500 cps carrier, insensitive to 60 or 120 cps pickup.

LOW DRIFT: Less than 5 microvolts long term drift.

LINEAR AMPLIFICATION: Better than 1% on all ranges.

GAIN: Up to 10⁵.

FREQUENCY RESPONSE: Up to 40 cps.

RUGGEDNESS: Withstands over-range signals up to 1500 times full scale.

HIGH POWER OUTPUT: Drives most commercial Pen Motors or Galvanometer Recorders.

Doelcam

A DIVISION OF MINNEAPOLIS-HONEYWELL



1400 SOLDIERS FIELD ROAD
BOSTON 35, MASSACHUSETTS

Instruments for Measurement and Control

Synchros • Gyros • Accelerometers • Amplifiers • Microsyns • Servo Motors



Uses

NATVAR
Styroflex[®] Film

TO MAINTAIN

Capacity Tolerance

AND

Longtime Stability

IN THEIR
ADJUSTABLE CAPACITORS



These SEC Polystyrene Capacitors have an accuracy in the order of 0.1% or better and longtime stability in the order of 0.05%. Natvar Styroflex film is used as the dielectric.

SOUTHERN ELECTRONICS CORPORATION, Burbank, California, manufactures precision capacitors for applications where difficult specifications have to be met, such as computer integrators, test equipment, secondary standards and certain weapons programs.

Because polystyrene comes closest to meeting specifications for a perfect dielectric, various polystyrene films were tested. Natvar Styroflex film was selected because of its uniformly excellent pliability, freedom from faults, high shock resistance and excellent dielectric characteristics.

Natvar Styroflex film is available in standard thicknesses from .0004" to .006" in widths from 1/2" to approximately 10" or in special put-ups to meet manufacturing requirements.



Natvar Products

- Varnished cambric—cloth and tape
- Varnished canvas and duck
- Varnished silk and special rayon
- Varnished—Silicone coated Fiberglas
- Varnished papers—rope and kraft
- Slot cell combinations, Aboglas[®]
- Isoglas[®] sheet, tape, tubing and sleeving
- Vinyl coated—varnished—lacquered tubing and sleeving
- Extruded vinyl tubing and tape
- Styroflex[®] flexible polystyrene tape
- Extruded identification markers

Ask for Catalog No. 23

NATVAR CORPORATION

FORMERLY THE NATIONAL VARNISHED PRODUCTS CORPORATION

TELEPHONE

RAHWAY 7-8800

CABLE ADDRESS

NATVAR: RAHWAY, N. J.

201 RANDOLPH AVENUE • WOODBRIDGE, NEW JERSEY

BUSS FUSES

*A complete line to meet
all your fuse requirements . . .*

You'll find the type and size fuse you need, quickly and easily, by turning to BUSS. The complete BUSS fuse line includes: standard, dual-element (slow blowing), renewable and one-time types — in sizes from 1/500 amp. up . . . plus a companion line of fuse clips, blocks and holders.

BUSS fuses are dependable and "trouble-free"

To assure you of top quality and proper operation under all service conditions — BUSS fuses are electronically tested. A sensitive device automatically rejects any fuse not correctly calibrated, properly constructed and right in all physical dimensions.

That's why BUSS fuses, by their unflinching dependability, help safeguard your most valuable asset — the good name of your product. When there is trouble on the circuit, BUSS fuses open and prevent further damage — saving the users of your equipment from unnecessary repairs. And BUSS fuses won't cause irritating, useless shut-downs because . . . BUSS fuses eliminate needless blows.

Why take a chance with your product being blamed for troubles caused by poor quality fuses? It is just good business to standardize on genuine BUSS fuses.

*For more information on BUSS and
FUSETRON small dimension fuses
and fuseholders, write for bulletin SFB.*

Makers of a complete line of fuses for home, farm, commercial, electronic, automotive and industrial use.

BUSSMANN MFG. CO.

UNIVERSITY AT JEFFERSON,



(Div. of McGraw Electric Co.)

ST. LOUIS 7, MO.

ELRC

55B

**ONLY *Glass*
CAN DO THIS JOB
SO WELL . . .**



Type ML-2G
New all-glass miniature
Shown Actual Size

Type ML-300
Developed by Midland
for color television
Shown Actual Size



Only glass makes it possible to get and keep such high vacuum in a crystal holder.

Only glass gives complete and permanent protection against atmospheric enemies of crystal efficiency and service life.

Type ML-1G
New all-glass
sub-miniature
Shown Actual Size

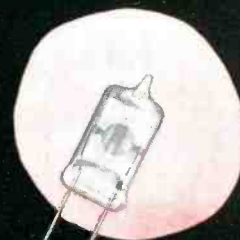

**only *Midland* provides you
ALL-GLASS CRYSTALS FOR ALL APPLICATIONS**

Now you can have a new high level of crystal performance that just wasn't possible before. All-glass holders for crystals are another "first" resulting from Midland's advanced research. It is another step in our continuous effort to overcome whatever problems stand in the way of longer crystal life or more precise, constant and unflinching performance . . . in short, **better** frequency control units! Check with us on all your crystal needs — and any special requirements.



Manufacturing Company, Inc.

3155 Fiberglas Road

Kansas City 15, Kansas

WORLD'S LARGEST MANUFACTURER OF QUARTZ CRYSTALS
... every one produced to the industry's highest standards.

58 years of know-how gives you complete service data + designs that cut costs in production

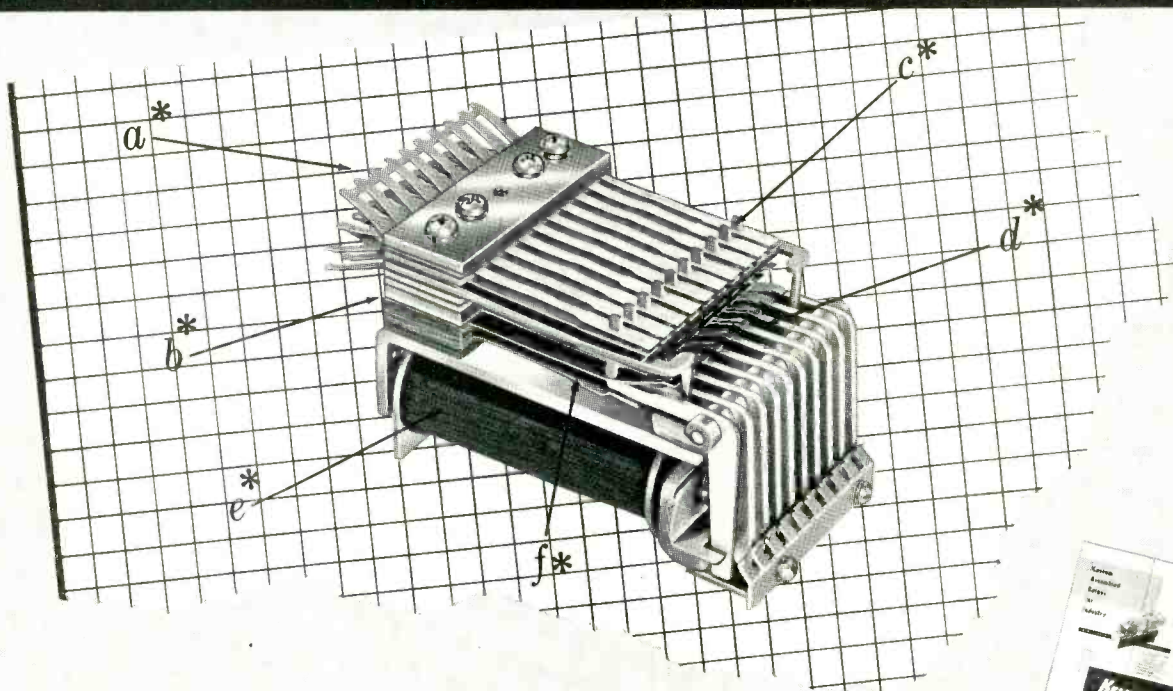

We have been making and improving relays for more than 58 years. The use of these relays in our own equipment has helped to make Kellogg the leader in the independent telephone field.

A typical example is this sequence relay, "the Kellogg Magnetic Impulse Counter." This unique counter eliminates sliding contacts, mechanical ratchets, etc. . . . the counting sequence is controlled electromagnetically, with relay-type contacts used throughout. Production advantages include: simplified circuitry, reduced size, lower cost and longer life.

You can save design time and cut production costs because our intimate experience as a relay-user, as well as relay-maker, enables us to develop relays that are rated to meet your requirements . . . build them to stand up in your equipment, for a lifetime of service.

* For the A.B.C.'s of the Magnetic Impulse Counter and other Kellogg relays use the attached card to send for this Kellogg Relay Bulletin.



KELLOGG
Switchboard & Supply Co.
Industrial Sales Dept.
A Division of International Telephone & Telegraph Corp.
79 W. Monroe St., Chicago 3, Ill.

Please send me the booklet on Kellogg Relays

NAME _____

FIRM _____

ADDRESS _____

CITY _____ ZONE _____ STATE _____

KELLOGG SWITCHBOARD AND SUPPLY COMPANY

A Division of International Telephone and Telegraph Corporation
Sales Offices: 79 W. Monroe St., Chicago 3, Ill.

QUALITY COMPONENTS FOR INDUSTRIAL CONTROL
QUALITY COMMUNICATIONS SYSTEMS

KELLOGG BRANCH WAREHOUSES AND OFFICES:

6000 W. 51st Street
Chicago 38, Illinois
REliance 5-5445

1515 Turtle Creek Blvd.
Dallas 2, Texas
Prospect 5191

KELLOGG Branch Office:
406 S. Main Street
Los Angeles 13, Calif.
Vandyke 6759

4501 Truman Road
Kansas City 1, Mo.
Humboldt 7085

1663 Mission Street
San Francisco 3, Calif.
Market 1-6011

Export Distributor:
International Standard
Electric Corp.
50 Church Street
New York 7, New York

410 N. Syndicate Ave.
St. Paul 4, Minnesota
Nestor 5878

1555 West Fourth Street
Mansfield, Ohio
Mansfield 7-2816

1594 Southland Circle, N.W.
Atlanta, Georgia
Sycamore 4-2441

TUNG-SOL[®]

Electron Tubes and "Golden Heart"^{*} Transistor

for the New Motorola
12-Volt Hybrid Car Radio

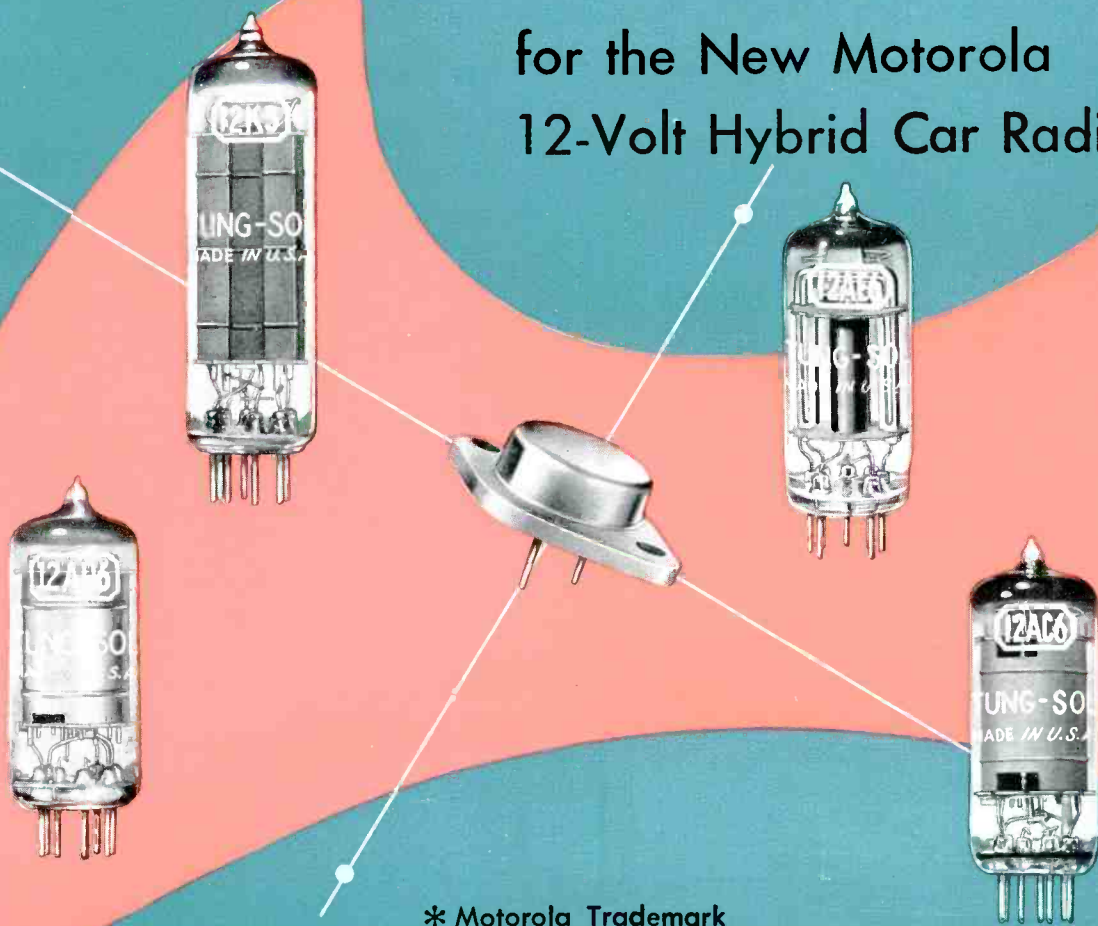

* Motorola Trademark

designed to operate directly from a 12-Volt car battery

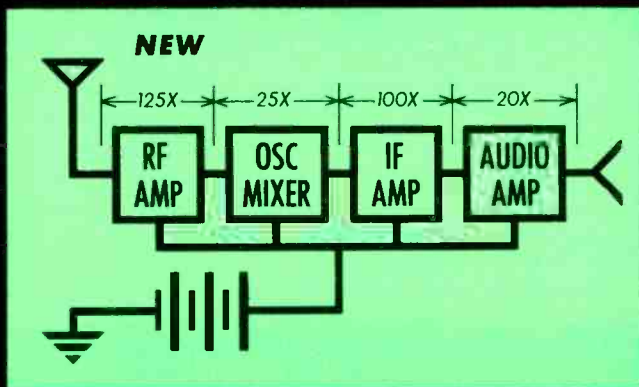
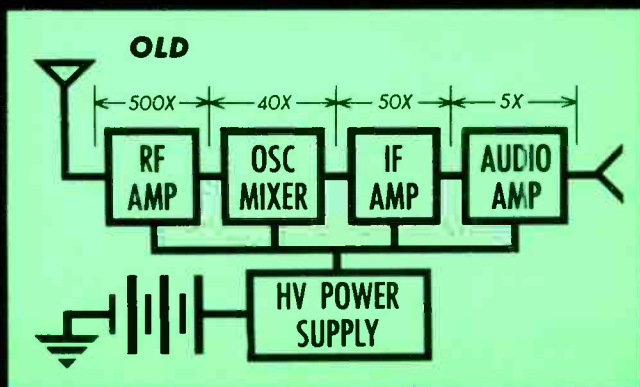

See other side for additional information

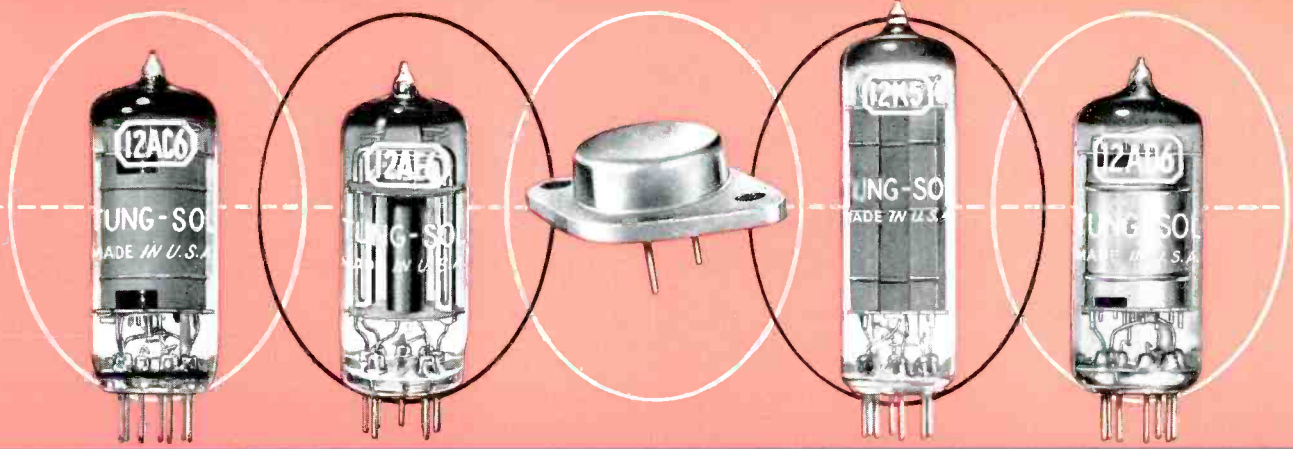

Tung-Sol Engineering Helps Pioneer a New Concept in Motorola Car Radios...

The new Motorola hybrid car radio represents one of the most significant advancements in car radio design. Fifteen vital parts, components of the customary high power supply, have been completely eliminated. In their place—a single high power transistor plus a complement of newly engineered electron tubes developed by Tung-Sol to operate with full efficiency directly off a 12-volt plate supply source.

In addition to circuit simplification which removes many potential sources of trouble, new standards of

performance are clearly indicated. Tubes operate at reduced internal temperature and dissipation. Drain on the car battery is cut almost in half.

This achievement—for many years considered impractical—is the result of Tung-Sol's intensive experience in the development of tubes for automotive applications. Thru it, Tung-Sol engineering has opened new avenues for the application of tubes to low voltage plate supply circuit designs.

As has always been the Tung-Sol policy, engineering assistance is offered impartially and all problems are treated with strictest confidence.

ELECTRON TUBE CHARACTERISTICS

TUBE TYPE	Heater Voltage	Plate Voltage	Grid #1 Voltage	Grid #2 Voltage	Grid #3 Voltage	Plate Current	Grid #1 Current	Grid #2 Current	Transconductance (Cont. Grid to plate)	Triode Ampl. Factor
12AC6	12.6 V	12.6 V	0 * V	12.6 V	Cathode	28 μ a	—	28 μ a	730 μ mhos	—
12AD6**	12.6 V	12.6 V	1.1 V RMS	12.6 V	0	120 μ a	30 μ a	650 μ a	100 μ mhos	—
12AE6										
Triode	12.6 V	12.6 V	0	—	—	750 μ a	—	—	1000 μ mhos	19
Diodes	12.6 V	10 V	—	—	—	2.0 ma	—	—	—	—
12K5	12.6 V	12.6 V	12.6 V	-2.0 V	—	8.0 ma	85.0 ma	—	7000 μ mhos	5.6***

*Grid #1 Resistor=2.2 Megohms **Converter Service ***Grid #2 to Plate

TRANSISTOR CHARACTERISTICS †

TYPE	I ₂	E ₂	R _L	R Source	Power Output	Power Gain	Distortion
TS-176	500 ma	-12 V	30 ohms	15 ohms	2.5 watt	30 db	8%

†With unit attached to heat sink.

MAY, 1956

ts **TUNG-SOL**[®]
ELECTRON TUBES AND
SEMICONDUCTORS

Information about these products and other special purpose tubes is available upon request to Tung-Sol Commercial Engineering Division.

TUNG-SOL ELECTRIC INC., NEWARK 4, NEW JERSEY

SALES OFFICES: ATLANTA, COLUMBUS, CULVER CITY, DALLAS, DENVER, DETROIT, MELROSE PARK (ILL.), NEWARK, SEATTLE.

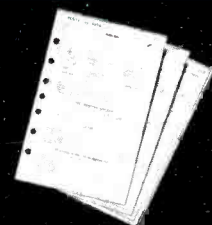

12K5 Another Engineering First from Tung-Sol

The 12K5 was originally designed to fill an enormous gap in the "hybrid" auto radio complement. Before this development, no single, high-gain tube was commercially available which even approached the power sensitivity required—at 12-volts plate supply voltage—to drive a single or push-pull high power output transistor from the small signal tube amplifiers. To accomplish this, the 12K5 utilizes a unique design feature known as the "space charge grid" which effectively greatly increases the cathode area. The resulting low output impedance and high transconductance render the type extremely useful for a great many low voltage driving, switching and control applications.



12K5 POWER AMPLIFIER TETRODE USING THE SPACE CHARGE GRID PRINCIPLE

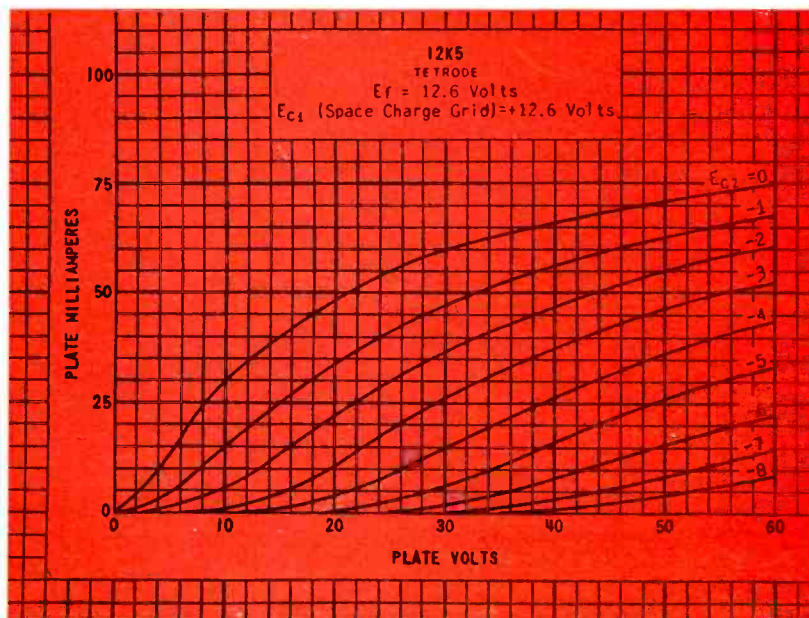

CHARACTERISTICS

- Tube Type: 12K5
- Heater Voltage: 12.6V
- Plate Voltage: 12.6V
- Grid #1 Voltage: 12.6V
- Grid #2 Voltage: -2.0V
- Plate Current: 8.0ma
- Transconductance:
(Cont. Grid to Plate) 7000 μ mhos
- Triode Ampl. Factor: 5.6*

*Grid #2 to Plate

The Tung-Sol engineering which has produced the 12K5 is constantly at work on a multitude of special electron tube developments for industry. Many exceptionally efficient general and special purpose tubes have resulted. Information about these and other types are available on request to Tung-Sol Commercial Engineering Division.

TUNG-SOL ELECTRIC INC., Newark 4, N. J.
Sales Offices: Atlanta, Columbus, Culver City, Dallas, Denver,
Detroit, Melrose Park (Ill.), Newark, Seattle.

 **TUNG-SOL**[®]
ELECTRON TUBES

TWO channels for ONE

with NORTHERN RADIO . . .



NEW! TWINPLEX COMMUNICATION UNITS

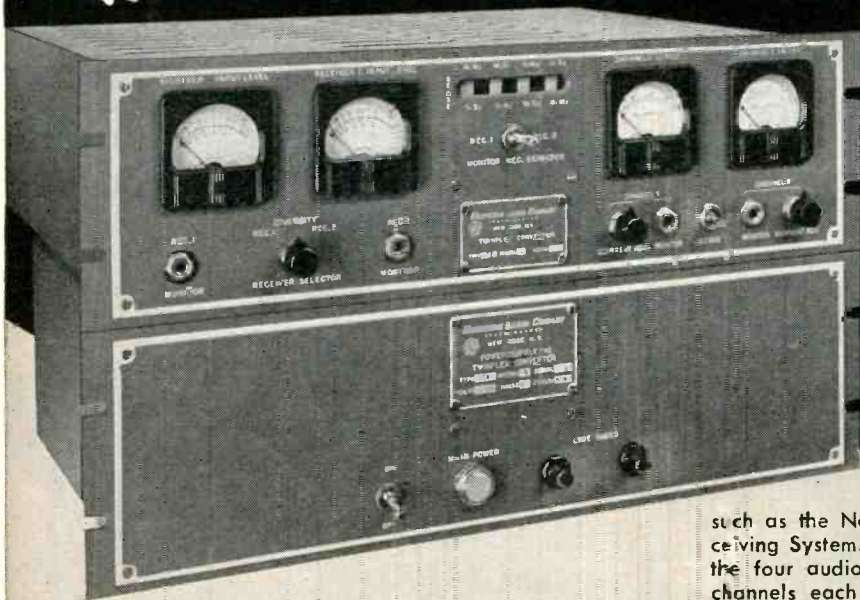

• provide 2 channels of FS communication with existing single channel transmitter and receiving facilities— with performance comparable to the existing single channel system

This Twinplex communication system makes possible a 2-channel radio circuit whereby 2 non-synchronous or synchronous telegraph transmissions modulate a single radio carrier wave by causing the carrier to assume one of four specific frequencies with 400 cps separations.

The transmitting equipment consists of the Twinplex Combiner Type 177 Model 1 and an RF Frequency Shift Keyer such as the Northern Radio Type 105 Model 4. The Combiner converts the four possible conditions of two telegraph signals (M1-M2, M1-S2, S1-M2, S1-S2) respectively into one of four voltages related in a 0-1-2-3 manner. The Combiner output voltage modulates the FS Keyer.

The receiving equipment consists of the Twinplex Converter Type 178 Model 1 and a single or diversity receiver

such as the Northern Radio Type 110 Dual Diversity Receiving System. The Converter demodulates and separates the four audio tones from the radio receiver(s) into two channels each carrying the originally transmitted intelligence. The Twinplex Converter replaces the standard FS Converter for this purpose.

The two telegraph channels provide the same operational flexibility as that of two separate single channel FS systems. One can, for example, simultaneously use channel #1 on 60 wpm teletype and channel #2 on high-speed Morse or Time Division Multiplex. It further permits the reception of channel #1 signals on all standard FS converters (tunable to 400 cps shift) without need for a Twinplex Converter: this is valuable for "Forked Circuit Operation" where the intelligence of channel #1 is intended for pick-up by other receiving stations which are not equipped for Twinplex Reception in addition to the main receiving stations which are so equipped. Reception of channel #2 (or of both channels) requires the receiving end to be equipped with a Twinplex Converter.



Write for complete information.

- Frequency Shift Keyers
- Master Oscillators
- Diversity Receivers
- Frequency Shift Converters
- Multi-Channel Tone Systems
- Tone Keyers
- Demodulators
- Monitors
- Radio Multiplex Systems
- Tone Filters
- Line Amplifiers
- Twinplex Equipment

NORTHERN RADIO COMPANY, inc.
 147 WEST 22nd ST., NEW YORK 11, NEW YORK
 Pace-Setters in Quality Communication Equipment

IN CANADA: Northern Radio Mfg. Co., Ltd., 1950 Bank St., Billings Bridge, Ottawa, Ontario.

Waldes Truarc Retaining Rings Eliminate Machining— Provide Stronger Assembly, Greater Accuracy

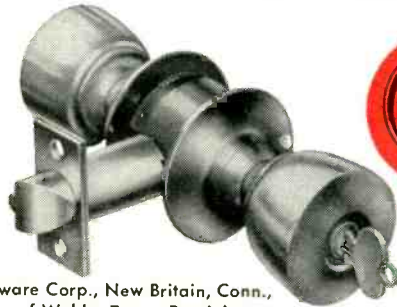

The American Hardware Corp., New Britain, Conn., uses 4 different types of Waldes Truarc Retaining Rings in the original design of these famous Corbin and Russwin Heavy Duty Cylindrical Locks. Truarc rings improve product performance, eliminate rejects, and cut labor costs.

Knob Sub Assembly

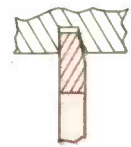
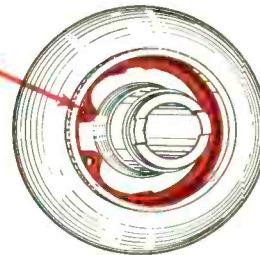

Truarc Beveled Ring (Series 5002) couples the knob to the knob shank. It eliminates two tapped holes and two screws, provides stronger assembly and greater accuracy. Beveled ring takes up end play rigidly.

Spindle Sub Assembly

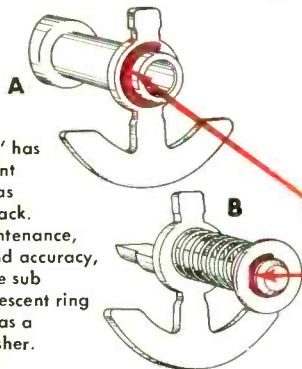

Spindle sub assembly "A" has two Waldes Truarc crescent rings (Series 5103) used as locating flanges for rollback. This saves labor and maintenance, improves performance and accuracy, eliminates rejects. Spindle sub assembly "B" uses one crescent ring as a spring retainer and as a locating shoulder for washer.

Cylinder Sub Assembly

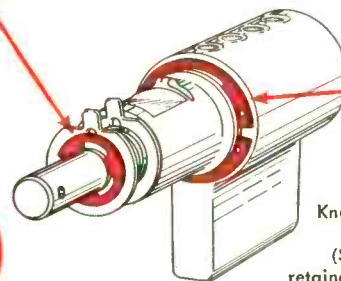

Knob unlocking mechanism uses one Truarc E-ring (Series 5133) as a spring retainer and one inverted ring (Series 5108) for retaining the cylinder plug. Rings are re-usable in the event of disassembly for maintenance. Rejects are eliminated.

Whatever you make, there's a Waldes Truarc Retaining Ring designed to improve your product...to save you material, machining and labor costs. They're quick and easy to assemble and disassemble, and they do a better job of holding parts together. Truarc rings are precision engineered and precision made, quality controlled from raw material to finished ring.

36 functionally different types...as many as 97

different sizes within a type...5 metal specifications and 14 different finishes. Truarc rings are available from 90 stocking points throughout the U.S.A. and Canada.

More than 30 engineering-minded factory representatives and 700 field men are available to you on call. Send us your blueprints today...let our Truarc engineers help you solve design, assembly and production problems...without obligation.

For precision internal grooving and undercutting...Waldes Truarc Grooving Tool!

Send for new catalog supplement

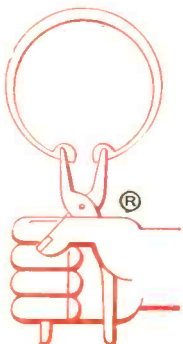

WALDES
TRUARC[®]
RETAINING RINGS

Waldes Kohinor, Inc., 47-16 Austel Place, L. I. C. 1, N. Y.
Please send the new supplement No. 1 which brings Truarc Catalog RR 9-52 up to date.
(Please print)

Name.....
Title.....
Company.....
Business Address.....
City..... Zone..... State.....

E-05E

WALDES TRUARC Retaining Rings, Grooving Tools, Pliers, Applicators and Dispensers are protected by one or more of the following U. S. Patents: 2,382,948; 2,411,426; 2,411,761; 2,416,852; 2,420,921; 2,428,341; 2,439,785; 2,441,846; 2,455,165; 2,483,379; 2,483,380; 2,483,383; 2,487,802; 2,487,803; 2,491,306; 2,491,310; 2,509,081; 2,544,631; 2,546,616; 2,547,263; 2,558,704; 2,574,034; 2,577,319; 2,595,787, and other U. S. Patents pending. Equal patent protection established in foreign countries.

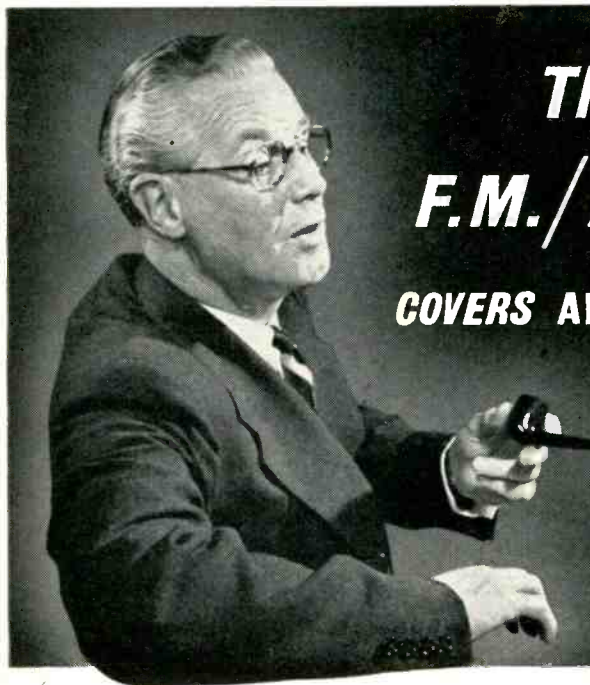

This **MARCONI** *F.M./A.M. Signal Generator* **COVERS ALL MOBILE COMMUNICATION BANDS**



The new Marconi Signal Generator type 1066/1 meets all requirements for the design and maintenance of f.m. equipment in the range 10-470 Mc. Here is a precision Marconi instrument for an exacting job.

The oscillator works on fundamentals throughout and there are no spurious submultiple outputs; its temperature compensation and fully-regulated plate and filament supplies give excellent frequency stability. A magnetically-biased ferrite frequency modulator ensures rock steady deviation characteristics. Other major features are the Marconi-patented contactless range turret and a 50Ω piston attenuator which is truly resistive. Engineers will appreciate the separate incremental frequency controls with meter calibration; these enable precise f.m. carrier shifts of as little as 1 kc in 450 Mc without readjustment of main frequency control.

F.M./A.M. SIGNAL GENERATOR TYPE 1066/1 Abridged Specifications

Frequency Range: 10 to 470 Mc in five bands—all on fundamentals • Frequency Stability: Better than 0.0025% per 10 minutes period after warm-up • Modulation, F.M.: 0 to 20 and 0 to 100 kc deviation monitored and continuously variable • Modulation, A.M.: 0 to 20 and 0 to 80% depth, monitored and continuously variable • Modulation Frequencies: 1 and 5 kc • Distortion due to Modulator: Less than 1% • Output: 0.1 μ V to 100 mV across a 500 termination • Output Accuracy: Incremental, 0.2 dB; within 2 dB overall • Leakage: Negligible; allows full use of 0.1 μ V output • Incremental Frequency Controls: Variable, 0 to \pm 100 kc. Stepped, \pm 5, 10 and 15 kc. • Tubes: 5Z4G, 6AK6, 6CD6G, 6AK5, OB2, 5861, 6C4, 6L6G, 12AT7.

MARCONI F.M. DEVIATION METERS 791C AND 934 ARE COMPANION INSTRUMENTS

MARCONI
INSTRUMENTS

Marconi - since 1897

44 NEW STREET • NEW YORK 4

CANADA: CANADIAN MARCONI COMPANY,
MARCONI BUILDING, 2442 TRENTON AVENUE,
MONTREAL.

ENGLAND: Head Office: Marconi Instruments Ltd., St. Albans, Herts. Managing Agents in Export: Marconi's Wireless Telegraph Co. Ltd., Marconi House, Strand, London, W.C.2

TC 79



ELECTRONIC DIVISION

this is electronics?

yes it is — at OTIS

(a) To calculate in an electro-mechanical computer, the gears must be machined to an accuracy of .0007 inch.

(b) To simulate a radar beam, the ultrasonic generator must perform to the highest possible accuracy as demanded by a scale reduction of 200,000:1.

(c) To simulate radar distance, the "plumbing" produces water with purity of two parts per million of calcium carbonate and temperature constancy of 1° F.

Here is the science of mechanics pushed to wizardry precision and wedded to the most advanced electronic circuitry... which creates the vital and critical weapons systems now so indispensable for our national defense.

This is what Otis has accomplished during the past 3 years — and is accomplishing now.

To those who need the performance-proven resources of an organization having comprehensive and diversified experience in the research, development and manufacture of large-scale complex electro-mechanical equipment and systems in the fields of:

- missile guidance and control
- gunfire control
- radar and counter measures
- simulators and training aids
- communication
- special electronic devices
- ultrasonics
- computers
- servomechanisms
- magnetic amplifiers
- testing instrumentation
- electro-mechanical components

— investigate Otis. Write on your letterhead for 32-page history and facilities report.

OTIS ELEVATOR COMPANY
35 RYERSON STREET, BROOKLYN 5, N. Y.
OTIS ELECTRONIC DIVISION

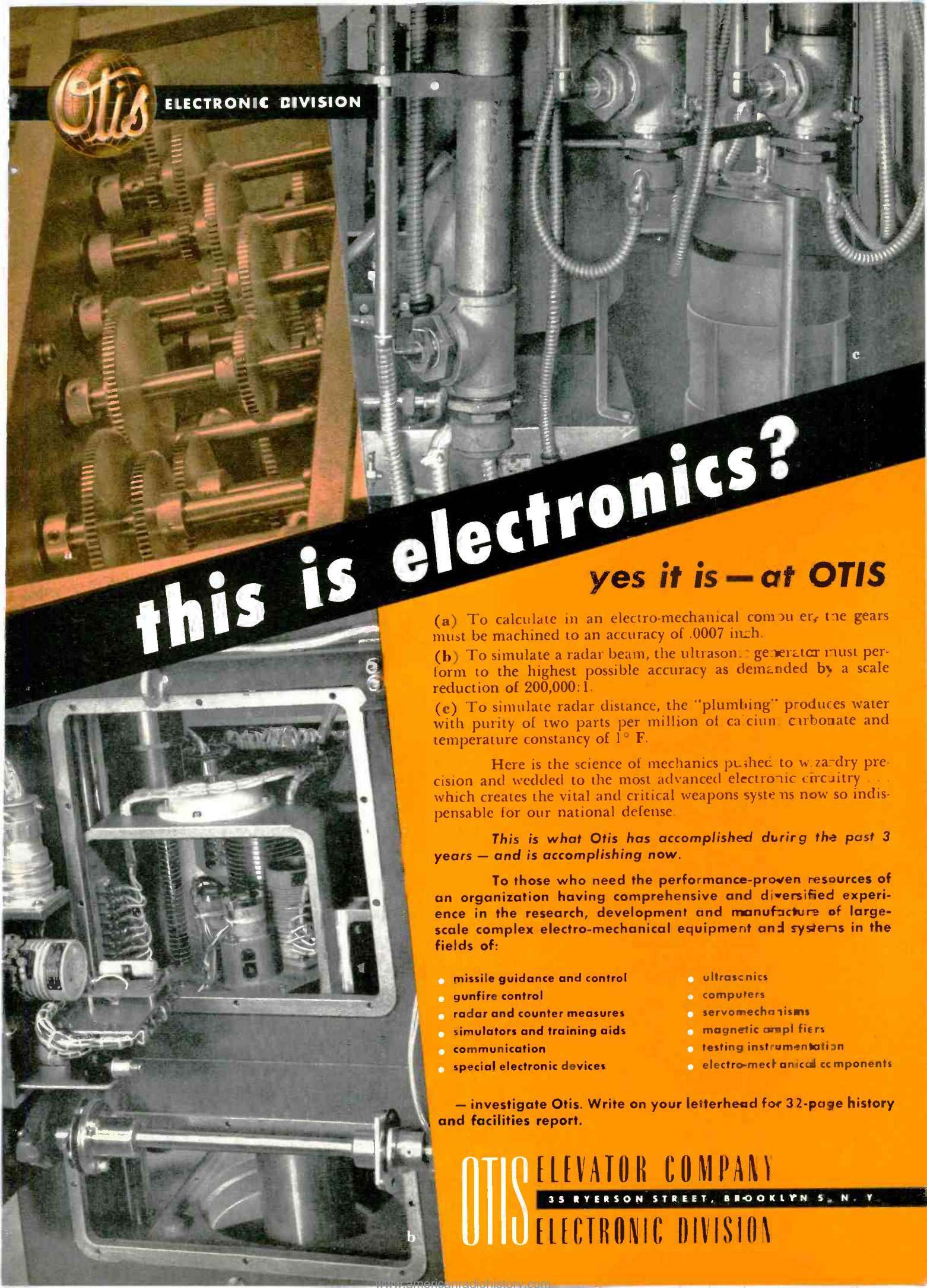

Electronic 'Erector Set' System . . .

Simplifies Circuitry Packaging,
Cuts Assembly Costs,
Minimizes Servicing Problems

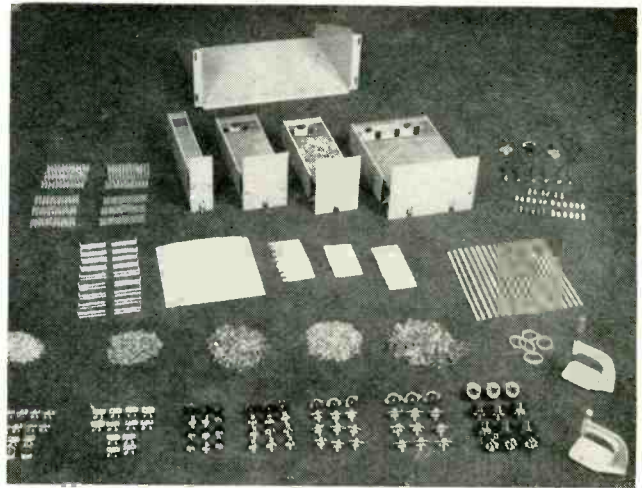

All necessary components to package your electronic circuitry using principles of Plug-in Units Construction are included in this Alden Kit #37.

SUMMARY—"Building Block" plug-in chassis system organizes circuits by function, provides for plug-in replacement and fast servicing by non-technical personnel.

DESCRIPTION

A complete system of integrated terminal card sub-chassis elements designed to snap into plug-in chassis now makes it simple for designers to take full advantage of the new mass production techniques of printed wiring and modular construction in the manufacture of custom-designed systems.

Alden Products Company of Brockton, Mass., is the developer of this system which is based upon standardized pre-punched mounting cards with associated terminals, tube sockets and holding devices which accept resistors, condensers, tubes and other components. The cards may be snapped into place in plug-in chassis units.

This eliminates the usual "rat's nest" point-to-point wiring and facilitates access for assembly and repair.

The terminal cards arrange all the components on sub-chassis in "planes of circuitry" which can be housed in standardized 2", 4", 8" or 17" Alden Basic Chassis. Each chassis contains all the sub-chassis associated with a single electronic function. "Tell-Tale" monitor lights mounted on the plug-in chassis front panel can be employed to give instant indication of service failure.

Plug-in chassis units are arranged in modular metal cabinets called Uni-Racks to make up and house complete systems.



Fig. 1. Circuitry laid out using terminal card mounting system.

ADVANTAGES

There are a number of primary benefits associated with the Alden System. Fundamentally, the break-down of the circuitry by function and the modular assembly concept of components and terminal cards means that even complicated electronic-electrical problems are reduced to relatively simple mechanical assembly problems once the theoretical design stage is passed.

The need for prototypes is eliminated since breadboard layouts can be lifted directly onto the terminal card system with the aid of planning sheets furnished by the manufacturer.

The finished system is easy to keep in service—even for non-technical personnel.

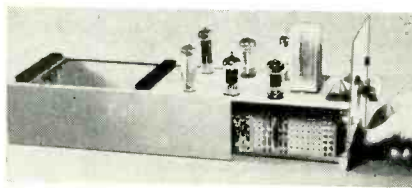

Fig. 2. Alden basic plug-in chassis.

"Tell-tale" trouble lights instantly locate malfunctioning chassis elements and non-technical personnel can replace them with spare plug-in units. The faulty unit can then be repaired and returned to service. In addition, provision for numbered and color-coded in-out leads conveniently grouped at the back of each chassis by Alden Back Connectors enables laymen to make accurate first-level checks.

APPLICATIONS

A leading research institute received an unexpected order for a computer. Using this Basic Chassis System for housing the circuitry as plug-in units, they assembled the computer so rapidly that more than seven weeks was saved in design time and in the packaging and mechanical engineering phase. Moreover, the flexibility of the system permits periodic up-dating of the computer with more modern circuits as these are developed.

Another important advantage lies in the shortening of required lead time on delivery dates. One manufacturer supplying electronic test gear to the Naval Ordnance Bureau on irregular schedules is able to quote extraordinarily fast delivery on custom equipment because the units go together so fast. This firm starts with a series of standard functions to which are added specialized circuit functions. The chassis are then housed in Uni-Racks and rushed to the job.

In addition to speed, costs are held to a level far lower than is usual for special or custom built equipment and one or a hundred can be produced at little cost variance.

"ERECTOR-SET" ELEMENTS

Terminal Cards: These cards are pre-cut to size, in lengths up to 3 feet. They

are pre-punched with 0.101" holes on 1/4" centers for maximum flexibility in chassis layout.

Mounting Sockets: Available for 7, 8, 9 pin connections, miniature and standard octal, tube sockets are furnished for stud mounting or with right-angle brackets for mounting directly to the terminal card. Eleven-pin socket is used for terminal card plug-in base only.

Miniature Ratchet Terminals: Stake into terminal card and provide positive grip for feed-through or single-end connections for all pigtail components. Soldering serves only to establish the electrical connection. Lead dress is simplified—excess pigtailed are snipped off at the terminal.

Jumper Strips: Stake under terminals for either jumper or common wiring. These strips and other wiring can be readily replaced with printed or etched wiring.

Plug-In Chassis Units: Built on the modular principle allow organization of circuitry by function and provides housing in replaceable units.

Front Panel Tell-Tales: Tiny lamps that provide visual indication of equipment malfunction.

SIMPLE TO GET STARTED

Alden Products Company offers a low cost "get started" chassis and terminal card assortment kit containing all components to mount, house, fasten and monitor electronic circuitry (Kit #37 shown above, price \$249.50).

This kit will enable you to determine quickly the advantages this system holds for your product development and production.

The Alden Handbook, "Ideas, Techniques, Designs" is supplied with each kit and contains a complete description of the Alden System.

To order your kit or to get further information write to Mr. N. Hearn, Alden Products Co., 5127 N. Main St., Brockton, Mass.

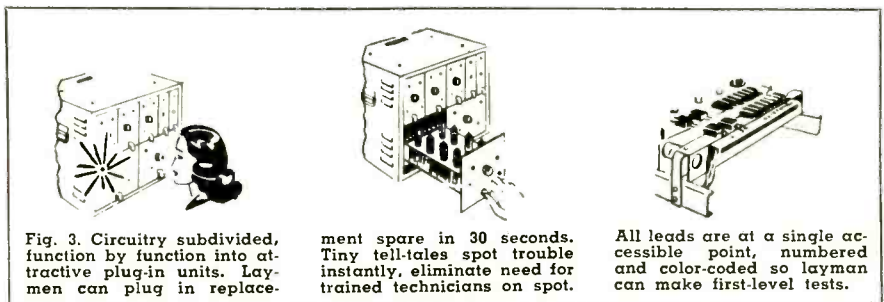

Fig. 3. Circuitry subdivided, function by function into attractive plug-in units. Laymen can plug in replace-

ment spare in 30 seconds. Tiny tell-tales spot trouble instantly, eliminate need for trained technicians on spot.

All leads are at a single accessible point, numbered and color-coded so layman can make first-level tests.

"Flight-Leader" in Dependability...

Federal's "Advance-Engineered" Aircraft Cables...



designed to meet the expanding Quality and Performance requirements of ground and airborne applications!

MODERN AVIATION is advancing with tremendous strides. When specifying cable *today*, aircraft designers *must* plan for *tomorrow's* performance demands!

To this urgent need for "Advance-Engineered" cables, Federal's vast development and production resources have been effectively geared.

Whatever the application . . . transmission lines, interconnecting cables, antennas, audio lines, navigation systems . . . Federal cables keep you in step with new and unexpected requirements . . . by utilizing the latest improvements in dielectric materials, manufacturing techniques and quality control.

Federal's constant testing assures peak efficiency of physical and electrical properties under the most rugged conditions of commercial and military applications.

Whatever your requirements for "Flight-Leader" dependability, Federal has the cable type you need . . . or can help you design it. Why not get in touch with Federal today about your aircraft cable problems?

Call NUTley 2-3600 or write Dept. D-713

Federal's Aircraft Cables and Principal Applications:

RG-8/U, RG-8A/U — 50-ohm general purpose coaxial cables for use as interconnecting cable and transmission line with airborne radio.

RG-9A/U, RG-9B/U — 50-ohm coaxial cables for use with airborne radio at UHF and higher frequencies.

RG-17/U, 18/U, 19/U, 20/U — 50-ohm coaxial cables used with ground equipment as low-loss antenna and transmission lines.

RG-11/U, 59/U — 73- and 75-ohm coaxial cables used chiefly in ground equipment such as ILS and GCA as transmission lines and interconnecting cables.

RG-55/U, 58/U, 58A/U — 53.5 ohms; RG-62/U, 71/U — 93 ohms; Federal's K-38, KT-107 — 72 ohms: coaxial cables with a wide range of aircraft applications, including audio lines for interphone.

Federal's K-1201 — Static Precipitation Aircraft Antenna, accepted by the major aircraft manufacturers.

RG-87A/U, 141/U — 50 ohms; RG-140/U — 73 ohms: solid-core "Teflon" coaxial cables for higher-temperature applications.

Federal's K-256, 257 and 258 (50, 70 and 93 ohms): miniature coaxial cables with "Teflon" dielectric . . . meeting the rigid requirements of the aircraft industry where smaller and lighter coaxial cables are required.

Federal



A DIVISION OF

ITT

"America leading manufacturer of solid dielectric coaxial cables"

Federal Telephone and Radio Company

A Division of INTERNATIONAL TELEPHONE AND TELEGRAPH CORPORATION
COMPONENTS DIVISION • 100 KINGSLAND ROAD • CLIFTON, N. J.

In Canada: Standard Telephones and Cables Mfg. Co. (Canada) Ltd., Montreal, P. Q.
Export Distributors: International Standard Electric Corp., 67 Broad St., New York

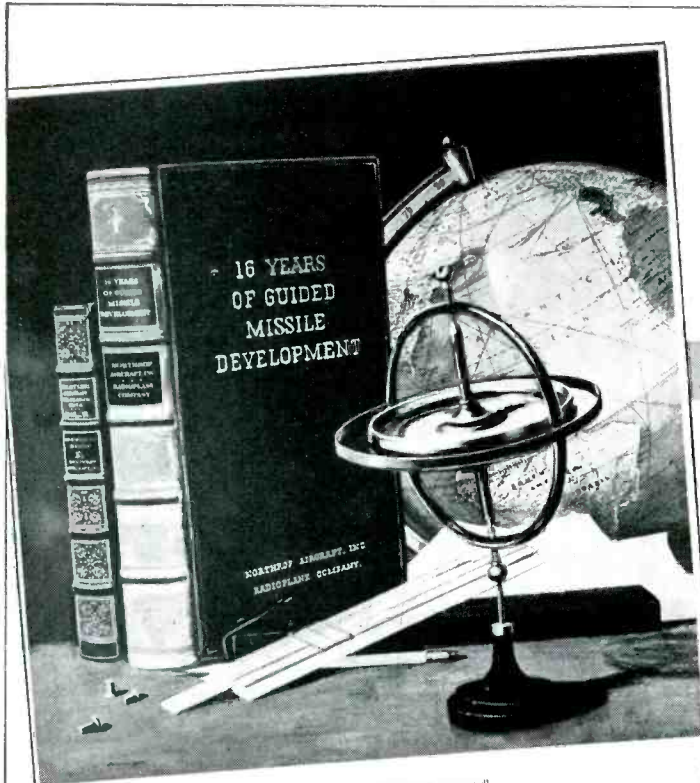

BALANCE—Foremost of Northrop achievements is an efficient organization well balanced between the poles of advanced research and economical production. Northrop scientists in physics, astronomy, metallurgy, electronics, aerodynamics, optics and many other fields are doing their work years in advance of the need. The Ballad-plans, thinking and planning within the Northrop complex have come the Ballad-plans, first and foremost, missiles, rockets, and missiles; Scorpion F-80 interceptors, present defense of our heartland approaches; and Stark SAMs, daily interceptors and defense of our heartland. As streamlined as its products, the well-balanced Northrop organization is at work on even greater weapons to strengthen this nation's defense and is more ready than ever to develop and produce them efficiently and on schedule.



Pioneers in All Weather and Pilotless Flight

Northrop Aircraft, Inc. selected their analog computing system from Electronic Associates, Inc. They chose EAI's PACE equipment, because their engineers insisted on absolute reliability for use in their long range interceptor, guided missile, and other research, development and production programs. One more example of two leading companies working together to break the problem barrier through progressive engineering. Details of Pace equipment on request. Write Dept. EL-5.

Break Through The PROBLEM Barrier

More and more engineers are turning first to Electronic Associates' Analog Computing Groups to conquer the problem barrier. For in these Groups they find an unparalleled accuracy, reliability and flexibility that has been improved by thousands of operational hours. These groups feature a building block method that simplifies the economical expansion of the system by the addition of standard components of the groups. A complete Group and staff is available for your experimentation on a rental basis at Electronic Associates' Computation Center just outside of Princeton, New Jersey. We will also gladly furnish details on our new line of high speed sounds, problem checks, high accuracy Electronic Multipliers, Function Generators and precision output equipment. Write Dept. EL-5.

ELECTRONIC ASSOCIATES
Incorporated

EAI SETS THE PACE
PRECISION ANALOG COMPUTING EQUIPMENT
LONG BRANCH, NEW JERSEY



EAI SETS THE

P A C E
PRECISION ANALOG COMPUTING EQUIPMENT

LONG BRANCH • NEW JERSEY



MEETING
THE TEST OF
things to come!

Reliable Tubes BY CHATHAM

Chatham ruggedized tubes afford a degree of dependability that actually exceeds present day requirements. Advance-designed by the pioneer developer of reliable types, these tubes stand ready to meet the ever more exacting demands of tomorrow. Products of continuous around-the-clock research backed by gruelling life tests, Chatham reliable tubes are the industry-wide standard for military and commercial applications requiring absolute unflinching dependability.

FOR COMPLETE INFORMATION — Call or write for data bulletins or recommendations on specific tube or equipment applications.



Chatham Electronics

Division of Gera Corporation — LIVINGSTON, NEW JERSEY

ENGINEERS,
DESIGNERS and
MANUFACTURERS of High Performance Electronic Tubes,
Airborne Conversion Equipment, Lightweight
Selenium Rectifiers, Radar Components, Radiation
Survey Instruments and Custom-Built Equipment.



TYPE 5651WA VOLTAGE REFERENCE TUBE

Miniature Cold Cathode Gas Discharge Tube for voltage reference. Maintains voltage of approx. 87 v. at a current range of 1.5 to 3.5 ma.



TYPE 5R4WGB RECTIFIER

Full wave, withstands 980 g's shock. Operates at full inverse ratings up to 40,000 ft. and at reduced ratings to 60,000 ft. Manufactured to Navy reliable tube specs.



6627/OB2WA CHATHAM VOLTAGE REGULATOR

Miniature cold cathode glow discharge tube for use as a voltage regulator. Regulating voltage approximately 108 volts at current range of 5 to 30 ma.



TYPE 6626/OA2WA VOLTAGE REGULATOR

Reliable miniature cold cathode glow discharge tube similar to Type 6627/OB2WA with regulating voltage approx. 150 volts at current range of 5 to 30 ma.

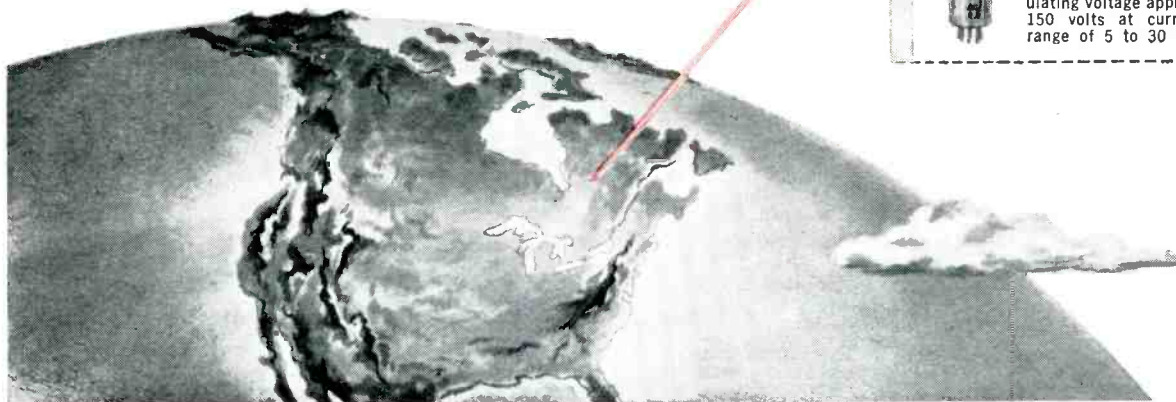

NEW!

TRANSISTORIZED REGULATED DC POWER SUPPLIES

FEATURES

- New, All-Transistor Designs
- High Conversion Efficiency
- Low Heat Dissipation
- Instant Warm-Up Time
- Fast Transient Response
- Continuously Variable Zero-Max.
- Small Size, Light Weight
- Non-Microphonic Operation
- Rugged, Long Life, Stable Performance

ERA, pioneer in transistorization presents a complete line of semi-conductor regulated DC power supplies. Ideal for all low and medium voltage applications, these supplies feature special circuitry* with germanium junction diode rectification, high efficiency filtering and germanium transistor regulation control. These tubeless designs are an important advance in the field of power conversion, and make obsolete the bulky, low efficiency, high heat vacuum tube equivalents, wherever used.

ADJUSTABLE VOLTAGE, LABORATORY AND INDUSTRIAL TYPES

Types listed are intended for 105-125 VAC input, 60 cps. DC output is continuously adjustable zero-max. Line regulation is better than 0.5%. Load regulation better than 0.5% or 5 ohms int. DC impede. Ripple less than 0.02%. Models numbered 100T and above include a 6.3 VAC, 2 amp. output.

These designs are for both bench and rack mounting and dimensions are sub-multiples of 19 inches, which permits several units to be mounted horizontally in a standard rack. All units are fused and amply protected against overload. Models designated by "TM" incorporate voltage metering.

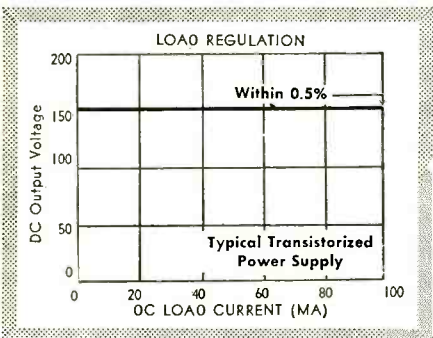
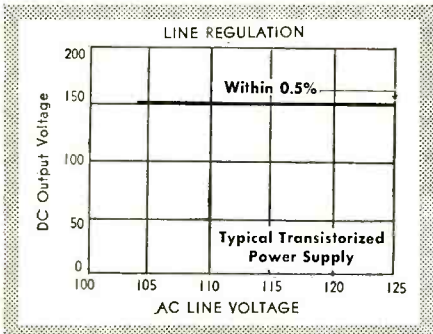
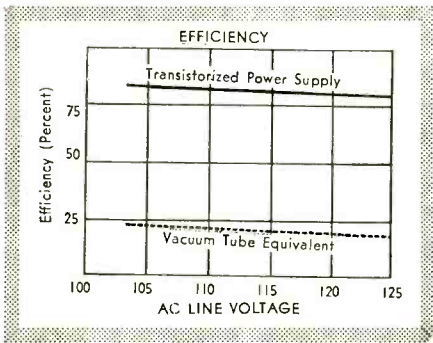

Model No.	Voltage Range VDC**	Current Ma-Max.	Size Inches	Price FOB Plant
50T	0-50	150	3 1/2 x 6 3/8 x 7	\$110.00
50TM	0-50	150	3 1/2 x 9 1/2 x 7	125.00
100T	0-150	100	3 1/2 x 6 3/8 x 7	125.00
100TM	0-150	100	3 1/2 x 9 1/2 x 7	140.00
101T	0-300	100	3 1/2 x 9 1/2 x 8	170.00
101TM	0-300	100	3 1/2 x 9 1/2 x 8	185.00
200T	0-150	200	3 1/2 x 9 1/2 x 7	155.00
200TM	0-150	200	3 1/2 x 9 1/2 x 7	170.00
201T	0-300	200	3 1/2 x 9 1/2 x 9	220.00
201TM	0-300	200	3 1/2 x 9 1/2 x 9	235.00

FIXED VOLTAGE, MINIATURIZED TYPES

Units listed are fixed voltage miniaturized TRANSPAC types, for incorporation into transistorized equipment, computer units, guided missile circuits, and all miniature and standard size electronic devices. Input 105-125 VAC, 60 or 400 cycles. Input reg-

ulation better than 0.5%. Output regulation better than 0.5%. Ripple less than 0.05%. Units are in transformer type housings and potted to resist shock and vibration, but incorporate replaceable transistor features.

Model No.	Output Volts**	Current Ma-Max.	Case Size Inches	Price FOB Plant
TR5	5	200	2 1/4 x 2 1/2 x 3 3/4	\$60.00
TR10	10	200	2 1/4 x 2 1/2 x 3 3/4	60.00
TR20	20	200	2 1/4 x 2 1/2 x 3 3/4	60.00
TR30	30	150	2 1/2 x 3 x 4 1/4	65.00
TR40	40	150	2 1/2 x 3 x 4 1/4	65.00
TR50	50	150	2 1/2 x 3 x 4 1/4	65.00
TR100	100	100	3 x 3 1/2 x 4 3/4	80.00
TR150	150	100	3 x 3 1/2 x 4 3/4	80.00
TR200	200	100	3 1/4 x 4 x 5 1/4	95.00
TR300	300	100	3 1/4 x 4 x 5 1/4	95.00

Special Designs can also be Supplied to Customers' Specifications. Write Us for a Quotation on Your Requirements.

Prices subject to change without notice.

For Further Information on These Products Write Dept. 13

* Patents Applied For

** Nominal Voltage, Specified within 5%.



ELECTRONIC RESEARCH ASSOCIATES, INC.

Laboratories and Factory: 67 East Centre Street Nutley, New Jersey Telephone: Nutley 2-5410

the Difference is **INSIDE** the **FIL-CAP**

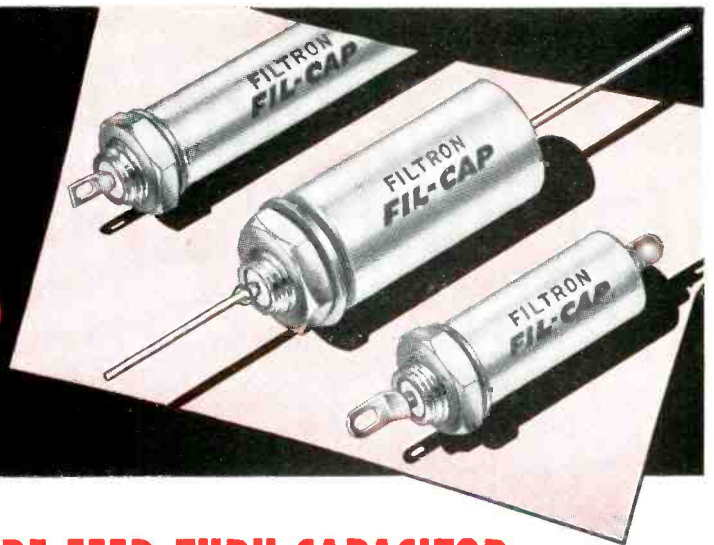

FILTRON'S NEWEST SUBMINIATURE FEED-THRU CAPACITOR SETS A NEW STANDARD OF RF ATTENUATION PERFORMANCE

- 1** For the first time—a complete line, ratings for 5 AMPS & 10 AMPS, continuous duty
- 2** Advanced internal circuit design . . . specially processed impregnant
- 3** Meets Spec MIL-C-11693 (proposed) for suppression capacitors
- 4** Closely matches theoretically ideal attenuation characteristics

An unusual internal circuit arrangement, precision mechanical components, and a specially processed silicone impregnant combine to afford outstanding electrical characteristics and stability—unobtainable in conventional feed-thru capacitors ordinarily used for interference suppression in electronic equipment.

Basically, FIL-CAPS are a four-terminal network inserted in the current-carrying line. The power line to be filtered must be broken, and each end connected to an insulated terminal of the capacitor. The feed-thru ground-plane mounting prevents mutual impedances between input and output terminals. The FIL-CAP de-

sign includes compression glass insulated terminals, and milled flats on the threaded mounting neck, to prevent rotation during installation and under service conditions.

Type FV is rated for 5 amps AC-DC continuous operation, and Type FX is for 10 amps AC-DC continuous operation. Both types are available in operating voltages of 100, 200, 300, 400 and 600 volts DC; 125 and 250 volts AC; 0 to 400 cycles.

All FIL-CAP subminiature feed-thru capacitors are 100% tested and inspected before shipment.

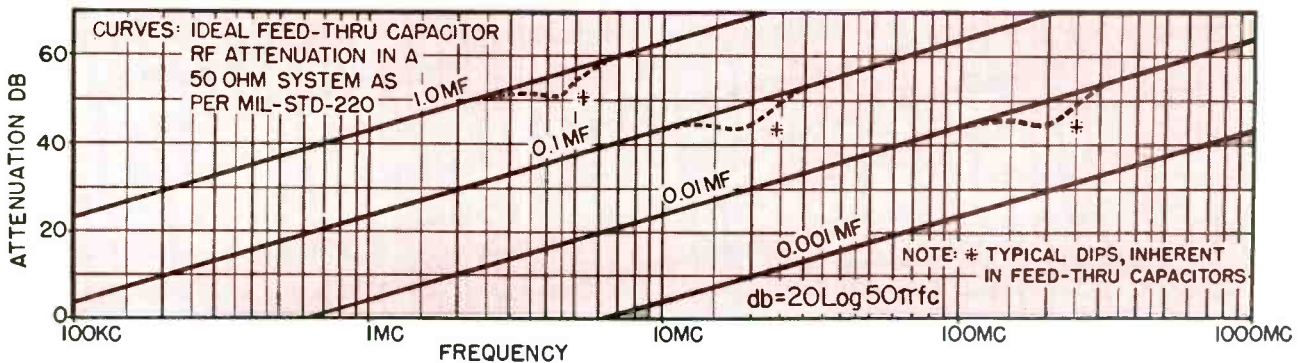

If your requirements call for greater attenuation than is obtainable with feed-thru capacitors, Filtron also manufactures a complete line of RF interference filters. More than 5000 filter types are offered for military, industrial, nuclear and commercial applications. Filtron is the world's largest

manufacturer of RF interference filters. Details and literature furnished on request.

For complete engineering data and installation diagram, ask for Filtron Catalog FV, and FV Supplement for FIL-CAP equivalents to MIL-C-11693 military designations.





Main Plant, Flushing, New York



FILTRON CO., INC., FLUSHING, LONG ISLAND, NEW YORK
PLANTS IN FLUSHING, NEW YORK, AND CULVER CITY, CALIFORNIA

NOW PHELPS DODGE **SODEREZE***

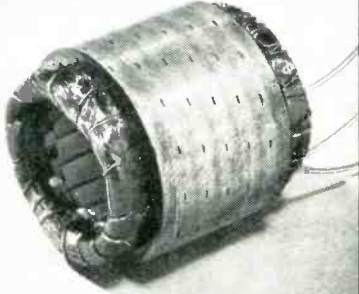
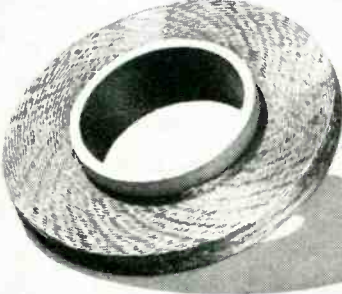
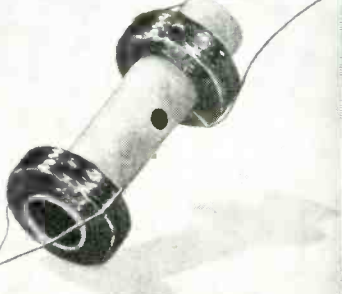
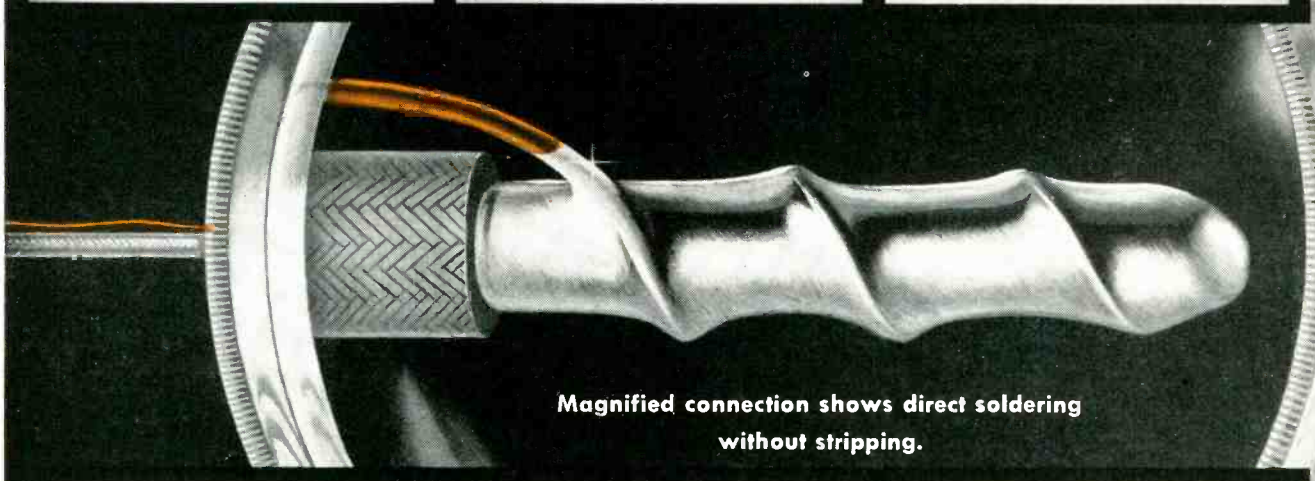
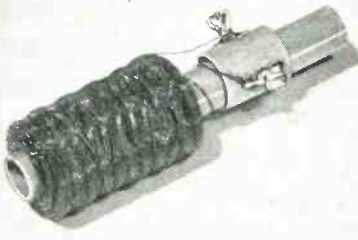
SUITABLE FOR ALL

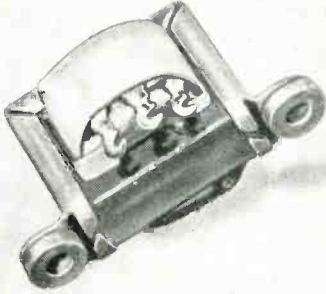
 <p>Instrument motor stator</p>	 <p>Fly-back coil</p>	 <p>I. F. coil</p>
 <p>Magnified connection shows direct soldering without stripping.</p>		
 <p>Universal wound TV choke coil</p>	 <p>Solenoid coil</p>	 <p>Transformer coil</p>

First for Lasting Quality—from Mine to Market!

*Reg. U. S. Pat. Off.

GIVES HIGH "Q"... CLASS "A" APPLICATIONS!

- * **New materials assure high "Q".**
- * **All essential properties equal or superior to existing film wires.**
- * **Positive uniform soldering. No stripping or cleaning necessary.**

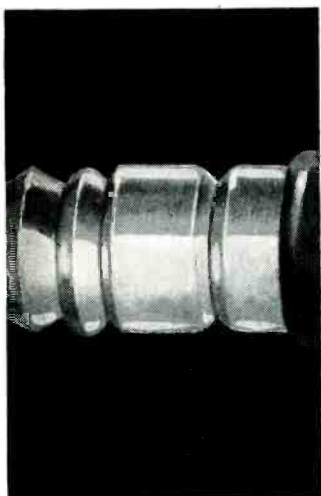

Phelps Dodge Sodereze represents a new advance in ready-to-solder magnet wire. It's a typical Phelps Dodge development designed to keep pace with industry's growing need for wires that handle easily, reduce over-all cost and satisfy a variety of operating conditions.

Phelps Dodge Sodereze offers a unique combination of improved chemical and mechanical properties with the advantage of high "Q". The versatility of Phelps Dodge Sodereze not only permits its use wherever solderable wires have been proven practical but suggests new applications, particularly in the finer sizes, to replace conventional wires.

Any time magnet wire is your problem, consult Phelps Dodge for the quickest, easiest answer!

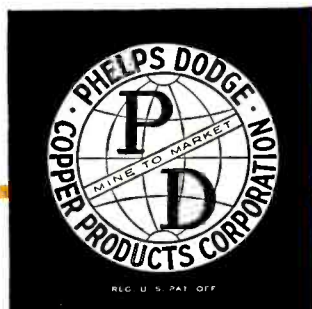

**PHELPS DODGE COPPER PRODUCTS
CORPORATION**

INCA MANUFACTURING DIVISION
FORT WAYNE, INDIANA

BURNELL

continues to offer the most advanced line of reliable MIL-T-27 inductors, filters and delay lines.



Variable Inductors

- inductance values up to 1000 henrys
- variable over a range of $\pm 10\%$
- high Q, small size
- for low-frequency tuning applications

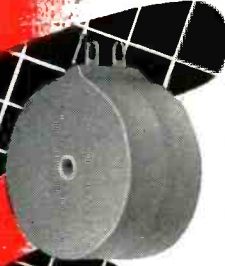

Molded Toroids

- inductance precision within 1%
- high Q because molded construction minimizes distributed capacity
- subminiature to standard sizes
- compact and sturdy

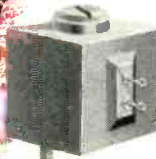

Subminiature Adjustoroids

- precise continuous adjustment of inductance over a 10% range
- no external control current needed
- hermetic sealing
- low cost



Encapsulated Toroids

- hermetically sealed
- high Q
- center mounting permits stacking
- miniature to standard sizes

FOR YOUR CIRCUIT NEEDS...

Write to Dept. K for application or procurement information



BURNELL & CO., INC.

YONKERS 2, NEW YORK • TELETYPE: YONKERS, N. Y. 3633

PACIFIC DIVISION

720 MISSION STREET • SOUTH PASADENA, CALIFORNIA



Crystal Filters

- nominal cost
- excellent delivery
- frequency range 50 kc to 5000 kc
- high stability



Tom Thumb Telemetering Filters

- miniaturized for guided missiles
- high temperature stability
- designed to withstand shock and vibration
- hermetically sealed



Delay Lines

- for audio and low radio frequency applications
- constancy of time delay
- flat frequency response
- low insertion loss

Brand New!

POTTER Model 905 Digital Magnetic Tape Handler

- 75 inches per second
- 3 msec starts and stops
- automatic threading
- fast rewind

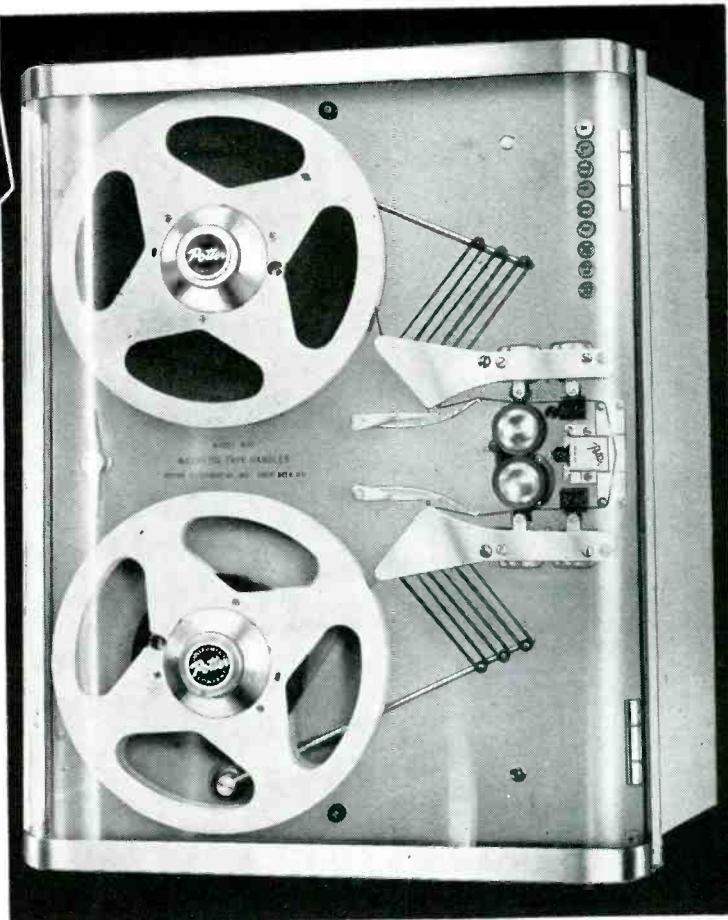

The Potter Model 905 Digital Magnetic Tape Handler combines many features not available on similar, more costly machines. A variety of dual speed combinations up to 75"/sec is available. Tape widths from $\frac{1}{4}$ " to $1\frac{1}{4}$ " can be accommodated.

Ease of operation is assured by simplified in-line threading, bi-directional high-speed rewind, automatic end-of-tape stopping and control of all machine functions by conveniently-grouped front panel push-buttons or remote contact closures and pulses.

Designed for standard 19" rack mounting, the hinged front panel provides immediate access to mechanical parts and all plug-in electronic components. Transparent dust covers are available for protecting tape and mechanical parts without hindering visual observation of entire tape track.

The 905 represents the ultimate in digital tape handlers for high-speed computers, electronic business machines, industrial control and other digital data-handling applications.

POTTER ENGINEERS welcome an opportunity to study your data-handling problems and to recommend equipment for satisfying your needs. Write today.

AUXILIARY EQUIPMENT

A complete line of digital data-handling accessories is also available from Potter.

Record-Playback Heads (Model 6400) are available in a wide variety of channel number and tape width combinations. All feature phosphor bronze construction that eliminates digit "drop outs" caused by oxide pickup and insures dimensional stability.

Record-Playback Amplifiers can be furnished as individual plug-in units (Models 52, 53) or in complete record-playback systems (Model 920) for return-to-zero or non-return-to-zero recording.

Shift registers, high-speed printers and other precision-engineered data-handling components are also available separately or in integrated systems for solving specific data-processing problems.



POTTER INSTRUMENT COMPANY, INC.

115 Cutter Mill Road

Great Neck, L. I., N. Y.



A triumph of over 3 years' research!

New Westinghouse Rectox[®] Industrial Selenium Stacks

Westinghouse research developed the unique evaporation process of applying selenium which gives better contact area, lower forward drop, and less leakage than any other selenium stack available.

Here's how Westinghouse selenium stacks give outstanding performance—

Lowest forward aging rate in the industry

Up to 90% conversion efficiency

100% conformity to NEMA standards

Improved durable finish

Sizes and rating to meet every industrial requirement

Standard mountings

Get all the information you need from your Westinghouse Sales Engineer—*The Man With The Facts.*

J-21927

WATCH WESTINGHOUSE!
WHERE **BIG THINGS** ARE HAPPENING **TODAY!**

GOT AN INSTRUMENT PUZZLE ?

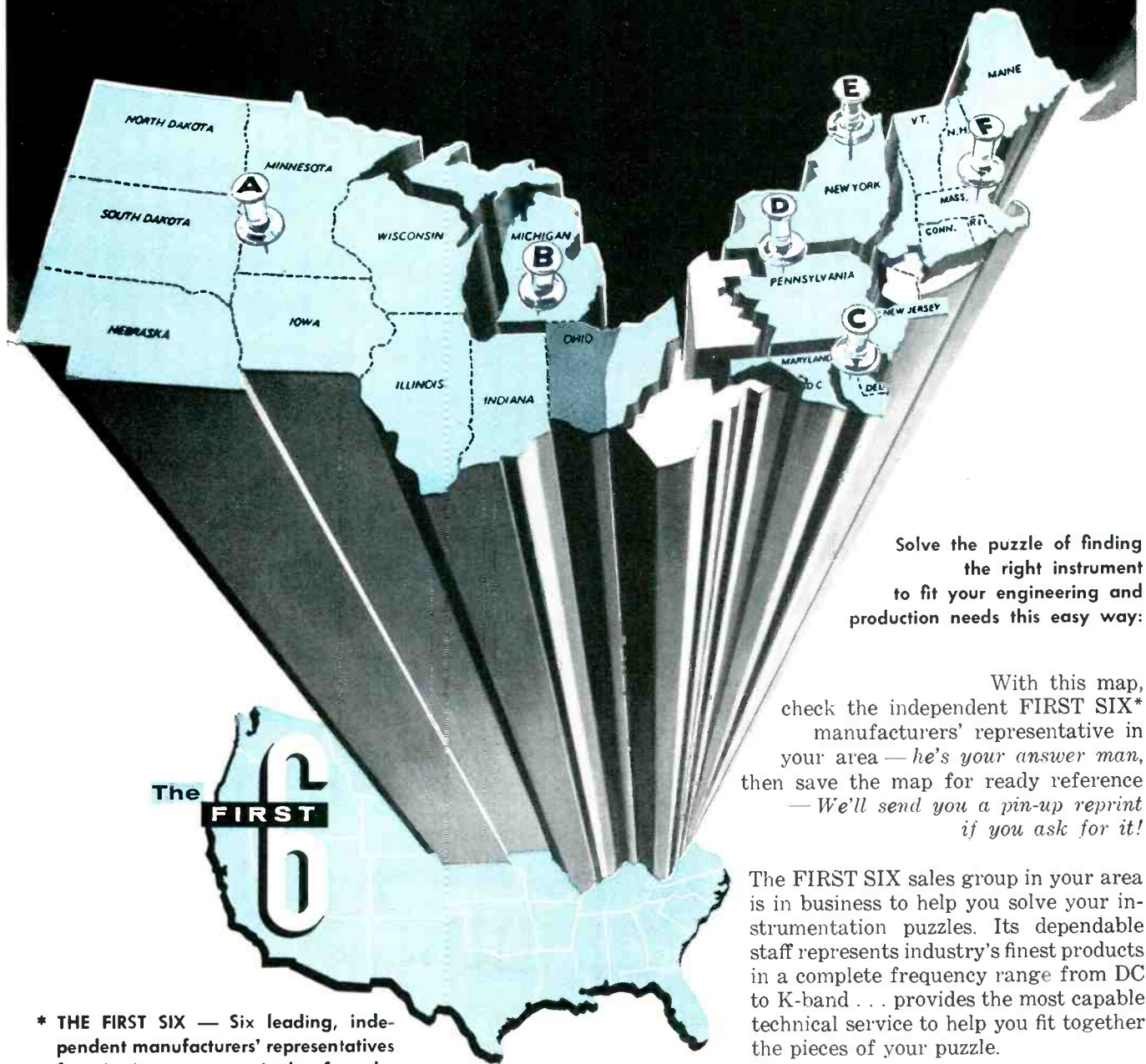

Solve the puzzle of finding the right instrument to fit your engineering and production needs this easy way:

With this map, check the independent FIRST SIX* manufacturers' representative in your area — he's your answer man, then save the map for ready reference — We'll send you a pin-up reprint if you ask for it!

The FIRST SIX sales group in your area is in business to help you solve your instrumentation puzzles. Its dependable staff represents industry's finest products in a complete frequency range from DC to K-band . . . provides the most capable technical service to help you fit together the pieces of your puzzle.

* THE FIRST SIX — Six leading, independent manufacturers' representatives functioning cooperatively for the advancement of improved electronic instrumentation in industry.



A. CROSSLEY ASSOC., INC.

Chicago, Ill.
Dayton, Ohio
St. Paul, Minn.



S. STERLING CO.

Detroit, Mich.
Cleveland, Ohio
Dayton, Ohio



HORMAN ASSOC., INC.

Washington, D. C.



THE I. E. ROBINSON CO.

Philadelphia, Pa. — (Upper Darby)
Camp Hill, Pa.
Asbury Park, N. J.



J. D. RYERSON ASSOC., INC.

Syracuse, N. Y.



YEWELL ASSOC., INC.

Waltham, Mass.
Bridgeport, Conn.

Shaded area indicates territorial overlap.

THE NEW WAVEGUIDE SWITCHES FEATURE:

HIGH ISOLATION

Designed for minimum leakage to insure radar silence.

RAPID OPERATION

Each switch performs its switching function in less than one-tenth of a second.

NO BOUNCE

Switch changes position without bouncing from its final position.

LOCKS MECHANICALLY

Special mechanical linkage locks positively in operating positions.

INTERLOCKS ELECTRICALLY

Electrical interlocks enable control of modulator and other system functions.

CHOICE OF ACTUATORS

Wide range of motor or solenoid drives available.

ELECTRICAL CHARACTERISTICS

1.1 VSWR; 0.2 db insertion loss.

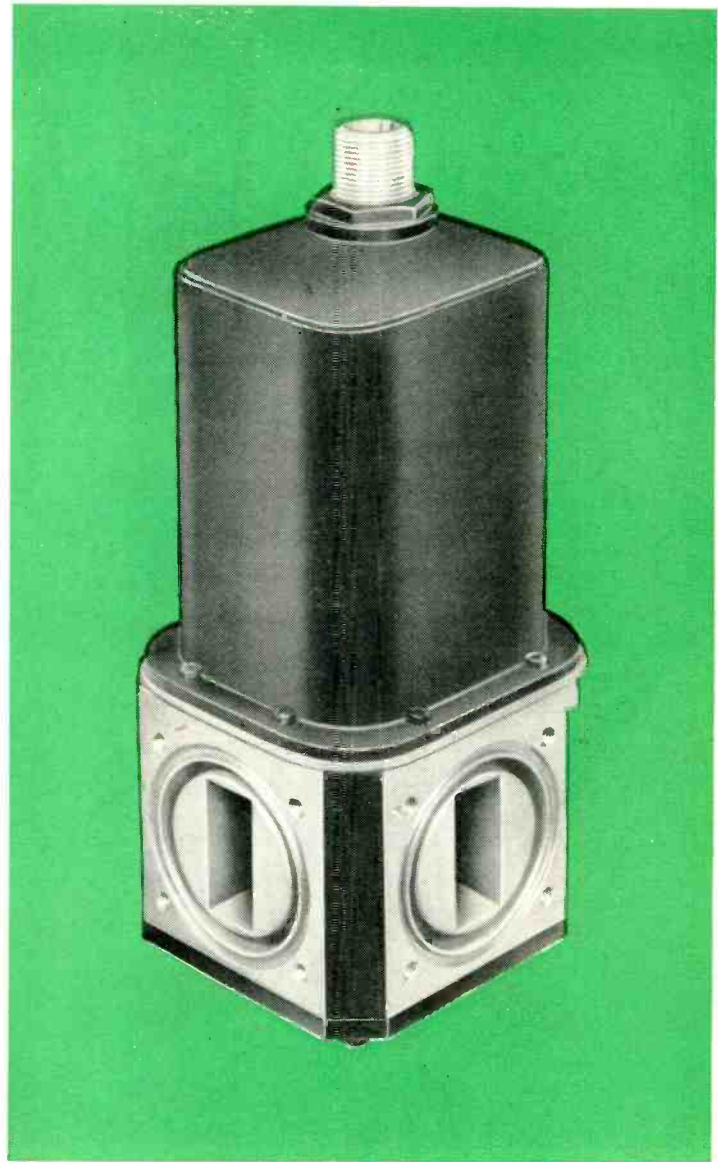

New Waveguide Switches insure radar silence

ENABLE TESTING OF HIGH-POWER RADARS

A group of light-weight, compact waveguide switches has been added to the Microline® group of quality system components. These switches permit simultaneous testing of several radars at one location—regardless of frequency—without interfering “noise”.

SPERRY *Microwave Electronics Division*
GYROSCOPE COMPANY
Great Neck, New York
DIVISION OF SPERRY RAND CORPORATION

CLEVELAND • NEW ORLEANS • BROOKLYN • LOS ANGELES • SAN FRANCISCO • SEATTLE
IN CANADA: SPERRY GYROSCOPE COMPANY OF CANADA, LIMITED, MONTREAL, QUEBEC

For transfer of microwave energy from one waveguide to another, the operator needs only to press a button and the waveguide switch will instantaneously route the radar energy into the antenna or dummy load as desired. This permits the radar radiation to be switched on or off at any instant without turning off the entire system.

Switch designs are available in waveguide sizes for S, C, X and K bands. Minimum size and weight make these units particularly useful for airborne application.

For further information on Sperry Waveguide Switches write our Microwave Electronics Division or our nearest district office.

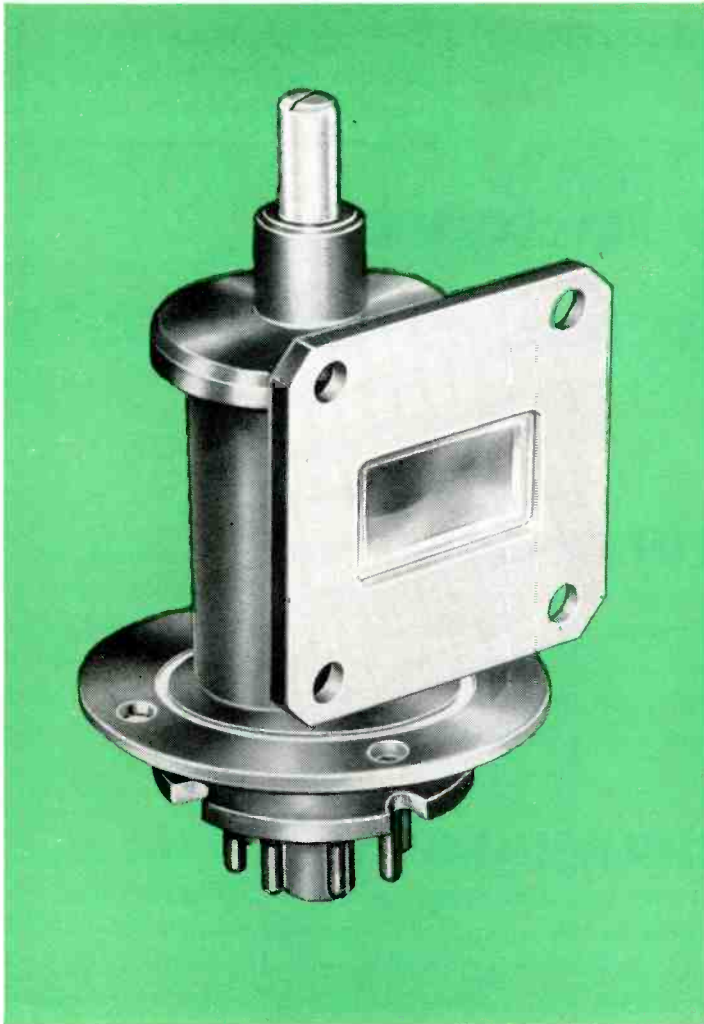

SRX-92

8,500 to 10,500 mc

Covers a 21% band. This rugged tube suits airborne applications requiring high stability, low hysteresis, symmetrical modes, and low leakage. Precision differential screw simplifies tuning, enables pre-tuning, and adapts readily to servo drives and remote mechanical tuning. Output, 50 mw. Beam voltage 300 v. Reflector range, -50 to -170 v. Ideal for instrumentation.

New Reflex Klystron covers broad frequency range

For airborne applications, new types of test equipment and new radar systems, Sperry has designed the SRX-92 Klystron to cover a 21% frequency band. This tube operates on low voltage and is especially valuable as a local oscillator.

The ruggedness of the SRX-92 assures reliability under the extreme conditions of shock and vibration found in aircraft and missile service. A high degree of stability prevents it from drifting off frequency or from varying in power or other characteristics when air temperatures about it fluctuate.

The SRX-92, because of its low hysteresis, symmetrical modes and high stability, is particularly suited for airborne applications requiring automatic frequency control. Its extremely low leakage makes it valuable for use in test equipment. Precision differential screw simplifies tuning, allows presetting to particular frequencies and adapts readily to servo drives and remote mechanical tuning.

FREQUENCY RANGE 8,500-10,500 mc

OUTPUT 50 mw

BEAM VOLTAGE 300 v

REFLECTOR RANGE -50 to -170 v

For further information on the SRX-92 and other new Reflect Klystrons, write our Electronic Tube Sales Department or nearest district office.

SPERRY *Electronic Tube Sales Department*
GYROSCOPE COMPANY
Great Neck, New York
DIVISION OF SPERRY RAND CORPORATION

CLEVELAND • NEW ORLEANS • BROOKLYN • LOS ANGELES • SAN FRANCISCO • SEATTLE
IN CANADA: SPERRY GYROSCOPE COMPANY OF CANADA, LIMITED, MONTREAL, QUEBEC

3

ways to save on assembly costs

Visit us at Booth 115
DESIGN ENGINEERING SHOW
Convention Hall, Philadelphia, May 14-17

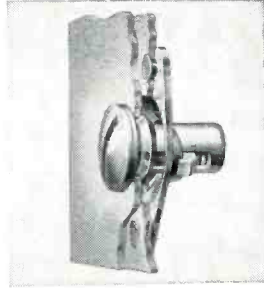
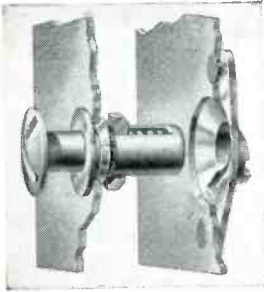

QUICK-LOCK For fastening removable access doors and panels. Because of its ease of installation, QUICK-LOCK is ideal for assembling removable panels. A 90° turn locks it in place. Stud is self-ejecting when unlocked; visual inspection shows whether fastener is locked. Spring loading takes initial load; solid supports carry increased load. Available in a wide range of sizes.

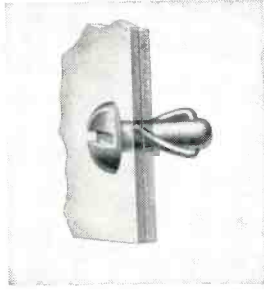
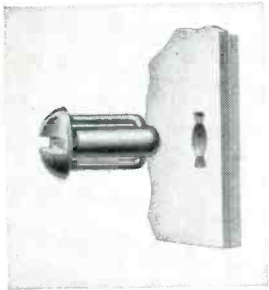

SPRING-LOCK One-piece fastener for blind holes has load-carrying steel spring wire. Spring steel arms lock fastener securely, prevent loosening under vibration. SPRING-LOCK will work with varying panel thicknesses, locks with a twist of the wrist. Made in all-metal and plastic with steel insert. The molded design permits heads to be made in various shapes for refrigerator shelf supports, washer knobs, brackets. Available in a wide variety of shapes and sizes, and also in custom designs.

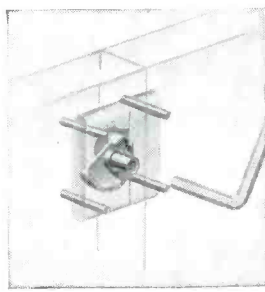
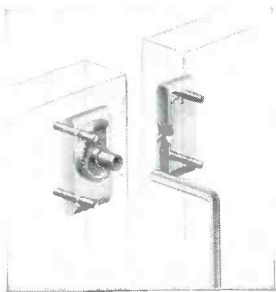

ROTO-LOCK Serrated, tapered cam is engaged by formed lug as fastener is locked. Cam action draws panels together tightly, insures locking even under conditions of misalignment. Opens easily for demounting. ROTO-LOCK carries heavy tension and shear loads; can be used for air and water-tight seals; recesses completely into panels. Solidly built without springs or delicate mechanical parts, unaffected by arctic temperatures or field service.

Simmons

QUICK-LOCK
SPRING-LOCK
ROTO-LOCK
LINK-LOCK
DUAL-LOCK

JUST OUT!
NEW 36-PAGE CATALOG WITH APPLICATIONS.
SEND FOR IT!

Simmons Fasteners are widely used in refrigerators, washing machines, electrical equipment, electronic assemblies, prefabricated portable shelters, coolers, demountable furniture. Every Simmons Fastener is a service-proved design with a long record of assembly-cost saving in many industries.

If you are interested in cutting your costs, turn to Simmons Fasteners—the fasteners with *uses unlimited*. Write for samples and catalogs today.

SIMMONS FASTENER CORPORATION
1750 NORTH BROADWAY, ALBANY 1, NEW YORK

Quickly...economically...

SOLVE CLOSURE PROBLEMS

with
HUDSON
Precision Drawn
CASES-COVERS



Thousands of Standard Designs available for fast delivery! Hudson offers a wide range of sizes from miniature to large in a variety of shapes that meet all but the most unusual closure requirements. Hundreds of optional features are available on most HUDSON standard cases and covers.

Complete Service on quality metal stampings and sheet metal work. Expert fabrication of simple or complex sub-assemblies to exact specifications.

SPECIFY HUDSON-

for precision components of:

**STEEL
BRASS
ALUMINUM
COPPER
MU METAL**

including:

certified alloy welding, certified spot welding, silver soldering and brazing. For complete information on standard closures write for the new Hudson catalog; for quotations on custom parts and sub-assemblies send drawings and specifications. HUDSON offers designers and engineers fast delivery of precision closures at commercial prices! Ask for quotations on your requirements today!



HUDSON STANDARD CLOSURES MEET PRACTICALLY EVERY DESIGN REQUIREMENT!



THREE
PLANTS TO
SERVE YOU



HUDSON TOOL & DIE COMPANY · INC

118-122 SOUTH 14th ST., NEWARK 7, N. J.
Telephone: HUMBOLDT 2-8561



New Lambda TRANSIENT-FREE Power Supplies

occupy only 5¼"
of panel height.

MODEL 281 125-325 VDC, 0-200MA.....\$149.50 MODEL 282 325-525 VDC, 0-200MA.....\$159.50
 MODEL 281M (with meters)125-325 VDC, 0-200MA.....\$179.50 MODEL 282M (with meters)325-525 VDC, 0-200MA.....\$189.50

S P E C I F I C A T I O N S

LAMBDA "200 MA SERIES"

DC OUTPUT* (regulated for line and load):

Voltage and Current

Models	Voltage Range ¹	Current Range ²
281, 281M	125-325 VDC	0-200 MA
282, 282M	325-525 VDC	0-200 MA

¹Voltage range for any given model is completely covered in four continuously variable bands.

²Current rating applies over entire voltage range.

Regulation (line)Better than 0.15% or 0.3 Volt (whichever is greater). For input variations from 105-125 VAC.

Regulation (load)Better than 0.25% or 0.5 Volt (whichever is greater). For load variations from 0 to 200 MA.

Transient Response

(line).....Output voltage is constant within regulation specifications for step-function line voltage change of plus (+) 10 volts or minus (-) 10 volts rms within the limits of 105-125 VAC.

Transient Response

(load).....Output voltage is constant within regulation specifications for step-function load change between 0 to 200 MA or 200 to 0 MA.

Internal ImpedanceLess than 6 ohms

Ripple and NoiseLess than 3 millivolts rms

PolarityEither positive or negative may be grounded

*NOTESufficient tolerance is incorporated in the specifications to allow for normal commercial component and tube deviations. Tube replacements may be made with any equivalent tubes meeting RETMA specifications.

AC OUTPUT (unregulated):6.5 VAC at 10A (at 115 VAC input). Allows for voltage drop in connecting leads. Isolated and ungrounded.

AC INPUT:105-125 VAC, 50-400 CPS

Models	Input Power ³
281, 281M	330 watts
282, 282M	385 watts

³With all outputs loaded to full ratings and input at 125 VAC.

AMBIENT TEMPERATURE

AND DUTY CYCLE:.....Continuous duty at full load up to 50°C (122°F) ambient.

OVERLOAD PROTECTION:

External Overload ProtectionAC and DC fuses, front panel, with built-in blown-fuse indicators

Internal Failure ProtectionFuse, rear of chassis

INPUT AND OUTPUT CONNECTIONS:

.....Heavy duty barrier terminal block, rear of chassis. 8 foot heavy duty rubber covered line cord with integral molded plug, also supplied.

METERS:

Output Voltage3½" rectangular voltmeter on metered models.

Output Current3½" rectangular milliammeter on metered models.

CONTROLS:

DC Output ControlsBand-switches and screw-driver adjusting vernier-control, rear of chassis.

AC and DC SwitchesFront panel

VOLTAGE REFERENCE:.....A stable 5651 reference tube is used to obtain superior long-time voltage stability.

PHYSICAL DATA:

MountingStandard 19" rack mounting.

Size5¼" H x 19" W x 14⅜" D

Weight53 lb. net, 80 lb. shipping weight.

Panel FinishBlack ripple enamel (standard). Special finishes available to customers' specifications at moderate surcharge.

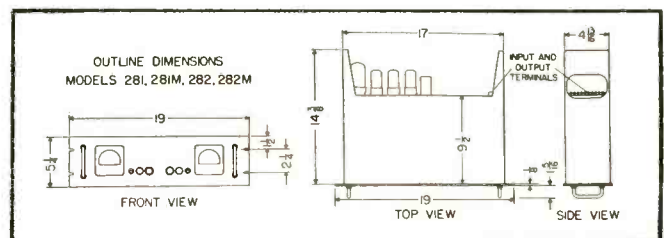

**INTRODUCED AT THE
1956
I.R.E. SHOW**

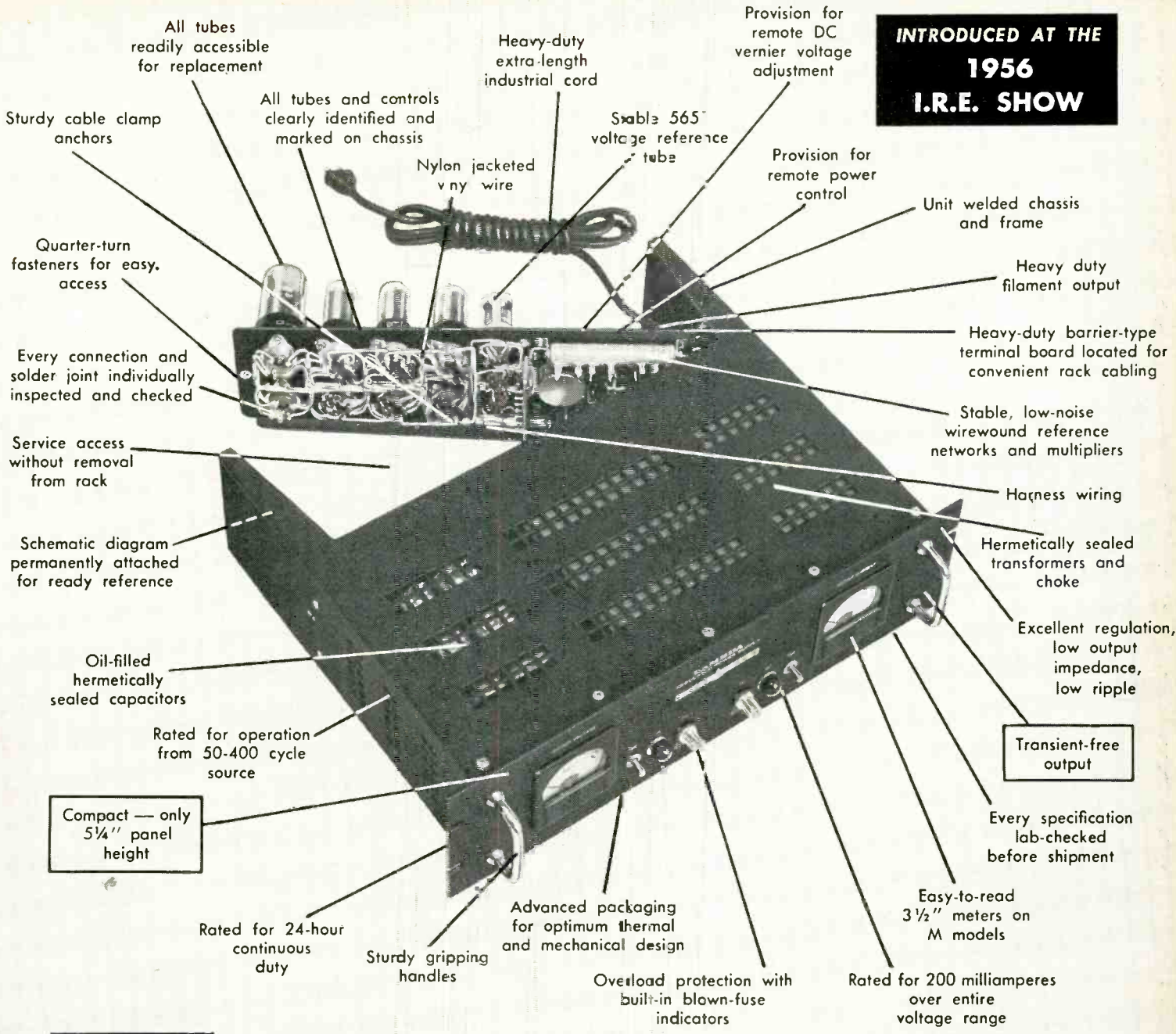

NEW!

**LAMBDA "200 MA" POWER SUPPLIES
SAVES
PANEL SPACE**

These compact, regulated D.C. power supplies have been designed to occupy minimum panel area. They combine new convenience and accessibility with precision engineering and heavy-duty construction. New features include fuse failure indicators, transient-free operation, and hermetically-sealed transformers and chokes.



LAMBDA Electronics Corp.

THE FIRST NAME IN POWER SUPPLIES

11-11 131 STREET • COLLEGE POINT 56, NEW YORK • INdependence 1-8500

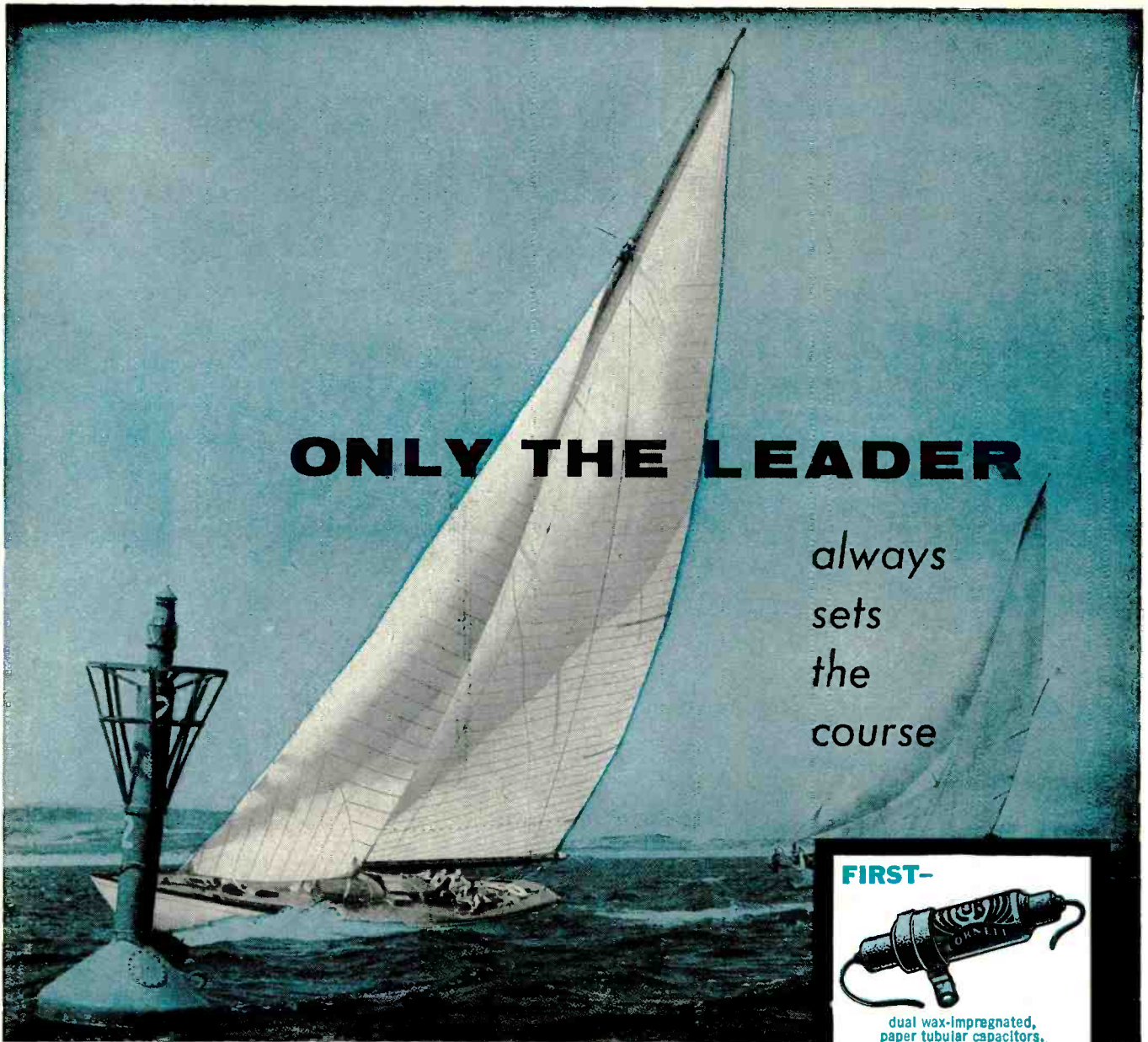

ONLY THE LEADER

*always
sets
the
course*

FIRST-



dual wax-impregnated,
paper tubular capacitors.

Charting the course of the future in the manufacture of capacitors has always been the practice at Cornell-Dubilier. Proof of this leadership is that capacitor developments originated at C-D invariably become the standards of comparison for the entire industry.

FIRST-



low voltage dry
electrolytic capacitors.

C-D...45 YEARS OF FAMOUS FIRSTS

Typical of these "famous firsts" are the three examples shown here . . . proof that whatever your capacitor requirements may be, your needs can be filled by C-D. Write to Cornell-Dubilier Electric Corp., Dept. K-56, South Plainfields, N. J.

FIRST-



capacitor used in proximity fuse.



CONSISTENTLY DEPENDABLE
CORNELL-DUBILIER CAPACITORS

PLANTS IN SO. PLAINFIELD, N. J.; NEW BEDFORD, WORCESTER AND CAMBRIDGE, MASS.; PROVIDENCE AND HOPE VALLEY, R. I.; INDIANAPOLIS, IND.; SANFORD AND FUQUAY SPRINGS, N. C.; SUBSIDIARY, RADIART CORP., CLEVELAND, OHIO.

THERE ARE MORE C-D CAPACITORS IN USE TODAY THAN ANY OTHER MAKE

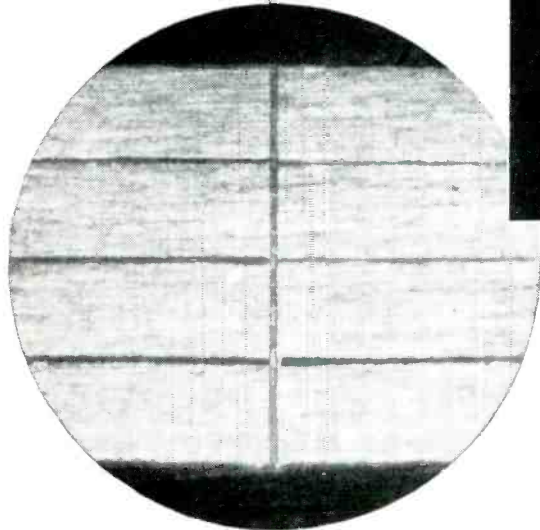
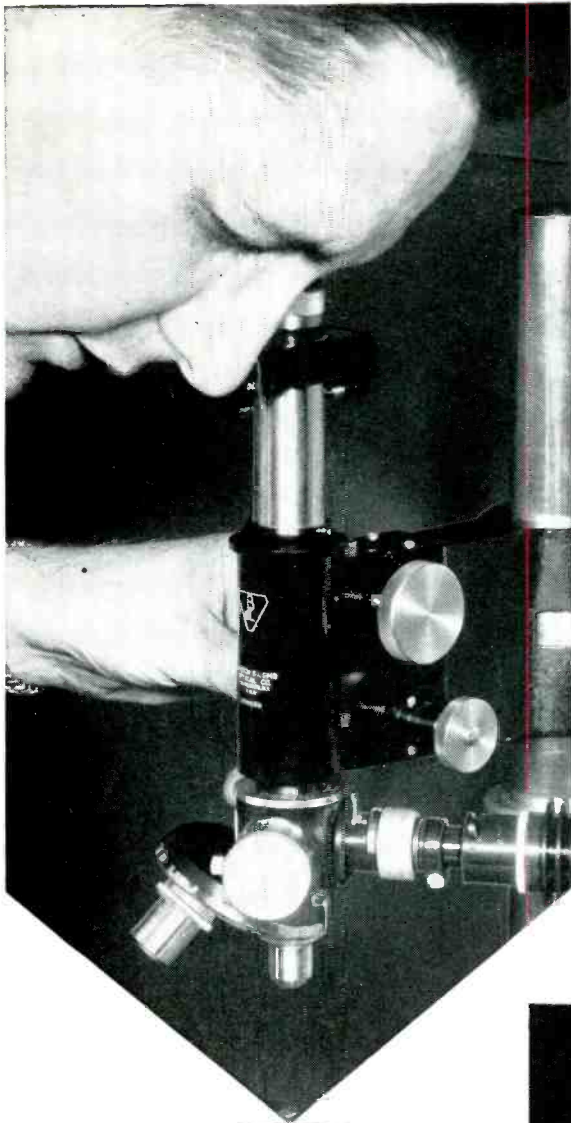

400X enlargement shows high precision gap and track construction.

BRUSH *announces...*

**NEW PRECISION
MAGNETIC HEADS FOR
CRITICAL RECORDING
APPLICATIONS**

Brush now offers a new design concept in multi-channel magnetic heads which provides extremely close tolerances to assure accuracy in recording and reproduction. These heads have already been proven in exacting airborne and missile applications.

ADVANTAGES

- Uniform output assured by close mechanical tolerances on track width and channel spacing ... $\pm .002$ in. maximum.
- Channel-to-channel timing accuracy provided by precise gap alignment... $\pm .0001$ in. maximum.
- Crosstalk minimized by full shielding.
- Sustained accuracy under severe operating conditions assured by our new construction techniques.

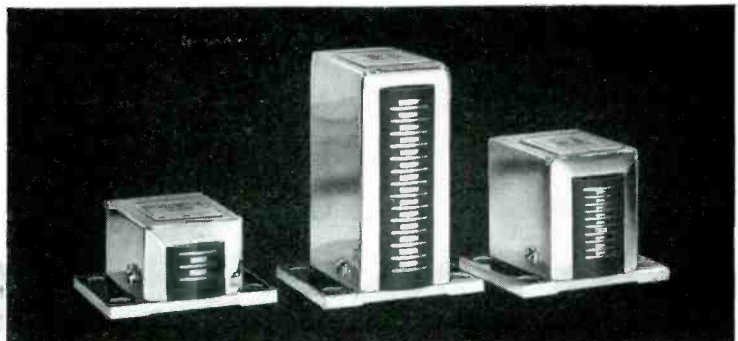

AVAILABILITY

Brush offers these heads in three designs: providing 7, 8, or 13 tracks per inch. Heads may be interlaced to provide up to 25 tracks per inch. Modifications or new designs using this construction technique may be made to your requirements. Consult Brush on your magnetic head needs—write Brush Electronics Company, Department K-50, 3405 Perkins Avenue, Cleveland 14, Ohio.

BRUSH ELECTRONICS

3405 Perkins Avenue, Cleveland 14, Ohio



COMPANY

DIVISION OF



We asked Servo Engineers what they needed

For testing
Servo Systems in:

missile guidance systems
aircraft control systems
machine tool control
material handling systems
automation systems
autopilots

new

SERVO ANALYZER



ELECTRONICS COMPANY

This new amplifier, coupled to a Brush direct-writing oscillograph, provides a package unit to record performance of any servo system operating in the carrier frequency range of 50 to 10,000 cps. It offers performance features available for the first time—features requested by leading Servo Engineers in a survey made by Brush application specialists.

EXCLUSIVE FEATURES

Exceptional frequency response . . . on a 400-cycle carrier, 1 db down at 100 cycles. On a 60-cycle carrier, 1 db down at 4 cycles, 3 db down at 7 cycles.

Flexibility . . . a high impedance input permits use in either single-ended or balanced operation. Error signal is isolated from the reference signal. In addition, pen drive d.c. amplifier section can be used as a separate unit.

High accuracy . . . phase-shift compensated attenuator permits holding phase shift to negligible amounts. Phase shifter with calibrated dial permits determining phase shift between error and reference signals within 1 degree.

The Brush Servo Analyzer system permits complete servo operation testing and trouble-shooting. Immediately available records aid in: synchronizing signals, measuring feedback signals, carrier phase measurements, checking angular difference, measuring voltage magnitude and wave shape, etc. Ask your Brush representative for complete information on the Model BL-560, or write Brush Electronics Company, Dept. K-5, 3405 Perkins Avenue, Cleveland 14, Ohio.

BRUSH ELECTRONICS
3405 Perkins Avenue, Cleveland 14, Ohio



COMPANY

DIVISION OF



in test instrumentation...then we designed the

Brush AMPLIFIER

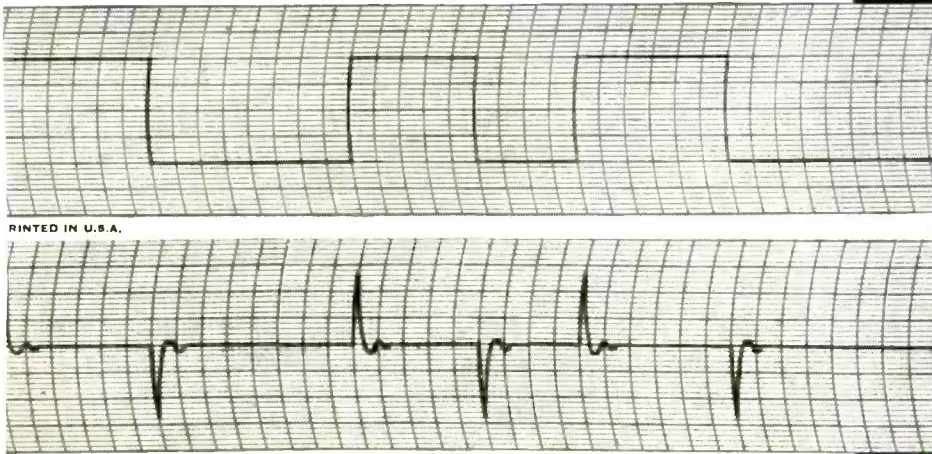

▲ Two channel recording of test of servo control system. Up to six channels of information can be recorded if desired.

Mobile instrument cart carries complete gear ▶ for servo testing, consists of two amplifiers and dual channel oscillograph. Equipment can also be mounted in racks or consoles.

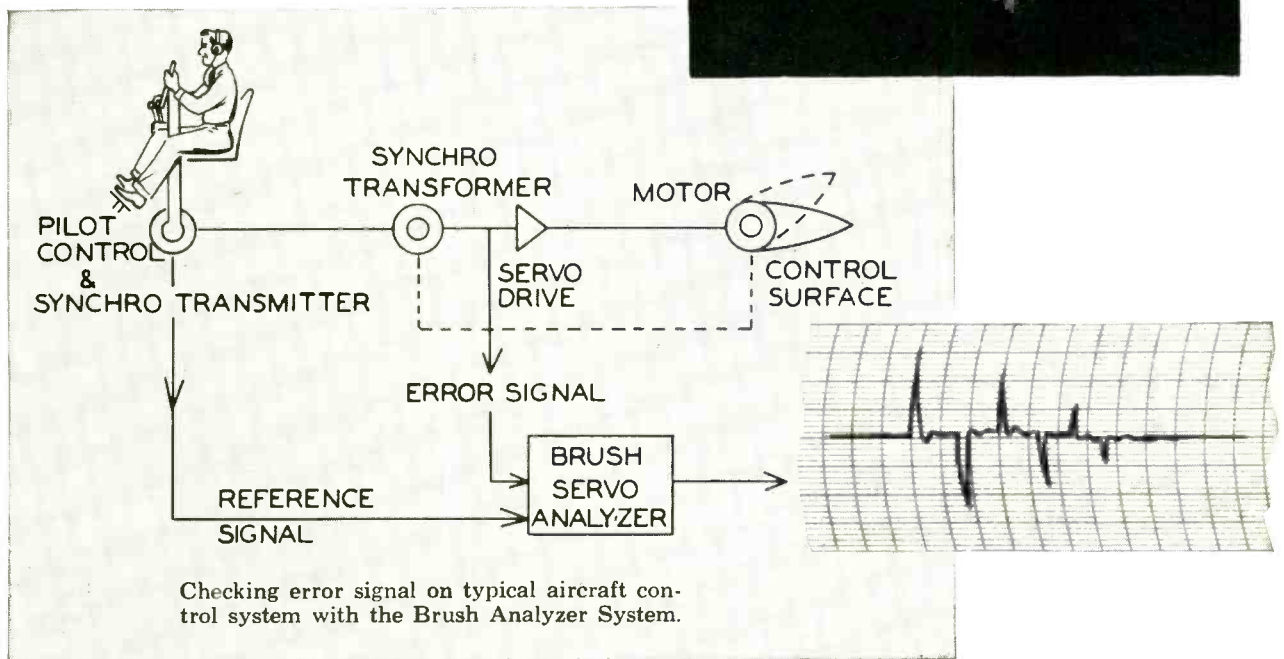
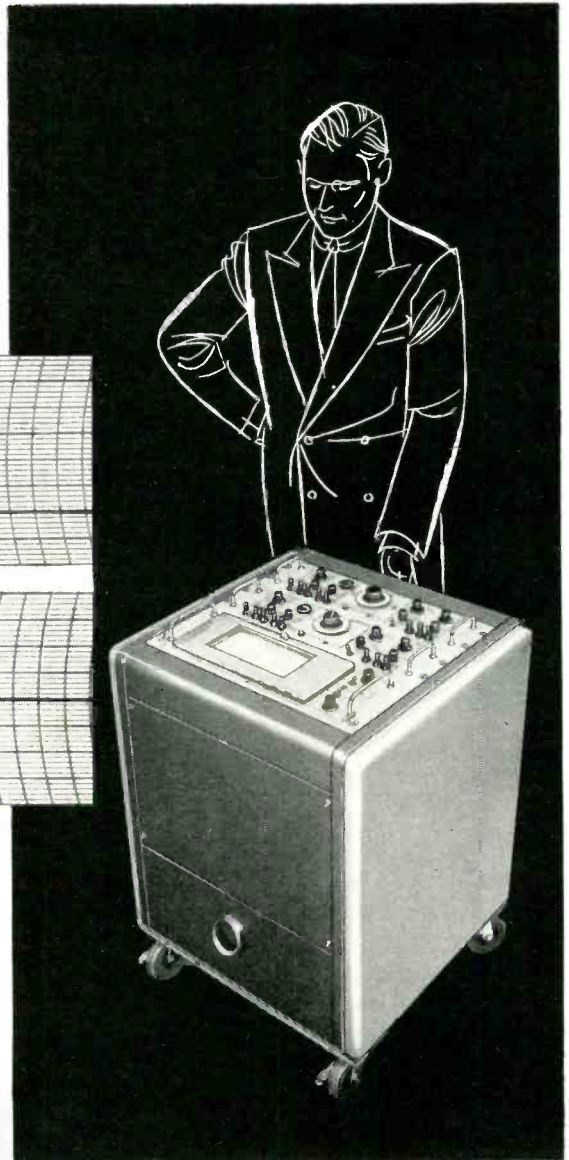

Checking error signal on typical aircraft control system with the Brush Analyzer System.



Westinghouse Germanium Semitron

*rated at 250 amperes . . .
no derating for
parallel operation*

The Westinghouse germanium Semitron* rectifying cell, rated at 250 amperes, is ideally suited to electroplating, electrochemical, anodizing and other low-voltage applications.

No derating is required for parallel operation. All production units have a *matched* characteristic of forward voltage drop at the maximum operating peak current.

The cell is water cooled. At recommended rate of flow of one gallon per minute, the maximum temperature rise of the water through one cell is $\frac{3}{4}^{\circ}$ C.

Hermetic seal protects against atmospheric contamination.

Three voltage ratings are available now in production quantities . . . 26 volts rms, a-c; 45 volts rms, a-c; and 66 volts rms, a-c. Use coupon for more information.

Important electrical data on production units . . .

WA-4052-C

250 amperes . . . Maximum average d-c per cell
66 volts a-c . . . Maximum rms a-c from no load to full load
.7 volts . . . Peak forward voltage drop at 250 amperes d-c
6500 amperes . . . Peak surge current for 1 cycle
4000 amperes . . . Peak surge current for 6 cycles
2400 amperes . . . Peak surge current for 6 seconds

*Trade-Mark

J-09003

Westinghouse Electric Corporation
3 Gateway Center, P.O. Box 868
Pittsburgh 30, Penna.

I'm interested in more information about Westinghouse germanium Semitron rectifying cells.

NAME _____ TITLE _____

FIRM _____

ADDRESS _____

CITY _____ STATE _____

YOU CAN BE SURE...IF IT'S
Westinghouse



ALSiMAG[®]

614

alumina ceramics

Industry Approved

Accurately Controlled

Available in Quantity

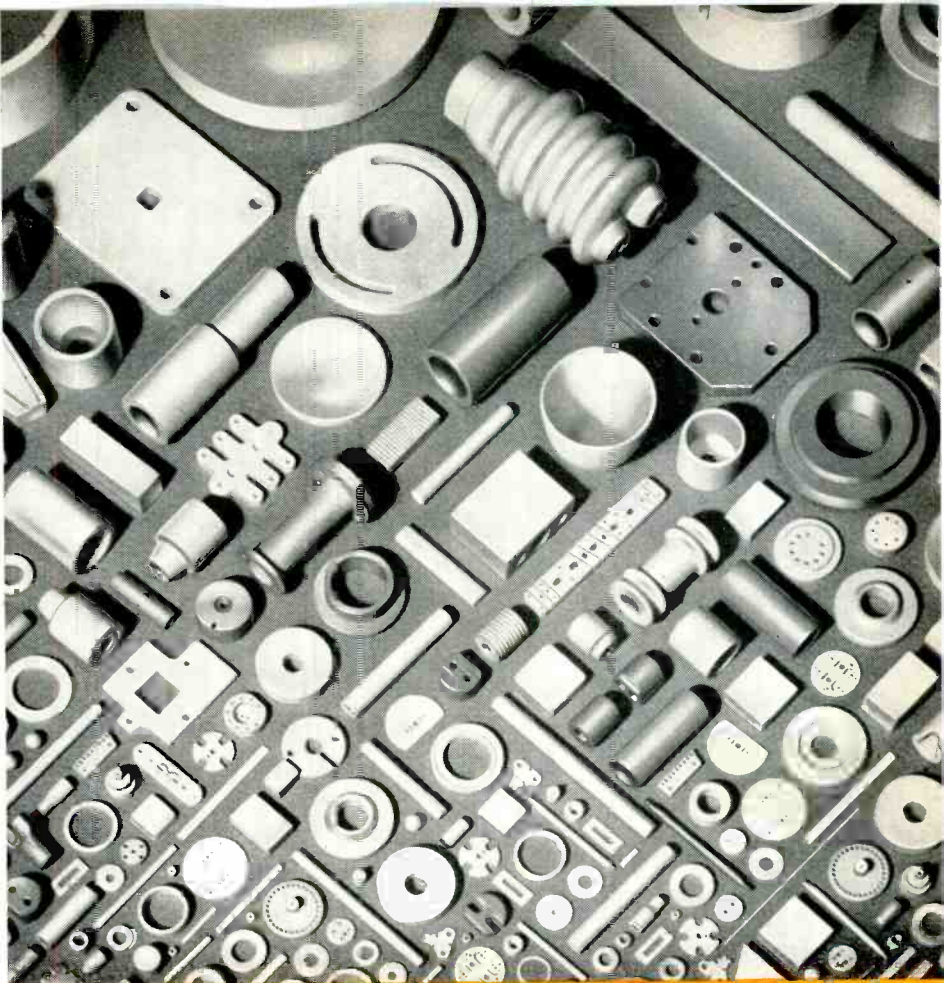

Technical ceramics perform the most difficult electrical, mechanical and chemical jobs. Where ordinary ceramics won't do, Aluminas take over. They're "Annie Oakleys" that do everything better—especially at high frequencies and temperatures or where mechanical wear is a problem.

Standout among Aluminas is ALSiMag 614—a proven success, industry tested. Available in quantity and of dependable high quality—stays uniform from piece to piece and lot to lot.

If ALSiMag 614 isn't right for your job, choose from a complete range of special characteristic Aluminas. As in regular ceramics, ALSiMag has the widest choice available from any source. Custom formulations for unusual requirements.



Large scale production facilities devoted exclusively to Aluminas . . . from raw material to high temperature, continuous firing . . . are ready to serve you NOW. Standard or custom high temperature metalizing also available.

PLANTWIDE VACATION

First two Weeks of July



Buy Alumina ceramics from this dependable source. Send blueprint or sketch for complete details. **NEW Bulletin 562 on Alumina ceramics sent on request.**

55TH YEAR
OF CERAMIC
LEADERSHIP

AMERICAN LAVA CORPORATION

CHATTANOOGA 5, TENNESSEE
A Subsidiary of
Minnesota Mining and Manufacturing Company

Branch offices in these cities (see your local telephone directory): Cambridge, Mass. • Chicago, Ill. • Cleveland, Ohio • Dallas-Houston, Texas • Indianapolis, Ind. • Los Angeles, Calif. • Newark, N. J. • Philadelphia, Pa. • St. Louis, Mo. • South San Francisco, Calif. • Syracuse, N. Y. • Tulsa, Okla. **Canada:** Irvington Varnish & Insulator Div., Minnesota Mining & Mfg. of Canada, Ltd., P. O. Box 757, London, Ontario. **All other export:** Minnesota Mining & Mfg. Co., International Division, 99 Park Ave., New York, N. Y.



DATA FOR

RCA BOOKLETS AVAILABLE

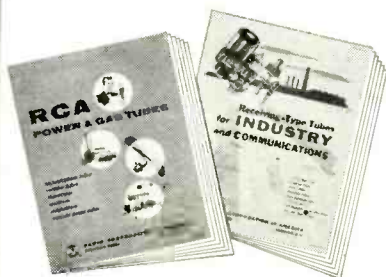

RCA Receiving Tubes for AM, FM, and Television Broadcast—gives characteristics and socket connections for more than 600 receiving-type tubes and TV-picture tubes. For your copy, circle 1275-G on coupon below.

RCA Photosensitive Devices and Cathode-Ray Tubes—contains physical descriptions and data: gas, vacuum, and multiplier phototubes; camera tubes; monoscopes; oscillograph tubes; and kinescopes for specialized uses. For your copy, circle CRPD-105 on coupon below.

For sales information on any of the products shown, contact your RCA Representative at the RCA District Office nearest you:

EAST: Humboldt 5-3900
744 Broad Street
Newark 2, N. J.

CENTRAL: Whitehall 4-2900
Suite 1181
Merchandise Mart Plaza
Chicago 54, Ill.

WEST: Raymond 3-8361
6355 East Washington Blvd
Los Angeles 22, Calif.

1275-G

CRPD-105

NAME _____

COMPANY _____ TITLE _____

ADDRESS _____

RCA MEMORY DEVICES: FERRITE CORES • TRANSFLUXOR

RCA-219M1 . . . a torroid-shaped, 0.55-ampere-turn-drive, ferrite core; **RCA-216M1** . . . a torroid-shaped, 0.95-ampere-turn-drive, ferrite core. Both types are characterized by hysteresis loops which provide reversal of magnetic-flux polarity when the correct current combination from two associated magnetized windings are coincidentally energized. These ferrite cores are primarily designed for use in matrices of the coincident-current type for applications as storage devices in digital computers.

RCA Dev. No. XF-1501 TRANSFLUXOR . . . this developmental memory device originated by RCA utilizes a ferrite core, has two apertures, and exhibits a nearly rectangular hysteresis loop. It can control the transmission of ac power according to a level established by a single setting pulse. It furnishes an output determined by the stored pulse for an indefinite length of time. Once "set" the TRANSFLUXOR does not require an input command to furnish output intelligence.

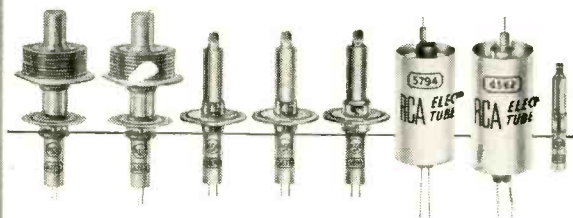

RCA "PENCIL" TUBES FOR RADIOSONDE METEOROLOGICAL SURVEY, AIRCRAFT-CONTROL EQUIPMENT, COMMUNICATIONS, AND UHF TEST APPARATUS

RCA-6263, -6264, -5876, -5675, -5893, -5794, -6562, and -6173 . . . among the outstanding features of these types are small size, light weight, low heater voltage, good thermal stability, minimum transit time, low lead inductance, low interelectrode capacitances, and high efficiency. Applications include oscillator, frequency multiplier, power amplifier, and pulse detection.

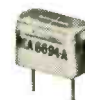

TINY-SIZE PHOTOCONDUCTIVE CELL

RCA-6694-A . . . head-on type cadmium-sulfide cell, features high luminous sensitivity, very low dark current, extremely low background noise. Signal output is approximately proportional to incident light intensity. Especially useful in light-controlled relay applications, and in light meters for measuring small luminous spots.

DESIGNERS

ELECTRON TUBES
SEMICONDUCTOR DEVICES
BATTERIES
TEST EQUIPMENT
ELECTRONIC COMPONENTS

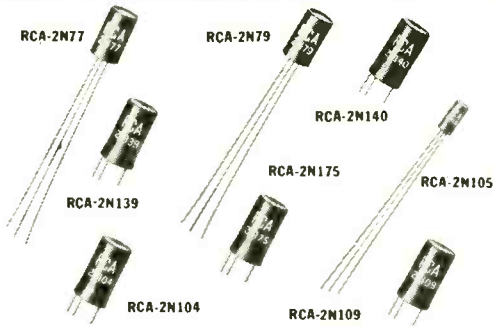

RCA HIGH-QUALITY TRANSISTORS COMMERCIALLY AVAILABLE

RCA's high-quality transistors are the result of years of experience in research, development, and production of solid-state materials and devices. RCA transistors are quality-controlled for exceptional uniformity of characteristics and stability throughout long life. All are hermetically sealed, germanium-alloy junction transistors of the p-n-p type. They are useful in the following services for commercial and military applications: low-power af, large-signal af, rf converter, rf amplifier, and low-noise preamplifier.

RCA COMPUTER-TYPE TUBES PROVIDE CONSISTENCY OF PLATE CURRENT DURING "ON" CYCLES

Designed, manufactured, and fully tested to assure long-life and stability of operation in "on-off" control applications; all are heater-cathode types. Except for type 5915, they are primarily designed for frequency-divider circuits in electronic computers.

RCA-5915
pentagrid ampli-
fier for "gating"
circuits, 7-pin
miniature type



RCA-5964
medium-mu twin
triode, 7-pin
miniature type

RCA-5965
medium-mu twin
triode, 9-pin
miniature type

RCA-6211
medium-mu twin
triode, 9-pin
miniature type

RCA-5963
medium-mu twin
triode, 9-pin
miniature type

RCA-6197
power pentode,
9-pin
miniature type

NEW KINESCOPIES AVAILABLE FOR PORTABLE AND LIGHTWEIGHT TV SETS

RCA-8DP4 . . . has spherical Filterglass faceplate, a screen $7\frac{3}{8}$ " x $5\frac{3}{8}$ ", and a minimum projected screen area of 35.5 sq. in. Utilizes 90° deflection, and low-voltage electrostatic focus. Short overall length: $10\frac{3}{4}$ " and light weight: 3 pounds, make RCA-8DP4 suitable for use in portable-type designs.

RCA-14RP4 . . . has spherical Filterglass faceplate, a screen $12\frac{1}{8}$ " x $9\frac{3}{8}$ " and a minimum projected screen area of 108 sq. in. Utilizes 90° deflection, and low-voltage electrostatic focus. Short overall length: $14\frac{7}{8}$ " and light weight: $8\frac{1}{2}$ pounds.

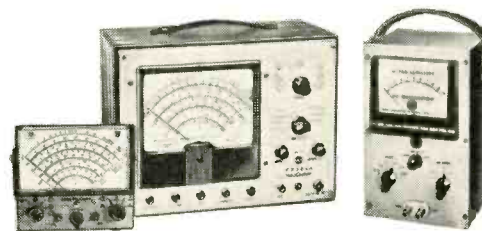

RCA TEST EQUIPMENT—CHOICE OF CRITICAL ENGINEERS FOR LABORATORY, PRODUCTION-LINE, FIELD USE

Senior VoltOhmyst®—RCA WV-98A . . . new addition to the well-known group of RCA Vacuum-Tube Voltmeters features large, easy-to-read wide-vision meter ($6\frac{1}{2}$ " w.); accuracy of $\pm 3\%$ full-scale on both ac- and dc-voltage measurements, direct peak-to-peak reading of complex waveforms. Your "work-horse," it can really take rough handling.

Master VoltOhmyst®—RCA WV-87A . . . features a 27-sq. in. meter. Has accuracy and stability necessary for many laboratory applications. Particularly useful for TV, radar, and other types of pulse work; calibrated scale reads peak-to-peak voltages directly.

Ultra-Sensitive DC Microammeter—RCA WV-84A . . . for reading extremely "feeble" currents from 0.0002 to 1000 μ a. Can be used as a very-high-resistance voltmeter—up to 1005 megohms on 100-volt range. As a megohmmeter, resistances to 90,000 megohms can be measured. Well suited for use in the fields of biology, nucleonics, chemistry, electromechanics. Completely self-contained, portable.

RCA TEST INSTRUMENTS ARE AVAILABLE THROUGH YOUR RCA DISTRIBUTOR



RADIO CORPORATION of AMERICA
TUBE DIVISION SEMICONDUCTOR DIVISION
HARRISON, N. J.

SPECIALIZATION IN

Communication

The excellence now attainable in communication systems is a product of 20 years of electronic research at Collins. Collins engineering research, development, and manufacturing facilities are without equal. Staffs of communication experts assure the highest level of radio communication performance, which backs the Collins reputation. A Collins installation incorporates the most advanced techniques—Transhorizon "Scatter" Propagation, Microwave Relay, and Single Sideband HF Developments—all compatible with existing communication systems.

TRANSHORIZON

Multi-channel Transhorizon circuits offer highly reliable and economical long range communication over water, mountainous or sparsely populated terrain where construction of microwave facilities is impractical. Collins is the only company to have available now the entire "Scatter Propagation" line of basic equipment including transmitters, exciter modulators, frequency standards, RF filters and VHF and UHF antennas, together with multiplex and predicted wave signalling equipment. Complete system planning is tailored to meet the individual installation's requirements.

MICROWAVE

Collins Microwave Systems provide extremely reliable channels for long distance communication and remote control. Collins Mechanical Filters assure the most efficient channel usage, and permit reduction of the number of components to facilitate maintenance. Building block construction gives flexibility in future expansions as system requirements change.

HIGH FREQUENCY SSB

New single sideband transmissions solve many problems in HF communication. Concentrating RF power in the sidebands conserves spectrum space and reduces adjacent channel interference. Selective fading and interference problems of multipath transmissions are also minimized by SSB. Collins pioneering in SSB has produced the most advanced line in HF equipment.

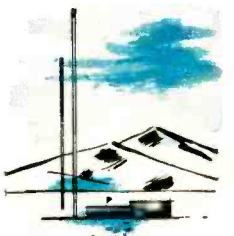
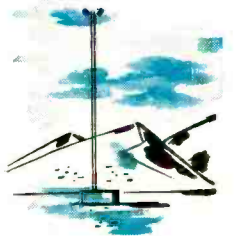

When planning a radio communication system, consult Collins for assistance in all phases of the engineering. Technical literature is available for the over-all design and individual equipment.

CREATIVE LEADER IN COMMUNICATION

Collins



COLLINS RADIO COMPANY, Cedar Rapids, Iowa; 1930 Hi-Line Drive, Dallas 2, Texas; 2700 W. Olive Avenue, Burbank, California; 261 Madison Avenue, New York 16, New York; 1200 18th Street N.W., Washington, D. C.; COLLINS RADIO COMPANY OF CANADA, LTD., 11 Bermondsey Road, Toronto 16, Ontario; COLLINS RADIO COMPANY OF ENGLAND, LTD., Sunflex Works, Colham Mill Road, West Drayton, Middlesex, England.



Amperex®

all-glass GERMANIUM DIODES

a complete line by a world leader in electron tubes and semiconductors

STABLE • UNIFORM • TIGHT-TOLERANCE

Each AMPEREX germanium diode is all-glass . . . fusion sealed . . . and available in both a clip-in ('GA') and a solder-in ('G') version.

Preferred ENTERTAINMENT DIODES

- video detector types
1N60G, 1N87G, and OA73
- DC restorer type 1N88G
- AGC and AM detector type 1N541
- matched-pair ratio detector
for TV and FM receivers — type 1N542

COMPUTER DIODES

- recovery-time and high-temperature tested types
- tight-tolerance, point-contact, high-temperature guaranteed types.

GENERAL PURPOSE and REPLACEMENT DIODES

- 100 volt types
- high back-resistance types
- 1 megohm back types
- video detector types

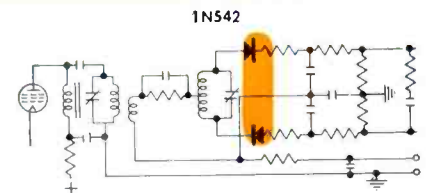

RATIO DETECTOR

	DIODE TYPE		DIODE TYPE
	1N480	1N490	1N476 & 1N478
Solder-In			1N477 & 1N479
Clip-In	1N119	1N120	
Back Resistance at -20 to -50 volts at 55°C.	400K	200K	Min. and Max. characteristic limits specified at both 25°C. and 60°C. Replace most point-contact types.
Forward Current	5 ma at +1 volt		

including . . .

1N34G	1N54G	1N63G	1N68GA
1N34GA	1N54GA	1N63GA	1N87GA
1N38G	1N58G	1N67G	1N89G
1N38GA	1N58GA	1N67GA	1N89GA
1N48G	1N60GA	1N68G	1N90G
1N48GA			1N90GA

. . . and other specially tested types

AMPEREX also has available a complete line of audio and switching *transistors* of all-glass construction.

For detailed data or applications-engineering consultation, write to
Semiconductor and Special Purpose Tube Department

Amperex ELECTRONIC CORP.

230 DUFFY AVENUE, HICKSVILLE, LONG ISLAND, N. Y.



How can **AMPEREX**® make
so many 4X-150's so fast
with such uniformity?

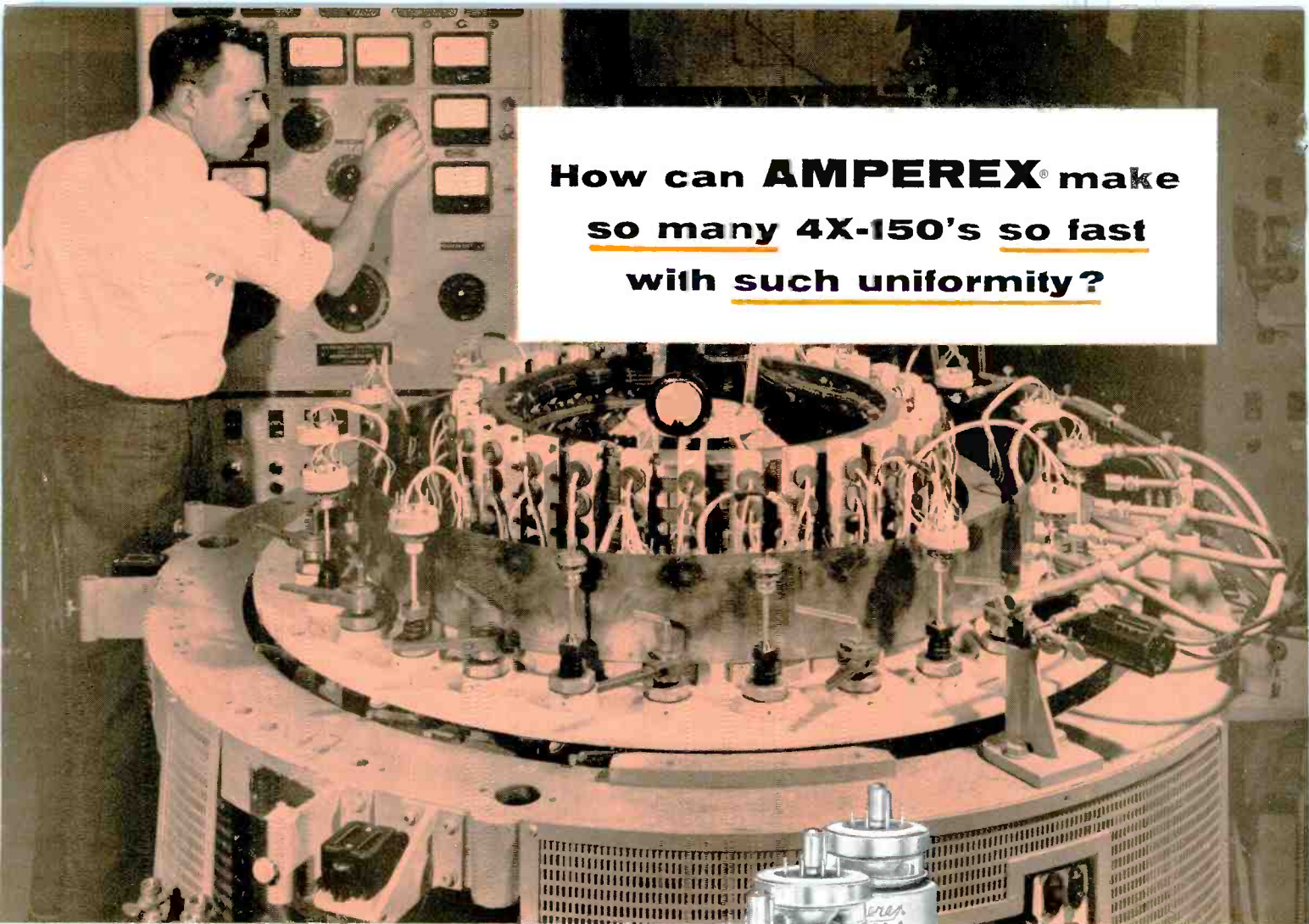

PRECISION AUTOMATION is the answer!

The sensational automatic exhaust machine recently developed by AMPEREX speeds up production of JAN approved 4X-150 series RF power amplifier tetrodes by a factor of four . . . helps achieve unprecedentedly uniform emission and life characteristics . . . yet leaves time for individual testing of each tube *beyond* JAN specifications! Precision automation at AMPEREX means higher performance and more rigid quality control *because of*, not in spite of, mass production. Any AMPEREX 4X-150 will perform exactly like its many hundreds of mates produced the same day . . . exactly like the many thousands produced the same week.

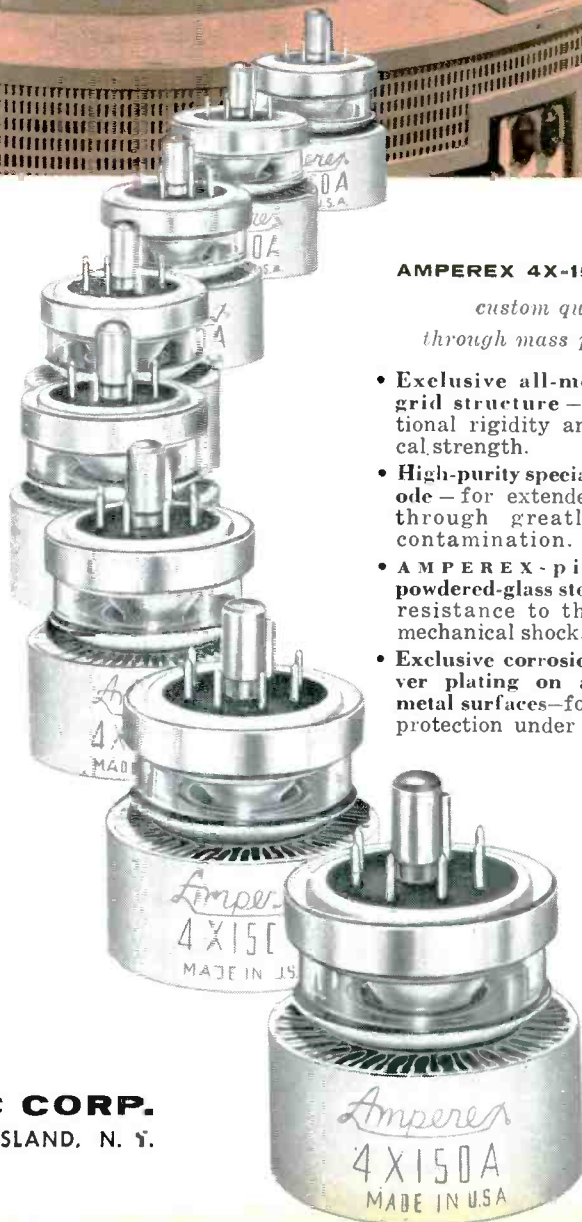

AMPEREX 4X-150 TYPES

*custom quality
 through mass production*

- Exclusive all-molybdenum grid structure—for exceptional rigidity and mechanical strength.
- High-purity special-alloy cathode—for extended tube life through greatly reduced contamination.
- AMPEREX-pioneered powdered-glass stem—for high resistance to thermal and mechanical shock.
- Exclusive corrosion-proof silver plating on all external metal surfaces—for maximum protection under exposure.

*If not available from your favorite
 Electronic Parts Distributor, write to:*



Amperex ELECTRONIC CORP.
 230 DUFFY AVENUE, HICKSVILLE, LONG ISLAND, N. Y.

PRECISION RESOLVERS

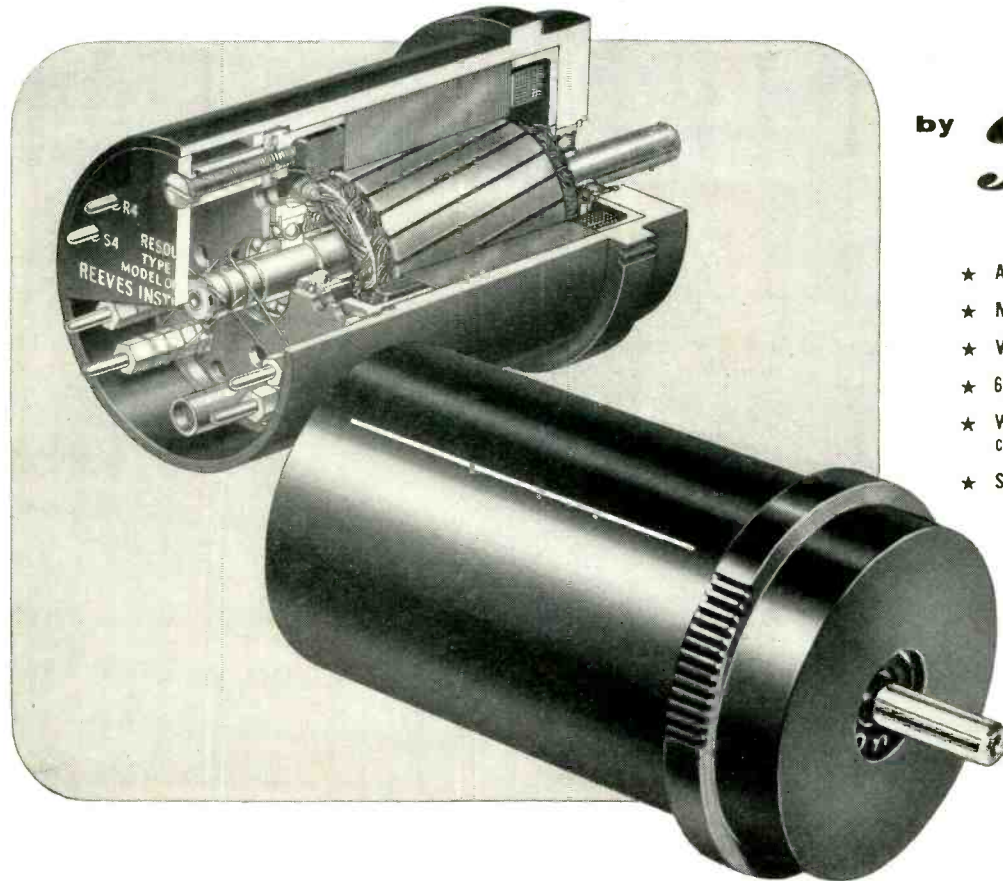

by **Reeves**
INSTRUMENT CORPORATION

- ★ Accuracy better than 0.05%.
- ★ Maximum interaxis error as low as 1'.
- ★ Very low distortion.
- ★ 60 or 400 cps. or wide band.
- ★ With or without booster amplifier compensation.
- ★ Standard military frame sizes.

the HIGHEST PRECISION resolvers available

REEVES PRECISION RESOLVERS AND RELATED COMPONENTS



MINIATURE
PRECISION
RESOLVERS



BOOSTER
AMPLIFIERS

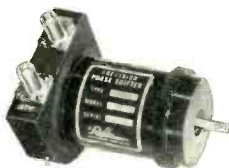

PHASE
SHIFTERS



CONTINUOUS
RESOLVER
CHECKER

Reeves' many years of experience as a pioneer in the field has made it possible to manufacture these compact precision resolvers in quantity production to a functional accuracy of 0.05% without culling—or to an accuracy of 0.03% on special order. Harmonic distortion and null voltages are held below one-tenth of one per cent.

Reeves resolvers are primarily designed for 60 and 400 cps. operation, with or without booster amplifier compensation. Special units are available for use at over 100 kc bandwidth. The Reeves R600 series is the standard of comparison among precision resolvers. Miniature resolvers of highest precision are also available.

Write for the Reeves Resolver Handbook.



REEVES INSTRUMENT CORPORATION

A Subsidiary of Dynamics Corporation of America

201 East 91st Street, New York 28, New York



Should a component failure cause down time on TV transmitting equipment, stations utilizing

S-E TRANSMITTING EQUIPMENT WITH EXCLUSIVE PATCHOVER

can return to the air more quickly and prevent the nightmare of complaint calls from sponsors, agencies, viewers . . . minimize loss of station revenue!

of the telecasting *dt*s *

**down time on transmitting equipment*

The unique Patchover System incorporated in Standard Electronics transmitting equipment enables stations to re-route RF signal the moment an amplifier fails. This system is based on identical impedances at the input and output of S-E amplifiers. The inoperative amplifier can be immediately patched out and the remaining transmitting equipment then connected to the antenna for temporary reduced power operation . . . all in a matter of seconds! Thus, telecasting can continue while amplifier maintenance is performed.

With this system, a station can also utilize an S-E Driver for full power standby service . . . eliminating the need for a costly transmitter line-up solely for standby! And the savings that result from the first time you might be called upon to use Patchover . . . may more than offset the cost of the entire transmitter!

There is less likelihood of transmitting failures with superbly engineered Standard Electronics transmitters and amplifiers. Will you be prepared should failure occur with your present equipment? Insure your operation against costly air time loss . . . with Standard Electronics Transmitting Equipment—featuring exclusive Patchover. Complete details on request.

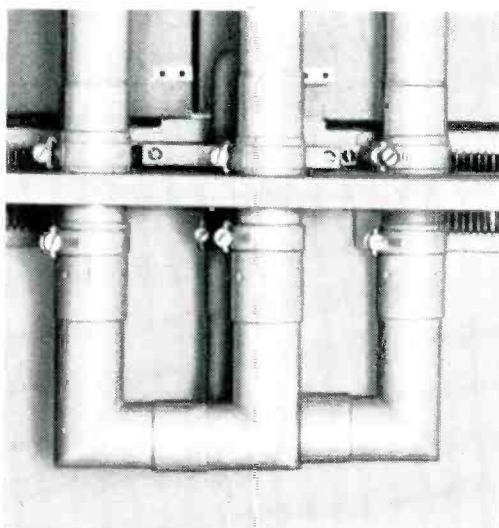

HOW PATCHOVER WORKS

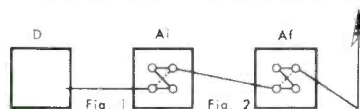

WITH AMPLIFIER FAILURE

Dotted line in Fig. 1 shows patch-out of inoperative amplifier Ai. Similar procedure shown in Fig. 2 applies if failure occurs with amplifier Af. The entire diagram shows patch-out procedure in the event both amplifiers should fail; driver is connected to antenna for reduced power operation.

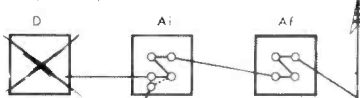

WITH DRIVER FAILURE

Dotted line indicates patch-over procedure called for by driver failure. Patch-over is made from amplifier Ai to the standby driver. Patch-over is done in seconds . . . requires just a screw driver!

standard electronics corporation

A SUBSIDIARY OF DYNAMICS CORPORATION OF AMERICA, INC.

VHF TV Transmitters	high band	500 W	10 KW	25 KW	50 KW
	low band	500 W	10 KW	25 KW	50 KW
VHF TV Amplifiers	high band		10 KW	25 KW	50 KW
	low band		10 KW	25 KW	50 KW



285-289 EMMETT STREET
NEWARK 5, NEW JERSEY

Notable Achievements at JPL

MISSILE GUIDANCE AND CONTROL... In applying advanced servo and noise-theory techniques to missile control systems, JPL has led and advanced the field of missile guidance.

Among specific achievements are the application of Wiener RMS methods to multiple-input, multiple-loop servos, and matching missile trajectory to missile control transfer function for optimum accuracy.

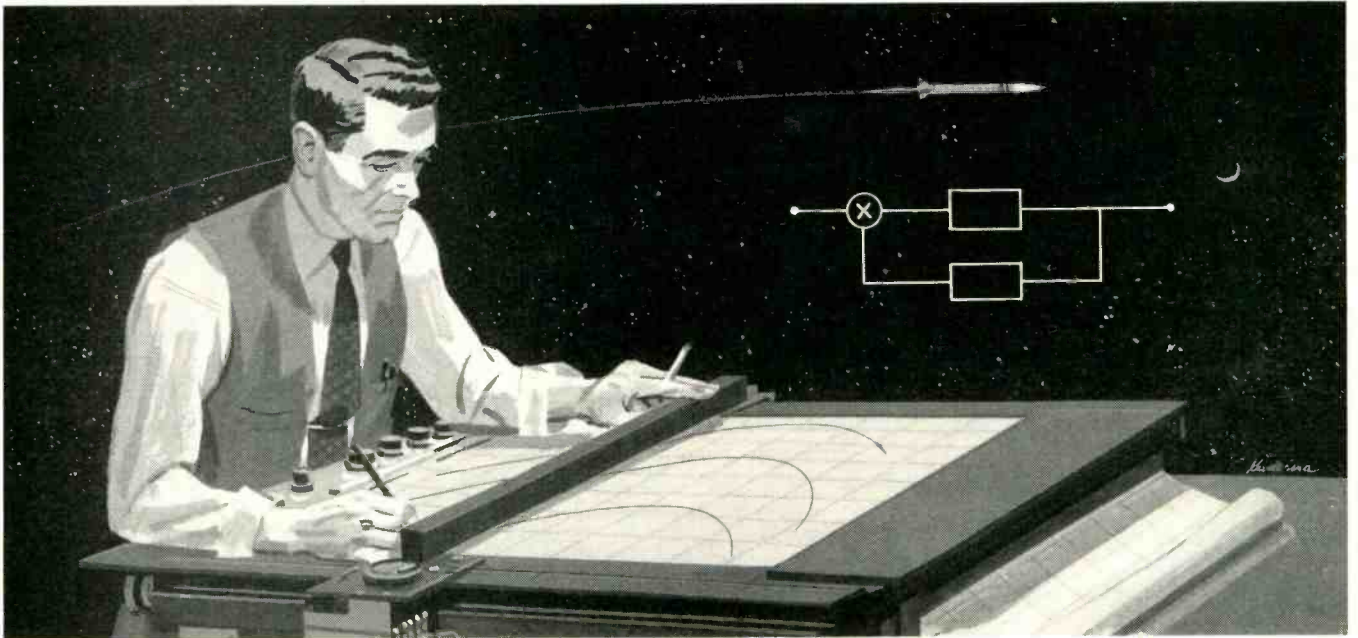

Research in Guided Missile Technology

JPL JOB OPPORTUNITIES ARE
WAITING FOR YOU TODAY
in these fields

RADIO GUIDANCE

MICROWAVES

SYSTEMS ANALYSIS

GUIDANCE ANALYSIS

APPLIED PHYSICS

ELECTRO MECHANICAL

INSTRUMENTATION

INERTIAL GUIDANCE

TELEMETERING

PACKAGING

MECHANICAL ENGINEERING

The Jet Propulsion Laboratory is an organization devoted entirely to scientific research and development. Covering an 80 acre area in the rising foothills of the San Gabriel mountains, north of Pasadena, it occupies an ideal location close to residential districts.

The working staff of the Laboratory consists of about 1250 people, all employed by the California Institute of Technology. The various projects are conducted under continuing contracts with the U. S. Government.

The prime objective of JPL is obtaining basic information in the various sciences related to missile systems development and in all phases of jet propulsion. Underlying the entire Laboratory activity, a major continuous program of fundamental research in the physical sciences is constantly in progress.

In its missile system and jet propulsion undertakings, the Laboratory maintains a broad technical responsibility, from basic research to prototype engineering. By virtue of this and the integrated nature of the JPL technical staff, each individual is drawn into close contact with the general field to which his specialized technical abilities contribute the most.

If you are interested in knowing more about our work and the specific employment opportunities now open, please send us an outline of your technical background and experience.

CALTECH



JET PROPULSION LABORATORY

A DIVISION OF CALIFORNIA INSTITUTE OF TECHNOLOGY
PASADENA, CALIFORNIA

J. N. Carman, Manager of PSI's Engineering Department, which designed the PSI diode envelope and manufacturing equipment.

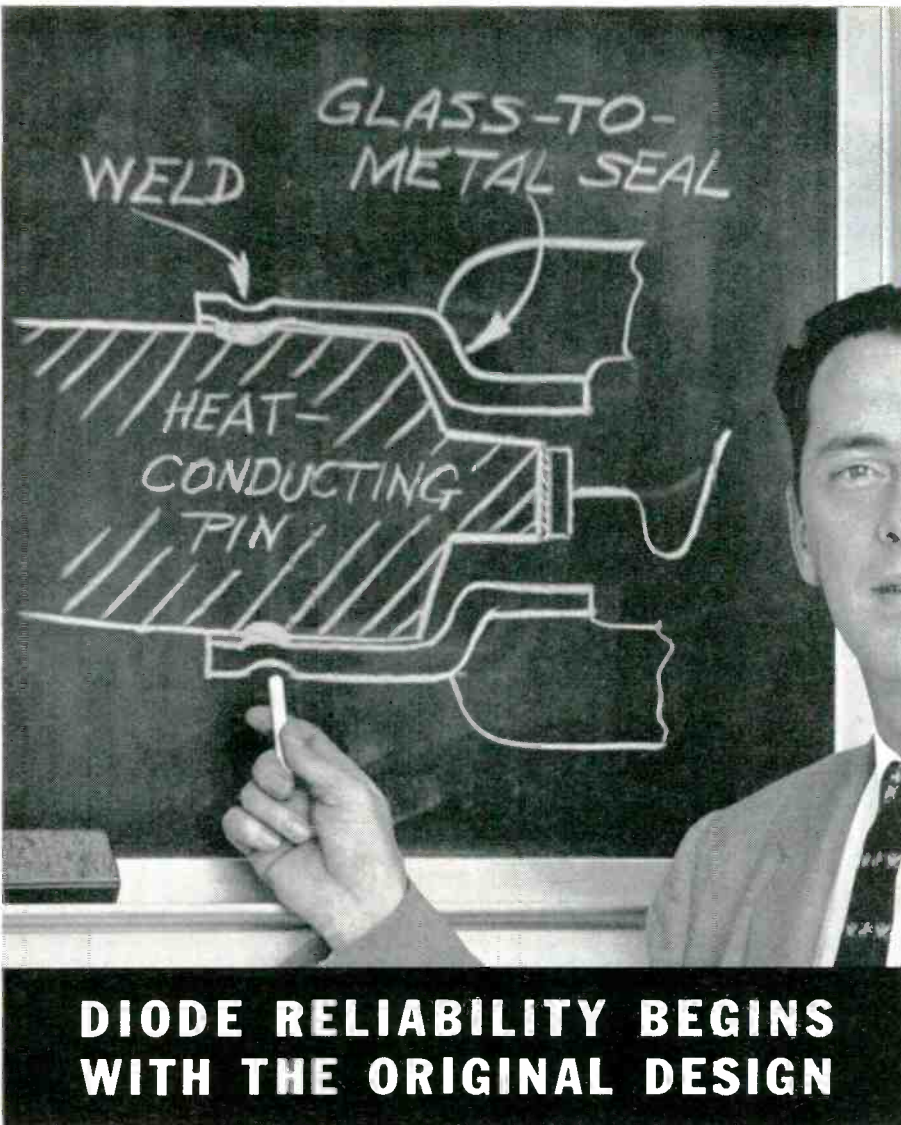

DIODE RELIABILITY BEGINS WITH THE ORIGINAL DESIGN

Reliability is intimately associated with the processes and equipment used in assembling the diode. Equipment and processes are, in turn, dictated by diode design. That's why we have carried our product development and equipment development as an integrated program. The result has been a diode envelope, half of which is sketched above. This design permits:

1. High heat conductance to minimize operating temperature for any device sealed in the envelope.
2. Cleaning, baking, and drying of parts to avoid contamination which leads to decreased life.
3. Sharp pig-tail bends without impairing hermetic seals.

Processes and equipment developed for the PSI diode include such features as:

1. Welded assembly ensuring permanent hermetic seals under even the most adverse conditions.
2. Control of whisker advance to ± 0.0001 " to assure uniformity of product characteristics.
3. Final sealing of the unit with relative humidity within the envelope less than 0.06% at 25°C.

Careful design of both diode envelope and equipment has made it possible for PSI to manufacture diodes meeting unusually rigid quality standards.



Every PSI diode must pass a hermetic seal test of 1/2 hour duration under water at 1000 p.s.i. pressure.

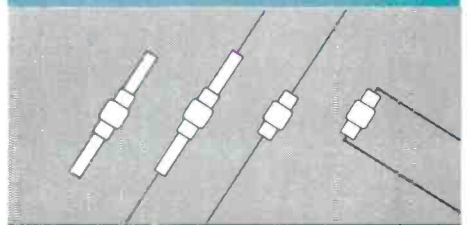

PSI offers both germanium and silicon diodes (here, actual size) with these four basic lead arrangements. WRITE FOR DATA.



PACIFIC SEMICONDUCTORS, INC.

10451 WEST JEFFERSON BOULEVARD
CULVER CITY, CALIFORNIA



in Britain

ELECTRONICS

EL34

The British Electronics Industry is making giant strides with new developments in a variety of fields. Mullard tubes are an important contribution to this progress.

***Britain's
foremost pentode
for 25W high
fidelity equipment***

The Mullard EL34 can be rightly acclaimed as the most efficient high fidelity output pentode tube yet produced in Britain. It is being fitted in many of the British sound reproducing equipments which are becoming increasingly popular in the United States and Canada.

Used in push-pull ultra-linear operation (distributed load), two EL34 tubes will give 32 watts output at a total distortion of less than 1%. The application of negative feedback reduces distortion even further.

The EL34 is equally capable of supplying higher power outputs where an increased distortion level is acceptable. Under class B conditions, 100 watts are obtainable from a pair of EL34 tubes in push-pull for a total distortion of 5%.

Another significant feature of this tube is its high transconductance value of 11,000 μ mhos, resulting in high power sensitivity and low drive requirements.

Supplies of the EL34 are now available for replacement purposes from the companies mentioned below.



Principal Ratings

- Heater 6.3V, 1.5A
- Max. plate voltage 800V
- Max. plate dissipation 25W
- Max. screen voltage 425V
- Max. screen dissipation 8W
- Max. cathode current 150mA
- Base**
Octal 8-pin

Available in the U.S.A. from:—
International Electronics Corporation,
Dept. EI, 81 Spring Street, N.Y.12,
New York, U.S.A.

Available in Canada from:—
Rogers Majestic Electronics Limited,
Dept. IE, 11-19 Brentcliffe Road,
Toronto 17, Ontario, Canada.

Mullard

ELECTRONIC TUBES

used throughout the world

MULLARD OVERSEAS LTD., CENTURY HOUSE, SHAFTESBURY AVE., LONDON, ENGLAND

Mullard is the Trade Mark of Mullard Ltd., and is registered in most of the principal countries of the world.



MEV35

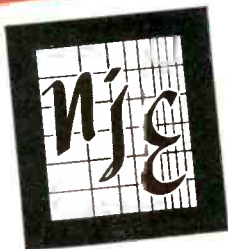

MEMO

FROM: THE ENGINEERING STAFF AT NJE
TO: DESIGN ENGINEERS AND PHYSICISTS

SUBJECT: CONSTANT CURRENT...

No matter how many regulated power supplies you may have designed, the first constant-current job you tackle is guaranteed to make you feel awkward.

It's like writing with the wrong hand. Even the specification of a constant-current supply is uncomfortable at first. Instead of a load current range, you must specify a resistance or voltage range over which the current must be held constant. Ripple must be carefully defined—and you find yourself looking for an internal impedance in megohms, instead of fractions of an ohm.

It's still Ohm's law, but it just doesn't feel right.

Basically, the circuit is simple. Instead of monitoring the output voltage, and regulating it against a reference standard voltage, we monitor the potential drop across an internal shunt resistor, and regulate it against the reference.

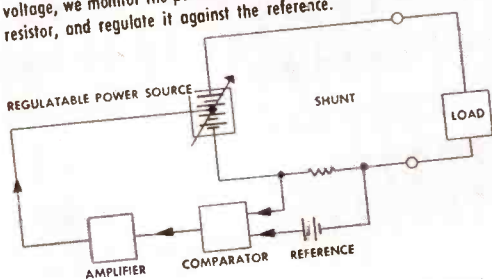

All very straightforward--until you take a look at the practical design problems people can toss at you. For example:

- A supply which holds constant current until the load resistance reaches a critical value-- and constant voltage above that!
- Current which is constant to 35 parts per million!
- Dynamic response better than 50 microseconds at 15 amperes!
- Power output in excess of 20 KW.
- Current control at 0.2 microamperes. (Think of the leakage around the shunt!)

We've been surprised at the recent upswing in orders for constant-current supplies...for cyclotron magnets, TWT helix control, electrolytic processes (batteries, plating, capacitor forming) computing devices, generator field control, etc. We've designed more than 40 different units this year.



CS-3826—One of a series of combination constant-current constant-voltage supplies we recently completed for electrolytic capacitor forming, battery forming, electrochemical processing. 15-600V, 0-10 Amps in two ranges, 1% voltage accuracy, 5% current accuracy over wide load resistance changes. (about \$2500.00)

Do you need one?
WE KNOW HOW.

NJE Corporation

Electronic Development & Manufacturing

345 CARNEGIE AVENUE, KENILWORTH, NEW JERSEY

Competent Engineering Representation Everywhere | Rapid, complete, competitive custom quotes from 1000 Amperes (low voltage) to 250 KV (low current.)

P O W E R S U P P L I E S U N L I M I T E D

P. R. MALLORY & CO. INC.
MALLORY

Etched cathode

FP plate for
85° C service

Leakproof seal

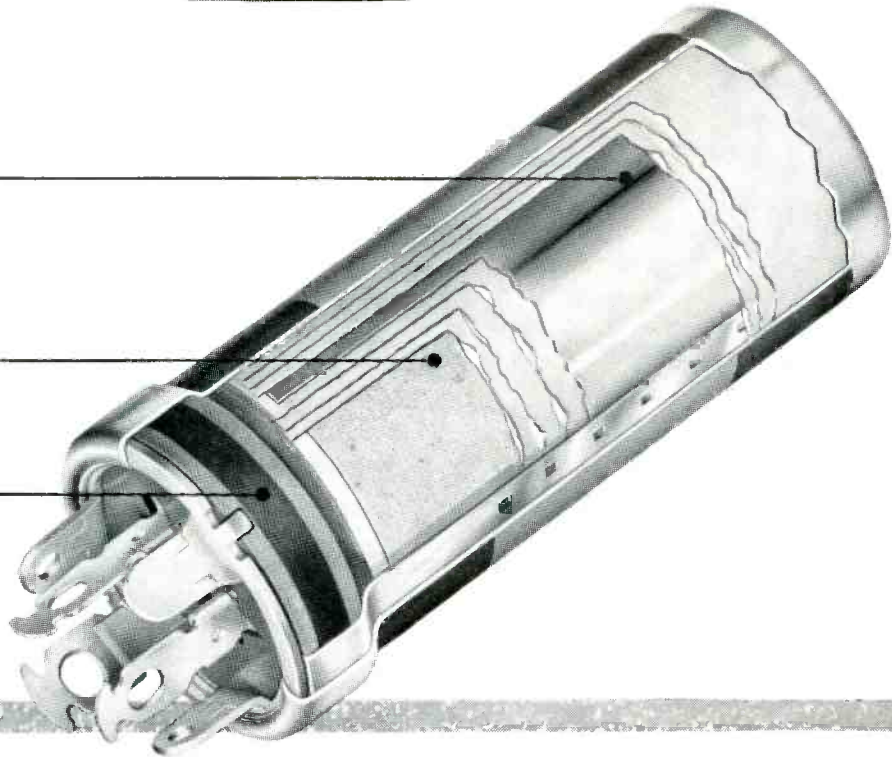

Look Inside to See Why FP Capacitors Perform Better

OUTSIDE similarity can be deceiving, with electrolytic capacitors. To find out why Mallory FP Capacitors have long been the leader in their field, you need to look *inside* the can . . . to see these extra value features of design:

Genuine fabricated plate anode, originated by Mallory, provides high capacitance in small volume . . . to give superior heat dissipation, handle high ripple current and provide low inter-section coupling.

Etched cathode prevents capacitance loss in service, helps reduce r-f impedance.

85° C construction, standard in FP capacitors for

years without premium cost, eliminates need for voltage de-rating.

Carefully integrated design assures extremely stable characteristics throughout entire life.

Strict quality control in manufacturing assures you complete dependability of every capacitor. Plan to use this high standard of quality and uniformity in the equipment you are now designing, or already have in production. A Mallory capacitor specialist can give you valuable help not only in selection of appropriate ratings and sizes, but also in coordinating capacitors with design of related components. Write today for our latest Technical Bulletin.

Serving Industry with These Products:

Electromechanical—Resistors • Switches • Television Tuners • Vibrators
Electrochemical—Capacitors • Rectifiers • Mercury Batteries
Metallurgical—Contacts • Special Metals and Ceramics • Welding Materials

Parts distributors in all major cities stock Mallory standard components for your convenience.

Expect more . . . get more from

P. R. MALLORY & CO. Inc.
MALLORY

P. R. MALLORY & CO., Inc., INDIANAPOLIS 6, INDIANA

CROSS TALK

► **CONTROL** . . . Systems designed to make production processes more automatic frequently start with sensing and measuring devices not unlike those used for years in the laboratory, and makers of such devices are aware of this.

At least one instrument manufacturer is currently setting up a systems department whose primary duty will be to weave more or less standard laboratory devices into industrial control proposals. Another is setting up a modification department which will make minor modifications in stock instruments, after they leave the production line. This better adapts the instruments to specific control problems.

► **SWITCH?** . . . "It is getting easier to hire brains than to hire brawn." This wryly facetious remark which reached our ears in the front office of a distant plant is obviously exaggerated, but it does contain a certain element of truth.

Everybody wants to be an engineer, and nobody wants to turn a crank. This attitude is making it tougher to find and to hold production help in several sections of the country. It has not yet been widely noted, because engineers are being sought on a national basis while production people are usually recruited locally, but the developing shortage is there just the same.

► **COMMUNICATIONS** . . . Scatter propagation is the latest com-

munications technique to make the headlines in technical news, so it is natural that many casual readers assume it to be the technique around which all advances of the future will be built.

Now "scatter" is truly important. But more important still is the fact that many methods of further harnessing the spectrum, and making communications more reliable, are currently being squeezed for the last small drop of efficiency. Included are such things as single-sideband, diversity, f-m, and frequency-shift. There is, as a matter of fact, a growing conviction that anything and everything that can be used to do a better job of communicating should be employed.

More and more technical tricks are being used in combination in new systems.

► **WANTED: MONEY** . . . We've been harping on the growing need

for service that matches sales, and recently speculated that there might be an opportunity for big business to move into this area on a national scale.

Now we'll throw another thought into the pot: Properly exploited, service might easily move into the charmed circle of "growth" industries within just a few years. The key could be one man with a lot of vision and considerable money, or the ability to attract it, and centralized direction of men now working largely on a catch-as-catch-can local basis.

► **IF BY AIR** . . . From where we sit at this minute electronics looks like a very large part of the aircraft business, not to mention its place in the nose or belly of military missiles.

If Paul Revere were alive today, watching the tower of the old North Church, he might be looking for *three* lanterns.

LOOKING AHEAD . . .

Trend toward a-c power systems in military aircraft likely to be followed in commercial planes. Might result in demand for frequency as well as voltage regulation right at primary source

Transistors and other semiconductors are not necessarily competitive with tubes alone; they can also be competitive with other components. Sensitivity to temperature change, for example, could be utilized to compete with bimetallic elements.

Picture-on-the-wall television tubes will come first for military applications, second in industrial systems. First-mentioned use appears to be close

SUMMARY — End-point analysis is supplementing measurement of process variables as another step toward automatic operation of chemical, petroleum and other continuous-flow plants. New measuring and control devices make extensive use of electronic circuits

By **JOHN M. CARROLL**

Associate Editor, *ELECTRONICS*

ELECTRONICS in the

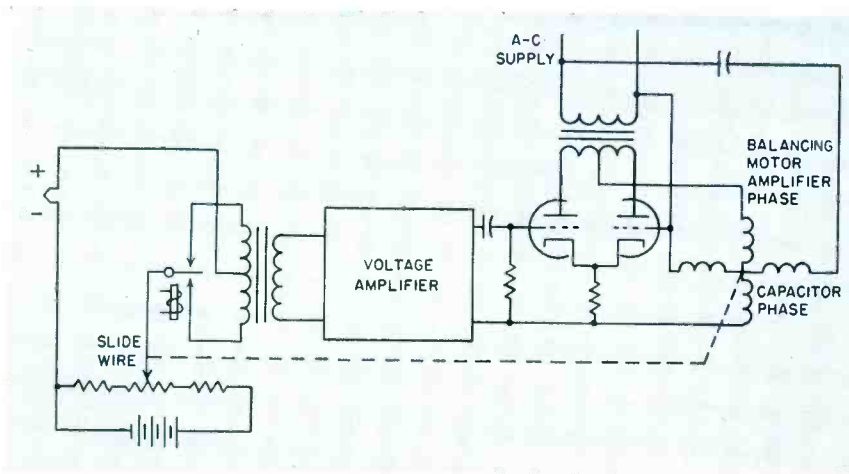

FIG. 1—Typical slide-wire potentiometer measuring thermocouple voltage

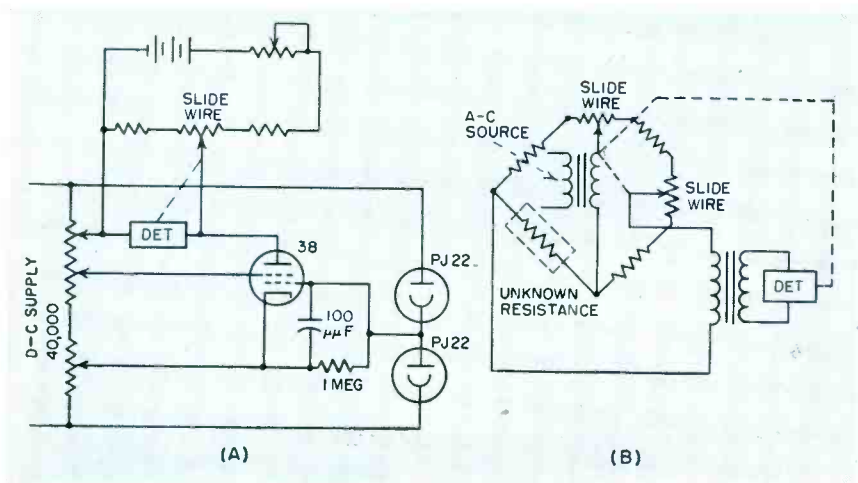

FIG. 2—Measuring current balance of a pair of phototubes (A) and an a-c Wheatstone bridge with resistance thermometer (B)

ELECTRONIC measuring and control equipment is becoming especially important in plants manufacturing such things as chemicals, petroleum products, paper pulp, foods and medicines, in which there is a continual flow from raw materials to finished product.

End-point analysis and control is being used to supplement measurement of process variables. End-point analysis is determination of the physical and chemical properties of the finished product. Measurement of variables involves checking quantities such as temperature, pressure, rate of flow and liquid level throughout the process to insure that they are kept within predetermined limits.

Automatic or closed-loop process control has brought about widespread use of electronic controllers. These units receive signals from a primary measuring device. The signals are amplified and fed back to control process conditions in such a way that deviation from a predetermined set-point is corrected.

Automatic logging involves sampling the outputs of measuring devices installed at critical points throughout the plant and trans-

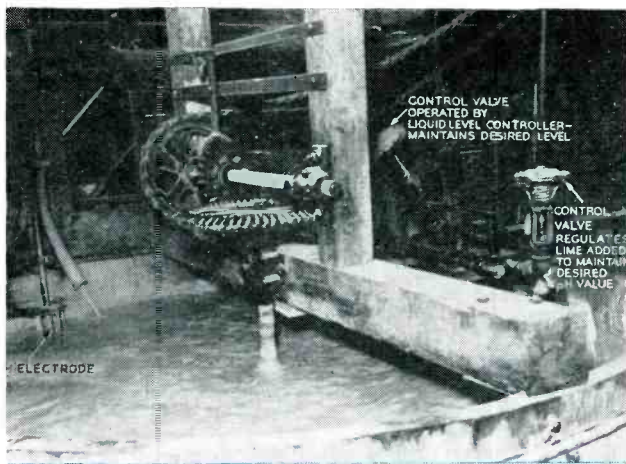

FIG. 3—Controlling manufacture of dicalcium phosphate by pH measurement

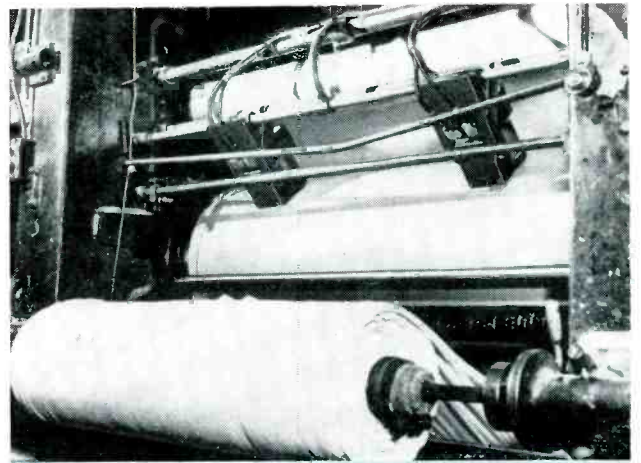

FIG. 4—Backscatter beta-ray gage regulates thickness of plastic sheeting

PROCESS INDUSTRIES

mitting these signals on a time-shared basis to a central operating location. The signals, usually analog, are digitized and printed out on a log which serves as a 24-hour record of plant operation.

Measuring Equipment

The recording slide-wire potentiometer is an electronic servomechanism which positions a resistance slide wire in conjunction with a null-balance measuring circuit. A typical setup is depicted in Fig. 1.

The voltage across the slide wire is standardized and a portion of it opposes the voltage input from an unknown source. In Fig. 1 this unknown voltage is derived from a thermocouple. When voltage unbalance exists, polarized d-c flows and is converted to a-c by a chopper. The a-c signal is amplified; its magnitude is proportional to the existing unbalance.

The a-c signal changes phase 180 deg with change in direction of unbalance. The amplified signal is fed to one winding of a two-phase servo motor which moves the slide-wire contact to reduce the unbalance.

A recording potentiometer may

measure either voltage or current unbalance. Voltage unbalance is used with primary sensing elements such as thermocouples, pH electrodes and current shunts.

In Fig. 2A, an unknown current is balanced against a calibrated current obtained from the slide wire. Current balance is used when the primary sensing element is a pair of phototubes.

Where a process variable is measured as a changing resistance, such as in a resistance thermometer or conductivity cell, a Wheatstone bridge is employed. Either a d-c Wheatstone bridge or the a-c bridge circuit shown in Fig. 2B may be used.

Temperature Measurement

The thermocouple consists of two bimetallic junctions, one of which is exposed to the unknown temperature, while the other is maintained at a reference temperature. A thermocouple measures temperature difference between the hot and cold junctions.

The fact that the radiation emitted from a hot body increases as the fourth power of its absolute temperature explains the useful-

ness of the radiation pyrometer as a primary sensing element. The sensing element is called a thermopile. It consists of several thermocouples connected in series.

Two phototubes connected in a bridge with an amplifier to measure bridge unbalance can constitute an optical pyrometer. The measuring phototube receives light emitted from the hot body, while the reference phototube is illuminated by a carbon-filament lamp. Light emitted by the hot body increases with temperature, increasing plate current in the measuring phototube. The signal from the amplifier increases the current fed to the lamp, illuminating the reference phototube. This restores bridge balance. The current fed to the lamp constitutes a measure of the temperature of the hot body. A red filter installed in the sighting tube narrows the spectral range of light falling on the phototube and minimizes the effect of gases and vapors in the sighting path.

A resistance thermometer is a coil of pure nickel wire connected as one arm of a Wheatstone bridge. As the resistance of the

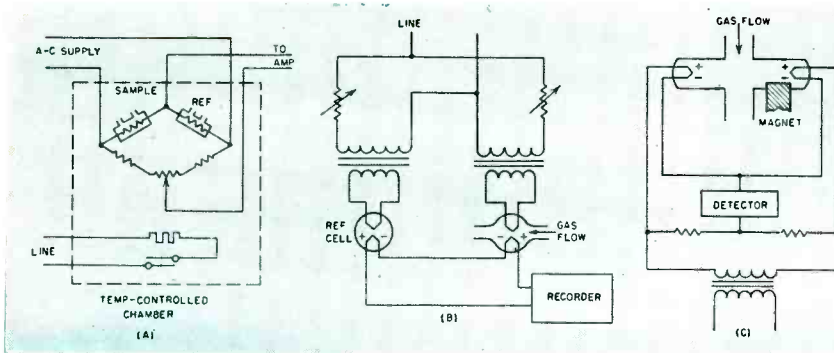

FIG. 5—Continuous gas analysis by thermal conductivity (A), catalytic combustion (B) and paramagnetic cooling (C)

sensing element varies with temperature, the amplifier senses bridge unbalance and repositions the slide wire recording the temperature.

Pressure Measurement

Two resistance thermometers may be used to measure pressure. The reference element is sealed in a tube at a reference pressure of one micron, while the other element is exposed to the pressure to be measured. Bridge unbalance measures pressure rather than temperature.

A hot-filament gage measures extremely low pressures. Electrons emitted by the filament cause ionization of the molecules of the residual gas and increase the current in the plate circuit. The plate current therefore measures residual gas pressure in the measuring cell.

Strain gages may be used to measure pressure, as may variable differential transformers.

Rate of Flow

Variable differential transformers have been used to measure rate of flow. Also used are ultrasonic devices that operate on the Doppler principle.

Rate of flow may be measured by an armature, upon which is mounted a propeller placed in the flow stream. The armature rotates at a rate depending upon the rate of flow. Field coils surround the pipe and pick up a varying frequency a-c signal which is clipped to form a pulse output. The pulse count measures rate of flow.

In catalytic cracking plants of the petroleum industry, radioactive isotopes have been injected into

the flow stream. A pair of radiation counters are set up, separated by a known distance along the pipe. The time for isotopes to pass from one counting station to the other determines rate of flow.

Liquid Level

A capacitance relay can be used to sense liquid level. Rising liquid in a tank causes a small change in capacitance referred to an electrode mounted on the side of the tank. Such a system has been used to indicate level of milk chocolate stored in 90,000-lb capacity tanks. When the level reaches a point 4 to 5 in. below the top of the tank an alarm is sounded which tells the operator to stop the pump.

In an oil tank farm, an ultrasonic transmitter installed at the bottom of the tank was used to measure

the distance to the air-liquid interface. In another application level is indicated by a radioactive float on the surface and radiation counters installed outside the tank.

Strain gages have been used to control the flow of liquid resin into processing kettles. Each kettle is mounted on four piers, with the strain-gage load cells installed between the bottom of the kettle and the pier. The change in resistance of the strain gages creates a varying voltage which is fed to an electronic controller.

Other Process Variables

The quantity pH is a measure of hydrogen-ion concentration in solution. The pH scale of 14 measures increasing acidity with 7 taken as neutral. The primary sensing device is a glass electrode which is immersed in the solution along with a reference electrode. The resulting voltage difference is a measure of pH. The commonly used reference electrode is the calomel half cell, which delivers a constant voltage irrespective of components in the solution or their concentration.

Figure 3 illustrates process control by pH in the manufacture of dicalcium phosphate. The electrode assembly is immersed in solution. The signals from the pH meter are amplified to control the flow of lime solution into the tank.

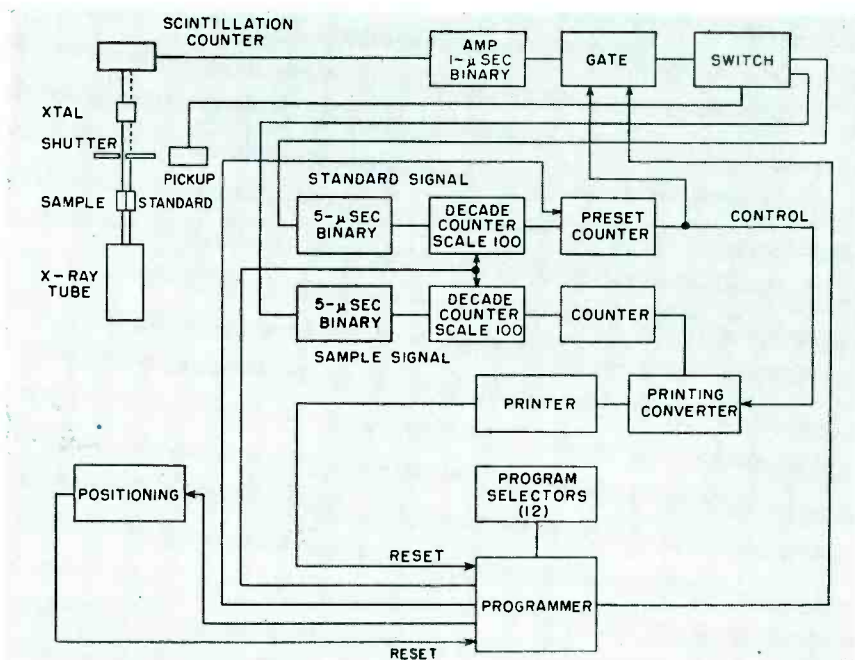

FIG. 6—Automatically indexing x-ray spectrometer can be used for process control

Viscosity has been measured by a paddle driven by series motor. Increasing viscosity of the fluid causes increasing motor loading which may be measured by recording potentiometer. Such a system has been used to control the consistency of paste in the manufacture of floor covering.

A more sophisticated means of measuring viscosity employs ultrasonics. A thin steel blade immersed in a fluid is excited at 28 kc by a pulsed signal. The ultrasonic energy causes the layers of liquid to slide back and forth. The amount of energy required to create this shearing motion is measured and converted into units of viscosity.

In the manufacture of paper or plastic sheet, thickness has been measured by beta-ray gages. In a beta-ray gage, a radioactive source causes a stream of electrons to pass through the sheet and the absorption of electrons is measured and calibrated in thickness of material. The instrument shown in Fig. 4 utilizes backscatter. Beta particles pass through the sheet, strike the backing plate, and return through the sheet to the detector.

End-Point Analysis

End-point analysis was perhaps first applied to continuous analysis of a stream of gas.

Ability of a gas to conduct heat can be used as an indication of its chemical composition. The thermoconductivity method is illustrated in Fig. 5A. One temperature sensitive resistor is placed in a chamber filled with the gas whose chemical composition is to be determined. Another is placed in a chamber filled with a reference gas. Both chambers are heated. The temperature-sensitive resistors form two arms of a Wheatstone bridge. An electronic potentiometer is used to sense bridge unbalance. Its output is calibrated in percent concentration of the gas to be measured.

Fig. 5B depicts the catalytic combustion method of continuous gas analysis. When a flammable gas is mixed with air or oxygen and passed over a hot-wire filament, it can be ignited. The lowest temperature at which such a gas and air mixture can be ignited is called the lowest explosive limit. The gas

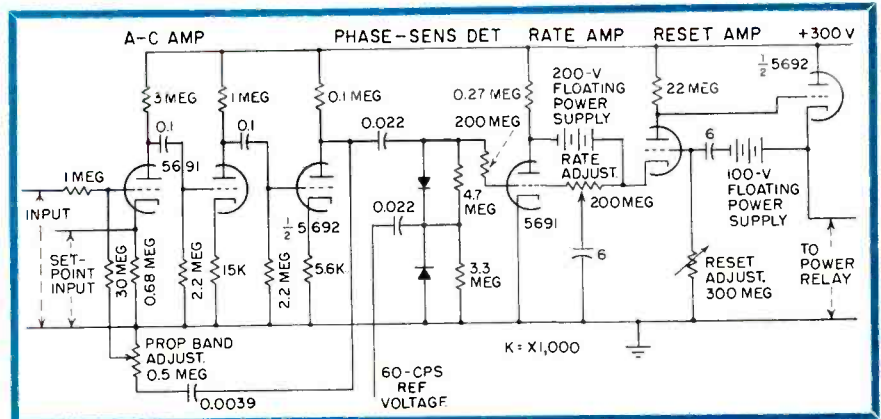

FIG. 7—Electronic controller features rate and reset action

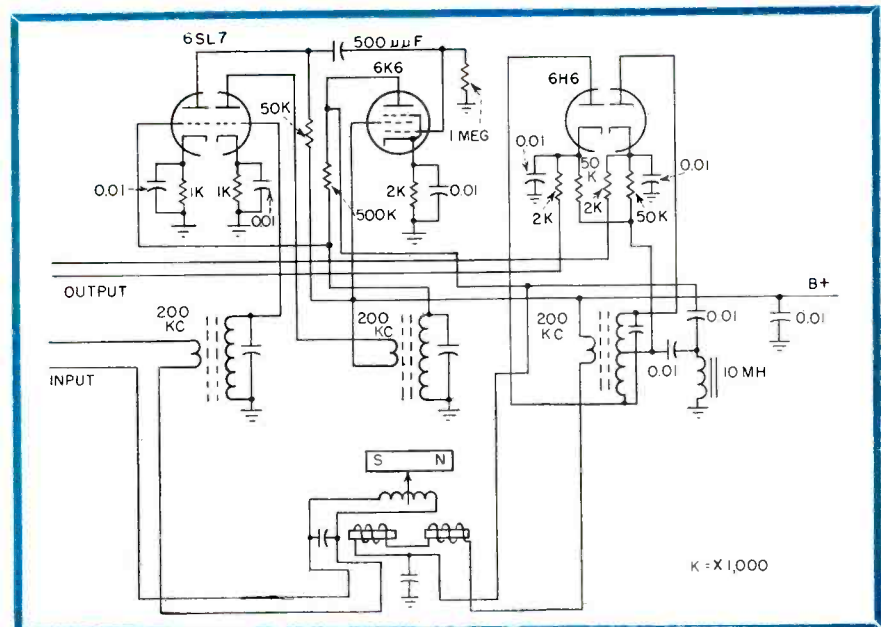

FIG. 8—Controller achieves additional amplification through galvanometer movement

analyzer contains a reference cell filled with air and sealed, and a cell in which the gas to be measured flows. Each cell contains an electrically-heated activated-platinum filament and a thermocouple. The thermocouples are connected in series opposition and their output fed to a recorder which senses the temperature increase when the flammable gas-air mixture is ignited. This temperature increase causes a change in voltage which is amplified and recorded in percent concentration.

Some gases disassociate when passed through water. By measuring the conductivity of the solution, gas concentration can be determined. A gas analysis instrument operating on the electrolytic conductivity principle compares the conductivity of distilled water be-

fore and after gas is dissolved in it. The change in the conductivity creates an unbalance in an a-c bridge circuit which is measured and recorded.

Oxygen is extremely paramagnetic. That is, it is easily drawn into a magnetic field. This property is used in the paramagnetic gas analyzer. Gas flows into a cell which has a permanent magnet on one side. A thermocouple is installed on the side of the cell closest to the magnet and another thermocouple is situated across the cell. The paramagnetic property of oxygen causes it to be drawn to the side of the cell on which the magnet is located. Thus the thermocouple closest to the magnet is cooled more by the gas flow than is the other thermocouple. In the gas analyzer shown in Fig. 5C,

the voltage difference between thermocouples determines concentration of oxygen in the gas stream.

Optical gas analyzers determine the amount of visible or ultraviolet light absorbed by a gas stream. The light source is fitted with a filter and a chopper, so that two phototubes can measure the intensity of light before and after it passes through the stream. The phototubes are connected in a bridge circuit whose unbalance determines gas concentration.

A similar instrument depends on the fact that all gases absorb infrared radiation in amounts and at wavelengths depending upon the type of gas present and its concentration. A beam of filtered infrared radiation is chopped and passed through a tube containing the gas to be measured. Radiation then falls upon a capacitor-microphone detector. One plate is a flexible membrane mounted between two gas chambers. The infrared impinging upon gas in one chamber causes it alternately to expand and contract. The magnitude of expansion depends upon how much radiation is absorbed by the gas stream. This causes an alternating current to flow in the detector.

Polarography and Redox

When a polarized voltage is pressed between two electrodes, the

resulting diffusion current may be measured. When plotted against voltage, the magnitude of the diffusion current indicates the quantity of the constituent producing it. The half-wave potential provides for identification. The null-balance current-measuring system is applied to the dropping mercury electrode.

Certain processes evolve ions which exchange electrical quantities as the reaction proceeds. Redox measurements determine to what extent an ion has gained or lost charge. This indicates how the reaction has progressed and can be used to control the addition of reagents. Measurement of the electrical potentials involved can be obtained by means similar to those used for measuring pH. A noble metal electrode is substituted for the glass electrode and the same calomel half cell is used as reference electrode.

Spectroscopy

The spectroscope takes electromagnetic radiation of many frequencies and separates it into pure components. Emission spectroscopy is used in the analysis of metals. When a sample of metal is flashed in an arc, an emission spectrum characteristic of the element contained in the sample may be obtained and recorded on photographic film.

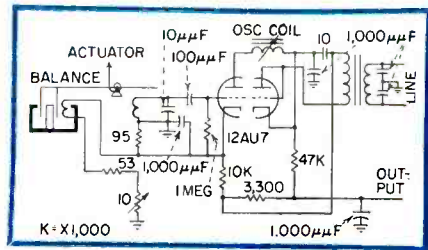

FIG. 9—Pressure transmitter varies inductance in oscillator tank circuit

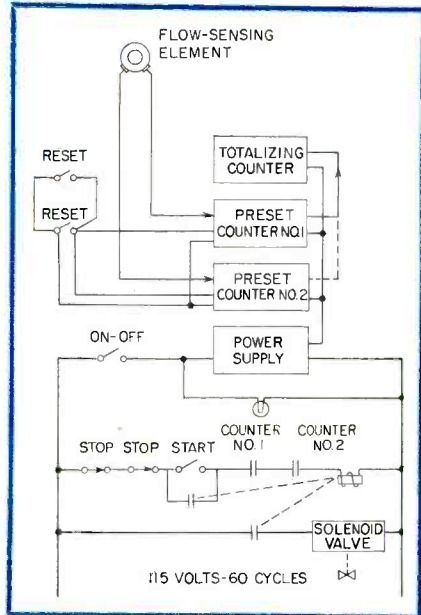

FIG. 10—Controlling flow of liquid plastic into a sheet mold

Absorption spectroscopy is widely used in the analysis of organic compounds. Spectral characteristics in many elements exist in the optical, ultraviolet, infrared,

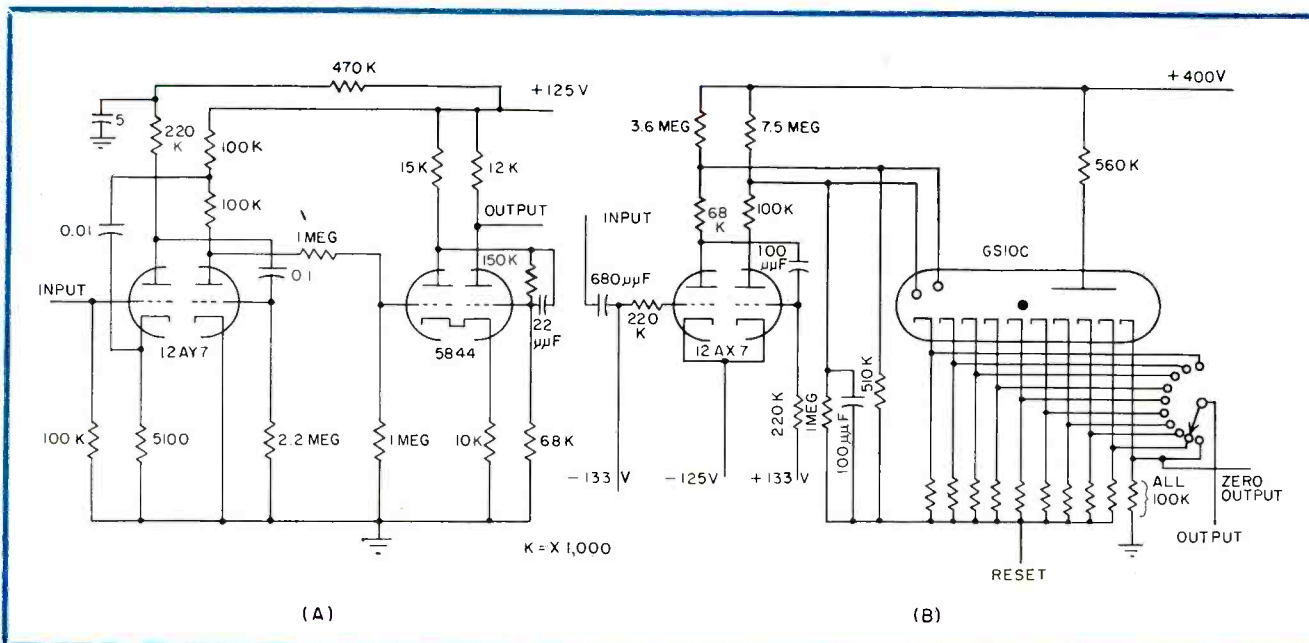
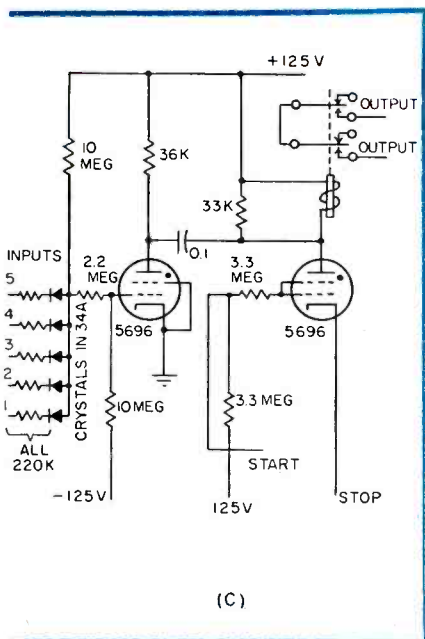

FIG. 11—Flow-control system uses counter input stages (A), decade counters (B) and output circuit (C). Each of the five decade count-

microwave and x-ray bands.

The mass spectrograph gets its name by analogy with the optical instruments and is becoming important in chemical research. It bombards molecules of a compound and measures the quantity of distinct fragments formed. Relative quantities constitute the mass spectrum of the substance. The molecular fragments or ions are accelerated into a strong magnetic field where particles of different weight travel distinct curved paths to an ion collector. The outputs from ion counters are amplified and signals fed to recording equipment.

A multielement indexing x-ray spectrometer may be used for process control. One such instrument can determine the presence of as many as 12 elements in a sample. As shown in Fig. 6 the radiation source is an x-ray tube. The shutter provides a signal from both the sample and standard. Shuttering is done on a time sequential basis and signals are channeled into a single detector. Read-out is a three-digit number which is registered on an automatic printer. The sensing element is a scintillation counter which feeds a chain of electronic counters which in turn feed the printer. Once a standard has been established, samples of the same element may be repetitively and continuously



ers employs a multielement gas tube

analyzed as in quality control work.

X-ray fluorescence analysis techniques have been applied in the analysis of many metals. They have been used to measure the presence of metallic materials and to analyze substances such as slags, ores and oils. In some x-ray fluorescence equipment a separate pickup is used to receive signals from the standard. Automatic indexing is available, so that the integrated output of each sample channel is presented as a ratio to the integrated output of the internal standard. At low counting rates geiger counters are directly connected to integrating capacitors, while at high counting rates scintillation counters are employed.

Electronic Controllers

The present-day trend, towards closing the control loop causes the measured signal to feed back and control the process itself. In the electronic controller diagrammed in Fig. 7, signals from the measuring device and a predetermined set-point voltage are both connected to an a-c amplifier. The voltages are compared and their difference amplified. Overall amplification is controlled by feeding back a portion of the output to the input. This negative feedback may be varied by an adjustable proportional-band network. The output of the amplifier is fed to a phase-sensitive rectifier which converts the a-c voltage to reversible polarity d-c.

Rate action is used when the output of the amplifier is fed through a network which temporarily delays the negative feedback. For a sudden change of voltage input there will be a large change in output since the negative feedback is temporarily delayed. After a short period the delay introduced by the rate network will no longer be effective. Then the amplifier returns to an overall gain of one. Rate action causes the amplifier output to respond both to the magnitude and to the rate of change of the difference between the input signal and the set-point voltage.

When reset action is turned on, the amplifier has a gain of greater than 200 to 1 for steady state or slowly changing values of input.

On more rapidly changing inputs, however, reset action provides a transient voltage feedback. This action provides the controller with an initially wide proportional band which will slowly reduce itself to a narrow band.

Moving-Coil Amplifier

Another type of controller incorporates galvanometer movement. The movement operates over small angles in an air gap through which there is a high magnetic flux. See Fig. 8. The moving coil is connected to the d-c potential to be measured and an input voltage causes the coil to rotate from its normal position.

Superimposed on the heavy continuous flux is a component of flux alternating at 200 kc. The high-frequency flux is obtained from a coupling coil mounted on the pole pieces and operating in conjunction with an oscillator.

When the moving coil rotates slightly, the coupling between the fixed and moving coils changes through change in flux linkage which in turn constitutes the variable mutual inductance between the fixed and the moving coil. This variable mutual inductance in the oscillator circuit may be considered as a variation of inductance in the oscillator tank circuit. The frequency of the oscillator changes. This frequency variation is amplified and detected through a discriminator. The f-m system provides a d-c output which reverses polarity as the moving coil passes through neutral position.

Pressure Controller

A similar circuit is used in pressure transmitter shown in Fig. 9 which compares a force produced by a mechanical pressure-sensing element against the instrument's electrical output. A beam structure with a hair spring mounted on a fulcrum is used. One end of the beam supports a coil in the field of the permanent magnet. The other end of the beam acts as a flag for a tuned oscillator circuit. A resistor in series with the output diverts a portion of it to the feedback coil.

A change in pressure is measured by a bourdon tube. The mo-

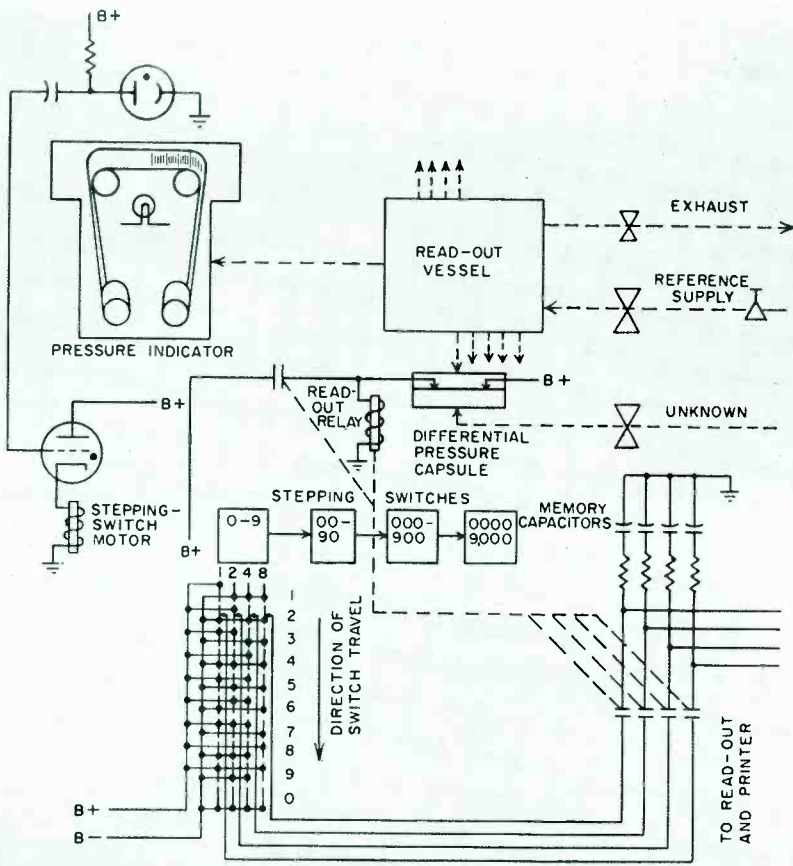

FIG. 12—Automatic equipment for centralized pressure logging

tion of the tube imparts mechanical motion to the hairspring. This causes rotation of the beam.

Subsequent motion of the flag detunes the oscillator, changing the current drawn by the oscillator. Current change through the resistor changes the field strength in the feedback coil.

The change in flux in the feedback coil opposes the motion of the hair spring and balances the beam. Thus the transmitter sends an electrical signal to the recorder.

In operation the recorder is similar to the pressure transmitter. The recorder pointer is positioned by a rotary solenoid. The current which actuates the solenoid is supplied by an amplifier. The level of the current is determined by the position of the beam of the force-balance meter.

Beam position is established by equal and opposite forces produced by the electrical input and a hair spring connected to the pointer. A change in input produces the force against the field of the balance magnet causing the deflection of

the beam. This creates the change in proximity of a flag to an oscillator coil. Changing the position of the flag detunes the oscillator and results in a change in amplifier current.

The armature of the rotary solenoid repositions the pointer lever until the loading of the hair-

spring equals the opposing force produced by the current level.

The set-point amplifier provides a d-c voltage proportional to the deviation between a mechanical set-point and the input current. The output voltage is polarized, depending on the direction of deviation. A force-balance structure is used consisting of a pivoted and balanced beam which supports the input feedback coils in the field of the permanent magnet. The other end of the beam acts as a flag in a tuned oscillator circuit. The opposing mechanical force is applied by a hairspring connected to the set-point control. When the input current level is equal to the corresponding set-point level, the beam is balanced and the output voltage is zero. A change in either the set-point or the current input produces an unbalance. Resulting beam motion detunes the oscillator which produces a voltage output from the amplifier. Polarity of the output voltage depends on direction of unbalance of the beam. The magnitude of the output voltage is a function of the deviation between the set-point and the current level.

An electronic controller receives signals from the recording or set-point amplifiers and provides reset and rate action. An additional unit provides manual valve operation. Voltage amplification and power output are furnished by the output amplifier of the controller. An output voltage is produced

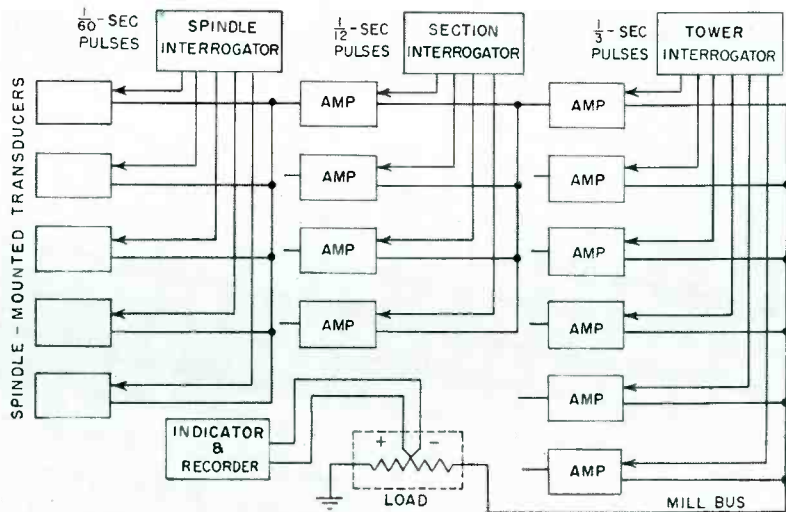

FIG. 13—Production planner used in textile mill

which is more than 10,000 times the input.

Signals from the electronic controller are transmitted to an electropneumatic controller where they are converted to a pneumatic pressure. This pressure operates diaphragm valves and dampers.

Flow Control

A system to control the manufacture of plastic sheet consists of a three-channel counter, two channels of which are preset and one of which is used for totalizing. The preset counters are exactly alike. Their input accepts signals from a propeller-type flow measuring device. The propeller-type pickup is installed in a pipe feeding the sheet molding device. The overall system is illustrated in Fig. 10. Each counter has a pair of relays which open when a preset count is attained. The relays are across a 115-v a-c line.

When either of the counter relays opens, the holding relay drops out, deenergizing a solenoid valve and cutting off the flow of liquid plastic to the mold.

The input stages to the counters are shown in Fig. 11A. These provide wave shaping and amplification. Each preset counter consists of five decade counting stages, each employing a multielement gas tube. One of the decade stages is illustrated in Fig. 11B. The counter output is shown in Fig. 11C.

Automatic Logging

The automatic logger provides a central digitized read-out of pressures and other process variables throughout a plant.

An unknown pressure is fed to a differential pressure capsule consisting of two chambers separated by a flexible diaphragm. The diaphragm has a shorting disk which closes a circuit between a pair of contacts. One chamber is connected to the unknown pressure. The other is connected to a pressure tank in which the pressure is slowly and steadily raised. A pressure-sensing cell incorporating a film strip and phototube is used.

The output of the phototube is fed to a thyratron which operates a mechanical stepping-switch counter. The stepping switch counts in bi-

nary-decimal code. Four stepping switches provide a 0-to-9999 digital output. Each stepping switch has a four-wire output corresponding to the binary bits 1, 2, 4 and 8. The output from the stepping switches is tied to the normally open contacts of all read-out relays in parallel.

When any read-out relay is energized through the contacts in its differential pressure capsule, the binary representation of the count is impressed on its individual sixteen-capacitor memory. Deenergizing the relay holds the last configuration as a series of charges on the memory capacitors. These charges may be retained as long as 15 min.

To start up the read-out cycle, pressure in the tank sensing cell and the stepping-switch counter readings are zero. The relays are energized and the memory capacitors connected to the outputs of the stepping switches.

When the rising pressure in the read-out tank becomes equal to a given unknown pressure. The contacts open, deenergizing the read-out relay. This in turn opens the contacts between the counter output and the channel memory capacitors. The pressure of the read-out tank continues to rise until all relays have dropped out. At this point the capacitor memories may be read out. By conventional circuitry each digit is sequentially scanned. The charges on the capacitors are used to fire thyratrons and set up a matrix to operate a Flexowriter. Output may be inserted directly into a digital computer. This automatic pressure logging system is illustrated in Fig. 12.

Production Planner

In the manufacture of moncord thread, a thread spindle is the unit for production. An operator tends sections of five spindles, while a unit of process equipment feeds raw material to a tower of 20 spindles. The mill in which this automatic production planner was installed has 120 spindles.

Each spindle is interrogated individually. Interrogation is accomplished by electrical impulses generated by a scanning device and

sent to the spindles consecutively and continuously. Pulse duration is 1/60 sec.

On each of the spindles is an electromechanical transducer that turns with the thread. When the thread is in motion the transducer generates an alternating current from the interrogation pulse. When the spindle is stationary, transducer output is zero. The equipment amplifies and rectifies the current from the electromechanical transducers mounted on the spindles.

A second interrogator sends pulses to the sections. These pulses have a duration of five times that previous: 1/12 sec. The five responses from individual spindles in the section are grouped in the section response. The resultant current is again amplified and rectified.

The third interrogator is used for the towers. The tower interrogator emits pulses having a 1/3-sec duration. The response to a single tower interrogation consists of 20 individual bits, five from each of four sections. Interrogation of the mill's six towers requires a 2-sec interval. This automatic production planner is illustrated in Fig. 13.

Each positive response from a spindle transducer results in a pulse. The summation of these pulses appears on the mill bus. These pulses are used to operate thyratron relays. Each positive response causes a pulse to pass through a calibrated load resistor. Current flow through this resistor causes a rise in its temperature which is measured by a thermocouple, amplified and recorded on a chart calibrated to indicate mill efficiency.

Thanks are due the following companies for making information available for this article: Applied Research Labs; Atomic Instrument; Beckman Instruments; Bristol; Consolidated Engineering; Daystorm; Fischer and Porter; Leeds and Northrup; Manning, Maxwell and Moore; Minneapolis-Honeywell; North American Philips; Robertshaw-Fulton Controls; Swartwout; and Tracerlab. Also, the Chemistry Department, Lehigh University, M. W. Kellogg and the Du Pont Co. for advice and orientation.

Electrons Produce High-

SUMMARY — Bombarding a special polyethylene formulation with 1-mev electrons produces wire insulation and structural dielectric that retains excellent electrical and physical properties up to 300 C. Article discusses problems of using electron accelerator on the production line and shows how to solve them

JAMES B. MEIKLE

*Senior Project Engineer
Sequoia Process Corp.
Redwood City, California*

and

BRUCE GRAHAM

*Head-Organic Chemistry
Stanford Research Institute
Menlo Park, California*

PLASTIC CHEMISTRY and radiation engineering have produced a new dielectric material. A formulation of polyethylene is subjected to massive doses of electrons moving with nearly the speed of light to produce an insulation that possesses the excellent electrical and physical properties of polyethylene and retains them at high temperature.

The material, known as Hyrad, can be operated continuously at 150 C, at 200 C for extended periods and at 300 C for a few hours. Now in commercial production, it shows excellent promise for use in electronic circuits as wire and cable insulation and as a structural dielectric in components.

Radiation System

Ionizing radiation is provided by a General Electric electron-beam generator. It employs a resonant transformer to accelerate electrons to 1-mev peak energy. Here their velocity is more than 0.9 the speed of light and the relativistic mass is 2.5 times the rest mass. The output current available for radiation is 1 ma. Power output is about 700 w. The voltage waveform approximates

a half sine wave. The beam passes through a 2.5-in. diameter titanium window which must be constantly cooled by a high-velocity air stream.

Radiation intensity 10 cm from the window at full beam power is approximately 70 million rep (roentgen equivalent physical) a minute at the center of the beam. Shielding must be provided for the absorption of both high-energy electrons and medium energy x-rays or bremsstrahlung generated by the slowing down of the high-energy electrons when they strike material of any type.

Shielding

The electron accelerator is enclosed in a room 8 by 12 by 13 feet. Entrance is through a maze. The walls of the room and maze consist of 32 in. of sand held between wooden forms, bound together with $\frac{3}{8}$ -in. diameter steel tie rods. The roofs are of wood with a foot-deep layer of sand. About 150 tons of sand are used in shielding.

Electrons of 1-mev energy penetrate only about 0.1 in. of material of unit density. Hence, the electrons are effectively stopped by the

wooden walls. However, a small percentage reflects into the maze generating x-rays of low energy. Reflection is further reduced by concrete block baffles placed so as to necessitate high angles of incidence and repeated reflection before the electrons can enter the maze.

The electron beam generates some ozone. Oxygen is converted to ozone at the rate of 0.03 lb a kw-hr. This ozone is removed by a 2,000-cfm blower that changes the air in the room every 40 seconds. Under the most unfavorable conditions the maximum ozone concentration is 17 ppm.

Radiation

With an electron accelerator of this type there is a problem in efficient utilization of the beam after its emergence from the window. The beam emerges in a cone 9 in. in diameter at a distance of 6 in. from the window, and 18 in. in diameter at 1 ft from the window.

The maximum density of electron flux is at the axis of the beam, but for efficient operation all electrons, including those in low density areas at the periphery of the cone, must

Temperature Dielectric

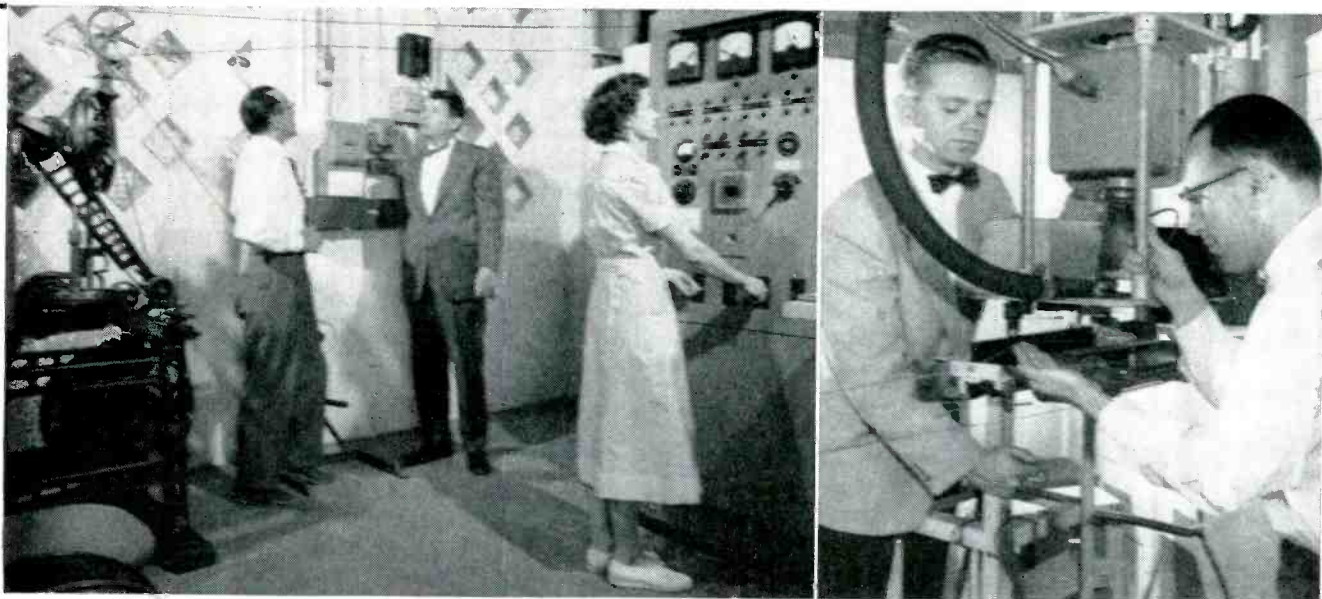

Wire covered with polyethylene is unwound from spool and passed over pulleys to radiation room. Operator controls accelerator remotely. Closeup of accelerator, right, shows how wire makes double pass through electron beam. Hose conducts forced cooling air to titanium window

be utilized. The material being irradiated must be sufficiently thick to stop completely and absorb the energy of the highest voltage electrons.

The wire with its coating of polyethylene is repeatedly passed between rollers, arranged so that the wire moves entirely across the beam twice, once on top of the rollers and once on the bottom.

The wire with its insulation is passed through every intensity level in the beam and all segments of insulation receive the same integrated radiation dose. The shielding effect of the copper conductor is counteracted by roller design that twists the wire slowly on its own axis to expose all areas equally. Larger wires move in a figure 8 on the rollers, exposing both sides to radiation. For larger cable jackets where tangential penetration on the sides is insufficient to irradiate the entire thickness, material of high molecular weight reflects the beam into the jacket sides.

The exact radiation dose is not critical. By passing Ozalid paper through the beam in the area to be used and comparing color intensity

with similar paper exposed in areas of known radiation intensity, an integrated radiation rate is obtained and the wire speed can be quickly calculated.

Heat is generated by stopping the electrons. If radiation rates are too high or cooling inadequate, the wire covering becomes too hot. When necessary, air is blown on the wire undergoing irradiation to cool it.

The wire payoffs and takeups and the control panel are located in the area just outside the radiation area. Emphasis has been placed on electrical interlocks rather than operator judgment. Doors to the room and maze must be closed and

Table I—Performance No. 22 Awg Stranded Conductor Insulated with 10-mil Hyrad

Breakdown voltage under water (min)	3,000 v rms
Insulation resistance at 20 C in megohms/1,000 ft	60,000
Cold bend (knot jerked tight at -80 C)	No cracking
Dielectric constant at 27 C and 150 C	2.24

locked from the outside prior to beam operation.

Also electrically interlocked into this series are the requirements that direct current be on, the dielectric in the transformer tank be at correct pressure and its cooling system operating, the output voltage reduced, the window cooling air stream operating and the focus coil current on.

Operation

The operator's only concern is with voltage and amperage. These are varied by remote switches that control motors driving the potential and current control rheostats.

Once the unit is brought up to voltage it is exceptionally stable in operation. Production runs over 16-hr, 2-shift periods are common.

Processing

Up to the point of irradiation, the manufacture of wire insulation is the same as the usual production of hookup wire. The polyethylene formulation is mixed as it is extruded around a wire or cable. Prior to irradiation, the material possesses the same characteristics as ordinary polyethylenes. Electric-

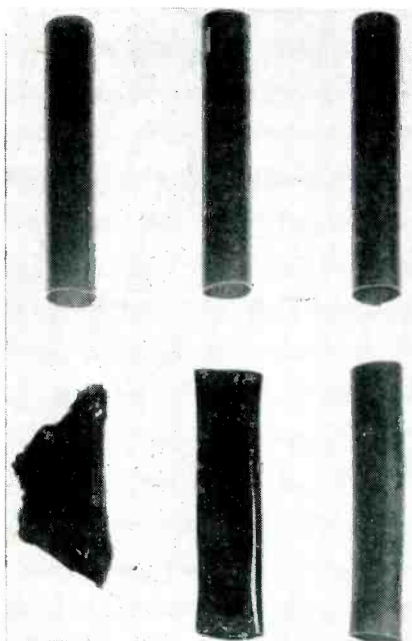

Cable jackets before (above) and after (below) aging 96 hr at 150 C. Samples at left are untreated polyethylene, center are irradiated polyethylene and at right are irradiated modified polyethylene

cal characteristics are excellent, but the material melts at about 100 C.

Volume resistivity is 10 to 100 times that of most vinyls and 10 times that of polytetrafluoroethylene. Tensile strengths are well over those required for wire and cable insulation. Dielectric constant is 2.2 to 2.3 and power factor is less than 0.0007 at 1 mc.

Characteristics

Plastics can be likened to interwoven chains with the chain structure dependent on the molecular links from which they were fabricated. Irradiation by high-energy electrons, gamma rays or neutrons breaks the molecular linkages resulting in either a degradation of the material or molecular cross linking between chains.

With the formulation under discussion the amount of scission caused by radiation is reduced and cross linking is increased to develop the thermal stability of the material.

Following irradiation the volume resistivity is about 10^{10} ohms per cu cm. When used as a dielectric, this characteristic holds leakage current loss to low values even in high-impedance circuits.

The molecular cross linking usually lowers the tensile strength of

a dielectric due to disruption of inherent molecular orientation during the forming process. However, with the retention of orientation obtained with the new formulation, the chain-to-chain molecular link is strengthened.

Dielectric constant is 2.3. Capacitance is a direct function of dielectric constant. The dielectric constant compares favorably with polystyrene, 2.5-2.7, silicones, 3.4-9.6, and vinyls, 4.0-5.0. If the material is formed into a foamed or cellular structure, it acquires a dielectric constant of 1.5 at a density of 0.48. The dielectric constant of 2.3 is maintained up to 150 C. Power factor is less than 0.0007.

Chemical Properties

Unirradiated polyethylenes are inert to most solvents. Detergents cause cracking. The new material is inert in detergents and the resistance to the action of aromatic and aliphatic hydrocarbons is increased. It is oxidized in a solution of boiling sulfuric acid when nitric acid is slowly added.

The loss of insulation strength because of stress crazing, a weakness of plain polyethylene, is completely eliminated.

Plastic memory is greatly increased in the method of linking used in the material under discussion. Cross linking changes a polymer from a two-dimensional to three-dimensional system. Any force that tends completely to displace a portion of a molecule must break a molecular bond. The new material resists cold flow, not by molecular friction, but by molecular bonding, and any force attempting to deform it must be sufficient to cause molecular chain rupture.

If the material is deformed by cold pressure until set occurs, it will return to its original configuration upon being heated to 125 to 150 C in the absence of stress. It is also characterized by the absence of internal stress created in many other dielectrics during molding or forming. As a result, exposure to heat cycling does not present the problem of warpage or shrinkage.

On the other hand, tolerances must be held closely on the originally formed product because the dimensional configuration during

irradiation is the final configuration since change by reworking is negated if the product is heated.

Plain irradiated polyethylene usually is rated for 120 C. The structure of the new molecular cross link permits operation at 150 C and for short periods as high as 350 C. In an inert atmosphere 350 C may be sustained. If the temperature is raised above 450 C decomposition may take place but the resulting products are nontoxic and noncorrosive.

If the material is heated by a flame to its ignition point, combustion is sustained. It is hoped that present lines of research will eliminate this problem.

The breakdown voltage necessary to puncture the insulation is approximately 1,000 rms per mil on 10-mil sections and about 700 v rms on 45-mil sections.

Wires and Cables

The electrical and structural properties of the dielectric make it a desirable insulation and jacketing on hookup wire and cable. The insulation prior to irradiation can be extruded on wire by the usual techniques. This can be done with the plastic either as a solid or foamed, containing discrete cells of inert gas that reduce the dielectric constant to a minimum of 1.48. This value is a mean between the dielectric constant of 2.3 for the plastic itself and 1.0 for the gas. Depending on the method of extrusion used and the amount of foaming agent added, any intermediate value is obtained.

Following irradiation, an insulated wire can be shielded with a copper braid. The insulating material's cross linking resists the normal tendencies of the shield to cut into the dielectric. A jacket of the same or another dielectric can be applied over the shield. If the jacket be of vinyl or regular polyethylene, the operating temperature range of the cable is limited to that of the lower temperature rated dielectric material. The material can be formulated in ten standard colors or as a transparent material. For circuit identification, any combination of up to three spiral stripes can be applied.

The finished wire is easily han-

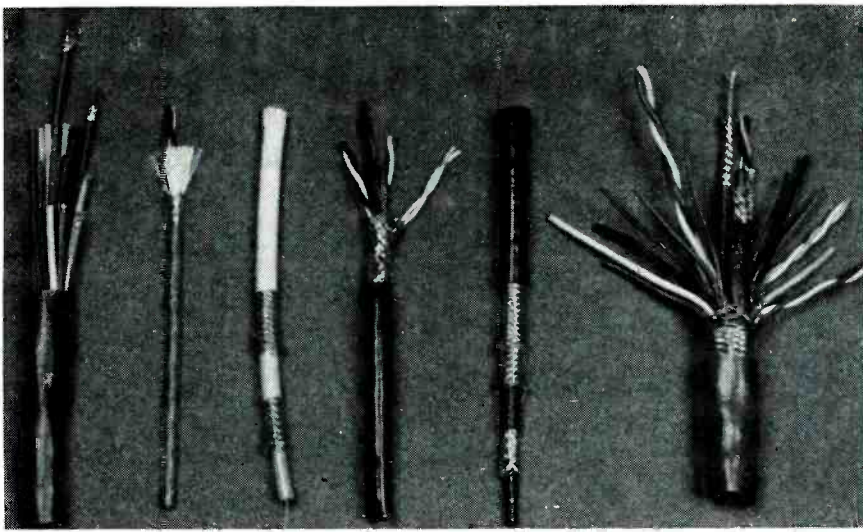

Irradiated modified polyethylene can be applied to many forms of wire and cable

dled in production work. The tensile strength, elongation and abrasion resistance are equivalent to those of the best vinyl and the handling and flexibility are approximately equivalent. The insulation is not affected by soldering. During tinning operations the insulation itself can be immersed in the molten solder without damage. Soldering a lead wire to a shield can be accomplished by dip soldering without affecting the dielectric under the shield.

Wire stripping is accomplished by the usual methods. Behavior of the insulation can be compared favorably with that of polyvinyl chloride. General performance is given in Table I.

Cable Design

Characteristics adapt it for use with coaxial cable, particularly for high-frequency applications. The capacitance in $\mu\mu\text{f}$ per ft of a single-conductor coaxial cable is

$$C = 7.364K/\log_{10}(D/d)$$

Where K = dielectric constant, D = dielectric diameter under the shield and d = diameter of inner conductor.

Variation of K directly affects C , so that for the same cable dimensions a 50-percent reduction in dielectric constant entails a 50-percent reduction in capacitance. A coaxial cable consisting of No. 22 solid conductor insulated with 0.025 in. of dielectric material plus a shield and outer jacket would have an outside diameter of 0.125

in. If the dielectric is silicone, the capacitance would be 52 $\mu\mu\text{f}$ per ft or higher. If solid material of the new type is used, the capacitance is 36 $\mu\mu\text{f}$ per ft. Use of foamed material would reduce capacitance to 22 $\mu\mu\text{f}$. Where low capacitance in a high-temperature application is needed, use of cellular Hyrad is indicated.

The same situation occurs in cable design where impedance is the basic requirement. From the impedance formula

$$Z_0 = (138/\sqrt{K})\log_{10}(D/d)$$

the characteristic impedance varies inversely as the square root of the dielectric constant. Thus coaxial cables of identical dimensions using cellular material would have the highest characteristic impedance. In constructions where the characteristic impedances were identical, the coaxial cable with cellular irradiated modified polyethylene has small overall diameter.

Elimination of cold flow in cellular and solid material inhibits the shift of capacitance or impedance of a cable due to conductor displacement in the dielectric. Unless strain sufficient to rupture the dielectric is placed upon the conductor, the characteristics of the cable remain constant.

This is particularly important for use in normally unattended matched circuits where periodic replacement of cable components is not feasible. It is also important in long transmission lines where differential conductor migration

may set up a high or variable standing-wave ratio in the transmission line. The ultimate deformation due to cold flow in coaxial cable insulations occurs when the conductor migrates sufficiently to short to the shield.

Prior to high-temperature cable design, the current capacity, voltage to be expected and the allowable capacitance and/or the impedance must be established.

Using the minimum conductor size, the impedance equation can be solved for the correct dielectric thickness. When the dielectric thickness is known it is possible to check the voltage protection offered by that thickness. Capacitance can then be calculated. It is usually found to be below the maximum allowable particularly if a material of low dielectric constant is used. This allows engineering of coaxial cables to meet specific electronic circuit requirements rather than substituting a standard cable.

Another use of the material is in encapsulation or in sleeving. A sleeving $\frac{1}{8}$ in. inside diameter may be originally extruded with an inside diameter of 0.120. Following cooling and irradiation, it may then be distorted to a diameter of 0.200 in. or more, allowing it to be easily slipped in place over the terminal or component to be sleeved. Upon momentary heating to 135 C, it immediately attempts to return to the 0.120-in. diameter. In so doing, it encapsulates the component being sleeved.

Research and Development

The properties of Hyrad may be changed over a broad range by adjusting the processing prior to forming and by varying the amount of radiation dosage given the plastic after forming. The material may have application for many other electrical insulation uses than wire and cable insulation. Attractive possibilities lie in the field of plastic pipe since it answers many problems unsolved by other plastics. Pipe made of plastic for hot water, low pressure steam, hydrocarbon streams, acids and brines are all within the realm of possibility. Other future applications may include plastic moldings, film and sheet, extrusions and shapes.

Toroidal Transformers

By G. W. GRAY

David Sarnoff Research Center
Radio Corporation of America
Princeton, New Jersey

SUMMARY — Design data is given for tv video transformers with 6-mc bandwidth that drive a 50-ohm coaxial cable. In addition to line-driver applications, transformers can also be used as interstage-coupling devices in transistor video amplifiers

WHEN DRIVING a low impedance such as a coaxial cable from a vacuum tube or transistor, there is a loss of gain due to the poor impedance match between the load and the driving source. If the signal is narrow band, a transformer is usually used to produce a better impedance match.

This article describes the development of transformers to drive a 50-ohm coaxial cable with television video signals of 6-mc bandwidth. To ease the low-frequency requirement to passing a 15-kc square wave, the technique of using a keyed-clamp stage following the transformer has been assumed. This is the existing situation in television cameras where the video signal is amplified first in the camera and then transmitted over cable to another amplifier for additional amplification.

A gain of one-third is usually realized from the grid of the last tube in the camera to the grid of the first tube in the remote amplifier. If a transformer with a three or four-to-one turns ratios could be inserted between the line driver and the line, the gain of one-third would be increased to unity. If a second transformer could be used to step up the voltage between the cable and the grid of the first tube in the remote amplifier, the gain could be raised from unity by whatever step-up ratio could be obtained.

Core Material

The transformers are wound on Supermalloy tape-wound toroids manufactured by the Arnold Engi-

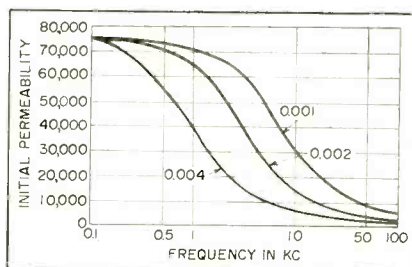

FIG. 1—Effect of tape thickness on initial permeability of Supermalloy

neering Co. Magnetic properties of this type core are particularly suited to video transformers. The low-frequency permeability is approximately 70,000, providing the necessary inductance with relatively few turns.

The permeability is a function of frequency—high at low frequencies and low at high frequencies. This feature is of importance since the distributed capacity that tends to resonate the primary would have to be impractically low if the permeability were uniformly maintained at all frequencies. This effect allows high primary inductance at low frequencies, where it is required, and effectively decreases the inductance at high frequencies, to prevent resonance with the distributed capacity within the pass-band.

As an example, transformers with a primary inductance of the order of $\frac{1}{2}$ henry at 1 kilocycle are needed for good low-frequency response. If such an inductance were maintained up to 6 mc, the capacity required to resonate the primary would be about 1,000 $\mu\mu\text{f}$. Fortunately, the permeability of tape-

wound cores changes radically from low to high frequencies so the required inductance is obtained at low frequencies, but a much lower inductance is present at high frequencies. Thus resonance with the distributed capacitance is avoided at least until a much higher frequency than with a constant permeability core.

Since it is a lack of penetration of the core material by the magnetic flux that causes the decrease in permeability with increasing frequency, the core tape thickness will control the frequency at which the permeability changes. This effect is shown in Fig. 1.

Coupling

Although loss of permeability with frequency is necessary, it is not without ill effects. With a high permeability toroidal core, the coupling between primary and secondary is good and independent of the physical configuration of primary and secondary. However, with

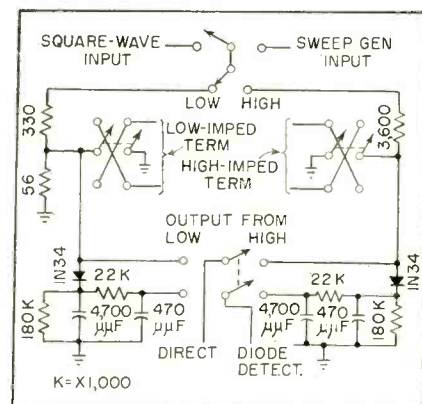
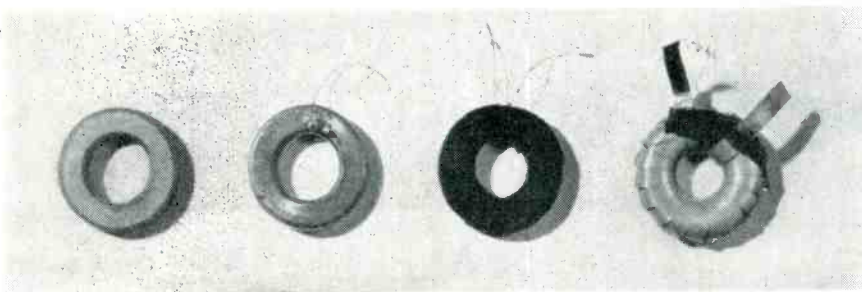
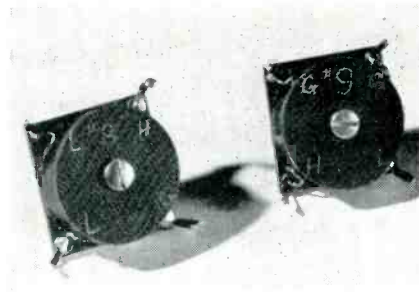

FIG. 2—Test circuit for video transformers

Pass Video Bandwidths



Steps in transformer construction, from left to right: core; core with primary; primary with rayon-tape cover; complete transformer



Completed video-transformers mounted in protective cases

a low permeability core, the coupling is almost entirely dependent upon the physical configuration of the primary and secondary. Therefore, the physical configuration of the windings must be designed for good coupling between primary and secondary without aid from the core material.

To evaluate and compare experimental transformers, the test setup of Fig. 2 was used. Either the low or high-impedance windings can be driven from a sweep or square-wave video generator, with about 3,600-ohm driving impedance for the high-impedance winding and about 50-ohm driving impedance for the low-impedance winding. Likewise, the voltage across either the high or low-impedance winding can be observed either directly for square waves or with a diode detector for sweep response. Two switches are provided to reverse the end of the winding which is grounded, for either primary or secondary.

Windings

The primary winding used on all of the transformers is a single layer of uniformly spaced wire going around the toroid, thus producing minimum distributed capacity for the number of turns required.

The secondary winding is similar to the primary but of fewer turns, distributed uniformly over the primary and spaced a small distance away. The secondary must be distributed over the primary to maintain coupling at high frequency where the core has negligible permeability. Spacing between pri-

mary and secondary is necessary to minimize the capacity between primary and secondary, although too wide a space will decrease coupling.

To verify the frequency range over which the core contributes to the coupling, a transformer was made with the primary wound on one half of the toroid and the secondary on the other half. Response was normal at low frequencies, but fell off rapidly in the region where permeability decreased in accordance with the curves in Fig. 1.

To show that coupling is good

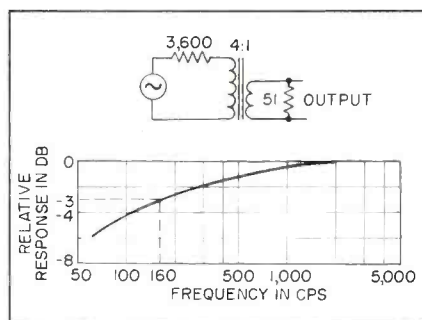

FIG. 3—Low-frequency response of video transformer

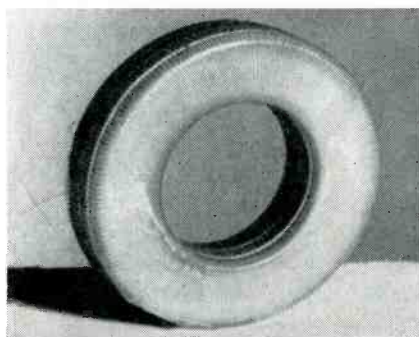

FIG. 4—Primary winding on 4-mil core

with the secondary wound over the primary, a transformer was wound with a lucite toroidal core the same size as the Supermalloy cores. The resulting transformer had a uniform response from 1 to 12 mc, showing that magnetic core material is not necessary above frequencies of 1 mc.

Core Permeability

The core material has a permeability considerably greater than unity even in the megacycle region. It increases the inductance so as to cause a resonance and limit the high-frequency response. The curves in Fig. 1 indicate the use of a thicker tape would result in a permeability that starts to decrease at a lower frequency and might thereby be expected to be down to a lower percentage of its low-frequency permeability at any particular high frequency. The material which loses permeability at the lowest frequency is 4-mil tape; therefore, this material was tried. One and 2-mil tapes have also been tried, but the 4-mil tape seems to be best.

Recently two cores with 6-mil tape have been obtained. Initial work indicates a marked superiority over 4-mil tape for high-frequency response, with somewhat poorer low-frequency response. Most transformers in this article use type 5340 S-4 cores; the 5340 refers to the physical size (0.810 in./o.d., 0.440 in./i.d., 0.195 in./thick); S-4 indicates the core material (4-mil Supermalloy).

In selecting the primary inductance an advantageous compromise

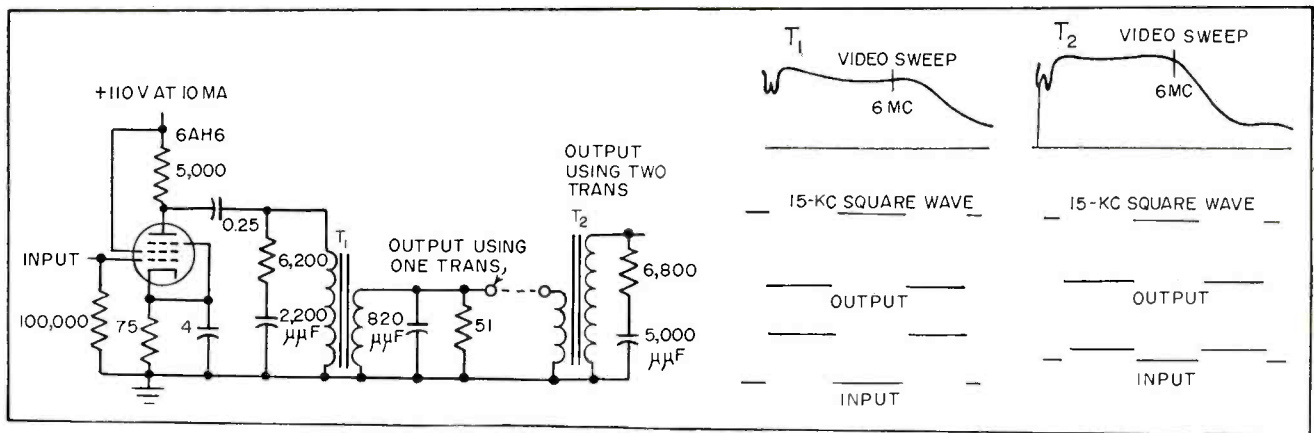

FIG. 5—Both T_1 and T_2 have 4-mil cores and 190-turn primaries; T_1 has 190-turn primary of No. 50 Formex wire and secondary of 26 turns of 0.002 by 0.070 in. copper; T_2 has 190-turn primary of No. 52 Formex and 44-turn secondary of 0.002 by 0.075 in. anodized aluminum. Video-sweep and square-wave responses are shown at right

is to allow approximately a 10-percent tilt in the response to a 15-kc square wave, thus necessitating fewer turns on the primary winding than if a more perfect low-frequency response is attempted. The fewer turns result in obtaining about a 50 percent greater turns ratio for the same high-frequency response.

The 15-kc square-wave tilt can be completely compensated at the cost of about 10-percent amplitude loss by placing a resistor in series with a capacitor across the primary; thus about 50-percent increase in gain is achieved at the expense of 10-percent loss. On this basis about 190 turns are required for the primary.

Figure 3 shows the sine-wave low-frequency response of such a transformer with a 4 to 1 turns ratio and terminated in 50 ohms. The response falls off more slowly than even a single R-C or R-L circuit would; this is caused by the peaking effect of the rising permeability as the frequency decreases. With this response, even though the amplitude does not start to fall until about 1 kc, there is enough phase shift to require compensation at 15 kc. The loss of low frequencies is due almost entirely to insufficient primary inductance. If the primary is driven from a lower impedance source, a much better low-frequency response can be obtained, confirming that the coupling in the transformer at low frequency is good.

Experimentally, it has been found advantageous to use wire at

least as small as No. 50 for the primary winding to have considerable space between adjacent turns and minimize distributed capacity. It is also important to have the uniformity of the winding virtually perfect. For example, a transformer made for a 6-mc response had one turn that crossed over the adjacent turn near the middle of the primary winding; the result was about a 5-mc response. The crossed turn was cut out and the two ends soldered together about $\frac{1}{8}$ inch from the core; this added about $\frac{1}{2}$ mc to the response, but did not bring the response to normal. Figure 4 shows the primary winding on a 4-mil core with 180 turns of No. 50 wire.

Experiments show that best results are obtained by winding all the way around the core. For example, a transformer that gave a 6-mc response with the winding on approximately 350 deg of the core only gave a 3.5-mc response with the same number of turns on 260 deg of the core.

Spacing Between Windings

Having wound the primary, the next step is to decide upon the spacing between primary and secondary. Good transformers have been made with spacing from as small as possible to about 0.050 inch. A wide spacing assures ability to ground either end of the secondary to select the desired polarity of signal output. A close spacing will require the same input and output polarity, but the transformer will operate equally well as a step-up or step-down transformer.

In general good results will be obtained with a moderate spacing as is obtained by winding the primary with a ribbon of Minnesota Mining and Manufacturing No. 14 rayon tape so there is a single layer on the outside edge while the inside will be about two layers of tape. Such a spacing usually allows the secondary polarity to be reversed while still operating well as a step-up transformer.

Though the secondary may be reversed with little change in frequency response, the primary requires one particular end to be grounded. If the other end of the primary is grounded, the frequency response is nearly cut in half independent of the polarity of the secondary.

The secondary is made from wire as large as is possible to use and still maintain a single layer on the inside of the toroid with the number of turns giving the proper turns ratio, usually about 4 to 1. It is wound uniformly over the primary, starting at one end of the primary and finishing at the other end. The direction or sense of the secondary winding should be the same as the primary.

Ribbon Wire

Instead of using round wire for the secondary, a considerable improvement in performance can be obtained by using anodized aluminum ribbon wire. This type of wire seems to produce a transformer with approximately twice the turns ratio and a bandwidth at least as wide in response as with round

wire and possibly better. Soldered connections to the aluminum are made by first copper plating the aluminum. The effect of the ribbon is to decrease leakage inductance at high frequencies by providing a continuous shield completely covering the primary.

Figure 5 shows a circuit that may be used with the transformers to drive a low-impedance line. The waveforms illustrate the gain and frequency response. Using one transformer the gain from the grid of the tube to a 51-ohm load is 1.4. The gain would be higher except for the low valued plate resistor of the 6AH6. With a higher plate supply voltage, the plate resistor could be raised to increase the gain about 3 db. The circuit provides double termination for the cable since the transformer transforms the 2,770 ohms in the plate circuit (5,000 ohms in parallel with 6,200 ohms) to 52 ohms. Thus, a cable terminated at the receiving end with a 51-ohm resistor, or gain-control po-

tentiometer, will look back into 52 ohms at the sending end. The gain can be increased about four times by using a second transformer at the receiving end.

Frequency Compensation

High-frequency peaking is obtained with the 820- μf capacitor across the 51-ohm resistor. Alternatively, an inductance can be placed in series with the 6,200-ohm resistor in the primary of T_1 .

Polarity can be reversed by reversing the low impedance winding of either transformer.

In addition to increasing the gain in driving a low impedance from the tube, the transformer also multiplies the current swing obtainable. The circuit shown in Fig. 5 will produce about 2.5 volts peak to peak across the 51 ohms, which is equivalent to a current swing of 50 ma. Total d-c current is less than 15 ma.

The resistor in series with the capacitor across the high impedance winding of each transformer

compensates the low frequency response. Without compensation, each transformer introduces about 15-percent tilt on a 15-kc square wave.

Figure 6 shows the results obtained with a 6-mil core. The winding would have given only one-half the bandwidth, if a 4-mil thick tape had been used.

Winding Machine

A device which has wound toroids with wire as small as No. 52 and maintained uniform spacing between turns is shown in a photograph. Since No. 52 wire is as small as is possible to obtain as yet, the minimum wire size the winder will handle is not known. To produce uniformity in the winding, tension is continually maintained on the wire so that the wire tends to stay where it is laid down. This is the principle feature of the winder. When the toroid with the primary winding is removed from the winding machine it is coated with a thin coating of rubber-base Bostick cement. The toroid is then wrapped with a strip of $\frac{1}{8}$ -inch wide rayon tape, starting at the same place as the primary winding and wound in the same sense and direction all the way around. The tape should be about a single thickness on the outer rim of the toroid.

The secondary is wound to start and finish at the same place the primary starts and finishes, with the turns in the same direction as the turns of the primary. If round wire is used for the secondary, it should be large enough so a close spaced single layer winding is produced on the inner side of the toroid. If ribbon wire is used, it should lap over itself on the inner side of the toroid to produce a nearly complete covering on the outside of the toroid.

Transformers of this type have been used as interstage-coupling devices in transistor video amplifiers. They are now finding further use in industrial-television equipment, both monochrome and color, where their advantages as line drivers are being utilized.

Credit is due E. K. Kurz for the design and construction of the winding machine without which these transformers would not have been developed.

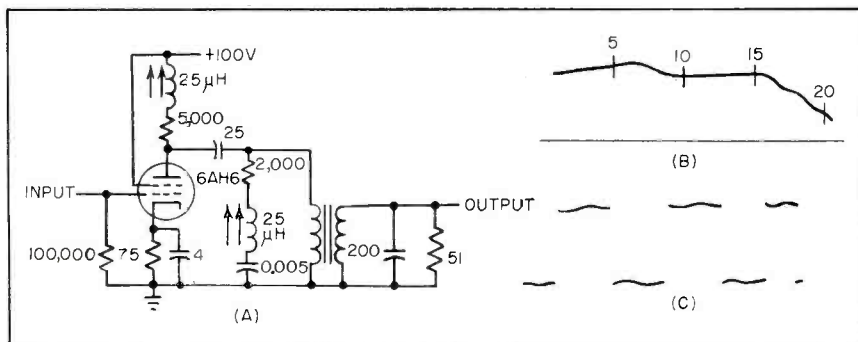
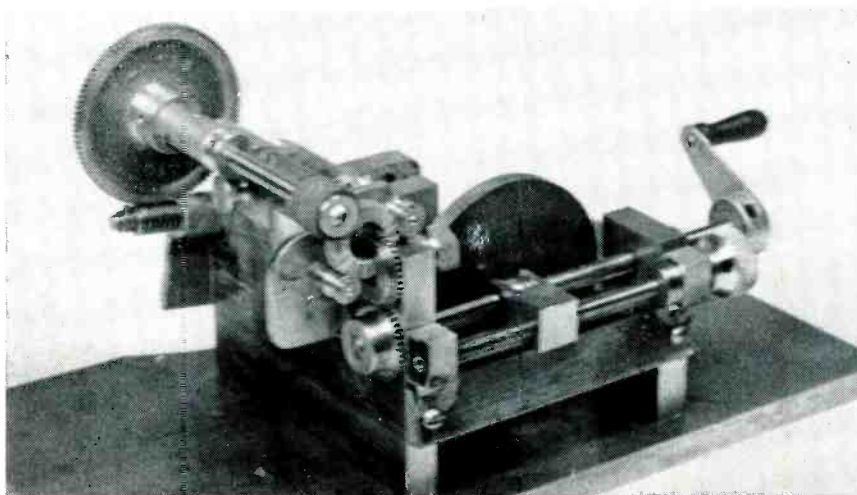
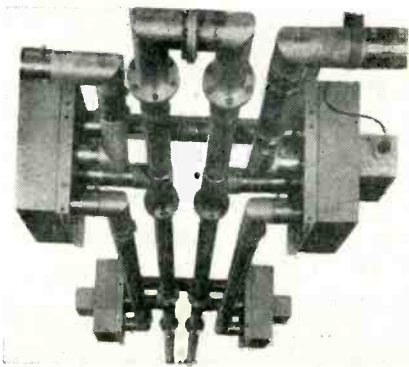

FIG. 6—Wide-band line driver (A) and response to video sweep (B) and 15-kc square wave (C). Transformer has 185-turn primary of No. 50 Formex and secondary of 40 trns of No. 24 eds wire



Machine winds toroid cores with No. 52 Formex insulated wire



Hybrid ring system used to parallel two transmitters is made up of coaxial line

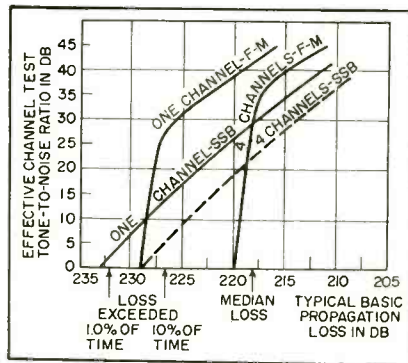

FIG. 1—Comparison of f-m and ssb for vhf transhorizon circuit at 30 mc

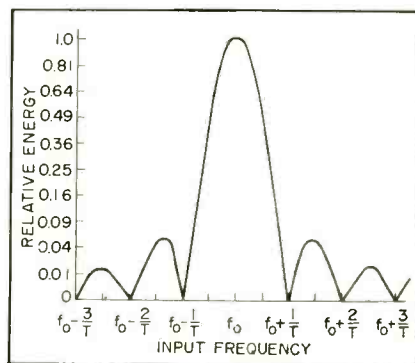

FIG. 2—Energy-frequency relationship of transmitted pulse

VHF TRANSHORIZON

SINCE 1946, new methods of reliable, long-distance radio communications have been under study. Out of this investigation have emerged what are known as transhorizon communications techniques¹. Most recently published articles have considered the problems, propagation mechanics and system requirements with little emphasis on equipment suitable for vhf ionospheric² transhorizon communications.

Signal Characteristics

For a typical vhf transhorizon system, the yearly median received signal-to-noise ratio as measured in a 3-kc band for 40-kw transmitted power is 25 db. One percent of the time this drops to 11 db and 0.1 percent of the time to 5 db. Even for a single voice-channel circuit the signal-to-noise ratio is low.

The signal received over vhf scatter circuits is at low level and has rapid fading associated with it. The fading rate under normal conditions will vary from approximately 0.2 to 5 cps. Fading amplitude follows a Rayleigh distribution. Fortunately, the fading at two points separated transverse to the path of propagation by 10 wavelengths or more is essentially incoherent.

Space diversity reception may be expected, therefore, to reduce the effects of this rapid fading. On circuits nearer the aurora region,

a very rapid fading known as sputter is encountered. This is thought to be caused by reflections from trails of high-velocity particles moving through the ionosphere.

As a consequence, the signal reflected has appreciable Doppler shift associated with it. At times, this shift may be 200 to 300 cps. Fortunately, in most cases, the signal reflected from the aurora during conditions of sputter is at a fairly low level so the fading range will normally be limited.

The signal received over a vhf scatter circuit also may result, in part, from reflections from the forward edge of meteor trails. The signal reflected from these meteor trails will be shifted owing to the movement of the meteor. It is expected that meteors may produce Doppler shifts up to 6 kc at 50 mc. However, measurements have indicated that the majority of meteor reflections will be shifted in frequency no more than 3 kc.

Meteor Reflection

The percentage of time that meteor reflections are present is small and is of little consequence for voice transmission. For teleprinter transmission where very low error rates are required, possible interference from meteor reflections should be considered in system design.

Multipath effects are also encountered in vhf scatter circuits.

The most severe of these is backscatter during periods of *F*-layer propagation. Multipath delays up to 50 milliseconds may be encountered during conditions of backscatter. Good antenna design should minimize such multipath effects. It is also possible to get multipath delays up to 2 milliseconds maximum from one or more meteor-trail reflections.

Occurrence of these phenomena will be rare. Under normal conditions of scatter propagation, the multipath delay within the medium should not exceed 20 microseconds. Therefore, the bandwidth of the medium will be more than adequate for voice transmission on a single-sideband basis since this method of modulation is least affected by delay distortion.

All the signal characteristics mentioned should be considered in design of a vhf transhorizon communications system. Since propagation by this mode is extremely persistent, the communications system should be designed to provide a high degree of reliability for teleprinter service. However, owing to sputter, meteor interference and the low signal-level conditions that exist during many periods throughout the year, the quality of voice circuits will be limited.

High-frequency communications systems must be capable of rapid frequency change since the optimum frequency will vary greatly

SUMMARY — Topography, climate and maintenance problems often make reliable communications circuits using wire or line-of-sight radio impracticable. Transhorizon techniques employing frequencies in the vhf spectrum make possible the establishment of radioteleprinter terminals at points between 500 and 1,500 miles apart. Reliability exceeds 99 percent in arctic

By R. M. RINGOEN and J. W. SMITH

*Collins Radio Co.
Cedar Rapids, Iowa*

Communication Techniques

from time to time. For vhf transhorizon propagation, the variation of propagation loss with frequency remains essentially constant throughout the year. The vhf system may, thus, be fixed in frequency.

Modulation

Ionospheric scatter propagation is more effective in the 25 to 50-mc range. This part of the spectrum is already crowded. It is then necessary to employ signaling means that utilize minimum bandwidth. Since the propagation mode is also subject to multipath delays, a broad-band modulation system would, in turn, have additional drawbacks.

For voice transmission, single sideband and frequency modulation must both be considered. In Fig. 1 is shown a comparison of ssb and narrow-band f-m for systems containing one to four channels. The effective channel test tone-to-noise ratio is plotted as a function of transmission loss for both ssb and f-m with the system parameters as indicated.

Also shown is the transmission loss that will be exceeded 50, 10 and 1 percent of the time on a typical circuit. From this graph it is shown that the signal on a typical circuit will be below f-m receiver threshold for a one-voice channel circuit, 10 percent of the time. This would result in a poor voice channel. For the four-chan-

nel case, f-m threshold is about at the median signal level. This means that most of the time the channels would be unusable.

It is evident that teleprinter transmission systems should operate with a s/n , as measured in a 3-kc band, well below 10 db if high reliability is to be achieved. This completely rules out placing teletypewriters in a voice channel, the output of which frequency modulates the transmitter, since then the f-m threshold would determine the minimum usable signal level. In view of these facts it would be difficult to engineer a flexible multichannel system using f-m voice and tone teleprinter.

During the low signal level conditions ssb should be superior to f-m for voice transmission. It is concluded that from a bandwidth, flexibility and s/n standpoint single sideband is sufficiently superior to frequency modulation for vhf

scatter circuits to offset the advantages of f-m equipment simplicity.

By employing linear amplifiers, it is possible to multiplex several ssb voice and printer channels onto a given vhf transmitter. The multiplex equipment used to accomplish this may be similar to that employed in voice multiplex telephone systems. Compandors are used on each channel to provide a large effective improvement in voice channel quality.

Diversity Reception

Dual-diversity reception may provide at least 10 db improvement in the performance of vhf scatter circuits. Special equipment techniques must be utilized to provide for diversity reception on ssb voice circuits. For diversity reception, the outputs of the two receivers should be held at the same level. On vhf scatter circuits, the fading

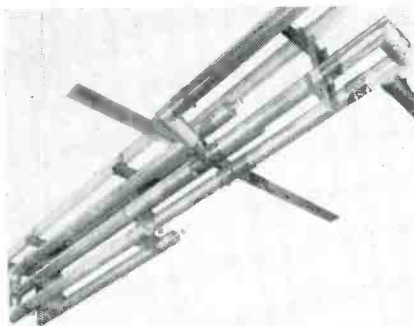

Rejection notch filter used at transmitter output to protect receiver when same antenna is used for sending and receiving

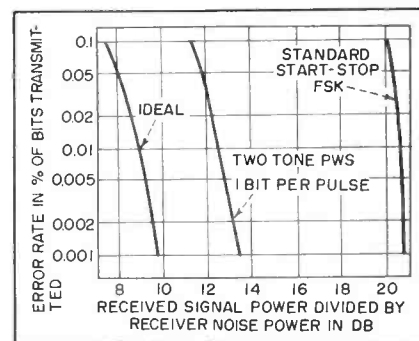

FIG. 3—Comparison of signal systems. Abscissa refers to bit-per-second capacity and noise power in 1-cycle band

rate may often pass the syllabic rate of a voice transmission.

The voice power itself may not be used for controlling the gains of the receivers. Consequently, a tone must be transmitted, detected in each receiver and used for deriving the agc voltage. The agc system should be designed to provide a flat amplitude response characteristic over a 60-db dynamic range. Preferably, the output level should not vary more than 1db with a 30-db change in the input signal level.

With the outputs of the two receivers established at identical levels they may be fed into a diversity selector circuit. Some measure of the signal-to-noise ratio of each receiver's output must then be made to determine the preferred receiver. It can be done by measuring the noise in a band in which no modulation is introduced. Out-of-band noise sampling may provide a voltage directly, which is inversely proportional to s/n in the output of each receiver. This voltage may be used to control an electronic switch that will connect the diversity output to the receiver with better s/n .

Methods of Combining

Switches have found considerable use in diversity receiving equipments but have some drawbacks. It is practically impossible to design a switch that will not have associated with it a distinct transient produced by the switching process. Although such a transient may be reduced to a low level by proper adjustment of the receiver selector circuitry, it is difficult to maintain over a long period of time the balance required to keep the transient at a permitably low level.

In switch-type diversity no advantage is taken of the intelligence contained in the signal with the poorer s/n . Finally, it is not practical to use a switch with a small increment of operation. Performance of a switching diversity system will always fall 1 db or so below ideal.

A diversity combiner may be employed to eliminate all three of the objections to the diversity switch. Diversity combiners have

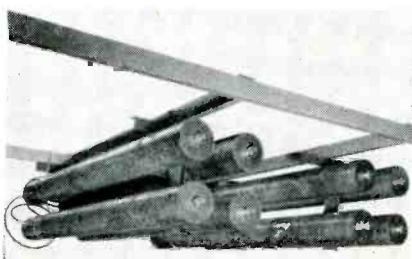

Bandpass receiver filter comprises four coaxial resonators in cascade

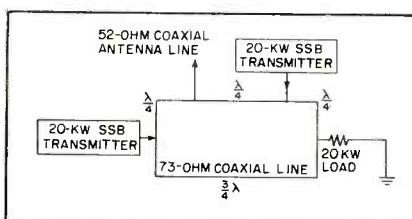

FIG. 4—Hybrid ring permits paralleling two transmitters

been described in the literature³. With a combiner each receiver contributes to the diversity output in proportion to its own output s/n . To utilize a combiner, both the phase and amplitude of the output of each receiver must be identical.

When a combiner is used, the pilot tone transmitted must be used to control both the output amplitude of the receiver and the output phase. This may be accomplished by transmitting the carrier as a pilot tone and effectively reinserting it in the receiver for demodulation. By proper circuitry it is possible to utilize one carrier for demodulation of all channels in a multichannel system without introducing any appreciable phase error as long as the phase response of the two propagation paths is the same.

If the noise in the output of one receiver is effectively incoherent with respect to the noise in the output of the other, the diversity combiner may be expected to give an improvement up to 3 db over the performance of an ideal diversity switch. This effect results because in the combiner output the two incoherent noise contributions will add on a power basis while the two signal contributions will add on a voltage basis. It is expected that under most conditions, the noise received by the vhf antennas will have a strong coherent component.

Triple and quadruple reception should be considered for use on vhf

scatter circuits. To accomplish this with switching-type diversity requires complex circuits and aggravates the transient problem as fading rates of 5 cps and higher may be encountered.

In most cases, it is preferable to use a diversity combiner for voice reception of vhf scatter circuits.

Transhorizon systems at vhf will undoubtedly find their greatest application in the transmission of teletypewriter data. However, even for this type of transmission, signal power is at a premium. On a typical circuit the channel test tone-to-noise ratio exceeded 99.9 percent of the time throughout the year, as measured in a 3-kc band, will be 5 db. This means that if appreciable information is going to be transmitted with low error rates, an efficient transmission system must be utilized.

The equipment required for teleprinter transmission must be efficient and lend itself to multiplexing so systems of various capacities may be easily assembled.

F-S Keying

Until recently, frequency-shift keying with an 850-cycle shift and 1,500-cycle channel bandwidth has been used for the transmission of teleprinter by h-f radio. The main merit of this system is in its simplicity. Because of excessive bandwidths used and other factors, the efficiency of standard fsk transmission is far from ideal.

If a teleprinter transmission system is to approach maximum theoretical s/n performance, it is evident that full use should be made in the detector circuitry of a detailed knowledge of the frequency, amplitude characteristics and timing of the received printer pulses. Until recently, techniques and components were not available to permit the development of such a system. In recent years, oscillators, filters and timing circuits have been developed to the extent required for such a system.

The teleprinter transmission system should make full use of the frequency stabilities now available. Present-day oscillators are capable of frequency stabilities exceeding one part in 10^9 per day. In terms of time, this stability would pro-

duce an error of one millisecond in a period of 28 hours. Possession of such a frequency standard provides the receiving circuits with the ability to remember the frequency and timing of the transmitted pulses for long periods.

Synchronous System

If full use is to be made of the knowledge of received-pulse-timing, a completely synchronous transmission system must be utilized. Because of the timing accuracy of the frequency standard and the length of pulses generally transmitted (2.5 to 22 milliseconds) it is easy to provide sufficiently accurate timing information to the receiving circuits without having to resort to the transmission of synchronous information more than once every several hours.

If full use is to be made of the knowledge of amplitude and frequency characteristics of the received data pulse, this pulse must be filtered in a circuit whose frequency response matches exactly the energy-frequency distribution of the received pulse. In other words, the filter should provide gain only at those frequencies at which energy is transmitted.

In Fig. 2 is shown the energy-frequency relationship of a square pulse at frequency F . The filter, the response of which matches exactly this distribution, is an infinite-Q circuit tuned to the received frequency and gated so the input to the filter is only open dur-

ing the length of the pulse. For up to 22-millisecond bauds such a filter may be approached using mechanical resonators directly in the audio-frequency range or mechanical resonators with positive feedback around them in the 20 to 24-kc range.

Making complete use of knowledge of received-pulse amplitude spectrum requires that the pulse be integrated over its complete length and the integrated value sampled in the detector circuit. This may be done easily in a synchronous system in which a gated infinite-Q filter is used for matching the filter response to the energy-frequency relationship of the transmitted pulse. An infinite-Q circuit acts as a perfect a-c integrator. The oscillation in the resonator is sampled only at the end of the pulse at which time the signal-to-noise ratio should be at its maximum.

A system called predicted-wave signaling¹ has been developed to incorporate the features described. The results of tests on this equipment are shown in Fig. 3. The signal-to-noise performance of this system in the presence of thermal noise is 7 to 8 db superior to that of standard fsk. These results have been verified in the laboratory and over h-f and vhf radio circuits.

Predicted-wave signaling lends itself both to time-division and frequency-division multiplexing. Time-division multiplexing has the advantage of permitting data to be

transmitted on a multichannel basis using only one frequency. In such a system Doppler interference from meteors or sputter would be of little consequence. Also, the peak-to-average ratio of the power transmitted will be unity so the transmitter may be operated at its maximum capability on a continuous basis. By employing time-division multiplexing, eight 60-wpm printer channels can be transmitted using 2.5-millisecond pulses.

By employing special coding techniques this may be increased to 16 channels without decreasing the pulse length. During the periods of low signal level, the capacity may be reduced in steps of two by doubling the baud length. In this manner, the transmitter will still be operating at its maximum rating no matter what the system capacity might be. In the synchronous predicted-wave system, it is easy to change pulse length—it is done by switching the timing of the time-base generators and multiplexing units at the receiving and transmitting terminals.

Frequency Control

It is not required that the vhf transhorizon system be capable of rapid shifts in operating frequency. Frequency stability is generally based on the frequency and timing requirements of the transmission system. It is advantageous to have sufficient frequency stability so the oscillators may be used as time references at both the transmitting and receiving terminals, eliminating the need for the continuous transmission of synchronizing information. A stability of one part in 10^8 per day is adequate for the predicted-wave system and for the transmission of single-sideband voice.

It would be feasible to engineer a vhf transhorizon system utilizing a crystal oscillator, the frequency of which is chosen for each operating frequency. Development of crystal oscillators has not advanced to the point, however, where it is relatively easy and inexpensive to obtain one part in 10^8 stability over a wide range of oscillator frequencies. Considerable development has been expended on crystals operating in a narrow frequency

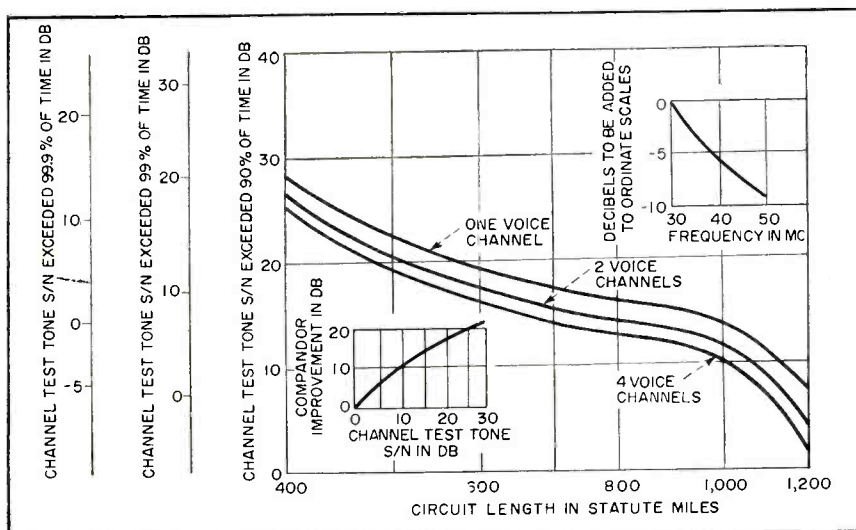

FIG. 5—Voice channel capacity and quality. When compandors are used, improvement derived from insert graph should be added to channel test tone signal-noise figure

range around either 100 kc or 1 mc.

For this reason, it appears logical to use a stabilized master oscillator in conjunction with a frequency standard at each terminal to provide injection frequencies to the exciters and receivers so they may be set up at any one of a number of frequencies separated by a distinct increment.

Basically, a stabilized master oscillator functions to generate a spectrum of closely spaced frequencies, the stability of each being determined by the frequency standard. A variable-frequency oscillator is then phase locked to one of these spectrum points. By taking a 1-mc oscillator and dividing its frequency down to 100 kc and 10 kc and in turn providing these two frequencies to a stabilized master oscillator, it is possible to obtain outputs from the stabilized master oscillator spaced sufficiently close together to provide the injection frequencies required for operation with 10-kc channel spacing. When the bandwidth required for a typical vhf circuit is considered along with the interference that may be encountered as a result of meteor Doppler shifts, it is not logical to space channels any closer than 10 kc.

Equipment Reliability

Since the most outstanding characteristic of vhf scatter propagation is its persistence, it is important that the reliability of the equipment used in vhf transhorizon systems be extremely high; otherwise the main system feature will be compromised. From a propagation standpoint, it is feasible to provide a teleprinter transmission reliability in excess of 99.9 percent. To achieve a similar equipment reliability requires the utilization of several special techniques.

The transmitter is generally considered to be the least reliable component in the system. For vhf single-sideband systems it is required that the transmitter or power amplifier linearity be such that the intermodulation distortion as measured with two tones be at least 30-db below one tone of the two-tone test signal. The utilization of r-f feedback not only improves the transmitter linearity

but also stabilizes the transmitter power output and stabilizes the amplifier⁵ phase characteristics.

At the present time it appears that power from 20 to 40 kw may be required for most vhf systems. There is no air-cooled tetrode available for 40-kw operation. Consequently, a multiplicity of tubes must be used. By employing the latest and highest power tetrodes, it is possible to obtain 40-kw peak envelope power with the required linearity using four tubes in parallel. One transmitter employing four such tubes in parallel generally fails if any one of the four tubes fails independently.

The reliability of a 40-kw vhf transmitter will be considerably less than the reliability of a 10-kw transmitter. This points up the need for providing standby transmitters at each vhf terminal and incorporating methods for rapidly switching a standby unit into service. Not only is this a costly solution in terms of primary-power requirements, space and investment, is also costly from the standpoint of switch-over time.

It appears more logical to utilize two completely independent lower power transmitters in parallel to provide 40-kw power for vhf transhorizon systems. In this manner, each transmitter serves as a standby for the other. However, some method of paralleling these units must be utilized to couple them into the same antenna. It has been found that the coaxial hybrid ring shown in Fig. 4 is ideal for this purpose.

By tracing the signal routes

through this circuit, it is found there is no coupling between the two transmitters. With both transmitters operating at the same power and phase output, all the power from each transmitter will be coupled to the antenna and none to the load. If one transmitter fails, half of the power from the other transmitter goes into the hybrid load, and half into the antenna. This means that a complete failure of one of the transmitters results in a 6-db decrease in transmitted power. No switch-over time is involved.

A hybrid ring circuit developed for paralleling two 20-kw transmitters over part of the vhf range is shown in the photograph. The coaxial switches on the network are provided for switching one transmitter directly to the load and the other transmitter directly to the antenna. This would normally be done within two or three seconds if one of the two parallel transmitters failed.

Using two transmitters in parallel, a large savings in primary power is also realized. During some times of the year, propagation will be much better than at other times. Often 20 kw of transmitter power will be adequate. Under these conditions, one transmitter may be shut down—unless the protection against failure is required—netting a large reduction in primary power consumption.

Diplexing Techniques

As described in the literature⁶, large antennas are required for use in vhf horizon systems. The use of 2,000-ft rhombics or antennas with apertures in excess of 10,000 square feet are common. For the minimum number of antennas to be utilized in any vhf system, it becomes desirable to transmit and receive on a common antenna and utilize a second antenna at the terminal for diversity reception and transmitting standby antenna.

Several problems are associated with duplex operation at the 40-kw level in the vhf frequency range. The equipment itself must be well shielded so that radiation from the power amplifier units does not interfere with the operation of the receivers located in the same area.

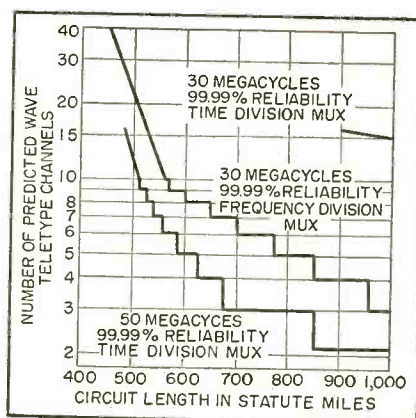

FIG. 6—Predicted-wave teletypewriter channel capacity in dual-diversity systems

High-performance filters must be used in the transmitting and receiving antenna lines so the receivers and transmitters are effectively isolated. In one system it has been found that noise in the output of the transmitter at a frequency removed 10 percent is -176 dbw per cycle bandwidth. The minimum receiver noise is approximately -200 dbw per cycle bandwidth. Therefore, the transmitter output noise must be attenuated at least 30 db if it is not to contribute to the receiver noise.

Receiver Selectivity

Measurements on typical receivers indicate that at a frequency removed 10 percent an interfering signal must be below a -37 dbw level if it is to result in negligible distortion, desensitization and cross modulation in the receiver. Since the transmitter power output is $+46$ dbw this means that for 10-percent frequency spacing, the filters in the receiving antenna line must attenuate the transmitter frequency by 83 db or more.

A rejection notch filter in the transmitter line is most practical to reject the noise in the transmitter output at the receiver frequency. Such a filter is shown in the photograph. This filter design was chosen because it required the use of coaxial line no greater than $3\frac{1}{2}$ in. The attenuation of a filter to the transmitter frequencies is negligible, being less than 0.1 db.

A bandpass receiver filter (illustrated) developed for a vhf transhorizon system consists of four coaxial resonators in cascade. It has an insertion loss of 1.1 db and is more than adequate for attenuating the 40-kw transmitter power sufficiently that duplex operation with a transmitter-receiver frequency spacing of 10 percent is feasible. By modifying the filter arrangement slightly, it should be possible to provide duplex operation at frequencies spaced as little as 4 percent for a system requiring a bandwidth of not more than 20 kc.

By employing the techniques described, channel capacity and quality shown in Fig. 5 and 6 may be obtained. In Fig. 5 is shown the channel test-tone-to-noise ratio

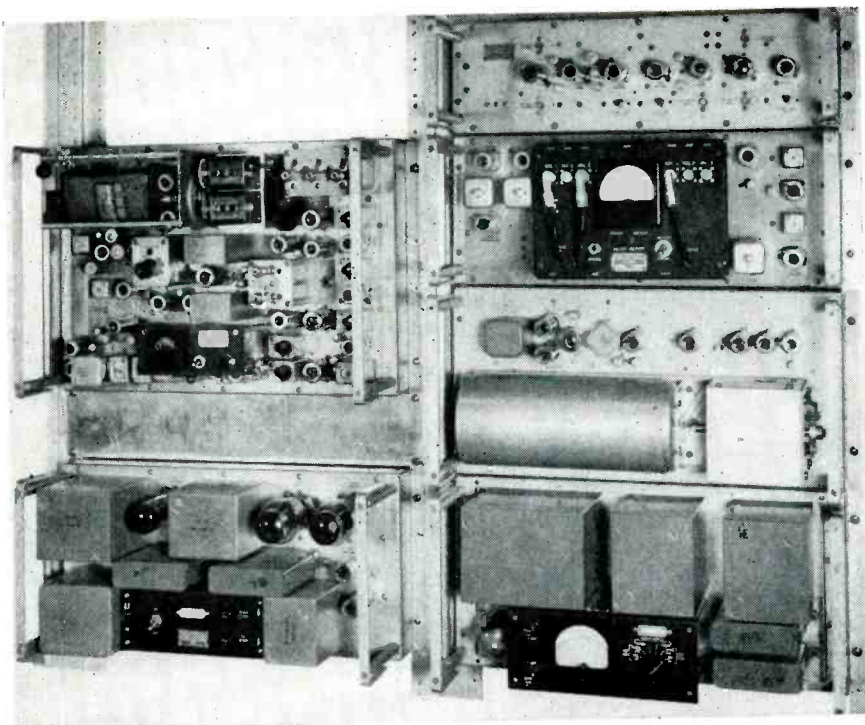

Highly stable oscillator, frequency divider and stabilized master oscillator. Station frequency can be changed within an hour if this should become necessary

that is exceeded 90, 99 and 99.9 percent of the time for a 1, 2 and 4-voice channel vhf circuit with the conditions listed. Also plotted in this curve is the effective improvement obtainable through the use of companders.

Variation in received s/n with frequency is also plotted in Fig. 5. The assumed propagation loss variation with frequency represents the average of that data presently available on the subject. Propagation loss variation with distance has been obtained as a result of numerous flight tests and propagation studies.

From Fig. 5 it is shown that a voice channel at 30 mc with the use of companders may have an effective test-tone-to-noise ratio which exceeds 37 db 90 percent of the time for a 600-mile circuit. This should be adequate for many requirements.

If teleprinter threshold is defined as a character error rate of 0.1 percent, then Fig. 6 shows the channel capacity versus distance and frequency for teleprinter using the predicted-wave signaling technique. At 30 mc, a channel capacity of fifteen 60-wpm teletypewriter channels at 99.99-percent reliability may be provided for circuits 1,000

miles in length, using time-division multiplexing.

This is reduced to three channels if frequency-division multiplexing is used. At 50 mc and 1,000 miles, only two predicted-wave 60-wpm teletype channels may be provided with a character error rate below 0.1 percent, 99.99 percent of the time throughout the year. Standard fsk could not be used under these conditions to provide 99.99-percent reliability.

In contrast, standard fsk could be used only to provide one 60-wpm channel with 99.9-percent reliability. This points up the necessity of using a high-performance data transmission system such as predicted-wave on vhf transhorizon circuits.

REFERENCES

- (1) James R. Day, Beyond-Horizon Signals Extend Communications, *ELECTRONICS*, p 122, Oct. 1955.
- (2) A. A. McKenzie, Reliable VHF Signals Up to 1,250 Miles Distance, *ELECTRONICS*, p 102, June 1955.
- (3) C. L. Mack, Diversity Reception in UHF Long-Range Communications, *Proc. IRE*, p 1,281, Oct. 1955.
- (4) M. L. Doelz, Predicted-Wave Radio Teleprinter, *ELECTRONICS*, p 166, Dec. 1954.
- (5) W. B. Bruene, Linear Power Amplifier for SSB Transmitters, *ELECTRONICS*, p 124, Aug. 1955.
- (6) D. K. Bailey, R. Bateman and R. C. Kirby, Radio Transmission at VHF by Scattering and Other Processes in the Lower Ionosphere, *Proc. IRE*, p 1,181, Oct. 1955.

Transistor Circuits for

SUMMARY — Junction transistors can perform all operations required in electronic portions of a digital computer. Circuits given include: two-input *and* gate, four-input *or* gate, flip-flop, counter, pulse amplifier and shaper. Also given are a counter and a flip-flop using point-contact transistors

SEVERAL BASIC DIGITAL computer circuits are described which show some of the important features of both point-contact and junction transistors for this type of application.

And, Or Circuits

The impedance properties and current gain of the common-emitter junction transistor stage are useful in the *and* gate shown in Fig. 1A. When the voltage at base input *B* is -12 volts or greater, the transistor is in saturation and effectively shorts the signal applied to collector input *A*, inhibiting the gate. When the base input level is -2 volts or less, the transistor is cut off by the $+3$ -volt supply, and the gate is primed.

With this type of gate current requirements on the control level are small and transistor dissipation is low. Multiple-control *and* gating is obtained by paralleling base resistors and/or transistor stages.

Switching time of the common-emitter stage requires a delay between gate and control signals. The capacitor is used to maintain prime and inhibit times of less than $3 \mu\text{sec}$, using low-frequency transistors. With high-frequency transistors, gating times of $1 \mu\text{sec}$ may be achieved without a base capacitor.

The junction transistor *or* gate shown in Fig. 1B uses the low input-impedance of the common-base stage for isolation between resistance inputs. Current gain is provided by the 3:1 step-down transformer. However, to maintain rise-fall times less than $0.5 \mu\text{sec}$ using low-frequency transistors the load impedance for the circuit is limited to 1,800 ohms. The stage is used as an overdriven amplifier with clamping by diode D_2 to standardize pulse-amplitude and to limit storage.

Current gain is approximately 1.4, with the total input impedance equal to 2,400 ohms permitting the gate to drive one *and-or* section using the *and* gate of Fig. 1A. With high-frequency transistors this circuit provides the useful combination of pulse *or* logic and current gain.

Flip-Flop Stages

A junction-transistor saturating flip-flop stage is shown in Fig. 2A. The on transistor is held in saturation by the base-current to the collector of the off stage which in turn is cut off by the $+3$ -volt bias. This circuit was designed to supply a -12 -volt minimum level at 1-ma maximum load without cutoff clamping. The low collector-emitter saturation impedance of the on stage provides efficient clamping. Collector voltage rise and fall times

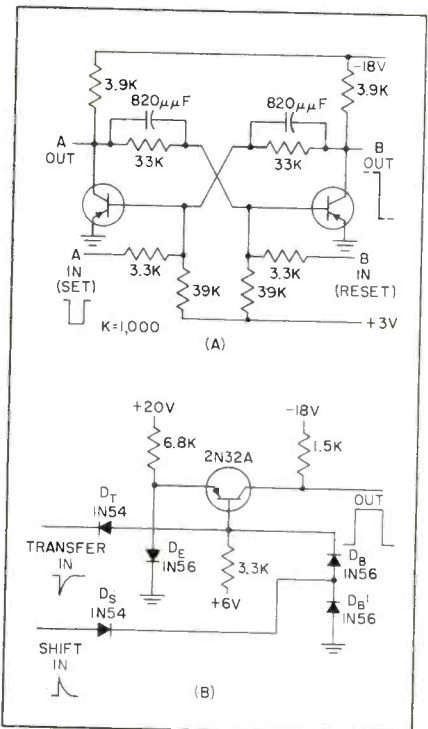

FIG. 2—Junction flip-flop (A) is highly stable and insensitive to noise. Point-contact flip-flop (B) may be operated synchronously by *anding* a positive set trigger at either the base or the emitter and reset triggering from a clock source

are $2 \mu\text{sec}$ and $3 \mu\text{sec}$ respectively, using a 6-volt, $2\text{-}\mu\text{sec}$ trigger pulse. Storage delay is approximately $1 \mu\text{sec}$.

Point Contact

A point-contact nonsaturating flip-flop circuit is shown in Fig. 2B. This circuit was designed specifically for a decade ring counter. It is applicable to other types of storage such as shift registers, and to synchronous computing systems.

Cutoff is established by the clamping action of diode D_E which holds the emitter potential near ground

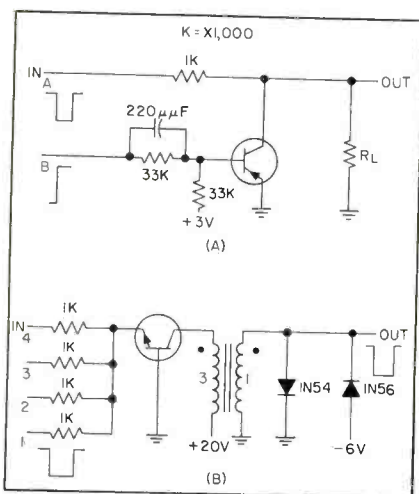

FIG. 1—Two-input *and* gate (A) provides good rise and fall times. Transient response of four-input *or* gate (B) is good

DIGITAL COMPUTERS

By **D. E. DEUTCH**

RCA Victor Division
Radio Corp. of America
Camden, N. J.

while the base voltage is raised positive by the +6-volt supply. In the on state, the 6,800-ohm emitter resistance and the 20-volt emitter bias form a constant emitter current supply which maintains nonsaturation on conditions, with the base voltage clamped to ground by diodes D_n and D'_n .

Circuit rise and fall times are less than $0.15 \mu\text{sec}$ (in most cases figures of $0.05 \mu\text{sec}$ are obtained). Transfer time in a ring counter using $220\text{-}\mu\text{mf}$ coupling capacitors between stages is $0.1 \mu\text{sec}$.

Counters

A junction-transistor counter is shown in Fig. 3A. Resistance trigger coupling is used for set, reset and count operation.

At the count trigger input, the diode D_o is held in conduction by the +3-volt supply. The voltage drop across D_o supplies reverse bias to the off transistor in the counter and clamps the input against noise signals.

With capacitance coupling, this count trigger input network forms a differentiation circuit for binary transfer from a previous counter stage. Pulse triggering may also be employed.

The stage is designed to supply 1 ma load current at minimum collector voltage of -12 volts. Rise and fall times are 2 and $2.5 \mu\text{sec}$ with circuit recovery at $5 \mu\text{sec}$.

A symmetrical point-contact transistor counter stage is shown in Fig. 3B. Emitter-follower buffer stages, using high-frequency junction transistors, are employed in the cross-coupling networks to reduce collector loading during circuit regeneration. Each half of the counter is identical to the single-

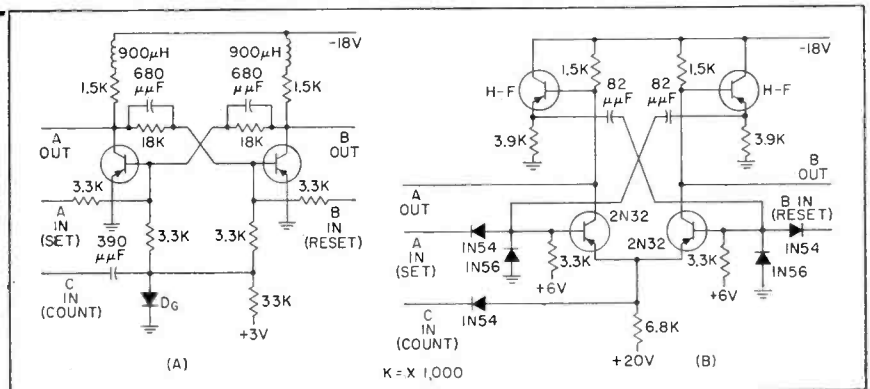

FIG. 3—Junction counter stage (A) is similar to flip-flop. Collector inductors provide improved fall time. Point-contact stage (B) achieves improved cutoff stability using common-emitter resistor

transistor flip-flop of Fig. 2B except that the function of the emitter clamp diode in the flip-flop is provided by the on stage in the counter.

Collector voltage rise and fall times are less than $0.2 \mu\text{sec}$. Counter operation is at 500 k-c, but it may count at trigger rates up to 1.5 mc.

Amplifier and Shaper

The point-contact pulse amplifier shown in Fig. 4A supplies a 6-volt pulse into 220 ohms from a 1,000-ohm input impedance level. Rise and fall times are $0.15 \mu\text{sec}$ with a leading edge delay of $0.1 \mu\text{sec}$. Cutoff stability is established by the small positive voltage produced across the base diode by the +6-volt base bias.

A point-contact transistor is used in the pulse shaper shown in Fig. 4B. A delay line with open-circuit termination is connected between the emitter and collector to establish the period of output pulse.

The circuit is triggered by a positive pulse applied through the 1,000 ohm input resistor to diode D_E , and is monostable thereafter for a period determined by twice the delay of the delay line. Diode D_E conducts during this operation, and isolates the circuit from the trigger source.

Cutoff stability is obtained by the small positive bias across diode D_n . The circuit is inhibited for approximately $10 \mu\text{sec}$ after the mono-

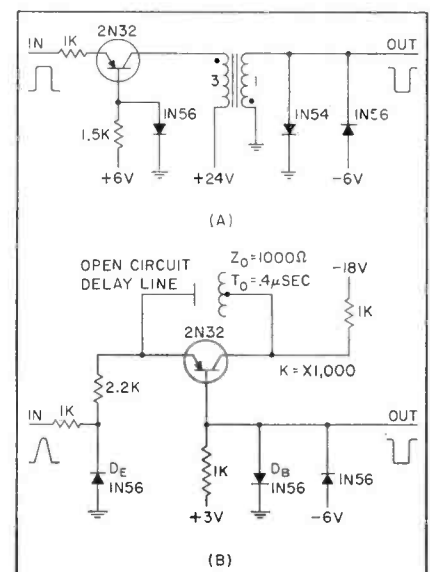

FIG. 4—Point-contact pulse amplifier (A) and pulse shaper (B). Delay line establishes shaper output pulse period

stable cycle during the decay in negative emitter voltage resulting from the retrigger action of the reflected signal from the delay line.

An input pulse of approximately 5 volts amplitude triggers the circuit with $0.3 \mu\text{sec}$ delay. An output pulse was obtained for two delay times, $1 \mu\text{sec}$ and $0.2 \mu\text{sec}$. Because storage of 0.05 to $0.15 \mu\text{sec}$ exists in the transistor due to saturation on operation, the delay time of the delay line is reduced. For the $1\text{-}\mu\text{sec}$ and $0.2\text{-}\mu\text{sec}$ output pulses, delay lines of $1.45 \mu\text{sec}$ and $0.075 \mu\text{sec}$ respectively are used.

Techniques for

SUMMARY — Quantitative and subjective noise measurements are both important in design of low-noise equipment. This third article in a series compares nine different scales for measuring noise, describes noise-figure determination for various networks and discusses noise effects in television

By W. R. BENNETT

*Bell Telephone Laboratories, Inc.
Murray Hill, New Jersey*

MEASUREMENTS of noise are essentially measurements of average power. The time over which the average is taken depends upon the ultimate application of the circuit or system. In steady noise sources of the thermal or gaussian variety, the average is usually taken over a long time—so long that if it were made still longer the result would be little affected.

In general this means an averaging time that is large compared with the reciprocal of the bandwidth. For gaussian noise with bandwidth b , the rms variation in the ratio of average power measured over time T to the infinitely long time average is approximately $1/(bT)^{1/2}$.

When the noise is intermittent averaging should be done in the same way as the intended receiver is affected. The ear, for example, requires about 0.2 second to register the full effect of a suddenly applied tone. Tones which last a shorter time produce proportionately less sensation. Hence an integration time of about 0.2 second is appropriate for noise meters used with sound systems.

If the noise is intermittent, the meter gives a series of isolated kicks instead of a steady deflection. Some convention must be established for reading this variable indication. The time weighting is based partly on the dynamic response of the meter and partly on instructions to the operator.

The volume indicator is an example of this type of noise meter. Its primary use is in adjusting signal

levels on systems transmitting speech and music. It can be used to measure noise on the same scale. When so used it contributes a weighting depending on the duration of noise bursts.

Units and Scales

Some of the common units and scales for measuring signal and noise are illustrated in Fig. 1.¹ At the top is a logarithmic scale in watts.

The next scale converts the first to decibels relative to one milliwatt. This unit is designated dbm. Sometimes the term dbw is used for db relative to one watt. One watt is equivalent to 30 dbm or 0 dbw.

Scale 3 shows the rms voltage corresponding to the power values of scales 1 and 2 when circuit impedance is 600 ohms.

Scale 4 is that of a volume indicator calibrated in the volume unit or v-u.² The v-u has become widely accepted in telephony, broadcasting and recording. It represents the reading of a specified combination of a d-c meter associated with a full-wave rectifier, resistors and calibrated attenuator.

The fact that the scale is the same as the dbm scale does not mean that v-u and dbm values coin-

cide. They agree for a steady 1,000-cps tone and almost agree for any steady tone from 25 to 16,000 cps.

The dynamic response to tones of short duration, however, is a specific property of the v-u meter chosen to represent the human-ear response and is not directly translatable into an average power measurement. To read speech or music in v-u, the attenuator is adjusted until the extreme deflections of the meter just reach the zero v-u mark. The attenuator setting then gives the volume in v-u.

Scale 5 applies to a volume indicator in which the reference level is established relative to a steady tone of 6 mw instead of 1 mw. Readings on this scale are in db above or below reference volume. For pure tones 0 dbm is equivalent to 7.8 db below reference volume. In the general case, no exact conversion exists because the two indicators differ in dynamic response.

Circuit Noise

When a volume indicator is used to measure noise,³ it is usually desirable to add a frequency-weighting network to evaluate the net interfering effect of various components. The interfering effect of a $1\text{-}\mu\text{w}$ 1,000-cps tone is chosen as a reference. This is called reference noise. The number of dbrn or db above reference noise for a noise wave is defined as the number of db loss which would have to be inserted to make its interfering effect the same as reference noise.

Scale 6 shows dbrn, with 0 dbm equivalent to 90 dbrn. This corre-

OTHER ARTICLES IN THIS SERIES

Characteristics and Origins of Noise p 154, March 1956
Equipment for Generating Noise p 134, April 1956

Measuring NOISE - Part III

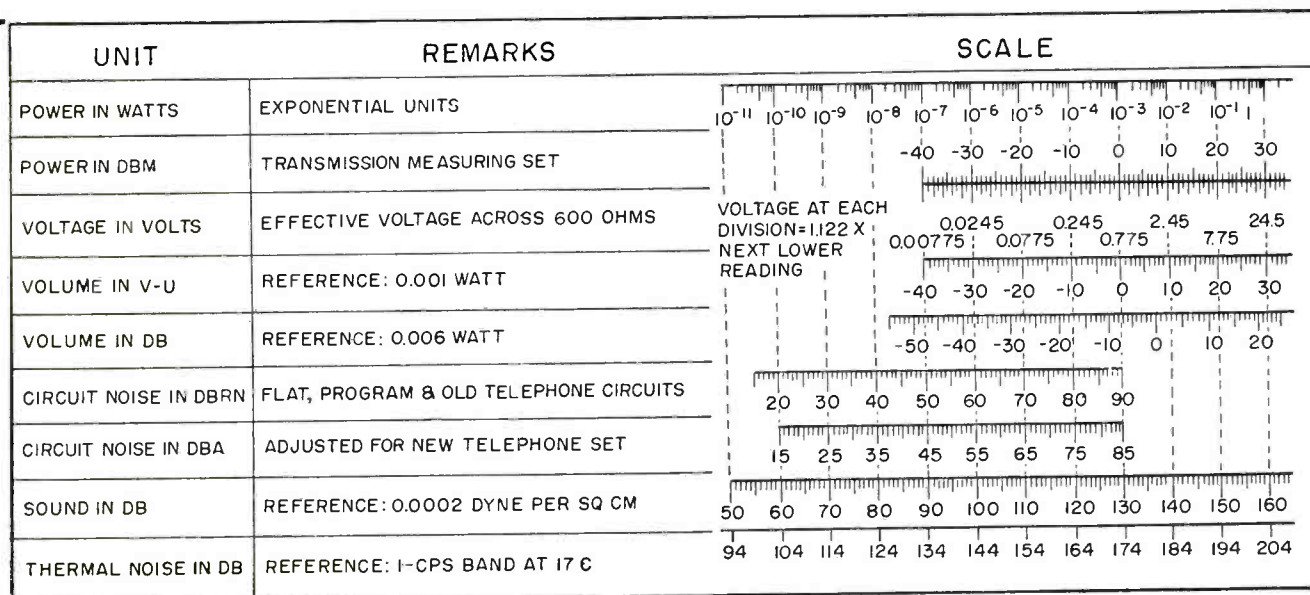

FIG. 1—Scales for measuring noise and communications signals

spondence holds only for a pure 1,000-cps tone.

The frequency weighting to be applied at a particular frequency depends on the purpose of the system, the point in the system at which the measurement is made and the characteristics of the receiver and ear. Weighting can be calculated from single-frequency masking data or determined by subjective tests with a number of observers. In general, the weighting network should attenuate the noise frequencies in inverse ratio to their interfering effects. Typical weighting curves are shown in Fig. 2.⁴⁻⁷

Scale 7 in Fig. 1 represents the dba, or db adjusted, a noise scale for newer telephones which have a wider response but are 5 db less efficient at 1,000 cps than older instruments. The correspondence between power and these noise units is as indicated only in the case of a 1,000-cps measurement.

Scale 8 is that of the sound-level meter.⁸ The reference point is a sound pressure of 0.0002 dyne per sq cm at 1,000 cps, a power of approximately 10⁻¹⁶ watt per sq cm. This is the average threshold of hearing at 1,000 cps for young people.

Scale 9 shows, for comparison,

the power in db above that in a 1-cps band of thermal noise at 17C. The thermal noise power in a band of width b is $10 \log_{10} b$ times as great.

Measuring Instruments

All the scales in Fig. 1 are based on average-power measurements. Therefore, mean square indication of current or voltage is required. An instrument which depends on heating effect such as a thermocouple, thermistor or temperature-saturated diode is accurate for this purpose.

One difficulty is that these devices may need to be operated at relatively high levels to get the desired sensitivity. They are then subject to burnouts from sudden overload. It is possible, however, to incorporate the heating element in a tight feedback loop which holds the current constant and gives the indication by the amount of current fed back.

Figure 3A shows a circuit using a temperature-saturated diode with the current to be measured supplied to the filament.⁹ Power measurements at low current levels are made with a crystal in series with an R-C combination as shown in Fig. 3B. This follows a square law if the excursion is small.

The square law can be checked by measurement of noise power against filament current in a temperature-saturated diode. The square-law range can be extended by selected resistors in series with the crystal and meter.

Noise Figure

Many noise measurements are made to test system components to determine their individual contributions to the noise in the system. The noise figure or noise factor¹⁰⁻¹² is a convenient criterion. These terms are used interchangeably.

The noise figure of any piece of apparatus is the ratio of actual noise output power to noise power which would be delivered if the only source of noise were thermal noise at standard temperature in the input termination. An equivalent definition of noise figure is the ratio of signal-to-noise ratios in the input and output circuits provided noise in the input circuit is that available from thermal noise.

Spot Noise Figure

Spot noise figure is measured in a narrow band centered at a specified frequency while average noise figure is measured over the entire range of a device. The former

is used when it is necessary to specify how the signal-to-noise ratio varies with the frequency of individual signal components. The latter is sufficient if only total output noise and signal over the whole system range are of interest.

Either noise figure is a numerical power ratio which is often expressed in decibels. The values are affected by the internal structure of the system and the source impedance. Spot noise figure is independent of output impedance since any mismatch affects signal and noise alike. The average noise figure is affected if the mismatch varies with frequency.

Average Noise Figure

It is possible to calculate average noise figure from the curve of spot noise figure against frequency, if the curve of insertion gain against frequency is known. This is done

and delivers noise power comparable with the equivalent input noise generated by the device under test, it is necessary only to know the noise ratio of the source. That is, the ratio of the available noise power from the generator to thermal noise at the standard temperature.

Noise Temperature

This ratio can be expressed numerically or in db. It is often defined by giving the equivalent noise temperature of the source. Thus, if the positive column of a gas discharge tube acts like a thermal noise source at 12,000 K, the noise ratio compared to a standard temperature of 17 C would be $12,000/290 = 41.4$, which is equivalent to 16.2 db.

If an attenuator is inserted to reduce the output of the noise genera-

thermal noise at the input, noise figure F is

$$F = Q_2/W_0$$

The value of Q_2 is

$$Q_2 = FW_0 + (n_2 - 1)W_0$$

and

$$F = \frac{(n_2 - 1)Q_1}{(Q_2 - Q_1)} = \frac{(n - 1)Q_1}{r(Q_2 - Q_1)}$$

Noise Figure Calculation

A convenient measurement procedure is to vary the attenuator until the noise output power is just double that when the noise generator is inactive. Then $Q_2 = 2Q_1$ and $F = n_2 - 1 = (n - 1)/r$.

If the doubled output power occurs for an attenuator setting of 7 db, substitute $n - 1 = 40.4$ and $r = 5$ to obtain $F = 8.08$ or 9.1 db. This method gives the spot noise figure if a narrow-band filter is inserted in the output circuit ahead of the power-measuring instrument. It gives the average noise figure if the output circuit passes the entire useful band.

In many microwave applications the spot figure does not change appreciably over the range of interest and the spot noise figure may be taken as the average noise figure. If the noise source is not white, the method can still be used to measure spot noise figures by calibrating at each measurement frequency.

In the range in which a noise diode delivers white noise the value of $n - 1$ is $20 I_0 R$ where I_0 is anode current in amperes and R is resistance in ohms. This value of $n - 1$ must be corrected for electron transit-time effects when the noise diode is used at higher frequencies.

Noise-figure measurements work best when the noise generator is capable of delivering power somewhat greater than the equivalent noise input of the device itself. If the noise generator delivers power enormously higher than needed, however, large attenuation is needed to prevent overloading the device under test and the problem of shielding to obtain accurate loss measurements becomes troublesome. If the noise generator delivers too little power the values of Q_1 and Q_2 become nearly equal and the accuracy of determining $Q_2 - Q_1$ is poor.

Noise-figure meters can be made

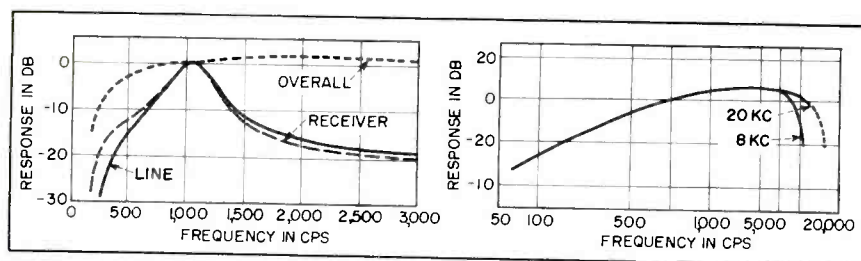

FIG. 2—Characteristics of frequency-weighting networks used with voice-channel (A) and program-channel (B) noise meters

by taking the ratio of the area under the curve of spot noise figure times power gain to the area under the power-gain curve. The gain and noise figures are expressed in power ratios, not db.

If the spot noise figure is constant throughout the frequency range the average and spot noise figures are equal. In systems of the heterodyne type there will be more than one output frequency for each input frequency and conversely. There are individual spot noise figures for the different pairs of corresponding frequencies making it necessary to consider image responses.

Measurement Technique

A convenient method of measuring either the spot or average noise figure is based on a calibrated noise source. The technique is shown in Fig. 4A. When the noise source is white or flat with frequency

tor, the reading of the attenuator in db does not apply to the noise ratio but to the excess over thermal noise, since the same standard thermal noise power is available from the attenuator output as from the input. If the noise ratio of the generator is represented by n and the attenuator introduces $k = \log_{10} r$ db, the noise ratio n_2 of the generator and attenuator combination is $n_2 = (n - 1)/r + 1$. Quantity r is the ratio of attenuator input to output power.

The quantities to be measured are Q_1 , the output noise power with input source containing thermal noise only, and Q_2 , the output noise power when a noise generator of effective noise ratio n_2 is applied. Impedance terminations must be the same in both measurements. If W_0 is the output noise power which would result if the device were noise-free and the only source of noise were that available from

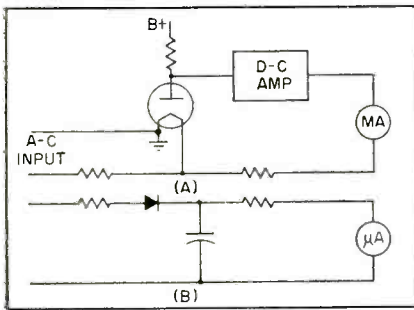

FIG. 3—Temperature-limited diode for rms current measurement (A) and crystal diode detector (B)

practically direct-reading. One method switches the noise generator on and off by a relay and displays the two meter readings on an oscilloscope.¹³ A scale is provided to read the noise figure in db directly from one trace when the other is adjusted to a standard position.

For production testing, a master standard of known noise figure may be used as reference. Since the characteristics of components are held within close limits, a measurement of signal-to-noise ratio after detection, with a fixed modulated-signal input is adequate for checking individual units.

It is likewise possible to measure noise figures by single-frequency inputs and by frequency-swept oscillator inputs.¹²

It is sometimes desired to calculate the noise figure of a combination of networks for which individual noise figures are known. A formula¹⁰ applies to networks in cascade as shown in Fig. 4B. If the individual networks have noise figures F_1, F_2, \dots , and gains G_1, G_2, \dots , the noise figure F of the combination is

$$F = F_1 + [(F_2 - 1)/G_1] + [(F_3 - 1)/G_1 G_2 + \dots]$$

Television Reception

Standards for the evaluation of noise effects on a television image have not been established to the same extent as for effects on speech and music. One study compares the effect of electrical noise on a tv picture to film graininess in a photograph.¹⁴

A microdensitometer can measure the variation in the density of a photograph evaluated for a small sampling aperture over a path

through a region having constant large-scale density. The finite-size aperture produces a smoothing effect on the graininess meaning statistically that the observed mean-square deviation in density varies inversely with the number of grains included in the scanning aperture.

In a noisy television signal a first approximation assumes that each half lobe of the noise wave, in effect, produces a grain on the image. The mean-square deviation of the density which would be measured with an infinitesimal aperture is proportional to the total noise power. To find the observed effect, the total noise power is divided by the number of grains in the scanning area.

The number of grains is obtained by multiplying the scanning area by the average number of axis crossings of the noise wave. In a band of white noise the observed effect is proportional to the density of noise power on the frequency scale. Thus, increasing the upper cutoff frequency of the noise band at constant density does not change the threshold of visibility.

The masking effect of the additional fine-grained noise compensates for the increased noise amplitude to keep the threshold of perception constant. A more exact treatment requires taking account of the correlation of the noise grains along the scanning direction.

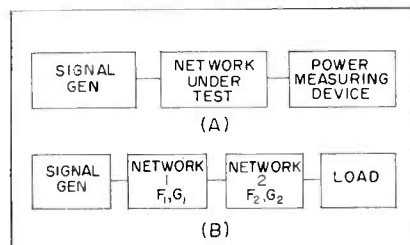

FIG. 4—Noise-figure measurement for one network (A) and for networks in cascade (B)

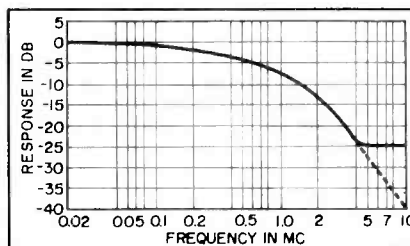

FIG. 5—Random-noise weighting curve for monochrome television

An experimental determination of relative interfering effects of noise components at different frequencies has been reported.¹⁵ The noise weighting curve deduced is shown in Fig. 5. The middle portion agrees with the photographic grain concept. Very low frequency noise was found to create a streaky nebulous effect that is subjectively most annoying. When the noise was concentrated at frequencies above 4.5 mc in a wide-band receiver, tiny flashing points of light were observed which were related to the instantaneous peaks of the noise waves.

Interference Effects

This sparkle effect calls for the solid branch of the weighting curve which flattens off above 4 mc. If the noise is spread out over the low as well as high frequencies the dashed continuation is more applicable since the high-frequency components are likely to be below the threshold of the sparkle effect. Precise weighting is further complicated by the fact that even in the same frequency range a given amount of noise power is more interfering if concentrated in a narrow band than if spread over a wider band.

REFERENCES

- (1) J. L. Merrill, Jr., Meter Scales for Transmission Measurements, *Bell Labs Rec.* 27, p 16, Jan. 1949.
- (2) H. A. Chinn, D. K. Gannett and R. M. Morris, A New Standard Volume Indicator and Reference Level, *BSTJ*, 19, p 94, Jan. 1940.
- (3) W. L. Black and H. H. Scott, Audio-Frequency Measurements, *Proc IRE*, 37, p 1,108, Oct. 1949.
- (4) R. S. Tucker, Measurements of Noise on Program Circuits, *Bell Labs Rec.* 14, p 233, March 1936.
- (5) J. M. Barstow, A New Noise Meter, *Bell Labs Rec.* 15, p 252, Apr. 1937.
- (6) E. Dietze and W. D. Goodale, Jr., The Computation of the Composite Noise Resulting from Random Variable Sources, *BSTJ*, 18, p 605, Oct. 1939.
- (7) J. M. Barstow, P. W. Blye and H. E. Kent, Measurement of Telephone Noise and Power Wave Shape, *BSTJ*, 15, p 151, Jan. 1936.
- (8) American Standard Sound Level Meters for Measurement of Noise and Other Sounds, *ASA*, 224.3, 1944.
- (9) R. D. Campbell, The Diotron—An Aid to RMS Instrumentation, *ELECTRONICS*, 23, p 93, July 1950.
- (10) H. T. Friis, Noise Figures of Radio Receivers, *Proc IRE*, 32, p 419, July 1944.
- (11) A. van der Ziel, Noise, Chapter 4, Prentice-Hall, Inc., New York, 1954.
- (12) Standards on Electron Devices: Methods of Measuring Noise, *Proc IRE*, 41, p 890, July 1953.
- (13) R. W. Peter, Direct-Reading Noise Factor Measuring Systems, *RCA Rev*, 12, p 269, June 1951.
- (14) P. Mertz, Perception of Television Random Noise, *Jour SMPTE*, 54, p 8, Jan. 1950.
- (15) J. M. Barstow and H. N. Christopher, The Measurement of Random Monochrome Video Interference, *Trans AIEE*, 73, Part I, *Communications and Electronics*, p 735, Jan. 1954.

Beam Deflection Tube

SUMMARY — Seven tubes formerly needed in radio compass are replaced by two miniature 6AR8 beam deflection tubes. Number of circuit components is substantially reduced providing smaller, lighter unit for aircraft

RADIO NAVIGATION equipment requires that units be produced which offer maximum reliability and contain a minimum of tubes and components. In developing a smaller and lighter radio compass to meet the demands for private aircraft, a number of circuit simplifications have been made.

Compass System

In the radio compass shown in Fig. 1A, the sense signal is modulated by the signal from the loop antenna. To effect this a balanced modulator switches the phase of the loop signal at a rate determined by the frequency of a reference oscillator. The modulated sense signal is then passed through a receiver of conventional design. The phase and amplitude of the recovered

By **J. M. TEWKSBURY**

*Project Engineer
Bendix Radio Division
Bendix Aviation Corporation
Towson, Maryland*

signal operates a thyatron motor control circuit causing the loop antenna to search out and remain on the correct null of the loop field pattern.

The sense antenna has a circular sensitivity pattern, and its output phase is constant regardless of the direction of arrival of the signal. The loop antenna has a figure eight field pattern and its output phase is inherently displaced 90 degrees from that of the sense antenna. The phase will be leading or lagging depending on whether the incoming signal is arriving from the right or

left of null. If the direction of arrival is to the right of null, the loop signal phase, after being shifted 90 degrees, will coincide with the sense antenna phase. Conversely, if the station is to the left of null, the loop phase will be opposite to the sense antenna phase.

Beam Tube

The 6AR8 beam deflection tube makes possible a reduction of tubes and components in this system as seen in Fig. 1B. This tube is a tetrode with two plates and deflectors so arranged that the cathode beam may be directed to one plate or the other by applying the proper polarity voltage to the deflectors.

The average transfer characteristics depicted in Fig. 2 show that with 250 volts on the plates, almost complete deflection of the beam is accomplished with 40 volts impressed on the deflector system. There is then, an amplification factor between the deflectors and the anodes. Thus, it is possible to make oscillations occur by connecting phase-shifting networks between the plates and their deflectors.

Modulation System

In the typical modulation system shown in Fig. 3, a double-triode 48-cps reference oscillator, drives a double-triode balanced modulator and furnishes a reference voltage to the thyatron loop motor control system.

The 48-cps reference voltage is applied to the grids in push-pull and allows first *A* and then *B* to conduct. The resultant voltage is then added to the sense antenna voltage producing a modulation envelope.

The first step in simplifying the radio compass circuit was to combine the functions of reference os-

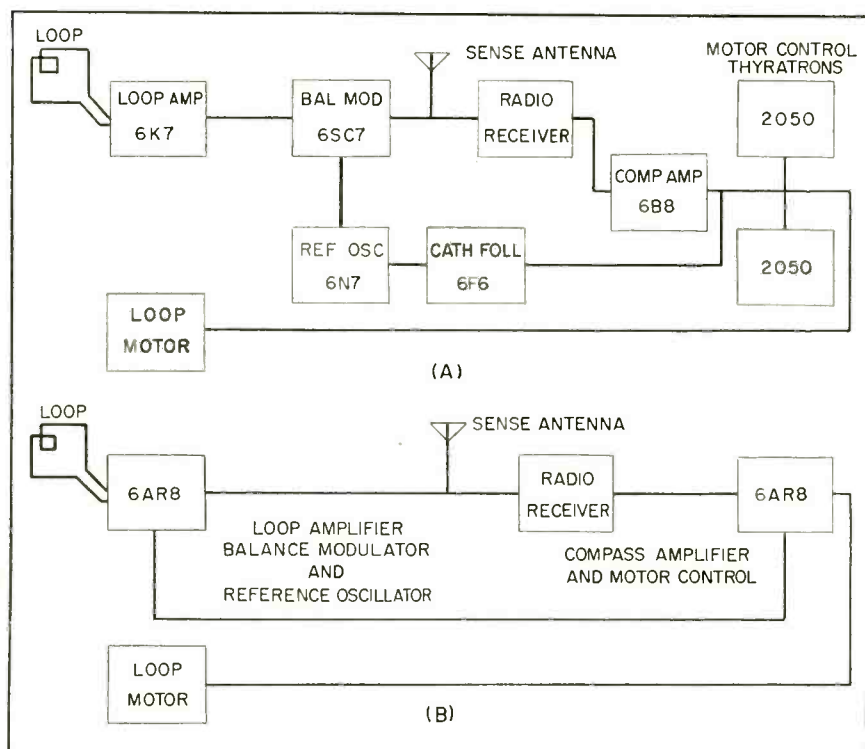

FIG. 1—Original radio compass system (A) and simplified system (B)

Simplifies Radio Compass

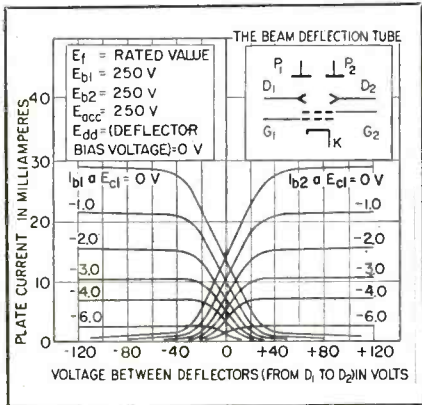

FIG. 2—Characteristics of 6AR8 beam switching tube

illator and balanced modulator in one double triode. Following that, use of the 6AR8 made it possible to reduce the number of components required for the balanced-modulator oscillator as well as inherently provide a loop amplifier. Figure 4 shows this circuit.

The r-f gains of the respective tube sections vary alternately at the frequency of the phase-shift oscillator function. The phase-shift oscillator operates at 48-cps, consequently the output of the balanced-modulator oscillator consists of 96 envelopes a second, with successive envelopes being of opposite r-f phase. These are actually the upper and lower sidebands, the carrier being entirely suppressed in the modulation process.

A transformer with two primaries is connected in the plate circuits. The loop signal is applied to the control grid. The loop phase-shift network is connected between the balanced modulator output and the sense antenna input.

Motor Control

The beam deflection tube also effects a saving in tubes and components of the loop motor control system.

The present compass receiver uses a pair of thyratrons in the loop motor control circuit, as shown in Fig. 5A. The a-c reference voltage is applied to the plates of the thyratrons through the 6F6 cathode

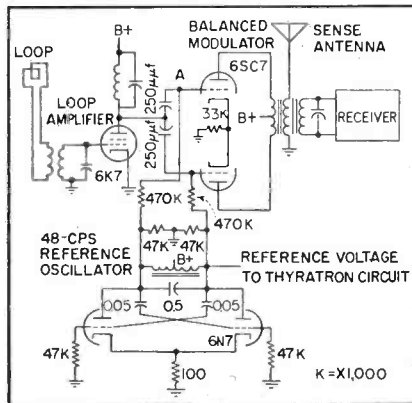

FIG. 3—Circuit of original modulation system uses three tubes

follower. The two plates are effectively in parallel and both come to a maximum positive potential at the same time.

Circuit Operation

The compass signal is amplified by the 6B8 and impressed on the thyatron grids in push-pull. The phase shifts in the compass circuits are carefully controlled so that the presence of a compass signal will cause one of the thyratrons to conduct. The saturating current drawn by one of the reactors reduces its impedance so that transformer current flows through the motor and causes motor rotation. When the compass signal reverses phase, the other thyatron conducts and the motor turns in the opposite direction.

Figure 5B illustrates the loop motor control circuit using the 6AR8 tube. The saturable reactors are connected in the plate circuits

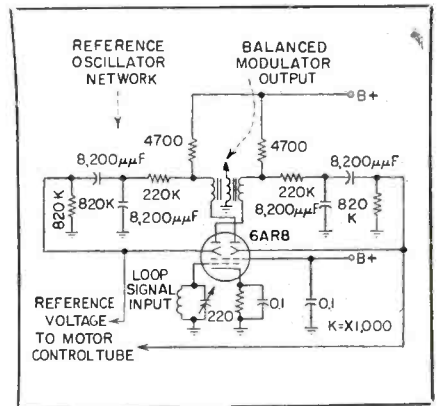

FIG. 4—Combined loop amplifier, reference oscillator and balanced modulator

of the beam deflection tube, and the reference voltage is derived by connecting the deflector plates to the corresponding elements of the balanced-modulator oscillator tube.

The compass signal acts on the control grid to vary the plate current, and the deflector system alternately switches the beam from one plate to the other. The action is similar to that of the thyatron loop motor control circuit in that one of the plates will draw more current than the other and, through the saturable reactor circuit, the loop motor is made to rotate in a direction determined by the phase of the compass signal.

This special application of the beam deflection tube may point the way to some interesting innovations in the design of simpler electronic circuits, particularly for small, inexpensive equipments.

The author thanks A. A. Hemp-hill and M. E. Lynn, for their aid.

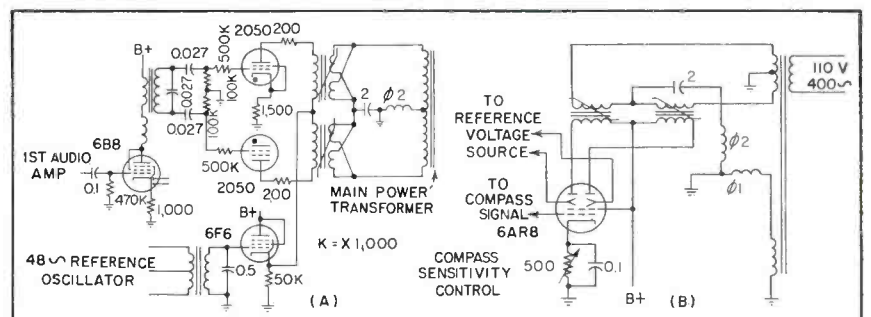
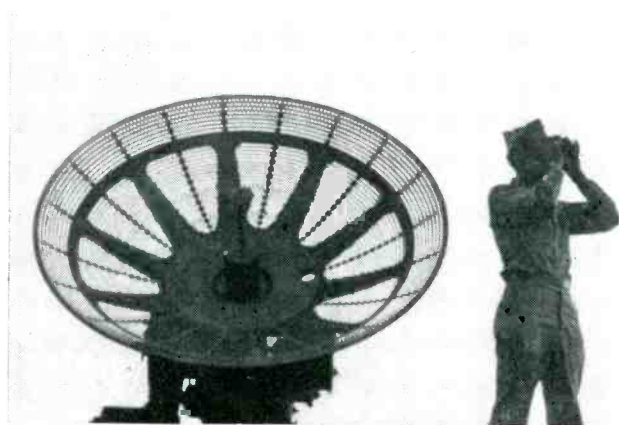
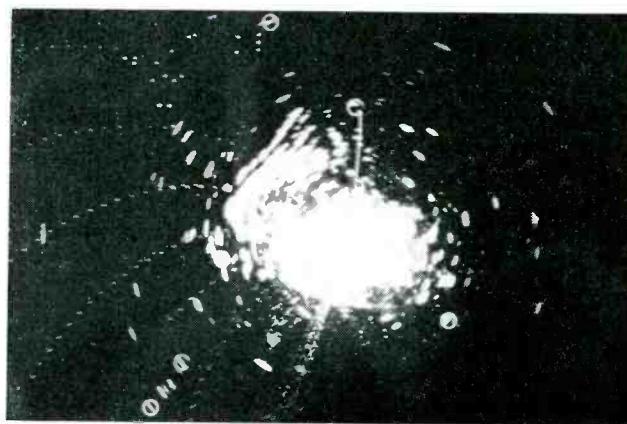

FIG. 5—Original thyatron motor control circuit (A) and motor control circuit using 6AR8 (B)



Information from radars provides data to computers



Computer output is fed to centralized ppi and appears as markers

Radar PPI Display Uses

RADAR DISPLAY techniques to be described show how a conventional ppi is designed to exhibit, in addition to the radar video information, the data output from a group of auto-tracking computers. Each computer output is a pair of d-c voltages representing cartesian-resolved slant-range positions that form the predicted position of a radar target.

Requirements

A dot is to be generated on the crt screen at the position determined by the d-c data potentials. The dot must be presented continuously, not once every scan like the radar video. Continuous presentation requires that the dot waveform be interlaced with the conventional sweep waveform. The two waveforms are shown in Fig. 1 before interlacing.

With a radar repetition rate of roughly 400 cps the dot flicker rate is about 7 cps which is too low. To improve the flicker rate, two dot waveform pulses are interlaced during each dead time period, producing a satisfactory flicker rate of about 14 cps. There is no correspondence between the sweep amplitude and adjacent dot waveform amplitude, since they are interlaced independently.

These dots are divided into two distinct categories representing different conditions of the associated tracking computers. These cate-

gories must be readily distinguishable, hence gated sinusoidal voltages are added to the X and Y deflection systems, so that one category of dots is transformed into small circles. A circle diameter of about $\frac{1}{4}$ inch satisfactorily encompasses the radar target afterglow.

The interlaced symbols are designated tags rather than dots. Three other distinct forms of tags are used. A remote tag, which is also a dot tag, is displayed much less frequently; about every 5 seconds instead of every 70 milliseconds. A leader tag is formed by intensifying the flyback from a tag position;

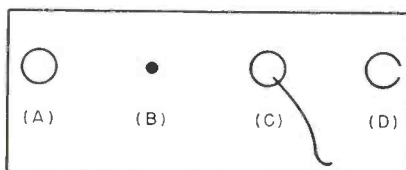

FIG. 2—Circle tag (A), dot or remote tag (B), leader tag (C) and circle marker tag (D)

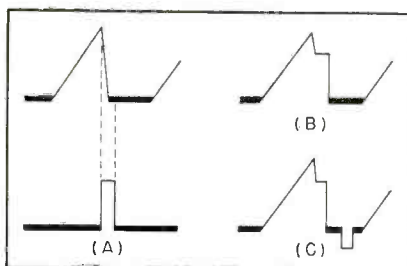

FIG. 1—Sweep and dot waveforms before interlacing (A), after interlacing (B) and with two dot waveforms interlaced (C)

this draws a wavy line from a tag to the display center. A circle marker tag consists of a pulse that removes the intensification from a small portion of the circle tag circumference, leaving a C shape. These tag forms are shown in Fig. 2.

Deflection System

A number of problems are caused by the interaction between the sweep and the tag waveforms. Among these are tag weave, breakup of tags, noise on the interlaced sweep and tag waveforms and registration error.

Tag weave is a small circular motion of the tag in synchronism with the antenna scan. It has been traced to at least three causes: the first is remanence in the magnetic yoke surrounding the deflection coil. The small flux density in the yoke during radar dead time is in the direction of the last sweep. If this flux density is of sufficient magnitude to deflect a dot tag, the result is tag weave.

The second cause of tag weave is eddy current in metallic masses adjacent to the deflection coil. The sweep sawtooth will induce an eddy current in an adjacent metal which will persist during radar dead time and will produce its own magnetic field. The time constant of such induced currents is of the order of milliseconds, being greatest for low-resistivity conductors such as alum-

SUMMARY — Marker symbols representing target position data from auto-tracking computers are displayed continuously on modified radar ppi by interlacing during radar dead time. System insures negligible error between display of target and its computed position and allows operator to coordinate manual aiding of auto-tracking computers

By **A. SHULMAN**

*Airborne Instruments Laboratory, Inc.
Mineola, New York*

PRECISION INTERLACE

inum or copper. The magnetic field rotates in synchronism with the induced sweep sawtooth so that it causes tag weave in the same way as remanence.

The third cause of tag weave is insufficient recovery time for the current in the deflection yoke to settle to its value at tag position. If the recovery is unduly prolonged during intensification of the tag, the result may be tag weave. A shorter recovery time only causes circle breakup.

The breakup of tags is caused by the top of the current waveform in the deflection coils being curved rather than flat during the intensification time. If the tag were a dot, it would be stretched out; if it were a circle, it would spiral. Breakup is most noticeable on circle tags.

Interference

Noise on the interlaced sweep and tag waveform can cause the circle tag particularly to wobble and become distorted. Noise is most

noticeable in magnified operation, since the sweep and tag waveform is amplified. Both circle and dot tags must be used at low intensity, and are therefore well focused. If the spot size diameter at low intensity is roughly 10 mils on a 14-inch display, noise of about 0.015 percent will cause the spot to fluctuate a full spot diameter in magnified operation.

The relative accuracy requirement for manual aiding of the auto-tracking computers is high. Tag

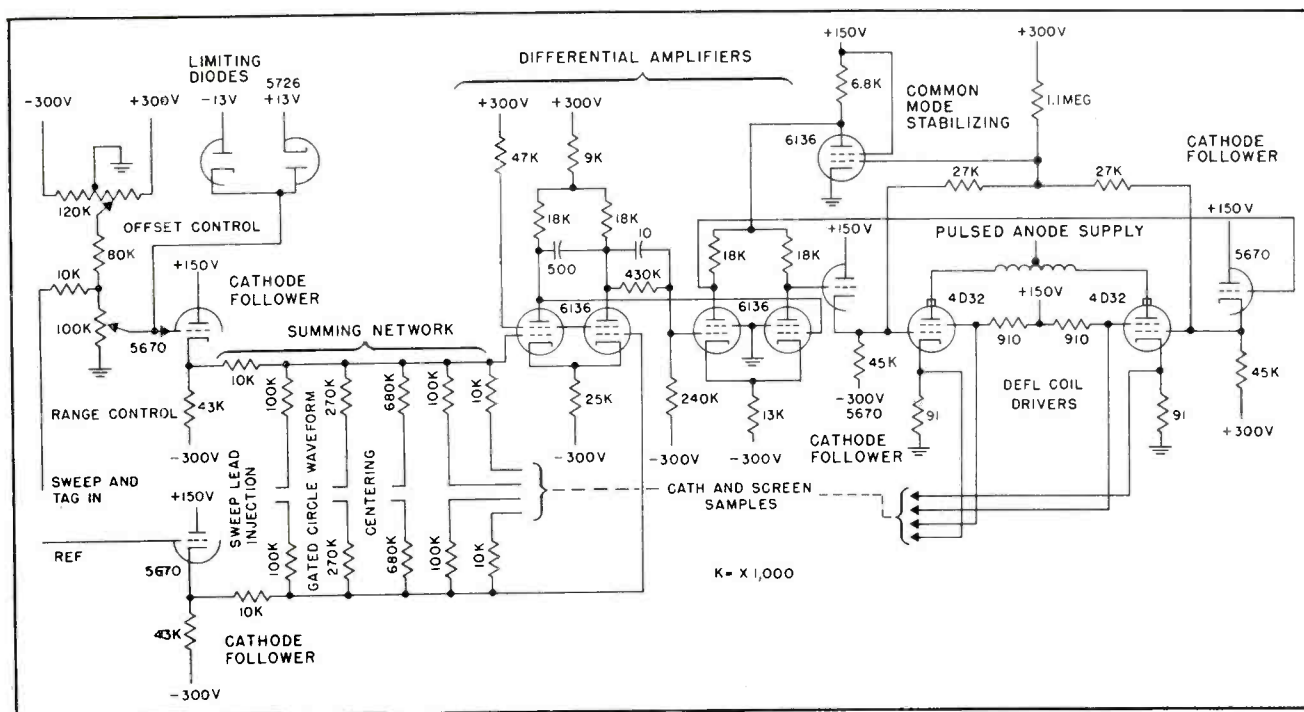

FIG. 3—Deflection circuits. Second differential amplifier makes the output less sensitive to tube drift

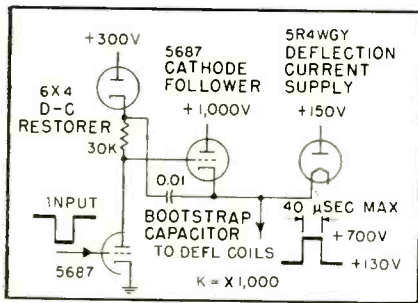

FIG. 4—Simplified circuit of anode pulser

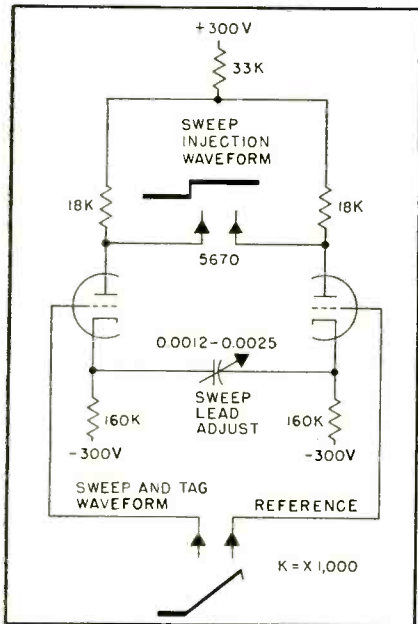

FIG. 5—Sweep lead generating circuit

and video at equal range must register within about 0.05 percent. Furthermore, a tag that had been accurately centered on video must not drift more than a fraction of this permissible error in a full scan.

Circuits

A two-stage direct-coupled differential feedback amplifier, shown in simplified form in Fig. 3, drives the deflection coils. A one-stage feedback loop has been added to stabilize the common-mode operation and to fix the quiescent deflection-coil current at a class A operating point.

The deflection coils require about 140 ma per radius at the cathode-ray tube anode voltage of 7,500 volts. To supply this current at reasonably low plate supply potential, type 4D32 high-perveance pentodes are used as deflection-coil drivers. A feedback voltage, proportional to deflection-coil current, is obtained from current-sampling resistors in the cathode and screen circuits of the driver tubes.

Timing of the tag waveforms is such that 100 microseconds are allowed for the deflection system to settle to the tag position before the tag is intensified. If the tag position were diametrically opposed to the end of the sweep line, it would be necessary to slew the beam a full diameter and to settle down to better than 0.015 percent within this time. Only a fraction of this time, however, is available for slewing. It has been found necessary to supply at least 700 volts to the anodes of the deflection-coil drivers in order to ensure sufficiently rapid slewing. The anode voltage is no greater than 120 volts, however, so a considerable power saving can be attained by pulsing the anode supply, during slew time, from a normal value of about +120 volts to a peak of about +700 volts.

An anode pulser, shown in simplified form in Fig. 4, has been devised to perform this function. The diode supplying the anodes is cut off by the conduction of the cathode follower supplying the anode pulse. The cathode follower is normally cut off. It conducts, when rapid slewing is required, by a pulse derived from differentiation of the incoming sweep and tag waveform. To improve the anode pulse rise time, the grid of the cathode follower is bootstrapped by capacitance coupling to its own cathode. The coupling capacitor requires a diode to restore its charge.

The deflection coil is sine-distributed, push-pull connected, encapsulated and fitted with a large Ferrite yoke. The Ferrite material used has negligible remanence, and there is no eddy-current problem. The coil sensitivity is about 140 ma per radius at an anode voltage of 7,500 volts, with inductances ranging between 50 to 70 mh. It is

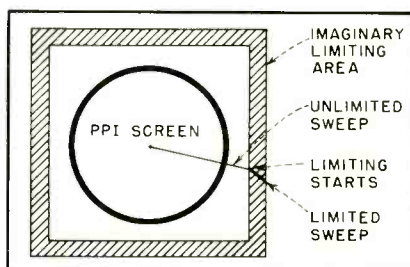

FIG. 6—Radar ppi deflection pattern is limited as shown

used with a 16-inch DuMont type K1132P7 tube.

Damping resistors on this coil cause a sweep delay of about 6 μsec. The delay is overcome by differentiating the incoming resolved sweep sawtooth and injecting the resultant step waveform into the deflection system. This sweep lead neutralizes the delay in the coil. Figure 5 shows the generation of the sweep lead injection waveform.

Magnification and Offset

Magnification, offset and limiting are also provided by the circuits shown in Fig. 3. The offset control essentially adds a variable d-c potential to the incoming sweep sawtooth, which is then attenuated by the range control. The range control is set to maximum attenuation of 4 to 1 for unmagnified operation and to minimum attenuation for a magnification of 4 to 1.

To prevent the coils and their drivers from being overloaded, a diode limiter is provided that makes use of the 25,000-ohm back resistance of the range and offset switch combination. The diodes saturate when the signal exceeds the preset bias so that the deflection pattern is limited to a square surrounding the screen as shown in Fig. 6. Sufficient over-deflection must be allowed between the picture perimeter and the limiting square so that, when sweeping from square-side into the picture area, the deflection systems have time to recover.

Tag Intensification

Tag writing speeds are different, but their apparent intensities need to be low and nearly alike to prevent interference with video afterglow. Thus an independent intensity control circuit and a mixer are required for each tag form. A separate pulse gates the circuit shown in Fig. 7, producing an area-balanced positive-going pulse with a flat top whose amplitude is controlled by a remote potentiometer. The pulse-top level is sufficiently independent of duty ratio so the tag intensity does not vary with the number of tags on the screen.

The crt cathode can be used for current limiting as shown in Fig. 7. The diode clamps the crt cathode

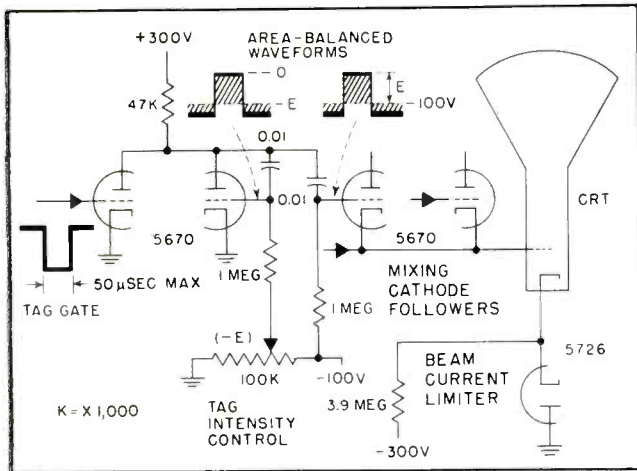

FIG. 7—Circuit for presentation of tags

close to ground potential. When the grid drive increases sufficiently so that crt cathode current increases beyond cathode resistor current, the diode cuts off, allowing the crt cathode to rise with its grid. The cathode current can therefore increase only slightly above the resistor current except for 1 to 2-μsec at the leading edge of a pulse.

The intensification of video and sweep waveforms is accomplished by the circuits shown in simplified form in Fig. 8. Amplified video at an amplitude of about +60 volts is d-c restored to the base-clipping level. The restored waveform is then base-clipped by a pair of non-additive-mixer cathode followers.

During radar dead time, the video is blocked by a video gate. The gate circuit consists of a distortionless divider feeding a cathode follower that can be cut off by

conduction of a gating triode. The gating triode is driven by a sweep gate waveform so it conducts during radar dead time. The cathode follower is cut off and the video gate closed, hence interference between video and tag intensification is prevented. The gated video output is shown in Fig. 8 without a tag waveform.

Off-Screen Blanking

Off-screen blanking requires a cartesian-to-polar coordinate conversion. The conversion is accomplished by the circuit shown in simplified form in Fig. 9. This circuit performs an approximate root-mean-square computation and transmits a blanking signal to the video gate whenever the rms value of the X and Y deflection-coil currents exceeds a preset value.

The off-screen blanking circuit is

driven by the cathode outputs of the deflection-coil drivers, which are differential signals approximately proportional to the beam deflection. An absolute-value computation is made on each pair of cathode outputs by two diodes forming a nonadditive mixer. These absolute values drive the rms computer.

The computer resistance divider output is mixed by a four-diode non-additive mixer. Constant output is obtained as the X and Y absolute values vary along one of the straight lines shown in the graph of Fig. 9. The output is derived on a nearly circular contour thus approximating an rms computation.

The computer output is sliced by a two-stage differential amplifier which generates a square blanking waveform as the beam passes beyond the preset blanking radius. A substantial margin must be allowed between the point at which the deflection system limits and that at which the off-screen beam is blanked. Off-screen blanking must occur first, otherwise the limiting will halt the differential cathode outputs and stop the blanking gate. In this type of off-screen blanking, the blanking contour requires a separate centering adjustment. The ppi display centering controls are ineffective because their action is similar to offsetting.

This work, was performed under Signal Corps sponsorship and under the supervision of R. N. Close of this laboratory. R. H. Edmonds and E. W. Karpen performed early work on this type of display. W. D. White was responsible for the rms computer.

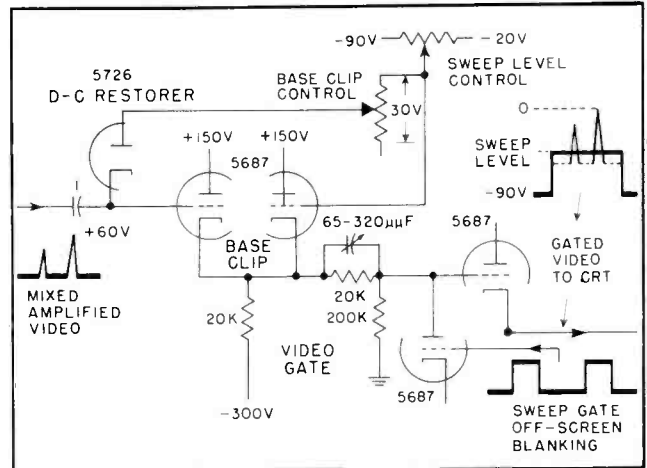

FIG. 8—Video and sweep intensifying and video gate circuits

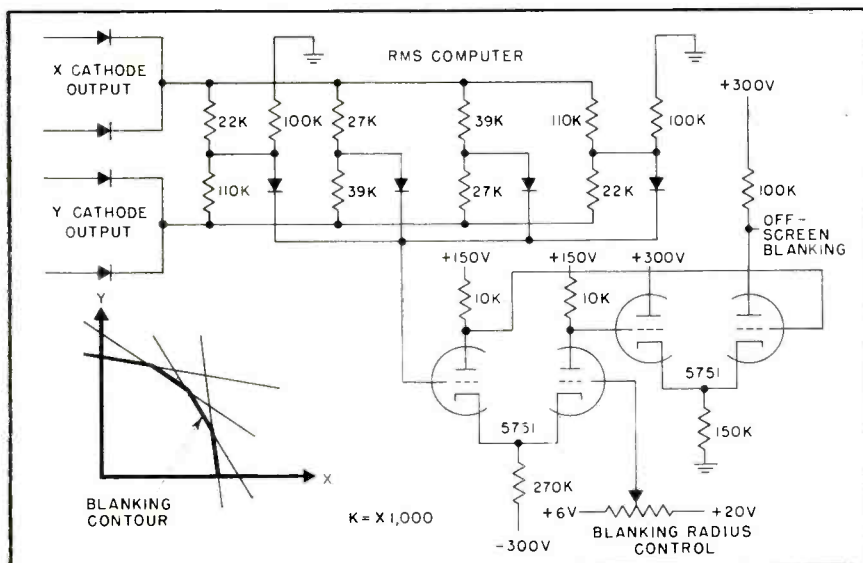

FIG. 9—Off-screen blanking circuits prevent halo effect from degrading contrast

TV Modulation Indicator

SUMMARY — Multivibrators serve in place of mechanical vibrator for interrupting video output signal of transmitter momentarily to obtain reference for checking percentage modulation of television picture transmitters. Chopping pulse is synchronized with television scanning system

TELEVISION STATIONS are required by FCC regulations to have available some method of measuring the percentage of modulation for both the aural and visual transmitters.

The visual monitoring signal, used for checking modulation, is normally obtained from a diode or demodulator unit coupled to the transmitter output. Since the visual carrier is amplitude-modulated, the instantaneous value of the detected carrier will drop to zero for 100-percent modulation. Thus, if the detected direct-coupled video output is viewed on an oscilloscope, it is only necessary to interrupt the signal momentarily to give a 100-percent modulation reference. Quite often this is accomplished by connecting the contacts of a vibrator across the video line from the output of the monitoring diode.

When a demodulator unit is used, the vibrator is sometimes connected to bias an i-f stage to cutoff, which accomplishes the same result. In either case, the vibrator contact resistance can adversely affect the modulation indication. As the contacts become pitted or dirty, the reference line becomes irregular and unreliable.

Requirements

Since the vibrator type of modulation indicator proved undesirable for the above reasons, it was decided to solve the problem by designing an electronic indicator. The following features were considered desirable:

(1) The chopping pulse should

By **EDWARD M. TINK**

Engineering Department
WLAC-TV, Inc.
Nashville, Tennessee

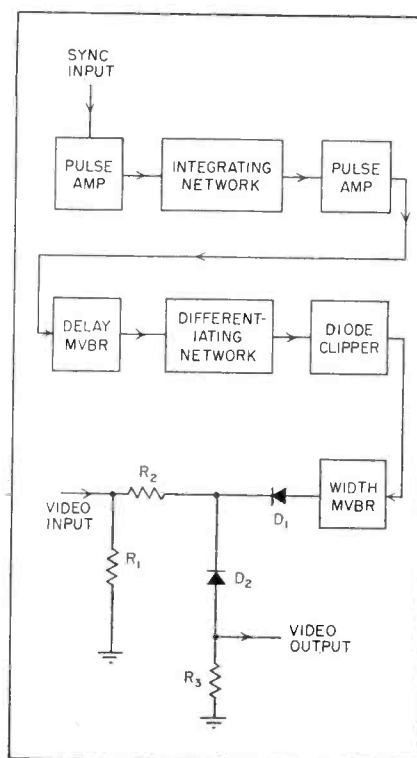

FIG. 1—Stages of modulation indicator

be synchronized with the television scanning system so it would not drift through the picture.

(2) The position of the pulse should be capable of being moved with respect to the vertical sync interval.

(3) The width of the pulse should be adjustable.

The first requirement eliminated the possibility of using a 60-cps chopper pulse derived from the a-c

line, since the pulse would be locked in only when the 60-cps component of the television synchronizing information was in phase with the local a-c line voltage. This situation does not normally occur when the station is broadcasting either a network or a color program.

In the case of a network program, the vertical sync information will normally be locked in to the a-c line frequency of some distant city, while for color programs the synchronizing information is not referenced to any line frequency.

Since separated sync is often available at the output of the transmitter stabilizing amplifier, it was decided to use this signal as a reference. If separated sync is not available, it can readily be obtained by feeding the monitor output of the stabilizing amplifier through a simple sync-separator stage. This insures that the chopper pulse is always synchronized with the signal being transmitted.

Final System

Figure 1 is the block diagram of a circuit that embodies these features. Separated composite sync is fed through a pulse amplifier, after which it is integrated to obtain the 60-cps component. The resultant pulse is then inverted and used to trigger a cathode-coupled monostable delay multivibrator. The output of this stage is differentiated and the pulse coincident with the leading edge of the waveform is removed by a diode clipper.

The pulse coincident with the trailing edge is used to trigger the width multivibrator. The output of

Uses Electronic Chopper

this multivibrator is a chopper pulse which interrupts the monitored signal in a diode-resistance network.

The positive chopper pulse at the output of the width multivibrator causes D_1 to conduct through R_1 and R_2 and develop a positive voltage at the cathode of D_2 , rendering it nonconductive. Since the video signal normally passes through D_2 , it is interrupted for the duration of the chopper pulse.

Actually D_2 consists of four diodes in parallel, used to increase the forward conductance. These can readily be replaced by one of the new high-conductance diodes now available.

Since R_2 and R_3 are relatively small in value, it is not necessary to employ video peaking in the output circuit. However, the output is of a relatively high impedance; should it be necessary to use a long interconnecting cable to the oscilloscope serving as monitor, it would be advisable to employ a cathode follower stage at the output.

Since the pulse width of both multivibrator outputs is variable, it is possible to position the chopper pulse by adjustment of the delay multivibrator and change its width by adjustment of the width multivibrator.

Complete Circuit

With circuit constants as shown in Fig. 2, it is possible to move the leading edge of the pulse over a

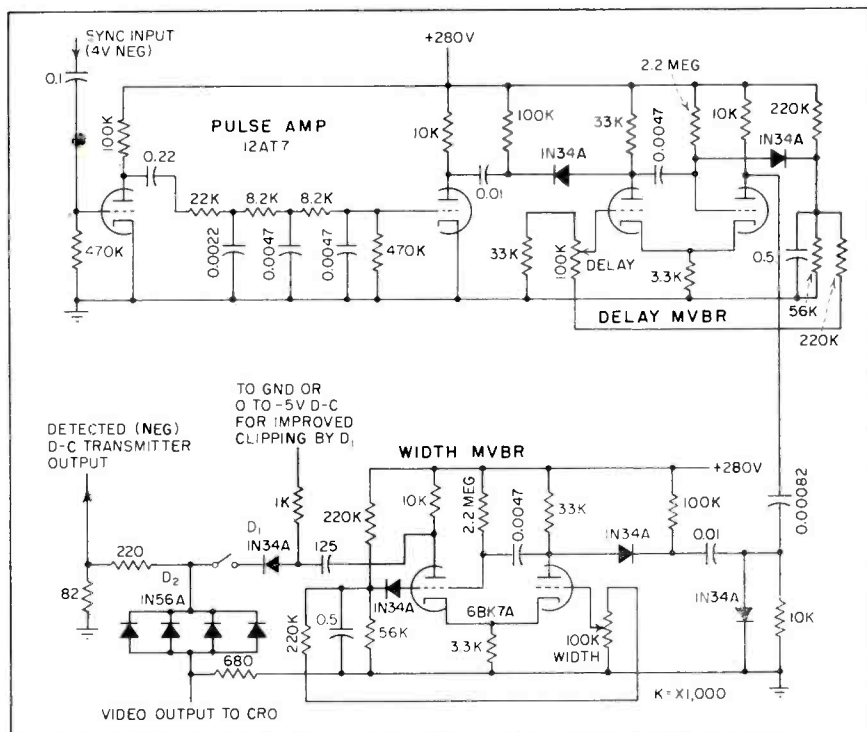

FIG. 2—Complete circuit of indicator uses three tubes and ten crystal diodes

range of 900 microseconds, following the last equalizing pulse, and change its width from 120 to 600 microseconds.

The results obtained with this circuit are shown in Fig. 3 for 100-percent modulation reference as viewed at a 30-cps rate. Figure 4 is identical except that an expanded sweep is used on the oscilloscope. Figure 5 shows the same information viewed at half the horizontal rate or 7,875 cps. The chopper pulse has been adjusted so that it does

not occur in either the vertical-sync interval or the picture. This is considered to be a desirable location since it will not interfere with the vertical sync in any picture monitor which might be viewing this signal nor will it destroy any of the picture information.

The electronic chopper as described in this article has been used at the WLAC-TV transmitter for a considerable length of time. It has proven accurate for indicating percentage of video modulation.

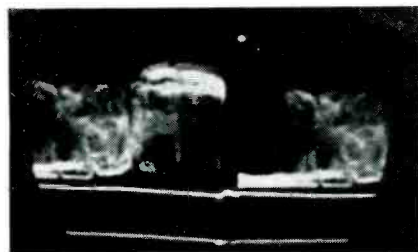

FIG. 3—Presentation on cathode-ray oscilloscope when viewed at 30-cps rate, with 100-percent reference line showing below pattern

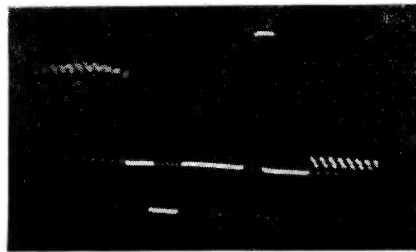

FIG. 4—Same presentation as in Fig. 3, viewed with expanded oscilloscope sweep to show chopping action that provides reference line

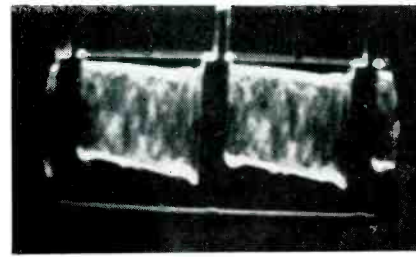

FIG. 5—Presentation of Fig. 3 viewed at one-half horizontal rate of video signal; this is pattern normally used for monitoring the transmitter video output

TELEMETERING Receiver

SUMMARY — Crystal-controlled double superheterodyne for 220-mc telemetry band provides separate i-f amplifiers for recovering f-m/f-m and pwp/f-m data. Grounded-grid 417A r-f amplifier contributes to low overall noise figure

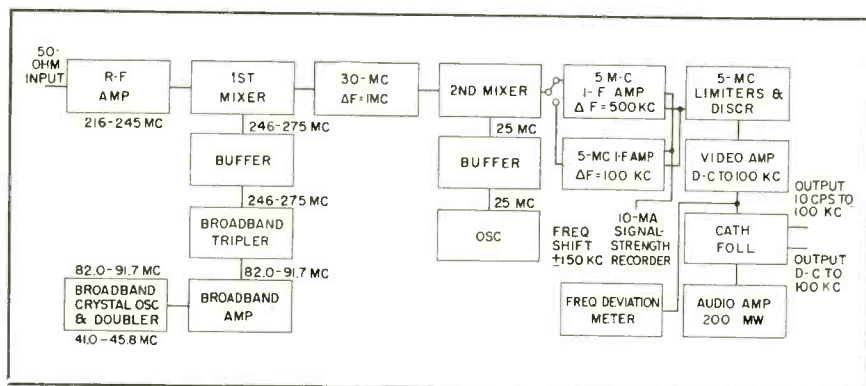

FIG. 1—Ground station receiver is double superheterodyne with separate second i-f amplifiers

AT MANY MISSILE test ranges a sufficient number of telemeters cannot be accommodated in the allocated 220-mc band without deleterious effects from carrier interference. The use of present wide-band telemetering receivers requires that even crystal-controlled transmitters be spaced a minimum of 2 mc from adjacent carriers to minimize interference. The bandwidth required for f-m/f-m telemeters is about 500 kc.

With carrier separations of 2 mc and a receiver bandwidth require-

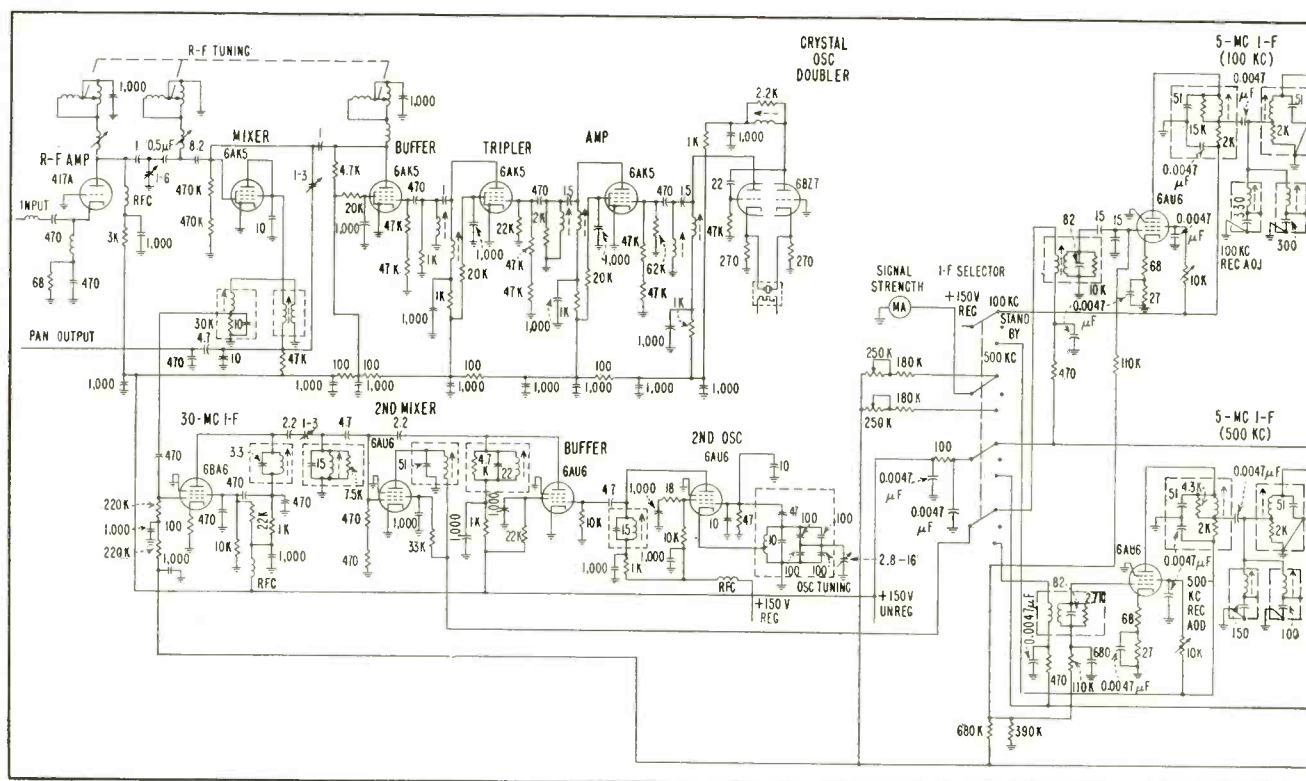

FIG. 2—Special features of telemetry receiver include low-noise r-f amplifier using 417A, crystal-controlled first oscillator and second use M-derived interstage networks. Limiters utilize 6BZ6 gated-beam tubes. Both audio and video outputs are provided. Output to a 10-

Conserves Bandwidth

BY M. S. REDDEN, JR. and H. W. ZANGANATA

Nemo-Clarke, Inc.
Silver Spring, Md.

Ballistic Research Laboratories
Aberdeen, Maryland

ment of 500 kc, the r-f spectrum is not being utilized efficiently. A receiver having the required bandwidth but having a high attenuation outside the passband would permit a greater number of telemeters to be used within the allocated frequency band.

General Description

Normally the same telemetering receiver is used to recover both f-m/f-m and the pwm/f-m data. Thus, the frequency guard band between successive telemeters is ap-

proximately the same for both systems. The signal-to-noise ratio of the RDB (Research and Development Board) pwm/f-m telemeter is proportional to receiver bandwidth.

The theoretical signal-to-noise ratio of pwm/f-m data when received on a 500-kc bandwidth receiver is approximately 2,000 on a peak basis and greater on an rms basis. This signal-to-noise ratio is considerably greater than necessary. For a receiver bandwidth of 100 kc, the signal-to-noise ratio on a peak basis is approximately 500.

This signal-to-noise ratio is adequate for many operations. The reduction of the receiver bandwidth from 500 to 100 kc will result in a theoretical increase in range of $(500/100)^{1/2} = (5)^{1/2}$. Thus for more efficient utilization of the r-f spectrum, plus the additional advantage of increased operating range, the receiver bandwidth for the pwm/f-m telemeter should be considerably less than the bandwidth requirement of the f-m/f-m telemeter.

A receiver which has been de-

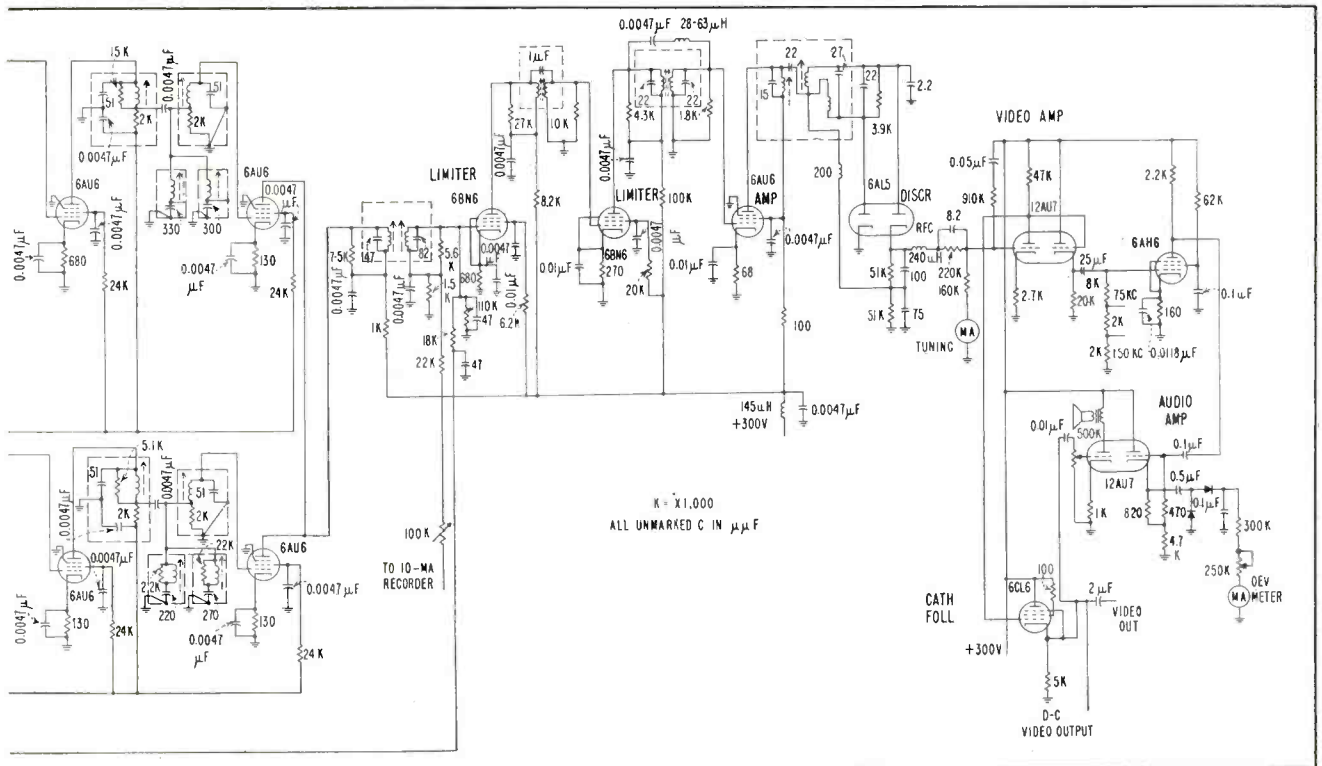

oscillator with tuned circuit in temperature-controlled compartment. Separate second i-f amplifiers for f-m/f-m and pwm/f-m respectively ma signal-strength recorder is provided for field-strength monitoring

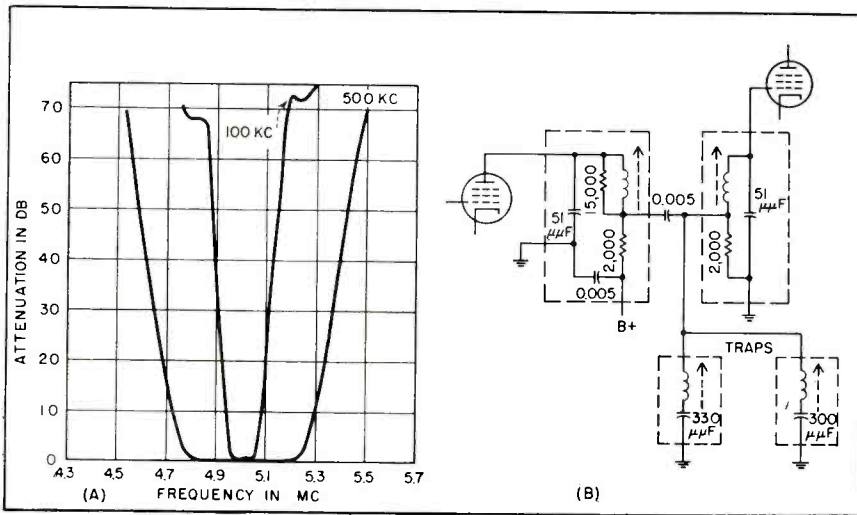

Fig. 3—Selectivity of 100-kc (pwm/f-m) and 500-kc (f-m/f-m) second i-f amplifiers (A) and M-derived interstage coupling network employed (B)

veloped is shown in Fig. 1 and 2. It is a crystal-controlled double superheterodyne covering the frequency range from 216 to 247 mc. A signal of 1 μ v to 10 mv is required at the input, which has a nominal impedance of 50 ohms.

The output of third-overtone crystals in the range 41-46 mc is multiplied by six in a broadband multiplier chain. The tuning of the final buffer stage is ganged to the r-f tuning to provide adequate injection over the frequency band. A first i-f of 30 mc and a second oscillator frequency of 25 mc are used.

The bandwidth and selectivity characteristics are obtained in the second i-f amplifiers, which are centered at 5 mc. A choice of two separate second i-f amplifiers is available from the front panel. One has a bandwidth of 100 kc and is intended primarily for pwm/f-m data. The other, with a bandwidth

of 500 kc, is used for f-m/f-m data. Both feature high attenuation outside the passband.

Included is a peak-frequency-deviation meter with full-scale ranges of 25, 75 and 150 kc. It is useful in setting up the desired frequency deviation of individual subcarriers when using f-m/f-m, or the peak deviations of pulses when used in the pwm/f-m system.

Two capacitively coupled video outputs are available with frequency response within 3 db from 10 cps to 100 kc. Direct-coupled output is available for applications where response to d-c is desired. Provisions are included for connecting an external field-strength recorder and a panoramic adapter.

In the front panel view of the receiver, the meter on the right is the signal-strength indicator. It gives an approximate indication of the input signal in the range 1 μ v to 10 mv on a scale which is roughly lo-

garithmic. The center meter is the tuning indicator and the meter on the left indicates deviation. The receiver includes a loudspeaker for aural monitoring.

To place the receiver in operation, a crystal for the desired frequency is plugged in the panel receptacle and the r-f dial set to the proper frequency. The receiver can be tuned exactly to the transmitter by the oscillator tuning control, which can vary the frequency of the second oscillator ± 150 kc.

The subchassis construction used in the r-f portions of the receiver is shown. The front-end chassis, at the right, includes r-f amplifier, mixer, crystal oscillator with multipliers, first i-f, second mixer and oscillator. A Mallory uhf Inductuner provides tuning elements for the r-f amplifier and final buffer stage of the local oscillator multiplier chain. The middle chassis contains the two second i-f amplifiers. On the left is the chassis for the limiters and discriminator.

Front End

The design of the front end determines noise figure, image and i-f rejection and input impedance. A noise figure of 7 db or better was set as the design goal.

The tubes available as low-noise amplifiers in the frequency range of this receiver are best used in the grounded-grid circuit. This is the result of mechanical construction of the tubes and their interelectrode capacitances. The grounded-grid amplifier, like the grounded-cathode amplifier, has an optimum value of source resistance that produces the lowest noise figure.

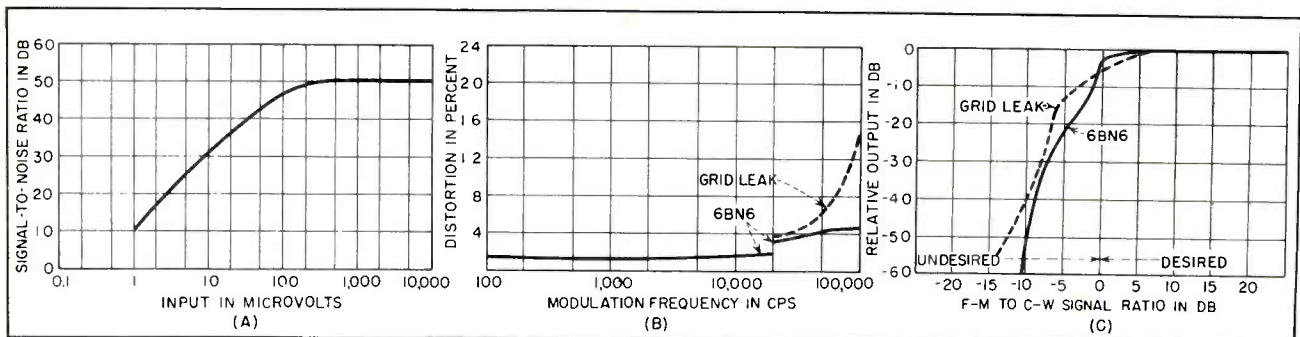
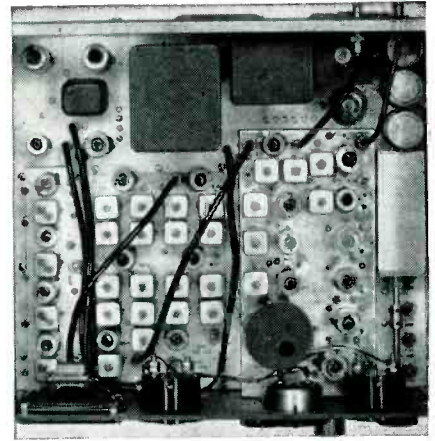
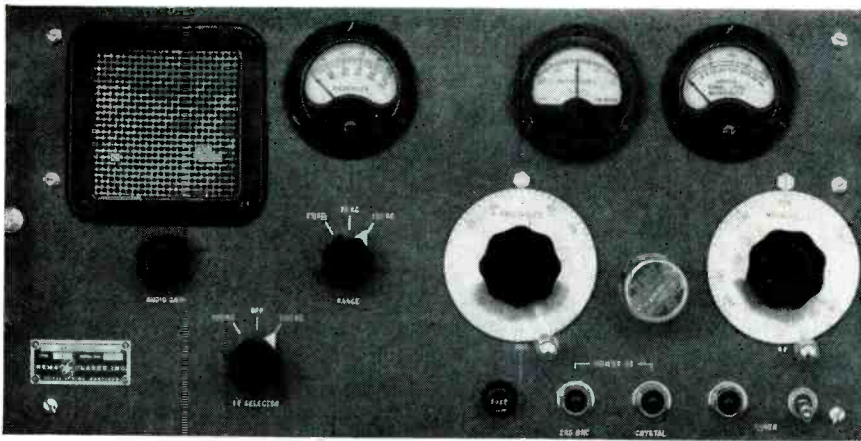

FIG. 4—Output signal-to-noise ratio of receiver with 500-kc second i-f in use (A), comparative output distortion using 6BN6 gated-beam limiters and conventional grid-leak limiters (B) and comparative susceptibility to cochannel interference (C)



Front panel incorporates loudspeaker and meters for aural and visual monitoring. Top view of chassis illustrates modular design of r-f and i-f portions of telemetering receiver for ground-station installation

If the tubes are operated under similar conditions the optimum source resistance for either case is the same. In the frequency range of this receiver the optimum source resistance is usually several times higher than $1/g_m$, the input resistance of a grounded-grid stage when the plate load is small compared to the plate resistance. To achieve a reasonable input match when the source impedance is close to optimum, the tube should have a relatively low plate resistance so the plate load will substantially increase the input resistance of the stage.

This follows from the input resistance of a grounded-grid stage at low frequencies

$R_{in} = 1/g_m [1 + (R_L/R_p)]$ if $\mu \gg 1$ where R_{in} = input resistance, R_L = plate load resistance, μ = amplification factor, R_p = plate resistance and g_m = transconductance. In addition, the tube should have as small a transit time as possible and a large transconductance.

Table I lists results of noise-figure tests on a number of the tubes considered for the r-f amplifier. They are all used at 230 mc ahead of a 6AK5 pentode mixer and the input circuits have been adjusted for a reasonable match as indicated in the vswr column. Measured overall noise figures and estimated noise figures of the r-f amplifier alone are given.

Noise Figure

Of the tubes tested, only the 417A and the 6299 appear to be satis-

factory for use in a receiver which must have a noise figure less than 7 db. The 417A uses conventional 9-pin miniature construction and its cost is well below that of the 6299. It was chosen for the r-f amplifier.

To obtain the ultimate in low-noise performance, the input of the grounded-grid stage is mismatched in the direction of optimum noise figure and a triode-connected 6AK5 is used as a mixer. The front end has a noise figure of 6 db, input vswr of 1.7 to 2.1, image rejection of 50 db and an i-f rejection greater than 70 db.

Second I-F

The second i-f amplifiers determine the bandwidth and selectivity characteristics of the receiver. Two amplifiers are provided. One has a bandwidth of 500 kc and a rejection greater than 60 db to signals removed 500 kc or more from center frequency. The other has a bandwidth of 100 kc and a rejection greater than 60 db to signals removed 250 kc or more from center frequency. Figure 3A shows select-

ivity curves of the 100 and 500-kc i-f amplifiers.

The M-derived band-pass filter used for interstage coupling is shown in Fig. 3B. The shape of the passband and the skirt is determined by limitations in trap Q.

The L-C ratio of the traps has a large effect on the shape of the response curve. When this ratio is high, the skirt selectivity is excellent but rejection is poor beyond the trap frequencies. Both i-f amplifiers in the receiver use two stages with M-derived filters.

The L-C ratio of the traps in one of the M-derived filters is chosen to provide good skirt selectivity. The L-C ratio of the traps in the other unit is made smaller, leading to high rejection beyond the trap frequencies. When the responses of these circuits are combined with the response of one double-tuned transformer in the 100-kc strip and two double-tuned transformers in the 500-kc strip, the desired selectivity characteristics are obtained.

Because of the many disadvant-

Table I—Comparison of Tubes Used in Grounded-Grid Amplifier

Type	Description	g_m in μ hos	R_p in ohms	Plate Input in watts	Overall NF in db	Interstage Bandwidth in mc	Input Vswr	Amp NF in db
6J4.....	7-pin min	11,000	5,000	1.0	8.8	3	1.3	8.3
WE 5342/417A*.	9-pin min	20,000	2,500	1.6	6.6	5.5	1.4	5.7
5876.....	pencil	6,500	8,600	4.5	9.2	5	1.4	8.25
5675.....	pencil	6,200	3,200	3.2	8.3	4	1.2	6.6
Sylvania 6BA4..	rocket	8,000	8,750	1.5	8.0	5.5	1.2	7.9
GE GL-6299....	ceramic disk seal	12,000	9,600	1.75	6.4	6	1.2	6.0

* Used at reduced ratings to obtain a more favorable g_m to plate current ratio

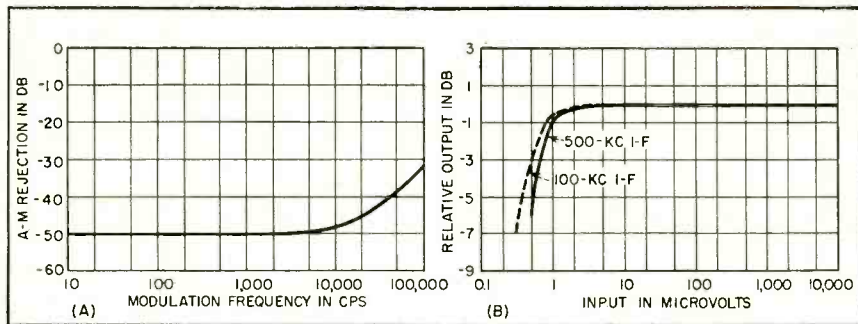

FIG. 5—Rejection of unwanted a-m by receiver using 500-kc i-f (A) and comparative video output using 100 and 500-kc i-f amplifiers (B)

ages of the grid-leak limiter resulting from its inability to reject high-frequency amplitude modulation, the 6BN6 gated-beam tube is used in the limiter stages. With this tube there is no time constant in the grid circuit. The grid draws a relatively small current even when driven positive, a characteristic which maintains almost constant loading on the grid-tuned circuit regardless of input level.

In addition, the tube is an excellent positive and negative peak clipper when biased properly. The only disadvantage is that it must be heavily driven to produce limiting. Because of this, a larger gain is needed in the stages preceding the limiter.

Output Amplifier

The final limiter is followed by a class A amplifier which drives a phase discriminator. The frequency separation of the positive and negative peaks of the S curve is roughly 750 kc. Every effort has been made to obtain an extremely linear region of the S curve within ± 150 kc of center frequency to minimize distortion. The receiver has an output distortion less than 1 percent when the input signal is frequency-modulated 125 kc at a 1,000-cps rate.

Distortion

The distortion measurement is difficult to make because the distortion of available f-m signal generators is greater than that of the receiver. Considerable reduction in the output distortion of the signal generator results when an input signal with one-half the r-f frequency and one-half the devia-

tion is fed into the radio-frequency stage.

If the signal is large enough, doubling action occurs which provides the mixer with a signal of the correct carrier frequency and deviation. Generally, the distortion of a f-m signal generator is proportional to the frequency deviation. As this method halves the deviation of the signal generator for a given deviation of the input signal at the mixer, a considerable reduction in distortion results.

Overall Performance

Figure 4A shows the output signal-to-noise ratio when the 500-kc i-f amplifier is in use. An input signal modulated at 1,000 cps with a deviation of 125 kc is applied. Low noise figure and the excellent limiting action of the gated-beam limiters result in a high output signal-to-noise ratio. An input signal of 4 μ v produces an output signal-to-noise ratio of 22 db.

In Fig. 4B the output distortion of the receiver with gated-beam tubes is indicated by the solid curve. The distortion is a minimum at low modulating frequencies and increases slowly as the frequency is increased until 4.8 percent is reached at 100 kc. This increase in distortion is due in part to the transmission characteristic of the steep-skirted i-f amplifier that alters the side bands of the f-m signal when the modulation frequency is high. If the limiters are driven directly, the distortion is only about 2 percent which indicates the signal-generator contribution.

The dashed curve of Fig. 4B was obtained on the receiver when grid-leak limiters were used in

place of the gated-beam limiters. Again the distortion increased with frequency, but now at 100 kc the distortion is about 15 percent instead of 4.8 percent. Simultaneous amplitude modulation is generated by the transmission characteristic of the i-f amplifier. At high modulation frequencies the grid-leak limiters are not capable of removing this amplitude modulation component.

The inability of the grid-leak limiter to remove amplitude modulation at high frequencies also shows up in the cochannel interference curves of Fig. 4C. A c-w signal and a f-m signal of the same carrier frequency are fed into the receiver. Ideally, the frequency modulation would appear in the output unimpaired whenever the f-m signal exceeds the c-w signal. If the f-m signal is less than the c-w signal, the output signal should disappear entirely. The receiver with gated-beam limiters demonstrates a superior capture effect to the receiver with grid-leak limiters.

Rejection Characteristics

Figure 5A shows the a-m rejection characteristics of the receiver. It is difficult to obtain a signal generator with low enough residual f-m to make this test. The curve indicates that the a-m rejection ratio decreases as the modulation frequency increases. This could be caused by a-m to f-m conversion in the selective portions of the receiver or to an increase in the residual f-m in the signal generator at high modulation frequencies.

In Fig. 5B, the video output with either the 100 or 500 kc i-f amplifiers as a function of the input signal is shown. A 400-cps band-pass filter is used in the output to eliminate the effects of noise at low input levels. With the 500-kc i-f amplifier, the output is constant within 1 db if the input signal is in the range of 1 μ v to 10 mv. The 100-kc amplifier has a higher gain and the output does not decrease 1 db until the input is 0.8 μ v.

This receiver was developed for the Ballistic Research Laboratories, Aberdeen Proving Ground, under contract DA-36-034-ORD-1451.

TRANSISTOR GENERATOR Simulates Radar Target

By WILLIAM ECKESS, JOE DEAVENPORT and KENNETH SHERMAN

*The Emerson Electric Manufacturing Co.
St. Louis, Missouri*

SUMMARY — Pulses obtained from transistorized pulse-forming circuit, counter, blocking oscillators and multivibrators provide video for field and bench testing of radars. Target pulse is variable in width, range and amplitude. Unit occupies only 15 cubic inches

TESTING OF COMPLEX electronic systems requires equally complicated test equipment. The need for smaller, lighter, more rugged and reliable test equipment is pressing. To alleviate this, work has been done to develop transistor

pulse circuits capable of simulating radar targets. The equipment to be described is approximately 2 percent of the weight and consumes 3 percent of the power of its electron-tube equivalent. Its electrical performance is equal to or

better than that of similar equipment.

Figure 1 is a schematic diagram of the video simulator. The pulse-repetition frequency generator is a grounded-base blocking oscillator that may be free-running

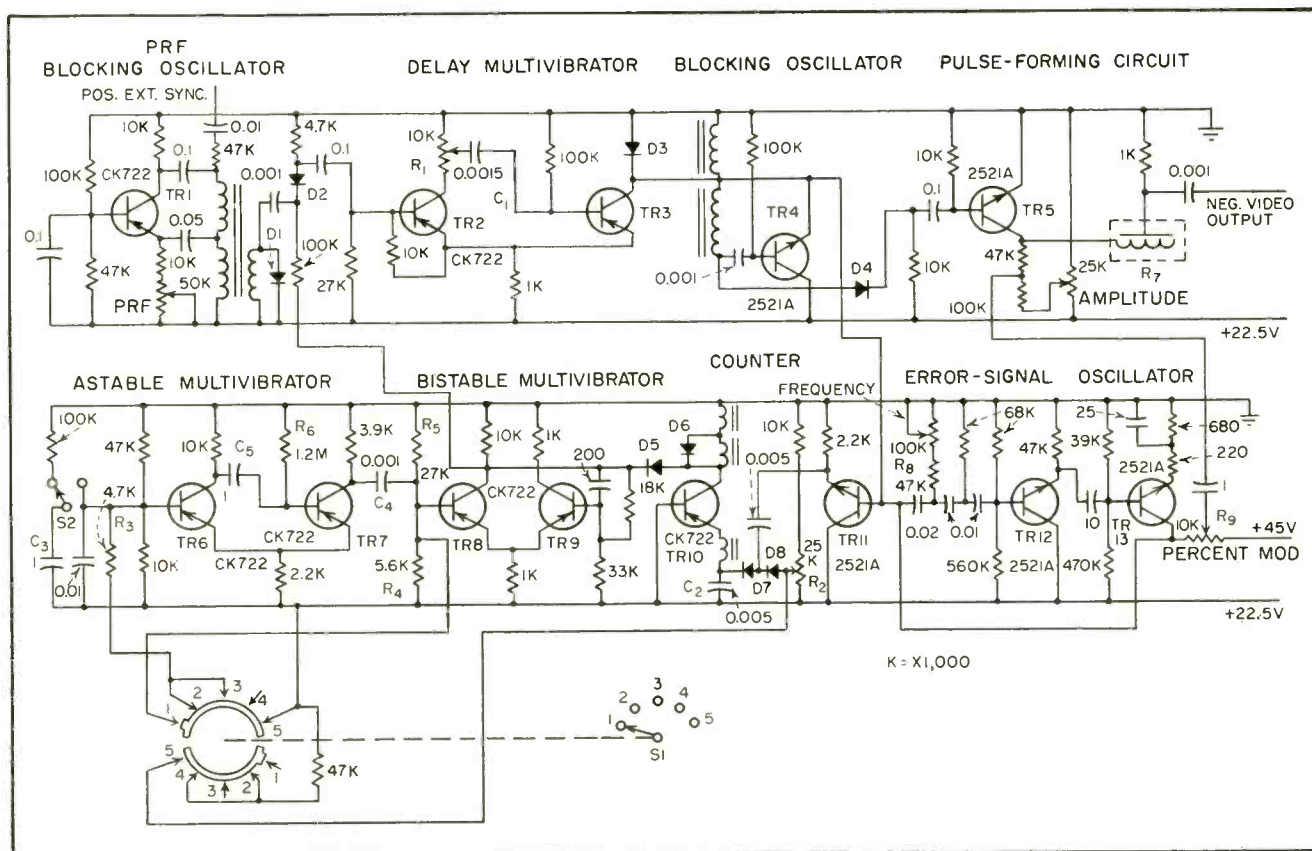

FIG. 1—All-transistor video simulator uses npn type CK722 and pnp type 2521A transistors

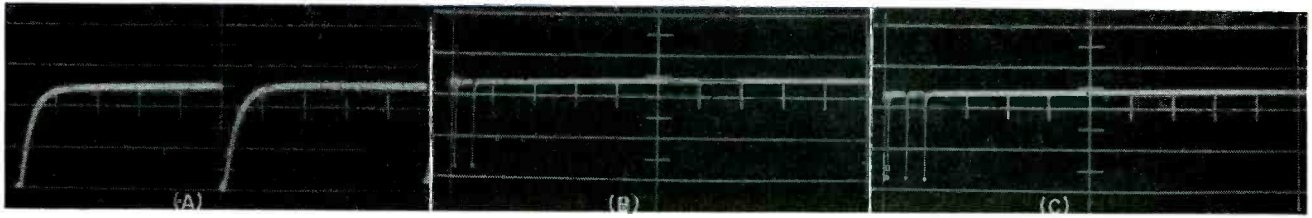

FIG. 2—Pulses at emitter of TR_6 showing one (A), two (B) and three pulses (C) determined by setting selector switch

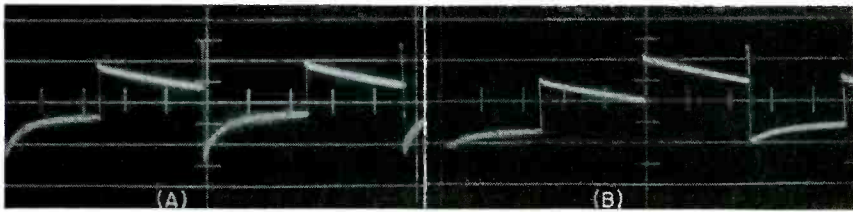

FIG. 3—Waveforms across C_2 in counter circuit for counts of two (A) and three (B)

or synchronized by an external pulse.

The positive pulse generated at the collector is fed back to the emitter to start oscillation. The output pulse of the prf generator is negative. Diode D_1 across the output winding clips the overshoot.

The negative pulse is capacitively coupled to the diode gate which is turned on or off by a bistable multivibrator. When switch S_1 is in position 1, the base of TR_8 is connected to +22 volts which will cut off this transistor. At cutoff this transistor draws little current and the collector is at ground potential. Therefore, the potential across diode D_2 is practically zero, which allows the negative pulse to pass to the base of TR_6 .

Delay Circuit

Transistor TR_2 and TR_3 form a monostable multivibrator. Initially transistor TR_3 is conducting and TR_2 is cut off. When the negative trigger pulse is applied to its base, TR_2 starts conducting and TR_3 is cut off. This action continues until capacitor C_1 has recharged. The time constant is determined by R_1 and C_1 . The setting of R_1 determines the simulated range.

The triggered grounded-collector delay blocking oscillator, TR_4 , which follows the delay multivibrator employs a npn type 2521A transistor. The circuit is triggered by the trailing edge of the delay-multivibrator output and generates a positive pulse at the emitter. Diode

D_3 serves to clip any overshoot. The emitter pulse is direct coupled to the input of TR_4 and to the base of TR_{11} , part of the counter circuit.

Pulse Formation

The output of blocking oscillator TR_4 is also coupled through diode D_4 to the base of TR_6 in the pulse-forming circuit.¹ Basically, transistor TR_6 acts as a switch to discharge the pulse-forming network and generate an output pulse of specified duration.

The amplitude of the output pulse can be varied by changing the supply voltage to the collector of TR_6 , and is accomplished by varying R_7 . The method shown preserves the shape of the output pulse from 0 to -11 volts. Pulses of larger amplitudes can be obtained by using a transistor with a higher voltage rating and a higher supply voltage. Photographs of the collector waveform of TR_6 are shown in Fig. 2. Figure 2A shows the basic prf when selector switch S_1 is in position 1 or continuous, while Fig. 2B and 2C show the counted pulse observed when the switch is in position 4 and 5 respectively.

Counter

The output of the delay blocking oscillator is applied to the base of TR_{11} which is connected as a grounded-collector stage to provide isolation between the delay blocking oscillator and the counter circuit. An energy storage or step counter is used in this circuit to count up

to six pulses.² Photographs of the voltage waveform across C_2 are shown in Fig. 3 for a count of two and three pulses respectively. The grounded-base counter blocking oscillator connected across C_2 acts as a switch to discharge C_2 at a fixed voltage level. The number of pulses that are counted depends on the bias level set by R_2 . Switch S_1 allows this level to be set so that either X or Y pulses may be selected.

Diode D_5 has been placed across the counter blocking oscillator transformer to clip the overshoot while diode D_6 couples the positive output pulse to the collector of TR_8 and base of TR_9 of the bistable multivibrator. When this positive trigger from the blocking oscillator is applied to the bistable multivibrator, diode gate D_2 is biased off and pulses from the prf generator are not allowed to pass through the gate until the bistable multivibrator has been transferred to the other stable condition.

Pulse Groups

The bistable multivibrator turns the diode gate on when switch S_1 is in position 1. When the switch is in position 2, the bias on the counter is set to count X pulses by the lower half of the wafer switch while the upper half of the wafer switch removes the +22 volts from the base of TR_8 and connects the base of TR_9 through R_8 to +22 volts. Positions 2 and 3 are the manual positions for X or Y pulses output. Switch position 3 is electrically the same as position 2 except for the change of bias voltage on the counter. To obtain X pulses at the output pushbutton switch S_2 is depressed.

Astable Multivibrator

Astable multivibrator operation may be explained as follows. With

switch S_1 in position 2, resistor R_3 is connected from the base of TR_6 to +22 volts which causes the astable multivibrator to become monostable. Capacitor C_3 is normally connected through 100,000 ohms to ground. When switch S_2 is opened, a negative pulse is applied to the base of TR_6 which causes this transistor to start conducting. Transistor TR_7 is then cut off by the positive voltage at its base.

The collector voltage waveform of TR_7 is then differentiated by C_4 and the parallel combination of resistors R_4 and R_5 . Since TR_6 is conducting heavily, the negative trigger has no effect on the operation of the bistable multivibrator until the positive trigger voltage is applied to the base. The time required before the positive trigger arrives is determined by C_6 and R_6 and is usually 0.5 second or more. The positive trigger causes the collector of TR_6 to return to ground potential, thus turning on diode gate D_2 which allows X pulses to pass before the counter again triggers the bistable multivibrator thus turning off the diode gate.

PPI Simulation

When the selector switch is in positions 4 or 5, the lower wafer again selects whether X or Y pulses are desired and the upper wafer removes resistor R_3 from the base of TR_6 , allowing the astable multivibrator to oscillate. The multivibrator period is varied from a

short time to over 20 seconds to simulate a specified scan frequency. The number of pulses selected simulates the number of hits from a searching antenna.

Audio Oscillator

Transistors TR_{12} and TR_{13} are employed in a phase-shaft audio oscillator.^{3,4} Transistor TR_{12} is used as an emitter-follower stage so that the phase-shifting network will not be loaded by amplifier TR_{13} . The gain of the amplifier is adjusted to give the proper amplitude of audio signal for 100-percent modulation of the video pulse, with a minimum amount of distortion. This is accomplished by bypassing only a portion of the emitter resistance of TR_{13} . Resistor R_8 controls the frequency while resistor R_9 determines the amplitude of the output or percentage of modulation. There is less than 1-percent frequency change when the output is varied from minimum to maximum.

A collector-modulation scheme is employed because of the low distortion obtained.⁵ A disadvantage of this type of modulation is the large amplitude of audio signal required. A transformer is not required to modulate the pulse-forming circuit since little average collector current is drawn by transistor TR_5 . In Fig. 4 three photographs of the modulated collector characteristics are shown for 0, 50 and 100-percent modulation. The output video pulse from the pulse-forming circuit is shown for the same degrees

of modulation mentioned above in Fig. 5. Figure 5A was displayed to a different scale than Fig 5B and 5C to show the good rise time obtained using the pulse-forming circuit.

Conclusion

The unit occupies approximately 15 cubic inches and weighs 8 ounces exclusive of the battery or power supply. Total power consumption is 0.5 watt at 22.5 volts and 0.1 watt at 45 volts.

The equipment was developed to show that pulse circuitry can be successfully transistorized. Several models have been constructed. Two breadboard models have been operated intermittently at room temperatures for about eight months without transistor failures. While these units were not designed for high temperature operation, since only germanium transistors were used, similar circuits have been successfully designed using silicon transistors.

The authors thank J. Brooks, F. Rohne and E. Logan for their advice and encouragement, also C. Toeneboehn who packaged the unit.

REFERENCES

- (1) Eckess, Deavenport, Sherman, Transistor Pulse Generators, *ELECTRONICS*, p. 132, Nov. 1955.
- (2) Chance, Hughes, MacNichol, Sayre, and Williams, Waveforms, MIT Rad. Lab. Series, McGraw-Hill Book Co. Inc., New York, 1949.
- (3) Ginzton, Hollingsworth, Phase-Shift Oscillators, *Proc IRE*, Feb. 1941.
- (4) W. W. Kunde, Phase-Shift Oscillator Design Charts, *ELECTRONICS*, p. 132, Nov. 1943.
- (5) J. D. Ryder, Electronic Fundamentals and Applications, Prentice-Hall, New York, 1950.

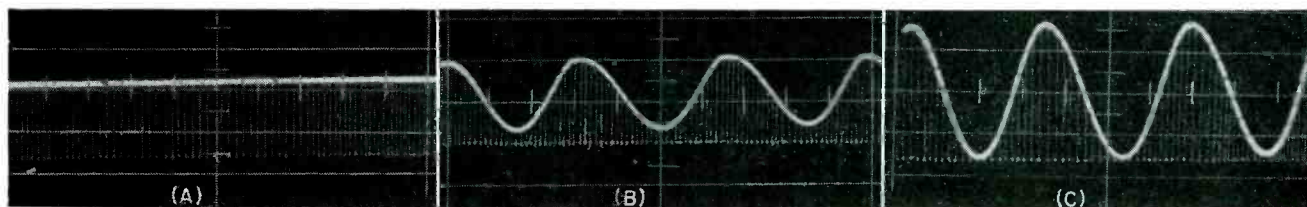

FIG. 4—Waveforms at collector of TR_5 with 0 (A), 50 (B) and 100-percent (C) modulation

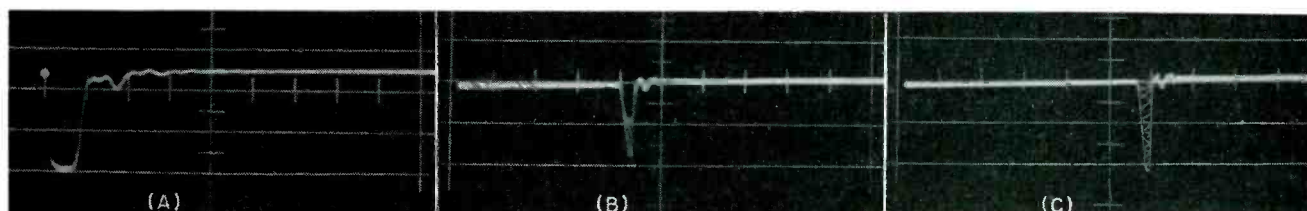

FIG. 5—Pulse output of video simulator showing 0 (A), 50 (B) and 100-percent (C) modulation

BEVATRON-FREQUENCY

SUMMARY — Digital techniques are employed to measure varying bevatron magnetic-field frequency at 32 predetermined points over 350 kc to 2,500-kc range. Bar-graph cathode-ray tube display shows departures from calculated frequency to approximately 0.1 percent accuracy

IN THE PROTON synchrotron of which the bevatron is an example, the relation of the oscillator frequency to the magnetic field which determines the radius of the orbit, is the most difficult operating parameter to control. As part of this control problem it is necessary to provide instrumentation to monitor this relation while the frequency and magnetic-field change during the accelerating period. Frequency increases from 350 to 2,500 kc in about 2 seconds during the acceleration. The cycle is repeated ten times per minute.

Measurement Theory

Radius of the orbit can be measured directly by the ratio of the voltages induced on a pair of electrodes on opposite sides of the radial aperture. However, if at the time of starting the machine, the beam current is too small to give a satisfactory signal from the electrodes, it is necessary to measure the frequency itself.

As part of the frequency-control

system, timing pulses are produced when the magnet current passes through each of 32 accurately determined values. These timing pulses are referred to as current pips. Since the relationship between the magnet current and magnetic field is known, it was decided to measure the frequency at each of these points.

As a change in the radius of the equilibrium orbit of 1 inch in 50 feet is significant, an accuracy of about 0.2 percent is required in each frequency measurement. It was found that cycle counting would be suitable if the counting time could be made short enough. The frequency measured is the average for the counting period and differs from the frequency at the time of the initiating pulse (current pip) by the change in bevatron frequency during half the counting time.

Frequency-Time Characteristic

The bevatron frequency-time characteristic has a slope of 12 mc per sec² for the first few measuring points and gradually decreases to a low value as the highest frequency of 2,500 kc is approached. The rate of rise of frequency can be considered constant within 10 per cent. If an error of 0.1 percent is allowed for this variation, the counting time at minimum frequency must not exceed 600 μ sec. As the frequency rises, the possible error rapidly decreases.

The frequency increments are displayed in the form of the departure of the bevatron frequency from the standard frequency, which

corresponds to the radial location of the beam in the magnet aperture at each measuring point. A range of ± 3.2 percent, corresponding to aperture width at low frequency, is included on the oscilloscope screen. Identification of the 32 measurements that appear during each magnet pulse is made by current pips, which can be simultaneously displayed.

Reference Frequencies

Crystal oscillators are used to provide the reference frequencies. The bevatron frequency is measured for the time required to count 992 cycles of the reference frequency at each point. The difference between the 992 and the number of cycles counted is the frequency departure. This quantity is displayed on the oscilloscope screen.

It was decided, considering available scaling equipment (10 mc max), that the ratio of bevatron r-f to standard crystal oscillator r-f would be $\frac{1}{3}$ for the first six points measured, $\frac{1}{4}$ for the next seven points and $\frac{1}{2}$ for the remaining 19 points. This limited the maximum counting time of the bevatron r-f to 360 μ sec at 350 kc, to 310 μ sec at 800 kc and 333 μ sec at 1,500 kc. The range of the standard crystal oscillators then is 2.8 mc to 5.6 mc.

It further was noted that some of the standard crystal oscillators could be used for more than one point, so that 23 oscillators could serve 32 points. This required more gates and switching equipment, which were justified because of the ease of interpreting the output display as percent frequency error.

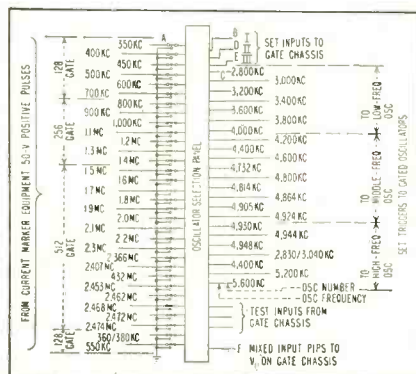

FIG. 1—Oscillator selection panel selects current pips and routes them

Measurement System

By WILLIAM M. BROBECK and WARREN C. STRUVEN

Radiation Laboratory, Department of Physics
University of California
Berkeley, California

The final system displays a straight horizontal line on the oscilloscope when the measured frequency is equal to the calculated frequency, zero error, at each measuring point.

Note that the bevatron frequency that is measured is different from the frequency at the instant the start pulse, a particular current pip, is received.

Operational Sequence

With reference to Fig. 1 and 2 a particular current pip will be followed through the whole circuit.

Take for example the current pip that is applied to input A on the oscillator selection panel. This pip corresponds to a frequency of approximately 357 kc.

In the oscillator selection panel, the pulse is fed to gate output B. This sets slow flip-flop I (FF I), and opens slow gate I on the gate chassis.

The pulse is also fed to output C, which is fed to standard oscillator chassis 1, oscillator 1 (2.8 mc). This pulse sets the associated flip-flop, opens the crystal gate and allows r-f to flow to V_{24} and to V_{25} in the gate chassis. The pulse that appears on input A of the oscillator selection panel is also supplied, from output F, to V_1 on the gate chassis.

Tube V_1 on the gate chassis supplies the following pulses: a preset pulse to the bevatron scaler to preset it to 64 counts (this scaler is operating at all times and when this pulse is supplied the scaler is immediately preset to 64 counts); a reset pulse to V_4 and V_5 in the

gate chassis; a preset pulse to the crystal decade scaler and read-out chassis. This pulse presets the eleven flip-flops, 7 in the crystal decade scaler and 4 in the read-out chassis, to a count of 2,016.

Because the bevatron scaler was preset to 64 counts, it starts scaling towards 128 from there. One count is added for every positive-going cycle of bevatron r-f. When the scaler contains 128 it produces two pulses at its output, one positive and one negative. The negative pulse is not used in conjunction with this particular current pip but it does trigger V_4 in the gate chassis.

The positive pulse is fed to gate I. Since this gate has previously been opened the pulse is fed from it to phase inverter V_{13} and then to fast flip-flops V_{20} and V_{21} , all in the gate chassis. Since the fast flip-

flop was in the reset position from the previous current mark, it is now set and opens the fast gate. As r-f has previously been supplied to this gate from standard gated crystal oscillator 1 (2.8 mc), this r-f then is applied to the crystal scaler and read-out flip-flops, where it is scaled.

The bevatron decade scaler, immediately after reaching 128 counts and putting out a positive and a negative pulse, starts counting again from 1 towards 128. When it reaches 128 the second time, the scaler produces a positive and a negative pulse as before and since gate I is still open, this positive pulse is inverted by V_{13} and applied to the fast flip-flop, resetting it.

When the fast flip-flop is reset it closes the fast gate and stops the counting. The number of counts contained in the crystal scaler and

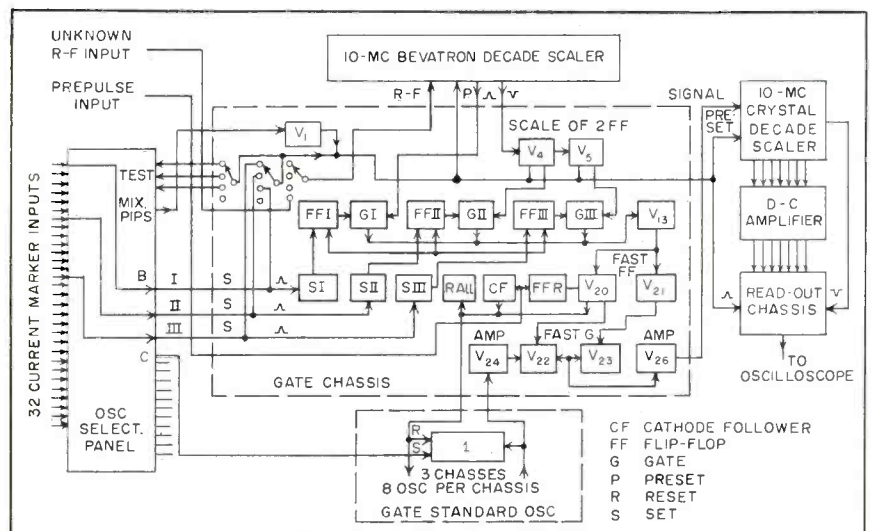

FIG. 2—Simplified representation of complete frequency-measurement system

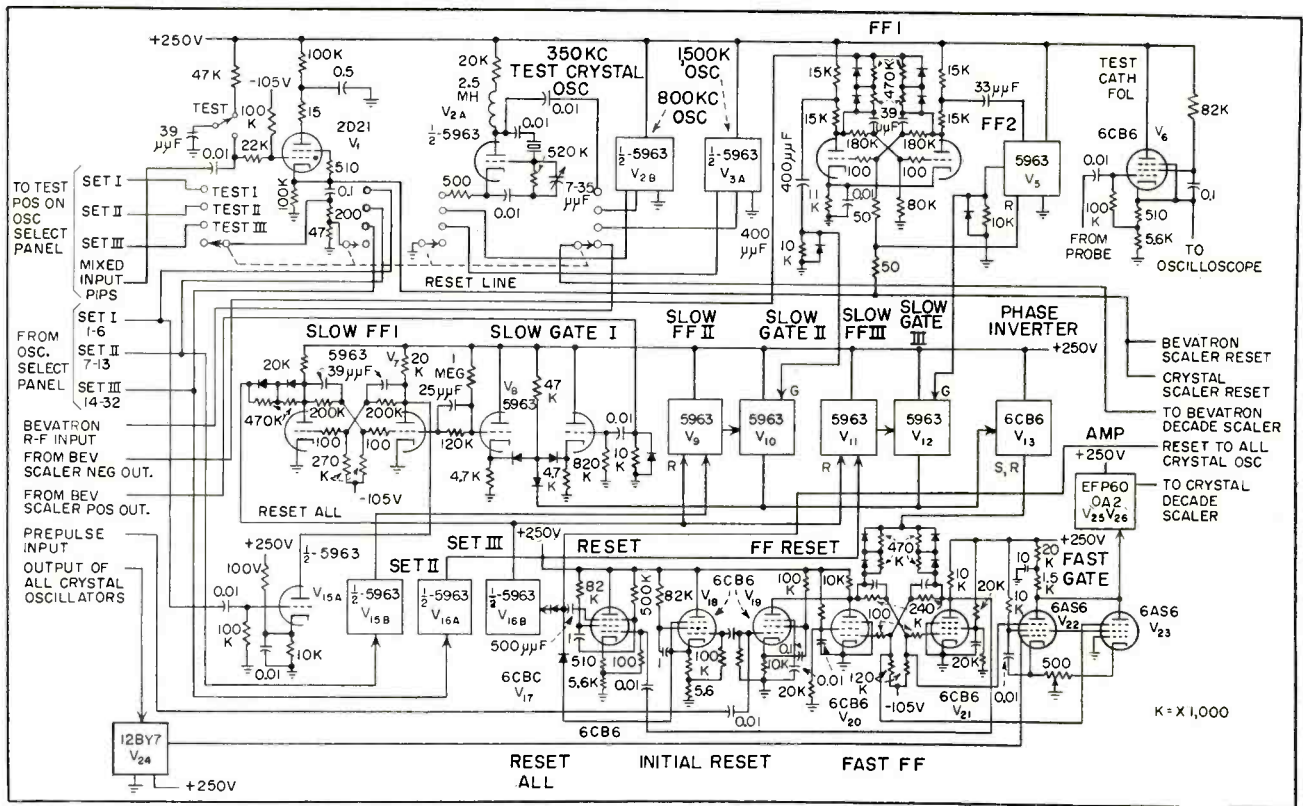

FIG. 3—Gate chassis includes three crystal test oscillators for checking gate-chassis circuit operation

read-out chassis are then displayed on the oscilloscope as a horizontal bar until another current mark is supplied to the oscillator selection panel.

When the fast flip-flop is reset by the pulse from V_{13} , it also supplies a reset pulse to the slow flip-flop, *FF* I (also *FF* II and *FF* III, which are already reset) and to all 23 standard crystal oscillators. Since only one of them is set, it is immediately reset and the other 22 oscillators, which are already reset, are not altered. This com-

pletes the sequence which occurs for every current mark, 32 times each time the bevatron magnet is pulsed.

Oscillator Selection Panel

The chassis of Fig. 1 selects any or all current pips and routes them to the proper standard crystal oscillator chassis as well as to the gate chassis. Thirty-two switches on the front panel enable or disable their respective input to the diode matrix, which is used to separate the pulses. This matrix also takes

pulses from the gate chassis, in test position, and feeds them to the proper crystal oscillators so the equipment can be self-checked. This does not, however, check all the crystal oscillators. Any number of frequencies may be displayed by selecting the proper switches.

Operation of this chassis is based on the property of a germanium diode to conduct a positive pulse in one direction only. To aid each diode, a slight reverse positive voltage is placed on each diode's cathode terminal. There are 32 in-

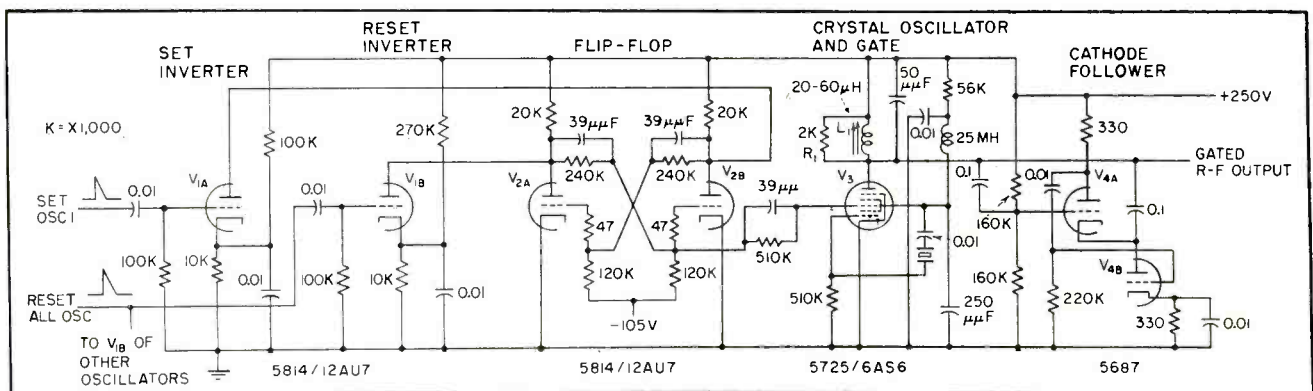

FIG. 4—Eight such oscillators are used in each of three oscillator chassis. Each of eight oscillators has separate set-signal input and common reset-signal input. Resistor R_1 and inductance L_1 are common to all oscillators on a chassis; L_1 is not used for 2.8 to 4.2 mc and R_1 is not used for 4.3 to 5.6 mc

put paths and 23 output paths.

Some oscillators are used two or three times during each pulse of the bevatron. The diodes separate these pulses and route them to the proper standard crystal oscillators. Outputs *B*, *D* and *E* are also furnished to the gate chassis to set one of flip-flops V_7 , V_8 or V_{11} and open the proper slow gate, V_8 , V_{10} or V_{12} .

Each time this unit receives an input pulse on any of inputs through 32, a pulse is supplied to the gate chassis through output *F*. This output is called mixed input pips and is fed to V_1 in the gate chassis.

Gate Chassis

The gate chassis, Fig. 3, consists of: thyatron V_1 which provides a reset pulse to the two scale-of-two flip-flops V_4 and V_5 as well as a pre-set pulse to the crystal decade scaler, the read-out chassis and the bevatron decade scaler; three test crystal oscillators V_{2A} , V_{2B} and

V_{2C} , selectable from the four-position switch on the front panel, to check the operation of the gate chassis; two flip-flops, V_4 and V_5 , which follow the bevatron decade scaler and extend its count capacity to 256 and 512; three slow gates, V_8 , V_{10} and V_{12} (*G* I, *G* II and *G* III) and flip-flops V_7 , V_8 and V_{11} (*FF* I, *FF* II and *FF* III), to feed the bevatron decade-scaler pulses to fast flip-flop V_{20} , V_{21} and fast gate V_{22} , V_{23} ; fast flip-flops, gate and wide-band amplifiers to gate a particular standard crystal oscillator through to the crystal decade scaler and read-out chassis; a cathode follower oscilloscope probe V_6 to check the operation of all circuits; a test switch with three test positions, arranged so that only one standard oscillator is checked in any one position of the switch.

Tube V_1 can be triggered manually with the pushbutton on this chassis or by any or all of the mixed input pips from output *F*

on the oscillator-selection-panel chassis.

Gating Sequence

Gate I is opened when a pulse appears on the first six inputs to the oscillator selection panel. Gate II is opened when a pulse appears on inputs 7 through 13. Gate III is opened when a pulse appears on inputs 14 through inputs 30. Tubes V_{15} and V_{16A} invert the positive pulses and supply them to V_7 , V_8 and V_{11} .

Gate I may also be called the 128 gate. For every 128 cycles of bevatron r-f applied to the bevatron decade scaler, a pulse is supplied gate I. Tube V_4 extends this count capacity to 256 and feeds a pulse to gate II (256 gate). Likewise, V_5 increases the count capacity to 512 and feeds a pulse to gate III (512 gate) every time 512 cycles are applied to the bevatron decade scaler.

The outputs of gates I, II and III are fed to V_{13} and then directly to

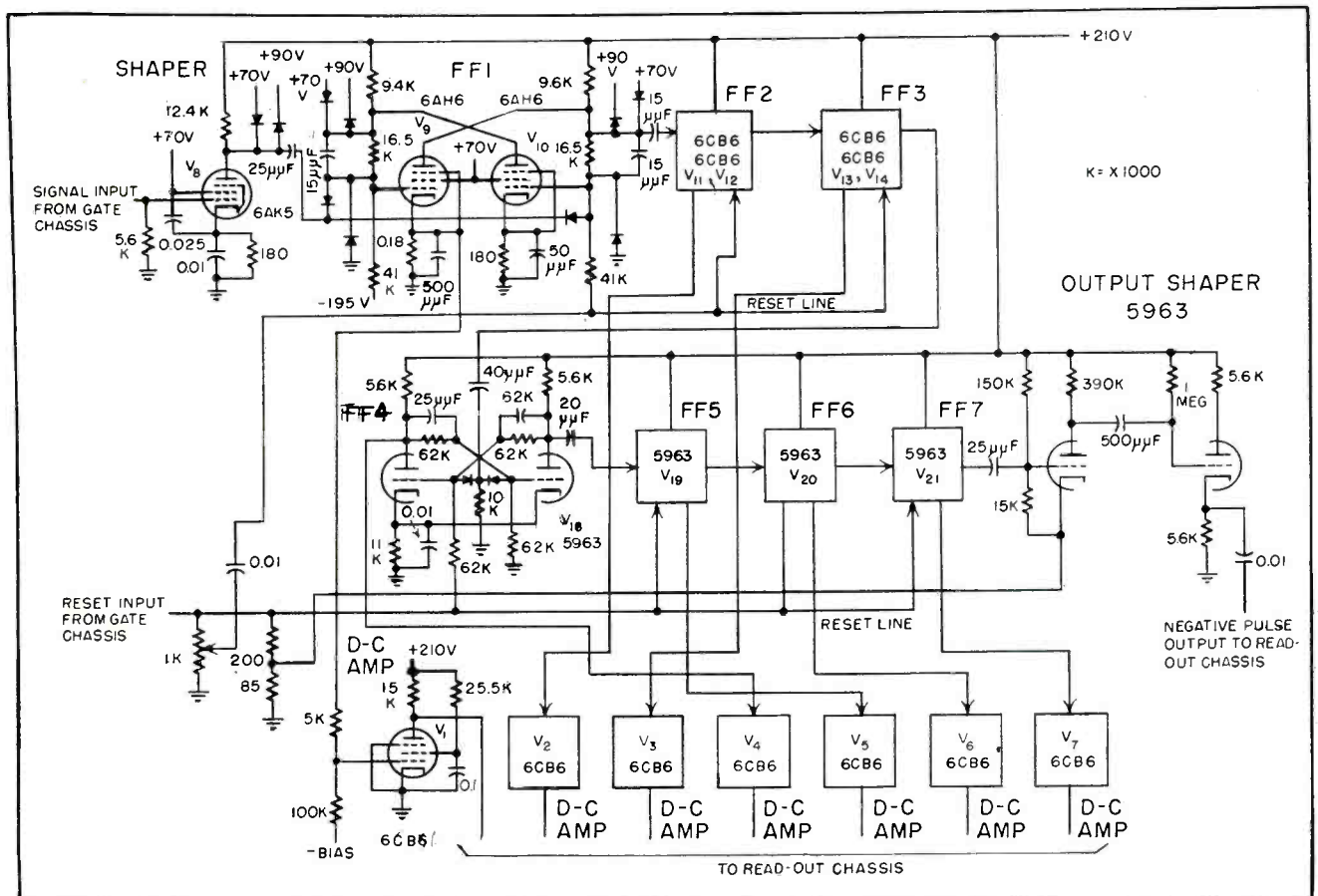

FIG. 5—Simplified circuit diagram of crystal 10-mc decade scaler and d-c amplifier used in measurement system. Flip-flops 1, 2 and 3 operate at 10 mc and flip-flops 4, 5, 6 and 7 at 1 mc

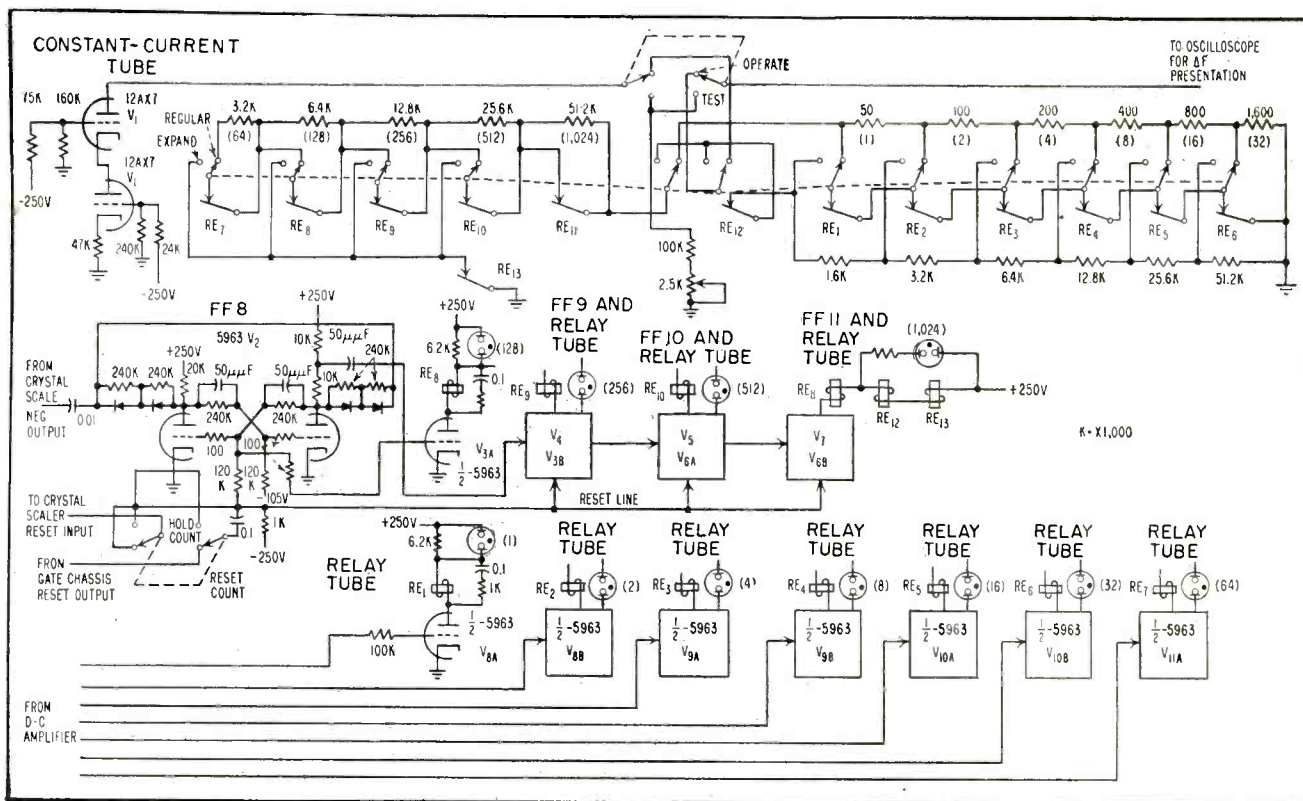

FIG. 6—Read-out chassis converts counts of crystal decade scaler and its own flip-flops to discrete voltages for cathode-ray-tube display. Unit has two count-display ranges that are selectable from front chassis.

V_{20} and V_{21} , the fast flip-flop, which in turn opens or closes the fast gate.

Since only one standard gated crystal oscillator is fed to fast gate V_{22} - V_{23} , this is the oscillator which is counted by the crystal decade scaler and read-out chassis when the fast gate is open. The proper slow gate (proper scaling factor 128, 256 or 512) and proper standard gated crystal oscillator are selected by a particular current pip, so when the bevatron frequency is equal to the calculated value the crystal decade scaler and read-out chassis always contain and indicate 991 or 992 counts.

When the first trigger pulse initiated by a particular current pip is supplied to the fast flip-flop, the fast gate is open and counting starts in the crystal decade scaler and read-out chassis. After 128, 256 or 512 cycles of the bevatron r-f have been scaled in the bevatron decade scaler, V_4 and/or V_6 stages, another trigger pulse is supplied to the fast flip-flop which resets it and closes the fast gate, stopping counting in the crystal decade scaler and read-out.

When the fast flip-flop is reset it supplies a reset pulse to reset cathode follower V_{17} and to all the standard gated oscillators as well as to all three slow gate flip-flops. The system now displays the output count until the next current pip is fed into the oscillator selection panel. The gate chassis also contains an initial-reset cathode follower to reset the fast flip-flop and gated crystal oscillators when the frequency-measurement equipment is first turned on.

Oscillator Chassis

Each of three of these chassis, Fig. 4, contains eight complete gated standard crystal oscillators and associated triggering equipment. In addition, each chassis contains one wide-band cathode follower to drive the output coaxial cable. Each gated oscillator is reset by a pulse from the gate chassis. The r-f outputs of the three gated r-f chassis are tied in common and fed to V_{24} in the gate chassis.

Each oscillator has two tubes associated with it, a set-reset tube and a flip-flop which operates the 6AS6 gated crystal oscillator. The

crystal is oscillating at all times and the gating is accomplished by swinging the suppressor grid. The plates of all oscillators are connected to the 5687 wide-band cathode follower.

Each chassis has one tuned circuit associated with the plate circuit of all oscillators. This tuned circuit is resonant at the mean frequency of the eight oscillators on any particular chassis.

Crystal Decade Scaler

The decade scaler, originally a Hewlett-Packard 520A with a count capacity of 100 which would scale up to 10 mc, has been modified so that it now has a scale of 128 and can be reset externally (Fig. 5). It no longer resets to zero, but in conjunction with four more scales of two in the read-out chassis is preset to 2,016 counts. It also has provisions so that the counts it contains can be read-out by the d-c amplifier and fed to the read-out chassis to be displayed.

The crystal decade scaler has been modified so that instead of being reset to zero it is preset to 32. This was done by reversing the

reset lines to V_{20} . The presetting is done when a trigger pulse from V_1 , in the gate chassis, is supplied. The d-c amplifier is connected to V_9 , V_{11} , V_{13} , V_{18} , V_{19} , V_{20} and V_{21} and amplifies the small voltage swings produced by these scalars. Tubes V_9 , V_{11} and V_{13} have their cathode voltages amplified while V_{18} , V_{19} , V_{20} and V_{21} have their plate swings amplified. Tubes V_9 , V_{11} and V_{13} are fast circuits, so any leads connected to their plates or grids would slow them down. All these amplified voltages are fed to the read-out chassis for display.

Read-Out Chassis

The read-out chassis, Fig. 6, converts the counts contained in the crystal decade scaler and its own four scale of two flip-flops to discrete voltages so that they can be displayed on an oscilloscope. It contains a constant-current source and a series string of precision resistors. Each resistor has a pair of relay contacts across it. These resistors are in the binary scaling ratio of 1, 2, 4 etc to 1,024 so a certain number of counts is displayed as a proportional voltage by operating the proper relays.

The chassis contains two ranges selectable from the front panel. In the regular position, all counts are displayed from 0 to 2,047. In the expanded position, 0 to 960 counts are displayed on one line (top of screen) and 1,024 to 2,047

are displayed on the bottom line. Counts between 960 and 1,024, corresponding to ± 3.2 -percent frequency departure, are displayed between the top and bottom line.

This chassis contains four scale-of-two flip-flops, which follow the crystal decade scaler and extend the count capacity to 2,048. Each flip-flop has a relay tube and relay associated with it. Each relay has a neon bulb associated with it, so counts corresponding to a single point can be read from the front panel.

The flip-flops are V_2 , V_4 , V_6 and V_7 ; the corresponding relay tubes are V_{3A} , V_{3B} , V_{6A} and V_{6B} .

Each of the seven inputs connecting the d-c amplifiers to this chassis has a relay tube and relay associated with it as well as a neon bulb.

The chassis also has provisions for disabling the preset pulse to the four flip-flops and crystal decade scaler, so that a count average can be taken. Normally when more than one point is to be read the hold count-reset count switch is in the reset-count position.

The flip-flops are connected so that in conjunction with the crystal decade scaler the scalars are preset to 2,016 instead of 2,048 or 0. This is necessary so that nominal frequency is displayed in the middle of the oscilloscope screen instead of at the bottom. Tube V_1 is a constant-current source for the

string of precision resistors which supply a d-c voltage proportional to the number of counts in the scalars.

To set up the display oscilloscope, the test-operate switch is placed in the test position. A d-c voltage corresponding to the maximum count is fed to an oscilloscope. Maximum downward deflection is then obtained. If the d-c signal is removed from the scope the maximum upward deflection is obtained. Usually the oscilloscope's vertical-portion control is used to set the upward deflection and the vertical-amplitude gain is used to set the downward position. The oscilloscope is calibrated for all magnet voltages as well as expand and regular read-out positions.

Bevatron Decade Scaler

This unit, Fig. 7, has been modified to count to 128 instead of 100 by removal of the feedback diodes associated with V_{11} , V_{14} , V_{19} and V_{20} . The preset value of 64 has been obtained by reconnecting the reset line to the V_{21} . In addition, V_{22} has been modified to produce both positive and negative pulses when it is triggered by V_{21} .

All bevatron work was done under the auspices of the U. S. Atomic Energy Commission.

Dick A. Mack is in charge of the Bevatron Electronic Group, which is responsible for the design and development of all monitoring and control equipment.

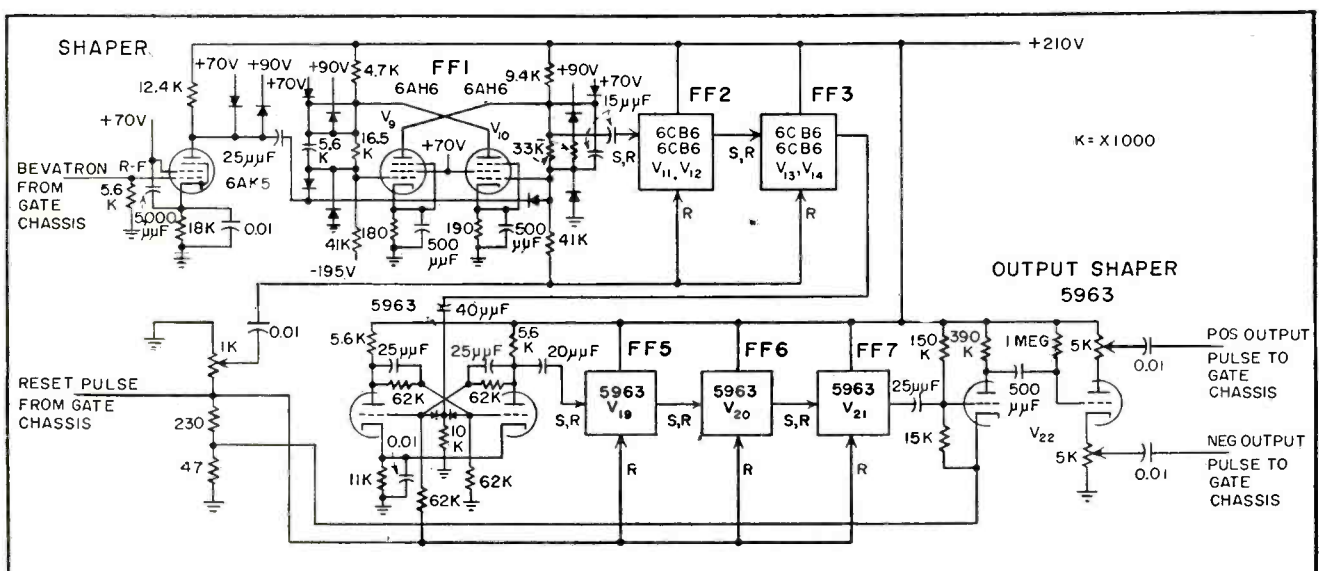
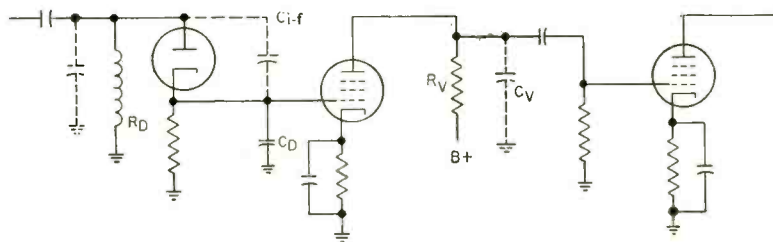

FIG. 7—Simplified circuit of bevatron 10-mc decade scaler. Unit has modification to count to 128 instead of 100

Radar Second Detector Filter Nomograph

SUMMARY — Gives optimum circuit constants for second detector and video circuits of radar receiver when i-f value, upper video cutoff frequency, tube and socket capacitances are known



Radar receiver circuit, showing constants covered by nomograph

ONE DETAIL which tends to receive little emphasis in radar receiver design is optimization of the filter constants of the second detector. The recurrent problem of compromising between adequately bypassing the i-f components of the signal and retaining the high-frequency components of the video signal is solved easily by the accompanying nomograph.

Nomograph Scales

The basic nomograph consists of the scales f_{i-f} (intermediate frequency), f_D (detector filter frequency) and f_V (upper video 3-db cutoff frequency). The equation governing the relationship, $f_D = \sqrt{f_{i-f} f_V}$, determines the optimum detector filter frequency to be the geometric mean of the intermediate frequency or the lower 3-db frequency of

By CHESTER W. YOUNG

Senior Research Engineer
Advanced Development Group
Convair Division of General Dynamics
Corp.
Pomona, California

the i-f pass band and the upper video cutoff frequency.

Additional scales C_V and R_V give video circuit constants. Since good detector efficiency is based upon a good C_D/C_{i-f} ratio, this scale is added to the right of the nomograph.

Example

As an example, determine the constants of the detector and video circuits when the i-f is 50 mc, the upper cutoff f_V is 1 mc for the video, the detector diode-socket capacitance C_{i-f} is $2 \mu\text{mf}$ and the video tube and socket capacitances C_V total $30 \mu\text{mf}$.

Starting at the 50-mc point on the left-hand scale (f_{i-f}), draw a straight line to the 1-mc point on the middle scale (f_V) and read 7 mc on the f_D scale (A).

Selecting a C_D/C_{i-f} ratio of 10 on the scale at the extreme right, connect this value with the $2\text{-}\mu\text{mf}$ value on the C_{i-f} scale and read the value $20 \mu\text{mf}$ on the C_D scale (B). By extending a line joining the 7-mc point on the f_D scale and the $20\text{-}\mu\text{mf}$ point on the C_D scale to the right, the value 1,100 ohms is obtained for R_D (C).

If no peaking compensation is used in the video circuit, the value of R_V can be determined to be 5,300 ohms by joining the 1-mc point on the f_V scale with the $30\text{-}\mu\text{mf}$ point on the C_V scale and extending it to the right to the R_V scale (D).

The rectified voltage developed at the output of a diode detector

(Continued on page 190)

QUICK, EASY ASSEMBLY... AND MAINTENANCE NOW WITH



CINCH TRANSISTOR SOCKETS:

The CINCH Sub-miniature socket insures positive electrical contact, holds transistors securely in place, permits easy maintenance and replacement, provides maximum insulation resistance and minimum high frequency loss. Exclusively CINCH; production of low loss mica components in quantity, quickly.

FOR PRINTED WIRE APPLICATIONS:



Also EXP 9402, Printed wire right angle socket (Not shown above)

TRANSISTOR SOCKETS:

Sockets available shown here, also No. EXP 9199:



46A 22468



46A 20928



46AZ20248



46P 22485
Printed Wire Socket



46A 22452
Printed Wire Right Angle Socket



54A 17431

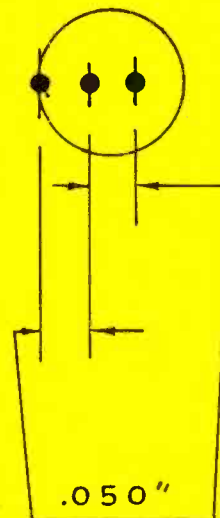
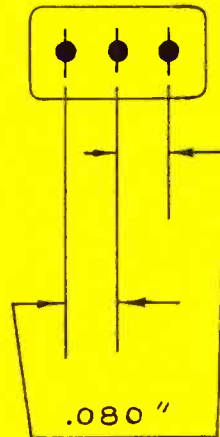

54A 14148



54A 14273

These sockets (above) are five contact wire subminiature sockets having .040" centers.

SOCKETS SHOWN ENLARGED TWICE AREA.



54A 16995

(Left) Four contact subminiature socket having .048" centers.

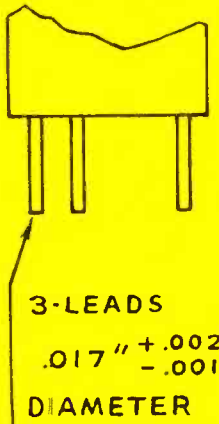
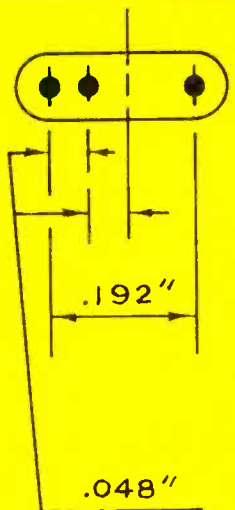

3-LEADS
.017" +.002
-.001
DIAMETER

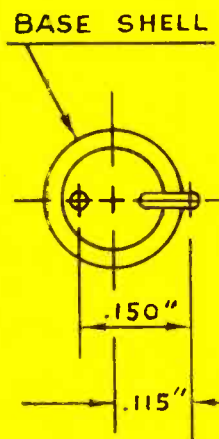

BASE SHELL



Cinch
ELECTRONIC
COMPONENTS

CINCH MANUFACTURING CORPORATION

1026 South Homan Ave., Chicago 24, Illinois

Subsidiary of United-Carr Fastener Corporation, Cambridge, Mass.

CINCH will design, or re-design, components to fit specific needs, and will assist in the assembly of components through proven automation technique.

CONSULT CINCH

Centrally located plants at Chicago, Pasadena, Shelbyville and St. Louis

Radar Second Detector Filter Nomograph (Continued from page 188)

is a function of the voltage distribution between capacitances C_D and C_{i-f} . The ratio of these two values was chosen to be 10 in the foregoing example so that most of the signal voltage (actually 10/11) is impressed across C_D for transfer to the next stage of the receiver.

From the aspect of pulse envelope rise and fall time, the diode resistance should be low compared to the diode load resistance and the impedance of the i-f stage driving the detector. Specifically, it is recommended here also that the diode anode-cathode capacitance should be

considerably lower (by a factor of 10) than the input capacitance of the following stage. This ratio of 10 is an arbitrary compromise between the driving impedance and consequent pulse envelope degradation and the amount of i-f voltage that can be utilized as a signal.

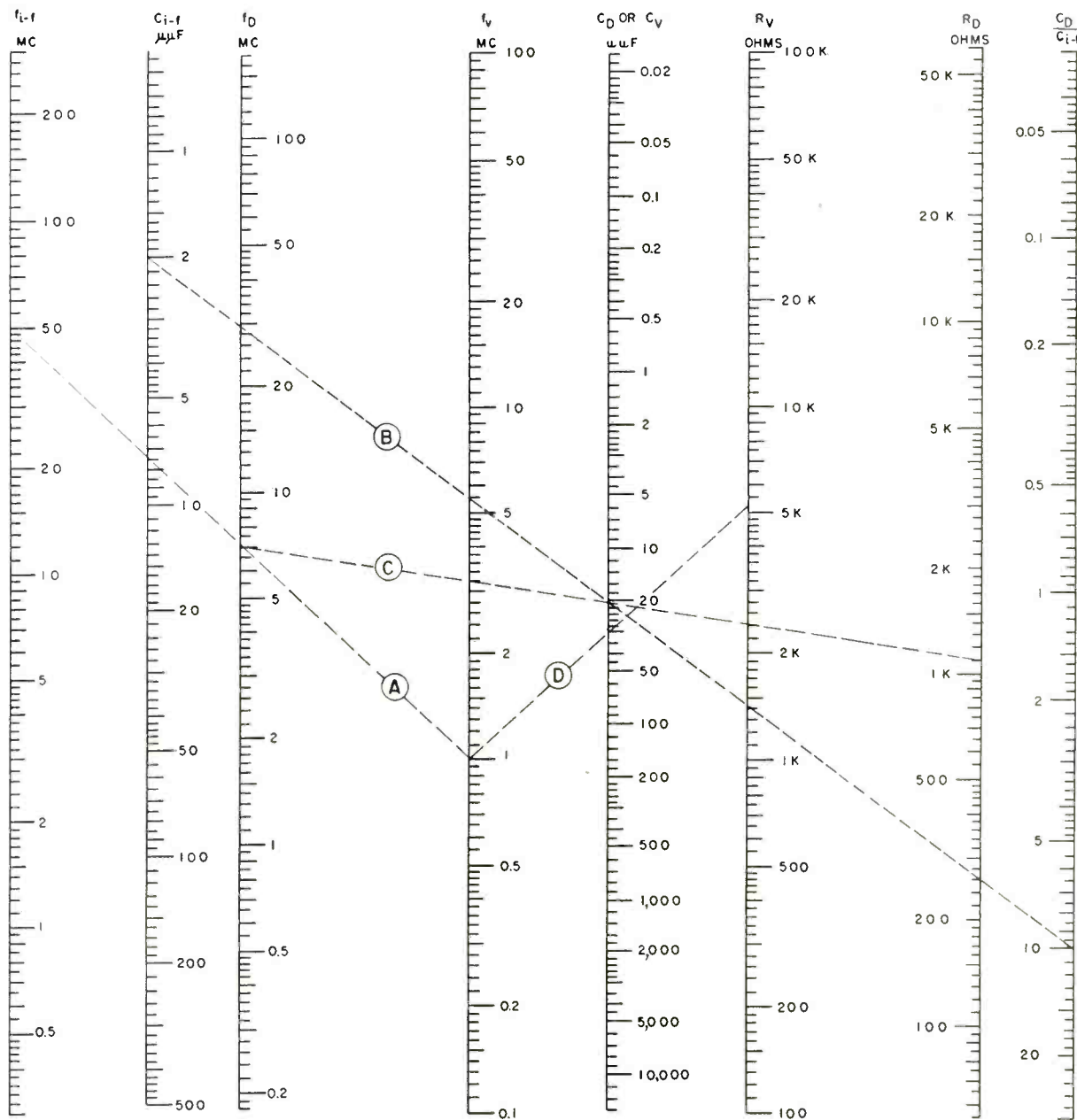

Second detector filter nomograph. Lettered lines indicate four steps of design procedure. Line A gives detector filter frequency from i-f value and upper video cutoff frequency. Line B gives detector load capacitance value from detector capacitance ratio and detector tube capacitance. Line C gives detector load resistance value from detector filter frequency and detector load capacitance value. Line D gives first video amplifier plate load resistance from upper video cutoff frequency and video tube plate-cathode capacitance

P. R. MALLORY & CO. INC.
MALLORY

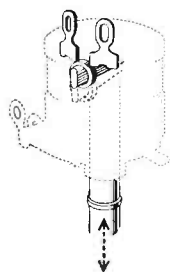

Push the shaft and the set turns off. Pull, and it turns on at the same volume setting. New "floating ring" contacts give exceptionally long, trouble-free life.

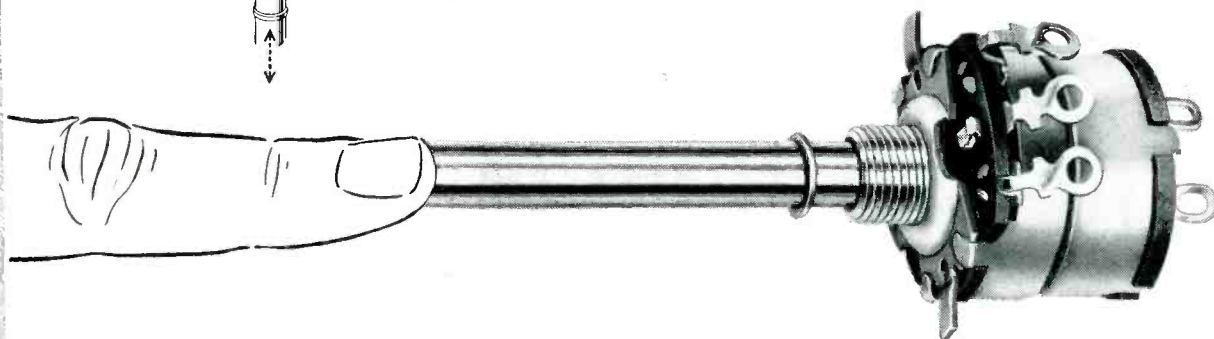

Mallory Controls Now Available With New Push-Pull On-Off Switch

FOR YOUR new designs for television receivers, home and auto radios, investigate the unusual, merchandisable performance features of Mallory controls with the new push-pull switch. This new kind of switch turns off when the shaft is pushed in . . . turns on when the shaft is pulled out.

No "groping" for volume setting. The set is turned on at the *same volume control* position as it was turned off.

Longer control life. The control needs to be rotated only for minor volume changes, instead of being moved through a major portion of its travel every time the line switch is actuated.

New switch design. The switch itself uses a unique "floating ring" contact design. Make and break is performed by spring-snapped motion of small rings made of special Mallory contact alloy. The rings float freely on pins . . . automatically align themselves perfectly. They rotate with each operation, exposing a new contact surface. Service life is extremely long. Make and break action is clean and positive.

Serving Industry with These Products:

Electromechanical—Resistors • Switches • Television Tuners • Vibrators
Electrochemical—Capacitors • Rectifiers • Mercury Batteries
Metallurgical—Contacts • Special Metals and Ceramics • Welding Materials

Single and dual types of Mallory carbon controls are now available with this new switch . . . and with an improved carbon element that has even greater stability, better wearing quality and lower noise than ever before. Write or call Mallory for full details.

★ ★ ★

Long-Lasting "Floating Ring" Switch also in Rotary Model



The new "floating ring" contact design is also available in a switch with conventional rotary action, on Mallory single and dual carbon controls. It gives exceptionally long service . . . positive snap action "feel" . . . protection against loss of spring tension during overloads. Write to Mallory for data.

Expect more . . . get more from



P. R. MALLORY & CO., Inc., INDIANAPOLIS 6, INDIANA

PARTS DISTRIBUTORS IN ALL MAJOR CITIES STOCK MALLORY STANDARD COMPONENTS FOR YOUR CONVENIENCE

Electrons At Work

Edited by ALEXANDER A. MCKENZIE

Thermocouple Effect Identifies Unknown Metals

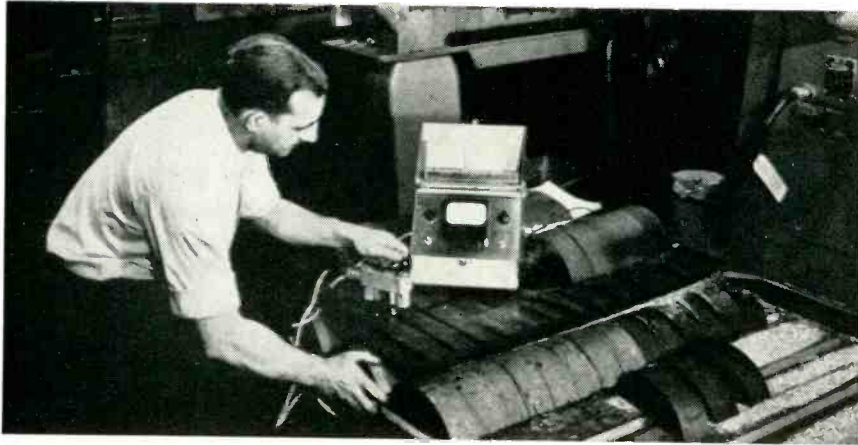

Castings are checked for uniformity using thermocouple probe and meter unit

tronics, can be used to check stock, parts in process or finished products.

Operation of the device is based upon the phenomenon wherein the junction of two dissimilar metals produces an electromotive force. An electrode with self-heating element is placed in contact with the metal to be tested. The voltage thus generated is amplified and displayed on a meter.

This reading is then compared to others obtained from samples for which composition and metallurgical characteristics are known. The test is nondestructive and as many as 3,000 pieces an hour can be checked. The metals can be ferrous or non-ferrous.

SENSITIVE to differences between two pieces of steel that vary by one point of carbon, the Metal Monitor, manufactured by Brush Elec-

Lemons Sorted Into Five Color Groups

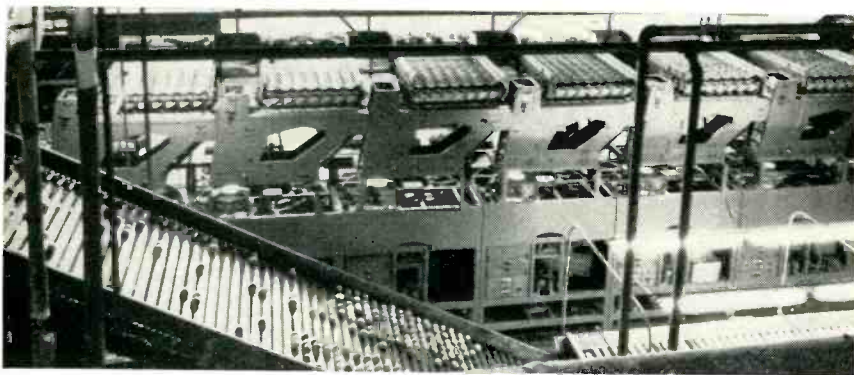

The battery of six automatic sorting machines shown can handle a million lemons a day. Careful discrimination is required among five color groups ranging from dark green to tree ripe. Each piece of fruit must be totally exposed to the photoelectric device used in order to detect minute discoloration. Manufacturers of the equipment, Electric Sorting Machine Co., say that manual sorting becomes inferior to the phototube technique because the onset of fatigue diminishes the individual's capacity for exercising judgment

Low-Cost Remote Broadcast Amplifier

By KEN MAXWELL
Dallas, Texas

MANY SMALL broadcast stations no longer maintain two or three remote amplifiers with several microphone channels that were carried to the remote location by an operator for each remote broadcast.

Now remote pickups tend to be restricted to one microphone when possible with a one-channel remote amplifier set up permanently at the location. It is turned on by the announcer or by those putting on the

FIG. 1—Low-cost remote amplifier is designed with minimum of controls

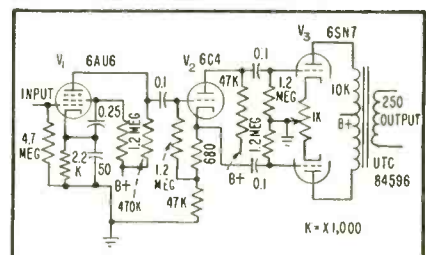

KEPCO

VOLTAGE REGULATED POWER SUPPLIES

for powering electronic equipment

SERIES

with **NEW-IMPROVED FEATURES**

- ★ **FAST** RECOVERY TIME
- ★ **GOOD** STABILITY
- ★ **LOW** OUTPUT IMPEDANCE

KR Voltage Regulated Power Supplies are conservatively rated and are designed for continuous duty at 50°C ambient.

REGULATION: Less than 0.2 volts for line fluctuation from 105-125 volts and less than 0.2 volts for load variation from 0 to maximum current.

RIPPLE: Less than 3 mv. rms.

STABILITY: The output voltage variation is less than the regulation specification for a period of 8 hours.

RECOVERY TIME: Less than 50 microseconds. The excursion in the output voltage during the recovery period is less than the regulation specification.

OUTPUT IMPEDANCE: Less than 0.1 ohms from 20 cycles to 100KC. Less than 0.5 ohms from DC to 20 cycles. Many units have very much lower output impedance.

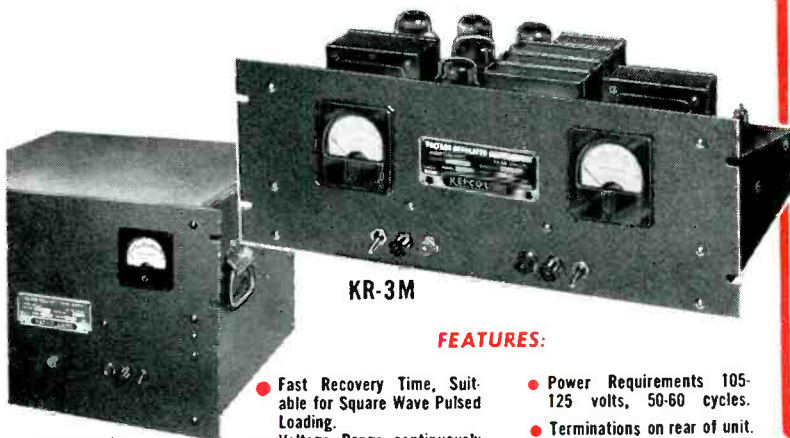

KR-18MC

KR-3M

FEATURES:

- Fast Recovery Time, Suitable for Square Wave Pulsed Loading.
- Voltage Range continuously variable without Switching.
- Either Positive or Negative may be Grounded.
- Oil Filled Condensers.
- Wire Harness and Resistor Board Construction.
- Power Requirements 105-125 volts, 50-60 cycles.
- Terminations on rear of unit.
- Locking type voltage control AC, DC Switches, Fuses, and Pilot Lights.
- Color Grey Hammertone.
- Guarantee One Year.

All models available for 400 cycle operation on special order.



KEPCO LABORATORIES

131-38 SANFORD AVENUE • FLUSHING 55, N.Y. • INDEPENDENCE 1-7000

1.5 Amp. **KR** SERIES

Model	Volts	6.3V AC	Rack Mount			Price
			W	H	D	
KR16	0-150	Each supply	19"	12¼"	17"	\$625
KR17	100-200	has two	19"	12¼"	17"	\$625
KR18	195-325	15 Amp.	19"	12¼"	17"	\$695
KR19	295-450	outputs	19"	12¼"	17"	\$695

600 ma. **KR** SERIES

Model	Volts	6.3V AC	Rack Mount			Price
			W	H	D	
KR 8	0-150	Each supply	19"	10½"	13"	\$330
KR 5	100-200	has two	19"	10½"	13"	\$240
KR 6	195-325	10 Amp.	19"	10½"	13"	\$240
KR 7	295-450	outputs	19"	10½"	13"	\$250

300 ma. **KR** SERIES

Model	Volts	6.3V AC	Rack Mount			Price
			W	H	D	
KR 12	0-150	Each supply	19"	7"	11"	\$270
KR 3	100-200	has two	19"	7"	11"	\$180
KR 4	195-325	5 Amp.	19"	7"	11"	\$180
KR 10	295-450	outputs	19"	7"	11"	\$190

125 ma. **KR** SERIES

Model	Volts	6.3V AC	Rack Mount			Price
			W	H	D	
KR 11	0-150	Each supply	19"	7"	11"	\$180
KR 1	100-200	has one	19"	7"	7½"	\$ 90
KR 2	195-325	3 Amp.	19"	7"	7½"	\$ 90
KR 9	295-450	output	19"	7"	7½"	\$ 97

To Include 3" Current and Voltage Meters, Add M to Model number (e.g. KR 16-M) and Add \$30.00 to the Price.

To include Dust Cover and Handles for Table Mounting, Add C to Model number (e.g. KR16-C) and Add \$10.00 to the Price.

To include Meters, Dust Cover and Handles, Add MC to Model number (e.g. KR-16 MC) and Add \$40.00 to the Price.

PRICES F.O.B. Flushing.

A LINE OF 50 MODELS

Available from Stock - Catalog on Request

Ceramic Military Tubes

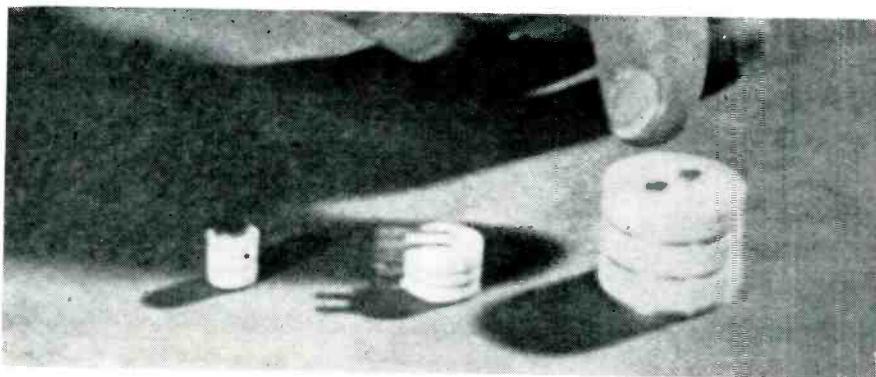

Printed from a frame of the GE color motion picture, "The Tube of Tomorrow", the photograph at the left shows three developmental types. At the far left is a military version (Z-2389) of the 6BY4 triode. Under normal operation this tube has a μ of 80 and g_m of 8,000 to 9,000 μ mhos. The center tube is the forerunner of a current type not shown, used in guided missiles. In one form, Z-2352, it is a high- μ amplifier; or as Z-2353 it is a voltage amplifier with a μ of 20 when plate current is 10 ma. Development triode Z-2354 (right) has 12.5 watts output. With plate current of 100 ma, μ is 45 and g_m is 5,000 μ mhos.

program. Since most stations have a number of such remotes the cost per installation is important.

The amplifier described here resulted from a desire to make it as foolproof as possible in operation and to keep the cost low. It was planned as a remote broadcast amplifier for a church.

► **Chassis**—Construction was from aluminum obtained by soaking a scrap 16-in transcription disk in water for several days, then removing the coating. This provides an inexpensive source of aluminum.

As many controls as possible were eliminated for simplicity of operation. The amplifier is designed to produce the desired gain operated wide open eliminating the need for a volume control. The only items available on the front panel are the fuse holder, power switch,

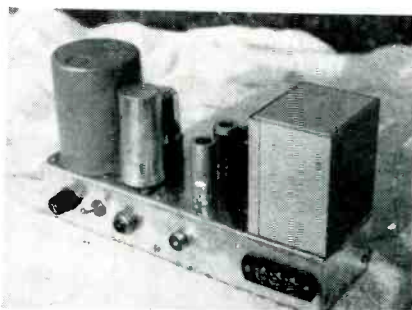

Front panel of amplifier has fuse post, on-off switch, pilot light, input and output connections

pilot lamp, microphone connector and output terminals.

There is usually some difficulty in locating the power transformer and the input transformer on the same chassis because of the problem of hum. For this reason the usual low-impedance microphone was replaced by a high-impedance type so that an input transformer



Underside wiring of amplifier. Power supply is on left

would not be required. This also allows a public-address microphone to be used in an emergency.

Another unusual feature of this amplifier is the pilot lamp. The customary 6.3-volt lamp connected across the filament is subject to frequent burn-out and at best only indicates whether the plug is in and the switch has been turned on as well as showing the fuse is functioning.

It was felt an NE51 neon lamp connected through a resistor between ground and the B+ would

Display Equipment Coordinates Nike Batteries

Operators use photoelectric light guns placed against cathode-ray screens to enter targets into electronic tracking system. Information on the location of aircraft and their identity is distributed to missile firing batteries, either through the Missile Master system, built by Martin and located at key anti-aircraft installations or in conjunction with the SAGE system.

Personnel observe activities of all batteries and, when necessary, direct specific fire units to a particular target or prevent friendly aircraft being fired upon. Up to now, Nike batteries have had to operate independently. As a result, there was danger that in a mass air attack, uncoordinated fire would result in planes eluding the missiles or that some might be attacked more than necessary. Experimental control at Fort Meade, Md. has been operating two years





time on our hands

Here's a handful of microtime . . . doled out in hundredths of a millimicro-second. It's our new HELIDEL* delay line.

It's precise . . . wide-band . . . continuously variable. This is not an adwriter's pipedream . . . it's an engineer's, come true.

Which means that definitions are in order.

Precise = delay increments of only 2×10^{-11} sec; resolution 0.01% and better; linearity "better than $\pm 1\%$ " . . . actually, so fine it can't be measured.

Wide-band = transmission of pulse signals up to 20 mc with negligible phase-distortion, overshoot, or distortion of waveshape.

Continuously variable = a distributed-constant, electromagnetic type . . . dreamed up in 1946 . . . developed in helical form since 1951, by Helipot and DuMont.

The HELIDEL is already used successfully in color-TV broadcasting and oscilloscopes . . . and as a trimmer in transmission systems.

What can you dream up?

 **Helipot** *first in precision potentiometers*

*Helipot Corporation/South Pasadena, California
Engineering representatives in principal cities
a division of BECKMAN INSTRUMENTS, INC.*



*To help you dream,
there's a 10-page technical
paper on the HELIDEL,
presented at the 1954
WESCON . . . and a new data
sheet, with complete specs.
For your copies, write
for Data File 501*

444 * TRADEMARK

function better on unsupervised equipment. It is advantageous in having longer life and since more items in the power supply are covered, their failure would be detected by failure of the lamp to light. An example is failure of the rectifier tube by low omission. This will extinguish the neon lamp but the filament type across the filament

supply would be unaffected.

For the amplifier circuit a push-pull 6SN7 output stage is used. This is driven by a 6C4 phase inverter with loads in the plate and cathode circuit. A pentode-connected 6AU6 gives sufficient gain to drive the cathode follower. The output transformer is a push-pull 10,000 ohm to 250 ohm unit.

A more expensive transformer with a higher primary impedance would have given improved response but this one was sufficient for the use it was put to. The setting of the 1,000-ohm cathode resistance was made with a harmonic-distortion analyzer using 100 cycles. The balance was set for minimum distortion there.

Robot Station Telemeters Weather



Ocean-based weather station can be left unattended for six months

DEVELOPED by National Bureau of Standards for the Navy, an automatic station translates information from each of five weather sensing elements into three-letter groups in continental code. It transmits the coded signals on a pulse-modulated carrier frequency at about 6 megacycles.

These signals can be received on standard communications receivers and compared with a decoding table that gives numerical values for each of the meteorological variables measured. A single transmission takes three minutes. During this interval six items of information are broadcast. The first transmission is a three-letter signal identifying the station. Coded transmissions follow containing information on air temperature between -25 and $+110$ F, water temperature between 15 and 90 F, barometric pressure between 950 and 1,050 millibars, wind speed from 0 to 68 knots

and wind direction oriented from magnetic north.

The vessel that carries the weather-sensing and radio transmitting equipment was designed by the David Taylor Model Basin and is 20-ft long and 10-ft wide. It is constructed of aluminum and other nonmagnetic alloys to avoid undesirable effects on the compass.

► **Location**—The vessel can anchor in waters as deep as 3,600 ft. Two masts and four water-tight wells extending below the boat deck hold all the electronic and meteorological equipment assembled in compact, shock-mounted units. Each unit may be replaced independently.

The weather-sensing elements convert variations of water surface conditions into variations of resistance for measurement by a motor-driven self-balancing bridge circuit. The air and water-temperature sensing devices are simple

thermistors. A precision barometer measures air pressure. This barometer is so modified that a slave needle rides above a resistance strip and is clamped to the strip at the time of measurement.

An especially rugged three-cup anemometer drives a small magnetic generator whose output is applied to the grid of a vacuum tube. Plate resistance of the tube is measured in the bridge. The wind vane is connected to a synchro transmitter and receiver circuit activating a servo system. The servo positions a magnetic compass synchronously with the wind vane. Mounted on gimbals, the compass has a slave needle and clamping system that gives resistance values corresponding to the wind direction relative to magnetic north.

Primary power comes from 180 dry cells connected in series-parallel. A rotary converter changes 13.5 v d-c to 120 v 60 cycles to op-

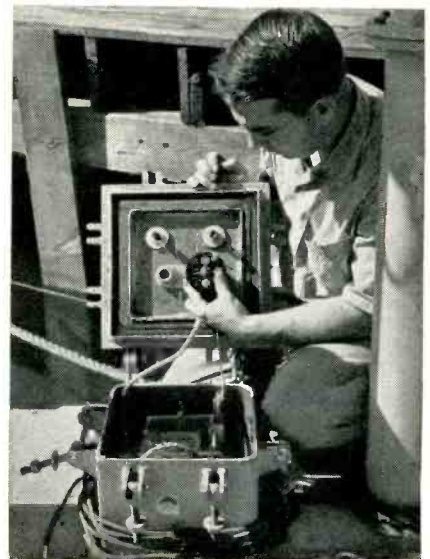

Control equipment used in marine weather station

A COMPLETE LINE OF DEPENDABLE ENCAPSULATED RESISTORS



PERMASEAL[®]

PRECISION WIREWOUND RESISTORS FOR 85C AND 125C AMBIENTS

For applications requiring accurate resistance values at 85C and 125C operating temperatures—in units of truly small physical size—select the precise resistor you want from one of the 46 standard Perma-seal designs in tab or axial lead styles.

Winding forms, resistance wire and embedding material are matched and integrated, resulting in long term stability at rated wattage over the operating temperature range. The embedding material is a

special plastic that extends protection well beyond the severe humidity resistance specifications of MIL-R-93A and Proposed MIL-R-9444 (USAF).

These high-accuracy units are available in close resistance tolerances down to $\pm 0.1\%$. They are carefully and properly aged by a special Sprague process so that they maintain their accuracy within the limits set by the most stringent military specifications.

SPRAGUE

FOR COMPLETE DATA
WRITE FOR COPY
OF SPRAGUE
ENGINEERING
BULLETIN NO. 122A



SPRAGUE ELECTRIC COMPANY • 35 MARSHALL ST. • NORTH ADAMS, MASS.

TRANSCO COAXIAL SWITCHES

-the complete line
for **broad-band,**
high efficiency
RF switching

You'll find TRANSCO switches reliable under all conditions described in existing military specifications. Reliability—plus minimum insertion loss, low V S W R, and high isolation between channels—make TRANSCO the most specified coaxial switches in the industry.

Send your coaxial switching problems to TRANSCO. Technical data on any unit or the complete line sent on request.



1460
series

MOTOR OPERATED
—SP2T to SP6T; also DP transfer
and DPDT. Frequencies to 11,000 MC.



M1460
series

MANUALLY OPERATED
— same contact arrangement and RF head as the 1460 Series.

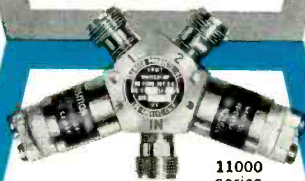

11000
series

MINIATURE—SPDT
—remote-control unit, excellent RF characteristics over wide frequency range.



14000
series

MINIATURE—SP4T
—for wide application flexibility. Weight only 0.75 lbs. Frequencies to 10,000 MC.

TRANSCO

PRODUCTS, INC.

Always the Finest in Avionics
12210 NEBRASKA AVE.,
LOS ANGELES 25, CALIF.

REPRESENTATIVES IN MAJOR AREAS

Want more information? Use post card on last page.

ELECTRONS AT WORK (continued)

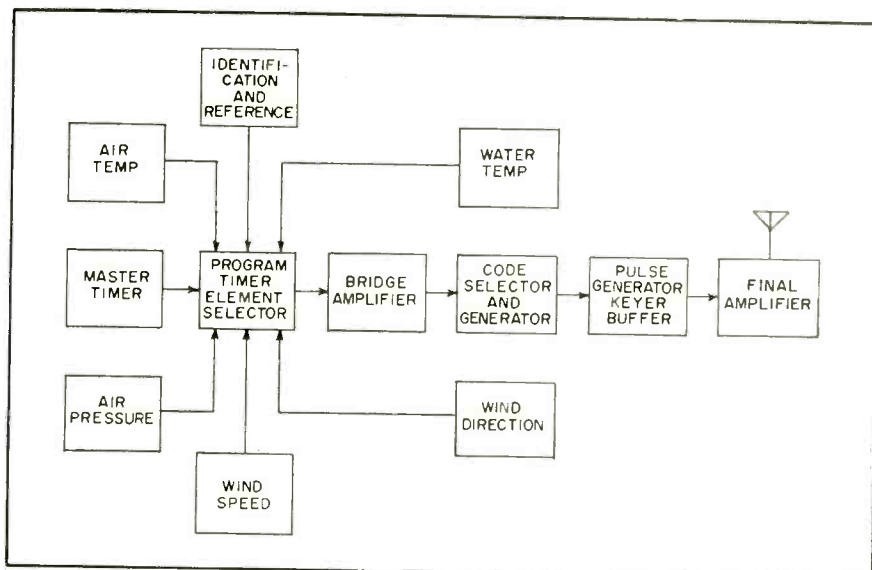

Block diagram of electronic equipment in automatic weather station

erate the power supply for the electronic components. In future models of the boat stations, a gasoline-powered generator and storage battery will replace the dry-battery supply.

At some predetermined time after a suitable warmup period, a master timer closes the contacts that feed power to all circuits. A chronometer watch, rewound by motor at the time of station activity to ensure accuracy over extended periods of time, furnishes reliable master control.

When power is applied, a program timer, consisting of a number

of circular switches driven by a constant-speed motor, inserts a precision resistance into the self-balancing bridge. As the first radio signal to be transmitted is the station identifying signal, this precision resistor, instead of one of the weather variable resistances, is the first contacted in the program timer.

The resistance of a helical potentiometer at the bridge balance point matches this resistance. On the same shaft with the potentiometer is a rotary code selector switch that selects letters on a code generator; these letters then corre-

Early Microwave Anniversary



Artist's drawing shows microwave dish antenna used 25 years ago to establish communications between Dover, England and Calais, France. Expected by IT&T scientists to be free of fading, the circuit showed seasonal variations of over-water path. Radio-frequency power was about half a watt at 17 centimeters

Magnetics, Inc. makes the performance-guaranteed permalloy powder core

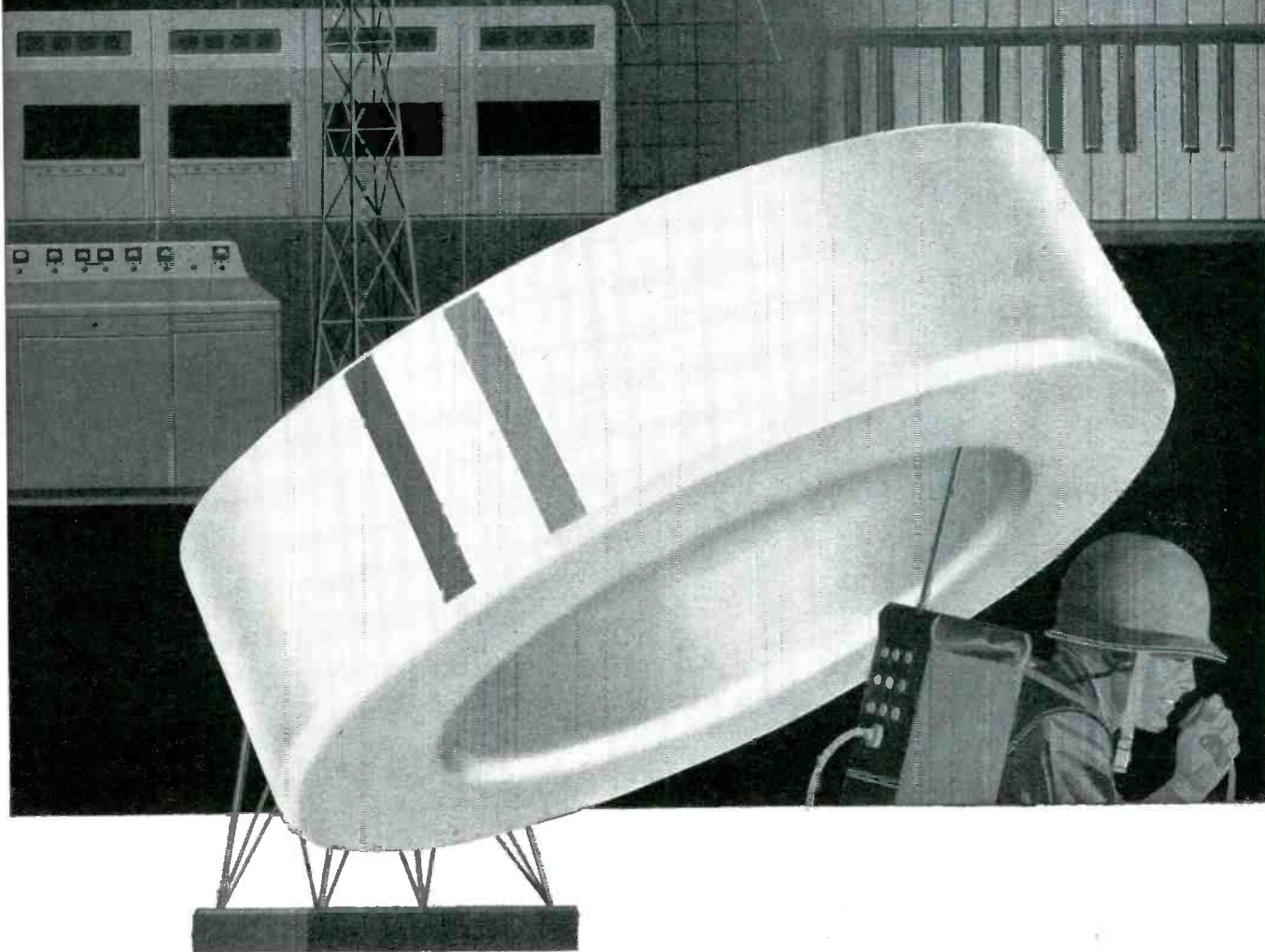

We have taken the guesswork out of using molybdenum permalloy* powder cores, for Magnetics, Inc. Powder Cores are Performance-Guaranteed. What's more you can specify as an extra, Magnetics' exclusive feature . . . color-coding. Color-coding tells your assemblers, without special testing, how many turns to put on these cores, for they are graded and coded according to inductance before they reach you.

Bulletin PC-103 gives you detailed information, and the Powder Core Color-Coding Card guides your assemblers and others with production responsibility. Why not write for your copies today? Magnetics, Inc., Dept. E-30, Butler, Pennsylvania. *Manufactured under a license with Western Electric Co.

MAGNETICS inc.

CABLE: Magnetics

MEASUREMENTS' MEGACYCLE METER

Gives You Extended
Coverage from
100 Kc to 940,000 Kc
PRECISION GRID-DIP METERS



MODEL
59
Power Supply
\$75.00

MODEL 59-LF OSCILLATOR UNIT

Frequency Range:
100 Kc to 4.5 Mc.
Price - Oscillator Unit
(Head) only \$98.50
with Power Supply
\$168.00



MODEL 59 OSCILLATOR UNIT

Frequency Range:
2.2 Mc to 420 Mc.
Price - Oscillator Unit
(Head) only \$98.50
with Power Supply
\$168.00



MODEL 59-UHF OSCILLATOR UNIT

Frequency Range:
420 Mc to 940 Mc.
Price - Oscillator Unit
(Head) only \$123.00
with Power Supply
\$198.00



Measurements' Megacycle Meter is now available in a choice of three oscillator heads providing frequency range coverage from 100 Kc to 940,000 Kc. Thus, the utility of this versatile instrument has been extended, making it, more than ever, indispensable to anyone engaged in electronic work; engineer, serviceman, amateur or experimenter.

Laboratory Standards



MEASUREMENTS CORPORATION
BOONTON • NEW JERSEY

Want more information? Use post card on last page.

ELECTRONS AT WORK (continued)

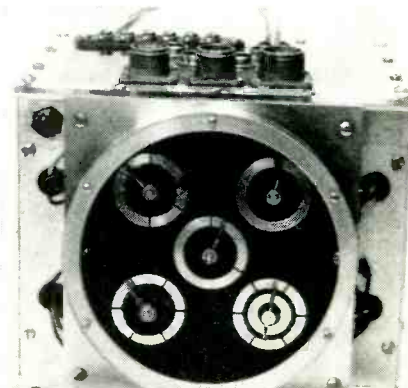
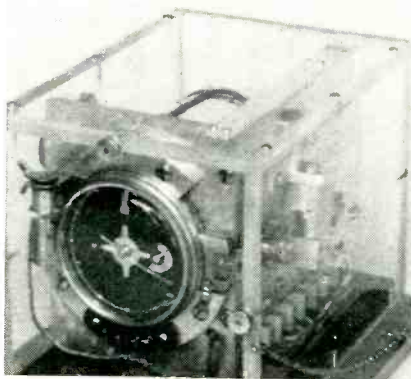

Equipment is turned on and weather sensing elements selected in sequence send out code depending upon position of contact arms on circular switches

spond to the value of the resistor inserted into the bridge. The code generator, a drum made up of eight metal rings insulated from each other, has the code characters machined in relief on the inner circumference of the rings.

A comb-type brush contactor sweeps inside the drum, contacting the raised segments. The raised code characters designated by the selector switch, when in contact with the comb, close a keying relay circuit. Then, over a 20-second interval, the transmitter is keyed in code with a three-letter group. Sending speed can be controlled by the comb speed and a rate of five to seven signal repetitions during the 20-second interval permits even inexperienced operators sufficient time to copy the signal.

During the interval when the station is identifying itself, a resistance determined by the first of the

five weather variables is connected to the bridge circuit. At the end of the identification interval, a 10-second delay ensues while bridge balance and code selection occur. Then the first of the weather data is broadcast. While this signal is being transmitted, the next weather variable is selected and then transmitted at the end of the first weather signal.

► Signals — The remainder are transmitted in like manner. Altogether, the three-minute transmission period contains six transmission intervals of 20 seconds duration, each preceded by 10-second balancing intervals. At the conclusion of the transmission period, the master timer contacts are broken to remove power from the equipment until time for the next period of station activity.

(Continued on page 202)

Warehouse Guarded With ITV

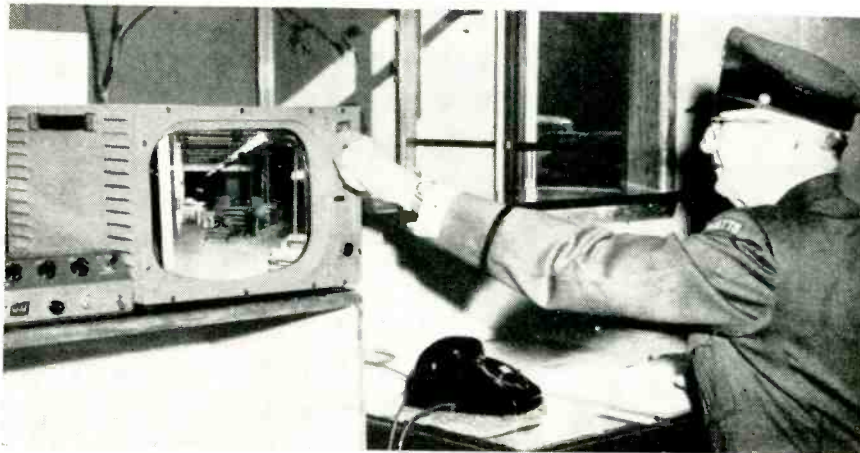

Cameras more than 1,500 feet away show security guard at Filene's Needham, Mass. warehouse what is happening at shipping and receiving docks in the merchandise storage area. Guard can point Dage tv cameras in any direction by remote control



GLENNITE® C-21 SUBMINIATURE CONNECTORS AND CABLES

Actual Size 

Born at
40,000 FEET
under severe vibration...

Gulton Industries' Research-on-the-Production-Line makes possible instant tailoring of basic materials, instruments or complete systems to fill difficult or unusual requirements.

THE PROBLEM: Sensitive instruments in today's missiles and aircraft are constantly being made smaller and smaller to conform to **exacting** space requirements. To carry back the vital information sensed by these instruments, a **completely unique type** of connector and cable was required extra ruggedness, superior shock and vibration characteristics had to be combined with minimum size and weight. Nothing with **all** the necessary qualities existed!

THE SOLUTION: Gulton engineers concentrated their unconventional approach and long years of experience in shock and vibration research on answering this problem . . . the result: new subminiature GLENNITE C-21 Connectors and Cables.

Only 1/4 the size and weight of comparable AN types (.565" O. D.—1" length), advance-design C-21 Connectors have a revolutionary, internal cable clamp, special free-floating pins and provision for cable coiling that prevent transmission of shock to the connector housing . . . C-21 Units withstand up to 25 lbs. cable tension **without effect!** And positive keying and polarization prevent incorrect assembly, **even if key is damaged** . . . they are available in a wide selection of styles and pin arrangements . . . each type has a matching C-21 Cable.

For complete technical information on GLENNITE Connectors and Cables or Gulton Industries' Electronic Systems, write for Catalog #202 today!

GULTON

MFG. CORP.



associated with GULTON INDUSTRIES, INC. Metuchen, New Jersey

PIONEERS IN MATERIALS RESEARCH, ELECTRONIC COMPONENTS, PRECISION INSTRUMENTS AND SYSTEMS ENGINEERING

Meter Adapter for Blind Technicians

By J. ATKIN, H. BICKEL AND V. PROSCIA

Columbia University Engineering Center
Electronic Research Laboratories
New York, N. Y.

BRILLE and sound are combined in an adapter that enables blind engineers and technicians to read many commercially available electronic instruments. The adapter was developed specifically for use with vacuum-tube voltmeters but its application is not limited to any particular class of test equipment.

The unit consists essentially of a potentiometer circuit that permits the measurement of the small d-c voltage which appears across the indicating meter. An a-c chopper or vibrator is used in conjunction with a pair of high-impedance earphones as a null indicator. Braille meters employing this principle of opera-



Adapter allows blind to use commercial vtm without circuit modification

tion have been built and described in the literature¹.

However, designing and constructing special test equipment for the visually handicapped is costly. The simple and inexpensive device described here can be connected easily to many commercial instruments in a manner that does not hamper their normal operation.

The deflection of the pointer of a d'Arsonval movement depends on the d-c current passing through its coil. This current is proportional to the voltage that produces it, since the resistance in the circuit is constant. By using a separate potentiometer circuit calibrated for full-scale deflection voltage of the meter, a null can be obtained when both voltages algebraically.

► **Reading**—Now, the d-c deflection voltage is equal to the voltage setting of the potentiometer.

When the voltages are not equal, the circuit becomes unbalanced. In the unbalanced state a difference voltage appears at the contact points of a 60-cycle chopper where it is chopped to produce an a-c signal. The error signal is then sent to a pair of earphones or amplifier-speaker system. Whenever a null is reached, a reading is taken on the Braille scale of the potentiometer, which corresponds to the reading on the visual meter.

The RCA Senior Voltohmyst was the first meter used with the adapter. The instrument was not altered in any manner. A shielded cable was connected across the indi-

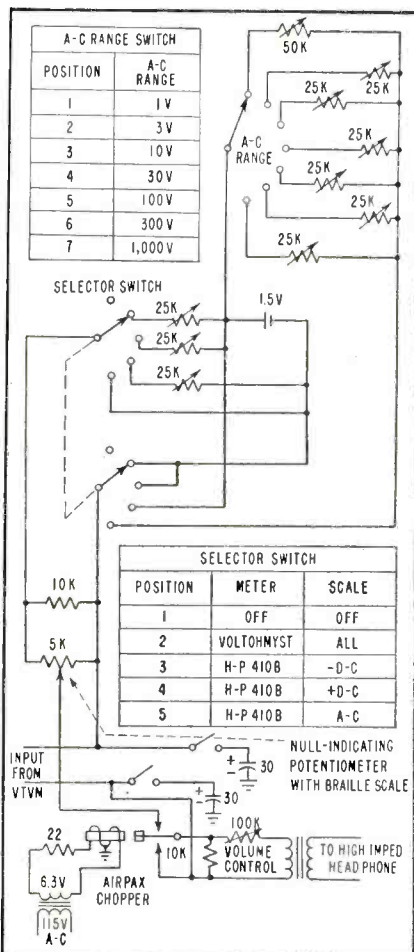
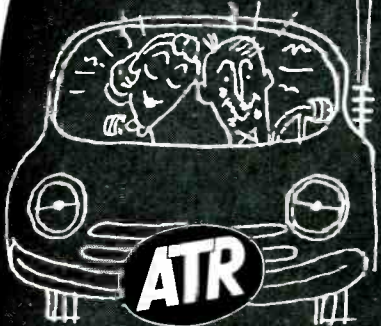

FIG. 1—Braille vtm adapter gives audio null in headphones when potentiometer balances measured voltage

by
every
test



ATR

is BEST!



ATR AUTO RADIO VIBRATORS

Have Ceramic Stack Spacers

A COMPLETE LINE OF VIBRATORS

Designed for Use in Standard Vibrator-Operated Auto Radio Receivers. Built with Precision Construction, featuring Ceramic Stack Spacers for longer lasting life. Backed by more than 22 years of experience in Vibrator Design, Development, and Manufacturing.



"A" Battery Eliminators, DC-AC Inverters, Auto Radio Vibrators

ATR

NEW MODELS NEW DESIGNS NEW LITERATURE

See your jobber or write factory

AMERICAN TELEVISION & RADIO CO.

Quality Products Since 1931

SAINT PAUL 1, MINNESOTA—U. S. A.

Want more information? Use post card on last page.

ask about **Amp's Creative Approach**
TO BETTER WIRING

More
Confidence...

Less
Expense

with



Taper Technique

A-MP Taper Pins, Taper Bloks, Taper Tips, Taper Tabs and Taper Tab Receptacles offer great freedom of circuit design and insure maximum electrical stability.

They cut material cost . . . cut labor cost . . . and reduce assembly time. Taper Technique is benefiting manufacturers of business machines, aircraft, guided missiles and electronic equipment.

You, too, can benefit by the A-MP Taper Technique. Consult your local A-MP salesman or write to Harrisburg.

©A-MP 1956



Aircraft-Marine Products, Inc.
General Office: Harrisburg, Pa.

A-MP of Canada, Ltd., Toronto, Canada • A-MP-Holland N.V., 's-Hertogenbosch, Holland
Aircraft-Marine Products (G.B.) Ltd., London, England • Societe A-MP de France, Courbevoie, Seine, France

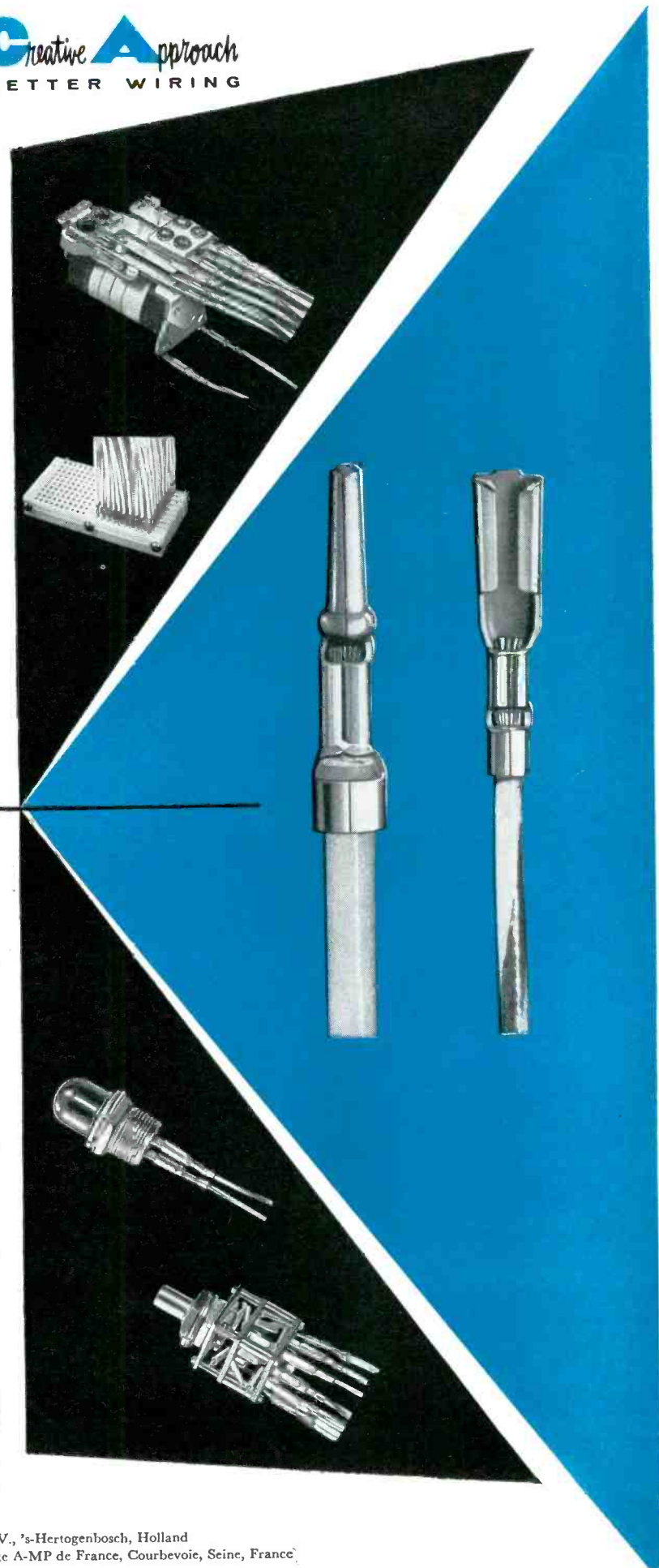

What's YOUR Timing Device Requirement ?

HAYDON* has the RIGHT answer

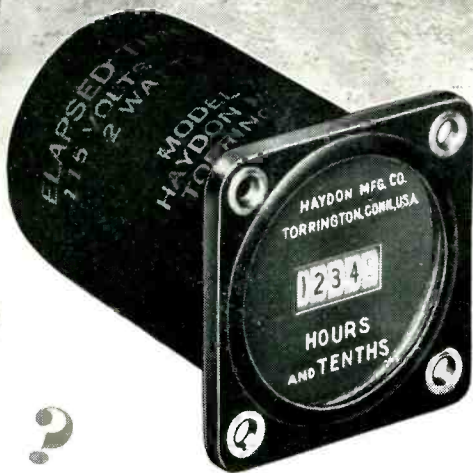

A TYPICAL EXAMPLE

Series 7010
Elapsed
Time
Indicator

THE RIGHT MOTOR . . . unusually compact, fully enclosed mechanism, controlled lubrication, simple, accurate and dependable, operates in any position.

THE RIGHT DESIGN . . . for any application because you can select from the full line of HAYDON STANDARD interval timers, time delay relays, cycle timers, and elapsed time indicators.

THE RIGHT FACILITIES . . . because HAYDON has the fully integrated engineering and manufacturing facilities to produce and deliver quality on time . . . economically . . . in large or small lots.

THE RIGHT SALES SERVICE . . . because the HAYDON Field Engineer in your area is a Timing Specialist fully qualified to counsel you. He's listed in your Yellow Pages. Have him come in to discuss your requirements . . . or, if you prefer, write to us direct.

*Trademark Reg. U.S. Patent Office

HAYDON
AT TORRINGTON

A Subsidiary of General Time Corp.

HEADQUARTERS FOR
TIMING

HAYDON Manufacturing Company, Inc.
2429 ELM STREET, TORRINGTON, CONN.

ating meter terminals and a plug fitted to the other end. The plug fits into a connector on the adapter, which, in turn, is connected to one of the fixed contact points of the chopper as shown in the circuit of Fig. 1.

The other fixed-contact point was joined to the arm of a one-percent linear potentiometer. A variable resistor and battery were placed across the potentiometer for calibration purposes. A known fraction of the voltage appearing across the potentiometer is added to the voltage of one meter terminal with proper polarity. When the voltage across the potentiometer equals the

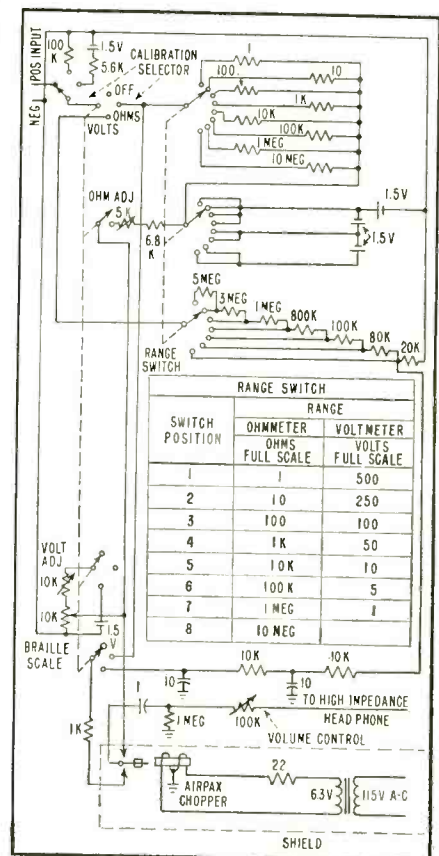

FIG. 2—Volt-ohmmeter circuit using same bridge-nulling technique as vtvm adapter

voltage drop across the meter, a null is indicated by the earphones.

A difficulty encountered was a broad null owing to the low signal level. This was overcome by placing a step-up voltage transformer in the reed circuit of the chopper, which increased the audibility range on either side of the null position. It was then necessary to insert a vol-

Where frequency stability
is important specify
**RMC TYPE JF
DISCAPS**

Type JF DISCAPS answer the need for a ceramic capacitor with outstanding characteristics in frequency stability. This new type extends the available capacity range of the RETMA Z5F ceramic capacitor between +10° and +85° C and meet Y5S specifications between -30° and +85° C.

Available in production quantities in capacities from 150 MMF to 10,000 MMF, type JF DISCAPS show a change of only $\pm 7.5\%$ in the range between +10° to +85° C.

If your applications require superior frequency stability it will pay to investigate RMC's new Type JF DISCAPS.

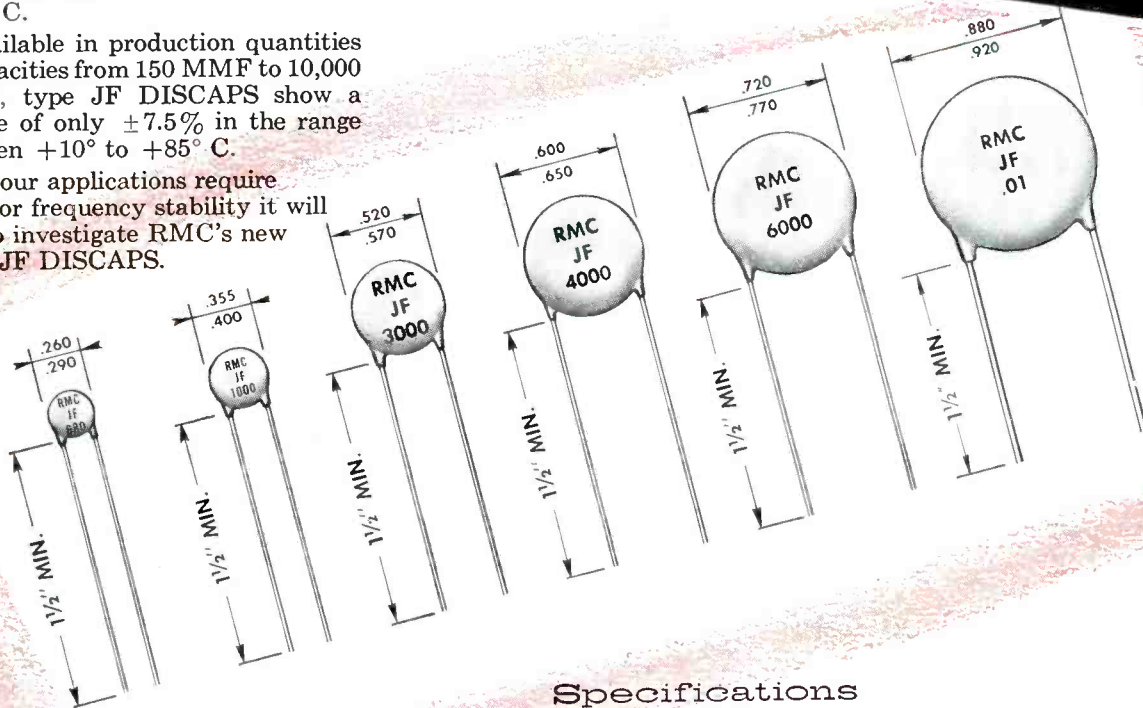
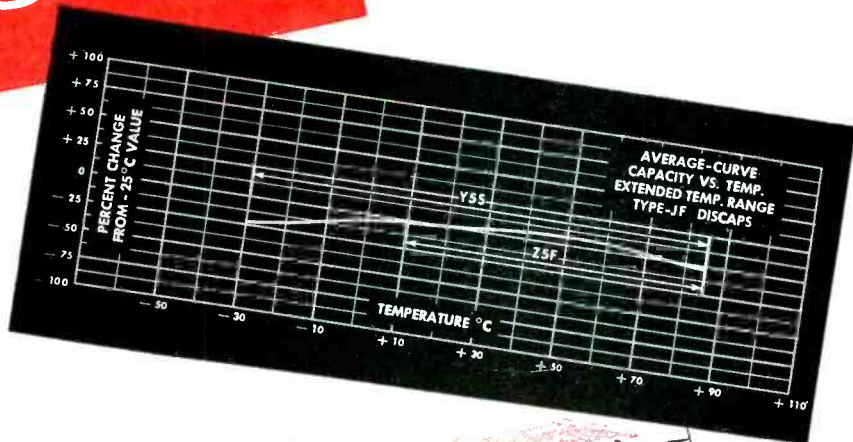

Specifications

Power Factor: 1.5% Max. @ 1 K C (initial)
 Power Factor: 2.5% Max. @ 1 K C after humidity
 Working Voltage: 1000 V.D.C.
 Test Voltage (Flash): 2000 V.D.C.
 Leads: No. 22 tinned copper (.026 dia.)
 Insulation: Durez phenolic—vacuum waxed
 Initial Leakage Resistance: Guaranteed higher than 7500 megohms
 After Humidity Leakage Resistance: Guaranteed higher than 1000 megohms.
 Test per RETMA Specifications REC-107-A.
 Capacity Tolerance: $\pm 10\% \pm 20\%$ at 25° C.

DISCAP
CERAMIC
CAPACITORS

RMC

RADIO MATERIALS CORPORATION
 GENERAL OFFICE: 3325 N. California Ave., Chicago 18, Ill.
 Two RMC Plants Devoted Exclusively to Ceramic Capacitors
 FACTORIES AT CHICAGO, ILL. AND ATTICA, IND.



CONNECTORS for POTTING

----- assured reliability
in the presence of
moisture and humidity

Potting of electrical connectors was pioneered by AMPHENOL in 1953—today a complete selection of AN and Miniature AN-type connectors are available from AMPHENOL in potting constructions.

The greatest benefit from potting is assured electrical reliability in the presence of moisture and humidity. Potted assemblies provide complete protection against the effects of moisture, fuel, oil, lubricants, hydraulic fluid, salt spray and carbon tetrachloride. Potting offers an actual bonded seal—not a seal dependent upon critical face-to-face mechanical seals which tend to create moisture traps under temperature cycling. The potted assembly is tamper-proof and vibration resistant. Potting provides cost, weight and space reduction.

For complete information (background, methods, ordering)
send for the newly issued brochure:
AMPHENOL CONNECTORS FOR POTTING

AMERICAN PHENOLIC CORPORATION
chicago 50, illinois
AMPHENOL CANADA LIMITED toronto 9, ontario



ume control in the circuit to maintain comfortable listening levels.

Braille scales are punched on interchangeable aluminum plates mounted as shown in the photograph. Dots are placed at convenient intervals along a 270-degree arc having a diameter of five inches. The changeable plates add to the versatility of the adapter and permit many scale changes when necessary.

The zero indication of the meter corresponds to the zero-resistance position of the one-percent potentiometer and the 270-deg position was nulled for a full-scale reading of the meter by the calibrating resistor. The adapter accuracy is comparable to that of the voltmeter.

The circuit can also be used in conjunction with the Hewlett-Packard 410B vacuum-tube voltmeter. The photograph shows the meter adapter in operation. It was not practical to measure the voltage appearing across the indicating meter of the Hewlett-Packard 410B directly.

This voltage was found to be too

Cycle Counting Resistance Welder

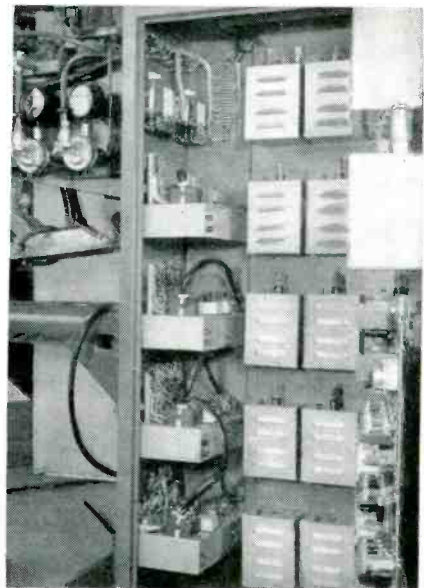

Controls for the resistance welding machine shown above are initiated by counting cycles of line current. A cold-cathode gas tube with ten cathodes and two guide pins between each pair of cathodes counts out timing pulses to initiate functions of the new Sciaky machine

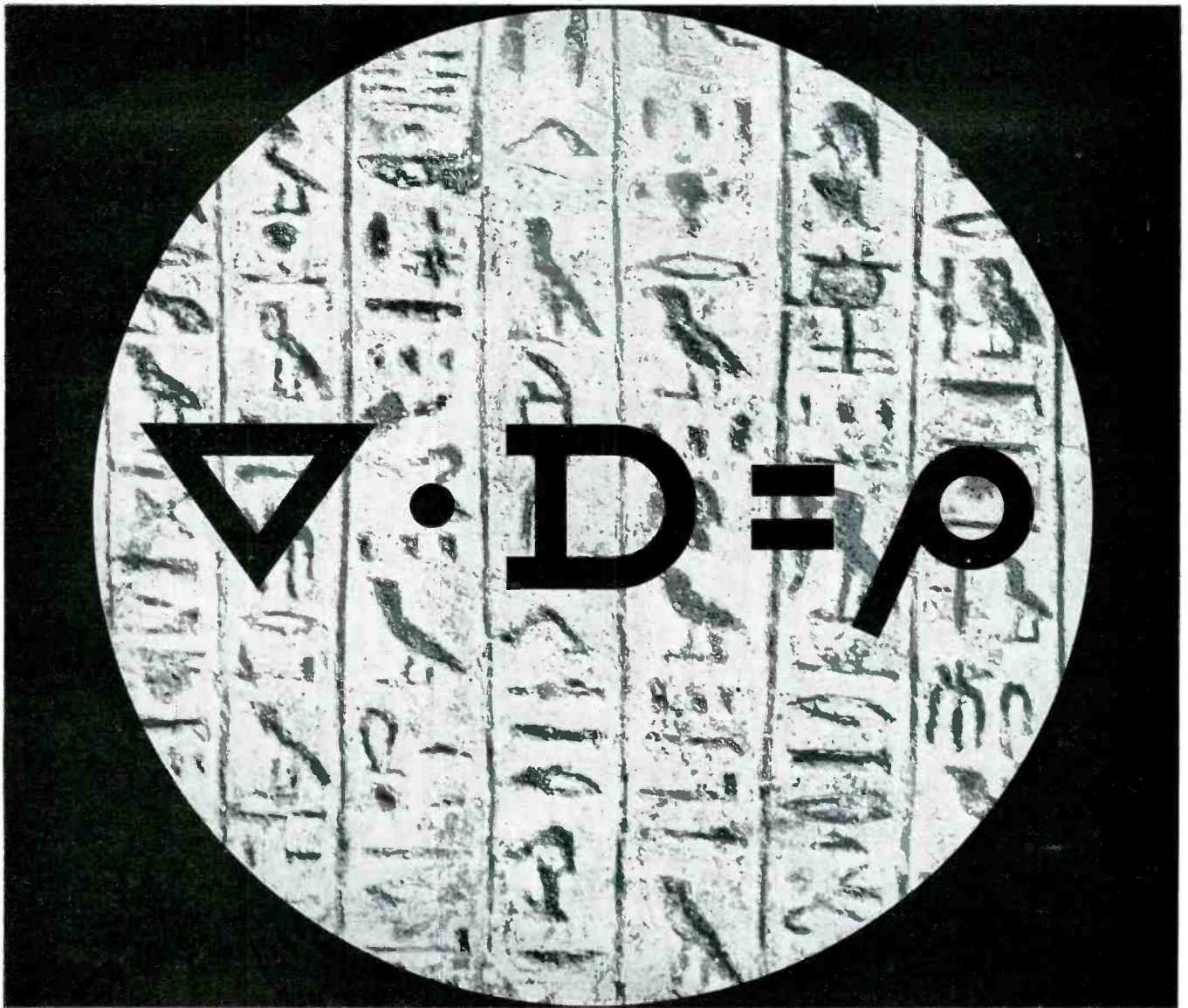

THE BIG STORY

Less than two million days have passed since man's first crude attempt to correlate his thinking and his knowledge with a new science of symbols and hieroglyphics.

And communication is still one of our most undeveloped sciences.

Today, something of great importance is happening at Martin in the technology of communication. It is a new method of harnessing and efficiently utilizing engineering mindpower for the solution of pre-

viously impossible design and development problems.

This new operational concept now holds the key to countless closed doors beyond which lie the "impossible" achievements of tomorrow.

Already the Martin concept is revising the calendar and the cost on top-rated projects in the most advanced areas of flight systems development. And the next frontier is space itself.

It is a big story.

Come to Martin if you are interested.

MARTIN
BALTIMORE

DECADE RESISTANCES & VOLTAGE DIVIDERS

delivered from stock

Accuracy: 10 ohms and
above: $\pm 0.1\%$
1 ohm: $\pm 0.25\%$
0.1 ohm: $\pm 1\%$
0.01 ohm: $\pm 5\%$

Temp. Coeff.: $\pm 0.002\%$ per degree C.

Maximum Load: $\frac{1}{2}$ -watt per step

Frequency Limit: Non-inductive
to 20KC

DECADE RESISTANCE BOXES

Type	Dials	Ohm Steps	Total Resistance—Ohms	Price
817	3	0.01	11,1	\$60.00
818	3	0.1	111	51.00
820	3	1	1,110	56.00
821	3	10	11,100	60.00
822	3	100	111,000	63.00
823	3	1,000	1,110,000	77.00
824	3	10,000	11,100,000	120.00
817-A	4	0.01	111,1	75.00
819	4	0.1	1,111	71.00
825	4	1	11,110	77.00
826	4	10	111,100	79.00
827	4	100	1,111,000	92.00
828	4	1,000	11,110,000	139.00
8285	5	0.1	11,111	94.00
829	5	1	111,110	101.00
830	5	10	1,111,100	113.00
831	5	100	11,111,000	155.00
817-C	6	0.01	11,111,1	105.00
8315	6	0.1	111,111	109.00
832	6	1	1,111,110	121.00
833	6	10	11,111,100	169.00

UNMOUNTED DECADE RESISTANCES

Type	Dials	Ohm Steps	Total Resistance—Ohms	Price
435	1	0.1	1	\$12.00
436	1	1	10	13.25
437	1	10	100	13.25
438	1	100	1,000	15.00
439	1	1,000	10,000	16.00
440	1	10,000	100,000	18.50
441	1	100,000	1,000,000	32.50
442	1	1,000,000	10,000,000	60.00

DECADE VOLTAGE DIVIDERS (Potentiometers)

Type	Dials	Ohm Steps	Total Resistance—Ohms	Price
845	3	1	1,000	98.00
837	4	0.1	1,000	126.00
835	4	1	10,000	132.00
836	4	10	100,000	146.00

SHALLCROSS MANUFACTURING COMPANY

522 Pusey Ave., Collingdale, Pa.

Shallcross

small for the proper operation of the earphone-chopper null detector. It was convenient to connect the adapter into the vacuum-tube voltmeter circuit at a point preceding the range-calibration resistors. For this reason all of the calibration adjustment had to be duplicated in the adapter box. Whenever a voltage measurement is made the range switch on the adapter must be turned to correspond to the range of the meter.

A Braille voltohmmeter with a sensitivity of 20,000 ohms per volt and seven full-scale ranges from 1 to 500 volts is shown in Fig. 2. The ohmmeter employs a bridge circuit with eight full-scale ranges from 1 ohm to 10 megohms. The principle of operation of the voltohmmeter is similar to that of the meter adapter.

REFERENCE

(1) R. W. Gunderson, Blind Improve Test Gear, *Radio-Electronics*, Mar. 1951.

Fusion Heat Stabilizes Crystal

UTILIZING the heat of fusion of an extremely pure organic compound—p-dibromobenzene—keeps crystal oven temperature within 0.01 degree of 87.31 C. Power requirements are 10 watts for normal operation and 20 watts during the brief warmup period. The instrument was developed for the Army Signal Corps by R. Alvarez and C. P. Saylor of the National Bureau of Standards' pure substances laboratory.

Quartz crystals are widely used as frequency standards, as filters in receiver circuits and as frequency stabilizing elements in oscillator circuits. Since a temperature change in a crystal will produce a change in its frequency, common practice has been to control the temperature of the crystal in precise frequency applications.

Such close temperature control is usually achieved only by relatively large and complex systems. The special-purpose oven described below eliminates the need for much of the complex and bulky equipment ordinarily used.

The oven uses p-dibromobenzene in its particular application but

in **color** tv, too

CRUCIBLE PERMANENT **MAGNETS**

*for beam correctors, color purifiers and color equalizers
give maximum energy . . . minimum size*

Designers of electronic and control equipment can count on a *consistently higher energy product* with Crucible alnico magnets. *It means greater power from a minimum size magnet!*

And they're available in practically any size you want—from a fraction of an ounce to several hundred pounds. What's more, Crucible alnico permanent magnets can be sand cast, shell molded, or investment cast to your exact size, shape, or tolerance requirements.

Crucible has been a leading producer of these permanent magnets ever since alnico alloys were developed. And their manufacture is backed by over a half century of fine steelmaking experience. That's why so many magnet applications begin at Crucible.

*Crucible Steel Company of America,
The Oliver Building, Mellon Square,
Pittsburgh 22, Pa.*



CRUCIBLE

first name in special purpose steels

Crucible Steel Company of America

New! Hit of the IRE Shows!

Advance

LABORATORY-PRECISION

Electronic Instruments

ADVANCE supplies a variety of electronic equipment to the British Government and Armed Forces of the British Empire. All Advance instruments are precision-engineered and functionally designed to provide many years of accurate, trouble-free service, even under difficult conditions.

PROFESSIONAL INSTRUMENTS AT MODERATE COST

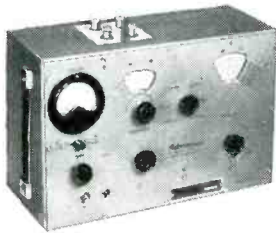

ADVANCE RF Q-Meter

■ Priced right, the Laboratory Q-Meter, Model T-1/E, incorporates an overload-proof VTVM indicator. Model T-1/E measures Q, Inductance, Capacitance, and Power Factor at frequencies between 100 Kc and 100 Mc, in six ranges. The frequency oscillator has an accuracy of $\pm 1\%$. OUTSTANDING SPECIFICATIONS: Tuning capacitor, calibrated in three scales, indicates Capacitance, 40 to 550 mmfd, $\pm 2\%$; Zf (ohms, Mc) 4,000 to 300, $\pm 2\%$; Lf² (uH, Mc) 600 to 50, $\pm 2\%$. Q is measured in two ranges, 10 to 100, and 40 to 400, with an accuracy of $\pm 5\%$. Only \$249.50

ADVANCE VHF Generator

■ Highly versatile, the ADVANCE VHF Signal Generator, Model D-1/DNA, covers 10 to 300 Mc in six ranges with an accuracy of $\pm 1\%$, and offers both square and sine wave modulation, with *direct* calibration. Output voltage, obtained through 75-ohm transmission line, is continuously variable from 1 uv to 100 mv and is calibrated in both uv and db. Accuracy: 10 to 150 Mc, ± 3 db, ± 1 uv; 150 to 300 Mc, ± 4 db, ± 2 uv. Output is modulated 30% ($\pm 3\%$) by a 1,000 cycle sine wave (± 100 cycles) or by a 1,000-cycle square wave (± 100 cycles). Only \$395.00

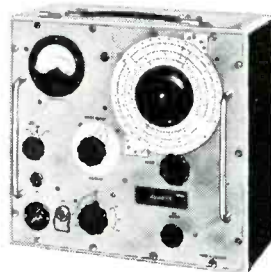

ADVANCE Audio Generator

■ Model J-2/NA meets the need for a highly accurate Audio Generator with low distortion. Covers the range from 15 to 50,000 cycles in three bands, with an accuracy of $\pm 2\%$, ± 1 cycle. The output is continuously variable into 600 ohms: 0.1 mw to 1.0 watt (0.25 to 25 volts) ± 2 db. Maximum into 5 ohms, better than 1 watt. Total harmonic distortion and hum content above 100 cycles is less than 2% at rated output, or less than 1% at 0.1 watt. Only \$149.50

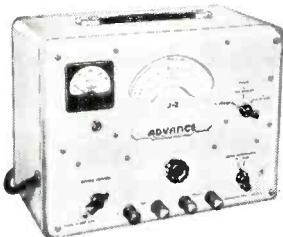

ADVANCE Precision Attenuators cover the frequency spectrum from audio to UHF. Model A-38 provides four 20 db steps of attenuation and is useful up to 300 Mc. Model A-55 is designed for extreme accuracy in its RF to VHF range. Model A-57 is an absolutely linear device for operation in UHF range.

WRITE TODAY FOR COMPLETE SPECIFICATIONS

Sole Agents for the United States

FISHER RADIO SALES CO., INC. · 21-39 44th Dr., L.I.C. 1, N. Y.

other substances with different melting points provide other operating temperatures. Phenoxybenzene, for instance, has been employed in maintaining quartz crystals at a constant temperature of 26.88 C where ambient temperature is low.

When a substance is partially molten, its latent heat of fusion provides thermal ballasting. That is, a heat loss causes crystallization of the material with evolution of the latent heat of fusion. A heat gain, on the other hand, results in absorption of heat as the solid phase melts. The melting temperature at the solid-liquid interface remains unchanged, provided that

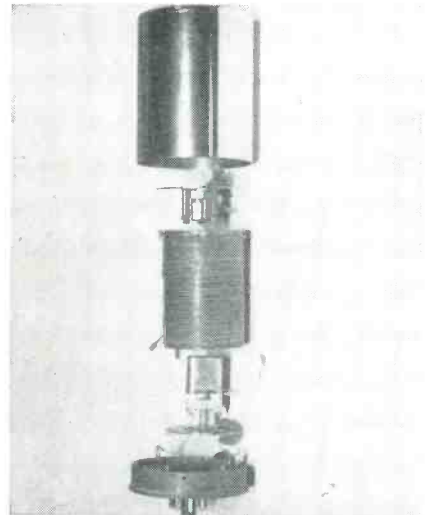

Constant-temperature oven used to stabilize temperature of a quartz crystal for precise oscillator frequency control shown disassembled

the material is pure and that the pressure is constant.

A substance used for temperature control in this way must possess a melting temperature within the desired operating limits, extreme chemical stability when in contact with the oven components, a high heat of fusion, and a high velocity of crystallization. The substance p-dibromobenzene meets these requirements.

The oven is contained in a cylinder 3½ in. high and 2½ in. in diameter, mounted on an octal base. Inside the cylinder is a vacuum-tight container into which a quantity of p-dibromobenzene has been sealed. During operation of the oven, the material is about half liquid and half solid and completely

another first!

MOLCOTE metallized ceramic coating

for
use with
all types
of
hard
solders!

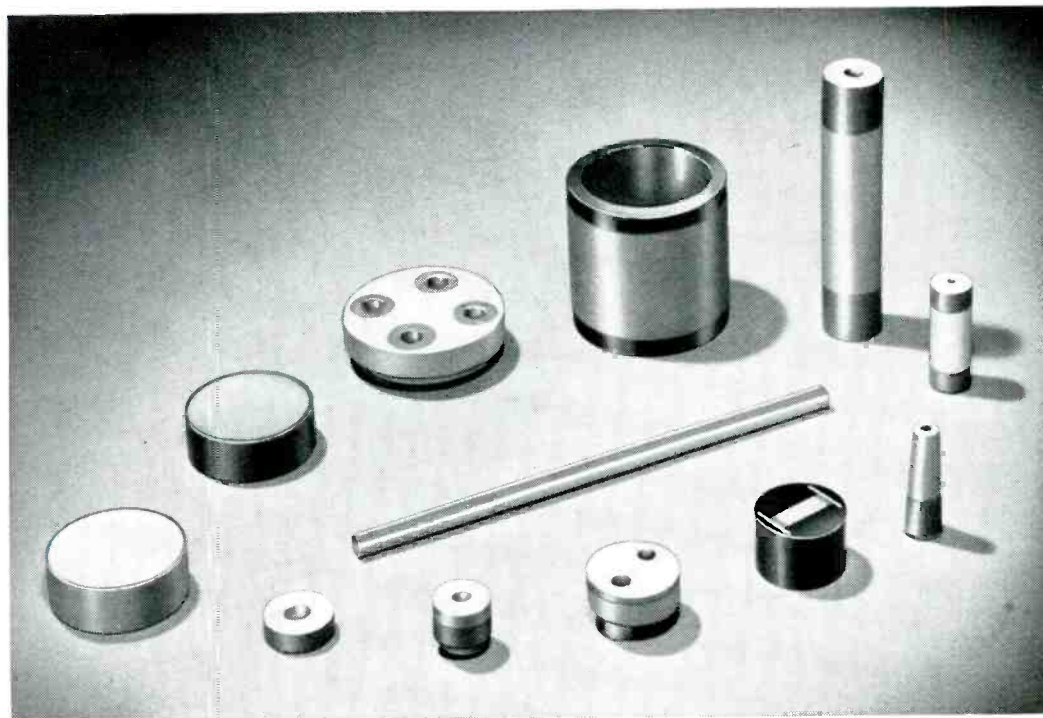

HERE'S another first from Frenchtown . . . a firmly bonded metal-to-ceramic coated surface to which a metal or metallized ceramic may be hard soldered up to 2200° F.

MOLCOTE, applied to ceramic bodies by a special Frenchtown process and fired at high temperature, offers distinct advantages over existing coatings. Its versatility permits use in a wide latitude of high temperature assembly manipulation. And, its extreme refractory qualities defy the attack of solders of the copper-silver, silver, and pure copper types.

With MOLCOTE, no expensive preliminary processing is required. You may use it immediately for any high temperature solder operation.

MOLCOTE's solder bonds are exceptionally strong to the point of fracture of the ceramic, making it ideal for such applications as vacuum type ceramic

envelope electronic equipment assemblies, support insulators, condenser shafts, hermetic seals, wave guide windows and a host of others. We'd like you to know more about the unlimited possibilities of MOLCOTE. Bulletin 1155 contains complete engineering details. Write for your free copy.

Bulletin 1155 contains complete engineering data on MOLCOTE, Frenchtown's metallized ceramic coating for use with all types of hard solders. Write for your copy.

VISIT US AT THE SHOW!

We'll be pleased to show you how MOLCOTE can help your product at our Booth No. 215, Design Engineering Show, Convention Hall, Philadelphia, May 14-17, 1956.

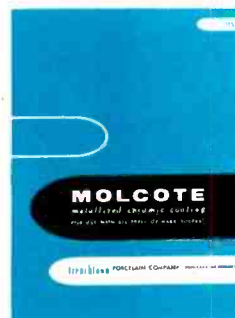

CALIFORNIA
REPRESENTATIVE:
Edwin E. Starr,
4101 Rhodes Ave.,
North Hollywood,
Cal. STanley 7-5879

frenchtown

PORCELAIN COMPANY

86 MUIRHEAD AVENUE | TRENTON 9, NEW JERSEY

AUTOMATIC PRODUCTION AND QUALITY CONTROL TESTING

with the

CTI Supertester

The CTI Supertester is an automatic, precision instrument for production testing, fault analysis, and preventive maintenance. It checks electronic and electrical products more completely and in a fraction of the time required by present methods.

Providing complete flexibility and rapid interchangeability between products, the Supertester can be programmed for any combination or sequence of the following measurements:

Impedance	A-C Voltage	Leakage
Resistance	D-C Voltage	Continuity

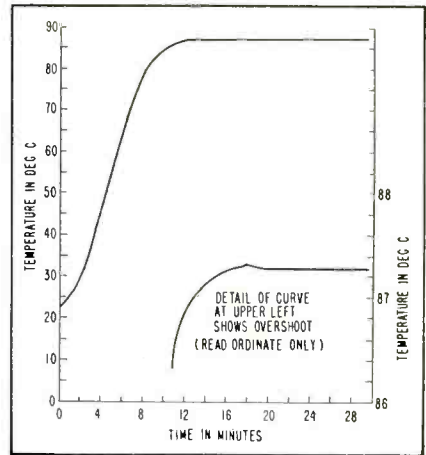

Time-temperature curve shows warm-up period and eventual stabilization of crystal oven. Total variation in 6 days did not exceed 0.007 C

★ REDUCE TEST COSTS

Requiring only an untrained operator, the Supertester frees valuable technical personnel for specialized work. One

Supertester is the equivalent of a series of custom built, single product testers, or a benchful of precision bridges and meters.

★ SPEED PRODUCTION

Complex circuits, gain and frequency measurements, involved relay operations—all are checked at the rate of 180

tests per minute. Hours of manual test procedure have been reduced to minutes. Time is not wasted checking good units.

★ INCREASE PRODUCT QUALITY

Accurately checking every production unit against design values and tolerances, the Supertester does not overlook tests or pass questionable circuits. Original specifications are

tirelessly and rigidly adhered to. Instead of checking only the essential circuit parameters, the Supertester tests equipment completely, quickly, and at far less cost.

Proved in Use!

The Supertester is being used daily by a number of the nation's leading manufacturers. Their testing applications include printed circuits, telemetering units, guided missile circuitry and pre-flight tests, and aircraft electronic equipment.

Whatever the problem, rigid test specifications, high production rates, or reducing test costs, automatic testing is the solution, and the CTI Supertester has proved itself to be the efficient, money saving means to this solution.

fills the container.

At the top of the container is a metal bellows that is linked to a spring-loaded miniature switch. The volume changes occurring during phase transformations are transmitted to the bellows, turning the heater on or off to keep the chemical partially molten. Spring-loading the switch provides a pressure relief system in case a greater proportion of liquid is formed during the warmup period than would be present at the normal operating point.

A second heater provides rapid warmup. It is controlled by a bimetallic element that cuts off the power when the substance is about seven degrees below the melting point. A copper vane system distributes the heat rapidly throughout the container and reduces any temperature gradients that might exist if solid and liquid become separated during operation. The crystal and its holder fit into a well within the container.

Atomic Reactor Camera

REMOTELY controlled and with its own source of illumination, a television camera has been constructed by Pye, Ltd. of England for insertion in a reactor furnace.

Designed for use while the furnace is still radioactive but not actually operating, the unit can withstand temperatures in the order of 200 C. The camera is housed

COLOR TELEVISION INCORPORATED



SAN CARLOS 1, CALIF.

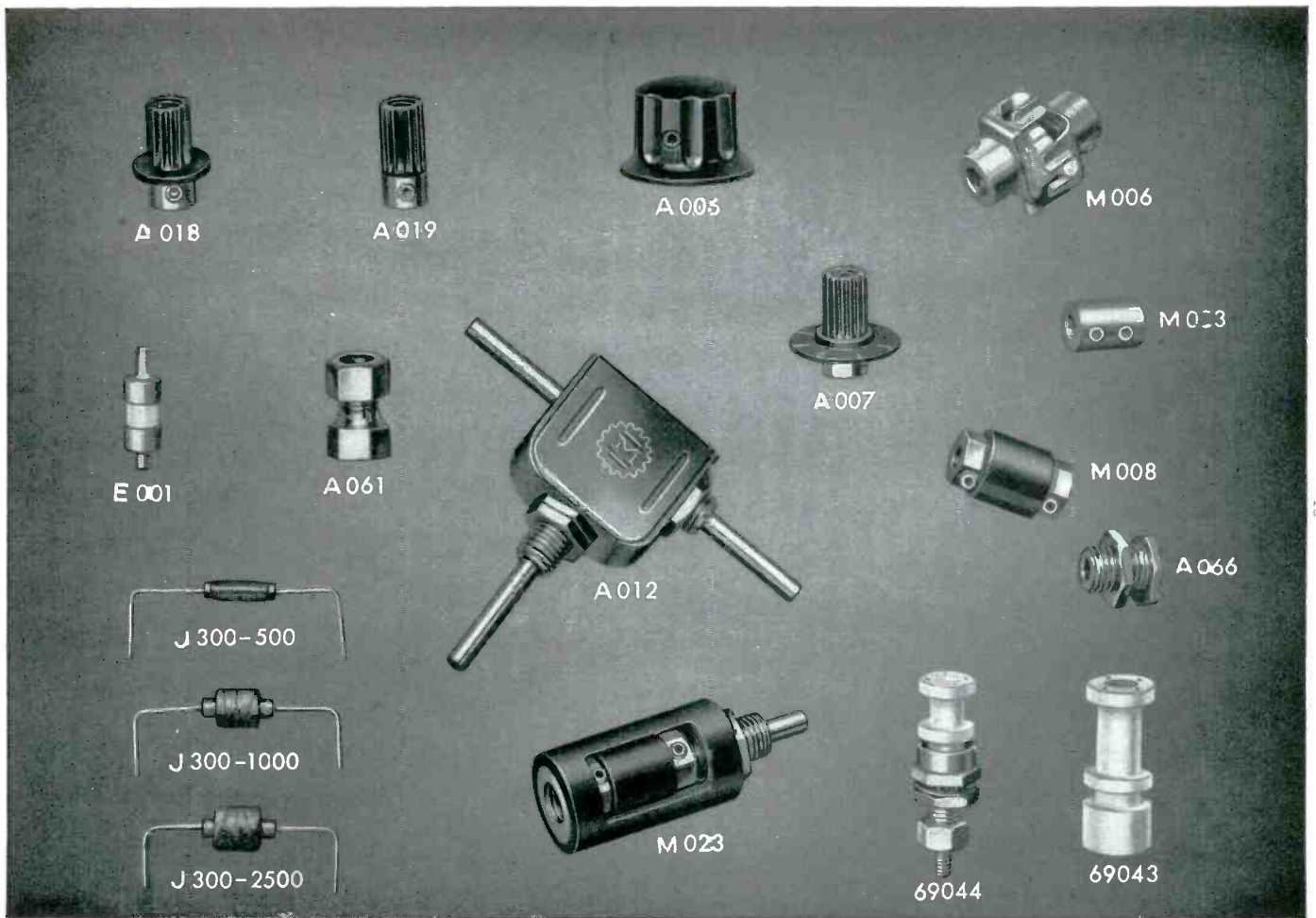

MINIATURIZED COMPONENTS

DESIGNED for APPLICATION miniaturized components developed for use in our own equipment such as the 90901 Oscilloscope, are now available for separate sale. Many of these parts are similar in most details except size with their equivalents in our standard component parts group and in certain devices where complete miniaturization is not paramount, a combination of standard and miniature components may possibly be used to advantage. For convenience, we have also listed on this page the extremely small sized coil forms from our standard catalogue. Additional miniature and subminiature components are in process of design and will be announced shortly.

CODE	DESCRIPTION	NET PRICE
A006	Matches standard knobs in style. Black plastic with brass insert. For 1/8" shaft. Overall height 1/2". Diameter 3/4".	\$.42
A007	Same as A018 except for 3/8" diameter plastic dial with 5 index lines.	.48
A012	Right angle drive. 1/8" diameter shafts. Single hole mounting bushing 1/4"-32 diameter.	3.90
A018	1/8" diameter black plastic knob with brass insert for 1/8" shaft. Skirt diameter 3/8". Overall height 3/8". Unique design has screwdriver slot in top.	.39

CODE	DESCRIPTION	NET PRICE
A019	Similar to A018, but without flange.	\$.36
A061	Shaft lock for 1/8" diameter shaft. 1/4"-32 bushing. Nickel plated brass.	.39
A066	Shaft bearing for 1/8" diameter shafts. Nickel plated brass. Fits 1/4" diameter hole.	.36
E001	Steatite standoff or tie-point integral mounting eyelet. .205 overall diameter. Box of five.	.90
J300-500	Iron core RF choke 500 uh.	.42
J300-1000	Iron core RF choke 1000 uh.	.42
J300-2500	Iron core RF choke 2 1/2 mh.	.42
M003	Solid coupling for 1/8" diameter shaft. Nickel plated brass.	.30
M006	Universal joint style flexible coupling. Spring finger. Steatite insulation. Nickel plated brass for 1/8" diameter shafts.	.75
M008	Insulated coupling, with nickel plated brass inserts for 1/8" diameter shafts.	.48
M023	Insulated shaft extension for mounting sub miniature potentiometer with 1/8" diameter shafts and 1/4"-32 bushing.	1.35
69043	Steatite coil form. Adjustable core. Top tuned. Tapped 4-40 hole in case for mounting. Winding space 1/4" diameter x 1 1/2" length.	.84
69044	Steatite coil form. Adjustable brass core. Bottom tuned. Mounting by No. 1D-32 brass base. Winding space .187 diameter by 3/16" length.	.84

JAMES MILLEN



MFG. CO., INC.

MAIN OFFICE

AND FACTORY

MALDEN, MASSACHUSETTS, U.S.A.



As aviation goes higher and higher in exploration and flight in upper altitudes, the requirements for airborne components become more demanding. Rugged operating conditions for such components are anticipated and built into the entire IMC line of AC and DC subfractional, servo and gear motors, fans, blowers and dynamotors. Each unit is custom-engineered to insure optimum performance under extreme conditions of humidity, temperature, vibration and altitude. Quality materials are combined with forward-looking engineering know-how to provide a line that has consistently proven its superiority in a wide range of industrial and military application.

IMC components have been chosen repeatedly for reliability in critical airborne installations. This is due directly to a number of "plus" design features which are standard in the line. For example, each motor is built to the closest possible tolerances to assure peak performance at all times. All rotating parts are dynamically balanced, with precision ball bearings used for longer life. The entire line—from the 1/1000 to the 1/10 hp units—features a performance quality all its own . . . at a level of efficiency all its own.

Our skills and facilities are available for assignment to your motor application problems.

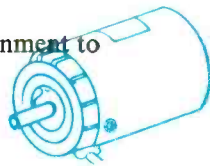

Induction Motors Corp.

570 Main St., Westbury, L. I., N. Y. • Phone EDgewood 4-7070

in a stainless steel case into which carbon dioxide is pumped.

The gas coolant passes out into the interior of the reactor through small vents in the camera, but has no effect upon operation of the reactor.

After undergoing tests the camera will be installed at the Calder Hall atomic power station in Cumberland, according to McGraw-Hill World News.

British Scatter Terminal

EQUIPMENT for direct vhf communication between the United Kingdom and Iceland is now being installed in Oxfordshire, England. The terminal located on an escarpment of the Chilterns at Kingston Blount is nearing completion.

Receivers have been in operation and permanent transmitters will soon be installed. Using ionospheric forward-scatter techniques, there will be at least eight teleprinter circuits and one voice channel.

Two-way communication through the Iceland repeater will eventually be possible from Limestone, Maine to the U. K. via Goose Bay, Labrador and Sondrestrom, Greenland. Also tied into the circuits will be stations at Thule and Narsarsuak, Greenland.

Color TV Monitors Nuclear Separation

TELEVISION chains installed in the Hanford separation facility crane are closed-circuit, field-sequential color systems. Filters used on the cameras and receivers are made up in six sections and have two sections of each of three primary colors: red, blue, and green.

The camera filter is rotated in synchronization and color phase with the receiver filter disk. Any picture picked up by the camera passes through the filter, creating a signal proportional to the amount of color in the scene being scanned, which is the same as that of the filter section being used. For each scanning period of the camera

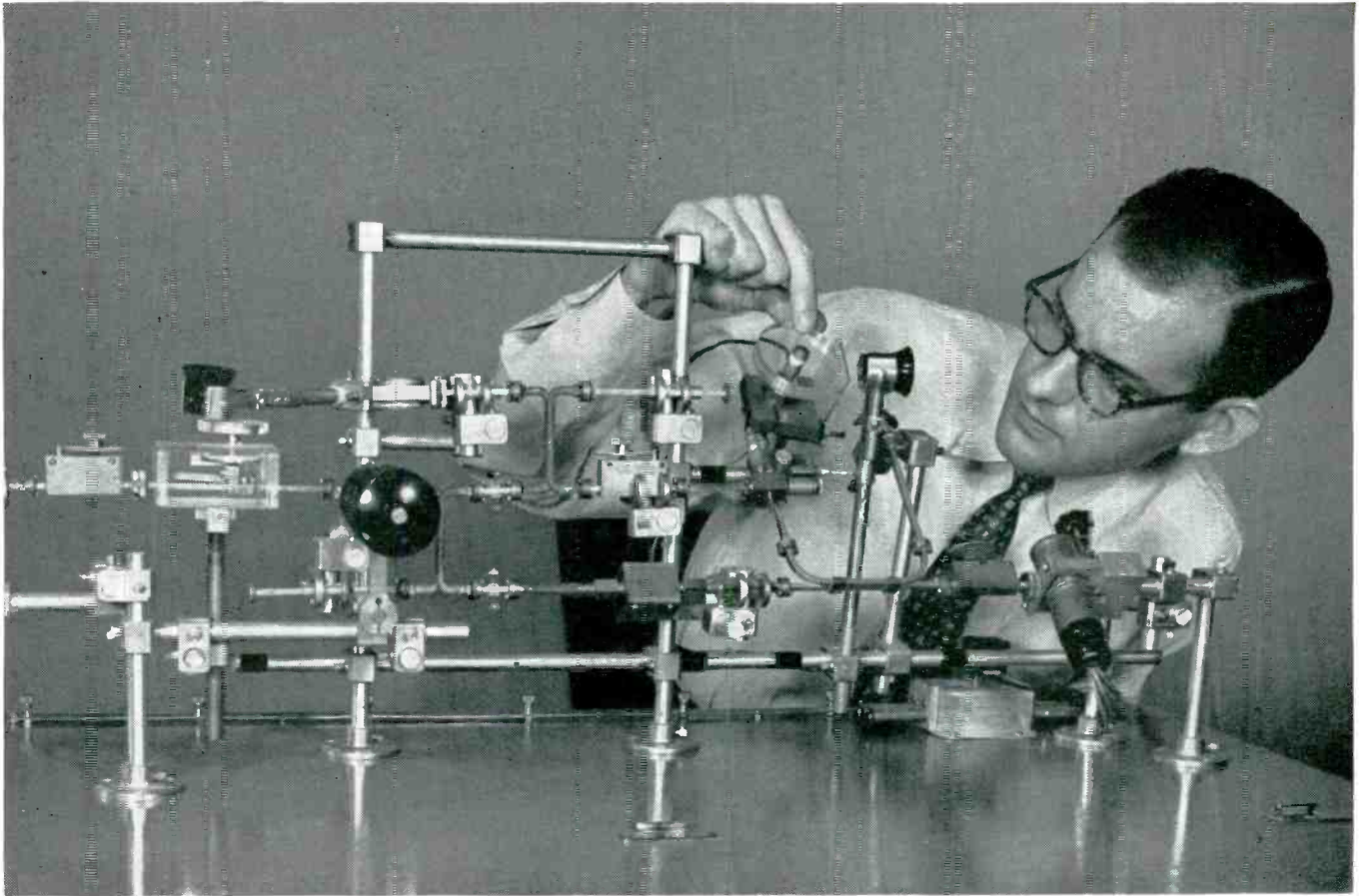

Physicist G. K. Farney checks the frequency of Bell's new klystron, which is located at far right. Tube's output is about 20 milliwatts.

Sixty billion vibrations per second

A great new giant of communications—a waveguide system for carrying hundreds of thousands of voices at once, as well as television programs—is being investigated at Bell Telephone Laboratories.

Such a revolutionary system calls for frequencies much higher than any now used in communications. These are provided by a reflex klystron tube that oscillates at 60,000 megacycles, and produces waves only 5 mm. long.

The resonant cavity that determines the frequency is smaller than a pinhead. The grid through which the energizing electron beam is projected is only seven times as wide as a human hair, and the grid "wires" are of tung-

sten ribbon $3/10,000$ inch in width.

G. K. Farney, University of Kentucky Ph. D. in nuclear physics, is one of the men who successfully executed the development of the klystron. Dr. Farney is a member of a

team of Bell scientists whose exciting goal is to harness the immense bandwidth that is available with millimeter waves . . . and to make certain that your telephone system remains the best in the world.

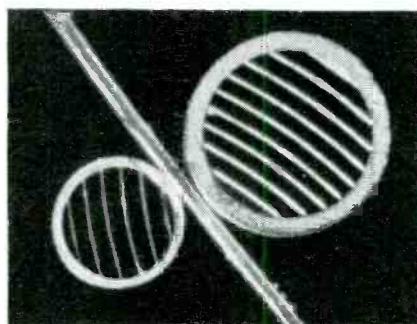

Grids in new tube, enlarged 30 times, with human hair for comparison. Electronic beam passes through smaller, then larger, grid.

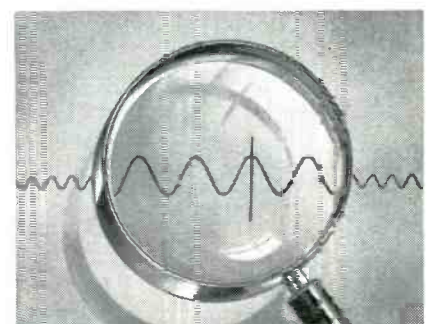

Wavelengths produced by the klystron tube are only .2 inch long— $1/15$ that of the transcontinental radio relay system.

BELL TELEPHONE LABORATORIES
WORLD CENTER OF COMMUNICATIONS RESEARCH



GLOBE PRECISION



*actual
size*

MIDGET A.C. MOTORS PACK A GIANT PUNCH!



*actual
size*

Globe's miniature a.c. motors are precision made for applications requiring *small size, light weight, high torque and high quality!* Hysteresis-synchronous, induction, and variable-frequency types are available for 1, 2 or 3-phase operation; 400 or 60 cps; voltages up to 200 v.a.c. Available with integral gear reducers for broad selection of speeds and torques up to 3500 oz. in. Units designed to meet military specifications for aircraft equipment. Type SC (above) and MC (left) are shown actual size. Write on your letterhead for bulletins on Globe's a.c. motors.



GLOBE INDUSTRIES, INC.

1784 Stanley Avenue, Dayton 4, Ohio
precision a.c. or d.c. motors and motorized devices.
dedicated to the best in product and in service.

tube, a different colored filter section is in position in front of the camera tube. The color filters change at a rate of every 1/144th second. Because of the retentivity of the human eye, the different colored pictures blend to reproduce the colors in the televised scene.

The camera employs an image orthicon pick-up tube. The optical



Separation facility crane used at Hanford AEC plutonium plant operated by GE requires remote monitoring of intensely radioactive areas. Crane control operator receives needed information telemetered by color television

system is made up of three lenses mounted on a turret head that can be remotely operated. The lenses used are a 9-inch, f4.5 telephoto; 135-mm, f4.5 enlarging raptar and an 82-mm, f3.2 raptar. The camera is mounted on a U-head pan and tilt assembly that is also remotely controlled. Two lights are mounted on the pan and tilt assembly and these along with the normal lighting installed on the crane provide illumination of the televised scene,

Quick Microwave



A microwave station that can be transported to a site by H-19 helicopter (as shown above) weighs 1,900 pounds with shelter. Developed by Motorola for the Air Force, the equipment operates at frequencies between 7 and 8 kmc

New Standard STABILINES

Meet Conditions Usually
Considered as Special Applications

The "Unusual"
is Usual for
STABILINE*
Automatic
Voltage Regulators

DESIGNED FOR MIL-E-16400

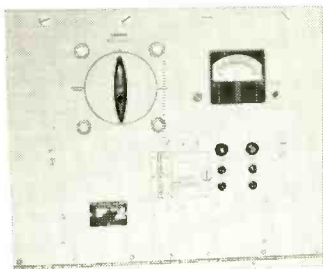

STABILINE TYPE EM10004 (Electro-mechanical)
INPUT: 195-255 volts, 50/60 cycles, single phase
OUTPUT: 230 volts, 24 KVA

MEETS MIL-E-4158



STABILINE TYPE EM10002 (Electro-mechanical) for Air Force land based installations.
INPUT: 105-135 volts, 55/65 cycles, three phase, 4 wire
OUTPUT: 120 volts phase to neutral, 55.5 amperes, 20 KVA, individual phase control

U. S. NAVY SPECIFICATIONS
16-E-4 AND 40-T-9

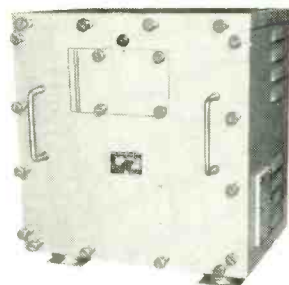

STABILINE TYPE EM10006 (Electro-mechanical) for applications involving shock and vibration requirements.
INPUT: 385-490 volts, 45/65 cycles, single phase
OUTPUT: 440 volts, 2.2 KVA

FOR NORMALLY LOW
INPUT VOLTAGES

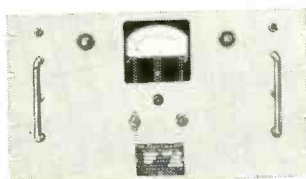

STABILINE TYPE EM10003 (Electro-mechanical)
INPUT: 80-115 volts, 50/60 cycles, single phase
OUTPUT: 115 volts, 2.0 KVA

MEETS SPECIFICATION MIL-E-4158

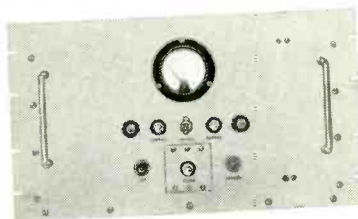

STABILINE TYPE EM10009 (Electro-mechanical)
INPUT: 187-229 volts, 410 cycles $\pm 5\%$, three phase, 4 wire
OUTPUT: 203-213 volts, 14.0 amperes, 5.0 KVA

FOR MILITARY APPLICATIONS

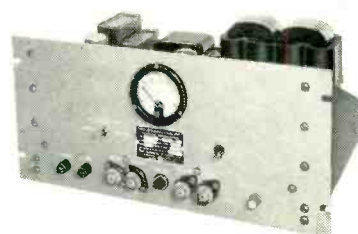

STABILINE TYPE IE20003 (Completely Electronic) with no moving parts.
INPUT: 95-135 volts, 60 cycles $\pm 10\%$, single phase
OUTPUT: 115 volts nominal, adjustable 110-120 volts, 8.5 amperes, 1.0 KVA

WITHSTANDS HIGH HUMIDITY

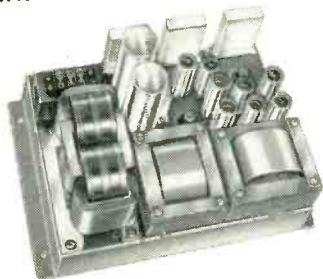

STABILINE TYPE IE20002 (Completely Electronic) with no moving parts.
INPUT: 190-250 volts, 50/60 cycles, single phase
OUTPUT: 230 volts, 150 VA

*Trade Mark Reg. U. S. Pat. Off.

14663 Titus St., Van Nuys, Cal. • P.O. Box 946,
2881 El Camino Real, Redwood City, Cal. • 482-B
Eglinton Ave., West, Toronto 12, Ontario, Can.
2217 Biscayne Blvd., Miami 37, Florida • P.O. Box
48, 721 So. Blvd., Oak Park, Ill. • 4033 W. Rogers
Ave., Office #2 Tippet Bldg., Baltimore 15, Maryland
250 Park Ave., Rms. 502-504 Postum Bldg., New
York 17, N. Y. • P.O. Box 132, 101 Public Sq.,
Medino, Ohio • 4515 Prentice St., Room 201, Dallas
6, Texas.

Check the characteristics of these new STABILINE Automatic Voltage Regulators against your "special" requirements involving automatic voltage regulation. You may find that you no longer need to look for special equipment. These units are standard STABILINES as are numerous other units with rated capacities from 0.25 KVA to 100 KVA. Look to SUPERIOR ELECTRIC for the solution to your automatic voltage regulation problems.

Be sure to see Superior Electric's MOBILE DISPLAY when it is in your area.



THE SUPERIOR ELECTRIC COMPANY
205 MIDDLE STREET, BRISTOL, CONNECTICUT

Please send prices and more facts on STABILINE Automatic Voltage Regulators Please have representative call

Name

Company Name

Address

City Zone State



The Curtiss-Wright "SNAPPER"

NEW CONCEPT... ADVANCED DESIGN
IN THERMAL TIME DELAY RELAYS

Designed for high performance and long life, the Curtiss-Wright "SNAPPER" Thermal Time Delay Relay is proving itself in countless applications involving time delay in electrical circuits. Such applications include circuits to provide definite on-off time intervals to delay the application of high voltage until after warm-up period and for over and under voltage protection with simultaneous fault indication.

These relays have single-pole double-throw contact action,

high ambient temperature range, freedom from chatter and arcing, and are small in size. The "SNAPPER" thermal time delay relays are factory pre-set from 3 to 120 seconds. They are available in metal envelope, miniature (7 and 9 pin) or octal (8 pin) and in a glass envelope in 9 pin only.

Curtiss-Wright manufactures the High-Low "SNAPPER" Differential Thermostat with high precision characteristics. Write to Thermal Devices for complete information.



ranging from 40 to 100 foot-candles.

The color control monitor has a 7-inch picture tube along with the sync generator circuits, scanning circuits and blanking circuits. Horizontal scanning frequency is 29,160 cps, vertical scanning frequency is 144 cps and complete color repetition rate is 24 cps. There are 405 interlaced scanning lines and video bandwidth is 12 mc.

One-Way Waveguide Correspondence

AN ARTICLE describing an asymmetrical waveguide was described, beginning on page 192 of the December 1955 issue of *ELECTRONICS*. There has been comment upon the device, which is summarized here in correspondence from three different sources.

From W. Sichak of Federal Telecommunication Laboratories:

"The . . . waveguide violates the reciprocity theorem for linear passive networks. The power transmis-

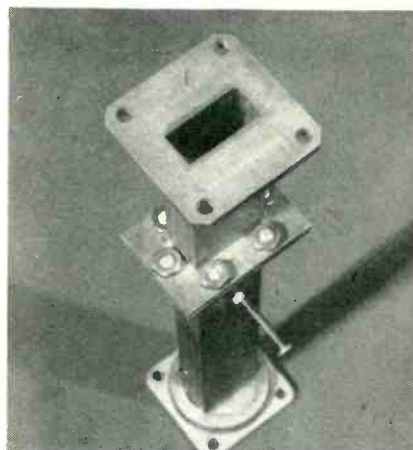

Photograph of waveguide built by Pritchard and used to test asymmetrical effect claimed by author of original article

sion coefficients were apparently calculated from swr measurements, which is valid only for nondissipative networks.

"Consider, for example, a network made of a 6-db matched attenuator and a reactance that produces a swr of 14 when terminated in a matched load. The swr's are considerably different, even though the transmission coefficient between a matched generator and a matched load is the same

*Miniaturization
takes a big step forward
as Driver-Harris
announces...*

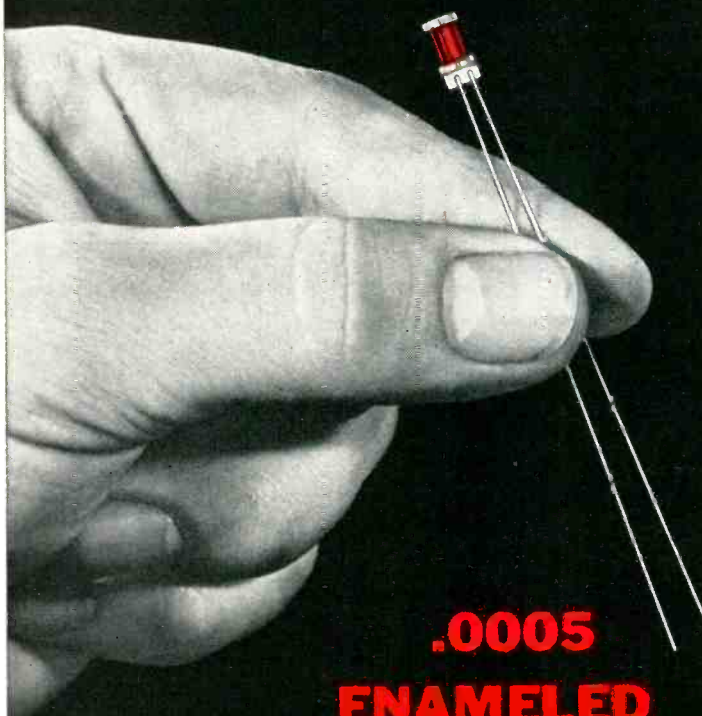

**.0005
ENAMELED
KARMA* WIRE**
rated 3200 Ω /ft.

What this development can mean to resistor manufacturers is here dramatically illustrated. The large wire-wound resistor is rated at 1 megohm. The infinitely smaller one, wound with .0005 Enameled Driver-Harris Karma is rated at 1½ megohms. In this particular application 50% more resistance or ½ megohm has been put on a ceramic spindle 1/5 the size of the original bobbin.

Even though we have succeeded in drawing Karma down to this fine size, its outstanding electrical and physical properties are maintained. Most important of these are:

- Low Temp. Coeff. of Resistance less than ± 20 parts per million
- Wider temperature range—65°C to 125°C
- Low thermal EMF against copper (equalled only by Manganin)
- High tensile strength combined with lower thermal expansion
- High resistance to oxidation

Add to these advantages the fact that the final cost per ohm is lower than in heavier sizes. Available now in commercial quantities. Complete data mailed on request.

*T.M. Reg. U. S. Pat. Off.



Driver-Harris
COMPANY

HARRISON, NEW JERSEY

BRANCHES: Chicago, Detroit, Cleveland, Louisville, Los Angeles, San Francisco In Canada: The B. GREENING WIRE COMPANY, Ltd., Hamilton, Ontario

MAKERS OF THE MOST COMPLETE LINE OF ELECTRIC HEATING, RESISTANCE, AND ELECTRONIC ALLOYS IN THE WORLD

**improved facilities
to serve you better . . .**



Artist's rendition of improved manufacturing facilities of Nothelfer Winding Laboratories, Inc.

**specialists in
transformers
for any custom
requirement**



Nothelfer

WINDING LABORATORIES, Inc.
P. O. Box 455, Dept. 106, Trenton, New Jersey

in both directions (Fig. 1).

"Assuming that the network is nondissipative gives power transmission coefficients of 0.95 and 0.25 instead of 0.062 in both directions. The device (Fig. 2) was built using the same taper dimensions given but a slide screw tuner was used instead of the three tuning screws.

"Measurements made at 8,760 and 9,100 mc showed forward swr's of 1.25 and 1.3, backward swr's of 4 and 3.6 and symmetrical insertion losses of 4 and 3 db."

Harry Gruenberg and W. J. Bleackley, National Research Council, Canada, comment:

The author . . . "purports to have

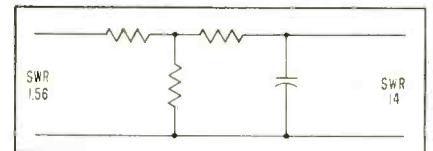

FIG. 1—Network used by Sichak

made a device which transmits power in one direction only without the use of any nonreciprocal elements such as ferrites. Since such a device obviously violates the reciprocity theorem, it follows that the author must somehow misinterpret his experimental results.

"It is not difficult to find the fallacy in the author's interpretation. It is apparent from the author's own admission and from an examination of his experimental curves that he never measured the power transmission coefficient of his device. He only measured input standing-wave ratios and deduced from these the transmission coefficient assuming that the structure is lossless.

"The fact that the values so obtained for forward and backward transmission differ from each other should not have been interpreted as a violation of reciprocity but as an indication that the tacit assumption of zero loss is incorrect. If direct measurements of the transmission coefficient were made the result is bound to be the same for both directions of propagation.

"The difference between the direct measurements and the values given by the author would give the power lost in the device. The

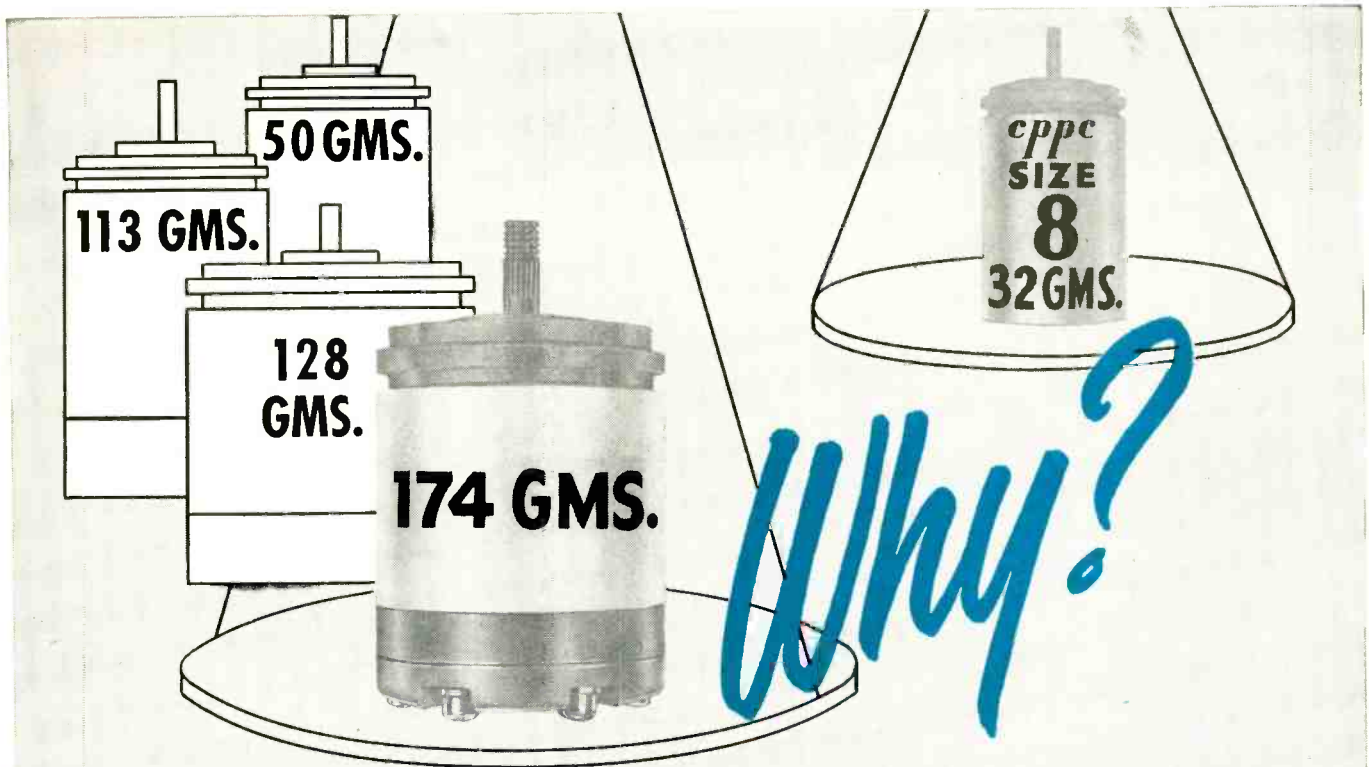

WHY USE 1945 SYNCHROS IN 1956 DESIGNS?



Function	Type Number	Primary Element	Excitation Voltage 400 cy.	Input Current (ma.)	Input Power (Watts)	Primary Impedance Secondary Open (Phase)	Primary Resistance (line)	Secondary Element	Output Voltage	Secondary Impedance Primary Open (Phase)	Secondary Impedance Primary Shorted	Secondary Resistance (line)	Phase Shift Degrees	Sensitivity mv./deg.	Accuracy Minutes Max.
Transmitter	CGC-8-A-7	Rotor 1 Phase	26.0	100	.50	54+ j260	37.0	Stator 3 Phase	11.8	12+ j45	15+ j3.5	11.8	8.0	200	7
Control Transformer	CTC-8-A-1	Stator 3 Phase	11.8	90	.23	28+ j110	24.7	Rotor 1 Phase	23.6	220+ j740	246+ j60	143	8.5	400	7
Control Transformer	CTC-8-A-4	Stator 3 Phase	11.8	37	.09	67+ j270	59.5	Rotor 1 Phase	24.0	508+ j1680	640+ j190	381	9.2	400	7
Resolver	CSC-8-A-1	Stator 2 Phase	11.8	84	.27	38+ j136	27.0	Rotor 2 Phase	23.2	280+ j600	344+ j75	230	11	400	7
		Rotor 2 Phase	26.0	39	.43	280+ j600	230	Stator 2 Phase	10.6	38+ j136	70+ j29	27.0	20	180	7
Repeater	CRC-8-A-1	Rotor 1 Phase	26.0	100	.50	54+ j260	37.0	Stator 3 Phase	11.8	12+ j45	15+ j3.5	11.8	8.0	200	30*
Differential	CDC-8-A-1	Stator 3 Phase	11.8	85	.21	27+ j120	25.0	Rotor 3 Phase	11.8	38+ j122	47+ j14	36.0	9.0	200	7 Rotor 7 Stator

Total Null max. 30mv for each unit

Also available in 115v 400 cy. primary, 90v secondary Transmitters, C.T.'s, Receivers

*Torque 2600 mg.-mm./degree from CGC-8-A-7



In equipment which must be flown, why load on extra weight?
Clifton's new Size 8 Synchros can take the place of larger units at very significant saving in bulk and weight.
These new Size 8's are now in use in some of the latest and lightest avionic equipment.
Samples are available from stock, quantities from the production line.

CLIFTON PRECISION PRODUCTS CO. INC.
CLIFTON HEIGHTS PENNSYLVANIA

PRECISION Continental Connectors

mechanical connect and disconnect



SM-34 with hood
34 Contacts
ACTUAL SIZE

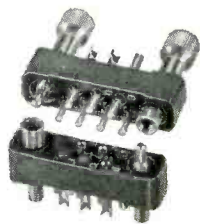

SM-7
7 Contacts
ACTUAL SIZE

now available in Continental subminiature screwlock* connectors

* Pat. Pending

Now, for the first time, you can have the dependability of a polarizing screwlock connector in subminiature size.

Polarizing screwlocks eliminate the need for prying, "rocking" or forcing the connector when disconnecting the plug from the receptacle. They provide absolute protection against accidental separation of the plug and receptacle.

These screwlocks were developed to provide vibration-proof connectors for critical armed services equipment.

Technical data on these connectors, and special designs requiring the use of subminiature, printed circuit, hermetic seal, pressurized, high voltage, or power connectors, are available on request. Write today for complete catalog.

From the tiny 7-contact (illustrated above, right) to connectors accommodating as many as 50 leads of #20 AWG wire, Continental can provide you with precision-made subminiatures for any project. The screwlock feature is also available in a variety of larger connectors, including miniature, hermetic seal, and high voltage.

Electronic Sales Division

DeJUR-Amsco Corporation,

45-01 Northern Boulevard, Long Island City 1, N. Y.

DeJUR

power loss need not be the same for both directions of propagation.

"The reason for the power loss is the high reactive nature of the discontinuities and especially the resonant cavity effect between iris and matching screws. This low-Q cavity is strongly excited by waves travelling in the forward direction and hence gives rise to large losses.

"The coupling of the cavity to the output guide through the cut-off throat of the iris is very weak. This explains the low transmission coefficient for both the forward and backward direction and the low excitation and power loss in the cavity for backward transmission."

W. L. Pritchard of Raytheon Manufacturing Co. writes:

The author . . . "describes a device that is apparently in flagrant violation of the reciprocity theorem. Application of this theorem to waveguide devices shows that the scattering matrix of any microwave junction is symmetrical. The proof of this theorem assumes Maxwell's equations and a scalar permeability and dielectric constant.

"Hence, devices employing magnetically biased ferrites that have tensor permeabilities are exempt from these conclusions. However, there is nothing in . . . the assembly which permits it to violate the theorem.

"In order not to be in the position of having rejected results on theoretical grounds only, we have built a model in scrupulous accord with . . . directions. It has been measured at 9,000 mc between a carefully matched generator and a power detector with the following results:

	insertion	loss
forward direction	1.05	2.0 db
reverse direction	2.0	2.2 db

"Both the generator and power detector mismatches were less than 1.05. These data are in essential agreement with reciprocity theorem.

"It is our conjecture that . . . anomalous data (in the article) are the result of assuming a relation between standing-wave ratio and transmission coefficient, which is

SPECIFY C-A-C TOROIDS

• IMMEDIATE DELIVERY • MIL. SPECS. • ADVANCED ENGINEERING • SUB-MINIATURE DESIGNS

Your research engineering, model development and pre-production engineering can be speeded up by utilizing quantities and varieties of toroids carried in our stock—available for immediate delivery. Because of our completely expanded and accelerated production facilities, regular orders of toroids can be filled in minimum time. Eliminate your toroid problems—specify CAC!

C-A-C

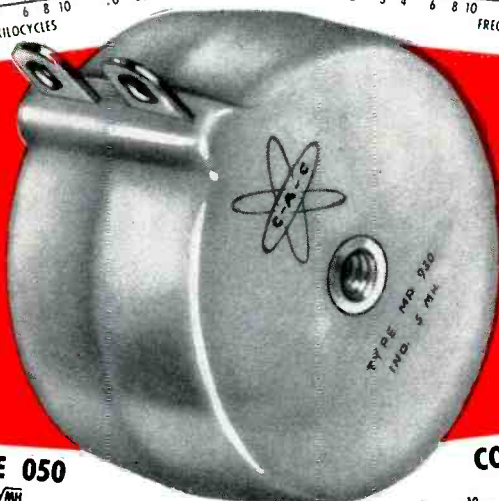
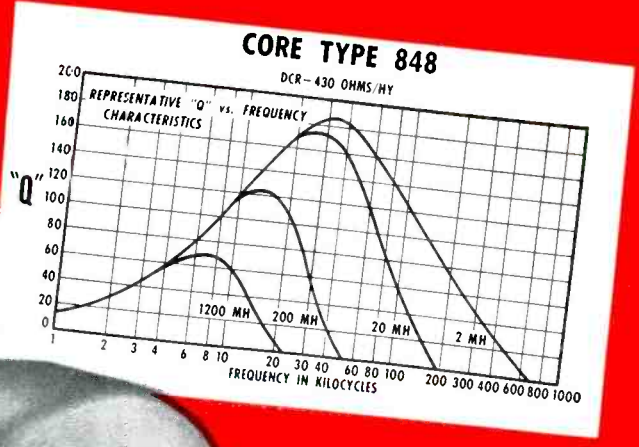
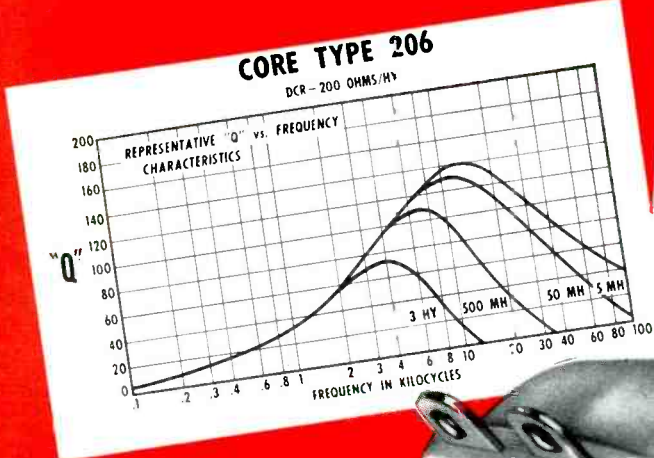

ORDER FROM STOCK

A wide variety of molded plastic and hermetically sealed toroidal units are available for delivery same day as orders are received.

A NEW SERVICE FOR ENGINEERING ORDERS.

Uncased coils and small orders are quickly produced in our specially equipped and staffed "rush order" department.

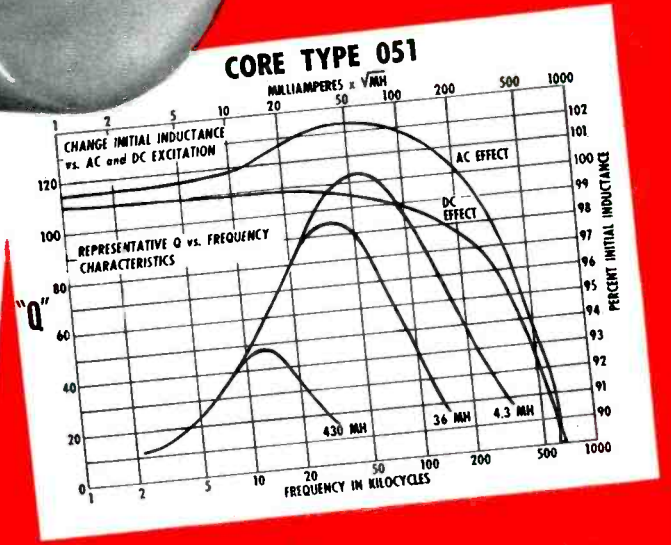
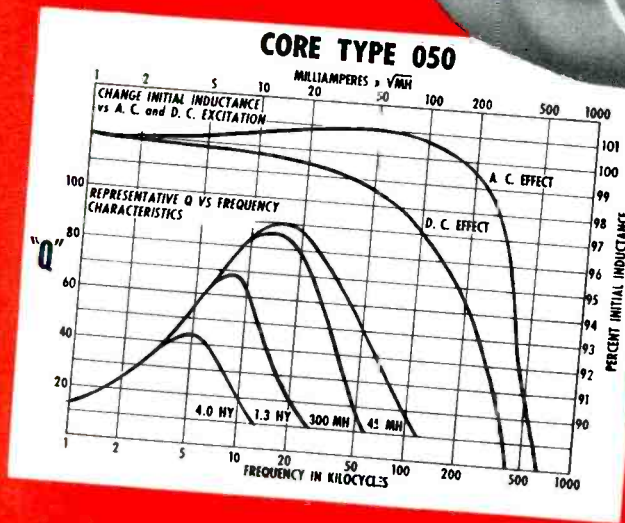

Precision Delivery Quality

There is a CAC man near you—write, wire or phone for complete information.

Communication Accessories Company

HECKMAN MILLS, MISSOURI • PHONE KANSAS CITY, SOUTH 1-5528

Want more information? Use post card on last page.

www.americanradiohistory.com

Comar's NEW MINIATURE DC RELAY

TYPE S

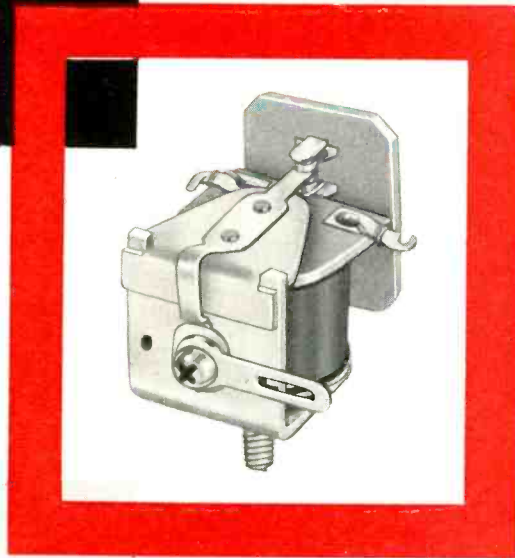

COMPACT SIZE

$\frac{7}{8}$ " wide, 1-3/16" long, 1" high
maximum size

SENSITIVITY

Rated at 40 milliwatts
(20 mw. minimum)

2 MOUNTING STYLES

Single stud, 6-32 x 5/16"
or insulated base

COIL RESISTANCE

7500 ohms, standard

CONTACT RATING

$\frac{1}{2}$ amp. at 115 VAC, for SPDT
Cross-bar contacts available

Applications:

Automotive
Radiosonde
Expendable Devices
Printed Circuits
Electrical Toys
Low Cost Electronic
Equipment
—and others

Send For Full Details

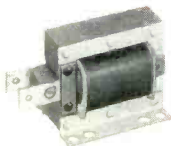

RELAYS • SOLENOIDS • COILS • TRANSFORMERS • SWITCHES • HERMETIC SEALING

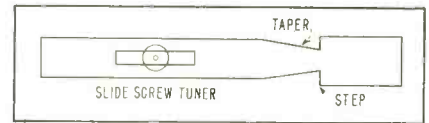

FIG. 2—One-way waveguide on which experiments were performed

valid only for lossless devices. The text supports this conjecture.

"In (a letter from the author) he implies that he has made direct measurements of transmission coefficients, again achieving the anomalous behavior contained in his article. In reply to this, we can only guess that his measurements are in error, very possibly because of signal-generator frequency drift and incidental mismatches in his generator and load.

"These conditions can occasionally cause surprisingly large experimental errors. We assume that he has desisted from inferring mismatch coefficients from measurements of standing-wave ratio. This is clearly not valid for the circuit in question."

The photograph shows the device built by and used in the experiments described above by Mr. Pritchard, John Reed and Joseph O'Donnell.

A considerable correspondence with Koryu Ishii, the author of the original article, is summarized below. The author points out that Fig. 3 and 4, appearing on pages 194 and 196 of the Dec. 1955 issue have been transposed by the editors.

In reply to Mr. Sichak's comments, the author says that in his many experiments, the forward-power transmission coefficient is almost 0 db and that front-to-back ratio of the power transmission coefficient was more than 20 db and frequency bandwidth was about 20 mc. Accuracy was 3 db.

He likewise feels that the steps (Fig. 2) make the Sichak experiment different from his own work. It is claimed that adjustment of the length of the screws is critical, 1/1,000-mm accuracy being required. Additional curves and discussion so far unpublished were sent by Mr. Ishii to those involved in the discussion.

Commenting upon Mr. Prit-

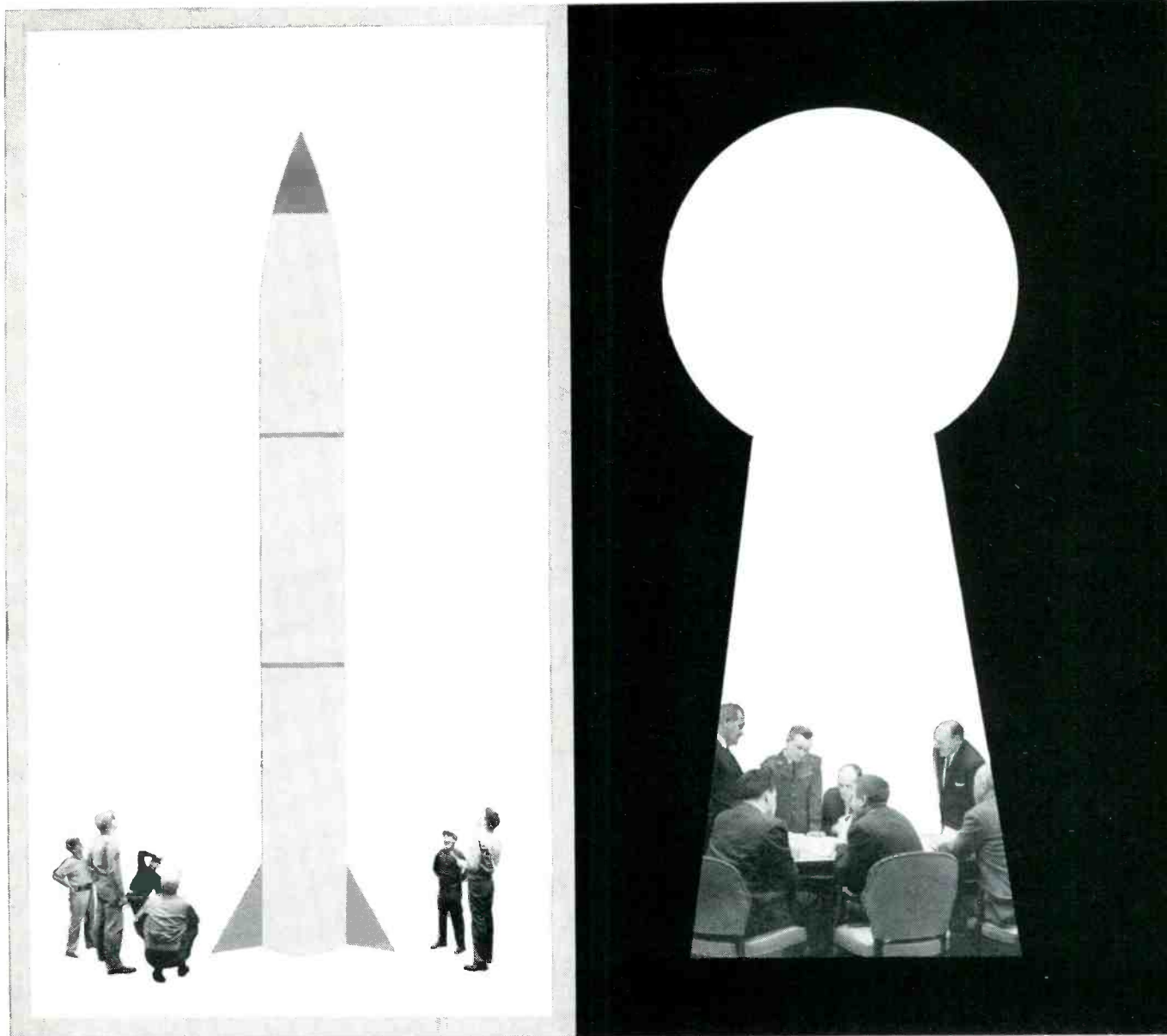

From V-2 type to Talos

AMF has missile experience you can use

● From the earliest missile types to the latest and most advanced developments, AMF has made major contributions to America's missile programs ● And today AMF is actively participating in *more than half* the programs under way ● One of its subsidiaries, Associated Missile Products Corporation, is the only private company devoted solely to missile support equipment. And AMF's missile activities cover practically every stage of design, development, and production... including mechanical and electronic test equipment... auxiliary power supplies... field and depot handling equipment... launchers... ground and flight control systems ● See for yourself why AMF's experience in missiles, as well as in a host of other fields, has made it the "can do" company.

Research, Development,
Production in these fields:

- Armament
- Ballistics
- Radar Antennae
- Guided Missile Support Equipment
- Auxiliary Power Supplies
- Control Systems



Defense Products Group

AMERICAN MACHINE & FOUNDRY COMPANY

1101 North Royal Street, Alexandria, Va.

HALL-SCOTT

ELECTRONICS

Precision Electronic Packages ... Ready for Application

Desk Top

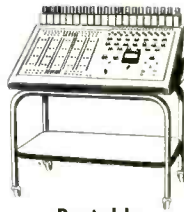
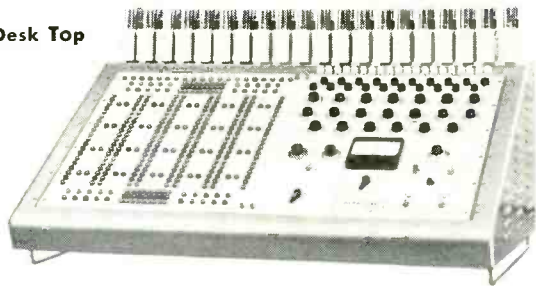

Portable

ANALOG COMPUTER (desk top or portable)—rapid and economical system synthesis. All accessories available, including a multiplier and function fitter.

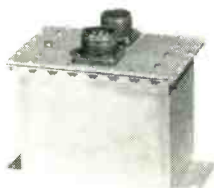

AUTOMATIC INVERTER CHANGE-OVER UNIT—an airborne sensing and switching package built to comply with MIL-R-6557.

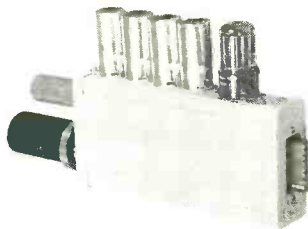

DC AMPLIFIER—chopper stabilized with both noise and drift less than 40 microvolts... a plug-in, system building-block.

Design, prototype development and quantity production of electronic equipment to your special requirements can be accomplished, in every detail, at Hall-Scott Electronics Division. Hall-Scott

laboratories include advanced condition simulation, electrical and mechanical testing equipment. Write today for complete information ... 2950 North Ontario Street, Burbank, California, Dept. E-556

HALL-SCOTT
Since 1909

Hall-Scott, Incorporated
Electronics Division
Burbank, California

7-4001

chard's experiments, the author says that the test was performed carefully but at only one frequency, whereas he believes that the examination should have been performed at various frequencies, since the asymmetrical waveguide has a pass band like a filter.

This summary would seem to close discussion of the subject.

PERTINENT PATENTS

By NORMAN L. CHALFIN

*Hughes Aircraft Co.
Culver City, Calif.*

SEVERAL patents have been issued to J. R. Anderson of Bell Telephone Laboratories describing the elements and circuits for storage devices.

Ceramic Unit

Patent 2,695,396 describes a "Ferroelectric Storage Device".

Substances such as barium titanate when subjected to an electric field exhibit a relationship between

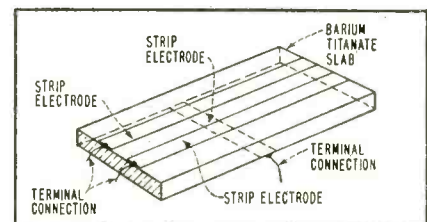

FIG. 1—Simplified version of ferroelectric element

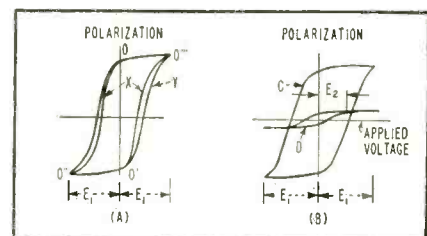

FIG. 2—Hysteresis loops under two different conditions

the electric field and polarization having the general form of a hysteresis loop similar to that exhibited by ferromagnetic materials.

This effect can be utilized in a device of the form of a capacitor having a pair of electrodes with a slab of the ferroelectric material between them. It is then possible to

NOW AVAILABLE!

SUPER-RUGGED!

ADVAC

HIGH VOLTAGE TERMINALS

Specify ADVAC High Temperature Ceramic-to-Metal Seals for:

JET ENGINE THERMO-COUPLE SEALS
FIRE DETECTION AND TEMPERATURE CONTROLS
EXPLOSION PROOF ASSEMBLIES
REFRIGERATION COMPRESSOR SEALS
KLYSTRON OUTPUT WINDOWS
T-R TUBE WINDOWS
IGNITION INSULATOR BUSHINGS
VACUUM TUBE CLOSURES
HEATING ELEMENT TERMINATIONS
NUCLEAR ENERGY EQUIPMENT
IMMERSION HEATER SEALS
POWER CABLE END SEALS
CHEMICAL RESISTANT INSULATORS
HEAVY-DUTY TRANSFORMERS
CAPACITORS
PULSE NETWORKS
RELAYS, DELAY LINES
FILTERS, REACTORS
MOTOR SWITCHES

- Pure silver brazed for higher temperature service
- Helium mass spectrometer tested for vacuum-tightness
- High mechanical strength and thermal shock resistance
- Adaptable for soft-soldering, brazing or welding

New ADVAC High Voltage Terminals withstand operating temperatures of over 1000°F. They have been service-proven in a wide range of applications where severe environmental conditions, including both mechanical and thermal shock, are encountered. ADVAC super-rugged high voltage terminals are available in nine economical standard types that meet most requirements. For special applications, custom terminals can be produced to your exact specifications.

—For Critical Commercial and Military Applications

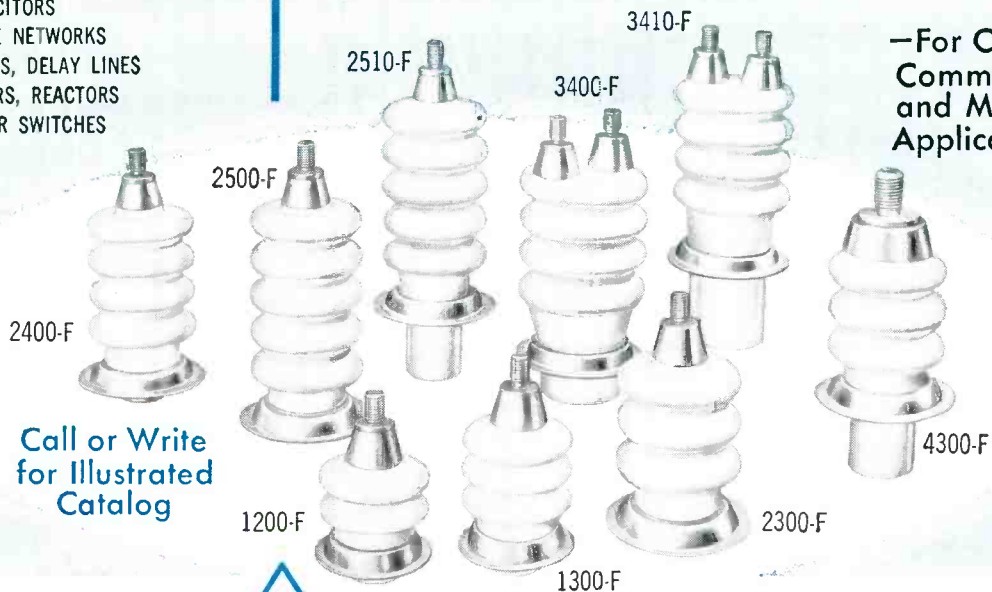

Call or Write for Illustrated Catalog

DIVISION OF
GENERAL CERAMICS
CORPORATION



ADVANCED VACUUM PRODUCTS • INC

18-22 Liberty Street, Stamford, Connecticut—Telephone: Davis 4-2148

HIGH TEMPERATURE, VACUUM TIGHT CERAMIC-TO-METAL SEALS FOR THE ELECTRONIC INDUSTRY

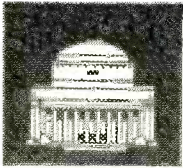

MIT
LINCOLN
LABORATORY

- Electrical Engineers
- Physicists
- Mathematicians

SAGE (semi-automatic ground environment)

AEW (air-borne early warning)

WHIRLWIND COMPUTER

SOLID STATE

HEAVY RADARS

MEMORY DEVICES

SCATTER COMMUNICATIONS

TRANSISTORIZED DIGITAL
COMPUTERS

If you are interested in participating
in any of these programs address:

Dr. M. G. Holloway, Director
M.I.T. Lincoln Laboratory
Lexington 73, Mass.

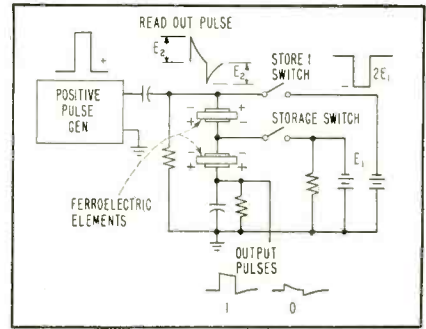

FIG. 3—Typical storage arrangement

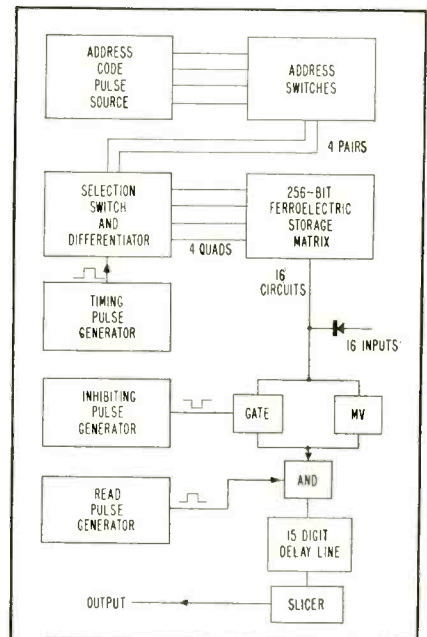

FIG. 4—Elementary computer using storage matrix

store charges so as to provide memory or storage devices. The material is polarized in one direction by application of a pulse of a polarity to reverse the existing polarization whereby energy is stored.

Read-out pulses are applied of the opposite polarity to restore the initial polarization. This lends itself to binary digital computer application.

► **Structure**—The ferroelectric element of this invention is illustrated in Fig. 1 in which a typical structure is shown. Fig. 2 illustrates the hysteresis loops of the polarization curves. The inner loop X of Fig. 2A is for the top strip electrode towards the far edge along with the bottom electrode.

Curve Y is for the strip electrode nearest the observer along with the bottom electrode. Each pair of elec-

Raytheon selects **RESINOX* 3700** for core of new microwave cooking oven transformer

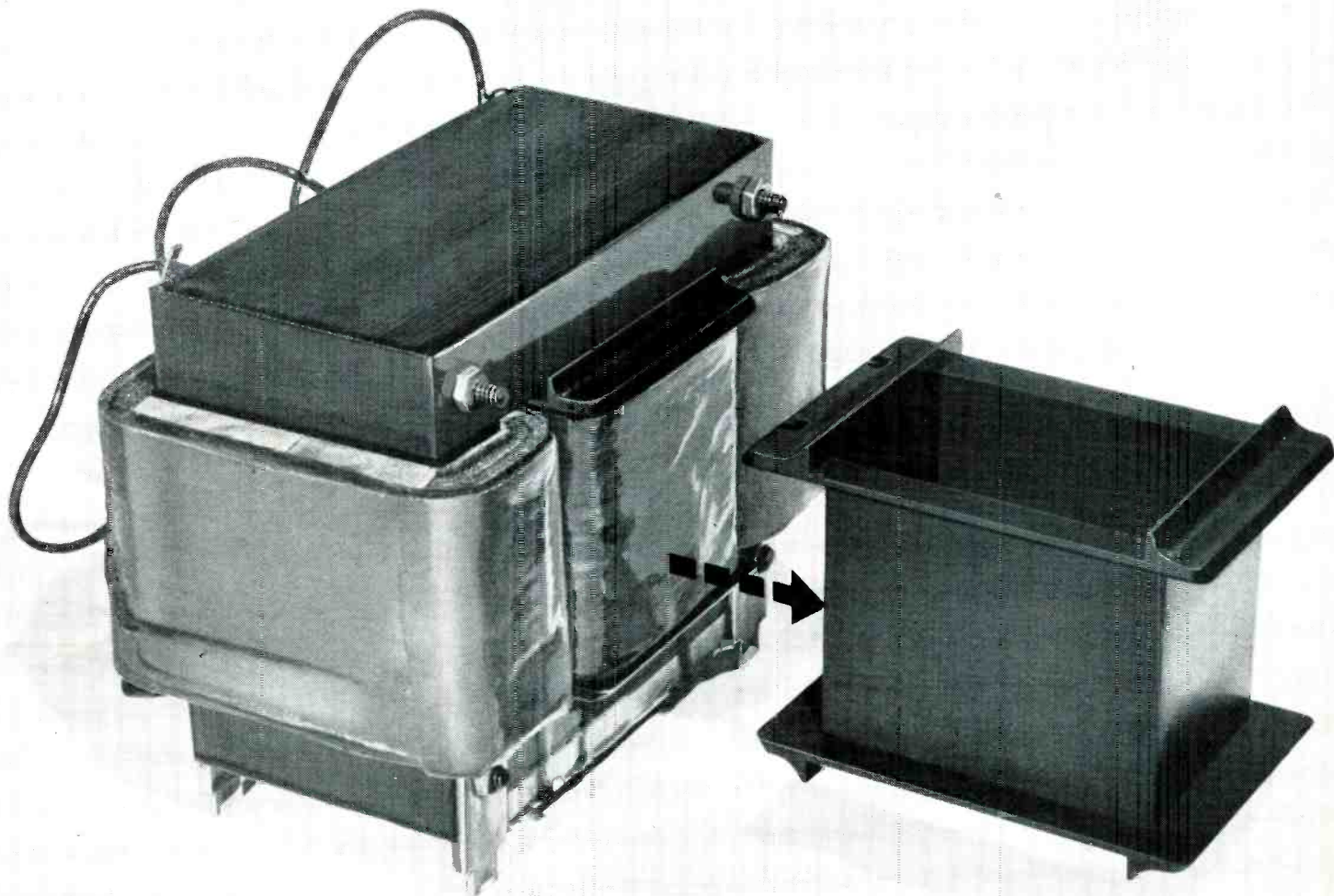

Monsanto material again demonstrates its outstanding physical-electrical properties!

Of all materials tested for the core of this intricate assembly—heart of a new microwave cooking oven—only Resinox 3700 qualified on every requirement.

For this highly critical application, Raytheon engineers needed a core material with outstanding electrical and physical properties. Unusual dimensional stability and low shrinkage were vital because the core is first wound, assembled, varnished and then baked at high temperatures. Core cracking under heat had been a common and costly complaint with the materials tested.

Since using Resinox 3700, these expensive losses and rejections of the final transformer coil assembly have been largely eliminated. Result? Faster, more economical production.

Other top-flight qualities of Resinox 3700, of special interest to electrical parts manufacturers, are its outstanding

arc resistance, dielectric strength, good impact resistance, and excellent moldability.

This complete transformer assembly, used in both home- and commercial-type microwave ovens, is made and patented by Raytheon Manufacturing Co., Waltham, Mass. The core is molded by Spools, Inc., Providence, R. I.

Perhaps Resinox 3700 can solve a critical electrical parts problem for you. Write today for data sheets. Monsanto Chemical Company, Plastics Division, Room 404, Springfield, Mass.

*Resinox: Reg. U.S. Pat. Off.



Want more information? Use post card on last page.

PHAOSTRON

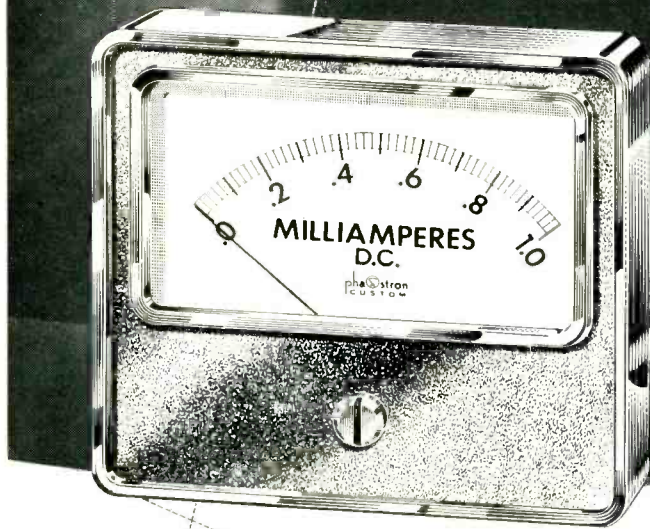

NEW 3½"
Rectangular
Meter

Now!... Phaostrom
custom panel
meters are
available in

colors

at no additional cost

Time-tested and proven movements, anti-magnetic shielding, insulated zero adjustments and fine accuracy are familiar features of Phaostrom Custom Panel Meters... now, something new has been added...

COLOR-CUSTOMIZED PANELS

Handsome harmonizing colors that will give a touch of distinction to your equipment. Send us a color swatch and we will make Phaostrom color-customized panels to match... and at no extra cost!

Phaostrom Custom Panel Meters, nine types in 77 Standard Ranges are available at your Parts Distributor. For special requirements, write to the Product Development Department for practical recommendations.

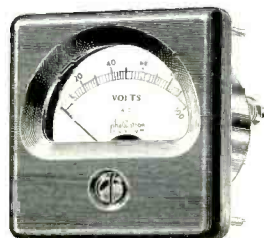

2½" or 3½" square meter

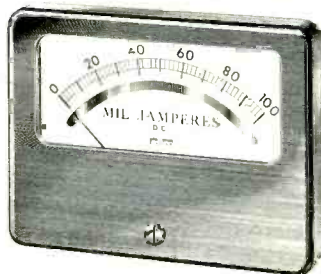

4" x 6" rectangular meter
with mirrored scale
also available illuminated

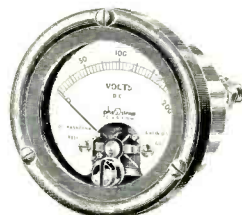

2½" or 3½" round meter

trodes (the bottom being common to both pairs) forms a capacitor. Both capacitors saturate at potentials equal to E_1 . Loop C in Fig. 2B is the resultant wave form when the polarizing potential E_1 is applied between the two strip electrodes on the top surface only.

Loop C is larger than either loop X or Y. If the two capacitors are energized in series at opposite po-

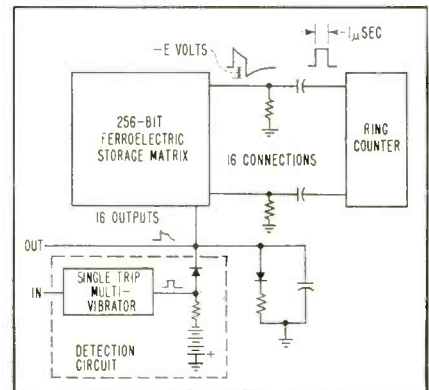

FIG. 5—Storage unit for 256 bits and detector circuit including multivibrator

larities applied to each the result is a straight line. However identical portions are not practically achieved in the manufacture of ferromagnetic devices so that loop D shown in Fig. 2B represents a typical result of the application of the oppositely polarized signals.

► **Practical Unit**—Figure 3 illustrates a typical circuit arrangement wherein the two ferroelectric elements are indicated as separate units.

A binary 0 is stored by closing the storage switch. Voltage E_1 at terminal Y and the storage units are charged in opposite directions.

A binary 1 is stored by applying a negative pulse of amplitude $2E_1$ while the storage switch is closed. The storage switch is opened just before the end of the negative storing pulse. This way, both units are stored in series. The upper unit for 1 storage is reversed in polarity while the lower unit remains the same as for 0 bit storage.

Application of a read-out pulse, in case of 0 storage, delivers a very small, if any, output charge. When a 1 is stored the readout pulse results in a high output charge.

In patents 2,695,397 and 2,695,398



Phaostrom Instrument & Electronic Co.

151 PASADENA AVE., SOUTH PASADENA, CALIF.

appropriateness.

re·li·a·ble (rē·lī'ā·b'l), *adj.* Suitable or fit to be relied on; worthy of dependence or reliance.

re·li·

This one definition sums up what we at Leach feel is the most important single thing we can build into a relay, be it a simple motor-starter type or a complex, hermetically sealed unit destined to help guide a missile. It's the starting point of our design thinking, the basis for all manufacturing and quality-control practices.

Reliability of any component is basically the *probability*

LEACH . . . standard of relay quality for over 30 years . . . offers a broad line for industrial, electronic and aircraft use . . . and, special types on order.

**commercial controls
and contactors**

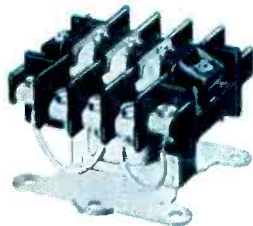

**hermetically sealed
aircraft types**



**radio and
high-frequency relays**



**motor starting
snap-action types**



of its successful operation during a given task. And in a relay, there's no halfway operation . . . it's either working or useless. So we say only this: whatever your relay needs, look to Leach *first*; then *test* Leach against any make on the market. You'll see why, for years, it has been a habit throughout industry to specify LEACH where complete system reliability is a must.

This is NEWS at LEACH

A new group of **system designed** relays, designed to insure **system** reliability in electronic, aircraft and missile work. Their square shape makes it possible to place 20% more relays in a given space . . . they have optional lead arrangements . . . are hermetically sealed, shock-resistant, can operate **dependably** at 120°C ambient. Complete specifications available on request.

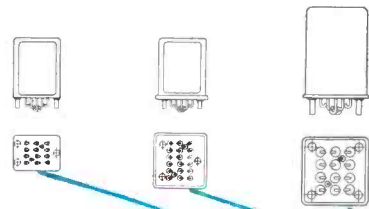

	9220	9226	9230
Contact arrangement	4PDT	6PDT	4PDT
Operating voltage	18-30 VDC	18-30 VDC	18-30 VDC
Contact rating at 28 VDC			
Resistive	5 amp	5 amp	10 amp
Inductive	1.5 amp	1.5 amp	7 amp
Coil resistance	250 ohms	200 ohms	150 ohms
Duty	Continuous	Continuous	Continuous
Weight	.25 lb.	.25 lb.	.5 lb.
Case dimensions, inches	1.3x1x1.7	1.5x1.5x1.7	1.7x1.7x2.6

LEACH CORPORATION

Send for the latest Leach Relay Catalog . . . your best starting point when selecting any relay.



LEACH RELAY DIVISION

5915 AVALON BLVD., LOS ANGELES 3, CALIFORNIA

DISTRICT OFFICES AND REPRESENTATIVES IN PRINCIPAL CITIES OF U. S. AND CANADA



Where dependability is vital...

METEX RF SHIELDING CONTROLS RADIO NOISE!

In radar systems — as in all types of noise-sensitive electronic devices — more and more design engineers are turning to METEX RF Shielding Products as the most practical and effective method of suppressing radio noise.

METEX Shielding Materials are formed from *knitted*, metallic wire for maximum *conductivity*. The inherent *resiliency* of the knitted structure provides a continuous line contact between imperfect mating surfaces with minimum contact impedance. The countless, interlocked loops, formed from continuous wire strands, impart maximum *cohesion* with no loose strands or frayed fibres.

This unique combination of electrical and mechanical properties not only re-establishes electrical conductivity across joints, but conforms to wide irregularities in mating surfaces with minimum closing pressure.

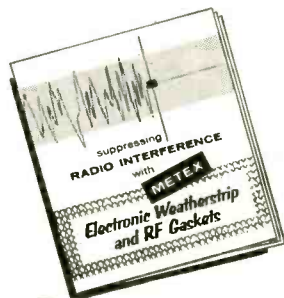

METEX Electronic Weatherstrip, RF Gaskets and Combination Fluid and RF Sealing Gaskets are available in a wide variety of types and sizes to solve your RF noise problems. Write for full information *today!*

Send for your copy of this fact-filled METEX Handbook NOW!

ELECTRONICS DIVISION

METAL TEXTILE CORP.
ROSELLE • NEW JERSEY

typical applications of ferroelectric circuits are described.

► **Storage Matrix**—Figure 4 is the block diagram of a computer employing a storage matrix of ferroelectric units of the type shown in Fig. 1. The storage matrix is a $\frac{7}{8}$ -in. square of barium titanate 0.005 to 0.01 in. thick.

The crystal has 16 0.004-in. electrodes vertically on one face and horizontally on the opposite face, giving 256 cross points or storage units.

In Fig. 5, taken from patent 2,695,398, a block diagram is given showing the 256-bit storage unit arranged in a computer circuit. The circuit shown is capable of 128,000 bits per second through the 8,000

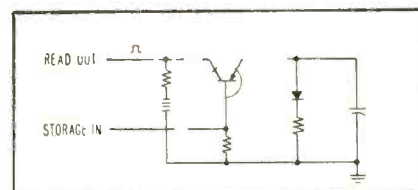

FIG. 6—Improved detector circuit uses transistor

bit-per-second read-out from each of the 16 ferroelectric units.

► **Transistor Unit** — The detector circuit of Fig. 5 includes a diode rectifier. In Fig. 6 an improved detector circuit is shown, incorporating a transistor. A change in the impedance value of the transistor is utilized to provide a variable impedance for the selective storage of information.

The emitter is an output connection to the storage matrix from the transistor, which is operating as a multivibrator. The storage unit sees a high impedance when the transistor is in the off state and a low impedance when the transistor is on. During the storage interval the transistor circuit is controlled by an information message pulse applied to the transistor base. The collector provides a convenient output for storage system output pulses.

The advantage of the transistor detector system is in an increased speed of operation due to shorter read-out intervals and a greater immunity from disturbing voltages.

**ONLY available source in
all welded construction**

STUD MOUNT
PIGTAIL

NOW! IN PRODUCTION QUANTITIES

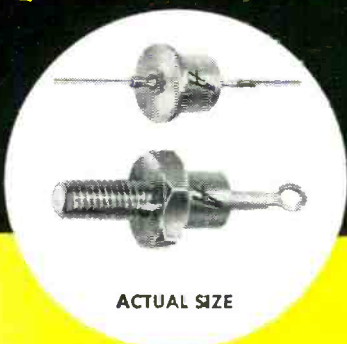

ACTUAL SIZE

AUTOMATIC SILICON POWER RECTIFIERS

At 100°C quality Automatic Silicon Power Rectifiers really perform, featuring negligible reverse leakage current and sharp zener breakdown, plus the exclusive **ALL WELDED CONSTRUCTION** on both stud-mount and pigtail lead types. These field-proven units are available in quantity.

Automatic Silicon Power Rectifiers are your best buy for switching circuits, blocking circuits, magnetic amplifiers, power supplies, and dozens of other applications.

Write or wire today for complete technical data. Automatic can supply types 1N253, 1N254, 1N255, 1N256 in conformance with JAN specifications.

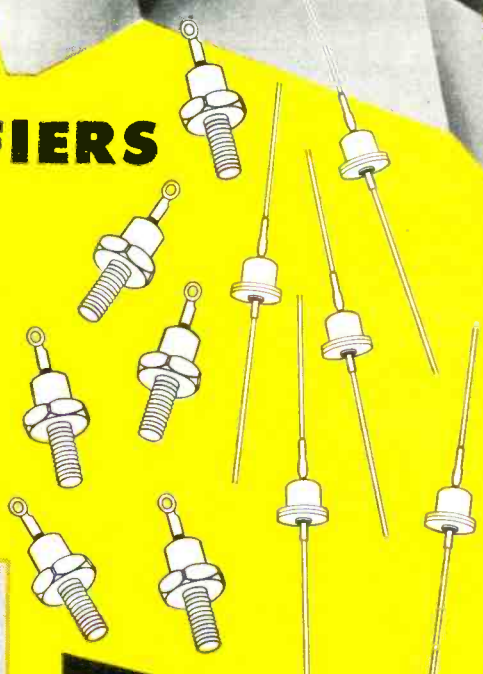

TYPICAL DATA FOR 25°C AMBIENTS

Type No.	Average DC Output At Rated		Reverse Leakage At Rated P. I. V.	Mounting	Type No.	Average DC Output At Rated		Reverse Leakage At Rated P. I. V.	Mounting
	P. I. V. (volts)	Current (mA)				P. f. V. (volts)	Current (mA)		
1N440	100	300	0.03	Pigtail Leads	1N535	600	300	2.00	Pigtail Leads
1N441	200	300	0.075	"	1N560	800	300	1.50	"
1N442	300	300	0.10	"	1N561	1,000	300	2.00	"
1N443	400	300	0.15	"	1N550	100	500	.05	Stud-Mount
1N444	500	300	0.18	"	1N551	200	500	.10	"
1N445	600	300	0.20	"	1N552	300	500	.15	"
1N530	100	300	0.30	"	1N553	400	500	.20	"
1N531	200	300	0.75	"	1N554	500	500	.25	"
1N532	300	300	1.00	"	1N555	600	500	.30	"
1N533	400	300	1.50	"	1N562	800	500	1.50	"
1N534	500	300	1.80	"	1N563	1,000	500	2.00	"



DIVISION OF GENERAL INSTRUMENT CORPORATION
65 GOUVERNEUR STREET NEWARK 4, NEW JERSEY

MASS PRODUCERS OF ELECTRONIC COMPONENTS

THE FRONT COVER: Automatic Circuit-Plating Machine

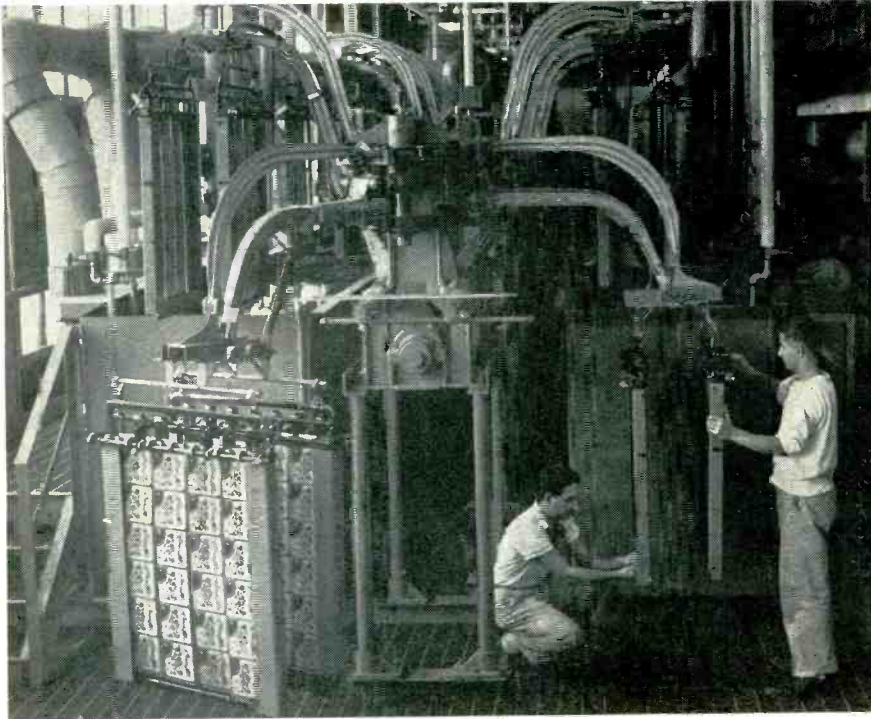

Boards are loaded and unloaded at closed ends of legs of U-shaped 75-foot-long plating tank. Conveyor running between legs of U has cast aluminum arms that move down to lower boards in turn into tank sections for cleaning, plating and final rinsing

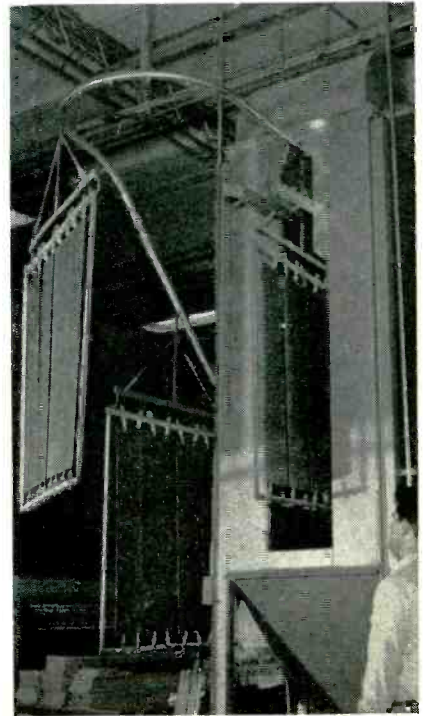

Entrance end of 65-foot-long cleaning tunnel in which punched plain boards receive two washes and air drying

AN AUTOMATIC electrolytic plating tank 75 feet long is the heart of a highly mechanized production system which this year will produce between five and six-million Thru-Ccn additive-type printing wiring boards at the Auburn, N. Y. plant

of General Electric's Electronic Components Department.

Racks with the boards to be plated are carried by 39 cast aluminum arms, two to each arm, counterclockwise around the U-shaped tank. Each arm indexes 39

times while moving through the processing steps of preplate cleaning, plating of the copper wiring patterns and final rinses.

In plating, the copper is deposited on one or both sides of the plastic boards and through com-

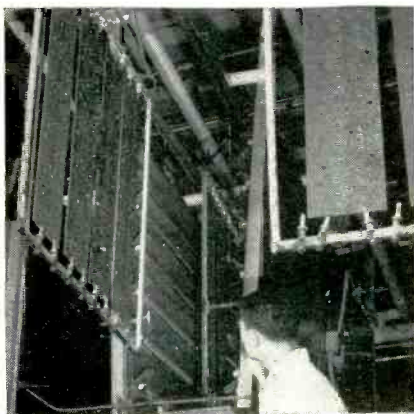

At output end of cleaning tunnel, strips pass through infrared drying section



Adhesive spray setup. Photoelectric unit cuts off spray between rack sections



Checking strips for smoothness and coverage of adhesive coating



soldering time saved!



KESTER "44" RESIN, PLASTIC ROSIN AND "RESIN-FIVE" FLUX-CORE SOLDERS are tried-and-proved remedies for almost every production situation where soldering time gets out of hand. Kester's great adaptability to widely divergent soldering requirements has time and again helped

so many manufacturers combat rising production costs. It could be the solution you've been looking for!

THIS IS IT . . . the informative 78-page free Kester textbook "SOLDER . . . Its Fundamentals and Usage." Send for your copy today!

KESTER SOLDER

COMPANY 4204 Wrightwood Avenue, Chicago 39, Illinois; Newark 5, N. J.; Brantford, Canada

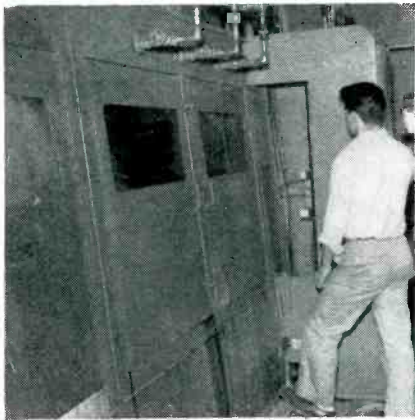

Enclosed spray tunnel having reciprocating spray units that spray on presilvering coating, wash with deionized air, apply silver and reducer, then rinse



Screen setup for applying resist to two strips at a time, each holding wiring patterns for ten transistorized portable radios using plated wiring boards



After final treatment, plated strips are cut into individual radio boards on punch press having positioning pins that automatically give accurate registry

ponent lead holes to provide a conductive pattern connecting to both sides of the circuit.

The racks carrying the plastic strips to be plated are loaded and unloaded manually. Each rack carries four to five-dozen individual wiring patterns on the strips, so several-thousand patterns are undergoing plating at one time.

► **Preparation**—Taking the entire processing procedure in order, the first step for the 36-by-72 inch sheets is cleaning. Next, the sheets are sheared into strips and the strips are punched with the component lead holes. Holes for from six to ten individual patterns are punched into each strip.

Conveyorized processing for the strips begins with the next step, as they move on an overhead conveyor through the 65-foot-long cleaning tank. The strips, clipped

to racks on the conveyor, dip and rise twice as they move through the different washes. Emerging, they are first air-dried, and then move between facing rows of infrared heating units for final drying.

► **Spraying**—Still on their conveyor racks, the strips move through spray stations where adhesive is applied. A photoelectric installation cuts off the spray mixture in the intervals between racks passing the spray fixture.

Inspected while moving on the conveyor, the strips on their racks move through a silver-spray tunnel for application of the silver which serves as a conductive coating for the copper wiring pattern. In the silver-spray tunnel the strips are sprayed with a presilvering coating, with deionized water and finally with silver and reducer so the silver will adhere to the board

in a microscopic layer, and finally with a water wash. After the silver-spray processing, the strips are air-dried as they leave the tunnel.

► **Plating**—The strips now move to a section where they are removed from their racks, coated with resist in a manual screening process and air-dried. Next they are moved on racks to the plating tank and loaded onto the special plating-tank racks for the plating operations.

After plating, the strips are manually cleaned to remove the resist (this process is currently being mechanized) and then heat-cured. Final processing steps include a bright-dip in chromic acid, screening on of a solder resist to prevent bridging-over of the solder in the assembly dip-solder process and blanking-out of the individual completed wiring board patterns from the strips.

Life-Testing Machines for Auto Radio and Television Tuners

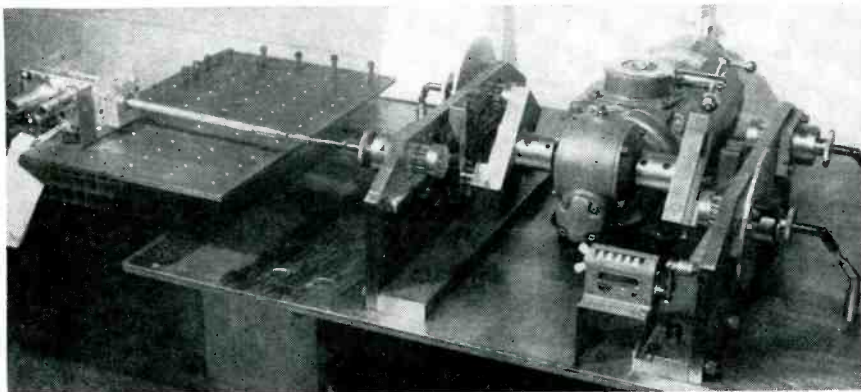

Drive mechanism as set up for testing television tuner mounted on plate at left

A SINGLE MOTOR and gear drive arrangement having four output shafts is designed to drive a variety of radio and television tuner mechanisms during life tests in the Camden, N. J. plant of Radio Condenser Co. Use of large steel plates having tapped holes at uniformly spaced intervals speeds the mounting of a tuner in correct alignment with the universal joint of one of the four drive shafts.

The shafts are arranged two on each side of a Graham variable-

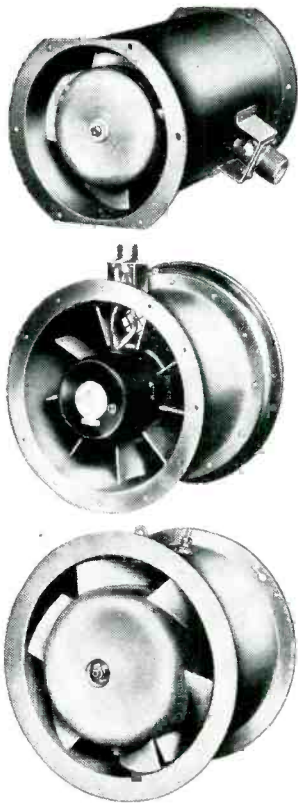

In Electronic Fan Design

Only **JOY**
AXIVANE[®]
FANS
 Offer All These
Advantages



PRECISION CONSTRUCTION



Precision construction insures performance that gives you great power in so compact a unit.

COMPACT DESIGN



Joy's axivane design permits installation of Axivane fans as part of the duct . . . requires no extra space.

LIGHT WEIGHT



Axivane fans are light in weight as well as compact because they are built from precision aluminum or magnesium castings produced in our own foundry under JOY engineering supervision.

AERODYNAMIC ENGINEERING



The airfoil blades and stationary vanes of JOY fans are made with power-saving, efficient airfoil cross-section. AXIVANE design provides equal pressure and velocity distribution across the fan outlet . . . eliminates turbulence . . . and produces the greatest cooling effect with the least expenditure of power.

MAXIMUM STRENGTH



Joy AXIVANE fans are durable because the outer casing, stationary vanes, and inner casing are precision-cast as a single unit, giving extra strength and maximum resistance to shock.

UNMATCHED EXPERIENCE



Joy's unmatched experience as the world's largest manufacturer of Vaneaxial fans and blowers is a bonus that costs you nothing extra . . . JOY'S leadership is due solely to the multitude of customers who are now enjoying the benefits of outstanding engineering. Why not join the number of satisfied JOY customers . . . you'll be in the best company.

COMPLETE LINE



Joy offers a large selection of fans in the standard line . . . as well as custom-designed types that are available to your specifications. The Joy line includes fans for all purposes ranging from 1/500 HP to 3000 HP. You'll find a fan to suit your needs in the JOY line. Let us work with you. *Joy Manufacturing Company, Oliver Building, Pittsburgh 22, Pa. In Canada: Joy Manufacturing Company (Canada) Limited, Galt, Ontario.*

Write for **FREE Bulletin 15-39**

W&D 15637-15

Consult a Joy Engineer

For VANEAXIAL FANS • COMPRESSORS • VACUUM PUMPS and BOOSTERS
 OXYGEN GENERATORS • HYDRAULIC FITTINGS • ELECTRICAL CONNECTORS



JOY

**WORLD'S LARGEST MANUFACTURER
 OF VANEAXIAL-TYPE FANS**

marion
 advancement
 in instrument
 design

**SETTING
 NEW
 STANDARDS**

rugged,
 lightweight,
 miniature
COAXIAL*
 mechanism



Actual Size
 Total Weight 0.8 oz.

An entirely new approach to the mechanical design of moving coil mechanisms, resulting in performance and durability exceeding that of larger, heavier mechanisms. Particularly suited to aircraft applications, as the basic mechanism in indicating instruments or a component of equipment utilizing the moving coil principle. Coaxial assembly provides self-shielded, uniform and stable magnetic field of great strength. Only two fasteners are used in the simple, rigid, interlocked assembly. Technical data for your application on request.



*Trademark for a basic Marion moving coil mechanism. Patents pending.

marion meters

marion electrical
 instrument company

GRENIER FIELD, *New Hampshire's NEW Air-Industry Area*
 MANCHESTER, N. H., U. S. A.



copyright 1955 M. E. I. Co.

BE SAFE WITH
Q-max
A-27
LOW-LOSS LACQUER

- Q-MAX provides a practically loss-free insulating coating for VHF and UHF components of every variety. Q-MAX penetrates deeply to seal out moisture, imparts rigidity to coil windings and promotes stability of electrical circuits. It scarcely alters the "Q" of R-F windings.
- Q-MAX is easy to apply, dries quickly, adheres to practically all materials and has a wide temperature range.

WRITE FOR DETAILED
 ENGINEERING LITERATURE

*Communication
 Products Company, Inc.*

MARLBORO
 NEW JERSEY

Want more information? Use post card on last page.

speed transmission made by Graham Transmission, Inc., Menomonee Falls, Wisc., driven by a Marathon electric motor. With an input speed of 1,450 rpm, the output speed can be varied from 0 to 24 rpm by turning a crank on top of the transmission. This is normally set at 15 rpm for tuner tests.

The two transmission output shafts have outward-facing channels at right angles, with an adjustable sliding button on each channel. These buttons ride in mating vertical channels on the two horizontally-mounted gear racks, which have gear teeth facing upward. Rotation of the transmission causes the racks to move back and forth horizontally on rollers, with the amount of displacement controlled independently by the positions of the two buttons in the rotating channels.

Above and meshing with each rack are two gears, serving as the output shafts to which the universal joints and the tuners are attached. One of the output shafts on each side has a pointer moving over a fixed dial calibrated in degrees, to indicate the amount of angular rotation being obtained. For switch-type television tuners, the drive is usually set for full 360-degree rotation.

► **Pushing Buttons**—A special holding fixture permits operating pushbuttons of auto radio tuners one after another in sequence to simulate normal use. This fixture holds two tuners at a time. In the center of the fixture is a shaft driven by the drive mechanism of



Fixture holding two auto radio pushbutton mechanisms at a time. When set up for use, the central drive shaft of the fixture is hooked up to one end of the universal joint linkages of the drive. Tuners shown here are of the cam-and-lever type

the life tester. On this shaft are six single-lobe cams spaced 60 degrees apart, positioned to move steel plungers outward on both sides.

When tuners are loaded, flat caps on the outer ends of the two sets of plungers bear against the ends of the pushbuttons to simulate human fingers. When a cam retracts after pushing in a button, the spring loading of the button brings the button back out and thereby pushes back the actuating pin.

A standard five-digit Productimeter made by Durant Mfg. Co., Milwaukee, Wisc., is so mounted that its crank arm is actuated each time one of the racks reaches the forward limit of its motion. This gives a visible indication of the status of the life test at all times.

Holding Fixture Aids Varnishing of Tiny Coils



Loading coils into dipping fixture. This fixture holds 42 coils

TINY coils must be accurately varnished for use in the electronic systems of several Martin aircraft. The varnishing operation is performed quickly and accurately with a newly-developed holding fixture. A spring-loaded plate, mounted between two rigid plates, clamps the ends of the coils when actuated by the two ears protruding from the sides.

After the coils are secured in the holding device, it is placed in a

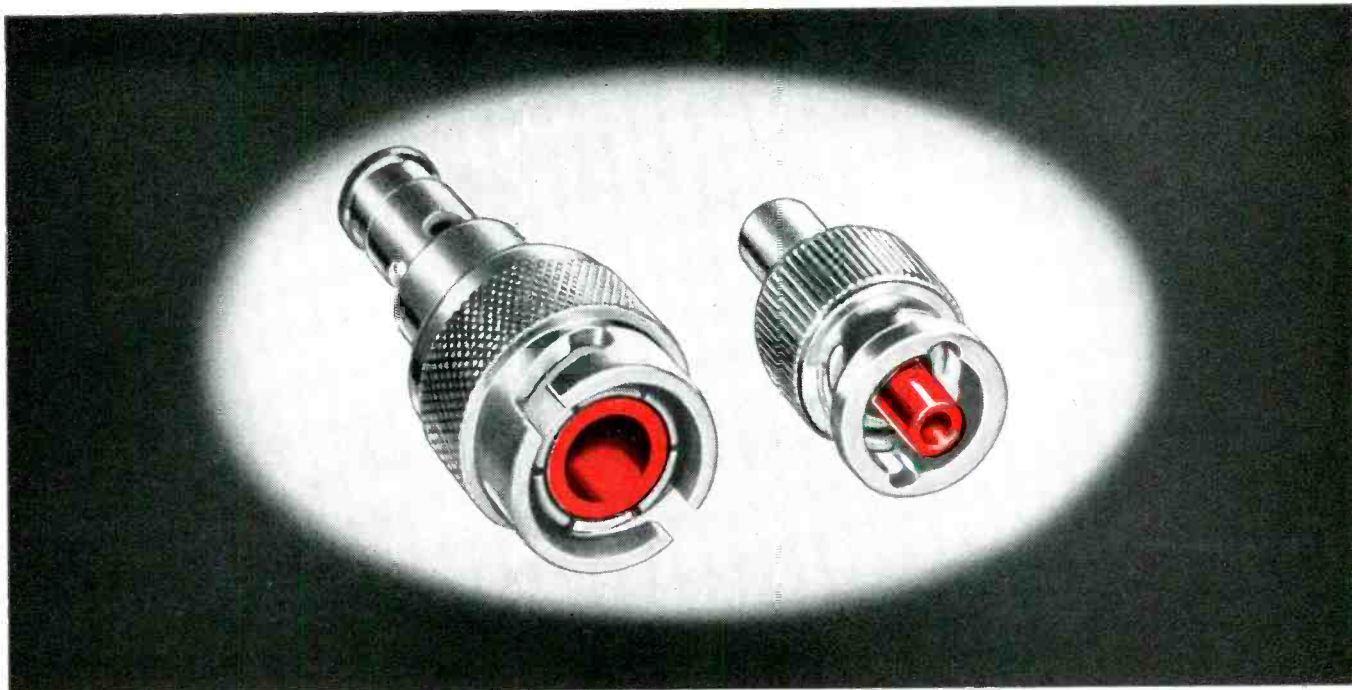

PRECISION CONNECTORS with KEL-F plastic parts have high RF insulation and dimensional stability. Plastic's high impact and compressive strength permit rough

handling without chipping, cracking, or deforming. Zero moisture absorption and anti-adhesive surface prevent formation of conductive residue.

KEL-F[®] FLUOROCARBON PLASTIC

permits components to operate over a wider temperature range . . . under highly humid and corrosive atmospheres

KEL-F plastic's unique combination of properties can help your product meet more rigid performance specifications. Because of the extreme stability of the fluorocarbon plastic molecule, this dense, tough thermoplastic has superior dielectric properties, excellent resistance to corrosive chemicals, outstanding thermal and dimensional stability, and zero moisture absorption.

Molded and extruded parts operate over an extremely wide range of temperatures (-320° F. to 390° F.) . . . are unaffected by humidity or operational vibration. Metal inserts, lugs and contacts are held

firmly, forming a hermetic seal.

KEL-F plastic is available from Kellogg as a molding material, or in sheets, rods, strips, tubing, film and "spaghetti" from qualified fabricators and molders throughout the country. For further information, write: The M. W. Kellogg Company, Chemical Manufacturing Division, P. O. Box 469, Jersey City 3, N. J.



Subsidiary of Pullman Incorporated

® Registered trademark of
The M. W. Kellogg Company for its fluorocarbon products.

Visit the Kellogg Booth #804, 901 Plastics
Exposition—June 11-15 Coliseum, New York City

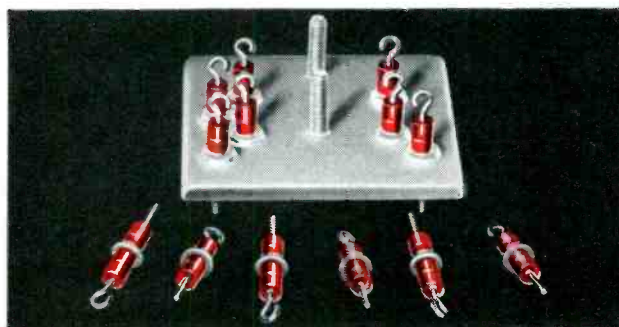

HERMETICALLY-SEALED TERMINALS with KEL-F plastic insulation handle high voltage without flash-over or tracking. Won't shrink, swell, age or lose hermetic seal at high and low operating temperatures. Can be used in contact with highly corrosive chemicals.



TUBE SOCKETS of tough KEL-F plastic. Hermetic seal defies thermal cycling, aging and humidity. Withstands high shock loads without chipping or cracking insulation. Plastic's high dielectric strength prevents shorting or arc-over at high altitudes.

Couch Rugged



RELAYS

Specify the COUCH MODEL 2A or 4A relay whenever HIGH SHOCK-HIGH VIBRATION capabilities are required and for DRY-CIRCUIT applications.

VIBRATION . . . 5 to 25 cps @ 0.4" peak to peak excursion; 25 to 2000 cps @ 20G acceleration; No contact opening, relay energized or de-energized.

SHOCK ELECTRICAL . . . 75G for 10 milliseconds minimum. No contact opening, relay energized or de-energized.

SHOCK MECHANICAL . . . 200G minimum . . . no physical damage to relay or change in electrical characteristics.

Models 2A and 4A are subminiature, hermetically sealed, D.C. relays which meet and in several respects exceed the requirements of MIL-R-5757B. They are actuated by a "balanced-armature" rotary motor. Both models are particularly suited to dry-circuit switching applications.

LEADING PARTICULARS

Ambient Temp.:	-65°C to +125°C
Weight:	3.2 oz. maximum
Height of Case:	1½" maximum
Diameter of Case:	1¾" maximum
Terminals:	Flattened & pierced
Contact	DPDT — Model 2A
Arrangement:	4PDT — Model 4A
Contact Material:	Fine silver to molybdenum
Operation:	Simultaneous operation, simultaneous release, no contact bounce
Pull-in-power (Coil):	¾ watt — Model 2A ½ watt — Model 4A

Test Data and Literature on Request
Built-in Dependability



NORTH QUINCY 71, MASSACHUSETTS

Want more information? Use post card on last page.

PRODUCTION TECHNIQUES

(continued)

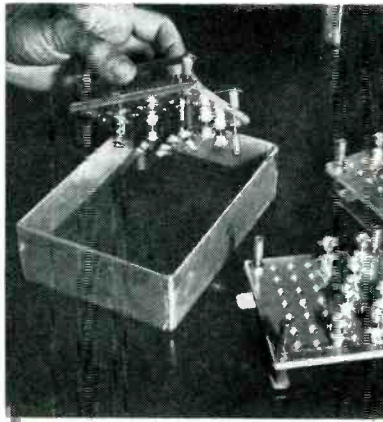

Dipping loaded fixture into varnish pan. Adjustable legs control depth of immersion

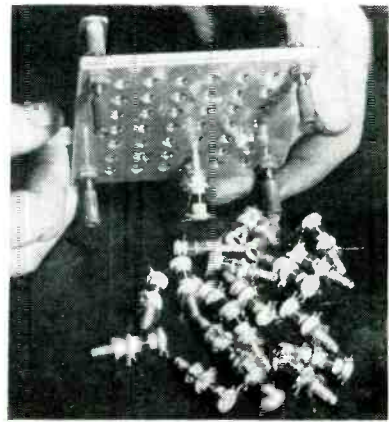

After baking, side tabs of fixture are pressed as shown, releasing all coils at once

tray of varnish, thus dipping the coils. The legs at the corners of the device can be adjusted to insure that the coils are dipped in the varnish to the correct depth.

After dipping, the fixture, still holding its coils, is placed in an

oven for baking. Once placed in the fixture the coils are not handled individually until the varnishing operation is complete. The final operation is removing the fixture from the oven and releasing the varnished coils.

Three-at-a-Time Grommet-Inserting Tool

RUBBER GROMMETS are loaded three at a time into the core bar for an auto radio tuner with the aid of a simple lever-operated fixture in the Camden, N. J. plant of Radio Condenser Co. The operator places a core bar over the positioning pins of the fixture, then moves the operating lever to bring the grommet-pulling fingers forward through the

holes of the core bar of the tuner.

Next, the operator places a grommet on each set of fingers and pushes the lever back to retract the fingers. Each grommet is held between two fingers, one being an extension of the shaft and the other being loosely pivoted to the shaft. As the grommet-holding fingers are retracted, the holes in the core bar

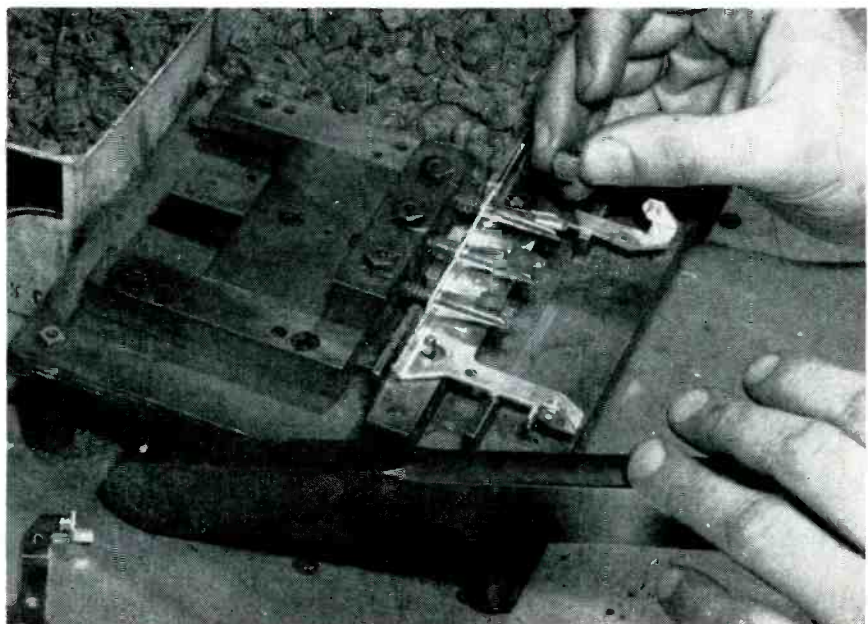

Appearance of fixture with two grommets loaded on fingers. Operator is preparing to place third grommet on remaining set of fingers

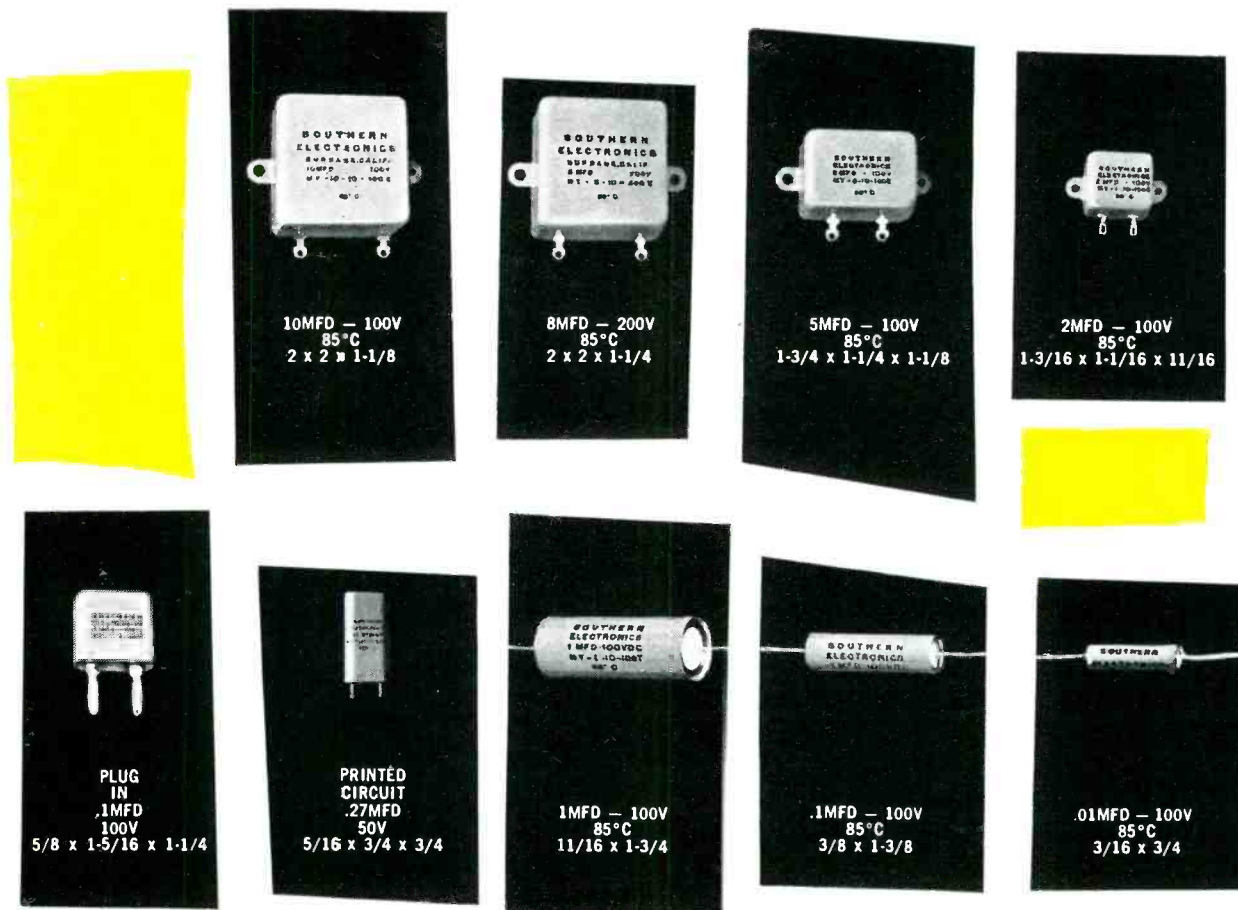

At last!
Mycon Plastic
Capacitors
up to 150° C!

- *Reliability proved*
- *Rated for infinite long life*
- *Insulation resistance 1×10^{11} OHMS*

Wire, write or phone for complete catalog today!

SOUTHERN ELECTRONICS
Corporation

239 West Orange Grove Ave., Burbank, California
 PIONEERS IN CUSTOM CAPACITOR ENGINEERING

Derated at 125°C as follows:

- 100 volts — 50%
- 200 volts — 50%
- 300 volts — 33⅓%
- 400 volts — 33⅓%
- 500 volts — 20%
- 600 volts — 16%

Tested and proved! Only Southern Electronics Corporation has developed a test procedure which insures built-in reliability! For your most exacting requirements—be sure—always specify S.E.C.

SUPER MYCON CAPACITORS
 Tolerance to 1%—lowest temperature coefficient. Superior insulation resistance at high ambient temp. Good stability compatible with material.



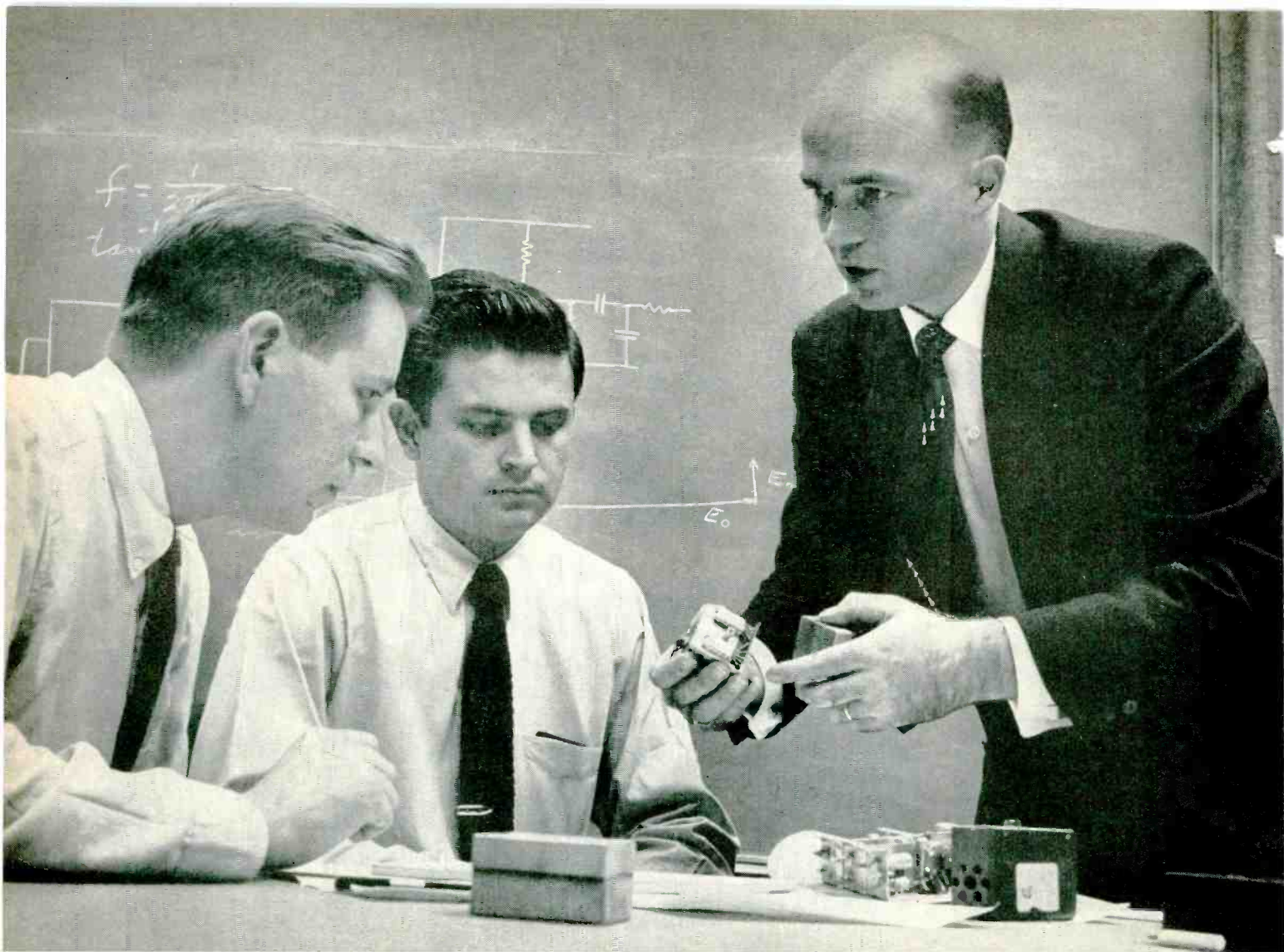

George L. Larse (right), Group Engineer, Instrumentation and Development, discusses development of high performance FM sub-carrier oscillators for application in advanced telemetry systems with Electronic Research Engineers Hans Becker (left) and Jay Cox.

ELECTRONIC SYSTEMS FOR GUIDED MISSILES

Continuing advances in guided missiles require electronic systems possessing ever faster, more accurate perceptions and reactions. Problems faced by missiles engineers and scientists grow constantly in magnitude and complexity.

At Lockheed Missile Systems Division, Electronic Systems and Components Engineers receive the broadest possible responsibility in fulfilling their assignments. New activities have created positions in a wide range of areas, including:

- Command guidance involving development and application of radio frequency communication, pulse circuitry and control devices.
- Data transmission and telemetry involving development and application of antennas, transducers, VHF transmitters and receivers.

- Automatic data processing equipment requiring analog-to-digital conversion, and electronic and magnetic storage devices.

Those possessing a high order of ability in both systems and component development are invited to write. Inquiries should be addressed to the Research and Engineering Staff at Van Nuys, California.

Lockheed

MISSILE SYSTEMS DIVISION
LOCKHEED AIRCRAFT CORPORATION
VAN NUYS • PALO ALTO • SUNNYVALE
CALIFORNIA

NATIONAL AERONAUTICAL AND NAVIGATIONAL ELECTRONICS CONFERENCE

Dayton, Ohio • May 14-15

The field of missile systems is literally a new technology. No field of science offers greater scope for achievement.

Engineers and physicists will be interested in new developments at Lockheed Missile Systems Division.

A. A. Daush and senior members of the technical staff will be available for consultation at the Dayton Biltmore Hotel. For interview phone Adams 2161.

NEW RESEARCH CENTER ANNOUNCED

Plans for new research laboratories at Stanford University's Industrial Park, Palo Alto, California, have been announced by Lockheed Missile Systems Division. Construction is underway.

Lockheed

MISSILE SYSTEMS DIVISION

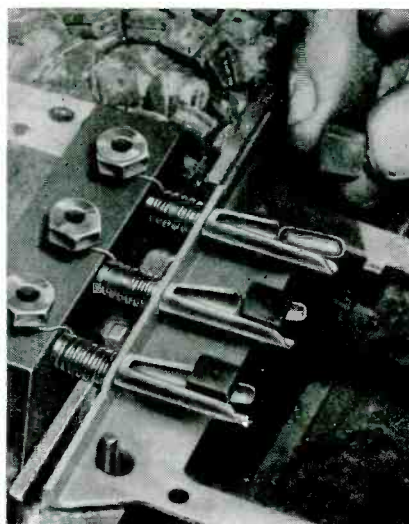

Upper left: Details of grommet-holding fingers. Upper right: Pushing lever back as shown pulls grommets into holes of core bar. Enlarged view below shows that grommets are here just about ready to snap into position in their holes



force the pivoted fingers closer to the fixed fingers, thereby increasing the grip on the grommets. This squeezes each grommet in such a way that when a grommet reaches the core bar, its groove goes into position on the upper half of each hole. Further retraction of the fingers then pulls the grommet the rest of the way into its hole, after which the fingers slide out easily.

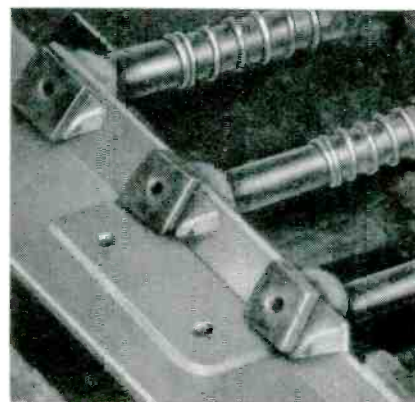

Solder-Loaded Grinder Tins Ceramics

AN UNUSUAL new technique which permits soldering such materials as aluminum, stainless steel, glass and ceramics without special equipment has been developed by Joseph C. McGuire of the University of California's Los Alamos Scientific Laboratory. It requires, in addition to

the usual soldering materials, only a hand grinder with an abrasive wheel that has been loaded with solder. The technique eliminates the usual firing of silver on ceramics.

► **Loading the Wheel**—The grinder is turned on and the abrasive wheel (preferably preheated by grinding metal or applying heat) is brought to bear on a soft solder such as Wood's metal or 60-40 lead-tin solder. The soft solder melts and flows onto the surface of the wheel. This wheel is then used to do the actual tinning.

A medium-grit grinding wheel $\frac{1}{4}$ inch in diameter and $\frac{1}{2}$ inch long, mounted on a $\frac{1}{8}$ -inch-diameter shaft, was used. The size is not critical, but a wheel of this kind seems best. Several wheel compositions have

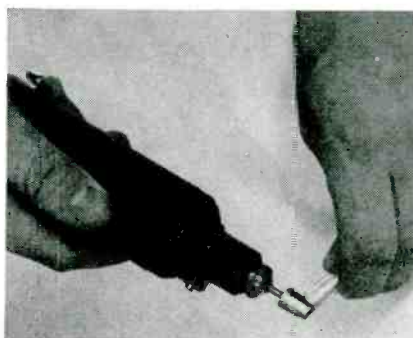

Method of loading grinding wheel with Wood's metal

Your Precision Parts can have these Highly- Developed Properties

PRODUCTION TECHNIQUES

(continued)



PROPERTIES AVAILABLE IN DIAMONITE	
Composition	to 97% Al ₂ O ₃
Tensile Strength	to 28,500 p.s.i.
Modulus of Rupture	to 49,500 p.s.i.
Compression Strength	to 500,000 p.s.i.
Impact Resistance	.23 / .25 Izod
Specific Gravity	to 3.82
Pore Volume	less than 1%
Softening Temperature	1850°C
Thermal Conductivity	.02-cal/sec/cm ² /cm/°C.
Average Co-efficient Thermal Expansion	cm/cm/°C 25°/700°C 7.3x10 ⁻⁶
Volume Resistivity,	250°C 2.0x10 ¹⁴
Ohms per CM ³	500°C 1.3x10 ¹¹
Te Value	
Vol. Res.=1 megohm	over 1,100°C
Dielectric Constant	
K @ 25°C	10 ¹⁰ ~ 8.77
Dielectric Loss	
Factors	25°C 10 ⁸ ~ .0009
Hardness	Mohs 9+
Water Absorption*	Absolute Zero
Thermal Shock	
Resistance†	over 1,000°C



(Illustrations of parts approximately half size)



Using loaded wheel to tin piece of stainless steel

by specifying **DIAMONITE** high alumina ceramics

The Diamonite Products Division of U. S. Ceramic Tile Company has been developing and producing high alumina ceramics for all types of industrial applications since 1941. With the advent of need for better materials in electronics, Diamonite pioneered in supplying high-quality precision high alumina parts in a wide range of shapes and sizes to meet the stringent requirements of the industry.

Forecasting the future of this unique material in electronics, Diamonite's ceramic and electronic engineers are currently working with leading manufacturers in the electronics field in meeting their requirements of the future.

You are invited to make use of this service.



products division

U. S. CERAMIC TILE COMPANY
Canton 2, Ohio

been tried; all seemed equally good.

Two types of grinders have been used—the standard Handy-Grinder and the Dumore with fixed motor and flexible shaft. The Handy Grinder is operated at slightly reduced speed from a Variac at 80 to 100 volts. It is low-powered, but reaches high speeds if allowed to run free. The Dumore is higher-powered and lower in speed, but is less easy to use in a confined space.

The tinning alloy is applied to the grinder in bar form. The warm grinder head and the heat of friction will deposit a liquid film of metal. If this process is repeated two or three times, a fairly heavy coat of tinning alloy is built up. There seems to be a definite conditioning period for a new grinder head. Once a good deposit is built up, it is very easy to renew the layer after each tinning use.

► **Tinning** — The solder-loaded wheel is applied to the surface to be soldered until a slight amount of abrasion has taken place. The pressure applied is the same as ordinarily used in grinding. The heat of friction again melts the soft solder,

International

Selenium Photo-Cells and Sun Batteries

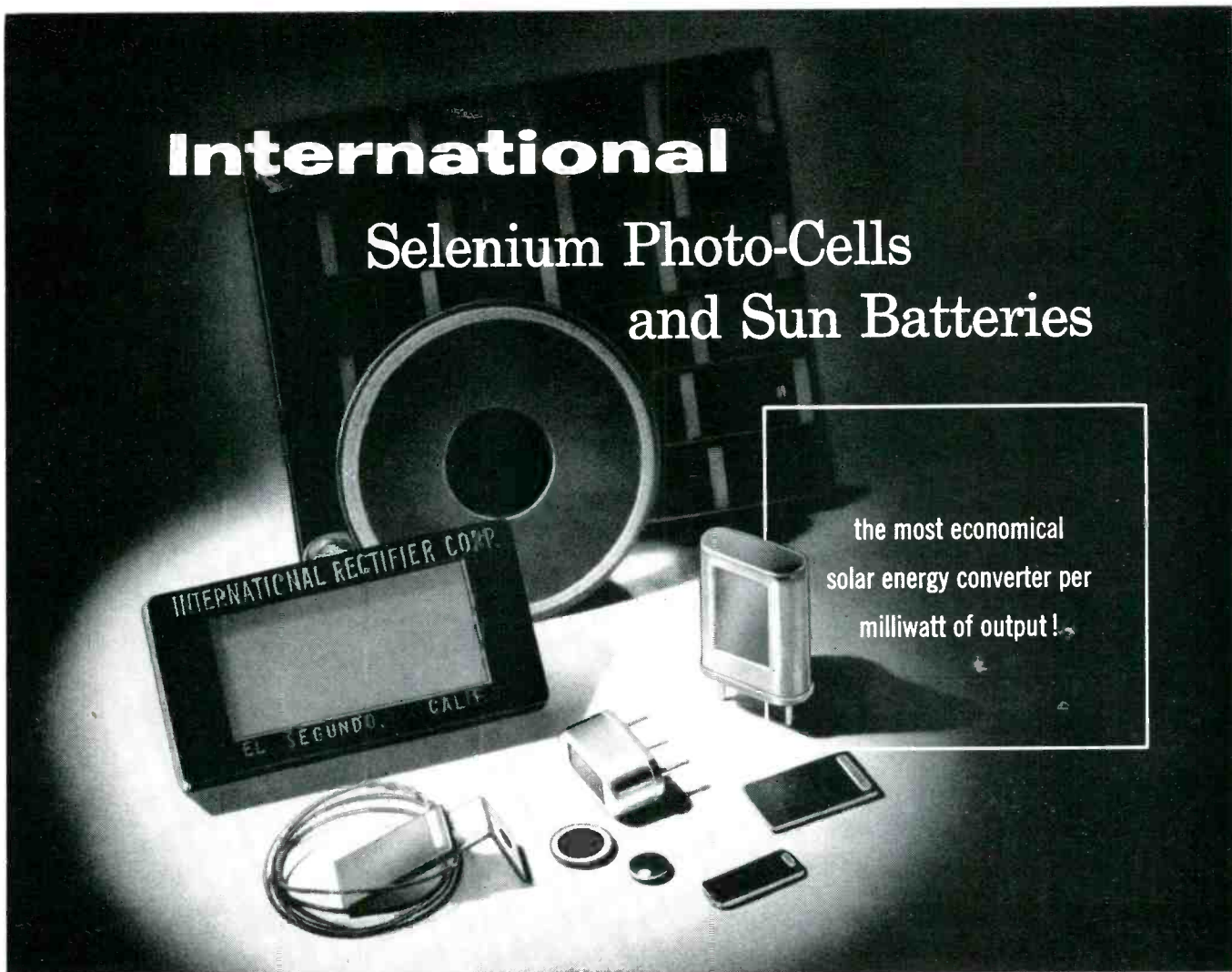

the most economical
solar energy converter per
milliwatt of output!

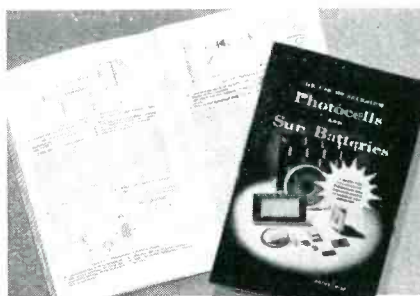

Write for the new
72 Page booklet entitled
**"The Use of Selenium Photocells
and Sun Batteries"**

This handbook, of interest to scientists, engineers and experimenters, contains the basic theory and typical applications of photovoltaic cells. Copies are available for \$1.50 from our Product Information Dept.

For over 8 years, International Rectifier Corporation has been a recognized leader in the development and production of high quality selenium photoelectric cells for industrial applications. Drawing from 15 years experience in this field, International's research engineers have pioneered many of the recent advancements in the field devoted to the conversion of solar energy to electrical power. The resulting selenium sun batteries now available provide performance equal to any type of solar energy converter commercially available to industry today, *at a cost up to 50% below that of units utilizing other generating materials!*

International Rectifier Photo-Cells and Sun Batteries are available in a wide variety of sizes, mounted or unmounted. Hermetically sealed units can be supplied to operate

submerged in liquids or for outdoor applications where protection from corrosion is required. When applied and mounted properly, International's photovoltaic cells provide virtually unlimited life expectancy, evidence no irreversible fatigue or aging.

Whatever your application, from light measurement and control devices of all types to supplying power for transistorized equipment, you will find the most economical unit to specify is an International Photovoltaic cell.

For complete technical data on incident illumination intensity ranges, spectral response, ambient temperature range, etc., write on your letterhead to the Product Information Department for bulletins on all types of photocells available.



A WORLD OF DIFFERENCE ... THROUGH RESEARCH

International Rectifier

C O R P O R A T I O N

EXECUTIVE OFFICES: EL SEGUNDO, CALIFORNIA · PHONE OREGON 8-6281

NEW YORK: 132 E. 70TH ST., TRAFALGAR 9-3330 · CHICAGO: 205 W. WACKER DR., FRANKLIN 2-3889

IN CANADA: ATLAS RADIO CORP., LTD., 50 WINGOLD AVE. W., TORONTO, ONTARIO, RU 1-6174

THE WORLD'S LARGEST SUPPLIER OF INDUSTRIAL METALLIC RECTIFIERS.

LAPP COOLING

GIVES LONGER LIFE TO HIGH-POWER TUBES



WATER-COOLED

Carrying cooling water which must undergo a change in potential is a job best handled by Lapp Porcelain Water Coils. These coils are completely vitrified, non-absorbent porcelain, white glazed inside and out, providing very low resistance to water flow and eliminating all possibility of contamination in the water. Assuring positive cooling and long tube life, a Lapp Porcelain Water Coil installation represents a permanent investment—a completely trouble-free cooling system.

AIR-COOLED

Use of Lapp standard-design tube supports facilitates circuit design, improves production economy, provides interchangeability and easy replacement. They are compact, efficient and attractive in appearance, with polished nickel-plated brass hardware permanently attached to the body. Equipment manufacturers will realize a triple service from these supports, for they support the tubes and act as an insulator, and channel air over the fins for maximum cooling of tubes.

WRITE for Bulletin 301 containing complete description and specification data. Lapp Insulator Co., Inc., 900 Sumner Street, Le Roy, New York.



Lapp

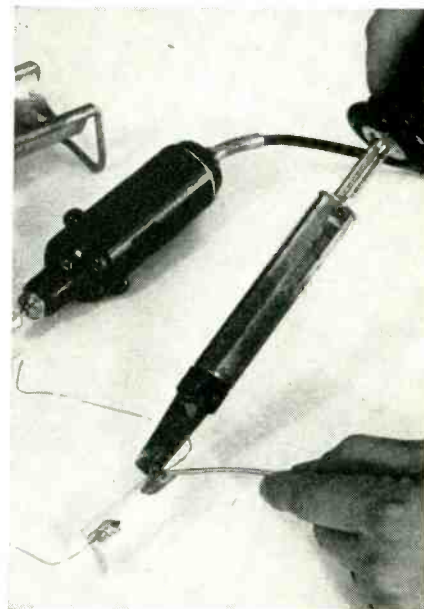

Soldering copper wire conventionally to previously tinned ceramic tube

which flows onto the freshly abraded surface and forms an intimate contact.

When using the Handy-Grinder and Variac combination, the grinder will slow down. This gives a good limit to the pressure applied because with excessive pressure the grinder will stop. If possible, the work should be warmed, preferably to the melting temperature of the tinning alloy (about 80 C). This may be done by applying a hot soldering iron to the area. The grinder head is passed back and forth over the spot to be tinned, to remove the oxide layer of the metal and replace it with solder. The tinning layer will be laid down as a shiny spot or strip and will have little ridges of excess alloy following the wheel as it moves.

► **Soldering**—After the tinning operation, soldering is done in the usual manner with standard 50-50 lead-tin solder. The other surface is also given the new treatment if it is a material not ordinarily wetted by solder. No soldering flux, surface cleaning or pretreatment is used.

The solder is applied to the tinned surface with a soldering iron, but an effort should be made to keep the hot iron from the subsurface layer of base metal. In other words, either heat the joint by applying

130 C

Vac-u-Sel

75 C

ORDINARY RECTIFIERS

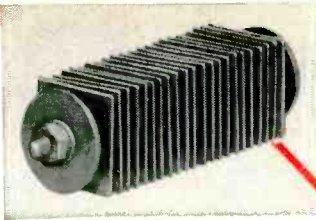

FOR HIGH TEMPERATURE APPLICATIONS such as mobile radios, G-E Vac-u-Sel rectifiers have given outstanding service. Unlike ordinary rectifiers limited to 75C, the G-E Vac-u-Sel rectifier will operate dependably at full rating up to 130C ambient . . . and at no price premium.

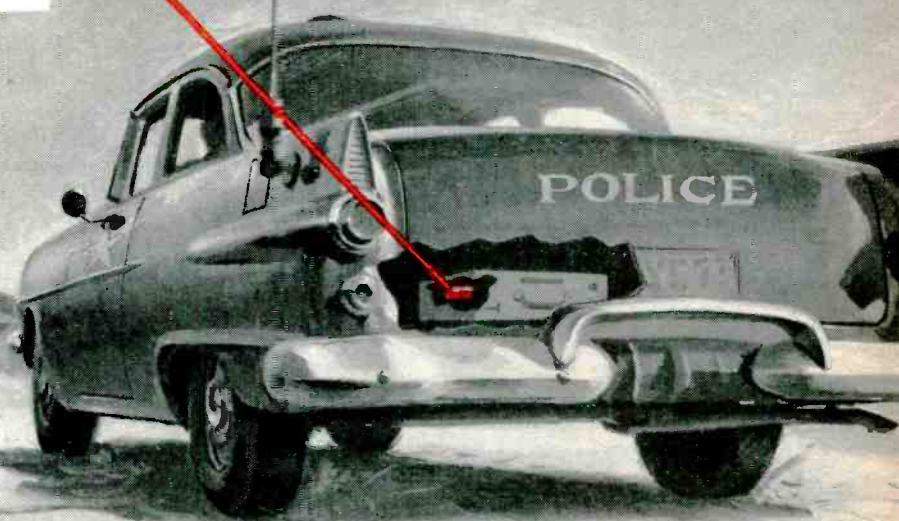

DESIGNED FOR HIGH-TEMPERATURE OPERATION . . .

G-E *Vac-u-Sel** Stacks Rectify at 130C; Cost No More Than Ordinary Rectifiers

Where temperatures are soaring and conditions rugged, General Electric Vac-u-Sel rectifiers continue to deliver dependable operation.

DEPENDABLE OPERATION IN HIGH AMBIENTS is a characteristic of Vac-u-Sel rectifiers made possible by the exclusive manufacturing process described below. This process results in a rectifier that operates successfully at 130C ambient at full voltage and current . . . **without derating**. To operate under these conditions, ordinary selenium rectifiers must be derated. This high-temperature characteristic is available in Vac-u-Sel rectifiers at no extra cost.

WHEN DESIGN SPACE IS AT A PREMIUM, the high-temperature 45-volt Vac-u-Sel stack is your best buy. Its higher voltage rating means that fewer cells can be used than with lower-rated cells. The 45-volt stack will operate at 110C ambient at full voltage and current with a life expectancy of over 1000 hours.

For further information, contact your nearest G-E Apparatus Sales Office, or write for bulletin GEA-6273 to: Section 461-43, General Electric Co., Schenectady 5, N. Y.

Vac-u-Sel is the trade-mark of the General Electric Co. It designates top-quality selenium rectifiers manufactured by an exclusive sphere-type vacuum-evaporation process by

the Rectifier Department, headquarters for silicon, germanium, selenium, and copper-oxide component rectifiers.

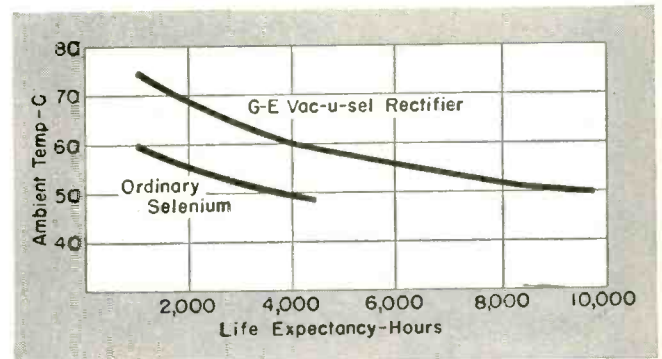

These curves show how a G-E Vac-u-Sel rectifier which is operating at twice normal current, will outlast an ordinary selenium stack operating at only normal current. This explains how a smaller, less expensive G-E rectifier can be used to match performance of ordinary rectifiers.

Progress Is Our Most Important Product

GENERAL ELECTRIC

MAGNETIC METALS COMPANY

*electromagnetic
cores and shields*

For all magnetic shielding requirements

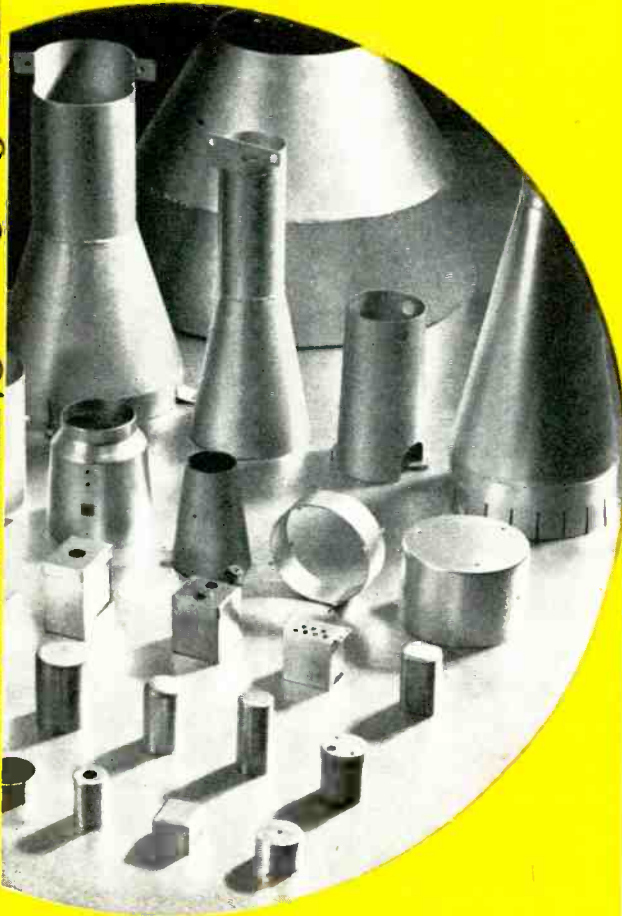

▪ To assist you in achieving high magnetic shielding efficiency, Magnetic Metals Company produces a wide variety of shielding structures to accommodate conventional transformer and tube assemblies. Shields are fabricated in cylindrical, conical or rectangular shapes, in nested or multilayer design of all commercial high permeability alloys. Magnetic Metals Company is prepared to consult on special applications requiring unusual design.

▪ A new bulletin is now available which presents valuable data on magnetic shielding and lists dimensions of standard shields. We invite you to write for Bulletin F-1.

MAGNETIC METALS COMPANY
HAYES AVE. at 21st ST. • CAMDEN, N.J.

the hot iron to some adjacent part of the metal which is not tinned, and then apply the solder in wire form directly to the tinned surface, or apply the solder to the iron and bring the hot drop of solder down to the tinned area without bringing the iron into actual physical contact with the base metal. This is particularly important when soldering titanium, niobium and tantalum.

► **Selecting a Solder**—When working with such materials as soft glass, Pyrex and ceramics, the best

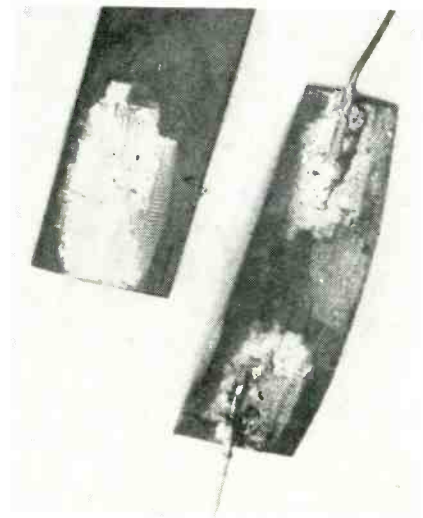

Closeup of grinder-tinned specimen of stainless steel and specimen of tantalum to which copper wires were soldered after tinning

tinning is accomplished with a mixture of Wood's metal and 50-50 indium-tin solder. However, when soldering glass to glass or ceramic to ceramic, it is necessary to use flame or furnace heating to get enough heat to the surfaces to be joined. The two surfaces need not be of the same material. Metals, soft glass, Pyrex and ceramics may be soldered in any combination.

Many of the low-melting alloys, ranging from 40 to 140C in melting point, seem to work in the tinning operation. Solders used include 40-60 and 50-50 lead-tin, 50-50 tin-indium and 50-50 lead-indium.

The 50-50 tin-indium solder may be applied easily to Pyrex glass without the usual degreasing and heating cycles. Once applied, it will take the higher-melting-point solders, for a surprisingly firm joint.

Ordinary solders probably can-

Now available—a complete line of improved insulating laminates with **Du Pont MYLAR[®]**

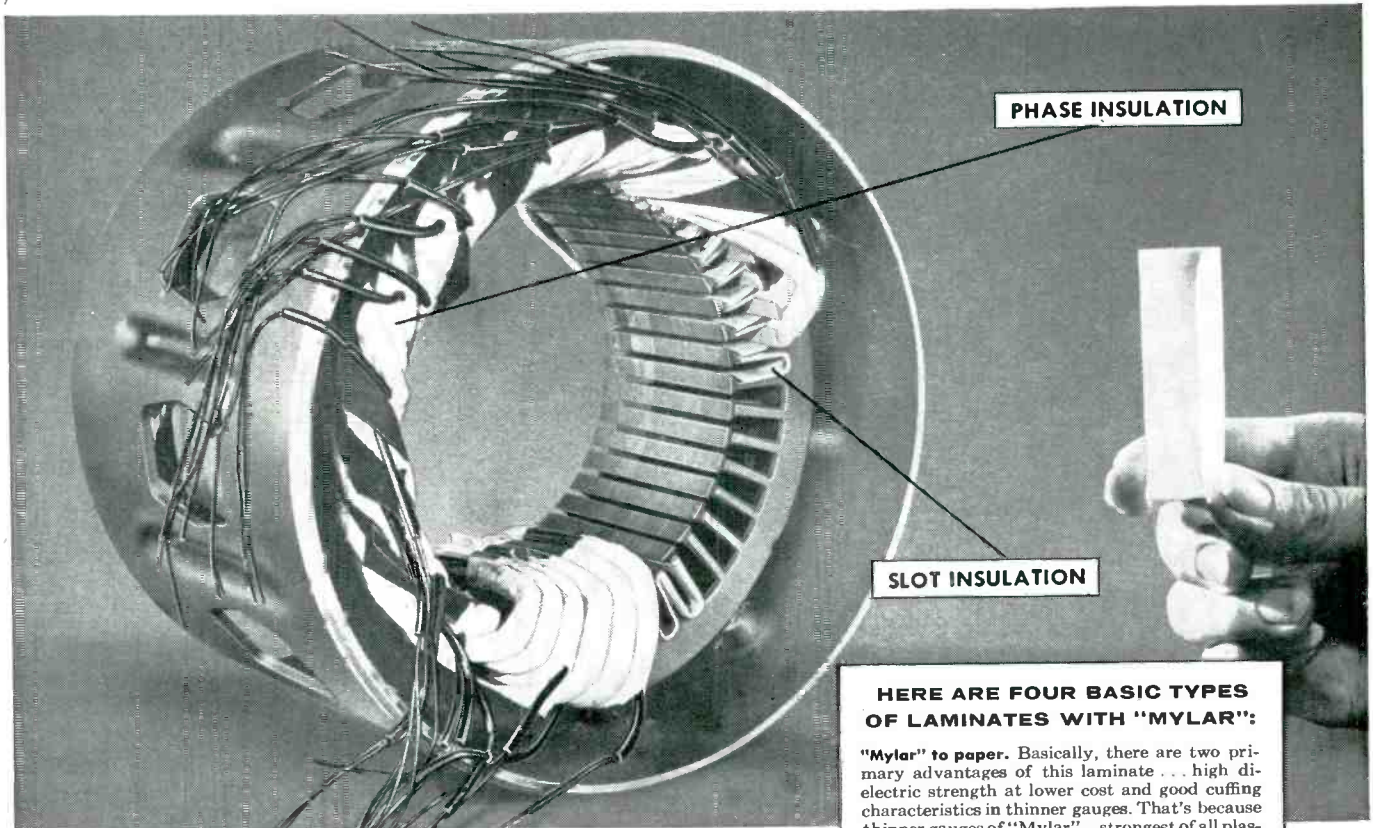

**HERE ARE FOUR BASIC TYPES
OF LAMINATES WITH "MYLAR":**

"Mylar" to paper. Basically, there are two primary advantages of this laminate . . . high dielectric strength at lower cost and good cuffing characteristics in thinner gauges. That's because thinner gauges of "Mylar"—strongest of all plastic films—can be used.

"Mylar" to glass cloth. Because "Mylar" remains dimensionally stable from -60° to 150° C., "Mylar" laminated to glass cloth offers superior insulation at both high and low temperatures. In addition to high flexibility, this laminate has good forming characteristics in thinner gauges.

"Mylar" to asbestos. Excellent for motors and generators operating in the Class "B" temperature range. Coated asbestos laminated to this tough polyester film produces a stronger product with increased moisture resistance.

"Mylar" to mica. This laminate offers *maximum* insulation plus flexibility. In short, mica is easier to work with when laminated to "Mylar". Costs are lower too because thinner gauges of mica can be used . . . Du Pont "Mylar" gives the mica "body."

Du Pont "Mylar"* polyester film is now available for a wide variety of electrical insulating uses, some of which are illustrated above. These laminates offer superior performance . . . make possible important space savings. That's because laminates with "Mylar" provide exceptionally high dielectric strength and heat stability . . . plus remarkable resistance to moisture and many chemicals.

While those types listed on the right are basic, there are numerous other combinations of "Mylar" available, depending on specific needs. So check your supplier today. It will pay you to investigate the new combinations of "Mylar" in his line. Or send in the coupon below for names of converters who manufacture electrical laminates with "Mylar". Be sure to mention the specific application you have in mind.

*Du Pont manufactures the basic material "Mylar"—not finished electrical laminates. "Mylar" is Du Pont's registered trademark for its brand of polyester film.



BETTER THINGS FOR BETTER LIVING . . . THROUGH CHEMISTRY

DUPONT[®]
MYLAR[®]
POLYESTER FILM

E. I. du Pont de Nemours & Co. (Inc.), Film Dept., Room E-5
Nemours Bldg., Wilmington 98, Delaware.

Please send your new booklet (MB-5) featuring "Mylar" polyester film in motors plus names of converters who manufacture laminates with "Mylar".

Application _____
Name _____
Firm _____
Address _____
City _____ State _____

not be used for the tinning operation on glass and ceramic materials. Wood's metal plus 50-50 indium-tin has been found best for this, with ordinary solder being used for the actual soldering. (Indium-tin alloy is known commercially as Cerro-Seal and is available from: Sterling Products Co., 121 N. Jefferson Blvd., Chicago 6, Ill.; Pick Steel Co., 4436 Long Beach Avenue, Los Angeles, California; Cerro de Pasco Copper Corp., 40 Wall St., New York, N. Y. Wood's metal is available from scientific supply houses such as Central Scientific, Baker, Fisher and Sargent.

► **Problems**—A soldering iron will not supply enough heat through a poor conductor such as glass to make a good glass-to-glass joint in large or thick pieces. With respect to glass and ceramic, this technique is most satisfactory for fastening electrical connections and similar light work. The process is not intended for fastening problems that might better be handled by one of the good glues.

Failure to deposit a satisfactory coating with Wood's metal on glass indicates that the wheel was too cold when loaded or was not completely loaded with Wood's metal. If rotational speed is too high the Wood's metal will be laid down as a black deposit on the glass and the solder will not adhere. The speed should then be cut down until

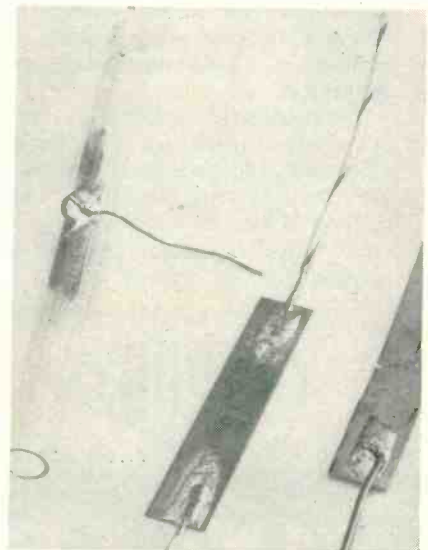

Examples of connections made on grinder-tinned Pyrex glass, titanium and molybdenum



Radar probes . . .

with no margin for component failure

G-V Thermal Relays and Thermostats provide the reliability which designers of radar must have to assure the dependable performance of their equipment. Throughout the entire field of electronic and aircraft equipment, the products of G-V Controls Inc. are known for sound design and reliable performance.



G-V Hot Wire Time Delay Relays
1/10 to 5 seconds with fast recovery

G-V Thermal Time Delay Relays
Adjustable delays of 2 to 300 seconds

G-V Voltage & Current Sensing Relays
For circuit protection

G-V Electrical Thermostats
Hermetically sealed, still adjustable

A well-qualified G-V Representative is ready to serve you. Write for data.

G-V CONTROLS INC.
24 Hollywood Plaza, East Orange, N. J.



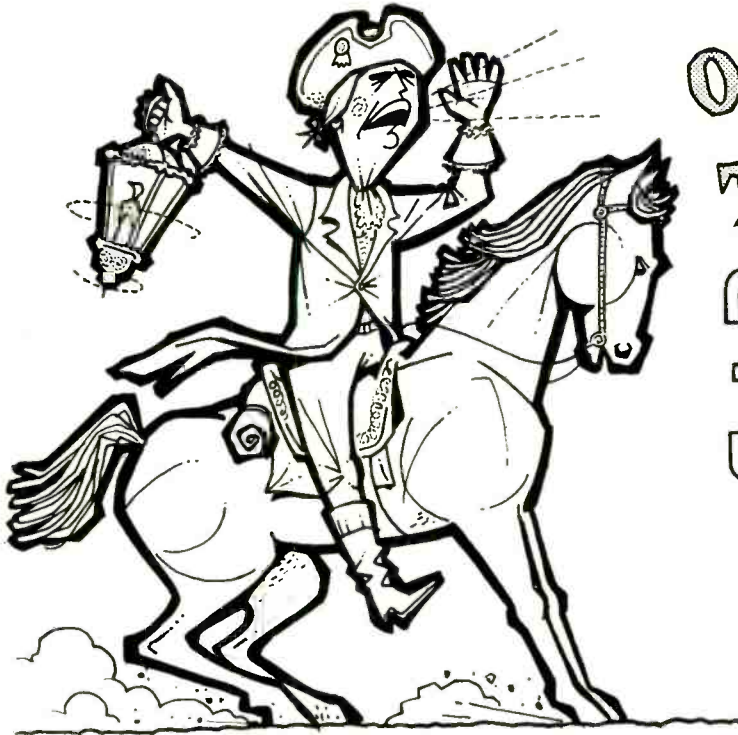

ONE IF BY LAND...
TWO IF BY SEA...

38*
IF BY AIR!

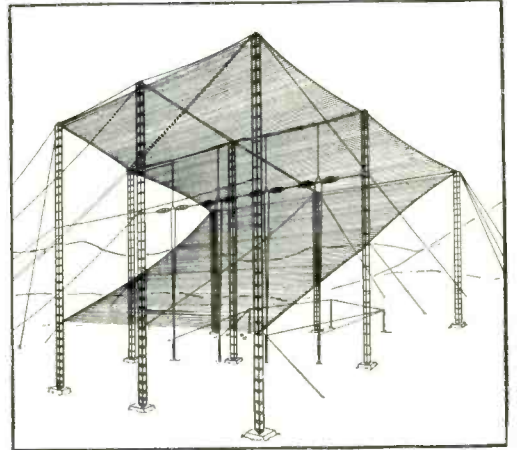

TOWER'S DEW LINE INSTALLATIONS GUARD US AROUND THE CLOCK

Paul Revere had a snap when it came to warning the countryside of impending attack. A fleet-footed horse, a feeble lantern or two, and a sharp eye cocked seaward were all that he needed to alert an infant nation's defenses. Today, danger moves swiftly on lightning wings, from any direction. Our security is measured not with an hour glass . . . but with a stop watch!

TOWER designed, fabricated and erected major elements of the Distant Early Warning (DEW) line spanning the frigid wastes of northern Canada. Instant warning of any aerial attack is flashed from this radar barrier to assure our nation of those precious extra seconds.

Write for free illustrated booklet

TOWER

CONSTRUCTION CO.
Sioux City, Iowa

*tower
fabricators
and erectors
the world
over*

*fictitious figure . . . actual number is classified information

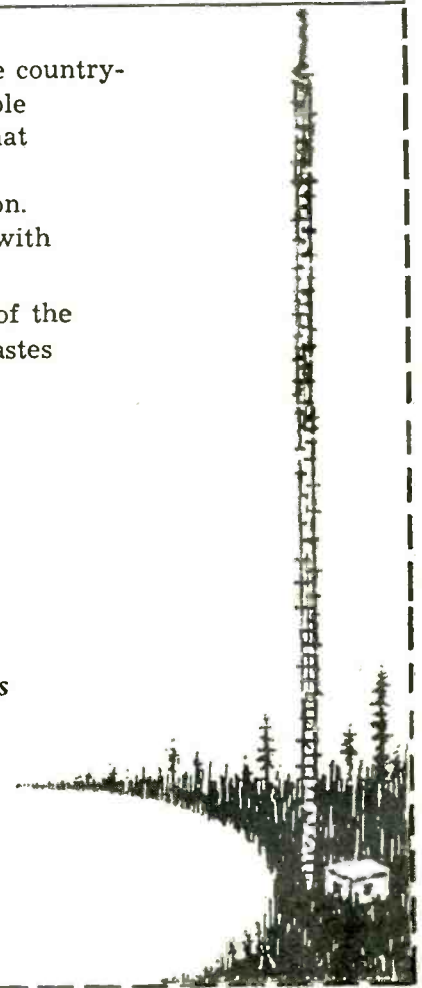

“...p-h...p-h-i...
here it is”
PHILLIPS



Shop-talk among engineers in various industries is spreading the good news about the *Phillips Plan*—a special combination of engineering skill* and personal service. To put the skids under a sluggish relay problem, contact Phillips. Write us, or call your local Phillips man for prompt consultation.

* **FOR EXAMPLE:**
Phillips Engineered Relays meet the highly critical requirements of radar tracking equipment,

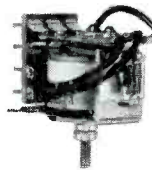

TYPE 13 QA/TYPE 13AC — Power relay, five pole, single stud mounting. O.D. 1-3/8" W x 1-3/16" H x 15/16" W. AC and DC.

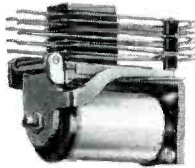

TYPE 3QA — Multi-contact relay, using short coil for economy in size and weight. O.D. 1-1/4" W x 2-1/2" L.



40006 TYPE 4 — Enclosed relay. Octal plug. O.D. 1-5/8" diameter x 2-19/64" H.

a shiny coating can be deposited. The black deposit will also appear if there is grease or oil on the glass.

Experience with materials such as aluminum, stainless steel and tantalum helps develop the technique for more difficult materials. Aluminum is particularly good to start with.

Socket-Holding Tool

INSTALLATION of the high-voltage rectifier tube socket deep inside the insulation ring of the 25,000-volt capacitor on a color-tv chassis is achieved efficiently with the aid of a unique socket-holding tool in RCA's Bloomington, Ind. plant. A screwdriver shaft is bent at right angles, the bit is sawed off, and a metal equivalent of a tube base is brazed to the end of the shaft. The base was made up by sawing off a section of metal cylinder, drilling a central hole through it for the screwdriver shaft, then drilling four smaller holes partly through at appropriate positions for inserting four tube pins that fit into the

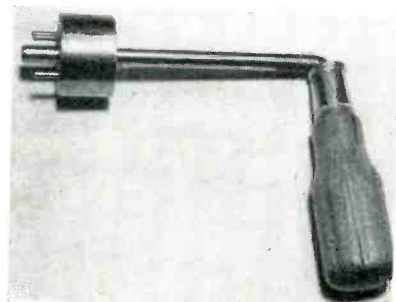

Construction of socket-holding tool

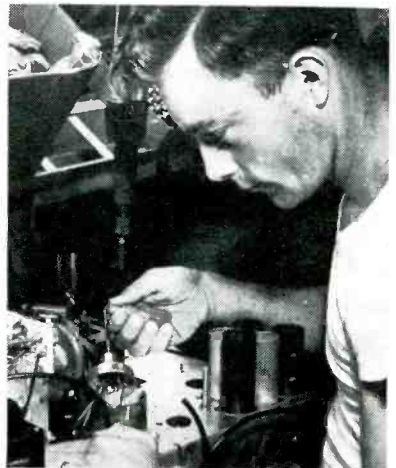

Method of using tool to lower socket into insulating ring after leads have been attached

MULTI-CONTACT, POWER, HERMETICALLY SEALED RELAYS - ACTUATORS

PHILLIPS

A THOR CORPORATION SUBSIDIARY

PHILLIPS CONTROL CORPORATION . . . JOLIET, ILLINOIS

SALES OFFICES: NEW YORK - PHILADELPHIA - SAN FRANCISCO - DENVER - SEATTLE
SANTA MONICA - CLEVELAND - DALLAS - BOSTON - WASHINGTON

NEW

NATVAR ISOGLAS® TUBING FILLS THIS GAP

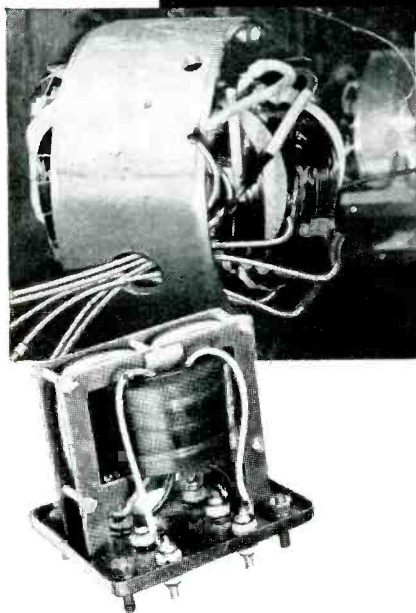

Isoglas tubing is ideal for protecting leads of motors, transformers and other apparatus for continuous operation at 150°C. Where conventional types of coated tubing and sleeving are vulnerable to abrasion or cracking from rough production handling, the exceptional toughness of Isoglas virtually eliminates failures. Potting presents no problems because the film shows no softening or loss of continuity after 15 minutes at 435°F.

Natvar Isoglas tubing—tubular glass braid coated with a newly developed isocyanate type resin—has outstanding

- resistance to heat
- resistance to crazing and cracking
- resistance to solvents including the askarels
- toughness and abrasion resistance
- wet dielectric strength
- low temperature flexibility
- fungistatic qualities

°C
CONTINUOUS OPERATING
TEMPERATURE

— 180°
CLASS H

— 150°

— 130°
CLASS B

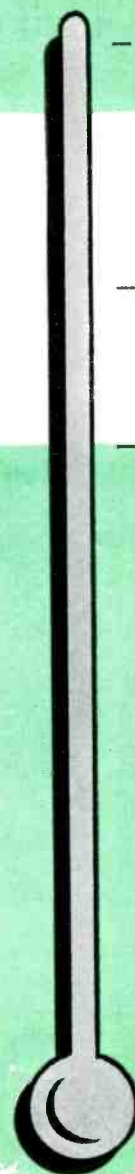

NATVAR Isoglas may now be used with great savings by making it unnecessary to use expensive Class H materials to solve temperature problems during the manufacture of products which do not require Class H rating.

Full technical data and samples are available on request.

NATVAR CORPORATION

FORMERLY THE NATIONAL VARNISHED PRODUCTS CORPORATION

TELEPHONE

RAHWAY 7-8800

CABLE ADDRESS

NATVAR: RAHWAY, N. J.

201 RANDOLPH AVENUE • WOODBRIDGE, NEW JERSEY

Natvar Products

- Varnished cambric—cloth and tape
- Varnished canvas and duck
- Varnished silk and special rayon
- Varnished—Silicone coated Fiberglas
- Varnished papers—rope and kraft
- Slot cell combinations, Aboglas®
- Isoglas® sheet, tape, tubing and sleeving
- Vinyl coated—varnished—lacquered tubing and sleeving
- Extruded vinyl tubing and tape
- Styroflex® flexible polystyrene tape
- Extruded identification markers

Ask for Catalog No. 23

transistor and digital computer techniques

APPLIED TO THE DESIGN, DEVELOPMENT
AND APPLICATION OF

*AUTOMATIC RADAR DATA PROCESSING,
TRANSMISSION AND CORRELATION
IN LARGE GROUND NETWORKS*

Engineers & Physicists

Digital computers similar to successful Hughes airborne fire control computers are being applied by the Ground Systems Department to the information processing and computing functions of large ground radar weapons control systems.

The application of digital and transistor techniques to the problems of large ground radar networks has created new positions at all levels in the Ground Systems Department. Engineers and physicists with experience in the fields listed, or with exceptional ability, are invited to consider joining us.

FIELDS INCLUDE

TRANSISTOR CIRCUITS • DIGITAL COMPUTING NETS •
MAGNETIC DRUM AND CORE MEMORY • LOGICAL DESIGN •
PROGRAMMING • VERY HIGH POWER MODULATORS AND
TRANSMITTERS • INPUT AND OUTPUT DEVICES •
SPECIAL DISPLAYS • MICROWAVE CIRCUITS

*Scientific
Staff Relations*

HUGHES

RESEARCH
AND DEVELOPMENT
LABORATORIES

Culver City, Los Angeles County, California

Want more information? Use post card on last page.

PRODUCTION TECHNIQUES

(continued)

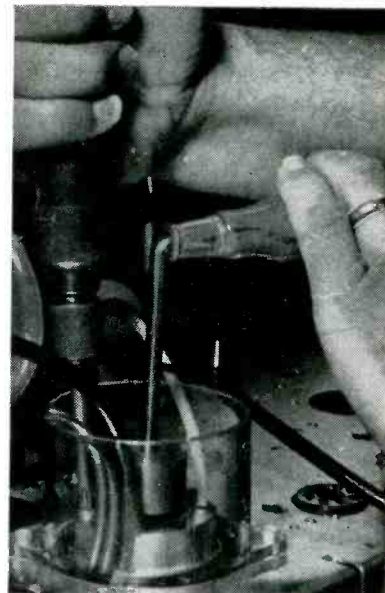

Inserting Phillips screw with air gun to anchor socket while holding it in position with tool

socket that is to be installed.

Assembly involves hooking the chassis leads to the tube socket terminals and soldering them while the socket is held outside the insulating ring. The tool is then plugged into the socket and used to position the socket down inside the ring. While holding the socket down, two Phillips screws are inserted with an air gun to mount the socket on the capacitor assembly. The bit of the driving tool is magnetized to hold the screws as they are lowered inside the ring. This technique eliminates the awkward if not almost impossible problem of positioning and holding the socket with fingers deep down inside the ring.

Shaft-Spinning Setup

PINION SHAFTS are spun onto clutch plates for auto radio tuners in a simple setup requiring only a holding fixture for the shaft, in the Camden, N. J. plant of Radio Condenser Co. The fixture has a convenient wood handle attached to one end. The operator loads a shaft into a hole drilled partly through the fixture to a precisely determined depth, places a disk over the necked-down end of the shaft and brings the spinning tool down over the shaft by pushing a foot pedal. After spinning, the fixture is opened, the assembly is

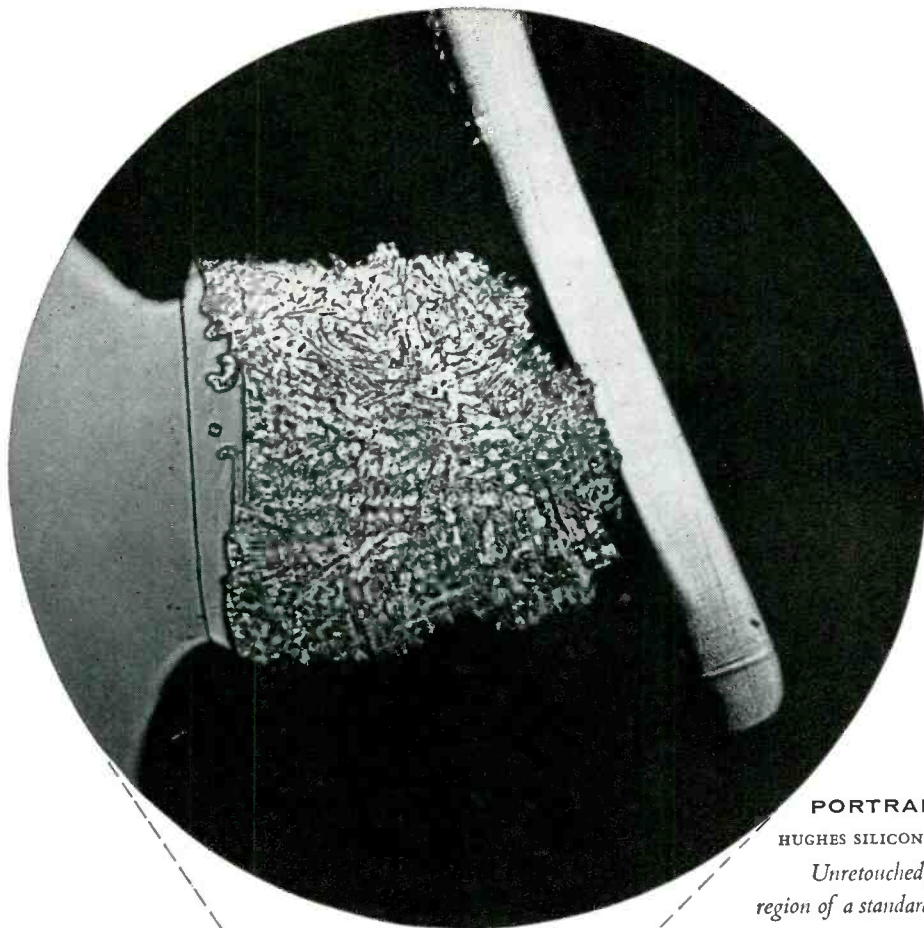

PORTRAIT OF RELIABILITY

HUGHES SILICON JUNCTION DIODES

Unretouched photomicrograph of the junction region of a standard Hughes Silicon Junction Diode. A cross section, taken at 220 magnification.

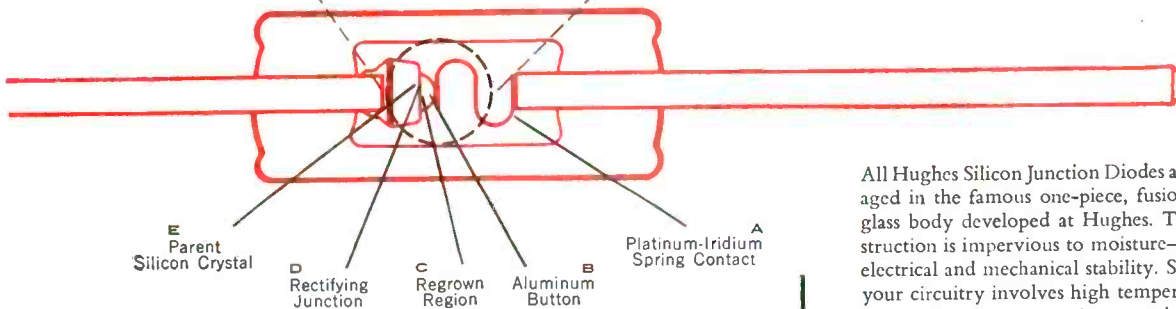

E Parent Silicon Crystal
 D Rectifying Junction
 C Regrown Region
 B Aluminum Button
 A Platinum-Iridium Spring Contact

RELIABILITY YOU CAN SEE

In this cross section (made from a standard, non-selected production specimen), renowned Hughes quality is clearly visible. (A) The platinum-iridium whisker makes firm, positive contact with the aluminum button. (D) The rectifying junction is clean, sharp, and straight. (E) The parent silicon crystal is free from strain-induced cracks, fissures or blemishes around the junction. Such meticulous workmanship gives microscopic evidence that, in semiconductors, HUGHES QUALITY means HIGHEST QUALITY.

**Characteristics rated at 25° C and at 150° C.
 Ambient operating range, -80° C to +200° C.*

Actual size

****Dimensions, diode glass body: 0.265-inch by 0.105-inch, maximum.**

HUGHES PRODUCTS

A DIVISION OF THE HUGHES AIRCRAFT COMPANY

All Hughes Silicon Junction Diodes are packaged in the famous one-piece, fusion-sealed glass body developed at Hughes. This construction is impervious to moisture—ensures electrical and mechanical stability. So, when your circuitry involves high temperature or high back resistance requirements, be sure to specify Hughes Silicon Junction Diodes. Available now, at lower prices, in nine different standard and several special types. And, as always, they are First Of All... For RELIABILITY!

FEATURES:

- High Temperature Operation**
- Extremely High Back Resistance*
- Very Sharp Back Voltage Breakdown*
- Excellent Forward Conductance*
- Subminiature Size***
- Exceptionally Stable Characteristics*

For descriptive product information, please write:

HUGHES



**SEMICONDUCTORS
 HUGHES PRODUCTS**

*International Airport Station
 Los Angeles 45, California*

© 1956, H. A. C.

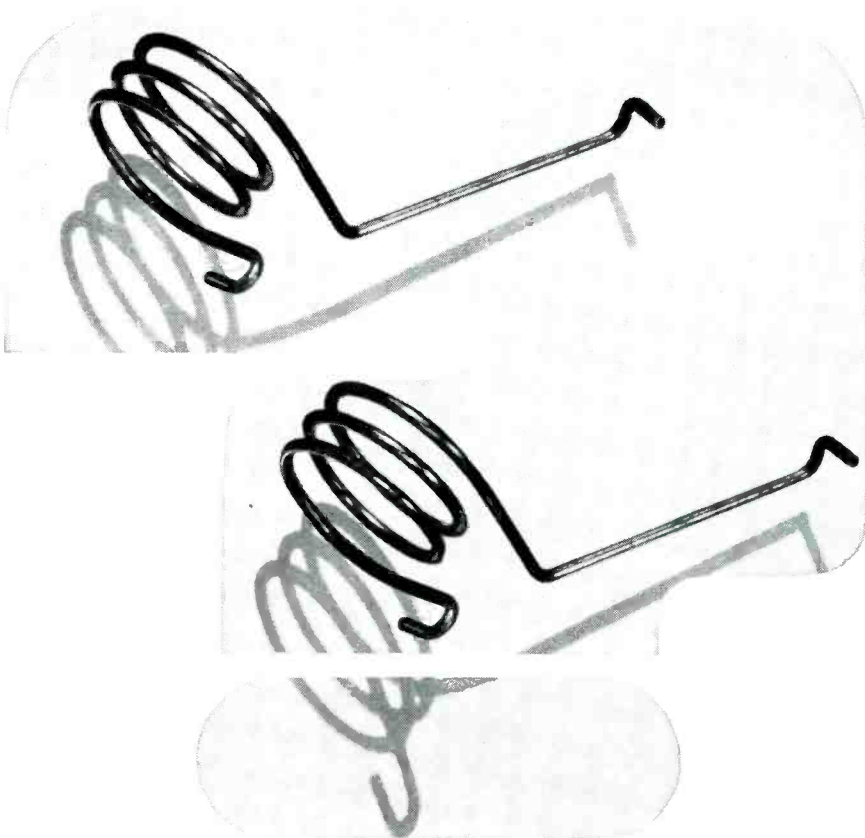

Which Spring Costs More . . . and Why?

■ These springs look identical—and one will work as well as the other, yet one costs more. The higher cost spring was the product of time consuming engineering effort, plus a demand for unnecessary close tolerances and secondary production operations. The other was the simpler, low cost result of Lewis engineering experience and production know-how.

Lewis engineering experience is one of many “extras” you get when you make Lewis your source for springs. Whether it’s help in spring design, packaging springs for efficient assembly line handling, or simply a case of getting top quality springs at competitive prices—call on Lewis .

LEWIS SPRING & MANUFACTURING COMPANY
2656 W. North Avenue, Chicago 47, Illinois

Lewis  **PRECISION SPRINGS**

The finest light springs and wireforms of every type and material



Operator prepares to bring holding fixture into position for reloading after steel shaft has been spun over clutch plate

lifted out, tossed down a chute into a tote box and the process is repeated.

The pinion shaft need only slide loosely in and out of the holding fixture, since pressure during spinning prevents the shaft from turning.

Air-Leak Gages Check Potentiometer Casings

MACHINED aluminum casings for precision potentiometers are checked for size and concentricity in Fairchild's Hicksville, N. Y. plant with special gages giving fast readings to an accuracy of tenths of a thousandth of an inch. This per-

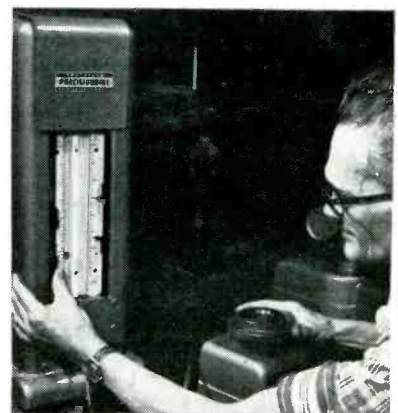

Setting tolerance slides of indicator with master cup in position on gage



SYMBOLS OF ENGINEERING FORESIGHT



Built-in Weston dependability pays off in many ways

Two valid reasons have established WESTON instruments as the designer's choice for all "built-in" requirements. *To equipment buyers* a WESTON on the control panel instantly establishes a conviction of rigid specifications and sound engineering sense. *For equipment manufacturers* WESTON dependability continues to work after the equipment is sold. Assuring a true check on operating conditions, it protects the device itself, and the reputation of its builder.

Weston panel instruments are available in types, sizes and ranges for all electronic or electrical "built-in" needs. Also in a complete line of *ruggedized* meters for a-c and d-c requirements. For information, or engineering cooperation, consult your nearest WESTON representative or write direct. Weston Electrical Instrument Corporation, 614 Frelinghuysen Avenue, Newark 5, N. J. A subsidiary of Daystrom, Incorporated.

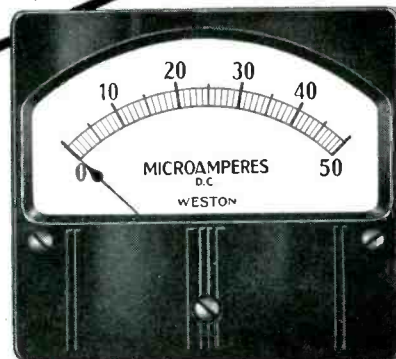

PANEL
INSTRUMENTS
by
WESTON

BALLANTINE Sensitive, Wide Band Electronic Voltmeter

measures 1 millivolt to 1000 volts
from 15 cycles to 6 megacycles

Accuracy 3% to 3 mc; 5% above
Input impedance 7.5 mmfds shunted by 11 megs

When used without probe, sensitivity
is increased to 100 MICROVOLTS but
impedance is reduced to 25 mmfds
and 1 megohm

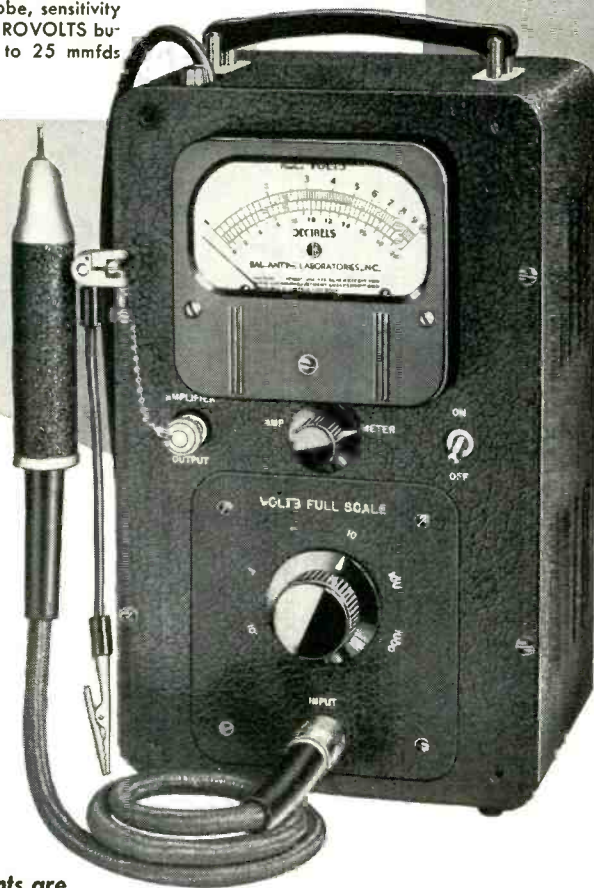

MODEL 314
Price \$285

All Ballantine instruments are

SENSITIVE — ACCURATE — DEPENDABLE

- Same accuracy at ALL points on a logarithmic voltage scale and a uniform DB scale.
- Only ONE voltage scale to read with decade range switching.
- No "turnover" discrepancy on unsymmetrical waves.
- Easy-to-use probe with self-holding connector tip and unique supporting clamp.
- Low impedance ground return provided by supporting clamp.
- Stabilized by generous use of negative feedback.
- Can be used as 60 DB high fidelity video pre-amplifier.

Write for catalog for more information about this and other
BALLANTINE voltmeters, amplifiers, and accessories.

BALLANTINE LABORATORIES, INC.

100 FANNY ROAD, BOONTON, NEW JERSEY



Placing casing on air-leak gage used to
check inside diameter of shoulder



Gage used for checking outside diam-
eter of cup

mits 100-percent inspection of in-coming casings, to give the accuracy of fit required for precision linear potentiometers. The indicator for both gages is a Sheffield Precisionaire column instrument calibrated to read directly in thousandths of an inch.

One gage measures the inside diameter of a machined shoulder that is only $\frac{1}{32}$ inch long inside the casing. The operator merely places the casing over the gage and notes the reading. Two spring-loaded segments on the gage move out against the shoulder of the casing. The positions of these segments control the amount of air that leaks through the gage. This leakage varies linearly with the positions of the segments, hence a measurement of leakage air pressure gives the desired check on dimensions.

The gage is set up initially by placing a precisely machined master in position. The sliding indicators

"ATMO SEAL CAME TO OUR RESCUE...THERE'S JUST NO OTHER WAY TO SAY IT!"

SPENCER CUNNINGHAM, *President . . . Medical Research Institute, Cincinnati, Ohio*



**ATMO DEVELOPS NEW
HERMETIC SEALING UNIT
FOR ELECTRONIC
THERMA-METER!**



"For over a year and a half we had been attempting to solve the problem of an adequate sealing terminal unit for our new electronic Therma - Meter (electric thermometer for medical use.)

Actually there were three problems:

1. Use of plastic fusion materials resulted in moisture pockets between the two electrodes, causing a short.
2. Moisture seeped down into the probe housing, also causing shorts.
3. The plastic proved breakable in repeated tests.

Then Atmo Seal Company came into the picture and solved the problem with their highly effective, perfectly tooled glass fusion unit."

IF YOUR COMPANY USES HERMETIC TERMINALS IN MODERATE QUANTITIES ATMO OFFERS YOU SPECIAL ADVANTAGES!

- Highly Qualified Design Assistance
- Competitive Prices
- Excellent Service
- Highest Quality Production

For Prices and Delivery on Standard Seals or Custom-Design Assistance, Write, Wire or Phone Today!

ATMO SEAL COMPANY
3475 - 3479 Cardiff Avenue
Cincinnati 9, Ohio
PHONE: ELmhurst 1-5512

RING-MOUNTED

PRECISION-BUILT

MINIATURE FAN UNITS

**400 CYCLE
Variable
Frequency**

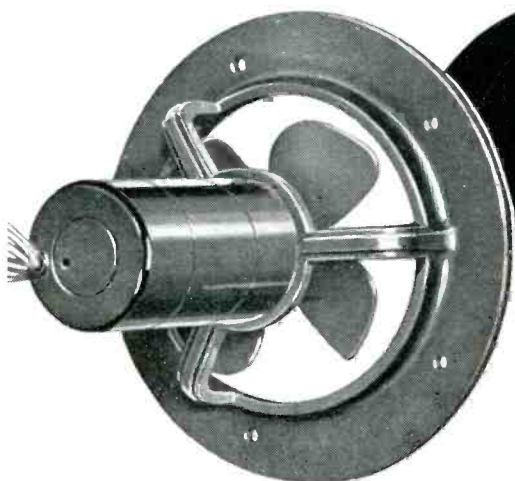

EAD's ring-mounted fans are designed for quick, easy installation in avionic and electronic equipment. Designed for peak performance, compactness, and versatility, these units utilize blade diameters as small as 2"—with air delivery greater than many heavier blowers. These fan units, using motor sizes from 1" to 2" in diameter, are designed to meet your most rugged conditions. There is a ring-mounted fan for your requirements. Write for complete technical and performance data.

REPRESENTATIVE UNITS

Air Delivery at 0" S.P.	Air Delivery at .5" S.P.	Blade Dia.	Voltage	Frequency	Input (Watts)	Phase Data	Basic Type Numbers
180	145	3 1/4"	115	400	90	1	F4H92H
65	30	3"	115	400	15	1	F2HIT
32	15	2"	115	400	10	1	F2H90U

EASTERN AIR DEVICES, INC.

SOLVING SPECIAL PROBLEMS IS ROUTINE AT EAD



387 CENTRAL AVENUE • DOVER, NEW HAMPSHIRE

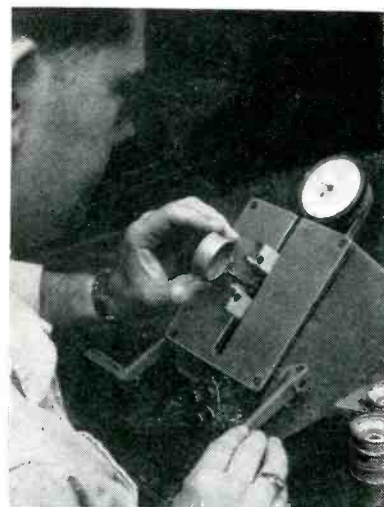

Gage used with conventional dial indicator for checking inside diameter deep in cup of precision potentiometer

on the column instrument are then set to the positions corresponding to 0.003-inch tolerance above and below the position of the float that rides up and down in the air column. An ordinary 90-lb shop air line is used, with the pressure being reduced to about 25 lb by a built-in filter and reducer in the instrument.

Another gage used with the same indicator checks the outside diameter of a lip on the aluminum casing. Here the part being checked is passed between a fixed guide and the movable air-leak segment.

The inside diameter deep down in the casing is checked with a three-button setup connected to a conventional Federal dial indicator that reads in tenths of thousandths of an inch. Two of the three buttons are movable. A lever on the side of the fixture is used to move the buttons together for loading a casing in position. When the lever is released, the buttons move out under spring loading and the position of the measuring button is indicated on the dial. Readings can be obtained here just as fast as the operator can move the crank and insert the cups to be measured.

**Production-Floor
Cable Rack**

CHEATER cords, signal generator leads, loading blocks and other cables used at test and alignment positions on RCA's color television

Stability

beyond a doubt



FIXTOHM^{*}
PRECISION RESISTORS

**When you want stable non-inductive resistors,
you want "FIXTOHM," because:**

TOLERANCE . . .

Plus/minus 1% tolerance, standard. ½%, 2% or 5% can be furnished.

TEMPERATURE COEFFICIENT . . .

Negative temperature coefficient of resistance between 0.02% and 0.05% per degree C. temperature change (200 to 500 PPM), depending on resistor style and ohmage. FIXTOHM resistors are approved under MIL-R-10509A, Characteristic X.

VOLTAGE COEFFICIENT . . .

Based on resistance readings at 1/10 full

rated continuous working voltage, not exceeding 0.002% per volt.

NOISE LEVEL . . .

At rated voltage, excluding thermal noise, less than 0.3 microvolt per volt.

H.F. CHARACTERISTICS . . .

Inductive and capacitive reactions extremely small and normally can be neglected. Approximate shunt capacitance, less than 0.6 micro-micro-farads.

POWER RATING . . .

½, ¼, ½, 1 and 2 watts.

Write for detailed literature. Let us quote on your deposited-carbon precision resistor requirements.

*Reg. U. S. Pat. Off.

CAMPBELL INDUSTRIES, INCORPORATED, 3806 ST. ELMO STATION, CHATTANOOGA 9, TENN.

A subsidiary of CLAROSTAT MFG. CO., INC., Dover, New Hampshire

✓ **LOW TIME JITTER**

✓ **HYDROGEN RESERVOIR**

are TOP features you'll find in these NEW
HYDROGEN THYRATRONS



6587

For pulse outputs of 2 megawatts — at an average power level of over 1.6 KW.

by *Kuthe*

5957/E-37B

For pulse outputs of 350 KW — at an average power level of more than 400 watts.

Outstanding for compactness, ruggedness, long life and dependability . . . in network discharge service

The new 6587 and 5957/E-37B are advanced developments of Kuthe . . . foremost producer in the field.

Both types include an internal hydrogen reservoir across the filament . . . to produce and maintain constant hydrogen pressure . . . to increase the life of these high-quality tubes.

Low time jitter and the power rat-

ing of the 6587 make this type ideal for Moving Target Indicator applications.

The 5957/E-37B, a rugged, miniaturized version of the 4C35 (with 30% of its volume) is especially suited for compact airborne systems.

For complete engineering data, write to Kuthe, Dept. W-113.

Principal Electrical-Mechanical Data and Ratings:

	6587	5957/E-37B
Heater voltage	6.3 volts $\pm 7.5\%$	6.3 volts $\pm 7.5\%$
Heater current	11 amperes	6.5 amperes
Reservoir	Conn. across Htr.	Conn. across Htr.
Minimum heating time	3 minutes	3 minutes
Over-all length	7.25" max.	4.375" max.
Greatest diameter	2.56" max.	1.56" max.
Peak anode v. forward	16 kv max.	8.0 kv max.
Peak anode current	325 amps. max.	83 amps. max.
Average anode current	225 ma. max.	100 ma. max.
Operation factor	3.9×10^9	2.5×10^9
Maximum τ_{ad}	0.60 μs	0.50 μs
Maximum Δt_{ad}	0.10 μs	0.10 μs
Maximum t_j	0.005 μs	0.01 μs

"World's Largest Manufacturer of Hydrogen Thyratrons"

Kuthe Laboratories, Inc.

An Associate of

INTERNATIONAL TELEPHONE AND TELEGRAPH CORPORATION
730 South 13th Street • Newark 3, N. J. • Blgelow 2-6000



Method of placing signal cable on rack

assembly line in Bloomington, Ind. are stored in neat plywood racks right on the floor when not in use. These tall, shallow racks fit up against the ends of test benches so as not to obstruct aisle space.

Threaded rods running through the backboard in appropriately spaced groups of two support the cables. Nuts at the front and rear of the backboard hold the rods in position. The threads here serve the added function of gripping the connectors, making it practically impossible for cables to fall out.

Jumper-Inserting Head for Assembly Machine

SPOOLED bare wire is automatically converted into U-shaped jumpers that are inserted in punched holes in etched wiring boards and clinched underneath, at one of the



Details of wire feed mechanism

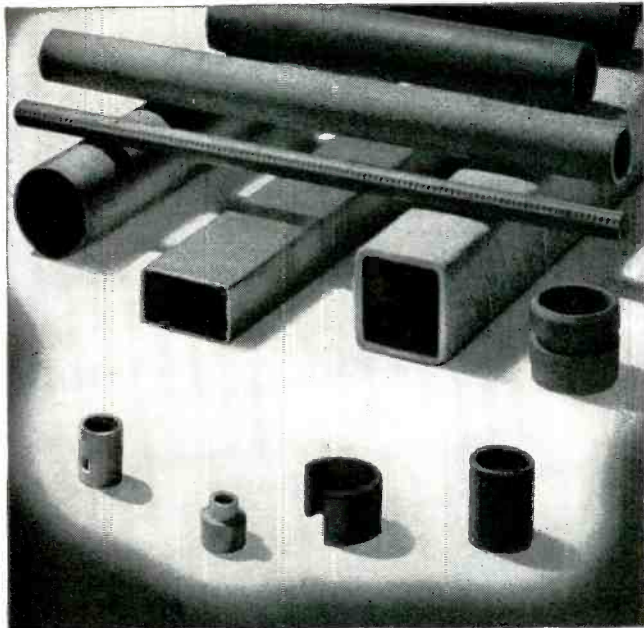

C-D-F SPIRAL TUBING offers many advantages to the cost-conscious design engineer and purchasing agent. It is low-cost, moisture-resistant, high-strength, and easy to fabricate. It has sufficiently low dielectric loss properties and good dielectric strength for many applications.

New C-D-F Plastic Spiral Tubing reduces unit costs, improves products

Using C-D-F's new Spiral Tubing is a way of saving money in buying electronic insulation . . . without lowering the electrical and mechanical characteristics of the part required. This special tubing is a high-strength plastic made from paper or vulcanized fibre that is spirally wound. It is available in two basic forms in various grades: (1) as plain untreated tubing. (2) as impregnated tubing containing various types of thermosetting insulating varnishes.

BUY ONLY THE PROPERTIES YOU NEED

Spiral Tubing can be used to replace rolled or molded laminated phenolic tubing in many cases. As the degree of moisture resistance and mechanical strength is established during the manufacturing process, you specify . . . and buy . . . only those properties required for the application. C-D-F also offers complete designing, machining and assembly. You can get finished components, or random length tubing, with fast deliveries. Write for Technical Folder ST-53 and samples, after checking our catalog in Sweet's Design File. Call the C-D-F sales engineer listed there—he can save you time and money immediately with C-D-F Spiral Tubing!



CONTINENTAL DIAMOND FIBRE

CONTINENTAL-DIAMOND FIBRE DIVISION OF THE BUDD COMPANY, INC.
NEWARK 16, DELAWARE

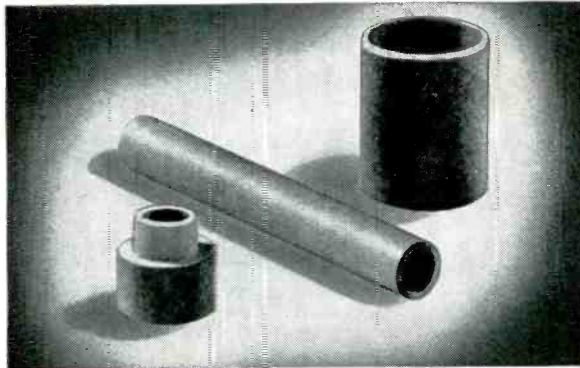

A VERY HARD TUBE is supplied in C-D-F Grade 6A. The parts shown have maximum mechanical strength, lowest water absorption rate under immersion conditions and most stable dielectric loss properties. Fine for bushings and cores.

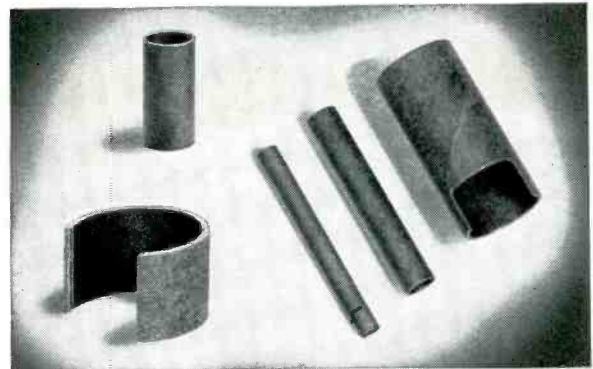

THIN-WALL SPIRAL TUBING has good concentricity and is tough. Note thin wall construction, cleanness of machining, variety of shapes. C-D-F Spiral Tubing is easily machined, formed, punched. Made in many grades for special applications.

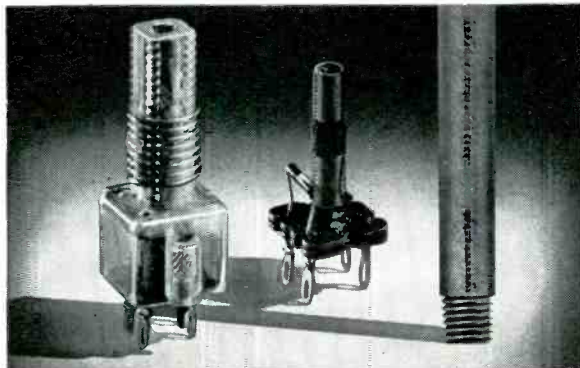

NEW CONSTANT TORQUE TUBING, for permeability tuning with iron cores, features exact internal threading with three point suspension of the core to prevent binding . . . no external embossing to lower dielectric strength. Write for samples.

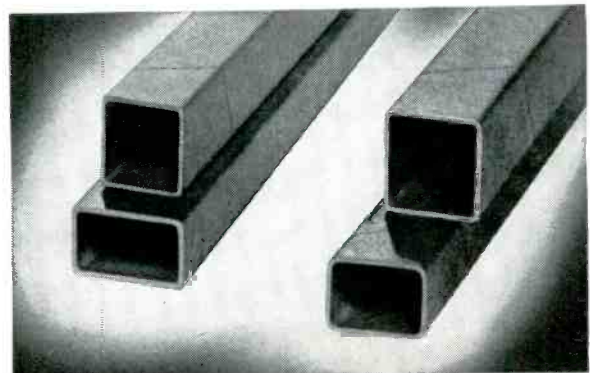

HARD OR SOFT, square or rectangular coil-form tubing is made for solenoid and transformer applications. Sides are straight with minimum gap in paper winding. Supplied in soft, varnished kraft, or hard, rigid tubing.

FOR SYSTEMS

see... **E E C O**

From a single-rack recording system to a multi-console data processing center, Electronic Engineering Company has the experience and personnel to design and produce the equipment you require. EECO design techniques, perfected over years of systems work, can be put to work for you in an EECO engineered system—freeing your own engineering staff for tasks specifically related to your products.

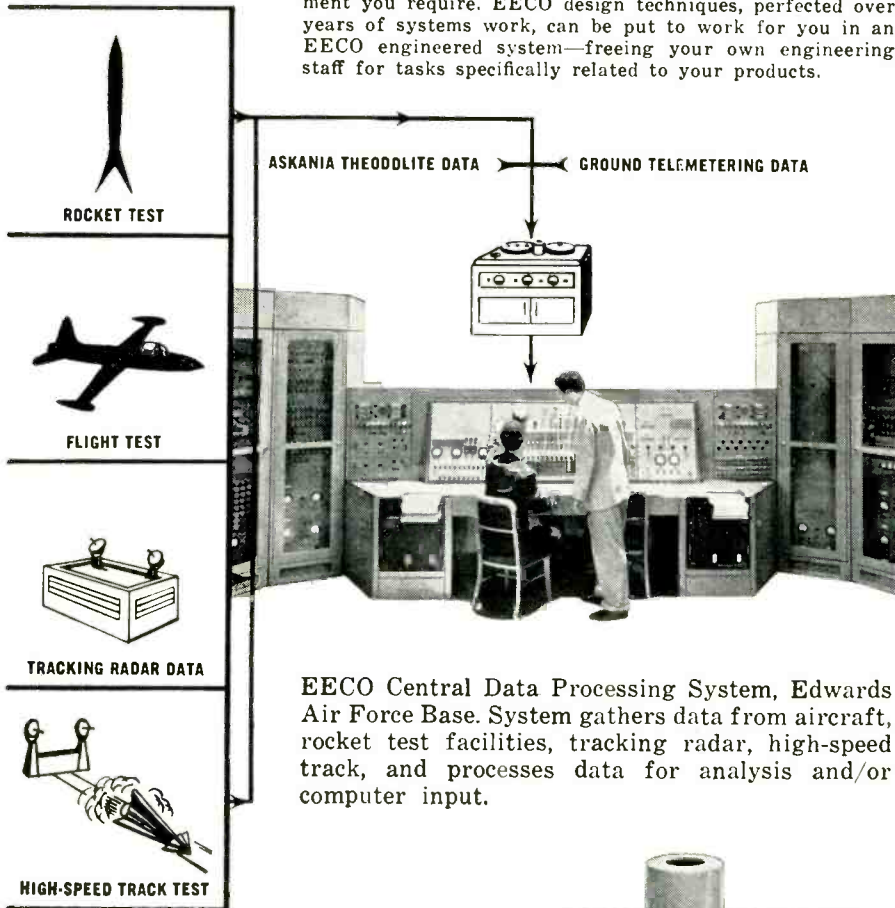

EECO Central Data Processing System, Edwards Air Force Base. System gathers data from aircraft, rocket test facilities, tracking radar, high-speed track, and processes data for analysis and/or computer input.

Plug-in Circuits

developed for EECO systems, provide a key to lower cost equipment design and fabrication.

Data on standard and custom circuits available in catalog G-2.



Electronic Engineers and Physicists

Interesting and challenging work in systems and related projects offers unusual employment opportunity at EECO. Send resume to the attention of R. F. Lander.



Electronic Engineering Company
of California

and its subsidiary

EECO Production Company

180 South Alvarado Street • Los Angeles 57, California

positions on the automatic assembly machine being used for table radio boards in Emerson's Jersey City plant. The manufacturer of the assembly machine and the new head for it is United Shoe Machinery Co. of Boston.

Insertion of jumpers is achieved with an action similar to that of a stapler. When the downward action of the inserting head drives in a jumper, a lever actuated by the descending head simultaneously cocks a spring on the wire feed mechanism. When the head retracts after insertion, an interlock enables this spring to advance the wire feed wheel a preset amount

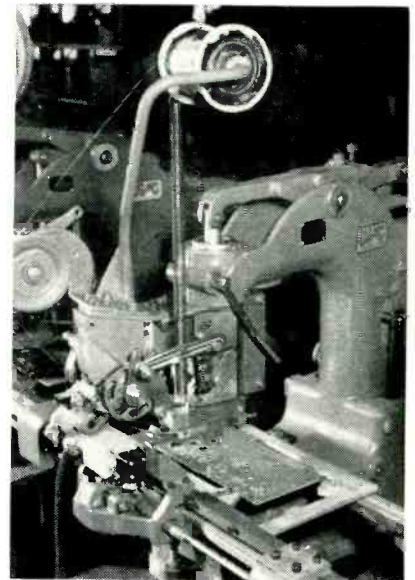

Jumper insertion head, showing wire supply reel at top and wire feed mechanism below. Table radio wiring board is positioned in pallet

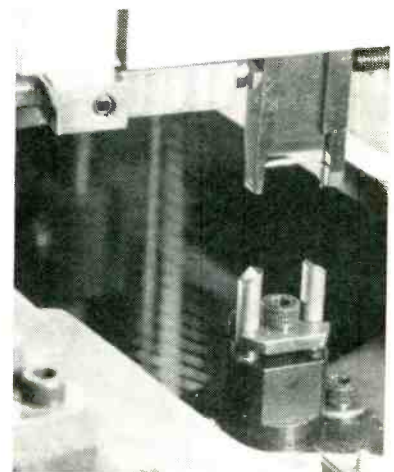

Close-up view of jumper-inserting head stopped half-way down, with wiring board removed to show lead-clinching anvils underneath

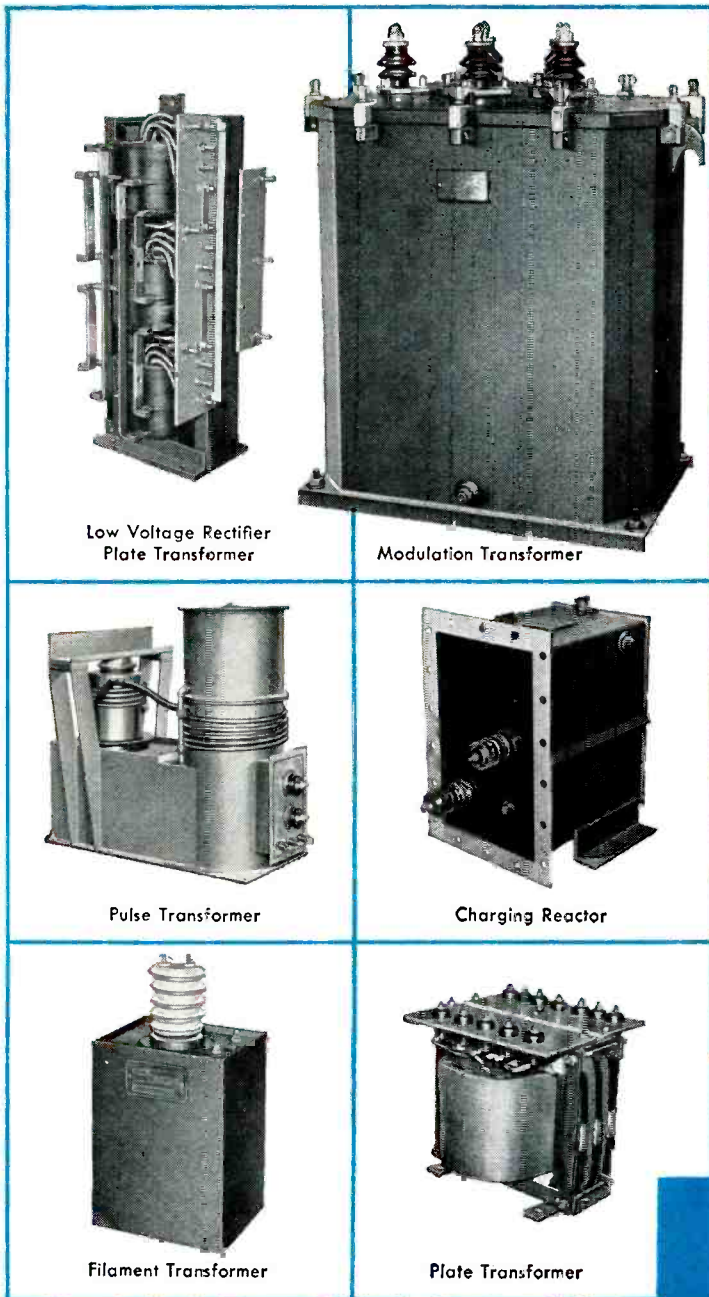

Low Voltage Rectifier
Plate Transformer

Modulation Transformer

Pulse Transformer

Charging Reactor

Filament Transformer

Plate Transformer



TRANSFORMERS for ELECTRONIC APPLICATIONS

Plate Transformers • Modulation Transformers
Reactors • Filament Transformers • Unit Rectifiers
Pulse Transformers • Charging Reactors
Oil, Askarel, Dry Type (Groups 1, 2, 3)
Per Mil-T-27, RETMA and ASA Specifications

Moloney engineers are pioneers in the use of grain-oriented, high permeability, silicon steel for transformer cores. This engineering background and experience enables the Moloney Electric Company to produce highest quality transformers that offer the maximum in reliability, endurance and efficiency with a minimum of size and weight.

ME56-0

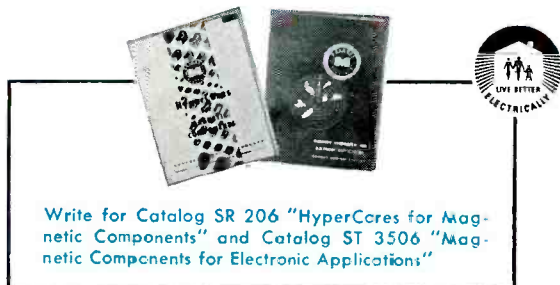

Write for Catalog SR 206 "HyperCores for Magnetic Components" and Catalog ST 3506 "Magnetic Components for Electronic Applications"



**HyperCore Cores for smaller,
lighter, low loss transformers.**

M O L O N E Y E L E C T R I C C O M P A N Y

Plate and Filament Transformers • Chokes • Unit Rectifiers • Modulation Transformers and Reactors • Pulse Transformers and Charging Chokes • HyperCores for Magnetic Components • Developmental Magnetic Components • Power and Distribution Transformers

SALES OFFICES IN ALL PRINCIPAL CITIES • FACTORIES AT ST. LOUIS 20, MO. AND TORONTO, ONT., CANADA

ELECTRONICS — May, 1956

Want more information? Use post card on last page.

265

HERE IT IS!

A NEW Plug-In Trimmer for Printed Circuit Boards

Another FIRST by ERIE

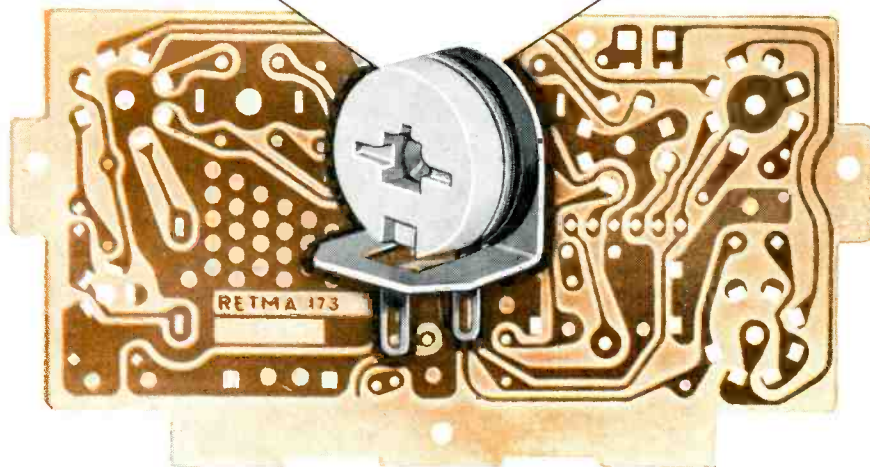

The ERIE 3192 Plug-In Trimmer keeps pace with current design trends while maintaining the qualities for which ERIE Trimmers have long been notable—fidelity to specifications, rugged stability, and straight-line capacity change throughout the total range. All the features of the popular Style 557 are embodied in this new trimmer.

Note these features:

- Designed specifically for Printed Circuit Boards
- Ideal for critical vibration applications
- Compact and convenient for application in miniaturized circuits
- Available with zero or negative temperature characteristics
- Custom built assemblies to suit the customer's needs

ERIE has been a leader since 1940 in the manufacture of Printed Circuits. The ERIE Printed Circuit Board shown above has these special features:

- Approved by Underwriters' Laboratories
- Unusually rigid construction
- Boards do not come in contact with acids of any type while being produced
- Custom designed to meet your requirements

Write for Engineering Bulletin on the ERIE 3192 Plug-In Trimmer and ERIE Printed Circuit Boards.

Sandblasting Rotors

ASSEMBLED ROTORS for gang-tuning capacitors are prepared for silver lume plating by sandblasting with 0.006-inch-mesh grit in a water-air mixture, in the Camden, N. J. plant of Radio Condenser Co.

The operation is carried out in a

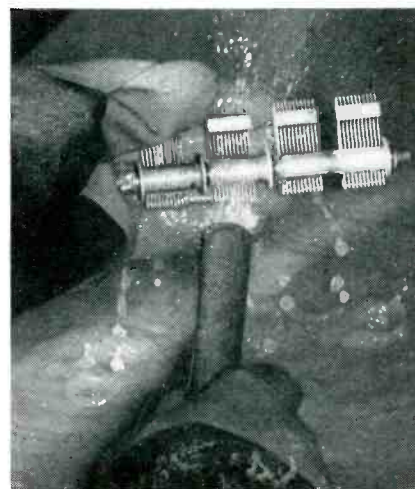

Cleaning rotor plates with sand-water-air blast coming from hose in foreground

ERIE ELECTRONICS DIVISION
ERIE RESISTOR CORPORATION
Main Offices and Factories: ERIE, PA.
 Manufacturing Subsidiaries
 HOLLY SPRINGS, MISSISSIPPI • LONDON, ENGLAND • TRENTON, ONTARIO

MEMO

TO *Engineering Dept.*

SUBJECT
MINIATURE SENSITIVE RELAY (TYPE MS)

(IDEAL FOR PRINTED CIRCUITS)

Note desired RBM features will cut our Assembly Costs
M.S.

Self locking Terminal position Relay before Soldering
X-Bar Contacts insure ultimate in Circuit Switching Reliability

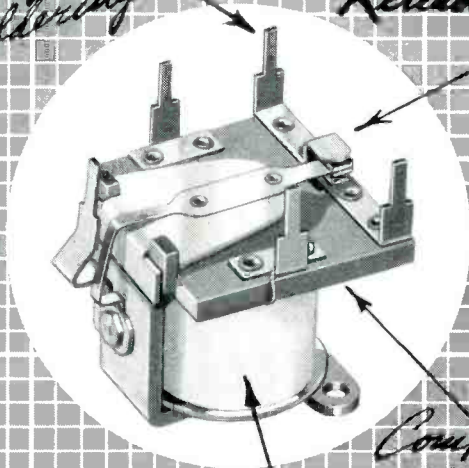

Compact size

Coil Construction meets unusual climatic conditions

Construction—Printed circuit terminals are designed with snap-in feature which holds relay in printed circuit board without lugging prior to solder dip.

Other versions of MS relay available with standard solder type terminals and insulating base, where required. Also with 4 N.O. isolated circuits having common make.

While not yet in production, extra-sensitive version has been developed. Maximum coil resistance 18,000 ohms, nominal sensitivity .030 watt, maximum sensitivity .020 watt, overall height 1-9/16". All other details same as standard MS relay.

Application—Type MS is an ideal relay for any application requiring a compact, highly reliable single pole D. C. device, where a low cost solution is required because of volume usage and competitive problems.

The fact that industry has already used over a million units of this design is your assurance that the R-B-M Type MS relay will meet your most exacting requirements.

Contacts used in Type MS are of the cross bar type, which offer the ultimate in reliability throughout the life of the relay. Molded bobbin design has eliminated coil failure on sensitive applications under severe climatic conditions.

OTHER VERSIONS



SOLDER TERMINALS
4 isolated circuits with common make contact.

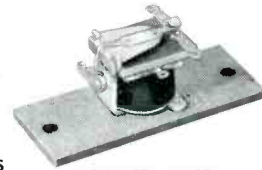

INSULATED BASE
Solder terminals mounted on insulating base.



EXTRA SENSITIVE VERSION

ENGINEERING DATA

ENGINEERING DATA	
Specifications	Miniature Sensitive Relay Type MS
Contact Form	S. P. D. T.
Contact Rating	1 amp. 32 V.D.C. non-inductive
Coil Resistance	Up to 10,000 ohms
Nominal Sensitivity (Coil Input)	.060 Watt
Maximum Sensitivity	.040 Watt
Approx. Dimensions	1 1/8 x 1 1/8 x 1 1/2"

Send for Descriptive Bulletin MS-1



RBM DIVISION
ESSEX WIRE CORPORATION, Logansport, Indiana

- CORD SETS
 - WIRE HARNESSES
 - MAGNET WIRE
- OTHER PRODUCTS

TROPOSPHERIC SCATTER

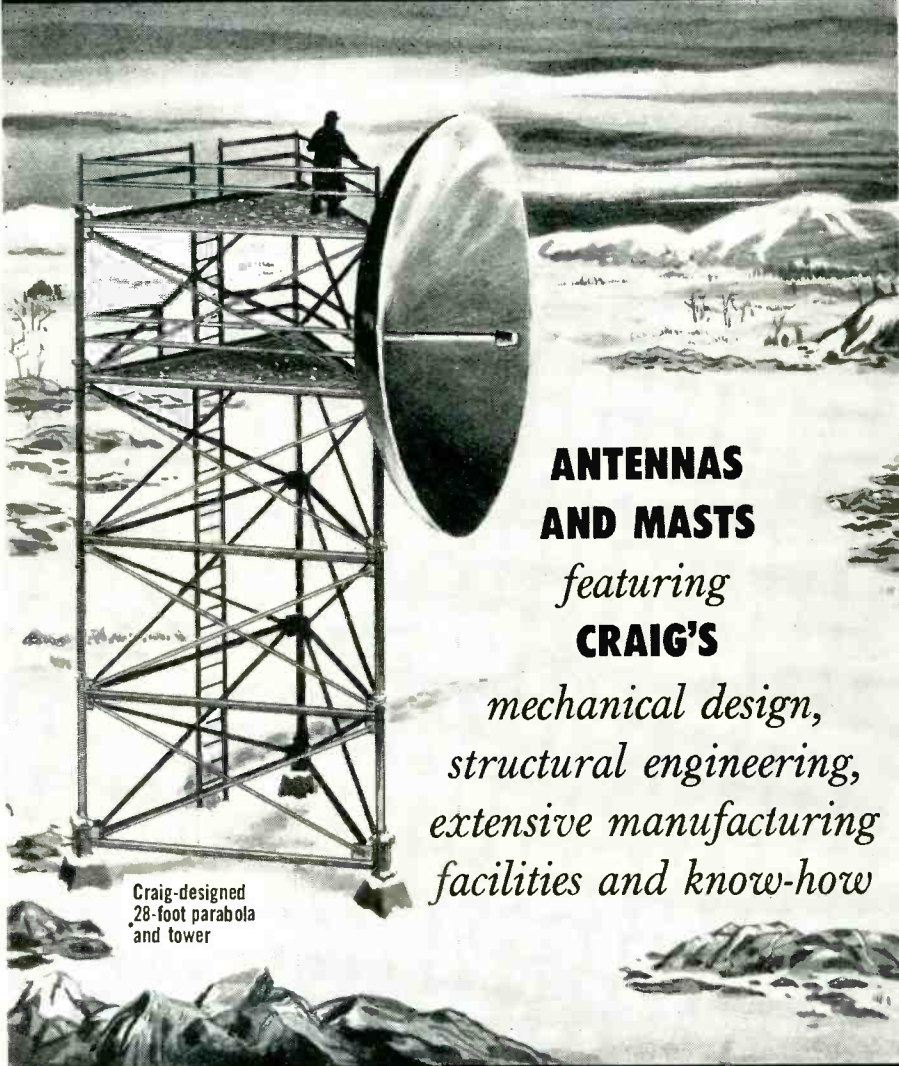

Craig-designed
28-foot parabola
and tower

**ANTENNAS
AND MASTS**
featuring
CRAIG'S
*mechanical design,
structural engineering,
extensive manufacturing
facilities and know-how*

SMALLER ANTENNAS AND MASTS ALSO AVAILABLE-

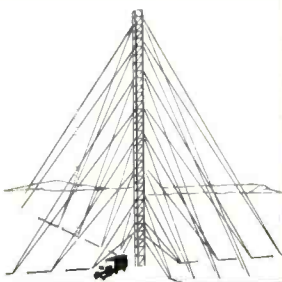

MICROWAVE INSTALLATIONS
75' to 200'
Portable and easily erected

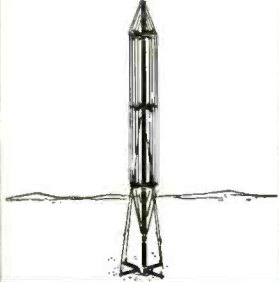

HF ANTENNA CM-1153
26 feet high, base requires only 4 square feet, frequency range of 1 to 30 megacycles. 91 pounds complete.



MAST AB-157/GR
Aluminum construction, adjustable — 16 to 33 feet, erected by two men in thirty minutes.

OTHER CRAIG PRODUCTS -

- system application engineering
- transportable and mobile
- shelters, trailers, vans
- mobile control towers
- mobile installations
- missile carriers
- re-usable containers for air frame assemblies, electronic and optical equipment

For further information write or phone —

Craig SYSTEMS, INC.
Danvers, Mass. Danvers 1870

hooded booth designed to collect the spray solution for reuse. A heavy stream at relatively low pressure gives the required action for cleaning both sides of the closely spaced plates to remove fire scale and acids.

After cleaning and rinsing, the rotors are plated at high current density in a special sodium-cyanide solution that gives good throw into the recesses between plates and produces a smooth nongranular silver plate.

Making Connections to Etched-Wiring Boards

MANY DIFFERENT techniques are currently in use for making connections to finished etched-wiring boards in the final equipment. Perhaps the commonest practice involves inserting plain stand-off terminals in the board, to which the external connections can later be made either with conventional soldered joints or with the Keller wire-wrapping tool.

The terminals can be inserted manually one at a time in holes in a steel template, and the board then pressed over them by an air-operated press, as is done in RCA's Indianapolis plant and Westinghouse's Metuchen, N. J. plant.

Alternatively, the terminals may be dropped directly into the board all at once by the new terminal-inserting machine made by Malco Tool & Mfg. Co., 4025 W. Lake St., Chicago. This machine fits over one of the stations of Admiral's in-line automatic assembly machines. The



Air-operated press used by RCA to push interconnecting terminals into wiring boards after terminals have been loaded manually by operators stationed along conveyor that advances one position each time the press comes down

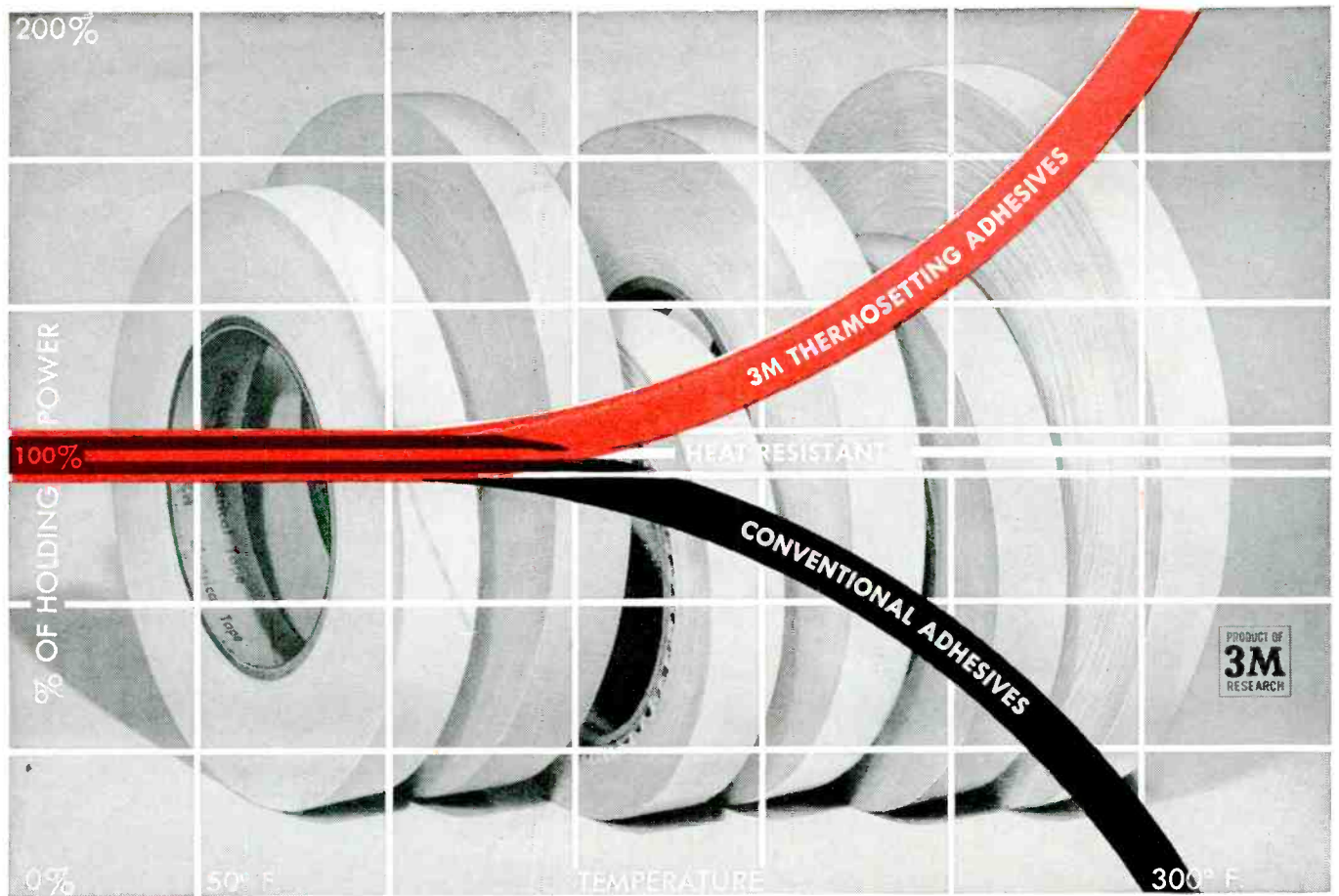

These curves tell a straight story!

Do you find such insulation adhesive terms as *thermosetting*, *heat-resistant*, and *solvent-resistant* confusing at times? For instance, the difference between a pressure-sensitive tape with a "thermosetting" adhesive and one with "heat-resistant" adhesive?

The difference in holding power of the two is graphically demonstrated in the chart above. A "heat-resistant" adhesive simply has a higher-than-average softening point. For many applications, where not subjected to high temperatures, tapes with conventional or heat-resistant adhesives may offer adequate holding power. But if extreme or prolonged temperature is the problem, you need "SCOTCH" Brand Tapes with 3M *Thermosetting* Adhesive.

The "thermosetting" adhesive on "SCOTCH" Brand Tapes is soft enough at application to be pressure-sensitive — tapes stick at a touch. When subjected to heat, however, a positive chemical

change takes place which *increases* the adhesive's bond strength — it develops into a firm, insoluble, infusible bond.

Once cured, 3M Thermosetting Adhesive holds under extreme operating heat without softening . . . has high bond-strength for anchoring leads . . . bakes dry to prevent throw-out . . . resists action of solvents, waxes, and varnishes. The only tapes combining all four of these advantages are "SCOTCH" Brand Tapes with 3M Thermosetting Adhesive.

Why not let us show you how 3M Thermosetting Adhesive Tapes can give better performance in insulating your products? Just write on your letter-head to 3M Co., St. Paul 6, Minn., Dept. CA-56.

These "Scotch" Brand Insulating Tapes have 3M Thermosetting Adhesive: No. 27, Glass Cloth Backing; No. 28, Acetate Cloth Backing; No. 29, Cotton Cloth Backing; Nos. 38 and 39, Treated Paper Backings; No. 56, Polyester Film Backing.

*The first true thermosetting adhesive
...still the industry standard...found
only in...*

REG. U.S. PAT. OFF.
SCOTCH Electrical Products
BRAND

The terms "Scotch" and "3M" are registered trademarks of Minnesota Mining and Manufacturing Co., St. Paul 6, Minn. Export Sales Office: 99 Park Ave., New York 16, N.Y. In Canada: P.O. Box 757, London, Ontario.



NOW *low voltage class 2* DISC CAPACITORS

for transistorized receiver application

made by
new **RI** low cost
volume
production
process

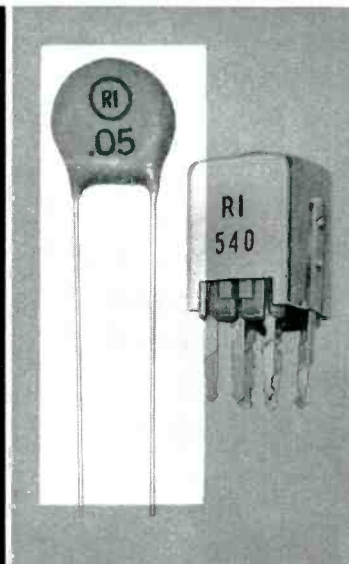

RI-CAP no. K-500 series

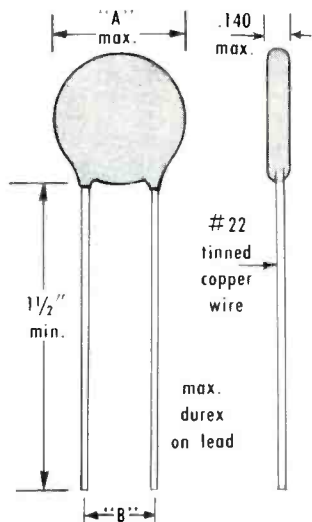

part no.	A dim.	B dim.	capacity in mfd*	+100% -20%
K-500-001	.285	1/4"	.001	
K-500-005	.285	1/4"	.005	
K-500-01	.340	1/4"	.01	
K-500-02	.340	1/4"	.02	
K-500-03	.560	3/8"	.03	
K-500-05	.560	3/8"	.05	
K-500-1	.690	3/8"	.10	
K-500-2	.690	3/8"	.20	

*Above values also available in ±20% tolerance

electrical specifications:

1. power factor—2½% max. at 1 KC
2. working voltage rating—30 VDC (available up to 200 VDC)
3. test voltage—2X above rating
4. I.R.—5000 megohm min.
5. marking—stamp capacity
6. temperature coefficient—from 25°C to 10°C not greater than 20%, and 25°C to 65°C not over 60%
7. coating—durex and wax

leading manufacturer of high frequency transformers for transistor applications

write for details and prices

RADIO INDUSTRIES, INC.
5225 no. ravenwood ave. • chicago 40, ill.

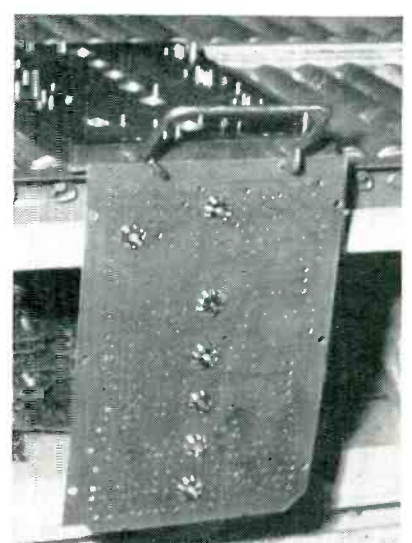

Pins loaded into steel template on Westinghouse line, with etched wiring board ready to be pushed onto pins

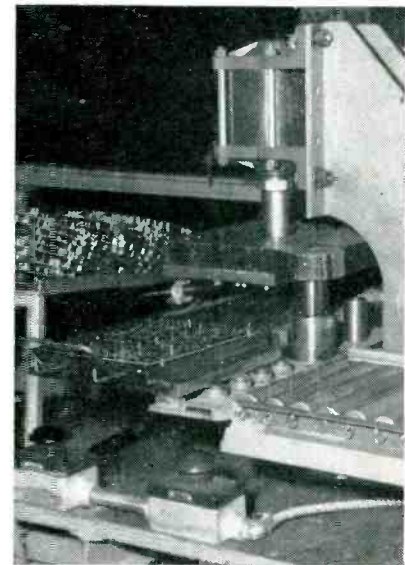

Press used for pushing Westinghouse audio-sync board over terminal pins

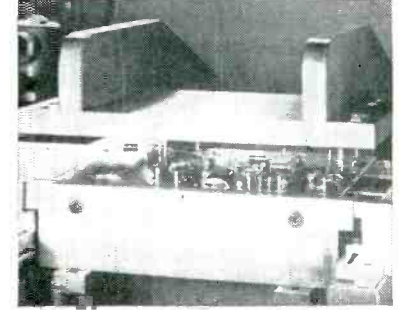

Maleo air-operated platen on automatic assembly line pushes self-locking terminals into holes

following station has an air-operated plate that pushes all of the terminals firmly down into their holes.

Insertion and push-down are combined in the universal terminal

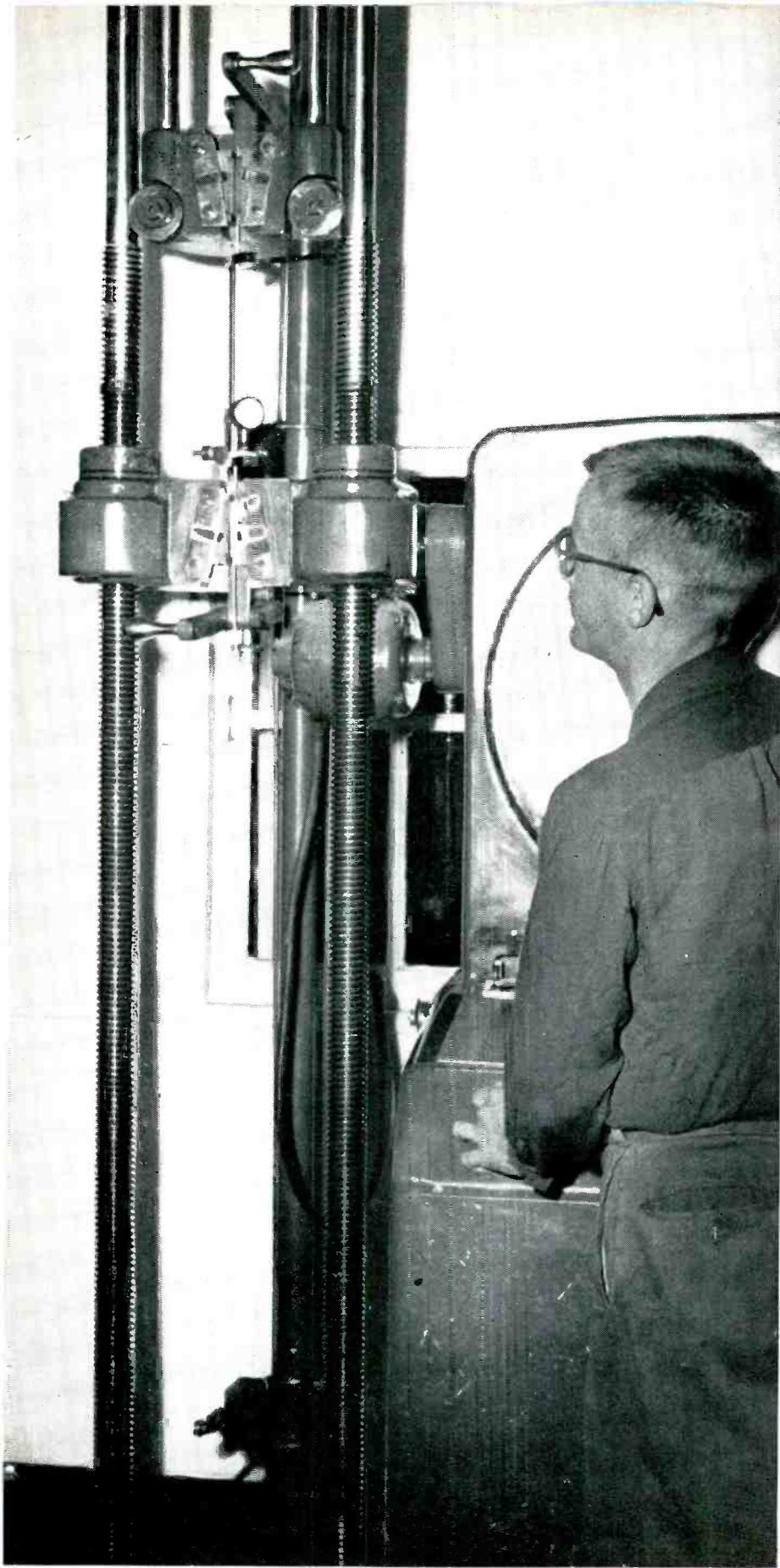

Tensile and elongation tests are part of Anaconda's strict quality-control program that assures users of wire meeting the most rigid requirements.

With elongation tests
on magnet wire

He helps you get longer break-free runs in your winding room

One of the best ways to get fewer breaks in winding, firmer coils, greater freedom from shorts, and fewer costly rejects, is to choose magnet wire with elongation and tensile strength properties that measure up to the strictest requirements.

In Anaconda's magnet wire mills, for example, samples of wire are taken at every machine each day for testing in the quality control laboratory—including measurements for tensile strength and elongation.

Every reel, spool or package of Anaconda wire undergoes rigid inspection and testing from raw material to finished product to packaging.

If you are not satisfied that you are getting the best results from the wire you are now using, why not give Anaconda magnet wire a trial. See the Man from Anaconda or your Anaconda distributor. Anaconda Wire & Cable Company, 25 Broadway, New York 4, New York.

66323

ask the man from **ANACONDA**[®]
for **MAGNET WIRE**

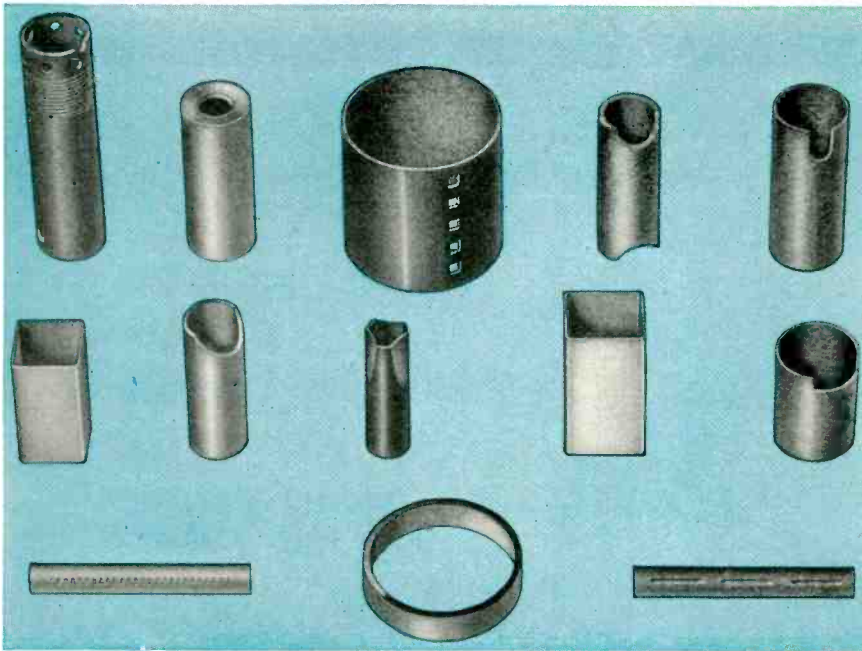

CLEVELITE *

THE PHENOLIC TUBING OF QUALITY

Low moisture absorption . . . Dimensional stability
 . . . High dielectric strength . . . Low loss . . . Great
 physical strength . . . Good machinability.

This combination of Clevelite's "Built-in-Quality"
 provides that extra protection for better product
 performance.

Minimize rejects and inspection costs . . . for
 Quality of material and workmanship . . . specify
 Clevelite . . . the economical tubing!

FAST DEPENDABLE SERVICE

Write for your copy of our latest CLEVELITE brochure!

Why pay more? For good quality . . . call CLEVELAND!

*Reg. U. S. Pat. Off.

THE CLEVELAND CONTAINER COMPANY
 6201 BARBERTON AVE. CLEVELAND 2, OHIO
PLANTS AND SALES OFFICES:
 CHICAGO • DETROIT • MEMPHIS • PLYMOUTH, WIS. • OGDENSBURG, N.Y. • JAMESBURG, N.J. • LOS ANGELES

ABRASIVE DIVISION of CLEVELAND, OHIO
 Cleveland Container Canada, Ltd., Prescott and Toronto, Ont.



Representatives:

- NEW YORK AREA: R. T. MURRAY, 604 CENTRAL AVE., EAST ORANGE, N. J.
- NEW ENGLAND: R. S. PETTIGREW & CO., 62 LA SALLE RD., WEST HARTFORD, CONN.
- CHICAGO AREA: PLASTIC TUBING SALES, 5215 N. RAVENSWOOD AVE., CHICAGO
- WEST COAST: IRV. M. COCHRANE CO., 408 S. ALVARADO ST., LOS ANGELES

machine recently developed by Berg Mfg. and Eng. Co., New Cumberland, Pa. This machine is too large to fit on an assembly line, but has the advantage of permitting almost instant pushbutton change of the terminal insertion pattern. This has worked out well at IBM's Kingston, N. Y. plant, where identical sizes of boards for a radar computer require upwards of 90 different terminal patterns for different purposes.

To aid in making connections to a large number of these identical boards going into a single chassis, IBM inserts each board in turn into a notch in a slotted strip running the length of the chassis frame. This allows the operator to flop the board back and forth over a limited angular range to get at the terminals more conveniently. An elastic band holds the boards in position until enough external leads have been connected to provide self-support. After assembly,



Output end of Berg terminal machine, showing eyelet-type terminals attached to board

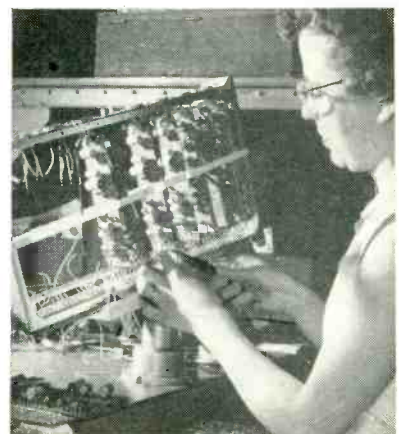

Bench holding fixture and unique notched strip in chassis aid in making conventional soldered connections to wiring boards for radar computer being built by IBM

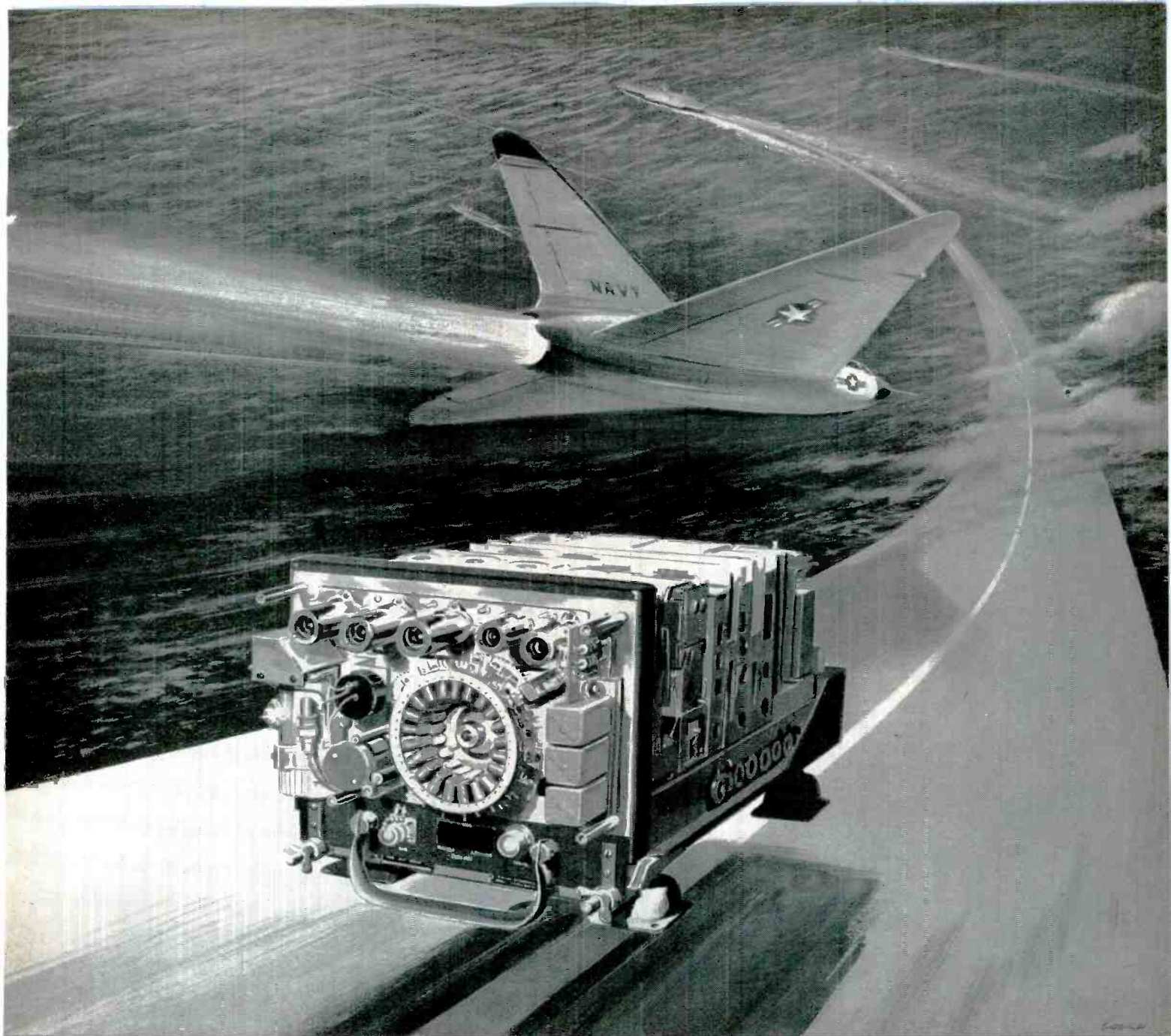

TACAN unit shown with covers removed; plane is a composite model.

tube **78-page road map for jets**

An 800-foot carrier may be as hard to find as a needle in a haystack, when the plane seeking it is at 20,000 feet and the time is 0200 hours.

To make the homing plane a homing pigeon, we build the "ARN-21" TACAN equipment illustrated above. Its 78 tubes and associated components add up to a self-contained transmitter and

receiver, rugged in its ride-resistance and accurate to pin-point tolerances.

The manufacture of equipment as important and complicated as this demands *perfection*, and nothing less. On the military as well as the home front, Stromberg-Carlson has long displayed the ability to take such problems in stride.

STROMBERG-CARLSON COMPANY

A DIVISION OF GENERAL DYNAMICS CORPORATION

General Offices at **ROCHESTER 3, N. Y.**



for complex **WAVEGUIDE** assemblies like this



Compact packaging of this complex Mixer-Duplexer typifies results achieved with the combination of Technicraft-designed components, and Technicraft's manufacturing know-how.

MAKE

TECHNICRAFT

YOUR PRIMARY SOURCE

Designed with Precision

Built with Precision

Tested with Precision

One of our representatives is near you. Sales engineering offices in: Dallas • Dayton • Los Angeles • Chicago • Seattle • St. Louis • Toronto (Canada).

SERVING RADAR AND COMMUNICATIONS WITH THE BEST IN MICROWAVE TRANSMISSION DEVICES

TECHNICRAFT LABORATORIES

INCORPORATED

1550 THOMASTON RD. • THOMASTON, CONNECTICUT

Designers and Manufacturers of Rigid and Flexible Waveguide Assemblies, Microwave Test Plumbing and Components, Waveguide Systems.

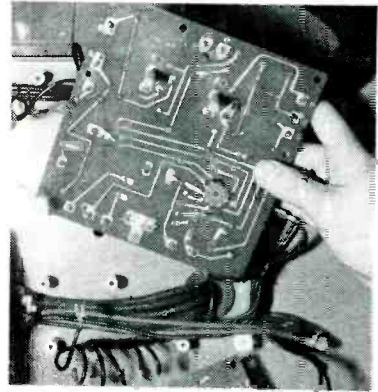

Dip soldering locks pin terminals into position on wiring board for GE Thy-motrol electronic adjustable-speed drive. Board is mounted with pin terminals outward (wiring behind) so that interconnections can be made quickly by pushing spring clips of cabled leads over the pins

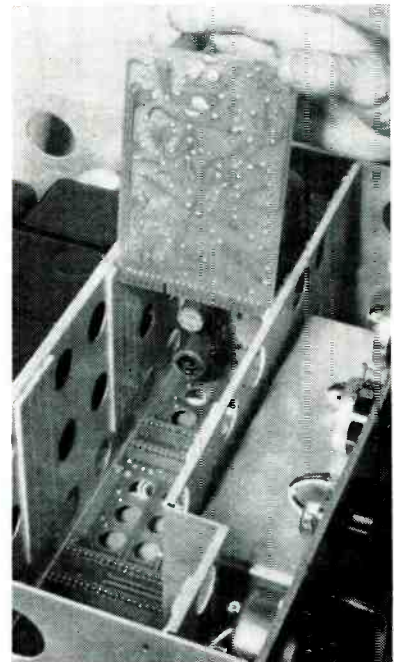

Connections to this wiring board for a subcarrier discriminator are made automatically when the board is pushed down chassis grooves into connector at bottom

metal side plates provide additional mechanical support for the array of wiring boards.

For industrial electronic equipment, GE inserts pin terminals into punched holes at appropriate positions on its etched wiring boards, for anchoring during the dip-soldering operation. Spring-type connecting sleeves are pushed over these pins to make connections to the board.

The Bendix Pacific Division solves its board-connecting problem

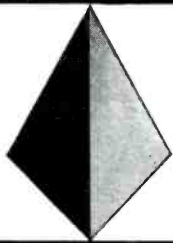
NO. 57

PYRAMID

technical bulletin

THERE IS MORE TO A CAPACITOR THAN ITS DESIGN FORMULA:

$$C = \frac{A}{K D}$$

Pyramid's production and life tests of their capacitors are among the most stringent in the industry. Production test for voltage breakdown, capacitance, power factor, insulation resistance and seal are performed on 100% basis. In consisting of life, temperature and immersion cycling, vibration, and corrosion where applicable. These serve to guarantee that the capacitors you purchase are consistently as represented to be.

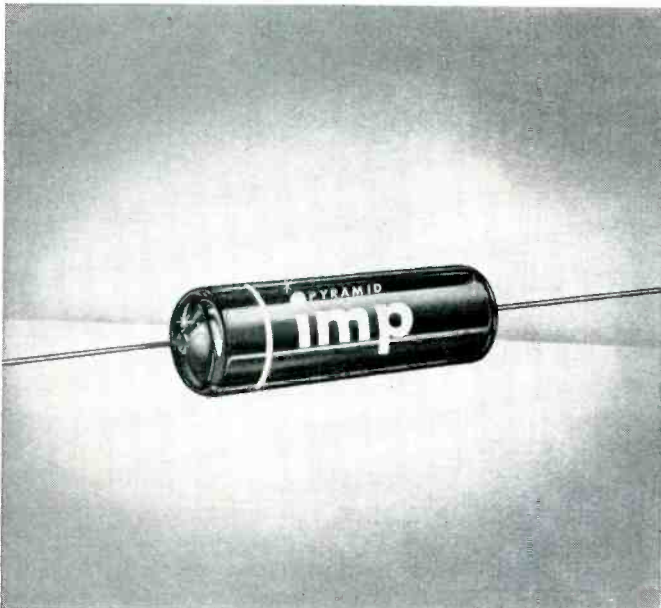

Pyramid capacitors also owe their exceptional performances to the type of materials used in their manufacture and the production methods which Pyramid engineers have devised. For example, in the new Pyramid IMP capacitor, a new, exclusive plastic molding technique was developed which bonds casing, impregnated element, and tinned copperweld leads into one compact assembly capable of withstanding severe physical abuse. In addition, this unit is heat and moisture resistant withstanding the RETMA humidity-resistance test to a remarkable degree. In another capacitor, type MT metallized paper units, vacuum impregnation is employed and the ends of the capacitor are sealed with plastic. Then, as a final step, the entire unit is completely coated with a highly moisture resistant wax. It is production techniques such as these which, in conjunction with high quality papers, impregnants (such as Halowax, Mineral Oil, or Silicone Base Synthetic Oil), and metals, that account for the excellent stability and long life that Pyramid capacitors exhibit.

Pyramid capacitors, particularly electrolytic capacitors, are specifically designed for long shelf life. To achieve this goal requires that the various materials and chemicals used in the manufacture of these units possess a high quality and long term stability. Another contributing factor to long shelf life is the care which is taken to provide maximum protection against the corrosive effects of chemicals in the atmosphere. This necessitates a container which is well insulated against the intrusion of moisture, i.e., one which is air tight and hermetically sealed.

* * * *

The number of different types of capacitors that Pyramid manufactures is extensive. Included in this line are the following:

1. Electrolytic capacitors, type TD, with each unit sealed in a metal tubular case. Available in single sections, dual sections, and triple sections.
2. Electrolytic capacitors in screw base metal containers, type MC. Available in single and dual sections.
3. Twist-Mount electrolytic capacitors, type TM. Available in single, dual, and triple sections. Different sections may have different working voltages.
4. HI-TEMP Twist-Mount Electrolytic capacitors, type TWH. Designed for 100°C operation.
5. Dry Electrolytic capacitors in wax-filled, impregnated cardboard tubes, type CDB. Available in single, dual, and triple sections. Sections may possess individual leads or share a common negative terminal.
6. Plug-in Electrolytic capacitors, type DO, provided with 4 pins on standard octal base.
7. High-capacitance, low voltage electrolytic capacitors, type PFB.
8. Molded tubular paper capacitors, type IMP.
9. Miniature tubular paper capacitors. Type 85LPT.
10. Ceramic-cased tubular paper capacitors, type CT.
11. Bath-tub-Type Oil-Paper Capacitors, types PDM, PDMT, PDMB.
12. Metal-tubular Oil-Paper capacitors, types PTIM, PTDMV, 4PTIM, 4PTIMV, 7PTIM.
13. Small-base oil-paper capacitors, types PKM, PKMF, PKMS, PKMT, and PKMB.
14. High-voltage oil-paper capacitors, types PLM, PLMF, PLMS, PLMU, PLMR.
15. Kraft-tube metallized paper capacitors, type MT.
16. Metal-can metallized paper capacitors, types MPGK, MPGM.
17. Metal-tube metallized paper capacitors, types MPTIK, MPTIM.
18. "Glasseal" subminiature paper tubular capacitors, and many others.

Pyramid capacitors are competitive in price because of the modern production methods that are employed throughout every phase of capacitor production. Whenever possible, automation techniques are being applied so that more uniform high quality may be achieved. Much of Pyramid's success is due also to the aggressiveness of Pyramid engineers in pioneering new products.

PYRAMID ELECTRIC CO.

FOR COMPLETE DATA SEND FOR ENGINEERING BULLETIN—FORM IMP-2

North Bergen, New Jersey

PYRAMID IS THE BIG NAME IN CAPACITORS AND SELENIUM RECTIFIERS TODAY!

SPECIALLY BUILT TO WITHSTAND
SEVERE OPERATING CONDITIONS



HARD GLASS TUBES

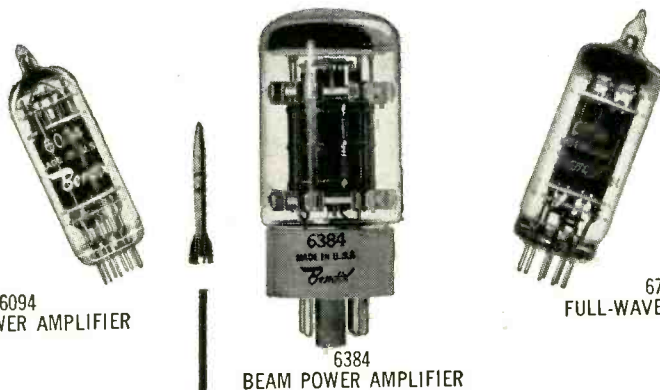

6094
BEAM POWER AMPLIFIER

6384
BEAM POWER AMPLIFIER

6754
FULL-WAVE RECTIFIER

- Ideal for modern high-performance aircraft and missiles.

- Processing at higher vacuum and under the higher heat permitted by the hard glass reduces gas and contamination and provides greater operating stability at higher temperatures.

- Ceramic element separators prevent emission loss from high heat and vibration.

- Solid aluminum oxide heater-cathode insulator eliminates shorts, reduces leakage.

For further information, write RED BANK DIVISION, BENDIX AVIATION CORPORATION, EATONTOWN, NEW JERSEY.

ELECTRICAL RATINGS*	6094 Beam Power Amplifier	6384 Beam Power Amplifier	6754 Full Wave Rectifier
Heater Voltage (AC or DC)**	6.3 volts	6.3 volts	6.3 volts
Heater Current	0.6 amp.	1.2 amp.	1.0 amp.
Plate Voltage (Maximum DC)	300 volts	750 volts	350 volts
Screen Voltage (Maximum DC)	275 volts	325 volts	—
Peak Plate Voltage (Max. Instantaneous)	550 volts	750 volts	—
Plate Dissipation (Absolute Max.)	14.0 watts	30 watts	—
Screen Dissipation (Absolute Max.)	2.0 watts	3.5 watts	—
Heater-Cathode Voltage (Max.)	±450 volts	±450 volts	±500 volts
Grid Resistance (Maximum)	0.1 Megohm	.1 Megohm	—
Grid Voltage (Maximum)	5.0 volts	0 volts	—
Grid Voltage (Minimum)	-200 volts	-200 volts	—
Cathode Warm-up Time	45 sec.	45 sec.	45 sec.

*For greatest life expectancy, avoid designs which apply all maximums simultaneously.

**Voltage should not fluctuate more than ±5%.

MECHANICAL DATA	6094	6384	6754
Base	Miniature 9-Pin	Octal T-11	Miniature 9-Pin
Bulb	T-6½	T-11	T-6½
Maximum Over-all Length	2½"	3½"	2¾"
Maximum Seated Height	2½"	2½"	2½"
Maximum Diameter	¾"	1½"	¾"
Mounting Position	Any	Any	Any
Maximum Altitude	80,000 ft.	80,000 ft.	80,000 ft.
Maximum Bulb Temperature	300°C	300°C	300°C
Maximum Impact Shock	500G	500G	500G
Maximum Vibrational Acceleration	50G	50G	50G

West Coast Sales & Service: 117 E. Providencia Ave., Burbank, Calif.
Export Sales and Service:

Bendix International Division, 205 E. 42nd St., New York 17, N. Y.
Canadian Distributor: Aviation Electric Ltd., P. O. Box 6102, Montreal, Quebec



in a still different manner to permit instant replacement of the board when necessary. Terminal strips are etched along one edge of the board on one or both sides, with appropriate spacings to match connectors permanently mounted in the chassis of the equipment. A board is then merely pushed down through guide slots into the connector to make upwards of twenty connections at a time automatically.

Stapling Cardboard Cup on Back Cover of TV Set



Method of pushing pressed paper cup into hole in back cover

USE OF a pressed paper cup in place of a metal or molded plastic cup for the projecting socket of a television picture tube has cut costs and speeded production of television sets in Emerson's Jersey City plant.

The die-cut paper cup has grooves pressed into it along folding lines, so that it is formed into a cup almost instantly when pushed into the opening in the back cover by the operator.

As the first step, the operator places a back cover over a slanting board frame positioned in front of the power stapling machine. A square opening in the platform board coincides with the opening in the back cover. The operator then places the almost-flat paper piece over the hole and presses down on it with both hands to form the cup. He then lifts the board up onto the anvil of the stapling machine and places a staple in each of the

FOR A WORLD OF TOMORROW

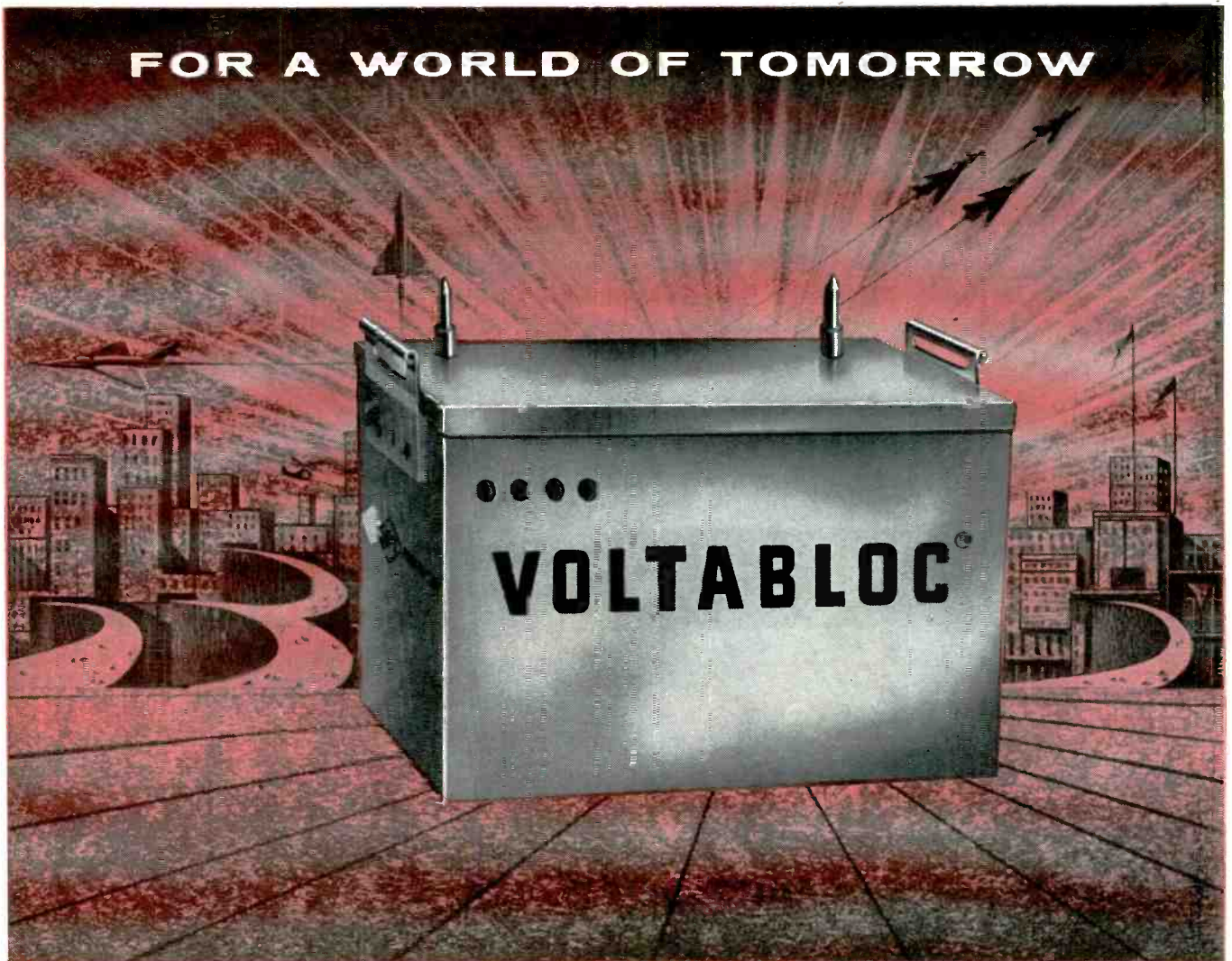

V O L T A B L O C[®]

The battery that

**DOES MORE
DOES IT BETTER**

New type, hermetically sealed cells
eliminate maintenance — save space

- Flattest of all discharge curves
- Peak discharge up to 20C
- No replacement of water or electrolyte
- Saves 50% of nominal battery floor space
- Life expectancy 10 to 20 years

A complete line from 0.8 a.h. to largest peak discharge requirements.

Every function that a battery can perform, from the smallest to the largest, can be done better — more dependably — longer — as a result of this great new development in battery construction.

VOLTABLOC[®] batteries, made in America under U. S. Patents, are the only hermetically sealed, nickel and cadmium batteries available to American industry. Their small size and outstanding performance characteristics have introduced an entirely new concept of battery service and economy.

Send today for complete data on your specific applications. Write to SAFT Corporation of America, 2 Gregg St., Lodi, N. J.



AMERICA

Your Future in Microphones...**TODAY!**

A S T A T I C

FUTURA

DYNAMIC MICROPHONES

Vogue 988

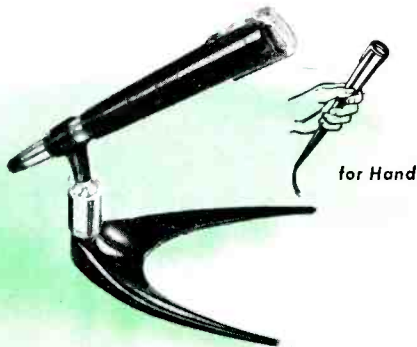

for Hand



for Lavalier

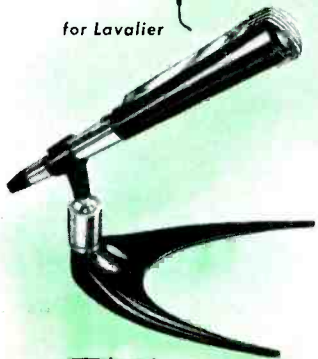

High Fidelity Dynamic Professional Microphones, Specifically Designed for Telecasting, Broadcasting, Recording, Public Address and Communications

Tempo 888

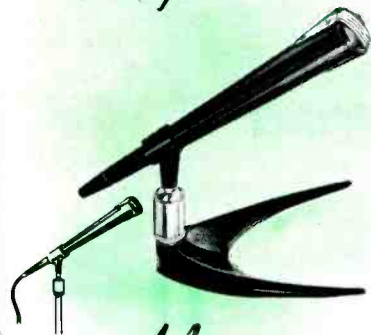

for Stand

Metro 788

FIRST with Astatic "quick connect" adaptors to permit permanent cable installation . . . take the mike to the cable!

Here is a dramatic new concept in microphone design . . . the incomparable "FUTURA" series! Striking beauty, all-around versatility, and electronic engineering of the highest quality are combined in each of these slender, distinctive instruments. Never before has any one series of microphones brought so many startling "firsts" to the industry!

FIRST with high fashion-styling . . . non-reflecting satin black finishes . . . brushed chrome or gold trim . . . subtle color touch for a new note of smartness.

FIRST with diaphragm made of DuPont "Mylar", newest and strongest of plastic films, to provide the ultimate in shockproof, weatherproof construction.

For Complete Information & Specifications, Write Today for Our New Illustrated Catalog, No. S-438!

THE **Astatic** CORPORATION, CONNEAUT, OHIO

IN CANADA: CANADIAN ASTATIC LIMITED, TORONTO, ONTARIO

Export Sales Representative: 401 Broadway, New York 13, N. Y. Cable—ASTATIC, New York

— KNOWN THE WORLD OVER —

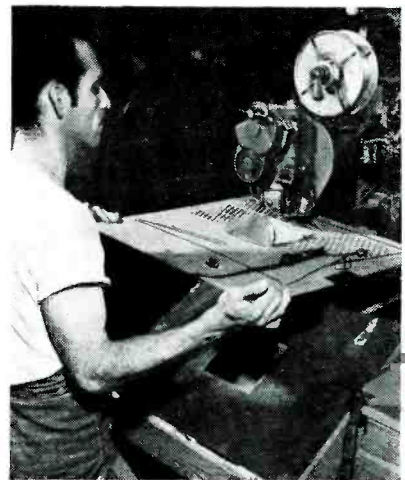

Stapling lips of cup to back board. Wood stand used for pressing cup into board can be seen below stapler

four lips of the cup. The board is rotated 90 degrees after each stapling operation. The lower anvil of the stapling machine bears against the projecting cup and thus serves as a stop for positioning the board precisely. With the aid of this stop, the four staples can be placed in the cup in about 5 seconds.

Assembling Targets for Image Orthicons

FACTORY production of image orthicons is now under way in ultramodern air-conditioned facilities at GE's Tube Department in Schenectady. Employees work in nylon clothes with hospital-clean glass lathes, punch presses and a variety of electrochemical manufacturing equipment.

There is general agreement among tube engineers that putting together the 256 parts of an image



Fragile section of glass bubble, about one ten-thousandth inch thick, is carefully placed on metal ring, to which it is later sealed in an oven to serve as the target

F.C.C. RADIATION INTERFERENCE LIMITS

Effective May 1, 1956 all radio receivers manufactured to operate in the range from 30 to 890 mc, including f-m and television receivers, shall not exceed the following field strength limits at 100 feet or more from the receiver:

The total electromagnetic field at any point a distance of $\frac{157000 \text{ ft.}}{f(\text{kc})}$ (equivalent to $\lambda/2\pi$) from the apparatus shall not exceed $15\mu\text{v}$ per meter. Radiation generated by oscillator sweep circuit must also be controlled.

COMPLY WITH F.C.C. REGULATIONS

Use Allen-Bradley Feed-thru and Stand-off Capacitors



Type SO with solder tabs



Type FT with solder tabs



Type FC Ferri-Cap filter

This new F.C.C. regulation on radiation interference imposes stringent requirements on radio and TV designers. Fortunately, Allen-Bradley Types FT and SO discoidal capacitors and Ferri-Cap filters completely satisfy these requirements.

Both Type FT (feed-thru) and Type SO (stand-off) can be supplied in standard nominal capacitance values from 5 mmf to 1,000 mmf. None of these Allen-Bradley units exhibits parallel resonance effects at frequencies of 1,000 megacycles or less.

Type FT feed-thru capacitors have soldering tabs or screw-thread mounting. Type SO stand-off capacitors are available with screw-

thread mounting, self-tapping threads, or solder tabs.

The rugged construction reduces breakage during assembly line handling or from contact with carelessly handled soldering irons. The terminals are specially treated for easy soldering.

The Type FC Ferri-Cap feed-thru filter is a discoidal feed-thru capacitor in combination with ferrite material to provide internal impedances effectively in series with both ends of the feed-thru electrode of the capacitor. The Ferri-Cap filter is not susceptible to pickup, and does not require physical isolation with respect to the source of an undesired frequency.

Send for bulletin, today.



Type SO—screw mounting



Type SO—self tap. screw

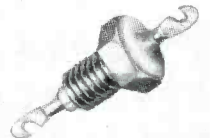

Type FT—screw mounting



Allen-Bradley Co., 110 W. Greenfield Ave., Milwaukee 4, Wis. • In Canada—Allen-Bradley Canada Limited, Galt, Ont.

OTHER QUALITY COMPONENTS FOR RADIO, TV & ELECTRONIC APPLICATIONS

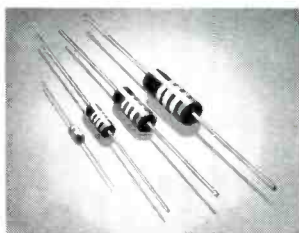

Fixed Molded Resistors
1/10, 1/2, 1 & 2 watt

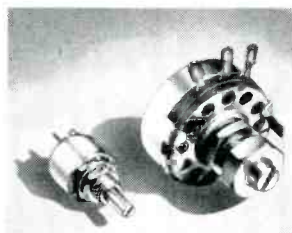

Variable Molded Resistors
1/2 & 2 watt

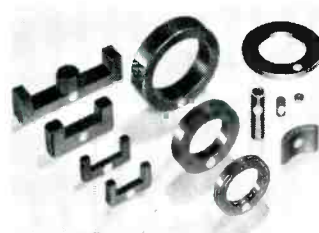

Ferrite Components
High Efficiency

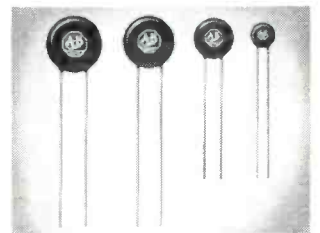

Ceramic Dielectric Capacitors
for by-pass and filtering

ALLEN-BRADLEY









RADIO, ELECTRONIC AND TELEVISION COMPONENTS

your "special" transformers are stock units at *Chicago Standard*

Most CHICAGO-STANCOR transformers are available in at least three different mountings and terminal types . . . some in as many as six! You can get the one that is best for your job . . . and get it fast, from stock, through your CHICAGO-STANCOR distributor.

CHICAGO-STANCOR transformers are the logical choice for

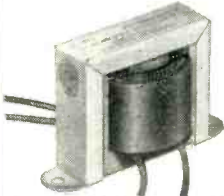
- Industrial and military research and instrumentation
- Prototype production
- Amateur and commercial broadcasting
- Communications
- High fidelity
- Public address

<p>H Type</p> 	<p>C and TD Types</p> 
<p>B Type</p> 	<p>S Type</p> 
<p>V and C Types</p> 	<p>M Type</p> 
<p>A, J, L, and U Types</p> 	<p>FS Type</p> 



FREE: CHICAGO STANDARD catalogs listing over 1000 transformers for original equipment and replacement applications.



CHICAGO STANDARD TRANSFORMER CORPORATION

ADDISON AND ELSTON
CHICAGO 18, ILLINOIS

Export Sales: Roburn Agencies, Inc.
431 Greenwich Street, New York 13, N. Y.

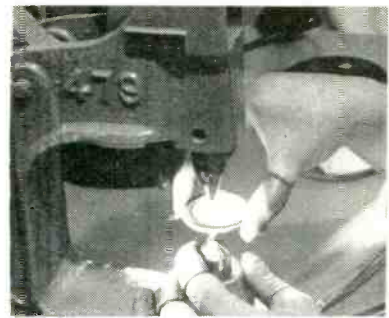

Riveting the 500-mesh screen to the metal ring of the target. One wrong move here will shatter the bubble-thin glass

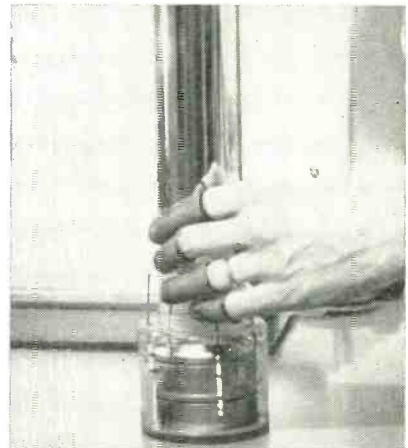

Using permanent magnet on rod to lower finished target and mesh assembly into image orthicon



Tightening set screws with 18-inch screwdriver to anchor target assembly deep inside tube. One slip here would shatter glass membrane and ruin tube, hence warning sign is hung up on door when tube is being put together

orthicon is the most difficult production job in the tube industry. It requires exceptionally high dust and lint control standards and calls for handcraft skill comparable to that of the artisans of centuries past.

► **Assembly Problems**—Heart of the image orthicon is the target and mesh assembly, which is diffi-

new CBS high-frequency transistors

NPN SYMMETRICAL ALLOY-JUNCTION

Alpha Cutoff Frequencies

2N182	2.5 to 5 mc
2N183	5 to 10 mc
2N184	10 to 20 mc

The basic design of these new CBS medium-power high-frequency transistors is:

1. *NPN symmetrical*... for better frequency response and reversible collector and emitter, permitting unusual applications.
2. *Alloy-junction*... for greater uniformity, high voltage and current, flatter gain characteristics, more stable and dependable performance.

The CBS 2N182, 2N183, and 2N184 are especially useful in radio-frequency... high-speed switching... and high-fidelity audio applications. Note the many desirable features. Write for Bulletin E-268 giving complete data and helpful application notes.

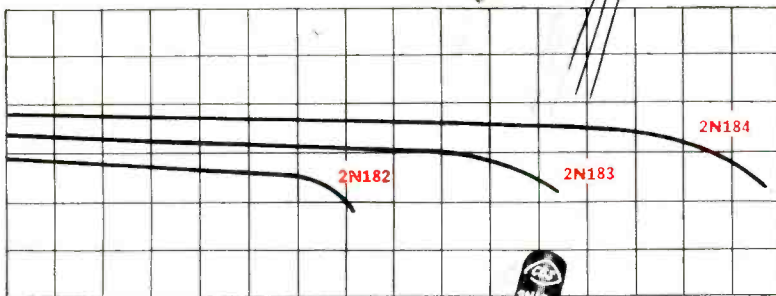
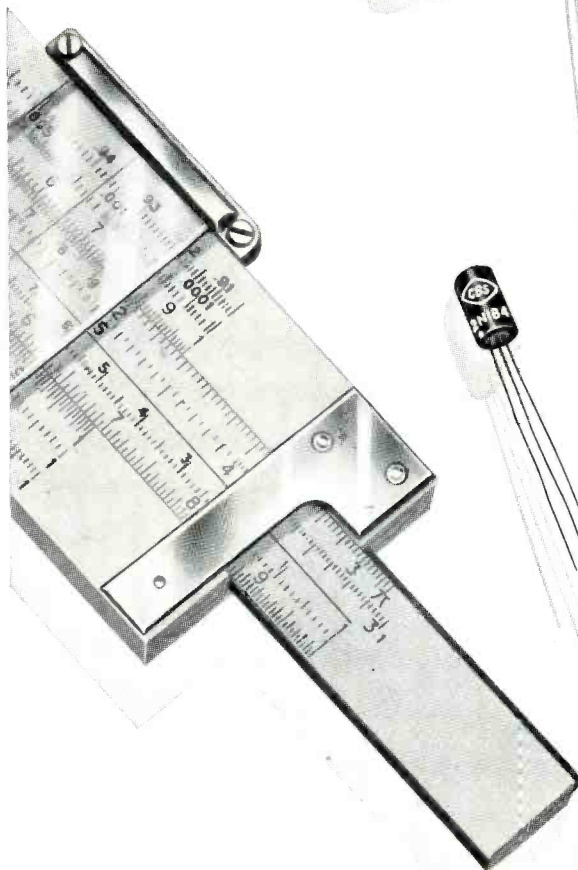

CHECK THESE FEATURES

1. High frequency response ... up to 20 mc.
2. High operating voltage ... up to 30 volts.
3. High power gain at 455 kc ... 35 db.
4. High dissipation rating ... 100 mw.
5. Low leakage current ... 3 μ amps av.
6. Low base resistance ... 150 ohms av.
7. Low collector capacitance ... 10 μ f.

*Reliable products
through Advanced-Engineering.*



semiconductors

CBS-HYTRON, Danvers, Massachusetts
A DIVISION OF COLUMBIA BROADCASTING SYSTEM, INC.

BOURNS now offers an expanded line of

TRIMPOTS®







... 7 stock models of sub-miniature potentiometers to serve many special needs—at no extra cost!



First there's the 120 Wirewound TRIMPOT, with features common to all other BOURNS TRIMPOTS. It's a 25-turn potentiometer, easily adjusted, and weighing only 0.1 oz. Rectangular in shape, it fits readily into miniature electronic circuits. You can mount it individually, or stack it compactly with standard screws. Mountings are interchangeable with those on all other TRIMPOTS.

The self-locking shaft holds stable settings under extreme environmental conditions. All parts are corrosion resistant. Every unit is inspected 100% for guaranteed specifications. Resistances: 10 to 20,000 ohms, with resolutions as low as 0.2%.

Now, to give designers greater latitude, BOURNS has developed and is manufacturing the following standard models—variations of the Model 120.

 <p>120 TRIMPOT — Carbon</p> <p>Infinite resolution is provided by the carbon element. Resistances are higher, ranging from 20,000 ohms to 1 megohm.</p>	 <p>130 TRIMPOT — Solder Lug</p> <p>For wiring direct to the instrument, using soldering iron or dip soldering techniques. Usable range of 98%.</p>	 <p>132 TRIMR — Variable Resistor</p> <p>High resistances—up to 50,000 ohms in a wire-wound rheostat.</p>
 <p>209 TRIMPOT — Dual Potentiometer</p> <p>Two outputs electrically independent, and controlled simultaneously by one adjustment.</p>	 <p>160 TRIMPOT — High Temperature</p> <p>Operates at 175°C. High power rating: 0.6 watt at 50°C.</p>	 <p>230 TRIMPOT — Humidity-proof</p> <p>Completely sealed, unit meets MIL-E-5272A Specifications for humidity.</p>



Write for literature on the BOURNS TRIMPOT line.
BOURNS LABORATORIES
 General Offices: 6135 Magnolia Ave., Riverside, Calif.
 Plants: Riverside, California—Ames, Iowa

cult to make and difficult to install. This consists of a copper mesh of 500 wires to the inch—which is difficult to even see with the naked eye—spaced 0.002 inch from a delicate glass membrane. The membrane, called the target, must be between one-tenth and two-tenths of a thousandth of an inch thick. The entire assembly, made under dust-free conditions, is inserted into the 13-inch stem of the tube and fastened in place with 18-inch screwdrivers—all without breaking the glass or permitting even the tiniest speck of dust to enter the tube.

The present facilities now are capable of producing camera tubes in quantity, to give the industry a second source of supply for image orthicons. Also planned is mass production of the less expensive and less critical vidicon tubes.

Hole Sizes for Etched-Wiring Boards

STRENGTH of a dip-soldered joint is a function of wire size and is virtually independent of hole size, according to curves obtained by Robert J. Roman of Eastman Kodak Co. in Rochester, N. Y. The

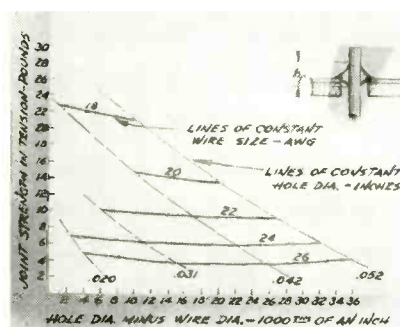

For a given wire size, joint strength remains essentially constant as diameter of hole in etched wiring board is increased

failures occur in solder immediately adjacent to the wire, this shear area being controlled by the circumference of the wire and the length of the fillet h_f . This indicates that larger holes can be used in etched wiring boards to simplify manual or machine assembly work, as long as the solder bridges the gap to form the fillet.

How Superior guards cathode quality to insure uniformly excellent performance

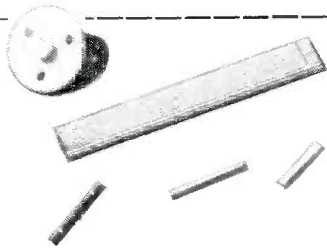

NEWEST CATHODE ALLOYS: THE CATHALOYS¹

Most versatile alloys. Available in both active and passive types. Promoted by, controlled by, and available only from Superior. Samples shown include seamless, Lockseam,² and WELDRAWN³ cathodes.

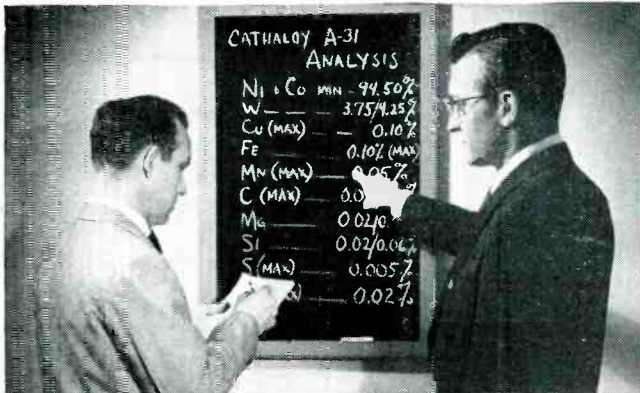

1. FIRST STEP: ALLOY SPECIFICATION. For each of the Cathalloys, Superior engineers specify precise percentages of constituent metals in order to give good control to the emission, sublimation, and interface impedance characteristics.

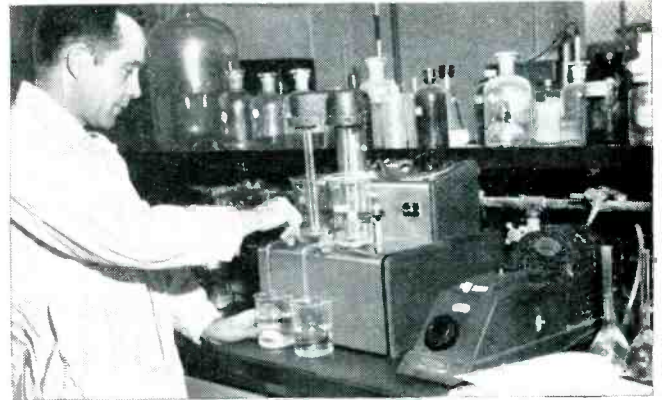

2. ANALYSIS OF EACH HEAT. Samples of each heat of the alloys are sent to Superior's metallurgical laboratory for extensive chemical and physical analysis. Metal must conform with rigid specifications before acceptance.



3. TESTED IN ELECTRON TUBE. Samples of each heat of Cathaloy are fabricated into cathodes and assembled into ASTM standard diodes. They are operated under controlled conditions. These tests evaluate each heat for emission and sublimation characteristics. Satisfactory results approve the heat for production.

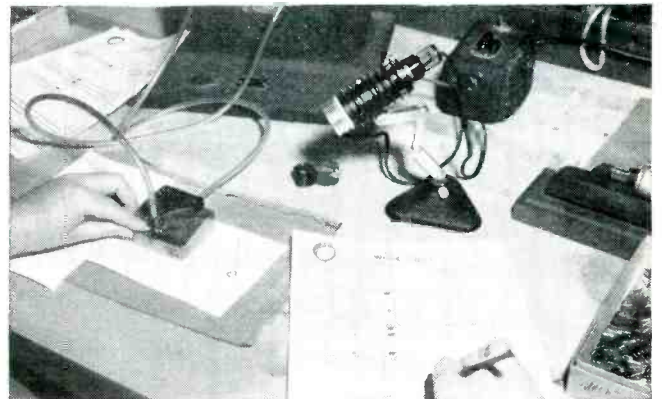

4. CHECKING OF MECHANICAL DIMENSIONS. Rigid quality control inspection standards assure constant checks on the finished cathode dimensions: length, diameter, bead position, etc. Must fall within close tolerances specified. The very latest precision measuring instruments are employed.

¹ Cathaloy is a trademark of Superior Tube Co., Reg. U.S. Pat. Off.

² Manufactured under U.S. Patents

³ T.M. Reg. U.S. Pat. Off., Superior Tube Co.

Superior Tube

The big name in small tubing
NORRISTOWN, PA.

JOHNSON & HOFFMAN MFG. CORP., Mineola, N.Y.—an affiliated company making precision metal stampings and deep-drawn parts

FREE 20-PAGE CATALOG

Superior Tube Co.
2500 Germantown Ave., Norristown, Pa.

Send me the new Catalog 50 with complete technical information on Superior cathode materials.



NAME.....
COMPANY.....
STREET.....
CITY..... ZONE..... STATE.....



New Products

Edited by WILLIAM P. O'BRIEN

81 New Products and 38 Manufacturers' Bulletins Are Reviewed
. . . Control, Testing and Measuring Equipment Described and
Illustrated . . . Recent Tubes and Components Are Covered

FERROMAGNETIC PLASTIC

in flexible rod and tape

THE POLYMER CORP., 125 N. Fourth St., Reading, Pa., has introduced a new ferromagnetic plastic in the forms of flexible rod and tape. Both the flexible and rigid Ferrotron materials are suitable for continuous operation to 200 C. They offer resistance to severe humidity conditions, very high impact strength, good machinability, high



volume resistivity and positive Q temperature coefficients.

The flexible forms permit better use of inherent magnetic properties, thus enabling the design of smaller and more efficient electronic components. This is true because they permit the design of magnetic circuits essentially within a magnetic atmosphere.

Data sheets are available covering both the flexible forms and rigid powdered iron cores.

C-R OSCILLOGRAPH

general-purpose type

ALLEN B. DUMONT LABORATORIES, INC., 750 Bloomfield Ave., Clifton, N. J. Type 350 oscillograph offers



identical direct-coupled high-gain X- and Y-amplifiers and amplitude calibration on both channels, together with superlative stability.

► **Performance**—The excellent stability in the type 350 is achieved by an internal self-regulating power transformer. This provides performance virtually independent of line-voltage changes. The d-c drift is scarcely noticeable even over extended periods of operation.

Another leading characteristic is the pushbutton amplitude calibration on both X- and Y-channels. This permits quantitative measurements not previously available in

comparable general-purpose instruments.

The linear sweeps are generated by a hard-tube circuit. A beam gate turns the beam on during only the forward sweep. Thus, no retrace is seen and the spot is not visible before sweep initiation. Therefore there is no danger of fogging film in making recordings with triggered sweeps. The type 5ADP crt used in the oscillograph is operated at 3 kv accelerating potential to assure high spot brightness even when using low repetition rates and long-persistence screens. The type 5ADP offers excellent spot size and high light output in addition to excellent vertical sensitivity. Its flat-faced plate simplifies precise quantitative measurement.

PREAMPLIFIER

added to i-f amplifier line

LEL, INC., 380 Oak St., Copiague, N. Y., has added a new preamplifier to their i-f amplifier line. Model IF 31 features a cascode input circuit.

► **Performance**—Typical performance specifications are 30-db gain and 1.4-db noise figure at 30 mc.

Model IF 31 is also available with custom modifications to any prac-

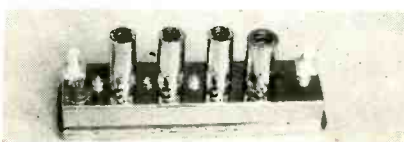

tical bandwidth and center frequency with either single or balanced input.

SWEEPING OSCILLATOR broad-band type

KAY ELECTRIC CO., 14 Maple Ave., Pine Brook, N. J., has announced

—if you have a need for any of these tube applications

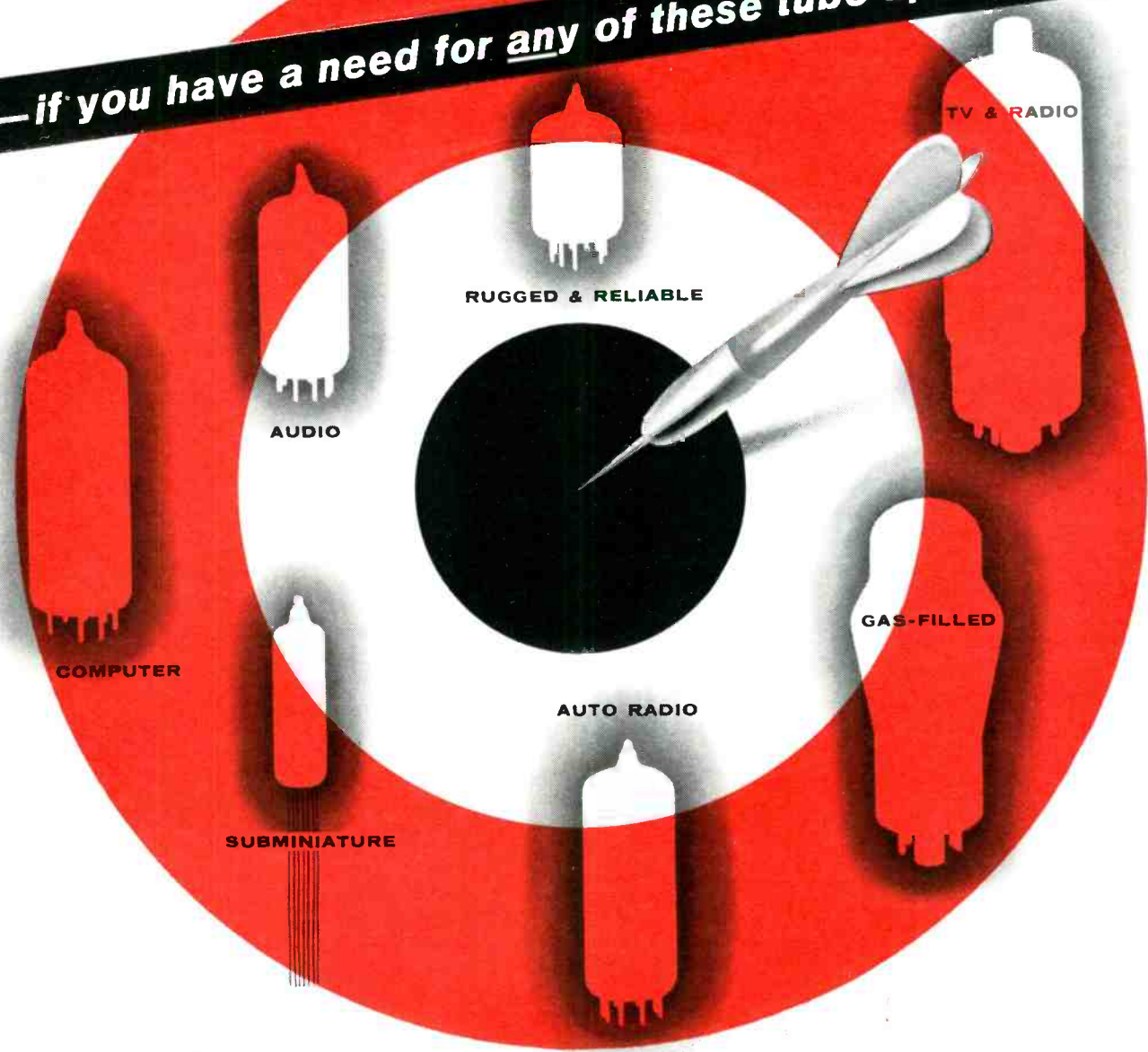

Odds are 350 to 1 you can
 "hit the mark" with existing Sylvania Types

ARE YOU DESIGNING a new TV sweep circuit which will see production in hundreds of thousands or special equipment to be produced in small quantities? If you have need for a new tube type, check with Sylvania first. The chances are you can solve your problem

with an existing Sylvania tube type. Covering a broad range of tube applications is Sylvania's biggest stake in electronics. Over 350 different types make up Sylvania's list of available tube types for original installation. More are being added every day. In 1955 more than one

third of all active new tube types registered with RETMA were Sylvania "Originals", designed and developed by Sylvania. Call your Sylvania Representative or write for complete listings indicating the categories which interest you. Address Dept. E20P.



SYLVANIA ELECTRIC PRODUCTS INC.
 1740 Broadway, New York 19, N. Y.
 In Canada: Sylvania Electric (Canada) Ltd.
 University Tower Bldg., Montreal

LIGHTING • RADIO • ELECTRONICS • TELEVISION • ATOMIC ENERGY

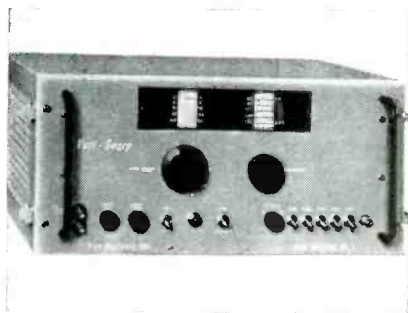

the Vari-Sweep, an all-electronic broad-band sweeping oscillator designed for continuous coverage from 2 to 220 mc with sweep to 30 mc plus, and with high output automatically held constant over frequency sweep and tuning range.

► **Specifications**—Frequency range is 2 to 220 mc, continuously variable in 10 switched overlapping

bands. Direct reading frequency dial is calibrated to ± 2 percent. The r-f output is 1.0 v rms into 75 ohms, metered. Sweep width is continuously variable ± 2 percent to ± 30 percent of center frequency to maximum of at least 30 mc. Sweep rate is continuously variable 10 to 60 cps, locks at line frequency.

Price is \$695. Literature and detailed specifications are available.

TIMING UNITS

long delay, high impedance

ESC CORP., 534 Bergen Blvd., Palisades Park, N. J., has available a new series of custom-designed, long delay-high impedance, distributed constant delay networks.

Constructed with radial leads for printed board wiring, the timing units can be supplied to meet low cost commercial requirements or military specifications. When supplied for military applications they are epoxy molded. In addition, to

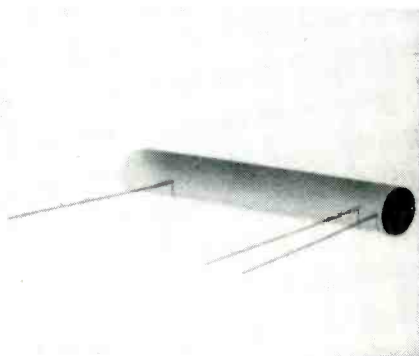

meet a customer's requirements, the units can be provided in hermetically sealed cases, as well as with terminals arranged to conform exactly with specific printed circuit board requirements. Another feature is that the units can be stacked in series to obtain still longer timing intervals.

► **Specifications**—In a typical unit, delay is 12 μ sec; impedance, 9,300 ohms; rise time, better than 10 percent of delay; attenuation, 20 percent; and size, $\frac{1}{8}$ in. diameter by $4\frac{1}{2}$ in. long.

WIRE-WOUND RESISTOR

for missile and computer use

HYCOR Co., INC., 12970 Bradley Ave., Sylmar, Calif., has announced a subminiature precision wire-wound resistor, especially suitable for missile, computer and instrument application.

Designated as type 128A, series PH, the resistor is encapsulated in a tough epoxy resin for protection against extreme hu-

midity, mechanical and thermal shock. Heat-conducting mineral combined in the plastic dissipates heat and equalizes hot spots in windings. Sealed-in terminal connections are welded.

Performance characteristics satisfy all requirements of MIL-R-93A. Temperature coefficient is ± 0.0022 percent per deg C; operating temperature, -65 C to $+125$ C. Dimensions are 0.160 in. diameter by 0.5 in. long.

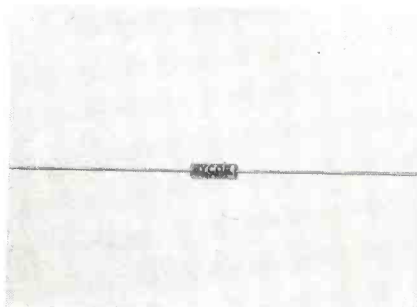

OFF-CENTERING YOKE

versatile, large size

SYNTRONIC INSTRUMENTS, INC., 170 Industrial Road, Addison, Ill., has announced a versatile large size off-centering yoke which can also be used as a very high speed, very high resolution deflection yoke. Type Y37() ()5 may be fitted over any $3\frac{3}{8}$ in. diameter yoke or crt. When used as an off-centering yoke, mounting can be forward and outside of such yokes as types Y25, Y27, Y15, Y17 and other rotating and fixed coil yokes.

When used as a deflection yoke, type Y37() ()5 is representa-

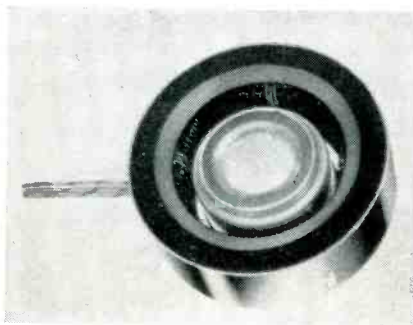

tive of a group of yokes available in a wide range of speeds and sensitivities for $3\frac{3}{8}$ in. and smaller neck diameter crt's. The yoke can be supplied in push-pull or single-ended windings.

MILLIAMMETER rectilinear recording

TEXAS INSTRUMENTS INC., 6000 Lemmon Ave., Dallas 9, Texas, has announced a rectilinear recording milliammeter. It is a ruggedized,

For

ACCURATE HIGH SPEED SWITCHING.

Specify

ELECTRO TEC

miniature ultra-low torque

Precision Selector Switch

- Withstands Shock and Vibration
- Offers High Accuracy Measurement
- Operates at High Speeds

This new Electro Tec Precision Selector Switch is ideal where miniature size, low friction torque, high accuracy, and low electrical noise at high speeds are requirements. Simplified circuits and long service life recommend it for a wide variety of uses including sampling, pulse generation for precision measurement, telemetering and strain gage applications, in aircraft, missiles, servos, computers, etc. Switch design incorporates many exclusive features that have gained industry-wide acclaim for Electro Tec precision slip rings, commutators and brush blocks.

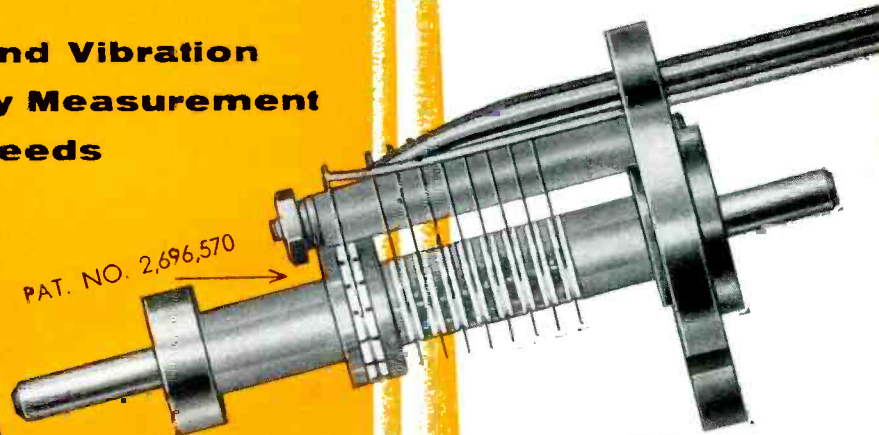
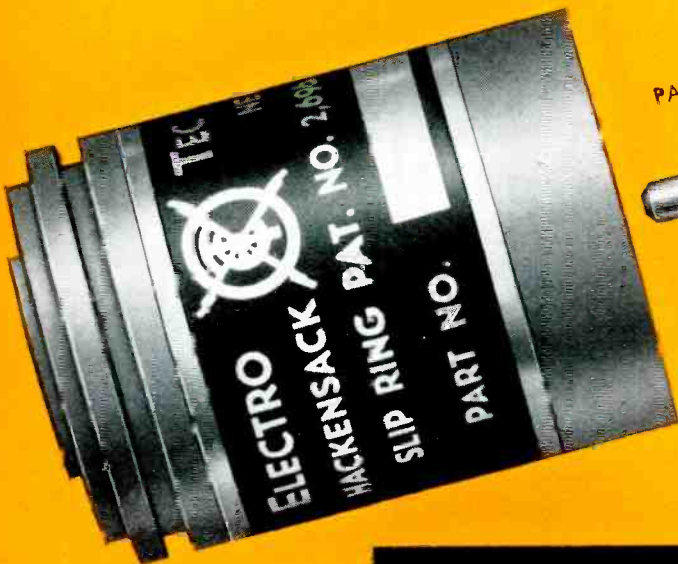

CALL OR WRITE FOR ILLUSTRATED BROCHURE

8 or 10 position switches in standard size 10 synchro housings are available for immediate delivery; other circuit combinations supplied to specifications.

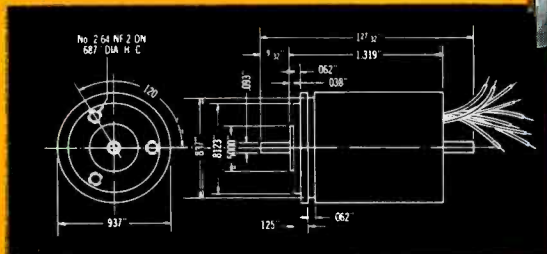
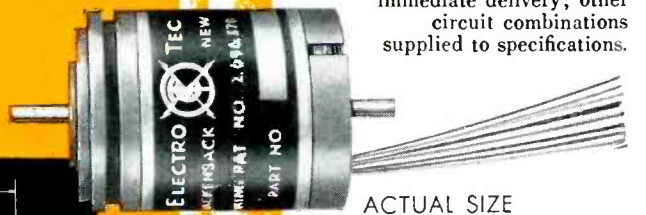

Electro Tec Corp.

SO. HACKENSACK
 NEW JERSEY
 Tel.: Hubbard 7-4940



marion
advancement
in instrument
design

new
MEDALIST*
meters

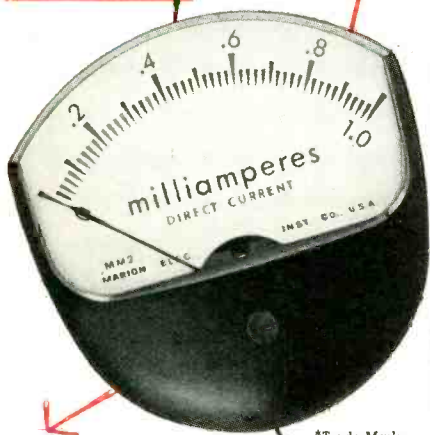

Greater readability and modern styling in minimum space. Interchangeable with ASA/JAN 2½ and 3½ inch sizes. Up to 50% longer scale in same space as ordinary type. Available in various colors. Complete data on request.

*Trade Mark
Patents Pending



marion meters

marion electrical
instrument company
GRENIER FIELD, New Hampshire's NEW Air-Industry Area
MANCHESTER, N. H., U. S. A.
Copyright © 1956 Marion

Molded
**BLACK NYLON
SCREWS and
NUTS**



Insulate and fasten without
bushings, washers, etc.
In stock 6-32, 8-32, 10-32



NyGrip
**BLACK
NYLON
Cable Clips**

Light-weight non-conducting
support for wiring, tubing, etc.
In stock ¼" to 1½" dia.

Free Samples...Write
WECKERSSER CO.

5267 N. Avondale Avenue • Chicago 30, Illinois

NEW PRODUCTS

(continued)



ink-writing, galvanometer-actuated instrument, with front access for all routine operations.

Rectilinear writing is made possible by a pantographic linkage. This includes a durable, fixed, jeweled gymbal mounting for the non-corroding pen and a freely moving A-frame with counter-balancing weights that insure uniform pen pressure throughout the full 4½ in. deflection and simplify calibration and adjustment.

Another feature is the fully enclosed inking system that is protected from dust, evaporation and spillage. Ink level in the sealed reservoir is visible from the front of the recorder and refilling, also from the front, is simple.

► Specifications — Weight is less than 27 lb and the unit occupies less than ¾ cu ft, measuring 15 in. by 9 in. by 8½ in. Electrical characteristics are: 1 ma for full scale deflection, (4½ in. active chart width), 1,500 ohms input resistance, and undamped natural frequency of 2 cps. The 100-ft chart roll can be run at a choice of 10 speeds, in ips or iph.

Complete details are given in bulletin DL-R 611.

MAGNET SUPPLIES
constant-current type

NJE CORP., 345 Carnegie Ave., Kenilworth, N. J., has available a group of four closely regulated constant-current magnet supplies for use with magnetrons, t-w tubes, mass spectrometers, cyclotrons and

on the
LINE

in the
FIELD

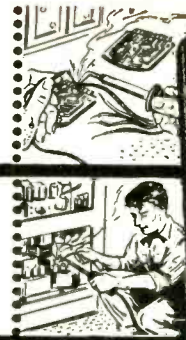

KWIKHEAT
Controlled Heat Soldering Irons

are better ... faster
for Printed Circuits!

Light weight, perfectly balanced, small size, controlled-heat Kwikheat Type 200 soldering irons are designed for close soldering. Sealed, high temperature, built-in thermostat maintains pre-set heat (800° for production, 700° for stand-by). Kwikheat irons, weighing only 7½ oz., are economical — maintaining heat on only one-third of heater capacity. Three versatile plunger-type tips are easily changed in the field.

For better, faster work —
at lower cost — switch to
KWIKHEAT soldering irons.

KWIKHEAT Manufacturing Co.
3732 San Fernando Rd., Glendale 4, Calif.

designed for Tomorrow



New **ILLINOIS TYPE SMT**
SUB-MINIATURE
Electrolytic Capacitors

Where space is at a premium—and absolute reliability is a must—there you will find ILLINOIS type SMT sub-miniature electrolytic capacitors.

- Immune to shock and vibration.
- Ideal for low voltage DC circuits.
- Hermetically sealed — Immersion - proof aluminum cases.
- Securely anchored "double sealed" construction.
- Extended temperature ranges.

If your application is a "tough one", specify ILLINOIS Type SMT for complete dependability. Wide range of capacities and voltages.



ILLINOIS CONDENSER CO.
1616 N. THROOP STREET
CHICAGO 22, ILLINOIS

"Reliability where it counts,"



says C. C. Harris,
Vice President and Chief Engineer,
Tropical Radio Telegraph Company,
about the Westinghouse . . .

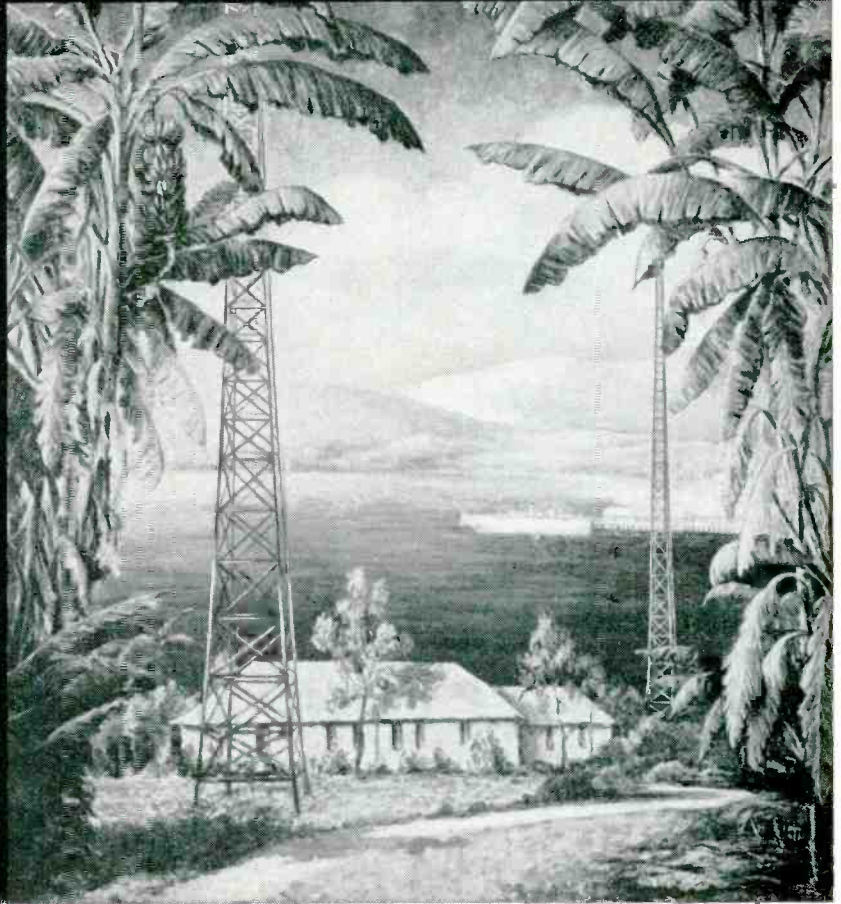

WL-5736 POWER TUBE

"We have been using the WL-5736 for seven years," says Mr. Harris. "We have found it to be highly reliable and to give long life. Tropical Radio Telegraph Company requirements are strenuous, especially in hot, humid, tropical climates. Our radio network is vital to Middle-American tele-communications service, and the WL-5736 has given us reliability where it counts."

Reports from dozens of other users echo the experience of Tropical Radio Telegraph. For the WL-5736 has long set the

6ET-4106

standard of excellence in communications and RF heating equipment of all types.

Wherever you need 2.5 kilowatts RF in a small, dependable package, you too will find its performance unbeatable.* Write today for full design data. Commercial Engineering Dept., Westinghouse Electric Corporation, Elmira, N. Y. **ENGINEERS!** For challenge, security, growth potential, investigate career opportunities now being offered by Westinghouse Electronic Tube Division. Write Technical Placement Director today.

*Where cooling by low-pressure blower is desirable, specify the new WL-6623 with extra-large radiator and "flying leads."

**YOU CAN BE SURE...IF IT'S
Westinghouse**

RELIATRON® TUBES

WESTINGHOUSE ELECTRIC CORPORATION, ELECTRONIC TUBE DIVISION, ELMIRA, N. Y.

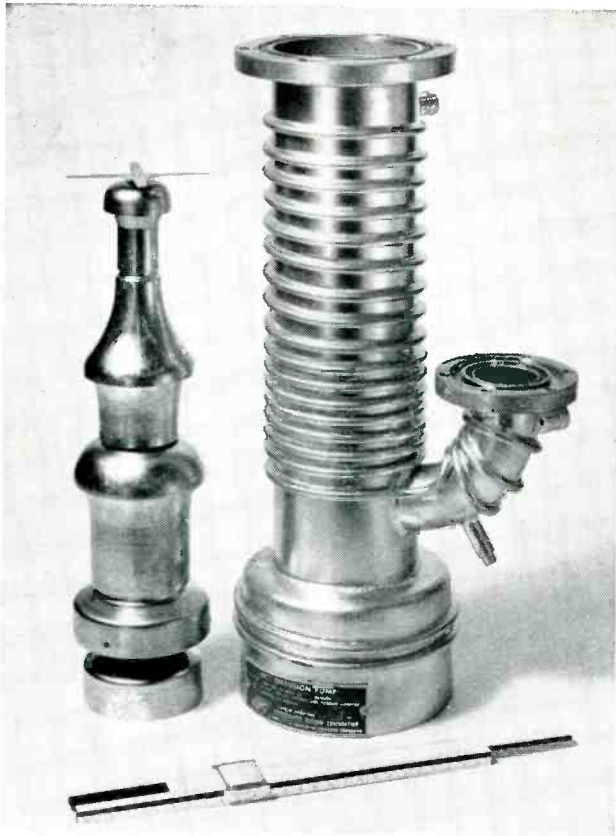

This is the 4" model, type MCF-300. Ultimate pressure— 5×10^{-7} mm Hg; speed for air—290 liters/second; throughput—800 micron-liters/second. Casing is stainless steel construction.

CVC fractionating oil diffusion pumps give you:

- ① low pressures (10^{-2} to 10^{-7} mm Hg)
- ② high speeds (65 to 19,000 liters/second)
- ③ high throughputs (100 to 15,000 micron-liters/second)
- ④ high limiting forepressures (up to 400 microns Hg)

If you want to exhaust electronic tubes to extremely low pressure, exhaust gases of low molecular weight, or large gas loads of any kind, there's an MCF pump to do the job.

There are seven of these fractionating oil-diffusion pumps, ranging in diameter from 2 inches to 32 inches. Here you have your choice of the widest range of size, speed, and throughput available.

The jet assembly of an MCF pump can be removed easily for

cleaning. Jets are plated to prevent rust and reduce heat loss. Large diameter cooling coils insure top operating efficiency. Heaters are mounted externally to facilitate maintenance.

These are just a few of the reasons MCF pumps have become the standard diffusion pumps of the electronic industry, outselling by far all other types.

For further information, write for data sheet 6-55.



Headquarters
for High Vacuum

Consolidated Vacuum Corporation Rochester 3, N.Y.

a subsidiary of CONSOLIDATED ENGINEERING CORPORATION, Pasadena, California

CVC sales now handled through Consolidated Engineering Corporation with offices located in: Albuquerque • Atlanta • Boston • Buffalo • Chicago • Dallas • Detroit • New York • Palo Alto • Pasadena • Philadelphia • Seattle • Washington, D.C.

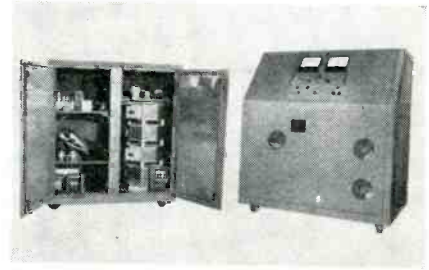

in ferromagnetic research and other similar applications.

Using techniques ranging from chopper-stabilized thyatron control to dual-speed, high-sensitivity electromechanical servo regulation, these supplies provide: long-term current stability better than 100 parts per million, independent of supply line fluctuation or magnet heating; voltage ripple of less than 0.1 percent peak-to-peak; dynamic range of -15 percent to 100 percent of rated maximum current; automatic reversing cycle and internal current monitoring shunt.

Illustrated is model CS-3866, rated at 0-8 amperes over the load voltage range of 0-2,500 v.

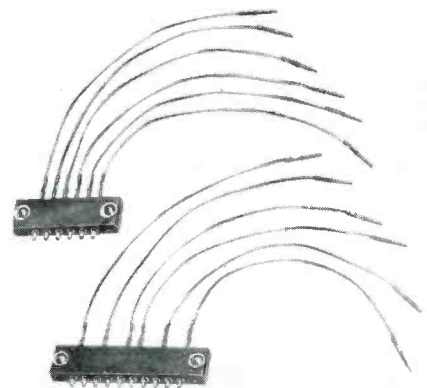

TERMINAL STRIP stacks in small area

DEJUR-AMSCO CORP., 45-01 Northern Blvd., Long Island City 1, N. Y., has a new subminiature terminal strip designed specifically for printed circuit computer applications. Available in 6 and 10 contacts, the new strip has the series designation M.B.

► Features—Two mounting holes on the body of the terminal strip permit stacking of the units in quantity and in a small area. One side of the strip accommodates paper tab (AMP series 53) for solderless wiring. The second side

IN COMPUTERS ... IT'S RELIABILITY THAT COUNTS!

GENERAL CERAMICS

FERRAMIC®

MAGNETIC
**MEMORY
CORES***

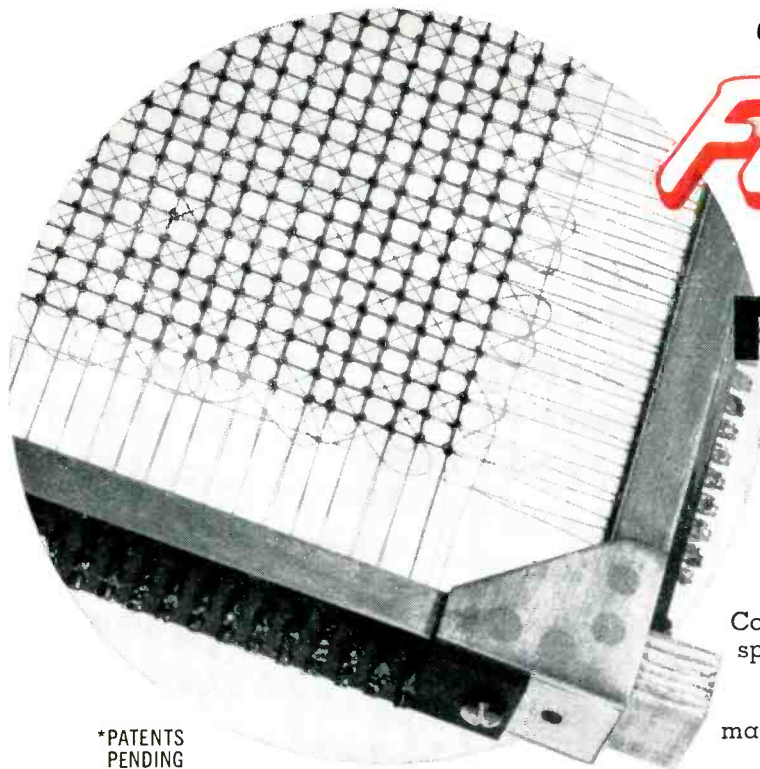

*PATENTS
PENDING

One or a million, every core can be depended on for uniform electrical and mechanical characteristics

General Ceramics has supplied all Square Hysteresis Loop Ferrite Cores for all of the presently operating large scale magnetic core memories. Our experience in manufacturing these millions of Ferrite Memory Rings is available to you to help solve your problems. We can supply you with unassembled and tested cores, or with fully assembled matrices to fit your needs.

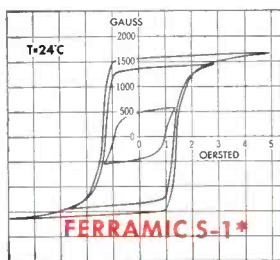

Diagram illustrates flux-current characteristics of ferrite toroid with rectangular hysteresis loop. In addition to high volume resistivity and low loss factor, high efficiency is maintained at both high and low frequencies. Response time is app. 1.0 microsecond.

Specify FERRAMIC S-1* and S-3* Memory Cores — Developed and Produced by General Ceramics

General Ceramics initiated the development of Rectangular Hysteresis Loop Ferrites, for which it has applied for patents and which it markets under the name Ferramic S-1* and S-3*. The application of these materials to Computer Memories has so vastly improved the speed, accuracy and reliability that this system of memory is replacing all others. The reduction in initial installation costs and maintenance have further enhanced the value of this development and has so increased the reliability and speed of digital computers that the use of this type is becoming more and more wide spread.

STANDARD CORE SIZES

SMALL F-394	MEDIUM F-426	LARGE F-262
.080" O.D.	.100" O.D.	.375" O.D.
.050" I.D.	.070" I.D.	.187" I.D.
.025" THICK	.030" THICK	.125" THICK

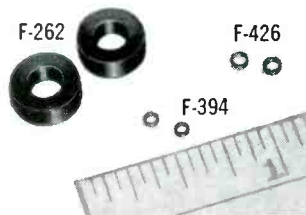

TABLE OF MAGNETIC PROPERTIES

		FERRAMIC "S-1"	FERRAMIC "S-3"
Initial permeability (1 Mc)	μ_0	40	45
Maximum permeability (DC)	μ_{max}	515	1800
Saturation Flux Density (DC) gauss	B_s	1780	2000
Retentivity (DC) gauss	B_r	1590	1920
Coercive Force oersteds	H_c	1.5 max.	.65 max.
Switching Time microseconds	τ	1	>4
Br/Bs Ratio		0.90	.96
Maximum Squareness Ratio $\frac{\phi(-I_m)/\phi(I_m)}{2}$	R_s	0.8	.95
Optimum Magnetomotive Force (oersteds)	H_m	2.0	.80

For complete information call or write Dept E



General CERAMICS CORPORATION
TELEPHONE: VALLEY 6-5100

GENERAL OFFICES and PLANT: KEASBEY, NEW JERSEY

MAKERS OF STEATITE, ALUMINA, ZIRCON, PORCELAIN, SOLDERSEAL TERMINALS, "ADVAC" HIGH TEMPERATURE SEALS, CHEMICAL STONWARE, IMPERVIOUS GRAPHITE, FERRAMIC MAGNETIC CORES

KILOWATT switching on MILLIWATT signals

Two Sigma relays, while far from the smallest, lightest or most sensitive, now provide all or nearly all the answers to switching loads in the 1 to 2 KW range on limited amounts of control power.

By eliminating the need for a pilot and slave relay combination, either the Sigma 51 or 61, although perhaps more expensive individually, can save in total cost and space.

The first of these, Series 51, was developed for a photoelectric lighting control to switch loads of the order of 10 amperes, with an inrush ratio of 10 to 1. Contact arrangement is SPST, normally closed, sensitivity 100 milliwatts D.C. (3.2 ma, 10,000 ohm coil). Since a coil circuit signal failure will close the circuit, Series 51 also has application in fail-safe alarms.

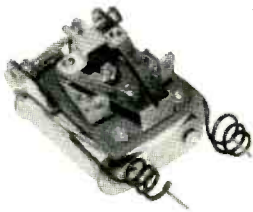

Series 51

The Series 61 is a polarized latching 20 ampere contactor, requiring only a momentary 1/4 to 1/2 watt signal to latch firmly in either of two positions.

Permanent magnetic instead of mechanical latching forestalls the life-shortening wear of triggers and catches. Each "throw" of the 61 opens two circuits and closes two others. It may be wired DPDT. When operated not more than once per second, Series 61 has a minimum rated life of 100,000 cycles on 20 ampere resistive loads at 28 VDC or 115 VAC.

The advantages of such a pulse-operated sensitive contactor are apparent in battery-energized supervisory control systems, as well as in controls for production machinery where contactors must be immune to vibration and the effects of wear.

Further information available on request.

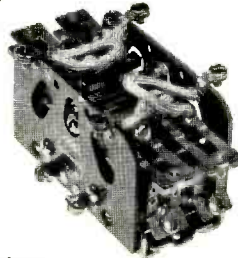

Series 61

SIGMA

SIGMA INSTRUMENTS, INC.,
62 Pearl Street, So. Braintree, Boston 85, Massachusetts

is suitable for conventional wiring. Body material is mineral-filled Melamine, type MME per MIL-P-14D specifications. Brass contacts are gold-plated over silver for low contact resistance and soldering ease.

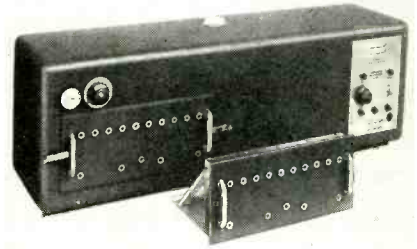

TEST CHAMBER portable, self-contained

STATHAM DEVELOPMENT CORP., 12411 W. Olympic Blvd., Los Angeles 64, Calif. Model TC-2A temperature test chamber is completely portable and self-contained. The low-cost unit (\$550) is especially designed for production line tests of small products such as basic instruments, electronic subassemblies and mechanical components.

► **Highlights** — Key features include a new anticipator-type thermostat which provides extremely accurate temperature control; three-heat selection switch; rugged welded aluminum construction and glass fiber insulation.

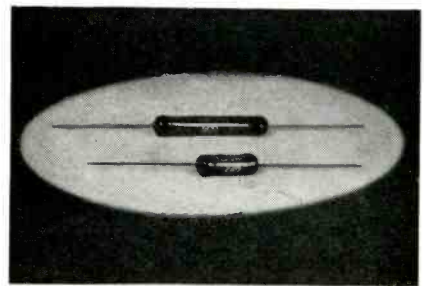

VITREOUS RESISTORS axial-lead type

TRU-OHM PRODUCTS, Div. of Model Engineering & Mfg. Co., 2800 N. Milwaukee, Ave., Chicago, Ill., announces the new vitreous axial-lead resistors, somewhat smaller in size than the standard variety of

THERE'S A WORLD OF DIFFERENCE IN VACUUM

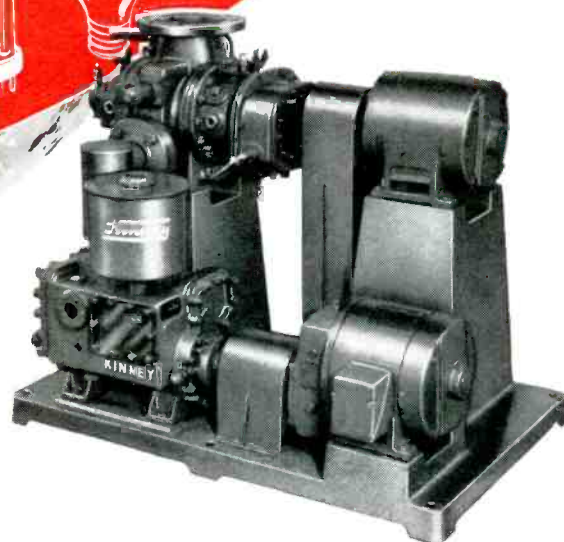

- HERE'S THE NEW MODEL **KMB-230!!!**
- KINNEY OFFERS THE WORLD'S LARGEST LINE OF VACUUM PUMPS!
- AND IT'S GROWING LARGER!!

- Mechanical Booster Vacuum Pump
- Highest volumetric efficiency
- Highest dollar return per CFM
- Outstanding performance
- Models from 2 cu. ft./min., 1/4 h.p. to 780 cu. ft./min., 40 h.p.

OPTIONAL FEATURES

- Controlled gas ballasting
- Dynamic balancing for reduced vibration
- Quick recovery of operating pressures
- And many more

Request complete data or contact one of our competently staffed district offices for a speedy solution to your vacuum problem. District offices are located in Baltimore, Chicago (La Grange), Cleveland, Detroit, Houston, Los Angeles, New Orleans, New York, Philadelphia, San Francisco, and St. Louis. Send coupon today for full details.

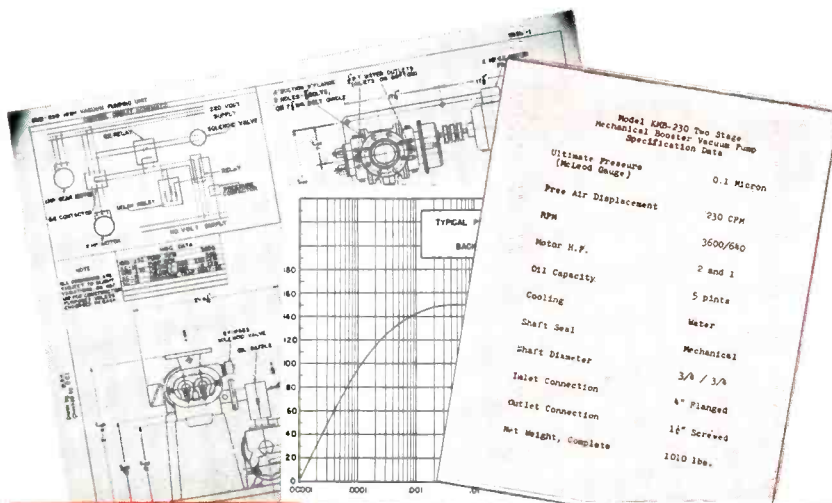

Send Today

KINNEY MFG. DIVISION
THE NEW YORK AIR BRAKE COMPANY
3565 WASHINGTON STREET • BOSTON 30 • MASS.
INTERNATIONAL SALES OFFICE, 90 WEST ST., NEW YORK 6, N.Y.



Name.....
Company.....
Street.....
City..... State.....

- Please send Catalog No. 425 describing the complete line of Kinney Vacuum Pumps.
- Our vacuum problem involves.....

UNION

MINIATURE RELAY Plate Circuit 10,000 OHMS

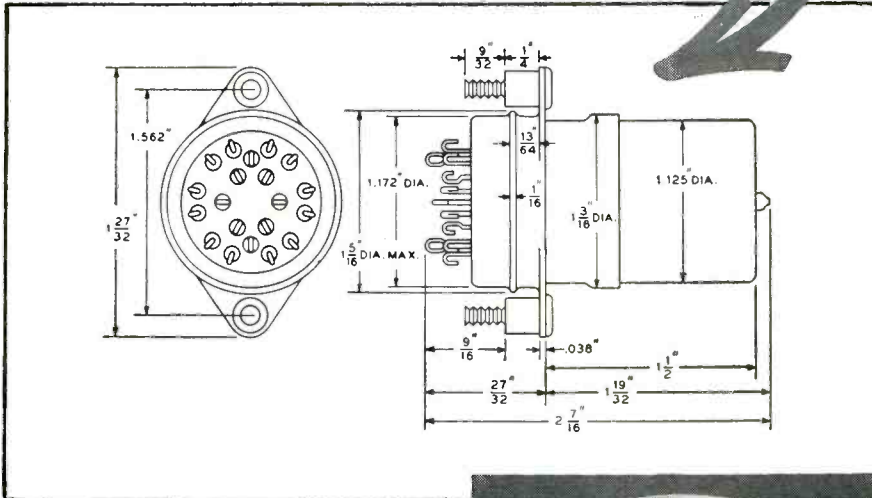

THIS NEW UNION 10,000 ohm, current-sensitive relay picks up at a nominal value of 8 milliamperes throughout the entire temperature range of -65°C to $+125^{\circ}\text{C}$, while maintaining the excellent shock and vibration characteristics inherent in our standard design. It can withstand 200 volts across the coil continuously.

These current-sensitive relays have a life expectancy of 100,000 operations. They meet or exceed all requirements of Mil-R-5757-B and withstand shock up to 50G's, vibration through 1500 cycles at 15G's.

The relays are available in 6PDT or 4PDT models, all the usual mountings and with plug-in or solder-lug connections.

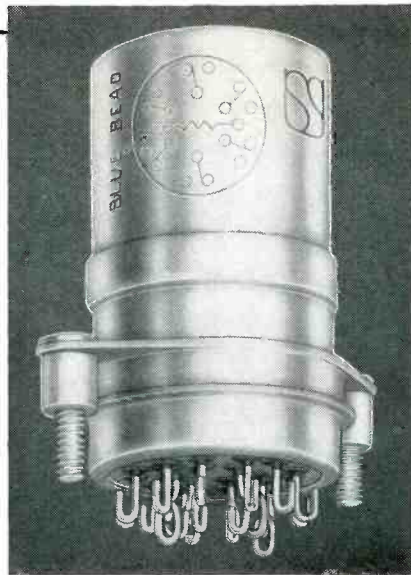

DRY CIRCUITRY APPLICATIONS

In grid switching applications where the relay contacts must operate at low-voltage, low-current levels, special gold-alloy contacts have proved highly reliable. They maintain their low resistance through hundreds of thousands of operations. They are available on the complete line of UNION miniature relays.

75 Years

1881



1956

OF EQUIPMENT AND SYSTEMS ENGINEERING

UNION SWITCH & SIGNAL

DIVISION OF WESTINGHOUSE AIR BRAKE COMPANY
PITTSBURGH 18, PENNSYLVANIA

NEW PRODUCTS

(continued)

vitreous resistors, yet capable of dissipating the same amount of power as the larger type.

► **Construction**—These units are constructed of quality ceramic cores on which are pressed alloy caps with their integral leads. The core assembly is wound to the proper resistance. The junction of the resistance element is silver brazed and then coated with vitreous enamel which is then fired at high temperature. This provides a glossy coating which is moisture resistant and readily dissipates the heat. This type unit is capable of continuous operation at 300°C .

The resistors are offered in 3, 5 and 10-w sizes.

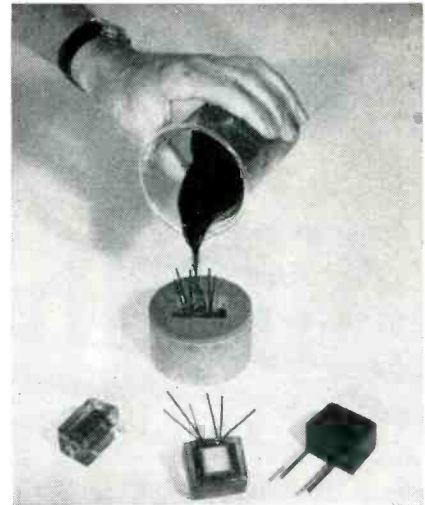

EPOXY RESINS have wide applications

MITCHELL-RAND INSULATION Co., INC., 53 Murray St., New York 7, N. Y., has announced a new family of epoxy resin systems designed for a wide range of insulating purposes. The Randac resins have many uses in the military and civilian electronic fields.

► **Applications**—Among the uses are: coating and encapsulating for purpose of moisture resistance, mechanical shock resistance, and electrical insulation on transformers, resistors, rectifiers, capacitors, transistors, printed circuitry, and electronic assemblies; corona control by void filling and coating h-v transformers, parts and assemblies; sealing parts such as capacitors, resistors and rectifiers into metal, ceramic and plastic cases; and cast

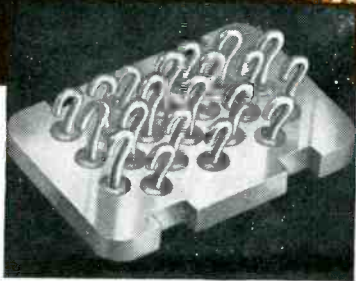
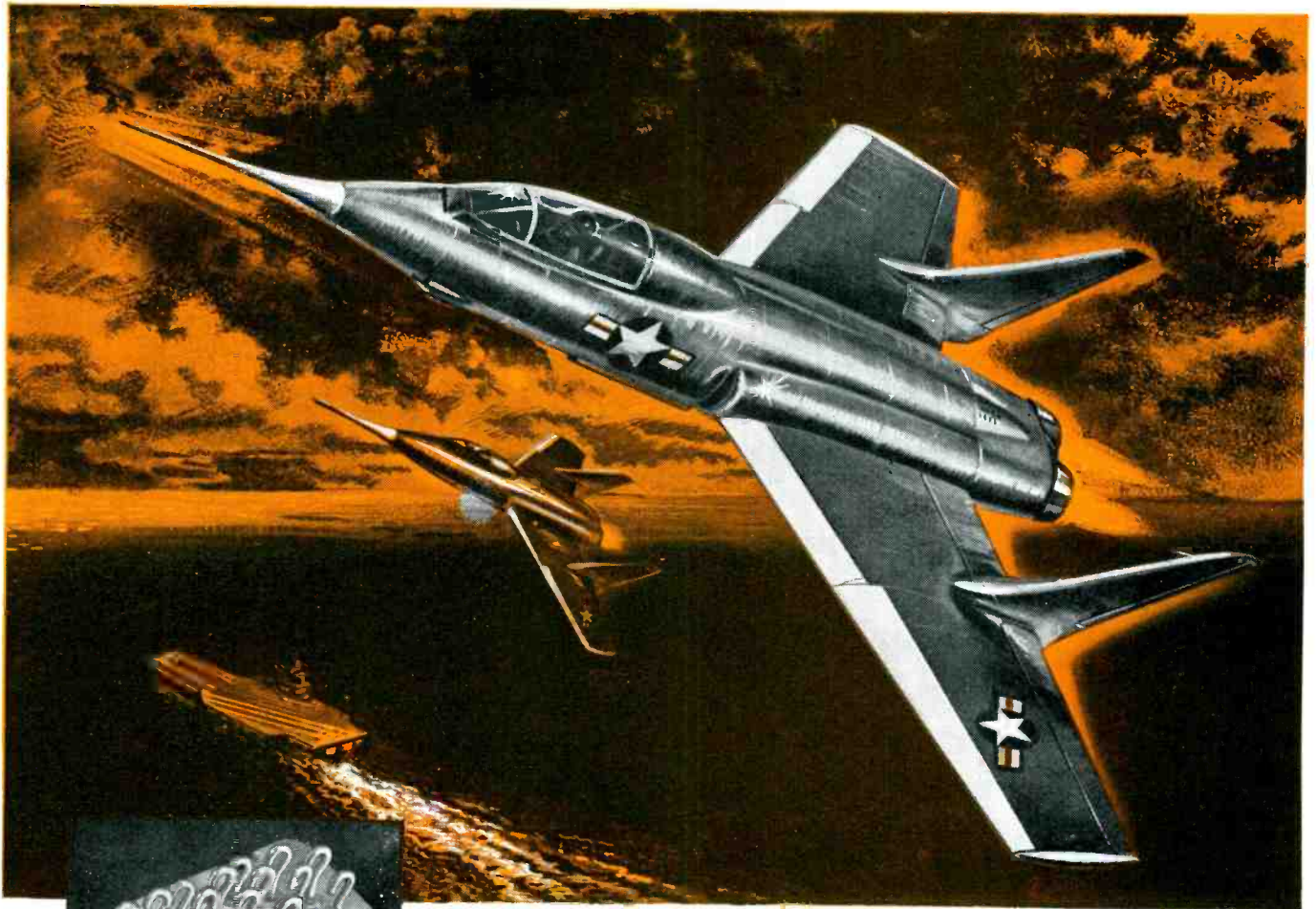

©N

CONSTANTIN
GLASS-TO-METAL SEALS ASSURE

telemetering dependability

Often the safety of an aircraft depends wholly on the accuracy of its telemetering equipment . . . these sensitive electronic systems must consistently withstand *rapid, almost violent* environmental changes, and remain completely reliable.

Their vital performance is positively protected by sealing components in various ways . . . and by rugged Constantin Glass-to-Metal Seals. These precision Seals lock out damaging conditions . . . lock in superior performance. Manufacturers know when you specify Constantin you're assured of "no leakage".

Thousands of standard Glass-to-Metal Seal types are *immediately* available from Constantin . . . *one's an exact fit for your present project!*

Constantin engineering experience and technical skills have developed mass production methods of great accuracy to meet the most exacting specifications. If you are faced with a problem involving Glass-to-Metal Seals of *any kind*, consult our engineering staff for a quick, satisfactory solution.



L. L. Constantin & Co.

**MANUFACTURING
 ENGINEERS**

Route 46, Lodi, N. J. • 187 Sargeant Ave., Clifton, N. J.

TRANSISTOR MOUNTS • SINGLE TERMINALS • COMPRESSION HEADERS • END SEALS • CRYSTAL BASES • CONNECTORS • MINIATURIZATION

ELECTRONICS — May, 1956

Want more information? Use post card on last page.

20
TO
200 D.P.

SEND YOUR
PRINTS FOR
QUOTATION

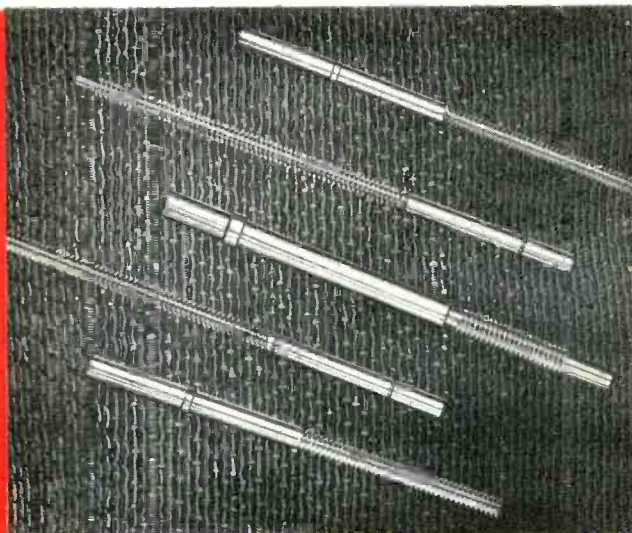

SPURS • HELICALS • WORM AND WORM GEARS • STRAIGHT BEVELS
LEAD SCREWS • RATCHETS • CLUSTER GEARS • RACKS • INTERNALS • ODD SHAPES

THE *Finest*

IN GEARS



Beaver Gear Works Inc.

1021 PARMELE STREET, ROCKFORD, ILLINOIS

479[®] PLATINUM ALLOY
POTENTIOMETER
RESISTANCE WIRE



- **HIGH TENSILE STRENGTH**
To permit easy winding of Potentiometers and Coils.
- **CORROSION RESISTANT**
Platinum Content provides unsurpassed resistance to corrosion . . . long shelf life.
- **MAXIMUM STABILITY**
of Electrical Characteristics. Available Bare or Enameled as small as .0004" diameter to as large as required. Resistance to 2500 ohms/ft.



Specialists in the **UNUSUAL**

Write for List of Products

SIGMUND COHN CORP.

121 SOUTH CCLUMBJS AVENUE • MOUNT VERNON, N. Y.

embedding of electronic parts and assemblies.

► **Types** — Three main types are available: casting or embedding resins R-4060 (rigid) and R-4059 (semiflexible), and the R-4053 hot-melt dip coating and sealing resins.

Technical data on each type are available to manufacturers on receipt of letterhead request.

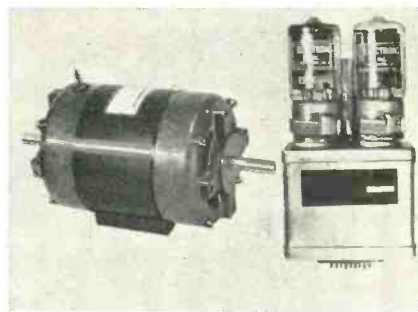

**INDUCTION MOTOR
and speed regulator**

WACLINE, INC., 35 S. St. Clair St., Dayton 2, Ohio, has developed a motor and speed regulator for use with film, tape, chart and other forms of transport mechanisms requiring torque in the order of 5 oz-in. The motor is a 400-cycle induction type with permanent-split capacitor phase. The regulator maintains within 1 percent any selected speed between 300 and 16,000 rpm regardless of load and regardless of wide fluctuations in line voltage and frequency. With a calibrated dial, any speed may be accurately preselected at will.

The drive may be used in many ways, where speed adjustability with close regulation is required.

**TINY TRIMMER POT
is a wire-wound unit**

TECHNOLOGY INSTRUMENT CORP., 531 Main St., Acton, Mass., announces the RWT subminiature wire-wound trimmer potentiometer. It provides precise, stable voltage adjustment for compact assemblies, in a low-cost unit.

► **Specifications** — Electrically, the RWT provides an independent linearity of ± 5 -percent standard, and a ± 10 -percent standard accuracy of total resistance. Low temperature



For dependable control... always use

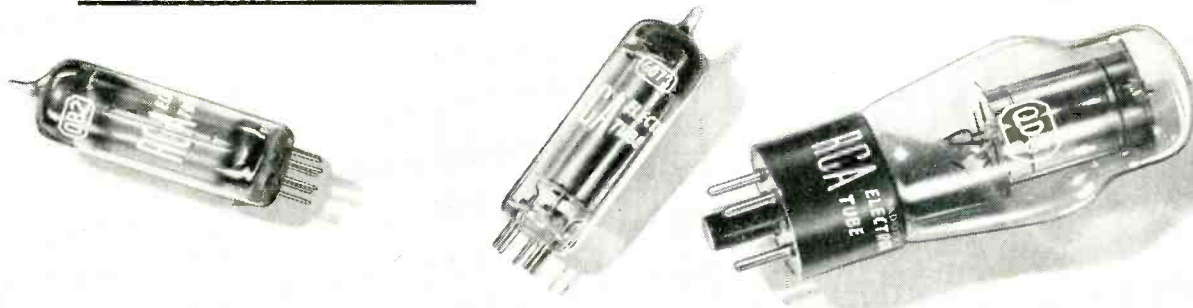

RCA THYRATRONS and VR TUBES

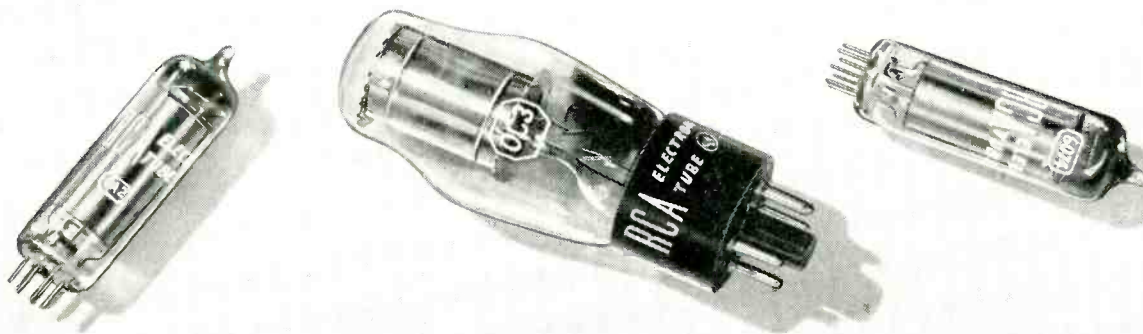

At the heart of industrial-electronics equipment are electron tubes. The continuous operation of many industrial production lines *depends* on the performance of these tubes—thyratrons for “on-off” operations, voltage-regulator tubes for dc voltage stability.

RCA... world renowned for advanced-design superior-quality electron tubes... offers a group of Thyatron and Voltage-Regulator tube types specifically designed for *dependable* control of industrial-electronic apparatus. Shown here are 10 of the RCA types most frequently specified.



TUBES FOR INDUSTRIAL-ELECTRONICS

Radio Corporation of America, Harrison, N. J.

ALWAYS REPLACE WITH RCA ELECTRON TUBES—AVAILABLE THROUGH YOUR LOCAL RCA DISTRIBUTOR. FOR FASTEST SERVICE, CONTACT HIM DIRECTLY.

RCA TYPE	DESCRIPTION
OA2—miniature 7-pin base OA3—octal 6-pin base OB2—miniature 7-pin base OC3—octal 6-pin base OD3—octal 6-pin base	Voltage-Regulator Types For regulation of dc voltage supplies for amplifiers, oscillators, etc. Also can be used as relaxation oscillators.
6073—miniature 7-pin base 6074—miniature 7-pin base	Like OA2 and OB2 but having very stable characteristics and intended for applications critical as to shock and vibration.
5823—miniature 7-pin base	Relay Type For use where “on-off” control of low-current electrical circuits is required.
2D21—miniature 7-pin base 2050—octal 8-pin base	Thyatron Types Primarily intended for high-sensitivity relay control circuits.

Send for these booklets today!

#RIT-104—Receiving-Type Tubes for Industry and Communications... contains up-to-date data on 130 RCA receiving-type tubes especially suited to industrial electronics.

#ID-1020-A—RCA Interchangeability Directory of Industrial-Type Electron Tubes... time saving information. Lists industrial tubes of 26 manufacturers and gives RCA direct replacement types or RCA similar types, whichever is available. Write: RCA, Commercial Eng., Sec. E192 Harrison, N. J.

NAME

COMPANY TITLE

ADDRESS

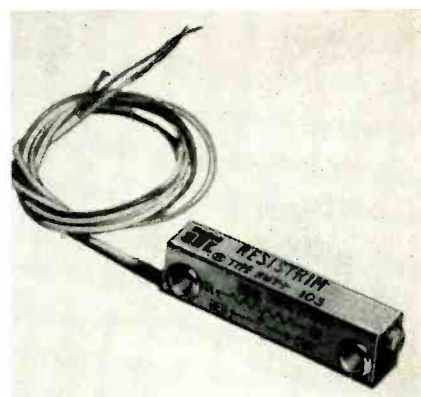

coefficient of the resistance wire (0.0017 percent per deg C) contributes to the high electrical stability of the unit over a wide temperature range. Standard temperature range is from -55 C to 95 C. Power rating is $\frac{1}{2}$ w at 30 C, derated linearly to 0.05 w at 95 C for standard units. A wide range of standard resistance values are available from 50 ohms to 15,000 ohms.

► **Other Features**—Ten units occupy less than 1 cu in. of space. Weight is 0.38 oz. The wiper-assembly and resistance-element design permits use of the full resistance range.

A stainless steel cover and an anodized aluminum body comprise the dust-proof, splash-proof, corrosion-protective sealed enclosure. The enclosure conforms with military specifications.

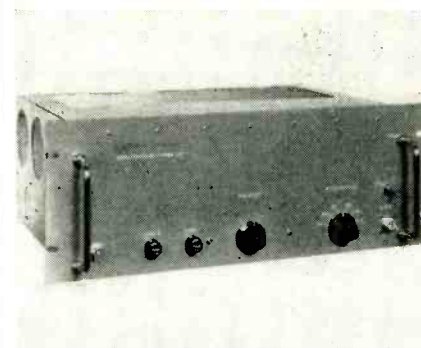

PULSE FORMING UNIT
for high repetition rate

RUTHERFORD ELECTRONICS Co., 3707 S. Robertson Blvd., Culver City, Calif. Model 300 pulse forming unit is designed to produce high repetition rate pulses of fast rise time and carefully controlled pulse shape. This unit may be triggered at repetition rates up to 1 mc and will produce pulses of either posi-

MERCURY BATTERIES

with dependable power can help you miniaturize your products

General Mercury Batteries with their small size and dependable high-energy output, are enabling manufacturers of portable and personal radios, hearing aids, and many other battery-powered products to miniaturize and improve performance.

Why not investigate the possibilities of these small but powerful batteries for your products? We will be glad to work with you in developing General Mercury Batteries which will exactly fit your requirements.

General Mercury Batteries can be made in "power packs" in an un-

limited number of series, parallel or series-parallel combinations. These "power packs" are made up of individual cells joined together by General's surge-weld process which makes a better battery with constant potential and uniform rate of discharge, and with resistance to humidity, corrosion, impact and acceleration . . . a battery that is usable over wide temperature and pressure ranges.

Complete technical data will be sent on request, and specific questions gladly answered. Just write and tell us how we can help.

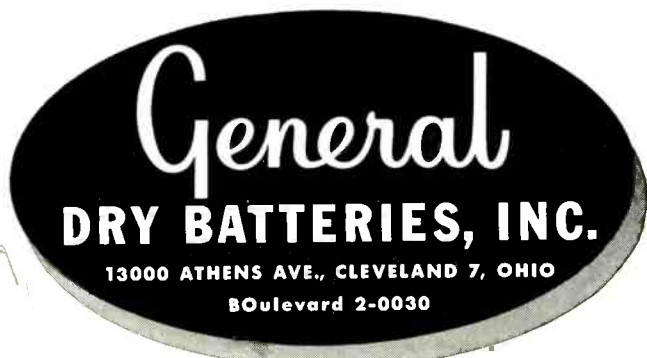

EXPORT OFFICE: 431 5th Ave., New York 16, New York
IN CANADA: General Dry Batteries, Ltd., Toronto 4, Ontario



Marron Kendrick, President of Schlage Lock Co., tells how

“I locked up 565 guests!”

“Building the luxurious Fontainebleau Hotel in Florida was tightly scheduled — with 565 guests due at the opening!

“Our problems were to create a special lock design, obtain model approvals, and install the locks before the great day. But could our San Francisco plant compete with other firms many hundreds of miles nearer the construction site?

“Yes — thanks to Air Express!

“The designs, the models, and the last-minute changes were all flown Air Express for customer O.K. Air Express

service gave us valuable added production time . . . End of story: the locks were in before the first guest!

“Delivering anywhere in the country in a few hours, Air Express is like having a factory in every state. We can bid successfully against *any* competition, no matter how local it is. That’s because Air Express, in daily use, has never failed us! Yet, sending most of these shipments Air Express costs surprisingly little. For instance, 10 pounds, San Francisco to Miami, with overnight delivery, costs only \$9.54 door to door!”



Air Express



GETS THERE FIRST via U.S. Scheduled Airlines

CALL AIR EXPRESS . . . division of RAILWAY EXPRESS AGENCY

more for your
money from the
leader in the field!

NEW

Berkeley

**MODEL
7360**

**1 mc UNIVERSAL COUNTER-
TIMER-EPUT* METER**



No other single instrument offers the wide range of usefulness of the truly universal Model 7360. It combines the functions of high-speed counter, time interval, EPUT*, frequency, frequency ratio and frequency period meters in one compact precision instrument.

No other instrument offers such outstanding value — 12 major improvements, at no increase in price:

- 1 0.1 v rms sensitivity
- 2 Step attenuators
- 3 More stable frequency dividers
- 4 Electronic (not relay) reset
- 5 External frequency standard input connection
- 6 Ac or dc coupling of all input circuits
- 7 Accessory socket to power photocells, etc.
- 8 Direct connection to digital printers, data converters
- 9 Crystal-controlled time marker output
- 10 Unitized modular design
- 11 Larger, brighter readout numbers
- 12 Modern-styled all-aluminum cabinets

BRIEF SPECIFICATIONS

Freq. Range: 0 cps to 1 mc
Time Int. Range: 1 μ sec to 10⁷ sec
Period Range: 0 cps to 1 mc
Time Base: 1 μ sec to 10⁷ sec
Accuracy: \pm 1 count, \pm crystal stability
Crystal stability: \pm 3 parts in 10⁷ per week
Input Req.: 0.1 v rms, 10 megohm imp.,
ac or dc-coupled
Dimensions, cabinet: 10 $\frac{1}{4}$ "H x 20 $\frac{3}{4}$ "W x 16 $\frac{1}{2}$ "D
(rack mount available)
Price, f.o.b. factory: \$1,175.00
(100 kc Model 7350, \$890.00)

If you want to get the most for your instrument dollar, investigate BERKELEY's outstanding new 7000 series Universal Counter-Timer-EPUT* meters now. Technical bulletin, complete data is yours for the asking; please address Dept. G-5.

*Trademark

Berkeley

division

BECKMAN INSTRUMENTS INC.
2200 Wright Avenue • Richmond 3, Calif.

NEW PRODUCTS

(continued)

tive or negative polarity having 25-v amplitude at 50 ohms, internal impedance with rise time of 0.02 μ sec. The unit can generate pulses from 0.05 μ sec to 1,000 μ sec pulse width with duty factors up to 25 percent.

Model 300 also features excellent r-f shielding and power line filtering to prevent the radiation of spurious signals. It is designed for standard 19-in. relay rack mounting and is 7 in. high.

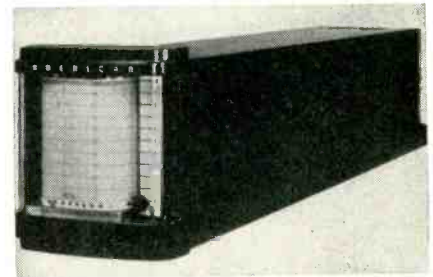

**ELECTRONIC RECORDERS
new graphic type**

MANNING, MAXWELL & MOORE INC., Stratford, Conn., has announced a new line of recording millivoltmeters and microammeters. With a measuring element that is more than 50,000 times more powerful than conventional direct-deflection movements, the pen drive mechanism has ample power to operate alarm contacts with no loss of accuracy.

The series 130 recorder measures input signals with an electromechanical transducer and amplifier which drives a powerful rotary solenoid to position the pen. It is available, as a microammeter, in ranges from 0-200 μ a to 0-100 ma. As a millivoltmeter, it is available in ranges from 0-20 mv to 0-100 v with input sensitivity to 6,700 ohms per v. Accuracy is within 0.5 percent of the range. Repeatability is better than 0.25 percent of range. The recorder responds to input changes of less than 0.2 percent of range.

► **Other Features**—Speed of response is 0.5 sec for 63 percent of a step change. On special order, response speeds up to 0.2 sec for 63 percent can be furnished. A switch is incorporated in the recorder to increase this response

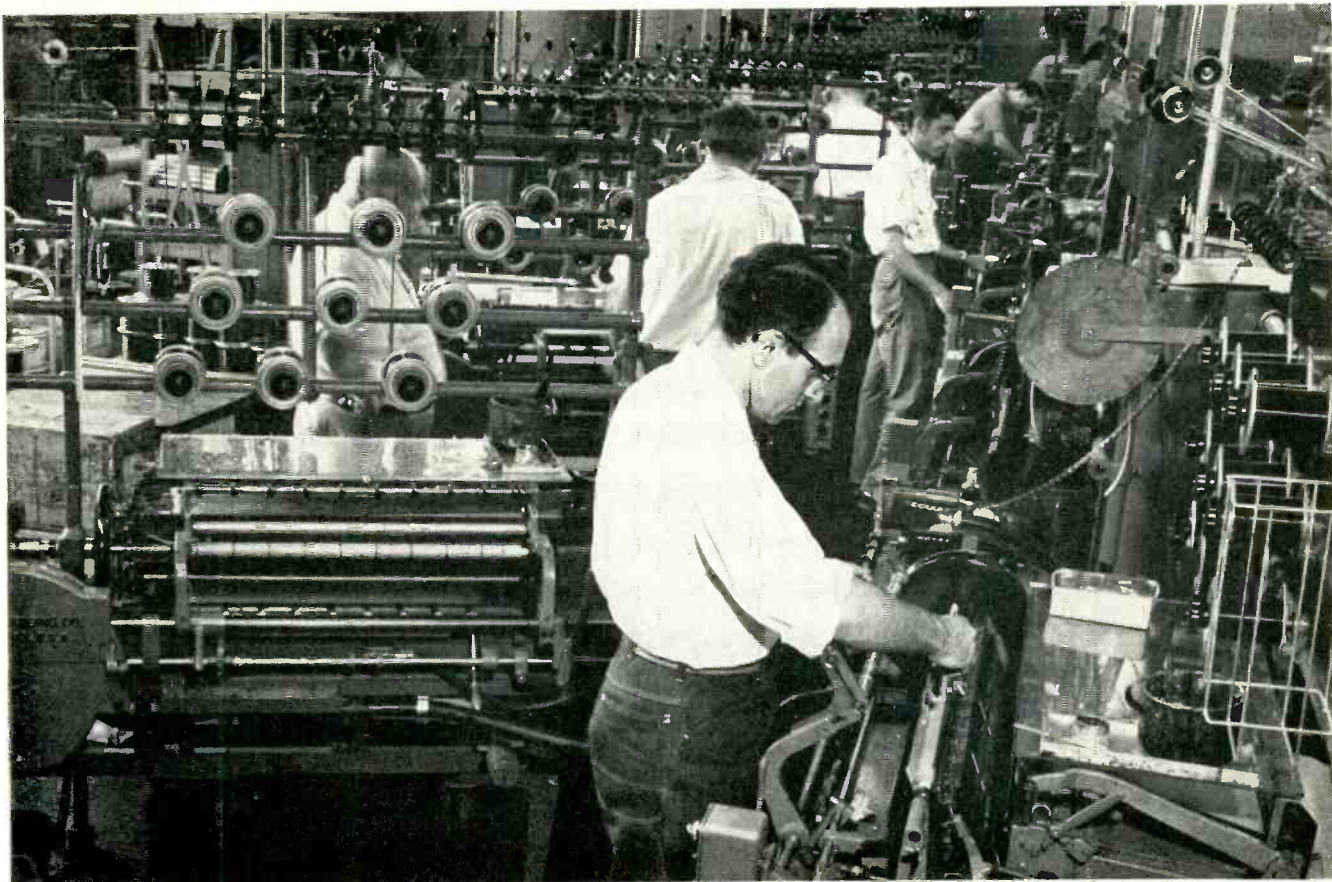

Installation of Leesona No. 107 Coil Winders at Ford Motor Company's Ypsilanti, Michigan, plant. New Paper Miss Detector enables operator to tend two machines.

Now FORD Motor Co. winds ignition coils on Leesona No. 107 winders

Machines stop automatically if there's a paper miss . . . one operator tends two machines . . .

These Leesona No. 107 Coil Winders, equipped with the new Paper Miss Detector, make quantity production of high-quality stick-wound coils virtually foolproof.

Humidity changes can cause the

paper to curl and miss an insert. Ordinarily, if there's a paper miss, and the machine is unattended, it continues to wind. Result . . . a worthless stick plus money wasted in wire and time. So an operator must be in constant attendance on each machine.

The new Leesona Paper Miss Detector cures this . . . by automatically stopping the machine. Thus, constant machine attendance is unnecessary.

• One operator can handle two or

three machines.

- Operator's coil production increases.
- Rejection rate is reduced . . . when the machine stops at a paper miss the operator re-inserts the paper, starts the machine which continues to wind an excellent stick of coils.

For the full story on Leesona No. 107 Coil Winders, and other helpful information write or get in touch with Universal.

B.5.2

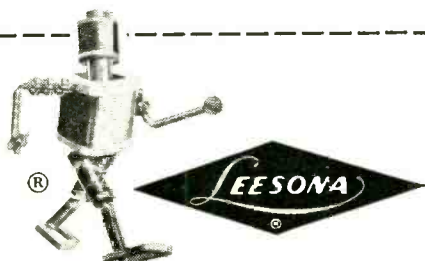

FOR WINDING COILS
IN QUANTITY . . . ACCURATELY
. . . AUTOMATICALLY . . . USE
UNIVERSAL WINDING MACHINES

UNIVERSAL WINDING COMPANY

P. O. BOX 1605, PROVIDENCE 1, RHODE ISLAND, Dept. 126

E. G. PAULES & COMPANY, 1762 West Vernon Avenue, Los Angeles, California
Western Representatives

W. J. WESTAWAY & COMPANY, LIMITED, Montreal & Hamilton, Canada
Canadian Representatives

UNIVERSAL WINDING COMPANY, 9 South Clinton Street, Chicago, Illinois

UNIVERSAL WINDING COMPANY, 1500 Walnut Street, Philadelphia, Pennsylvania

still going... *Strong*

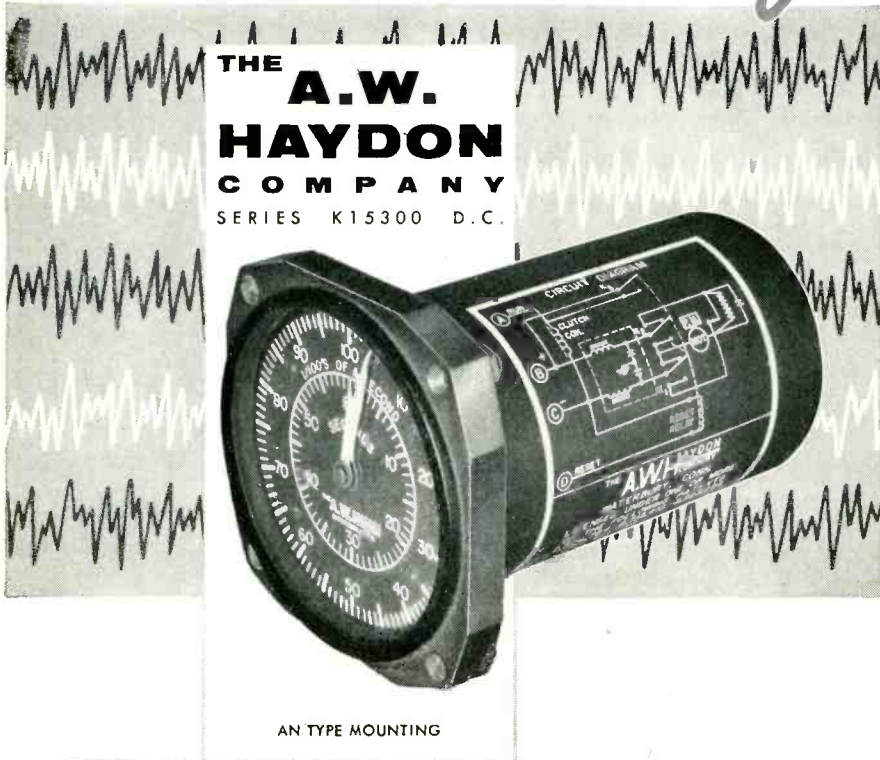

THE
**A.W.
HAYDON**
COMPANY
SERIES K15300 D.C.

AN TYPE MOUNTING



FLANGE MOUNT

STOP CLOCKS

withstand rugged conditions, voltage and temperature variations, with unfailing performance. Used where time intervals must be accurately measured and electrical reset is desired.

S P E C I F I C A T I O N S

Voltage Range—Motor and Clutch Coil: 20-30 Volts D.C.
Temperature Range—From -55°C. to 85°C.
Maximum Current Requirement—475 Milliamps at -55°C.
and 30 Volts D.C.
Accuracy—±0.10% of reading ±20ms @ 20°C.
±0.20% of reading ±20ms from -55°C. to 85°C.
Reset Time—3 seconds maximum.
Dielectric Test—140 Volts RMS-60 CPS or 200 Volts D.C.
for 1 minute.

Meet military specifications.
Hermetically sealed enclosure and connector. AN connector
or glass metal header optional. Choice of flange mountings.
Electrical reset permits local or remote control.

PREFERRED WHERE PERFORMANCE IS PARAMOUNT.

GENERAL
CATALOG
SENT ON
REQUEST



The
A.W. HAYDON Company

235 NORTH ELM STREET, WATERBURY 20, CONNECTICUT

Design and Manufacture of Electro-Mechanical Timing Devices

time by a factor of four in order to damp out unwanted fluctuations.

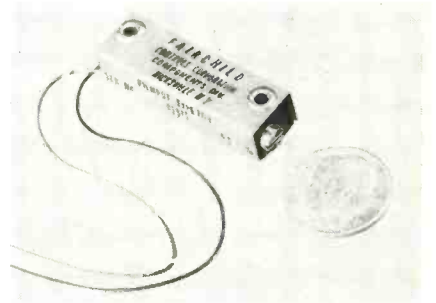

TINY TRIMMER POT with new resistance element

FAIRCHILD CONTROLS CORP., 225 Park Ave., Hicksville, N. Y., has announced a tiny new Film Pot trimmer potentiometer. Featuring Nobl-Ohm precious metal film resistance element, the tiny pot provides infinite resolution throughout the 28½ turn adjustment screw travel.

Serviceable over a wide range of temperature, this model may be adjusted to operate at temperatures as cold as -57 C or as hot as 125 C. Linearity of 5 percent is standard for resistance element values ranging from 50 to 25,000 ohms.

Ideal where weight and space are critical, type 769 is ½ by 13/22 by 1¼ in. overall.

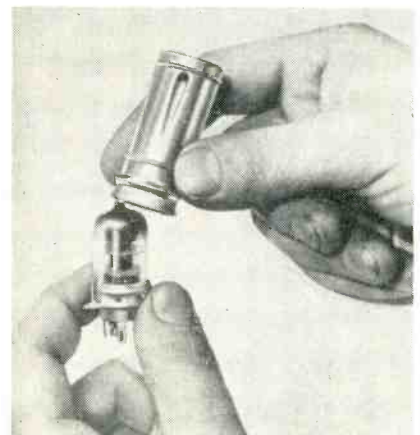

TUBE SHIELDS of wrap-around construction

THE FRED GOAT CO., 314 Dean St., Brooklyn 17, N. Y. Developed especially to aid in the solution of assembly and operational problems that have arisen with the use of

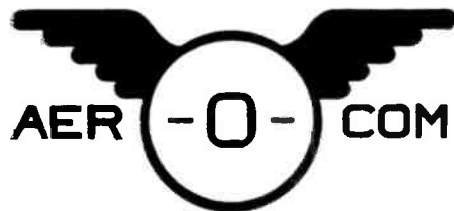

DEFINITELY DEPENDABLE!

Aerocom's Dual Automatic Radio Beacon

Reliability is built into every part of this dual 1000-watt aerophare unit. Ruggedly constructed and conservatively rated, it provides trouble-free unattended service, and at truly low operating and maintenance cost. It operates in the frequency range 200-415 kcs, using plug-in crystal for desired frequency.

Uses single phase power supply, nominal 220 volts, 50 or 60 cycles. Consists of two 1 kw transmitters with keyer (2 keyers if desired), automatic transfer unit and weatherproof antenna tuner. Each transmitter housed in separate standard rack cabinet, with controls in rack cabinet between the transmitters.

Nominal carrier power is 1000 watts. High level plate modulation of final amplifier is used, giving 30%-35% tone modulation. P-T switch interrupts tone, permitting voice operation. Operates in ambient temperatures from -35°C to 50°C, humidity up to 95%.

Standby transmitter is placed in operation when main transmitter suffers loss (or low level) of carrier power or modulation, or continuous (30 sec.) tone. Audible indication in monitoring receiver tells when standby transmitter is in operation.

Antenna may be either vertical tower or symmetrical T type.

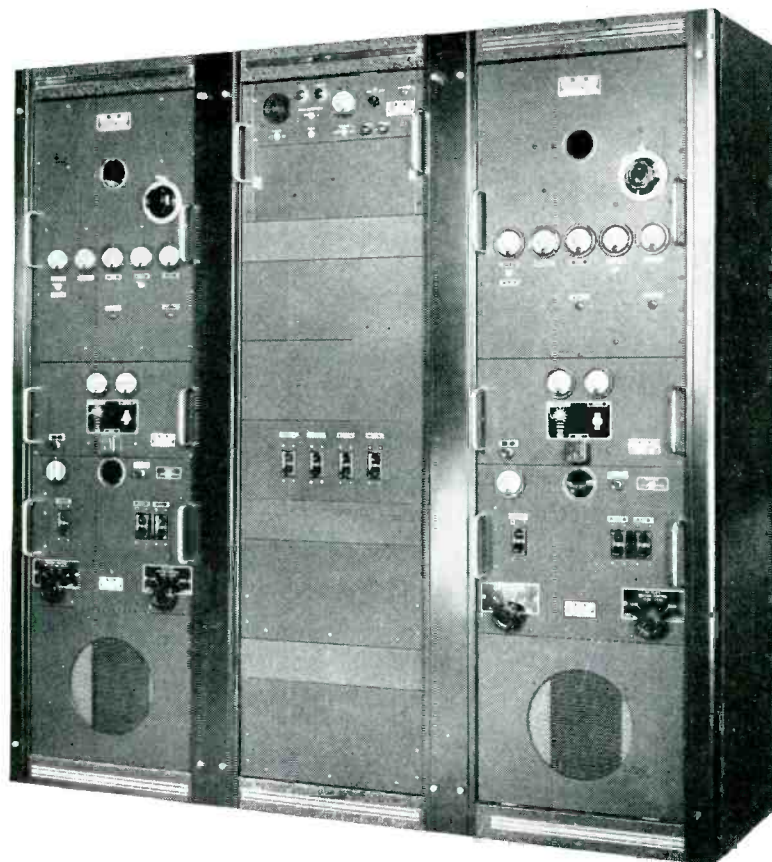

Now! Complete-package, lightweight airborne communications equipment by Aer-O-Com! Write us today for details!

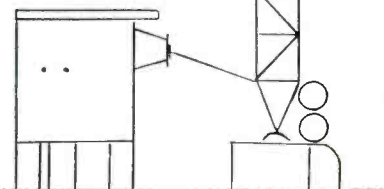

A-101

3090 S. W. 37th AVENUE • MIAMI, FLORIDA



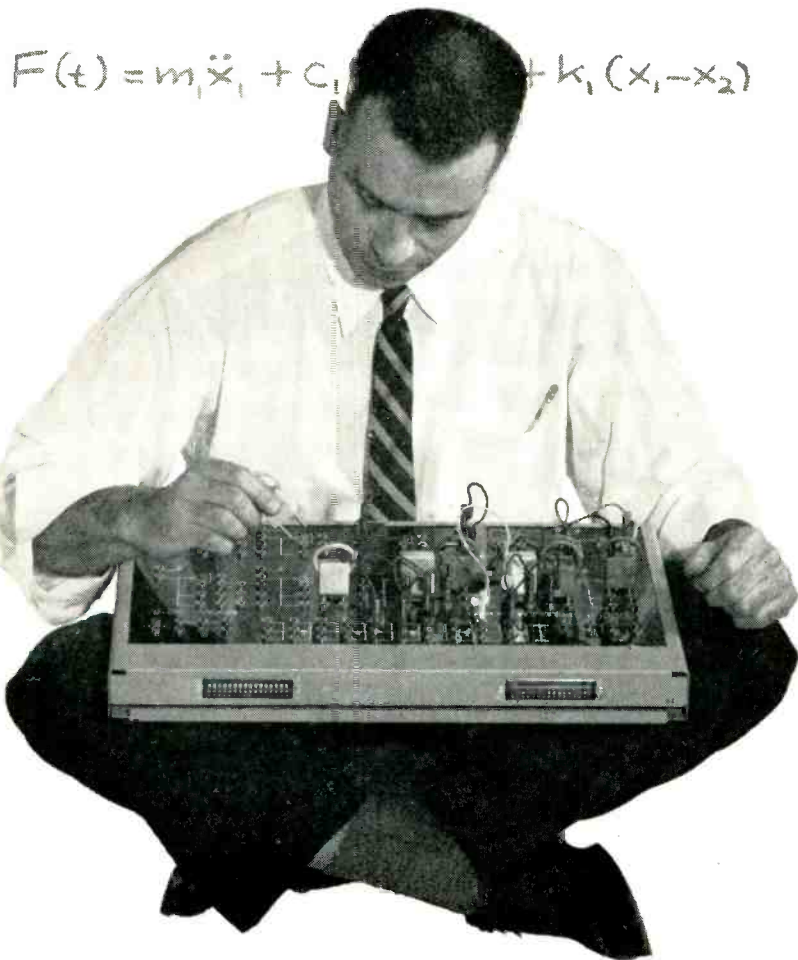

Portrait of **one** engineer doing the work of **two**



...A PERSONAL TOOL

FOR EVERY ENGINEER... **ANALOG
COMPUTER**



MODEL 30

Simplified analog computer solves wide variety of engineering problems. Detachable problem boards and plug-in components facilitate rapid problem set-up. Function generator, multiplier, chopper stabilizer, and other accessories available.

Model 30, \$995 F.O.B. Factory.

DONNER SCIENTIFIC COMPANY

2812 Seventh Street
Berkeley 10, California

WRITE FOR COMPLETE DATA

printed circuits, vertical and hot chassis, the new Uni-Shield features efficiency and economy.

► **Construction**—The tube shields are of wrap-around construction and are available to fit any 7 or 9-pin type T-5½ or T-6½ outline glass envelope. The base of the Uni-Shield clamps firmly on all types of sockets or clips, minimizing vibration and breakage.

► **Features**—The outstanding features of the shields is the unique and economical clamping method. Three angled extrusions, equally spaced around the inside of the shield, center the tube in the socket and exert a downward pressure on top of the envelope, preventing it from vibrating or working loose.

Made of electrolytic tin-plated steel, the straight tubular construction provides maximum air circulation with minimum heat radiation, and can be insulated to customer specifications for use in hot chassis.

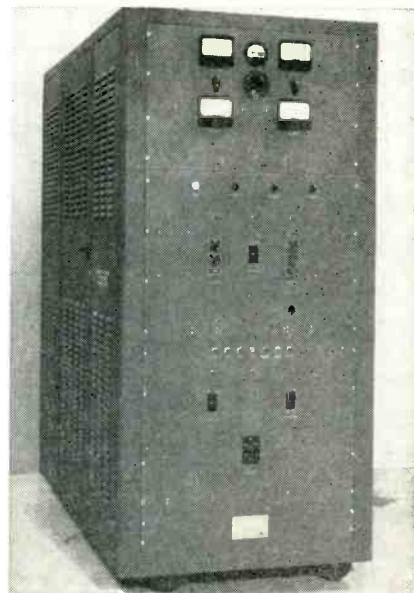

POWER SUPPLY
provides up to 30-kv d-c

LEVINTHAL ELECTRONIC PRODUCTS, INC., 2760 Fair Oaks Ave., Redwood City, Calif. Developed as part of MTI radar system, this power supply provides up to 30 kv d-c at less than 0.05 percent ripple. Supply is capable of providing more than 30 kw of d-c power from a 3-phase, 208-v 50/60-cps input. Output d-c voltage is continuously

**"These *Payoffpaks* of
CHASE® wire sure cut our
wire forming costs!"**

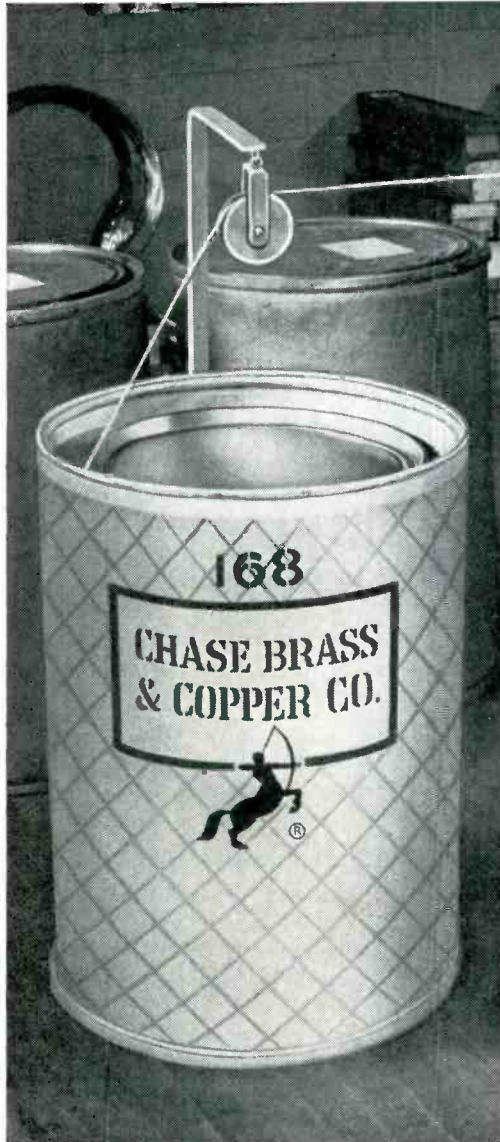

***NOW* you can form
miles of wire with
no costly down time**

In this new PAYOFFPAK you get a continuous length of Chase copper alloy wire up to a total of 400 to 500 pounds in weight.

This extremely long wire length cuts to a minimum the amount of time lost in setting up a wire-forming machine, permits more continuous operation, reduces scrap loss. The Payoffpak is safe to use, easy to store ... cuts down on stock space.

In transit and storage, the Payoffpak protects the clean, smooth surface of Chase wire from rough and tumble handling. Your Chase wire comes out as bright and free of kinks as the day it was made.

Check with your Chase Wholesaler or nearest Chase Warehouse about getting your next shipment of wire in the new Payoffpak.

Chase  **BRASS & COPPER CO.**

WATERBURY 20, CONNECTICUT • SUBSIDIARY OF KENNECOTT COPPER CORPORATION

NEW! Chase's informative wire and rod movie: "IN THE CHIPS." Arrange for a free loan of this film by contacting the Chase warehouse or sales office near you. Write on your company letterhead, today!

The Nation's Headquarters for Brass & Copper (†sales office only)

Atlanta	Chicago	Denver	Indianapolis	Minneapolis	Philadelphia
Baltimore	Cincinnati	Detroit	Kansas City, Mo.	Newark	Pittsburgh
Boston	Cleveland	Grand Rapids†	Los Angeles	New Orleans	Providence
Charlotte†	Dallas	Houston	Milwaukee	New York	Rochester†
	St. Louis	San Francisco	Seattle	Waterbury	

What is the Current Rating of a Vacuum Capacitor?

Jennings VMMHC 25 to 450 mmfd, 55 kv, vacuum variable capacitor is rated in the catalog at 125 amperes rms.



But The Girdler Company needed a variable that would handle **four times** that much current—500 amperes rms at 17 kv with transient voltages up to 55 kv.

This variable capacitor was to be used in a dielectric heating circuit in the automotive trim panel press shown at the right.

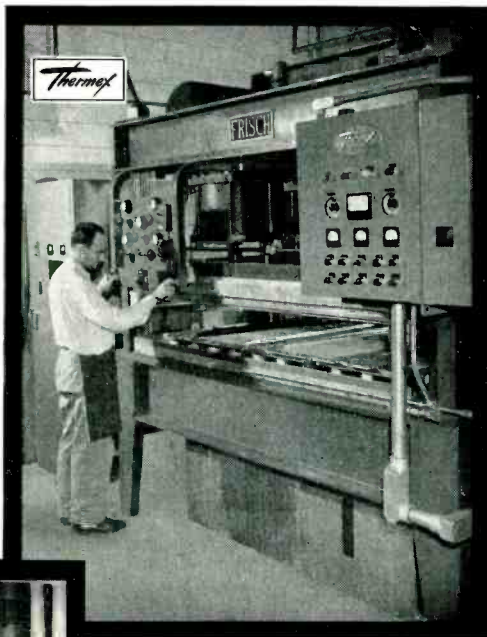

Forced air cooling would have doubled the current rating to 250 amperes, but to carry 500 amperes it was necessary to water cool the variable end of the capacitor and to provide internal air ducts for cooling the fixed end. Working models of this unit were in Girdler's hands within 90 days of the original request.

Most of Jennings capacitors — both fixed and variable types — can be provided with ducts for carrying air or water cooling right to the base of the plates so that heat can be dissipated at its source.

Each capacitor therefore has three current ratings. Its catalog rating is established on a 75 kw variable frequency test transmitter with the capacitor operating in still air at a maximum surface temperature of only 175° F. A flow of air past the capacitor doubles this rating at the same operating temperature. And a still higher rating may be obtained by internal cooling with either air or water.

A new catalog summary has been prepared describing all of our standard components — capacitors, switches, and high voltage measuring equipment. We will be happy to send you a copy.

JENNINGS RADIO MANUFACTURING CORPORATION • 970 McLAUGHLIN AVE. P.O. BOX 1278 • SAN JOSE 8, CALIF.

NEW PRODUCTS

(continued)

variable from zero and is motor-controlled.

Metering is provided for line voltage, line current, running time, d-c voltage and d-c current. Supply is completely interlocked to protect both operator and equipment, is designed to be interlocked with auxiliary units.

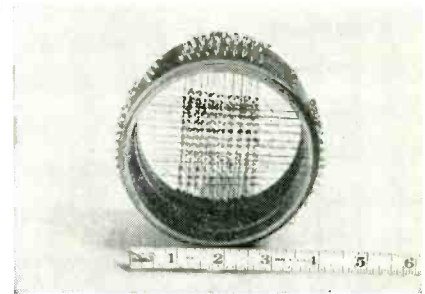

MAGNETIC MEMORIES coaxial, bead type

TRANSDYNE CORP., 7337 Grand Ave., Maspeth 78, N. Y., has announced coaxial, magnetic bead memories featuring completely new construction. They feature a delicate mesh of wires and beads safely enclosed inside a phenolic cylinder. All soldering during final assembly into computer is done on the outside, making it impossible to damage the bead matrix. Simple stacking of units into a complete memory cylinder permits cooling beads with filtered air, eliminating pickup of magnetic dust.

► **Specifications** — Random access memories have speeds up to 1 μ sec. Units hold up to 64 by 64 bits. They are easily stacked to form complete memories of any capacity.

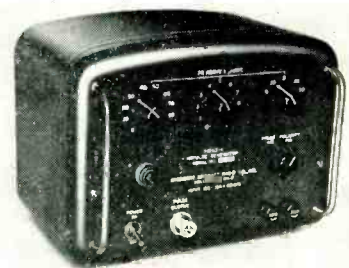

IMPULSE GENERATOR with broad applications

STODDART AIRCRAFT RADIO CO., INC.,
6644 Santa Monica Blvd., Holly-

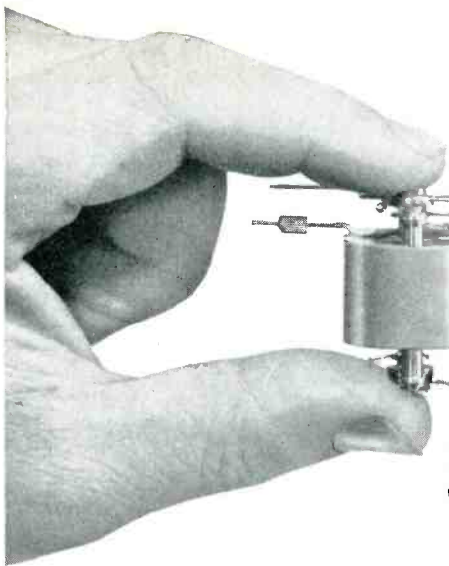

These mechanisms need special shipping protection

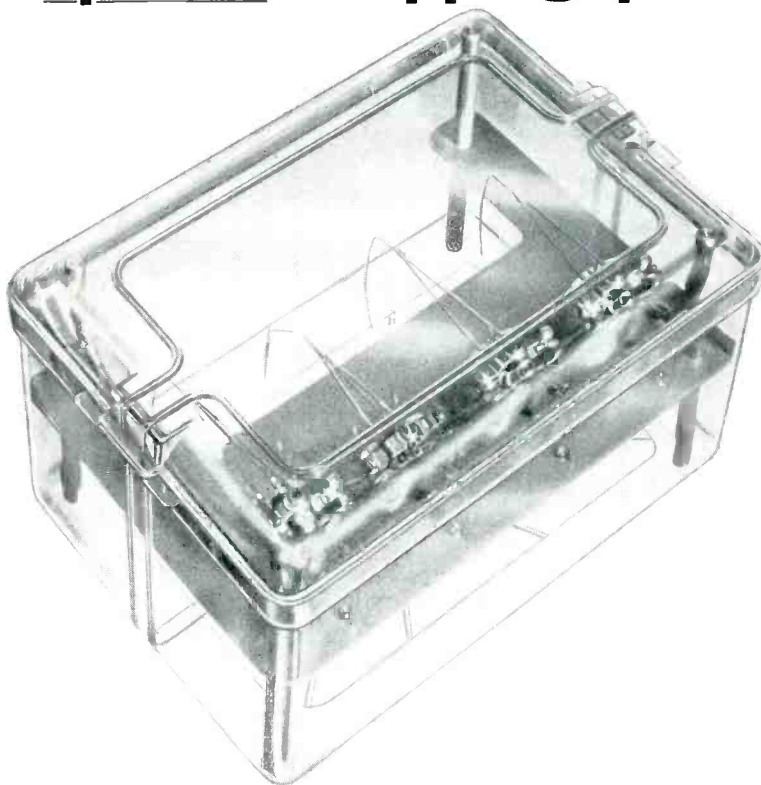

These precision-made aircraft navigation instrument mechanisms must have perfect protection during shipment and handling. So, WESTON ELECTRICAL INSTRUMENT CORPORATION insists on the superlative shipping protection of Tri-State rigid plastic boxes. These rugged, shatter-proof, crystal-clear containers lock out moisture, dust, static and prevent tampering. Delicate contents, seen at a glance are handled carefully. They can be checked and counted without opening of the lid. They are completely protected, from insertion through inspection, in Tri-State rigid plastic.

Whatever your product . . . whatever your packaging problem, be it shipping or promotional . . . may we suggest that you look

into Tri-State. As molders of the world's greatest assortment of rigid plastics . . . for every facet of industry . . . we can fill your packaging need economically and better.



Tri-State Box No. C-79,
5 1/4 x 7 3/8 x 3 3/4"

From a huge variety of stock sizes and shapes, or we will mold large quantities to your specifications.

LOOK INTO

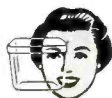

TRI-STATE PLASTICS



HENDERSON 5, KENTUCKY

NEW YORK: 12 E. 41st St., Murray Hill 3-8743
CHICAGO: 176 W. Adams St., Franklin 2-5367
ST. LOUIS: 1089 Francis Place, Delmar 1089
DETROIT: 18401 E. Warren Ave., Tuxedo 5-5500

wood 37, Calif. The 91263-1 impulse generator offers a broad range of applications. Principal uses include bandwidth determination, rapid gain check for vhf and uhf tuners, standard signal source for constantly monitoring the performance of radar and pulse-operated receivers, testing effectiveness of noise suppression filters, studying methods of noise suppression in radio receivers and receiver alignment.

► **Specifications** — Spectral intensity is flat within ± 0.5 db over the frequency range of 10 kc to 1,000 mc. A maximum output of 101 db above $1 \mu\text{v}$ per mc is provided, adjustable in $\frac{1}{2}$ db steps from 10 db to the maximum output. The output circuit is designed to work into a 50-ohm load. Repetition rate is 60 pulses per sec, each pulse having a duration of $0.0005 \mu\text{sec}$. Power requirements are approximately 30 w at 105 to 125 v a-c, 60 cps.

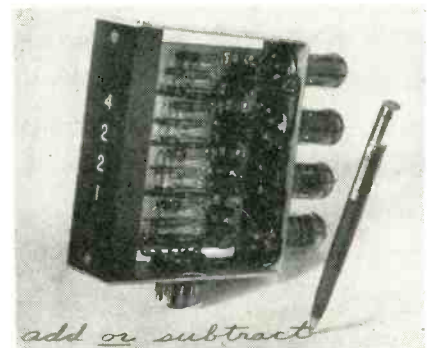

DECADE COUNTER the up-and-down type

CONTROLLER INSTRUMENT Co., 1612 Que St., Northwest, Washington 9, D. C. Model CN-1 up and down decade counter is available for measurement and control. In a package no larger than ordinary one-way counters, the reversible innovation can be electronically or manually controlled continuously by either an external flip-flop, or d-c voltages.

Applications are unlimited, ranging from continuously tracking digital voltmeters and data converting devices to integrators and digital differential analyzers. The internal gating is a new circuit employing reliable long-life neon bulbs. Readout is visual in binary

THE FRUITS OF "KNOW HOW"

- ★ HARDENED AND GROUND GEARS
- ★ MASTER GEARS AND INVOLUTE SPLINE GAUGES
- ★ CONIFLEX AND SPIRAL BEVEL GEARS

- ★ THREAD GROUND WORMS
- ★ GEAR ASSEMBLIES

QUAKER CITY GEAR WORKS



BETHAYRES, PA., CHAPEL HILL 0800

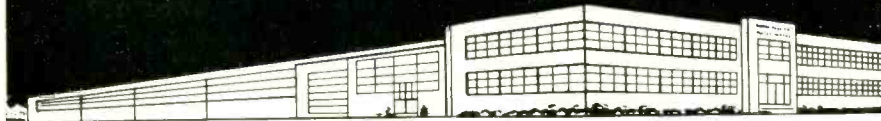

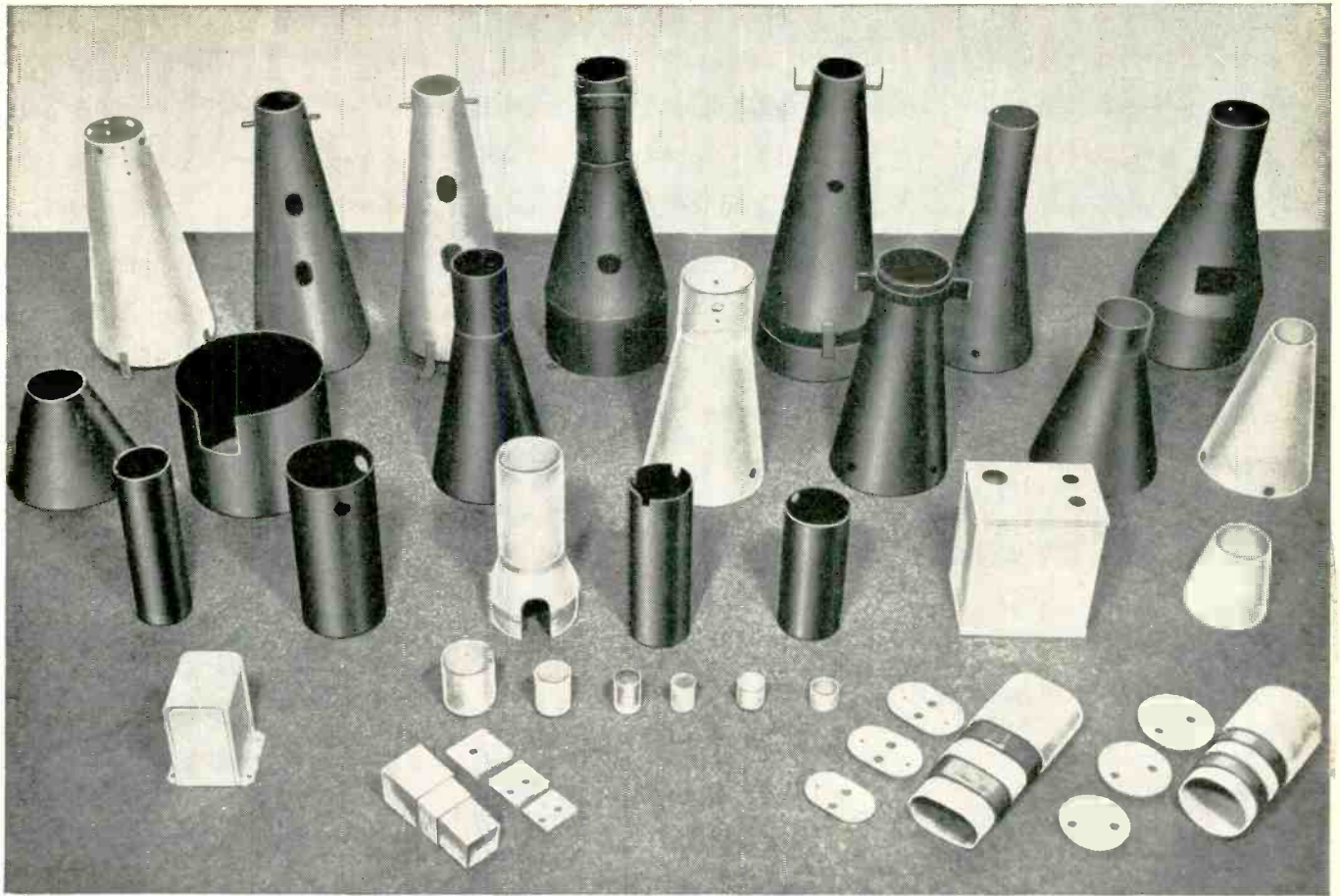

For your Magnetic Shielding Problems . . .

MUMETAL is the answer!



Write for your copy
"MAGNETIC MATERIALS"

This 32-page book contains valuable data on all Allegheny Ludlum magnetic materials, silicon steels and special electrical alloys. Illustrated in full color, includes essential information on properties, characteristics, applications, etc. Your copy gladly sent free on request.

ADDRESS DEPT. E-77

Mumetal shields will give instant relief to interference caused by extraneous magnetic fields. This material can cure many troubles—solve many a problem for you.

Use it where high permeability is required at low flux densities, such as in input and microphone transformers, hearing aid diaphragms, instruments, wire and tape recorders, etc. For properly heat treating Mumetal, we can also offer commercial hydrogen annealing facilities.

A fund of technical data on shields

and other applications for Allegheny Ludlum Mumetal is available—let us help with your problems.

In addition to Mumetal and other high-permeability alloys, we offer a range of magnetic and electrical alloys and steels that is unmatched in its completeness. Our services also include the most modern facilities for lamination fabrication and heat treatment. • Let us supply your requirements. *Allegheny Ludlum Steel Corporation, Oliver Building, Pittsburgh 22, Pa.*

STEELMAKERS to the Electrical Industry
Allegheny Ludlum

Warehouse stocks of AL Stainless Steels carried by all Ryerson plants



MSW 6094

CUT DOWN ON THE HIGH COST OF MOISTURE AND CORROSION RESISTANT COIL FORMS...

Specify
RESINITE

Resinite coil forms are the economical answer to your moisture, heat and corrosion resistant problems. Coil manufacturers have reported that in many applications they are proving equal or superior to previously used and much costlier extruded or molded plastic forms.

Resinite coil forms provide the highest resistivity of any resinated or phenolic product. They are manufactured by an exclusive process to provide the optimum in both dielectric and mechanical characteristics under the most severe operating conditions. In addition, TruTork internally threaded or embossed forms assure exceedingly high torque control of ± 1 inch ounce—axial pressure in excess of 25 pounds.

Various grades of Resinite are available to meet particular requirements. These include: AC for applications where a cellulose acetate covering is desirable; 104 for severe forming, fabricating and stapling; 8104 for minimizing effects of electrical property degradation; and TruTork to provide an internally threaded or embossed form to fit any threaded core—regardless of diameter or threads per inch.

Get full facts on Resinite coil forms. Write, wire or phone.

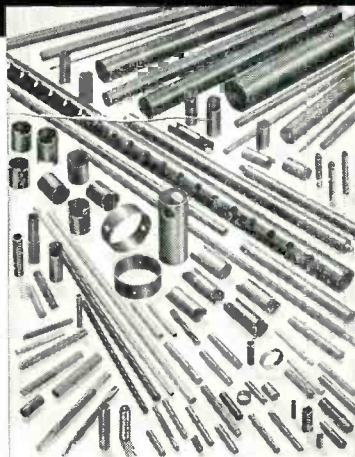

Resinite coil forms are custom-fabricated to specification.



Flyback transformer coil forms are fabricated from select materials.

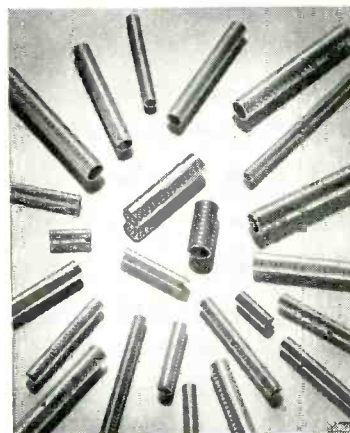

Special embossed construction eliminates torque control problems.

coded decimal and electrical by a staircase voltage indicating the count. Decades can be cascaded to add or subtract any desired number of pulses.

► **Some Specifications**—Maximum continuous counting speed is 50,000 cps; circuit, 4 binary stages with natural scale of 16, permuted to scale of 10; input requirement, negative pulse 90 v peak. Dimensions are $1\frac{3}{8}$ in. by $5\frac{1}{2}$ in. by 6 in. overall; weight, 1 lb; tubes, 4 each 5963.

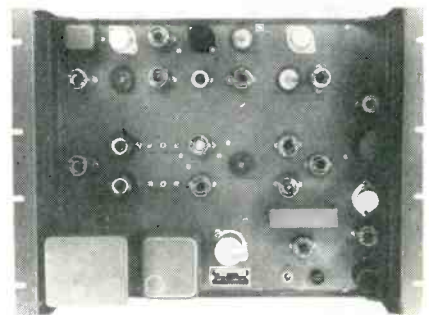

TELESYNC EQUIPMENT generates sync signals

NEMS-CLARKE, INC., Silver Spring, Md. Type TS-1 Telesync equipment will supply vertical driving pulses, horizontal driving pulses, mixed blanking and mixed sync. In operation it is supplied with a composite synchronizing signal usually obtained from an off-the-air receiver. The TS-1 breaks down this signal into its horizontal and vertical components and generates blanking signals.

Low cost and simplicity of operation is obtained by using the radiated signal of a tv broadcasting station. The TS-1 has been designed for reliable, continuous operation. Bathtub construction provides maximum accessibility to all tubes and controls from the front and small components from the rear. This construction is the same as that normally used in tv studio equipment.

DIODE BEADER produces lead wires fast

KAHLE ENGINEERING Co., 1310 Seventh St., North Bergen, N. J.,

RESINITE CORPORATION

Division of

PRECISION PAPER TUBE COMPANY

2035E W. CHARLESTON ST. • CHICAGO 47, ILLINOIS

Representatives Throughout the United States and Canada

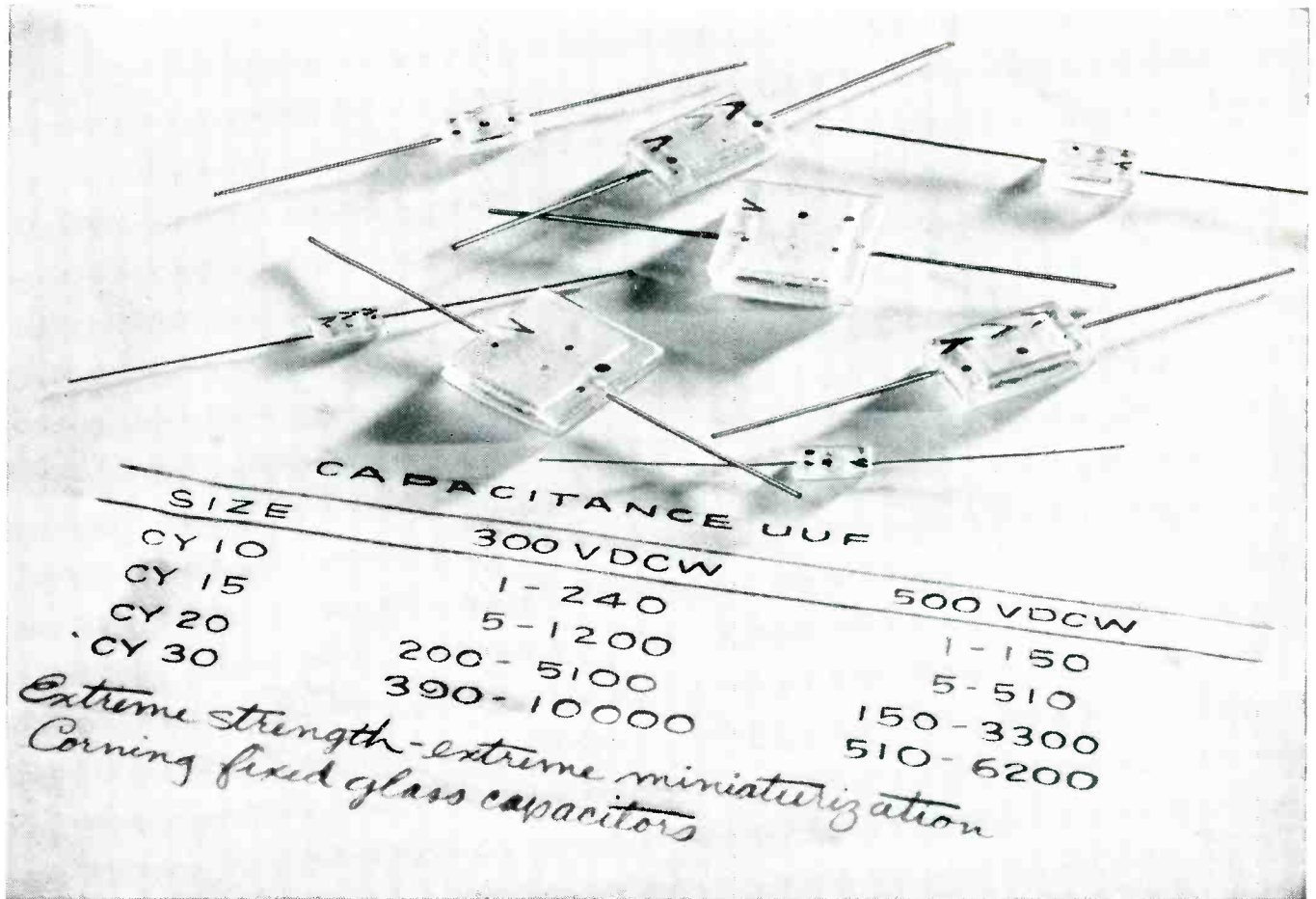

You'd have to smash a Corning Capacitor before you could alter its values by mechanical shock

That's how rugged these miniature fixed glass capacitors are. ("Miniature" means about one-third smaller than other kinds of equal capacitance.)

Their strength comes from the way we make them. Layers of conductor and dielectric are sealed together under heat and pressure into a monolithic structure. No mechanical shock short of shattering the seal alters the value. Speaking of values, the table illustrated above shows them.

Because everything is sealed in the same material as the dielectric, nothing outside can get inside.

You can use these capacitors to tem-

peratures of 125° C. and higher with proper voltage derating. Even after repeated temperature cycling, the TC remains the same. And TC stays within close limits over a wide temperature range, varies little between capacitors. Capacitance drift is so close to zero that it's generally less than the error of measurement.

We can make capacitors to your electrical and physical specifications over an unusually varied range. Single, self-supported units can be designed for high voltages or high capacitances. Series parallel combinations still further extend the range.

Circle the reader service of this publication, or write direct for more information about Corning Fixed Glass Capacitors, prices and samples.

Ask for information on these other Corning Capacitors:

Medium Power Transmitting—CY-60 and CY70. Ideal for mobile RF transmitters.

Canned High Capacitance—provide the advantages of rugged glass design to your specifications.

Subminiature Tab-Lead—up to 90% less volume compared to pigtail types. To your specifications.

Special Combinations—the performance and benefits of glass in infinite shapes, sizes and leads. To custom order.

Other electronic products by Corning Components Department:

Fixed Glass Capacitors*, Transmitting Capacitors, Canned High-Capacitance Capacitors, Subminiature Tab-Lead Capacitors, Special Combination Capacitors, Direct-Traverse and Midget-Rotary Capacitors*, Metallized Glass Inductances, Resistors.

*Distributed by Erie Resistor Corporation



CORNING GLASS WORKS, 94.5 Crystal Street CORNING, N. Y.

Components Department, Electrical Products Division

Corning means research in Glass

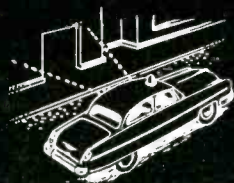

MOBILE PATROL SURVEILLANCE

Farnsworth

INFRARED VIEWER

LETS YOU
SEE
IN THE DARK

FILM PROCESSING
INSPECTION

MEDICAL BIOLOGICAL RESEARCH

MILITARY
LAND-SEA-AIR
APPLICATIONS

Another example of Farnsworth's pioneering achievements in the field of infrared.

Originally developed for the military this compact, light weight Viewer is proving equally useful in industry and science, wherever there is a need to see in the dark.

For complete details on the Infrared Viewer write Dept. V-56.

Farnsworth



FARNSWORTH ELECTRONICS CO. • FORT WAYNE, INDIANA

a division of International Telephone and Telegraph Corporation

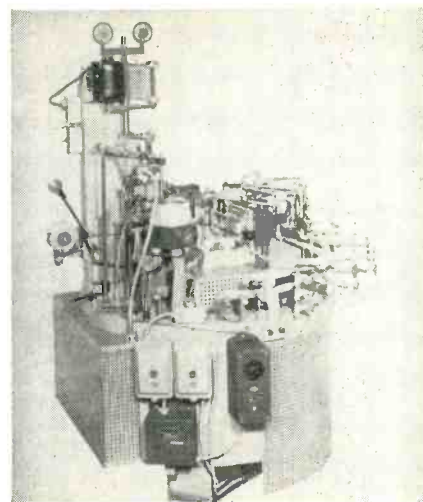

has introduced a new automatic diode beading machine for the high-speed production of lead wires. The No. 2719 automatic diode beading machine produces beaded lead wires for use in crystal diodes and other applications. It is fully automatic with all parts fed by a special drive system.

► **Other Features** — This machine highlights a 16-position, 16-head, turret-type design with precision barrel cam and tapered roller index mechanism. Difficult three-shift operation presents no problem.

Close tolerances on o.d., length and concentricity are automatically maintained. The wire is cut square. The glass bead is precise, undistorted.

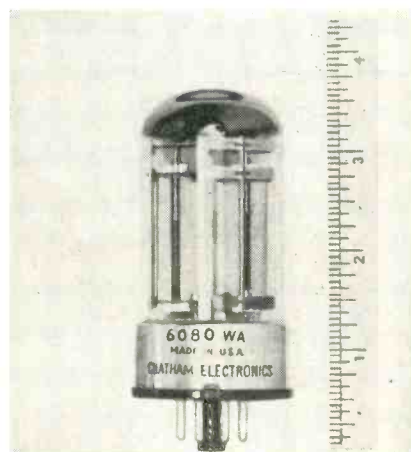

TWIN POWER TRIODE for industrial equipment

CHATHAM ELECTRONICS, Division of Gera Corp., Livingston, N. J. Designed originally to withstand the severe operating conditions encountered in military applications,

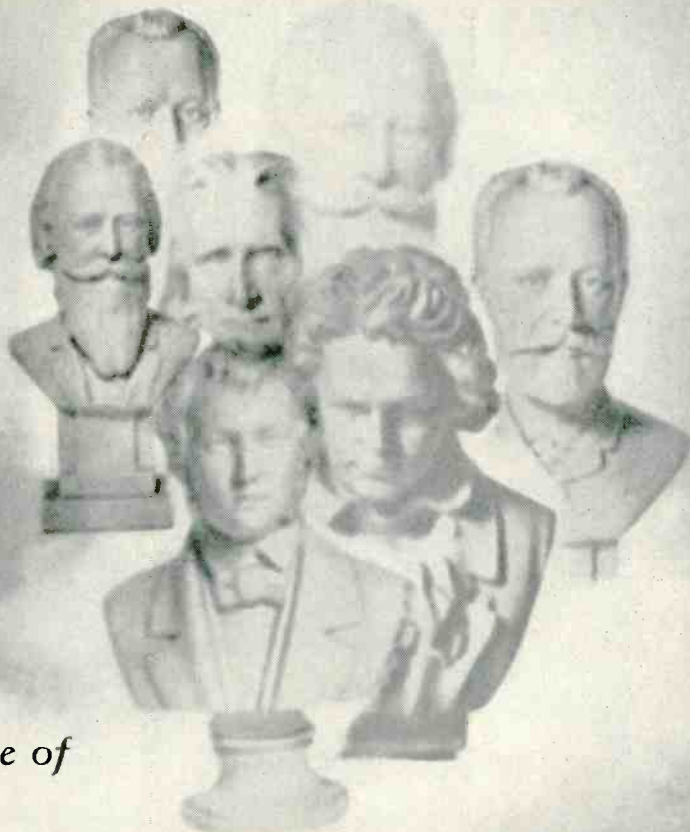

*Nine-tenths of
modern science is ... the produce of*

MEN WHOM THEIR CONTEMPORARIES THOUGHT DREAMERS!

Walter Bagehot

Once, scientific advances stemmed from the revolutionary thoughts of patient, determined men who worked, usually, in isolation and often amidst scorn.

Today, advances are born of the cooperative endeavor of many minds, supported and respected.

IBM, acknowledged leader in the computer field, has always sought in engineers and scientists that one source of all scientific achievement—the ability to think fearlessly!

To the engineer who possesses this ability, IBM offers projects of challenging interest in the world's most advanced laboratory facilities. With the assistance of stimulating associates, he has every opportunity to make important and rewarding contributions to scientific progress.

To find out more about IBM write, outlining your background and interests, to William M. Hoyt, Room 405, International Business Machines Corporation, 590 Madison Avenue, New York 22, N. Y.

WORK ASSIGNMENT AREAS

- Research in solid state materials
- Information handling theory
- Machine organization research
- Systems planning and logical design
- Electronic circuit design
- Transistor circuitry
- Component development
- Input-output device controls
- Functional and reliability analysis
- Computer programming
- Mechanical development and design
- Publications engineering

IBM
®

**INTERNATIONAL
BUSINESS MACHINES
CORPORATION**

DATA PROCESSING • ELECTRIC TYPEWRITERS • TIME EQUIPMENT • MILITARY PRODUCTS

extra-compact delay lines

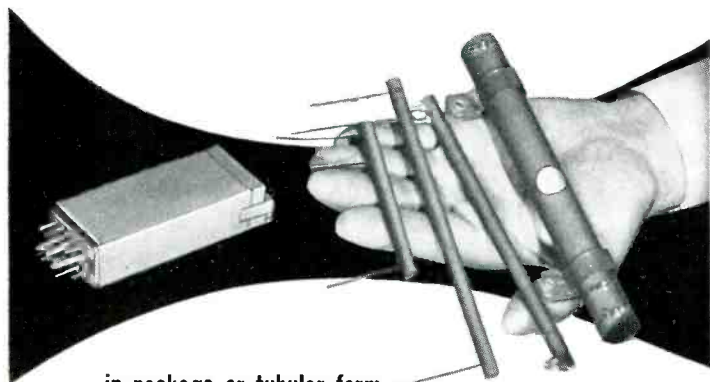

in package or tubular form

Standard series or designed for your particular application

Continuously wound Technitrol Delay Lines assure minimum pulse distortion and are virtually unaffected by temperature variations. They are offered in a variety of mountings. Technitrol engineers are prepared to design lumped parameter or continuously wound delay lines to your specifications.

Technitrol also produces miniature Pulse Transformers, wound to your requirements. Let us know your performance specifications.

*for additional information,
write for Bulletin E174.*



TECHNITROL

engineering company

2751 North Fourth Street • Philadelphia 33, Pennsylvania

type 6080WA is now available for commercial use. The twin power triode is ideal for use in industrial equipment where long life under adverse conditions is essential.

Type 6080WA is manufactured under the reliable tube program and is rigidly tested to assure performance as specified. The tube plugs directly into any socket using the popular 6080 or 6AS7G series regulator tubes. Design features include mount of heavy duty parts, shock insulated from the bulb by spring-metal snubbers.

► **Electrical Data**—Maximum plate dissipation is 13 w per plate. Shock rating is 450 g. A new illustrated bulletin is available.

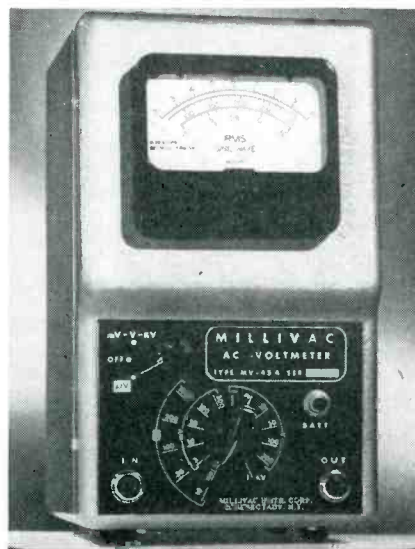

VOLTMETERS use hushed transistors

MILLIVAC INSTRUMENT CORP., 444 Second St., Schenectady 6, N. Y., has announced two new transistor voltmeters. The design of both instruments is based on the principle of transistor hushing, a manner of operation which greatly reduces noise. Hushed transistors have essentially zero or reversed collector junction voltages.

► **Advantages**—The MV-45A transistor voltmeter (trvm) not only duplicates the performance of vtm's, as far as frequency range (10 cps — 150 kc), voltage range (10 mv — 1 kv) and accuracy (2 percent) are concerned, but provides additional more sensitive voltage ranges, its lowest being

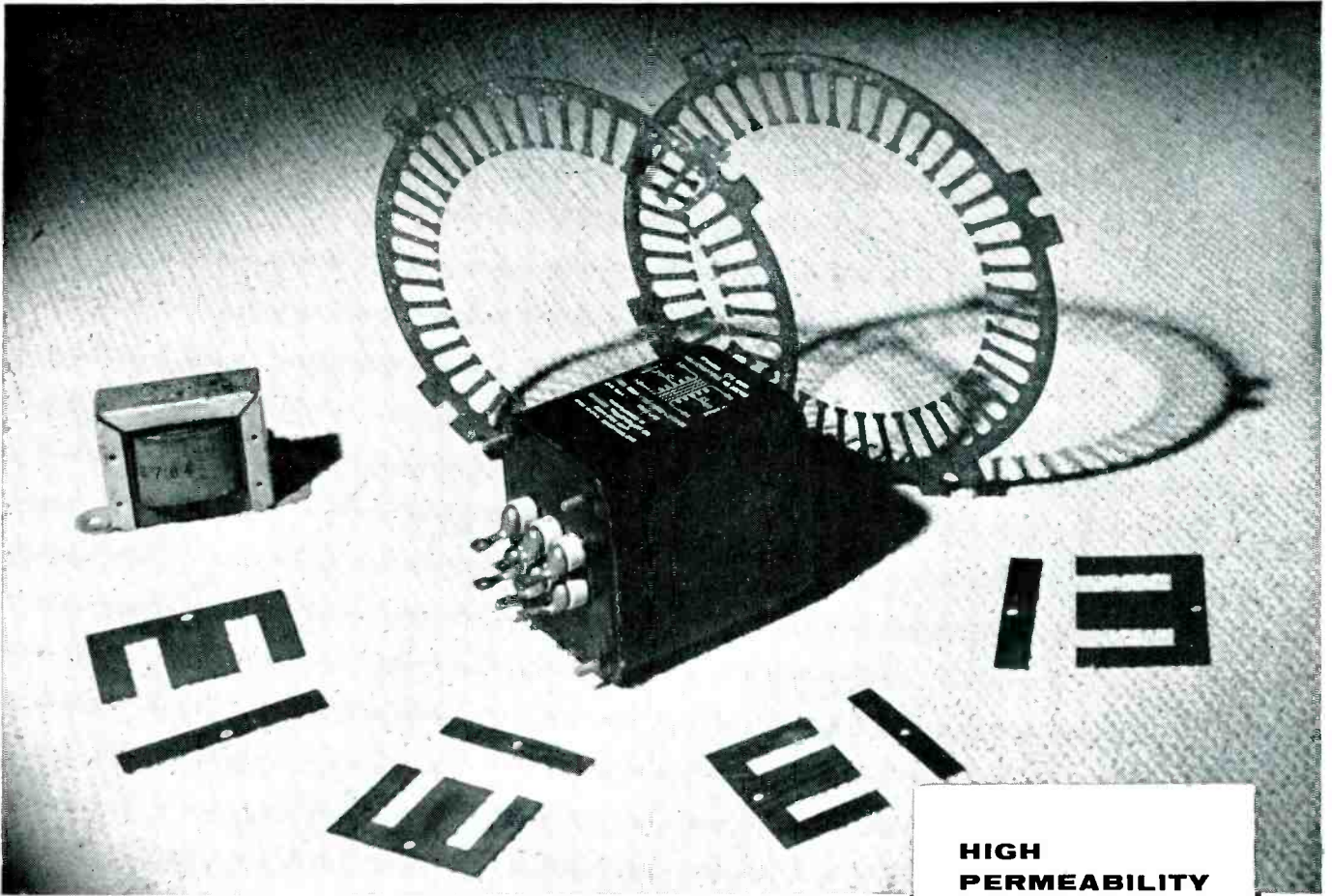

**ARMCO TRAN-COR A-6 GIVES YOU
this unusual combination:**

**HIGH
PERMEABILITY**

PUNCHABILITY

**UNIFORM
DIRECTIONAL
PROPERTIES**

If you need an electrical steel with high permeability at low and moderate inductions, good punching quality and reasonably uniform properties in all directions, Armco TRAN-COR A-6 may be the answer to your problem.

Properties of TRAN-COR A-6 offer many unique design advantages for applications such as audio transformers, high-impedance devices and high-frequency generators (400-1200 cycles).

High Permeability

What you can do with this material

is clearly indicated by its high permeability. Here are a few typical values:

Induction (gausses)	Permeability (gausses/oersted)
100	2300
1000	6000
4000	12000

(Volume electrical resistivity—
56 microhm-cm)

These properties, along with minimum

directional variation, make TRAN-COR A-6 especially useful in the design of servo-mechanisms and similar units.

Punchability

And because of its punching quality and ductility, you can utilize the outstanding magnetic properties of this grade even in complicated laminations.

Armco TRAN-COR A-6 is available in welded coils or cut lengths, in 26 and 29 gage.

Write for complete data on this special Armco Electrical Steel that fills a specific need in electrical design.

ARMCO STEEL CORPORATION

1306 CURTIS STREET, MIDDLETOWN, OHIO



SHEFFIELD STEEL DIVISION • ARMCO DRAINAGE & METAL PRODUCTS, INC. • THE ARMCO INTERNATIONAL CORPORATION



HAVE YOU PUT THESE MEN TO WORK?

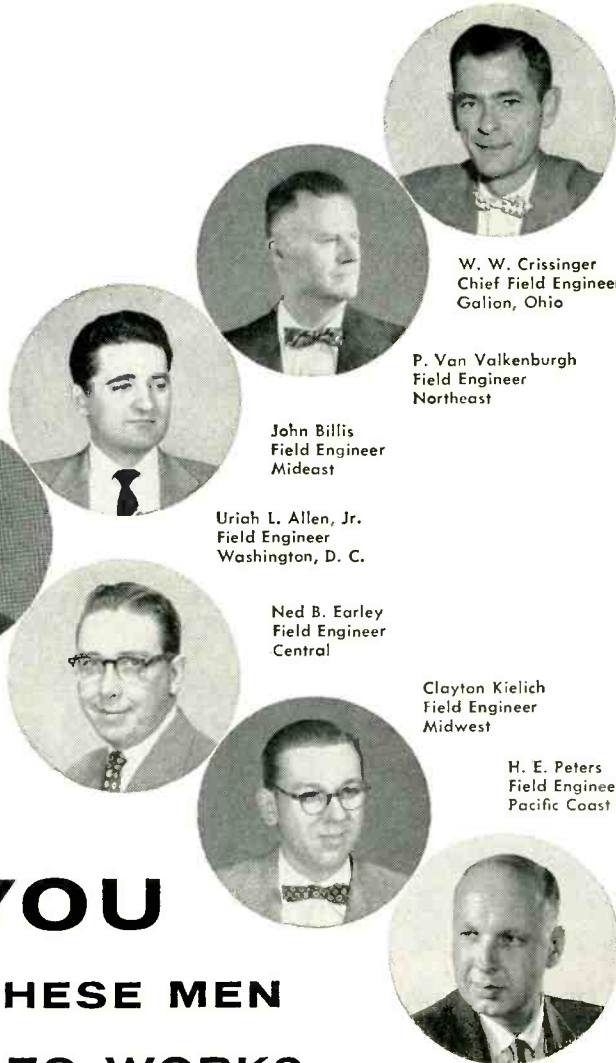

W. W. Crissinger
Chief Field Engineer
Galion, Ohio

P. Van Valkenburgh
Field Engineer
Northeast

John Billis
Field Engineer
Midwest

Uriah L. Allen, Jr.
Field Engineer
Washington, D. C.

Ned B. Earley
Field Engineer
Central

Clayton Kielich
Field Engineer
Midwest

H. E. Peters
Field Engineer
Pacific Coast

Meet the Industrial Field Engineering Staff of North Electric Company. Their job is to serve your design groups as engineering consultants (without fee) in determining whether and how to use relays as control components.

This exclusive North engineering service pays off for you, and for North, because of the many cases in which they can aid in the development of simplified dependable systems . . . with all relay controls. These competent engineers are based near the key centers of industry. One of them can be at your doorstep promptly if you will write, wire or call the Galion office — Galion 2-4201 . . . regarding

NORTH RELAYS

as components or control assemblies

"BUILDING BRAINS IS OUR BUSINESS"

INDUSTRIAL DIVISION



NORTH ELECTRIC COMPANY

557 S. Market

Galion, Ohio

2 μ v to 10 μ v. The instrument is operated from a 6-v dry-cell battery having a minimum life of 200 hr.

The MV-45AS is identical with the MV-45A, except that it has a hermetically sealed storage battery with built-in charger, providing over 2,000 hr of operation before requiring recharging.

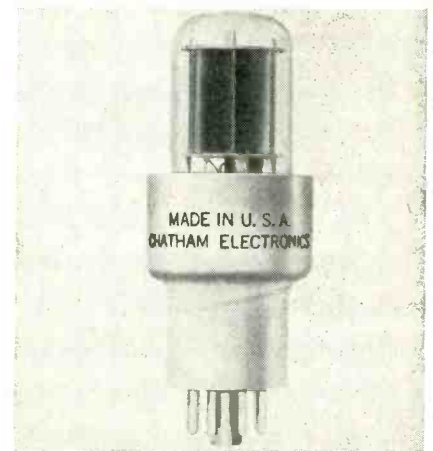

THYRATRON withstands rough service

CHATHAM ELECTRONICS, Div. of Gera Corp., Livingston, N. J. Type 2050W Xenon filled, shield-grid thyratron for grid controlled rectifier service is specially designed to provide longer service where shock, vibration and other causes of tube failure are present.

Design features include external vibration insulation of silicone rubber between base and bulb, durable ceramic beads and double, mica mount supports.

► **Specifications** — Electrical data are as follows: heater—6.3 v, 0.6 ampere; peak inverse anode voltage, 1,300; and average anode current, 100 ma.

A new illustrated bulletin is available on request.

K-BAND BARRETER of the coaxial type

MICROWAVE ASSOCIATES, INC., 22 Cummington St., Boston, Mass. Model MA-571 coaxial type barreter (bolometer) has been developed for r-f attenuation and power measurements in the 26.5-40 kmc region. It is housed in a coaxial cartridge which is physically in-

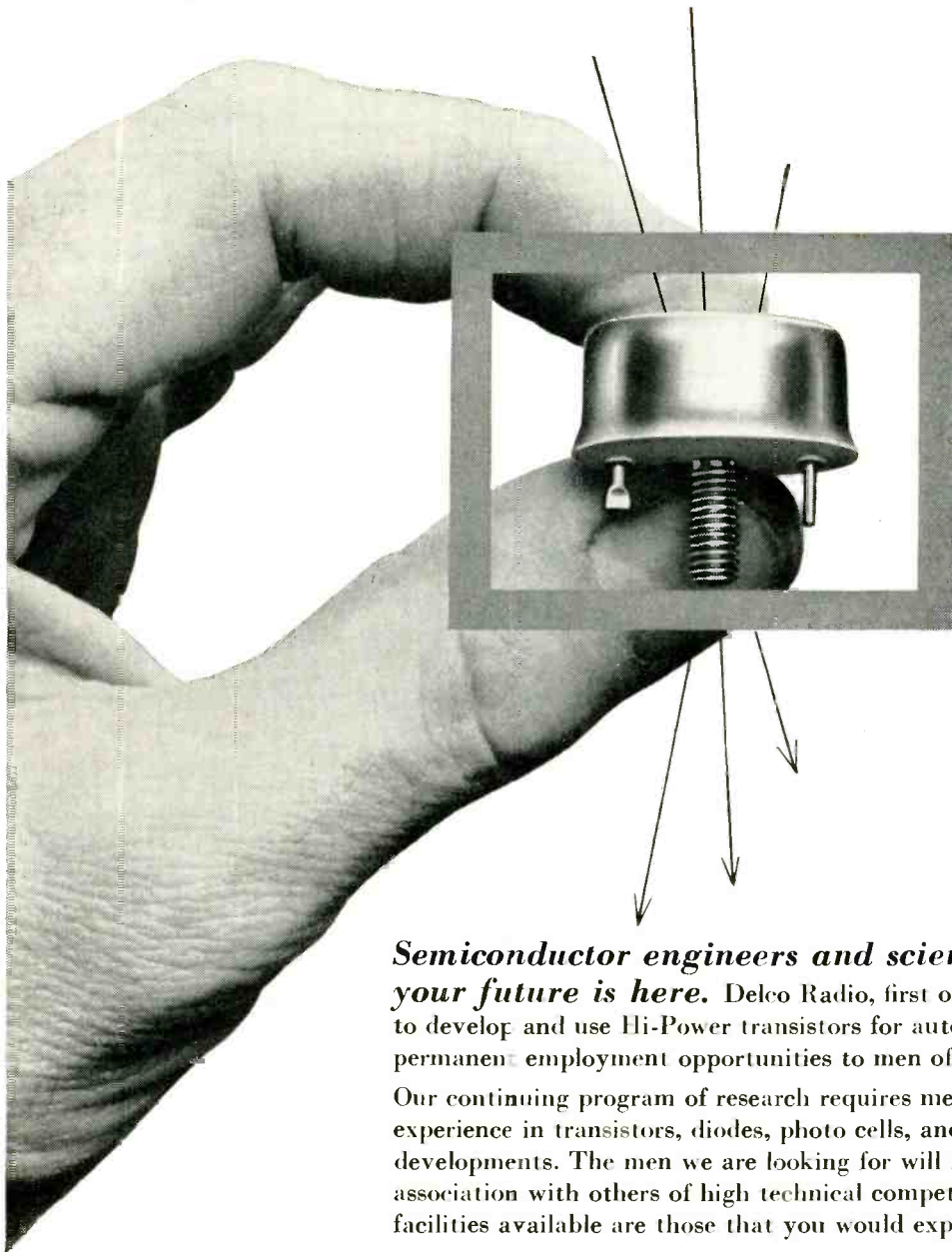

***Semiconductor engineers and scientists . . .
your future is here.***

Delco Radio, first organization to develop and use Hi-Power transistors for automotive application, now offers permanent employment opportunities to men of highest caliber.

Our continuing program of research requires men with advanced training and experience in transistors, diodes, photo cells, and other semiconductor developments. The men we are looking for will find the satisfaction of association with others of high technical competence. Furthermore, the type of facilities available are those that you would expect to find in General Motors.

Here is presented unusual opportunity for recognition and achievement in the realm of research and development of semiconductor devices and their processing. Upper level positions are open for those who qualify.

You will find pleasant living conditions in our central Indiana community. If you are qualified and would like a permanent position of importance within our organization, write to us now. Your letter will be held in confidence.

Address: Personnel Director, Department G.



DELCO RADIO—first to make transistor-equipped radios for automobiles—now offers many challenging opportunities for physicists, physical chemists, electronic and mechanical engineers and other professional men interested in research and development of transistors and other semiconductor devices or their processing and production. Apply now for permanent positions with this rapidly expanding activity in this division of General Motors.



Delco Radio

DIVISION OF GENERAL MOTORS, KOKOMO, INDIANA

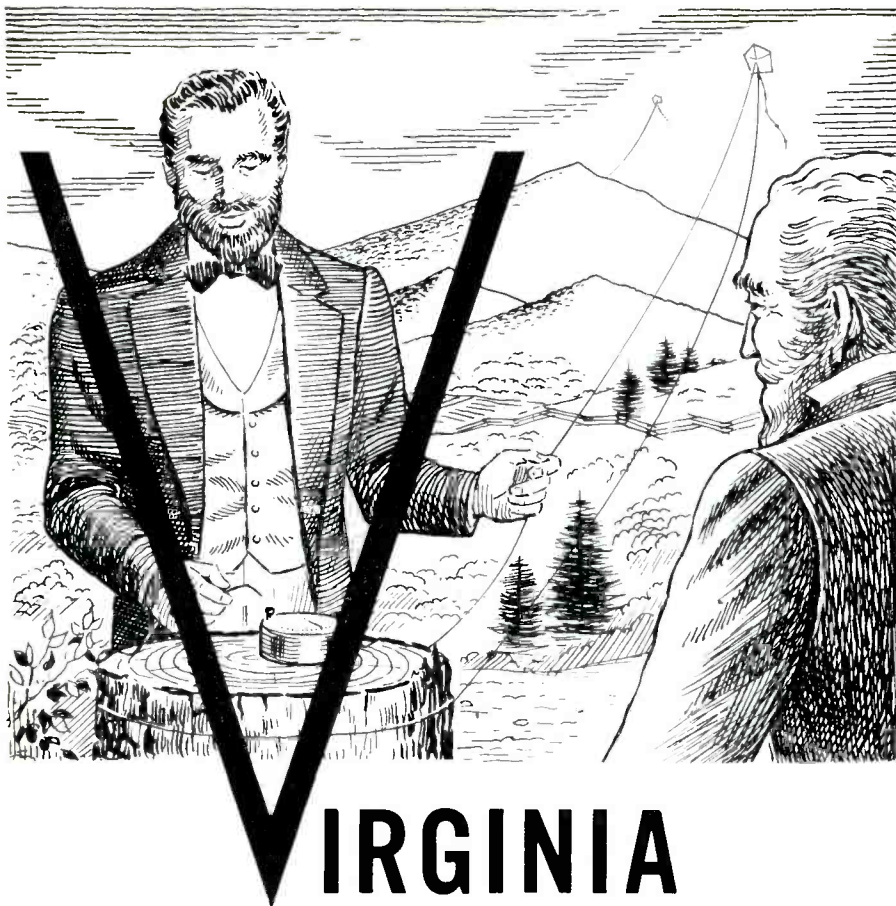

IRGINIA

BIRTHPLACE OF THE WIRELESS!

In the 1860's, Nearly Thirty Years Before Marconi, the world's first wireless signal flashed from peak to peak in Virginia's Blue Ridge Mountains. Flying two kites, some 15 miles apart, Dr. Mahlon Loomis showed congressmen how electric waves could travel from one antenna to another... the Electronics age was born!

Today, Electronics is Growing Fast in Virginia. And your new electronics plant can grow with it. Here are some reasons why:

Southern Climate and Southern Manpower are both competitive advantages for your factory. Here you enjoy them close to the nation's great markets with favorable freight differentials to speed products by plane, train or truck.

You're Close to Major Research Facilities. Raw materials such as coal, and resin, more than 40 different industrial minerals, plus supplies like basic chemicals and packing cartons... all roll to your plant at short-haul cost. There's natural gas. And you have ample, low-cost electric power.

For Complete Facts on taxes, zoning, available skills and wage scales... or for confidential aid in finding a plant site or ready-built factory, write or telephone:

Division of Planning and Economic Development

Virginia Department of Conservation and Development
State Finance Building, Richmond, Virginia • Telephone: 3-3449

Facts Favor Virginia

NEW PRODUCTS

(continued)



terchangeable with the 1N53 mixer diode. This feature allows its use in any tunable 1N53 crystal holder such as the MA-513A. For optimum performance, the d-c bias is adjusted to approximately 6 ma, which allows operation of the bar-reter at 200 ohms resistance.



FLEXIBLE COAX

isolates shock, vibration

AIRTRON, INC., 1103 W. Elizabeth Ave., Linden, N. J., has announced a new 3¼-in. uhf flexible coaxial section. This makes it possible to isolate shock-mounted gear from its associated rigid transmission line in an increased number of radar and communication systems. In addition, the new uhf section is useful in complex rigid transmission lines for either the absorption of large mechanical tolerance build-up, expansion and contraction, or misalignment between rigidly mounted mating flanges.

► **Construction**—The flexible coax is constructed with flexible inner and outer conductors which utilize the soldered convolute type of flexible waveguide tubing. Center conductors are supported by compensated Teflon disks. Standard contact type of polarized coaxial 3¼-in. brass flanges are used. Flanges

INDIANA PERMANENT MAGNET DESIGN INFORMATION

published for industrial and consumer
product engineers and designers

HOW PERMANENT IS A PERMANENT MAGNET?

Permanent magnets *are* permanent. Proof of permanence is substantiated by many practical applications over long periods of years.

The continued accuracy of some of the most exacting scientific electrical measuring instruments, or of the familiar house-type, watt-hour meter depends upon a permanent magnet.

The speedometer in your car, the magneto in your power lawn mower, or your wife's magnetic knife rack in the kitchen may be consigned to the junk pile in time because of mechanical failure or obsolescence . . . but definitely not because of magnetic failure.

There is a common belief . . . which is incorrect . . . that a permanent magnet supports its external magnetic field by dissipating some of its *internal* magnetic energy. This definitely is not the case.

Adverse Factors on Remanent Magnetism. The magnetism of a permanent magnet can be adversely affected by any one, or a combination of, the following:

Elevated Temperatures can cause very appreciable initial losses in magnetism, up to complete demagnetization, even though metallurgical properties are not affected.



External Magnetic Fields from electrocoils, high electrical currents, or even other permanent magnets can partially or completely demagnetize the permanent magnet, and obviously, if the field is



sufficiently strong, completely reverse the polarity.

Contact with Ferromagnetic Material by a permanent magnet in such a way that the normal internal field pattern is distorted can adversely affect the remanent magnetism. This is an important condition to avoid in the handling of magnetized magnets.

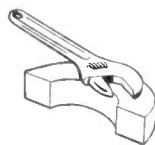

Changes in the Magnetic Circuit such as to produce a larger air gap than that on which it was initially magnetized, will reduce the strength of the magnet instantly and it is not recovered by reassembly to the original gap. A typical radio loud-speaker magnet, if removed from its associated steel circuit, then reassembled without remagnetizing, may lose as much as two thirds of its initial strength.



Vibration and Shock have little effect in most applications.

In all of these cases where only the remanent magnetism has been affected, losses can be recovered by remagnetization.

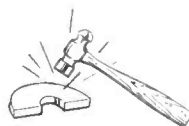

This article is a condensed version of a recently published feature article carrying the same title. Reprints of the full length article are available on request.

For assistance in designing the most efficient magnet for your product, consult our design engineers—without obligation, of course.

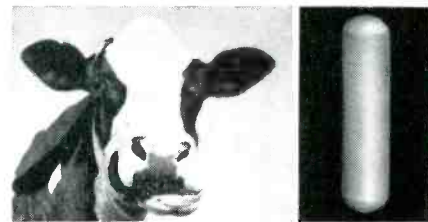

"CATTLE MAGNETS" PROTECT BOSSIE FROM STOMACH-ACHES: Cows often consume nails, staples and wire with their food. This causes a disorder called "hardware disease." To prevent it, you feed Bossie an Indiana "Cattle Magnet" (above). The magnet remains in her first stomach, gathering the stray metal. This keeps it from passing to her other stomachs (she has four, you know) where it can cause great distress.

New manual discusses selection of permanent magnet materials

This newly published, 12-page manual entitled, "Permanent Magnet Materials and Their Selection," discusses physical and magnetic characteristics and the applications of Cast Alnico Magnets (Grades I, II, III, IV, V, VI, XII); Sintered Magnets (Alnico II, IV, V, VI, Indalloy and Indox I); Ductile Magnets (Cunico and Cunife I) and Formed Magnets (Chromium and Cobalt).



Also included is a selector-type chart which lists magnetic characteristics, design factors, material characteristics, and manufacturing methods and limitations of the various magnetic materials. In addition, special sections present a "Glossary of Magnetic Terms" and a list of magnetic "Symbols."

Copies of this publication are available on request. Ask for Manual 5-A-5 on your company letterhead.

THE INDIANA STEEL PRODUCTS COMPANY
Valparaiso, Indiana

WORLD'S LARGEST MANUFACTURER OF PERMANENT MAGNETS

INDIANA
PERMANENT
MAGNETS

RADIO INTERFERENCE AND FIELD INTENSITY *measuring equipment*

Stoddart equipments are suitable for making interference measurements to one or more of the following specifications:

AIR FORCE—MIL-I-6181B

150 kc to 1000 mc

BuAir—MIL-I-6181B

150 kc to 1000 mc

BuShips—MIL-I-16910A (Ships)

14 kc to 1000 mc

SIGNAL CORPS—MIL-I-11683A

150 kc to 1000 mc

SIGNAL CORPS—MIL-S-10379A

150 kc to 1000 mc

The equipments shown cover the frequency range of 14 kilocycles to 1000 megacycles.

Measurements may be made with peak, quasi-peak and average (field intensity) detector functions.

F.C.C. PART 15—Now in effect, the revised F.C.C. Part 15 places stringent requirements upon radiation from incidental and restricted radiation devices. Stoddart equipment is suitable for measuring the radiation from any device capable of generating interference or c-w signal within the frequency range of 14 kc to 1000 mc.

Write Stoddart Aircraft Radio Co., Inc., for your free copy of the new revised F.C.C. Part 15.



NM-10A (AN/URM-6B)
14 kcs to 250 kcs



NM-20B (AN/PRM-1A)
150 kcs to 25 mcs



NM-30A (AN/URM-47)
20 mcs to 400 mcs



NM-50A (AN/URM-17)
375 mcs to 1000 mcs

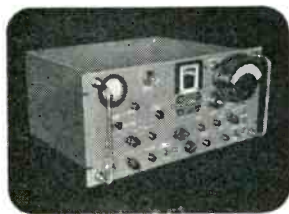

The Stoddart NM-40A is an entirely new radio interference-field intensity measuring equipment. It is the commercial equivalent of the Navy type AN/URM-41 and is tunable over the audio and radio frequency range of 30 CPS to 15 kc. It performs vital functions never before available in a tunable equipment covering this frequency range. Electric and magnetic fields may be measured independently over this range using newly developed pick-up devices. Measurements can be made with a 3 db bandwidth variable from 10 CPS to 60 CPS and with a 15 kc wide broadband characteristic.

and electrical conducting surfaces are silver plated. Assemblies are either vinyl dipped or supplied with a low-temperature pressure model synthetic rubber jacket.

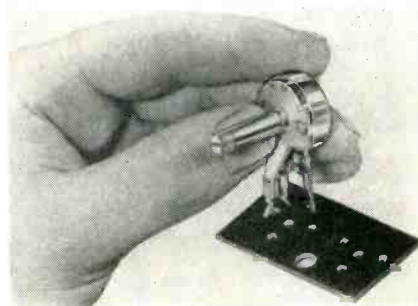

SNAP-IN CONTROL used in printed circuits

STACKPOLE CARBON Co., St. Marys, Pa. Type LR-70 self-supporting, snap-in variable resistor for printed wiring measures only 57/64 in. diameter and stands 1/4 in. off the mounting board. It is supported by 4 legs—the 3 regular voltage taps, and a larger, case ground leg. No mounting hardware is required since the legs merely snap into the printed wiring board to form a strong support. Terminals are heavily tin-lead coated for fastest soldering with dip-solder techniques.

► Uses—These resistors find wide applications in tv, f-m, a-m receivers, auto radios, and other printed circuits chassis where space and cost must be held to a minimum.

Single or double-pole snap switches are available with ratings from 15 amperes, 15 v d-c, to 6 amperes at 125 v a-c/d-c. The LR-70 is rated at 0.75 w for values above 10,000 ohms, and 0.50 w below 10,000 ohms.

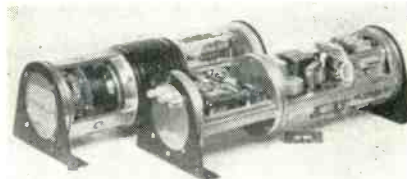

MULTICODER low level pulse-width type

APPLIED SCIENCE CORP. OF PRINCETON, P. O. Box 44, Princeton, N. J., announces a new line of functional

STODDART Aircraft Radio Co., Inc.

6644-A SANTA MONICA BLVD., HOLLYWOOD 38, CALIFORNIA • Hollywood 4-9294



If fluctuating supply voltage is your problem current Sola literature may aid you

THEORY OF DESIGN AND OPERATION, THE SOLA CV PRINCIPLE NO. CV-210 . . . Technical monograph for electrical engineers and others interested in the underlying electro-magnetic relations of the Sola Constant Voltage Principle. It contains schematic diagrams, vector diagrams, performance curves, and photographs illustrating typical assemblies.

COMPLETE CATALOG BULLETIN (NO. CV-200) . . . Electrical and mechanical specifications for all stock sizes of the five general types of Sola Constant Voltage Transformers and general information on special design service. Also describes typical applications, and gives technical data useful in making a proper selection of size and type. Helpful to design and specification engineers, draftsmen, and electrical technicians.

CONSTANT VOLTAGE DC POWER SUPPLIES (NO. CV-235) . . . Operational data, including charts and diagrams, on new Sola Constant Voltage DC Power Supply assemblies for computing and telemetering equipment, and other applications involving intermittent or pulse loading and/or high amperage requirements. Models available from stock . . . typical assemblies . . . design-and-assembly service.

SPECIAL DESIGN SERVICE FOLDER . . . Outlines the various ways in which the basic CV types and sizes can be modified on order to meet the exact requirements of an application as a component of a manufacturer's product. Special voltages or frequencies . . . special structures . . . multiple outputs. Also lists representative special designs available on "assemble-to-order" basis.

CONDENSED CATALOG CIRCULAR (NO. CV-170D) . . . Complete listing of stock items by volt-ampere rating, input and output voltages, structure type, and catalog number. Handy for purchasing departments, stockmen, and field salesmen.

OPERATING AND SERVICE MANUALS (NOS. CV-171 to 175 incl) . . . Information booklets on installation, service, and repair. In addition, they include valuable operating and engineering data that has proved helpful in getting maximum results under various power system and loading conditions. Manual No. 171 treats Standard Type CV; No. 172, Harmonic-Neutralized Type CVH; No. 173, Adjustable AC Power Supply Type CVL; No. 174, Plate and Filament Power Supply Type CVE; and No. 175, Constant Voltage Transformer for Television Receivers.

SOLA
Constant Voltage
TRANSFORMERS

LITERATURE REQUEST COUPON

Sola Electric Co., 4633 West 16th Street, Chicago 50, Illinois

Gentlemen:

Please send me the literature I have checked below.

- | | |
|--------------------------------------|---------------------------------|
| <input type="checkbox"/> CV-210 | <input type="checkbox"/> CV-171 |
| <input type="checkbox"/> CV-200 | <input type="checkbox"/> CV-172 |
| <input type="checkbox"/> CV-235 | <input type="checkbox"/> CV-173 |
| <input type="checkbox"/> CV SPECIALS | <input type="checkbox"/> CV-174 |
| <input type="checkbox"/> CV-170D | <input type="checkbox"/> CV-175 |

Name _____

Title/Dept. _____

Company _____

Address _____

City _____ Zone _____ State _____

Send for this **FREE SAMPLE FOLDER**

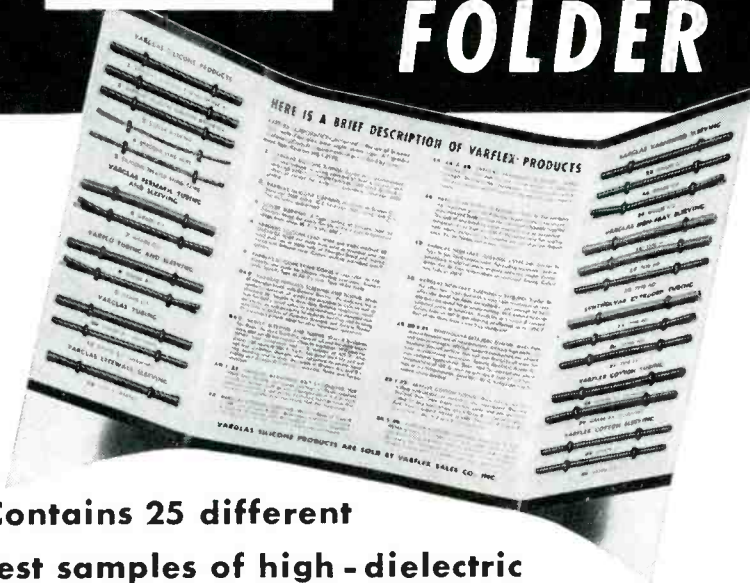

Contains 25 different
test samples of high-dielectric
INSULATING TUBING and SLEEVING

Includes samples and descriptions of...

VARGLAS SILICONE—Class H tubing, sleeving, lead wire, tying cord. Withstands temperature from -85°F to 500°F .

PERMAFIL-IMPREGNATED VARGLAS TUBING—Fiberglas impregnated with General Electric Permafil.

VARGLAS SLEEVING AND TUBING—synthetic-treated, varnished, lacquered, saturated and others.

VARGLAS NON-FRAY SLEEVING—three types available. Withstands temperatures up to 1200°F .

VARFLO TUBING AND SLEEVING—full range of colors, sizes and grades. Vinyl coated Fiberglas.

VARFLEX COTTON TUBING AND SLEEVING—varnish or lacquer impregnated—all NEMA grades.

SYNTHOLVAR EXTRUDED TUBING—listed by UL for use at 105°C . Various formulations to meet unusual requirements.



**MAIL COUPON TODAY
FOR SAMPLE FOLDER**

VARFLEX CORPORATION
506 W. Court St., Rome, N. Y.

Please send me free folder containing samples of your electrical tubing and sleeving.

I am particularly interested in insulation for

Name

Company

Street

City Zone State

units which operate collectively as a low level pulse-width multicode. The equipment is designed for operation under the conditions usually encountered in flight-test instrumentation of aircraft, missiles and other vehicles.

► **What It Does**—Its function is to accept output voltage signals in the low millivolt range from 43 or 88 transducers or reference sources, sample these signals in time sequence, code, the data samples in pulse-width form, and provide an output of pulse-width signals for operating Ampex series 800 airborne tape recorders or similar devices.

Sampling rates of 2.5, 10 or 20 rps and inputs of 15 mv or 30 mv are available. Each unit is contained in a cylindrical pressurized package of approximately $4\frac{1}{2}$ in. diameter and 13 in. in length.

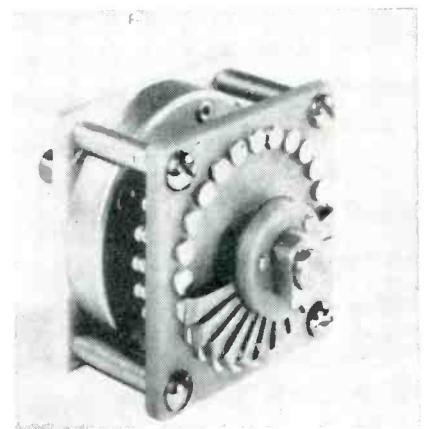

INSTRUMENT SWITCH progressive shorting type

THE DAVEN Co., 530 W. Mt. Pleasant Ave., Livingston, N. J., announces a new multifinger progressive shorting type switch, type 24-FM. It has a fan blade assembly which can be supplied in a variety of combinations. The blade assembly, with its special wiping action and rugged construction, is designed for long switch life and minimum contact wear.

► **Uses**—These switches are useful in applications which require the progressive shorting of capacitors, resistors or other circuit elements. With the addition of a deck which has standard operation, they may be used in sequential applications

ENGINEERS...

LOOK

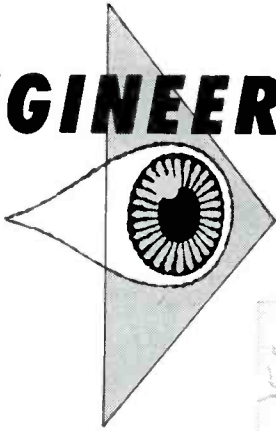

TEN YEARS AHEAD!

Will your income
and location allow
you to live in a
home like this...
spend your leisure
time like this?



A Douglas engineer lives here

*They can...if you start your career
now at Douglas!*

Take that ten year ahead look. There's a fine career opportunity in the engineering field you like best waiting for you at Douglas.

And what about the Douglas Aircraft Company? It's the biggest, most successful, most stable unit in one of the fastest growing industries in the world. It has giant military contracts involving some of the most exciting projects ever conceived... yet its commercial business is greater than that of any other aviation company.

The Douglas Company's size and variety mean that you'll be in the work you like best — side by side with the men who have engineered the finest aircraft and missiles on the American scene today. And you'll have every prospect that ten years from now you'll be where you want to be career-wise, money-wise and location-wise.

For further information about opportunities with Douglas in Santa Monica, El Segundo and Long Beach, California divisions and Tulsa, Oklahoma, write today to:

DOUGLAS AIRCRAFT COMPANY, INC.
C. C. LaVene, 3000 Ocean Park Blvd., Santa Monica, California



DOUGLAS



First in Aviation

"do-it-yourself" is OK...
but not for microwave!

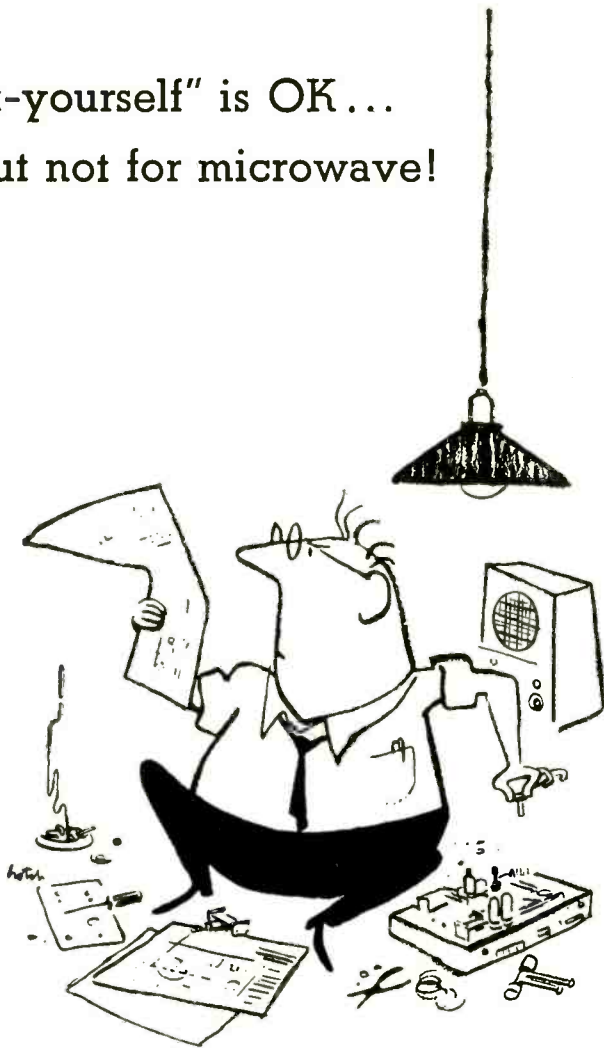

Sometimes it just isn't economical to 'do-it-yourself'. In setting up microwave frequency standards, for example, matching individual components can be an awful chore... and the end results are seldom satisfactory.

Narda's new Microwave Frequency Standard provides wavemeter calibration at frequencies from 2400 to 40,000 mc within .001% accuracy. The basic package consists of a temperature-stabilized crystal oscillator, with multiplication for stabilized outputs at 100, 500 and 1500 mc. Harmonic beats for wavemeter calibrations at higher frequencies are provided by mixing the Standard's output with that of a swept klystron. Specially designed waveguide assemblies in all sizes are available for the Standard. And it's all built with Narda's attention to detail, assuring long, trouble-free service.

Narda can supply all your microwave and uhf instrumentation. Our experience and complete line can save you time, trouble and expense.

Write us today for our complete catalog, prices and the name of our representative who can serve you.



the **narda** corporation

160 HERRICKS RD., MINEOLA, N. Y. • PIONEER 6-4650

COMPLETE INSTRUMENTATION FOR MICROWAVE AND UHF

where all contacts but one are shorted. This contact is connected to an external circuit.

Size of the switch is 1 3/4 in. square by 2 in. deep.

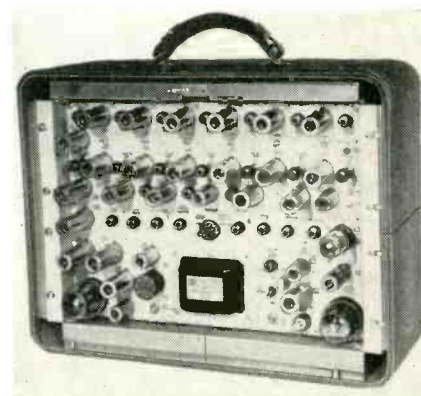

SIGNAL GENERATOR
checks video transmission

TELECHROME INC., 632 Merrick Road, Amityville, N. Y. Model 1003-A video transmission test signal generator is a portable and standard rack mounting unit which produces multifrequency burst, stairstep, modulated stairstep, window signals including composite sync. It produces composite tv waveforms for measuring amplitude vs frequency, differential amplitude vs amplitude, dynamic linearity, differential phase vs amplitude, high-frequency transient response, low-frequency phase or streaking, smears and mismatches of individual units, amplifiers and cables in all parts of the tv system from the studio through all local facilities including the transmitter.

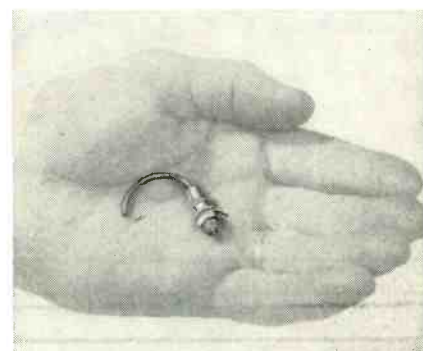

TINY CONNECTORS
are extremely compact

NUGENT ELECTRONICS Co., 621 E. 8th St., New Albany, Ind. Mini-

ELECTRONICS ENGINEERS:

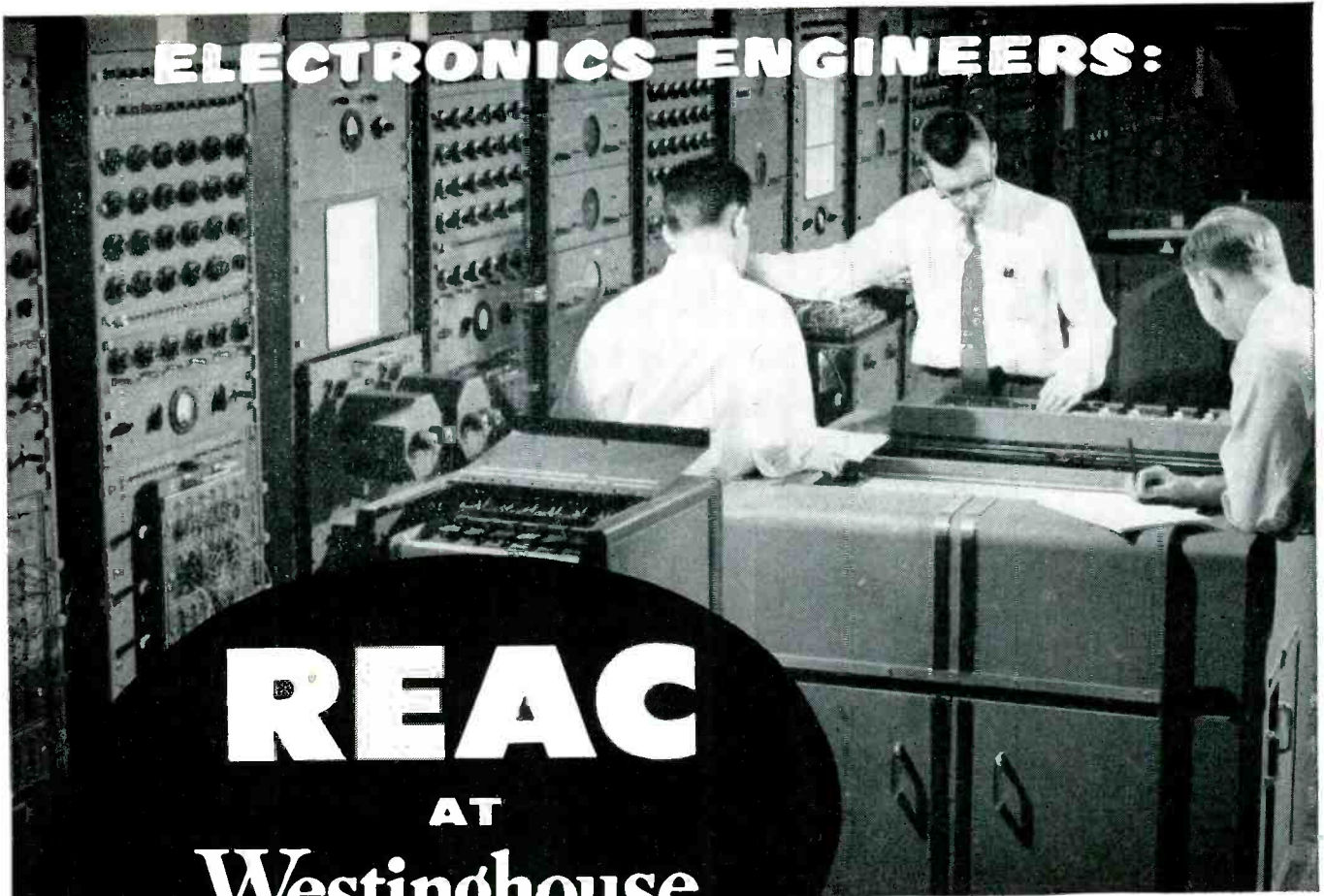

REAC AT Westinghouse

BALTIMORE DIVISIONS

REAC — Reeves Electronic Analog Computer being used by Westinghouse engineers in the analysis of flight performance under simulated flight conditions.

The Baltimore Divisions lead with such facilities.

Current Openings

NOW EXIST IN THE FIELDS OF:

CIRCUITRY
MICROWAVES
SERVOMECHANISMS
MAGNETIC AMPLIFIERS
DIGITAL COMPUTER
PROGRAMMING
FIRE CONTROL SYSTEMS
OPTICS

PACKAGING
TRANSFORMERS
ANALOG COMPUTER
DESIGN
VIBRATION
RADAR DESIGN
FIELD SERVICE
INFRA-RED

TO APPLY

Send resume of education and experience to
Technical Director, Dept. 316
Westinghouse Electric Corp.
2519 Wilkens Avenue • Baltimore 3, Maryland

Investigate

THESE CAREER ADVANTAGES

CREATIVE OPPORTUNITIES ON ADVANCED PROJECTS.

Typical of the advanced projects at the Baltimore Divisions is the guidance and control phase now under development for the IM-99 BOMARC, a pilotless interceptor.

UNLIMITED OPPORTUNITIES FOR ADVANCEMENT.

YOU CAN PURSUE BOTH M.S. AND PH.D. WORK AT COMPANY EXPENSE.

TOP INCOME AND COMPLETE EMPLOYEE BENEFITS.

EXCELLENT HOUSING FACILITIES IN OUR IDEAL GEOGRAPHIC LOCATION.

YOU CAN BE SURE...IF IT'S
Westinghouse

DI-FORMED PAPER TUBES IMPROVE YOUR COILS ...SAVE MONEY AND PRODUCTION HEADACHES

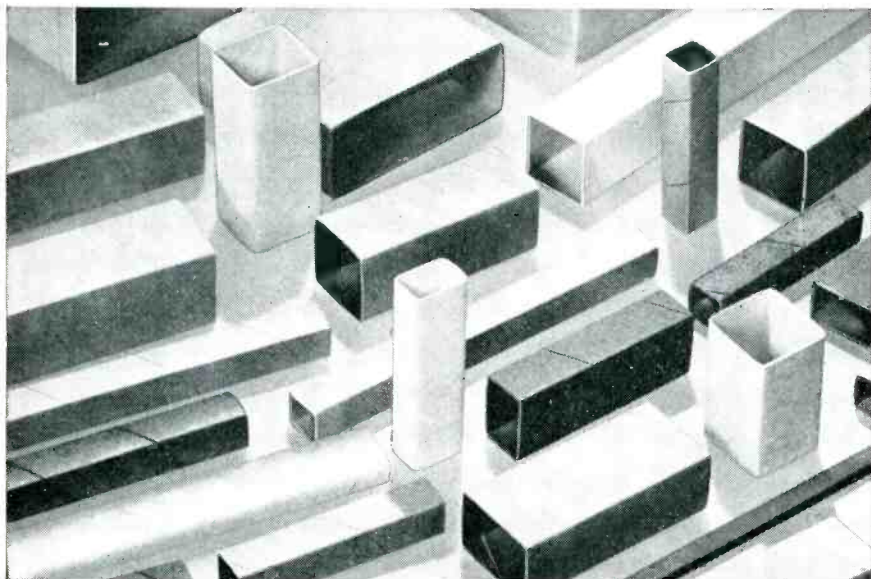

HERE ARE THE FACTS

Di-Formed Tubes feature a special patented Precision Paper Tube construction which produces a completely ridgeless surface, thus eliminating wire pile up and resultant coil shorts.

Side walls are straightened under pressure during the winding operation. The bow being thus controlled permits a perfect fit between mandril and tube as provided by Precision's low-cost Related Mandril Service.

Under the Related Mandril Service, Precision supplies the coil manufacturer with accurately ground steel or aluminum mandrils at a price comparable to commonly used unsatisfactory wood or undersized steel mandrils. *This is not a profit-making service.* Its sole purpose is to give the coil manufacturer these advantages:

1. Provide proper tube support.
2. Facilitate stacking operations.
3. Prevent coil collapse.
4. Save machine and operator fatigue.
5. Permit smaller core, thus decreasing coil size and eliminating pressing.

Get full details on Precision Di-Formed Tubes and Related Mandril Service. Write, wire or phone today.

Sales Representatives in:

Illinois; Indiana; Iowa; Wisconsin; Missouri; Minnesota: Chicago, Illinois, ARmitage 6-5200.
 Indiana; Southern Ohio: Logansport, Indiana, Logansport 2555.
 Northern Ohio: Cleveland, Ohio, ATLantic 1-1060.
 New England: Framingham, Massachusetts, TRinity 3-7091.
 Delaware; Washington, D. C.: Maryland; New Jersey; Metropolitan New York; Eastern Pennsylvania; Virginia: Jersey City, New Jersey, Swarthmore 5-2480.
 Upper New York: Syracuse, New York, Syracuse 4-2141.
 CANADA: Montreal, Quebec, Canada, Walnut 0337.
 MEXICO: Mexico 6, D. F., Telephone: 35-06-18.



PRECISION PAPER TUBE COMPANY
 2041 West Charleston Street, Chicago 47, Illinois
 Plant No. 2: 79 Chapel Street, Hartford, Conn.

con-X trade names a new line of miniature connectors for electronic use.

► **Design Features**—To firmly lock connectors, mating parts are pushed together until a snap is felt. To disconnect plug, a quarter turn of mating parts and slight pull separates the unit. Positive connection of center conductor to connector guards against loss of contact, from either severe vibration or from someone accidentally pulling on cable. Connectors can be easily assembled in the field and no special tools are required for the job.



AUDIO OSCILLATOR delivers 3 watts

HEWLETT-PACKARD Co., 275 Page Mill Road, Palo Alto, Calif. Model 201C audio oscillator covers frequencies 20 cps to 20 kc in three bands with calibration accuracy of ± 1 percent, frequency stability of ± 2 percent or 0.2 cps, and full range frequency response of ± 1 db.

► **Other Specs**—Output is 3 w or 42.5 v into 600 ohms. Distortion is less than 0.5 percent from 50 cps to 20 kc at 1 w, and less than 1 percent, 20 cps to 20 kc at 3 w input. An output attenuator lowers the output 40 db in steps of 10 db. With zero attenuation the internal impedance is approximately 75 ohms. With 10 db or more attenuation the output impedance is approximately 600 ohms over the entire frequency range providing a constant internal impedance for precise audio measurements. Hum voltage is less than 0.03 percent of

Cathode-ray Tubes beyond the usual...

The cathode-ray tubes shown here are among the many that have been developed and manufactured by DuMont for specialized applications. Though not considered the "usual" types, they lend themselves to many applications

requiring special characteristics and features.

This group is representative of the practical designing offered by DuMont. You name the application—we'll make the tube.



K1253P-

Two-beam radar and general purpose; useful for high altitudes to 70,000 feet; has integral mu-metal shield and special high altitude connector; electrostatic focus and deflection.

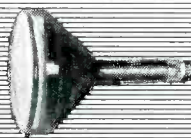

B1125P-

Space-saver radar tube; over-all length only 7 1/4"; small diameter neck; fits miniature 9-pin socket; 5-inch magnetic focus and deflection.



K1327-

Barrier grid storage tube; useful, for example, in computer memory storage.

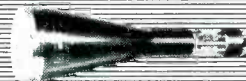

B1141P-

High-voltage mono-accelerator; full scan on both X- and Y-axes; aluminized; electrically similar to Type 5ATP-.



K1388P-

Light source tube; provides standard phosphor spectrums; can be modulated for stroboscopic applications up to 1 microsecond pulses.

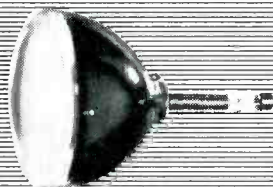

B1157P-

High-resolution, magnetic focus and deflection 12" metallized cathode-ray tube; screen area is large and relatively flat; similar to Type 12DP-.



K1409P-

Ultra-high frequency cathode-ray tube; coaxial connectors; extremely high writing rates; has back-lighted fiducial marks; mu-metal shield is integral.



B1148P-

Flat-face, 7" mono-accelerator; useful in general-purpose oscillographic applications; electrically similar to Type 5AQP-.

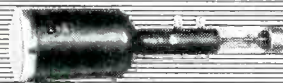

K1421P-

Traveling-wave deflection (one axis); coaxial connectors to deflection system; back-lighted fiducial marks in phosphor for precision measurements of extremely high-speed phenomena with frequency components in the microwave region.



5ARP-

Two beam mono-accelerator with independent guns and common accelerator; each gun identical in characteristic to Type 5AQP-; excellent tube for dual-beam instrument designs requiring high accuracy, low interaction and outstanding tracking accuracy.

DU MONT

Write on company letterhead for special CRT chart

ALLEN B. DU MONT LABORATORIES, INC., 2 MAIN AVE., PASSAIC, N. J.

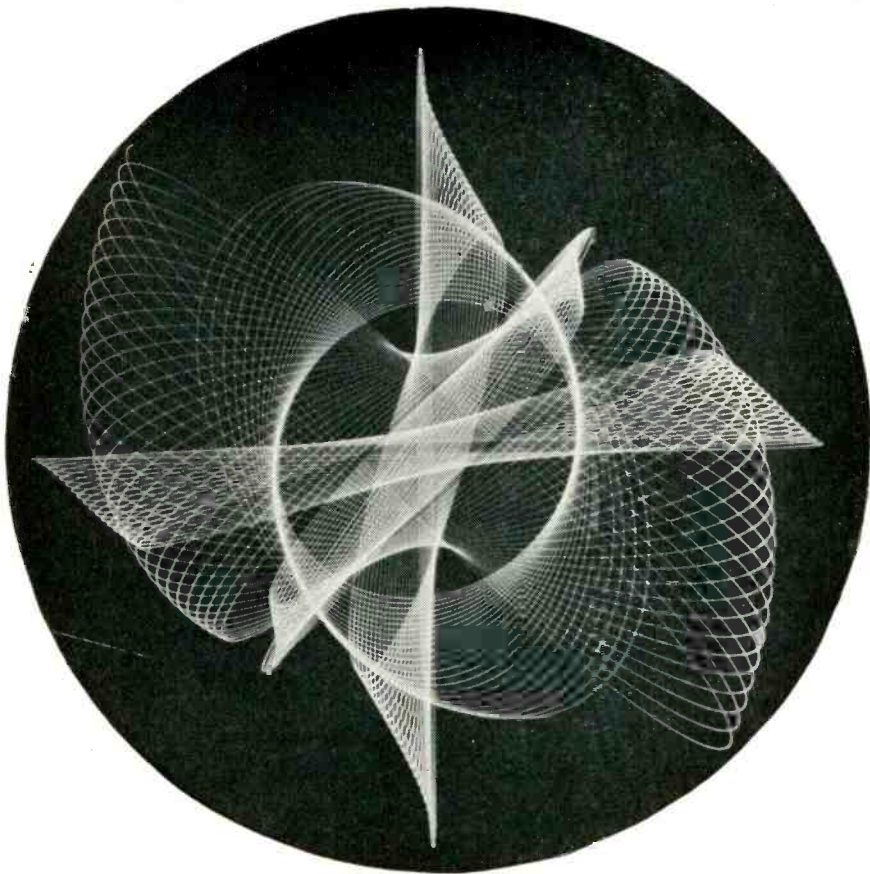

**are you
"lost"
in
electronics?**

Developments have been so rapid in the horizonless science of electronics that many creative engineering talents lie hidden "under a bushel" of non-creative detail work.

If your ability exceeds the use that is now being made of it, you'd do well to learn what's happening at Martin.

For there are—and always will be—excellent opportunities at Martin for electronics engineering talent in the fields of aircraft, missiles, rocketry, nucleonics and space vehicle development.

Contact J. M. Hollyday, Dept. E-05, The Martin Company, Baltimore 3, Maryland.

MARTIN
BALTIMORE

rated or attenuated output.

Model 201C is priced at \$225.

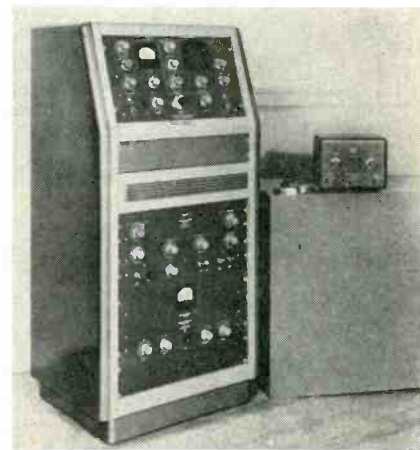

**PRECISE REGULATOR
controls magnetic fields**

NUCLEAR MAGNETICS CORP., a subsidiary of The Perkin-Elmer Corp., 154 Boylston St., Boston 16, Mass. The Numar magnetic field control system model C-1, can be used to control the magnetic analyzing field of a particle accelerator, thus producing accurate beam energy control. It also assures highest accuracies in analysis by controlling deflection magnets, and can be used to control the magnets of microwave spectrometers and mass spectrometers.

► **Parts**—The system consists of an r-f oscillator which generates the r-f signal and amplifies and detects the nuclear magnetic signal; a modulator which supplies small modulation to the detected r-f signal and permits a-c amplification; power supply; and a set of four probes which are used as sensing elements to cover the complete range of magnetic field under control.

Price is \$4,350.

**SILICON DIODE
is hermetically sealed**

RAYTHEON MFG. Co., 55 Chapel St., Newton 58, Mass. The CK863A bonded silicon diode features a peak inverse voltage rating of 300 v. It operates at ambient temperatures from -55 C to + 150 C with excellent stability and low reverse current. At -275 v the reverse

TIME-TRIED TETRODE

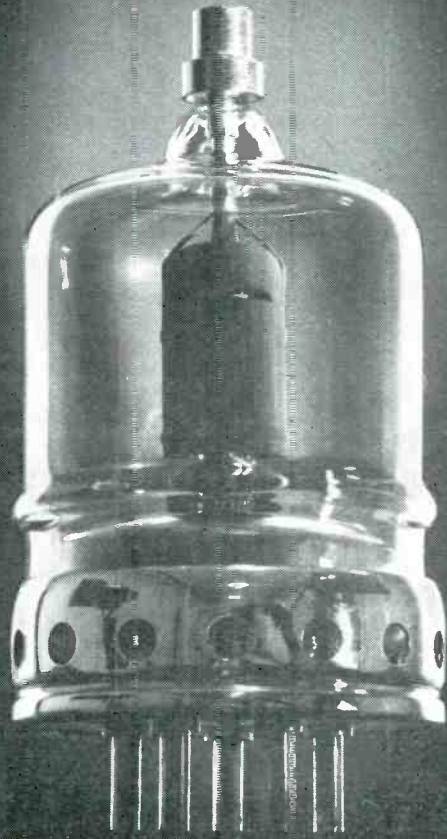

LOS GATOS 4D21/4-125A

Exclusive Sintercote black-body high-dissipation anode and emission-free grids make the Los Gatos 4D21/4-125A an efficient and durable tetrode for modern circuitry. Check Los Gatos for your requirements in other types—especially when the emphasis is on long service life. Write:

LEWIS and KAUFMAN, Ltd.

LOS GATOS I

CALIFORNIA



Export Representatives:
MINTHORNE INTERNATIONAL CO., INC.
15 Moore St., N.Y. 4, N.Y., Cable: Minthorne

In Canada:
RADIO VALVE COMPANY, LIMITED
189 Dufferin Street, Toronto 1, Ontario, Canada

WHAT'S NEW AT BRISTOL...



BRISTOL'S SYNCROVERTER SWITCH is made to fit 7-pin miniature tube socket (left) or 3/4-in. diameter chassis hole (right). Covered by patents.

"Most reliable miniature chopper we've tested!"

That's the playback we're getting from electronic engineers all over the country on the high-performance Bristol Syncoverter® switch. One engineer writes:

"In seven years of experience in applying similar devices, we have not found a chopper as reliable . . . after our tests no deterioration in performance was found, and we believe there is no equivalent meeting our requirements."

Another electronics engineer comments on his life-tests:

"The switch has passed the 1000-hour mark without the slightest degradation of the wave form."

The Syncoverter switch has a normal *operating life of thousands of hours*. It's a polarized, SPDT, non-resonant switch that provides break-before-make action in synchronism with a sine or square-wave driving current anywhere in the frequency range of 0 to 2000 cps. In addition to reliability and long life, it's noted for light weight (only 1.7 ounces) low noise level, and clean wave form.

Write today for free bulletin on the high-performance Syncoverter switch. The Bristol Company, 152 Bristol Road, Waterbury 20, Conn. 6.10

TYPICAL OPERATION

	400 cps	500 cps
Coil voltage	6.3V sine, square, pulse wave	6.3V sine, square, pulse wave
Coil current	55 milliamperes	45 milliamperes
Coil resistance	85 ohms	85 ohms
*Phase lag	55° ± 10°	65° ± 10°
*Dissymmetry	less than 4%	less than 4%
Temperature	-55°C to 100°C	-55°C to 100°C
*Switching time	15° ± 5°	15° ± 5°

Mounting—Any position—fits 7-pin miniature socket

*These characteristics based on sine wave excitation

BRISTOL FINE PRECISION INSTRUMENTS
FOR OVER 60 YEARS

NEW PRODUCTS

(continued)

current is only 1/10 μ a. The CK-863A has parallel leads and is enclosed in a hermetically sealed metal package having a volume of about 0.009 cu in.

► **Specifications**—Each diode maintains exact characteristics during four complete temperature cycles of one hour at -55 C and one hour at +150 C followed by 36 hours at 95 percent relative humidity and 70 C. Forward current measured at 1.0 v is 3 ma. Maximum rectified current at +150 C is 10 ma. Capacitance measured at -10 v is only 1 μ f.



MARKER-BEACON RECEIVER

an all-transistor unit

RADIO CORP. OF AMERICA, Camden, N. J., has developed an all-transistor electronic marker-beacon receiver for commercial and military aircraft—a 15 oz navigational aid. It requires only 1/4 w, or less power than is needed to light a standard flashlight bulb. The unit measures only 2 in. high, 4 in. deep and 5 in. wide. It will operate at unpressurized altitudes of up to 40,000 ft, and at temperature extremes ranging from -65 to +160 F. The receiver operates on the standard marker-beacon frequency of 75 mc.

NEW ADHESIVE

improves printed circuits

HOUGHTON LABORATORIES, INC., 100 Bush St., Olean, N. Y. Uniform peel strength of over 12 lb per in. of

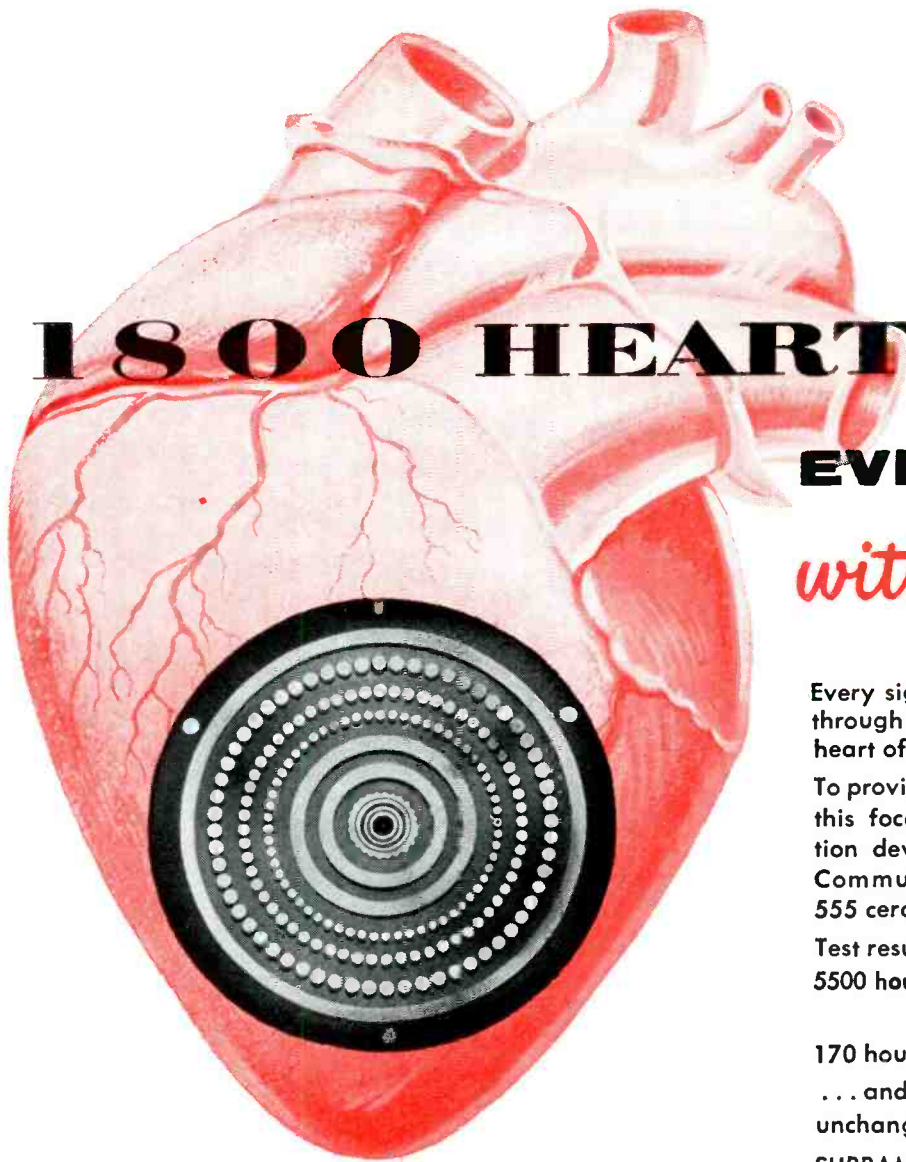

1800 HEART BEATS

EVERY SECOND

without **A MISS***

Every signal, in a telemetering system, passes through the commutation switch — truly the heart of the system.

To provide superior operating characteristics at this focal point, Mycalex Electronics Corporation developed Mycalex Model TM-55 Series Commutation Switches using SUPRAMICA® 555 ceramoplastic commutator plates.

Test results showed unquestionable superiority: 5500 hours at 600 RPM,

with only a simple brush cleaning

170 hours **continuous** operation at 1800 RPM

... and still functioning perfectly with a clean, unchanging signal!

SUPRAMICA 555 ceramoplastic is precision-molded in a wide variety of shapes and sizes offering: absolute dimensional stability—zero moisture absorption — dependable operation at temperatures as high as 950°F. — precise tolerance control — high dielectric strength — contacts cannot loosen even at widely different operating temperatures.

For information on Mycalex Model TM-55 Series Commutation Switches, MYCALEX® glass-bonded mica, and SUPRAMICA® ceramoplastics, write to General Offices and Plant, Box 311, Clifton, New Jersey.

*600 RPM Operation



MYCALEX ELECTRONICS CORPORATION

UNDER EXCLUSIVE LICENSE OF THE MYCALEX CORPORATION OF AMERICA

EXECUTIVE OFFICES:
30 ROCKEFELLER PLAZA NEW YORK 20, NEW YORK



WORLD'S LARGEST MANUFACTURER OF GLASS-BONDED MICA AND CERAMOPLASTIC PRODUCTS

Los Angeles Office:
Mycalex Corporation of America, 5657 Wilshire Boulevard, Los Angeles, California, WEbster 8-2169
Chicago Office:
Mycalex Corporation of America, 6677 Northwest Highway, Chicago 31, Illinois, NEwcastle 1-7062
Minneapolis Office:
Mycalex Corporation of America, 8th St., Minneapolis, Minnesota, FIlmore 7701
Washington Office:
Mycalex Corporation of America, 1411 Pennsylvania Avenue NW, Wash. 4, D. C., REpublic 7-7040

NOW!
Gamewell
gives you
7 NEW
PLUS
FEATURES
in RL-270A
Precision Pots



The completely new Gamewell RL-270A series of Precision Potentiometers greatly extends performance and dependability.

Here are the important extras . . .

- New housings are dimensionally stable, withstand higher temperature, and are inherently moisture and fungus resistant.
- Positive precious metal spring contacts (A at right) give dependable low-resistance contact, even under severe and prolonged vibration and shock.
- Closer tap spacing.
- Redesigned shaft and slit-ring (B at right) reduces electrical noise and minimizes wear.
- Longer wearing insulation-bridge joint.
- Wide selection of resistance alloys for optimum performance.
- Made for continuous operation from -70°F to $+300^{\circ}\text{F}$.

These RL-270A features meet high standards for linearity and dependability, yet compare in price with the best commercial precision pots.

THE GAMEWELL COMPANY
NEWTON UPPER FALLS 64, MASS.
In Canada: Northern Electric Co., Ltd.

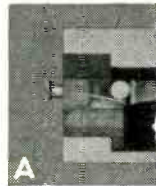

A

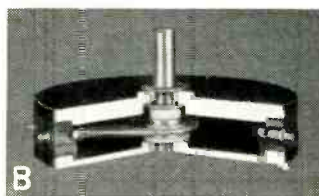

B

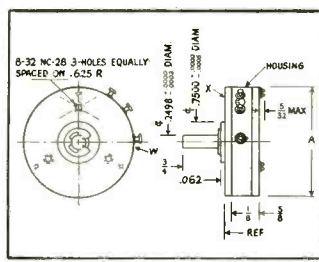

8-32 NC-28 3-HOLES EQUALLY SPACED ON .625 R
 .498 .0005 DIAM
 .7500 .0005 DIAM
 .062
 HOUSING
 .33 MAX
 REF

Model Numbers & Sizes

All dimensions same, except "A"

RL-270A-1 1/4	1 1/4 inches
RL-270A-1 1/8	1 1/8 inches
RL-270A-2	2 inches
RL-270A-3	3 inches
RL-270A-5	5 inches

width for copper clad laminates are now available from several laminate manufacturers using Hysol 2217 in a new bonding process developed by the labs. The new process assures uniform strength from sheet to sheet.

In addition, exhaustive outside lab tests have proven excellent solder dip resistance limited in temperature only by the basic laminate itself. Higher temperature solder baths result in not only better reliability, but in shorter soldering cycles and increased production.

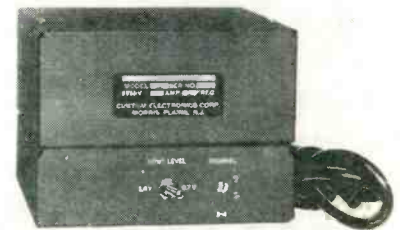

VIDEO MODULATOR
for tv monitoring

CUSTOM ELECTRONICS CORP., 738 Speedwell Ave., Morris Plains, N. J. Model 3A video modulator converts any tv receiver into a studio line monitor. A video feed of either 0.7 or 1.4 v peak-to-peak is converted to a modulated carrier adjustable to channel 3 or 4. The input is bridging, permitting several video modulators to be fed on the same video line. The output is 0.1 v across an unbalanced impedance of 75 ohms. Several balanced input receivers may be satisfactorily fed from the video modulator, provided that proper impedance match is maintained.

MICROWAVE GENERATOR
for 8,500-9,600 mc

MICROWAVE DEVELOPMENT LABORATORIES, INC., 92 Broad St., Babson Park, Wellesley 57, Mass. Model 10X stabilized microwave generator is a c-w microwave source for X-band, 8,500 to 9,600 mc. It is an ideal source for Q measurements

Send for complete technical story
 Get the specifications sheets for all sizes — available now. They give the complete information to specify and use this new RL-270A series.



PRECISION POTENTIOMETERS

Manufacturers of
Precision Electrical Equipment since 1855

**make it better
with
STAR
LAVOLAIN®**

Here's another outstanding member of the Star family of electrical porcelains. This steatite ceramic is ideal for small parts which must provide excellent mechanical strength plus good thermal shock resistance.

LAVOLAIN'S high dielectric strength at elevated temperatures makes it basic for small rods, bushings, resistance-wire holders, and switch bases for use in a wide variety of electrical products. It is available in various colors to conceal assembly stains or to provide identification of electrical circuits or parts of equipment.

Ball and socket insulating bushings made of LAVOLAIN provide superior high temperature wire insulation, especially when flexibility is a must. These ball and socket bushings are stocked in 13 standard sizes.

Complete information of LAVOLAIN and the complete Star family of electrical porcelains is contained in a 26-page, fact-filled catalog.

Write for a free copy.

Star Porcelain Company
42 Muirhead Ave., Trenton 9, New Jersey

STAR
porcelain company

SINCE 1920 QUALITY PRODUCTS **SPADE BOLTS**

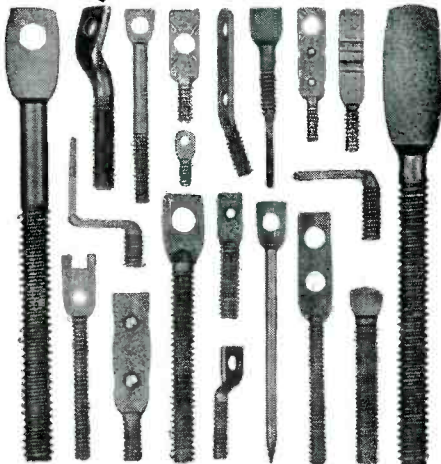

Specialists in designing and manufacturing of all-purpose fasteners and wire forms. Tooled to produce over 1000 styles in any screw size, material, finish, quantity, to your specifications.

Serving Industry for Thirty-five Years
— OTHER PRODUCTS —

Simplex
WIRE STRIPPERS & CUTTERS

• TOOLS • DIES • STAMPINGS
Bulletins on complete line upon request

WENCO MANUFACTURING CO.
1133 W. Hubbard St., Chicago 22, Ill., U.S.A.

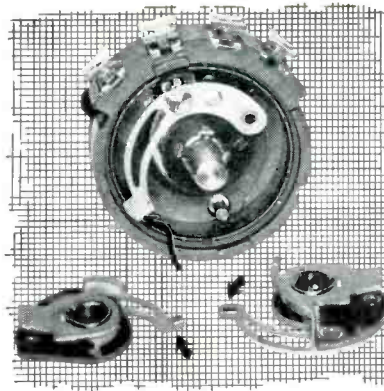

Arrows show Paliney #7 contacts used in this potentiometer manufactured by Clarostat Mfg. Co., Inc.

Paliney #7*, a Ney precious metal alloy, has been selected by Clarostat Mfg. Co., Inc., Dover, N.H., for use as wipers and sliders in their precision potentiometers. The use of this alloy assures long service and shelf life, excellent maintained linearity and low noise within close tolerances throughout the life of the potentiometer.

Ney offers many other precious metal alloys which bring increased reliability to electrical or electronic precision instruments. Like Paliney #7, they have excellent electrical characteristics and resist tarnish. These alloys are widely used today in precision instruments throughout industry for sliding contacts, slip rings and assemblies, commutator segments and assemblies, brush and brush holder assemblies, and for precious metal resistance wire.

The Ney Engineering Department will be glad to study your particular contact problems and make suggestions and recommendations to improve the efficiency of your electrical or electronic instruments. Call or write Ney today.

(All contacts capsule-packed in plastic)

THE J. M. NEY COMPANY • 179 ELM ST., HARTFORD 1, CONN.

Specialists in Precious Metal Metallurgy since 1812

*Registered Trade Mark

NEY'S small parts play a BIG part in precision instruments

for service and lab. work

Heathkit
PRINTED CIRCUIT
OSCILLOSCOPE KIT
FOR COLOR TV!

① Check the outstanding engineering design of this modern printed circuit Scope. Designed for color TV work, ideal for critical Laboratory applications. Frequency response essentially flat from 5 cycles to 5 Mc down only 1 1/2 db at 3.58 Mc (TV color burst sync frequency). Down only 5 db at 5 Mc. New sweep generator 20-500,000 cycles, 5 times the range usually offered. Will sync wave form display up to 5 Mc and better. Printed circuit boards stabilize performance specifications and cut assembly time in half. Formerly available only in costly Lab type Scope. Features horizontal trace expansion for observation of pulse detail — retrace blanking amplifier — voltage regulated power supply — 3 step frequency compensated vertical input — low capacity nylon bushings on panel terminals — plus a host of other fine features. Combines peak performance and fine engineering features with low kit cost!



Heathkit TV
SWEEP GENERATOR KIT
ELECTRONIC SWEEP SYSTEM

② A new Heathkit sweep generator covering all frequencies encountered in TV service work (color or monochrome). FM frequencies too! 4 Mc — 220 Mc on fundamentals, harmonics up to 880 Mc. Smoothly controllable all-electronic sweep system. Nothing mechanical to vibrate or wear out. Crystal controlled 4.5 Mc fixed marker and separate variable marker 19-60 Mc on fundamentals and 57-180 Mc on calibrated harmonics. Plug-in crystal included. Blanking and phasing controls — automatic constant amplitude output circuit — efficient attenuation — maximum RF output well over .1 volt — vastly improved linearity. Easily your best buy in sweep generators.

Heath
COMPANY
A SUBSIDIARY OF DAYSTROM, INC.
BENTON HARBOR 14, MICH.

WRITE FOR FREE CATALOG
... COMPLETE INFORMATION

PRECISION TRANSDUCERS

NEW PRODUCTS

(continued)

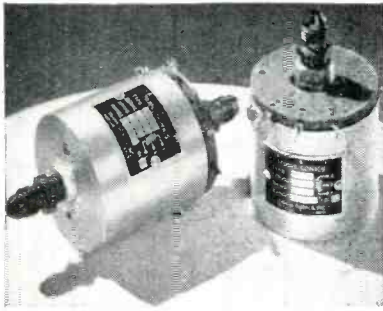

← PRESSURE OPERATED POTENTIOMETERS

Outputs: Linear and nonlinear functions of applied pressure.
Resistances: 100 to 50,000 ohms.
Ranges: 0-5 to 0-5000 psi.
Types: Absolute and differential.
Vibration Ambient: 0 to 55 cps, 0 to 500 cps, and severe vibration 25g to 2000 cps.
Construction: Hermetically sealed.

Write for Pressure Operated Potentiometer Bulletin



← ULTRA-SENSITIVE PRESSURE SYSTEM

Output: 50 volts at full scale.
Range: $\pm \frac{3}{4}$ psi, differential.
Resolution: 1×10^{-6} psid.
Zero stability: Better than 1×10^{-3} psid.

Write for Bulletin EPMS



← RESISTANCE BRIDGE PRESSURE PICKUPS

Sensitivity: 5 mv/v at full scale.
Ranges: 0-10 to 0-1500 psi.
Types: Absolute and differential.
Construction: Hermetically sealed.

Write for Bulletin No. 7



← RATE OF CLIMB

Outputs: 5 volt signal and/or dial indicator.
Range: $\pm 25,000$ ft./min.
Time constant: 0.2 sec. at sea level to 2 sec. at 50,000 ft.

Write for Vertical Speed Transducer Bulletin

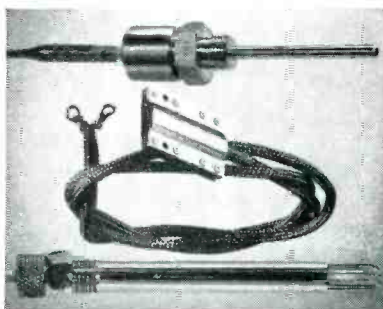

← RESISTANCE THERMOMETERS

Resistance: 5 to 500 ohms at 32°F.
Materials: Platinum or nickel.
Range: -350 to +2000°F.
Types: Liquid, surface, gas.
Characteristics: Corrosion proof, severe vibration ambient, fast speed of response.

Write for Resistance Thermometers Bulletin



requiring a high degree of r-f stability.

► **Makeup**—It consists of a klystron oscillator, a tunable reference cavity, a frequency stabilizing circuit and a power supply.

To operate the model 10X, the desired frequency is selected by the tuning control which drives the reference frequency cavity. The klystron adjustment for optimum output is then made. All controls and meters are located on the front panel for easy operation.

Price is \$790. Bulletin MG-1 contains complete specifications.



SUMMATION COUNTER a bidirectional unit

NEMETH, INC., 2223 S. Carmelina Ave., Los Angeles 64, Calif., has available a high-speed pulse-actuated electromagnetic counter which both adds and subtracts. It utilizes a dynamically balanced bidirectional stepping mechanism that cannot double index during shock, vibration or excessive electrical input.

It has inherent long life, exceeding 100 million counts due to its

"For Transducers See Trans-Sonics"

Trans-Sonics, Inc.

P.O. BOX 328 • LEXINGTON • MASSACHUSETTS

impact-free mechanism. The unit operates to 60 counts per sec in either direction or to 50 cps random input on d-c. It is available for a-c with an external rectifier.

Power requirement is 15 w, continuously rated. Coils are wound to specification for 6 to 250-v operation. The standard model measures 2 by 2 $\frac{3}{8}$ by 3 $\frac{7}{8}$ deep. Weight is 1 $\frac{1}{2}$ lb.

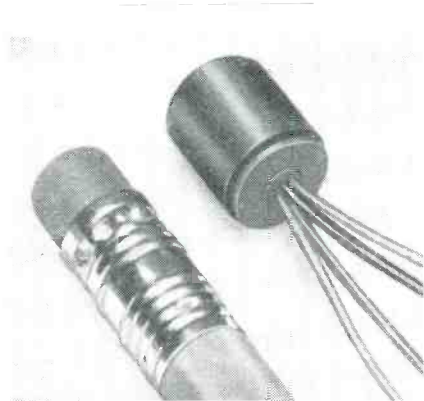

TRANSFORMERS for transistor applications

UNITED TRANSFORMER CO., 150 Varick St., New York 13, N. Y., announces the Deci-Ouncer transformers for transistor applications. The miniature units (0.03 cu in. in volume) will operate at 100 times the power level of similar sized units of conventional structure with the same distortion level.

► **Other Features**—They have 30-percent greater efficiency than conventional transformers, are fully cased and hermetically sealed for maximum life. Leads will take a 10-lb pull and have excellent frequency response.

Eight standard types cover virtually every application at 100-mw level. It is down only 1 db at 200 cycles, and has winding resistances of 850 ohms and 125 ohms. Literature is available.

SILICON RECTIFIERS high-power devices

TRANSITRON ELECTRONIC CORP., Melrose 76, Mass., has in production new high-power silicon rectifiers rated up to 35 amperes forward current at 125 C case temperature. They feature high forward conductance and low leakage current

If You Can Imagine It...

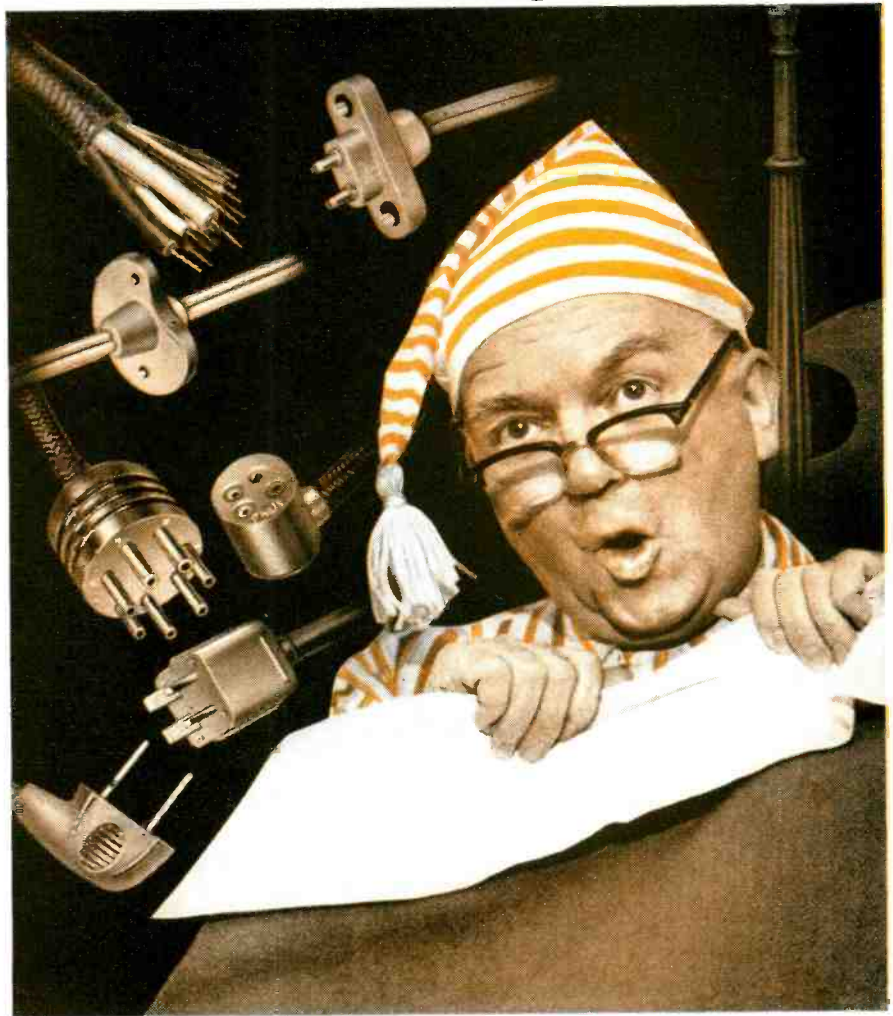

PHALO Can Mold It!

We know there are molded shapes in plugs, strain reliefs, harnesses and other molded insulations that we have not even dreamed of as yet . . . but maybe you have, or will soon!

When you do come up with the first shape of its kind, we modestly suggest you get in

touch with Phalo. Judged by past *and* present performance, Phalo is your most direct answer when the question is special molded shapes in insulation. Phalo can show you a list of some of America's finest firms who have proven how really specialized Phalo's services can be!

Ask For The Complete Phalo Catalog

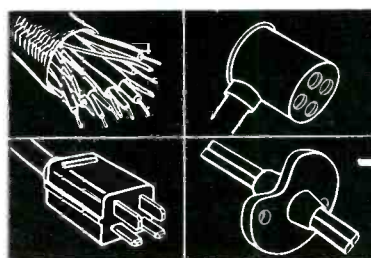

PHALO

PLASTICS CORPORATION

The Custom Insulation House

CORNER COMMERCIAL STREET
WORCESTER, MASS.

Insulated Wires, Cables — Cord Set Assemblies

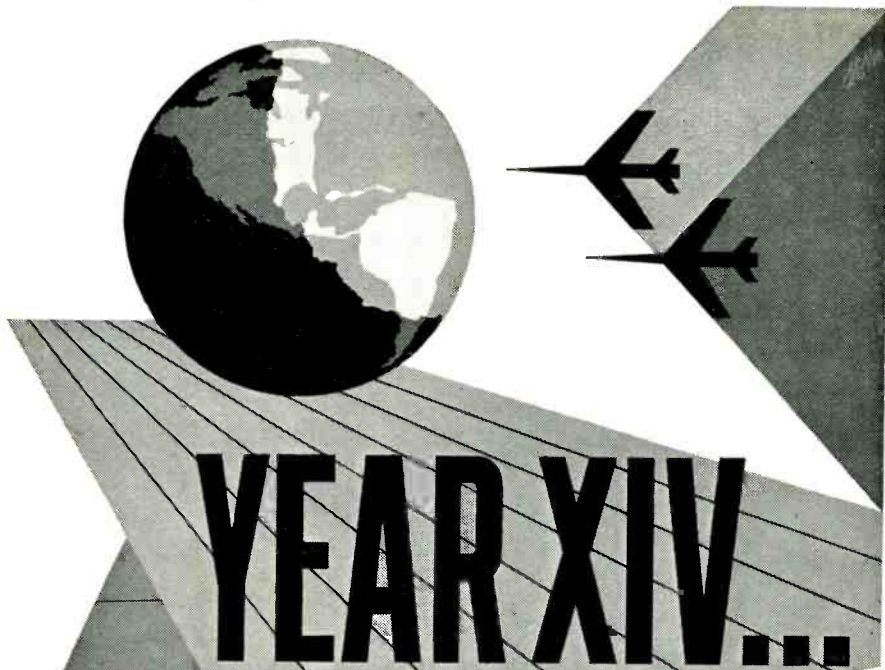

YEAR XIV...

... IN THE AGE OF NUCLEAR AND THERMONUCLEAR DEVELOPMENT

Interested in it? So are we!
 For here at world-famous Los Alamos Scientific Laboratory, responsible for unleashing the terrifying power of the atom, we are now pioneering in harnessing this power for beneficial uses.

There is exciting adventure in the application of nuclear and thermonuclear energy to weapons, power and propulsion. Supporting these diverse activities here at Los Alamos are many challenging projects in basic physics, chemistry, metallurgy, mathematics and engineering.

Los Alamos needs men and women with imagination and research ability for permanent career positions. Interested? So are we!

Write us for an illustrated brochure describing the Laboratory, its delightful mountain location and its excellent housing and community facilities. Mail your request to

DIRECTOR OF PERSONNEL
 DIVISION 803

LOS ALAMOS SCIENTIFIC
 LABORATORY IS NOW IN ITS
 14TH YEAR OF OPERATION.

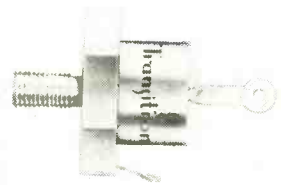

for high operating efficiency. High current handling capacity reduces the number of rectifying cells required for any given application. Peak inverse voltage ratings to 200 v are available.

► **Applications** — Particularly useful for aircraft or other 28 v d-c systems, six of these new rectifiers will supply up to 200 amperes output current, and their total combined weight, including hardware, will be less than 10 oz.

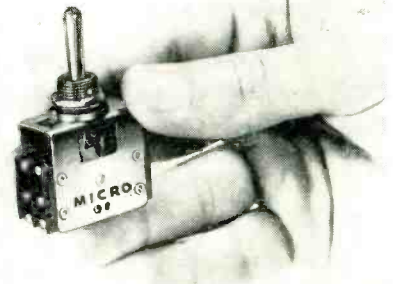

TOGGLE SWITCH
 has ability to remember

MICRO SWITCH, a division of Minneapolis-Honeywell Regulator Co., Freeport, Ill. A new toggle switch with an electrical memory is designed to simplify basic circuit designs of complicated ground radar units, computer devices, aircraft control panels and other types of remote control equipment.

► **How It Works**—The switch assembly (designated 21AT1) uses 3 spdt functional basic switches and 1 spdt memory switch. In application, the memory switch indicates through a pilot light or buzzer which circuit was last actuated. The three functional switches operate at three lever positions; maintained center and momentary

from each extreme position. Two of the switches are actuated when the lever is moved to one extreme position and the other switch is actuated in the other extreme position.

The basic switch, which is used for the electrical memory, is actuated (maintained) in one extreme lever position and is released (maintained) in the other extreme position. The lever returning to the center position does not affect the memory switch, which indicates the extreme position in which the lever is in or was in most recently.

► **Ratings**—The basic switches are electrically listed by U/L at 5 amperes 125 or 250 v a-c. Their d-c rating at 30 v is: inductive—3 amperes at sea level and 2.5 amperes at 50,000 ft; resistive—4 amperes at sea level and 4 amperes at 50,000 ft; maximum inrush—15 amperes.

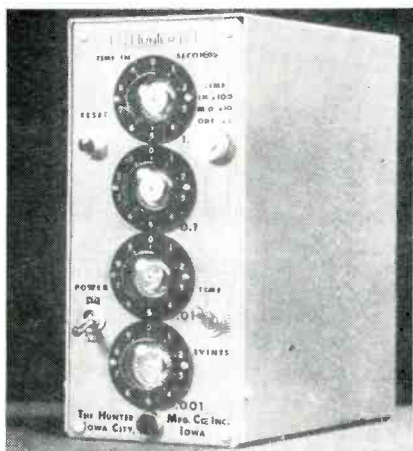

COUNTER
performs two functions

HUNTER MFG. Co., 930 South Linn St., Iowa City, Iowa. The Kloc-counter is both a timer and a decade counter in one compact piece of equipment weighing less than 8 lb. It is 4 in. wide, 9 in. high and 9 in. deep. Terminals are available so that it may be connected to measure either the time an external circuit is open or the time such a circuit is closed.

► **Counting** — By using the new glow transfer tube it is possible to achieve maximum counting rate of 2,000 counts per sec. Total maxi-

nonsense!

you can't mix magic
with **IF transformers**

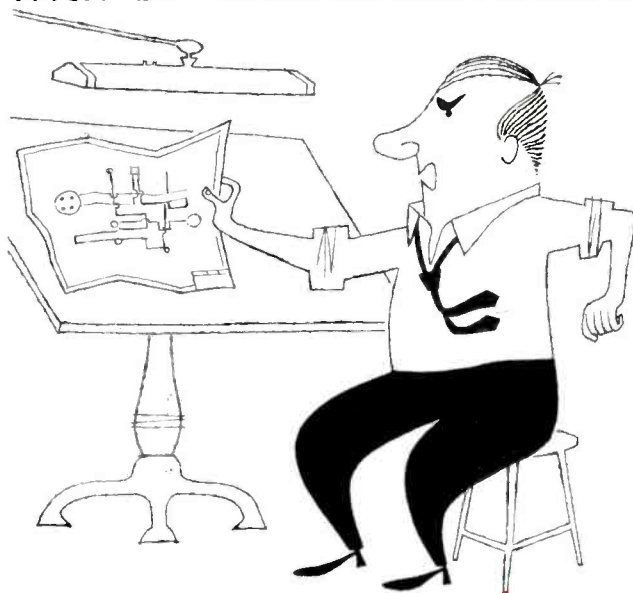

but—sir— **you're wrong**
and here's why...

There's an element of electronic magic in the way Aladdin saves you costly, time-consuming hours of engineering. Let Aladdin worry about the design and construction of your IF transformers and IF strips. Don't spend your own valuable engineering hours doing something we have done hundreds of times. Our experience covers a wide range of special applications. If Aladdin does not already have the solution to your problem in the files, we have probably solved another one so close to it that we can be in full-scale production with almost magical efficiency.

The modern way to conjure up the genie is to rub your pencil across the coupon below. We'll send you literature that will help you tell us what you need—then get together with you at your convenience to solve your *particular* problem.



ALADDIN RADIO INDUSTRIES, INC.
717 Murfreesboro Road, Nashville 2, Tenn.

Send Bulletin giving technical information on Aladdin IF Strips.

NAME _____

COMPANY _____

ADDRESS _____

CITY _____ STATE _____



Introducing...

7

SAGE "MITES IN ARMOR"*

NOW . . . an ALL-NEW line of Sage miniature wire-wound power resistors in 7 dimensions and 2 to 10 watt ratings —engineered to meet today's electronic equipment requirements.

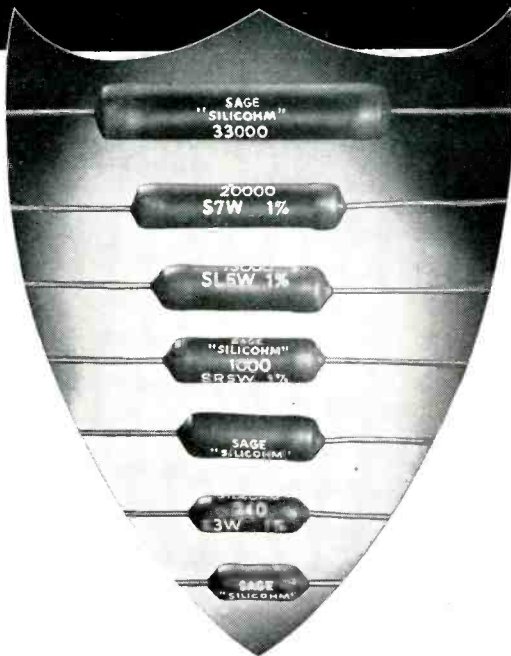

Sage "Silicohm" Resistors are designed to meet or exceed all the electrical, physical and environmental requirements of MIL-R-26B with tolerances ranging from .3% to as low as .05%.

Miniaturization is the broad answer to many problems of the electronic designer. But to implement miniaturization there must be a wide selection of sizes, so that the component does its intended job in the smallest possible space.

That is why SAGE Resistors are now available in *seven dimensions* from 2 to 10 watt ratings so that you can select the resistor that will develop the highest resistance with the least possible sacrifice of space.

And once the selection is made, you can depend on the rugged construction and sturdy silicone coating of SAGE "Silicohm" Resistors to withstand humidity, salt spray, temperature changes, vibration and other external forces . . . for they truly are mighty "mites in armor."

*Referring to the tough silicone coating used exclusively on SAGE "Silicohm" Resistors.

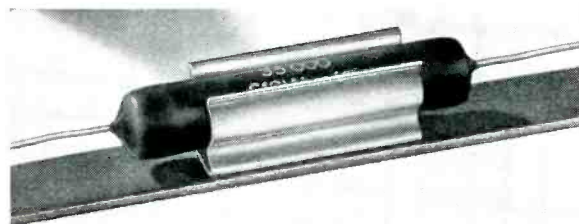

The tough silicone "armor" coating now used on all SAGE Type "S" Resistors will not crack, chip or peel. Nor will the quality of the coating change at high ambients. Yet this coating is not brittle and will not craze even when repeatedly cycled in thermal shock. Also offers many advantages where vibration or high "G's" are inherent and permits up to 50% more power because heat is partly dissipated through the base of the clip into the chassis on which it is mounted. Thus, the resistor may be rated upward allowing more power for a given size.

Tough Silicone Coating Provides Extra Advantages for Clip Mounting

SAGE



Write for complete data.

SAGE

ELECTRONICS CORPORATION

302 North Goodman St., Rochester 7, N.Y.

imum count capacity is 9,999. This count can be increased by using an inexpensive mechanical counter or by using additional Klockounters. The Klockounter will measure time intervals in units of 0.1, 0.01 or 0.001 sec.

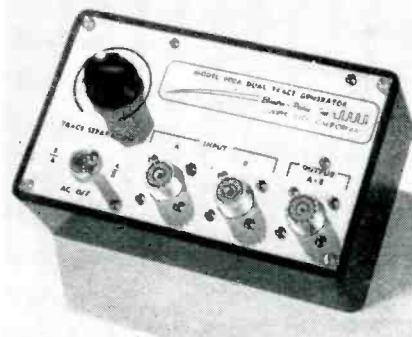

DUAL TRACE GENERATOR chopper samples 2 inputs

ELECTRO-PULSE, INC., 11861 Teale St., Culver City, Calif. The model 600A dual trace generator converts any standard oscilloscope to a dual input unit by chopper sampling two inputs at a 60 cycle rate. The two signals then appear simultaneously on the oscilloscope, with vertical separation between the two adjustable by a control on the 600A.

► Uses—The unit is particularly useful for comparison or delay, pulse rise time, and waveform amplitude or distortion.

Size is 6½ in. wide by 3½ in. high by 2 in. deep.

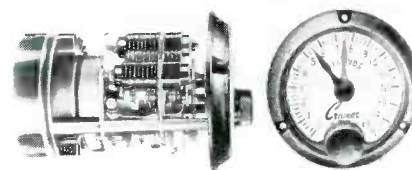

TIME DELAY RELAYS with high repeat accuracy

THE R. W. CRAMER CO., INC., Centerbrook, Conn., has announced types 412 and 422 time delay relays. Both are capable of maintaining repeat accuracy within ±¼ of 1 per-

cent full scale (30 sec and longer ranges); $\pm\frac{1}{2}$ of 1 percent on faster ranges.

► **Additional Features**—They have full-vision white-on-black dial with 300-deg scale, allowing fast, precise settings and easy reading, with dial and pointer protected by full transparent cover. New silver cadmium contacts rated at 15 amperes have quick-make, quick-break wiping action and are of much larger size than previously used, with ample capacity for high in-rush currents. New 9-position terminal block permits easier wiring from side or back with a wider range of circuit possibilities than before.

Type 412 timer automatically resets on power failure and begins a complete new cycle when service is restored. Type 422 includes a special reverse action clutch which causes it to suspend operation in case of power interruption, resuming and completing the same cycle when service is restored.

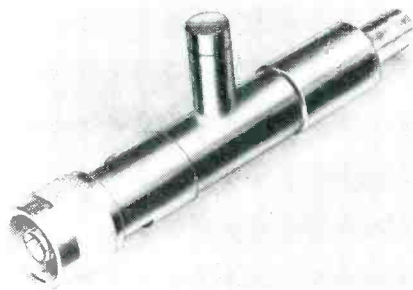

COAX CRYSTAL MOUNTS with internal d-c returns

MICROLAB, 71 Okner Parkway, Livingston, N. J., announces a new line of fixed tuned coaxial crystal mounts with internal d-c returns. They utilize ceramic cartridge crystals such as the 1N21B and 1N23B and are designed for a nominal impedance of 50 ohms. Each mount has a video output capacitance of 30 μ f and provides an untuned tangential signal sensitivity in excess of 50 dbm.

► **Other Features**—A broadband impedance matching network is incorporated to reduce the input vswr and increase signal sensitivity. The output polarity of the mount is

PANELSCOPE

by

Waterman

**FOR AUTOMATIC
PORTRAYAL**

SIZE:

5-1/4" x 5-3/16" x 10"
5 Pounds

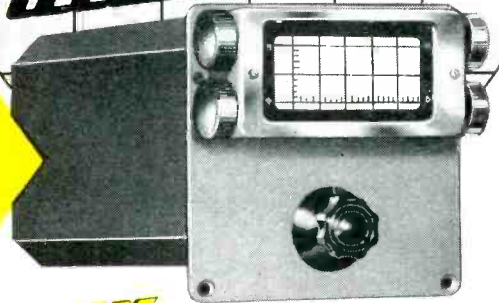

ANOTHER EXAMPLE OF *Waterman* PIONEERING...

The Waterman **PANELSCOPE** is a custom-built cathode ray tube oscilloscope, with simplified operation, and yet available at a low price. The **PANELSCOPE** concept provides for the following:

- **MINIATURIZATION** — Panel space required is only 5 1/4" x 5-3/16" — depth is 10" and the weight is less than 5 lbs. The **PANELSCOPE** can be installed in practically any equipment — mobile or stationary air, sea, or land — military or commercial.
- **SIMPLICITY OF OPERATION** — Twist of a single rotary switch provides a synchronized pattern of desired incoming signal (up to 11 circuits) against proper linear time base. This is ideal for monitoring and trouble shooting, as it removes the need of fiddling with knobs as it is done now on general purpose oscilloscopes. The static controls, such as beam, focus, positioning, and graticule brightness are located in tube escutcheon.
- **CUSTOM DESIGN** — A wide variety of — signal amplifiers with response from dc to megacycles and sensitivities from 5 millivolts — synchronized or triggered linear time base generators from 1/2-cycle (and lower if need be) to 2 microseconds — can be specified by you to fit your needs for particular equipment.
- **PARTIAL KIT FORM** — The **PANELSCOPE** comes fully wired and tested with chosen signal amplifier, linear time base generator and attendant sync. amplifier. The desired signal attenuators, frequency and amplitude determining components, and method of synchronization can be installed either by us or by you.
- **POWER REQUIREMENT** — Less than 10 watts of line power for built-in high voltage supply — The required B+ and heater current as selected by your requirements. For those cases where B+ and heater power is not available, auxiliary power pack can be supplied.

There is a place in your equipment for Waterman **PANELSCOPE**, a custom built oscilloscope at production prices, although your needs may be but one or two. May we have your requirements?

WATERMAN PRODUCTS CO., INC.

PHILADELPHIA 25, PA.

CABLE ADDRESS: POKETSCOPE

MANUFACTURERS OF

PANELSCOPE*
S-4-C SAR PULSESCOPE*
S-5-C LAB PULSESCOPE*
S-11-A INDUSTRIAL POKETSCOPE*
S-12-B JANized RAKSCOPE*
S-12-C SYSTEMS RAKSCOPE*
S-14-A HIGH GAIN POKETSCOPE*
S-14-B WIDE BAND POKETSCOPE*
S-14-C COMPUTER POKETSCOPE*
S-15-A TWIN TUBE POKETSCOPE*
RAYONIC* Cathode Ray Tubes
and Other Associated Equipment

*U. S. PAT. REG.





KOVAR

glass-sealing alloy

Makes the BEST SEALS with glass
(for perfect vacuum and pressure tightness)
because . . .

KOVAR matches perfectly

the thermal expansion characteristics of certain hard glasses over the entire working temperature range. Thus, seals can be formed strain-free.

KOVAR bonds readily

with its matching glass. The oxide of the alloy fuses into the glass, resulting in a strong, chemically bonded vacuum tight seal.

KOVAR is versatile

being available as rod, tube, wire, sheet, strip and foil as well as fabricated shapes, such as: cups, eyelets, leads. Kovar can be welded, soldered and brazed to other metals, and is not attacked by mercury.

KOVAR is dependable

due to precision manufacturing controls, backed by 20 years of experience on this critical alloy. With Kovar uniform, dependable results are insured.

Write for Detailed Information

Stupakoff

DIVISION OF

Write Dept. E

LATROBE,
PENNSYLVANIA

The CARBORUNDUM Company

negative. Mounts are available in six overlapping bands covering the frequency range of 50 to 8,000 mc.



COUPLING CAPACITOR has higher rating

WESTINGHOUSE ELECTRIC CORP., P. O. Box 2099, Pittsburgh 30, Pa. Type PC-3 carrier current coupling capacitor has a high capacitance. Rated from 46 kv to 345 kv, the unit features mechanical strength and ease of tuning. It provides a low-loss path for broadband coupling of carrier signals to h-v transmission lines.

The capacitor is also available with a class A potential device, providing a source of 1-v power for relaying functions.

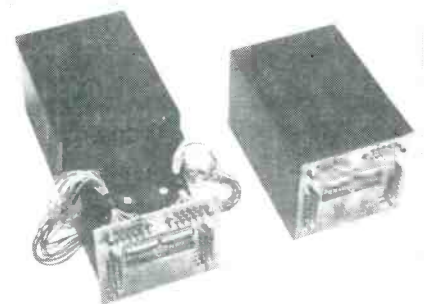

SAMPLING SWITCH is hermetically sealed

GENERAL DEVICES, INC., P. O. Box 253, Princeton, N. J. This new switch has up to 6 poles and 12 non-shortening channels per pole, with integral special design 400-cycle hysteresis synchronous motor and starting capacitor.

► **Features**—The unit shown utilizes exclusive, long life, constant

force Perma Brush providing 1,000 hours or more service-free life. It is available with variations in numbers of poles and channels, with or without hermetic sealing. Approximate size is $2\frac{1}{8}$ in. by 3 in. by $4\frac{1}{8}$ in.

Current models include single or multiple pole, stacked, concentric, opposed, raised contact, segmented or printed circuit designs.



AIRCRAFT BATTERY SUBSTITUTE conforms to MIL-E-7894 spec

OPAD ELECTRIC Co., 69 Murray St., New York 7, N. Y. Model KM81 aircraft battery substitute operates from 115 v a-c 60 cycles single phase and provides a continuously adjustable output from 0 to 30 v d-c. Ripple is held to 1 percent at the maximum rated load current of 10 amperes. It conforms to the requirements of specification MIL-E-7894, as a power source for testing and operating aircraft electrical equipment and components.

The KM81 mounts in a standard 19-in. rack and occupies only $8\frac{1}{2}$ in. of panel height. Controls include a power switch, pilot light, voltage control dial, a $3\frac{1}{2}$ in. 2-percent accurate d-c voltmeter and ammeter, line and load fuses and a pair of insulated output binding posts. An additional pair of output terminals are provided at the rear of the chassis.

GROUND DETECTOR new lamp-type unit

SUNSHINE SCIENTIFIC INSTRUMENT, 1810 Grant Ave., Philadelphia 15, Pa. Catalog No. 32 lamp-type ground detector uses lamps in place of voltmeters to indicate a ground



Stupakoff Kovar HARD-GLASS Seals

PERFECTLY FUSED BOND eliminates "leakers"

The single terminal hermetic seals shown here are among the most widely-used of literally hundreds of designs of Stupakoff Kovar Hard-Glass designs.

At the right is a typical cross-section showing how hard glass and Kovar alloy are intimately fused in an oxide bond that forms a true hermetic seal. Because the thermal expansion of Kovar exactly matches that of hard borosilicate glass, Stupakoff Seals are free from strain over the entire working temperature range.

Principal sizes available are:

- Dimension A
Over-all length $.220$ in. to $3\frac{7}{16}$ in.
- Dimension B
Flange to lead end $.110$ in. to $2\frac{7}{8}$ in.
- Dimension C
Cup diameter $.119$ in. to $.625$ in.
- Dimension D
Terminal diameter $.015$ in. to $\frac{3}{16}$ in.

Special sizes can be made if desired.

Terminals may be solid or tubular, with plain ends, or with flattened and punched or hook ends, as shown in the photograph.

WRITE for catalog 453A, which gives complete data and dimensions of all standard Stupakoff Kovar Hard-Glass Hermetic Seals.

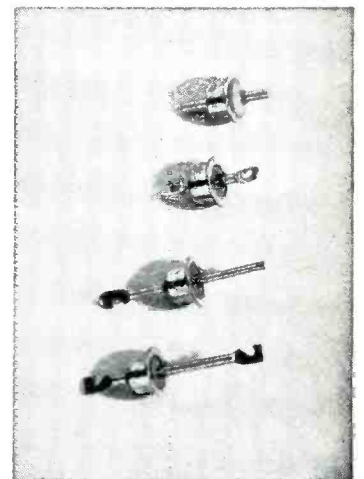
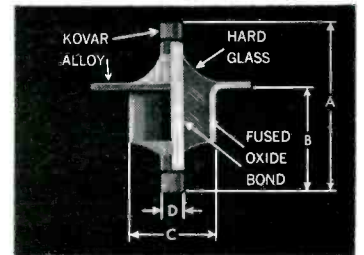

Representative terminal designs are illustrated above.

Write Dept. E
LATROBE,
PENNSYLVANIA

Stupakoff

DIVISION OF

The CARBORUNDUM Company

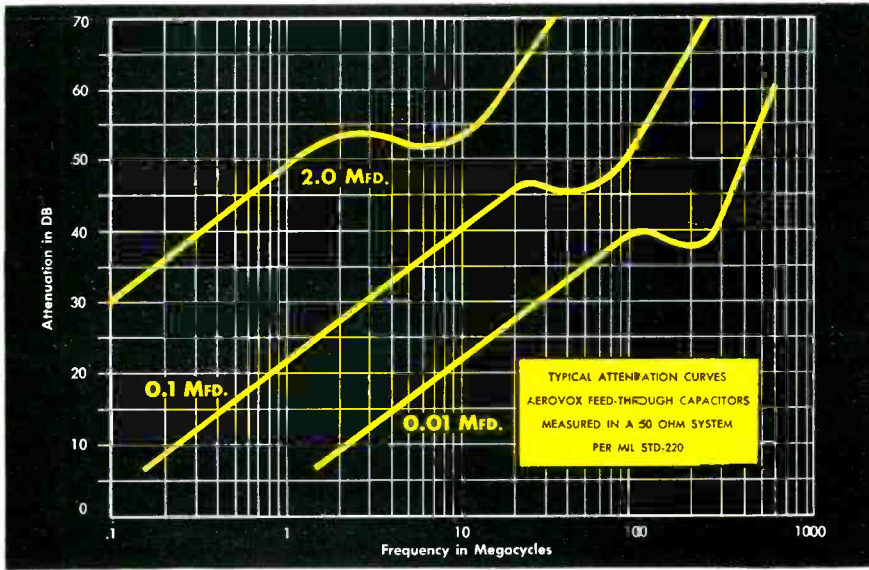

FEED-THRU INTERFERENCE SUPPRESSION

Capacitors

Designed as three-terminal feed-thru units in which the capacitor terminals, incorporated in the circuit, reduce to a minimum the inductance and resistance between capacitor element and system to be filtered.

These AeroVox Feed-Thru Interference Suppression Capacitors are especially useful as filters for power-supply and control-circuit conductors going to shielded high-frequency equipment. Maximum filtering effectiveness is achieved by minimizing mutual impedance between input interference sources and output terminal. Feed-thru units are mounted so that leads being filtered pass through shield, bulkhead or chassis, utilizing one of the several mounting styles for such purpose.

★ Capacitor elements connected directly to line, and directly to ground through metal casing.

★ Attenuation approaches theoretical ideal capacitor. (see curves above)

★ Minimum inductance of connections through use of "plates" and "flat conductors" between capacitor and terminals.

★ All types suitable for operating temperatures from -55°C. to +85°C.

★ Specially designed terminals provide for use of keyed parts for maximum torque required for heavy conductors, eliminating dependence on friction.

★ Wide selection of types and ratings.

★ Hermetically-sealed tubular metal casing. Choice of mountings and terminals.

★ Meet all requirements of Signal Corps Specifications MIL-C-11693



Write for further details. Let us collaborate and quote on these and other filtering or capacitor requirements.



AEROVOX CORPORATION

NEW BEDFORD, MASS.

In Canada: AEROVOX CANADA LTD., Hamilton, Ont.

Export: Ad. Auriema, Inc., 89 Broad St., New York, N. Y. • Cable: Auriema, N. Y.



in a 120-v, 3-phase, 3-wire circuit. Under normal conditions each lamp will glow dimly on phase voltage. If a ground occurs, the lamp connected to the grounded line will go out completely, and the other two lamps will burn brightly, thereby indicating full line-to-line voltage.

This switchboard-type ground detector matches the General Electric AB-18 style instrument case. All connections are made to four studs on the rear, and lamps are easily replaceable from the front of the panel.



INSTRUMENT SIGNAL CONVERTER
a three-channel unit

DYNALYSIS DEVELOPMENT LABORATORIES, INC., 11941 Wilshire Blvd., Los Angeles 25, Calif. Model 108 three-channel instrument signal converter is designed for the measurement of aircraft and laboratory physical parameters. The system accepts signals from 400-cps transducers and drives conventional magnetic galvanometer recording devices.

Frequency and voltage regulated

power is supplied to the transducers from unregulated power, and a large demodulated signal output with a 0.5-percent linearity is available without amplification.

GERMANIUM DIODES of the subminiature type

RADIO RECEPTOR CO., INC., Brooklyn, N. Y., has introduced a new line of subminiature germanium diodes. Hermetically sealed and cased in glass, they feature superior electrical properties. The diodes are available in most standard types, and also in a series of special high-conduction types signified by certain DR numbers. Some in the latter series can handle an operating voltage of 150, can deliver a minimum of 400 ma at +1 v, with reverse leakages as low as 20 μ a maximum at -100 v.

These high-conduction diodes are particularly useful in computers and in any other application that calls for ruggedness, long life and reliability.

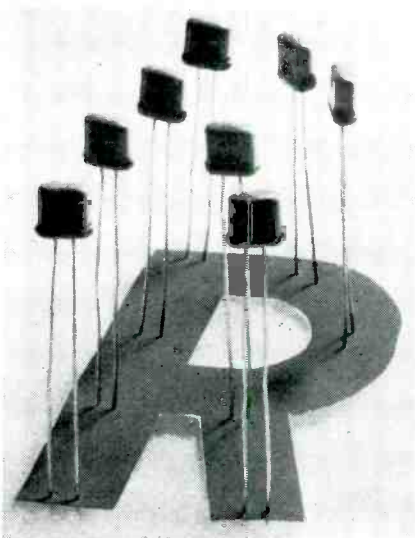

SILICON DIODES eight new bonded types

RAYTHEON MFG. Co., 55 Chapel St., Newton 58, Mass., announces eight new bonded silicon diodes with peak inverse voltage ratings from 15 v to 225 v. Types 1N300A, 1N301A, 1N302A, 1N303A, 1N432A, 1N433A, 1N434A and 1N460A are similar to units not designated "A"

Versatile

RIGHT ANGLE TUBE SOCKETS

Still greater compactness, ruggedness, reliability, from printed wiring, thanks to another Aerovox development, **Right Angle Tube Sockets**. Ideally suited for hand or mechanized insertion in printed-wiring boards. Silver-plated beryllium-copper contacts. Easy insertion and withdrawal. Molded materials satisfy military or commercial requirements. Designed to meet existing MIL specs. Available in 9-pin and 7-pin styles, in the following types:



TYPE A...

For general-purpose applications, where unusual rigidity and resistance to vibration are not important factors.

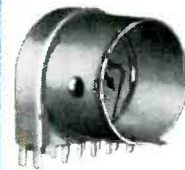

TYPE B...

Type A Socket with tube shield added. For general-purpose applications under normal service conditions.



TYPE AX...

For special applications (military or commercial) requiring extra rigidity, high strength and maximum resistance to shock and vibration.



TYPE BX...

Type AX Socket with tube shield shell added. For special applications where extra strength, rigidity and shock resistance are required.

Write for engineering bulletin, and quotations on any required quantities.



AEROVOX CORPORATION

PACIFIC COAST DIVISION

2724 South Peck Road, Monrovia, Calif.

In Canada: AEROVOX CANADA LTD., Hamilton, Ont.

Export: Ad Auriema, Inc., 89 Broad St., New York, N. Y. Cable: Auriema, N. Y.

all kinds of "specials"



are "standards"! with



MANDEX ELECTRONIC COMPONENTS



CHECK THIS LIST

- | | |
|---|---|
| <input type="checkbox"/> Anode Connectors | <input type="checkbox"/> Tube Sockets |
| <input type="checkbox"/> Test Point Receptacles | <input type="checkbox"/> Lugs . . . Brackets . . . Contacts |
| <input type="checkbox"/> Terminal Strips | <input type="checkbox"/> Printed Circuit Wiring |

. . . also Custom Moldings and Laminating . . . Stampings

The complete line of MANDEX Electronic Components is so big and broad . . . chances are you can get what you want with no delay for tool and die work. Costs to you are a lot lower this way . . . an important consideration when you're next in the market for products such as these.

Affiliate, P. R. Mallory & Co., Inc., Indianapolis

SEND TODAY for your free copy of the new 60-page MANDEX Illustrated Catalog . . . a real "gold mine" of valuable data and information!

CLIP COUPON AND MAIL!

MANDEX MANUFACTURING COMPANY, INC.
2612 West 16th Street • Chicago 8, Illinois

Gentlemen: Please send me my free copy of your new Catalog.

NAME _____
FIRM _____
ADDRESS _____
CITY _____ ZONE _____ STATE _____

but have higher forward current ratings with no increase in reverse current. All types operate at ambient temperatures from -55 C to +150 C with excellent stability and low reverse current. Volume is about 0.009 cu in.

Every diode receives four temperature cycles of one hour at -55 C and one hour at +150 C, followed by 36 hours at 95-percent relative humidity and 70 C. Exact characteristics are maintained.



P-M ALTERNATOR features high output

JOHN OSTER MFG. Co., Avionic Division, Racine, Wis. Type PG-3323 p-m alternator measures 1.6 in. diameter, 1.8 in. long and weighs 8.5 oz., yet has an output of 24 v-a per phase, 0.33 lagging power factor at 400 cycles when driven at 12,000 rpm. Other voltages and current are also available and can be supplied in single, 2 or 3 phases.

► **Other Features**—The device will operate continuously for 1,000 hours without maintenance and will meet applicable portions of MIL-E-5272A. Harmonic distortion is less than 5 percent.

Applications include use as a tachometer generator and as a source of power for driving servos and gyros.

H-V TRANSFORMERS for dielectric strength testing

DEL ELECTRONICS CORP., 39-41 N. MacQuesten Parkway, Mt. Vernon, N. Y., announces a high-voltage transformer for use in dielectric strength testing apparatus as specified in D149-44ASTM test. Primary

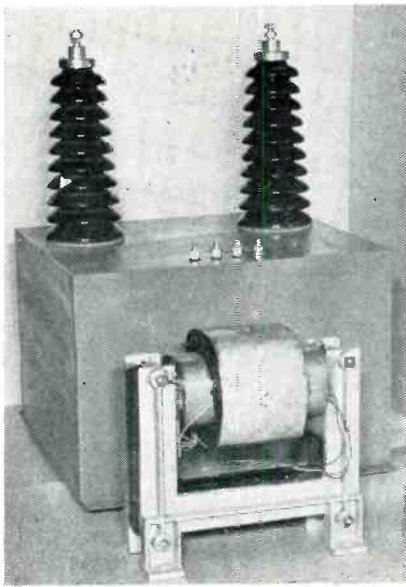

voltage is 115 v, 60 cycles. Output is 100,000 v peak at 500 va.

This unit is a conservatively designed oil-immersed transformer in a sealed container with porcelain insulators. The photograph shows the complete assembly together with the uncased transformer.



TOGGLE SWITCH
weighs only about 3.6 oz

BENDIX AVIATION CORP., Eclipse-Pioneer Div., Teterboro, N. J., has added to its line a miniature solenoid toggle switch designed for long life and satisfactory operation under severe environmental conditions.

Type CQ-31 switch has been designed for use in systems which require a visual on-off indication. It consists essentially of a miniature microswitch which is actuated by a toggle that is held in position by means of a solenoid-operated detent.

The switch is manually operated by flipping the toggle to ON position. This energizes the solenoid to hold the toggle in position. The toggle can be returned to its normal or OFF position manually, or in the

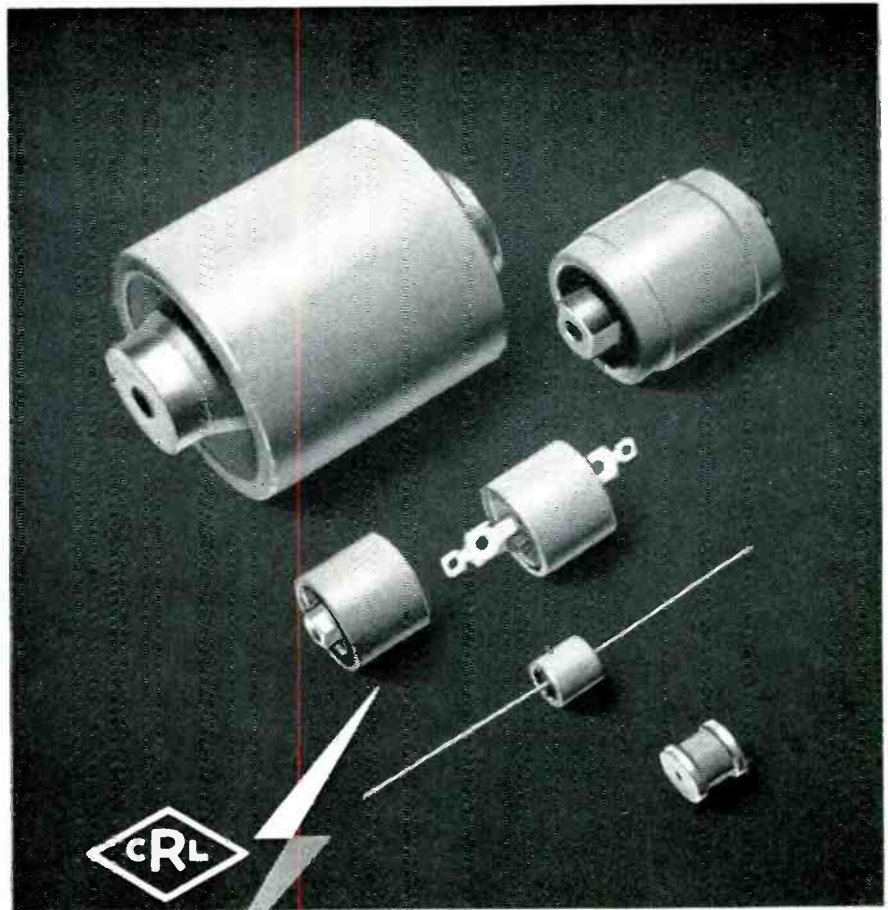

the ONLY COMPLETE LINE of
Ceramic Transmitting Capacitors

Smaller and more economical than mica, vacuum, or oil-filled paper types for the same applications

Increasingly used in equipment like this:

- Transmitters*
- Induction heaters*
- Diathermy equipment*
- Mobile transmitters*
- Tuned tank circuits*
- Antenna circuits*
- X-ray equipment*
- Electronic welding equipment*
- Cyclotrons*
- Other applications*

- ◊ Eleven terminal styles. Capacitance, 3 to 1,000 mmf., 5 KV to 20 KV d. c. Special sizes, shapes fabricated to specifications.
- ◊ Extremely low power factor — down to .1%.
- ◊ Temperature coefficients controlled to your specifications.
- ◊ Low moisture absorption. Meets applicable MIL specifications.
- ◊ Double-cup design affords long leakage paths — provides large area to dissipate heat.

Centralab

D-956

Write for Technical Bulletin 42-102R.
*Trademark

A DIVISION OF GLOBE-UNION INC.

914E East Keefe Avenue • Milwaukee 1, Wisconsin
In Canada: 804 Mt. Pleasant Road, Toronto, Ontario



VARIABLE RESISTORS

ENGINEERED CERAMICS

SWITCHES

PACKAGED ELECTRONIC CIRCUITS

CERAMIC CAPACITORS



TESTING EQUIPMENT STANDARD AND CUSTOM MICROWAVE COMPONENTS



UNIVERSAL TEST SETS FOR X, K_u, and C BANDS

Combined in one unit are means to measure power—a spectrum analyzer—a unit to measure frequency, and a signal generator.

Each test section is modular in construction, with separate plug-in chassis. Available for X, K_u, and C Bands.



STANDARD microwave equipment for laboratory or production includes attenuators, directional couplers, crystal mixers, wavemeters and other components. Units are available for S, C, X_u, X and K_u Microwave Bands in aluminum or brass.

CUSTOM-DESIGNED Microwave equipment is a Kearfott specialty. Skillful engineering, wide experience, with complete laboratory testing facilities can be brought to bear on your problem. Kearfott can supply special components such as rotary joints, R.F. sources and matched assemblies.

NEW FERRITE ISOLATOR... a useful device with many applications, such as oscillator isolation. This light-weight unit (less than 2 lbs.) improves system performance by reducing long-line loading. It also prevents undesired frequency shift, insures uniform power output with improved transmitted pulse spectrum.

FERRITE Resonance Absorption Transverse Field Isolator for use where high power handling capacity is required. Over a 10% band width this unit has...greater than 9 db isolation, less than 0.4 db insertion loss and VSWR less than 1.03.

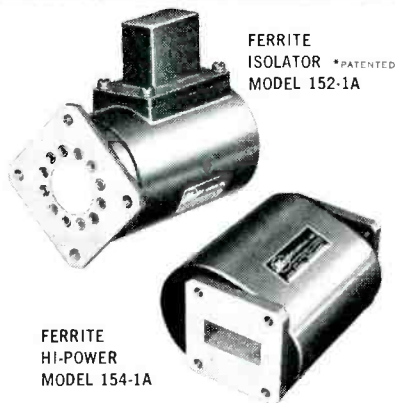

Write today for complete technical bulletins.



COMPANY, INC.

LITTLE FALLS, NEW JERSEY

WESTERN DIVISION

253 Vinedo Avenue, Pasadena, Calif.

SALES OFFICES

Eastern Office:
1378 Main Ave.
Clifton, N.J.

Midwest Office:
188 W. Randolph St.
Chicago, Ill.

South Central
Office:
6115 Denton Drive
Dallas, Texas

Western Area
Office:
253 Vinedo Ave.
Pasadena, Calif.

event of any failure of the system's circuitry, the solenoid is immediately deenergized and the toggle returned to its OFF position automatically.

The unit is environmentally sealed and is designed for easy installation.

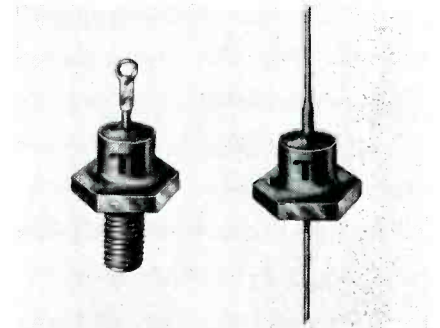

SILICON RECTIFIERS three new JAN types

TRANSITRON ELECTRONIC CORP., Melrose 76, Mass. Types 1N254, 1N255 and 1N256 silicon power rectifiers, recently incorporated into MIL-E-1B, are now available. The miniature units have peak inverse voltage ratings up to 600 v, and will handle up to 400 ma at 135 C. No voltage or current derating is necessary throughout their operating temperature range of -55 C to -135 C.

Stringent environmental specifications, including 500 g shock test and 5,000 g centrifuge test, are included to insure reliability under the most severe operating conditions.

► **Applications**—They are intended for power supply, magnetic amplifier and other rectifier applications where minimum size and weight are important. Complete details are included in bulletin TE-1336.

F-M GENERATOR with carrier shift control

MARCONI INSTRUMENTS, 44 New St., New York 4, N. Y. Designed to cover all mobile communications frequencies, type 1066 f-m/a-m signal generator takes the place of two or more instruments previously required. Frequency stability of better than 0.005 percent per 10

A SUBSIDIARY OF
GENERAL PRECISION
EQUIPMENT
CORPORATION



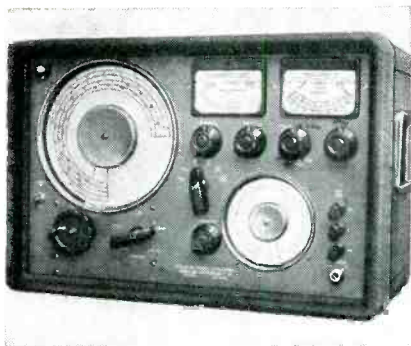

minutes is achieved by use of a magnetically biased ferrite reactor as the frequency modulator.

► **Carrier Shift**—A valuable feature is the calibrated carrier shift control which enables the frequency modulated carrier to be shifted by any amount from 1 to 200 kc without readjustment of the main frequency dial. Accurate bandwidth measurements can thus be rapidly made.

The piston attenuator is calibrated in db and volts in the range 0.2 μ v to 200 mv, 52 ohm output. Deviation ranges are 0 to 20 kc and 0 to 100 kc—wider deviations to special order.

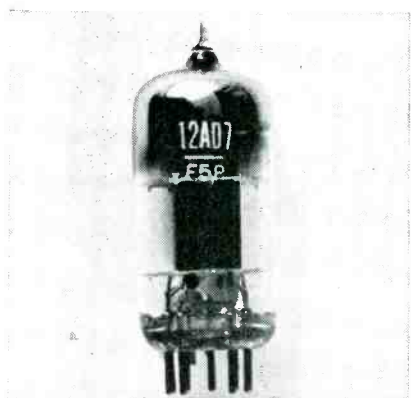

DOUBLE-TRIODE TUBE for low-hum audio use

SYLVANIA ELECTRIC PRODUCTS INC., 1740 Broadway, New York 19, N. Y., has developed the 12AD7 double triode, a 9-pin miniature tube that fills the need for a low-hum pre-amplifier in audio applications.

Established tube ratings of the 12AD7 assure an extremely low hum level—less than 3.0 mv rms on the plate of each triode when the tube is operated in a typical resistance coupled amplifier circuit. This has been achieved by design fea-

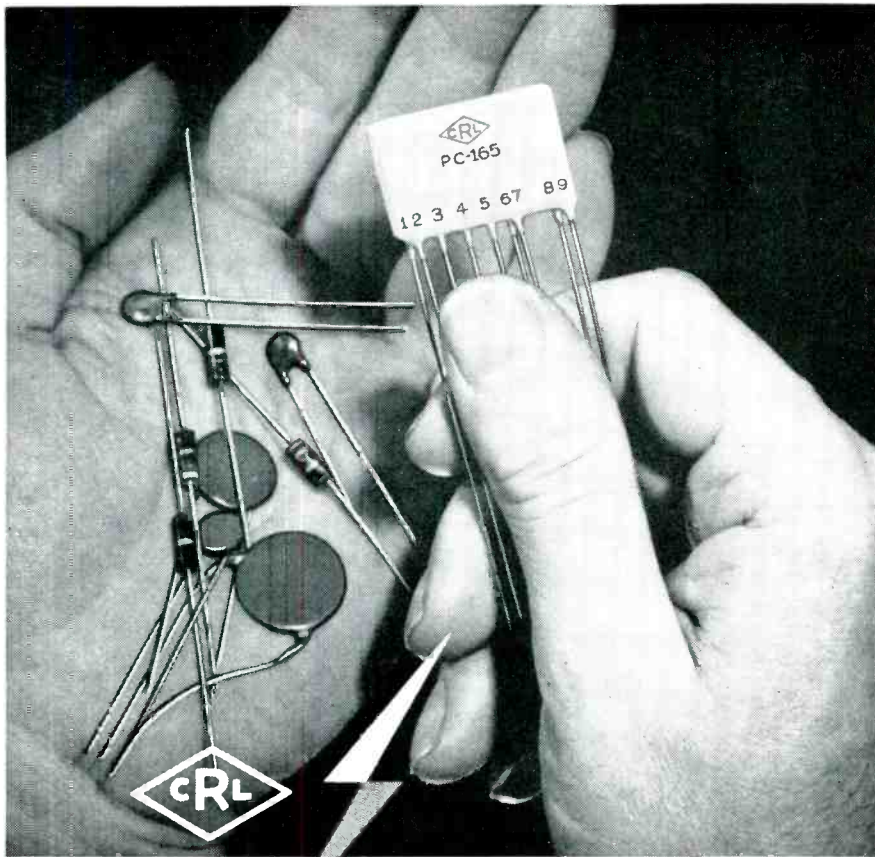

1 packaged electronic circuit replaces 9 separate components!

60,000,000 Centralab P.E.C.'s like this — in various component values — are being used by leading manufacturers

- ◊ A Centralab Packaged Electronic Circuit is a *complete circuit* which includes capacitance, resistance, and often inductance — in addition to wiring.
- ◊ Design one compact package into your equipment, instead of several individual parts, to . . .
 - . . . reduce inventory
 - . . . reduce size
 - . . . reduce weight
 - . . . eliminate wiring errors
 - . . . reduce assembly cost
 - . . . improve circuit stability
- ◊ Centralab P.E.C.'s pass all Mil-R-11A and Mil-C-11015A requirements within their range.
- ◊ Over 160 standard P.E.C. designs are available for your immediate use. For special requirements, call on Centralab engineers — but *early* in the planning stage, *before* you've "frozen" your design.

Write for Centralab Printed Electronic Circuit Guide No. 3 — and Technical Bulletin 42-227.

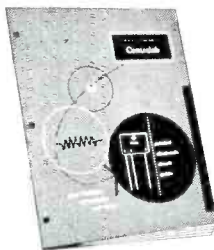

*Trademark

Centralab

A DIVISION OF GLOBE-UNION INC.

914E East Keefe Avenue • Milwaukee 1, Wisconsin
In Canada: 804 Mt. Pleasant Road, Toronto, Ontario

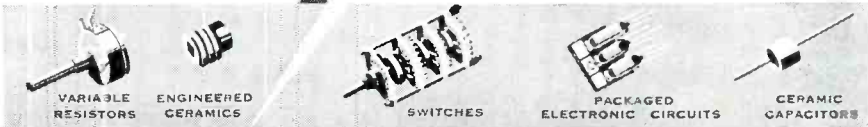

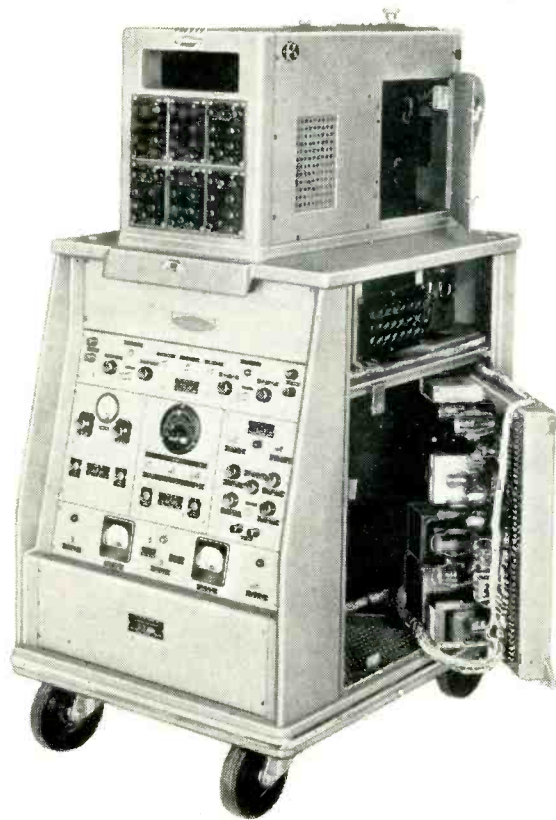

Multi-channel Recording D-C to 200 kc

Hathaway New SC-16B

The SC-16B is a complete oscillograph which records up to 12 signals on a single chart. It produces sharp, well defined records even at the highest frequencies. The SC-16B is useful in research programs requiring multi-channel, high frequency recording of pressure, strain, vibration, and acceleration.

SPECIFICATIONS

Number of Channels: Up to 12 Chart Speed: 1.6 to 6000 inches per second Chart Size: 6 inches x 100 or 200 feet; 6 inches x 15 inches; 6 inches x 10 feet; 35 mm x 400 or 1000 feet
Frequency Response: D-C to 200 kilocycles Writing Rate: 5,000,000 inches per second Chart Speed Change: 16 speed quick-change transmission Voltage Input Level: 1.5 volts r.m.s. per inch on tube screen; 1.5 millivolts r.m.s. per inch on tube screen with type ASC-10 D-C Amplifier Timing Lines: Precision tuning fork controlled at 1/100 or 1/1000 second intervals Synchronization: Transient can be initiated from oscillograph, or transient can initiate oscillograph Record Length Control: For continuously-moving-chart recording, 0.75 to 15 seconds; for drum-type-chart recording, 5 milliseconds to 1 second.

Write for bulletin 2-G1-A

Hathaway

INSTRUMENT COMPANY

DIVISION OF

HAMILTON

WATCH COMPANY

1315 SOUTH CLARKSON • DENVER, COLORADO

tures that include a reverse coil heater which helps cancel magnetic coupling.



PULSE STANDARDIZER with 1/2 sine-wave output

BURROUGHS CORP., 1209 Vine St., Philadelphia 7, Pa. Applicability of the company's standard pulse control equipment (utilizing 0.10 μ sec pulses) can now be extended through use of the No. 1020 pulse standardizer.

Input can consist of any waveform that has a change of level. The unit will trigger on either polarity, and will accept signals up to 1 mc. Output is 1/2 sine wave, 0.10 μ sec pulse with adjustable amplitude and polarity control.

The unit, designed for rack mounting, measures 19 by 3 1/2 by 10 in., with amateur notches.

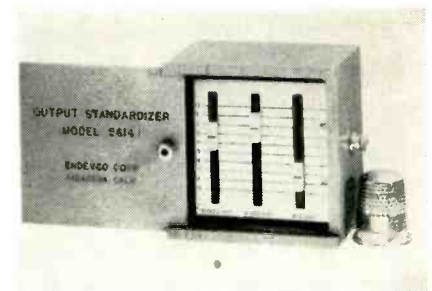

OUTPUT STANDARDIZER simplifies data reduction

ENDEVCO CORP., 161 E. California St., Pasadena, Calif., announces a subminiature decade switch capacitor for use as a precision trimmer capacitor for telemetering equipment, oscillators, capacitance fuel gages and networks, and for reduction of piezoelectric pickup outputs to a standard value with the improvement of the l-f response.

► **Technical Data**—The precision decade capacitor (silver mica) switch provides capacitance values from 10 μ mf to 9,990 μ mf (+1 percent) that is variable in discrete

switch steps of 10 $\mu\mu\text{f}$. The primary design use is for standardizing the voltage output from self-generating pressure, force and acceleration pickups to one value of output voltage.

This unit used as a pickup standardizer establishes a preselected data scale factor. Groups of pickups may be standardized within a similarity of 1 percent. This pickup output adjustment aids in simplifying direct data reduction and interpretation of all tests.

The switch design of small size and ruggedized construction is ideal for airborne applications.

PORTABLE POT features digital dial

ALLEGANY INSTRUMENT CO., INC., 1091 Wills Mountain, Cumberland, Md., has gone into production on a new line of portable potentiometers with a 4-place digital readout. The P-55A in a mahogany case, and the P-55MA in an aluminum case measure just 4 1/4 in. by 4 1/2 in. by 7 1/2 in. and weigh only 3 1/2 lb, yet are accurate to 0.1 percent of range.

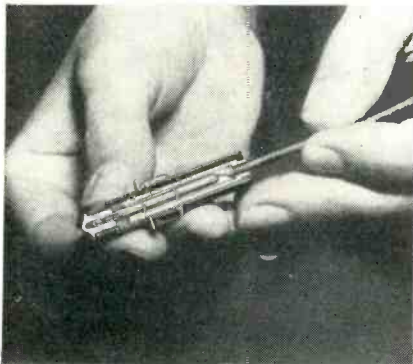

THERMAL SWITCH weighs only one ounce

VAPOR HEATING CORP., 6420 W. Howard St., Chicago 31, Ill., has developed a new bearing overheat detector thermostat for airplanes, industrial bearings and other equipment where an accurate overheat warning signal is needed. Thermal switch 3162 is a miniature control that weighs only 1 oz.; made and tested in accordance with Air Force Military Specifications MIL-S-25345 and MIL-E-5272A.

Inside the metal housing of this

newest
what's ~~new~~ in electronics?

You'll find it in this

Free Book

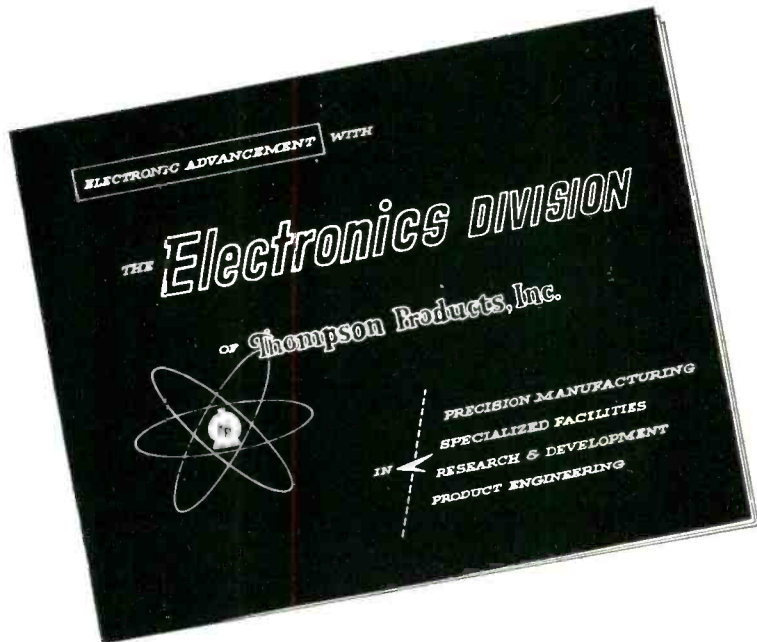

This brand-new book is your 1956 guide to the latest advancements to come from the expert electronic engineering and production staffs of Thompson, offering you the most modern facilities to help solve your every electronic problem.

Electronics Division
Thompson Products

2196 CLARKWOOD ROAD
CLEVELAND 3, OHIO



ELECTRONICS DIVISION, DEPT. E-5

THOMPSON PRODUCTS
2196 Clarkwood Road
Cleveland 3, Ohio

Please send me a FREE copy of "Electronic Advancement".

Name _____ Title _____

Company _____

Address _____

City _____ Zone _____ State _____

HERE'S THE POT THAT COULDN'T BE BUILT

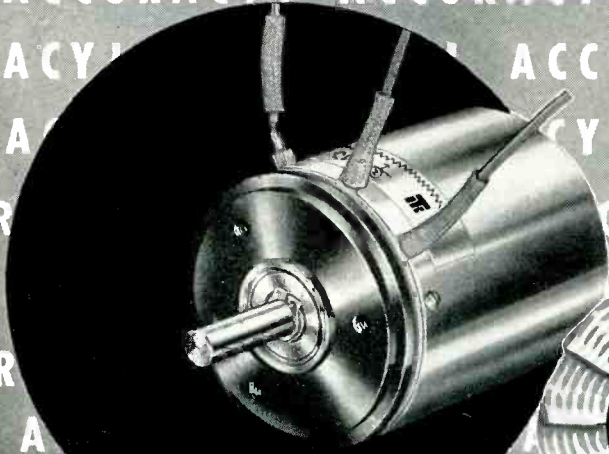

NEW M10T

Over two years ago TIC's design engineers undertook a supposedly impossible project — design of an ultra-precision potentiometer adaptable to mass production. Old techniques and designs were discarded . . . new methods and concepts were pioneered . . . advanced production methods were developed. And the result, the all-new 10-turn M10T with unmatched electrical accuracy and mechanical precision.

Custom design for precision computer, servomechanisms and electro-mechanical instrumentation service, the wound coil, multiturn M10T provides the extreme electrical accuracy and stability required by these systems. Winding techniques, specially developed for the M10T, make possible linearities of 0.025% and lower. Special resistance wire permits a $\pm 1\%$ accuracy of total resistance . . . high temperature stability with a 0.002% per degree C temperature coefficient of resistance. Wide temperature range (-55°C to $+85^{\circ}\text{C}$) . . . high dielectric strength . . . low equivalent noise resistance . . . and high leakage resistance are other M10T features in-built for maximum electrical performance.

Extremely precise mechanical tolerances — shaft diameter, concentricity, and perpendicularity — assure complete transfer of M10T accuracy to external systems. Universal mounting surface offers choice of servo or precision-pilot and tapped-hole mounting. Spring loaded, stainless steel ball bearings eliminate radial and end play of the shaft . . . reduce running torque to 1.0 oz.-in.

New design concept places all functional parts of M10T in a one-piece unit. Stainless steel cover bonded to the one-piece base provides complete environmental protection. External surfaces are all corrosion-resistant stainless steel or anodized aluminum. The M10T has been thoroughly tested to pertinent military specifications.

Complete specifications on the new TIC Type M10T are available upon request.



new control is a sensitive and accurate mercury contact thermostat which will detect a bearing overheat temperature of 275 F and light a warning signal in the cockpit in less than 4 sec from the time the overheat condition takes place.

The switch has passed military specification tests pertaining to temperature contact accuracy, insulation leakage, voltage variation, vibration, high/low humidity, altitude, salt spray, immersion and time response, plus other tests.

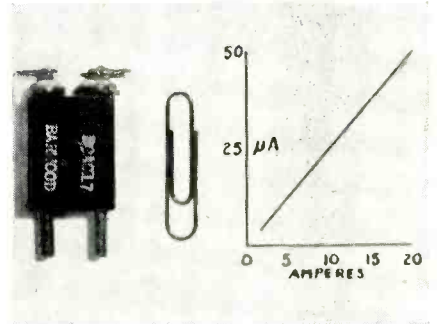

CURRENT TRANSFORMER weighs only 0.9 oz

BARWOOD ELECTRONICS INC., 546 W. Garfield Ave., Glendale 4, Calif., has introduced an instrument current transformer weighing only 0.9 oz and occupying only 0.43 cu in.

The volume conscious designer of airborne equipment will find many uses in metering circuits for this new miniature component for measuring a-c using a standard d-c 50- μa movement.

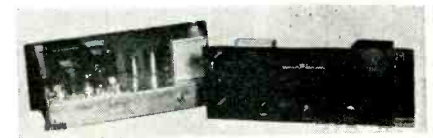

MULTICOUPLER broad band type

APPLIED SCIENCE CORP. OF PRINCETON, P.O. Box 44, Princeton, N. J. A new multicoupler feeds up to 4 radio receivers in the 215 to 235-mc frequency band from a single antenna. A high degree of isolation between the 4 outputs is obtained and the individual receivers may be tuned to different frequencies in the band. Model AMC-2 multi-

TECHNOLOGY INSTRUMENT CORP.

533 Main Street, Acton, Mass. COLonial 3-7711
West Coast Mail Address Box 3941, No. Hollywood, Calif. POplar 5-8620

coupler is a self-contained, self-powered unit which is designed for mounting in a standard 19-in. relay rack. The r-f circuitry is mounted on a separate subchassis for ease of maintenance.

When used in conjunction with the model APA-2 preamplifier it not only allows simultaneous operation of up to 4 radio receivers from the same antenna with improved sensitivity, but also results in an improvement in signal-to-noise ratio of a typical receiving installation by approximately 5 db. This unit, weighing 20 lb, operates from a 115-v 60-cps power source.

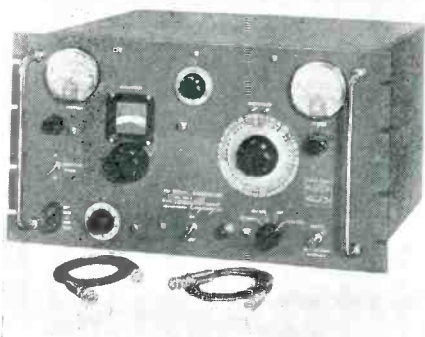

SIGNAL GENERATOR
for precision testing

NEW LONDON INSTRUMENT CO., INC., 14 Union St., New London, Conn., has announced the model 100D f-m signal generator for precision testing of the alignment, bandwidth and sensitivity of f-m receivers. Frequency deviation accuracy of the new f-m signal generators is better than 5 percent of full scale at 1,000 cps over two ranges of 0 to 30 kc and 0 to 250 kc.

Model 100D features low drift made possible through the use of a novel circuit utilizing a simple, fundamental frequency system requiring only a single stage.

No reactance tube is used, eliminating drift problems resulting from variations in the transconductance of such a tube. The absence of multiple tubes also eliminates drift caused by excess heat in the r-f compartments.

► **Other Features**—The simplified circuit employed results in low modulation distortion, low a-m and

From **DIALCO**—New, Compact

OIL TIGHT

INDICATOR LIGHTS

for heavy duty industrial applications

**OIL TIGHT
DUST TIGHT
OMNIDIRECTIONAL**

Exceptionally Rugged!

Perfect oil-tightness is effected by retained oil-proof gaskets and the gasketed glass lens assembly.

These units have many heavy-duty features: *One-piece solid brass bushing, solid brass lens holder, high impact phenolic insulation, rugged binding screw terminals.*

They install easily in a single 1" or 1 3/16" panel mounting hole. Other units available for 1 1/16" mounting hole. A choice of 3 lens styles, 7 lens colors, and other optical features provide adaptability. If you have an unusual problem, consult our engineering department.

DISCS with legends, behind flat lenses, deliver specific messages.



OIL TIGHT INDICATOR LIGHTS

accommodate a wide range of Incandescent and Neon Glow Lamps. For neon, DIALCO offers an exclusive feature — **BUILT-IN RESISTORS** (U. S. Patent No. 2,421,321) for operation on 105-125 V, or 210-250 V. Simple external resistors are provided for all higher voltages. **EVERY ASSEMBLY IS AVAILABLE COMPLETE WITH LAMP.** For design purposes we will send :

SAMPLES ON REQUEST—AT ONCE—NO CHARGE

CATALOG "L-200" gives you complete specs on DIALCO'S Oil-Tight Indicator Lights. Also available—a file of Special Catalogs on DIALCO Pilot Lights covering every indication requirement.

FREE — Brochure on "Selection and Application of Pilot Lights".

Foremost
Manufacturer
of Pilot Lights



DIALIGHT
CORPORATION

58 STEWART AVENUE
BROOKLYN 37, N. Y.
HYACINTH 7-7600

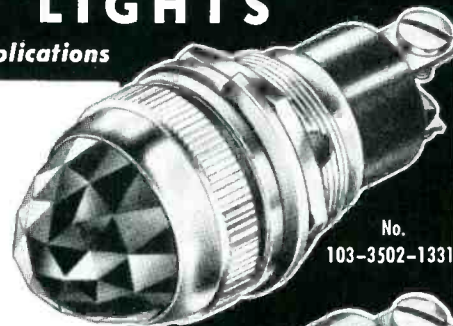

No. 103-3502-1331



No. 103-3502-1211



No. 104-3502-XP10-231

Illustrations are approx. actual size



DIALIGHT CORP., 58 Stewart Ave., Brooklyn 37, N. Y.

Please send Cat. "L-200" on Oil-Tight Lights
 "Selection" Brochure. Pilot Light Catalogs.

Name _____

Company _____

Address _____

City _____ State _____

GYROS

designed beyond requirements

To give the vital few minutes of service required by a missile, gyros must possess ruggedness and dependability that will give them life of a thousand hours or more. Kearfott Gyros possess this ruggedness and dependability. That is why they are so widely used in other forms of aviation as well as in missiles. Kearfott Vertical Gyros conform to MIL-E-5272 A Procedure 11, parts 1 and 2. Kearfott Free Gyros withstand vibration of 5-500 cps at 5 G's, 5 to 2000 cps at 3 G's and 6 G shock of .015 sec duration. Kearfott has Gyros for every application. Write for technical data.



KEARFOTT COMPANY, INC. LITTLE FALLS, N. J.

Sales and Engineering Offices:
1378 Main Avenue, Clifton, N. J.
Midwest Office:
188 W. Randolph Street, Chicago, Ill.
South Central Office:
6115 Denton Drive, Dallas, Texas.
West Coast Office:
253 N. Vinado Avenue, Pasadena, Calif.

KEARFOTT COMPONENTS INCLUDE:

GYROS, SERVO MOTORS, SYNCHROS, SERVO AND MAGNETIC AMPLIFIERS, TACHOMETER GENERATORS, HERMETIC ROTARY SEALS, AIRCRAFT NAVIGATIONAL SYSTEMS AND OTHER HIGH ACCURACY MECHANICAL, ELECTRICAL AND ELECTRONIC COMPONENTS.

SEND FOR BULLETIN GIVING DATA OF COMPONENTS OF INTEREST TO YOU



low hum. Leakage is so low it cannot be measured with a $0.1\text{-}\mu\text{V}$ detector.

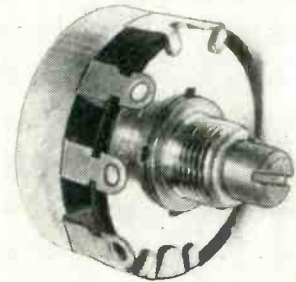

WIRE-WOUND CONTROLS for printed-circuit uses

CLAROSTAT MFG. CO., INC., Dover, N. H., has announced a 2-w wire-wound control with terminals that facilitate mounting and connections, for use in printed-wiring assemblies. A variation of the company's series 43, the printed-circuit control measures $1\frac{1}{2}$ in. in diameter by $\frac{1}{8}$ in. deep. It is available with or without tap. The tap is mechanically positioned 180 deg from center terminal, but can be electrically positioned to any percentage of resistance desired. Resistance values are from 1 ohm to 50,000.

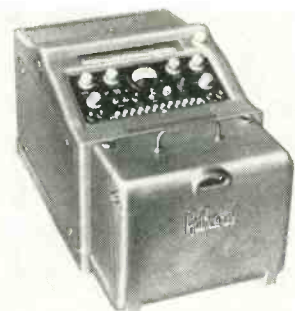

LAB OSCILLOGRAPH with operating convenience

HATHAWAY INSTRUMENT Co., 1315 South Clarkson St., Denver 10, Colorado. The S25 laboratory oscilloscope features: 12 chart speeds from $\frac{1}{8}$ to 160 ips; speed changes possible during operation; timing line intervals from one to 1/1,000 sec are automatically controlled by chart speed or selected manually; and the galvanometer trace zero adjustment is featured on an easy-

to-use sloping top panel.

Remote control operation is possible from distances up to 100 ft by means of the removable control panel. The S25 is available with up to 14 bifilar galvanometers or 36 pencil-type coil galvanometers of new design.

INDIUM AND ALLOYS for transistor sealing

ALPHA METALS, INC., 56 Water St., Jersey City, N. J., can now supply indium 99.99+ pure; also special alloys of indium/gallium, indium/aluminum, etc. in the following forms: cubes, spheres, disks, pellets, wire and cylinders to precision specification and close tolerances. Also available are special low melting alloys, one at 294 F for low temperature sealing of transistor and other semiconductor units. These materials may be supplied in washers, disks and special preform shapes to suit particular requirements.

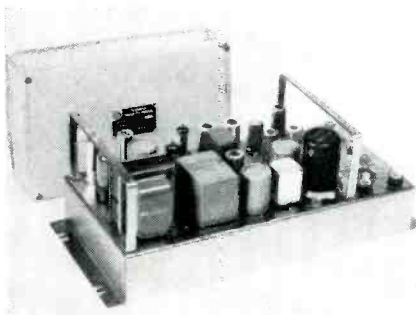

TELEMETER TERMINALS are frequency-type units

RADIO FREQUENCY LABORATORIES, INC., Powerville Road, Boonton, N. J. Model 1025 telemeter transmitter and model 1090 telemeter receiver will accurately and instantly telemeter quantities which can be converted into d-c millivolts through use of a transducer or primary detector. The transmitter converts the d-c millivolts to an a-c signal which in turn frequency modulates an included audio tone channel.

The receiver converts the audio tones to d-c millivolts which may then be used to operate a recorder or indicating instrument. At least 45 individual channels are available

now... a
THIRD DIMENSION
in panoramic
analysis...

NEW PANORAMIC

TIME-FREQUENCY analyzer

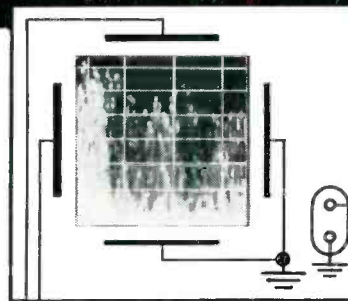

▲ Panoramic Spectrum Analyzer

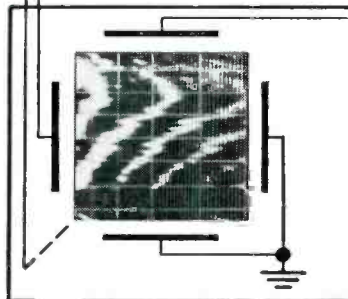

▲ Panoramic Time-Frequency Analyzer, Model TFA-1

TFA-1

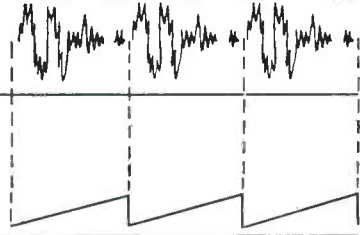

◀ Y-axis scan, synchronized to loop recording represents playback interval.
X-axis represents frequency distribution.
Intensity indicates component level.

FLEXIBLE because • TFA-1 analyzes loop recordings having a playback time of a fraction of a second to 60 sec. • TFA-1 permits rapid re-examination of existing recordings.

VERSATILE because • Two types of presentation are available simultaneously. Frequency vs. amplitude with the Panoramic Spectrum Analyzer; and frequency vs. time vs. amplitude (intensity) with the TFA-1. • Wide ranges of sweepwidth, frequency resolution and center frequency are same as those in companion Panoramic Spectrum Analyzers.

ECONOMICAL because • TFA is operable with Panoramic Subsonic Analyzers LF-1, LF-2, Panoramic Sonic Analyzer LP-1, Panoramic Ultrasonic Analyzer SB-7a, Panoramic Telemetering Indicator TMI-1 and others. • TFA-1 analyzes records on any magnetic tape recorder which may be on hand.

NEW Panoramic Subsonic Analyzer Models LF-2 and LF-1

For waveform analysis from 0.5 to 2250 cps, featuring resolution from one tenth to 20 cps

Model LF-1 Panoramic Subsonic Analyzer is an adjunct to Model LP-1 Panoramic Sonic Analyzer. Model LF-2 is a complete instrument in itself. Both provide permanent ink on paper recordings of waveform components.

NEW Frequency Meter Model F-4

Rapid measurement of frequencies up to 2 megacycles

Model F-4 measures the frequency of ac voltages from 10 cps to 2 mc. The overall frequency range is covered in 10 ranges with full scale meter readings of 60, 200 and 600 cps; 2, 6, 20, 60, 200 and 600 kc and 2 mc.

Made by the makers of Panadaptor, Panalyzer, Panoramic Sonic Analyzer and Panoramic Ultrasonic Analyzer



10 S. Second Ave., Mount Vernon, N. Y.
Mount Vernon 4-3970
Cables: Panoramic, Mount Vernon, N. Y. State

DO YOUR PRECIOUS METAL PARTS

MEET SPECIFICATIONS?

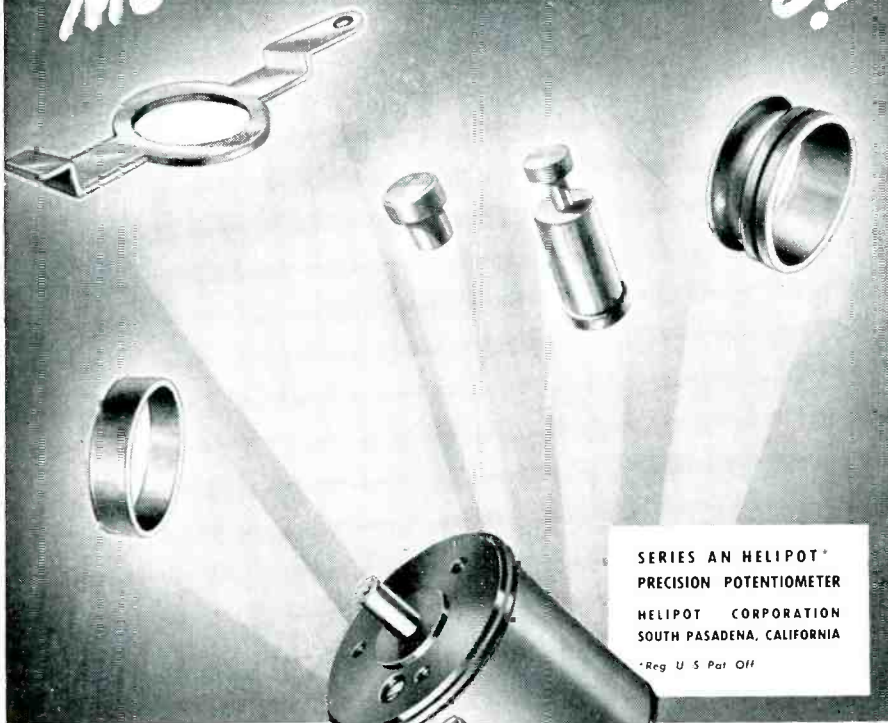

SERIES AN HELIPOT[®]
PRECISION POTENTIOMETER
HELIPOT CORPORATION
SOUTH PASADENA, CALIFORNIA
*Reg. U. S. Pat. Off.



EMPLOYS OUR EXPERIENCE TO
PRODUCE PRECISION POTENTIOMETERS

Precious metal parts made to exacting specifications are regularly used by the Helipot Corporation. These and other precious metal fabrications including contact arms, contact rivets, slip rings (flat and cylindrical) and contact brushes are produced for many of the leading manufacturers of the electronic industry. Fifty years experience in fabricating precious metals enables us to answer your problems of dimensional tol-

erance, finish or alloy composition and properties. Maintaining high quality, making prompt deliveries at competitive prices for our many customers (like Helipot, leaders in electronics) is proof of our ability to serve you.

For recommendations and quotations contact our engineering department. We BUILD OUR BUSINESS ON PROMPT DELIVERIES AT COMPETITIVE PRICES.

Mill forms of precious metals are available from our affiliate,
LEACH & GARNER CO., Attleboro, Mass.

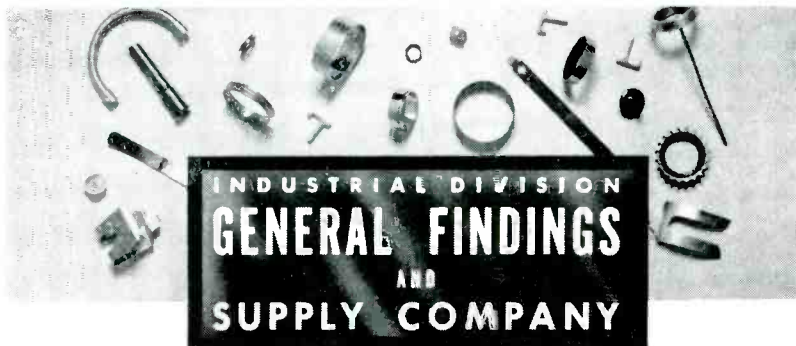

INDUSTRIAL DIVISION
GENERAL FINDINGS
AND
SUPPLY COMPANY

GENERAL FINDINGS & SUPPLY COMPANY, INDUSTRIAL DIVISION, ATTLEBORO, MASS.

SALES OFFICES: NEW YORK — CHICAGO — LOS ANGELES

Visit Us at Booth 117—Design Engineering Show

NEW PRODUCTS

(continued)

in the frequency range of 765 cps to 20 kc.

► **Protective Circuits** — Included are special protective circuits which will prevent reverse current in the output circuit in the event of signal failure and erroneous readings when operating with below minimum input levels. Printed circuits, ruggedized tubes and the best commercial grade components are used to provide for interchangeability and trouble-free operation. Overall dimensions are 8½ by 7 by 19 in.

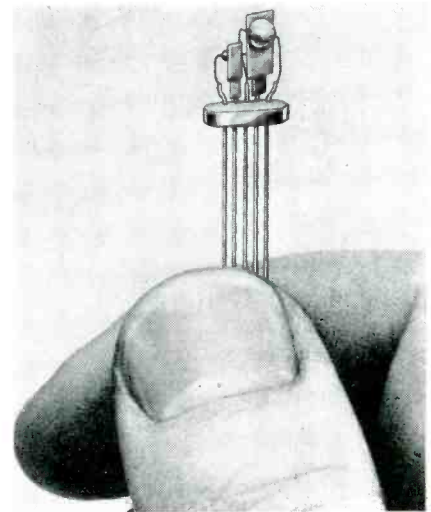

TANDEM TRANSISTOR
has high input resistance

MARVELCO ELECTRONIC DIV. OF THE NATIONAL AIRCRAFT CORP., Burbank, Calif. Housed in a single case, the MT-1 tandem transistor is not a mere twin or dual transistor with two independent semiconductor elements, but a d-c coupled, two-stage cascade. It will have useful applications as a high-gain amplifier, oscillator, multivibrator, flip-flop and switching device.

► **Features**—In the tandem transistor, a common-collector transistor stage is the input device of a second transistor to serve as a useful type of d-c transformer. The current gain reaches values as high as 75 db. The high input resistance and the low output resistance permit tandem transistors to be driven by high-impedance sources and to be cascaded by R-C coupling without the necessity of matching transformers. No extra power is re-

quired since the input transistor forms the base leak for its successor.

DEVIATION METER
suited for telemetering

MARCONI INSTRUMENTS, 44 New St., New York 4, N. Y. The TF928 wide range deviation meter, especially suitable in telemetering, measures deviations to ± 400 kc at modulation frequencies of 50 cps to 120 kc in the r-f band of 20 to 500 mc. The unit employs a stable counter-type measuring circuit with built-in crystal standardization. This arrangement gives an accuracy of ± 3 percent. Housed in a waterproof case it is ruggedized and tropicalized throughout.

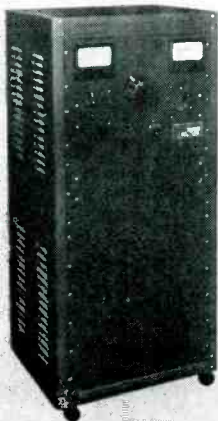

POWER SUPPLY
magnetic amplifier type

ENGINEERED MAGNETICS, a division of Gulton Mfg. Corp., Metuchen, N. J., has developed the model EM-117 continuously variable magnetic amplifier power supply which includes no moving parts, no filaments and no maintenance. Critical-tolerance engineering provides high overload capacity, eliminates warmup time and insures long life.

► **Technical Data**—It utilizes an input voltage of 105-125 v a-c, 55-65 cps, single phase; and produces a continuously variable output of 2-300 v d-c, 0-5 amperes with a regulation of 1 percent or better. Ripple is 0.2 percent rms with recovery time of 0.2 sec.

Now being produced in the stand-

**For
Miniature
Helical
Potentiometers**

Call...
CIRCUIT
INSTRUMENTS INC.

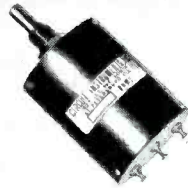

TYPES H-150 and H-155

Miniature 1½" diameter size. Turret type terminals. Rotation: Type H-150 3600, $-0 +4^\circ$; Type H-155 1800, $-0 +4^\circ$. Power rating 6 watts and 5 watts respectively. Patented stop mechanism completely separate from element and brush.

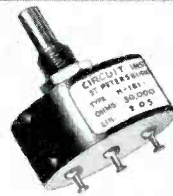

TYPE H-151

Only 1½" diameter x ¾", exclusive of shaft and turret terminals. Continuous rotation; stops available on special order. Standard linearity $\pm 0.5\%$. Power rating 3 watts. Standard resistance values from 50 to 15,000 ohms. Weight 2 ounces.



TYPES H-100 and H-105

Slim 1" diameter. 5 and 10 turn types. Rotation: Type H-100 3600, $-0 +4^\circ$; Type H-105 1800, $-0 +4^\circ$. Power rating 4 watts and 3 watts respectively. Flexible silver plated terminals or rigid turrets available.

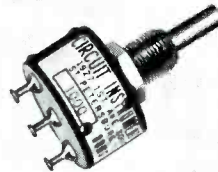

TYPE H-101

Tiny 1" diameter by ¾", exclusive of shaft and turret terminals. Weight is 1 ounce. Power rating 1½ watts. Standard resistance values from 50 to 10,000 ohms. Continuous rotation; stops available on special order.



TYPES H-750 and H-755

Ultra-thin ¾" diameter size. Type H-750 3 watts, standard resistance values from 250 to 50,000 ohms. Type H-755, standard resistance values from 125 to 25,000 ohms. Either flexible silver plated terminals or rigid turrets available.



TYPE H-751

Small ¾" diameter by ¾" body size, exclusive of shaft and turret terminals. Weight 1 ounce. Power rating 1 watt. Standard resistance values from 100 to 10,000 ohms. Continuous rotation; stops available on special order.

Note: Linearities (independent) can be supplied to $\pm 0.1\%$ for most resistance values.

SEND COUPON FOR
SPECIFICATION SHEETS

Subsidiary of



INTERNATIONAL RESISTANCE CO.

CIRCUIT INSTRUMENTS INC.

P.O. Box 355
St. Petersburg, Florida

Send technical data sheets on the following Type H Potentiometers:

() () () ()

Name _____

Address _____

City _____ State _____

TO PROVIDE THE MISSING LINK

The solution to some of today's most critical frequency management problems is being provided by these and other advanced-design JK products—now available on a production basis.

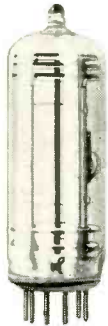

JK G-7

Miniaturized Precision Crystals, in a range from 1000 cycles to 150 mc, combining minimum size with maximum stability.

JK H-3



JK G-12A

Precision "Glasline" Crystals over a complete range of 800 cycles to 5 mc, including the JK G-12A, with a proven stability of one part in one billion per day at 1000 kc.



JK-THERMYSTAL

"Thermystal", an advance design frequency control unit that combines plug-in simplicity with extreme precision. Calibration accuracy: ± 1 cycle $\pm .0001\%$. Temperature stability: 30 to 900 kc $\pm .0001\%$. 1000 kc to 150 mc. $.00005\%$.

THE JAMES KNIGHTS COMPANY
SANDWICH, ILLINOIS

Crystals for the Critical



PRODUCTS

Write for descriptive literature.

ard size of 22 in. wide by 18 in. deep by 48 in. high, other sizes can be supplied to meet particular requirements.

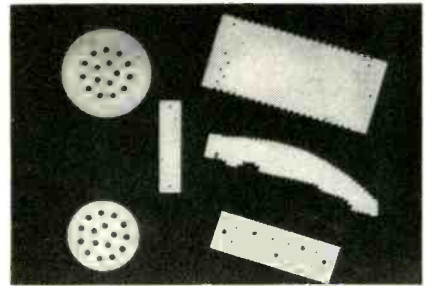

INSULATING MATERIAL in sheet forms

SPRUCE PINE MICA Co., Spruce Pine, N. C., and Farnam Mfg. Co., Ashville, N. C., are now fabricating Micaramic, a new insulating material made from flake mica and a mineral binder.

► **Features**—It possesses the properties of heat distortion at 1700 F, complete flame resistance, and arc resistance with no carbon tracking, as well as excellent dielectric strength and workability.

The material is available in thin sheets (20 mils to $\frac{1}{2}$ in.), and can be easily punched and shaped as well as extruded.

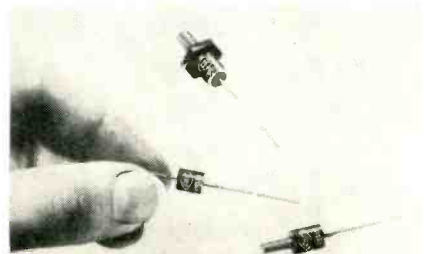

POWER RECTIFIERS feature little dissipation

CBS-HYTRON, a Division of Columbia Broadcasting System, Inc., Danvers, Mass. Types 1N503 through 1N526 silicon power rectifiers feature large power handling capacity for their size. They are capable of operating with extremely high reverse voltages and accompanying low reverse currents. This feature, together with a very low forward voltage drop, enables the rectifier to deliver large power to the load with relatively little dissipation.

The units are capable of operat-

ing in ambient temperatures up to 125 C due to their inherently low thermal resistance.

► **Uses**—Typical applications are high current-low voltage regulators, magnetic amplifiers, power supplies and other uses where high rectification efficiency and large currents are desirable.

Data sheet E-263 gives additional data.

SERVO AMPLIFIERS

400-cycle, plug-in type

SERVOMECHANISMS, INC., 625 Main St., Westbury, L. I., N. Y., announces release of a line of 400-cycle electronic servo amplifiers. These ruggedized plug-in amplifiers are available for immediate delivery and are designed to drive a wide range of instrument motors in aircraft and missile servo systems.

► **Design**—The units are available in 2, 4 and 10-w ranges and are functionally packaged for simple installation and designed to assure long life and reliability with high performance characteristics under extreme environmental conditions.

These hermetically-sealed amplifiers incorporate the latest miniaturization techniques. Plug-in features facilitate their application to any control system requiring this function and reduce maintenance problems by permitting simple and quick replacement of the complete unit.

Also available as companion equipment is a complete line of 400-cycle power supplies and modulators. All 400-cycle amplifiers are designed to meet applicable USAF specifications.

RECEIVING TUBES

triode-pentode converters

RADIO CORP. OF AMERICA, Harrison, N. J., has announced two new 9-pin miniature type receiving tubes (the 5CG8 and 6CG8), each containing a medium- μ triode and a sharp-cutoff pentode in one envelope. The tubes were designed especially for use as a combined oscillator and mixer tube in tv re-

*Engineered for
tomorrow's needs...today...*

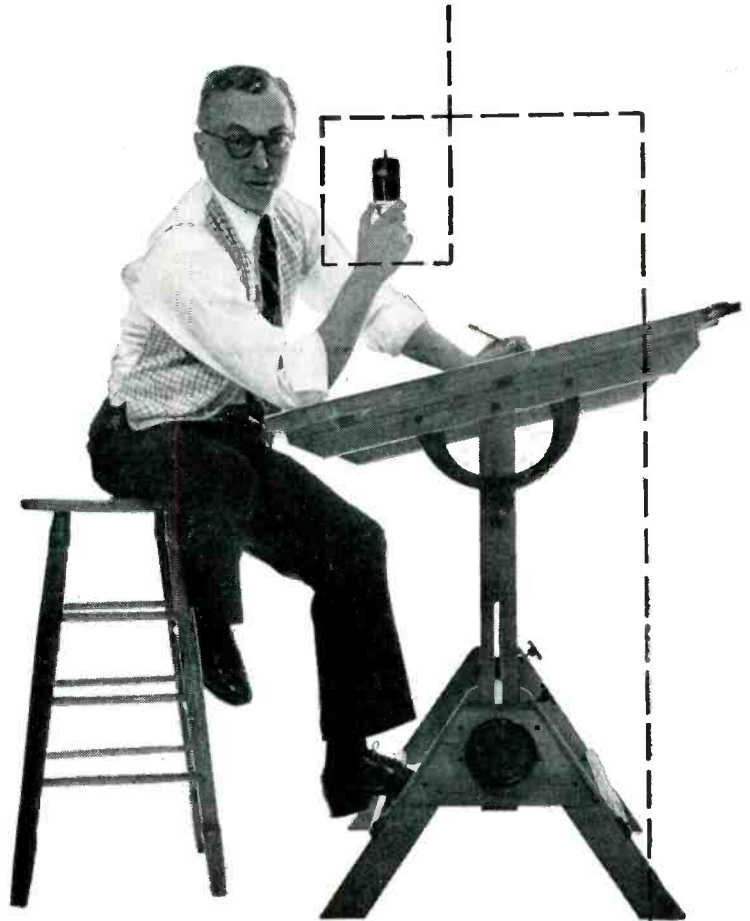

NORDEN-KETAY OFFERS YOU DIRECT ANALOG-TO-DIGITAL CONVERSION WITHOUT TRANSFORMATION

Combining accuracy with compact design, Norden-Ketay's ADC-1A family of Analog-To-Digital Converters provides you with *unambiguous natural binary output*. All digits are available nearly simultaneously...allowing a high reading rate and may be read while the shaft is in motion. Both the binary number and its complement are available, simultaneously.

RAPID READOUT—up to 10⁶ per second.

PARALLEL READOUT—greatly simplifies external circuitry.

COMPACT DESIGN—engineered for minimum size and weight.

INPUT—DC or pulse voltages.

LOW TORQUE—less than 0.2 inch ounces to turn input shaft.

LOW INERTIA—approximately 9 gram centimeters².

CLOCKWISE OR COUNTER CLOCKWISE OPERATION—either is possible by selection of appropriate output leads.

AVAILABLE IN ANY CAPACITY TO 19 DIGITS—other capacities available on special order.

For full details write for File #112.



NORDEN-KETAY CORPORATION

INSTRUMENT AND SYSTEMS DIVISION

Wiley Street, Milford, Connecticut

Indicating Precision Pressure Gages • Remote Indicating Devices • Analog Digital Converters • Force Balance Pressure Transducers • Electromechanical Control Systems • Airborne Radar • Shipboard Line Control Equipment • Aircraft Fuel Flow Instrumentation • Accelerometers

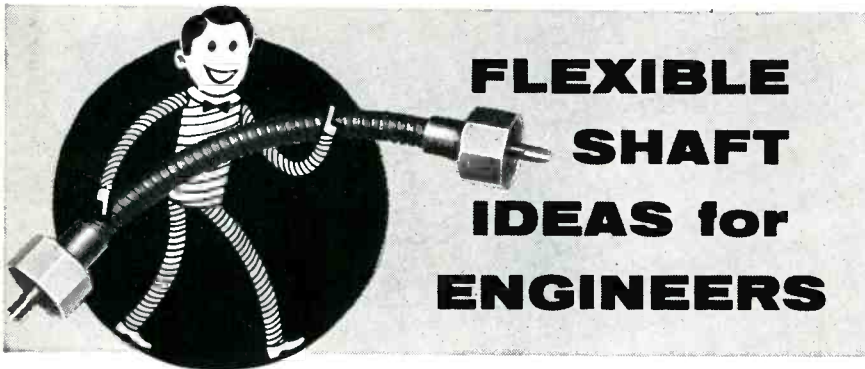

Gain extra design freedom... create cost-saving opportunities with S.S.White flexible shafts

S.S.White "Metal Muscles"® are readily adaptable to a wide range of space, operating and service requirements

BY USING S.S.WHITE FLEXIBLE SHAFTS to transmit power or control between two points, many of the restrictions placed on a design by rigid connections can be quickly removed.

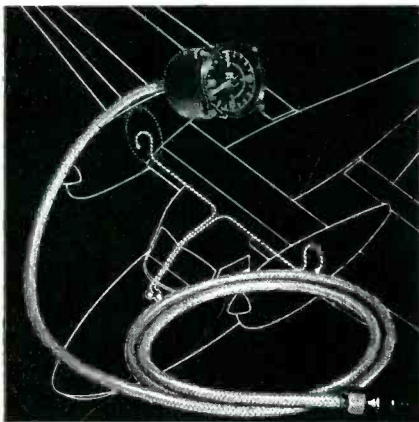

A flexible shaft tachometer drive application.

Save time and costs

Power sources and driven members or controlled parts and their controls can be positioned to better advantage. Costly methods of connection and adapting can be eliminated and general overall design can be improved. And, because an S.S.White flexible shaft does away with alignment problems and reduces the number of parts required for a control or power drive, costly and time-consuming assembly operations can be avoided.

Early consideration best

By far the best time to consider using S.S.White flexible shafts is when your product is still in the design stage. Then

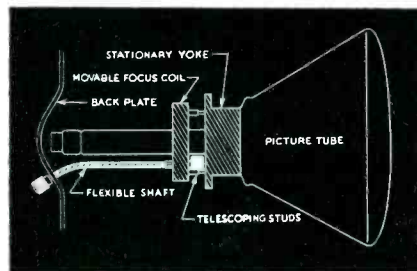

A remote control flexible shaft used in a TV-focusing device.

you can use them to maximum advantage and will also have a wider selection of shaft sizes, styles and characteristics to choose from than if your design is "locked up."

Satisfaction assured

Once selected, you can always count on S.S.White flexible shafts to measure up to the requirements of your application. S.S.White's many design and manufacturing developments have made S.S.White flexible shafts first in the field for quality, performance and dependability. Experience has shown that when it comes to flexible shafts you'll always be right — if you specify "S.S.WHITE".

A "must" for every design engineer

Bulletin 5601 contains the latest information on flexible shafts, tells how to select and apply them. Send for your copy today.



F6-5

S.S.White

FIRST NAME

IN FLEXIBLE SHAFTS

S.S. WHITE INDUSTRIAL DIVISION, DEPT. E, 10 EAST 40th ST., NEW YORK 16, N.Y.
Western Office: 1839 West Pico Blvd., Los Angeles 6, Calif.

ceivers utilizing an i-f in the order of 40 mc.

► **Design Information**—The tubes feature a cathode having two leads connected to separate base-pin terminals. This arrangement reduces effective cathode-lead inductance thereby minimizing input loading effects of the pentode-mixer unit; it provides greater flexibility in circuit design, and makes it possible to eliminate a common return for the input and output circuits of the pentode-mixer unit, thus minimizing interaction between the two circuits.

The 5CG8 is like the 6CG8 except that it has a 4.7-v/0.6-ampere heater having controlled heating time to insure dependable performance in tv receivers employing series-heater string arrangement.

Literature

Germanium Transistors. Texas Instruments Inc., 6000 Lemmon Ave., Dallas 9, Texas, has available literature on its *npn* grown junction germanium transistors and its *pnp* alloy junction germanium type. Specifications, characteristic charts, circuits and a price list are included.

House Organ. General Radio Co., 275 Massachusetts Ave., Cambridge 39, Mass. Volume 30 No. 10 of the *Experimenter* illustrates and describes the type 1230-A d-c amplifier and high-sensitivity electrometer; type 1220-A unit klystron oscillator; and the type 1550-A octave-band analyzer. Information on accessories, specifications and prices is given.

Electromagnetic Focus Coils. Syntronic Instruments, Inc., 170 Industrial Road, Addison, Ill., has released a revised catalog page picturing and completely describing its type F33 focus coil for 2½ in. neck diameters and its type F10 focus coil for 1½ in. neck diameters. Data given include tables listing electrical and mechanical characteristics, schematic drawings and

three outstanding design features consisting of elimination of spot distortion, elimination of external magnetic field and sharp focus for high beam currents.

Rheostat Potentiometers. International Resistance Co., 401 North Broad St., Philadelphia 8, Pa. Catalog data bulletin A-3 covers type 2W-2w rheostat potentiometers. Comprehensive data on construction, specifications, ratings, outline drawings of switches, shafts, locating lugs, nuts and the like are given in detailed charts and graphs. Ask for the 4-page bulletin.

Sun Battery Applications. International Rectifier Corp., 1521 E. Grand Ave., El Segundo, Calif., has published a new technical booklet entitled "The Use of Selenium Photocells and Sun Batteries." The handbook contains 58 pages of technical information and over 35 illustrations, charts and diagrams which describe in detail applications and devices in which sun batteries and other photocell products are successfully employed.

The booklet is available at \$1.50 per copy.

D-C Power Supply. Perkin Engineering Corp., 345 Kansas St., El Segundo, Calif. A new bulletin describing the model MR2432-100XA, 24 to 32 v 100-ampere magnetic amplifier regulated d-c power supply is available. Advantages of the use of the tubeless d-c power supply are outlined.

The model described in the bulletin has an input voltage of 208-, 230 or 460 v and an output voltage of 24 to 32 v at 100 amperes with regulation accuracy of $\pm \frac{1}{2}$ percent and a response time of 0.2 sec maximum.

Complete characteristics and physical features of the unit are described in the new bulletin.

Analog - To - Digital Conversion. Beckman Division, Beckman Instruments, Inc., Fullerton, Calif., has available reprint R-78, "Analog Measurement and Conversion to Digits." It is primarily concerned with analog-to-digital conversion by voltage converter systems. Three systems involving three different

Performance through Precision

AIR MARINE MOTORS . . . leading manufacturers of high specification rotating equipment . . . is your outstanding source for fans, motors and blowers to meet most sub-fractional power requirements.

Adaptability through Variety

years-ahead engineering...

Air Marine Motors equipment features stainless steel thru-bolts . . . die-cast aluminum housings . . . riveted stators . . . positive bearing alignment . . . uniform air gap . . . ball bearings . . . shock and vibration resistance . . . humidity and fungus resistance . . . omni-position mountings . . . temperature lubrication.

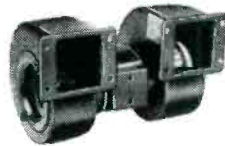

A15BD-8
115 Volt 60 cycle double blower. 46 CFM at .28" static pressure.

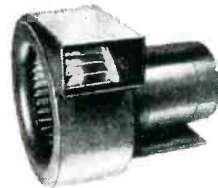

B20B-7
115 Volt 60 cycle (or 400 cycle) blower. 50 CFM at 1.5" static pressure.



A15AD3
115 Volt 60 cycle axial blower. 35 CFM at .2" static pressure.

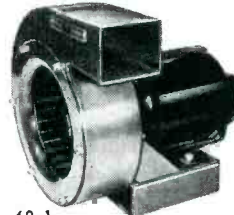

60-1
115 Volt 60 cycle blower. 100 CFM at 2.5" water gauge.



60-6
115 Volt (or 220 Volt) 60 cycle blower, 1 or 3 phase. 250 CFM at 2.5" water gauge.



A11A-4 115 Volt 400 cycle single phase propeller type blower using 4" 4-blade fan. Delivers 250 CFM at 0" static pressure.

Write for specific information and brochure about any of these units . . . and use the Air Marine advisory services without obligation.



air-marine motors, inc.

369 Bayview Avenue

West Coast Factory: 2055 Pontius Avenue

Amityville, N. Y.

Los Angeles 25, Calif.

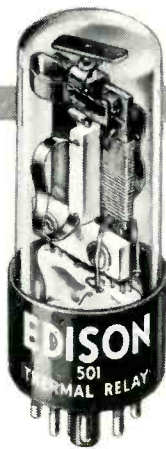

FREE DESIGN DATA BOOKLET

HOW TO APPLY
THERMAL RELAYS

Based on 10 years experience in the design, manufacture and engineering application of thermal relays, this booklet contains diagrams and recommendations to save you hours of engineering time. Here is data on thermal relays with specifics on their use in high-power electron tube circuits, automatic controls and other applications.

The booklet discusses design factors that influence the time delay, instantaneous and saturation values, re-operate and recovery periods... gives information on contact protection, how to eliminate contact chatter, temperature compensation and vibration problems.

For your free copy of "How to Apply Thermal Relays"* write:

*Reprinted from "Electrical Manufacturing"

Thomas A. Edison

A GREAT NAME CONTINUES GREAT NEW ACHIEVEMENTS

Thomas A. Edison

INCORPORATED
INSTRUMENT DIVISION • 54 LAKESIDE AVENUE • WEST ORANGE, NEW JERSEY

principles of operation are described in detail.

Other systems offering certain advantages are also briefly described.

Rheostat Potentiometer. International Resistance Co., 401 North Broad St., Philadelphia, 8, Pa. Bulletin A-3 covers the type 2W, a 2-w rheostat potentiometer used for many electronic applications. The resistance element of the control described is uniformly wound with the highest grade alloy resistance wire on winding machines especially developed by IRC. The deep housing is designed to provide good heat dissipation, accurate location of terminals, true location of bushings and greater rotational accuracy.

Temperature for Magnets. The Indiana Steel Products Co., Valparaiso, Ind., has available an article discussing temperature effects on the remanence of permanent magnets.

Because permanent magnets are exposed to varying temperatures in many applications, these data are of value to engineers designing these products.

The article also discusses the nonreversible and reversible variations of remanence for Alnico V, Alnico VI and Indox magnets and explains how to use temperature data.

Power Supply. Perkin Engineering Corp., 345 Kansas St., El Segundo, Calif., has available a new bulletin describing the model 28-10 WX, 28-v ± 10 percent at 10 amperes magnetic amplifier tubeless regulated d-c power supply. The unit discussed has a voltage range of 28 v ± 10 percent at 10 amperes (continuous) with a regulation of $\frac{1}{2}$ percent and a ripple of 1-percent rms. All characteristics and specifications on this unit are shown in the bulletin.

Microwave Components. Microwave Associates, 22 Cummington St., Boston, Mass. Catalog 56CP is a 4-page illustrated price list brochure which describes over 150 different microwave components

TOROIDS

from

SIZE

8 A.W.G.

to

SIZE

44 A.W.G.

Whatever your need . . . whatever your size requirement . . . we can provide machine-wound toroidal coils in core sizes from 17" I.D. to $\frac{1}{4}$ " I.D.

Two to three day delivery on cores in stock for your sample and prototype work.

NEW ENGLAND TRANSFORMER COMPANY
SOMERVILLE, MASS. • SOMerset 6-6100

and test equipment for use in radar systems and microwave laboratory applications. Included are circular waveguide equipment, antenna components, r-f switches, waveguide accessories, power dividers, detection and power measurement instruments, frequency meters, attenuators, terminations, tuners, s-w detectors and radar system components.

Computing and Simulation Service. J. B. Rea Co., Inc., 1723 Cloverfield Blvd., Santa Monica, Calif., has available a 7-page brochure explaining the complete services offered for simulation, computing, data reduction and data processing. The written explanations are further clarified by descriptive diagrams showing the flow of data. From the problem analysis and preparation service, the data is routed to the desired facility— analog simulation; digital computing and record reading; analog-to-digital conversion; digital-to-analog conversion.

Microwave Equipment. Roger White Electron Devices, Inc., 10 Fourth Ave., Haskell, N. J., has published a new short-form folder illustrating many of its standard product line. The 4-page folder gives thorough information concerning design features, physical dimensions, and application of varied types of attenuators, noise sources, t-w tubes and backward wave oscillators. Handy specification charts, easy-to-read attenuation curves and specific operational data are all prominent features.

Electronics Laboratory. Electrical Testing Laboratories, Inc., Two East End Ave., New York 21, N. Y., announces a new bulletin covering its recently expanded electronics laboratory, now equipped to operate in the microwave region. Consisting of 4 pages and 2 gatefolds, the new bulletin lists 39 measurements and determinations which ETL is equipped to make; lists 43 typical electronic items tested; and includes 14 illustrations of various test facilities.

In addition to electronic test facilities, the bulletin also illustrates and briefly covers several of

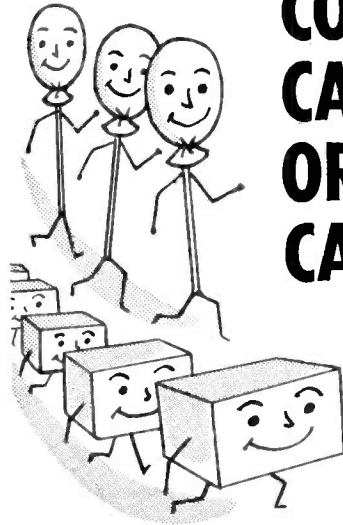

COUNT CANDY OR CARTONS?

*there's an
ATOMIC
counter or
controller
for the job*



The widest variety of counting models available . . . decade or duodecade types . . . speeds up to 2000 c.p.s. for controllers, up to 20,000 c.p.s. for counters . . . straight totalizing counters, single or dual preset controllers provide wide versatility for production control.

Atomic's Functional Plug-In Strips provide complete instruments for specialized requirements . . . eliminate

costly "custom-design" charges. Strip construction, using low-current, low-heat glow transfer tubes simplifies circuitry . . . provides extreme reliability. Plug-in replacement of strips eliminates downtime . . . keeps production rolling.

"Write today for new catalog B15, just off the press!"

ATOMIC



INSTRUMENT COMPANY

84 MASSACHUSETTS AVE.

CAMBRIDGE 39, MASS.

—they're dependable!

**precision, deep drawn
KOVAR
PARTS**

—from 1/4" dia. and 3/4" deep, .025" thickness

Consult the Engineering Company for quality parts or sub-assemblies of steel, aluminum, copper, brass, kovar, nickel and monel. Fast, economical service on long or short runs. The most modern machines and micro-precision tools assure highest accuracy.

WRITE TODAY for quotations, sending your sketches or blueprints; no obligation.

THE engineering CO., 27 WRIGHT ST., NEWARK 5, N. J.

NEW

DIODE-CURVE TRACER

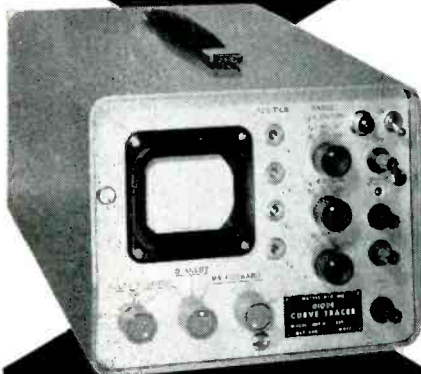

Gives large display
for
all types of diodes

NOW YOU CAN TEST dynamic characteristics of all common types of diodes — including both germanium and silicon — more accurately, rapidly, and easily than ever before.

- Full-screen display of forward and reverse characteristics separately gives four times the previous visibility for greater speed and accuracy.
- Feed-out connection permits use of external 'scope for even larger display.
- Dual inputs provide for high-speed comparison or differential checking against standard diode or resistor.
- Forward-scale sensitivity is increased to 1 volt /inch.
- Forward-scale current range is increased to 50 ma/inch; current adjustable from zero to 100 ma.
- Reverse-scale voltage ranges increased to 50, 100, and 250 volts/inch; voltage adjustable from zero to 500 volts.
- Reverse-scale current ranges increased to 1, 10, 100, and 1000 μ a.
- Provision for diode-capacitance compensation.
- Accuracy \pm 5%.
- Size: 9-1/2 x 7-5/8 x 14 inches.

Write for data sheets giving complete description of the new Model 1003B Crystal-diode-curve Tracer.

WATERS
MANUFACTURING, inc.



Wayland, Massachusetts
P.O. Box 368 So. Sudbury, Mass.
APPLICATION ENGINEERING OFFICES IN PRINCIPAL CITIES

Want more information? Use post card on last page.

NEW PRODUCTS

(continued)

the company's other laboratories, and emphasizes the fact that a complete series of tests can be carried out under one roof.

Oxygen Analyzer. The Hays Corp., Michigan City, Ind. A new 16-page color catalog, 55-829-56, explains principle, construction, operation and features of both the paramagnetic type Magno-Thermanalyzer and the electronic recorder. A chart of major applications lists functions, examples of services, and how and why this analyzer is used. Special models are also described.

Precision Inverter. The Bristol Co., Waterbury 20, Conn., has released a bulletin describing and illustrating a miniature precision inverter, the Syncroverter switch. The inverters discussed are designed for use over the excitation frequency range of 0 to 1,800 cps. Full engineering specifications are given on this polarized, spdt non-resonant reed chopper. Typical characteristics are given for operation at 400 cps, as well as mounting dimensions for both pin-socket and flange-mounting models. Ask for bulletin AV 2002.

Wire-Wound Resistors. International Resistance Co., 401 N. Broad St., Philadelphia 8, Pa. Catalog data bulletin C-1a covers tubular and flat power wire-wound resistors. The 12-page booklet includes illustrations, comprehensive data on construction, features, types, ratings, terminations and leads, coating, insulation and winding. Detailed charts and graphs are shown.

Pressure Transducers. Statham Laboratories, Inc., 12401 W. Olympic Blvd., Los Angeles 64, Calif. Bulletin No. P60 covers models P60 and P60TC pressure transducers. Included are a full description, specifications and dimensional diagram. Model P60 described is priced at \$175; the P60TC, \$200.

Phase Measurement. Industrial Test Equipment Co., 55 E. 11th St., New York 3, N. Y. A recent brochure contains applications, principle of operation, features and

Details on a BETTER PENCIL

(MARS TECHNICO with Mars Lumograph lead)

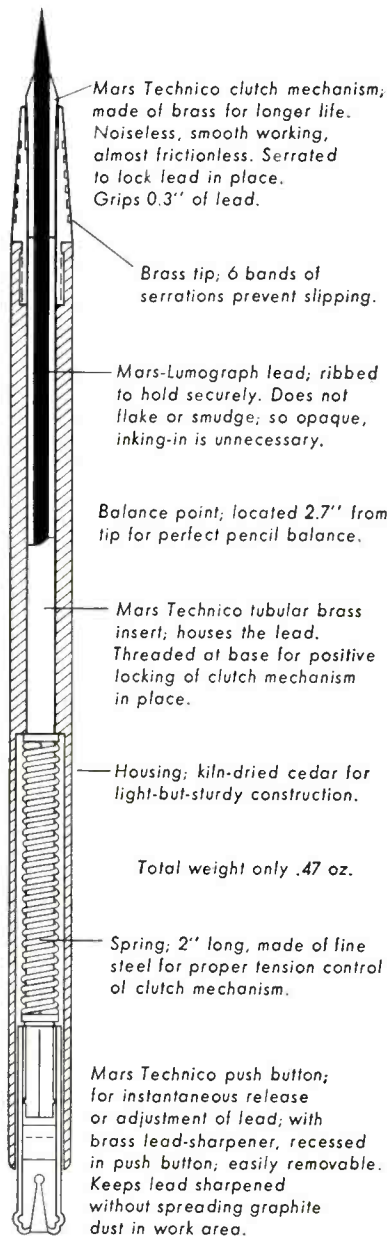

Mars-Lumograph lead; finest graphite meticulously graded from EXB to 9H (18 degrees) for better reproduction



Unique brass cap at top, prevents lead from falling out when clutch mechanism is released.

J.S. STAEDTLER, INC.

HACKENSACK, NEW JERSEY

at all good engineering and drawing material suppliers.

Want more information? Use post card on last page.

May, 1956 — ELECTRONICS

specifications for the model 200A Phazor phase meter which is priced at \$349.50. Also available is an article entitled "Precision Phase Shift Measurements," which outlines a procedure whereby the model 200A can be employed to measure phase shifts of the order of 0.01 degree.

Germanium Power Transistors. P. R. Mallory & Co., Inc., 3029 E. Washington St., Indianapolis 6, Ind., has available a folder containing engineering specifications on the 400 series germanium power transistors for multipurpose use. Outstanding features, delivery information and prices are included.

Infrared Detectors. Barnes Engineering Co., 30 Commerce Road, Stamford, Conn. The latest type of Opti Therm infrared detectors used as sensing elements in radiometers, pyrometers, infrared spectrometers and other infrared instruments are described in a new bulletin. The bulletin covers a complete new line of detectors with controlled time constants—detectors with specific times of response ranging from 1 to 50 milliseconds. They are particularly applicable to systems requiring precise control of detector response time.

Miniature Terminal Strip. DeJUR-AMSCO Corp., 45-01 Northern Blvd., Long Island City 1, N. Y. Bulletin 52A illustrates and describes a new subminiature terminal strip designed specifically for printed circuit computer applications. Available in 6 and 10 contacts, the new strip has the series designation MB.

Supervisory Control System. Builders-Providence, Inc., Division of B-I-F Industries, Inc., Providence 1, R. I. Bulletin 240-M6 is a 4-page folder illustrating and describing the Synchro-Scan multifunction control system. Information on operation, applications and accessory equipment is given. A typical system is shown.

A-C Voltmeters. Arga Division, Beckman Instruments, Inc., 220 Pasadena Ave., South Pasadena, Calif. Expanded scale a-c volt-

NEW!

*1/2-inch
wire-wound*

ACTUAL SIZE

UP TO 100 K

PRECISION POTENTIOMETERS

Now You Can specify a Waters pot for your miniaturized designs that require 50K and 100K potentiometers. In the reliability-proved construction of the AP-1/2, these new, higher values give you:

- Resistances — 10 ohms to 100 kilohms
- Ganging — up to four units
- Three mounting styles — plain-bushing, split-bushing, or servo
- Three terminal styles — radial, axial, or wire-lead
- Automation models — for printed circuits
- Encapsulated designs available

General specifications: Centerless-ground, stainless-steel shaft can be sealed with O-ring; gold-plated, fork-type terminals; 2% standard linearity for 50K and 100K — 5% for lower values; temperature range — 55 to +105C, to 125C on order; 2 watts at 80C; anodized aluminum body 1/2" diameter x 1/2" long — 5/8" long for 100K; corrosion-resistant-alloy bushing; all electrical connections spot-welded or soldered; furnished with stops or for continuous rotation. Write for data sheet on these dependable 1/2" potentiometers.

Do you ever need pots that are "just a bit different"? Maybe we can help you — by modifying a standard Waters design or by taking a bold, new approach. Tell us your need and we'll tell you what we can do.

WATERS MANUFACTURING, inc.
Wayland, Massachusetts
Mail address: P.O. Box 368, So. Sudbury, Mass.
APPLICATION ENGINEERING OFFICES IN PRINCIPAL CITIES



here's what **DIE CAST** **GRC** ZINC ALLOY THREADED **FASTENINGS** mean to you...

in terms of a better product, in
terms of a more economical product!

Gries' unique techniques make possible
closer tolerances, cleaner threads, greater
dependability, durability, die-cast uniform-
ity. Mass production means lower costs!



NEW BULLETIN AVAILABLE
Fact-packed—shows how Gries
ingenuity and money-saving
methods can solve your fasten-
ings problems.

Send today for your
copy, prices and samples.

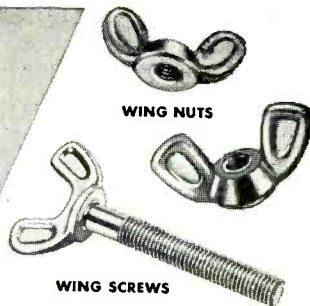

WING NUTS

WING SCREWS



THUMB NUTS

THUMB
SCREWS

CAP NUTS

GRIES REPRODUCER CORP.

151 Beechwood Ave. • New Rochelle, N. Y.
Phone: NEw Rochelle 3-8600



World's
Foremost
Producer of
Small
Die Castings

RADIO NOISE SUPPRESSION FILTERS

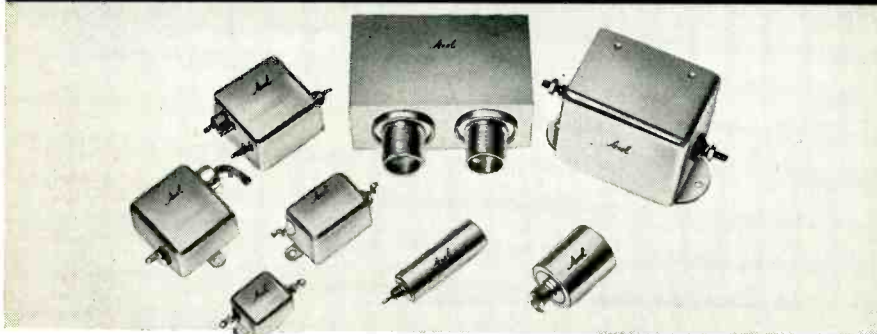

FEATURES

- Maximum attenuation from 14 kc to 22,000 mcs
- Low impedance and voltage drop with minimum heating
- Maximum vibration and shock resistance
- Standard, miniature and sub-miniature sizes
- Operating temperatures—55°C to 125°C
- Custom-made to conform with MIL-F-15733 and all other applicable design and performance specifications

AXEL's Filter Engineering Staff is composed of skilled design, development and application engineers. At their disposal is the most modern research and development laboratories designed exclusively for the measurement and testing of your equipment and the design of quality filters to meet any specifications.



AXEL ELECTRONICS

division of AXEL BROS., INC.
134-20 Jamaica Avenue • Jamaica 18, New York
REpublic 9-1700

meters for panel mounting are presented in a new bulletin. The units discussed embody the following features: high accuracy and readability, linearity, wide frequency range, true rms reading and sturdy construction. The bulletin fully describes the patented electrical circuit that expands the useful portion of the scale and eliminates the rest.

Standard scales and accuracies are listed. Custom and military models are illustrated with photographs and dimensional drawings.

Products Catalog. Sorensen and Co., Inc., 375 Fairfield Ave., Stamford, Conn. The 1956 illustrated catalog of condensed standard specifications on a wide range of power supplies, voltage regulators, voltage reference sources and frequency changers has been released.

Included in the catalog are data on regulation accuracy, input and output voltages, ripple, recovery time, load range and other basic specifications. Also listed are local technical representatives and special service facilities.

Magnetic Tape's Coating Thickness. Minnesota Mining & Mfg. Co., 900 Fauquier St., St. Paul 6, Minn. A technical discussion on effect of coating thickness on frequency response of magnetic tape is the title of *Sound Talk* bulletin No. 31.

The 3-page bulletin—illustrated by 4 charts—is intended for broadcast engineers, electronics specialists and others interested in magnetic recording. It covers optimum recording conditions, bias and audio recording currents and their effects on high and low frequency response of tapes with various oxide coating depths.

General Catalog. Insuline Corp. of America, 186 Granite St. Manchester, N. H., has released a most comprehensive presentation of products in its 1956 general catalog. The line covered includes metal fabrications, plugs, jacks, leads, tools and associated components. All are graphically illustrated with schematics, specifications and descriptions throughout the 80 pages

Genisco's New GOH Accelerometer
**WITHSTANDS VIBRATIONAL
 ACCELERATIONS**
of 15 G's up to 2000 cps



PHYSICAL DIMENSIONS	
OVERALL HEIGHT	3 1/4"
OVERALL WIDTH	3 1/4"
OVERALL DEPTH	3 1/4"
WEIGHT	38 OUNCES
Hermetically sealed	

This newest Genisco Accelerometer is a rugged, oil-damped, potentiometer-type instrument designed to operate in the most severe missile and aircraft vibrational environment. For example, in a recent production test the GOH performed satisfactorily after vibrational environment of 15 G's up to 2000 cps. As further proof of its ruggedness, the GOH will withstand 40-G shocks of 5 millisecond duration on the sensitive axis and steady-state accelerations of 30 G's on the non-sensitive axes and 10 G's on the sensitive axis without damage.

HEATING ELEMENT AVAILABLE — A thermostat-controlled, internal heater may be installed in the GOH to keep operating characteristics constant between -50° F. and +160° F. However, thermostat operation is limited to 60,000 feet or less, 95% relative humidity at 160° F., and a vibrational environment of 10 G's up to 500 cps.

SPECIFICATIONS

- Ranges:** ±1 G to ±3 G's inclusive.
- Natural Frequencies:** 7 cps. to 12 cps.
- Nominal Damping:** 0.65 of critical at 75° F.
 Values between 0.4 to 1 set if desired.
- Resistance:** 14000 ohms (±5%); center tap at 0 G-point. Other resistances also supplied.
- Potentiometer Voltage:** Up to 60 volts.
- Resolution:** One part in 300 for standard potentiometer.
- Noise Levels:** Less than 10 mv at 0.1 ma brush current.
- Linearity:** Within 1% of full scale from best straight line through calibration points.

Complete technical data on the GOH and other Genisco Accelerometers and Pressure Transducers is available from Genisco, Incorporated, 2233 Federal Avenue, Los Angeles 64, California. Write for your copy today.

RELIABILITY FIRST

Genisco
 INCORPORATED

NEW PRODUCTS

(continued)

of the new 3-color catalog. The catalog is suited for engineers, technicians, government agents and laboratories.

Copper-Clad Laminates. International Resistance Co., 401 N. Broad St., Philadelphia 8, Pa. Bulletin AR-2 covers new copper-clad laminates for printed circuitry. The laminate described, in which no resin adhesive is used, features very low cold flow, zero water absorption, excellent machineability and a water-repellent surface. Also, it is unaffected by acids, alkalies or common organic solvents.

Magnetic Head. J. B. Rea Co., Inc., 1723 Cloverfield Blvd., Santa Monica, Calif. A single-sheet data page covers a single-track read and record magnetic head designed specifically for digital computers. This head has complete flexibility of circuitry—can be transistor driven. This literature contains physical configuration and performance characteristics as well as descriptive text.

Capacitors. Chicago Condenser Corp., 3255 W. Armitage Ave., Chicago, Ill. A new 20-page catalog describes the company's new line of capacitors. Included are specifications and listings for the new upright Perm-A-Caps, paper capacitors, film, glass, and bathtub capacitors.

Performance characteristics and construction are carefully detailed in the catalog.

Transducer. Statham Instruments, Inc., 254, Carpenter Road, P. O. Box 607, Hato Rey, Puerto Rico. Bulletin G7A gives a 2-page illustrated description of the G7A transducer. A force or displacement applied to the probe of the unit discussed is translated into an exact electrical analog by the complete balanced bridge of unbonded strain sensitive resistance wire. Specifications, selection table and dimensional drawing are included.

High Temperature Terminals. American Lava Corp., Chattanooga 5, Tenn., Bulletin 553 supplies complete information on the company's new line of high temperature ter-

LET *Almo* SHOW
 YOU HOW TO CUT
**WELDING
 IGNITRON
 REPLACEMENT
 COSTS!**

WITH THE NEW



**REMANUFACTURED
 IGNITRON
 EXCHANGE PLAN**

**GIVES YOU NEW-TUBE LIFE AT NEW
 LOW PRICES. SAVE 28% ON WELDING
 IGNITRONS**

A G-E "first"! Cuts your replacement costs sharply! Only General Electric brings you the new Remanufactured Ignitron Exchange Plan, whereby you obtain reliable ignitron replacements at substantial savings . . . with no compromise in quality.

Remanufactured ignitrons come to you at prices much lower than new tubes. Savings average 28% on the three ignitron types now being remanufactured — GL-5551, GL-5552, GL-5553-A. And remember: General Electric's new-tube warranty on remanufactured ignitrons assures you of new-tube performance!

You lose no time from delivery delays. Remanufactured ignitrons are stocked right at your local Almo Store. Supply Almo with one exchangeable G-E tube and receive on the spot a low-cost remanufactured ignitron. It's as easy as that!

SAVING PER TUBE

TYPE	DOLLARS SAVED	% PRICE SAVED
GL-5551	\$17.90	27%
GL-5552	28.50	28%
GL-5553-A	63.00	29%

**HOW YOUR SAVINGS INCREASE WITH
 NUMBER OF IGNITRONS EXCHANGED**

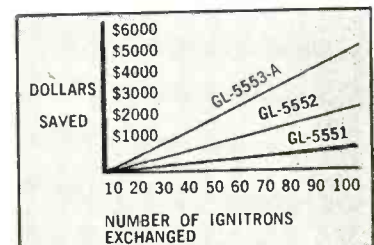

**G-E NEW-TUBE WARRANTY GOES WITH
 EACH REMANUFACTURED IGNITRON!**

General Electric's Remanufactured Ignitron Exchange Plan provides a standard new-tube warranty with each remade G-E ignitron tube. This is your assurance of new-tube performance.

SEE YOUR ALMO SALESMAN TODAY

Almo RADIO CO.
 509 ARCH ST., PHILA., PA.
 BRANCHES: CAMDEN, N. J. TRENTON, N. J.
 ATLANTIC CITY, N. J. NORRISTOWN, PA.
 WILMINGTON, DELAWARE SALISBURY, MD.



THE NEW SERIES 100 RELAY
(Hermetically Sealed)

One of the greatest challenges in the field of electronics is the designing of components small enough and rugged enough for today's and tomorrow's "miracle" machines and equipment.

The engineers of Wheelock Signals, Inc., always alert to this challenge, now offer the new Series 100 Miniature Relay which is among the smallest and most sensitive of the double-pole type. It maintains high precision under varying conditions and is ideally suited to such equipment as military guided missile controls which must withstand extremes of shock, vibration, and temperature.

Write now for Bulletin SR-6

Signal Engineering & Mfg. Co. has changed its name to



Engineering Representatives in Principal Cities.

COLOR SIGNAL CHECKING have you SPINNING?

use **TIC'S** NEW
Type 2015
DIFFERENTIAL GAIN & PHASE MEASURING GENERATOR
and Type 2036
DIFFERENTIAL GAIN & PHASE ANALYZER

Now you can conveniently measure small values of differential gain and phase with no more than a 5cm scope deflection! Differential gain can be read at 2% /cm. Differential phase at better than 0.5% /cm. The test signal contains the measurement signal, sync, color burst and front and rear porches. The measurement signal is a saw or 10-step, with 5% to 20% superimposed RF. Color certification tests are made to $\pm 1\%$ with the continuously variable, calibrated phase shifter. Type 2007 Sync Signal Simulator is available as attachment.

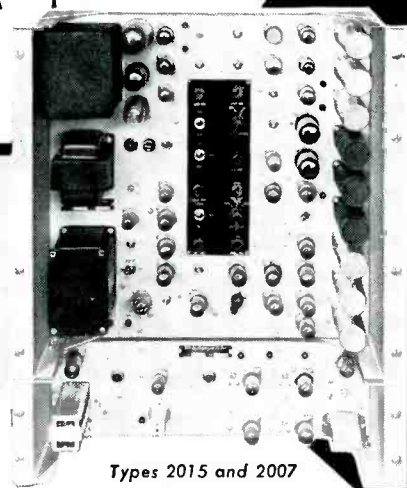

Types 2015 and 2007 illustrated

Write for COMPLETE INFORMATION



Tel-Instrument
ELECTRONICS CORP.

728 GARDEN STREET, CARLSTADT, NEW JERSEY

minals. Illustrations, dimensional drawings, specifications and a property chart are included.

Variable Resistor Catalog. Chicago Telephone Supply Corp., Elkhart, Ind., has released a new 56-page catalog, No. 71, illustrating and describing their complete line of wirewound and composition variable resistors for both commercial and military applications. It includes many new types such as controls designed for ear mounting, printed circuits and wire wrapping. The catalog covers detailed technical data on electrical specifications and mechanical characteristics as well as many special features including locking type bushing, high torque and water seal bearing.

Helpful suggestions are given to assist in selecting the type of control to meet the requirements of an application in the most economical construction. Other pages illustrate typical operational views of the 315,000-sq ft plant.

Coil-Winding Machines. Geo. Stevens Mfg. Co., Inc., Pulaski Road at Peterson, Chicago 30, Ill. Catalog No. 56 has 62 pages illustrating and fully describing 42 coil-winding machines. Virtually all types of coils may be wound on the various models discussed—including continuous resistance coils, deflection yokes, bobbin, repeater transformer, solenoid, resistor, lattice-wound universal, space wound, variable pitch, toroidal, armatures and field coils.

In addition, 5 new tailstocks, 15 tensions, 3 counters, model 105 wire scraper, model WS-1 wire insulating equipment, 6 wire guides, carboloy eyelet and a variety of gears and cams are pictured and full details given. A page of time-saving, helpful winding formulas is also included.

Hermetically Sealed Terminals. Electrical Industries, Division of Amperex Electronic Corp., 44 Summer Ave., Newark 4, N. J. A tab-indexed booklet gives complete specifications and illustrations for a wide line of hermetically sealed terminals. Types covered are as follows: strain-free single lead ter-

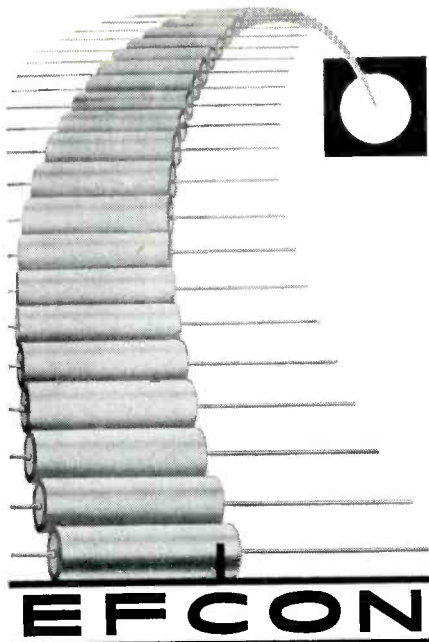

EFCON

where close tolerance is
standard tolerance

DON'T DERATE DELIVERY DATES FOR CLOSE TOLERANCE CAPACITORS

Only EFCON mass-produces miniature plastic film capacitors to close tolerances.

No need to delay your equipment delivery dates while awaiting delivery of precision capacitors. At Electronic Fabricators, Inc., the standard production runs are for $\pm 1\%$, $\pm 2\%$, and $\pm 5\%$ tolerance capacitors. It is not necessary to pick and choose from wider tolerance production runs nor is it necessary to pay premium prices for close tolerance.

EFCON Mylar* and Polystyrene Film Capacitors are each available in two styles: Types MC and PC have a rigid cardboard tube construction; Types MH and PH are hermetically sealed in a metal case with glass-to-metal, solder-sealed terminals. Extended foil construction with leads directly soldered to the foil minimizes inductance and contact resistance for all types.

The plastic film ensures high insulation resistance, low dielectric absorption and stability over extended temperatures and life. Types MC, PC, MH and PH capacitors are available in a range of standard capacitance values from 0.001 to 2 mfd. Non-standard values and tolerances closer than $\pm 1\%$ are obtainable to your specifications.

Other EFCON CAPACITORS . . .

Type TH Teflon* Film Capacitors . . . for high-temperature and high humidity application.

Type S Molded Silver Mica Capacitors

ELECTRONIC FABRICATORS, INCORPORATED

682 Broadway, New York 12, N. Y.

Write Dept. K for technical data

*DuPont Trademark



minials; compression-type single lead terminals; strain-free end seals; compression-type end seals; strain-free multi-lead headers; compression-type multi-lead headers; compression-type plug-in connectors; diode and transistor closures; crystal and subminiature closures; special application and custom seals. General information and installation data are included.

Inductronic Instruments. Weston Electrical Instrument Corp., Newark 4, N. J. A new bulletin contains a series of technical articles on the company's line of Inductronic instruments compiled for easy reference. Performance, applications and ranges of the sensitive model 1411 Inductronic d-c amplifier are discussed in detail. The amplifier, which provides higher accuracy, stability, and response speeds than would be possible by direct instrument application, has several accessories to give it utmost flexibility.

Features in the units discussed are: a reactive damping adaptor; a fluxmeter which allows the amplifier to be used as an integrator; a control unit; a sensitizing amplifier; and a photocell range network. Comprehensive data on each accessory are included.

Also reviewed in detail are the model 1475 multirange Inductronic d-c amplifier, and the Inductronic product resolving system.

High Potential A-C Testing. Associated Research, Inc., 3758 W. Belmont Ave., Chicago 18, Ill. A new manual entitled "High Potential Dielectric Strength Testing With Hypot Juniors" is now available. The 7-page manual also includes information applicable to the dielectric testing of small electrical components and equipment such as relays, switches, potentiometers, servo motors, pulse transformers and wiring harnesses.

Power Supplies. Lambda Electronics Corp., 11-11 131 St., College Point 56, N. Y. A recent *Newsletter* contains a checklist of the company's regulated and unregulated d-c power supplies. Specifications, models and prices are included.

THE Theory of Linear Antennas

WITH CHARTS AND TABLES FOR
PRACTICAL APPLICATIONS

By RONOLD W. P. KING

The first systematic and comprehensive survey of linear antennas and arrays of linear antennas, including circuit and field properties. Only a small part of the material has been available before, either in book form or in journals. Both theoretical and experimental aspects of the subject are treated—with particular emphasis on the correlation of theory with experiment.

The book constitutes an advanced study of electromagnetic radiation, transmission, reception, and scattering as related to practical structures made from cylindrical conductors of relatively small cross section. Proceeding from fundamental electromagnetic theory, the work derives formulas and calculates numerical results for actual, rather than idealized, structures. Approximations in analysis are pointed out, as are the limitations of experimental techniques in verifying theoretical predictions. Extensive tables, charts, and curves are included, so that the theoretically derived and experimentally verified results may be more easily applied in practice. 968 pages. More than 700 linecuts. \$20.00

Through your bookseller, or from



HARVARD
UNIVERSITY PRESS

Cambridge 38, Massachusetts

Plants and People

Edited by WILLIAM G. ARNOLD

Electronics manufacturers plan additional plant and facility expansions, acquire subsidiary companies. Engineers establish new companies, gain promotions to higher responsibilities. Industry associations elect new personnel, plan future activities

RETMA To Honor Galvin, Elects Three New Directors

PAUL V. GALVIN, president of Motorola, and a director of the Radio-Electronics-Television Manufacturers Association for 22 years, will receive the 1956 Medal of Honor during RETMA's convention June 12-14 in Chicago.

Galvin was nominated by the annual awards committee, headed by Leslie F. Muter, who cited his long leadership in Association activities and called particular attention to his work in behalf of the industry during World War II. Galvin was president of RETMA from 1942 through 1944 and has served as chairman of most major committees.

Three new directors were elected by the set and technical products divisions.

David T. Schultz, who formerly

represented Raytheon Manufacturing Co. on the board, was elected as a director from the set division representing Allen B. Du Mont Laboratories, following the acceptance with regret of the resignation of Dr. Du Mont.

Chester G. Gifford, president of the Crosley and Bendix home appliances divisions of the Avco Manufacturing Corp., was elected a director representing the set division following the acceptance of the resignation of Parker H. Ericksen.

David R. Hull, vice-president of Raytheon Manufacturing Co., was elected a director of the technical products division to fill the vacancy created by the resignation of Schultz.

John S. Holmes, president of

Warwick Manufacturing Corp., was elected a member of the set division executive committee, and R. B. Leng, vice-president of the technical products division of the Packard-Bell Co., was elected a member of the military products division executive committee to succeed director Robert S. Bell.

Captain Henry E. Bernstein, commanding officer and director of the Navy Electronics Laboratory at San Diego, Calif., will join the RETMA staff about July 1 as military engineering coordinator.

He will serve as a staff officer of the military products division and maintain close liaison with the RETMA engineering department. His major responsibility will be to coordinate various RETMA military engineering activities.

Varian Plans Future Plant Expansion In California

A MASTER building plan for Varian Associates has been approved and construction will begin in May on new buildings in Palo Alto, Calif. that will more than treble the company's floor space over the next few years. The firm now occupies a laboratory and office buildings in Stanford Industrial Park, Palo Alto, and a microwave tube factory in nearby San Carlos. The Palo Alto building recently has been enlarged to 63,000 sq ft, and the company's leasehold from Stanford University increased from 16 to 33 acres. The new master plan calls for a total of approximately 500,000 sq ft of research, development, manufacturing and administrative facilities.

Construction to begin in May is for the firm's instrument division. Construction of the vacuum tube manufacturing plant is scheduled to start in July. Another building



Russell Varian (left) and Sigurd Varian, president and board chairman, respectively of Varian Associates, stand before the building where the company opened for business in 1948. At right is drawing of firm's new building plans

to be built at a later date will house all administrative offices, freeing additional space for research and development laboratories.

It was also announced that a \$160,000 addition will be made to the Stanford University microwave laboratory. It will be financed largely by contract income and a



gift from Varian Associates.

The Varian-Stanford contract, under which the firm will manufacture and market linear accelerators for medical and industrial use, is expected to provide about half the total cost. The Varian gift, \$50,000, will be paid in \$10,000 annual installments.

***The right people
with the right facilities
produce the
right solutions***

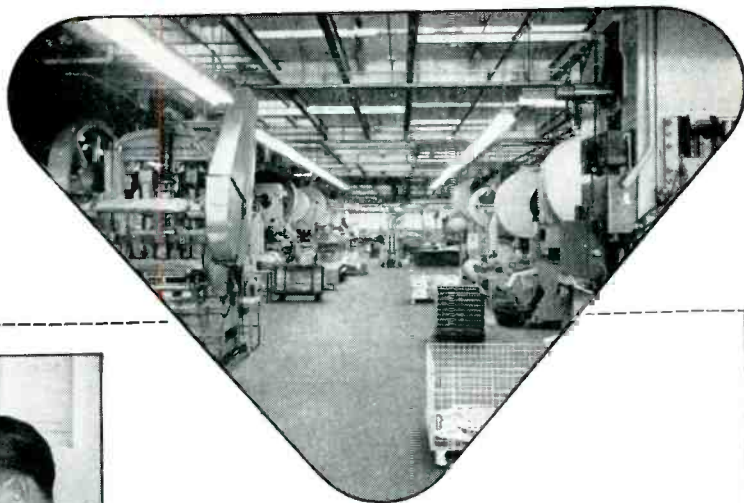

Sheet stock press room and machine shop in Sylvania Buffalo manufacturing plant.



G. L. Downs, Plant Manager, S. Ferrantini, Senior Industrial Engineer, and B. J. Pratt, Supervisor of Industrial Engineering, discussing typical manufacturing techniques involving etched wiring assemblies.

Seven-tube, fixed-frequency "Guard Receiver" (top)—a Sylvania-produced sub-assembly of the AN/ARC-34 UHF Aircraft Transmitter-Receiver (bottom).

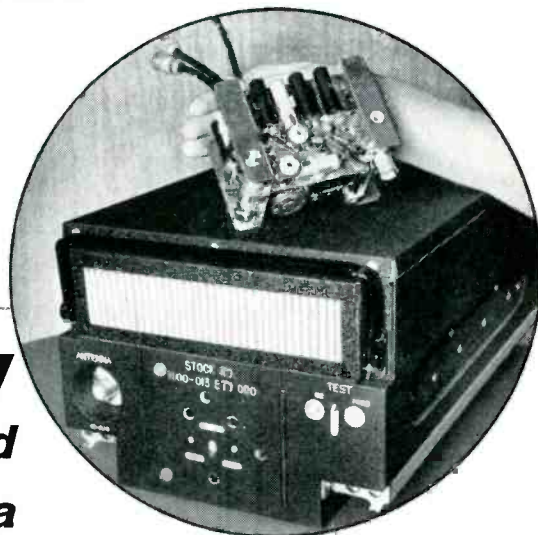

Air-Com reliability ... mass-produced by Sylvania

THE HIGH RELIABILITY essential to multi-channel voice communication for military aircraft is achieved by the AN/ARC-34 UHF Transmitter-Receiver illustrated. Used as a tactical Command Set, the ARC-34 provides dependable communications under all flight conditions.

Major sub-assemblies of this unit are produced by Sylvania in the Electronic Systems Division plant in Buffalo, New York. Because product engineering, manufacturing operations and quality

control are thoroughly integrated within the Division, reliability of the end equipment is achieved on a mass-production basis.

In all of Sylvania's Electronic Systems Division installations, the *right* people work with the *right* facilities, within a sound managerial environment. That is why they have produced the *right* solutions to a variety of problems, and have made many important contributions in the fields of aviation electronics, guided missiles, countermeasures, communica-

tions, radar, computers and control systems. Whether the problem is military or industrial, Sylvania's business is to come up with electronic solutions that are *producible*.

In addition to its Buffalo manufacturing plant and laboratory facilities, the Electronic Systems Division has installations at Waltham, Mass., and Mountain View, Calif., staffed with top-ranking scientists and engineers, and backed by Sylvania's extensive resources in the electronics field.

SYLVANIA IS LOOKING FOR ENTERPRISING ENGINEERS

Sylvania has many opportunities in a wide range of defense projects. If you are not now engaged in defense work, you are invited to contact

Edward W. Doty, Manager of Personnel, Electronic Systems Division, Sylvania Electric Products Inc., 100 First Avenue, Waltham 54, Mass.



SYLVANIA

SYLVANIA ELECTRIC PRODUCTS INC.



LIGHTING • RADIO • ELECTRONICS • TELEVISION • ATOMIC ENERGY

French and U. S. Electronics Firms Form American Company

THE Compagnie Generale de Telegraphie Sans Fil and its group (CSF) of Paris, France, and Airborne Instruments Laboratory, (AIL) of Mineola, N. Y., have formed an American company to manufacture and market in the U. S. electronic products developed in France.

The new company, called the Intercontinental Electronics Corp., is to be financed by 1,500,000 shares of stock of which 250,000 have been subscribed as follows: 100,000 shares by AIL, 100,000 shares by CSF and its group, 12,500 shares by the Bank of Paris, 12,500 shares by the American Research and Development Corp. and the remaining 25,000 shares to other interested parties.

The board of directors of Intercontinental consists of Hector R. Skifter and John N. Dyer of AIL, Arnold Haase-DuBosc and Jean Roy of CSF and its group, and Longstreet Hinton, senior vice-



Robert F. Schulz

president of J. P. Morgan & Company, Inc.

Robert F. Schulz has been appointed president of the new firm. Schulz brings to his new position 28 years of experience in the field of electronics. For the last three years, he was manager of the microwave division of Motorola in

Chicago, Ill. Before joining Motorola, Schulz was associated with Airborne Instruments Laboratory, one of the parents of the new company.

Hector R. Skifter, president of AIL, said that since the end of World War II, tremendous strides have been made in engineering in the European countries, particularly in France and that CSF and its group will contribute substantially to AIL's engineering efforts by offering an opportunity to join with them in a unified program of engineering.

With 10,000 employees, of which 2,500 are trained engineers, distributed over 18 French companies, CSF and its group is one of the chief European electronic concerns. The various companies of the group are organized under a common management headed by Maurice Ponte, general manager of CSF. Total facilities consist of 1,500,000 sq ft of industrial and laboratory space.

Motorola Selects Heads For Defense And Transistor Groups

ARTHUR H. JONES has been appointed director of engineering of Motorola's national defense department.

He was formerly vice-president for engineering of Frank C. Brown and Co. of New York and Hartford. He was concurrently consultant to the Research and Development Board of the office of the Secretary of Defense and to the operations research office of the Johns Hopkins University.

During World War II, Jones, then a colonel, was assigned to General Omar Bradley's First Army Staff as electronics officer.

Motorola announced the promotion of William E. Taylor and appointment of W. R. Sittner at its new transistor laboratory at Phoenix, Ariz. Dr. Taylor becomes chief engineer of the materials research department. He has been associated with the firm's semiconductor program as senior project leader since its inception in 1952. He formerly was associated with the Oak Ridge National Laboratory as a metallurgist.

From 1953 until his appoint-



Arthur H. Jones

ment, Dr. Sittner was associated with the Hughes Aircraft and Pacific Semiconductors, Inc. He will be responsible for the admin-



William E. Taylor

istration of research and development contracts between semiconductor divisions and government agencies.

Maxson Buys Into White, Names Rugge

W. L. MAXSON CORP. has acquired a substantial interest in Roger White Electron Devices, Inc. of Ramsey, N. J. White specializes in the development and production of traveling-wave amplifier tubes, microwave gas tubes, backward-wave oscillators and other elec-

tronics equipment.

Raymond A. Rugge has been elected vice-president in charge of the research and development division of The W. L. Maxson Corp. He will direct all research and development activities for the firm.

Before joining Maxson, he was

See this "Show-Case" of VEEDER-ROOT COUNTERS...

at your
Industrial Supply Distributor

Useful "facts-in-figures" on practically every machine, operation, system or process in industry can be supplied by Veeder-Root Counters for mechanical, electrical and manual operation. And now Veeder-Root Counters can be supplied from stock by certain leading Industrial Supply Distributors. Find out from your own distributor how they can add to the efficiency and *Control* of your plant operation. And if you are selling or designing equipment, contact Veeder-Root for engineering recommendations.



Everyone Can Count on
VEEDER-ROOT
"The Name that Counts"
HARTFORD 2, CONN.

Stocked at Hartford 2, Conn. • New York 19, N. Y.
Greenville, S. C. • Chicago 6, Ill. • Montreal 2, Canada
Offices and Agents in Principal Cities

Insist on Standard VEEDER-ROOT COUNTERS

from your Industrial Supply
Distributor or write us
on special problems

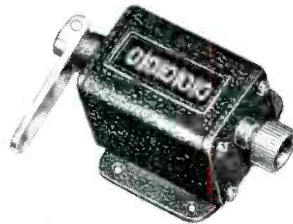

SMALL RESET COUNTER

A compact, rugged reset counter for moderate duty in parts inspection, quality control, conveyors, machine tools, light presses, etc.

Dimensions: 1 3/4" long, 1 1/8" high, 1 1/16" wide

Speed: Up to 1000 counts per minute.

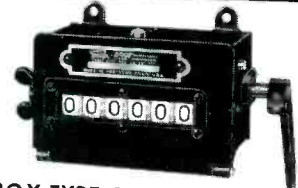

BOX-TYPE RESET COUNTER

For punch press installations, conveyors, metal-working equipment, die casting, plastic-molding, rivet, spring and wire machining, or any installation requiring a heavy duty counter.

Dimensions: 4 1/4" long, 2 5/32" high, 3 3/8" wide.

Speed: 500 counts per minute.

RESET MAGNETIC COUNTER

For remote indication of machine operation from plant to office.

Dimensions: 3 1/16" long, 2 1/2" high, 1 5/8" wide.

Speed: Up to 1000 counts per minute.

Coils: 110V-AC are standard. Other voltages are available. Panel mounting feature also available.

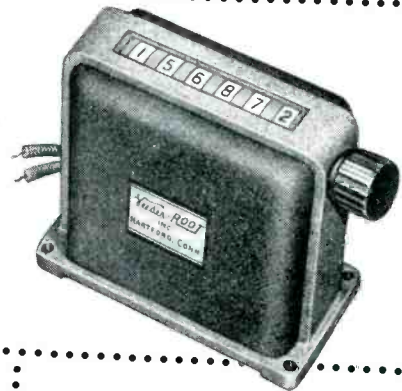

HAND TALLY

For quick spot-checks of production or performance.

Dimensions: 1 1/8" long (to end of reset knob), 1 3/4" deep, 2" high.

Counts one for each depression of the thumb lever, and resets to zero by a turn of the knob.

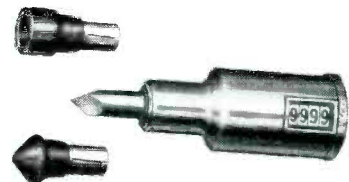

CLUTCH SPEED COUNTER

For checking to make sure that the machine is operating at the required R.P.M. Dimensions: 3 1/4" long, 7/8" max. diameter. Non-Reset.

Internal clutch operates counter only when rubber tip is pressed against the shaft.

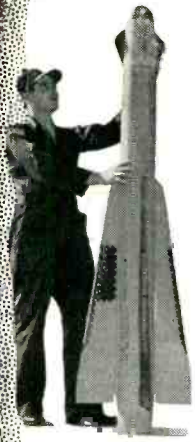

ATLAS Precisioneers "HUSH-HUSH" Assemblies for THE FALCON

● NO HIDING place "upstairs" for enemy bombers with *The Falcon* on the hunt. This newest guided missile is being produced for the U. S. Air Force by Hughes Aircraft Company.

Some of the "innards" of this bird of prey are ATLAS-Precisioneered and classified "confidential." But there's no secret as to how ATLAS can help you develop parts and assemblies from pilot stage to production efficiency for radar . . . sonar systems . . . computers . . . correctors . . . all types of electro-mechanical devices. Just bring your designs to ATLAS. At your disposal on a job basis are our men, equipment, techniques; a prototype is turned over to you for volume production.

When war or peace demands a product, call on ATLAS Precision Products Co. (div. of Prudential Industries), Philadelphia 24, Pa.

Send for booklet, "Precisioneering Electro-mechanical Equipment."

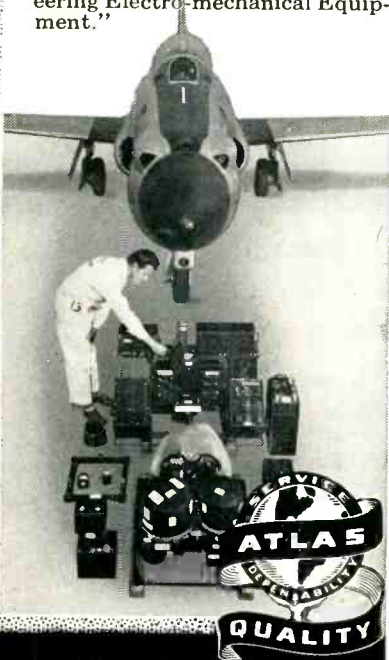

ATLAS

Precision Products

associated with the Minneapolis-Honeywell Regulator Co., first as chief engineer of the aeronautical division and, more recently, as assistant director of aero engineering. Prior to that, he served as chief engineer and division manager of Lear and for 14 years was with Curtiss Wright in charge of the engineering work involved in the design and installation of electrical and electronic equipment in aircraft.



Raymond A. Rugge

Emerson Elects Research Head

HAROLD GOLDBERG has been elected vice-president in charge of research of Emerson Radio. Dr. Goldberg, who has been director of the Emerson Research Laboratories in Washington, D. C. since its establishment more than two years ago, has been succeeded in that post by Donald P. Burcham, assistant director of the laboratories.

Prior to joining Emerson in

1953, Goldberg, for six years, had been co-director with Dr. Burcham of the ordnance electronics division of the National Bureau of Standards, whose activities centered on guided missiles.

In 1946, Burcham joined the ordnance research section of the ordnance development division of the National Bureau of Standards in Washington, D. C.

Honeywell Teaches Automatic Control



MINNEAPOLIS HONEYWELL enrolled its second class of customer students in its European training school at Perivale, England. The newly established school was set up to groom company and customer engineers and technicians in the use of automatic control equipment. Martin Ladden (second from right), director of the firm's school in Philadelphia, explains to two students and the school's European director, Harry Horton (far left) the operation of an electronic recorder. Stu-

dents for the class came from 13 industrial firms.

Mitchell Sells Electronics Division

ELECTRONICS division of Mitchell Manufacturing Co. has been sold to Esco Electronics of Chicago.

The sale follows the purchase of Mitchell's lighting division by Comco Corp. in Chicago.

The electronics division, which manufactured and sold phono-

graphs, radios, high fidelity equipment, tape and wire recorders, intercommunication systems and transistor radios, was bought in its entirety by Esco, headed by Max A. Leavitt, president.

Esco will manufacture and market these products under the Mitchell brand name. Esco also will continue Mitchell's present sales policies and pattern of distribution. The company has been engaged in research, engineering and manufacture of phonographic and other electronic products. For some time they produced phonographs for Mitchell and have manufactured phonographs under private brand contracts for others.

Sale of its electronics division makes Mitchell a producer of air conditioning equipment only. Mitchell was purchased last year by Cory Corp.

RCA Plans Labs, Names DeMooy

RCA plans to establish an advanced development laboratory in the New England Industrial Center at Needham, Mass.

A new building, comprising 20,000 sq ft, has been leased and occupancy was planned for April. The plant will be utilized for advanced developmental work on ferrites under the direction of Francis E. Vinal. Until the laboratory is opened, Dr. Vinal will make his headquarters in Waltham, Mass.

The lab will be an extension of the firm's work on ferrites. Product design utilizing ferrites will be continued at Camden, N. J., and Findlay, Ohio.

During World War II, Vinal was associated with several projects of the National Defense Research Committee after which he returned to M.I.T. as assistant professor of ceramics. In 1952, he transferred to the M.I.T. Lincoln Laboratories, and in 1955 came to RCA as manager of the advanced development ferrites lab.

RCA also announced that a flight laboratory for air and ground testing of airborne electronic equipment and systems has been established at the New Castle County Airport, New Castle, Del.

The new facility is now in

DEFLECTION YOKES

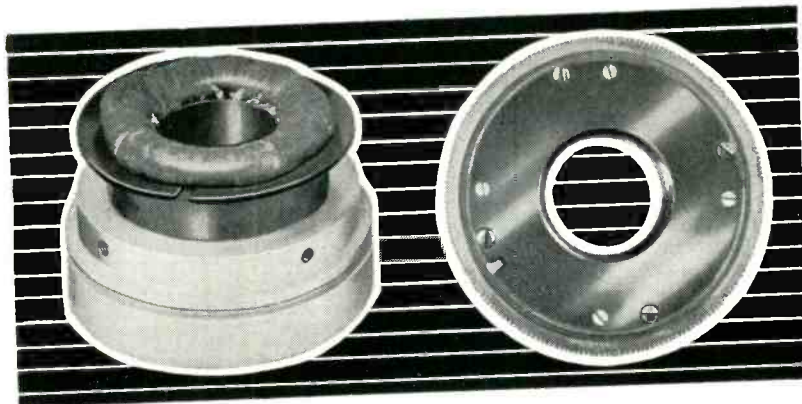

We specialize in the design and manufacture of precision deflection yokes for military and commercial applications. Phone or write for immediate engineering evaluation of your critical display problems.

Celco

Phone: RAMsey 9-1123

Constantine Engineering Laboratories Co.

Island Avenue

Mahwah, N. J.

FOR TRANSISTOR CIRCUIT DESIGNERS!

The New **MA** Automatic Universal TRANSISTOR CURVE TRACER



- Displays Output or Transfer Curve in Grounded Base or Grounded Emitter Connection
- Dynamically Displays Entire Family of Curves Simultaneously on Oscilloscope
- Internally Generated Calibration Axes Displayed at All Times in Any One Quadrant

Designed for comparing, matching and selecting—detecting anomalies—studying effects of temperature, age, normal usage and overloading—and for detecting failures and causes. Instrument tests NPN, PNP, Junction and Point Contact Transistors and features flexibility to accommodate new types. Plots entire family of curves simultaneously on a standard laboratory DC oscilloscope.



For illustrated literature containing complete specifications, call or write:

MAGNETIC AMPLIFIERS • INC

AFFILIATE OF GENERAL CERAMICS CORPORATION

632 TINTON AVE., NEW YORK 55, N. Y.

Telephone: CYpress 2-6610

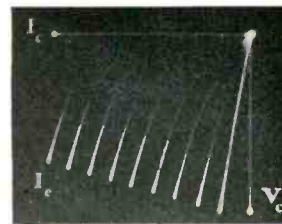

TRANSISTOR CURVES, Output (V_c vs. I_c): Transfer (V_e vs. I_e)

VERTICAL CALIBRATOR: 0-1, 10, 100 volts
HORIZONTAL CALIBRATOR: 0-1, 10, 100 volts

QUADRANTS: I, II, III, IV
LOAD RESISTANCE: 100-10,000 ohms
ACCESSORIES FURNISHED: Transistor receptacle

Designers & Manufacturers of Servomechanisms, Magnetic Amplifiers & Industrial Controls

advanced
technique



AVIONICS

fighter situation
display by AVION



Fighter Situation Display (FSD) is an automatic, continuous indication on a map of the aircraft position during flight.

Developed by Avion for the Air Force. FSD eliminates manual computation and facilitates pin point navigation.

Avion's flexibility and ingenuity, coupled with extensive experience in Electronics, Mechanics and Optics can better serve you.



Investigate the career opportunities in our expanding organization.

AVION DIVISION

— QCF INDUSTRIES
INCORPORATED

299 State Highway #17, Paramus, N. J.

PLANTS AND PEOPLE

(continued)

limited operation and will be completely equipped with maintenance and laboratory test apparatus by May.

Charles L. Sharp, veteran test pilot and aeronautical engineer, has been appointed manager of the laboratory.

The flight laboratory occupies 27,000 sq ft of a new hanger.

The tube division of RCA announced that Harold A. DeMooy has been appointed manager of manufacturing for receiving tube activities at Harrison and Woodbridge, N. J., Indianapolis, Ind., and Cincinnati, Ohio. For the past five years, he has been manager of the firm's tube plant in Cincinnati.

DeMooy joined RCA in 1926 as an engineer and in 1932 was promoted to general foreman, quality control, at Harrison. From 1939 to 1947 he was successively manager of quality control; general fore-



Harold A. DeMooy

man in the assembly of special purpose type tubes, and assistant superintendent in the same section. He was made superintendent of the miniature tube factory in 1947 and continued in that position until 1950 when he was transferred to Cincinnati to direct the opening of the new receiving tube plant.

Beckman Expands Two More Divisions



Left to right, D. C. Duncan, Helipot general manager; A. O. Beckman, president and Mayor Dora Hill of Newport Beach, Calif.

GROUND was broken in Newport Beach, Calif. for the two-million-dollar plant Beckman Instruments will build for its Helipot division. Upon completion late this year and with full expansion, it will employ approximately 2,000 persons.

Initial buildings on the 15-acre site will contain more than 150,000 sq ft of floor space.

Three major interconnected units are planned. A three-level structure, housing administrative and engineering offices, will dominate with a two-level unit devoted to as-

sembly operations and a single-level building to house shop functions.

The Newport Beach site was purchased from actor James Cagney.

By late fall Helipot hopes to consolidate all of its present Southern California facilities in the new building. Currently, it operates manufacturing facilities in 14 locations in Pasadena, South Pasadena, San Gabriel and Alhambra. Helipot will continue to maintain offices and production facilities in Mountainside, N. J., and Toronto, Canada.

Arga division of Beckman, which employs approximately 200 persons in the manufacture of electro-mechanical control systems, will move to Costa Mesa, Calif. in July from its present location in South Pasadena. The firm expects to be fully established in the harbor community by next February.

Arga ultimately will occupy 45,800 sq ft of manufacturing and office space in five buildings.

Arga also announced the purchase, from Belock Instrument Corp. in New York, of manufacturing rights to various mechanical and electro-mechanical devices which give Arga a complete line of servo components.

Beckman also announced that

George K. Turner has been named chief electronics engineer at its Spinco division. He was previously a senior engineer in the military electronics division of Hycon Manufacturing Co. in Pasadena. Prior to this he was chief electrical engineer and works manager at Alabama Engineering and Tool Corp., supervisor of the systems engineering unit of the computer group at North American Aviation Corp. and project engineer at Consolidated Engineering Corp.

Hughes Promotes Six Engineers

SIX engineers working in research and development of guided missiles, have been promoted by Hughes Aircraft.

Renne S. Julian has been appointed technical director of the Hughes guided missile laboratories. With Hughes since 1949, Dr. Julian previously served as head of the electronics department of the laboratories.



Renne S. Julian

Charles C. LeGrand replaces Julian as head of the electronics department. A former associate head of the department, LeGrand also became associated with Hughes in 1949.

Appointed as assistant to LeGrand is George McLaughlin, who joined the firm in 1951.

Other appointments in the guided missile laboratories include:

Thomas B. Carvey, Jr., assistant head of the design integration department; Robert E. Sears, assist-

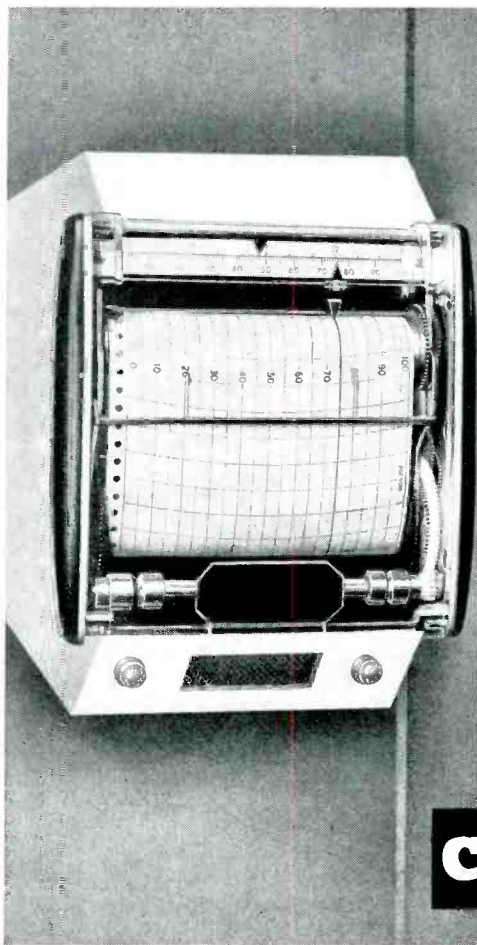

COTO-COIL and *Controllability*

The rapid spread of automation throughout industry would be impossible without efficient control systems. Some of the finest measuring instruments depend upon Coto-Coils to attain the highest degree of precision and dependability.

If you use coils, Coto-Coil can save you countless hours of laboratory and production time by producing the exact coil you require in the desired quantity.

Send details to . . .

COTO-COIL CO., Inc.
65 Pavilion Avenue
Providence 5, Rhode Island



Short Cut for Executives Considering NEW PLANT SITES

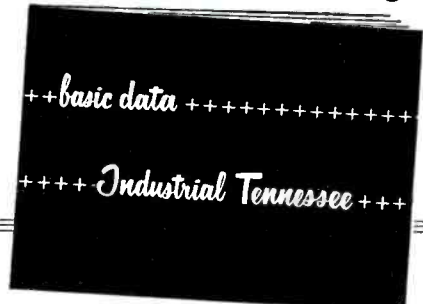

This 28-page booklet outlines, without exaggeration, the principal advantages of a state which has been designated by industrialists already located in Tennessee as "America's No. 1 Industrial Opportunity."

From the booklet you can get a clear picture of Tennessee towns and cities, markets, labor, raw materials, fuels and power, transportation, industrial capacity and diversification, living conditions, industrial

tradition, recreational facilities, and the close cooperation you will obtain from Tennessee officials in choosing the exact location you need.

Don't make any decision about a new plant site until you investigate Tennessee thoroughly. As an invaluable short-cut to this investigation, fill out the coupon below.

Mail Coupon Today

TENNESSEE

Industrial & Agricultural
Development Commission
L-1 Cordell Hull Building
Nashville, Tennessee

Please send
"Basic Data" booklet

• NAME _____
• FIRM _____
• ADDRESS _____
• CITY & STATE _____

NEED RELAYS?

SPECIFY



and get more for your relay dollar!

Quality construction

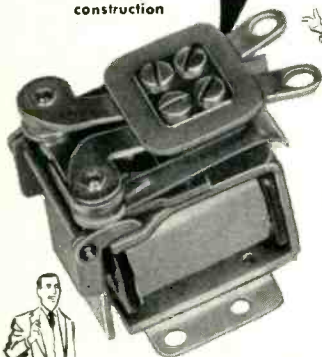

Speedy delivery

Lower costs

Pick the size you want... choose the features you need...

you'll find that an AEMCO relay will meet or exceed your specifications. Compact in design, dependable in performance, AEMCO relays are manufactured with extreme care—the choice of more than 100 top names in American industry—and here are the reasons why:



Lower cost—due to modern production techniques and fresh, new engineering ideas. All AEMCO products are designed with short-cuts and specific production economies in mind.



Top quality—based on more than 30 years experience. We'll work closely with your design engineers, and we'll do it without red tape or confusion.



Many standards—to choose from. AEMCO relays are available in a wide variety of spring and coil combinations, operating potentials, and contact ratings. Types include: open, can, plug-in base, hermetically sealed, midgets, dual-purpose, delayed make or break, circuit control, current, and potential relays.



Speedy prototype delivery—and quick tool up for production. Yes, at AEMCO we're selling service as well as design and manufacturing ability.



For more information on the standard AEMCO relay line, write for your free descriptive bulletin today!

AUTOMATIC ELECTRIC MFG. CO.
11 STATE ST. • MANKATO, MINNESOTA

Want more information? Use post card on last page.

ant head of the propulsion department and Lowell C. Parode, assistant head of the electronics department.

Firms Expand In Santa Monica

CONSTRUCTION has begun in Santa Monica, Calif. on the first multi-million dollar project in the new John M. Stahl industrial development, devoted exclusively to the field of electronics. The 30-acre development, when completed around mid-1957, will represent an investment of around \$38 million, and will house some 6,000 workers in one million sq ft of facilities. A \$600,000 building for the Burton Mfg. Co., makers of scientific instruments, servo mechanisms and other devices, is already in use.

The first major project, now getting under way, is a \$2.5 million research and office building for Rand Corporation's system development division. The two-story, 102,000 sq ft building, like all the structures in the development, will be constructed of tilt-up concrete walls and prestressed concrete floors and roof. An additional 160,000 sq ft structure for the division will be started on completion of the first, probably this fall. The Rand division is currently engaged in a training program for the conduct of a manual aircraft control and warning system, and is preparing a similar training program for SAGE crews.

In addition to the Rand project, Radar Corp. of America, an electronics research firm, is said to be planning a multi-million dollar facility.

Burroughs And Electrodata May Merge

THE board of directors and stockholders of Electrodata Corp. will be asked to approve a plan whereby one share of Burroughs Corp. common stock will be issued for each two shares of outstanding Electrodata stock.

Burroughs is presently manufacturing and marketing desk-size digital computers and will shortly

MODEL MH15A For mounting on drums having as few as 30 channels or as many as several hundred. Simple Design—Flexible Operation—Low Noise—High Voltage Insulation. Moisture Proof unit completely encapsulated.

CHARACTERISTICS

Recording System; Non-return to zero. Drum Speed; 2300 in. per sec. Writing Current; 70 ma. Cell Density; 100 bits per in. Head to Drum Spacing; .001 inch. Drum Coating; Red oxide, .001 in. thick. Output; 1 volt peak to peak. Track Width; .125 in. Core Width; .090 in.

The performance characteristics of Model MH15A can be incorporated in the MH10A case if desired.



LIBRASCOPE

READ-RECORD HEADS

Specifically Designed for Reading or Recording on Magnetic Drum Memory Systems

MODEL MH10A Designed for use with an eccentric for radial position adjustment in relation to the drum. Low write current. High readback voltage. 2 piece sintered ferrite core. Potted. Dimensionally stable.

CHARACTERISTICS

Recording System; Non-return to zero. Drum Speed; 1200 in. per sec. Writing Current; 20 ma. Cell Density; 100 bits per in. Head to Drum Spacing; .001 in. Drum Coating; Red oxide, .001 in. thick. Output; 0.5 volt peak to peak. Track Width; .062 in. Core Width; .040 in.

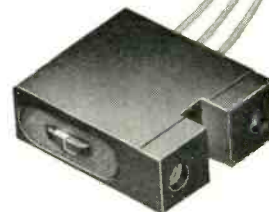

Other models available... write for brochure.

LIBRASCOPE

A SUBSIDIARY OF GENERAL PRECISION EQUIPMENT CORPORATION

808 WESTERN AVENUE • GLENDALE, CALIFORNIA
Want more information? Use post card on last page.

May, 1956 — ELECTRONICS

announce completion of the first model of a large scale electronic system. Addition of Electrodata would result in a complete line of electronic data processing systems ranging from the desk-size computer to large electronic systems.

U. S. Hoffman Buys Into Anton Electronics

U. S. HOFFMAN MACHINERY CORP. entered the atomic energy field through purchase of a majority interest in Anton Electronic Laboratories, Inc., of Brooklyn.

The Anton firm will operate as an independent subsidiary with Nicholas G. Anton, founder and president, continuing in that post. The parent firm will shortly add several representatives to the Anton board.

Anton was the founder and president of Amperex Corp. before resigning to form his present firm to specialize in its field of interest and is a veteran engineer with more than 25 years' experience in the field of electronics.

U. S. Hoffman is one of the largest sellers of dry cleaning and laundry machinery. Its six subsidiaries manufacture such varied products as aircraft and guided missile components and test equipment, agricultural and industrial machinery, vending machines, metal containers and candy. In addition, the company operates three munitions plants.

Nuclear Acquires Central Sales

NUCLEAR Corporation of America, Inc., has acquired the assets and business of Central Sales & Mfg. Corp. of Denville, N. J. in exchange for 408,000 shares of Nuclear's Class A stock.

The acquisition will increase overall manufacturing facilities of Nuclear by more than 50 percent, will add projected sales of \$1,500,000 and a gross profit of about \$200,000 to Nuclear's earnings for 1956.

The move is the second phase of Nuclear Corporation's plans for a

IF IT'S NEW ... IF IT'S NEWS ... IT'S FROM **ELCO**

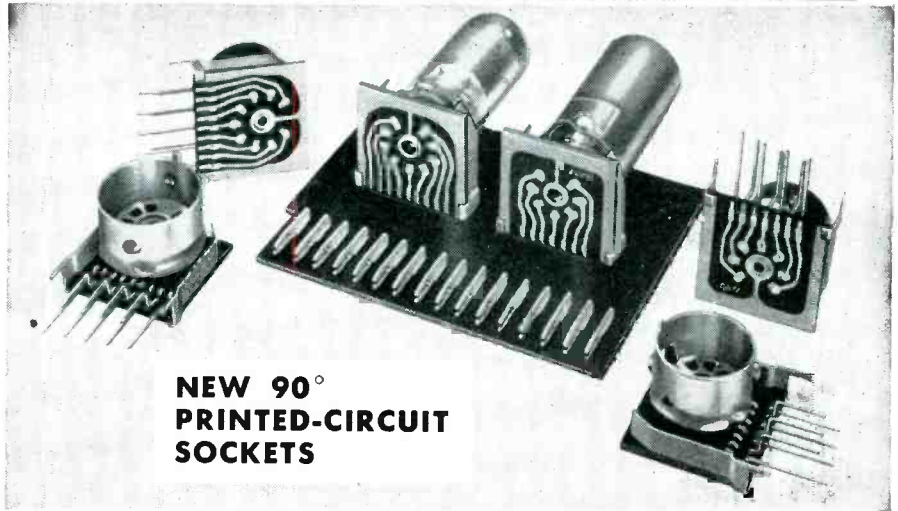

NEW 90° PRINTED-CIRCUIT SOCKETS

Newsworthy and newsmaking are Elco's new 90° Printed Circuit Sockets for 7-pin and 9-pin miniature tubes. These Elco quality components permit installation of the tubes in a position parallel to the printed-circuit chassis, thus conserving space where height is limited. The new sockets carry the same characteristics as standard miniature tube sockets. Furthermore, mounting brackets are designed to maintain rigidity and cannot be loosened from the chassis. For further information, please address your inquiry on your company's letterhead.

ELCO CORPORATION, M STREET BELOW ERIE, PHILA. 24, PA., CU 9-5500

unique in design — rugged in construction

GREEN PANTOGRAPH ENGRAVERS

THE NEW HEAVY-DUTY MODEL D-2



THE FAMOUS MODEL 106

The three-dimensional bench Model 106 cuts costs — engraves, routs, models and profiles, giving you expert results even by unskilled workers.

The Model D-2 heavy-duty two dimensional Pantograph is a precision machine with a multitude of new features. Open on three sides, it permits complete freedom for engraving, milling, profiling large panels (up to 30" in diameter) or bulky pieces. Single, micrometer adjustment controls vertical depth of cut, automatically adjusting copy table with pantograph. Range of reduction ratios from 2-to-1 to infinity! Vertical range over 10 inches!

For complete information, write to

GREEN INSTRUMENT COMPANY

363A Putnam Ave.

Cambridge, Mass.

NOW!

a ONE MEGACYCLE PULSE GENERATOR with CONTINUOUS CONTROL of REPETITION RATE, PULSE WIDTH, and DELAY

MODEL B-3 PULSE GENERATOR

Featuring:

- Excellent RF shielding to prevent the radiation of spurious signals
- Pulses of either Positive or Negative polarity
- External triggering and push button single pulse operation
- Modular construction

The Rutherford Model B-3 Pulse Generator is a highly versatile, general-purpose instrument designed for applications involving repetition rates through one megacycle, delays from 0 to 10,000 μ s, and fast rise time pulse output of positive or negative polarity and widths to 10,000 μ s.

Write for complete data: our Bulletin E-B-3

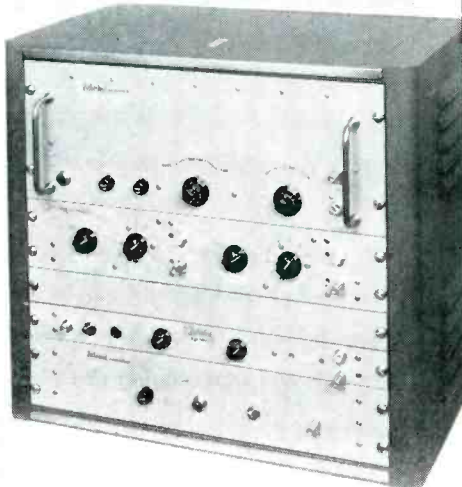

OTHER PRECISION PULSE INSTRUMENTS.
WIDE RANGE PULSE GENERATORS.
DIGITAL AND ANALOG TIME DELAY GENERATORS, TIME MEASURING SYSTEMS

Rutherford

ELECTRONICS CO.

Telephone: TEXAS 0-4362
3707 S. ROBERTSON BLVD.
CULVER CITY, CALIFORNIA

nylo-fast

ALL-NYLON FASTENINGS

IN STOCK



FAST
SERVICE
ON SPECIALS

WRITE
FOR FREE
CATALOG

Anti-Corrosive Metal Products Co., Inc.

CASTLETON-ON-HUDSON, N. Y.

broad expansion of its operations through internal growth and the acquisition of companies in its field. In November of last year, Radioactive Products, Inc., of Detroit, Michigan, was acquired.

Lyle A. Backer, president, and James V. Cosman, vice-president, will continue in these posts with Central Sales which will operate as a wholly-owned subsidiary of Nuclear Corp.

Organized in March, 1947, Nuclear's new subsidiary is engaged in engineering and manufacturing of electron tubes and equipment.

Central operates in three buildings located on six acres of land. The buildings provide 20,500 sq ft of space, of which 17,500 presently are devoted to manufacturing, and the balance houses the engineering and office staffs. Company employees total 60, with technical personnel numbering 12. From a sales level of only \$12,000 in 1947, operations of the company have expanded to a point where sales exceeded the \$500,000 mark in 1955.

Nuclear manufactures radiation detection equipment, electronic components and related end-equipment, radio pharmaceuticals and special chemicals. Special emphasis is being placed on the development of industrial process control instrumentation.

Polarad Elects New Vice-President

FRANK J. SKWAREK has been elected a vice-president of Polarad Electronics Corp. Prior to his elec-



Frank J. Skwarek

a complete line of
Printed Circuit Hardware
and
Terminal Inserting Equipment

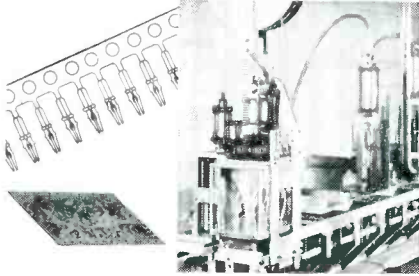

Tubular Pin Terminals—Insert automatically into printed circuit board at huge production savings. Snap into position with positive locking action by means of self-retaining snap-in feature. Double ends permit wrapping or inserting leads at either end. Ask for Bulletins 550 and 551.

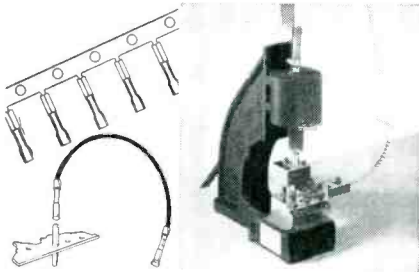

Solderless Wire Disconnect Female Terminals—Speedily applied to leads by means of cost-saving automatic equipment. Fits quickly and firmly to tubular pin terminals. Solderless wire crimp can be varied to fit various size insulated wires. Ask for Bulletin 553.

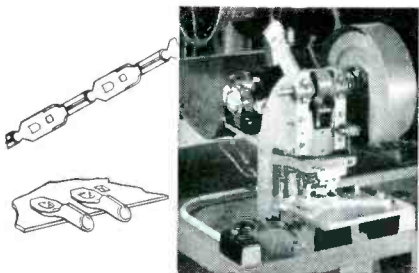

Line Cord Interlock Terminals—For single or multiple lead connections. Another Malco automation development to provide production short cuts and assembly economy. Terminals are staked quickly and firmly into printed circuit boards. Ask for Bulletin 554.

Malco printed circuit hardware can be engineered to your specific requirements. Give us the facts about your operation. We'll show you how your costs can be lowered and your production increased. Ask for Bulletin 551.

Malco TOOL and MANUFACTURING CO.
4023 W. Lake St., Chicago 24, Ill.

Want more information? Use post card on last page.
ELECTRONICS — May, 1956

tion he was manager of engineering operations.

Since 1944 Polarad has been engaged in the development and manufacture of precision electronic devices, microwave test equipment and color television equipment.

Skwarek has had engineering and administrative experience with the Sperry Gyroscope Co., the Doelcam Corp. and Raytheon.

**Diamond Power
Names Chief Engineer**



John A. Rado

JOHN A. RADO has been appointed chief engineer of the electronics department of Diamond Power Specialty Corp. in Lancaster, Ohio. The department develops and manufactures closed circuit tv.

Rado was previously with Telechrome Manufacturing Corp. as assistant chief engineer, directing work on information storage devices, color tv receivers and studio equipment development.

Following World War II he spent several years with Federal Telecommunications Laboratories and the New London Instrument Co. In 1950 he returned to Hazeltine as a member of the advanced research group. He had worked for Hazeltine before the war.

**Mohawk May
Acquire Carol**

MOHAWK Business Machines of Brooklyn, N. Y., may acquire all the outstanding capital stock of Carol Electronics Corp. of Martins-

**CODE
MARK**
Anything!

WITH



★ **CODE MARKING INKS**

For Resistors and Capacitors. For Machine or Hand Application.

Whatever the substance, Phillips has an ink to mark it permanently and legibly—or can make one. Marking experts insist on "Clear Print" Wood Block Stamp Pads and Opaque Inks. They get clear, sharp, fast-drying impressions. Also inks for brush, pen, stencil or machine application available in a variety of colors and quantity containers.

★ **Quick Laboratory Service** On Your Problem Markings.

★ **To Permanently Mark . . .** Metals, Plastics, Glass, Wood, Paper, Leather, Ceramics—glazed, varnished or lacquered surfaces and virtually every other known material.



35



PART NO
10

RI

WRITE FOR
FREE
BOOKLET



L. A. PHILLIPS, President
**PHILLIPS
PROCESS CO. INC.**
192 MILL STREET
ROCHESTER 14, N. Y.

Want more information? Use post card on last page.

Recharge
Your own
Instrument
Magnets!

Model 107A is a basic charger for most shops

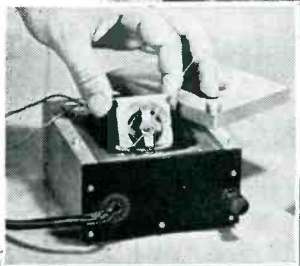

Wire-wound fixture for core type mechanisms

Any Type,
Size or
Shape!

RECOMMENDED BY LEADING INSTRUMENT MAKERS

Charging current equivalents up to 200,000 ampere-turns (sufficient to saturate 30 lbs. of Alnico V) are available in the Model 107A and new Model 942 condenser discharge magnet chargers. Both units employ same versatile pulse transformer and wire-wound fixture methods. Adapters for any shape or pole configuration can be supplied to charge all instrument or other permanent magnets made from any magnetic material.

All units are easy and safe to operate and are designed for continuous production use over many years.

The benefits of charging magnets in your own plant or laboratory are well worth investigating.

WE CAN HELP YOU

Our 12 years of magnet charging experience is yours for the asking — send a sample magnet or sketch for free charging analysis.



Write for Technical and Application Data.

**Radio Frequency
LABORATORIES, INC.**
Boonton, New Jersey, U.S.A.

Want more information? Use post card on last page.

burg, West Virginia for 425,000 shares of the common stock of Mohawk, if stockholders approve.

Carol manufactures electronic equipment for the government.

Mohawk manufactures miniature tape recorders.

Mohawk's net sales climbed from \$432,188 in 1954 to \$957,608 in 1955. It is expected that combined sales of Mohawk and Carol will reach nearly 3 million dollars in 1956.

Van Norman Elects New President

HERBERT I. SEGAL, a director of Van Norman Industries, was elected president of the company, succeeding James Y. Scott, resigned.

He is also president of Segal Affiliates, Inc. of New York City, business counsellors; chairman and director of Hasco Machinery Co. of Newark, N. J., distributors of machine tools; and vice-president and director of Curtice-Lyle Properties, Inc., and Rochester Industrial Terminal, Inc., both of Rochester, N. Y., operators of industrial property.

Donner To Build New Plant

DONNER Scientific Co. of Berkeley, Calif., will build a \$250,000 plant in Concord that will replace the Berkeley facility. The new 22,000 sq ft plant is to be ready for occupancy by September. It will enable Donner to manufacture the test equipment, analog computers and servo accelerometers it has developed. They now are manufactured for Donner by Sargent-Bayment Co., Oakland producer of high fidelity equipment.

Eimac Makes Administrative Changes

GEORGE WUNDERLICH, vice-president and general manager of Eitel-McCullough has been named to fill the newly created position of vice-president of manufacturing. E. E. McClaran has become vice-president of finance. Frank Mansur will head a new marketing department as manager of marketing. John S.

let Williams
help you apply

**FERRIC
OXIDES**

to the manufacture
of your

FERRITES

You'll be well repaid by getting the facts on a special group of Pure Ferric Oxides, developed by Williams especially for use in the manufacture of ferrites.

Williams Ferric Oxides analyze better than 99% Fe₂O₃. They contain a minimum of impurities. They are available in a broad range of particle sizes and shapes. Among them, we're certain you'll find one that's "just right" for your requirements. The proper application of Ferric Oxides to the manufacture of Ferrites is our specialty.

Tell us your requirements . . . we'll gladly send samples for test. Chances are good that our Ferric Oxide "Know How" can save you considerable time and money. Address Dept. 25, C. K. Williams & Co., Easton, Pa.

WILLIAMS
COLORS & PIGMENTS

C. K. WILLIAMS & CO.
Easton, Pa. • East St. Louis, Ill.
Emeryville, Cal.

P.S. We also produce IRN Magnetic Iron powders for the Electronic Core Industry, the Magnetic Tape Recording Industry and others. Write for complete technical information.

Want more information? Use post card on last page.

McCullough has been appointed director of research and Fred A. Speaks has been named assistant director of research.

Wunderlich, who joined Eimac in 1941 and became vice-president and general manager in 1951, will direct all the expanding manufacturing activities of the company in his new position.

McClaran came to Eimac in 1951 as controller.

Mansur, new manager of marketing, comes to Eimac from Hazeltine Electronics Corp. where he served as sales manager and manager of the government and commercial department.

McCullough, director of research, joined the firm in 1946. In 1951 he was named assistant director of research.

He succeeds the late Harold E. Sorg, vice-president, who served as director of research for 14 years.

Speaks joined Eimac in 1954.

Du Mont Moves Missile Group



Melvin B. Kline

HEADQUARTERS for Du Mont's missile engineering department will be transferred to the firm's new plant in Los Angeles, Calif. Headquarters for missile work had previously been at Clifton, N. J., and it is planned to continue work at that location.

Melvin B. Kline has been promoted to manager of the missile engineering department in Los Angeles.

Prior to his new appointment, he



★ **ULTRA LOW**

capacitance & attenuation

WE ARE SPECIALLY ORGANIZED TO HANDLE DIRECT ORDERS OR ENQUIRIES FROM OVERSEAS
SPOT DELIVERIES FOR U.S.
 BILLED IN DOLLARS—
 SETTLEMENT BY YOUR CHECK
CABLE OR AIRMAIL TODAY

TYPE	μF/ft	IMPED.Ω	O.D.
C1	7.3	150	.36'
C11	6.3	173	.36'
C2	6.3	171	.44'
C22	5.5	184	.44'
C3	5.4	197	.64'
C33	4.8	220	.64'
C4	4.6	229	1.03'
C44	4.1	252	1.03'



NEW 'MX and SM' SUBMINIATURE CONNECTORS
 Constant 50Ω-63Ω-70Ω impedances

TRANSRADIO LTD. 138A Cromwell Rd, London SW7 ENGLAND

CABLES: TRANSRAD, LONDON

For sensitive electrical devices

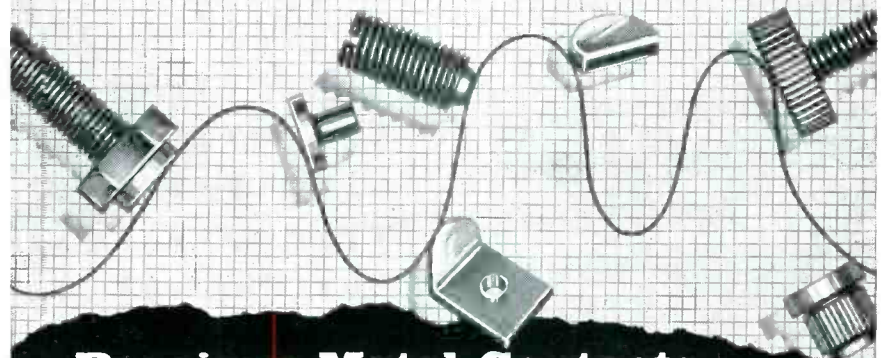

Precious Metal Contacts

provide unvarying performance

Made of platinum, palladium, silver, gold and their alloys—Baker contacts offer the unvarying performance required for extremely sensitive electrical apparatus and instruments. High purity metals, controlled at every stage of production,

insure quality Baker contacts.

The most diversified selection of contact materials and types of contacts can be supplied by Baker in practically any specified dimension to meet your requirements.

Write for complete data

BAKER PRECIOUS METALS
 & COMPANY, INC.

113 ASTOR ST., NEWARK 5, N. J.
 NEW YORK • SAN FRANCISCO
 LOS ANGELES • CHICAGO

ENGELHARD INDUSTRIES

HIGH PRODUCTION,
PRECISION,



*Electronic Circuits
*Nameplates *Dials...

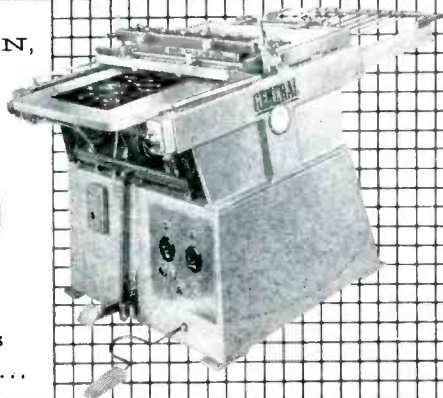

GENERAL

DECORATOR PRESSES—SERIES "B"

A new General precision built screen process press, especially adapted to the high volume production of printed circuits, nameplates and dials. Incorporates a new and completely different approach to the handling of many difficult materials. Precision register assures proper placement of print on panel and accurate backing-up of two-sided circuits. Heavy deposits of

plating and acid resists can be laid down assuring quality printed circuit results. Fine lines print clean and sharp and the enamel effect required in the manufacture of nameplates and dials is effectively reproduced. Work can be both fed and delivered at front of press, or delivered at rear for in-line operation with the General Thermo-Jet Dryer, or other drying equipment.

Model	Sheet Size	Speeds Up To
B1224	13"x25"	1000 iph
B2230	22"x30"	800 iph
B2236	22"x36"	800 iph

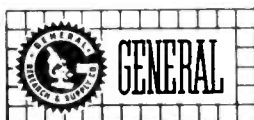

Write for
complete information!

RESEARCH & SUPPLY CO.
572 S. Division Avenue
Grand Rapids 3, Michigan

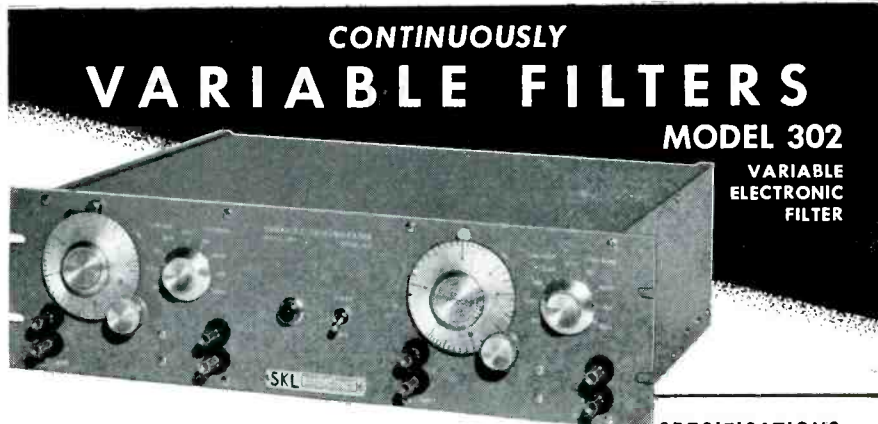

CONTINUOUSLY VARIABLE FILTERS

MODEL 302

VARIABLE
ELECTRONIC
FILTER

Fast, Accurate, Reliable

The — SKL — Model 302 includes two independent filter sections, each having a continuously variable cut-off range of 20 cps to 200 KC. Providing a choice of filter types each section has 18 db per octave attenuation. When cascaded 36 db is obtained in the high and low pass setting and 18 db in the band pass position. With low noise level and 0 insertion loss this versatile filter can be used as an analyzer in industry and the research laboratory or to control sound in the communications laboratory, radio broadcasting, recording and moving picture industries.

SPECIFICATIONS

- CUT-OFF RANGE
20 cps to 200 KC
- SECTIONS
2—can be high, low and band pass
- ATTENUATIONS
36 db/octave maximum
- INSERTION LOSS . 0 db
- NOISE LEVEL
80 db below 1 volt
- FREQUENCY RESPONSE
2 cps to 4 MC

SKL SPENCER-KENNEDY LABORATORIES, INC.
1321 SOLDIERS FIELD ROAD, BOSTON 35, MASS.

was manager of government and special products engineering for the technical products division. He joined the Du Mont organization early in 1941 as an electronic engineer, and was associated primarily with the development and design of cathode-ray oscillographs and related equipment. For several years he was head of the special products section of the instrument engineering department.

Canadian RETMA Names Manager

FRED W. RADCLIFFE has been appointed general manager and secretary of Canadian RETMA.

The position became vacant when Stuart D. Brownlee, who held it for ten years, resigned to become executive vice-president of Canadian Admiral Corp.

In accepting the appointment, Radcliffe relinquishes his position of commercial vice-president of RCA Victor Company Limited. He has been in the commercial and administrative departments of RCA Victor for the past 36 years.

He has served as a RETMA director for twenty years and is currently the chairman of the sales and merchandising committee of the receiver division.

Triplet Instrument Elects President

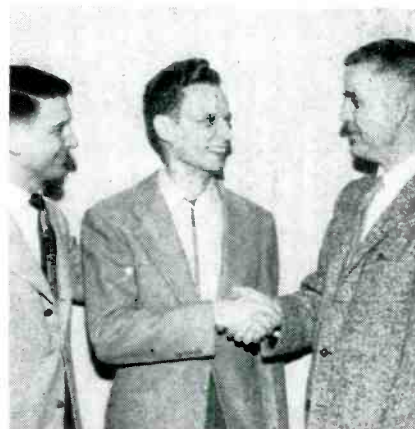

Left to right: M. M. Triplett, W. R. Triplett and N. Triplett

W. ROPP TRIPLETT, general manager of the Triplett Electrical Instrument Co. of Bluffton, Ohio, has

STAVOLT POWER RECTIFIERS

30
Standard
U.L. Approved
Models

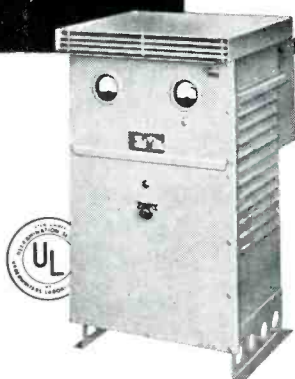

- Stationary or Mobile Types
- For Hangars, Air Fields, Missiles
- For Factories and Labs

Mag-Amp Control, Stable, Fast
15 to 1500 amps

Write for interesting information
on STAVOLT RECTIFIERS

McCOLPIN-CHRISTIE CORP.
27th Year of Rectifier Manufacturing
3410 W. 67th St., Los Angeles 43, Calif.

WIDE-RANGE FREQUENCY METER 85-1000 MEGACYCLES

TS-175A/U

- Government
Approved
Calibration
Accuracy:
.005%
- Stability:
.0025%
- Resettability:
.0025%



A VERSATILE PRECISION MEASURING INSTRUMENT

Recommended Applications:

- Precise Measurements of Frequencies
- Production Testing
- Alignment of Transmitters and Receivers
- Laboratory Testing
- Portable Field Testing
- A Secondary Frequency Standard
- Signal Generator Calibration
- U.H.F. and V.H.F. Television Alignment

COLORTONE

ELECTRONICS, Incorporated
200 Frank Road, Hicksville, L. I., N. Y. HI 4-2124

Want more information? Use post card on last page.

been named president of the company.

Ray L. Triplett, founder and president of the firm becomes chairman of the board of directors.

W. Ropp Triplett is one of two sons of Ray L. Triplett. The other son, M. Morris Triplett, is currently serving as vice-president in charge of engineering.

Mycalex Appoints Research Engineer

PHILIP S. HESSINGER has been appointed research and development engineer of Mycalex Corp. of America. He will assume responsibility for new product development and research at the Clifton, N. J. plant.

He was a research associate in the laboratory development of ceramic sandwich-type dielectrics at the Ohio State University Research Foundation.

He served three years in the Air Force as a project officer in the aeronautical research laboratory and in the electronics components laboratory WADC-USAF development program.

Precision Technology Opens New Plant

PRECISION TECHNOLOGY, a GPE subsidiary, has opened a new engineering laboratory and production facility in Livermore, Calif.

The new facility will produce electrical and electronic instruments designed primarily to measure transient phenomena such as blast, detonation, shock tube studies and wind tunnel studies.

Bell Sound Gets New President

K. L. BISHOP has been named president and general manager of Bell Sound Systems, Inc., of Columbus Ohio, a Thompson Products subsidiary.

Bishop was vice-president and general manager of W. E. Payne, Inc. of Chicago and, for the past eight years, general sales manager of V-M Corp. in Benton Harbor, Mich.

Other members of the Bell Sound management include: W. H. Bunce,

New!

A LOW COST BRIGHT RHODIUM PLATING PROCESS

for electronics and
electrical components



BRIGHT RHODIUM PROCESS

At last . . . a long sought rhodium plating process which provides all the desirable characteristics of rhodium plus many exclusive features which makes it particularly suited for electronic and electrical component manufacture.

Sel-Rex BRIGHT RHODIUM used extensively in following products



Printed Circuits



Connectors



Tubes



Wave Guides



Switches



Reflectors

Sel-Rex BRIGHT RHODIUM deposits are mirror bright, resistant to tarnishing and corrosion, have excellent conductivity and reflectivity. Produces a hard surface that is excellent for sliding and wiping electrical contacts where light or heavy pressures and low contact resistance are required.

EXTRA! Sel-Rex BRIGHT RHODIUM offers ASC — Automatic Stress Compensation — a special technique which counteracts the high stress characteristics inherent in conventional rhodium plate.



Sel-Rex Precious Metals, Inc.

229 Main Street • Belleville 9, N. J.

Sel-Rex Precious Metals, Inc.
229 Main Street, Belleville 9, N. J.

Please rush literature on Sel-Rex BRIGHT RHODIUM and other famous Sel-Rex Plating Processes.

Name _____
Company _____
Address _____
City _____ Zone _____ State _____

Want more information? Use post card on last page.

THE RAYOTRON

First Low-Cost Electrostatic Generator and Particle Accelerator



X-ray analysis, high-voltage research, physics laboratories.

Generator produces 1/2 million volts, 16-inch sparks. Cost, \$175. Optional instrumentation, \$25. Choice of several beam tubes. Diffuse, high-energy X-ray beam tube (.5 mev, 20 microamps, up to 20 R/hr), \$120. Focused high-energy X-ray beam tubes, from \$350. Thin-window beam tube for high-energy electrons in air, at various prices. Small fluoroscopic screen and six X-ray plates, \$20. New Accelerator Syllabus and experiment manual included in all orders.

GLASSBLOWER'S SET

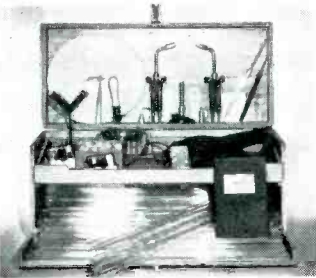

Complete with 21-lesson glassblowing course by Morley Corbett, Instructor of Student Glassblowing, Physics Dept., University of Calif., Berkeley.

Here is a comprehensive training program in Scientific Glassblowing organized into 21 one-hour lessons with all the necessary tools, apparatus, equipment (except fuel) and glass supplied in a handsome wooden chest. Now schools and colleges may train students for one of America's highest-paid vocations, without engaging the expensive services of a professional glassblower. Set with course, \$149.50; Course alone, \$7.50.

See Cosmic, Alpha, Beta Rays

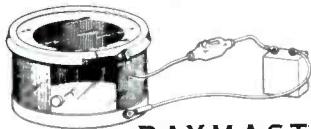

RAYMASTER CLOUD CHAMBER

Now in use in 650 leading universities and high schools. Ideal for nuclear physics experiments at home.

Unconditionally guaranteed to register all tracks continuously. Fused silver electrodes. Optical-grade cover glass permits overhead viewing and photography. Comes complete with Alpha and Beta sources, clearing field battery, manual of experiments, nuclear physics syllabus. Only dry ice and alcohol must be procured locally. Price, \$32.50.

For further information write



ATOMIC LABORATORIES

P.O. Box 343 • Berkeley, California

All prices F.O.B. Berkeley. In California add 3% sales tax.

Want more information? Use post card on last page.

384

PLANTS AND PEOPLE

(continued)

operations manager; H. H. Seay, sales manager and Floyd W. Bell, in charge of engineering.

IT&T Selects New Lab Personnel

FIVE engineering and administration executives have been named to supervise preliminary operations of the new California branch of IT&T's Federal Telecommunication Laboratories.

Headed by Paul R. Adams, director of the electronic systems laboratory, who has been selected manager of the new laboratories, the group will be the nucleus of a staff which will conduct research and development of inertial air navigation systems, digital computers for aircraft, and airborne electronic systems.

Accompanying Adams will be Coleman Clark and Carlos Miller, of the senior technical staff, who will direct digital computer research and mechanical engineering, respectively.

Theo C. Allen, executive training and development manager, and J. Eugene Bower, assistant secretary and associate contract manager, are also in the advance group.

The new laboratories are the first of a projected series of five structures on a 13-acre tract. The building will serve also as the West Coast headquarters for IT&T's Federal Telephone and Radio Co. Earlier IT&T announced that Joseph A. Frabutt, general sales manager of Federal Telephone and Radio Co., had been appointed a vice-president in charge of Fed-



Joseph A. Frabutt



DANO COILS

LIFELINE TO PRODUCTION

From design engineer to the purchasing agent to Dano—a perfect "lifeline" to production.

CALL or WRITE TODAY and DANO'S quote will be on the way.

- Bobbin Coils
- Form Wound Coils
- Paper Section Coils
- Acetate Bobbin Coils
- Cotton Interweave Coils
- Coils for High Temperature Applications
- Encapsulated Coils—in either Polyester or Epoxy Resins

Also, TRANSFORMERS MADE-TO-ORDER



THE DANO ELECTRIC CO.
MAIN ST., WINSTED, CONN.

D-B broad band gas-filled cavity wavemeters

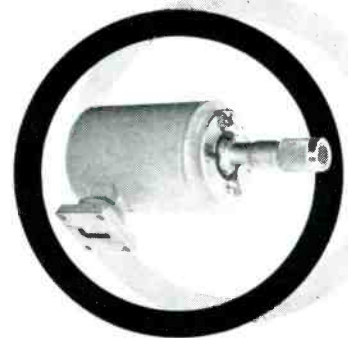

Each instrument covers a wide segment of the total range. Only 11 sizes serve from 2.6 KMC to 90 KMC. Accuracy is so high they may be used as secondary standards. Nitrogen filled and sealed for long life and high Q. Bi-metallic structure provides high degree of thermal compensation. Write for literature.



780 South Arroyo Pkwy. • Pasadena, Calif.

Want more information? Use post card on last page.

May, 1956 — ELECTRONICS

eral's pacific division in Los Angeles. He will direct all operations of the new pacific division which produces electronic products, including power supplies and other devices particularly useful in aircraft manufacture.

He joined Federal in 1939 as a radio engineer, specializing in airplane navigational and communications systems, and was closely identified with the technical development by Federal of instrument landing systems and other navigational aids.

In 1946 he was appointed government sales manager and general sales manager in 1953.

Production Research Control Changes

EVERETT FRANK and Harrison Johnston with a group of associates have purchased control of Production Research Corp.

Johnston, formerly manager of the international division of the Ampex Corp., has been elected president. Leon Hillman will continue as senior vice-president.

Until joining Ampex in 1951, Johnston was with General Electric as a commercial engineer, sales engineer and then sales manager for the laboratory products division.

Warwick Builds New Headquarters

WARWICK Manufacturing's new engineering and administrative offices building in Chicago, will be completed and ready for occupancy in July.

Construction of the 65,000 sq ft structure began in December, 1955.

The new building will allow the combining under one roof of all of Warwick's engineering and administrative offices which are now at six different locations.

Warwick also announced that Robert B. Kempe has been appointed chief production engineer of Crescent Industries, a subsidiary.

Prior to joining Crescent he was the electronic production engineer

Lacing tapes for every purpose

Gudebrod Lacing Tapes are easy to tie, easy on the hands. Knots tie securely—stay put!

GUDELACE* . . . the original braided nylon wax-coated lacing tape.

GUDELACE-H* . . . rubber-coated, easier to handle, no slipping, fungus and flame resistant.

NEW TEFLACE . . . the latest advance in tapes, coated with DuPont Teflon, to withstand extreme temperature conditions.

*T.M.

WRITE FOR INFORMATION AND TRIAL SUPPLY TODAY!

GUDEBROD BROS. SILK CO., INC.

Electronics Division
225 W. 34th St.
New York 1, N.Y.

Executive Offices
12 S. 12th St.
Philadelphia 7, Pa.

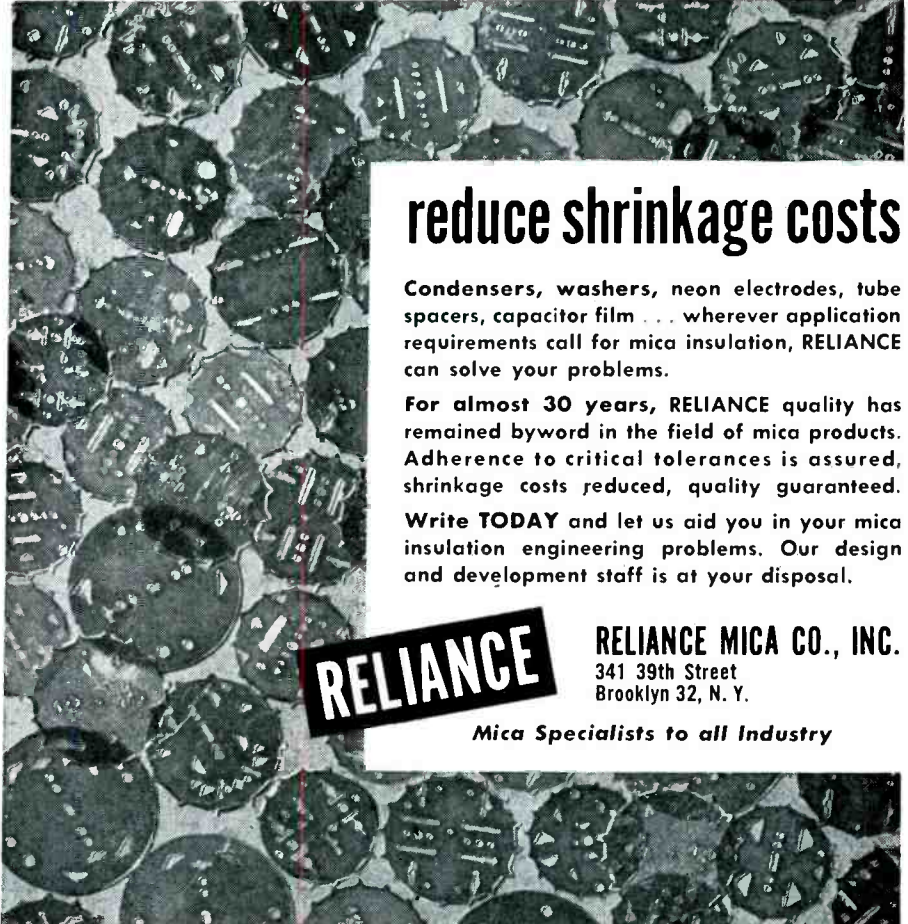

reduce shrinkage costs

Condensers, washers, neon electrodes, tube spacers, capacitor film . . . wherever application requirements call for mica insulation, RELIANCE can solve your problems.

For almost 30 years, RELIANCE quality has remained byword in the field of mica products. Adherence to critical tolerances is assured, shrinkage costs reduced, quality guaranteed.

Write TODAY and let us aid you in your mica insulation engineering problems. Our design and development staff is at your disposal.

RELIANCE

RELIANCE MICA CO., INC.
341 39th Street
Brooklyn 32, N. Y.

Mica Specialists to all Industry

BRING US YOUR HEADER PROBLEMS!



SIMPLE OR COMPLEX

— We make them all, ranging from 2- and 3-electrode crystal holder bases and standard octal headers, to 14- and 18-terminal headers for sealed Transformer and Relay applications — with a wide selection of styles and sizes in our series of basic designs.

SPECIAL DESIGNS

— We also manufacture Sealed Headers and Terminals to meet special requirements, and will be glad to quote upon receiving your specifications.

COMPLETE ASSEMBLIES

— We have facilities for handling the complete assembly of many units — including wiring, evacuating and pressure-filling enclosures.

NEW CATALOG

— Just off the press, a new Hermaseal catalog, with descriptions and specifications of some of our standard Sealed Headers and Terminals. Write for your copy today!



THE HERMASEAL CO, Inc. Elkhart 10, Indiana

of Webster-Chicago Corp. for 2½ years. From 1948 to 1953 he was production manager and assistant plant manager at Pioneer Electric & Research Corp. Prior to this, he held executive engineering posts with Stewart-Warner and Motorola.

Arthur D. Little Elects President

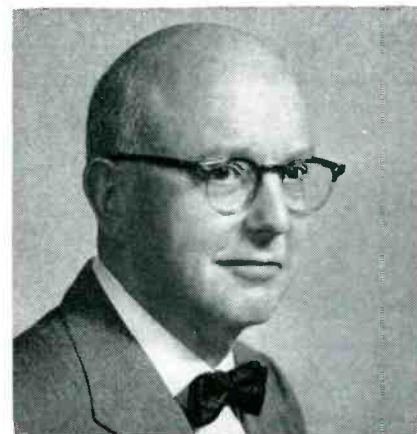

Raymond Stevens

RAYMOND STEVENS was elected president of Arthur D. Little, Inc., Cambridge, Mass., industrial research company. He has been a vice-president of the company since 1930. He has directed the expansion of the company's scientific activities into various fields such as operations research. He will succeed Dr. Earl P. Stevenson, who is now ADL board chairman.

Cal-Tronics Appoints Operations Director

JOHN F. O'ROURKE has been appointed as director of operations of Cal-Tronics Corp of Los Angeles, designers and manufacturers of electronic test equipment.

He was formerly test engineer with General Engineering Laboratory and was a test development engineer with General Electric. More recently he was chief of quality control engineering and chief of planning with Hughes Aircraft.

ARDC Sets Up Contact Office

TO INSURE better contact and relationship with industrial and private research and development

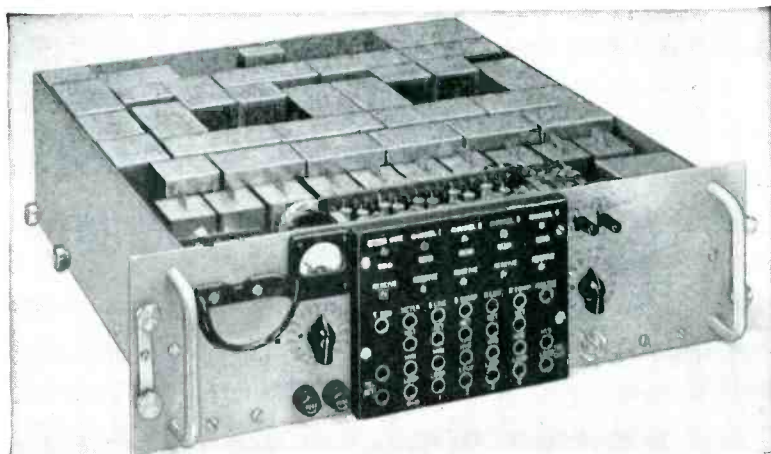

FOUR-CHANNEL CARRIER-TELEPHONE TERMINAL FOR RADIO LINKS

This is a miniaturized unit of advanced design which provides four voice channels on a frequency-division basis above a voice-frequency order-wire channel. Each of these five channels is provided with a 4-wire 2-wire termination and a voice-frequency ringing circuit for d-c or 20-cycle signals. Adjustable attenuators are provided in the 4-wire side of all channels, and a built-in test oscillator and meter permit complete line-up, maintenance and trouble-shooting checks to be made. Channel levels are from -9 to 0 dbm and line levels from -30 to 0 dbm. Channel width is 300 to 3500 cycles within 1 db.

This unit is only 5¼" high by 19" wide by 14" deep. It mounts on a standard rack and operates from 115 volts 50-60 cycles a.c.

RADIO ENGINEERING PRODUCTS
1080 UNIVERSITY ST., MONTREAL 3, CANADA
TELEPHONE UNIVERSITY 6-6887
CABLES RADENPRO, MONTREAL

agencies, a new office, the technical relations division, has been created by the Air Research and Development Command Headquarters in Baltimore.

It provides an initial contact between potential contractors and ARDC.

The new office does not award contracts. It conducts preliminary evaluation of ideas presented by potential contractors, then recommends further action to the ARDC branch concerned.

Chief of the technical industrial relations division is Warren L. Baker, former chief of the systems division of the office of analysis and evaluation headquarters ARDC.

Pacific Automation Company Formed

PACIFIC Automation Products was recently established in Glendale, Calif. The firm specializes in the design, engineering and manufacturing of electronic cable for missiles and industry.

The company is headed by Frank C. Jameson, formerly president of International Design Group, president and general manager of Lennan Lights, Inc. and more recently board chairman of Enterprise Development and Manufacturing Corp.

Vice-president and general manager of the company is Arthur P. Jacob, formerly in missile engineering at Cal-Tech's jet propulsion laboratory.

Staff members include Howard Skouby, treasurer; Marvin T. Bordon, production control engineer; Ralph Darch, senior project engineer; Donald Studer, project engineer; Thomas Byron, materials control; William Buckley, contracts engineer and Sydney Radus, sales manager. There are fifty employees at present.

American Bosch Names Thompson

ALAN F. THOMPSON has been appointed vice-president of manufacturing for the Arma division of the American Bosch Arma Corp. Prior to the present appointment, he had been manager of manufacturing

COAXWITCH

COAXIAL SELECTOR SWITCH

CUT-A-WAY VIEW, MODEL 74

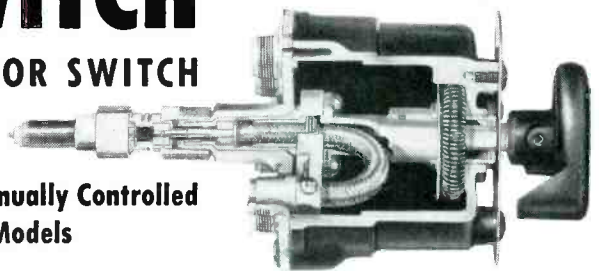

50 Ohms —
Type N Connectors — Manually Controlled
Low VSWR — 4 Models

The COAXWITCH is an RF switch for use in coaxial circuits where it is important that the 50 OHM impedance of the cables be maintained. In a circuit sense, this switch consists of two pairs of "N" connectors spaced 4½" apart using RG-8/U as the connecting link. The COAXWITCH itself introduces no VSWR other than that of connectors. Characteristic impedance is maintained thru all switch details. Cut-a-

way view shows that shield as well as center conductor is switched. Beryllium copper contacts, on the gooseneck, mate directly with male "N" (Type UG-21B/U) connectors, which connect directly to back plate of switch. Since all connectors come out in line with axis of switch, right angle connectors are usually unnecessary.

Literature Gladly Sent

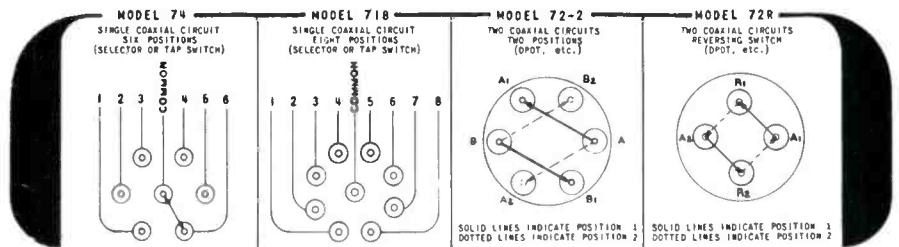

BIRD
ELECTRONIC CORP.
 1800 EAST 38TH ST., CLEVELAND 14, OHIO
TERMALINE Coaxial Line Instruments

VAN GROOS COMPANY
 Sherman Oaks, Cal.

PRECISION CONNECTORS for PRINTED CIRCUITRY

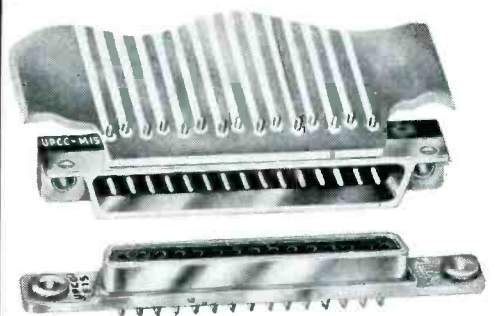

U. S. Components' printed card connectors embody all the design features demanded by printed circuit users. Minimum space, high-compression molded inserts, die-cast aluminum shells result in polarization flexibility and high electrical and mechanical performance even under the most severe environmental conditions.

Series UPCC connectors are available with 7, 11, 15, 19 or 23 contacts for 1/16", 1/8" and 1/4" printed cards.

Write TODAY for complete information on U.S.C. printed card connectors and receptacles and the name of nearest U.S.C. engineering representative.



U.S. COMPONENTS, INC.

associated with U. S. Tool & Mfg. Co., Inc.
 454 East 148th Street, New York 55, New York

"Pioneers in Connectability"



Welwyn

leaders in the field of high
stability deposited carbon resistors

Now Offers

VITRICON

Vitreous Enamelled Miniature Capacitors

Tolerances:
±20%, ±10%, ±5% and ±2%
(±0.5 uufd at low values)

Max. Ambient Temperature:
150° Centigrade

Values:
18 to 1000 uufd

Temperature Coefficient:
Substantially zero — with spread of
±40 parts/million/degree C

Power Factor at 1 mc:
better than 0.001

Manufactured in England and Canada

For complete data and specifications write to Dept. OE-7

Welwyn International, Inc.

3355 Edgecliff Terrace, Cleveland 11, Ohio

control for Convair and previously held the same position with Northrop Aircraft.

Electro Engineering Moves To New Location

ELECTRO Engineering Works, producers of transformers, moves to a new 15,000 sq ft building in San Leandro, Calif. The plant is located on a 23-acre tract purchased by the firm, which will permit further expansion.

New TV Firm Formed In Hollywood

A NEW electronics firm, American Microwave Corp., has been formed in North Hollywood, Calif. Fred W. Bailey, formerly secretary-treasurer and sales manager of Lambda-Pacific Engineering, is president. Harold W. Jury, formerly with CBS-TV and consulting tv engineer, is chief engineer.

The firm is engaged in design, development and manufacture of television studio equipment, microwave systems and custom electronic equipment to specifications.

Acme Electric Elects Top Officers

JAMES A. COMSTOCK who joined Acme Electric 26 years ago as chief engineer has been elected chairman of the board of directors. He served the company as president and preceding that, as vice-president.

The newly elected president of the company, Wm. E. Wilson, joined the company in 1945, as sales



W. E. Wilson

WIRE CLOTH

SAVE
on Quality Cloth

IMMEDIATE DELIVERY
Wide range of meshes from
large Pittsburgh stock

SPECIALIZING IN
Extra fine precision-
woven meshes used
in electronics industry.

VARIOUS MESHES

Brass, copper, monel and pure nickel etc. Available in a variety of weaves, with stainless steel and phosphor-bronze regularly woven up to 400 X 400 mesh.

FOR FAST SERVICE CALL OR WRITE . . .

FACTORY ENTERPRISES, INC.

3431 BUTLER STREET, PITTSBURGH 1, PA.
TELEPHONE MU. 1 1199



TUBULAR RIVETS
SPLIT RIVETS
COLD-FORMED SPECIALTIES
RIVET-SETTING MACHINES



THE MILFORD RIVET & MACHINE CO.

PLANTS: MILFORD, CONNECTICUT
 HATBORO, PENNSYLVANIA • ELYRIA, OHIO
 AURORA, ILLINOIS • NORWALK, CALIFORNIA

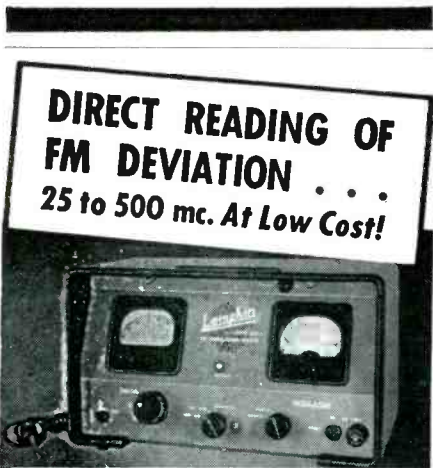

**LAMPKIN 205-A
 FM MODULATION METER**

- Indicates instantaneous modulation deviation, positive or negative up to 25 KC.
- Accuracy 10% of full scale.
- Tunable 25 to 500 MC. in one band, with fast and slow controls.
- Sensitivity 10 millivolts or better throughout range.
- Speaker for aural monitoring, oscilloscope output for visual monitoring.
- Meets FCC specs for mobile-radio maintenance.
- Size only 7" x 12" x 7 1/4". Weight 13 lbs.
- Price \$240.00 net. Satisfaction guaranteed or money refunded.

For measuring transmitter frequencies from 0.1 to 175 MC. (crystal-controlled transmitters to 500 MC.), within 0.005%, use the companion unit—the LAMPKIN 105-B MICROMETER FREQUENCY METER

Write today for technical data on both instruments.

LAMPKIN LABORATORIES, INC.
 Instruments Div., Bradenton, Florida

Want more information? Use post card on last page.
 ELECTRONICS — May, 1956

manager, and in turn served in the positions of vice-president in charge of sales and executive vice-president.

He served as chief of the transformer section of the radio and radar division of the War Production Board.

Stromberg Establishes Nucleonics Section

A NUCLEONICS research section has been established in the research department of Stromberg-Carlson, a division of General Dynamics Corp.

This section will design and develop instruments and control equipment in the nuclear energy field.

The new section will be headed by Robert L. Deming. He joined Stromberg-Carlson recently after having served over four years as a research staff member at the Los Alamos Scientific Laboratory.

Ace Electronics Appoints Roberts

ACE Electronics Associates of Somerville, Mass. manufacturers of potentiometers and trimmers appointed Warren Roberts as engineer in charge of quality control.

Roberts was formerly chief of the potentiometer unit at Air Force Cambridge Research Center.

Wiley Electronics Expands In Arizona

A \$60,000 research laboratory for Wiley Electronics Co. has been started at Phoenix, Ariz. The company is a division of Savage Industries, which has been in business at Phoenix for 15 years.

The company has been operating for the past eight months under contracts from the University of Michigan and Hughes Aircraft Co. for radar measurement instruments and test instruments.

Calbest Electronics Builds New Lab

CALBEST Electronics Co. of Los Angeles, Calif. is building a new research lab and office with 6,000 sq ft of space for research and

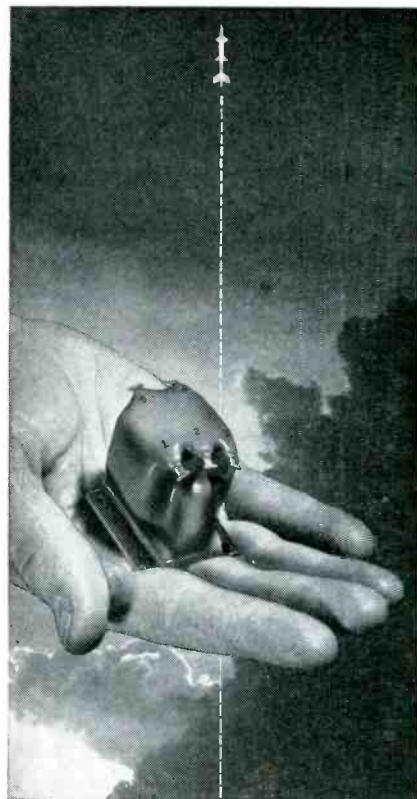

180° C. operation makes transformers smaller... helps missiles gain range

Problem: Design a set of different transformers for a missile program. Make them as light and as small as possible. Make them to operate for at least 500 hours in an ambient temperature of 125° C. Make them to withstand 100 G shocks. Make them *fast*.

Solution: We made them light and small, with new bracketry design to meet the shock-resistance requirement.

The transformers are so small, they run hot—as hot as 180° C.

They operate for the specified life, thanks to Class H insulation, special high-temperature wire, solder, etc.—thanks especially to their silicone rubber encapsulation.

Fortunately, we were able to make them quite fast—for this was a “crash” program. Samples were ready in *three to five weeks*, followed by full production in three months.

When you need transformers—by hundreds or thousands, straightforward or special design—make use of our engineering and production facilities and experience. We can do your MIL-T-27A qualification testing too.

CALEDONIA
 ELECTRONICS AND TRANSFORMER CORPORATION

Dept. E-5, Caledonia, N. Y.

In Canada: Hackbusch Electronics, Ltd.
 23 Primrose Ave., Toronto 4

Want more information? Use post card on last page.

Europe's *Largest* Selling Electronic Tubes Now Available to the discriminating American tube buyer — at standard prices.



not just a replacement—
but an improvement



TELEFUNKEN

PIONEER IN ELECTRONICS
SINCE 1903

Write for your Telefunken Tube Manual and for the name of your nearest jobber.

Imported exclusively by

AMERICAN ELITE, INC.

Dept. 2
7 Park Avenue
New York 16, N. Y.

Want more information? Use post card on last page.

PLANTS AND PEOPLE

(continued)

4,000 sq ft for offices. It is to be completed in July, 1956. With the firm's newly completed factory, space will total more than 35,000 sq ft and cost over \$300,000.

Calbest makes television and radio sets in addition to remote controls and home intercom systems. The firm recently developed a Poll-O-Meter which electronically determines television and radio tuning for audience research.

Sylvania Plans New Parts Plant

A NEW 110,000-sq-ft plastics plant, to be erected in Warren, Pa., is planned by the parts division of Sylvania.

The new plant will be located across from the division's present wire and plastics plant. All plastics operations in this plant will be transferred to the new location. The present plastics operational space will be henceforth devoted to lamp-base manufacture.

Completion of the new plant is scheduled for December 15, 1956.

When the new buildings are finished, Sylvania's facilities in Warren will account for some 310,000 sq ft of manufacturing space.

With the completion of the new building, the division will have three plants in Warren, one in York, Pa., one in Nelsonville, Ohio, one in Cleveland, Ohio and its newly acquired 20,000 sq ft formatic plant in Naugatuck, Conn.

Sylvania also announced that V. Hubert Campbell was appointed assistant chief engineer of the radio tube division.

For four years previous to his new assignment, he was manager of design engineering and product development of the radio tube division.

He joined the company 21 years ago as a junior engineer in the radio tube division in Emporium, Pa. Following this he joined the general engineering group of the division and in 1946 became section head of the design engineering department. In 1949 he was named manager of the design engineering.

In another recent move, the headquarters of the electronic systems division of Sylvania were

VHS* RELAY

(*Very High Sensitivity)



Model 266

Sample specs. are: 0.2 micro-amperes, (12,000 ohms coil) or, 0.1 millivolts, (5 ohms.)



• The VHS is a balanced armature, Alnico magnet type relay. It is internally shock-mounted and resistant to vibration. The screw-on cover is gasket sealed. It can be opened and resealed. Connections: 9 pin octal style. Dimensions: 1 3/4 diameter x 2 1/4 long. Weight: 4 ounces. Sensitivity: Infinite variations from 0.2 Ua. to 10 Amp. or 0.1 Mv. to 500 volts, self contained. Higher volts or amps with external multipliers. A.C. rectifier types. Trip point accuracies to 1%. Differential 1%. The degree of resistance to shock and vibration primarily depends upon sensitivity and type of action wanted. In general, the relays will not be permanently damaged by shocks of 100 G's and vibrations up to 2,000 cps at 4 G's. The most sensitive relays may close their contacts under these conditions.

Contacts: S P S T or SPDT. 5-25 Ma. D.C. Other ratings to 1/2 Amp. A.C. A locking coil gives high pressure and chatter free contact under shock and vibration. Prices: \$20-\$80.

Delivery 4 to 6 weeks. Assembly Products, Inc., Chesterland 4, Ohio.

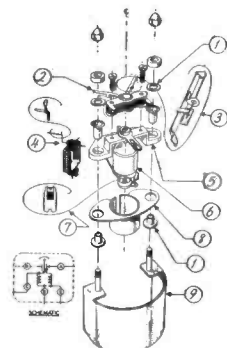

Write for explanation of symbols

(West Coast: Desert Hot Springs 4, California. Phone 4-2468)

Booth 507, Design Engineering Show, Philadelphia, May 14-17.

FREED Direct Reading LOW FREQUENCY "Q" INDICATOR

TYPE 1030A

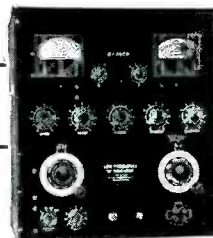

USES

Measures the "Q" factor of coils directly and the inductance of coils, distributed capacity, impedance and dielectric losses. The "Q" Indicator can be used to study the magnetic properties of iron, such as stability of iron cores in function of applied voltages, and, iron losses as a function of the frequency.

FEATURES

- Direct reading
- Unaffected by line voltage variations
- Self contained — A.C. operated

SPECIFICATIONS

Range of "Q" Measurements: The range of "Q" factors is from 0.1 to 1000 over the frequency range from 20 to 200,000 cycles with an accuracy of 5%.
200,000 cycles in four ranges.

Power Supply: The instrument is entirely self-contained and A.C. operated. Total power consumption 200 watts.

Oscillator Frequency Range: Continuously variable from 20 to
Dimensions: Width 19 1/2" x Depth 14 1/2" x Height 23".

Send for Complete Transformer & Instrument Catalogs

FREED TRANSFORMER CO., INC.
1722 Weirfield St., Brooklyn (Ridgewood) 27, N. Y.

Want more information? Use post card on last page.

May, 1956 — ELECTRONICS

transferred from Buffalo, N. Y., to the division's new Waltham Laboratories in Waltham, Mass.

The headquarters shift involved about 15 persons.

Westinghouse Builds Tube Warehouse

GROUND was broken for a new Westinghouse electronic tube warehouse in Elmira, N. Y. It will add 120,000 sq ft of floor space to the existing 450,000 sq ft plant building, and will adjoin the new color television picture tube manufacturing facilities. Existing warehouse areas in the plant will be available for expanded manufacturing operations.

Into the new warehouse will go testing equipment, inspection facilities, branding machines, and packaging devices, the latest of which handles up to 96,000 receiving tube units on each 8-hour shift.

Permacel And Furnane Set Agreement

AN OVERALL marketing and distribution agreement to handle Epocast insulating resins has been made by the Permacel Tape Corp. of New Brunswick, N. J., with Furnane Plastics, Inc., of Los Angeles.

Epocast insulating resins are a special form of epoxy resin. The main uses of Epocast are controlled electrical insulation, impregnation, potting and coating. Principal demand is from the electronics industry.

Research groups of the two companies will work together to further develop the resins.

Until the present agreement, Permacel's activities have been primarily in the tape field. The company manufactures approximately 180 different kinds of tape for use in industry, business offices and the home.

Ball Purchases Control Cells

CONTROL CELLS CORP. of Boulder, Colo., has been purchased by Ball Bros. Co. of Muncie, Ind. The purchase included exclusive rights to continue manufacture of an elec-

New!

COLOR

& BLACK & WHITE
LAB & TV SERVICE
5" SCOPE

5 MC BANDWIDTH & DC AMPLIFIERS



• Flat from DC to 4.5 mc to reproduce 3.58 mc sync burst and oscillator signals in color TV sets.

• 4-step freq-compensated attenuator in both AC and DC positions.

• Built-in calibrator permits peak-to-peak voltage measurement.

• Automatically syncs anything visible on the screen.

• Pre-set TV V & H sweep positions (30 cps & 7875 cps).

• Edge-lit lucite engraved graph screen with dimmer control; filter; standard bezel fits standard photographic equipment.

• 5U1 CRT

Kit # 460
Factory Wired \$129.50 **\$79.95**

- V amplifier direct-coupled and push-pull thruout; gradual roll-off beyond 4.5 mc; useful at 10 mc.
- High V sensitivity: 25 mv/in.
- Choice of direct coupling (DC) or capacitive coupling (AC).

EICO®

Write for FREE New 1956 Catalog E-5 and Name of Distributor

84 Withers Street • Brooklyn 11, N. Y. ©56 Prices 5% Higher on West Coast

NOW IN STOCK AT YOUR NEIGHBORHOOD DISTRIBUTOR . . . ORDER NOW!

PIX

INTRICATE STAMPING SPECIALISTS



PIX Manufacturing Co., Inc.
81-A Hudson St.
Newark 3, New Jersey

Precision Parts to meet your production and engineering needs. From .002" to .187" thickness. Radio tube parts, drawings, piercing, wire straightening, cutting and forming, relay components, transistor bases, terminal lugs, multi-slide stampings, beryllium copper contacts and printed circuit connectors.

Send sketch or print for quotation.

Brew Delay Lines are

DEPENDABLE



Distributed
Constant



Lumped
Constant



Ultrasonic

... custom made to
meet your most
exacting requirements

Brew offers complete design, development and large scale production of delay lines to meet your most critical requirements . . . covering an extremely wide range of characteristics . . . for both commercial and government applications.

Each line is custom made to exactly satisfy your needs. You get the benefit of continuous research and development and experience on all type lines. Latest packaging techniques, dependable materials, special manufacturing and test procedures assure you of finest quality, ultra compact units with best possible operational characteristics.

Prompt delivery on prototype and production quantities. Catalog 54 gives the complete Brew story. Send for your copy.

BREW

Richard D. Brew and Company, Inc.
Concord, New Hampshire
design · development · manufacture

tronics industrial scale made by Control Cells. The scale records weight by variations of current flow through an electronic unit.

Added pressure changes the current flow through the unit, about the size of two cigarette packages placed end-to-end. United Air Lines has recently put the scale to use in checking load limits and weight distribution in planes.

Hallicrafters Okays Penn-Texas Deal

NEARLY 82-percent of the stockholders of Hallicrafters Co. of Chicago approved the sale of their corporation's assets to the Penn-Texas Corp.

The management of the firm will continue unchanged.

Chatham Electronics Promotes Steiger

B. F. STEIGER, chief engineer of the Chatham electronics division of Gera Corp., was named vice-president in charge of engineering.

He has made contributions to manufacturing processes, and improvements in the ruggedization and reliability of electron tubes.

Mason Joins Electronic Specialty

CLARE MASON has joined Electronic Specialty Co. as executive vice-president. Prior to joining the firm, he was executive vice-president and general manager of Vard, Inc. of Pasadena, Calif. From 1935 to 1950 he was associated with the Beckman Instrument Co.

Electronic Specialty recently concluded an agreement for production facilities at U. S. Time Corp.

Norden-Ketay Elects Thompson

LOUIS TEN EYCK THOMPSON has been elected vice-president for research of Norden-Ketay Corp. Dr. Thompson is a member of the Norden-Ketay board. He previously held the post of director of research of the company.

During World War II, he was

PRECISION*



MODEL 2200

3 1/2" x 12 3/8" x 3 7/8" • WT 5 1/2 lbs.

Combination **AC VOLTAGE DIVIDER & BRIDGE**

- * **ACCURACY:** 0.004% of input
- * **RESOLUTION:** 0.0005% of input
- * **PHASE SHIFT:** 0.05 Milliradian max.
- * **BRIDGING TRANSFORMERS:** with specified max. error

DESIRABLE ELECTRICAL CHARACTERISTICS

Frequency: 30cps to 3kc and higher •
Low Output Impedance • High Input Impedance
Also available: Unit for panel mounting

WRITE FOR COMPLETE DESCRIPTIVE LITERATURE

SOME AREAS AVAILABLE
FOR REPRESENTATION

COAST COIL COMPANY

WE 6-6188



MANUFACTURERS OF CUSTOM TOROIDAL WINDINGS AND PRODUCTS

Dept. A-2 5333 W. Washington Blvd., Los Angeles 16, Calif.

HIGH FIDELITY EXTRUDED & MOLDED THERMOPLASTICS

● POLYSTYRENE

Low cost, rigid; dimensional stability to +200°F.

● FLUOROCARBON (Kel-F)

Unequalled properties & stability from -300°F. to +390°F.

● NEW, SPECIAL - SERVICE POLYETHYLENE

—for rigid & high temperature requirements—test samples & preliminary data now available for service evaluation.

● POLYETHYLENE—?

Of course—big inventory—all sizes.

● Property Charts and Literature available on request

Visit us at Booth 309—7th Natl. Plastics Exposition, new Coliseum, New York, June 11 to 16 inclusive. Free tickets on request.

Westlake
plastics co.

133 W. Lenni Road
Lenni Mills, Penna.
In Delaware Valley, U.S.A.
Phone: Valleybrook 2700

MOLYBDENUM

PURE and THORIATED TUNGSTEN

For ELECTRONIC APPLICATION

RIBBONS

STRIPS

FORMED PIECES

Your special metals
rolled to thin sizes
- close tolerances

H. CROSS CO.

15 BEEKMAN ST., N. Y. 38, N. Y.
WOrth 2-2044 and COrtlandt 7-0470

Want more information? Use post card on last page.
ELECTRONICS — May, 1956

special consultant to the Manhattan Project. Since then, he has been technical director of U. S. Naval Ordnance Test Station at Inyokern, China Lake, and Pasadena, Calif. He has also been vice-chairman of the research and development board of the Department of Defense; a member of the scientific advisory board of the U. S. Air Force; and consultant to the assistant secretary of defense for research and development.

Universal Electronics Operates New Plant

UNIVERSAL ELECTRONICS Co., manufacturers of regulated d.c. power supplies, have completed installation of equipment in their new factory in Santa Monica, Calif. The plant is now in full operation.

Rubber Firm Expands Facilities

CONSTRUCTION began on the fourth expansion in less than three years for Minnesota Rubber and Gasket Co. of Minneapolis. Estimated cost of this project is \$500,000.

The firm makes connector seals and capacitor and transformer bushings for the electronics industry and idler wheels, pressure rollers and drive belts for the phonograph and tape recorder field.

When completed in July, the addition will increase present facilities by about 32,000 sq ft.

Perkin-Elmer Forms Two Divisions

PERKIN-ELMER Corp. formed two new operating divisions—the instrument division, and the engineering and optical division. The instrument division will be responsible for the development, production and sale of the company's line of laboratory analytical instruments and process control instruments. The engineering and optical division will handle the design and production of precision optics, and contracted research.

Van Zandt Williams has been named general manager of the instrument division, and Roderic M.

NOW!
QUICK-EASY SELECTION

Johnson
PILOT LIGHTS

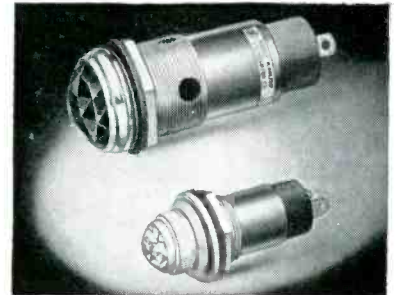

For "in the field" replacement or original equipment manufacture, you'll find that it's easier and faster to specify Johnson Panel Indicators. Available in a wide variety of types, Johnson "preferred" units are immediately available at parts distributors throughout the country. Careful standardization, with an eye to replacement as well as interchangeability, makes Johnson Pilot Lights the first choice of many leading manufacturers.



Available types include: continuous indication neon types; models for high and low voltage incandescent bulbs; standard or wide angle glass and lucite jewels in clear, red, green, amber, blue, or opal lenses. Specials, including those meeting military specifications are also available in production quantities. For full information write today!

NEW CATALOG! Covers complete Pilot Light Line—write for your copy today!

SOLDERLESS NYLON CONNECTORS

Available in 11 bright colors. Shock-proof nylon sleeves won't chip or crack with hardest usage. Excellent for high voltage applications. Highly resistant to extremes of heat, cold, and moisture. Tip and banana plugs designed for simplified solderless connection of up to 16 gauge stranded wire — jacks require soldered connection. Simple, functional design gives top quality at low cost.

Write for samples, prices, and further information.



E.F. Johnson Company

2514 SECOND AVE. S.W. • WASECA, MINN.

Want more information? Use post card on last page.

PRECISION ATTENUATION to 3000 mc!

**SINGLE "in-the-line"
ATTENUATOR PADS
and 50 ohm COAXIAL
TERMINATIONS**



PROTECTED UNDER STODDART PATENTS

This new group of pads and terminations features the popular Types C and N connectors, and permits any conceivable combination of the two styles.

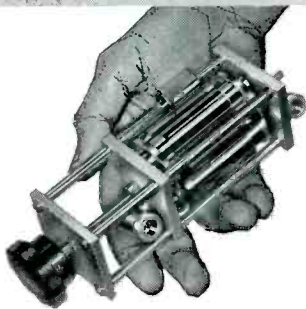

PROTECTED UNDER STODDART PATENTS

six-position
TURRET ATTENUATOR

- Frequency Range: dc to 3000 mc.
- Characteristic Impedance: 50 ohms.
- Available Attenuation: Any value from 1 db to 60 db.
- Accuracy: ± 0.5 db.
- Power Rating: One watt sine wave power dissipation.

STODDART
Aircraft Radio Co., Inc.
6644-A SANTA MONICA BLVD.
HOLLYWOOD 38, CALIF. • HO 4-9294

PLANTS AND PEOPLE

(continued)

Scott general manager of the engineering and optical division. A third division, the vernistat division, has been in operation since 1954 to produce potentiometer type devices used in servo systems and analog computers.

North American Promotes Duncan

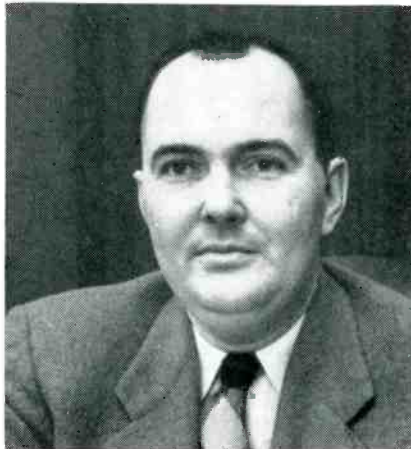

D. B. Duncan

D. B. DUNCAN has been appointed assistant chief of the guidance section of autonetics, a division of North American Aviation.

Dr. Duncan first joined autonetics in 1950 as a research engineer in the guidance section's investigation unit. In 1954 he was promoted to group leader of the guidance analysis group. Due to a reorganization, he became group leader of the section's research group in 1955 and held that position until his recent appointment.

Naval Station Needs Engineers

TEST and development of aircraft ordnance and guided missiles at the Naval Aviation Ordnance Test Station, Chincoteague, Virginia, is being seriously hampered by the lack of professional engineering personnel, according to the station.

Engineers are urgently needed in the fields of electrical, electronic, ordnance, mechanical, and metallurgy. The annual salary ranges from \$4,345 to \$7,570 for most of these positions.

The station also has a critical

YOUR BEST SOURCE COILS THAT ARE ENGINEERED FOR QUALITY

- TRANSMITTER • R.F.
- OSCILLATOR • I.F.
- CHOKES • RELAY
- PEAKING • MAGNET
- FILTER • SPECIALS

N. Y. AREA REPRESENTATIVE:
BEN JOSEPH & ASSOC.
521 FIFTH AVE.
NYC 17-MU 2-0815

COILS-ELECTRONICS CO.
2943 N. 2nd ST.
PHILADELPHIA 33, PA.
REgent 9-6465

SOME TERRITORIES OPEN
TO QUALIFIED REPRESENTATIVES

ZOPHAR

---WAXES
---COMPOUNDS

Zophar Waxes, resins and compounds to impregnate, dip, seal, embed, or pot electronic and electrical equipment or components of all types; radio, television, etc. Cold flows from 100°F. to 285°F. Special waxes non-cracking at 76°F. plain or fungicidal. Let us help you with your engineering problems.

For immediate service contact:

L. E. Mayer, Sales Manager
A. Saunders, Technical Director
H. Saunders, Chemical Laboratory

Phone 50uth 8-0907



ZOPHAR MILLS, INC.
112-130 26th Street,
Brooklyn 32, N. Y.

Want more information? Use post card on last page.

May, 1956 — ELECTRONICS

need for a mathematician, GS-12 or GS-13, the starting salary for which is \$7,570 or \$8,990.

Bendix Consolidates Mobile Radio Activities

NORMAN CAPLAN, formerly assistant director of engineering and research, has been promoted to manager of mobile radio products at the radio division of Bendix Aviation.

He will be responsible for all activities concerned with the division's mobile and railroad two-way radio activities now consolidated into a separate department. He joined Bendix in 1951.

W. C. Vergara has been appointed chief engineer, and E. McDonald manufacturing manager of the department. A. Ellis Jones continues in the post of sales manager.

UTC Names West Coast Head

H. C. HORNICKLE has been appointed general manager of the Pacific division of United Transformer Co.

He developed the "Shickelgruber" noise cancelling microphone during World War II.

The sales staff for U. T. C. will be located at C. R. Strassner Co. in Los Angeles, Calif.

Zenith Appoints Hearing Aid Manager

ROBERT L. GEIB has joined Zenith Radio Corp. as manager of hearing aid engineering at the main plant in Chicago.

Zenith is expanding its developmental program in the field of hearing aid manufacture.

Geib joins Zenith with almost ten years of experience in hearing aid engineering.

Firm Expands For ICBM Program

CUBIC CORP. is building a new facility in the Kearny Mesa industrial area of San Diego. The first unit in the 220,000 sq ft development will house the expanded

400 CYCLE

American Electric Motors

POWER SUPPLIES

*in the range of \$510 to \$585 including Model 250 Electronic Exciter Regulator**

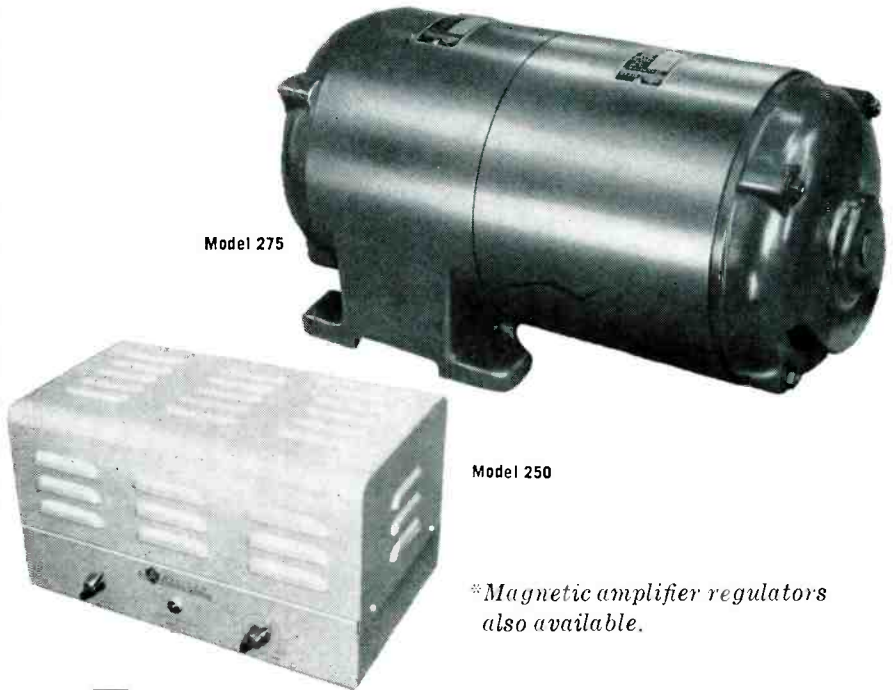

*Magnetic amplifier regulators also available.

These small, compact motor alternators are ideal for laboratories, test installations, checkout of aircraft components and for ground supplies. Exclusive inductor-type alternator is exceptionally maintenance free... no wearing parts other than its anti-friction ball bearings! Easily portable—125 to 140 lbs. 3600 r.p.m. motor (no load), 420-410 cps output; maximum total harmonic distortion 5%. Voltage regulation $\pm 1\%$ with $\pm 10\%$ adjustability from nominal voltages.

	INPUT		OUTPUT		MODEL NO.
	VOLTAGE	HP	WATTS*	VOLTAGE	
3 PHASE INPUT AND 3 PHASE OUTPUT	220/440	1	500	115/230	275FA
	220/440	2	1000	115	275BA
	220/440	3	1800	115/200	275E
	220/440	3	1800	115	275EA
	550	3	1800	115/200	275K
	220	3	1800	115/200-115	275L
	208	3	1800	115	275M
	550	3	1800	115	275N
3 PHASE INPUT AND 1 PHASE OUTPUT	220/440	1	500	115	275CA
	220/440	2	1000	115	275B
	208	2	1000	115	275G
	115/230	2	1000	26	275H
1 PHASE INPUT** AND 3 PHASE OUTPUT	115/230	1	500	115/200	275F
	115/230	2	1000	115/200	275BB
	115/230	2	1000	115	275AA
	230	3	1800	115/200	275D
	230	3	1800	115	275DA
1 PHASE INPUT** AND 1 PHASE OUTPUT	115/230	1	500	115	275C
	115/230	2	1000	115	275A

*Watts output at unity power factor. Volt Ampere output with 90% lagging power factor is somewhat lower.

**Notice that these are large single phase motors. Adequate service must be available. These motors are of the capacitor-start induction-run type.

Other combinations of input/output voltages can be supplied.

FOR MORE SPECIFIC INFORMATION on how a 400 cycle power supply can be designed to suit your particular application contact Dept. 491-E5



American Electric Motors

electric mach. & equip. division of American Electronics, Inc.

2112 N. Chico Avenue, El Monte, Calif.

Telephone: CUMberland 3-5331

PLASTICON

200°C
Teflon
Capacitors



Smallest Size for
Applications From -70°C. to 200°C.

Type TACM. Hermetically sealed in tubular brass shells. Have an operating temperature range of -70°C. to +200°C. Voltage ranges: 200, 400, 600 and 1,000 vdc with a standard tolerance of ±20%. 10, 5 and 2% tolerances are available upon request.

Type TAG. Glass encapsulated. Have an operating temperature range of -70°C. to ±165°C. Not to be used at above +170°C. Voltage ranges: 200, 400, 600 vdc with a standard tolerance of +20%. 10, 5 and 2% tolerances are available upon request.

WRITE FOR BULLETIN #123
CONDENSER PRODUCTS

DIVISION OF
THE NEW HAVEN CLOCK & WATCH CO.
NEW HAVEN, CONN.

CHARACTERISTICS TYPE TACM AND TAG.

CAPACITANCE RANGE001 mfd. to 1.0 mfd.

POWER FACTOR @ 25°C05%
@ 165°C07%

TEMPERATURE
COEFFICIENT -70°C to 200°C -200 ppm/°C.

INSULATION
RESISTANCE @25°C 500,000 meg x mfd.
But need not exceed 10,000,000 megohms

..... @ 165°C 7,000 meg. x mfd.
But need not exceed 50,000 megohms

..... @ 170°C 4,000 meg. x mfd.
But need not exceed 25,000 megohms

..... @ 200°C 1,000 meg. x mfd.
But need not exceed 5,000 megohms

DIELECTRIC ABSORPTION @25°C02%

research, development and production activities devoted to government systems connected with the ICBM and satellite programs. Specialized instruments and industrial instrumentation and automation systems will also be covered.

GE Selects Microwave Engineers

DONALD B. HARRIS, formerly associate director of Stanford Electronics Laboratories, was named manager of electron tube research at GE's microwave lab in Palo Alto, Calif. He succeeds J. W. Nelson, Jr. who was appointed laboratory manager.

Charles J. Marsh, formerly treasurer and assistant to the president of Varian Associates, has been appointed manager of administration and finance, succeeding George C. Trotter.

Both Trotter and H. R. Oldfield Jr., former laboratory manager, became sales and general managers, respectively, of G-E's newly formed industrial computer section headquartered in Syracuse, N. Y.

Harris has been associated in the research field with Northwestern Bell Telephone Co. and Collins Radio Co., both in Iowa, and with Airborne Instruments Laboratory on Long Island, N. Y. Dr. Marsh was an instructor and the dean of admissions at Golden Gate College in San Francisco and, before joining Varian Associates, was market analyst with Pabco Products.

In Schenectady, N. Y. Austin E. Rankin was appointed manager of klystron and traveling wave tube product engineering for GE's power tube sub-department.

He is responsible for all product designs of klystrons and traveling wave tubes.

He joined G.E.'s tube department in 1942 where he worked on various assignments until 1947 when he was appointed supervisor of high vacuum tube design. In 1953 he was named supervisor of klystron design, a position he held until his recent appointment.

GE also announced that James H. Schussele has been appointed manager of magnetron and space charge tube product engineering

the only complete source for
WAVE GUIDE
castings in

BRONZE
ALUMINUM
MAGNESIUM
and ferrous alloys

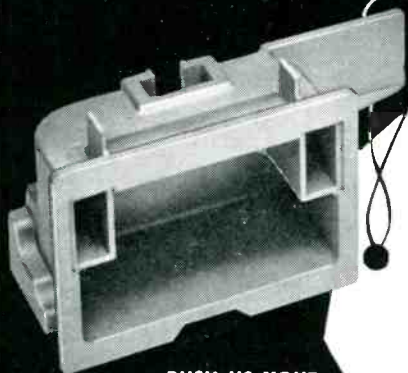

RUSH US YOUR
BLUE PRINTS
TODAY!

ONLY AT ALLOY PRECISION can you obtain all 3 precision casting processes from a single source!

ONLY AT ALLOY PRECISION is the process selected to match your part. Your design is not limited by the requirements of a single process.

ONLY AT ALLOY PRECISION can you be sure of a completely unbiased production evaluation of your existing or projected precision castings.

ALLOY PRECISION
castings company

Dept. 46 • East 45th and Hamilton
Cleveland 14, Ohio

- Frozen Mercury
- Lost Wax
- Shell Molding

TEST YOUR MAGNETIC CIRCUITS



**RAWSON FLUXMETER
TYPE 504**

The only portable fluxmeter available which returns rapidly to zero when a single button is depressed. Simple and fast in operation. Convenient and light in weight.

Not limited to a single type of measurement. Has universal application for laboratories or production. Measures strength of magnets and electromagnets, permeability and hysteresis loops for iron and steel, total flux lines in circuit, flux lines developed in air gap, etc.

Has a mechanical clamp to protect the pivots and jewels when in transit.

RAWSON ELECTRICAL INSTRUMENT COMPANY

111 POTTER STREET, CAMBRIDGE 42, MASS.



FIVE STAR ELECTRICAL COMPONENTS



COILS

Wound to Your
Specifications



SOLENOIDS

Light
and Miniature
Types



RELAYS

Power and
Sensitive
Types

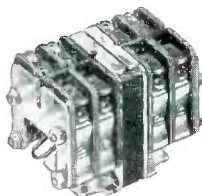

Send for catalog sheets describing these items in detail. Prompt quotations will be furnished on receipt of your complete specifications and requirements.

THE FIVE STAR COMPANY
10 WEST MAIN STREET
PLANTSVILLE, CONN.

PLANTS AND PEOPLE

(continued)

for the General Electric power tube sub-department.

In his new position, Schussele is responsible for all product designs of magnetron and space charge tubes.

He joined the GE tube department in 1951, as a tube development engineer in the electronics laboratory at Syracuse. In 1953 he was named supervisor of magnetron product design. He remained in this position until his recent appointment.

U. S. Testing Appoints Two

UNITED STATES TESTING CO. appointed Benjamin E. Ellis and Milton Geller as senior engineers in the electronics department of the firm's main laboratories in Hoboken, N. J.

Ellis was formerly associated with Lavoie Laboratories as contract administrator for the purchase of electronic components and equipment, and the investigation and redesign of electrical and electronic equipment.

Geller was formerly associated with Magnetic Amplifiers, Inc., as supervisor of the test department, and with Panoramic Radio Products, Inc. in development engineering.

Martin Builds Denver Plant

CONSTRUCTION of the Glenn L. Martin Co. plant southwest of Denver, Colo. is due for completion by Nov. 1 with full production scheduled to be reached four years later.

The plant is to be used for the research and development of guided missiles.

The plant is being built on a 7,000 acre site. The company's facilities will cover about 500,000 sq ft. Martin officials said they were spending \$10 million on the initial phase of the project.

About 5,000 will be employed when production reaches its peak. About 1,000 of the total will be engineers and scientists.

Albert L. Varrieur has been appointed general manager of the Denver division of the Maryland-

Lavoie DOUBLE Pulse Generator

- ✓ Dual Output Connection
- ✓ Dual Amplitude Control
for Individual or Combined Use



MODEL
LA-592D

Light, compact, double-pulse generator for general field or laboratory use. Bench or rack mounting.

- 20-200,000 pps internal trigger, 0-200kc external
- 1.5 to 2,500 microsecond delay
- 0.5 to 2,500 microsecond pulse width
- Approx. 0.1 microsecond rise time
- One or two pulses; individual control

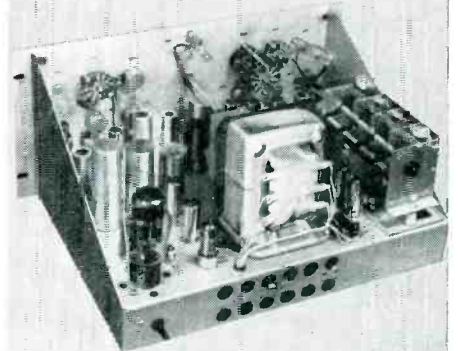

STABILIZED POWER SUPPLY • DUAL PURPOSE MOUNTING • WIDE RANGE OSCILLATOR • FULL SYNCHRONIZATION • INDEPENDENT PULSE CHANNELS • ADVANCED CIRCUITRY

Get all the facts on this outstanding, Lavoie-developed instrument. Brochures and specifications available at all representatives... or write

Lavoie Laboratories, Inc.

MATAWAN 1, NEW JERSEY

ALBANY, J. A. Reagan Co., Albany 4-7676 - ATLANTA, Southeastern Industrial Instruments, Exchange 7801-BALTIMORE, Thomas L. Taylor, Belmont 5-9126 - CHICAGO, R. Edward Stemm, EStebrook 9-2700-DENVER, Allen I. Williams Co., Main 3-0343-FLINT, Sam Robbins, Inc., Cedar 5-7310 - FORT WORTH, Mitchell Spears Co., Walnut 3-8811 - HARTFORD, M. S. Coldwell, Jackson 2-5832 - LOS ANGELES, T. Louis Snitzer, Webster 8-2074-MONTCLAIR, Louis A. Garten & Associates, Pilgrim 6-2900 - SAN MATEO, R. L. Pfeiffer Co., Fireside 5-1134 - ST. LOUIS, Edwin H. Murty, Jefferson 1-2075

Want more information? Use post card on last page.
ELECTRONICS — May, 1956

Want more information? Use post card on last page.



**DC-AC
CHOPPERS**

For 60 Cycle Use

Built to rigid commercial specifications.

Twenty-two types, both single and double pole.

Long life.

Low noise level.

Extreme reliability.

Write for Catalog 370.

**STEVENS
INCORPORATED
ARNOLD**

22 ELKINS STREET
SOUTH BOSTON 27, MASS.



S/A-10

Raytheon Promotes Two In Chicago



Stanley E. Rendell

STANLEY E. RENDELL has been promoted to the post of factory engineering manager of Raytheon's tv and radio operations in Chicago. He was previously chief industrial engineer.

Norman R. Teifeld was promoted to material control and traffic manager, from his previous position of traffic manager.

Rendell has been with Raytheon since 1936 when he joined the company as a receiving clerk. Since then he has held posts as time study engineer, assistant to works manager, production superintendent, and production control manager. He had been chief industrial engineer for the last three years.

White Industries Changes Its Name

WHITE INDUSTRIES, wholly-owned subsidiary of Mack Trucks, Inc., has become Mack Electronics Division, Inc.

No management or personnel changes are contemplated in connection with the name change. Robert Edwards will continue as general manager.

White Industries was acquired by Mack early in 1955. Its main offices and production facilities are adjacent to the Mack plant in Plainfield, N. J.

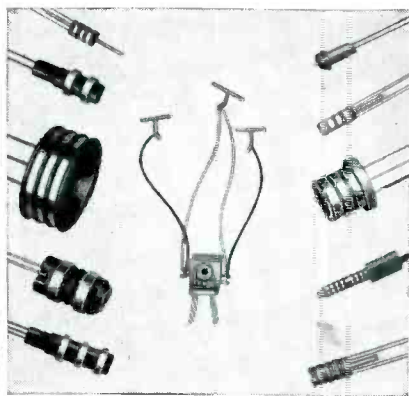

Miniature and Sub-Miniature SLIP RING ASSEMBLIES BRUSH BLOCK ASSEMBLIES COMMUTATORS

and other
Electro-Mechanical Components

**PRECISION MADE
TO YOUR OWN SPECIFICATIONS**

Precision molded products with exacting tolerances in precious and non-precious solid metals of all alloys. All types of Thermo-Plastic and Thermo-Setting materials.

Slip Ring Assemblies fabricated or one-piece precision molded to your specifications in Nylon, Kel-F, Mineral filled Mellamine, Phenolic, and other materials. Rings and leads spot welded or brazed together for positive electrical circuit.

Our Swiss methods and techniques are geared to meet exacting requirements. We invite your inquiries.

COLLECTRON CORPORATION

MUrray Hill 2-8473 • 216 East 45th Street • New York 17, N. Y.

New Books

Reliability Factors for Ground Electronic Equipment

BY KEITH HENNEY, IRVING LOPATIN, ELMER T. ZIMMER, LEONARD K. ADLER AND J. J. NARESKY

McGraw-Hill Book Co., New York, 1956, 228 p, \$7.50

AS military electronic equipment has become increasingly complex, the problem of reliability has grown steadily in magnitude.

► **Approaches**—Initially engineers reasoned that if reliable components were used throughout a piece of equipment, the equipment itself would be reliable. One of the first approaches to this problem was quality control of component parts. However, it was soon found that no matter how many times you inspect a Ford, you cannot make it into a Cadillac.

► **Project**—To assist designers of ground electronic equipment for the Air Force, Rome Air Development Center had the McGraw-Hill Book Company prepare this volume. Information was gathered from many sources including research laboratory reports originating both here and abroad and articles in foreign and domestic scientific and engineering journals.

► **Content**—The book describes reliability concepts, then treats causes of unreliability and systems aspects of reliability. There follows a discussion of statistical methods applicable to the problem.

Specific areas treated include electrical and electronic, mechanical and environmental, human engineering, components, interference, automatic production, instruction books and maintenance techniques.

► **Evaluation** — The chapters on electronic and electrical factors and on mechanical and environmental factors are particularly comprehensive. The chapter on human engineering contains a wealth of useful although somewhat disassociated information that is not readily available in any other place.

This book is the first contribu-

tion in a field that indeed requires a lot of work. It has its shortcomings, particularly in organization of the material. However, it is far and away the best thing available at the present time and should be of considerable help to equipment designers. Of particular value will be the comprehensive bibliographies included at the end of each chapter.—J. M. C.

Switching Relay Design

BY R. L. PEEK, JR. AND H. N. WAGAR
D. Van Nostrand Company, Inc., New York, 1955, 478 p, \$9.50

WRITTEN as an outgrowth of training courses given at Bell Telephone Labs., the present book presents design criteria for switching relays. The structures considered are those commonly used in the message handling circuits of telephone and telegraph systems and in the signal circuits of computing devices and automatic control apparatus.

► **Fundamentals**—The book is divided into two parts: the first dealing with the fundamentals, and the second part presenting the analytical approach to relay design. The four chapters of the first part describe the mechanical requirements for relays, which includes such factors as contact chatter, the statics of electromagnets, leading to considerations of sensitivity and work capacity, dynamical performance in operation and release and a chapter in which these fundamentals are coordinated into the design of the complete relay.

► **Analysis** — Part two, which includes slightly more than half of the book, takes up each of these aspects of relay design in greater detail, in each case developing design procedures leaning toward the optimum choice of relay parameters to provide their specified performance. Methods of measuring critical parameters are described and, in many cases, actual measurements are compared with theoretical predictions. Chapters in this second part deal with spring design, relay vibration (vibration causes within

How to Calibrate Your own Instruments



FAST ACCURATE CALIBRATION

Now possible with one completely self-contained AC-DC calibration standard requiring a minimum of operator training and previous instrument calibration experience.

Use the Compact Model 829 INSTRUMENT CALIBRATION STANDARD for

LABORATORY STANDARDS
INSTRUMENT REPAIR
PRODUCTION TESTING
INSPECTION & SERVICE

All Circuits, Power Supplies and Standards are contained in One Single Cabinet!

Precise, practically error-proof checking of most types of electrical indicating instruments in daily use is a routine convenience for Model 829 users. Maintenance of quality control by frequent calibration of instruments and allied test equipment can be accomplished within departments by available personnel. A mechanical index explains step-by-step test procedure.

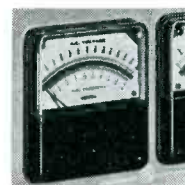

WESTON Special Meters

used as standards have 5-inch mirror precision scales, knife edge pointers and are adjusted to better than 0.2% accuracy.

Calibration to full scale accuracy of 0.5% can be accomplished for all instruments measuring d-c voltage (22 ranges) from 0.25 mv to 2000 volts, d-c current (22 ranges) from 2 μ a to 20 amperes, a-c voltage (19 ranges) from 1.5 mv to 1500 volts, and a-c current (14 ranges) from 1.5 ma to 20 amperes. Net price \$2345. FOB Boonton, N.J.

Write for Technical and Application Data.

Radio Frequency LABORATORIES, INC.
Boonton, New Jersey, U. S. A.

Want more information? Use post card on last page.

Make a **GM** PORTABLE D'ARSONVAL

GALVANOMETER

the Heart of Your Instrument



FOR MEASURING HEMOGLOBIN content of blood samples, the Fisher Scientific Co. of Pittsburgh uses a Model 100 G-M Galvanometer in its popular Electro-Hemometer (at left). Whatever your own particular instrument field, you can achieve this same self-contained portability, ruggedness and high sensitivity with G-M Galvanometers. Complete catalog on request.

GM LABORATORIES · INC.

4336 NORTH KNOX AVE., CHICAGO 41

the relay by its own action), the magnetic field of electromagnets, the magnetic circuit, analysis of magnetization and pull relations, the dynamics of electromagnets, and finally the chapter on the practical design of relay coils.

Although each chapter in the second part can be referred to fairly independently of the other chapters, it is best to do so only after reading the first part. Problems at the end of chapters enable the reader to assess his grasp of the material. One feature of the book that makes it particularly useful to the practicing engineer is the outline of material to be presented. The book begins with an

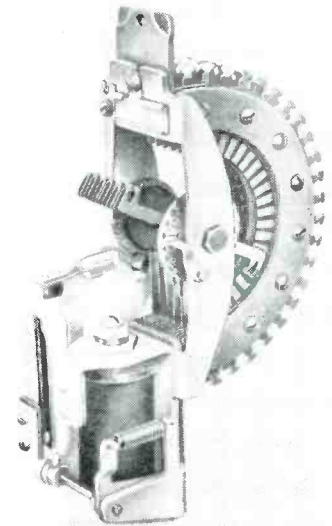

Rotary switch

introductory chapter that sets relays in their perspective of historical evolution and describes the plan of the book.

Introductory sections of subsequent chapters show the relationship of the material to be presented to relay design as a whole so that, although each design parameter is dealt with independently of the others, at no time does the reader lose sight of the interrelationships of all the parameters and their influence on overall performance.

► **Usefulness**—Some engineers who will find a direct use for this book will undoubtedly be working in fields other than telephone communication. For such readers, it is un-

TRANSFORMERS FOR ELECTRONICALLY REGULATED POWER SUPPLIES

Now... over the counter

Avoid delay in making your breadboards, no waiting for a special when a

STERLING 2K SERIES

transformer will meet your requirements exactly. Stock STERLING 2K units are available for supplies

from 100 milliamperes at 100 volts to 400 milliamperes at 300 volts

Each 2K transformer provides:

- PLATE VOLTAGE ALLOWANCE FOR PASS TUBE..... VOLTAGE DROP
- RECTIFIER FILAMENT POWER.....
- PASS TUBE FILAMENT POWER.....
- REGULATOR CIRCUIT FILAMENT POWER.....
- AUXILIARY FILAMENT POWER FOR..... OTHER CIRCUIT REQUIREMENTS
- REGULATOR CIRCUIT PLATE POWER.....
- APPLICATION BULLETIN WITH EACH UNIT

Military versions of each of these units is also available. Technical data on the complete line is available on request.

SAMPLES? SPECIALS? SHORT RUNS?

The 2K series is only one of the many types we make. We specialize in custom-built transformers to your specifications. Let our engineering staff help solve all your transformer problems.

Samples delivered in 1 to 3 weeks.



ST2010

Primary: 115 Volts AC, 50 to 1000 cps

Secondaries: 570-0-570V 240 madc*

5.0V	3 A
6.3V	3 A
6.3V	1.2A
6.3VCT	6 A

*Note 40 ma provided

Size: 5 1/4 x 4 5/8 x 5 1/2 H
Mtg. Centers: 3 1/2 x 3 1/2
Weight 15 lbs.
Associated Choke: ST2009
4 Henries at 240 madc.



299 North 7th St., Brooklyn 11, N. Y.
STagg 2-4200

fortunate but understandable that the same thoroughness of treatment could not be given to other aspects of relay design. This book covers its chosen subject well and by so doing makes more noticeable the absence in the literature of a comparable treatment on the effects of external shocks and vibration and the design and production of coil and other types of springs.—RODNEY B. FABER, *Project Engineer, Airpax Products Baltimore, Maryland.*

Machine Translation of Languages

By WILLIAM N. LOCKE AND A. DONALD BOOTH
Technology Press and John Wiley & Sons, Inc., New York, 1955, 243 p., \$6.00

THIS BOOK is a good compilation and summary of the study and accomplishments to date in this field. It should be read by everyone who is interested in the scientific conquest of human communication problems. It should also be read by teachers and students who desire to have a wide background in the field of data processing and computing machines.

► **Approach**—The majority of the book is devoted to the problems of differing structures of languages, translation of meanings, idioms, dictionaries, and some of the solutions which have been tried. Only one chapter describes the actual use of a machine to do translation—that is the Georgetown-IBM experiment. It is interesting to note in the editors' footnote to this one chapter that they do not accept all the author's views. This leads the reader to think that the editors believe all views of all other authors in the book and wonder which views were not accepted. In other chapters are discussions of components, size, capacity, speed and logic of a computing machine which may be built in the future specifically for language translation.

In Chapter 2, punctuation is mentioned briefly. The authors missed the opportunity to comment on Victor Borge's phonetic punc-

Operation Demonstration!



offers

FREE TRIAL
of the
550A DIRECT WRITING RECORDER

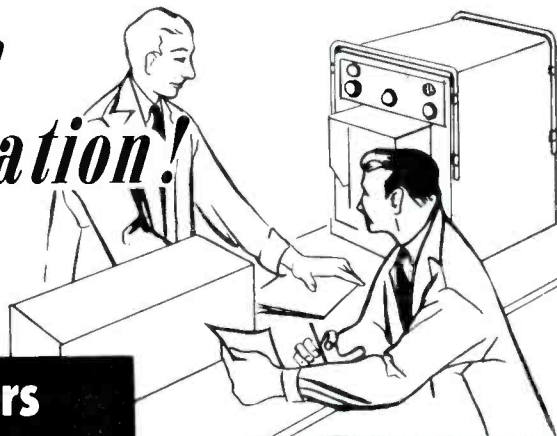

The 550A Recorder introduces such a marked improvement to the field of direct-writing recorders that its advantages can only be realized by testing it in *your* application.

A free trial will enable you to compare the wide frequency response (DC to 900 cycles) . . . the unique, direct-writing method that provides immediate magnified monitoring of the 8-channel recording . . . the five recording speeds (1, 2, 4, 8, and 16 cm./sec.) . . . the exceptional clarity of the high definition trace . . . and the convenience of the permanent, compact records offered by the lacquer-coated, 35 mm. acetate film. No inks to worry about, no photographic development to delay investigations, and the recordings can be magnified up to 50X in standard microfilm or slidefilm projectors.

Request your free trial of 550A, Direct Writing Oscillographic Recorder with wide frequency response . . . laboratory precision . . . and rugged construction for field testing. Absolutely no obligation. We will arrange a demonstration of the 550A . . . and you may use the instrument on a free-trial basis to compare in your own application.



Write today for the ALI
*Handbook of Instrumentation and
the Oscillographic Recorder Brochure*

Acton Laboratories, Inc.

520 MAIN ST., ACTON, MASS.



MARKEM[®] MACHINES

Solve "IN-PLANT" PRINTING PROBLEMS
- FASTER - NEATER - AT LOWER COST

COLOR BANDING WIRE LEAD COMPONENTS

The Markem 69A Machine semi-automatically applies up to six color bands to wire lead components such as resistors and condensers. Band width and color changes are easily made. Automatically feeds and ejects; bands about 50 objects per minute. The 69A will also mark cylindrical objects with complete label detail, in one or two colors.

Other Markem machines available for marking electrical parts and products of all sizes and shapes. Write for detailed information.

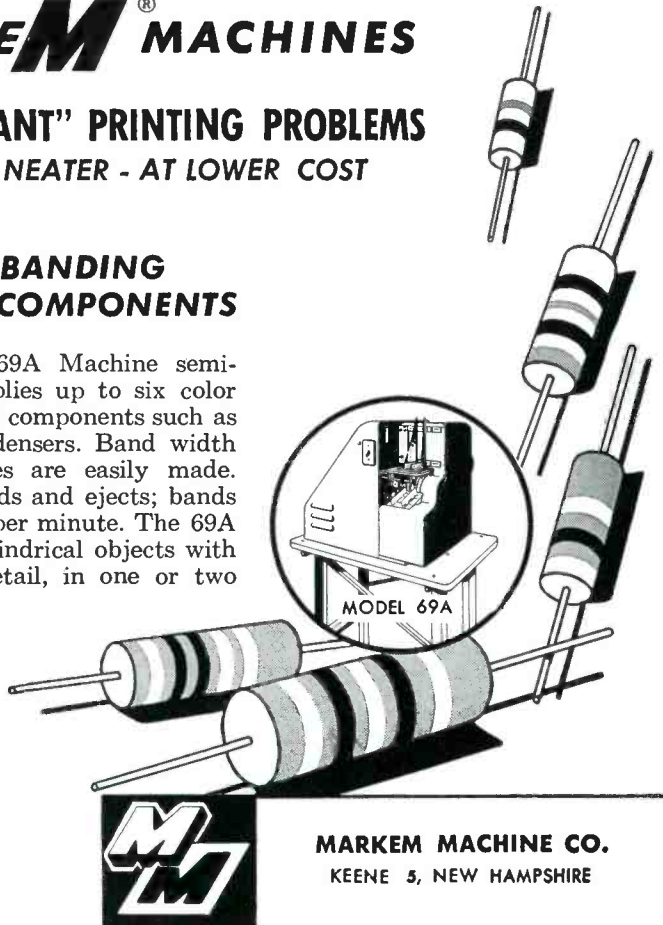

MARKEM MACHINE CO.
KEENE 5, NEW HAMPSHIRE

IMPREGNATING
SEALING
DIPPING
INSULATING
BLENDING



POTTING
HEAT CONDUCTING
MOISTURE PROOFING
FUNGUS PROOFING
ENCAPSULATING

WAXES BIWAX COMPOUNDS

Standard compounds available from stock.
Samples and specifications on request.

Modifications developed and produced to meet specific requirements.
Information relating to your problem will enable us to make recommendations. Write to

BIWAX CORPORATION 3445 HOWARD ST.
SKOKIE ILLINOIS

for complete
selection of Basic Requirements
for your Coil Winding needs it's . . .

Coil Winding Equipment Co.

write for complete
technical literature

COIL WINDING EQUIPMENT CO., Oyster Bay, New York

NEW BOOKS

(continued)

tuation in the future may be required when we speak directly into a translating system.

Chapter 6 discusses the concept of speech input. It describes the possible fundamental units as sounds, phonemes, and syllables, and then points out that real meaning may be conveyed by accent, intonation or other things. This chapter clearly shows many of the difficulties standing in the way of mechanical translation of speech.

► **Machines**—All the machine components for speech translation are mentioned as existing so that the true translation of words as well as meanings "seems hardly more extravagant now than an automatic dictionary did ten years ago." The idea of speech input and recognition is discussed along with a brief mention of present electronic devices which have a limited ability in this field. Computing and data handling components and devices are discussed. The authors failed to mention the device called the Vocoder demonstrated as early as 1939 by Bell Telephone Laboratories. An operator depressing keys could control impulses which emerged as a reasonable reproduction of the human voice.

The obvious conclusion which will be drawn by every reader is that until language is reduced to a smaller set of rules with a much smaller number of exceptions, there is not much hope for a practical translation machine. It remains to be seen whether those interested in the maximum communication of information and those interested in the most unusual and flowery forms of expression will ever be able to agree.

—G. T. HUNTER, *Assistant Director, International Business Machines Corporation, New York, N. Y.*

Theory of Alternating-Current Machinery

By A. S. LANGSDORF
McGraw-Hill Book Co., New York,
1955, 666 p., \$7.50

THIS BOOK is a basic text covering the design and operating charac-

May, 1956 — ELECTRONICS

NEW SYNCHRO TRANSCIVER

for error readout in
missile guidance systems
developed by American Electronics
features internal magnetic brake

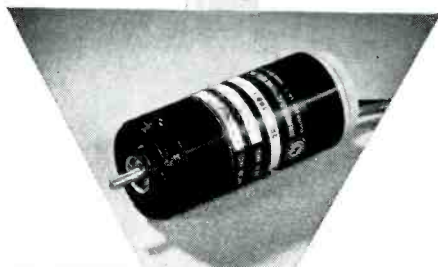

The TR11C4
Synchro
Transceiver
now in
volume
production.

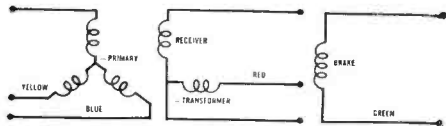

Windings are shown in electrical zero position.

The TR11C4 is a miniature unit combining the advantages of a synchro-receiver and control transformer, featuring:

- Receiver winding—26 volts 26 cps.
- Primary winding—11.8 volts, 400 cps line to line.
- Transformer—26 volts d.c.
- Voltage Gradient (null voltage—50 millivolts) of transformer winding—0.34 volts per degree.
- Brake locks Primary and Secondary in stationary position when energized.

For specific information write:
Dept. 492-E16



AMERICAN ELECTRONIC MFG., INC.
Instrument Division of
American Electronics, Inc.
9503 W. Jefferson Blvd.
Culver City, California

Want more information? Use post card on last page.
ELECTRONICS — May, 1956

NEW BOOKS

(continued)

teristics of electromagnetic machinery. The book covers transformers and rotating machinery including asynchronous and synchronous motors and generators in a comprehensive manner.

Chapter 16 deals with the mercury-arc rectifier. Basic principles are explained using the single-phase full-wave mercury-arc rectifier as an example. Operation of the excitor and the ignitron are described.

Problems relating to the effect of phase control on the d-c voltage output and the regulation of the d-c voltage are discussed. Operation of the mercury arc inverter and frequency changer are explained.—

J. M. C.

Coordination, Control, And Financing Of Industrial Research

Edited by ALBERT H. RUBENSTEIN
Kings Crown Press, New York, 1955,
429 p, \$8.50

THIS book is the fourth in a series reporting the proceedings of the Annual Conferences On Industrial Research sponsored by the Department of Industrial Engineering at Columbia University. It includes papers presented by executives of some of the leading companies in industry.

The volume, in part one, covers nine papers presented at the fourth annual conference in 1953 on coordination and control of the industrial research organization. The interaction and integration within the research organization, with the company and outside of the company, are examined.

► **Fiscal**—Part two deals with the fifth conference on the economics of industrial research which encompasses costs, budgeting and financing. A total of 19 papers is presented in addition to an interesting and well edited section covering the clinic session. The relevant parts of discussions after most papers are also included.

Following are some of the subjects dealt with in the 1954 conference: The Control Of Research



HYCOR TELEMETERING FILTERS

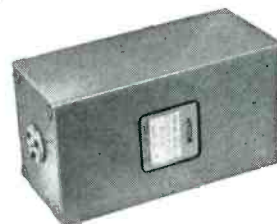

Hycor band-pass and low-pass telemetering filters are produced in exact accordance with accepted military standards. In addition to designs which conform to Applied Physics Laboratory specifications, miniature units are available.

Hycor telemetering filters are potted for complete protection against vibration and humidity. The finest components are used to minimize aging effects on characteristics.

Send for **Bulletin TF** which describes standard types available.

Hycor engineers will be pleased to quote on your most exacting specifications.

Representatives in
Principal Cities

HYCOR

DIVISION OF
INTERNATIONAL RESISTANCE COMPANY

12970 Bradley Avenue, Sylmar 1, Calif.

Want more Information? Use post card on last page.

NEMS-CLARKE
INCORPORATED

TYPE 1501 Special Purpose RECEIVER for UNEQUALED PERFORMANCE

- TELEMETERING
- GUIDED-MISSILE MONITORING
- RADIOSONDE RECEPTION

The Type 1501 Special Purpose Receiver is now being offered as the improved version of the NEMS-CLARKE 167-J1 and 167-J2. The all new 1501 receiver incorporates the best qualities of both of the former types plus many new features including a BFO. A video bandwidth control is provided to greatly improve signal-to-noise ratio when full bandwidth is not needed.

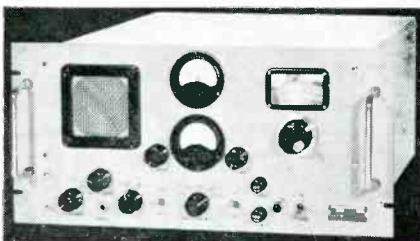

NEMS-CLARKE Type 1501 receiver is useful in application in telemetering, guided missile monitoring, radio-sonde reception and as a high quality general purpose laboratory AM/FM receiver where superior performance is desired in the frequency range of 55-260 mcs.



NEMS-CLARKE

Incorporated

PRECISION ELECTRONIC INSTRUMENTS
SILVER SPRING, MARYLAND

For Further Details Write Dept. H-1

NEW BOOKS

(continued)

Funds. The Influence Of Capital Availability On Research Policy, Preparation Of Research Budgets And The Control Of Research Expenses, Evaluating The Cost And Utility Of Industrial Research And Development, Research Project Evaluation, Application of High Speed Computers To Research Problems.

The growing importance, both technically and financially, of industrial research, particularly in electronics, would seem to make this book virtually must reading for responsible research executives in the industry. Although it does not deal with electronics research exclusively, the similarity in economic problems encountered in research administration in most companies makes nearly all of the discussions valuable.—W.G.A.

Thumbnail Reviews

High-Vacuum Technique. J. Yarwood. John Wiley & Sons, Inc., New York, 1955, 208 p, \$5.50. Production and measurement of high vacuums. Industrial applications and properties of materials used in high-vacuum technique. Of interest to tube engineers.

Messen und Rechnen in der Physik. Ulrich Stille. Fried. Vieweg & Sohn, Braunschweig, Germany, 1955, 416 p, DM 54. Defines basic laws and quantities used in all areas of physical measurement and calculation. Contains several conversion tables.

Der Transistor. Joachim Dosse. Verlag von R. Oldenbourg, Munich, Germany, 1955, 109 p, DM 11.80. Explains behavior of semiconductors, the *p-n* junction and transistor action in point-contact and junction types. Discusses other transistor structures. Presents transistor equivalent circuits and several circuits utilizing the device.

Practical Radio Servicing. William Marcus and Alex Levy. McGraw-Hill Book Co., Inc., New York, 1955, 565 p, \$7.95. Simplified approach to servicing a-c/d-c superhet receivers, battery radios, three-way portables and small radio-phono combinations.

Electroacoustics. Frederick V. Hunt. John Wiley & Sons, Inc., New York, 1954, 260 p, \$6.00. Presents uniform

CONTACTS

THE RIGHT LOCATION

for your operation

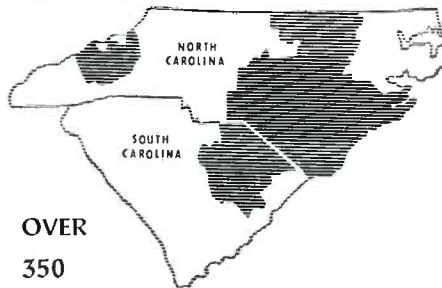

OVER
350

COMMUNITIES TO CHOOSE FROM

(Address
S. P. Vecker, Vice President
Area Development Dept.

CAROLINA POWER & LIGHT COMPANY

RALEIGH / NORTH CAROLINA

SEAMLESS LATEX TISSUE COTS

For Electronic
Part Assembly

- GOSSAMER THIN
- TOUGH AND DURABLE
- MINIMUM DUSTING
- SIZE OF EVERY SEED
- WRITE FOR SAMPLES



THE SEAMLESS RUBBER COMPANY
NEW HAVEN 3, CONN., U.S.A.

MICA

India • Brazil

BLOCKS • FILMS • SPLITTINGS

All Grades & Qualities—Warehouse Stocks
New York—Prompt Forward Shipments

Phone: WOrth 4-4192 or write
ASSOCIATED COMMODITY CORPORATION
Woolworth Bldg., New York 7, N. Y.

Wind Perfect Coils
Check Wire Tensions
with the New Saxl

TENSION METER

Tensitron, Inc., Harvard, Mass.



Want more information? Use post card on last page.

Want more information? Use post card on last page.

NEW Subscription Order

Please enter my new subscription for
TWO YEARS of **ELECTRONICS** for \$9.

If you prefer 1 year of **ELECTRONICS** for \$6 check here

C-

Name:..... Position.....

Home Address:.....

City:..... Zone..... State.....

Company Name:.....

Foreign Rates (1 year) Canada \$10, Latin America \$15, Other \$20

L 5-56

NOTICE TO PUBLISHER OF CHANGE OF ADDRESS

Please change the address for my copies of

ELECTRONICS

FROM

(Street Number, Apt. Number, P. O. Box Number or RFD Number)

.....
(City) (Zone Number) (State)

.....
(Show any numbers or dates included in address on copies for identification)

TO

(New Address—Street and No., Apt. No., P. O. Box No., or RFD Number)

.....
(City) (Zone Number) (State)

NAME Date.....

(As it appears on your magazine)

L 5-56

Postage
Will be Paid
by
McGraw-Hill
Pub. Co.

No
Postage Stamp
Necessary
if Mailed in the
United States

BUSINESS REPLY CARD

First Class Permit No. 64

New York, N. Y.

4¢ POSTAGE WILL BE PAID BY —

McGRAW-HILL PUBLISHING CO., Inc.

ELECTRONICS

330 WEST 42nd STREET

NEW YORK 36, N. Y.



Postage
Will be Paid
by
McGraw-Hill
Pub. Co.

No
Postage Stamp
Necessary
if Mailed in the
United States

BUSINESS REPLY CARD

First Class Permit No. 64

New York, N. Y.

4¢ POSTAGE WILL BE PAID BY —

McGRAW-HILL PUBLISHING CO., Inc.

ELECTRONICS

330 WEST 42nd STREET

NEW YORK 36, N. Y.

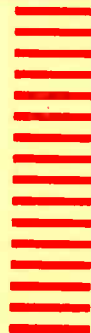

analytic treatment of both electrostatic and electrodynamic modes of electromechanical coupling. Begins with lengthy discursive introduction tracing development of electromechanical transducers from eighteenth century.

Nuclear Magnetic Resonance. E. R. Andrew. Cambridge University Press, New York, 1956, 265 p, \$6.50. Deals with a phenomenon gaining increasing importance as an analysis technique. Presents electronic equipment for detecting nuclear magnetic resonance. Discusses general physical measurements using nmr, properties and applications of nmr to liquids, gases, metallic and nonmetallic solids.

Modern Physics. Robert L. Sproull. John Wiley & Sons, Inc., New York, 1956, 491 p, \$7.75. Written specifically for undergraduate engineering student this book provides much basic information essential to the electronics engineer. Subjects treated include magnetic properties of solids, luminescence, semiconductors, physical electronics and applied nuclear physics.

Proceedings of the XIth General Assembly, International Scientific Radio Union, Vol. X, Part 6. Secretary General URSI, Brussels, Belgium, 1954, 140 p, \$3.00 (paper). Deals with radio waves and circuits. Includes list of papers, reports of national committees, subcommittees and working groups. Subjects cover information theory, microwave optics, circuit theory, antennas and electromagnetic theory.

Multivibrators. A. Schure. John F. Rider Publisher, New York, 1956, 52 p, \$0.90 (paper). The basic principles of multivibrator circuits including bistable, monostable and astable. Circuit schematics are given and operation is described with the help of waveform diagrams.

The Earth's Magnetism. V. E. Matulaitis. The Mands Co., Franklin, Michigan, 1956, 20 p, \$1. Attempts to explain the earth's magnetism as a consequence of the earth being a rotating solid body.

TV Repair, Questions and Answers. Sidney Platt. John F. Rider Publisher, New York, 1956, 128 p, \$2.10 (paper). Service technique for home television receivers explained in question and answer form. Deals with horizontal deflection, horizontal output, damper boost, keyed age, and vertical output stages and deflection yokes and systems.

Television—How It Works. J. Richard Johnson. John F. Rider Publisher, New York, 1956, 352 p, \$4.60. Qualitative explanation of television systems and operation of television receivers.

Any marking problems?

- ENGRAVING
 - ARC ETCHING
 - NUMBERING
 - LETTERING
 - CALIBRATING
- Also
Tracer Guided
- PROFILING
 - SLOTTING
 - MILLING

The world's largest specialist

offers a full line of portable and heavy duty engraving machines, with arc etching equipment.

- 24-PAGE BOOKLET EXPLAINS THESE FACTS:
- Fastest set-up time for unskilled labor
 - Covers a larger engraving area than any other machine of its kind.

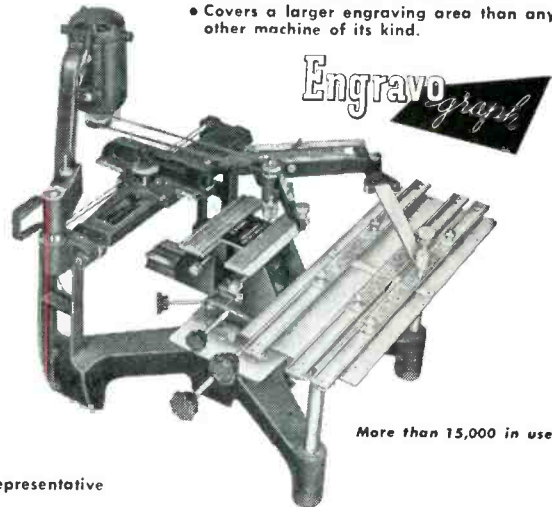

More than 15,000 in use.

Send for booklet 29
Write for name of nearest representative

new hermes ENGRAVING MACHINE CORP. 13-19 UNIVERSITY PLACE • NEW YORK 3, N. Y.

If your problem involves accurate division of AC voltage, you need a

STANDARD RATIO TRANSFORMER

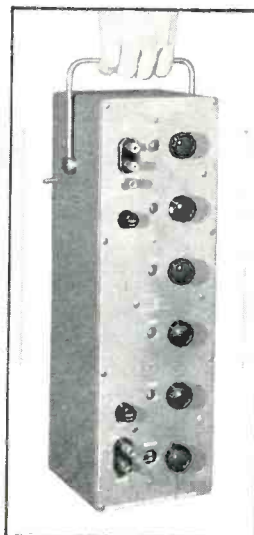

AC voltages can be divided with accuracies as good as .005% and resolution as good as .00001%

The PT Series (7 models) precision AC voltage dividers have been specifically designed to divide AC voltage with unusual accuracy. Push button and rotary switch models available, in both carrying case and rack mounting styles. Models available to cover frequencies from 30 to 3,000 cps (to 10,000 cps at reduced accuracy). PT-5, illustrated, covers 50-3,000 cps, with continuous resolution.

For design and production use

Applications include: Bridge Ratio Arm, AC potentiometer; checking resolvers, servos, transformers, computers; for meter calibration, and as a ratio standard.

For complete information contact your Gertsch representative or

— GERTSCH —

GERTSCH PRODUCTS, INC.
11846 Mississippi Avenue
Los Angeles 25, California

Looking for the right resistor?

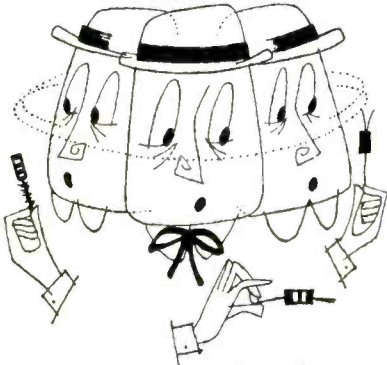

you can find it in this catalog...



...along with everything you'll want to know about the complete standard line of Speer Resistor Products — specifications, characteristics and applications:

- Fixed Composition Resistors
- Phenolic Coil Forms
- Iron Coil Forms

Be sure to send for your copy today.

Other Speer Products for the Electronics Industry

anodes • contacts • fixed carbon resistors
coil forms • discs • brushes • battery carbon • graphite plates and rods
also R. F. coils • fixed composition capacitors • chokes made by Jeffers Electronics



SPEER RESISTOR DIVISION
SPEER CARBON COMPANY
Bradford, Pennsylvania

Send copy of the Speer Resistor Catalog.

Name _____

Title _____

Company _____

Address _____

City _____ State _____

Want more information? Use post card on last page.

Backtalk

Staggered Crystal Filters

DEAR SIRS:

IT SEEMS to me there's a mistake in the article dealing with staggered triple crystal filters in the December 1955 issue of *ELECTRONICS* (p 166).

The transition from equivalent circuit B (Fig. 1) to equivalent circuit C seems incorrect.

The capacitor shunting R_1 in Fig. 1C should be $C_i + 2C_h = C_i + 2C_h$ instead of C_i which appears in the figure.

Considering the fact that the gain of the stage is inversely proportional to this capacitance and that a typical value of C_h is 15 $\mu\mu\text{f}$ compared to 5 $\mu\mu\text{f}$ only for C_i , we see that the actual gain would be $15.2/5 = 6$ times lower than calculated in the article. (A simple derivation of the equivalent circuit followed in the letter.)

SHALHAV ZOHAR
Givataim, Israel

DEAR MR. ZOHAR:

A COPY of your letter with reference to my article on a filter system has been forwarded to me. I appreciate very much your interest in the subject.

In answer to your letter, I should like to state that gain does suffer very much under the conditions that you state. Fortunately crystals may be obtained with holder capacitance as low as 1 $\mu\mu\text{f}$ with the present state of the art using plated systems, shear modes of operation etc. In filter systems, the crystal is only required to handle a small percentage of the power usually fed to an oscillator crystal hence it may be made much smaller.

Capacitor C_i , though not defined completely in the article, actually is made up of $2C_h$ plus C wiring plus whatever the tube input shows to the system. All of these were lumped into the term C_i to enable the writing of a generalized gain equation of a partial element.

As is apparent in elementary circuit theory, input capacitance of the vacuum tube can vary widely depending on whether, for example,

a pentode cathode follower or a triode with a high value of resistance load is used as an isolation stage. In the circuit shown, a compromise was used.

If one cannot obtain crystals with low holder capacitances, the situation could be improved by adding some inductive reactance across C_i . Under these conditions some of the simplicity of the circuit would be lost.

As you can see, some compromise was made in order to obtain a system with no adjustments after the Q's are fixed.

D. E. HILDRETH
Electronic Products Corp.
Santa Barbara, California

Magnetic Demodulation

DEAR SIRS:

HAVING just read the communication by B. F. Miessner in *Backtalk*, p 386, September, 1955, I am reminded that whilst demonstrating a Marconi magnetic detector at a lecture before a university engineering society as recently as two years ago, the hissing sound mentioned by Mr. Miessner also formed part of my demonstration, and was heard with interest by the audience.

In this demonstration I used the detector as a demodulator for audio-frequency amplitude-modulated r-f signals, and the apparatus worked tolerably for radio frequencies up to about two megacycles per second. Of the audio frequency characteristics of the apparatus I remember little, except that to demodulate the higher audio frequencies it was necessary to speed up the belt travel.

The theory of this detector is given by Marconi himself in the pages of *The Electrician* of the early part of this century. Also amongst those early pages is to be found a letter by Marconi refuting charges of insensitivity levelled at his device. The charges, I think, were made by an American shipping company.

H. V. HARLEY
Weymouth, Dorset
England

PROFESSIONAL SERVICES

Consulting—Patents—Design—Development—Measurement

in

Radio, Audio, Industrial Electronic Appliances

ATLANTIC ELECTRONICS LABORATORIES

Design Development Prototypes
Specialists in

Electronic Timing and Switching Devices
606 Bond St. Asbury Park, New Jersey

WHEN TIME IS SHORT . . .

put the solution of your problems up to a specialized Consultant whose professional card appears on this page. His broad experience may save you months of costly experimentation.

ELECTRONICS

330 West 42nd St., New York 36, N. Y.

NUCLEAR-ELECTRONICS CORPORATION

From Engineering Design to the Finished Product
Specialists in
Nuclear Instrumentation—Communications
Test and Measuring Equipment
Industrial Electronics—Audio Equipment
2632-36 W. Cumberland St. Philadelphia, Pa.

H. O. BIXBY ASSOCIATES

Consultants to the Electronic Industry

SURVEYS — PROMOTIONS — LIAISON
PERSONNEL PLACEMENT — TECHNOLOGY

238 Main St. Cambridge 42, Mass.
ELiot 4-0104

ERCO RADIO LABORATORIES, INC.

Radio Communications Equipment

Engineering - Design - Development - Production
Our 27th Year in Air to Ground
Communications and Radio Beacons
Garden City • Long Island • New York

PICKARD & BURNS, INC.

Consulting Electronic Engineers

Analysis and Evaluation
of Radio Systems
Research Development and Production
of Special Electronic Equipment
240 Highland Ave. Needham 94, Mass.

BRIGGS ASSOCIATES, INC.

Engineering Services

ELECTRONICS MECHANICAL

Development — Manufacturing — Consulting
Special Machines — Instrumentation — Automation
Electron Tube Design, Materials, Reliability

10 DeKalb St. Broadway 9-2120 Norristown, Pa.

HANSON-GORRILL-BRIAN INC.

Product & Mfg. Development

ELECTRICAL - ELECTRONIC
HYDRAULIC - MECHANICAL

One Continental Hill Glen Cove, N. Y.
Glen Cove 4-7300

ALBERT PREISMAN

Consulting Engineer

Television, Pulse Technique, Video
Amplifiers, Phasing Networks
Industrial Appliances
Affiliated with

MANAGEMENT-TRAINING ASSOCIATES
3224 - 16th St., N. Y. Washington 10, D. C.

BART LABORATORIES

Division of BART MANUFACTURING CORP.

Consultation and Manufacturing Services on precision electro-forming and precious metal plating since 1916.

227 Main Street Belleville 9, N. J.
PLYmouth 9-0200

THE KULJIAN CORPORATION

ELECTRONICS DIVISION

Consulting Electronic Engineers

Research Development, Production of
Automatic Controls — Special Instrumentation
1200 No. Broad St., Philadelphia 21, Pa.
Stevenson 2-9000

SUNSTEIN ENGINEERING CO.

David E. Sunstein and Associates

Consulting Services for Research, Engineering
and Production of Industrial, Consumer, and
Government Products.

464 Conshohocken State Road
Bala-Cynwood (Phila.) Pa.
MOntawk 4-0459

CROSBY LABORATORIES, INC.

Murray G. Crosby & Staff

Radio - Electronics
Research Development & Manufacturing
Communication, FM & TV

Robbins Lane, Hicksville, N. Y.
WElls 1-3191

Measurements Corporation

Research & Manufacturing Engineers

HARRY W. HOUCK MARTIAL A. HONNELL
JOHN M. VAN BEUREN
Specialists in the Design and
Development of Electronic Test Instruments
Boonton, New Jersey

THE TECHNICAL MATERIAL CORPORATION

Communications Consultants

Systems Engineering
General Offices and Laboratory
700 Fenimore Rd., Manamorneck, N. Y.

DELAWARE PRODUCTS CO.

Analog Voltage to Digital Conversion
Digital Voltage Recording Systems

Design-Development-Manufacturing

300 Broadway Camden 3, N. J.

MINOT INFORMATIC DEVICES

AUTOMATIC RECOGNITION OF
SHAPES, PATTERNS & INFORMATION
RESEARCH - INVENTION - CONSULTING

on detection and interpretation of
complicated forms, characteristics of
materials, printed characters, etc.
Otis N. Minot, 22 Elliot Rd., Lexington 73, Mass.
Tel. VOLunteer 2-9465 or -3974

TELECHROME, INC.

Electronic Design Specialists

COLOR TELEVISION EQUIPMENT
Flying Spot Scanners, Color Synthesizers, Keyers,
Monitors, Oscilloscopes and Related Apparatus
J. R. Popkin-Clurman, Pres. & Ch. Engr.
88 Merrick Rd. Amityville, L. I., N. Y.

Eldico of New York, Inc.

Pioneers of Television Interference Elimination from
Transmitters, Induction Heaters, Diathermy and etc.

Donald J. S. Merten & Engineering Staff

12 E. Second St. Mineola, L. I., N. Y.
Pioneer 6-5213

DR. HAROLD NARCUS

Consultant

METALLIZING NON-CONDUCTORS

Pioneer in the field of metallizing non-conductors
such as plastics, ceramics, glass, etc. for both industrial
and decorative applications. Techniques and
processes developed during 20 years specialization in
the field. Recognized authority with well-known record
of achievement.

Tel. PLeasant 3-5918
15 Vesper Street Worcester 2, Mass.

WHEELER LABORATORIES, INC.

Radio and Electronics

Consulting — Research — Development
R-F Circuits — Lines — Antennas
Microwave Components — Test Equipment
Harold A. Wheeler and Engineering Staff
Great Neck, N. Y. HUnter 2-7876

ELECTRONIC RESEARCH ASSOCIATES, INC.

"TRANSISTORIZE" YOUR PRODUCT!

Complete Service in consulting, research, development,
and production on Transistor circuitry, products
and instrumentation.

67 East Centre Street Nutley, N. J.
NUTley 2-5410

NIAGARA ELECTRON LABORATORIES

CONSULTATION - DESIGN - CONSTRUCTION
MFG. THE THERMOCAP RELAY

Specializing in solution of problems of electronic
and electro-physical instrumentation for the research
or analytical laboratory. Industrial plant problems
also invited.

Andover, New York Cable Address: NITRONLAB

YARDNEY LABORATORIES

Research-Design-Development

Electro-Chemical Generators of Energy
40-46 Leonard Street Worth 6-3100
New York 13, N. Y.

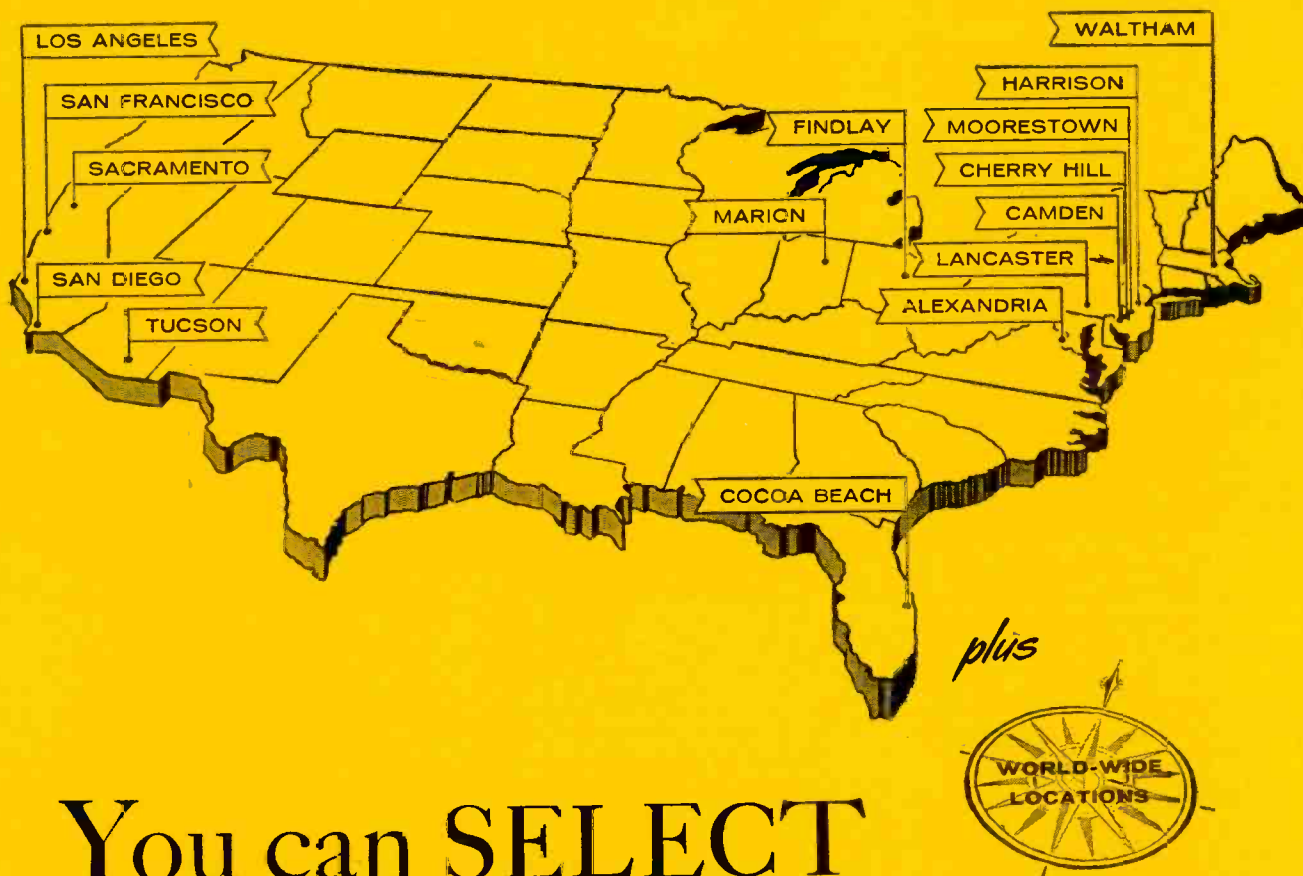

You can SELECT at RCA!

... New Opportunities ... 17 + Locations ... One Best For You And Your Family

**Can anyone but RCA offer you
a choice of locations like this?**

At Camden, Moorestown or Cherry Hill, you enjoy cultural advantages of Greater Philadelphia, live at moderate cost in pleasant suburban communities. Waltham offers at-home opportunities for New England engineers. Four ideal West Coast locations. Harrison borders on Greater New York. Lancaster, Marion and Findlay have small-town advantages. There's pleasant year-round outdoor living in Cocoa Beach, on Florida's central east coast. RCA Service Company and International Division assignments include ideal locations in the United States, and wherever RCA electronic equipments are installed and serviced throughout the world.

Individual Recognition—

RCA organizes engineering activities into groups small enough to allow broadest scope for your individual accomplishment. The average group has just 11 engineers. Yet, in all activities, you are supported by the entire facilities and engineering resources of RCA.

Salaries—

RCA engineering salaries average measurably higher than other companies' in the field. Intermediate engineers, \$5000-\$8500; senior engineers, \$8500-\$15,000; staff and supervisory salaries open.

Advancement—

Scheduled, objective appraisal of your work speeds promotion. Professional and financial progress is just as sure as your achievements make it.

Professional Status—

RCA bases world leadership in electronics on the abilities of exceptional men at every organizational level. Many have notable engineering and scientific reputations. You work in day-by-day association with men of this caliber.

Benefits—

There's a complete program at RCA. A very liberal Tuition Refund Plan. Company-paid life, sickness and accident, hospital-surgical insurance for you and your family. Modern retirement plan. Relocation expenses paid. Suggestion and patent awards.

Now, Pinpoint Your Future

...Here are the Opportunities!

...Here are the Locations!

FIELDS OF ENGINEERING ACTIVITY		MANAGERS	TYPE OF DEGREE AND YEARS OF EXPERIENCE PREFERRED											
			Electrical Engineers			Mechanical Engineers			Physical Science			Chemistry Ceramics Glass Technology Metallurgy		
			0-2	2-3	4-15	0-2	2-3	4-15	1-2	2-3	4-15	1-2	2-3	4-15
<ul style="list-style-type: none"> SYSTEMS (Integration of theory, equipment and environment to create and optimize major electronic concepts.) 	AVIATION ELECTRONICS • CONTROLS			W	W	M			W	W				
	DIGITAL DATA HANDLING DEVICES	M	C	M	C		C	C		C	C			
	MISSILE ELECTRONICS • RADAR	M	W	M	W		M	M		M	M			
	INERTIAL NAVIGATION	W			W			W				W		
	COMMUNICATIONS				C							C		
DESIGN • DEVELOPMENT														
KINESCOPIES (B & W and COLOR), OSCILLOSCOPES —Electron Optics—Instrumental Analysis—Solid States (Phosphors, High Temperature Phenomena, Photosensitive Materials and Glass to Metal Sealing)			L	L	L	L	L	L	L	L	L	L	L	
RECEIVING TUBES —Tube Design—Test and Application Engineering—Chemical and Physical Development—Methods and Process Engineering—Advanced Development			H	H	H		H	H		H	H		H	
SEMI-CONDUCTORS —Transistors—Semi-Conductor Devices—Materials			H	H	H	H	H	H	H	H	H	H	H	
MICROWAVE TUBES —Tube Development and Manufacture (Traveling Wave—Backward Wave—Magnetron)		H		H	H		H	H		H	H		H	
GAS, POWER AND PHOTO TUBES —Photosensitive Devices—Glass to Metal Sealing—UHF and VHF—Power			L	L	L	L	L	L	L	L	L	L	L	
AVIATION ELECTRONICS —Radar—Computers—Servo Mechanisms—Shock and Vibration—Circuitry—Remote Control—Heat Transfer—Sub-Miniaturization—Automatic Flight—Automation—Transistorization		W	C	W	C	W	C	W	C	W	C	W	C	
COMPUTERS —Systems—Advanced Development—Circuitry—Assembly Design—Mechanisms—Programming			C	C	C	C	C	C	C	C	C	C	C	
RADAR —Circuitry—Antenna Design—Servo Systems—Gear Trains—Intricate Mechanisms—Fire Control—Information Handling—Displays		M	C	M	C	M	C	M	C	M	C	M	C	
COMMUNICATIONS —Specialized Military Systems—Microwave—Aviation—Audio—Propagation Studies			C	C	C		C	C	C	C	C	C	C	
MISSILE ELECTRONICS —Systems Pinning and Design—Radar—Fire Control—Shock Problems—Servo Mechanisms		M	M	M	M	M	M	M	M	M	M	M	M	
COMPONENTS —Transformers—Coils—TV Deflection Yokes (Color or Monochrome)—Resistors—Ferrites (Material and Parts)			C	Z	Z	C	Z	Z	C	C	C		Z	
SYSTEMS APPLICATION (Evaluation and Planning—Design and Development—Modification—Specification)														
MISSILE TEST INSTRUMENTATION (Data Acquisition and Processing)—Radar—Telemetry—Timing—Communications—Optics—Computers		F	F	F	F	F	F	F	F	F	F	F	F	
RADAR —Airborne—Surface—Shipboard—Sonar—Fire Control		F	F	F	F	F	F	F	F	F	F	F	F	
COMMUNICATIONS —Radio—TV—VHF—UHF—Microwave—Telephone—Teletype—Telegraph Terminal Equipment—Wave Propagation		F	F	F	F	F	F	F	F	F	F	F	F	
MACHINE DESIGN Mechanical and Electrical—Automatic or Semi-Automatic Machines			L	L		L	L	H	H		L	L		

Locations: C—Camden, N.J. F—Cocoa Beach, Fla. H—Harrison, N.J. I—International Div. L—Lancaster, Pa. M—Moorestown, N.J. S—RCA Service Co. (Cherry Hill, N.J.; Alexandria, Va.; Tucson, Ariz.; San Diego, Sacramento, San Francisco, Calif.; Foreign Assignments). W—Waltham, Mass. X—Los Angeles, Calif. Y—Marion, Ind. Z—Findlay, Ohio



Please send resume of education and experience, with location preferred, to:

Mr. John R. Weld, Employment Manager
Dept. A-15E, Radio Corporation of America
30 Rockefeller Plaza, New York 20, N.Y.

RADIO CORPORATION of AMERICA

Copyright 1956 Radio Corporation of America

EMPLOYMENT OPPORTUNITIES

The Advertisements in this section include all employment opportunities—executive, management, technical, selling, office, skilled, manual, etc.



**Positions Vacant
Positions Wanted
Part Time Work**

**Civil Service Opportunities
Selling Opportunities Wanted
Selling Opportunities Offered**

**Employment Agencies
Employment Services
Labor Bureaus**

DISPLAYED

RATES

UNDISPLAYED

The advertising rate is \$21.50 per inch for all advertising appearing on other than a contract basis. Contract rates quoted on request.

An advertising inch is measured 3/8" vertically on a column—3 columns—30 inches to a page.
Subject to Agency Commission.

\$2.10 per line, minimum 3 lines. To figure advance payment count 5 average words as a line.

Box Numbers—counts as 1 line

Position Wanted ads are 1/2 of above rate.

Discount of 10% if full payment is made in advance for 4 consecutive insertions.
Not subject to Agency Commission.

Send NEW ADS to Classified Advertising Division of ELECTRONICS, 330 W. 42nd St., N. Y. 36, N. Y., for June issue closing May 4th



Career Opportunities for

TRANSISTOR and DIODE ENGINEERS and SCIENTISTS

BS, MS and PhD levels required in Electrical and Mechanical Engineering, Physics, Chemistry, and Metallurgy. Positions available in development, evaluation, application, and product engineering of diodes and transistors and mechanization of production equipment.

Please send resume to

S. V. Andrews, Technical Placement Office
or call Blgelow 4-7500, Extension 253 for appointment

SEMICONDUCTOR DIVISION

150 California St., Newton 58, Mass.



MANUFACTURERS' REPRESENTATIVES

IN THE ELECTRONIC INDUSTRY

As a service to readers, ELECTRONICS presents the advertisements for some of the leading manufacturers' representatives in the electronic industry. These firms are qualified to help the Manufacturer with his distribution problems; the Buyer with his product needs.

MARYLAND

MACLEN CORPORATION
Manufacturers Representative
8616 Georgia Ave. Silver Spring, Md
Components & Equipment

Territory:
Pennsylvania New Jersey
Delaware Maryland
Virginia W. Virginia
District of Columbia

Government
and
Industry

PENNSYLVANIA

SAMUEL K. MACDONALD, INC.
manufacturers representatives over 25 years
1531 SPRUCE STREET, PHILA. 2, PA.

Territory:
Pennsylvania • New Jersey
Delaware • Maryland
Virginia • West Virginia
District of Columbia

Other Offices:
Pittsburgh
Baltimore
Washington, D.C.

REPLIES (Box No.): Address to office nearest you
NEW YORK: 330 W. 42nd St. (36)
CHICAGO: 620 N. Michigan Ave. (11)
SAN FRANCISCO: 68 Post St. (1)
LOS ANGELES: 1125 W. 6th St. (17)

POSITIONS VACANT

Progressive Western New York Company desires product engineer for research and development in deposited carbon resistors. Excellent opportunity for the right individual. P-1181, Electronics.

Wanted Resistor engineer with experience in the manufacture of ceramic based printed circuits by large eastern manufacturer. Salary open, commensurate with ability and experience. All replies held in strictest confidence. Please reply to P-1064, Electronics.

Engineers—High frequency heating. Design or sales experience with dielectric or induction heating equipment or power oscillators preferred. Expanding medium size company within 30 miles of New York has challenging opportunities for technicians, draftsmen and engineers. Send brief resume. P-1089, Electronics.

SELLING OPPORTUNITIES OFFERED

Manufacturer's Representatives — Custom Plastics electronic parts fabrication. Expanding Eastern custom fabricators and machinist (automatic screw) of plastic parts—stampings, terminal board assemblies, connectors, insulation—from Teflon, Rexolite, Nylon, laminated phenolics, etc. Need reps with active contacts and experience in electronics industry. Attractive commissions—protected territories. Send data on experience and territories. RW-1049, Electronics.

Representatives Wanted most territories leading resistor manufacturer, wire wound vitreous enamel power resistors, precision bobbins, commercial and military. Aviation contacts important. Give background, lines carried and territories covered. RW-1290, Electronics.

SELLING OPPORTUNITY WANTED

Established Metropolitan New York salesman seeks component lines for manufacturers and industrials. Please reply to RA-8897, Electronics.

CHIEF ELECTRONIC ENGINEER

\$10,000 to \$15,000 a year. Capable of directing multi-project groups. Will supervise engineers from initial design to finished product. Opening created through expansion program. Send resume to:

J. J. COOPER
64 E. Jackson Blvd. Suite 940
Chicago, Ill. WAbash 2-1918
Prompt and confidential service

ASST. TO V.P. ENGINEERING

Nationally renowned electronic research engineer and inventor has sold his company to large New York firm and is now V.P. this division. Needs assistant to aid in advanced theoretical research and development. Starting salary \$12,000. Your reply confidential. Employer assumes all costs.

Monarch Personnel, 28 E. Jackson Blvd.
Chicago 4, Ill.

ELECTRONIC PROJECT ENGINEERS

\$8400 to \$12,000 a year. Experienced in all types of Electro-Mechanical design, research and development on Electro-Mechanical products. Capable of successfully directing groups of engineers. Send complete resume to:

J. J. COOPER
64 E. Jackson Blvd. Suite 940
Chicago, Ill. WAbash 2-1918
Prompt and confidential service



Moonbeams or a **beam to the moon...?**

You're a creative engineer. Your success depends upon your imagination—your ideas—and, most important, the *transformation* of those *ideas* into *realities* that pay off.

At Goodyear Aircraft, our success is measured by these realities. Here, ideas are a prime commodity. And our engineers have at their disposal the most modern facilities available, to help transform these ideas into practical realities.

During the past 46 years, in both peace and war, our engineers have turned ideas into realities that today affect nearly every aircraft in our skies. Airships, missiles, electronic guidance equipment, structures, electronic computing equipment—the list is long and broad. And when that trip to the moon is ready to leave, you can be sure we'll be in on that one, too.

Our growth and diversification demand that our staff be expanded. Opportunities for rewarding professional careers in all specialties of creative engineering are available both at Akron, Ohio, and Litchfield Park, Arizona. Salaries are based upon individual merit and benefits are, of course, liberal. For those who wish to continue academic study, company-paid tuition courses leading to advanced degrees have been established at nearby colleges.

For further information on the opportunities awaiting *you* at Goodyear Aircraft, write: Mr. C. G. Jones, Personnel Department, Goodyear Aircraft Corporation, Akron 15, Ohio.

They're doing big things at

GOOD YEAR AIRCRAFT

THE TEAM TO TEAM WITH IN AERONAUTICS

Fort Wayne, Ind.
"America's Happiest City"

Dear Bill:

Now that Joe is on the team here at Farnsworth, he's asked me to write and give you the same story that got him interested in coming with us.

Actually, Bill, it wasn't a "story." Just a few honest-to-goodness reasons why he and Marge should make the move and let the family really live as well as let Joe grow professionally.

For instance, do you know what "sold" Marge? The fact that in living here you are only 10 minutes from everywhere—schools, churches, stores etc. and Joe goes home for lunch every day instead of week-ends. She also liked the idea of some 300 lakes within 70 miles. (Guess where they're planning to spend the summer!)

As for Joe, he's all hepped up about the work he's doing on such missiles as Bomarc, Talos, Terrier and others. Say the top-notch scientists and engineers he's working with are all big league and he's on the team.

That's about it, Bill. An engineer with your talents shouldn't be waiting around when he can get in on the ground floor here at Farnsworth in research, development or production engineering in missile guidance and control, radar, microwaves, test equipment, counter-measures, transistor applications etc.

So—why not write, right now to Don Dionne, Farnsworth Electronics Co. Fort Wayne, Ind. (A division of International Telephone and Telegraph Corp.)

You, Joe, I and Farnsworth will be mighty glad you did.

Sincerely, Jack

ELECTRONIC ENGINEERS!

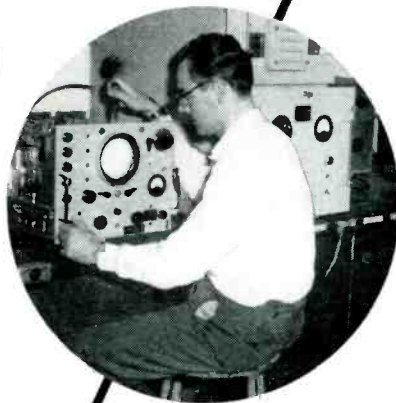

ARE YOU ENGINEERS . . . OR TIME CARD NUMBERS?

If you are tied up in red tape . . . if the scope of your work is limited . . . if you can't use your creative engineering abilities . . . then MEMCO offers you a sound escape from stagnation and monotony.

AT MEMCO:

every electronic engineer . . .

- is encouraged to use his creative talents.
- works on all phases of his projects.
- is appreciated as an engineer, not as a replaceable cog in a big machine.
- gets top pay and many benefits.
- can build a sound, worthwhile future.

For full details please write to:

MARYLAND ELECTRONIC

MANUFACTURING CORPORATION

5009 Calvert Road

College Park, Maryland

(A suburb of Washington, D. C.)

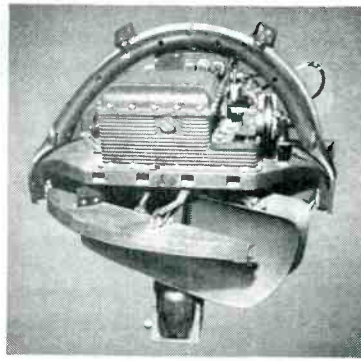

TO THE FINE ENGINEERING MIND
SEEKING THE CHALLENGING PROJECTS IN

ELECTRONICS

ELECTRONICS ENGINEERS are urgently needed to fill career openings at Convair in beautiful San Diego. Opportunities include positions for engineers experienced in missile guidance; airborne radar systems; microwave techniques, analog or digital computers; servomechanisms; test systems and equipment design and development; telemetry including special need for telemetered data reduction personnel; circuit design and analysis; transistor and/or magnetic-amplifier specialists; engineers experienced in the design development and testing of electronic equipment from the standpoint of reliability. Antenna engineers are also required for missile and other airborne systems design development.

CONVAIR offers you an imaginative, explorative, energetic engineering department... truly the "engineer's" engineering department to challenge your mind, your skills, your abilities in solving the complex problems of vital, new, long-range programs. You will find salaries, facilities, engineering policies, educational opportunities and personal advantages excellent.

SMOG-FREE SAN DIEGO, lovely cool city on the coast of Southern California, offers you and your family a wonderful, new way of life... a way of life judged by most as the Nation's finest for climate, natural beauty and easy (indoor-outdoor) living. Housing is plentiful and reasonable.

Generous travel allowances to engineers who are accepted. Write at once enclosing full resume to: **H. T. BROOKS, ENGINEERING PERSONNEL DEPT. 917**

CONVAIR

A Division of General  Dynamics Corporation

3302 PACIFIC HIGHWAY • SAN DIEGO, CALIFORNIA

MEN OF VISION



Apply your creative engineering to research, development and design . . .

THE KEY TO YOUR SOLID SUCCESS AT

Admiral®

These positions are tailor-made for highly imaginative engineers who like problems of more than average difficulty; assignments that require a maximum of individual electronic creativeness.

CURRENT OPENINGS INCLUDE:

RADAR AND PULSE SYSTEMS

Background of VHF-UHF development including circuitry design for air-borne and ground equipment. Long term development involves application of interesting new techniques.

DEFLECTION CIRCUIT ENGINEERS

To do original work on the design and development of horizontal and vertical deflection components and circuitry for both monochrome and color receivers.

PHYSICISTS—ENGINEERS

Experienced in measuring and evaluating reactor fields—neutron and gamma measurements, calculation of effects of these fields on electronic components.

COMPONENT PARTS

Long terms projects on the design of television components with emphasis on engineering control of yokes, tuners and flyback transformers in production.

COMMUNICATION SYSTEMS

For design of complex systems. Familiarity with air-borne receivers and transmitters required. Knowledge of transistor theory and application to military equipment an asset.

ENGINEERING WRITERS

To organize, write and edit operating and maintenance manuals. Openings also available for compiling technical dissertations used for government bid proposals.

RECENT GRADUATES OR EXPERIENCED MEN

This is an invitation to both of you to inquire about these and other opportunities. Liberal salaries based on education, ability and experience. Paid life insurance and hospitalization plus a retirement plan, liberal vacation policy and periodic salary reviews are added benefits.

If you are interested in a secure future, write and give full details to Mr. W. A. Wecker, Personnel Division.



See Admiral's equipment and facilities display at the NATIONAL CONFERENCE ON AERONAUTICAL ELECTRONICS. BOOTH NO. 8A. Biltmore Hotel, Dayton, Ohio on May 14, 15, and 16. Arrangement made for employment interviews at the Conference.

Admiral Corporation

3800 W. Cortland St. • Chicago 47, Illinois

Needed Now...

Engineering Talent

- in ■ Electronics
- Physics
- Mechanics



You owe it to Your Future...

. . . to investigate the opportunity of a career with Industrial Research Laboratories in suburban Baltimore. Live and work in an atmosphere which encourages high level engineering, associate with top-notch engineers and, with them, develop yourself by being in contact with an entire project, not just a segment of a project.

Industrial Research Laboratories is large enough to become involved with varied and interesting defense projects as well as commercial undertakings, yet small enough to insure individual recognition.

The company has a liberal approach to paid vacations, sick leaves, incentive plans and other employee benefits.

Our production and earning curves have been on the upswing constantly, since our inception, and we have never discharged or furloughed an employee due to lack of work.

You owe it to your future to ally yourself with this firm with a future. Write.

INDUSTRIAL RESEARCH LABORATORIES



Div. of Aeronca Manufacturing Corp.

Dept. A-5 Hilltop & Frederick Rds.
Baltimore 28, Maryland

An Invitation
 TO DISCUSS YOUR FUTURE
 WITH THE WORLD'S LEADING
 PRODUCER OF SEMICONDUCTORS

LOOK AT THIS RECORD OF GROWTH

A few short years ago, a handful of people pioneered advanced semi-conductor development at Transitron.

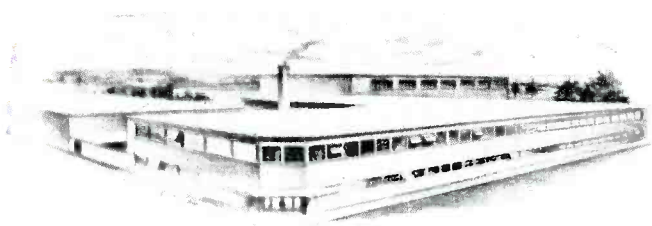

Today Transitron employs over 600 people in a modern plant of 65,000 square feet at Melrose, Massachusetts.

AND NOW . . . FURTHER EXPANSION

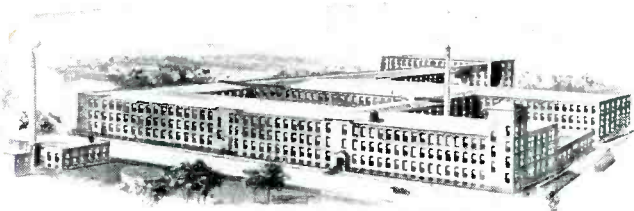

A newly modernized second plant of 250,000 square feet is being equipped at Wakefield, Massachusetts.

If you're in search of real opportunity, you'll find your professional horizons unlimited at Transitron. In a few short years this young company has carved out a leading position in the field of semiconductors. It is now undergoing further expansion into a second plant of 250,000 square feet.

Here is your chance to work with stimulating, congenial associates in an atmosphere of progress — informal and *free of red tape*. You'll be located in pleasant, suburban Boston, in the heart of one of America's technical centers — where cultural and educational advantages are found for you and your family. And you're only an hour's drive from New England's vacationland!

So, if your experience is any of these fields:

SEMICONDUCTOR RESEARCH
 COMPONENTS ENGINEERING
 APPLICATIONS ENGINEERING
 PRODUCTION ENGINEERING
 SALES ENGINEERING

... there is an unparalleled opportunity for you *right now* with Transitron. Salaries are attractive; vacation, insurance and retirement benefits are liberal and your opportunities for professional growth are unlimited.

A letter to Transitron with your resume will receive our prompt attention, and will be held in strictest confidence. Transitron Electronic Corporation, Telephone: MELrose 4-9600.

Transitron electronic corporation
 melrose 76, massachusetts

Leadership in Semiconductors



Experience Pays Off at



GUIDED MISSILE SECTION

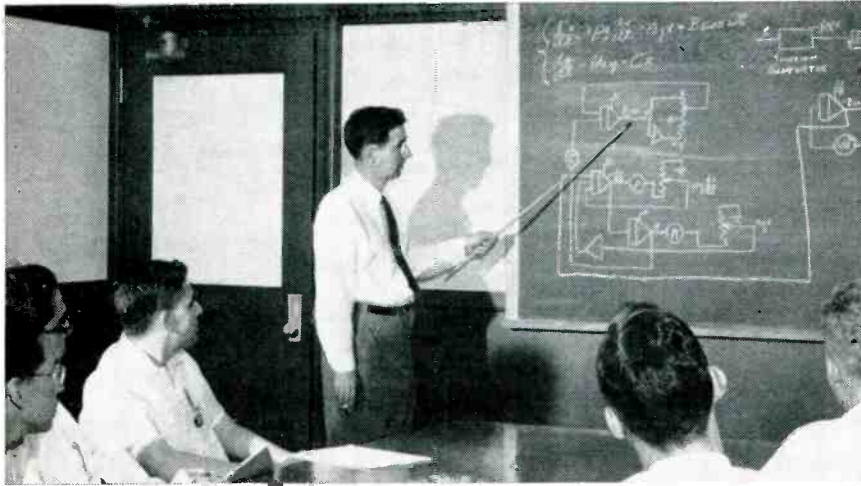

Unusual Job Opportunities for:

TEST EQUIPMENT

Experienced engineers required for design of precision electronic and electro-mechanical automatic test equipment and instrumentation. Programming, signal generation from low frequency to microwave, analogue and digital data handling, and go-no-go comparators and indicators are involved.

ELECTRONIC GUIDANCE

Senior Electronic Engineers are needed to design and develop guidance systems for a major guided missile project. Backgrounds in microwave, radar and serva systems are required.

Senior Mechanical Engineers are needed to design and develop electronic packaging for complex missile guidance systems.

SYSTEMS ANALYSIS

Senior Engineers are needed with extensive backgrounds in the over-all dynamic behavior of missiles and weapons systems, as well as airframe systems of a missile, particularly in terms of weapon performance, to work with analogue computers, digital differential analyzers, breadboards, prototypes of missiles and missile equipment, and special mechanical and electronic simulators. Experience with aerodynamics, servo-mechanisms, electronics, heat transfer, stress analysis, shock and vibrations is desirable.

Bendix Guided Missiles offer interesting job opportunities for Senior Engineers, Assistant Engineers, Junior Engineers and Technicians.

A thirty-six page book, "Your Future in Guided Missiles", describing in detail the many phases of our guided missile operation and the job opportunities available to you, will be sent to you on request. Write for your copy today. BENDIX PRODUCTS DIVISION—MISSILES, 403F, Bendix Drive, South Bend, Indiana.



OPPORTUNITIES IN ELECTRONICS

Varo Manufacturing Co., a young and vigorously expanding organization located just outside Dallas, Texas, has a number of position openings which offer exceptional opportunities to engineers and scientists who are interested in research and development work of unusual scope and diversity.

RESEARCH ASSOCIATE

Eng. or Physics graduate with experience in high vacuum technique, metal vaporization, electron optics. Several positions open for personnel with five years or more experience.

ELECTRO-MECHANICAL ENGINEERS

E.E., M.E., or Physicist with experience in magnetics, audio oscillators or audio filters for design and production engineering of Tuning Forks.

ELECTRONIC ENGINEERS

Several positions for E.E.'s or Physicists with three years or more experience in (1) UHF or VHF communication (2) audio telemetering circuits (3) D.C. amplifiers and controls (4) Transistor audio circuits.

TRANSFORMER ENGINEERS

Excellent opportunity for man with both Design and Production experience in Mil-T-27 type transformers.

MECHANICAL ENGINEERS

E.E. or M.E. with three years or more experience in airborne electronic packaging.

Please send your resume to:

Jim Eidson, Personnel Director

Varo Mfg. Co.
2201 Walnut Street Garland, Texas

An employment advertisement in this EMPLOYMENT OPPORTUNITIES section will help you find the engineers you need. It's an inexpensive, time saving method of selecting competent personnel for every engineering job in the electronic field.



“SUCCESS
breeds
SUCCESS”

An old chestnut,
perhaps — but
still TRUE!

It is important to us, too, because this is why we continue to attract the best.

We lead the field because we have the best engineers . . . the best engineers seek employment here because we lead the field.

It's as simple as that!

“Not quite”—you say? Then why not come in and talk it over?

Since many tube programs continue to expand, we require PhD's, Masters and Bachelors in EE, ME, Physics and Chemistry to fill openings as follows:

TRAVELING WAVE TUBE DEVELOPMENT
—A recent addition, but we're fast gaining the necessary momentum to attain the lead.

MAGNETRON RESEARCH & DEVELOPMENT
—Raytheon's leadership in this field was earned during World War II and is being increased now for both defense and industry.

CROSSED FIELD TUBE DEVELOPMENT
—High & Low Power Backward Wave Tubes, as well as some you've never heard of.

PRODUCT ENGINEERING—Parlayed with our R.&D. you have an unbeatable combination.

APPLICATIONS ENGINEERING—The engineer who likes to travel couldn't make a better choice.

CATHODE RESEARCH & DEVELOPMENT
—We need one man in this section and he must be outstanding.

METHODS & FACILITIES DEVELOPMENT
—Four men were recently promoted from this group leaving the field wide open for the right men.

KLYSTRON ENGINEERING—A basic interesting part of the microwave tube field in which new developments appear constantly.

Please send complete resume of your qualifications and experience to Mr. D. Hamant at:

RAYTHEON MANUFACTURING COMPANY

Foundry Avenue

Waltham 54, Massachusetts

Excellence



in Electronics

ENGINEERS,
Electronic & Mechanical
PHYSICISTS:

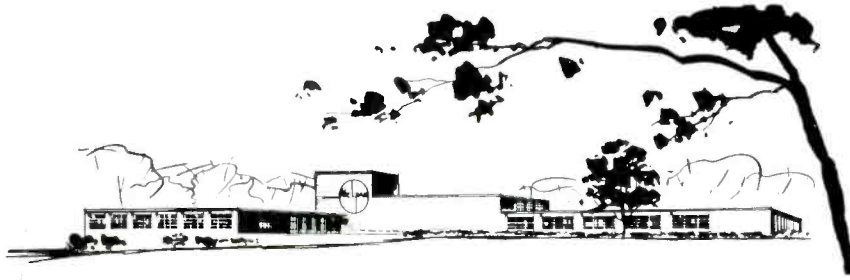

Top Grade Openings At Melpar *Leader in Electronic Research & Development*

Due to our continuing expansion program, a number of top grade openings exist in our new laboratories suburban to Washington, D. C. We urge you to consider the following:

1. At Melpar the engineer is not tied to a pre-arranged schedule of advancement. Instead, promotion and advancement are based on *individual recognition*, where skill and ability are the paramount factors of determination.
2. Melpar has doubled in size every 18 months for the past 10 years. New openings occur constantly. This enables the engineer to advance to positions of increased responsibility as soon as *he is ready*.
3. Our unique "project team" basis of organization gives the engineer an opportunity to participate in *entire* problems from conception to completion of prototype, and thus experience the "over-all" approach to engineering problems necessary to eventual directorship responsibility.
4. Our new air-conditioned laboratories encompass over 285,000 square feet and offer *complete* facilities for creative research and design. In addition to our central Model Shop, supplementary facilities, personnel and test equipment are available for *immediate* use within each project group.
5. The Northern Virginia Area, suburban to Washington, D. C., in which Melpar is located, offers excellent living conditions, enjoys the Nation's highest per capita income, fine homes and schools. Recreational, cultural and educational facilities abound. Fully-accredited graduate courses are offered at the Melpar laboratories and at 5 universities in the Area.

Top Grade Openings Exist in These Fields: Network Theory • Systems Evaluation • Microwave Technique • UHF, VHF, or SHF Receivers • Analog Computers • Magnetic Tape Handling • Digital Computers • Radar and Countermeasures • Packaging Electronic Equipment • Pulse Circuitry • Microwave Filters • Flight Simulators • Servo-mechanisms • Subminiaturization • Electro-Mechanical Design • Small Mechanisms • Quality Control and Test Engineering

Write for fuller information. Qualified engineers and physicists will be invited to visit Melpar at Company expense.



Write: *Technical Personnel Representative*

MELPAR *Incorporated*

A Subsidiary of Westinghouse Air Brake Company

3062 Arlington Boulevard, Falls Church, Virginia

Positions also available at our laboratories in: Cambridge, Mass., 99 First St. Watertown, Mass., 11 Galen St.

**Engineers
of Stature!**

High level positions now available for far-seeing, higher calibre Engineers in the CROSLY Radio and Television Laboratories.

The CROSLY expansion and development program is in its early phases. We need leader-type Engineers who can "take hold" and see important jobs through.

We are placing special emphasis on new applications in color and monochrome television. On the radio side, we are working on transistorized miniature radios and printed circuits.

If you're an Electronic, Electro-Mechanical or Mechanical Engineer, we'd like to talk with you about a future with CROSLY. Salaries will be in line with ability and responsibility. Here are the various areas in product design, applied research and advanced development where we have openings:

- 1 SUPERVISORY ENGINEERS
- 2 PROJECT ENGINEERS
- 3 SENIOR DESIGN ENGINEERS
- 4 DESIGN ENGINEERS
- 5 JUNIOR ENGINEERS

Please send us a written resume or contact the director of Engineering.

**CROSLY
AND BENDIX**

Home Appliances Divisions

AVCO
MANUFACTURING CORPORATION

DEPT. 11

1329 Arlington Street
Cincinnati 25, Ohio
Kirby 1-6600

ENGINEERS UNLIMITED...

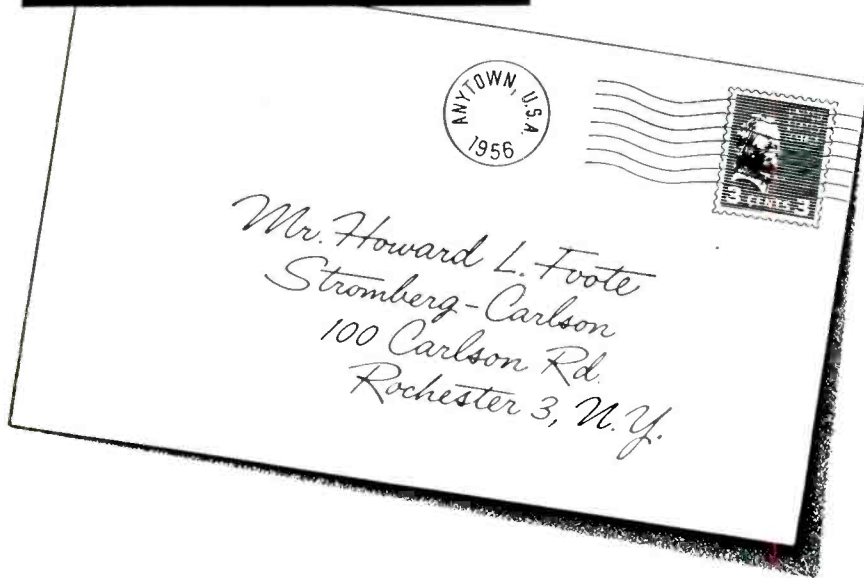

This might well be the
most important letter *you'll* ever write

... because it could open the door to a
lifetime job in a wonderful company

If you're an Electrical Engineer, with a high degree of skill and imagination in any of the fifty-odd fields listed right, we believe we can offer you the most promising opportunity in America.

Since 1940, Stromberg-Carlson's volume has increased *sixteen times*. In 1955, we became a division of the headline-making General Dynamics Corporation. Our future is as unlimited as humans can promise themselves—and *you* could well grow with us.

We are not looking for job-hoppers—but for men now stymied either by the limitations of a little company or the complexity of a giant. In any of the job classifications listed here, you'll find satisfaction and opportunity.

And you'll like Rochester—well-known for its grand schools, handsome residential sections and wide entertainment, vacation and cultural facilities. This firm's employee relations (including a liberal bonus plan) make it one of the state's preferred industries.

The list at right shows where there's room for you and your ideas to grow. Dig in now—with a detailed letter to Mr. Howard L. Foote, at the address below. We think you'll like what he has to say to you.



STROMBERG-CARLSON COMPANY

A DIVISION OF GENERAL DYNAMICS CORPORATION
104 CARLSON ROAD, ROCHESTER 3, N. Y.



*You'll find your future
in one of these
specialized areas*

RESEARCH

Communication and Data Systems • Information Theory • Semi-Conductor • Digital Techniques • Servo Mechanisms • Electronic Switching • Acoustic Transducers • Magnetic Amplifiers • Nucleonics • Microwave and Wireline Carrier

ELECTRONICS

Radio Communications • Mechanical Design Engineering • Infrared • Automatic Test Systems • Countermeasures • Navigational Systems • Radar • Computer Techniques • Military Transistor Applications • Missile Guidance Systems • Microwave Development • Electronic Communications

AUTOMATION

Systems Engineering • Automatic Assembly • Transistors • Amplifiers & Filters • Automatic Test Equipment • Numerical Control • Computers • Counters • Instrument and Power Servos • Production Engineers

WIRE COMMUNICATION

Dial Central Office Equipment • Telephone Instruments • Wireline Carrier • Frequency Multiplex • Toll Ticketing • Transistor Circuitry • Microwave Links • Electro-mechanical Design • Electronic Switching Systems

AUDIO-ACOUSTICAL

Transformers • Tape Recorders • Audio Amplifiers • Loudspeakers • Electronic Carillons • Intercommunication Systems • Auto Radio • Home Radio • High Fidelity Music Reproduction • Sonar



needs
ELECTRONIC
and
MECHANICAL
ENGINEERS
in
SOUTHERN
CALIFORNIA

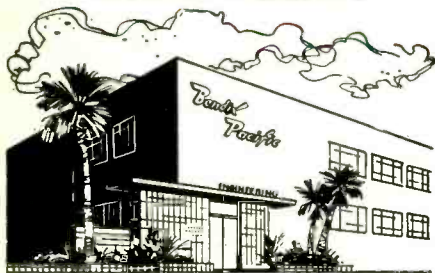

Unusual engineering positions in electrical and mechanical design of radar, sonar and telemetering are available. These positions, which are directly associated with our long-range projects for industry and for defense, are available at all levels.

Now nearing completion at Bendix-Pacific is the new Engineering Center. With more than 100,000 square feet of area it represents the latest and one of the most complete engineering facilities in the nation.

You are invited to consider becoming a member of this vital engineering group — with a forward looking company in Southern California.

Please fill in the coupon or write us for complete information.

W. C. Walker, Engineering Employment Manager
 Pacific Division, Bendix Aviation Corp.
 11608 Sherman Way, North Hollywood, Calif.

Please send information.

I am a graduate engineer with _____ degree.
 I am not a graduate engineer but have _____ years experience.

Name _____

Address _____

City _____ Zone _____ State _____

e **l** **e** **c** **t** **r** **i** **c** **a** **l**
 ELECTRICAL NAVIGATION COMMUNICATION
d **e** **s** **i** **g** **n**
 FIRE CONTROL RADAR INSTRUMENT SYSTEMS
 INSTRUMENTATION SYSTEM ANALYSIS
 SYSTEM INTEGRATION ANTENNAS

With 16 years leadership in the vital field of missile research and development, Northrop Aircraft offers unusual opportunities for advancement in the categories listed below. Here you can apply your skill and ability on the pilotless Snark SM-62 A-bomb carrier; on Northrop's new long-range interceptor project; and on numerous other weapon system assignments. Where better could you be, and grow, than with a pioneer? There's an interesting position for you in one of the following groups:

Electrical Group, which is responsible for the design of such things as power generation and distribution systems, rectifiers and power converters, and auxiliary systems as applied to manned aircraft, guided missiles and ground support equipment.

Communications and Navigation Group, which is responsible for the design of C/N systems in manned aircraft and installation of guidance systems in missiles. Considerable research effort is devoted to air-borne antennas and the elimination of radio interference in C/N systems.

Fire Control Radar Group, which is responsible for the installation and application of the most advanced type of fire control systems in fighter-interceptor aircraft. The work covers the installation of the equipment and associated wiring; continuing liaison with equipment manufacturers; preparation of system analysis and reports; and follow-up of system performance in the field as aircraft become operational.

Instrument Group, which is responsible for the design of instrument systems for manned aircraft and the installation of flight test instrumentation for guided missiles. Typical systems for which the group is responsible include: Flight Instruments; Engine Instruments; Instrument Panel Design; Automatic Pilots and Augmenters; Fuel Flow and Quantity Systems; and Integrated Electronic Instrument Systems.

All four basic groups originate their basic design and layouts, prepare production design releases and originate all types of tests to support flight, design and production requirements.

There are now a number of openings available for engineers in each of these groups at all experience levels. Too, there are opportunities for draftsmen with either electrical or mechanical experience.

If you qualify for any of these challenging opportunities, we invite you to contact Manager of Engineering Industrial Relations, Northrop Aircraft, Inc., Hawthorne, California, or call ORegon 8-9111, Extension 1893.

NORTHROP AIRCRAFT, INC.

PIONEERS IN ALL WEATHER AND PILOTLESS FLIGHT



8-A-47-A

Paths to Success

FOR
ENGINEERS & PHYSICISTS

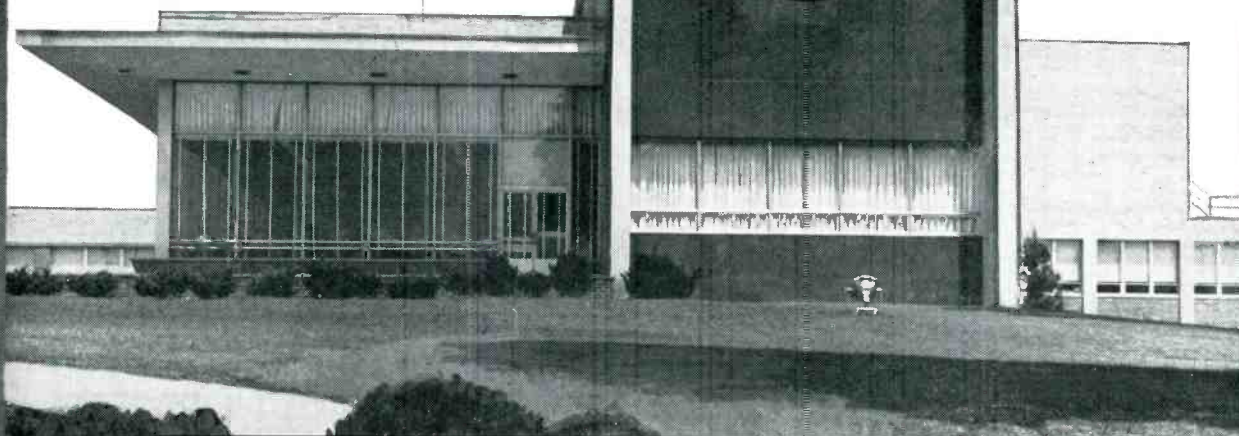

Every path to success

... each highway to achievement ... must have a beginning and what better place to start than right here ... in the new ultra-modern multi-million dollar Research Center which is only one of three erected in the immediate area within the past 3 years.

Located on Philadelphia's Main Line, within sight of historic Valley Forge, Burroughs multi-unit Research Laboratories are less than an hour by train or car over express highways to

Philadelphia where cultural and educational facilities of known merit are available to engineers interested in advance study at The University of Pennsylvania, Drexel Institute or Temple University during the evening hours.

Naturally, a retirement program and other benefits for you and your family are part of Burroughs Progressive Employment Policies. So, too, is association with outstanding men in the business machine field.

Looking to future expansion, Burroughs invites inquiries from those qualified as:

**ELECTRICAL ENGINEERS • PHYSICISTS • ELECTROMECHANICAL ENGINEERS
MECHANICAL ENGINEERS • TECHNICIANS • MECHANICAL DESIGN ENGINEERS**

... in the following fields — Control Computers, Pulse Circuitry, Digital Computers, Optical Devices, High Speed Mechanisms, Guided Missiles, Solid State Circuitry, Electronic Packaging, Electrographic Recording Devices.

Burroughs

CORPORATION
RESEARCH CENTER
PAOLI, PA., NEAR HISTORIC VALLEY FORGE

Send Complete Resumé to
M. E. JENKINS
PLACEMENT MANAGER
For Interview at Your Convenience

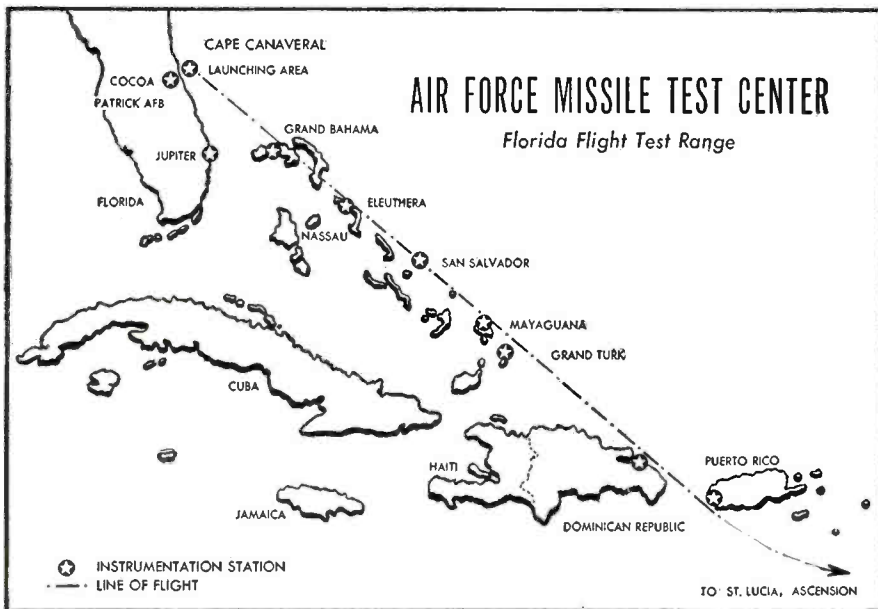

Engineers and Scientists:

INSTRUMENTATION SYSTEMS ENGINEERING
for MILITARY APPLICATIONS

➔ **SALARIES UP TO \$14,000.**

IN THESE NEW PROGRAMS AT THE MISSILE TEST PROJECT, FLORIDA

Have you as an engineer or scientist considered the problems and projects associated with the instrumentation and control of a long range missile, guided over a course that extends thousands of miles?

To achieve precision performance, missile launching and guidance require a vast network of instrumentation and control. New development programs have created challenging opportunities for Electronics Engineers and Scientists who are interested in data acquisition, transmission, recording and processing systems.

A world leader in electronics provides instrumentation for the Air Force Long Range Testing Laboratory, which extends from Patrick Air Force Base, on the Central East Coast of Florida, to the Mid South Atlantic.

You will enjoy top salaries, liberal company-paid benefits, and ideal Florida living for you and your family. Relocation assistance, too.

➔ **TODAY . . . get complete information on arrangements for personal interview. Send a complete resume of your education and experience to:**

PERSONNEL MANAGER
MISSILE TEST PROJECT—Dept. N-10E
P. O. Box 1226
Melbourne, Florida

MISSILE TEST PROJECT
Melbourne, Florida

Electronics engineers

do you see...
the over-all picture...

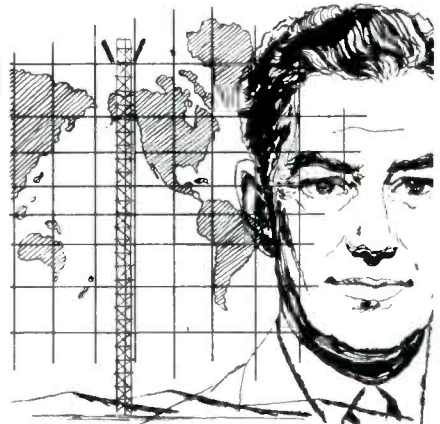

or just the details?

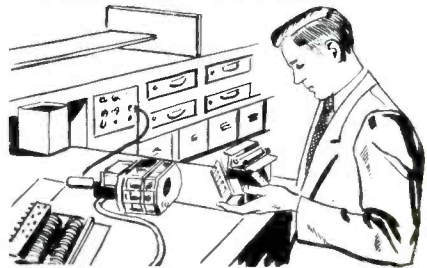

As a Publications Engineer at COLLINS you will . . .

- 1** work with the creative leader in the electronics field,
- 2** write engineering reports on over-all projects, including some of the most advanced electronic work in the industry.
- 3** write on complete systems, their operation, installation, theory and test.

COLLINS offers outstanding opportunities for electronics engineers in the field of technical writing on:

- | | |
|------------------------|-------------------|
| MICROWAVE RELAY | FLIGHT CONTROL |
| NAVIGATION SYSTEMS | RADAR SYSTEMS |
| COMMUNICATIONS SYSTEMS | GUIDED MISSILES |
| SSB SYSTEMS | COMPUTERS |
| RADIO ASTRONOMY | AMATEUR EQUIPMENT |

. . . plus top salaries, opportunity for advancement, company sponsored life, accident, sickness and hospitalization insurance, retirement plan and liberal moving expense allowance.

Electrical Engineers or Physics Majors with good electronic background and an aptitude for writing are desired. Actual writing experience is not necessary.

OPENINGS IN CEDAR RAPIDS, IOWA, BURBANK, CALIF. AND DALLAS, TEXAS

Send Resume to: MR. L. R. NUSS

COLLINS RADIO COMPANY
CEDAR RAPIDS, IOWA

W. W. Lindsay, Jr., Electronics Committee Chairman, Sherwood C. Frey, Navy Studies Department Manager, and R. P. Buschmann, Company Studies Department Manager examine relationships between plane and radar performance.

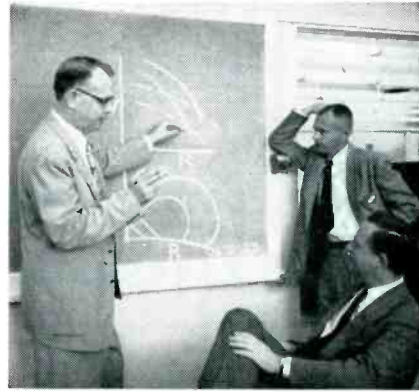

Expansion at Lockheed:

Operations Research creates new positions for physicists and engineers

Operations Research at Lockheed is a unique division which projects studies covering the entire spectrum of airborne systems five to twenty years into the future. It is concerned only with work of a most advanced nature.

Operations Research experience is not necessary to join the division. A high degree of scientific ability and proven analytical traits in your field of endeavor are primary requirements.

An address by Robert A. Bailey on "Application of Operations Research Techniques to Airborne Weapon System Planning" is available to interested scientists. Address inquiries to Mr. Bailey.

The growing importance of this field has created new positions for:

Electronics Specialists to evaluate and predict electronic equipment capabilities.

Requirements — advanced education in Electronics or Physics and experience in the field.

Fire Control and Guidance Specialists to evaluate and predict aircraft fire control and missile guidance capabilities.

Requirements — advanced education in Electronics or Physics and experience in the field.

Mathematicians to devise analytical methods and models for operations research.

Requirements — advanced education and experience in research.

Physicists to apply their knowledge of the fundamental laws of physics to the analytical solution of problems.

Requirements — Advanced education with experience in research.

Those interested are invited to write
E. W. Des Lauriers, OR-9-5.



LOCKHEED

AIRCRAFT CORPORATION

California Division

BURBANK

CALIFORNIA

W. P. Gruner, Jr., Senior Military Analyst, T. P. Higgins, Airborne Systems Engineer, and Robert A. Bailey, Director of Operations Research, discuss global implications of new concepts in air defense systems.



Engineers

HOW INCREASED SYLVANIA SALES



HELP YOU AS AN ENGINEER

Sylvania has quadrupled its 1947 sales and is expanding rapidly. We plow back into research and engineering an unusually high percentage of each year's income; it rates with the highest figures in industry today. These increases make for a broader based engineering while adding engineering management...creating unusual opportunities for men of talent.

At the base are recent college graduates with little or no experience. Filling in the essential positions of research direction, supervision and testing are engineers with experience and proven ability in their specialized fields.

Increasing our overall research constantly creates openings. These openings lead eventually to far greater responsibility either in engineering management or research specialties. Top engineers are key men in creating new and better products that open new markets to Sylvania.

There are openings now for experienced men at Sylvania.

WALTHAM Laboratories

Majors in E.E., M.E., Math, Physics. Research & Development experience in —

Avionics

Countermeasures
Systems Analysis
Transistor Applications
Noise Studies
Antenna Res. & Dev.
Systems Development
Mechanical Design
Miniaturization
Digital Computer
Circuits & Systems
Circuit Designs
Shock & Vibration
Technical Writing
Missile Analysis

Missile Systems

Radar Research & Development
Missile Guidance & Ground
Equipment Analysis
Systems Evaluation Operations
Research

BUFFALO Engineering Laboratory

Majors in E.E., Math or Physics.
Experience in Advanced Development and Product Design

Information Theory
Advanced Circuit Design
VHF-UHF Systems Design
& Evaluation
Logical Circuit Design
Mathematical Analysis and/or
Numerical Computation
Pulse Techniques
Data Processing Devices
Magnetic Amplifier Techniques
Servo Techniques & Applications
Digital Computer Design
Control Circuits & Devices

INTERVIEW & RELOCATION EXPENSES WILL BE PAID BY SYLVANIA

Sylvania provides financial support for advanced education as well as liberal insurance, pension and medical programs.

Please forward resume to: Professional Placement Supervisor

Erling Mostue | E. F. Culverhouse
100 First Ave. | 175 Great Arrow Ave.
Waltham, Mass. | Buffalo 7, N. Y.
Your inquiries will be answered within 2 weeks



ENGINEERS

Honeywell

"First in Controls"

OFFERS EXCELLENT
OPPORTUNITIES IN

NUCLEAR ENGINEERING

PROJECT

... with nuclear science background. Position requires interest and ability in the design of control systems. Employment with HONEYWELL offers broad opportunities in the nuclear field.

RESEARCH

... including analysis of electronic controls and control systems, using control theory and analog tests. Variety of other applied research activities.

DEVELOPMENT

... of electronic and electro-mechanical devices for detection and control of all types of industrial process variables.

... development and design of complex industrial instrumentation systems, data reduction and data handling systems.

... development of pneumatic and mechanical devices for flow measurement and control and other small electromechanical controls and recording instruments.

APPLICATION

... personal contact with customers, determining exact needs for custom-built devices or systems, determine feasibility of manufacturing special products by estimating engineering time necessary, etc.

Contact Our Representative

MR. D. R. GARVEY

HONEYWELL BROWN INSTRUMENTS

Wayne & Windrim Avenues

Philadelphia 44, Pa.

Bendix Aviation Corporation

YORK DIVISION

YORK, PENNSYLVANIA
TELEPHONE YORK 5521

Dear Engineer,

If you are a fortune-hunter, turn the page; this is not for you. But if you are one of the great majority of professional men who is primarily interested in a satisfying job and attractive working and living conditions with reasonable security and good promise for the future, read on!

Sure, this is a sales pitch - but different, since it aims to be honest! We need Engineers, just like every other leading company. You've seen the screaming ads promising Utopia, or Nirvana, to anybody with any semblance of engineering qualifications. We're different! At York, we cling to the belief that you will be more impressed with a frank statement of the pros and cons.

First, we are in the electronics business. Most of our work is military. Since we are working with five or six government agencies, our activities are diverse. We are a small, but full-fledged division of the Bendix Aviation Corporation, which conveys the security and stability of a large company. On the other hand, Bendix operates its divisions on a practically autonomous basis, so that we also have the flexibility and healthy atmosphere of a small, independent company. Nobody gets buried!

The plant is 100,000 sq. ft. big - about 3 years new and excellently equipped with machinery and test equipment. The plant is located about five miles east of York, Pa., on the Lincoln Highway, in what the real estate dealers describe as a "beautiful suburban area". (And it is.) You can live (as I do) within three minutes drive of the plant. For \$10,000 you can have a 2-bedroom house (cheaper if you buy a run-down farm house).

The town (of about 75,000) has at least one of everything you could find in a bigger city, including a symphony orchestra of some note. (Sorry, the pun was unintentional.)

Here in our plant, we believe that engineers are people, individuals yet, and not hired hands. We exercise some care in hiring, because we want them to stick; and, in fact, our turn-over rate is negligible. The work and status of each individual is reviewed every six months. This doesn't mean that he gets a raise every time, but 10% a year isn't far from the average. As an engineer, it's possible to make over \$10,000 a year, but you have to be good.

We operate basically by a project system, with a great deal of responsibility vested in each Project Engineer. The supporting departments - Drafting, Mechanical Engineering, Model Shop (you should see our Model Shop), technical publications and the like - furnish service to the project groups. We do about \$1,000,000 a year engineering business alone, and seem to have no difficulty in acquiring more. We're growing fast!

We don't offer you the moon, but we do offer you a fair shake!

Sincerely yours,

*P.S. If what I've said
interests you, get in
touch with me!*

K. F. Umpleby

K. F. Umpleby
Chief Engineer

K.F.U.

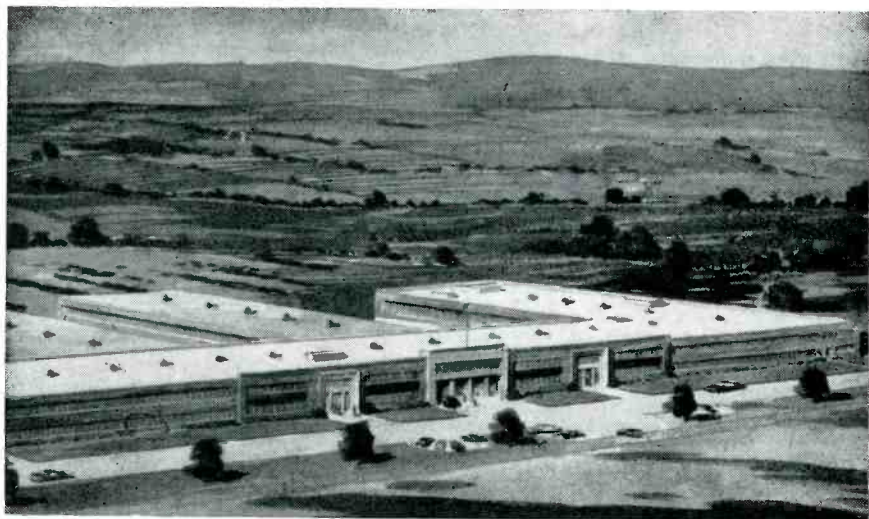

Raytheon's new Wayland Laboratory is devoted exclusively to the design and development of advanced electronic equipment. Under one roof an engineer can see has program carried through completely . . . from idea to reality.

A delightful location—only 17 miles from the heart of Boston—offers a choice of rural or urban living, and access to the entire New England area is convenient via a network of modern highways.

Positions are available for

Engineers and Physicists

experienced in the Systems Analysis and Design of Radar equipment

For further details, send your name and address * to
MR. ROBERT E. DOHERTY AT:

**RAYTHEON
MANUFACTURING COMPANY
WAYLAND LABORATORY
WAYLAND, MASSACHUSETTS**

* No resume required—we will send you a brief form which can be completed in just a few minutes.

Excellence **RAYTHEON** *in Electronics*

CIRCUIT DESIGN ENGINEER

Formed just 3 years ago, GE's Aircraft Products Department is rapidly expanding . . . creating unique openings for career-minded Design Engineers.

Position involves providing technical guidance for electronic component circuitry and establishing general circuit applications and objectives for electronic devices to insure optimum performance and compatibility.

B.S.E.E. with an electronics or communications option, and 4 to 6 years experience including familiarity with electronic packaging and creative electronic circuit design.

This position includes all GE benefits and opportunity for advancement. Fine location in upper New York State means good living too.

Write in confidence to:

Mr. C. E. IRWIN

Engineering Administration
AIRCRAFT PRODUCTS DEPT.

GENERAL  ELECTRIC

600 Main Street, Johnson City, N. Y.

ADVERTISING MAN WANTED FOR TECHNICAL PRODUCTS

- Previous advertising experience not
- necessary but helpful. Must have
- at least two or three years of college
- with courses in engineering and
- technical subjects and like to write
- If you have the qualifications we
- have an opportunity open for you.
- Man selected will be trained in all
- phases of industrial advertising. In
- your letter of application state age,
- education, positions held, and give
- statement of why you want a career
- in advertising. Location: well-known
- Connecticut company.

F 1212 Electronics
330 W. 42 St. New York 36, N. Y.

ENGINEERS

for immediate placement

**ELECTRICAL ENGINEERS
MECHANICAL ENGINEERS
ELECTRONIC ENGINEERS
COMPUTER ENGINEERS
SOLID-STATE PHYSICISTS**

Engineering at NCR:

1. Immediate, permanent positions in Mechanical Engineering, Electrical Engineering and Physics Research Divisions.
2. Engineering project work in Adding Machines, Cash Registers, Accounting Machines, Computers and related Data Processing Equipment in Dayton, Los Angeles, and Ithaca, New York.
3. Opportunities in design, development, production-engineering and packaging of mechanical, electronic, and electromechanical devices.
4. Some experience in development, design, and application of high-speed, light-weight mechanisms of the intermittent-motion type; or, experience in digital devices and components, is desirable, but not essential.
5. Ample training and indoctrination is available to all employees.

As an NCR engineer you, with your family, will enjoy:

1. UNLIMITED OPPORTUNITY in the broad, ever-expanding field of Business Machine Engineering and Research.
2. AN EXCELLENT SALARY, plus exceptional benefits of lifetime value for you and your family.
3. A RECREATIONAL PROGRAM for year-round enjoyment of the entire family, including a new NCR Country Club with 36 holes of golf, and a 166-acre employees' park for outings with swimming, boating, and supervised play for the children.
4. LIVING IN DAYTON . . . considered a clean, attractive, progressive city with outstanding school facilities.
5. YOUR WORK AT NCR with its friendly, family atmosphere, with its employee morale at a very high level, and with people who, like yourself, have decided to build their professional future with NCR.



ACT AT ONCE — Send résumé of your education, experience and geographic preference to:

EMPLOYMENT DEPARTMENT, TECHNICAL PROCUREMENT SECTION 4

THE NATIONAL CASH REGISTER COMPANY
Dayton 9, Ohio

*Trade-Mark—Reg. U. S. Pat. Off.

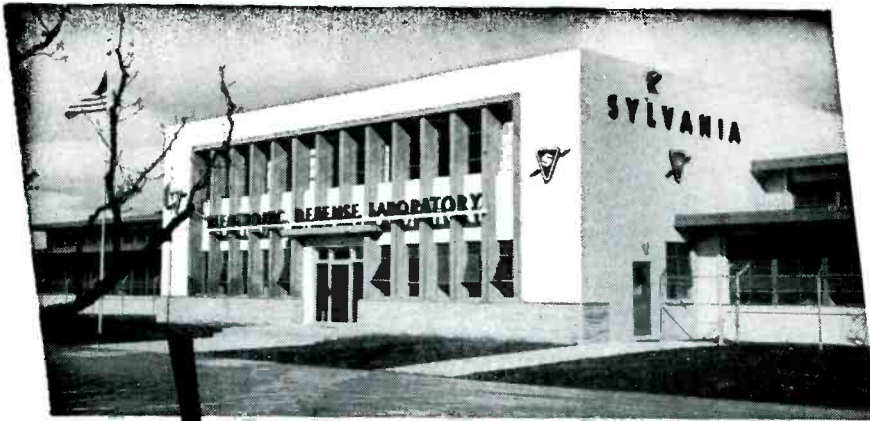

SYLVANIA'S
CALIFORNIA RESEARCH LABORATORY
 (San Francisco Bay Area—Near Palo Alto)

Needs experienced creative engineers for a long range research and development program in micro-wave electronic systems and components. Also needs experts in design and custom packaging of specialized electronic communications equipment.

We have specific openings for ENGINEERING SPECIALISTS, SENIOR ENGINEERS and ENGINEERS in:

SYSTEMS ANALYSIS For weapons systems planning, operational analysis and data handling problems.

MICROWAVE ANTENNAS For investigation of new concepts in polarization and pattern control, direction finding and multi-function radiators.

MICROWAVE CIRCUITS For advancements in synthesis of filters, broadband mixers, power dividers, etc., involving modern techniques of stripline, ridge guide and periodic structures.

TRANSMITTER DEVELOPMENT For research and development involving microwaves and pulse techniques.

FIELD ENGINEERING For advanced engineering field tests of prototype equipment.

RECEIVER DEVELOPMENT For design and development of microwave and communications receivers and pulse circuitry.

Sylvania offers the finest facilities and equipment available. We also provide financial support for advanced education, as well as a liberal insurance, pension and medical program.

Our Laboratory is located 5 miles from Palo Alto in the San Francisco Bay area, close to excellent schools and universities, unexcelled living conditions, ideal climate and ample housing.

RELOCATION EXPENSES PAID

Please send complete resume to
JOHN C. RICHARDS
 Electronic Defense Laboratory
 Box 205
 Mountain View, California

ELECTRONIC DEFENSE LABORATORY



SYLVANIA
 SYLVANIA ELECTRIC PRODUCTS INC.

All inquiries will be answered within two weeks.

ENGINEERS

**MECHANICAL
 ELECTRICAL
 CHEMICAL**

WORK WITH TOP ENGINEERS IN RESEARCH AND ENGINEERING DIVISIONS OF ESTABLISHED AIRCRAFT IGNITION AND ELECTRONIC EQUIPMENT MFR.

MECHANICAL ENGINEER

Excellent opportunity for man with ME Degree Experience in design of electro-mechanical devices. Mechanical design experience in aircraft industry desirable.

CAPACITOR ENGINEER

Experience in design and development of capacitors—Knowledge of dielectrics and chemistry of various dielectrics. Minimum educational requirements: EE Degree or BS in chemistry.

ELECTRICAL ENGINEER

Degree required. Experience in electronic component work and circuitry. Challenging opportunity for career position.

TEST ENGINEER

Diversified testing—Large amount of instrumentation. Excellent position—Considered training for Research and Development Project Engineer. E.E. or M.E. required.

LOCATED PLEASANT CENTRAL N. Y. STATE COMMUNITY—SEND COMPLETE RESUME TO:

Personnel Department
General Laboratory Associates, Inc.
 1 Lee Avenue
 Norwich, New York

ELECTRONICS ENGINEER

Research division of large mining company requires **ELECTRONICS ENGINEER, E.E., M.A., D.Sc.** or equivalent to carry on geophysical experimental developments. Good salary, pension plan, work freedom and responsibility. Location, Connecticut.
Apply Box 366, Jerome, Arizona

**SUPERVISOR
 navigation
 systems**

\$12,500

Major electronics manufacturer needs top-flight man to develop programs and direct activities of project leaders and engineers in navigational systems. Must have a good solid background in radar, inertial guidance, analog computers and radio aids to navigation. Project leader experience required.

**THIS IS A TOP SPOT
 IN OUR ORGANIZATION.**

Reply to:
 P-1331, Electronics
 330 W. 42 St., New York 36,
 N. Y.

ENGINEERS



**Working hard
but going
"No Place..."**

*Please address
complete resume,
in confidence,
outlining details
of your technical
background to:*

Why let routine work slow your advancement

*...when varied, creative assignments, with high
promotion potential, are open at Republic Aviation*

It's easy to be so busy that you fail to notice that the work you're doing offers little opportunity to grow in professional knowledge and advance rapidly in individual achievement.

At Republic Aviation, however, the very nature of this highly competitive business insures a continual flow of new and stimulating problems. Every new aircraft design created at Republic must embody a real advance in the "state of the art." Proud as Republic is of the famous planes that bear its name — the F-84 Thunderjet, F-84F Thunderstreak, RF-84F Thunderflash, and the incredible new F-105, RF-105 and F-103 — *the real attention here is focused on radical new concepts under development.*

And your personal life is set in pleasant places, when you work for Republic. You live on Long Island, famous vacation land where you can keep your own boat or board a charter fishing boat any weekend. Play golf, tennis, even polo, and yet downtown New York is at your doorstep.

You enjoy, too, the practical, personal advantages of Republic's comprehensive benefit program including:

REPUBLIC'S NEW 2-FOLD RETIREMENT INCOME PLAN that's the talk of the industry. Part I provides a basic Retirement Income, paid in full by Republic. Part II is optional. It offers additional income on a liberal contributory basis, the company paying over 50%.

REPUBLIC SALARIES ARE HIGH ...among the highest in the country ...and these are permanent jobs.

OTHER OUTSTANDING BENEFITS include an all-expense paid relocation plan for qualified engineers living outside the New York-Long Island area; Life, Accident and Health Insurance; Hospital-Surgical Benefits for the whole family; Educational Aid covering $\frac{2}{3}$ of the cost of advanced study.

POSITIONS ARE OPEN AT ALL LEVELS IN:

Aerodynamics • Systems • Propulsion • Operations Research • Dynamics • Stress • Controls • Electronics • Staff Engineering • Electromechanics • Flight Test • Research • Thermodynamics • Flutter & Vibrations • Weights • Weapons Systems Analysis • Servo • Airframe & Mechanical Design • Analog Computers • Antennae • Control Systems • Instrumentation



REPUBLIC AVIATION

AIRCRAFT

Assistant Chief Engineer
Administration
Mr. R. L. Bortner
Farmingdale, L. I., N. Y.

MISSILES

Administrative Engineer
Mr. R. R. Reissig
Guided Missiles Division
Hicksville, L. I., N. Y.

ENGINEERS

Put Yourself Ahead in Engineering

with the  Leadership

MECHANICAL ENGINEERS

Mechanical or electromechanical engineers familiar with the packaging of military electronic equipment, vibration, shock and other environmental problems, kinematic design of mechanisms.

ELECTRONIC ENGINEERS

Experienced in Product Design and Production. Production liaison requires wide knowledge of electronic circuits and packaging. System and Component Testing. Some experience in cost estimating and project administration. Familiarity with all types of military specifications.

SYSTEMS SPECIALIST

Analysis of electronic system performance and establishment of design parameters for electronic systems. Able to prepare or supervise preparation of technical proposals and act in capacity of technical advisor on engineering program. Approximately 10 years experience in general electronic design work.

FIELD ENGINEERS

Experience in radar, ultrasonics, servomechanisms, or computers. Positions involve field assignments in the continental United States after in-plant training.

AMP is well known for its liberal benefits program. Join AMF in Boston where a gigantic electronics boom is on . . . in fact, this is the new electronics center of America. Here you will be surrounded by the nation's leading universities—M.I.T., Harvard, Tufts—outstanding historical sites and gateway to all New England's four-season resorts and sports, easily accessible on new super-highways—and our smart, modestly priced home communities are models for today and tomorrow.

*Please forward your resume to
Personnel Manager*

**Electronics Division
AMERICAN MACHINE & FOUNDRY CO.**

1085 Commonwealth Avenue • Boston, Mass.

ENGINEERS

ELECTRONIC ENGINEERS

For circuit design of communications equipment. Experience in radar, microwave & pulse work desirable.

MECHANICAL ENGINEERS

For design of electro-mechanical communications equipment to government specifications. Experience in servomechanisms desirable.

You are needed, well appreciated, and well-rewarded . . . in:

**GOOD PAY
INTERESTING WORK
LONG-TERM PROGRAMS**

Our plants are located close to centers of culture, advanced learning, entertainment and shopping.

Send resume to: Mr. S. Winston

RADIO RECEPTOR CO.
240 Wythe Avenue, Bklyn., N. Y.
EVergreen 8-6000

ENGINEERS SCIENTISTS

**Make More Money
—Improve Your Position**

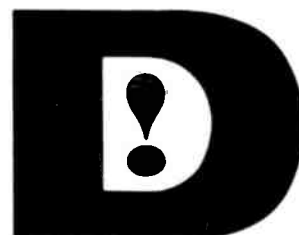

DECISION/INC is retained by leading manufacturers and research firms in all sections of the country. *Our clients pay us to find you!* No obligation to you—no cost whatsoever. Completely confidential.

All you have to do is send us your name, type of work, company and home address. We will forward brief forms to your home. We will then present to you various openings in diversified companies from which you can choose the one you like best.

If you would like to know what you're really worth, write, phone or wire us **now!**

DECISION/INC
Management and Recruitment Consultants
Oliver P. Bardes, President

1445 FIRST NATIONAL BANK BUILDING
CINCINNATI 2, OHIO

Design and evaluation of advanced Weapons Systems represent a significant portion of C. A. L.'s applied research efforts.

Shock tube permits study of hypersonic flight under realistic conditions where gas temperatures in excess of 6000°K can be simulated.

One of C. A. L.'s experimental radars used in research on target characteristics.

C. A. L.'s 12' wind tunnel is operated on an "around-the-cock" basis providing answers to aerodynamic problems in the high subsonic and transonic regions.

Novel application of Rogge-Hilsch tube to the complex problem of measuring free air temperature from a high-speed aircraft.

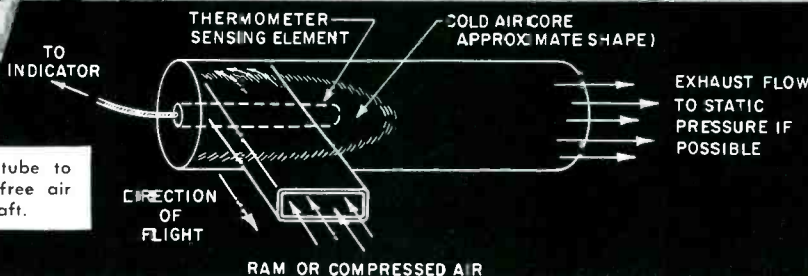

WHAT'S THE DIFFERENCE?

Plenty! It makes a big *difference* to you and to your technical reputation when you earn a position in a respected research laboratory. It makes a *difference* to you as a professional man to play a creative role in such projects as those depicted above. Yet those are just a few of the 150 projects currently active at Cornell Aeronautical Laboratory.

You'll find the fascinating stories behind these and many other programs told in our new 68-page brochure, "A Decade of Research." In it you'll read about some of the most advanced aeronautical research

ever conducted. You'll read about the Laboratory's search for new knowledge and its application—a search which has now reached an annual volume of \$12,000,000. *You'll be able to see for yourself* that the Laboratory's programs present a real challenge, that they present technical problems which will tax your capabilities to the limit. In other words, you'll read the story of pioneering research as conducted by one of the country's leading research laboratories.

Whether you're contemplating a change or not, if you're a scientist or an engineer this

brochure will be of interest and value to you. Write today for your copy.

J. L. Swannie
Cornell Aeronautical Laboratory, Inc.
Buffalo 21, New York

Please send "A Decade of Research" to:

Name.....
Street.....
City..... Zone..... State.....

Cornell Aeronautical Laboratory, Inc.

OF CORNELL UNIVERSITY



**ALLISON
DIVISION
General Motors
Corporation**

is spending

\$75,000,000

on a long range
expansion program in
**ENGINEERING RESEARCH
and
DEVELOPMENT FACILITIES**

Completion of the program will give Allison one of the world's most complete, best-equipped centers for the development of new, high performance turbo-prop and turbo-jet aircraft engines.

This extensive expansion program—financed by General Motors—creates an immediate need for a 40% increase in engineering personnel.

Also, the Allison Model 501 turbo-prop engine and Aeroproducts propeller have been selected by leading airlines to power the passenger planes for tomorrow's turbo-prop transport travel creating additional opportunities for you in the commercial field.

Experience in the aircraft industry isn't always necessary. If you are an engineering graduate, we'd like to talk to you. There's everything to gain—nothing to lose.



ALLISON Division General Motors Corporation
Indianapolis 6, Indiana

Design, development and production — high power **TURBINE ENGINES** for modern aircraft . . . **Aeroproducts PROPELLERS, ACTUATORS and DIESEL ENGINE STARTERS** . . . Heavy duty **TRANSMISSIONS** for Ordnance and Commercial vehicles . . . **DIESEL LOCOMOTIVE PARTS** . . . **PRECISION BEARINGS** for aircraft, Diesel locomotives and special application.

New Opportunities
for
ENGINEERS

Here are some of the advantages offered by Allison: stability of a growing organization . . . security . . . advanced educational facilities opportunity for rapid advancement . . . excellent working conditions with the most modern facilities in industry . . . and association with top level technical men in the industry. If you've had experience or training, in any of the following fields, we'd like to talk to you about your future at Allison in aircraft engines and Aeroproducts propellers:



STRESS ANALYSIS — DESIGN OF HIGH SPEED ROTATING MACHINERY — THEORY and DESIGN SERVO-MECHANISMS PROPELLER, ENGINE and AIRCRAFT PERFORMANCE ANALYSIS — EXPERIMENTAL TEST of PROPELLERS, GAS TURBINE ENGINES and COMPONENTS — DESIGN of AXIAL FLOW COMPRESSORS and TURBINES — DESIGN of BLADING for AXIAL FLOW COMPRESSORS and TURBINES — AERODYNAMICS and PROCESS ENGINEERING — TOOL DESIGN.

Also immediate openings for:

PHYSICISTS, NUCLEAR PHYSICISTS and ENGINEERS with ELECTRONICS EXPERIENCE.

Write direct to Salaried Personnel, Dept. E, telling us about yourself . . . your qualifications . . . your academic and work experience background.

**ENGINEERS
ELECTRONIC
AND
MECHANICAL**

Openings exist for project engineers in challenging work in the fields of Radar, Test Equipment, UHF Receivers, Digital and Analogue Computers. A B.S. degree and five years experience in similar or related fields in both design and production is desirable.

UNUSUAL SALARY OPPORTUNITIES

Excellent working conditions in the small town atmosphere of suburban

CINCINNATI, OHIO

Liberal fringe benefits including an advanced pension plan with an eighty-two year old company.

EXCEPTIONAL OPPORTUNITIES

for Advancement
with the newly established

**ELECTRONIC PRODUCTS DIVISION
of the
GRUEN WATCH CO**
Reading, Ohio

Send resume to
Gerald C. Schutz, Division Manager

**OPERATIONS
RESEARCH ANALYSTS**

To apply training or experience in:

- Pure or Applied Mathematics
- Mathematical Statistics
- Management Science
- Econometrics
- Psychophysics

Toward solution of challenging and widely diversified military and industrial problems. Currently expanding activities include:

- Analytical Statistics & Design of Experiments
- Air & Road Traffic Control Studies
- Weapons Systems Evaluation
- Communication System Analysis
- Inventory & Production Control
- Equipment Reliability Analysis
- Countermeasure—Development

These are permanent positions offering salaries comparable with those in industry and educational benefits for graduate study. Qualifications include advanced degree, prior operations research experience, familiarity with application of electronic computers.

**J. A. Metzger
ARMOUR RESEARCH FOUNDATION
of Illinois Institute of Technology
10 West 35th Street
Chicago 16, Illinois**

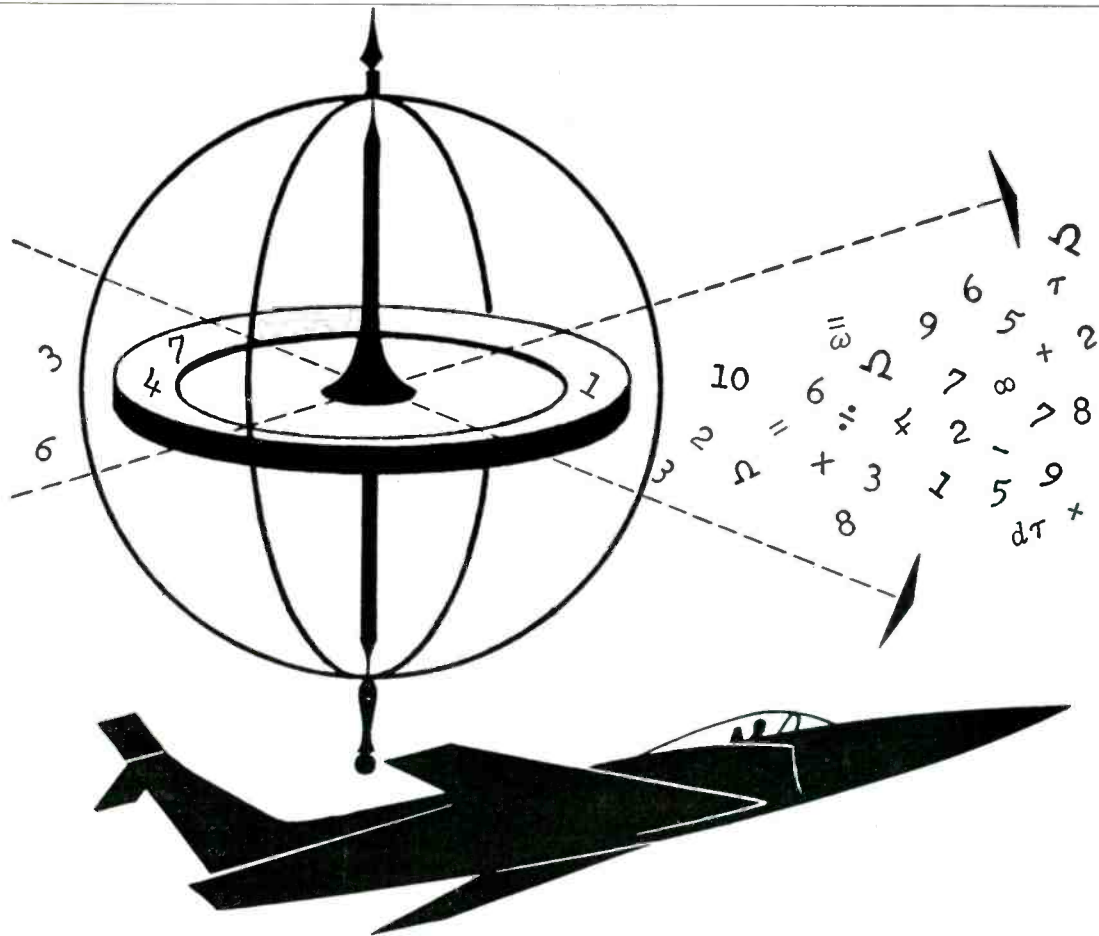

build your future with

NEW ELECTRONIC ACHIEVEMENTS

Here at AUTONETICS nearly 100 advanced *electronic* and *electro-mechanical* projects are in progress—projects whose long-range implications are moving forward the frontiers of technical knowledge.

Most of the work is *well* in advance of reports in technical publications, or even confidential texts. The one way to keep abreast of this unique and highly rewarding research is to be *in* it.

At AUTONETICS you'll work with men of excep-

tional professional standing in a congenial atmosphere. You'll have access to the very latest digital and analog data processing equipment. You'll have the opportunity to contribute to the advances in electronics and electro-mechanics and at the same time further your own career. What's more, you'll like living in Southern California.

Write now for complete information. Your inquiry will be handled promptly and confidentially.

UNIQUE OPPORTUNITIES FOR:

Computer Specialists Electro-Mechanical Designers Environmental Test Engineers Electronic Component Evaluators
 Instrumentation Engineers Fire Control Systems Engineers Flight Control Systems Engineers
 Electronics Research Specialists Computer Programmers Computer Application Engineers Automatic Controls Engineers
 Electronic Engineering Writers Inertial Instrument Development Engineers Preliminary Analysis and Design Engineers

Also Openings for Draftsmen and Technicians

CONTACT: Mr. D. S. Grant,
 Engineering Personnel Office Autonetics, Dept. 991-20, EL,
 12214 Lakewood Blvd., Downey, Calif.

Autonetics

A DIVISION OF NORTH AMERICAN AVIATION, INC.





FIELD ENGINEERING WITH A FUTURE — at Raytheon

PLAN YOUR CAREER HERE — Raytheon needs men like you who are qualified for field engineering and have the ability to build a future in electronics. Experience in the field has enabled many of our engineers to become executives at Raytheon. Unlimited opportunity is open to you now in the following programs:

- MISSILES** Air-to-Air — Ground-to-Air
- RADAR** Search — Fire Control
Bombing — Countermeasures
- Other Equipment**.... Ship and Airborne Sonar — Multiplexers —
Microwave Relay Links — Communications

Raytheon has designed and built complicated electronic equipment for the past 30 years. One of its present equipment projects is the world's most publicized radar—the DEW LINE radar.

If you have a college degree, you'll rate preference. However, if you have an extensive electronic background, send in your application. Special training will be provided by our Training Facility to prepare you for your assignments.

Attractive salaries, benefits, and allowances. Domestic and overseas assignments.



RAYTHEON MANUFACTURING COMPANY
100 River St., Waltham 54, Mass.

ELECTRONIC ENGINEERS

FOR
GUIDED MISSILE
DEVELOPMENT

SENIOR ENGINEER

experienced in Micro-Wave Techniques to assume major responsibility in Monopulse, high power duplexer, antenna feeds and related items.

SENIOR ENGINEER

experienced in Radar Data Utilization to assume major responsibility in ranging circuits, quantization, digital techniques and related work.

Write for our new brochure
"A decade of Research."



**CORNELL
AERONAUTICAL**
Laboratory, Inc.
4352 GENESEE ST. BUFFALO 21, N. Y.

engineer

MISSILE GUIDANCE SPECIALIST

\$10,000

Advanced engineering design and development of missile guidance equipment employing the latest techniques in the fields of radar and communications. The essential job emphasis is directed toward the mechanical aspects of design and development of a complex nature.

Please reply in confidence to:

P 1332 Electronics
330 W. 42 St. New York 36, N. Y.

MANUFACTURERS REPRESENTATIVES WANTED

Well established West Coast instrument manufacturer wants young, aggressive organizations to handle specialized line of electronic instruments used in nuclear field, electronics manufacturing, research and wide range of industrial applications. Territories available include New York, Los Angeles, Ohio, Chicago areas. Send complete information: territories covered, present products handled and qualifications to

RW-1239, Electronics
1125 W. 6 St., Los Angeles 17, Calif.

ELECTRONIC SYSTEMS ENGINEERS and SCIENTISTS in

RADAR • COUNTER MEASURES • MISSILE GUIDANCE

DATA REDUCTION • AIR DEFENSE • COMMUNICATIONS • UNDERWATER ORDNANCE

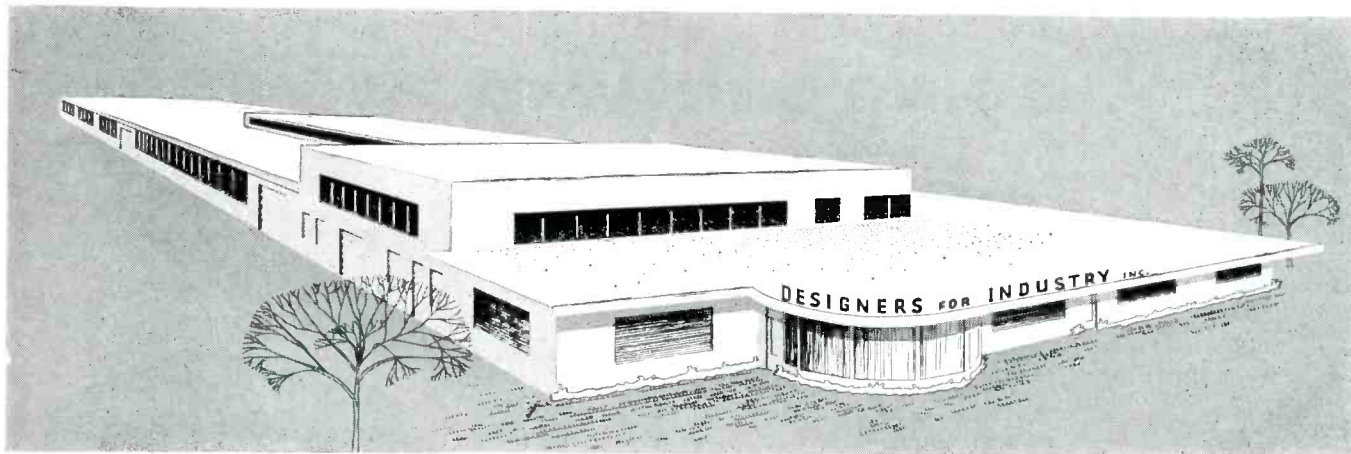

For trained, experienced men (advanced degree preferred) with creative ability, DESIGNERS FOR INDUSTRY INCORPORATED offers challenging work and an unusual opportunity.

We are looking for those who have grown into the systems field via the equipment research and development road — and who have the ability to conceive completely new approaches to highly difficult problems . . . *men who can spearhead major technical break-throughs.*

In return we offer permanent career opportunities at DFI where:

You will work in an independent research and development organization incorporated in 1935 and showing a history of steady growth serving both military and commercial clients

the employees own the corporation (over 70 senior employee-stockholders)

a pension trust and a merit bonus return 62½% of all profits to the employees in a combination of annuities, cash and stock

the “fringe” benefits include such things as a paid vacation schedule providing two weeks per year after one year, three weeks per year after five years and five weeks every fifth year after ten years

professional freedom, mutual trust, challenging work and a dynamic, growing organization are combined into the proper atmosphere for stimulating creative development.

If you are interested write — all information will be treated in complete confidence — to James E. Burnett, Vice President, giving pertinent professional information.



Designers for Industry

Incorporated 1935

4241 Fulton Parkway • Cleveland 9, Ohio

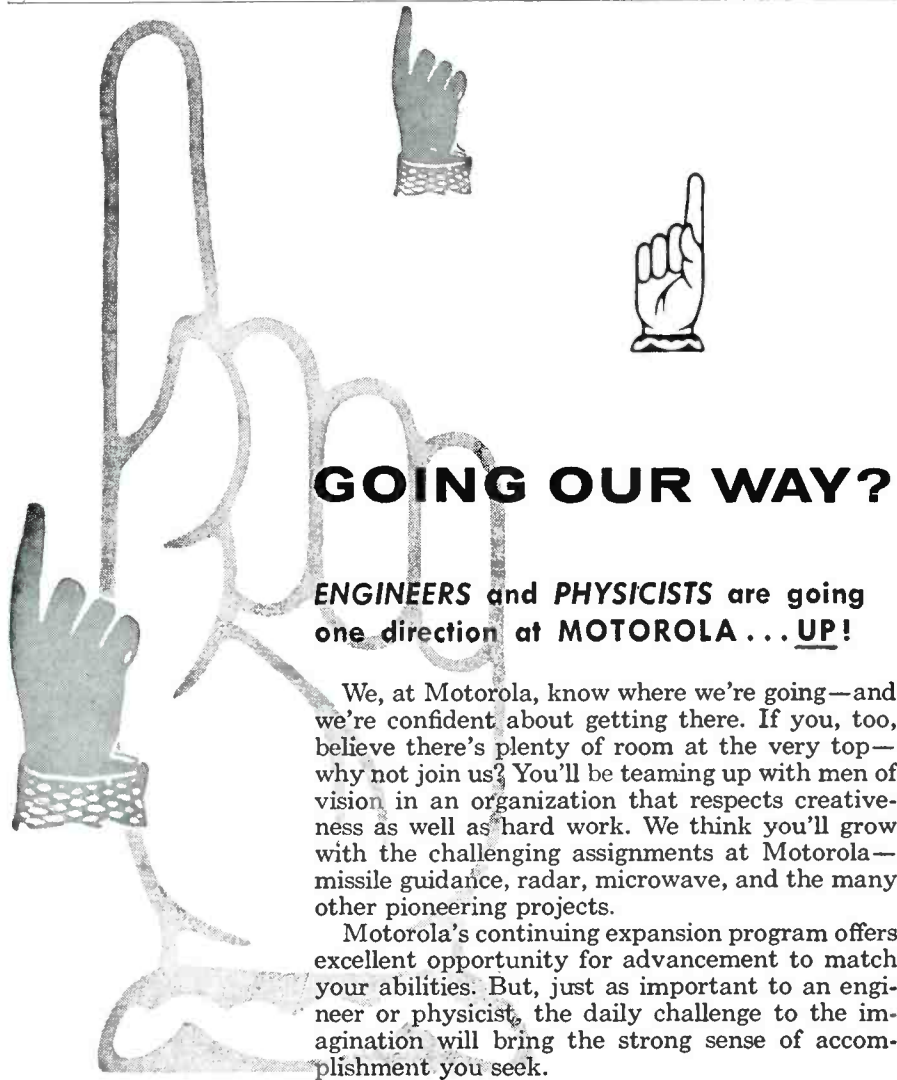

GOING OUR WAY?

ENGINEERS and PHYSICISTS are going one direction at MOTOROLA . . . UP!

We, at Motorola, know where we're going—and we're confident about getting there. If you, too, believe there's plenty of room at the very top—why not join us? You'll be teaming up with men of vision in an organization that respects creativeness as well as hard work. We think you'll grow with the challenging assignments at Motorola—missile guidance, radar, microwave, and the many other pioneering projects.

Motorola's continuing expansion program offers excellent opportunity for advancement to match your abilities. But, just as important to an engineer or physicist, the daily challenge to the imagination will bring the strong sense of accomplishment you seek.

If you're an electrical engineer, mechanical engineer, or physicist (senior or junior level), and looking for more important assignments in:

CHICAGO, ILLINOIS

Two-Way Communications

- Receivers and Transmitters
- Power Supply
- Antenna design
- Systems Engineering

Microwave

- Pulse Circuit Design
- Systems Design
- Circuit Design

PHOENIX, ARIZONA

- Microwave Antennas
- Transmitters and Receivers
- Modulators
- Pulse and Video Circuitry
- Environmental Test
- Packaging of Missile Borne Electronic Equipment

Military Communications

- Receiver and Transmitter Design
- Circuit Design
- Antenna Design
- Radar Design

Field Engineers

- Microwave Maintenance
- Airborne Radar

- Radar Systems Design
- Logical Circuitry
- Servo Mechanisms
- Transistor Applications
- Electro-Mechanical Devices

RIVERSIDE, CALIFORNIA (65 miles from Los Angeles)

- Military Operation Analysis
- Dynamics Analysis
- Analog Computer Flight Simulation
- Digital Computer Analysis
- Digital Computer Design

- Circuit Design
- Microwave Systems
- Servo Mechanisms
- Missile Systems
- Aerophysics

For Assignments with a FUTURE UNLIMITED write:

MOTOROLA, INC.

Engineering Personnel Mgr., 4501 W. Augusta Blvd., Chicago 51, Illinois

opportunities in

OPERATIONS RESEARCH

The Operations Research Office of The Johns Hopkins University offers exceptional opportunities for scientists who prefer the challenge of operational problems of unusual scope and diversity to routine design and development work.

Our current research program has openings for men qualified in electronics and physics who are particularly interested in:

- Mathematical Analysis
- Determining applications of known photographic, acoustic, infrared and radar techniques to military problems
- Military communications systems planning, analysis and evaluation
- Electronic Countermeasures Analysis

Please send your resume to
Research Personnel Officer

THE OPERATIONS RESEARCH OFFICE

THE JOHNS HOPKINS UNIVERSITY

7100 Connecticut Avenue
Chevy Chase, Md.

Electronic Engineers Physicists in MISSILE RADAR

Several attractive positions, associated with an original missile system design of an advanced type, are available in the following fields:

- High Power Transmitters
- Advanced Antenna Systems
- Target Characteristics
- Receiver Research
- Radar System Design
- Radar Data Processing
- Microwave Propagation

You are encouraged to write for more information and for a copy of our new brochure "A Decade of Research" which describes our activities.



CORNELL AERONAUTICAL
Laboratory, Inc.

4352 GENESEE ST. BUFFALO 21, N. Y.

Your Application...



With your ideas and experience in electronics, it's ten to one you feel the need for a stimulating and vital outlet... with real promise for the future.

Here at Philco we welcome men with creative talents... men who enjoy seeking out new and unique ways to do things in radar, microwave communications, underwater ordnance, guided missiles and high speed data processing. Great opportunities in electronic and mechanical industrial engineering and research are open to men who apply now.

Even more, Philco has one of the most liberal profit-sharing, retirement and insurance programs in all industry.

ENJOY THESE CONVENIENCES

- Delaware Valley, Center of Industrial Activity
- Choice of City or Suburban Residence
- Unexcelled Transportation—just 20 minutes to Philadelphia's beautiful suburbs
- Abundant Shopping and Entertainment Centers
- New Houses, Apartments
- Schools and Colleges with Highest Ratings
- Near Seashore and Mountain Resorts
- Many Professional Society Chapters

Long Range Industrial and Diverse Military Engineering Fields

- Guided Missiles • Radar • TRANSAC Digital Computers • Underwater Ordnance • Bombing and Fire Control Systems • Servo-Mechanisms • Microwave Communication Systems • Infra-Red Devices • Transistor Circuit Application • Multiplex Equipment • Television Relay Systems • Industrial TV • Color Broadcast Equipment • Forward Scatter Communications • Fire Control Systems • REDAP

*Write, Phone Collect, or Apply in person to John F. Morrissey
... Your Inquiry will be held in Strictest Confidence*

PHILCO CORPORATION
GOVERNMENT AND
INDUSTRIAL DIVISION • PHILADELPHIA 44
 PENNSYLVANIA



ELECTRONIC ENGINEERS

RESEARCH DEVELOPMENT

Expansion of our engineering department requires electronic engineers with radar, servo, sonar or transistor circuit experience. Excellent opportunity for advancement with top-calibre associates. New modern plant in the suburbs with ideal laboratory facilities and well-trained technical assistants.

Other Opportunities in the following areas:

- TECHNICAL WRITERS
- DRAFTING Electrical Layout
- DETAILING Electrical - Mechanical

DESIGN ENGINEERS

Must have EE degree or equivalent, with 3-5 years experience in one of the following:

- Flight Simulators
- Analog Computers
- Radar & Sonar Trainers
- Radar Guidance & Fire Control Systems
- Redesign, Modification & Testing of Radar & Electronic Systems
- Electronic Installation & Maintenance
- Coil & Transformer Design
- Packaged Power Supplies

Other Openings For:

COMMUNICATIONS EQUIPMENT DESIGNERS

COMPUTER DESIGNERS

FIELD ENGINEERS

(*) Must have E.E. degree or equivalent with 5-10 yrs. experience.
*Positions located throughout USA

LOCATION:

On U. S. Highway 22, thirty miles (45 minutes) from New York City.

ENVIRONMENT:

One of the finest plants of its kind . . . spacious, modern, air-conditioned. Conducive to bringing out the best of your abilities!

ABOUT THE COMPANY:

Organized in 1945. Engaged in research, design and development for the Armed Services.

ITS BENEFITS:

- Pension Plan
- Group Life Insurance
- Paid Holidays
- Paid Sick Leave
- Paid Vacations
- Education & Tuition Assistance
- Other Group Insurances

Interviews in Your Community by Appointment

Send resume, write or call for additional information.

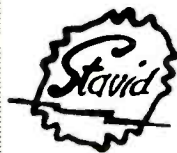

STAVID
ENGINEERING
Incorporated
U. S. Highway 22
Watchung, P. O.
Plainfield, N. J.
Plainfield 7-1600

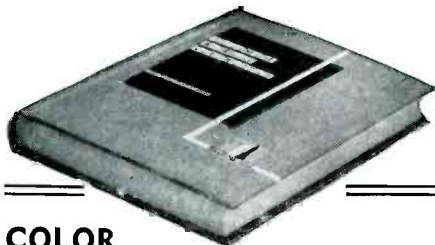

COLOR TELEVISION STANDARDS

JUST OUT! States the underlying factors relating to the choice of color television standards, and the effect of the standards on practical broadcasting and receiving equipment. Covers NTSC color TV standards and terminology, compatibility, performance, and FCC rules and regulations. Selected Papers and Records of the National Television System Committee. Edited by Donald G. Fink, Vice-chairman, NTSC (1950-52), Director of Research, Philco Corporation. 520 pp., 290 illus., \$8.50.

INTRODUCTION TO ELECTRONIC ANALOGUE COMPUTERS

JUST OUT! Covers principles, operation, and design of analog computers. Gives descriptions of components, computing elements, and procedures for arranging problems for analog computation. Emphasizes the effects of imperfections in computing elements, and means for reducing these factors. By C. A. A. Wass, Supt. of the Dynamic Analysis Division, Royal Aircraft Establishment, Farnborough, England. 237 pp., 149 illus., \$6.50.

TRANSMISSION-LINE THEORY

Systematic, rigorous, and thorough treatment of theory of transmission lines of various types. Proceeds from basic electromagnetic principles and derives the conventional transmission-line equations together with the formulas for line constants and all approximations involved. Formulation is sufficiently general to permit analysis of end effects and discontinuities as well as the more usually treated properties. By R. W. P. King, Gordon McKay Prof. of Applied Physics, Harvard Univ. 525 pp., 629 illus., \$12.00.

JUST OUT

P
E

ROFESSIO
NGINEER'S
XAMINATION

QUESTIONS
AND
ANSWERS

Over 500 questions and complete answers to help engineers pass state license examinations. Covers mechanical, electrical, civil, and chemical engineering, and includes engineering economics and land surveying. Latest questions—suitable for all states. Author has worked on New Jersey examination preparation for 19 years. By William S. LaLonde, Jr., 462 pp., 234 illus., \$6.50.

10 DAYS' FREE TRIAL

McGraw-Hill Book Co., Inc., Dept. LF-4B
327 West 41st St., New York 36, N. Y.

Send me book(s) checked below for 10 days' examination on approval. In 10 days I will remit for book(s) I keep, plus few cents for delivery costs, and return unwanted book(s) postpaid. (We pay delivery costs if you remit with this coupon—same return privilege.)

Fink—Color TV Standards—\$8.50
 Wass—Elec. Analogue Computers—\$6.50
 King—Transmission-Line Theory—\$12.00
 LaLonde—Prof. Engr. Ques. & Ans.—\$6.50

(Print)
 Name
 Address
 City Zone State

Company
 Position

For price and terms outside U. S. Write McGraw-Hill Int'l., N. Y. C. LF-4B

FOR RATES OR INFORMATION

About Classified Advertising,

Contact
The McGraw-Hill
Office Nearest You.

ATLANTA, 3
1321 Rhodes-Haverty Bldg
WALnut 5778
W. KEARNS

BOSTON, 16
350 Park Square
HUBbard 2-7160
H. J. SWEGER

CHICAGO, 11
530 No. Michigan Ave.
MOHawk 4-5800
W. HIGGINS

CINCINNATI, 37
1915 Rockingham Ave.
REdwood 1-4537
W. GARDNER

CLEVELAND, 15
1510 Hanna Bldg.
SUperior 1-7000
W. SULLIVAN

DALLAS, 2
Adolphus Tower Bldg., Main
& Akard Sts.
PRespect 5064
G. JONES

DETROIT, 26
856 Penobscot Bldg.
WOodward 2-1793
L. SEEGAR

LOS ANGELES, 17
1125 W. 6th St.
MADison 6-9351
C. W. DYSINGER

NEW YORK, 36
330 West 42 St.
LONgacre 4-3000
S. HENRY
D. COSTER
R. LAWLESS
R. HATHAWAY

PHILADELPHIA, 3
17th & Sansom St.
RITtenhouse 6-0670
E. MINGLE
H. BOZARTH

ST. LOUIS, 8
3615 Olive St.
JEfferson 5-4867
W. HIGGINS

SAN FRANCISCO, 4
68 Post St.
DOuglas 2-4600
R. C. ALCORN

ENGINEER, EE

packaging design

Under increasingly difficult operating conditions encountered by today's aircraft and missiles, proper packaging of electronic components continually grows in importance. A good position in this field is open with an organization growing, too — General Electric's Aircraft Products Department.

If you have 4-6 years familiarity with electronic circuit and creative electronic packaging design, and an EE degree with electronics or communication option you can qualify for this job. In it you will provide technical guidance for electronic component packaging, establish general packaging methods and objectives, determine component specifications, etc.

Salary is excellent, benefits broad, and living conditions good in this New York state vacation area.

Write in confidence to:

Mr. C. E. IRWIN
Engineering Admin.
Aircraft Products Dept.

GENERAL ELECTRIC

600 Main Street
Johnson City, N. Y.

ELECTRONIC ENGINEERS

To those interested in extending the "State of the Art" at VHF and UHF—I. F. I. offers challenging opportunities on long range programs. Wide band experience particularly useful, but not necessary. Expanding electronics firm. All normal fringe benefits.

Send resume or phone.

INSTRUMENTS FOR INDUSTRY, INC.

150 GLEN COVE ROAD MINEOLA, N. Y.
MR. T. C. VILLA. PIONEER 2-5300

COMMUNICATIONS ENGINEERS and TECHNICIANS

EXCELLENT SALARIES
MINIMUM PREREQUISITES

ENGINEER EE Graduates with 3 years experience
TECHNICIAN 2 years technical school in communications and 3 years experience.

Require installation adjustment and maintenance experience with communication receivers and associated terminal equipment. Also, men with similar experience with high-powered transmitters, antennas, transmission lines.

Must be willing to travel in United States and Overseas.

Page Communication Engineers, Inc.
710 Fourteenth St., N.W., Washington 5, D.C.

CONVAIR
1st in Electronics

DYNAMICS

AERODYNAMICS

THERMODYNAMICS

OPERATIONS RESEARCH

HYDRAULICS

MECHANICAL DESIGN

LABORATORY TEST ENGINEERING

UNEQUALLED OPPORTUNITIES IN ENGINEERING

Now is the time . . . Convair is the place! Yes! If you are planning for a career in engineering look to Convair Pomona, the leader in Electronics. America's fastest growing young industry. Now engaged in Design, Development, Engineering and production of Electronic equipment and complex weapons systems. Convair-Pomona is the country's only exclusive guided missile plant, with the most modern, best equipped engineering facilities. Be first with Convair, live in the beautiful Pomona Valley only minutes from Los Angeles, the mountain, seashore and desert playgrounds. Country living near the city at its best!

Generous travel allowance to Engineers who are accepted. Write now enclosing a complete resume to:

Employment Dept. 3-G

CONVAIR

A DIVISION OF
GENERAL DYNAMICS
CORPORATION

POMONA
CALIFORNIA



COOK RESEARCH LABORATORIES

THE FIELD OF RESEARCH OFFERS Satisfying CAREERS

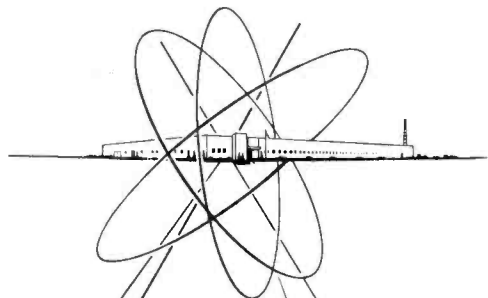

Cook

RESEARCH

LABORATORIES

Immediate Openings In—

RADAR — COMMUNICATIONS — MICROWAVE TECHNIQUES — INFORMATION THEORY — CIRCUIT DESIGN — TELEMETERING — PULSE TECHNIQUES — SERVO — FIRE CONTROL — WEAPONS SYSTEMS — MATHEMATICAL ANALYSIS FOR NUMERICAL COMPUTATION — THERMODYNAMICS — AERODYNAMICS — AIRCRAFT INSTRUMENTATION — NUCLEAR PHYSICS — MECHANICAL DESIGN — TEST ENGINEERS, COMPONENT & EVALUATION.

Cook Research Laboratories offers outstanding opportunities in the field of Research and Development for Engineers and Physicists at both the Senior and Junior levels. Cook Research maintains one of the nation's foremost research and development laboratories and has on its staff men who are nationally known in their respective fields.

At Cook Research, employees are encouraged in the publishing of technical papers. Undergraduate and graduate work is fully subsidized by the company.

The Research division offers highly diversified work in both research and development, excellent salaries and working conditions.

Company products are to be found on all commercial and military aircraft.

The Laboratory activities ARE WORLD WIDE IN SCOPE.

Cook Research Laboratories are located in the northwest suburbs of Chicago. This location is conveniently located to many fine universities, civic and shopping centers and many excellent resort areas.

Contact
D. M. HALLIDAY

• 8100 N. Monticello Ave.
Skokie, Illinois KEystone 9-2060

• A DIVISION OF COOK ELECTRIC COMPANY
2700 N. Southport Ave., Chicago, Illinois

ELECTRICAL AND MECHANICAL ENGINEERING AND MANUFACTURING SINCE 1897

TO BE SPECIFIC...

ABOUT OPPORTUNITIES
IN ELECTRONICS WITH

GENERAL  ELECTRIC

ENGINEERS • PHYSICISTS

GE has instituted a new service to aid engineers in making a career choice. Just fill out and mail the coupon below. GE will send you information on openings in your specific field of interest, and the location of these openings.

Every engineer seriously interested in the electronics field should consider what a GE career can mean: the broad scope, the varied opportunities, the exceptional chances for professional achievement. There are personal advantages too: stability, benefits, educational and advancement opportunities.

Bachelor's or advanced degrees in Electrical or Mechanical Engineering, Physics, and experience in electronics industry necessary.

If your professional goals are high, send the coupon below, to learn how and where you can begin your GE career.
(Or send complete resume, if you wish.)

TO: GENERAL ELECTRIC

Electronics Park, Syracuse, New York
ATTN.: Dept. 5-6-E, Technical Personnel

FROM: Name _____

Address _____

Degree _____

I am interested in

- Advanced development
- Design
- Field Service
- Technical Writing
- Sales

In the field of:

- Military Radar, Sonar, or Communication
- Electronic Components
- Commercial Television
- Tubes
- Semiconductors

NOW!
 a practical engineering
 introduction to
**COLOR
 TV**

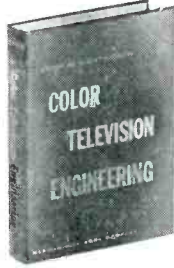

Here is practical ground-
 ing in the complex techni-
 ques of color television for
 engineers and technicians
 already familiar with mono-
 chrome television. The book
 takes you from basic prin-
 ciples of color and color
 sensation, right through to the actual trans-
 mitters, studio equipment, and receivers repro-
 ducing a color show in the set-owner's home.

Features
 approved
 commercially
 important
 fundamentals

Just Published!

COLOR TELEVISION Engineering

By
**John W.
 Wentworth**
 Manager,
 Television
 Terminal
 Equipment
 Engineering,
 Radio
 Corporation
 of America
 448 pages, 6 x 9.
 296 illustrations,
 \$8.00

Color television is ex-
 plained in simple and large-
 ly non-mathematical form.
 The block diagram ap-
 proach is used extensively,
 and step-by-step derivations
 lead you gradually from
 familiar principles of mono-
 chrome television to the advanced techniques
 of color television. The book reviews the basic
 theory of color, and the problems involved in
 transforming color images into electrical
 signals, then back again into color images.
 Various electronic techniques used for proces-
 sing, multiplexing, and transmitting color tele-
 vision signals are discussed in an orderly
 sequence.

Covers these 4 main areas:

- ▶ Basic principles of color, color perception, and color measurement
- ▶ Principles of color reproduction, covering the application of colorimetry to color television
- ▶ Principles of color television transmission systems, including multiplexing techniques, sequential color television systems
- ▶ Apparatus and circuits for color television, covering transmitters, receivers, and test equipment

Contains these useful appendixes

- Standardized CIE Colorimetric Data
- Data for Color Mixture Curves for the FCC Primaries
- FCC Standards for Compatible Color
- Television Trigonometric Identities
- Mathematical Proof of the Two-Phase Modulation Technique

10 DAYS' FREE EXAMINATION

McGraw-Hill, Attn: H. Buhrow
 Industrial & Business Book Dept.
 327 West 41st St., NYC 36

Send me Wentworth's PRINCIPLES OF COLOR TELEVISION ENGINEERING for 10 days' examination on approval. In 10 days I will remit \$8.00, plus few cents for delivery costs, or return book postpaid. We pay delivery cost if you remit with this coupon; same examination and return privileges.

PRINT
 Name
 Address
 City Zone State

Company
 Position
 For price and terms outside U. S.,
 write McGraw-Hill, Int'l., N. Y. C.

LF-4A

TOP careers for TOP ENGINEERS at "FTL"

*One of the world's great centers of
 electronic research and development*

Top opportunities for achievement and recognition are available at Federal Telecommunication Laboratories, a division of the world-wide International Telephone and Telegraph Corporation.

Here, a man works with the finest facilities . . . with recognized leaders in his field. As a part of FTL's long-range development program he has a dependable road into the future . . . a future of stability, achievement, and commensurate rewards.

Why not write today for your copy of the booklet that tells the fascinating story of FTL . . . the broad and generous employee benefits . . . the many opportunities for permanence and satisfying progress.

Interesting Assignments in:

- Radio Communication Systems • Electron Tubes
- Microwave Components • Electronic Countermeasures
- Air Navigation Systems • Missile Guidance
- Transistors and other Semiconductor Devices • Computers
- Antennas • Telephone and Wire Transmission Systems

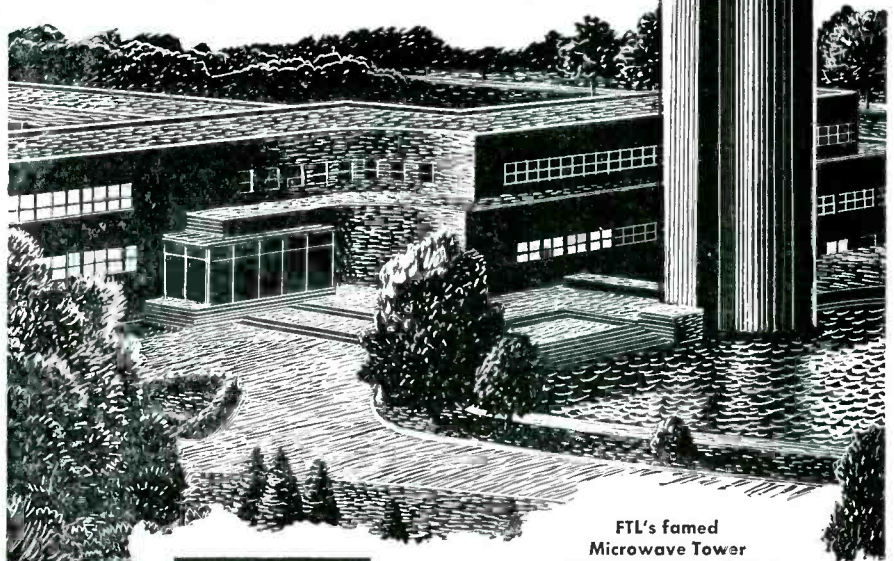
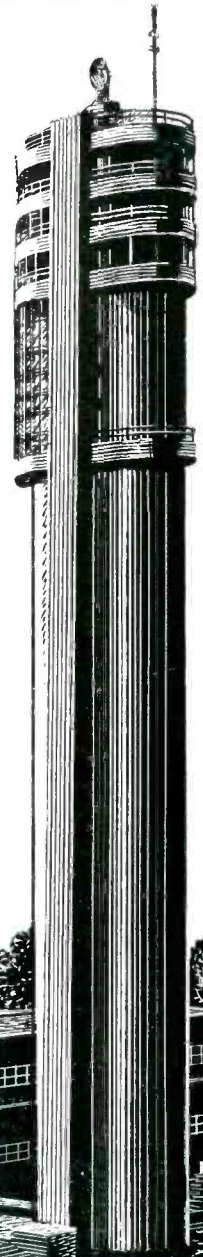

FTL's famed
 Microwave Tower
 — 28 minutes from N. Y. C.



MAIL THIS COUPON TODAY

Federal Telecommunication Laboratories
 500 Washington Avenue, Nutley, N. J.
 Please send a copy of your booklet describing
 opportunities at FTL.

Name
 Address
 City Zone State

FTL



Federal Telecommunication Laboratories
 A Division of INTERNATIONAL TELEPHONE
 AND TELEGRAPH CORPORATION

Guided **MISSILE**

RESEARCH and DEVELOPMENT

THE JOHNS HOPKINS UNIVERSITY APPLIED PHYSICS LABORATORY

offers an exceptional opportunity to qualified men who want to advance themselves professionally in the guided-missile field. The Laboratory has a reputation for the recognition and encouragement of individual responsibility and self-direction.

Outstanding developments at APL include:

- The proximity fuse
- The first supersonic ramjet
- The Navy's Terrier & Talos Guided Missiles

OPENINGS AT ALL STAFF LEVELS for Engineers, Physicists, and Mathematicians in
 Design and Analysis of Pulse Circuits
 Research and Development in Radar and Microwaves
 Electronic Packaging
 Development of Telemetry, Data Processing and Special Switching Equipment
 Magnetic Amplifier Design and Analysis
 Development and Application of Printed Circuits
 Servomechanisms and Control System Design & Analysis
 Transistor Circuit Research
 Dynamics and Flight Simulation
 Flight Test Planning and Operations

- Laboratories located in beautiful residential suburbs of Washington, D.C.
- Liberal leave policy
- Retirement and Insurance Plan
- Educational benefits
- Moving and relocation expenses paid for applicants selected.

Please send your resume to
Professional Staff Appointments

Applied Physics Laboratory

THE JOHNS HOPKINS UNIVERSITY

8609 GEORGIA AVENUE
SILVER SPRING MARYLAND

Opportunities in . . .

INDUSTRIAL ELECTRONICS

RESEARCH and DEVELOPMENT ENGINEERS
PHYSICISTS • SALES ENGINEERS
SYSTEM ENGINEERS

Work in the following fields:

ELECTRONIC WEIGHING • ELECTRONIC CONTROLS
ELECTRICAL TRANSDUCERS • DATA HANDLING
SERVO MECHANISMS

Growth Opportunities Created By Company's
Expanding Activities In *Non-Military* Industrial
Electronics Contracts.

Send resume to:
MR. G. C. REISER

TOLEDO SCALE CO.
Telegraph Road • Toledo, Ohio

ELECTRICAL ENGINEERS Physicists

Immediate openings in
fast-growing field of

SEMI-CONDUCTORS

Permanent career positions
with General Electric in
Syracuse, New York . . . for
development, instrumentation,
design and processing of
transistors and rectifiers.

Unusual opportunity for
electrical engineers and
physicists with B.S., M.S.
or Ph.D. degrees.

Chance to work with the
industry's leading engineers
and scientists . . . under
ideal working conditions in
modern laboratories, fully
equipped with all facilities.

To learn more about your
G-E opportunity to live and
work in the heart of New
York's vacation land, write
today to:

Mr. M. D. Chilcote,
Department 156-E

Electronics Park
Syracuse, New York

GENERAL  ELECTRIC

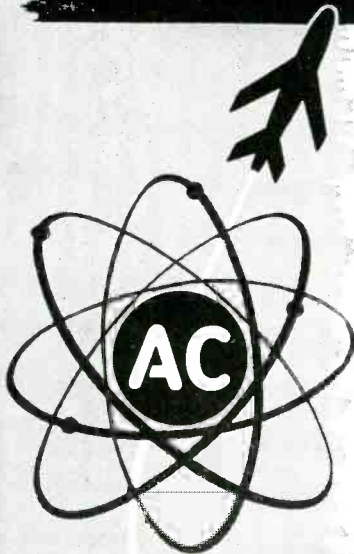
ENGINEERS and DESIGNERS NEEDED**for:****MISSILE GUIDANCE
SYSTEMS****BOMBING NAVIGATIONAL
COMPUTER SYSTEMS****NEW CIVIL AVIATION
PRODUCTS****JET AND TURBO-PROP
ENGINE CONTROLS****AIRBORNE FIRE
CONTROLS****GM CAREER OPPORTUNITIES IN**

**Systems Engineering and Analysis
Experimental Engineering
Development Engineering
Project Coordination**

**Design Engineering
Product Engineering
Product Evaluation
Field Engineering**

AND WE ALSO NEED:**DESIGNERS • CHECKERS • LAYOUT MEN**

Positions Are Permanent

Excellent Advancement Opportunities

Every inquiry treated confidentially and given
immediate attention and personal reply.

WRITE TODAY FOR EMPLOYMENT APPLICATION

Mr. John F. Heffinger

Supervisor of Salaried Personnel

**AC SPARK PLUG DIVISION
THE ELECTRONICS DIVISION**

GENERAL MOTORS CORPORATION

Milwaukee 2, Wisconsin

Flint 2, Michigan

Opportunity...

TO WORK WHERE IT'S FUN TO LIVE**Can You Qualify?**

- Electronics Technician or Engineer
- Design, Development and Research Engineer (Aircraft—Mechanical—Electrical)
- Physicist
- Draftsman
- Precision Production Machinist
- Precision Machine Operator
- Experimental Machinist
- Aircraft Sheet Metal Worker

Here is what you should do:

- ✓ Analyze your own qualifications carefully.
- ✓ Send a summary of your qualifications and experience. State when you are available.
- ✓ Do not come to Phoenix without first writing. Job opportunities are mainly restricted to specialists listed here. If your summary qualifies you for consideration you will be contacted by mail, phone or in person for further interview.

Phoenix and the Valley of the Sun is a friendly, roomy place in which to live and work... a healthful land of sunshine and clean easy-to-breathe air. It's a land of progress, constantly attracting more and more substantial industries. Good housing is plentiful and low in cost. Excellent schools and colleges and abundant year-round recreation... with lots of interesting things to do and see... make this one of the most desirable living areas in the world. Your inquiry will be considered promptly and in complete confidence.

Phoenix Industrial Committee, P. O. Box 2751-D

Phoenix, Arizona

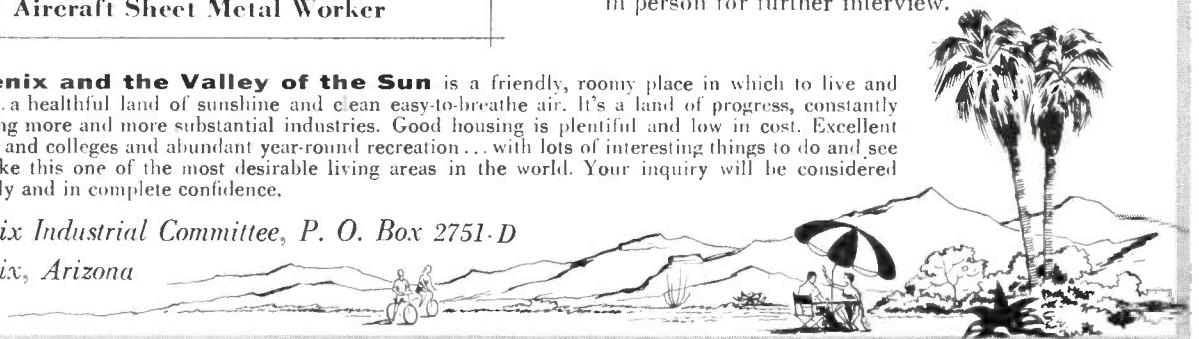

ELECTRICAL ENGINEERS:

A Career at Electric Boat... Is An **ADVENTURE** in Engineering

In the past several years, Electric Boat has been making one headline after another as the nation's first adaptor of nuclear power for propulsion. The Electric Boat-designed and built atom submarines, Nautilus and Seawolf, are already accomplished fact.

Behind the headlines, the work of designing even more advanced atomic submarines goes on. Every day, Electric Boat engineers are coming to grips with problems in nucleonics that pave the way for applications in other fields.

There is room—and opportunity—for more engineers able to cope with these problems. Current openings are for Electrical Engineers versed in servo-mechanisms, circuitry, motors and generators, radar and sonar, or electro-mechanical systems.

These jobs offer more than engineering adventure. There's common-sense practicality involved, too. Electric Boat's backlog of orders and years-ahead plans; its record stable engineering employment; its sponsorship of advanced study at leading universities and within the plant are some of the practical features. New England living on the shores of Long Island Sound is another.

To find out more details about these opportunities, write us details of your background and experience including initial salary requirements. Interviews will be arranged promptly for qualified applicants. Please address **Peter Carpenter**.

ELECTRIC BOAT

DIVISION OF GENERAL DYNAMICS CORPORATION
GROTON, CONNECTICUT



LITCHFIELD PARK
PHOENIX, ARIZONA

New Electronic Laboratory Now Being Staffed

This modern laboratory is a key part of the larger well-established, and progressive AEROPHYSICS DEPARTMENTS at GOODYEAR AIRCRAFT CORPORATION in Akron, Ohio; a division of the world-wide GOODYEAR TIRE AND RUBBER COMPANY.

Positions are open at all levels of experience in:

**ELECTRONIC SYSTEM ANALYSIS
MICROWAVE AND SERVOMECHANISMS
AIRCRAFT INSTRUMENTATION
RADAR**

Design of complete radar including receiver sections, wave guides, antennas, modulators, display circuitry

Long-range, interesting work. Inexpensive modern housing.

**WESTERN LIVING AT ITS BEST
"IN THE VALLEY OF THE SUN"**

GOODYEAR AIRCRAFT

Send resume to: MR. A. E. MANNING
GOODYEAR AIRCRAFT CORPORATION, LITCHFIELD PARK, ARIZONA

Similar opportunities are open in our Akron, Ohio Plant

*To EMPLOYERS
Who Advertise
for MEN:*

Frequently, when there are many applicants for a position, only the most promising letters are acknowledged. The other applicants never know whether their letters reached a prospective employer or not. These men often become discouraged, will not respond to future advertisements and even question their bona fide character.

Every Advertisement Printed in the Searchlight Section Is Duly Authorized.

You can help keep our readers interested and get better returns to your advertising in this section if you acknowledge each reply—in plain envelopes, if you wish.

Classified Advertising Division

McGRAW HILL PUBLISHING CO., INC.

"Put Yourself in his place."

Employment Opportunities ADVERTISERS INDEX

Admiral Corp.	414
Allison Div., General Motors Corp.	432
American Machine & Foundry Co.	430
Amra Div., American Bosch Arma Corp.	448
Armour Research Foundation of Illinois Institute of Technology	432
Avion Div. of ACF Industries, Inc.	446
Autonetics, A. Div. of North American Aviation, Inc.	433, 449
Beech Aircraft Corp.	447
Bendix Aviation Corp., Pacific Division	420
Products Div., Missile Section	416
York Division	425
Burroughs Corporation	421
CBS Hytron Corp.	449
Collins Radio Co.	422
Convair, A. Div. of General Dynamics Corp., Pomona, Calif.	439
San Diego, Calif.	413
Cook Research Labs.	440
Cooper, J. J.	410
Cornell Aeronautical Lab., Inc.	431, 434, 436
Crosley and Bendix, Home Appliance Div., Avco Mfg. Corp.	418
Decision, Inc.	430
Designers For Industry	435
Electric Boat Div., General Dynamics Corp.	444
Erco Div., of ACF Industries	447
Farnsworth Electronics Co.	412
Federal Telecommunication Labs	441
General Electric Co., (Johnson City N. Y.)	426, 439
General Electric Co., (Richland, Wash.)	447
General Electric Co., (Syracuse, N. Y.)	440, 442
General Laboratory Assoc., Inc.	428
General Motors, AC Spark Plug Div.	443
General Precision Laboratory	446
Goodyear Aircraft Corp., (Akron, Ohio)	411
Goodyear Aircraft Corp., (Litchfield Park, Arizona)	444
Gruen Watch Co.	432
Honeywell Brown Instruments	424
Industrial Research Laboratories	414
Instruments for Industry, Inc.	439
Johns Hopkins University, Chevy Chase, Md.	436
Silver Springs, Md.	442
Kollsman Instrument Corp.	448
Land-Air, Inc.	445
Lockheed Aircraft Corp.	423
Maryland Electronic Mfg. Corp.	412
Melpar, Inc.	418
Missile Test Project	422
Monarch Personnel	410
Motorola, Inc.	436
National Cash Register Co.	427
Northrop Aircraft, Inc.	420
Page Communications Engineers, Inc.	439
Philco Corp.	437
Phoenix, Arizona, Chamber of Commerce	443
Radio Corp. of America	408, 409
Radio Receptor	430
Raytheon Mfg. Co., Newton, Mass.	410
Waltham, Mass.	417, 434
Wayland, Mass.	426
Republic Aviation Corp.	429
Stavid Engineering, Inc.	438
Stromberg-Carlson Co., Div. of General Dynamics Corp.	419
Sylvania Electric Products, Buffalo, N. Y.	424
Mountain View, Calif.	428
Waltham, Mass.	424
Toledo Scale Co.	442
Transitron Electronic Corp.	415
Varo Manufacturing Co.	416

This index is published as a service to the readers. Care is taken to make it accurate but CLASSIFIED assumes no responsibility for errors or omissions.

LAND-AIR, INC.

SUBSIDIARY OF CALIFORNIA EASTERN AVIATION, INC.

OFFERS EMPLOYMENT

IN

NEW MEXICO

Interesting positions open on U. S. Army-Air Force integrated missile-test range working for private contractor.

Work located near cities of Alamogordo and Socorro, New Mexico. Dry climate, pleasant communities, good schools, outdoor and indoor duties. Congenial working groups:

ENGINEERS—

We have several excellent opportunities for Electronic Engineers, with some experience, to work with various instrumentation systems used in guided missile testing. Graduate engineers will find this work both challenging and interesting. Lab positions open in development of instrumentation systems. Pertinent experience desired. Opportunity exists for gaining experience in advanced electronic techniques including, pulse, digital, computer, C-W, microwave, telemetry, analog, controls, etc.

TECHNICIANS—

Electronic Technicians needed for operation, maintenance, and improvement of electronic, electro-optical-mechanical instrumentation devices used in obtaining data from guided missile tests. Very interesting, mainly outdoor work—some lab work, requires good physical condition, good vision, driving ability, plus technical background. Radio-T.V. experience or industrial electronics experience helpful. Some positions require mechanical background for precision instrument work.

NOTE OUR EMPLOYEE BENEFITS:

1. Excellent pay
2. Paid vacation (2 weeks per year)
3. Paid accident & health (income) insurance
4. Paid hospital, surgical, polio & life insurance
5. Excellent contributory insurance plan for dependents
6. Merit system of pay raises
7. Travel and moving expense
8. Paid holidays
9. Bonus—contingent upon company profits

YOUR CONTACT IS:

Mr. W. J. McClarin, Personnel Director, Land-Air, Inc.,
P. O. Box 394, Holloman, New Mexico.

YOUR ORGANIZATION

Is it complete? Are you expanding it? Making Replacements?

Naturally, you are anxious to secure the most suitable man or men available. You want men with the special training that will make them an asset to your organization. You can contact such men through an advertisement in the Employment Opportunities Section of ELECTRONICS.

Classified Advertising Division—

ELECTRONICS

330 W. 42nd St.,

New York 36, N. Y.

ENGINEERS

today the choice is yours -

choose wisely... choose

GPL

GPL—with its widely diversified operations in today's most active fields—offers you a lifetime of achievement, satisfaction and advancement.

Here you'll be working with men who have repeatedly broken ground on the frontiers of science, made GPL one of the country's outstanding technological leaders. You'll be part of the nationwide General Precision Equipment organization whose many companies operate in highly advanced areas.

We offer you work on challenging new projects in various stages of research and development. We offer you stimulating professional problems, top pay levels and working conditions, and ideal family living in semi-rural Westchester—just an hour from New York City.

GPL's engineers are men of skill and imagination—and we are seeking more men of their caliber. If you have the inherent capabilities and skills we need and if you are seeking a stable and rewarding career, send resume to Mr. H. F. Ware. Interviews can be arranged in advance at any time, including weekends. Security limits us to considering applications of U. S. citizens only. We will pay the expenses of qualified applicants to come for an interview.

RADAR NAVIGATION AND BOMBING SYSTEMS (DOPPLER AND INERTIAL)
 Research . . . Development . . . Applications . . . System Analysis . . . Project Management
 Computers . . . Servos . . . Microwave Techniques . . . Pulse Circuitry



GENERAL PRECISION LABORATORY

INCORPORATED

63 Bedford Road, Pleasantville, N. Y.

A SUBSIDIARY OF GENERAL PRECISION EQUIPMENT CORPORATION



ELECTRONIC DEVELOPMENT ENGINEERS

Challenging DESIGN & DEVELOPMENT POSITIONS for CREATIVE ENGINEERS

These positions are tailor-made for highly imaginative engineers who enjoy problems of more than ordinary difficulty; problems that require a maximum of individual electronic creativity. Men selected will be entrusted with the complete electronic or electro-mechanical design and development tasks (initial circuits, systems, components, or product design) entailed in carrying a prototype project from original conception to its completion

REQUIREMENTS: Senior and intermediate engineers with degrees and 4 to 8 years' experience; Junior engineers with degrees and 1 to 3 years' experience, capable of growing with our long-range, electronic design and development program in the following fields:

- (1) ANALOG COMPUTER
- (2) RADAR BEACONS
- (3) MAGNETIC AMPLIFIERS
- (4) ELECTRO-OPTICS
- (5) MISSILE SYSTEMS
- (6) SERVOS
- (7) FIRE CONTROL SYSTEMS

WE ARE LOCATED in a suburban area, at the Paramus exit of Garden State Pkwy., convenient to the N. J. Turnpike and only 15 minutes from Manhattan. If you choose, you can live nearby, avoiding the discomforts, costs and time wasted in commuting. Enjoy living in a clean, friendly community, minutes from work!

Interviews will be arranged at convenient locations. Send resume to:

AVION DIVISION
OF ACF INDUSTRIES INCORPORATED

Route 17, Paramus, N. J. COLfax 1-4100

Only 15 minutes from
 George Washington Bridge

EMPLOYMENT PROBLEM?

When you are in need of specialized men for specialized jobs, contact them through an employment ad in a McGraw-Hill Publication.

Management, Engineering, Production, Maintenance, Selling . . . these represent broadly the principal functions in business and industry. And it is principally to the men and executives who fill key jobs in these important divisions that McGraw-Hill publications are directed.

McGraw-Hill Domestic Publications

- AMERICAN MACHINIST
- AVIATION WEEK
- BUS TRANSPORTATION
- BUSINESS WEEK
- CHEMICAL ENGINEERING
- CHEMICAL WEEK
- COAL AGE
- CONTROL ENGINEERING
- CONSTRUCTION METHODS AND EQUIPMENT
- ELECTRICAL CONSTRUCTION AND MAINTENANCE
- ELECTRICAL MERCHANDISING
- ELECTRICAL WHOLESALING
- ELECTRICAL WORLD
- ELECTRONICS
- ENGINEERING AND MINING JOURNAL
- ENGINEERING NEWS-RECORD
- FACTORY MANAGEMENT AND MAINTENANCE
- FLEET OWNER
- FOOD ENGINEERING
- NATIONAL PETROLEUM NEWS
- NUCLEONICS
- PETROLEUM PROCESSING
- PETROLEUM WEEK
- POWER
- PRODUCT ENGINEERING
- TEXTILE WORLD

THE MEN YOU NEED ARE
 THE MEN WHO READ THE

McGraw-Hill PUBLICATIONS

330 West 42nd St.,
 New York 36, N. Y.

ELECTRONIC INSTRUMENTATION ENGINEERS

Beechcraft has immediate openings for Electronic Instrumentation Engineers. Three to five years experience in experimental research testing of high speed aircraft or missiles required. Knowledge of instrumentation and telemetry coupled with ability to instrument, record and analyze is essential. Graduates with E.E. degree preferred. Excellent opportunity with a progressive company. Please address inquiry with resume of past experience to Roy F. Kunz, Dept. 69E, Beech Aircraft Corporation, Wichita, Kansas.

BEECHCRAFT

NEED ENGINEERS?

An employment advertisement in this EMPLOYMENT OPPORTUNITIES section will help you find the engineers you need. It's an inexpensive, time saving method of selecting competent personnel for every engineering job in the electronics field. The selective circulation of ELECTRONICS offers you an opportunity to choose the best qualified men available.

DO YOU NEED ENGINEERS EXPERIENCED IN:

- Research
- Development
- Design
- Instrumentation
- Servomechanisms
- Missiles
- Audio Systems
- Control Systems
- Radar
- Computers
- Transistors

Place an "ENGINEERS WANTED" advertisement in this EMPLOYMENT OPPORTUNITIES SECTION. It's an inexpensive, time saving method of selecting competent personnel for every engineering job in the electronic industry. The selective circulation of ELECTRONICS offers you an opportunity to choose the best qualified men available throughout the industry.

For Rates and Information
Write:

Classified Advertising Division
McGRAW-HILL PUBLICATIONS
330 West 42nd St., N. Y. 36, N. Y.

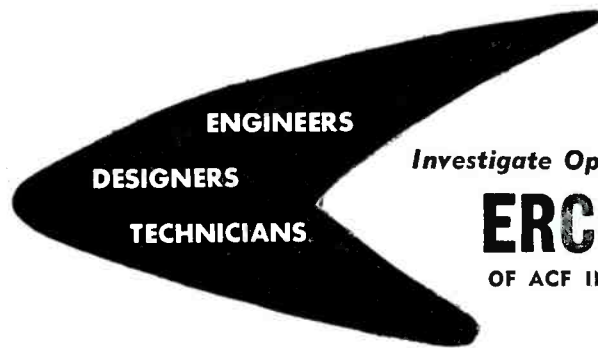

Investigate Opportunities at

ERCO DIVISION
OF ACF INDUSTRIES INC.

ERCO Engineers have built a record of continuous progress and growth for themselves and for the Company for a quarter of a century . . . growth in physical plant, personnel, number and diversity of products and services.

Today this growth continues and we are constantly on the alert for new men to add fresh impetus to that progress . . . paying top salaries to capable people.

Your work will be interesting and stimulating . . . it might include electronic flight simulators, machine tools, guided missiles, or a variety of specialized electronic devices.

You can choose a home from a number of fine nearby residential areas convenient to both shopping centers and plant . . . and you can further your education at the many nearby Universities . . . you can enjoy suburban living and be within easy reach of the cultural advantages of the Nation's Capital.

ERCO now needs Electronic Engineers (all levels with some overseas positions available). Aerodynamicists, Analog Computer Engineers, Mechanical Design Engineers, and supporting personnel. Send resume or request for additional information to:

ERCO DIVISION
OF ACF INDUSTRIES
RIVERDALE • MARYLAND

Physicist or
Engineer

*Analog
Computer
Head*

We're looking for an individualist. We'd like him to be of a high order of analytical ability, and to have already become proficient in computer programming in support of activities in the fields of reactor physics, heat transfer, hydraulics, and mechanics. After that he will take the reins, and using his administrative abilities, show us that this is one position that is definitely fitted to the man.

If you have the vision to keep on looking ahead and are realistic enough to keep a staff looking ahead right up there with you, then we invite you to write in confidence to General Electric. For now, more than ever, people like you are creating the positions they will continue to grow with.

In writing, please include your experience, age, academic background and technical references. Personal interviews will be arranged with all selected candidates.

Mr. E. P. Galbraith
Technical Personnel Placement

GENERAL ELECTRIC

RICHLAND, WASHINGTON

**IMMEDIATE
OPENINGS**

As designers of America's finest aircraft instruments, Kollsman can provide excellent opportunity for professional growth. And the congenial atmosphere, the modern facilities contribute to an environment in which a man can do his best work.



kollsman INSTRUMENT CORPORATION

80-08 45th AVENUE, ELMHURST, NEW YORK • SUBSIDIARY OF *Standard* COIL PRODUCTS CO. INC.

SYSTEMS ENGINEERS

For development, testing and field service of airborne navigational systems. Some experience with servos utilizing electronic and electro-mechanical components desirable.

ELECTRICAL ENGINEERS

Experience in small electro-mechanical devices, motors, synchros and induction pick-offs.

FIELD SERVICE ENGINEERS

For work associated with airborne navigational equipment. Should be versed in electronics circuitry and mechanical repairs. Entails some travel.

DESIGNERS

Electronic, Electro-mechanical, Mechanical

1. Electronic and electrical packaging. Knowledge of sub-miniaturized techniques. Work is associated with servos, amplifiers and components.

2. Mechanical or electro-mechanical packaging of precision flight instruments.

Please submit resumes to the Employment Manager. Confidential interviews will be arranged.

**INDEX
TO THE
SEARCHLIGHT
SECTION
ADVERTISERS**

Alltronics	456
Arrow Sales Inc.	454
Barry Electronics Corp.	459
Blan	458
C & H Sales Co.	453
Columbia Electronics	460
Communication Devices Co., Inc.	457
Communications Equipment Co.	451
Electronicraft	454
Empire Electronics Co.	456
Engineering Associates	456
Fair Radio Sales	454
Fay-Bill Distributing Co.	456
Finnegan, H.	459
Haydu Brothers	449
Instrument Service Co.	458
J S H Sales	455
Lectronic Research Labs.	460
Leru Laboratories Inc.	461
Liberty Electronics	452
McNeal Electric & Equipment Co.	456
Monmouth Radio Labs.	452
M. R. Co., The	460
North Electronic Supply	449
Photocon Sales	459
Radalab Inc.	461
Radio and Electronic Surplus.	458
Radio-Research Instrument Co.	458
Relay Sales	459
Ruxur Electronics Corp.	450
Sagal Co., Inc.	452
Semler Industries Inc.	452, 460
S & R Electronics	449
Stemet Ltd.	456
"TAB"	462
Universal General Corp.	457
V & H Radio & Electronics Supply.	460
Western Engineers	450
Wilgreen Industries	456

This index is published as a service to the reader. Care is taken to make it accurate but Classified assumes no responsibility for errors or omissions.

ENGINEERS

ARMA pioneers in

INERTIAL NAVIGATION

Immediate openings for Supervisory and Staff positions as well as for

Senior Engineers, Engineers, and Associate Engineers.

experienced in:

- SYSTEMS EVALUATION
- GYROSCOPICS
- DIGITAL COMPUTERS
- ACCELEROMETERS
- TELEMETRY
- GUIDANCE SYSTEMS
- STABILIZING DEVICES
- SERVOMECHANISMS
- AUTOMATIC CONTROLS
- THERMODYNAMICS
- OPTICS
- ENVIRONMENTAL RESEARCH
- TRANSFORMERS
- RELIABILITY
- WEIGHT CONTROL

ARMA, recognized for its accomplishments in the fields of navigation and fire control, is a leader in the development of Inertial Navigation. This new system deals solely with space, time and acceleration... acting independently of external influences.

Creative engineering of the highest order is required to develop components making Inertial Navigation possible: *accelerometers* to measure acceleration; *integrators* to convert this information into velocity and distance; *gyros* to provide directional reference and hold the system stable; *computers* to calculate course-to-steer and distance-to-go. Components must meet rigid weight and size requirements... and function with undreamed-of accuracy.

ARMA, one of America's largest producers of ultra-precise equipment, offers unlimited opportunity for engineers to help in this great endeavor. Challenging projects and ARMA's extensive supplementary benefits make an ARMA career doubly attractive.

ARMA engineers are currently working a 48 hour week at premium rates to meet a critical demand in the Defense Dept's missile program. Moving allowances arranged.

Send resume in confidence to:

Technical Personnel Dept. 2-500
Division of American Bosch Arma Corporation
Roosevelt Field, Garden City, Long Island, N. Y.



Experienced Electronics Writers...

Immediate Openings at AUTONETICS

For writers who can prepare trouble analyses, check-out and line-maintenance procedures for service handbooks on electronics equipment. Practical experience desired in laboratory or field work in radar, computers, receivers and transmitters.

Please write immediately to:

D. S. Grant
Engineering Personnel Office, Dept. 991-20E,
12214 Lakewood Boulevard, Downey, California

Autonetics



A DIVISION OF NORTH AMERICAN AVIATION, INC.

YOU'LL LIKE MASSACHUSETTS...

Just as you'll like the challenging engineering jobs with a future available at CBS-Hytron's Massachusetts plants and laboratories. You can live near the ocean and also enjoy winter sports at their best in a state renowned for its scenic beauty. All of our plants are within easy reach of the educational and cultural centers in Boston.

**We need engineers
in these rapidly
expanding areas:**

Research and Development
Commercial Engineering
Factory Engineering
Semiconductor Applications
Quality Control

Send your resume or request for additional information to:
ALBERT NELSON,
Director of Personnel

ELECTRON TUBES  SEMICONDUCTORS

CBS-HYTRON

Danvers, Massachusetts

A DIVISION OF COLUMBIA BROADCASTING SYSTEM, INC.

ELECTRONICS — May, 1956

SEARCHLIGHT SECTION

(Continued on pages 450-462)

REPLIES (Box No.): Address to office nearest you
NEW YORK: 330 W. 42nd St. (36)
CHICAGO: 520 N. Michigan Ave. (11)
SAN FRANCISCO: 68 Post St. (4)

FOR SALE

Patent No. 2,700,070 Intercommunication system see Electronics March 1950 make offer. FS-1342, Electronics.

HOME STUDY

Engineering Degrees earned by home study. American College of Engineering (University of the West). Box 27724 (G) Hollywood 27, Calif.

WANTED

Anything within reason that is wanted in the field served by Electronics can be quickly located through bringing it to the attention of thousands of men whose interest is assured because this is the business paper they read.

851 TRANSMITTING TRIODE

AMPLIFIER. Brand new original packing. Regular net \$253.00 each.

While they last \$6.95 each

SEARCH RECEIVER ARD-2. Brand new \$49.50 MODEL YJ-2

TRANSPONDER. Special while they last \$49.50. Brand new . . . many

other tube types in stock. All tubes subject to prior sale. Terms 25%

deposit with order or send full remittance to save c.o.d. charges.

f.o.b. Bethpage, N. Y.

S & R ELECTRONICS

297 Central Ave., Bethpage, L.I., N.Y.
Wells 1-8600

BEST QUANTITY PRICES ON LARGE STOCKS OF CONDENSERS, RELAYS, TUBES, ETC.

WRITE FOR LIST.

8-8 600V	1.20	.01—600V Mica 4LS25
8-8-8-8 600V	3.00	.01—1200V Mica30
.2-.2-.2 4000V	2.50	.00024—2500V Mica30

110 V AC RELAYS

Advance Ant. 1001-1B	2.50	Potter Blum latching	3.00
Str. Dunn 1XBX DPDT	1.75	Allan Brad. 702 50 A	10.00
Snap action 1/2 HP DPDT	2.00	Kerman Keying 1700Ω DC . . .	3.00

CRT trans. 850V-CT 250MA 950V +3-6V & 2-5V . . . \$5.00

Sealed 3H. Chokes 350MA 25Ω \$2.50 550MA 15Ω \$3.50

Taxi type coax car top ant. AN 95B \$1.50

Sub. Min. hearing aid pots 5/8x1/4 250K ± 20%80

Onan 59R Gas. Gen. 110V 1500W 800~28V 500W DC \$1.50

Onan 213G Same with 5HP 220-440 3φ motor drive . . \$1.50

Hartman 6HP gas gen 28V 100A DC Pnuze tires . . \$1.50

5HP 230V DC motors with Cut. Ham. starter . . . \$80

5HP 220-440V 3φ motors. Remote. start (Exc. used) . \$80

NORTH ELECTRONIC SUPPLY

3704 Bandini St. San Diego 1, Calif.

SURPLUS MANUFACTURING EQUIPMENT

For Television Cathode Ray Tubes Available.

For Full Information Contact

HAYDU BROTHERS

BOX 1226 PLAINFIELD, NEW JERSEY

SPECIAL PURPOSE TUBES

0A2 .70	3HP7 .300	VX-41 .500	446B .150	SN-976D .850
0A4G .100	3J21 .500	RK-49 .285	464A .215	991/NE-16 .30
0A5 .400	3J31 .350	CP-54 .350	CK-510AX .50	CK-1005 .30
0B2 .60	3K27 .125	HK-54 .200	GL-546 .200	CK-1006 .250
0B3/VR-90 .75	3KP1 .575	T-55 .350	559 .45	SN-1006 .650
0C3/VR-105 .65	3X2500A3 .100	VX-55 .600	575A .750	CK-1007 .45
0D3/VR-150 .65	4B22 .650	RK-60/1641 .125	631-P1 .600	SN-1007A .650
EL-CIB/3C31 .100	4B23 .500	RK-61 .300	WL-632A .1750	SN-1007B .850
1AD4 .115	4B27 .925	HY-65 .75	WL-652/57 .4000	CK-1009/BA .300
1AF4 .250	4B31 .200	RK-65 5D23 .700	WL-655/58 .10000	SC-1016C .650
1AG5 .200	4C27 .500	FG-67 .900	WL-681/86 .2500	SC-1017C .650
1B22 .150	4C35 .1750	HY-69 .275	WE-701A .250	CK-1026 .290
1B24 .500	4E27/8001 .800	RK-72 .50	703A .125	SN-1039A .650
1B35 .450	4J34 .300	RK-73 .50	WE-705A .70	SC-1156A .650
1B38 .250	4J38 .1000	CK-75/307A .75	706AY-GY .1250	1500T .12500
1B47 .500	4J39 .1000	75TL .750	707B .350	1603 .350
1P21 .300	4J52 .500	FG-81A .350	SN-714A .1000	1614 .150
1P22 .500	4X100A .1500	FG-95 .1750	WE-714AY .2000	1619 .30
1P28 .750	EL-C5B/5C30 .100	100R .500	715B .350	1624 .100
1P29 & 30 .150	5AP1 .250	100TH .500	715C .1100	1625 .30
1P36 & 37 .200	5B21 .100	WE-122A .150	717A .35	1846 .5000
2AP1 .400	5B21 .100	F-123A .500	WE-719A .1250	1851 .150
2AP1A .600	5BP1A .500	WE-123A .250	720AY-EY .3500	2050 .100
2AS15 .575	5BP2A .475	F-128A .1500	721A .75	ZB-3200 .10000
2C38 .750	5BP4 .200	VXR-130 .165	721B .700	R-4330 .750
2C39 .400	5C22 .2500	HK-154 .400	723A/B .800	5528 .500
2C39A .1250	5CP1 .750	FG-166 .1250	WE-725A .500	5550 .2500
2C40 .1000	5CP1A .750	FG-172 .2500	WE-726A .500	5551 .4000
2C42 .1000	5CP7 .800	QK-181 .2000	WE-726B .2500	5553 .10000
2C43 .1250	5CP7A .1000	FG-190 .750	WE-726C .1500	5556/PJ-8 .675
2C44 .45	5CP12 .1000	HF-200 .850	WE-730A .650	5557 .325
2C46 .600	5D21 .750	CE-203 .350	750TL .4000	5558 .500
WE-2C51 .290	5FP7 .150	203A .350	WL-759 .1000	5560 .1750
2D21 .75	5FP14 .750	207 .2500	SA-782B .200	5610 .100
2D21W .100	5GP1 .500	WE-211C .1000	WL-786 .1250	5632 .850
2D29 .100	5HP1 .200	WE-211D .800	801A .50	5634 .650
2E22 .300	5J29 .750	WL-218 .1500	802 .200	5637 .375
2E24 .195	5J30 .500	232CH .10000	GL-803 .200	5638 .650
2E26 .300	5J32 .1000	CE-235A .500	804 .850	5640 .850
2E29 .100	5J31 .1250	WE-242C .700	805 .500	5642 .100
2E36 .125	5J32 .625	WE-244A .750	807 .110	5644 .650
2J21A .250	5J34 .625	WE-245A .750	807W .200	5645 .850
2J26 & 27 .400	5J35A .625	WE-249B .350	808 .100	5650 .8500
2J29 .1500	5J311 .900	WE-249C .250	809 .250	5651 .125
2J30 .350	5LP1 .750	250R .375	810 .1000	5654 .100
2J31 .1250	5NP1 .200	250TH .1750	811 .290	5656 .550
2J32 .1000	5R4Y .100	250TL .1450	811A .350	5670 .145
2J33 .1750	5R4WGY .250	WE-251A .7500	812 .290	5672 .115
2J34 & 36 .1250	5X3 .300	WE-252A .750	813 (RCA) .1200	5676 .125
2J37 .400	5X3P1 .750	WE-253A .250	814 .150	5678 .100
2J38 .1000	5Z2P7 .5000	WE-254A .350	815 .100	5687 .200
2J39 .750	5Z4P11 .10000	WE-257A .300	816 .100	5691 .400
2J40 .1500	EL-C6J .600	FG-258A .10000	826 .50	5692 .400
2J51 .11500	EL-C6L .500	WE-262B .500	SD-828A .650	5693 .350
2J52 .5000	EL-C6/4B25 .800	267B .500	SD-828E .650	5696 .100
2J54 .3500	6ACTW .100	WE-268A .750	828 .950	5703 .100
2J55 .5000	WE-6AK5 .100	FG-271 .4000	829 .550	5720 .1500
2J56 .7500	6AK5W .100	WE-271A .750	829B .850	5725 .150
2J61 .1500	6AL5W .55	WE-274B .90	830B .50	5726 .55
2J62 .50	6AN5 .200	WE-276A .750	832 .300	5727 .125
2K22 .1500	6AR6 .125	WE-282A .600	832A .500	5728 .900
2K25 .1150	6AS6 .115	WE-283A .350	833A .3500	5734 .900
2K30 .10000	6AS6W .150	WE-285A .500	SD-834 .375	5740 .3500
2K33A .5000	6AS7G .275	WE-286A .600	834 .600	5750 .250
2K34 .8500	6C21 .1500	287A .250	836 .150	5763 .135
2K39 .12500	6J4 .175	HF-300 .2000	837 .110	5800 .750
2K41 .7500	6J4WA .250	WE-300B .500	838 .125	5801 .500
2K45 .3000	6J6W .150	304TH .750	842 .185	5803 .600
2K47 .12500	6L6WGB .250	304TL .1250	845 .400	5819 .3000
2K54 .600	6SK7W .150	307A .75	845W .750	5827 .500
2K55 .500	6SN7W .150	WE-310A .400	849 .2000	CK-5829 .150
2P21 (I.O.) .2500	6SU7GT .200	WE-313C .300	851 .900	5842 .1250
2V3G .125	6X5W .125	316A .50	860 .250	5847 .1250
2X2A .90	7BP7 .350	WE-323A .750	866A .120	5915 .75
3A4 .50	7CP1 .1000	323B .400	866 JR .100	5932 .400
3A5 .50	7EP4 .1000	WE-328A .350	869B .3500	5933 .200
3AP1 .200	7HP7 .1000	WE-337A .750	872A .125	5948/1754 .25000
3AP11A .500	10KP7 .2500	WE-339A .750	884 .95	5949/1907 .12500
3B21 .350	12AP7 .5000	WE-347A .300	885 .95	5962/BS-101 .650
WE-3B24 .100	12DP7 .1750	WE-350A .250	902A/P1 .200	5963 .140
3B24W .475	12GP7 .1750	WE-350B .250	913 .2000	5979/BS-1 .1500
3B25 .300	LM-15 (I.O.) .3500	WE-352A .1500	SD-917A .375	5980/BS-2 .1000
3B26 .250	FG-17 .325	WE-355A .1200	917 .200	5981/5650 .8500
3B27 .300	RK-20A .750	WE-356B .500	918 .150	5998 .700
3B28 .485	TZ-20 .150	WE-368A AS .175	922 .200	6328 .1250
3BP1 .200	RK-23 .250	371B .150	923 .140	8002R .1500
EL-3C 4B24 .500	HK-24 .300	WE-388A .150	927 .75	8005 .475
EL-3CJ .850	HK-24G .200	WE-393A .450	931A .250	8012A .350
3C23 .450	RK-25 .225	394A .225	SN-947C .650	8013 .250
3C24 .250	25E6WG .400	WE-396A .290	SN-947D .850	8013A .325
3C33 .750	25T .300	WE-403A .100	SN-948B .650	8020 .150
3C45 .585	25TG .250	WE-404A .1250	SN-948D .650	8025 .125
3D22 .975	FG-27A .1300	WE-409A .110	954 .30	8025A .200
3DP1 .300	28D7W .150	GL-415 .2500	955 .35	PD-8365 .5000
3DP1A .750	FG-32 .500	WE-417A .1250	SN-956B .100	9001 .85
3E29 .800	VX-32B .750	WL-417A .250	956 .35	9002 .60
3EP1 .200	FG-33 .1500	WE-418A .1500	957 .35	9003 .125
3FP7 .200	VX-33A .500	WE-421A .700	958A .35	9004 .35
3FP7A .250	35T .300	GL-434A .1000	959 .135	9005 .140
3GP1 .250	35TG .200	446A .40	SN-974B .850	9006 .25

ALL TUBES ARE NEW, INDIVIDUALLY CARTONED, FULLY GUARANTEED

Western engineers

ELK GROVE, CALIFORNIA
GEORGE WHITING, OWNER

Orders for less than ten dollars cannot be processed

Bargains in Brand New Surplus

★ Starred Items Available in Production Quantities at Special Prices
These are specials; write us your requirements

OIL FILLED CAPACITORS

VOLTS	MFD	Price	VOLTS	MFD	Price
25KV	1.0	*49.95	1000	28.0	5.50
25KV	.5	*39.95	1000	2.0	.69
25KV	0.1	14.95	1000	0.5	.19
7.5KV	0.5	4.25	600	10	1.29
6KV	0.25	1.09	600	8	1.19
3KV	0.5	1.59	600	4	*.69
3KV	0.1	*1.19	600	2	*.39
2.5KV	2.0	*2.95	600	1	*.19
2KV	5.0	2.95	660AC	5	2.99
2KV	.25	.89	330AC	5	1.25

MULTIPLE SECTION OIL CAPACITORS

10 mfd 400V meets 9 1/2 mfd 600V meets 600V specs; Dual 5mfd 1000V specs; 8 sect. 2-2-2-1-1-1/2-1/2-1/2 4 3/4 3 term. 3 3/4 Hx 3 3/8 W H x 4 3/4 W x 1 1/2 x 2 D .59c D .59c

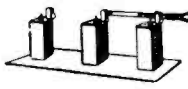

Square D Antenna change switch Bakelite base 2x8x1/4 ★49¢

SWITCH	DESCRIPTION	PRICE
Mu Switch	RC-1P norm. closed	.59
Mu Switch	RO-1P norm. open	.59
Mu Switch	RD-1P double throw	.69
Micro Switch	WZ-RQ1 norm. closed	.69
Micro Switch	VZ-RQ1 norm. open	.79
Micro Switch	WZ-RL8 norm. closed	.49
Micro Switch	BZ-R norm. open	.49
Micro Switch	G-R32 norm. open	.34
ST 50 R DPDT	on-momen. on	.89
ST 40 G SPDT	momen.-off-momen.	.44



SW 141 DPST norm. open Suitable for 115 V. AC SPECIAL ★19¢

PULSE NETWORK SPECIAL

Sprague 15-1-400-50 15 KHz 1.0 usec 400 P.P.S. 50 ohm Z ★\$295

TRANSMITTING CAPACITORS



12KV	0025	*29.50	3KV	00025	.99
10KV	0002	5.95	3KV	0002	.99
10KV	00015	*5.95	2KV	02	1.29
6KV	00024	4.95	2KV	015	1.29
2KV	02	10.95	2KV	00015	.69
1KV	04	4.95	1KV	-1	1.39
3KV	0068	*.99	600V	-4	1.39
2500WV	005	.89	2500WV	005	.89
1200WV	01	.59	2500WV	0036	*.69
1200WV	0051	.49	2500WV	001	.44
600WV	01	*.32	2500WV	0001	.29
600WV	001	.19	2500WV	0001	.29

VARIABLE TRANSMITTING CAPACITORS

19 to 116 mmfd. 27 plates .085" air gap. o/a dim. 4 3/4 L x 3 1/2 x 2 1/4. SC part # 3D 9019V .★98¢

POWER RHEOSTATS		POTENTIOMETERS	
Types H, J and I	2 Watts	Types JU and JLU	
ohms type bush. shaft each	ohms type bush. shaft each		
1 150(L) 3/8 7/16 2.65	50 JU 1/2 1/2 .54		
3000 50(J) 3/8 9/16 .79	1000 JU 1/4 3/16al. .49		
2 25(H) 3/8 1/2 al. .79	500K JU 1/4 1/2 .59		
8 25(H) 3/8 1/2 .79	2000 JLU lock 3/16al. .44		
100 25(H) 3/8 7/16 .79	3000 JLU lock 3/16al. .54		
150 25(H) 3/8 7/16 .79	10000 JLU lock 3/16al. .59		

RELAYS

Amperite 6N0-110 time delay relay, octal tube base 6V Heater, normally open. Contacts rated 3A ★99¢
Allied BO 13035 SPST Double break normally open 24V DC Coil Silver contacts each rated 15 Amp @ 24V DC or 115V AC ★98¢
Autelco Jr Type 16 115V AC coil DPDT Snap Action contacts rated 15 Amp 115V, 5 Amp 230V ★2.95
Cook #773 Standard Telephone Relay 900 ohm DC coil double arm 14 contacts 11A-1B-1C-1D 4" Lx1 1/2" W x 2 1/2" H ★1.09

COAXIAL CABLE & CONNECTORS

RG 9 B/U .★15.00 C FT
PL 259 Plug .★29¢
Amphenol 83-TAP Angle Adaptor .★18¢

Octal stearite & Mica filled sockets .★\$5.00 C
ALL PRICES F.O.B. OUR WAREHOUSE

WHERE DEPENDABILITY COUNTS MOST

• DEPENDABLE QUALITY • DEPENDABLE ORDER HANDLING •

3 WAREHOUSES
LOADED WITH
ELECTRONIC MATERIEL
AND END EQPT.

• DEPENDABLE DELIVERY • NEW HEADQ'TR'S.
COMMUNICATIONS EQPT. CO.

343 CANAL ST., N. Y. C.

PHONE: CANAL 6-4882

POWER TRANSFORMERS

COMBINATION—115V/60~INPUT		
CT-518	160-0-160V/70MA, 6.3V/2A, 2.5V/1.75A	\$2.15
CT-875	1600V/2MA, 6.3V/6A, 2.5V/1.75A	4.95
CT-127	900V/25MA PK, 5V/2A, 2V/1.5A	2.79
CT-006	350-0-350V/120MA, 5VCT/3A, 2.5VCT/1.25A, 2.5VCT/3.5A	4.39
CT-965	78V/0.6A, 6.3V/2A	1.95
CT-004	350-0-350V/190MA, 5VCT/3A, 2.5VCT/1.25A	4.60
CT-002	350-0-350V/50MA, 5VCT/2A, 2.5VCT/1.25A	3.65
CT-479	7000V/.018V, 2.5V/5A/17,800V T	22.50
CT-403	350VCT .026A 5V/3A	2.75
CT-931	585VCT .086A 5V/3A, 6.3V/6A	4.25
CT-349	24VCT/1A, 175VCT/50MA, 500VCT/90MA	3.25
CT-159	2-2.5VCT/3A, 2-22.5V/100MA, 27V/50MA, 40V/50MA	2.35
CT-913A	4.5V/3A, 5.5V/3A, 650VCT 75MA	2.65
CT-607	2.3V/2A, 85V/.1ACT, 400VCT/1A	3.95
CT-616	3V/10A, 10.5V/.1A, 45V/.1A, 60V/.1A, 140V/100MA	\$3.75

PLATE—115V/60~INPUT		
CT-047	1.5VCT/2A, 2-2.5VCT/2A, 2-3VCT/2A, 340VCT/100MA	3.50

PT-07	400VCT/4.0 AMPS For RA43	17.50
PT-034	125V45MA (For Preamp)	1.15
PT-133	3340/1570V, 2.36KVA	85.00
PT-521	750V/0.5A, Half Wave	59.50
PT-913	2500V12 VA H'SLD	4.95
PT-38-2	37.5/40V AT 750 MA	2.15
PT-87P	860VCT/230MA DC	4.75
PT-876	1500-0-1500V, 400MA	18.50
PT-153	2060VCT/0.175A	12.75
PT-428	Autotrans. 70V/2A	1.75
PT-078	300V/.05MA	1.85
PT-599	40V/10A CT	6.15
PT-823	220VCT/75 WATT	2.95
PT-973	160V/100MA	3.20
FT-551	2.5V/10AMP	2.95
FT-598A	3V/10A, 12.5V/10A	4.95
FT-204	6.3V/1AMP	1.45

FT-139	1V/2ACT, 5V/1AMP	1.15
FT-450	18.5V/1AMP	1.75
PT-241	(ISO-TRAN) 110V/1 AMP	1.79
PT-440A	110V/1AMP, 6.3V/2A, 2-2.5V/5A	2.65

FILAMENT—115V/60~INPUT

FT-157	4V/16A, 2.5V/2.75A	2.95
FT-101	6V/.25A	.79
FT-924	5.25A/21A, 2x7.75V/6.5A	14.95
FT-824	2x26V/2.5A, 16V/1A, 1.2V/7A, 6.4V/10A, 6.4V/2A	8.95
FT-463	6.3VCT/1A, 5VCT/3A, 5VCT/3A	5.49
FT-55-2	7.2V/21.5A, 6.5V/6.85A, 5V/6A, 5V/3A	8.95
FT-38A	6.3V/2.5A, 2x2.5V/7A 5KV Test	2.79
FT-650	2.5V/10A-3KV TEST LO-CAP	7.50
FT-025	2.5VCT/10A, 10KV TEST	6.95
PT-588	2.5V/10A	1.75
PT-580A	2-6.3V/2A, 150V/.05A, 230V/75MA	2.45
FT-964	2.9V/2A	1.39
FT-608	2.9V 5A, 2-3.5V/2A, 5V/2A	2.15
FT-068	5V/2A	1.35

FILTER CHOKES

Stock	Description	Price
CH-914	12HY/250 MA 2500 V. Test	53.25
CH-CEC	117: 9-60H/.05-400 MA, 10 KV Test	14.95
CH-113	2.5H/700 MA, 2.5 KV Test 18 Ohms	5.75
CC-044	8.5H/350 MA, 3.5 KV Test 50 Ohms	12.50
CH-291	0-1H/12 A DCR: 0.3 Ohms	2.75
CH-322	.35H/350 MA—10 Ohms DCR	4.69
CH-141	Dual 7H/75 MA, 11H/60 MA	2.35
CH-69-1	Dual 12H/17 MA	2.25
CH-776	1.28H/130 MA/75 Ohms	2.35
CH-344	1.5H/345MA/1200V Test	6.95
CH-366	20H/300 MA	1.95
CH-999	15HY/15 MA—400 Ohms DCR	1.79
CH-445	0.5HY/200 MA, 32.2 Ohms, 3000 V.T.	2.39
CH-170	2x0.5H/380 MA, 25 Ohms	1.39
CH-124	5H/200MA, 3KV Test	3.25
CH-139	12H/300 MA, 3KV Test	4.65
CH-88C	Swing 5-20H/0-300 MADC	5.25
CH-223	Dual: 2H/100MA, 75 Ohms, —2H/100MA, 240 Ohms	1.79
CH-564	Dual 0.5H/100MA, 15 Ohms	1.35
CH-934	5H/200MA, 92 Ohms Tap 3 Ohms	2.25
CH-756	2H/50 MA, 60 Ohms	.79
CH-511	7.5H/50MA, 0.5 Ohms	1.15
CH-306-1	15H/200 MA, Tap 7.5H, 300 Ohms	2.79
CH-779	0.5H/50 MA, 10 Ohms	1.15
CH-862	7.5H/50 MA, 60 Ohms	1.25
CH-246	30 H/75 MA, 175 Ohms	1.55
CH-461	5H/100 MA, 2 Ohms (Tapped)	1.55

COAXIAL R.F. FILTERS



F-29/SPR-2. Hi-Pass, with 1000 mc. Cut-off. Type "N" input and output. 50 Ohms Z. \$9.50
F-41/SPR-1. Hi-Pass, with 300 MC cut-off. Type "N" input and output. 50 Ohms Z. \$14.00
F-5/AR. 400 MC, lowpass 50 Ohms impedance, type & Connectors 20 1/4" x 1 1/4" dia. \$27.50

DYNAMOTORS

	INPUT VOLTS	AMPS	OUTPUT VOLTS	AMPS	PRICE
BDAR83	14	375	.150		\$6.50
35X-059	19	3.8	.405	.095	4.35
DM33A	28	7	540	.250	3.95
B-19	12	9.4	275	.119	6.95
			500	.050	
DA-3A*	28	10	300	2.6	3.95
			150	.010	
			34.5	5	
PE 73 CM	28	19	1000	.350	17.50
BD 69	14	2.8	220	.08	8.95
DAG-33A	18	3.2	450	.06	2.50
BDAR 93	28	3.25	375	.150	5.75

* Less Filter. * Replacement for PE 94.
† Used, Excellent.
PE 94., Brand New 5.95
Navy type CAJO-211444. Input: 105 to 130 VDC. Output: either 26 VDC at 20 amps. or 13 VDC at 40 amps. Radio filtered and complete with line switch. New \$69.50

SPECIAL VALUES

10 CM. ANTENNA ASSY. (Airborne). 30" dish with conical dipole feed. Focal length is 10 1/2" Horiz polarization. 350 deg. azimuth. Tilt: plus and minus 20 deg. 28 vdc drive motor, seslin takeoff. \$65.00
CRYSTAL OVEN. B liley #TCO 2B. Loctal base, with provision for 2 crystals, 6.3V heater 75 deg. C. \$22.50
COAX. SWITCH. 4 pos. 52 ohms imp. Fitted with type C connectors. Useful up to 3,000 mc. \$7.50
APT-4 Jamming transmitter. Uses 5130 or 5131 magnetron. Power output: 130 watts, 350-760 mc. New complete with tubes. \$115.00
MD 30/APT-4. Modulator. For noise modulating of APT-4. Operates from 115 v, 400 cy. New. \$45.00
L & N RATIO BOX, #1553. Basic unit for capacitance, impedance, and conductance bridge. New, complete with instruction book. \$225.00
FILTER, Artificial Line: WECO D163169. 650 ohms imp. insertion loss: 5 db. \$32.50
Barré shock mounts: nos. 2045, C-2060, C-2070, C-2080. .45¢ ea.
Trihedral radar reflector, MK-1, aluminum. \$3.50
SPLICER, for 11/16 perforator tape. WECO #X-61859 list 20 SCS #4TW 61859-20. Complete set, with number type dispenser. \$8.50
MN 28V Control box, unit of MN 26 compass. New \$3.75
Noise filters, Mallory NFI-1, 100 amp/35vdc. \$1.00
Power supply unit, navy type—EL-2. Input: 115 vac, 60 cy. Output: 135 vdc/10 ma, 90 vdc/5ma; 3 vdc/360 ma. New, complete with spare parts box. To be used with model TBX radio gear. \$9.50
Coaxial switch, 12 position, with type "N" fittings. Type SA-14/SPR-1. \$17.50
Pulse analyzer, type APA-6. With 3 in. scope. \$235
BC 602 Control box for SCR 522 (pushbutton). \$3.75
24-Volt Transformer. Input 115/60 cy. Output 24 v/3A. \$1.79
Phase-shifter. Helmholtz type 0-360 deg. \$2.50
Capacitor, oil-filled, 0.25 mid./25,000 volts dc. \$15
Hydrophone, MODEL MI-2. A lattice of 3 crystals in a disk-like structure: 17-37 Kc. \$27.50
AN/CRW-2A Remote control receiver, for operating target planes, etc. New, with soundproof mounting box. \$34.50
TEL. REPEATER, EE 89, complete with tubes and tech. manual. \$17.50
TEL. REPEATER, EE 99, with 12 vdc. vibrator power supply (PE 201). \$49.50
F.T.&R. 101-A. Two-wire applique, contains equalizing devices, and balancing circuits. Used for adapting 2-wire military circuits to 4-wire systems. \$17.50

PULSE NETWORKS

H-616 10KV, 2.2 usec., 375 PPS, 50 ohms imp. \$27.50
H-615 10KV, 0.85 usec., 750 PPS, 50 ohms imp. \$27.50
KS8865 CHARGING CHDKE: 115-150 H @ .02A. 32 40H @ .08A. 21 KV Test. \$37.50
G.E. 25T5-1-350-50 P2T, "E", CKT, 1 Microsec. Pulse @ 350 PPS, 50 Ohms Impedance. \$69.50
KS823 CHARGING CHDKE: 16H @ 75 MA, 380 Ohms DCR, 9000 Vac Test. \$14.95
H-605: 25 KV, "E" CKT, 1.5 usec. 400 PPS, 50 Ohms Impedance, 5 sections. \$62.50

X BAND - 1" x 1/2" WAVEGUIDE

AT-68/UP 3 Cm Horn with type N feed for receiver measurements, etc. New. \$7.45
ROTARY JOINT (APS-6) Sperry PT #658275, 180 deg. rotation, choke to choke, "Built-in" Di-Coupler, 20 DB, with "N" Takeoff \$22.50
PARABOLOID DISH, 18" diam. Spun Aluminum, 8" Focus. For AN/APS 6. \$4.95
3 CM. DIPOLE and Feed Assembly. (May be used with above dish), 8 inches long. \$5.00
FLEXIBLE SECTION 9 in. long. Cover-to-Cover. \$5.50
ROTARY JOINT (APS-6) Sperry PT #658275, 180 deg. rotation, choke to choke. Has "Built-in" Di-Coupler, 20 DB, with "N" Takeoff. \$22.50
3 CM. DIPOLE FEED, 15" L for APS-15. \$14.50
MITRED ELBOW, cast aluminum, 1 1/4" x 3/4" W.G. W.E. Flanges, "E" Plane. \$33.50
3 CM. ANTENNA ASSEMBLY: Uses 17" paraboloid dish, operating from 24 vdc motor. Beam pattern: 5 deg. in both Azimuth and elevation. Sector Scan: over 160 deg. at 35 scans per minute. Elevation Scan: over 2 deg. TH. Over 24 deg. \$35.00
RG52/U Waveguide in 5' lengths, fitted with UG 39 flanges to UG40. Silver plated. . . . per length \$5.00
Rotating Joints supplied either with or without deck mountings. With UG10 flanges. . . . each \$17.50
Bulkhead Feed thru Assembly. . . . \$15.00
Pressure Gauge Section with 15 lb. gauge. . . . \$10.00
Directional Coupler, UG-40/U, Take off 20db. . . . \$17.50
MAGNET AND STABILIZER CAVITY For 2141 Magnetron. Fitted with magnetron well. \$24.50
90 degree elbows, "E" Plane 2 1/2" radius. \$8.50
ADAPTER, waveguide to type "N", UG 81-U, 7/8" TS-13, Etc. \$7.50
ADAPTER, UG-163/U round cover to special BTL, Flange for TS-45, etc. \$2.50 ea.



PULSE TRANSFORMERS

MAGNETRON PULSE TRANS. #964: Prim. imp. 30 ohms, 1600 v. pulse. Secondary imp. is 1250 ohms, 12 KV pulse. Turns ratio sec:pri is 7.5:1. Duty ratio is 0.001 at 1.2 usec. Bilhar winding 1.2A. \$8.50
#P37: Primary, 50 Ohms 750V, 001 Duty. Sec. 15KV, 1000 Ohms Impedance Bilhar 12.6V/2.5A. \$32.50
RAYTHEON WX 4298E: Primary 4KV, 1.0 USEC. SEC. 16KV-16 AMP DUTY RATIO: 001 400 CYCLE FIL. TRANS. "BUILT-IN" \$22.50
WECO: D-163247 For Modulator of SCR 720. \$22.50
GE #K-249A: Primary: 9.33 KV, 50 Ohms Imp. Secondary: 28 KV, 450 ohms. Pulse length: 1.05/5 usec @ 635/120 PPS. PK Power Out: 1.740 KW. Bilhar: 1.5 amps. GE #K-2748-A, 0.5 usec @ 2000 Pps. Pk. Pwr. out is 29 KV. Impedance 40:100 ohm output. Pri. volts 2.3 KV Pk. Sec. volts 11.5 KV Pk. Bilhar rated at 1.3 Amp. Fitted with magnetron well. \$24.50
K-2745 Primary: 3.1/2.8 KV, 50 ohms Z. Secondary: 14/12.6 KV, 1025 ohms Z. Pulse length: 0.25/1.0 usec @ 600/600 PPS. Pk. Power 200/150 KW. Bilhar: 1.3 Amp. Has "built-in" magnetron well. \$32.50
K-2461-A. Primary: 3.1/2.6 KV—50 ohms (line). Secondary 14/11.5 KV—1000 ohms Z. Pulse Length: 1 usec @ 600 PPS. Pk. Power Out: 200/130 KW. Bilhar 1.3 Amp. Fitted with magnetron well. \$29.50

COMMUNICATIONS EQUIPMENT CO.

MAIL ORDERS PROMPTLY FILLED. ALL PRICES F.O.B. NEW YORK CITY, N.Y. OR CHECK. ONLY SHIPPING SENT C.O.D. RATED CONCERNS SEND P. O. PARCELS IN EXCESS OF 20 POUNDS WILL BE SHIPPED VIA CHEAPEST TRUCK OR RAILEX.

343 Canal St., New York 13, N.Y. Dept. E-5 Chas. Rosen Phone: Canal 6-4882

NEW YORK'S RADIO TUBE EXCHANGE

NEW TUBES

Standard brands. First grade only. No pull outs. No rejects. No rebrands. At lowest prices.

Type	Price	Type	Price	Type	Price	Type	Price	Type	Price	Type	Price
OA2	\$1.00	3734	36.00	3GP1	5.00	12DP7A	45.00	36BAS	4.95	730A	22.50
OA3	1.10	2136	30.00	3J21	7.50	1M15	200.00	371B	1.50	750TL	45.00
OB2	.99	2139	8.95	4B2E	5.40	15E	1.75	385A	4.50	801A	.90
OB3	1.10	2139	8.59	4C27	10.00	15R	.75	393A	1.50	802	3.95
OC3	.96	2140	29.00	4C28	35.00	NE16	.59	393A	1.50	802	3.95
OD3	.89	2142	135.00	4E27	16.00	20.4	.75	394A	3.95	805	6.95
CIB	2.95	2149	80.00	4J25	50.00	KY21A	8.25	MX408U	.50	807	1.25
1B22	1.50	2150	55.00	4J26	50.00	RK21	2.50	417A	15.00	808	1.95
1B23	6.95	2155	150.00	4J27	50.00	RX21	8.00	434A	15.00	809	2.95
1B24	9.00	2156	110.00	4J28	50.00	KH24G	5.00	446A	1.95	810	10.50
1B26	1.75	2161	20.00	4J29	50.00	25T	2.95	446B	3.95	811A	3.75
1B27	15.00	2161A	25.00	4J30	30.00	35T	4.95	450TL	45.00	812A	5.95
1B38	35.00	2162	15.00	4J31	150.00	35TG	5.95	450TH	52.50	813	13.75
1B50	2.00	2K22	29.00	4J32	150.00	RK39	2.75	464A	7.50	814	3.75
1B51	7.50	2K23	15.00	4J33	150.00	HPS	1.75	471A	1.25	815	3.25
1B56	35.00	2K25	19.50	4J34	100.00	HR54	4.50	527	24.00	816	1.45
1B60	35.00	2K26	68.00	4J35	150.00	RK72	1.00	WL530	23.00	829	11.00
1N21	.55	2K28	35.00	4J36	150.00	RK73	1.00	WL531	22.50	829A	12.00
1N21A	.95	2K29	35.00	4J37	150.00	FG95	19.95	WL533	15.00	829B	12.50
1N21B	1.50	2K30	75.00	4J38	150.00	100TH	7.95	HK654	35.00	830B	2.00
1N21C	12.50	2K39	140.00	4J39	150.00	FG105	20.00	700A/D	10.00	832A	9.95
1N22	.66	2K41	135.00	4J40	150.00	122A	1.75	701A	4.50	833A	40.00
1N23	.90	2K42	180.00	4J41	150.00	203A	7.50	703A	3.95	834	7.50
1N23A	.90	2K43	190.00	4J42	190.00	211	.95	704A	1.95	836	3.95
1N23B	1.50	2K44	195.00	4J51	190.00	217C	12.00	705A	2.75	837	2.75
1N23C	7.50	2K45	80.00	4J52	225.00	242C	10.90	706AY	838	5.95	
1N25	4.50	2K48	95.00	4J53	225.00	244C	9.50	249C	4.25	707A	25.00
1N26	6.75	2K50	295.00	5HP1	3.95	249C	4.25	707B	6.57	849	35.00
1N27	3.50	2K54	35.00	5HP2A	12.00	250TH	19.95	707B	6.57	860	150.00
1N34A	.79	2K55	25.00	5HP4	3.95	250TL	19.95	714AY	36.00	861	25.00
1N38	1.00	2K56	72.00	5CP1	9.95	252A	3.00	715A	4.50	866A	25.00
1N43	2.25	3A1PA	10.00	5CP7	9.95	275B	1.00	715B	9.00	869B	67.50
1P25	75.00	3BP1	7.20	5CP7A	18.00	304TH	10.00	715C	15.00	869BX	50.00
2C39A	13.50	3BP2	5.50	5CP12	15.00	304TL	12.50	717A	1.50	872A	2.25
2C40	12.00	3B25	5.50	5D21	10.00	307A	2.50	719A	15.00	874	1.50
2C43	14.50	3B26	5.00	5J1P1	27.50	310A	4.50	720AY	878	1.50	
2C44	6.00	3B28	5.00	5J1P2	19.50	310B	6.75	GY	50.00	879	1.50
2C46	7.50	EL3C	5.50	5J1P4	25.00	312A	3.50	721B	7.50	885	1.50
2D29	.99	3C22	75.00	5J23	25.00	312A	3.50	724A	1.95	931A	5.00
21A	12.00	3C24	1.75	5LP11A	25.00	323A	15.00	723A/B	18.00	902P1	6.00
2322	9.00	3C31	2.95	5SP7	96.00	327A	3.75	724B	2.25	954	.35
2126	15.00	3D1P1	7.50	6C6A	11.00	325A	6.75	725A	18.00	955	.75
2127	15.00	3D1A	10.00	6C6B	7.50	350A	4.50	726A	45.00	956	.75
2131	24.00	3D1A	52.10	7HP7	5.00	350B	5.95	726B	45.00	958A	.60
2132	29.00	3EP1	5.00	7DP4	9.00	HK354C	15.00	726C	45.00		
2133	32.00	3E29	15.50	12AP4	50.00						

VARIOUS 5000 AND 6000 SERIES OF NEW PRODUCTION TUBES

Mfd	Volts	Price	Mfd	Volts	Price	Mfd	Volts	Price
.01	1500	.65	5	1500	.59	4	7500	24.95
.02	1500	.79	5	2000	1.19	4	2000	2.95
.012	25KV	12.95	5	2500	1.49	4	2500	4.95
.015	16KV	14.50	5	3000	2.39	4	3000	6.99
.02	5000	.79	5	5000	3.09	5	600	1.19
.02	8000	4.75	5	5000	6.25	5	1000	1.89
.02	10KV	5.25	5	2000	1.99	5	10KV	67.50
.02	20KV	13.95	2x.5	600	.69	5	1500	27.50
.025	50KV	22.95	2x.5	900V	9.25	2x.5	400	1.39
2x.025	50KV	34.50	2x.5	15KV	69.50	3x.5	400	1.29
.03	7500	.98	3	4KV	8.75	3	600	1.69
.03	16KV	8.50	5	4KV	8.75	6	600	1.69
.03	30KV	25.50	65	12.5KV	13.95	9	330AC	1.69
.04	17KV	14.95	1	500	.55	6	1000	2.30
.05	7500	2.95	1	1000	.69	7	1500	2.95
.05	20KV	12.95	1	1500	.99	7	110AC	.79
.05	25KV	16.50	1	2500	1.85	7	600	.98
.05-.05	12KV	9.95	1	2000	2.20	7	600	1.35
.1	1250	.29	1	5000	6.25	7	800	1.75
.1	1500	.39	1	6000	5.95	8	5000	29.95
.1	2000	.49	1	6000	7.50	8	110AC	.75
.1	2000	.89	1	7500	8.95	8	500	.99
.1	3000	.69	1	10KV	23.50	8	600	1.49
.1	3000	1.19	1	15KV	26.95	8	660AC	4.25
.1	5000	1.49	1	20KV	45.95	8	800	1.39
.1	4000	1.29	1	25KV	49.50	8	1000	2.78
.1	6000	2.25	1	25KV	65.00	8	1400	3.05
.1	7500	.85	1.5	15KV	49.50	8	1500	3.65
.1	7500	4.25	1.75	330AC	.69	8	2500	6.50
.1	10KV	6.35	2	600	.55	2x.8	600	1.89
.1	12KV	6.95	2	600	.65	10	600	.89
.1	50KV	42.50	2	1000	.65	10	600	2.25
2x.1	2000	3.50	2	1000TLA	1.25	10	1000	3.75
2x.1	7000	3.50	2	1500	1.15	10	1500	4.25
2x.1	6000	2.29	2	2000	2.80	10	2000	5.45
.15	65KV	73.50	2	2500	3.45	10	6000	59.50
.2	10KV	8.50	2	3000	4.25	12	660AC	3.75
.2	13KV	8.50	2	4000	7.50	14	66AC	3.95
.2	15KV	13.90	2	5000	12.50	15	330AC	3.50
.2	50KV	49.50	2	7500	21.95	15	400	1.29
3x.2	4000	2.85	2	10KV	35.95	15	330AC	4.84
.25	1500	.88	2	12.5KV	59.50	15	1500	5.40
.25	2000	.98	2	20KV	89.75	20	330AC	3.30
.25	3000	1.45	2	20KV	89.75	20	600	1.69
.25	4000	1.98	2x.2	600	.85	20	600	1.69
.25	6000	.85	3	1000	.98	25	350	1.69
.25	15KV	14.95	3	2000	2.50	25	500	3.99
.25	20KV	18.95	3	4000	8.50	28	1000	5.95
.25	25KV	40.50	3x.3	15KV	95.00	30	330AC	5.25
.25	32KV	49.00	3x.3	400	.68	30	2500	12.95
.25	35KV	55.00	1	600	.79	35	600	4.75
.25	50KV	62.95	4	600TLA	.98	50	330AC	6.50
.3	2000	.59	4	1000	1.89	80	220AC	6.50
.3	35KV	57.4	1500	2.65				

THOUSANDS OF OTHER TUBES

Special! TS45 X BAND GENERATOR—\$990

NEW UNUSED SURPLUS TS 259 K BAND
23400-24500 MEGACYCLES SIGNAL GENERATOR

SPECIAL! 5,000 V. POWER SUPPLY
For IP25 Infrared Image Converter from 3 V. Battery Source. **\$990**
NEW, Complete with RCA 1654 Tube.

NEW MICROWAVE TEST EQUIPMENT TS148/UP SPECTRUM ANALYZER

TS147D SIGNAL GENERATOR

Field Type X Band Spectrum Analyzer. Band 8430-9580 Megacycles.
Will Check Frequency and Operation of various X Band equipment such as Radar Magnetrons, Klystrons, TR Boxes. It will also measure pulse width, c-w spectrum width and Q or resonant cavities. Will also check frequency of signal generators in the X band. Can also be used as frequency modulated Signal Generator etc. Available new complete with all accessories, in carrying case.

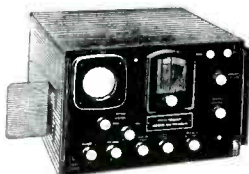

OTHER TEST EQUIPMENT USED CHECKED OUT SURPLUS

TSKI/SE	T35/AP	TS108	TS226	SURPLUS EQUIP. APA10 APA38 AP3 3 AP4 APR4 APR5A APT2-APTS
TS3A/AP	TS36/AP	TS110/AP	TS239A-TS239C	
RF4/AP	I-96A	TS125/AP	TS251	
TS12/AP	TS-45	TS126/AP	TS258	
TS13/AP	TS47/APR	TS147	TS270	
TS14/AP	TS69/AP	TS174/AP	TS418	
TS33/AP	TS100	TS175/AP	TF890/1	
TS34/AP	TS102A/AP	TS182	834	

SPECIAL RESONANCE CHAMBER

TYPE CA07-14 AAT including sweep motor crystal 1N23 with holder and output plug. New. **\$32.50**
Minimum Order 25 Dollars



Phone: ORegon 4-7070

LIBERTY ELECTRONICS, INC.

119 PRINCE ST.
NEW YORK 12, N. Y.
Cables: TELSERUP

WESTINGHOUSE AB De Ion 3 pole, 6 amp 250 V AC E frame. Original cartons. **\$5.00 ea.**
HEINEMANN 3XAM1510 3 pole, 5 amp 400 cycle 115 V AC curve 3. Original cartons. **7.00 ea.**
LEO SAGAL CO.
860 GLENMONT, L. A. 24, CALIF.

MUST HAVE FOR CURRENT ORDERS

PHONE COLLECT
BC-312 BC-314 BC-610
BC-342 BC-344 T-47/ART-13
R-5/ARN-7 ARC-3 ATC/ART-13
SEMLER INDUSTRIES INC.
Stanley 7-1554
6853 Lankershim Blvd., North Hollywood, Calif.

CONDENSERS

OVER 25,000 SOLD

10 mfd.—600 V \$.89

Three term. bot. mfg. channel type. Dims. 3 3/4" x 2 1/2" x 2". Two 5 mfd. sections rated 400V at 72 deg "C". 1800 V test. Meets commercial specs. for 600 V operation up to 10 deg "C". Ideal for filter or power factor application. Repeat sales prove its rugged high quality condenser to be of outstanding value. Carton of 24, weight 42 lbs. Large quantity avail.79

3x4 mfd.—600, 1000 & 2000 V —4 3/4x3 3/4x3 1/4 @ \$1.39

6 mfd.—600 V \$.72

Mfd	Volts	Price	Mfd	Volts	Price	Mfd	Volts	Price
.001	50KV	24.94	2x.25	2000	1.10	4	2000	2.95
.002	35KV	13.95	4	10KV	10.90	4	2500	4.95
.005	15KV	9.75	2x.4	7500	5.25	5		

ELECTRONIC

WAR TERMINATION INVENTORIES

WRITE OR WIRE FOR INFORMATION ON OUR COMPLETE LINE OF SURPLUS ELECTRONIC COMPONENTS. ALL PRICES NET F.O.B. PASADENA, CALIFORNIA

C&H SALES CO.

2176-E East Colorado St.
Pasadena 8, California
RYon 1-7393

INVERTERS

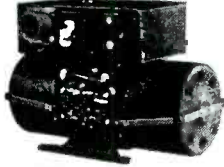

- 10042-1-A Bendix
DC Input 14 volts; output: 115 volts; 400 cycles. 1-phase; 50 watt **\$35.00**
- 12116-2-A Bendix
Output: 115 VAC; 400 cyc; single phase; 45 amp. Input: 24 VDC, 5 amps. **\$35.00**
- 12117 Bendix
Output: 26 volts; 400 cycles, 6 volt amperes, 1 phase. Input: 24 VDC; 1 amp. **\$15.00**
- 12121 Bendix
Input: 24 volt D.C. 18 amp. 12000 r.p.m. Output: 115 volts, 400 cycle, 3-phase, 250 volt amp, 7 pf. **\$49.50**
- 12123 Bendix
Output: 115 V; 3-phase; 400 cycle; amps .5 Input: 24 VDC; 12 amp. **\$49.50**
- 12126-2-A Bendix
Output: 26 volts; 3 phase; 400 cycle; 10 VA; .6 PF. Input: 27.5 volts DC: 1.25 amps. **\$24.50**
- 12130-3-B Bendix
Output: 125.5 VAC; 1.5 amps. 400 cycles single phase, 141 VA. Input: 20-30 VDC. 18-12 amps. Voltage and frequency regulated. **\$49.50**
- 12133 Bendix
Input: 26/29 volt D.C., 28 amps Output: 115 volt, 3 phase, 400 cycle, 250 volt amp., .8 pf. **\$59.00**
- 12143-2-A Bendix
Output: 115 volts; 400 cycles; 250 VA; single phase pf. 9-1. DC Input: 26-29 VDC; 25-22 amp; voltage & frequency regulated **\$49.50**
- 778 Bendix
Output: 115 volt, 400 cycle; 190 VA; single phase and 26 volt, 400 cycle, 60 VA, single phase. Input: 24 VDC. **\$37.50**
- 10285 Leland
Output: 115 volts AC; 750 VA, 3 phase, 400 cycle, .90 pf and 26 volts. 50 VA, single phase, 400 cycle, .40 pf. Input: 27.5 VDC, 60 amps. cont. duty, 6000 rpm. Voltage and frequency regulated. **\$59.50**
- 10339 Leland
Output: 115 volts; 190 VA; single phase; 400 cycle; .90 pf. and 26 volts; 60 VA; 400 cycle, .40 pf, Input: 27.5 volts DC, 18 amps cont. duty, voltage and freq. regulated. **\$49.50**
- 10486 Leland
Output: 115 VAC; 400 cycles; 3-phase; 175 VA; .80 pf. Input: 27.5 DC; 12.5 amps; cont. duty. **\$70.00**
- 10563 Leland
Output: 115 VAC; 400 cycle; 3-phase; 115 VA; 75 pf. Input: 28.5 VDC; 12 amps. **\$35.00**
- PE109 Leland
Output: 115 VAC, 400 cyc; single phase; 1.53 amp; 8000 rpm. Input: 13.5 VDC; 29 amp. **\$50.00**
- PE218 Leland
Output: 115 VAC; single phase pf 90; 380/500 cycle; 1500 VA. Input: 25-28 VDC; 92 amps; 8000 rpm; Exc. Volts 27.5 BRAND NEW. **\$30.00**
- MG149F Holtzer-Cabot
Output: 26 VAC @ 250 VA; 115 V. @ 500 VA; single phase; 400 cycle; Input: 24 VDC @ 36 amps. **\$40.00**
- MG153 Holtzer-Cabot
Input: 24 VDC; 52 amps. Output: 115 volts - 400 cycles, 3-phase, 750 VA. Voltage and frequency regulated. **\$95.00**
- DMF2506M Continental Electric
24-30 volts input; 5.5-45 amps; cont. duty. Output: 115 volts; .44 amps; 400 cyc; 1 phase; pf 1.0; 50 watts. **\$39.50**

Precision 10 Turn Potentiometer Mfg by Litton Industries



Model
#LMR-20-10
Resistance 10k
Linearity .02%
Calibration chart with each instrument Approx.—2" diam. X 2" long
Price \$25.00 ea.

SELSYNS-SYNCHROS



- 1CT Cont. Trans. 90/55V 60 cy. **\$37.50**
- 1DG Diff. Gen. 90/90V 60 cy. **37.50**
- 1F Syn. Mtr. 115/90V 60 cy. **37.50**
- 1G Gen. 115V 60 cy. **37.50**
- 1SF Syn. Mtr. 115/90V 400 cy. **12.50**
- 211F1 Gen. 115/57.5V 400 cy. **7.50**
- 211F3 Gen. 115/57.5V 400 cy. **10.00**
- 211FA1 Gen. 115/57.5V 400 cy. **7.50**
- 57.5/57.5V 400 cy. **5.00**
- 211H1 Diff. Gen. 57.5V 400 cy. **7.50**
- 215D1 Cont. Trans. 105/55V 60 cy. **17.50**
- 215F1 Cont. Trans. 105/55V 60 cy. **17.50**
- 215H1 Gen. 115/105V 60 cy. **17.50**
- 2115M1 Gen. 115/57.5V 400 cy. **17.50**
- 5CT Cont. Trans. 90/55V 60 cy. **34.50**
- 5D Diff. Mtr. 90/90V 60 cy. **34.50**
- 5DG Diff. Gen. 90/90V 60 cy. **34.50**
- 5F Syn. Mtr. 115/90VAC 60 cy. **42.50**
- 5G Syn. Gen. 115/90VAC 60 cy. **34.50**
- 5HCT Cont. Trans. 90/55V 60 cy. **42.50**
- 5SDG Diff. Gen. 90/90V 400 cy. **12.50**
- 6DG Diff. Gen. 90/90V 60 cy. **25.00**
- 6G Syn. Gen. 115/90VAC 60 cy. **34.50**
- 7G Syn. Gen. 115/90VAC 60 cy. **42.50**
- R110-2A Kearfott Cont. Mtr. 115V 400 cy. **17.50**
- R200-1-A Kearfott Cont. Trans. 26/11.8V 400 cy. **15.00**
- R210-1A Kearfott Trans. 26/11.8V 400 cy. **15.00**
- R235-1A Kearfott Resolver 26/11.8V 400 cy. **22.50**
- C56701 Type 11-4 Rep. 115V 60 cy. **20.00**
- C69405-2 Type 1-1 Transm. 115V 60 cy. **20.00**
- C69406 Syn. Transm. 115V 60 cy. **20.00**
- C69406-1 Type 11-2 Rep. 115V 60 cy. **20.00**
- C76166 Volt. Rec. 115V 60 cy. **10.00**
- C78248 Syn. Transm. 115V 60 cy. **12.50**
- C78249 Syn. Diff. 115V 60 cy. **5.00**
- C78863 Repeater 115V 60 cy. **7.50**
- C79331 Transm. Type 1-4 115V 60 cy. **20.00**
- 851 Bendix Autosyn Mtr. 32V 60 cy. **7.50**
- 403 Kollsman Autosyn Mtr. 32V 60 cy. **7.50**
- CK5 Bendix Mtr. 2 phase 26V 400 cy. **17.50**
- FPE-25-11 Diehl Servo Mfr. 75/115V 60 cy. **22.50**
- FPE-43-1 Resolver 400 cy. **25.00**
- FJE-43-9 Resolver 115V 400 cy. **25.00**
- 929-0411 Kollsman 26V 400 cy. **15.00**
- 1377-0410 Kollsman 26 V 400 cy. **10.00**
- 15158-0410 Kollsman 26V 400 cy. **20.00**
- 10047-2-A Bendix 26V 400 cy. **12.50**
- 2900 Transicoil 115 V 400 cy. **15.00**

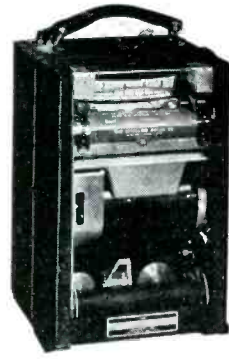

ESTERLINE ANGUS RECORDER

Model AW 0-1 MA

D C Milliammeter permanent magnet moving coil type. Spring clock dual speed drive (hour and minute). Instructions including connection diagrams and instrument data sheet with each instrument. Portable case **\$200.00**

PRECISION AUTOSYNS



Mfg. by ECLIPSE PIONEER

- AY200-4-B **\$12.50 ea.**
- AY201s-2-B **15.00 ea.**
- AY201-3-B **12.50 ea.**
- AY201s-4-B **15.00 ea.**
- AY202-2-B **15.00 ea.**
- AY202-4-B **15.00 ea.**
- AY221-3-B **12.50 ea.**
- AY231-3-B **9.50 ea.**

Centralab Rotary Power Switches

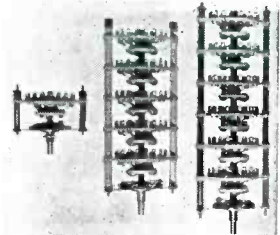

Stealite—750 watts at 115 VAC. Has positive, non-stall 20° indexing, double wiping solid silver contacts. (Mounting bushing 3/8"-32 thd)

- a) 1 deck, 17 positions, 3 pole **\$2.50**
- b) 5 deck, 17 positions, 3 pole **7.50**
- c) 6 deck, 17 positions, 3 pole **8.50**

SMALL DC MOTORS



- (approx. size overall 3/4" x 1 1/4" dia.)
- 5069600 Delco PM 27.5 VDC 250 rpm **\$12.50**
 - 5069230 Delco PM 27.5 VDC 145 rpm **15.00**
 - 5068750 Delco 27.5 VDC 160 rpm w/brake **6.50**
 - 5068571 Delco PM 27.5 VDC 10,000 rpm (1x1x2") **5.00**
 - 5069625 Delco 27.5 VDC 120 rpm w/governor **15.00**
 - MM A-11 Globe PM 24 VDC **7.58**
 - 5BA10AJ18 GE 24 VDC 110 rpm **10.00**
 - 5BA10AJ37 GE 27 VDC 250 rpm reversible **10.00**
 - 5BA10AJ52 27 VDC 145 rpm reversible **12.50**
 - 806069 Oster series reversible 1/50 h.p. 10,000 rpm 27.5 VDC 1 3/4" x 3 1/2" **5.00**
 - C-28P-1A 27 VDC 1/100 h.p. 7,000 rpm **3.00**
 - 7100-B PM Hansen 24 VDC, 160 rpm **7.50**
 - SSFD-6-1 Diehl PM 27.5 VDC 10,000 rpm **4.00**
 - 6-volt PM Mtr. mfgd. by Hansen 5,000 rpm 1 1/4" in dia. 2" long overall **4.00**

SEARCHLIGHT SECTION

**F M TRANSMITTERS
1 KW output at 27.75 Mc.**

Readily modifiable to other frequencies. Up to the minute design, including harmonic suppression, double cabinet shielding, AC and antenna line low-pass filtering, etc. Starts out with oven-controlled 6 Mc Osc. and phase modulator; two doubler stages to 27 Mc into 4E2T 1 P.A. into 2-450 P.H. push-pull P.A. running class "C" at 800 MA, 2000 volts D.C. Fully metered, lowered, start, stop, and automatic relay controlled. Brand new in original overseas packing cases. Transmitter Cabinet size 7x30x30 inches. Further details on request. Price \$985.00

HIGH POT TRANSFORMER

Westinghouse, P.R.I. 115. 60 cy. Sec. 15-000V C.T., @ .060A. C.T. ungrounded. Excellent for high-potting tests. Size OA 12 1/2 x 8 1/2 W x 9 1/2 D. Weight 67 lbs. Fully enclosed steel case. Price... \$29.50

RADAR ANTENNAS

SO-1 (10CM) assembly with reflector, waveguide nozzle and drive motor... \$279.50
 SO-3 (3CM) Surface Search type with reflector and drive motor, but less plumbing. New in original cases. \$149.50
 SO-13 (10 CM) Complete assembly with 2 1/2" dish, dipole, drive motor and gearing. New... \$39.50

**PLUG
IN
RELAYS**



Clare octal base 75 ohm coil. 115 V, 60 Cy. Makes two breaks one. New... \$1.95

SCR-522 EQUIPMENT

Complete BC-624 receivers and BC-625A Transmitters including mounting racks, plugs, connectors, dynamotor. Brand new equipment with instruction manuals. New. Price... \$149.50

1000 Kc. CRYSTALS

TYPE DC-9-AJ. Octal base plug-in type in metal tube holder. As used in BC-221 freq. meter. New. Price... \$8.95
 TYPE CR-28(A). 200 Kc. mounted crystals. New. Price... \$1.65

HIGH-VOLT OIL CAPACITORS

Mfd.	KV	Price	SPECIAL	Mfd.	KV	Price
.001	50	\$22.95	1 MFD. 7500 Volt Pyranol Filled \$695	.25	20	\$15.95
.002	20	9.75		.25	50	54.50
.025	50	17.95		.25	25	39.50
.025/.025	50	24.50		1.	7.5	6.95
.1	4.5	3.50		1.	15	29.50
.135	7.5	6.95		1.	25	49.50
.25	15	9.95		2.	5.5	9.50



BARGAINS IN TEST EQUIPMENT

FLUXMETER. Measures field strength of magnets from 500 to 4000 gauss. Indicates polarity. Probe gap 1 1/2". British handcraft in fine hardwood case with hinged cover. Operating instructions on underside of cover. Size 12-3/4 x 9 x 6 in. A lab instrument. Also ideal for classroom magnetics instruction. Price... \$14.95

FREQUENCY METER 375 to 725 Mc. Model TS-127/U. Compact. Self-contained, precision (± 1 Mc). Sturdily constructed III-"Q" resonator has average "Q" of 3000. Uses 957, 186 and 384 tubes. Requires standard 1 1/2 V "A" and 45V "B" battery, not supplied. Brand new with instruction book, probe and spare set of tubes. Price... \$27.50

TEST OSCILLATOR TS-17/APR. 40-2000+ Mc. Fundamental coverage 40-500 Mc in two ranges. Harmonics above 2000 Mc. Provides a calibrated (dial accuracy ± 0.7 per cent) I.F. source for testing receiving equipment. Output 3MV or more up to 400 Mc. less on harmonics. C.W., mod. pulse or sine wave output. Operates on 115/230 60 Cy. or batteries. Part of APR countermeasures equipment. New with handbook of Maintenance Instructions. Price... \$149.50

300-1600 Mc TRANSMITTER TB5/AP75. Nominal output 10 to 30 watts. Tunable cavity provides range from 300-1600 Mc. Filament transformer operates from 115 V 60 Cy. Uses 8 tubes: 1-931A, 2-6AC7, 2-6AG7, 1-6L6G, 2-890B, 1-6X2 (oscillator). New. Price with 400 cy power supply, plugs, ant. etc. \$169.50

INSULATION RESISTANCE TEST SET. Leeds & Northrup portable type. Mfgd. for U.S. Coast Guard Spec. S-408. Consists of sheet brass covered carrying case 17 x 8 x 14 in. containing telescope, piston galvanometer, clamp and scale reading device, multiplier shunts, calibrating resistor, cables, etc. New and unused with inst. Special... \$7.50

LORAN

APN-9. Complete set consisting of R-65/AFN-9 Receiver, PE-206 Inverter, Antenna Coupler, Mounting and Connectors. New. Price... \$285.00
 APN-4. Complete set consisting of ID-6/APN4 Indicator, R-9B/APN-4 Receiver, PE-206 Inverter and set of connectors. New. Price... \$125.00

MODULATION TRANSF.

For RCA. Type 250-K Broadcast Transmitter (311-7242) P to P Primary Imp. 35,000 ohms. Secondary Load 5,050 ohms. Size 1 1/4 x 9 1/2 x 13". Wt. 143 lbs. New... \$29.50

PARABOLOIDS

46 in. dia. paraboloid. F/D = 0.25. Perforated for low windage. Constructed of steel and aluminum for strength and low weight. Price... \$29.50
 Spun Magnesium Dishes 17 1/2 in. x 4 in. deep. Per pair... \$12.50

MOTOR-GENERATORS

120dc to 120/60/1 @ 2.5kva... \$285
 115dc to 120/50/1 @ 2.0kva... \$185
 115dc to 120/60/1 @ 1.8kva... \$235
 230dc to 120/60/1 @ 1.25kva... \$155

AMPLIDYNES

5 AM21J7. Input 27 VDC @ 15 A. Output 60 VDC @ 2.5A 4600 RPM. New... \$34.50
 5AM31NJ9A. Input 27 VDC @ 42 A. Output 60 VDC @ 8.8 A., 7500 RPM. New... \$23.50

INVERTERS

Leland Elec. Co., PE206A. Input: 28DC at 28 Amperes. Output, 80V, 800 cy, 1 Ph., 485VA. New... \$22.50
 G.E. J8169172. Input: 28DC. Output: 115. 400 cy., 1 Ph., 1.5KVA. New \$32.50
 G.E. 5AS131551A. Model 218J. Input: 28 DC. Output: 115. 400 cy., 1 Ph., 1.5 KVA. Regulated. New... \$89.50
 G.E. 5D21M3A. Input 27 V. D.C. Output 110V., 400 Cy., 1 Ph., 485 VA. New... \$29.50
 Type PU-7/AP. 2500 VA. Input 28 V. D.C. Output 115 V., 400 Cy., 1 Ph. D.C. Output 115 V., 400 Cy., 1 Ph. New... \$49.50

DYNAMOTORS

Navy type CAJ0-2144. Input: 105 to 130 VDC. Output: either 26 VDC at 20 amps. or 13 VDC at 40 amps. Radio filtered and complete with line switch. New... \$89.50

SMALL DC MOTORS

G.E. 5BA50LJ2A. Armature 60 VDC at 8.3 Amperes. Field 27.5 VDC at 2.3A RPM 4000. H.P. 0.5. New... \$27.50

9 CONDUCTOR CABLE

Army spec. CG-215 Weatherproof 9 Cond. No. 20 AWG stranded tinned copper, plastic ins., color coded, double vinyl jackets with tinned copper braid between. Dia. 9/16" made by G.E. Available 1000, 1500, 2000 ft. reels. Price \$ 5.10 ft. Sample 100 ft. Coil... \$10.00

INDICATOR

ID-14/APN-1. 0-4000 ft. Basic range 6.5 ma. Good experimental item. New meters 3 for \$5.00

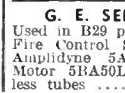

G. E. SERVO AMPLIFIERS

Used in B29 planes for Central Station Fire Control Systems. Used to drive Amplidyne 5AM31NJ9A and Control Motor 5BA50LJ2A listed above. New less tubes... \$29.50

PHONE: DEERFIELD 7-0044

ELECTRONICRAFT INC.

Cable Address: Electcraft, N.Y.

27 MILBURN ST. BRONXVILLE 8, N. Y.

115 V. 60 CYCLE BLOWERS:

- At Left: 115 VAC 60 Cycle SINGLE TYPE—100 CFM—2-3/4" intake; 2" outlet. Complete size: 5" x 6" — \$8.95
- 115 VAC 60 Cycle DUAL TYPE—100 CFM—4" intake; 2" Dis. Each Side. Complete size: 8" x 6" — \$13.95
- 115 VAC 60 cycle COMPACT TYPE—108 CFM; Motor built inside squirrel cage; 4-1/2" intake; 3-3/4" x 8" Dis. Complete size: 4-1/2" W x 8-3/4" H x 8-1/8" D—No. 2C067. — \$14.95
- 115 VAC 60 cycle FLANGE TYPE—140 CFM; 3-1/2" intake; 2-1/2" Dis. Complete size: 7-1/2" W x 7-1/4" H x 6-3/4" D—No. 1C807. — \$13.95
- 115 VAC 60 cycle FLANGE TWIN—275 CFM; 4-1/2" intake; 3-3/4" x 3" Dis. Complete size: 11-3/4" W x 2-3/8" H x 8-1/16" D—No. 2C069 — \$21.95
- 115 VAC 60 Cycle BLOWER—200 CFM; 3" intake; 3" x 5" outlet. Overall size: 8" x 7" x 6". Iodine Motor N81-33. Removed from New Equipment #BOD-200 — \$14.95
- 115-VAC 60 Cycle BLOWER—100 CFM; 3-3/4" intake; 2" outlet; Rd. Flange with Flap Director. Overall size with bracket: 8" L x 6-1/2" W x 7" H. Removed from New Equipment. Diehl Motor PB-2106-6 No. FDBL-2106. Same as above, but with 12-Curved Director. No. CDBL-2106. — \$7.95

OTHER BLOWERS:

- 12/24 VDC—AC CAST ALUMINUM BLOWER 100 CFM—3" intake; 2" outlet. Shunt Motor 4" x 2" 5000 RPM @ 24 VDC. — \$5.95
- 6 VDC SINGLE—100 CFM—No. 6100. USED: \$4.95
- 24 VDC DUAL—20 CFM—Min—No. 2420. — \$7.95
- 10 CFM BLOWER—27.5 VDC; 1/100 HP; 7000 RPM; Oser Motor C2BP-1A; L-R Mfg. Co. Bakelite Blower #2. Overall Size: 3 1/2" x 4 1/2". Price... \$5.95
- Same as Above, 12 VDC operation — \$5.95
- 115 V. 400 CYCLE—10 CFM—Eastern Air Dies Motor J31A—7200 RPM; 1/100 HP; L-R #2 Blower Assy. Overall Size: 4-1/2" x 3-1/2". No. 3110... \$5.95
- 10 CFM BLOWER—28 VDC .6 A; 5000 RPM. Pioneer Motor SS-2345. Aluminum Blower Housing—Overall Size: 4 1/2" x 3-1/4". Price... \$5.95

NEW LIST: Write today for FREE New Listing of many, many items!

**RECEIVER—TRANSMITTER
FM 20 — 28 MC**

BC-603 RECEIVER: 20-28 MC variable tuning. 10 Pre-Set push button channels, squelch circuit, 4" speaker; 10 Tubes: 2/12SG7, 2/6SL7, 1/6V6, 1/6J5, 3/6AC7, & 1/6H6. Price... USED: \$29.95
 PLUG for rear of Receiver... \$1.00
 DYNAMOTOR: 12 V input; Output 220 V, 80 MA. #DM-34. NEW: \$4.95. Re-ISSUE: \$2.95
 BC-604 TRANSMITTER: 20-28 MC, 30 Watt; companion to BC-603 Receiver. Crystal control. 10 Pre-Set channels, interphone communication; 8 Tubes: 7/1619 & 1/1624. USED: \$18.95
 PLUG for rear of Transmitter... \$1.00
 DYNAMOTOR: 12 V input; Output 625 VDC 225 MA. #DM-35. NEW: \$12.95. Re-ISSUE: \$8.95
 FT-237 BASE for mounting Receiver & Transmitter (No plugs required) USED: \$9.95

BC-500 RECEIVER—TRANSMITTER: FM Crystal Control on 5 channels. 100 KC separation 20-28 MC. Transmitter: 25 Watt output, 7 Tubes: 1/625, 1/12A6, 3/12S17, & 2/12SA7. Receiver: 11 Tubes: 1/12SL7, 2/12A6, 3/12SA7, 3/12H6, 2/12K8, & 1/12K7. Dynamotor Supply. Receiver 28 VDC 1.2 A input; output 250 VDC 60 MA. Transmitter 28 VDC 4.1 A input; output 550 V 120 MA. Control Panel: For Local Control & outlets for Remote also. Heavy duty 5" speaker. Size: 12" x 25" x 9 1/2". With Schematic and Conversion. Weight: \$59.50
 65 lbs. Price... NEW: \$59.50

TELEPHONE EQUIPMENT

EE-8 Field Telephone—Ideal for private telephone system for two or more phones, up to 17 miles, hand ring generator with handset, carrying case, uses two flashlight batteries... Used. Checked: \$14.95
 New Equipment, Used Cases: \$18.95

RM-13 Remote Control Unit for telephone & radio equipment. Telephone unit same as EE-8; Radio remote, pre-amplifier, 115 V 60 cycle with input & output jacks. DB Motor, one tube amplifier with TS-9 handset... USED: \$19.95 — NEW: \$24.95

SOUND POWERED HEAD & CHEST SETS
 Used, Checked: \$3.95
 TS-9 HANDSETS... NEW: \$6.95 — USED: \$3.95
 TS-13 HANDSETS w/PL-55 & PL-68... USED: \$5.95

INVERTERS & GENERATORS:

GENERATOR—115 V. 400 Cycle, 1400 Watt, Single Phase, 28.5 VDC 400 Watt... USED: \$89.50
 GENERATOR: Motor 3 HP, 115/230 60 cycle single phase Generator 115 Volt, 400 cycle single phase 1400 Watt & 28.5 VDC 400 Watt, Belt Drive. Reconditioned... \$95.00

DO YOU NEED?

- ★ Test Sets
- ★ Airborne Electronics
- ★ Radar
- ★ Navigation Aids
- ★ Parts—Meters—Tubes

WHAT ARE YOUR NEEDS?

Write—wire—or phone. Immediate reply assured.

VARIABLE VOLTAGE

AMERTRAM TRANSTAT. 11.5 KVA. Input 115 V., 60 cycles. Output continuously variable 0 to 115 V., up to 100 amperes. Easily re-connected for input of 230 V., with output of 0-230 V, 50 amperes. Brand new. Special... \$99.50

GERMANIUM DIODES

SUPER SPECIAL!

1N70, Jan, New and Clean!

8 for \$2.98

Stock up while they last! Extremely high (100) Inverse volts. So only 8 are needed to make a full-wave 115 V. bridge (2 in series in each leg, with high safety factor. Instead of the usual 3 per leg.) 30 ma average. Also, greatly reduced reverse current: only 300 uA at -50 V! Normally, a very high priced unit, so this is a terrific buy! Next price break is: 1,000 for \$325.00.

ARROW SALES, INC.

P. O. Box 3007-E

North Hollywood, Cal.

Phones: Stanley 7-0406 POpolar 5-1810
 Telegraph Address: WUX, No. Hollywood
 Cable Address: ARROWSALES,
 North Hollywood

FAIR RADIO SALES • 132 SOUTH MAIN ST LIMA, OHIO

SAVE ON TUBES BRAND NEW TUBES GUARANTEED TUBES

OA2 .75	2J48 .35.00	5CP1A .8.00	WL-218 .15.00	WE-404A .10.00	805 .6.00	5556/PJ-8 .10.00
OA3 .90	2J49 .40.00	5CP7A .8.00	RX-233A .75	GL-414 .99.50	806 .4.00	5559/FG57 .10.00
OB2 .65	2J50 .35.00	5CP11A .9.50	FG-235A .25.00	WE-416B .45.00	807 .1.20	5586 .125.00
OB3/VR90 .85	2J55 .35.00	5C22 .27.50	QK-249 .150.00	417A .2.75	807W .3.00	5591/403B .2.75
OC3/VR105 .65	2J56 .50.00	5C30/C5B .1.00	WE-249B .2.50	WE-417A .10.00	808 .1.25	5611 .65.00
OD3/VR150 .65	2J61 .15.00	5JP2 .7.00	WE-249C .3.00	WE-423A .8.50	809 .2.25	5634 .7.00
ELC1B .1.50	2J62 .6.50	5JP4 .7.00	250-R .4.00	446B .2.00	810 .10.00	5636 .4.00
1AD4 .1.25	2K22 .14.50	5JP5 .7.00	250-TL .14.50	WL-456 .59.50	813 .10.00	5639 .8.00
1B22 .1.30	2K23 .14.50	5JP11A .9.50	WE-251A .39.50	464A .2.25	814 .1.35	5647 .5.00
1B23 .2.75	2K25 .11.00	5MP1 .3.95	WE-252A .7.95	527 .22.50	815 .1.50	5651 .1.40
1B24 .5.50	2K26 .45.00	5NP1 .5.00	WE-254A .3.75	ML-531 .4.00	826 .75	5654 .1.25
1B24A .12.50	2K28 .25.00	5R4GY .90	FG-258A .90.00	KU-610 .3.50	829 .5.00	5656 .7.00
1B26 .1.25	2K33 .60.00	5R4WGY .2.75	FP-265 .20.00	KU-627 .10.00	829B .8.50	5657 .125.00
1B27 .10.00	2K33A .60.00	C6J .6.50	FG-271 .25.00	KU-628 .10.00	830B .50	5663 .1.50
1B32 .1.00	2K33B .110.00	6AK5W .1.00	271A .10.00	648P1 .5.00	832 .3.50	5667 .125.00
1B35 .4.50	2K34 .85.00	6AN5 .2.00	WE-274B .1.00	WL-652 .20.00	832A .5.00	5670 .1.50
1B36 .4.00	2K35 .175.00	6AR6 .1.25	WE-282A .5.00	HK-654 .25.00	834 .7.00	5687 .3.00
1B40 .2.00	2K39 .100.00	6AS6 .1.25	WE-282B .6.00	681/686 .25.00	836 .1.50	5691 .4.75
1B42 .4.00	2K41 .100.00	6BM6 .25.00	WE-285A .5.00	WE-701A .1.85	838 .70	5702 .1.75
1B47 .6.50	2K42 .125.00	6F4 .3.25	287-A .2.50	702A .50	842 .1.50	5702WA .6.00
1B51 .6.75	2K43 .110.00	6J4 .1.95	HF-300 .15.00	WE-703A .1.25	845 .4.00	5703 .1.10
1B62 .4.00	2K45 .40.00	6J4WA .3.50	WE-300B .5.00	WE-705A .75	849 .17.50	5718 .3.00
1B63A .22.00	2K46 .200.00	6K4 .2.25	GB-302 .5.00	706AY-GY .10.00	851 .9.50	5719 .2.50
1N21 .60	2K47 .110.00	6Q5G .3.25	304TH .8.00	707A .2.50	852 .4.00	RK-5721 .150.00
1N23B .1.50	2K48 .75.00	6L6WGB .2.75			858 .Q	5725 .1.50
1N23BM .3.50	2K50 .200.00	6SK7W .2.00			861 .15.00	5726 .60
1N23C .2.50	2K54 .7.00	6SN7W .2.00			865 .90	5727 .1.30
1N25 .3.00	2K56 .50.00	6SU7GT .2.75			872A .1.35	5744 .1.90
1N26 .3.75	2X2A .1.00	6X4W .1.00			884 .1.00	5750 .3.10
1N28 .5.00	3AP1 .2.95	6X5WGT .1.30			GL-889 .35.00	5763 .1.30
1N31 .3.00	3BP1 .2.00	FG-17 .2.95			GL-889A .50.00	5778 .3.00
1N34A .50	3B24 .1.00	RX-21 .4.00			889RA .75.00	5787 .4.95
1N38A .65	3B24W .5.00	7C22 .50.00			902A .3.00	5814 .80
1N42 .8.00	3B26 .2.50	7C24 .90.00			902P1 .2.00	5814WA .3.50
1N52 .65	3B28 .5.00	HK-24 .3.00			905 .2.00	5819 .29.50
1N63 .1.75	3B29 .5.50	RK-28A .2.50			917 .2.00	5825 .7.95
1N69 .40	3C22 .60.00	HK-54 .2.00			919 .2.00	5829 .1.40
1P21 .30.00	3C23 .5.00	D-42 .40.00			927 .1.00	5829WA .8.00
1P22 .6.50	3C27 .1.00	QK59 .25.00			931A .2.50	5837 .70.00
1P28 .9.00	3C31 .1.50	QK-60 .25.00			935 .4.00	5840 .4.50
1W5 .1.00	3C33 .8.00	RK-60/1641 .1.35			954 .35	5844 .2.00
1Z2 .1.75	3C45 .7.00	RK-61 .2.50			955 .35	5851 .4.00
2AP1 .4.00	3DP152 .5.00	QK-62 .20.00			956 .35	5851 .4.00
2C33 .75	3DP11A .6.00	HY-65 .1.00			957 .35	5876 .11.50
2C35 .2.50	3D21A .3.00	RK-65/5D23 .7.50			958A .35	5889 .18.00
2C36 .30.00	3E29 .8.50	FG-67 .12.00			959 .1.25	5896 .5.00
2C39 .4.95	3FP7A .2.50	HY69 .3.00			991 .35	5899 .5.00
2C39A .10.00	3J30 .35.00	RKR-72 .50			CK-1005 .35	5901 .6.50
2C42 .10.00	3K22 .150.00	RKR-73 .50			CK-1006 .3.50	5905 .8.95
2C43 .9.00	3K30 .100.00	ML-100 .50.00			CK-1007 .55	5908 .7.95
2C44 .50	4B23 .5.00	100TH .6.50			1603 .3.00	5932 .4.00
2C46 .6.00	4B31 .22.00	FG-105 .11.00			1620 .3.25	5933/807W .4.00
2C51 .2.75	4C27 .5.00	F-123A .2.95			1923 .1.75	6005 .1.75
2C52 .3.00	4C28 .25.00	F-124A .Q			1624 .1.00	6021 .4.50
2C53 .10.50	4C35 .17.50	F-128A .7.00			1625 .30	6044 .30.00
2D21 .60	4E27 .8.75	FG-154 .15.00			1926 .25	6045 .Q
2D21W .1.25	4J22 .35.00	VT158 .9.75			1636 .75	6046 .75
2E26 .3.25	4J29 .35.00	FG-166 .8.75			1641 .1.35	CK-6050 .2.00
2E27 .60	4J31 .65.00	FG-172 .20.00			1642 .50	6096 .1.50
2E32 .1.00	4J34 .50.00	HF-200 .10.00			1945 .65.00	6100/6C4WA .2.25
2J31 .15.00	4J42 .25.00	QK-181 .15.00			2000T .150.00	6111 .6.50
2J32 .12.50	4J50 .99.50	WL-200 .75.00			2050 .90	6147 .3.00
2J33 .14.50	4J52 .50.00	204A .25.00			2051 .65	6177 .49.50
2J34 .14.50	4X150A .22.50	207 .25.00			ZB-3200 .69.50	6211 .1.50
2J36 .15.00	4X500A .55.00	211/VT4C .50			5517 .1.75	6246 .Q
2J42 .60.00	5BP2A .5.00	212E .15.00			5551/FG271 .25.00	6764 .Q
					5553 .90.00	8005 .4.95
					FG258A .90.00	8012A .1.00
						8025A .2.00
						9001 .85
						9002 .55
						9004 .85
						9005 .1.50

SPECIAL!
5" DUAL GUN TUBE
 Long persistency face, P7 screen. Value at \$200.00. This tube has been rejected for military use.
 Tested Before Shipped & Fully Guaranteed. Only **\$17.95**

VACUUM CAPACITORS
 6 mmfd. 30 KV. 9.00
 50 mmfd. 32 KV. 9.00
 75 mmfd. 20 KV. 12.50
 Also Other Values!

THIS IS ONLY A PARTIAL INVENTORY.

CHECK WITH US FOR YOUR REQUIREMENTS

Thousands of other types in stock. Send us your requirements. RECEIVING TUBES! We Carry a complete line in stock. Standard brands only.

Jsh
 SALES CO.
ELECTRONICS
 Dept. E-A
 1108 Venice Blvd
 Los Angeles 15
 California

All prices F.O.B. Los Angeles, subject to change without notice. Minimum order \$5.00. Check with us for items not listed.

TUBES • ALL FAMOUS ADVERTISED BRANDS ONLY • TUBES

RMA GUARANTEE — From 10% to 95% Below Manufacturers Price — Look and Compare

Special Prices to Quantity Buyers. Most of Our Tubes are Jan.—95% are Original boxed — Brands such as R.C.A., G.E., Ken-Rad, Sylvania, Tung-Sol and Raytheon.

Type	Price	Type	Price	Type	Price	Type	Price	Type	Price	Type	Price	Type	Price	Type	Price	Type	Price
AB-150	\$1.99	OB2	.89	2K54	8.95	5CP1A	12.49	26C6	1.19	304TL	12.00	707B	3.95	830B	2.99	1626	.29
C3J	6.35	1B22	1.69	2K55	9.50	5CP7	9.99	28D7	.89	307A	1.85	832A	2.99	832A	7.49	1630	.79
CG-5	7.39	1B24	5.99	2V3/G	1.39	5CP11A	14.99	28P7	6.25	310A	3.99	709A	1.69	836	31.99	1632	.59
CRP RK-72	.49	1P30	1.39	2V3/G	1.39	5D21	6.99	9L7	5.00	316A	.69	714	1.99	836	1.99	1641	1.88
E1-1C	5.49	2A4/G	1.10	3A5	.89	5F7	2.49	10Y	1.59	327A	3.35	714AY	24.95	838	1.99	1642	.39
EC1	1.39	2AP1	3.39	3AP1	5.95	5HP4	2.49	18C	.29	329A	4.69	715A	2.63	841	.59	1806P1	4.99
EF-50	.30	2BP1	5.99	3B24W	4.99	5JP4	14.99	35T	4.99	347A	3.88	715B	2.99	845	.49	2050	.95
EIM-48	.29	2BP11	7.99	3B25	3.99	5J33	7.99	35T	7.25	350B	2.99	715C	14.50	845	6.49	2050W	2.40
EM-3GA	39.50	2C21	1.39	3B28	4.69	5LP1	13.99	35T	2.25	356B	7.45	717A	.49	851	16.50	2051	.76
F123A	5.99	2C22	.39	3B28	3.99	5NP1	6.99	35T	4.95	358A	1.49	719A	14.65	860	3.49	2051	1.33
F128A	19.00	2C26A	.39	3B28	4.69	6C21	19.95	100TH	4.95	393A	4.35	720C/Y/DY	29.75	864	.69	2052	1.40
FG-105	12.99	2C33	.79	3B28	4.69	6AC7	6.49	203A	5.99	394A	2.99	EY	29.75	864	.69	2052	3.25
FG-154	14.99	2C39	4.99	3BP1	2.99	6AC7W	1.50	205B	5.99	GL-434A	6.66	EY	29.75	864	.69	2052	2.20
HF-100	7.49	2C39A	11.50	3C21	1.29	6AG7	.79	205D	3.99			721A	1.49	866A	1.19	2052	1.79
HK-24	3.99	2C40	10.99	3C22	64.95							721B	8.45	868	30.00	2052	2.69
HK-54	3.99	2C41	9.75	3C23	64.95							722	1.99	872A	2.49	2052	1.49
HK-114B	.69	2C43	10.99	3C24	1.50							723A/B	8.99	872A	1.29	2052	3.10
KU-610	1.70	2C44	1.35	3C33	8.99							724B	1.45	872A	1.25	2052	1.00
REL-21	1.00	2C46	7.49	3C45	6.25							725A	3.99	878	.90	2052	.91
RK-34	.39	2C53	9.50	3CP1	2.25							726A	9.50	884	1.00	2052	2.10
												726B	25.00	885	1.10	2052	1.25

CRYSTAL DIODES	Type	Price	Type	Price
	1N21	.19	1N23B	1.10
	1N21A	.55	1N26	3.55
	1N21B	.59	1N27	.61
	1N23A	.49	1N34	.64
	1N23A	.49	1N34A	.61

LARGEST SURPLUS DEALER IN USA

RK-59	1.88	2D21	.69	3D23	4.99	6AJ5	1.19	207	49.50	446A	1.49	726C	24.50	9-3	.69	5814	1.39
RK-60	1.99	3D21W	1.39	3DP1	1.88	6AK5	.54	211	3.72	446B	1.79	730A	7.95	902P1	.69	5851	3.25
RK-61	3.50	2J21	2.99	3EP1	1.88	6AN5	2.12	217A	2.99	WL-460	8.99	800	1.29	927	1.45	5933	2.95
RK-65/5D23	14.99	2J22	4.99	3GP1	3.95	6AR6	1.49	217C	4.99	WL-464A	4.95	801A	8.45	931A	2.99	5963	1.15
RK-73	.69	2J27	5.99	3J21	49.95	6AS6	1.19	221A	3.99	CM-508AX	1.10	802	2.89	932	1.39	5964	.74
RX-233A	.69	2J30	14.50	4-65A	19.00	6AS7/G	2.49	233A	1.19	CM-521AX	1.10	803	2.69	955	.29	5977	3.89
VT-25/10	.49	2J31	14.50	4-125A	26.50	6B16W	39.50	242C	8.00	527	14.50	804	9.99	956	.29	6080	2.99
VT-25/10	.49	2J32	13.50	4A-11	4.99	6C4	3.99	249C	3.99	WL-530	19.50	805	3.55	956	.29	6080W	3.90
VT-25A/10Y	.39	2J33	13.50	4AP12	6.49	6D4	2.99	249C	3.99	WL-531	6.25	807	1.25	958A	1.39	6080W	3.90
VT-67/30 Spec	.26	2J34	13.50	4B22	4.49	6F4	2.99	250TH	24.95	532A	.39	807W	3.25	959	.49	6080W	3.90
VT-158	17.50	2J36	14.00	4B25	7.55	6J4	2.50	260R	4.99	700A/B/C/D		809	1.99	959	.39	6080W	3.90
VU-111	.19	2J39	11.00	4B36	4.69	6J4W	3.75	258B	4.49	701A	10.99	809	3.15	CK1005	.46	8012	1.85
1832/532A	.99	2J49	39.50	4C27	35.95	6K4	3.99	259A	5.99	702A	2.25	810	9.95	CK1006	1.97	8013	2.50
QK-59	29.50	2J62	9.60	4C35	12.95	6K4W	1.49	274A	5.95	702A	1.90	811	3.19	1500T	94.50	8013A	3.49
QK-61	32.00	2K22	14.50	4E27	9.95	6LW	1.49	274A	5.95	702A	2.25	913	11.49	1608	2.99	8020	2.99
QK-165	99.00	2K23	14.50	5AP1	3.95	12A77	.85	274B	1.79	703A	1.90	914	2.49	1613	1.49	8025	1.99
VR-78	.89	2K25	18.99	5BP1	8.99	12A77	.85	282A	6.49	705A	1.25	816	1.05	1616	.59	9001	.79
VR-90	.89	2K28	28.50	5BP1A	8.99	12A77	.85	282A	6.49	706A	6.75	826	.75	5703	1.19	9002	.69
VR-105	.79	2K33A	59.95	5C22	25.00	15R	.39	287A	6.61	706C	17.50	876	1.99	5725	1.99	9004	.19
VR-150	.79	2K41	72.50	5CP1	3.99	26A7/GT	2.99	304TH	10.00	707A	3.55	829B	8.99	1619	.29	9006	.19

COAX CONNECTORS

	PL259A 28¢		SO239 24¢		M359A 15¢
	831SPN		831R		831AD

All boxed and fully guaranteed. Special quantity discount—10% on 100 or more of same type. Minimum order \$10.00. Thousands of other types in stock. . . . Send us your requirements. F.O.B. New York 25% deposit with order or if paid in advance save C.O.D. charges. Rated firms net 10 days. Prices subject to change without notice. For fast service ask for Sy.

FAY-BILL DISTRIBUTING CO. DEPT. E1
418 Broome St., N. Y. 13, N. Y.
Telephone CA-nal 6-8404

AN/APR-4 LABORATORY RECEIVERS
Complete with all five Tuning Units, covering the range 38 to 4,000 Mc; wideband discone and other antennas, wavetraps, mobile accessories, 100 page technical manual, etc. Versatile, accurate, compact—the aristocrat of lab receivers in this range. Write for data sheet and quotations.
We have a large variety of other hard-to-get equipment, including microwave, aircraft, communications, radar; and laboratory electronics of all kinds. Quality standards maintained. New Reduced Prices On:
NEW TS-13/AP X-BAND SIGNAL GENERATORS with manual; T-47A/ART-13 Transmitters; H-P, Boonton, G-R, Measurements, many others in stock.

ENGINEERING ASSOCIATES
434 PATTERSON ROAD DAYTON 9, OHIO

GLASS INFRA-RED FILTERS
Special Designed Filter When Placed In Front Of Any Light Source. Filters Out All Visible Light But Freely Passes Invisible Infra-Red Rays. Army Snooperscope Part #A-1529-5-7/8" Dia. By 1/8" Thick. Total Wt. 5 lbs. BRAND NEW. Package Of Ten Filters For ONLY
LOW-VOLTAGE TRANSFORMERS
New Release of Government Surplus Material Model #S-9527. K E N Y O N TRANSFORMER CO. — 2.2 KVA. Input 110/220 volts 50/60 Cc. Output 11 Volts C-T (5.5-0-5.5) At 200 Amperes! Continuous 1500V. Case Size 8 1/2 x 10 1/2 x 13".
Price BRAND NEW ONLY \$25.95 Ea. #S-9527-WE. WESTINGHOUSE. — Same Specs. But Single 115 V Input & Lighter Wt. NEW \$21.95
Terms: Prices FOB St. Louis. Cash With Orders. Well Rated Concerns (D&B) Net 10 Days Cash.
McNEAL ELECTRIC & EQUIPMENT CO.
4736 Olive St. Dept. E-5 St. Louis 8, Mo.

ART-13 APR-4 BC-610-E
BC-348, BC-312, BC-342, TCS, BC-221, TS-173, ARC-1, APR-5AX, RTA-1B
FRA Teletype Converters (RTA)
ALLTRONICS,
Box 19, Boston 1, Mass. Richmond 2-0048

TIME DELAY RELAY
Haydon 115v 60 cy. adj. in 5 sec. steps to 40 sec. apdt mu sw. \$5.95. With 2 arms & 2 sw. \$9.95
Haydon 5901-2, to 1 min. in .1 min. steps. \$7.95
Hundreds of other items, see ad in Buyers Guide Issue, write for listings.
EMPIRE ELECTRONICS COMPANY
409-Q Ave. L. Brooklyn 30, N. Y. Cloverdale 2-4000

PRIME MOLYBDENUM WIRE
1,000,000 meters, 0.05mm diameter, tensile strength 87 Kg/mm² in 1500 meters lengths on bakelite rims. Offers to:
STEMET LIMITED
92, Portland Place, London, W. 1., England

AN CONNECTORS
FAST DELIVERY FROM STOCK LOW PRICES
Let us quote on your requirements.
All comply with government specifications
Wilgreen Industries
99 MURRAY ST., NEW YORK 7, N. Y.
Worth 4-2490-1-2
Cadmium or olive drab finish.

- NO SEPARATE ANTENNA TUNER
- NO PLUG-IN TANK COILS
- NO PLUG-IN TUNING UNITS
- NO INTERNAL VFO ADJUSTING
- ALL FRONT PANEL CONTROL

BRAND NEW
T-350XM
 RADIOTELEPHONE
 RADIOTELEGRAPH
TRANSMITTER

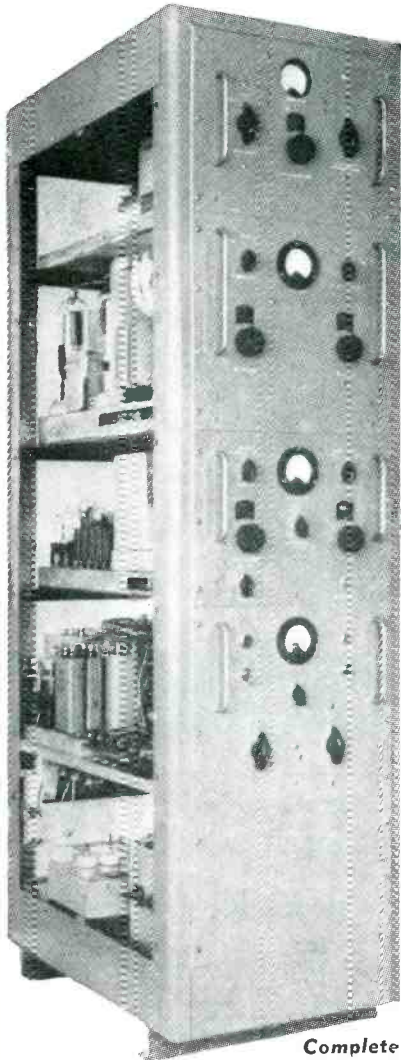

Complete

• 2,000-20,000 KCS • 350 Watts—A1 Output • 250 Watts—A3 Output • Built in Master Oscillator • 5 Crystal Positions • Multi Range Impedance Antenna Tuning Network • Manual or High Speed Keying • Uses 2—813 P.A. and 2—805 Modulators Hi-Level Class B • Speech Amplifier, Remote, Mfg by RCA • Technical Manuals (2) with Each Transmitter • Size 59" x 15" x 24" • Wt—690 Lbs. Net • Power Input: 210/250 Volts Single Phase 50/60 Cycles • Brand New—Complete—Unused This transmitter is similar in characteristic to the RCA Model ET-4336. The T-350XM was manufactured by Technical Radio Corporation, San Francisco, California, for the U.S. Signal Corps. All are new, unused and export cased. Each transmitter carries our guarantee. Spare parts available. Quotations on request.

Communication Devices Co., Inc.
 2331 Twelfth Ave., N. Y. 27, N. Y.
 TWX—NY1—223
 Cable—Communidev, N. Y.
 Tel. ADirondack 4-6174

KURMAN GENERAL ELECTRIC NORTH ELECTRIC GUARDIAN
 PRICE ELECTRIC CLARE WESTERN ELECTRIC
A LARGEST STOCK OF RELAYS IN THE WORLD!
 STRUTHERS DUNN ADVANCE AUTOMATIC ELECTRIC
 SIGMA POTTER BRUMFIELD LEACH

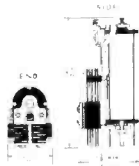

**TELEPHONE TYPE
 RELAYS**
**PRODUCTION QUANTITIES
 IN STOCK**

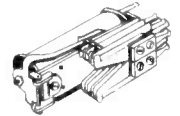

These relays have been standardized so that coils and frames of most manufacturers can be interchanged without affecting adjustments. A wide variety of applicable combinations are thus possible from a comparatively small number of relays.

Listed below are frames and coils from our stock. They may be purchased separately. However, a complete relay consists of coil and frame. In ordering complete relays specify which coil with which frame, i.e.: F101 with K117.

For coils with typical ratings see "Automatic Electric Time Delay" below. For example: 500 ohm coil with nominal rating of 24 VDC and 48 ma will operate continuously below 66 VDC.

Quantity Discounts
 1 to 9 as quoted
 10 to 49 10%
 50 to 99 15%
 100 or more 20%

Immediate Delivery

FRAMES



For Cost of Relay Add Price of Coil to Price of Frame)

Stock No.	Price	Stock No.	Price
F101	1A, 1.25	F181	3A, 1C 2.25
F102	2A, 1.50	F182	3A, 2C 2.75
F103	3A, 1.75	F183	3A, 1B, 4C 4.00
F104	4A, 2.00	F184	4A, 1B 2.25
F105	5A, 2.25	F185	5A, 1B, 1D 3.00
F106	6A, 3.00	F186	5A, 4B 3.25
F107	7A, 3.50	F187	5A, 1C 2.75
F108	1A, 1B 1.50	F188	6A, 3B 3.25
F109	1A, 2B 1.75	F189	6A, 1C 3.00
F110	1A, 3B 2.00	F190	9A, 1C 3.75
F111	1A, 1C 1.75	F191	11A, 1B, 1C, 1D 5.00
F112	1A, 2C 2.25	F192	15A, 1B 5.00
F113	1A, 3C 2.75	F193	1B 1.25
F114	1A, 1D 1.75	F194	1B, 1C 1.75
F115	1A, 1E 2.00	F195	1B, 1D 1.75
F116	1A, 2E 2.50	F196	2B, 1C, 1D 2.50
F117	1A, 3E 3.00	F197	2B, 3C 3.00
F118	1A, 1B, 1C 2.00	F198	2B, 1C 2.75
F119	1A, 1B, 2C 2.50	F199	2B, 1C 2.75
F120	1A, 1B, 1C 2.50	F200	2B, 1C 2.75
F121	1A, 3B, 1D 2.50		
F122	2A, 1B, 1C 2.25		
F123	2A, 1D 2.00		
F124	2A, 2B 2.00		
F125	2A, 1C 2.00		
F126	2A, 2C 2.50		
F127	2A, 3C 3.00		
F128	2A, 2B, 2C 3.00		
F129	2A, 2E 3.00		
F130	2A, 1B 2.00		
F131	3A, 1B, 1C 2.25		
F132	3A, 1B, 1D 2.50		
F133	3A, 1B, 1D 2.50		
F134	3A, 1B, 1D 2.50		
F135	3A, 1B, 1D 2.50		
F136	3A, 1B, 1D 2.50		
F137	3A, 1B, 1D 2.50		
F138	3A, 1B, 1D 2.50		
F139	3A, 1B, 1D 2.50		
F140	3A, 1B, 1D 2.50		
F141	3A, 1B, 1D 2.50		
F142	3A, 1B, 1D 2.50		
F143	3A, 1B, 1D 2.50		
F144	3A, 1B, 1D 2.50		
F145	3A, 1B, 1D 2.50		
F146	3A, 1B, 1D 2.50		
F147	3A, 1B, 1D 2.50		
F148	3A, 1B, 1D 2.50		
F149	3A, 1B, 1D 2.50		
F150	3A, 1B, 1D 2.50		
F151	3A, 1B, 1D 2.50		
F152	3A, 1B, 1D 2.50		
F153	3A, 1B, 1D 2.50		
F154	3A, 1B, 1D 2.50		
F155	3A, 1B, 1D 2.50		
F156	3A, 1B, 1D 2.50		
F157	3A, 1B, 1D 2.50		
F158	3A, 1B, 1D 2.50		
F159	3A, 1B, 1D 2.50		
F160	3A, 1B, 1D 2.50		
F161	3A, 1B, 1D 2.50		
F162	3A, 1B, 1D 2.50		
F163	3A, 1B, 1D 2.50		
F164	3A, 1B, 1D 2.50		
F165	3A, 1B, 1D 2.50		
F166	3A, 1B, 1D 2.50		
F167	3A, 1B, 1D 2.50		
F168	3A, 1B, 1D 2.50		
F169	3A, 1B, 1D 2.50		
F170	3A, 1B, 1D 2.50		
F171	3A, 1B, 1D 2.50		
F172	3A, 1B, 1D 2.50		
F173	3A, 1B, 1D 2.50		
F174	3A, 1B, 1D 2.50		
F175	3A, 1B, 1D 2.50		
F176	3A, 1B, 1D 2.50		
F177	3A, 1B, 1D 2.50		
F178	3A, 1B, 1D 2.50		
F179	3A, 1B, 1D 2.50		
F180	3A, 1B, 1D 2.50		

A = Normally open, B = Normally closed, C = Double throw, D = Make before break

ELECTRICAL COUNTER: Automatic Electric Series CDC Non-Reset type; Auxiliary SPST (1A) Contacts; Speed: 4 steps/sec; 4 digits; 223 ohms; 24VDC; #R897. \$5.00

ACCESSORIES FOR TELEPHONE TYPE RELAYS

Clare	Part No.	Description	Price
Clare	CR1	Molded Bakelite Cover overall 2 3/8" x 4 3/4"	#CR1... .90
Clare	CR3	Steel Cover 2 3/8" x 1 1/2" x 4 3/8" overall	#CR3... .95
Clare	CR5	Steel Cover 2 3/8" x 1 1/2" x 4 3/8" overall	#CR5... .95
Clare	BR4	Short Relay Bracket	#BR4... .15

Orders Under \$10 Remittance With Order. Plus Approximate shipping charges (overage will be returned).
 TERMS:—All prices F.O.B. Our Plant. Rated Firms Net 10 days; All Others Remittance with Order.
 Merchandise returnable within 10 days for full credit.
SEND FOR OUR LATEST CIRCULAR

COILS

(For Cost of Relay Add Price of Coil to Price of Frame)

Stock No.	Ohms	Price each	Stock No.	Ohms	Price each
K101	9.75	1.25	K185	800	1.50
K131	5.0	1.25	K108	900	1.50
K102	12	1.25	K109	1000	1.50
K156	50	1.25	K138	1200	1.50
K157	70	1.25	K111	1300	1.50
K168	100	1.25	K158	1400	1.75
K132	175	1.25	K139	1500	1.75
K169	200	2.25	K112	2000	2.00
K153	300	1.25	K155	2500	2.25
K154	400	1.25	K130	3000	2.25
K104	450	1.25	K182	3300	2.25
K105	500	1.25	K134	3600	2.50
K133	600	1.50	K116	6500	2.75
K134	700	1.50	K117	10000	3.00
K107	750	1.50			

SLOW-MAKE

Copper Slug at Armature End

Stock No.	Ohms	Price each	Stock No.	Ohms	Price Each
K160	120	1.50	K147	500/1500	2.50
K122	33	1.50	K148	1300	2.50
K146	125/1300	2.50	K172	1800	2.50
K171	500	2.00			

SLOW-MAKE & RELEASE

Coil Wound Over Copper Clad Core

Stock No.	Ohms	Price each	Stock No.	Ohms	Price Each
K189	200	1.50	K191	2250	2.50
K190	500	1.75			

SLOW RELEASE

Copper-Slug at Heal End

Stock No.	Ohms	Price each	Stock No.	Ohms	Price Each
K185	1.98	1.50	K187	788	2.00
K149	3.9	1.50	K150	800	2.00
K161	30	1.50	K106	500/1100	2.00
K123	75	1.50	K188	1200	2.25
K124	200	1.50	K152	1300	2.25
K186	500	1.75			

DUAL COILS

Stock No.	Ohms	Price each	Stock No.	Ohms	Price Each
K162	20/400	2.00	K192	250/1000*	2.00
K163	25/200	2.00	K106	500/1100	2.00
K141	50/2000	2.00	K144	500/1800	2.25
K166	125/125	2.00	K165	550/550	2.25
K142	125/1300	2.00	K170	800/800	2.25
K164	200/200	2.00	K145	1000/1000*	2.50
K143	200/1000*	2.00	K194	1300/1300	2.50

* Resistance winding

A-C COILS

Stock No.	Voltage	Price each	Stock No.	Ohms	Price Each
K121	110VAC	2.25	K195	220VAC	2.75

AUTOMATIC ELECTRIC TIME DELAY

AWS Weighted Spring Assembly; when used with ASO or ASA relay provides an overall operating delay of approx. 2 seconds. Provided with single normally open contacts.

Following types available:

Volts	Nom. Max	Nom. Ma	Ohms	A. E.#	Each
6	21	120	50	RE27	#R307... 3.00
12	36	80	150	RE28	#R308... 3.00
18	47	72	250	RE29	#R309... 3.25
24	66	48	500	RE30	#R310... 3.25
48	81	37	1300	RE31	#R311... 3.75
115	170	36	3300	RE32	#R312... 4.25

AVR Vibrating Reed Assembly; When used with ASO, BSO, BSA, or ASA to secure overall release delay adjustable between 1 and 15 seconds. Can also be used with slow-operate relay to secure operate delay adjustable between 1 and 15 seconds and in self-cycling circuits to generate time pulses.

Following types available:

Volts	Nom. Max	Nom. Ma	Ohms	Part No.	Each
24	40	60	200	RF71	#R313... 3.50
115	202	17	3300	RF73	#R314... 4.00

Cable address: UNIGENCOR, N. Y.

324 CANAL ST., N.Y.C. 13, N.Y. WALKER 5-9642
Universal general corp.

WANTED

We will buy the equipment listed below
REGARDLESS of CONDITION!

Special Price Paid For R.C. 286 Antenna

JUNCTION BOXES

CBY-62018—CW-22081—CBY-62008A—CBY-23049

RELAYS

5059R—5058—5055—5053SM—5053—Price Bros. Relay #10
A-18259—Antenna Switching Relay Box—BG-AN-198—BC-408

TUBES

35T Eimac—53A—VT-127A—WL-530—100TH—250TH
450TL—750TH—15E

TRANSFORMERS

D 163248—RET. D 163250—D 163254—D 162899—D 183254
D 165964—KS 9273—KS 9012—KS 9536—KS 9336
KS 9608—KS 9602—KS 9605—KS 9117—KS 9607
KS 8984—KS 9153—KS 8983—X 330005—A 14987

AIRCRAFT SPARK PLUGS

RB-19R—RB-485S2—590 S2—613 S2—RB 5/2—RD 5/3—RB 5/4
RB 5/5—RB 23-R—RP-43-S—63-S*—64-S—LE-44—LE-45—LS-48
AC-181—AC-281—RB-212 S2—RB-312 S2—RC-9R—RS-14-1R
RZ-14-R—R-214—RB 27-R—RB 23—RS 19-2R—RN-5/3

Will also purchase new or used magneto points.

RADIO and ELECTRONIC SURPLUS

14000 Brush Street • Detroit 3, Michigan

Phone: TOWNSEND 9-3403

GUIDED MISSILE BEACON

**S
B
A
N
D**

FILTER CAVITY F-28/APN-19

2700-2900mc. 1.5-db max. loss at ctr. freq. over band, 3db at 15 mc band ends. JAN spec. Ideal as standard reference cavity. Brand new. Guaranteed, \$37.50.
AN/APN-60 Crystal Mounting, \$19.50.
COAXIAL CRYSTAL MOUNT, Type N fittings, tuneable silver plated. Holds any IN21 type Xtal. \$15.00.

FEEDBACK DIPOLE 7/8"

COAX. 1 1/4" o.d. \$14.50.

COAX MIXER ASSEMBLY

IN21 type crystal detector RF to IF. "N" fittings, matching slug, duplex couplings, mtg. G.E. New, \$18.50.

WEATHER EYE RADAR 10

mi. - 5,000-mcs. 4-20-50-100 mile range, 360° azimuth, 80° elevation sweep, 7" PPI. Beacon position ref. scope. Lightweight, Western Electric Mfg. Brand new. Complete.



**X
B
A
N
D**

CUTLER FEED DIPOLE, 1"x1/2" slvr

pl. \$4.75.

E PLANE BENDS UG39/40 std Radius.

slvr. plated, \$14.75.

MITRED BEND. Vy Short Radius, E

plane, \$10.00.

TWIST 45 DEGREE, UG39 to UG40.

Silver plated, \$6.50.

CRYSTAL MOUNT. Hold any IN23 type

xtal. 1" x 1/2" guide and coax output.

UG40 input, \$15.00.

AS 24/APS 6 ROTARY JOINT SET, \$75.00.

DIRECTIONAL COUPLER "Airtron" 20 db. presurized cross guide type. Aluminum, \$18.50.

DUPLEXER, latest type incl. ATR switch tube mount, directional coupler, etc. 1"x1/2" guide, \$27.50.

LINE STRETCHER, VSWR matching device for XMSN Lines, \$34.50.

WAVEGUIDE to type N adapter, \$8.75.

TEST EQUIPMENT

MIT type TS155 Signal Gen. 2C40 lighthouse cavity

2700-2900mc. wg below cutoff atten. thermistor bridge, 115vac reg. pwr. supply \$325.00.

MINIATURIZED IF STRIP 100 db. gain uses 6

AKS \$9.50.

10CM THERMISTOR BRIDGE — Power meter,

direct reading, complete, Western Electric, \$85.00.

ECHO BOX, TS-207/UP 2700-2900mc. . . \$4.50.

ECHO BOX, OBU-3, Precision w/detector and

meter.

TTX 10RH 3 CM FM TEST SET. Sig. Gen., Freq.

meter, calib. attenuator, Thermistor Bridge. 115v. 60 cy ac, \$175.00.

SO-9 RATHEON RADAR

F.C.C. Approved, 10 CM. shipboard radar 4. 20, 80 mile range absolutely complete and brand new in original export boxes. Including installation drawings and instruction books. Large quantity in stock. Price \$1,500.00 per set.

RADIO-RESEARCH INSTRUMENT Co.

550 - 5 Ave., N. Y. 19, N. Y. Tel: JU 6-4691

PAUL J. PLISHNER

KOILED KORDS 3 wires

22 inches long stretches to 9 ft. \$126

REVERSIBLE GEARED-MOTOR

Delco-PM-Permanent Magnet Alnico Field Motor



#5071895 1/4 SHAFT or 11/16 GEAR... \$17.50
#5069600... \$18.50
Two Types of Clamps to hold motor: \$1.50 ea.

MERCURY SWITCHES
59¢ to \$6.00

FILAMENT TRANSFORMER
6v—1 1/2 amps 97¢
Weights—1 lb.

HG We Buy MERCURY HG

G.E. Switchettes
All types—75¢ ea.
10 for \$6.00
100 for \$50

115 v. AC RELAY
\$2.90

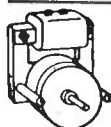

TELECHRON Motors

4 RPM on 50cy	3.6 RPM. \$3.15
or 4 1/4 RPM	1 RPM . . . 3.95
on 60 cy. \$2.85	3 R.P. Hr 2.85
2 RPM . . . 2.90	1 R.P. 2Hr 2.80
3 RPM . . . 2.90	1 R.P. 12Hr 3.25
4 RPM . . . 2.90	60 RPM. . . 4.85

Laboratory Special 1 of Each Motor \$25.

please include postage

BLAN

BLOWERS 115 Volts A.C. 60 cy.



REDMOND 5" 18 watts. . . . \$8.95
DELCO 60 cfm. 40 watts.
#5062369 used in 584 RADAR \$14.50

HAND WOUND 10 Sec. to 24 Min. TIMER SWITCH. . . \$1.25

6 Watt Most POWERFUL TELECHRON MOTOR 110V 60 CY

1 RPM \$6.50
6 RPM (Reverse) \$10.00

3" Round Elapsed Time Meter \$13.75

Square Case \$14.50

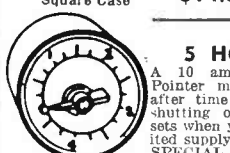

MARKTIME 5 HOUR SWITCH

A 10 amp. timing device. Pointer moves back to zero after time elapses. Ideal for shutting off radios and TV sets when you go to bed. Limited supply at this SPECIAL PRICE. . . \$4.90
Also available in 15 min., or 30 min. or 1 hr. at. . . \$6.50

HAYDON TIMING MOTORS

110v 60 cycle 80 RPM. . . . \$2.60
110v 60 cycle 1 RPM. . . . 2.60
230v 1 RPM. 1.00
60cy 2 RPM. 1.00

64B Dey Street
New York 7, N. Y.

EST. 1923

NEED METERS?

STANDARD or SPECIALS

ANY QUANTITY — NEW — SURPLUS

FOR ELECTRONIC — MILITARY
AIRCRAFT — HAMS

ALL MAKES — MODELS
RANGES — SIZES

METERS REPAIRED
RESCALED
RECALIBRATED

WRITE - PHONE - WIRE
INSTRUMENT SERVICE

455 E. 67th St.
Arverne, New York
CAA No. 4264 Ltd. NE 4-8594

HIGH

QUALITY ELECTRON TUBES

AT SENSIBLE PRICES!

GUARANTEED • UNUSED • BOXED • 1st QUALITY • WRITE FOR COMPLETE LIST

OB3/VR90	5.85	2E35	1.95	5C22	27.50	RK65/5D23	7.50	337A	6.00	GL562	50.00	891	125.00	5656	6.00	5879	1.4
OC3/VR105	.75	2J49	40.00	5D21	7.95	FG67	12.00	339A	10.00	GL575A	10.00	902A/902P1	2.50	5663	1.25	5883	6.0
OD3/VR150	.75	2J54	45.00	5F7	1.20	RM/R-72	.50	347A	3.25	UE577	22.00	918	1.65	5670	1.10	5890	35.00
VG-1A	20.00	2K61A	35.00	5J23	20.00	RM/R-73	.50	348A	4.95	WL551/5552	50.00	921A	2.50	5672	1.25	5894/AX9903	19.00
1B24	4.95	2K25	12.00	5JP4	11.00	E-83-F	2.75	350A	3.00	WL653B	110.00	932	1.75	5675	8.65	5896	4.50
1B24A	15.00	2K33	85.00	5JPS	6.00	90-NB	12.00	350R	2.75	HK-654	20.00	SN947/5640	6.50	5676	1.25	5899	4.00
1B25	1.25	2K34	95.00	5LPS	10.00	100R	2.95	357A	1.10	CK-1007	.75	5686	6.50	5677	1.25	5902	4.75
1B27	10.00	2K41	95.00	5MP1	2.95	100R(Surp)	5.00	357A	1.10	CK-1007	.75	5686	6.50	5678	1.25	5906	15.00
1B32	2.00	2K45	35.00	5RPSA	9.95	100TL(Surp)	14.00	359A	1.75	705A	.85	1258	12.50	5679	4.75	5915	8.0
1B35	3.50	2K47	110.00	6AQ5W/6005	1.95	FG-105	15.00	375A	3.00	CK707	1.15	5692	4.00	5680	1.25	5916	6.50
1B36	3.75	2K55	15.00			120-NB	40.00	374A	4.00	707A	3.50	5692	4.00	5681	1.25	5917	7.0
1B62A	20.00	2Z2A	1.25	*****		F-123-A	5.00	387A	4.00	707B	4.00	5693	4.75	5682	1.25	5918	8.0
NV10/868	1.50	3B23/RK22	3.30	4PR60A		VT127A	2.00	393A	3.50	708A	2.00	5694	4.75	5683	1.25	5919	1.60
1N21B	1.25	3B24	1.00	(Surp)		VX R130	1.75	394A	2.50	709A	1.75	5702	1.65	5684	1.25	5920	1.50
1N23B	1.50	3B24W	5.00	\$50.00		QK155	255.00	404A/5847	12.50	715B	3.00	5704	1.90	5685	1.25	5921	1.50
1N23CM	2.75	3B25	35.00	*****		FG172	19.50	356A/2C51	3.00	715B	3.00	5718	5.00	5686	1.25	5922	1.50
1N34	.45	3B29	3.50	450-TH		QK181	255.00	(Surp)		725A/B	8.50	5719	2.25	5687	1.25	5923	1.50
1N38A	.75	3B29	3.50	\$50.00		HF-201A	27.50	450-TH		726B	20.00	5722	2.25	5688	1.25	5924	1.50
1N38	1.90	3B31	1.00	*****		QK202	255.00	450-TH		800	20.00	5725/6A56W	2.75	5689	1.25	5925	1.50
1N39	2.50	3C24	1.50	450-TH		203A	2.50	450-TH		803	2.00	5726/6A15W	6.60	5690	1.25	5926	1.50
1N48	.85	3C45	7.05	*****		207	45.00	450-TH		807	2.00	5727/2D21W	1.40	5691	1.25	5927	1.50
1N52	.85	3C45	7.05	450-TH		211/VT4C	45.00	450-TH		808	2.00	5732	3.00	5692	1.25	5928	1.50
1N54	.55	3D21A	3.95	450-TH		FT231	12.50	450-TH		806	7.50	5744	1.25	5693	1.25	5929	1.50
1N56	.55	3D21	3.30	450-TH		245A	15.00	450-TH		807	1.20	5745	1.25	5694	1.25	5930	1.50
1N64	.70	3J30	30.00	450-TH		246A	10.00	450-TH		807W/5933	2.85	5751	1.50	5695	1.25	5931	1.50
1N65	.85	3K21	200.00	450-TH		249A	3.50	450-TH		811	3.00	5752	1.50	5696	1.25	5932	1.50
1N67	.45	3K30/410R	115.00	450-TH		251A	45.00	450-TH		812A	3.50	5753	1.20	5697	1.25	5933	1.50
1N69	.60	4-65A(Surp)	18.50	450-TH		252A	45.00	450-TH		812A	3.50	5754	1.20	5698	1.25	5934	1.50
1N70	1.20	4B24/E13C	4.50	450-TH		253A	45.00	450-TH		812A	3.50	5755	1.20	5699	1.25	5935	1.50
1N71	1.20	4B24/E13C	4.50	450-TH		254A	45.00	450-TH		812A	3.50	5756	1.20	5700	1.25	5936	1.50
1P23	1.90	4E27	8.50	450-TH		255A	45.00	450-TH		812A	3.50	5757	1.20	5701	1.25	5937	1.50
1P30	1.25	4J21	77.50	450-TH		256A	45.00	450-TH		812A	3.50	5758	1.20	5702	1.25	5938	1.50
1P49	1.25	4J21	77.50	450-TH		257A	45.00	450-TH		812A	3.50	5759	1.20	5703	1.25	5939	1.50
1S21	2.50	4J36	75.00	450-TH		258A	45.00	450-TH		812A	3.50	5760	1.20	5704	1.25	5940	1.50
1Z2	1.55	4J50	99.50	450-TH		259A	45.00	450-TH		812A	3.50	5761	1.20	5705	1.25	5941	1.50
CL7-2	1.55	4K50A	99.50	450-TH		260A	45.00	450-TH		812A	3.50	5762	1.20	5706	1.25	5942	1.50
2C35	2.50	(Surp)	22.50	450-TH		261A	45.00	450-TH		812A	3.50	5763	1.20	5707	1.25	5943	1.50
2C35A	9.00	4X150G	37.50	450-TH		262A	45.00	450-TH		812A	3.50	5764	1.20	5708	1.25	5944	1.50
GL-2C39B	9.50	4X500A	50.00	450-TH		263A	45.00	450-TH		812A	3.50	5765	1.20	5709	1.25	5945	1.50
ZC40	9.50	4X500F	50.00	450-TH		264A	45.00	450-TH		812A	3.50	5766	1.20	5710	1.25	5946	1.50
2C53/396A	1.25	4X500P	65.00	450-TH		265A	45.00	450-TH		812A	3.50	5767	1.20	5711	1.25	5947	1.50
2D21W	1.40	5BP1	2.50	450-TH		266A	45.00	450-TH		812A	3.50	5768	1.20	5712	1.25	5948	1.50
2E30	1.95	5BP4	3.95	450-TH		267A	45.00	450-TH		812A	3.50	5769	1.20	5713	1.25	5949	1.50
				450-TH		268A	45.00	450-TH		812A	3.50	5770	1.20	5714	1.25	5950	1.50
				450-TH		269A	45.00	450-TH		812A	3.50	5771	1.20	5715	1.25	5951	1.50
				450-TH		270A	45.00	450-TH		812A	3.50	5772	1.20	5716	1.25	5952	1.50
				450-TH		271A	45.00	450-TH		812A	3.50	5773	1.20	5717	1.25	5953	1.50
				450-TH		272A	45.00	450-TH		812A	3.50	5774	1.20	5718	1.25	5954	1.50
				450-TH		273A	45.00	450-TH		812A	3.50	5775	1.20	5719	1.25	5955	1.50
				450-TH		274A	45.00	450-TH		812A	3.50	5776	1.20	5720	1.25	5956	1.50
				450-TH		275A	45.00	450-TH		812A	3.50	5777	1.20	5721	1.25	5957	1.50
				450-TH		276A	45.00	450-TH		812A	3.50	5778	1.20	5722	1.25	5958	1.50
				450-TH		277A	45.00	450-TH		812A	3.50	5779	1.20	5723	1.25	5959	1.50
				450-TH		278A	45.00	450-TH		812A	3.50	5780	1.20	5724	1.25	5960	1.50
				450-TH		279A	45.00	450-TH		812A	3.50	5781	1.20	5725	1.25	5961	1.50
				450-TH		280A	45.00	450-TH		812A	3.50	5782	1.20	5726	1.25	5962	1.50
				450-TH		281A	45.00	450-TH		812A	3.50	5783	1.20	5727	1.25	5963	1.50
				450-TH		282A	45.00	450-TH		812A	3.50	5784	1.20	5728	1.25	5964	1.50
				450-TH		283A	45.00	450-TH		812A	3.50	5785	1.20	5729	1.25	5965	1.50
				450-TH		284A	45.00	450-TH		812A	3.50	5786	1.20	5730	1.25	5966	1.50
				450-TH		285A	45.00	450-TH		812A	3.50	5787	1.20	5731	1.25	5967	1.50
				450-TH		286A	45.00	450-TH		812A	3.50	5788	1.20	5732	1.25	5968	1.50
				450-TH		287A	45.00	450-TH		812A	3.50	5789	1.20	5733	1.25	5969	1.50
				450-TH		288A	45.00	450-TH		812A	3.50	5790	1.20	5734	1.25	5970	1.50
				450-TH		289A	45.00	450-TH		812A	3.50	5791	1.20	5735	1.25	5971	1.50
				450-TH		290A	45.00	450-TH		812A	3.50	5792	1.20	5736	1.25	5972	1.50
				450-TH		291A	45.00	450-TH		812A	3.50	5793	1.20	5737	1.25	5973	1.50
				450-TH		292A	45.00	450-TH		812A	3.50	5794	1.20	5738	1.25	5974	1.50
				450-TH		293A	45.00	450-TH		812A	3.50	5795	1.20	5739	1.25	5975	1.50
				450-TH		294A	45.00	450-TH		812A	3.50	5796	1.20	5740	1.25	5976	1.50
				450-TH		295A	45.00	450-TH		812A	3.50	5797	1.20	5741	1.25	5977	1.50
				450-TH		296A	45.00	450-TH		812A	3.50	5798	1.20	5742	1.25	5978	1.50
				450-TH		297A	45.00	450-TH		812A	3.50	5799	1.20	5743	1.25	5979	1.50
				450-TH		298A	45.00	450-TH		812A	3.50	5800	1.20	5744	1.25	5980	1.50
				450-TH		299A	45.00	450-TH		812A	3.50	5801	1.20	5745	1.25	5981	1.50
				450-TH		300A	45.00	450-TH		812A	3.50	5802	1.20	5746	1.25	5982	1.50
				450-TH		301A	45.00	450-TH		812A	3.50	5803	1.20	5747	1.25	5983	1.50
				450-TH		302A</											

ELECTRONIC TUBES — All types — one dependable source!

ALL V. & H. TUBES

are new, first quality, unconditionally guaranteed! advertised here are in stock—now. are standard brands: R.C.A., Sylvania, G.E., etc. are obtainable from one source. That includes NATO, JAN, commercial, special purpose, transmitting, receiving, etc.

EIT	514.00	2K29	35.00	6X4W	1.75	5654	1.35	5750	2.75	5864	1.75	594	1.75	
OB2	1.70	2K33	90.00	7BP7	4.50	5654/GASAK	1.35	5751	1.75	5903	1.50	6021	4.95	
OC3/VR105	.65	2K41	95.00	7CP1	4.99	6096	3.75	5751WA	3.00	6021	4.95	6032	POR	
OD3/VR150	.70	2K45	35.00	7FBW	2.00	5657	125.00	5763	1.10	6032	POR	6044	15.00	
IC	1.00	2K48	75.00	7HP7	6.50	5659	POR	5783	4.50	6044	15.00	6045	1.75	
CIB	1.50	2K54	7.00	7YP2	150.00	5660	POR	5784	5.50	6045	1.75	6050	1.50	
1B22	1.25	2K55	12.50	12A7TW	2.75	5661	4.00	5784WA	7.50	6050	1.50	6072	POR	
1B26	1.75	2K56	45.00	25Z6W	3.75	5663	1.25	5785	1.75	6072	POR	6073	2.75	
1B27	10.00	3AP1	2.95	QK60	25.00	5670	1.10	5787	4.85	6073	2.75	6074	POR	
1B32	1.00	3BP1	2.00	QK62	25.00	5670WA	3.50	5794	6.00	6074	POR	6080	8.00	
1B35	4.25	CP1	6.00	20DTW	1.35	5672	1.50	5797	8.50	6080	8.00	6082	3.70	
1B35A	7.50	3FP7	3.00	HY65	1.25	5676	1.25	5798	12.50	6080WA	8.00	6087	8.00	
1B40	2.00	3DP7	6.00	RM72	1.50	5677	3.25	5799	POR	6087	8.00	6088	3.70	
1B43A	20.00	3DP152	9.00	RM73	17.50	5678	17.50	5799A	POR	6088	3.70	6092	1.50	
1B58	42.00	3GP1	1.95	FG-95	17.50	5686	2.00	5800	6.75	6098CT	5.50	6101	3.50	
1N21	1.55	3JP	6.00	100TH	6.00	5687	2.75	5803	1.10	6101	3.50	6110	7.50	
1N21C	12.75	3WP21	50.00	100FC	15.00	5687WA	3.50	5814	2.50	6110	7.50	6113	2.25	
1N22	.65	3EP1	1.25	F124A	400.00	5691	4.75	5814A	4.00	6113	2.25	6135	POR	
1N23	1.60	3B22	1.50	F129R	150.00	5692	5.00	5814WA	2.50	6135	POR	6136	1.75	
1N23B	1.50	3B24	1.00	VT-158	7.95	5722	1.75	5814	3.00	6136	1.75	6141	9.00	
1N25	3.75	3B24W	5.00	20A4	25.00	5697	1.65	5829WA	7.50	6141	9.00	6152	7.00	
1N26	3.75	3B25	5.00	211	40.00	5702	3.00	5896	6.00	6152	7.00	6232	POR	
1N31	3.00	3B26	2.50	220C	40.00	5702A	1.75	5881	2.75	6232	POR	6236	250.00	
1N32	12.00	3B29	5.25	220C	75.00	5703	1.50	5881	6.50	6236	250.00	6293	POR	
1N34	1.50	3C22	60.00	250TH	17.50	5703WA	6.00	5842	10.00	6293	POR	6326	POR	
1N35	1.75	4CP1	1.50	320TL	15.00	5704	3.50	5844	1.30	6326	POR	6327	4.00	
1N38	7.75	3E29	8.50	HF300	17.50	5718	3.00	5845	POR	6327	4.00	6335	5.50	
1N41	8.00	4C27	5.00	314A	80.00	5719	2.25	5851	4.00	6335	5.50	6346	4.75	
1N42	8.00	4C35	13.50	304TL	4.00	5722	1.75	5851	2.75	6346	4.75	6347	9.00	
1N43	2.00	4C36	20.00	304TH	7.50	5725/GAS6W	1.00	5876	1.80	6347	9.00	6352	7.00	
1N44	POR	4J64	250.00	307A	1.00	5726	1.67	5879	8.00	6352	7.00	6353	70.00	
1N60	1.00	5BP1	2.50	407H	5.00	5725	6097	3.00	5896	6.00	6353	POR	6354	1.50
1N67	7.75	4-125A	17.50	450TL	35.00	5726	3.00	5896	3.75	6354	1.50	6355	3.00	
1N68	1.75	4-65A	16.00	508	275.00	5726/GAL5W	3.00	5896	19.00	6355	3.00	6356	POR	
1N73	3.00	4-400A	58.50	531	5.00	5732	3.00	5898	6.00	6356	POR	6357	250.00	
1N76	4.80	4-1000A	120.00	HK-654	20.00	5732	3.00	5898	7.50	6357	250.00	6358	POR	
1N91	1.00	4X150A	21.50	715A	2.00	5734	9.00	5899	4.00	6358	POR	6360	POR	
1N92	1.75	4X150G	36.00	715B	4.00	5744	2.00	5948/1754	65.00	6360	POR	6386	5.50	
1N93	2.65	4X500A	50.00	715C	12.00	5744WA	5.00	5949/1907	1.30	5963	1.65			
1N100	1.00	5BP1	2.50	803	2.50	5749	1.30	5963						
1N127	4.00	5BP1A	12.50	810	10.00									
2AP1	6.00	5CP1	2.00	813	10.50									
N52A	1.00	5CP7	6.00	830B	7.75									
2C27	1.00	5CP7	6.00	830B	7.75									
2C39	4.75	5CP11	8.00	832	4.00									
2C39A	9.50	5FP7A	15.50	832A	6.00									
2C40	13.00	5FP14A	12.50	833A	39.00									
2C42	9.50	5GP1	15.00	838	1.00									
2C43	9.00	5HP4	12.00	843	5.00									
2C46	6.00	5JP1	15.00	845	5.00	1019	53.25	323A	7.50	416B/6280	47.00			
2C51	2.75	5LP1	7.50	849	17.50	101F	3.10	328A	3.50	421A/5998	12.00			
2C53	10.00	5LP7A	14.00	851	10.00	101A	3.00	328A	7.50	421A/5998	12.00			
2D21	6.00	5NP1	2.00	858	275.00	104D	3.50	332A	6.00	423A/6140	8.00			
2D21W	1.20	5RP11	25.00	860	3.00	121A	3.50	337A	6.75	427A/6141	7.50			
2D23	1.40	5R6	60.00	868	75.00	105F	8.00	344A	10.00	427A/6141	7.50			
2E24	2.25	5X3P7	50.00	869B	30.00	221A	7.00	349A	5.75	429A	8.75			
2E26	3.00	6C6M	7.00	872A	1.75	244A	7.50	350A	2.75	431A	200.00			
3E28	1.75	6A7W	45.00	876	40.00	249B	3.50	354A	2.75	438A	55.00			
2E30	1.95	6A7WA	2.50	878	.50	249C	3.50	354A	15.00	703A	1.00			
2E35	1.95	6A15	7.25	880	250.00	253A	3.50	359A	2.00	704A	.85			
2J21	2.75	6A5	4.45	889A	100.00	254A	3.85	368A	1.50	705A	.75			
2J22	4.00	6AK5W	1.00	892-R	225.00	259A	14.00	371B	5.50	708A	.75			
2J26	3.75	6AL5W	.50	1619	35	262B	5.50	373A	5.00	709A	.65			
2J27	3.75	6AN5	2.00	5588	POR	267B	10.00	374A	1.00	719A	.60			
2J31	12.50	6AN5WA	3.75	5610	1.60	274B	7.00	388A	1.00	717A	1.00			
2J32	12.00	6AQ5W	1.70	5611	75.00	282A	7.00	394A	8.00	719A	9.50			
2J33	14.50	6AR6	1.25	5633	8.00	282B	8.00	395A	POR	719A	1.00			
2J36	15.00	6AS6W	2.75	5635	12.50	293A	12.50	396/2C51	2.35	725A	4.00			
2J37	4.00	6AS7G	2.50	5636	3.00	300B	5.00	397A/2K56	45.00	5842/437A	10.00			
2J43	125.00	6AUGWA	1.55	5637A	5.00	305A	60.00	400A	4.00	5847/404A	10.00			
2J44	60.00	6BF7	1.25	5638	6.50	310A	4.00	403A/GAK5	1.25	5998/421A	12.00			
2J51	120.00	6BF7W	3.50	5639	9.00	310B	6.00	403B/5591	2.75	6028/408A	3.50			
2J54	25.00	6C4W	4.50	5640	8.50	311A	4.50	404A	10.00	6140/423A	8.00			
2J55	45.00	6F4	3.25	5641	6.00	311B	5.50	407A	4.00	6141/427A	7.50			
2J56	45.00	6J4	1.90	5642	1.00	313C	2.00	408A	3.50	D178461/	45.00			
2J61	12.00	6J4WA	3.95	5643	6.00	313CA	4.12A	4.95	439A					
2J62	5.50	6J6W	1.50	5644	7.50	316A	.50	416A	35.00	D79512 MAN	15.00			
2K22	14.00	6K4	2.25	5645	6.50									
2K23	14.00	6L5Y	5.66	5646	7.50									
2K25	11.00	6SK7W	2.00	5647	5.00									
2K26	45.00	6SN7W	2.00	5651	1.50									
2K28	25.00	6SU7GTY	2.75	5651WA	3.50									

WESTERN ELECTRIC TUBES

53.25	323A	7.50	416B/6280	47.00
3.10	328A	3.50	421A/5998	12.00
3.00	332A	6.00	423A/6140	8.00
3.50	337A	6.75	427A/6141	7.50
7.50	344A	10.00	427A/6141	7.50
7.00	349A	5.75	429A	8.75
7.50	350A	2.75	431A	200.00
3.50	358A	2.75	438A	55.00
3.50	354A	15.00	703A	1.00
3.50	359A	2.00	704A	.85
1.50	368A	1.50	705A	.75
14.00	371B	5.50	708A	.75
5.50	373A	5.00	709A	.65
10.00	374A	1.00	719A	.60
7.00	388A	1.00	717A	1.00
7.00	394A	8.00	719A	9.50
8.00	395A	POR	719A	1.00
12.50	396/2C51	2.35	725A	4.00
5.00	397A/2K56	45.00	5842/437A	10.00
60.00	400A	4.00	5847/404A	10.00
4.00	403A/GAK5	1.25	5998/421A	12.00
6.00	403B/5591	2.75	6028/408A	3.50
4.50	404A	10.00	6140/423A	8.00
5.50	407A	4.00	6141/427A	7.50
2.00	408A	3.50	D178461/	45.00
2.00	412A	4.95	439A	
.50	416A	35.00	D79512 MAN	15.00

A ... Always
B ... Buy
C ... Columbia

WHAT DO YOU NEED?

- Communication Equipment?
- Dynamotors? Inverters?
- Automatic Direction Finders?
- Radar? Spare Parts?
- Equipment Accessories?

GET OUR PRICES FIRST

Columbia ELECTRONICS

WANTED

RT-66, 67, 68, 69, 70 GRC
AN/PRC-8, 10 AN/PRC-6
R-109-110 GRC PARTS AND
COMPONENTS OF AN/GRC
EQUIPMENT

Radalab Inc.

Phone Virginia 9-8181-23

TWX-NY-4-4361

87-17 124TH ST.

RICHMOND HILL 18, NEW YORK, N. Y.

**MOBILE RADIO
SCR-508**

10 Channel FM Receiver and Transmitter. Frequency Range 20-27.9 mc. Receiver is manually tuned, transmitter is crystal controlled. Consists of 2 BC-603 Receivers, BC-604 Transmitter, PT-237 mount. Box 80 Xials BC-606 Control, A-82 Phantom Aut., Headsets, mike, and antenna. Input 12 v. D.C. SCR-608 also available.

**SCR-291A GROUND
AUTOMATIC DIRECTION FINDER**

1.5-30 mc. automatic direction finder. This equipment used to take bearings on transmitters. Complete equipments available comprising the following: BC-117A Rec., PN 51, Power Panel, BC-1159, automatic bearing goniometer, RC-223 antenna system consisting of 5 masts with legs, MC-412, MC-413 phase inverters calibrating transmitter.

SCR-536 HANDI-TALKIE

Freq. range 3.7-5.5mc crystal controlled battery operated handitalkie. The range of this equipment is approximately 2 miles. We can supply these sets to your specified freq. Completely reconditioned and guaranteed. Large quantity available.

SCR-506A

Mobile radio transmitter-receiver covering 2-4.5 mc phone and CW. 10-90 watts output 5 channel operation. 12 or 24 volt input. Consisting of: BC653, BC 652, Rack, dynamotors, microphone, headset, antenna and mounts, etc.

AN/APR-4

38-4000 mc precision receiver consists of receiver and five tuning units to cover the full range. Each tuning unit is calibrated directly in mc. Input 115v 60 cyc.

**SCR-682-A SEARCH
AND WEATHER RADAR**

Technical Specifications:

- 1—Operating freq.—3000em 10mc.
- 2—Power output—225kw.
- 3—Pulse width—1 micro second.
- 4—ranges—500-240,000 yds. in four ranges. 10,000 yds, 40,000 yds, 160,000 yds, and 240,00 yds.
- 5—360 scan.
- 6—azimuth accuracy 1°.
- 7—7" P.P.I. indicator.
- 8—Antenna beam width 1°.
- 9—110v 60 cyc power input.

**AN/ASQ-1
AIRBORNE MAGNETOMETER**

This is an airborne chart recording magnetometer. The set consists of an amplifier, oscillator, detector head, chart profile recorder, power supply. The equipment has a sensitivity of 2 gamma. The AN/ASQ-1 records on an Esterling Anus recorder disturbance in the earth's magnetic field caused by an ore deposit or a sunken boat or submarine. An indicator is provided that gives a bearing on a magnetic disturbance. Input is 28v DC. Weight about 130 lbs.

AN/APN-3-AN/CPN-2 SHORAN

The AN/APN-3 and AN-CPN-2 are airborne and ground. Precision distance measuring installations. This equipment operates on 225 mc. The range is 250 miles with an accuracy of 25 feet. This is the most accurate distance measuring equipment built to date. The AN-APN-3 used with the K-1 computer (also available) will permit taking a photograph up to 250 miles from the CPN-2 beacons completely automatically. The AN-APN-3 can be fed into the aircraft auto pilot to fly it to the drop point. This equipment is very widely used by geological survey companies for oil prospecting and mapping. Power input is 110v 400cyc and 28/ DC. COMPLETE SETS AND SPARES ARE AVAIL.

**REMOTE P.P.I.
REPEATER INDICATORS**

- VD-7" P.P.I. Upright Mount.
- VE-7" P.P.I. Table Mount.
- VF-5" B Scope 5" P.P.I. Upright.
- VG-24" Plotting Table P.P.I. Repeater. This unit just installed in new air control center at Idlewild Airport, N. Y. Very Elaborate System.
- VJ-12" P.P.I. Upright Mount.
- VK-12" P.P.I. Upright Mount.
- VL-12" P.P.I. Upright Mount.

RADIO TELETYPE TERMINALS

- AN/SGC-1 Very Compact. Late Model.
- AN/CV-60/URR All Miniaturized. Late Model.
- FRA, FRR, FRF.
- AN/FGC-1.

OTHER EQUIPMENT

- AN/URC-1 Air-Sea Rescue Trans-Rec.
- AN/ARC-12 and Higher.
- AN/AFG-15 and Higher.
- AN/APS-10 and Higher.
- AN/CPN-6, 8, 17 Radar Beacons.
- AN/UPN-1, 2, 3, 4 Radar Beacons.
- AN/APA-17 300-10,000 MC Direction Finder.
- AN/GRC, 3, 4, 5, 6, 7, 8, 9 Field Radios.
- AN/PRC, 9, 10 Walkie Talkies.
- AN/TRC-1, 3, 4 V.H.F. Radio.
- SCR-193 Field Mobile Radio.
- SCR-300A Walkie Talkie.
- SCR 399, 499 Mobile Radio.
- AN/ARM-1 ARC-3 Test Set. 1—208.
- LAF 90-600 MC Sig. Gen.
- LAE 300-1,200 MC Sig. Gen.
- LAG 1000, 4000 MC Sig. Gen.
- SG-13 Pulse Gen.
- TS-3 S-Band Test Set.
- TS-15 Fluxmeter.
- TS-62 X-Band Echo-Box.
- TS-117 S-Band Wave Meter.
- TS-146 X-Band Test Set.
- TS-173, 174, 175 Freq. Meters.
- TS-250/APN Actimeter Test Set.

SCR-616—BC-1269

F.M. & A.M. 145-600mc communications receiver. The receiver is a superhet covering the 145-600mc in 2 bands. The dial is calibrated in megacycles.

TEST EQUIPMENT — RADAR SETS

- AN-107A
- AN/APM-3
- AN/APR-1
- AN/APR-2
- AN/APR-4
- AN/APR-5
- AN/APR-5
- AN/APT-5
- AN/APT-10
- AN/PSM-2A
- AN/PSM-6
- AN/SPR-1
- AN/TRM-3
- AN/URM-1
- AN/URM-23
- AN/URM-43
- AN/URM-67
- AN-USM-24
- AN-USM-45
- AN-USM-50
- AS-23/AP
- AS-251/AP
- AT-49/APR
- AT-48/UP
- BC-221
- BC-376H
- BC-638
- BC-650A
- BC-905A
- BC-1060B
- BC-1066B
- BC-1096
- BC-1148
- BC-1155
- BC-1236A
- BC-1277
- BC-1287
- FR-13/U
- I-83F

- I-96A
- I-98B
- I-108
- I-122B
- I-143
- I-144
- I-144
- I-148
- I-178A
- I-196B
- I-198
- I-200
- I-203A
- I-208
- I-212
- I-223A
- I-233
- IE-17E
- IE-21A
- IE-36
- IE-56
- LAF-2
- LM-13
- LS-1
- LW
- LZ
- ME-73
- MK-20A/UP
- MK-23/AP
- ME-6C/U
- ME-9/U
- ME-11/U
- ME-73
- MX-206/AP
- OAV-1
- OAD-2
- OBU-2
- OBU-3
- OS-8/U

- RF-4A/AP
- TAA-16EA
- TBN-35E
- TFX-10GA
- TFX-13GA
- TPS-51PB/10
- TS-1/ARR-1
- TS-2/TG
- TS-3A/AP
- TS-6/AP
- TS-8A/U
- TS-10B/APN-1
- TS-12/AP
- TS-13/AP
- TS-15/AP
- TS-16/APN
- TS-19/APQ
- TS-24/ARR-2
- TS-26/TSM
- TS-27/TSM
- TS-32C/TRC
- TS-33/AP
- TS-34/AP
- TS-35/AP
- TS-36/AP
- TS-45/APM
- TS-46/AP
- TS-47/APR
- TS-48/AP
- TS-51/APG-4
- TS-53/AP
- TS-56/AP
- TS-59/APN
- TS-61/AP
- TS-62/AP
- TS-69/AP
- TS-70/AP
- TS-74/UPM

- TS-76/APM-3
- TS-89/AP
- TS-90/AP
- TS-91/TPS-1
- TS-92/AP
- TS-98/AP
- TS-100/AP
- TS-101/AP
- TS-102/AP
- TS-103/TPM
- TS-105/TPM
- TS-107/TPM
- TS-108/AP
- TS-110/AP
- TS-111/CP
- TS-114/APS
- TS-116/APS
- TS-117/AP
- TS-125/AP
- TS-126/AP
- TS-131/AP
- TS-143/CPM
- TS-146/AP
- TS-147/AP
- TS-148/UP
- TS-153/AP
- TS-155C/UP
- TS-159/TPX
- TS-164/AR
- TS-170/ARN-5
- TS-173/UR
- TS-174/U
- TS-175C/U
- TS-184/AP
- TS-186/UP
- TS-189/AP
- TS-192/AP
- TS-197/U

- TS-203/AP
- TS-207/AP
- TS-222/MPM
- TS-226/APA
- TS-239C/U
- TS-250/U
- TS-251/UP
- TS-263A/TPS
- TS-268/U
- TS-270B/UP
- TS-278/AP
- TS-285/GP
- TS-294/U
- TS-297/U
- TS-305/AP
- TS-319/URM
- TS-320/URM
- TS-322/URM
- TS-328A/U
- TS-330/TSM
- TS-338/U
- TS-343/U
- TS-352B/U
- TS-358/U
- TS-363/U
- TS-382A/U
- TS-418B/U
- TS-419/U
- TS-452C/U
- TS-488/U
- TS-505/U
- TS-509/UR
- TS-537/TSM
- TS-545/UP
- TS-670/UP
- TS-710/TSM
- TV-3C/U
- TV-7/U

- AN/APS-3 Mark 16
- AN/APS-4 Mark 20
- AN/APS-13 SCR-548
- AN/APS-15 SCR-882
- AN/CPN-6 SCR-717C
- AN/CPN-8 SCR-720

Leru Laboratories, Inc. offers the most comprehensive inventory of Radar Sets and Test equipment. Leru has the vast laboratory facilities and Engineering talents to certify this equipment to original specifications. Leru offers a ten year record as a prime supplier, both at home and abroad of Radar, Communications and Navigation Equipments and their associated Test Sets.

Many other types available. Allow us to quote on your needs.

Leru Laboratories, Inc.

827 BLACK OAK RIDGE ROAD
Wayne Township, Paterson 2, N. J.

Terhune 5-2765-6
Cable Address: LERULABS, New Jersey

"TAB"

High Current Power Supplies



ONE YEAR GUARANTEE
Variable 0-28VDC. Completely Built. Ready to go. Full Wave Selenium Rectifier. Transformer Variable 0-28 Vdc. 5 Amp Meters. Switch. Terminals & Fuse. Heavy Duty Steel Cabinet Std 115V/60 cps 1 input or 220V (3 phase) to order

Stock NUMBER	Rating	With Meters
T28V5A	0-28 VDC at 5 Amp	580
T28V5ACC	5 Amp (1% Ripple)	85
T28V5AZCC	5 Amp 0.01% Ripple	145
T28V12A	0-28 VDC at 12 Amp	125
T28V12ACC	12 Amp (1% Ripple)	160
T28V12AZCC	12 Amp 0.01% Ripple	220
T28V24A	0-28 VDC at 24 Amp	155
T28V24ACC	24 Amp (1% Ripple)	225
T28V24AZCC	24 Amp 0.01% Ripple	310
T28V50A	0-28 VDC at 50 Amp	285
T28V50ACC	50 Amp (1% Ripple)	410
T28V100A	0-28 VDC at 100 Amp	500
T28V100ACC	100 Amp (1% Ripple)	700

Variable 75 to 135 VDC. Completely Built. Ready to go. Includes F. W. Selenium Bridge Rectifier 4" Rectangular V-type & Ammeter. Specify for 115 or 220 VAC. 1 phase 60 cps Input. T120V5AC 75 to 135 VDC at 5 Amp \$190
T120V5ACC 5 Amp (1% Ripple) 285
T120V5AC 75 to 135 VDC at 10 Amp 245
T120V5ACC 10 Amp (1% Ripple) 295
*Write Meter & Other Meters POWER SUPPLIES TO YOUR SPECS. WRITE US YOUR REQUIREMENTS

DC Power Supply

6 or 12V DC Power Supply
Model 5DC5 5 Amp 1% Ripple \$12.95
Model 2DC5 2 amp 1% Ripple \$12.95
Model 5DC5 5 amp 1% Ripple \$8.95

TRANSFORMERS

ALL 115V 60 CYC INPUT
2500V/200MA, 8.3V/6A, 2.5V/17.5A
4/9C/412 Scope, Repliment \$7.95
900V/35MA, 2X2.5V/2A, Xelit
1800V DBLR 2T0 2X2 PTL
W.DOS 500V/100MA 12.0V/7
778VCT/200MA, 5V/3A 8.3VCT/6A THORADARSON 54.98; 2 for \$8.44
2.5V/3A, HVINS HMSLD includes FILTER
550VCT/250MA, 5V/2A 8.3VCT/6A, 12.0V/7
3.6 ACSD HCA
XFMR, DBL Shell Universal mt. Etastio \$8.00
PRT 117V. Send 520VCT/250MA, 5V/3A, 6.3V/10A @ 5.50; 6 for \$18; 100 for \$250
NEW FILAMENT XFMR, 115 Volt Pri/Sec'd, 6.3V/350 ma. Cased \$5.00; 10/55

HEAVY DTY 115v/60cy SATURABLE REACTOR TRANSFORMER
4 wds. wgt. 14 lbs. control line voltage fluctuations up to 400 Vatts. WITH DATA \$3 ea.; 2 for \$5

WRITE FOR OUR NEW BARGAIN CATALOG \$ \$ SAVES \$ \$

INFRARED SNOOPSCOPE

Selected GTD Image-Converter Tube Hi-Sensitivity simplified design of dia. 1/4" illuminates screen Resolution up to 350 lin/in. Tube & Data "TAB" Special \$33.30; \$37.50
Snoopscope Pwr Supply Kit 4500VDC/35MA. Using Dual Doubler Ckt. Transformer, Rectifier, Sockets, Capacitors and Diagram 115/60cy Oper. \$33.50

BUILD-IT-YOURSELF

NEW "TABLITE" ELECTRONIC PHOTOFLASH KITS

AC & Battery Operation All In One Camera Case

Uses new no cost to voltage ever circuit constant bright light output; light duration 1/600 sec.; color K 6800; cont. per flash less than \$6. 1000 to 2000 flashes per set of batteries. All kits with inbuilt AC pack. (Kits less batteries)

TWO (2) 240V BATTERIES @ \$10
Model 400V, 60W Sec color #75; B&W 225 - 5. Recycles 2 sec'd, less than 4 hrs \$29.95
Model 600V, 120W Sec. color #101; B&W 300 - 5. Recycles 5 sec'd, less than 5 hrs \$44.95
Model 1000V, 240W Sec color #150; B&W 450 - 1. Recycles 10 sec'd, less than 6 hrs \$54.95
KITS ASSEMBLED, additional @ \$10 SOLD WITH "TAB" MONEY BACK GUARANTEE

PHOTOFLASH & STROBE LAMPS

"TAB" Replaces W-sec Each
TWL FA 104/FT118 100 58.98
PHI Amelo 5804X 100 10.98
GE FT 210 200 3.98
THVA YLV. 4330 200 3.98
V4x4 X400 200 10.98
DX D & FA100 150 3.00
TDX D & C250-580 150 3.00
353GTQ FT 603 2000 49.98
FRIGGER COIL TO VOLT FLASH \$1.47
COND-525 MF/450VDC/53 Wolt \$4.00
NEW low leakage famous mgr. - 58; 2/515; 6/539
Send 50c for "TAB" Photoflash Data

KLYSTRON "X" BAND HOUSING, Latest Sealed Cast design for 2K25 or 7Z3AB. Contains locking tube socket, variable frequency control, couples to hand w. w. containing geared variable attenuator. Ideal front end for generator or rep. Mtr. Controls at front. SPECIAL \$25

"TABTRAN" Rectifier Xfms

Sec'd Volts (DUAL) 0-9-15-18-18-15-9-0
Series: Sec'ds 0-3-6-9-12-15-18-21-24-27-30-33-36 Volts
TR5007 1 Amp 54.50
TR5008 2 Amp 6.50
TR5001 2 Amp 8.65
TR5002 12 Amp 11.50
TR5003 24 Amp 35.50
TR5004 50 Amp 58.50
TR5005 100 Amp 107.00
18 Volt 2 Amp \$1.98; 2 for \$3.50
1 Wdags in Series at Ratings shown: Parallel 2X Current, 60 Volts Face 95-118.
Dated Pri 115 & 220V 60cy.

New Variable Voltage X-fms

SUPERIOR-GR-STACO-UTC
0-132V-1.25A \$7.23
0-135V/3A 10.63
Cased 0-135V/7.5A 19.55
Cased 0-135V/7.5A 15.30
Cased 0-270V/3A 22.10
Cased 0-270V/3A 17.00
Cased 0-135V/15A 31.60
Cased 0-270V/9A 39.10
Cased 0-270V/7.5A 51.64
Cased 0-270V/9A 81.50
Cased 0-270V/12A 107.10
Cased 0-270V/15A 124.50
Cased 0-270V/30A 154.70
GR50B/0-270V/31A/LN 115.00
BUY AS YOU NEED AT FACTORY Large Stocks & Immediate Delivery

FILTER CAPACITORS

CE156M 6000MFD 15V .98c; 2/\$1.50; 10/\$5
CE502M 2000MFD 50V .52; 50/\$2.50; 10 for \$27
CE603M 3000MFD 60V .53; 98; 2 for \$20

Heavy Duty Battery "Fast" Charger Rectifier

13-0-13V (CT) 100 Amp Fan Cooled or 34 Amp Air Cooled. Reprint 6V Model CR16 \$12.00
18-0-18V (CT) Fan Cooled for 12V/18V @ 100A. Booster Charge \$14.00
Model CR30 \$14.00

MICA CONDENSERS

MFD	WVDC	Price
.01	1200	45c; 100/540
.01	1200	35c; 100/530
.001	1200	20c; 100/515
.001	1200	15c; 100/510
.002	2500	95c; 100/580
.002	2500	45c; 100/540

PLANETARY DRIVE

5:1 & 1 to 1 RATIO
Reg. \$3.29 "TAB" \$2
SPECIAL \$3.10 "TAB" \$3

BARGAIN BUYS FOR HAMS

ALL NEW DEMONSTRATOR MODELS
Hammarlund PRO-310, \$595 Regular
Gosset Communicator II, \$229.50 Regular
Halicrafter SX-96, \$249.95 Regular
Johnson Viking Ranger Kit, \$214.50 Regular
National NC-300, \$369.95 Regular
For All Ham Gear—Get Our Price B-4-U-Buy

BOURNS MINIATURE PRECISION "TRIMPOT", 2000 Ohms \$2 EA; 6 for \$10
EDISON TIME DELAY RELAY, Octal Base, 28 or 128 Volts .98 EA; 12 for \$10
Bridg-Pioneer Autosyn AY-201A, Rotor 1 Phase 28V Stator 3 Phase 11.8V/400~58; 2 for \$12
Bridg-Pioneer Autosyn AY-106-AL, Rotor 1 Phase 115V Stator 3 Phase 18.2V/400~58; 2 for \$12
STEVENS ARNOLD DC-AC CHOPPER, 0-500CPS Type CH395 SPDT Coil DC 26V/80001, imp 60 cps/850 ohms, 400 cycles, Electro-Mech. Used as chopper, rectifier, demodulator, SSB, etc.
BANDPASS FILTER TRANSFORMER, Sharp Cutoff HIG Cased & Shielded 60, 50, 140 cycles "TAB" Special \$1.50; 3 for \$4

NEW "TABTRAN" SELENIUM RECTIFIERS

ENGINEERED FOR INDUSTRY
"Technical Apparatus Builders" mgrs. Power Rectifiers to your specs. From one amp up to and above 1000 amps, convection or fan cooled, single or 3 phase. "NEMA" & JAN. Specs Write for catalog.
* FULL WAVE BRIDGE * DATED & ONE YEAR GTD

Max Amp	18VAC	36VAC	45VAC	72VAC	130VAC	266VAC	Ctr Tap	3 Phase	Bridges
1	14VDC	28VDC	42VDC	56VDC	100VDC	217VDC	30/32	120VAC	240VAC
2	2.00	3.40	5.00	5.85	10.25	28.00	2.70	18.25	35.50
3	2.90	4.10	5.75	7.80	12.70	37.00	3.05	20.00	38.50
4	3.50	5.40	7.15	14.20	25.00	50.00	3.10	21.70	42.40
6	3.95	7.70	12.75	17.25	29.65	59.00	3.70	24.00	45.95
10	5.85	11.35	19.40	24.75	41.25	85.00	5.45	42.40	82.70
12	7.20	14.25	22.00	29.50	43.85	100.00	6.30	48.15	94.20
20	13.00	25.00	37.00	48.00	78.00	161.00	9.15	58.50	112.60
24	15.00	28.50	44.25	57.50	80.65	191.00	11.45	103.35	183.90
30	17.85	34.25	56.25	70.50	108.00	236.00	14.70	135.55	259.80
36	22.35	42.00	64.75	86.50	133.65	296.00	17.20	155.10	310.40
50	29.40	54.00	105.00	115.00	173.00	405.00	27.50	206.85	413.90

RETURN YOUR OLD DUD RECTIFIER - DEDUCT 5% FROM PRICE

"TABTRAN" Rectifier Chokes

CR6001/1 Amp/0.1 H/1.4 Ohm \$4.50; 2 for \$8
CR6002/2 Amp/0.1 H/1.67 Ohm \$5.75; 2 for \$11
CR6003/3 Amp/0.1 H/1.6 Ohm \$7.90; 2 for \$15
CR6004/12 Amp/0.1 H/1.1 Ohm \$14.50; 2 for \$28
CR6005/24 Amp/0.04 H/0.025 Ohm \$29.50; 2/\$58
CR6006/50 Amp/0.04 H/0.012 Ohm \$52; 2/\$100

New! Quality Voltage REGULATOR

ONLY \$16.98
Line Voltage Stabilizer
Stabilizes line voltage within plus or minus 3% regardless of VOLTAGE & FREQ. 2 for \$32
Ideal for INDUSTRIAL, LAB or TV & RADIO use. Automatically operated. Regulator turns on off with 80% Equipment. TROUBLE FREE, QUIET, needs no adjustment. Universal Use—from 100 to 300 Watts. Input 100-125V Output 115V plus or minus 3% 60/80 cycles—

230 to 115 V Autotransformers

For 220V/60cy Input. To 110-120V or Step up. 1 With Cord, Plug & Receptacle.
TPA050/50W... \$2.55
TPA075/75W... 3.00
TPA100/100W... 4.00
TPA200/200W... 5.75
TPA350/350W... 8.25
TPA600/600W... 8.25
TPA750/750W... 11.79
Model TPA1000 Watt 1 Lw. Intermittent
TPA1500/1500W+1, \$22.50; TPA2000/2K W. \$34
* Less Cord, Plug & Receptacle.

NEW G.E. PHONO CARTRIDGES

RPX050A .001 & .003... \$6.75
RPX652A Gold Treasure... 19.25
RPX050A Gold Treasure... 28.00
RPX050A Single (S) .001... 5.08
RPX041A Single (S) .001... 5.08

Repl'ment Needles "TETRAD"

RPJ010A Dual (S) .001 & .003 GE... \$2.29
RPJ010B Dual (D) .001 & .003 Tetrad... 18.35
RPJ033A Dual (DS) .001 & .003 Tetrad... 11.10
Repl'mt for New A Cartridge Only
RPJ010D RPJ033 Single (D) Tetrad... 9.55
RPJ015 RPJ035 Single (S)... 1.35
RPJ015 RPJ035 Single (S)... 1.95
Repl'mt styl for RPX060 & 041 Only
RPJ001 or RPJ005 Single (S) GE... 8.27
RPJ003 or RPJ004 Single (D)... 9.85
Complete Stock of Repl'mnt Needles
Send Cartridge Name and Number

WRITE FOR OUR NEW HI-FI CATALOG

\$ \$ SAVES \$ \$

IMPROVED HI-FI SPEAKERS

With inbuilt network Ticonal Alnic 5 PLUS Magnet, 4 to 8 Ohm V.C. 15" TRIAx, 25 Watt/20-20000 cycles MODEL F15HX \$36
12" TRIAx, 20 Watt/40-20000 cycles MODEL F12HX \$28
8" COAX, 6 to 10 Watt/75-19000 CYCLES MODEL PH2X \$17

HI-FI RECORDING TAPE

Sold on Money Back Guarantee
PRECISION COATED & SLIT
Control Splices Free. Quality Control. Plastic. 50' Reel. 45.00
Constant Output. Freq. 7 1/2
15" 40-15KC Oxide Wind. In
7 Reel; 1200 ft. per Reel.
"TAB" SPECIAL @ \$1.59 EA; 3 @ \$1.50 EA
12 FOR \$14.95 EA

NEW SCOTCH RECORDING TAPE

#150A, 7"-1800 FT \$5.30 Reg. "TAB" \$4.75
#150A, 10 1/2"-3600 FT \$11.97 Reg. "TAB" \$10.70
#190A, 7"-1800 FT \$8.07 Reg. "TAB" \$7.30
#190A, 10 1/2"-3600 FT \$8.57 Reg. "TAB" \$7.75

SHURE CERAMIC CARTRIDGE #WC

20T, 3 Speed, 1/2" Plowover. With needles \$3.50
Reg. "TAB" SPECIAL \$3.95

NEW PORTABLE PHONOGRAPH

3 SPEED, Beautifully Styled & Engineered to perfection. Concise clear, crisp distortion. Free performance. Plays 7, 10 & 12" records at 78, 45, 33 1/3 RPM. Features 3 speed automatic intermic V.P. changer. Dual Cartridge, Tone & Volume Control. Size 15 1/4" x 14 1/4" x 8". A "TAB" SPECIAL \$39.95 @ \$39

NEW THOR ELECTRIC TOOLS

3DP1 2.75
3DP1A 6.50
7DP1 2.40
3FP7 1.91
3FP7A 3.00
3FP7A 3.00
3BP1 1.95
3CP1A 9.00
115V AC/DC 5.22
475, New 7" Buzzsaw, Depth of cut at 90°-2 1/4" at 45°-1 1/2". 5500 RPM-116VAC/DG, with Ringuin. \$44.95
15T, New Speedsander, Light Duty, All Ball bearing, air cooled motor, 4 1/2" x 5", sanding area. \$45.00/RPM/116VAC \$17.50

SELVINS-SYNCHROS

AY1 & AY5, Autosyn/25V/400CY @ 2/53.95
21H1-5V Dn Diff/57.5/57.5V/400CY @ \$5.98
3495H-5V Rtr/115V/60CY @ \$12.98
C8248-Syn Trns/116V/60CY @ \$8.98

WRITE FOR FULL LIST

Money Back Guarantee (Cost of Mds. Only) \$5 Min. Order FOB N. Y. C. Add shpg. charges or 25% Dep. Prices Subject to Change Without Notice.

THAT'S "TAB" THAT'S A BUY
Dept. SE6 111 Liberty St., New York 6, N. Y., U.S.A.
PH. RECTOR 2-6245
CABLE: "TABPARTS"

INDEX TO ADVERTISERS

Ace Electronic Associates	464	Bourns Laboratories	282
Acton Laboratories, Inc.	401	Brew & Co., Inc., Richard D.	392
Admiral Corp.	64	Bristol Engineering Corp.	330
Advanced Vacuum Products, Inc.	227	Brush Electronics Company	121, 122, 123
Aeronautical Communications Equipment, Inc.	303	Burnell & Co., Inc.	110
Aerovox Corp.	342, 343	Burroughs Corp., Electronic Instruments Div.	84
Aircraft-Marine Products, Inc.	203	Bussmann Mfg. Co.	94
Air Express Division, Railway Express Agency	299	C B S Hytron, A Div. of Columbia Broadcasting System, Inc.	281
Air-Marine Motors, Inc.	359	Caledonia Electronics & Transformer Corp.	389
Airpax Products Co.	50, 51	Campbell Industries, Inc., a sub. of Clarostat Mfg. Co., Inc.	261
Aladdin Radio Industries, Inc.	337	Cambridge Thermionic Corp.	36
Alden Products Co.	102	Cannon Electric Co.	66
Allegheny Ludlum Steel Corp.	309	Carolina Power & Light Co.	404
Allen-Bradley Co.	279	Celco-Constantine Engineering Laboratories Co.	373
Alloy Precision Castings Co.	396	Centralab, A Division of Globe-Union, Inc.	345, 347
Almo Radio Co.	365	Chase Brass & Copper Co.	305
American Electric Motors Electric Machine & Equipment Division of American Electronics, Inc.	395	Chatham Electronics, Division of the Gera Corp.	105
American Electronic Mfg., Inc.	403	Chicago Standard Transformer Corp.	280
American Elite, Inc.	390	Chicago Telephone Supply Corp.	79
American Lava Corporation	125	Cinch Mfg. Corp.	189
American Machine & Foundry Co.	225	Circuit Instruments, Inc.	355
American Phenolic, Corp.	206	Cleveland Container Co.	272
American Photocopy Equipment Co. 64A, 64B		Clifton Precision Products Co., Inc.	221
American Television & Radio Co.	202	Coast Coil Company	392
Amperex Electronic Corp.	128A, 128B	Cohn Corp., Sigmund	296
Anaconda Wire & Cable Co.	271	Coils-Electronics Co.	394
Anit-Corrosive Metal Products Co., Inc.	378	Coil Winding Equipment Co.	402
Arceo Steel Corp.	315	Collectron Corp.	398
Arnold Engineering Co.	13	Collins Radio Co.	128
Assembly Products, Inc.	390	Color Television, Inc.	212
Associated Commodity Corp.	404	Colortone Electronics, Inc.	383
Astatic Corp.	278	Comar Electric Company	224
Atlas Precision Products Co.	372	Communication Accessories Company	223
Atmo Seal Company	269	Communication Products Co., Inc.	238
Atomic Instrument Co.	361	Computer-Measurement Corp.	90
Atomic Laboratories	384	Condenser Products, Div. of the New Haven Clock & Watch Co.	396
Automatic Electric Mfg. Co.	376	Consolidated Vacuum Corp.	290
Automatic Manufacturing	233	Constantin & Co., L. I.	295
Avion Division A C F Industries Inc.	374	Continental-Diamond Fibre, Div. of the Budd Company, Inc.	30
Axel Brothers, Inc., Electronics Div.	364	Cornell-Dubilier Electric Corp.	120
		Corning Glass Works	311
Baker & Co., Inc.	381	Ceto Coil Co., Inc.	375
Ballantine Laboratories, Inc.	258	Couch Company, Inc., S. H.	240
Barry Controls, Incorporated	21	Craig Systems, Inc.	268
Bausch & Lomb Optical Co.	40	Cramer Co., Inc., R. W.	43
Beaver Gear Works, Inc.	296	Cross Co., H.	393
Bell Telephone Laboratories	215	Crucible Steel Company of America	209
Bendix Aviation Corporation, Red Bank Div.	276	Curtiss-Wright, Electronics Div.	218
Bentley Harris Mfg. Co.	32	Dale Products, Inc.	86
Berkeley Div., Beckman Instruments, Inc.	300	Dano Electric Co.	384
Bird Electronic Corp.	387	Daven Company	3rd Cover
Biwax Corporation	402		
Bomac Laboratories, Inc.	60		



A New Idea

**STACKED
DELAY
LINES**

MILITARY - COMMERCIAL

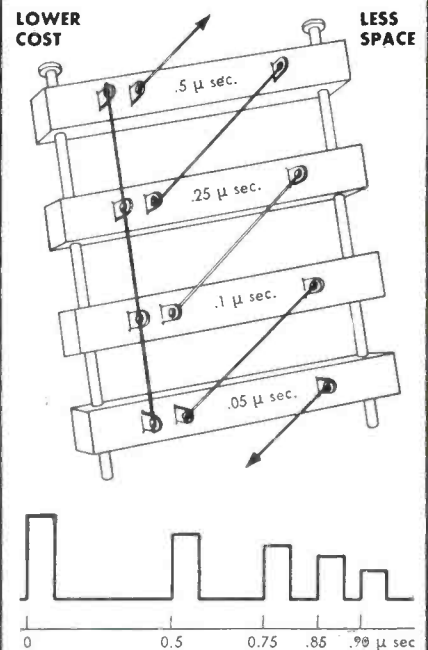

Your special delay line needs can be met by assembling standard units for laboratory or production requirements.

WRITE FOR DATA SHEET

ESSEX ELECTRONICS

Berkeley Heights
New Jersey
CRestview 3-9300

7303 Atoll Ave.
No. Hollywood Calif.

Trenton, Ontario
Canada



Acepot actual size

Ace Dependable

sub-miniature
Potentiometers
(.3% linearity)
Trimmers (3% linearity)

... because they've been tested,
tried, and proved in use!

Why are ACEPOTS and ACETRIMS being written into the specifications of so much new equipment? Because they not only meet the requirements of space and weight saving compactness, but they also meet the vital requirement of *dependability*.

Special design and use of newest materials are features you get in ACEPOTS and ACETRIMS. The design is the result of 3½ years' development and 1 year of *successful use*. Ace's system of manufacture and exacting inspection and quality control assure you of highest quality standards. A Polaroid picture record is supplied with each ACEPOT showing linearity and resolution.

If you want sub-miniaturization, yet want to be sure of the performance and dependability of a heavyweight champion, consult Ace and you'll be right. Expedited delivery on prototypes. Prompt delivery on production orders. Send for catalog sheets and application data sheets.

ACEPOT (potentiometer)

200 \sim to 100K std., $\pm 2\%$; ½" size; linearity .3% or better; highest resolution; weight ¼ oz.; temperature -55°C. to 125°C. ; Std. bushing, servo or flush mtg., up to 6-gang units; 2 W. for 60°C. rise; low or high torque as required; meets MIL-E-5272A stds.

ACETRIM (trimmer)

10 \sim to 50K std., $\pm 5\%$; ½" size; linearity 3%; excellent resolution; weight ¼ oz.; temperature -55°C. to 125°C. ; 2 W. for 60°C. rise; low or high torque as required; meets MIL-E-5272A stds.

*Trademarks applied for

ACEPOT* **ACE ELECTRONICS ASSOCIATES**
ACETRIM* Dept. E, 101 Dover Street • Somerville 44, Massachusetts

Hundreds of standard JONES TERMINAL PANELS Complete equipment for SPECIALS



Send your specifications for prompt quotation

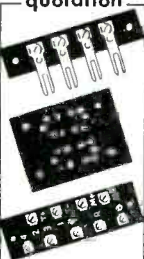

Several pages of Jones Catalog No. 20 illustrate standard and special panels we are constantly producing. Latest special equipment enables us promptly to produce practically any panel required. Send print or description for prices, without obligation. Hundreds of standard terminal strips also listed. Send for Catalog 20 with engineering drawings and data.

JONES MEANS Proven QUALITY

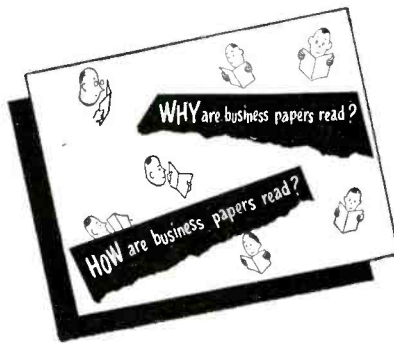
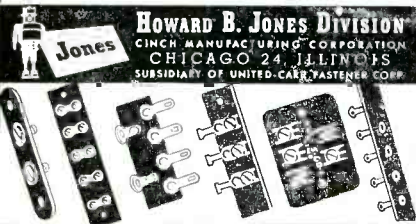

A copy of this quick-reading, 8-page booklet is yours for the asking. It contains many facts on the benefits derived from your business paper and tips on how to read more profitably. Write for the "WHY and HOW booklet."

McGraw-Hill Publishing Company, Room 2710, 330 West 42nd St., New York 36, N. Y.

DeJur-Amsco Corporation	222
Delco Radio, Div. of General Motors	317
DeMornay-Bonardi	384
Dialight Corporation	351
Division of Nebraska Resource	87
Doelam, A Division of Minneapolis-Honeywell	92
Diamonite Products Div. of U. S. Ceramic Tile Company	244
Donner Scientific Co.	304
Douglas Aircraft Company, Inc.	323
Driver-Harris Company	219
Du Mont Laboratories, Inc., Allen B.	327
duPont de Nemours & Co., (Inc.) E. I. Film Dept.	249
Polychemicals Dept.	67

Eastern Air Devices, Inc.	260
Edison, Inc., Thomas A.	360
Edo Corporation	38
Eitel-McCullough, Inc.	57
Eleo Corporation	377
Electro Motive, Mfg. Co., Inc.	75
Electro-Snap Switch & Mfg. Co.	55
Electro Tec Corporation	287
Electronic Associates, Inc.	104
Electronic Engineering Company of California	264
Electronic Fabricators, Inc.	367
Electronic Instrument Co., Inc. (EICO)	391
Electronic Research Associates, Inc.	106
Engineering Co., The	361
Erie Electronics Division, Erie Resistor Corp.	266
Essex Electronics	463

Factory Enterprises, Inc.	388
Fairchild Controls Corp.	85
Farnsworth Electronics Co.	312
Federal Telephone & Radio Co.	45
Filtron Company, Inc.	107
First Six	113
Fisher Radio Sales Co., Inc.	210
Five Star Co.	397
Freed Transformer Co., Inc.	390
Frenchtown Porcelain Co.	211

G. M. Laboratories, Inc.	400
G-V Controls, Inc.	250
Gamewell Ceramics Corp.	332
General Ceramics Corp.	291
General Dry Batteries, Inc.	298
General Electric Co. Apparatus Dept.	23, 247
Electronics Dept.	53
General Findings & Supply Co.	354
General Radio Co.	17
General Research & Supply Co.	382
Genisco, Inc.	365
Gertsch Products, Inc.	405
Globe Industries, Inc.	216
Good-all Electric Mfg. Co.	41
Grant Pulley & Hardware Corp.	42
Green Instrument Co.	377

Gries Reproducer Corp.	364
Gudebrod Bros. Silk Co., Inc.	385
Gulton Mfg. Corp.	201

Hall-Scott, Inc., Electronics Div.	226
Hammarlund Mfg. Co., Inc.	25
Harper Company, H. M.	78
Harvard University Press	367
Hathaway Instrument Co., Div. of Hamilton Watch Co.	348
Haydon Company, A. W.	302
Haydon Mfg. Co., Inc.	204
Heath Company	333
Helipot Corp., Div. of Beckman Instruments, Inc.	195
Hermaseal Co., Inc.	386
Hewlett-Packard Company	68, 69
Hudson Tool & Die Company, Inc.	117
Hughes Products, a div. of Hughes Aircraft Co.	81, 255
Hughes Research & Development Laboratories	254
Hycor, Div. of International Resistance Co.	403

Illinois Condenser Co.	288
Indiana Steel Products Company	319
Induction Motors Corp.	214
Industrial Development Committee of 100, Lakeland Florida	466
International Business Machines Corp.	313
International Nickel Co., Inc.	63
International Rectifier Corp.	245

Jennings Radio Mfg. Corp.	306
Jet Propulsion Laboratory	132
Johnson Company, E. F.	393
Jones Div., Howard B., Cinch Mfg. Co.	484
Joy Manufacturing Co.	237

Kahle Engineering Co.	15
Kay Electric Co.	27
Kearfott Co., Inc.	346, 352
Kellogg Company, M. W.	239
Kellogg Switchboard & Supply Co.	96
Kepeo Laboratories	193
Kester Solder Co.	235
Kinney Mfg. Division, New York Air Brake Company	293
Knights Company, James	356
Krohn-Hite Instrument Co.	466
Kuthe Laboratories	262
Kwikheat Manufacturing Co.	288

Lambda Electronic Corp.	118, 119
Lampkin Laboratories, Inc.	389
Lapp Insulator Co., Inc.	246
Lavole Laboratories, Inc.	397
Leach Corporation	231

WHEN QUESTIONS ARISE — REMEMBER...
The SURE WAY is to CHOOSE and USE the transformers of proven performance and quality

MAGNETIC COMPONENTS FOR THE ELECTRONICS INDUSTRY SPECIFICATIONS

MAGNATRAN® LEADS THE WAY

UNITIZED RECTIFIERS®
 RECTIFIER PLATE TRANSFORMERS
 FILTER REACTORS
 MODULATION TRANSFORMERS- REACTORS
 FILAMENT TRANSFORMERS-AMPLIFIER RECTIFIER

Magnatran transformers have become "Standard" for many of America's largest Electronic Manufacturers. Whether you require conventional equipment or specially engineered products, choose and use Magnatran. Be modern and secure. All Magnatran components meet or exceed the standards of AIEE, ASA, NEMA and RETMA.

Write for BULLETINS **MAGNATRAN** incorporated
 P.O. Box 211 KEARNY, NEW JERSEY, U.S.A.

PRECISION PHASEMETER

- 0.1° ABSOLUTE ACCURACY
- 0.01° incremental accuracy
- 30 to 20,000 cycles per second
- 0 to 360° phase range
- 10-megohm input impedance (shunted by 25 μf)

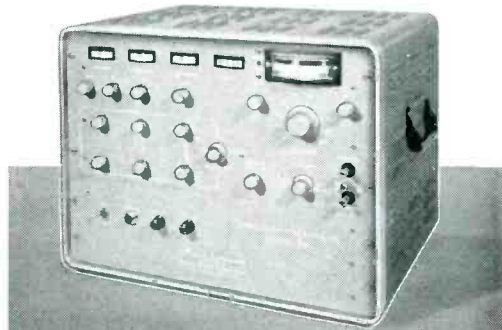

- **Output connection for strip-chart recorder.**
- **Self-contained power supply for 105-125 volts, 50-60 cycles.**
- **Adaptable to standard relay-rack mounting.**
- **Price \$3990 net F.O.B. Long Island City.**

THE NEW MAXSON Model 901 Precision Phasemeter is a direct-reading electronic instrument adaptable to a wide variety of demanding measurement applications in computers, synchros, and amplifiers. The instrument measures phase difference between two sinusoidal voltages; phase angles are read from a two-degree, step control with vernier indicator having a precision of 0.01°. Built-in sensing provides direct reading of proper quadrant. Accuracy is independent of even harmonics and of third harmonics up to 1%. Input-level range is from 0.5 to 10 volts rms.

Write or phone us for further information.

MAXSON INSTRUMENTS
 A DIVISION OF THE W. L. MAXSON CORPORATION

47-37 Austell Place
 Long Island City 1
 New York
 Tel: RAvenswood 9-1850

REGULATED POWER SUPPLY

0.001% Regulation and 0.1 Millivolts Ripple



Model UHR-220

able in addition to two 6.3 volt unregulated a-c outputs of 5A capacity. Price \$350.00, f.o.b. factory

The KROHN-HITE Model UHR-220 is a compact Power Supply for applications requiring up to 0.2 ampere of d-c at 0 to 500 volts with ULTRA-HIGH REGULATION, extremely low ripple and unusual stabilization under severe input line voltage transients. The internal impedance is less than 0.01 ohm for low frequencies and d-c, and less than 0.1 ohm for frequencies as high as 100 kc. Stabilization for $\pm 10\%$ change in line voltage is 0.003%. Transient response is 0.001 millisecond and typical 10-hour drift is 300 ppm. A 0-150 volt, 0-5 ma, bias supply with 0.05% stabilization and 0.002% ripple is available

For Further Details Write

KROHN-HITE INSTRUMENT CO.

DEPT. E, 580 MASSACHUSETTS AVE.

CAMBRIDGE 39, MASS.

An Invitation TO MANUFACTURERS OF ELECTRONIC EQUIPMENT

1. Friendly labor supply.
2. Unusual city, county, and state tax advantages.
3. Industrial sites plentiful.
4. Good banking facilities.
5. Full cooperation guaranteed.
6. Strategic location.

for
SMALL
or
MEDIUM
INDUSTRIES

Businessmen of Lakeland, Florida will cooperate fully and furnish complete information to manufacturers who will consider relocating or establishing a branch unit in this fast-growing central Florida city

INDUSTRIAL DEVELOPMENT COMMITTEE OF 100
LAKELAND TERRACE HOTEL

LAKELAND, FLORIDA

Leeds & Northrup	62
Lewis & Kaufman Ltd.	329
Lewis Spring & Mfg. Co.	256
Librascope, a Sub. of General Precision Equipment Corp.	376
Lockheed Missile Systems Div.	242, 213
Los Alamos Scientific Laboratory	336

M B Manufacturing Co.	65
M. I. T. Lincoln Laboratory.	228
MacDonald, Inc., Samuel K.	410
Maclen Corp.	410
Magnatran, Inc.	465
Magnetic Amplifiers, Inc.	373
Magnetic Metals Company	248
Magnetics, Inc.	199
Maleo Tool & Manufacturing Co.	379
McColpin-Christie Corp.	383
Mallory and Co., Inc., P. R.	136, 191
Mandex Manufacturing Company, Inc. ...	344
Marconi Instruments, Ltd.	100
Marion Electrical Instrument Co.	238, 288
Markem Machine Co.	402
Martin Company, Glenn L.	207, 328
Maxson Instruments, A Division of the Maxson Corp.	465
Measurements Corporation	200
Metals & Controls Corp., General Plate Div.	48
Metal Textile Corp.	232
Midland Mfg. Co., Inc.	95
Milford Rivet & Machine Co.	389
Millen Mfg. Co., Inc., James.	213
Minneapolis-Honeywell Regulator Co., Industrial Div.	74
Minnesota Mining & Mfg. Co.	269
Moloney Electric Co.	265
Monsanto Chemical Company.	229
Motorola Communications & Electronics Div.	52
Muirhead & Co., Ltd.	5
Mullard Overseas Ltd.	134
Mycalex Electronics Corp.	331

N J E Corporation	135
Narda Corporation	324
National Moldite Company	33
Natvar Corporation	93, 253
Nems-Clarke, Inc.	404
New England Transformer Co.	360
New Hermes Engraving Machine Corp.	405
Ney Company, J. M.	333
Norden-Ketay Corp.	357
Northern Radio Co., Inc.	98
North Electric Co.	316
Nothelfer Winding Laboratories, Inc.	220

Ohmite Manufacturing Co.	32A, 32B
Oster Manufacturing Co., John.	80
Otis Elevator Co.	101

Pacific Semiconductors, Inc.	133
Panoramic Radio Products, Inc.	353
Perkin Engineering Corp.	31
Phalo Plastics Corp.	335
Phaotron Instrument & Electronic Co.	230
Phelps-Dodge Copper Products Corp., Inca Mfg. Div.	108, 109
Philco Corporation	91
Phillips Control Corp.	252
Phillips Process Co., Inc.	379
Pix Manufacturing Co., Inc.	391
Polarad Electronics Corporation	37
Polytechnic Research & Development Co., Inc.	88
Potter Instrument Co., Inc.	111
Precision Apparatus Co., Inc.	468
Precision Paper Tube Co.	326
Pyramid Electric Co.	275
Quaker City Gear Works, Inc.	308
R-B-M Division, Essex Wire Corp.	267
Radiation, Inc.	468
Radio Corporation of America	126, 127, 297 4th Cover
Radio Engineering Products	386
Radio Frequency Laboratories, Inc.	380, 399
Radio Industries, Inc.	270
Radio Materials Corp.	205
Radio Receptor Co., Inc.	39
Rawson Electrical Instrument Co.	397
Raytheon Mfg. Company	18, 19, 28, 29, 35
Reeves Instrument Corp.	129
Raybestos-Manhattan Inc., Plastic Products Div.	46
Remington Rand Univac Div. of Sperry Rand Corp.	72, 73
Reliance Mica Co., Inc.	385
Resinite Corp., Div. of Precision Paper Tube Co.	310
Resistance Products Co.	54
Rome Cable Corp.	56
Rutherford Electronics Co.	378
Saft Corporation of America	277
Sage Electronics Corp.	338
Seamless Rubber Co., The	404
Sel-Rex Precious Metals, Inc.	383
Shalleross Manufacturing Co.	208
Sigma Instruments, Inc.	292
Simmons Fastener Corp.	116
Simpson Electric Co.	76, 77
Sola Electric Co.	321
Sorensen & Co., Inc.	4
Southern Electronic Corp.	241
Speer Resistor Division, Speer Carbon Co.	406
Spencer Kennedy Laboratories, Inc.	382
Sperry Gyroscope Co., Div. of Sperry Rand Corp.	114, 115
Sprague Electric Co.	11, 197
Stackpole Carbon Co.	89

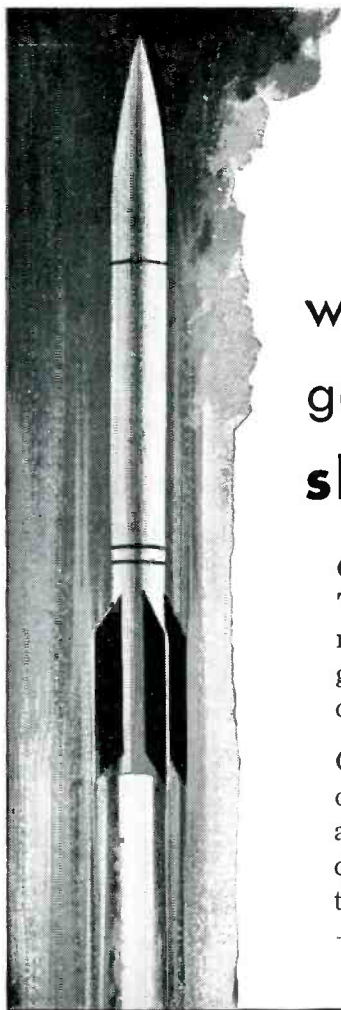

withstanding rigid government tests for **shock, vibration**

Chemelec (TEFLON*) Stand-off and Feed Through Insulators are replacing brittle materials in many electronic devices for guided missiles, fire control, radar, mechanical computers, etc.

Chemelec compression-type Insulators offer the highest quality—electronically and mechanically—without increasing costs . . . due to the assembly savings they provide. Simply press into position—no additional hardware.

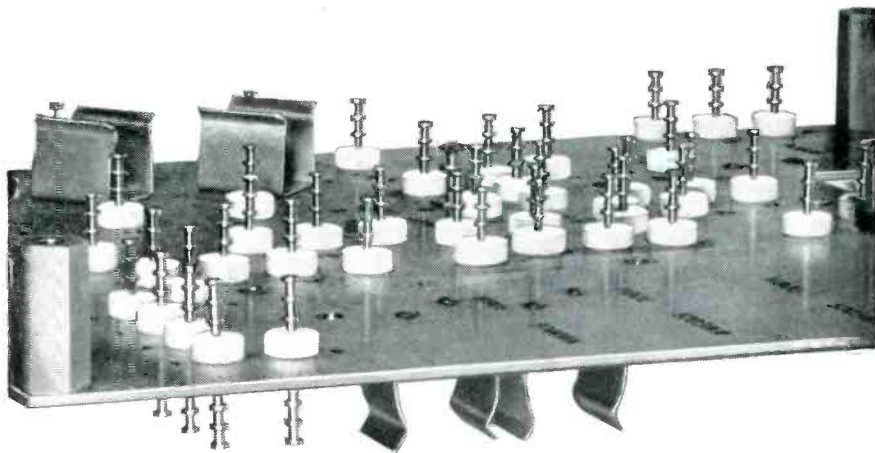

● Write for further information and Catalog EC-1153.

**du Pont Trademark*

Fluorocarbon Products Inc.

DIVISION OF UNITED STATES GASKET COMPANY
CAMDEN 1, NEW JERSEY



THE PRECISION MODEL 120

GIVES YOU WHAT YOU WANTED
IN A

**HIGH SENSITIVITY
MULTI-RANGE TEST SET**

20,000 OHMS PER VOLT D.C.
5,000 OHMS PER VOLT A.C.

The '120' gives you . . .

- ✓ MORE RANGES
- ✓ AN EXTRA-LOW RESISTANCE RANGE
- ✓ AN EXTRA-LOW VOLTAGE RANGE
- ✓ AN EXTENDED LOW CURRENT RANGE
- ✓ A LARGER METER SCALE FACE
- ✓ SIMPLE, POSITIVE RANGE SELECTION
- ✓ POSITIVE CONTACT JACKS and PLUGS

Compare These Wide Spread Ranges and Special Features:

- ★ 8 DC VOLTAGE RANGES: 20,000 ohms per volt.
- ★ 8 AC VOLTAGE RANGES: 5,000 ohms per volt.
0-1.2-3-12-60-300-600-1200-6000 volts.
- ★ 8 AC OUTPUT RANGES: same as AC volt ranges.
Built-in 600 volt blocking capacitor.
- ★ 7 DC CURRENT RANGES:
0-60-300 Microamperes. 0-1.2-12-120-600 Ma.
0-12 Amperes.
- ★ 5 RESISTANCE RANGES: self-contained.
0-200-2000-200,000 ohms. 0-2-20 megohms.
- ★ 8 DECIBEL RANGES: -20 DB to +77DB.
0 DB = 1 Milliwatt, 600 ohms.
- ★ EXTRA LARGE 5¼" RUGGED 'PACE' METER:
40 microamperes sensitivity, 2% accuracy.
- ★ 1% MULTIPLIERS and SHUNTS:
Wire-wound and deposited film types.
- ★ TWO JACKS SERVE ALL STANDARD RANGES:
Separately identified and isolated jacks
provide for extra high ranges.
- ★ "TRANSIT" SAFETY POSITION on range selector
protects meter during transport and storage.
- ★ CUSTOM-MOLDED PHENOLIC CASE and PANEL:
Compact, laboratory styled instrument.

MODEL 120... complete with internal ohmmeter
batteries, banana-plug test leads and detailed
operating manual. Overall case dimensions,
5¾ x 7 x 3¾" Net Price \$39.95

PRECISION Apparatus Company, Inc.
70-31 84th Street, Glendale 27, L. I., N. Y.
Export: 458 Broadway, New York 13, U. S. A.
Canada: Atlas Radio Corp., Ltd., 50 Wingold Ave., Toronto 10

Staedtler, Inc., J. S.	362	Waldes Kohinoor, Inc.	99
Standard Electronic Corp.	130, 131	Waterman Products Co., Inc.	399
Star Porcelain Co.	333	Waters Manufacturing, Inc.	362, 363
Sterling Transformer Corp.	400	Weckesser Co.	288
Stevens Arnold, Inc.	398	Welwyn International, Inc.	388
Stoddart Aircraft Radio Co., Inc.	320, 394	Wenco Manufacturing Co.	333
Stokes Machine Co., F. J.	58, 59	Westinghouse Electric Corp.	112 124, 289, 325
Stromberg-Carlson Company	273	Westlake Plastics Co.	393
Stupakoff Ceramic & Mfg. Co. Div. of the Carborundum Company	340, 341	Weston Electrical Instrument Corp.	257
Superior Electric Company	217	Wheelock Signals, Inc.	366
Superior Tube Co.	283	White Dental Mfg. Co., S. S.	358
Sylvania Electric Products, Inc.	9 285, 369	Williams & Co., C. K.	380

Taylor Fibre Co.	44	Zophar Mills, Inc.	394
Technitrol Engineering Co.	314		
Technicraft Laboratories, Inc.	274		
Technology Instrument Corp.	350		
Tektronix, Inc.	34	MANUFACTURER'S REPRESENTA- TIVES	410
Tel-Instrument Electronics Corp.	366		
Tennessee Industrial & Agricultural De- velopment Commission	375		
Tensitron, Inc.	404		
Thompson Products, Electronics Division	349		
Tower Construction Co.	251		
Transco Products, Inc.	198		
Transradio, Ltd.	381	PROFESSIONAL SERVICES	407
Transitron Electronic Corp.	47, 49		
Trans-Sonics, Inc.	334		
Tri-State Plastics	307		
Tung-Sol Electric, Inc.	96A, 96B, 97		

Ucinite Co.	82
Union Switch & Signal Div. of Westing- house Air Brake Company	294
United-Carr Fastener Corp.	83
United States Gasket Co.	467
U. S. Components, Inc.	387
United Air Lines	61
United Transformer Co.	2nd Cover
Universal Winding Co.	301
Vadflex Sales Co., Inc.	322
Veeder-Root, Inc.	371
Virginia Department of Conservation & Development	318

CLASSIFIED ADVERTISING

F. J. Eberle, Asst. Mgr.

SEARCHLIGHT ADVERTISING	449-462
ADVERTISERS INDEX	448
EMPLOYMENT OPPORTUNITIES	408-449
ADVERTISERS INDEX	445

This index is published as a service. Every care is taken to make it accurate, but ELECTRONICS assumes no responsibility for errors or omissions.

CONTROL FORCE MEASURING SYSTEM

that provides



1. Accurate measurements of better than 1/2%
2. Accurate measurements of pressure, force, acceleration, and position among others.
3. High gain with a frequency response of 15 cps.
4. Excellent operation under adverse environmental conditions.
5. Miniaturized and ruggedized construction.
6. Direct operation from resistive type transducers.

RADIATION Inc. Melbourne, Fla.
Orlando, Fla.
Electronics • Avionics • Instrumentation
Personnel Inquiries Invited

electronics

READER SERVICE SECTION

A method that provides readers with a . . .

"DIRECT-TO-THE-MANUFACTURER"

method of obtaining information on:

1. Products advertised in this issue
2. New Products and Literature covered in the editorial section of this issue

This direct method prevents loss of time in remailing your request from publication to manufacturer.

THESE POST CARDS ARE FOR YOUR USE 

and

HERE IS WHAT YOU DO:

1. Fill in with ink or typewriter your name, company, address and title.
2. Then fill in the name of the specific product and the page number on which it appears.
3. Place a check mark in the box or boxes applicable to your needs.
4. Tear out the postcard on the perforated lines and address it to the manufacturer(s) whose products you are interested in. Place a stamp in the box indicated and drop into the mail.

THE MANUFACTURER WILL PROMPTLY SEE THAT YOU RECEIVE THE NECESSARY PRODUCT DATA OR THAT HIS REPRESENTATIVE CALLS UPON YOU, WHICHEVER YOU DESIRE.

If there is insufficient space on the postcard for describing your problem specifically, we suggest you write to the manufacturer, spelling out your requirements in detail. Be sure your filled in postcard accompanies your letter.

THIS SERVICE IS A CONVENIENCE
FOR THE READERS OF ELECTRONICS.

Name
Company
Address
Title
Please send me further information on
(Product or Service).....

As described in ad on page..... of May 1956 Issue

..... or, Check on Page
New Product	(Name of Product or Literature)
Literature	

- I want this information for my files 
- I wish to see your representative
- Please contact me by telephone. Phone Number.....

Name
Company
Address
Title
Please send me further information on
(Product or Service).....

As described in ad on page..... of May 1956 Issue

..... or, Check on Page
New Product	(Name of Product or Literature)
Literature	

- I want this information for my files 
- I wish to see your representative
- Please contact me by telephone. Phone Number.....

Name
Company
Address
Title
Please send me further information on
(Product or Service).....

As described in ad on page..... of May 1956 Issue

..... or, Check on Page
New Product	(Name of Product or Literature)
Literature	

- I want this information for my files 
- I wish to see your representative
- Please contact me by telephone. Phone Number.....

Name
Company
Address
Title
Please send me further information on
(Product or Service).....

As described in ad on page..... of May 1956 Issue

..... or, Check on Page
New Product	(Name of Product or Literature)
Literature	

- I want this information for my files 
- I wish to see your representative
- Please contact me by telephone. Phone Number.....

ELECTRONICS
May 1956

Place
3¢
Stamp
Here

TO: _____

To the Readers

of

electronics

ELECTRONICS
May 1956

Place
3¢
Stamp
Here

TO: _____

A New Reader Service designed to provide prompt response

You, as a reader, may never have thought specifically of the viewpoint of the advertisers whose informative and up-to-date product news reaches you through the advertising pages of ELECTRONICS.

ELECTRONICS
May 1956

Place
3¢
Stamp
Here

TO: _____

They are VITALLY interested in you and your needs. You and thousands like you constitute the market and without you they cannot continue to present their product story; indeed, they cannot remain in business.

These manufacturers whose products and services are shown in this issue welcome your inquiries and your desire for more information.

ELECTRONICS
May 1956

Place
3¢
Stamp
Here

TO: _____

If your requirements are complicated and you require more space, we suggest that you write directly to the manufacturer, stating your problem in detail and asking for specific information or assistance. Be sure to include the postcard with your detailed request in order that your inquiry be given prompt and expeditious attention. Make certain that you specify which PRODUCT you are interested in if more than one appears in the advertisement.

electronics

READER SERVICE SECTION

A method that provides readers with a . . .

"DIRECT-TO-THE-MANUFACTURER"

method of obtaining information on:

1. Products advertised in this issue
2. New Products and Literature covered in the editorial section of this issue

This direct method prevents loss of time in remailing your request from publication to manufacturer.

THESE POST CARDS ARE FOR YOUR USE 

and

HERE IS WHAT YOU DO:

1. Fill in with ink or typewriter your name, company, address and title.
2. Then fill in the name of the specific product and the page number on which it appears.
3. Place a check mark in the box or boxes applicable to your needs.
4. Tear out the postcard on the perforated lines and address it to the manufacturer(s) whose products you are interested in. Place a stamp in the box indicated and drop into the mail.

THE MANUFACTURER WILL PROMPTLY SEE THAT YOU RECEIVE THE NECESSARY PRODUCT DATA OR THAT HIS REPRESENTATIVE CALLS UPON YOU, WHICHEVER YOU DESIRE.

If there is insufficient space on the postcard for describing your problem specifically, we suggest you write to the manufacturer, spelling out your requirements in detail. Be sure your filled in postcard accompanies your letter.

THIS SERVICE IS A CONVENIENCE
FOR THE READERS OF ELECTRONICS.

Name
Company
Address
Title

Please send me further information on

(Product or Service).....

As described in ad on page..... of May 1956 Issue

or, Check	
New Product on Page
Literature	(Name of Product or Literature)

- I want this information for my files
- I wish to see your representative
- Please contact me by telephone. Phone Number.....

electronics

Name
Company
Address
Title

Please send me further information on

(Product or Service).....

As described in ad on page..... of May 1956 Issue

or, Check	
New Product on Page
Literature	(Name of Product or Literature)

- I want this information for my files
- I wish to see your representative
- Please contact me by telephone. Phone Number.....

electronics

Name
Company
Address
Title

Please send me further information on

(Product or Service).....

As described in ad on page..... of May 1956 Issue

or, Check	
New Product on Page
Literature	(Name of Product or Literature)

- I want this information for my files
- I wish to see your representative
- Please contact me by telephone. Phone Number.....

electronics

Name
Company
Address
Title

Please send me further information on

(Product or Service).....

As described in ad on page..... of May 1956 Issue

or, Check	
New Product on Page
Literature	(Name of Product or Literature)

- I want this information for my files
- I wish to see your representative
- Please contact me by telephone. Phone Number.....

electronics

ELECTRONICS
May 1956

Place
3¢
Stamp
Here

TO: _____

ELECTRONICS
May 1956

Place
3¢
Stamp
Here

TO: _____

ELECTRONICS
May 1956

Place
3¢
Stamp
Here

TO: _____

ELECTRONICS
May 1956

Place
3¢
Stamp
Here

TO: _____

**For PRODUCTS
and SERVICES**

not specifically advertised
or described in the issue

of

Electronics

Consult your

1955-1956

ELECTRONICS

BUYERS' GUIDE

or

Write to:

Reader Service Department

Electronics

330 West 42nd Street

New York 36, N. Y.

Size has nothing to do with accomplishment



Inside these fully encapsulated miniature precision wire wound resistors, Daven furnishes the solution to problems presented by space limitations. A new winding technique permits the use of extremely fine sizes of resistance wire to obtain two or three times the resistance value previously supplied on a miniature bobbin. This new development more firmly establishes DAVEN's leadership in the field of miniature and standard size precision wire wound resistors.

Types and Specifications

Type	Dia.	Length	Max. Res.	Wattage Rating	Terminals
1273	1/4	5/16	400K	.1	One End #22 Gauge
1283	1/4	5/16	400K	.1	Axial #22 Gauge
1274	3/16	3/8	100K	.1	Axial #22 Gauge
1284	1/4	27/64	.5 Meg.	.25	One end #20 Gauge
1192	1/4	1	1.0 Meg.	.75	Axial #22 Gauge

- Fully encapsulated.
- Meet and exceed all humidity, salt water immersion and cycling tests as specified in MIL-R-93A, Amendment 3.
- Operate at 125°C continuous power without de-rating.

- Can be obtained in tolerances as close as $\pm 0.05\%$.
 - Standard temperature coefficient is $\pm 20\text{PPM}/^\circ\text{C}$.
- Special coefficients can be supplied on request.

For maximum resistance in minimum space:

Daven's new winding technique cuts giants down to size

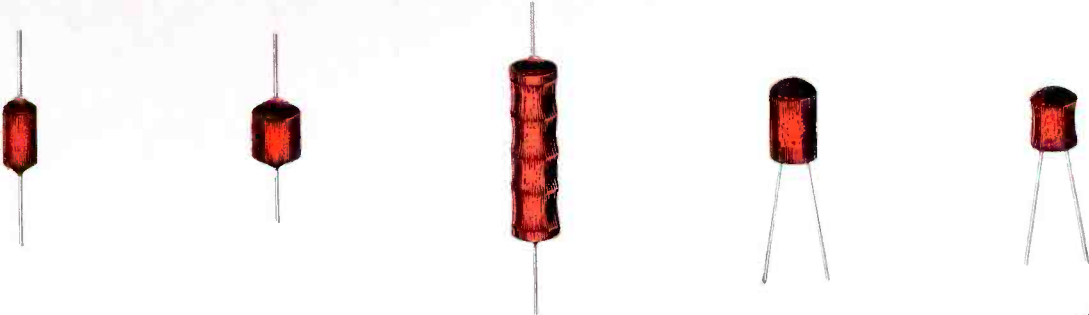

THE **DAVEN** CO.



526 West Mt. Pleasant Ave.
Route 10, Livingston, N. J.

Write for complete resistor catalog.

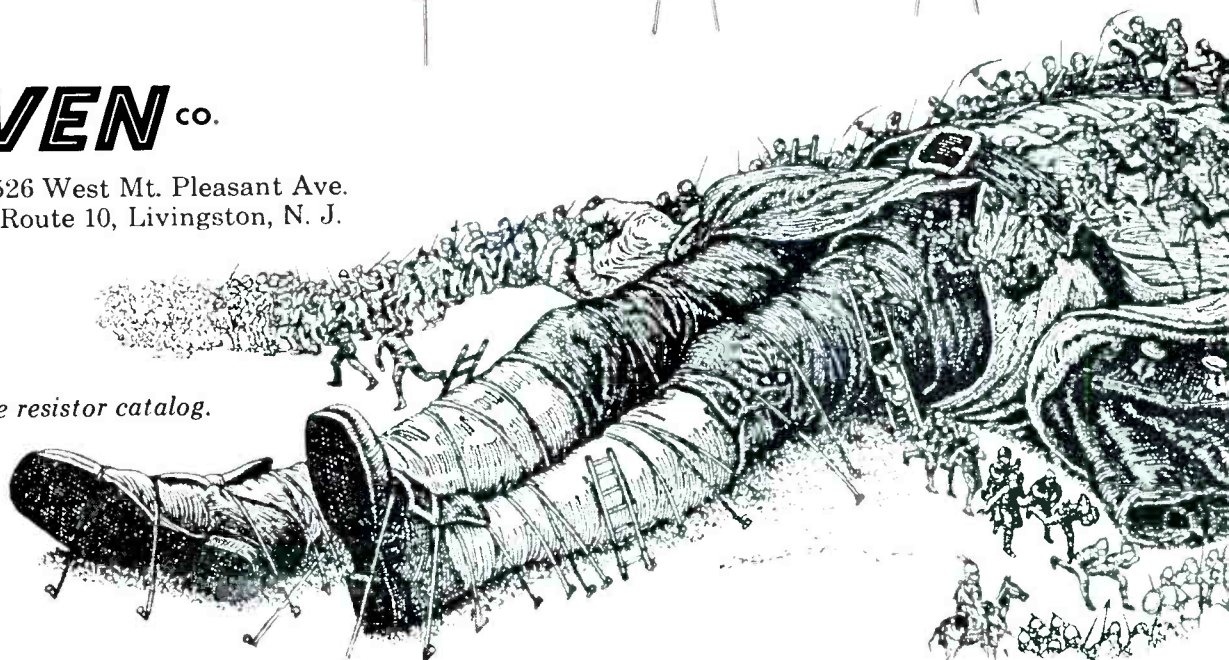

WORLD'S LARGEST MANUFACTURER OF ATTENUATORS

FIRST COMMERCIALY AVAILABLE

LOW-NOISE TRAVELING-WAVE TUBE

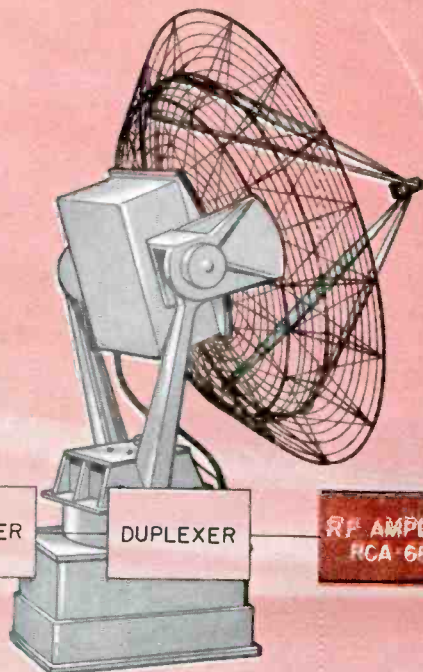

**with av. noise figure of 6.5 db
over entire 2700-3500 Mc band**



- increases S-band receiver sensitivity
- eliminates crystal "burnouts"

Now in production, RCA-6861 is a major advance in electron tube design for microwave receivers. It enables—for the first time—the practical application of low-level rf-amplifier stages in radar, scatter-propagation, and other microwave receivers, and if-amplifier stages for millimeter-wave receivers.

The unusually low noise figure of 6.5 db is obtained by the use of an RCA-designed special type of electron gun which deamplifies noise generated in the electron beam.

Sales information on sample units or quantity deliveries is available. Contact your RCA Representative at the RCA District Office nearest you.



Patterns show signal-to-noise ratio at input to S-band receiver's crystal detector with and without a stage of rf amplification. Utilizing RCA-designed-and-developed type 6861 Traveling-Wave Tube, high signal-to-noise ratio and extended range are obtained. In addition, crystal "burnouts" caused by TR-tube leakage are eliminated by the isolation afforded by the rf stage.

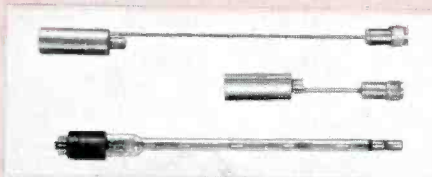

Glass portion of RCA-6861 is enclosed with rf-input and rf-output transducers in tubular metal capsule. Transducers are factory-set for optimum tube performance; require no adjustment in the field. Capsule has terminals which fit the standard octal socket.

RCA-6861 DATA	
Heater Voltage	5.0 ± 5% volts
Collector Voltage	400 volts
Collector Current	150 μ a max.
Magnetic Field*	525 gauss
Noise Figure	6.5 db
Gain	25 db
Frequency Range	2700 to 3500 Mc

*field supplied by RCA solenoid Dev. No. 1-2006, or equivalent.



RCA DISTRICT OFFICES

EAST: HUmboldt 5-3900
744 Broad Street
Newark 2, N. J.

MIDWEST: WHitehall 4-2900
Suite 1181
Merchandise Mart Plaza
Chicago 54, Ill.

WEST: RAymond 3-8361
6355 East Washington Boulevard
Los Angeles 22, Calif.

For technical data on RCA-6861, write RCA, Commercial Engineering, Section E19Q, Harrison, N. J.



RADIO CORPORATION OF AMERICA
TUBE DIVISION
HARRISON, N. J.