

JUNE · 1955

PRICE 75 CENTS

electronics

A M E G R A W - H I L L P U B L I C A T I O N

6/1

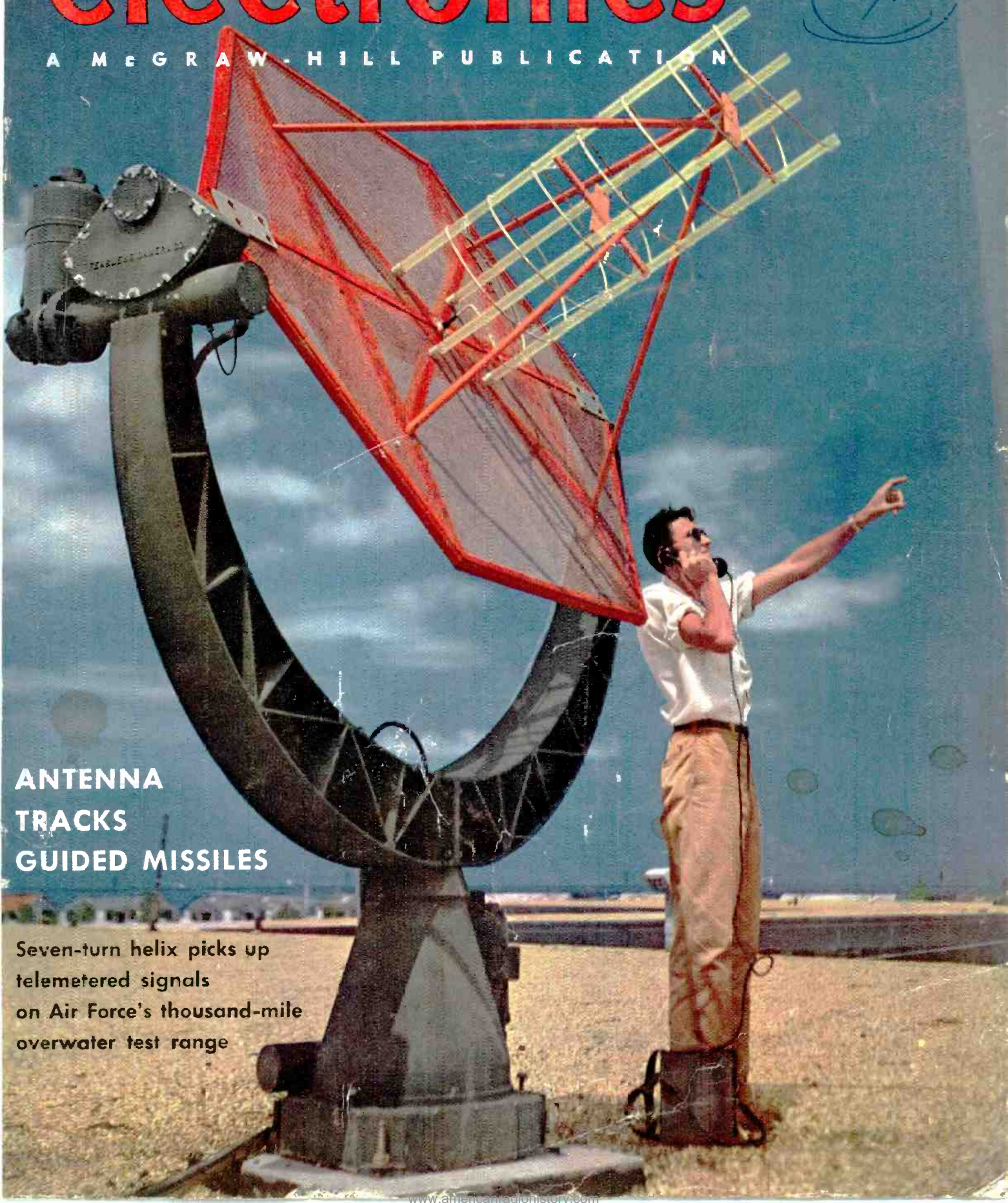

ANTENNA TRACKS GUIDED MISSILES

Seven-turn helix picks up
telemetered signals
on Air Force's thousand-mile
overwater test range

THE STANDARD OF COMPARISON FOR OVER 20 YEARS

HIGH FIDELITY TRANSFORMERS

FROM STOCK... ITEMS BELOW AND 650 OTHERS IN OUR CATALOGUE B.



TYPICAL UNITS

LINEAR STANDARD series

Linear Standard units represent the acme from the standpoint of uniform frequency response, low wave form distortion, thorough shielding and dependability. LS units have a guaranteed response within 1db. from 20 to 20,000 cycles.

Hum balanced coil structures and multiple alloy shielding, where required, provide extremely low inductive pickup.

These are the finest high fidelity transformers in the world. 85 stock types from milliwatts to kilowatts.

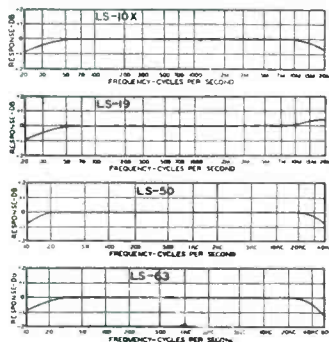

LS-10X Shielded Input
Multiple line (50, 200, 250, 500/600, etc.) to 50,000 ohms... multiple shielded.

LS-19 Plate to Two Grids
Primary 15,000 ohms.
Secondary 95,000 ohms C.T.

LS-50 Plate to Line
15,000 ohms to multiple line... +15 db. level.

LS-63 P.P. Plates to Voice Coil
Primary 10,000 C.T. and 6,000 C.T. suited to Williamson, MLF, ul-linear circuits.
Secondary 1.2, 2.5, 5, 7.5, 10, 15, 20, 30 ohms. 20 watts.



CASE	LS-1	LS-2	LS-3
Length	3 1/8"	4 7/16"	5-13/16"
Width	2 5/8"	3 1/2"	5"
Height	3 1/4"	4 3/16"	4-11/16"
Unit Wt.	3 lbs.	7 1/2 lbs.	15 lbs.

HIPERMALLOY series

This series provides virtually all the characteristics of the Linear Standard group in a more compact and lighter structure. The frequency response is within 1 db. from 30 to 20,000 cycles. Hipermalloy nickel iron cores and hum balanced core structures provide minimum distortion and low hum pickup. Input transformers, maximum level +10db. Circular terminal layout and top and bottom mounting.

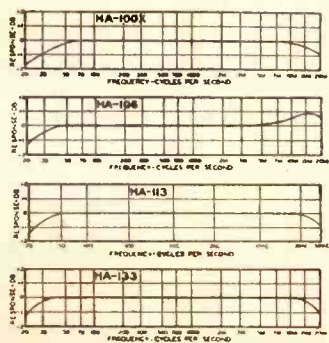

HA-100X Shielded Input
Multiple line to 60,000 ohm grid... tri-alloy shielding for low hum pickup.

HA-106 Plate to Two Grids
15,000 ohms to 135,000 ohms in two sections... +12 db. level.

HA-113 Plate to Line
15,000 ohms to multiple line... +12 db. level... 0 DC in primary.

HA-133 Plate (DC) to Line
15,000 ohms to multiple line... +15 db. level... 8 Ma. DC in primary.



Case	H-1	H-2
Length	2 3/8"	3-9/16"
Width	1-5/16"	2-13/16"
Height	3 1/8"	3 1/2"
Unit Weight	2 lbs.	5 lbs.

ULTRA COMPACT series

UTC Ultra Compact audio units are small and light in weight, ideally suited to remote amplifier and similar compact equipment. The frequency response is within 2 db. from 30 to 20,000 cycles. Hum balanced coil structure plus high conductivity die cast case provides good inductive shielding. Maximum operating level is +7db. Top and bottom mounting as well as circular terminal layout are used in this series as well as the ones described above.

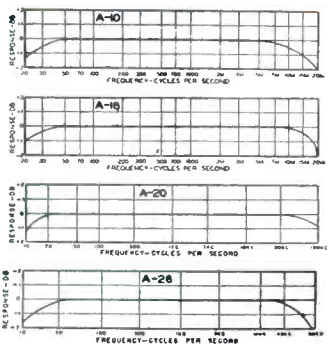

A-10 Line to Grid
Multiple line to 50,000 ohm grid.

A-18 Plate to Two Grids
15,000 ohms to 80,000 ohms, primary and secondary both split.

A-20 Mixing Transformer
Multiple line to multiple line for mixing mikes, lines, etc.

A-26 P.P. Plates to Line
30,000 ohms plate to plate, to multiple line.



A CASE	
Length	1 1/2"
Width	1 1/2"
Height	2"
Unit Weight	3/2 lb.

OUNCER series

UTC Ouncer units are ideal for portable, concealed service, and similar applications. These units are extremely compact... fully impregnated and sealed in a drawn housing. Most items provide frequency response within 1 db. from 30 to 20,000 cycles. Maximum operating level 0 db. These units are also available in our stock P series which provide plug-in base. The O-16 is a new line to grid transformer using two heavy gauge hipermalloy shields for high hum shielding.

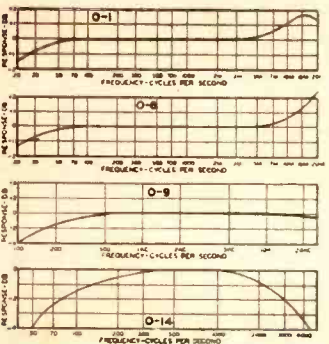

O-1 Line to Grid
Primary 50, 200/250, 500/600 ohms to 50,000 ohm grid.

O-6 Plate to Two Grids
15,000 ohms to 95,000 ohms C.T.

O-9 Plate (DC) to Line
Primary 15,000 ohms, Secondary 50, 200/250, 500/600.

O-14 50: 1 Line to Grid
Primary 200 ohms, Secondary .5 megohm for mike or line to grid.



OUNCER CASE	
Diameter	7/8"
Height	1-3/16"
Unit Weight	1 oz.

SPECIAL UNITS TO YOUR NEEDS

If you manufacture high fidelity gear, send your specifications for prices.

UNITED TRANSFORMER CO.

150 Varick Street, New York 13, N. Y. EXPORT DIVISION: 13 E. 40th St., New York 16, N. Y. CABLES: "ARLAB"

H. W. MATEER, *Publisher*

W. W. MacDONALD, *Editor*

VIN ZELUFF, *Managing Editor*

JOHN MARKUS, *Associate Editor*

ALEXANDER A. MCKENZIE, *Associate Editor*

JOHN M. CARROLL, *Associate Editor*

WILLIAM P. O'BRIEN, *Assistant Editor*

WILLIAM G. ARNOLD, *Assistant Editor*

DAVID A. FINDLAY, *Assistant Editor*

HAIG A. MANOOGIAN, *Assistant Editor*

EDMUND B. PALMQUIST, *Assistant Editor*

JANE CHRISTIE, *Editorial Assistant*

GLORIA J. FILIPPONE, *Editorial Assistant*

ARLENE SCHILP, *Editorial Assistant*

GLADYS T. MONTGOMERY, *Washington Editor*

HARRY PHILLIPS, *Art Director*

ELEANORE LUKE, *Art Assistant*

WALLACE B. BLOOD, *Manager*

R. S. QUINT, *Buyers' Guide Manager*

FRANK H. WARD, *Business Manager*

GEORGE E. POMEROY, *Classified Manager*

DONALD H. MILLER, *New York*

JAMES GIRDWOOD, *New York*

WM. S. HODCKINSON, *New England*

JAMES T. HAUPTLI, *Philadelphia*

CHARLES WARDNER, *Chicago*

BRUCE WINNER, *Chicago*

HENRY M. SHAW, *Cleveland*

T. H. CARMODY, *San Francisco*

R. C. ALCORN, *San Francisco*

CARL W. DYSINGER, *Los Angeles*

WM. D. LANIER, *Atlanta*

JAMES H. CASH, *Dallas*

KEITH HENNEY, *Consultant*

ANTENNA TRACKS GUIDED MISSILES—Helical array with ground plane provides from 11.4 to 12.0-db average power gain above an isotropic type at Air Force Missile Test Center, Patrick Air Force Base, Florida (See p 164).....COVER

SHOPTALK 2

FIGURES OF THE MONTH 6

INDUSTRY REPORT 7

Bankers See Industry Healthy.....	7	Arizona Wants Plants.....	16
Transistor Radio Hits Market.....	7	Taxi Radio Market Grows.....	20
Tape Used For Network Color.....	8	Punchcards Batch Concrete Mix.....	20
Industry Stresses Reliability.....	8	Traveling-Wave Tubes Grow Up.....	22
Magnetic Memory Goes Juke Box.....	10	Fire Alarms Go Radioactive.....	22
Manufacturers Eye Sales Cost.....	10	F-M Subsidiaries Subsidize F-M.....	22
Broadcasters Make Progress.....	12	Radar Folds Into Floor.....	24
Oil Firms Team With Electronics.....	14	Tubes Moving Underground.....	24
Capacitor Makers To Up Output.....	14	Financial Roundup.....	24
Armed Forces TV Comes Of Age.....	16	Future Meetings.....	26
Industry Shorts.....	26		

CROSSTALK 121

FEATURES

Electronic Computers for the Businessman..... 122
By John M. Carroll

Directly Coupled Transistor Circuits..... 132
By Ralph H. Beter, William E. Bradley, Ralph B. Brown and
Morris Rubinoff

Alloy Improves Magnetic Recording..... 137
By Carroll W. Lufcy and Wesley T. Heath

How to Design Sailboat Antennas..... 140
By Elbert Robberson

Color-Video Envelope-Delay Measurement..... 144
By Ralph C. Kennedy and Hubert French

Waveform Generator Uses Pulse Techniques..... 149
By E. E. Newhall

Electronic Weighing on the Production Line..... 152
By R. E. Bell and J. A. Ferstle

Getting the Most From Mobile Radio..... 156
By Alexander A. McKenzie

CONTINUED ON NEXT PAGE

contents

continued

SHOP

Capacitive Transducer Has Low Impedance.....	161
By Henry P. Kalmus	
Antenna System for Missile Telemetering.....	164
By Garth E. Bower and James B. Wynn, Jr.	
Industrial Microwave Calibrator.....	168
By J. G. Vogler and H. E. Stinehelfer, Sr.	
Kerr-Cell Shutter Has Submicrosecond Speeds.....	171
By William Q. Nicholson and Irving Ross	
Tracing Electron Paths (Reference Sheet).....	174
By William J. Spaven	
Delay-Line Design (Reference Sheet).....	176
By Joseph F. Sodaro	

ELECTRONS AT WORK 178

Navigating By Carrier-Based TACAN.....178	Dominion Time Signals.....196
Automatic Blood Pressure Recorder.....178	Bovine Gyration Measured.....198
Data Processor for Ram Jets.....180	Ionization Chamber Detects Fires.....200
Spider Antenna Can Beam Signals.....180	Lathe Speed Constant.....204
Table Receiver Uses AFC For F.M.....180	Alfenol Sources.....208
Solar Battery Efficiency Doubled.....182	Radar Cane Guides Sightless.....208
Canadian Observatory Talking Clock.....182	Evaporated Magnetic Materials.....210
Small Airport ADF.....184	Experimental Radio Link.....218
Low-Frequency Sound Reducer.....188	Facsimile Speeds Plant Messages.....222
Radio Control Gives Right-of-Way.....194	

PRODUCTION TECHNIQUES 224

Silk-Screening Selenium Rectifiers.....224	Applying Selenium to Rectifier Cells.....242
Testing Ceramic Capacitors.....224	Value-Averaging Device.....246
Mechanized Speaker Magnet Testers.....225	Drill-Press Extrusion of Tube Grids.....250
Transparent Covers For Charts.....230	Automatic Electroplater for Rectifiers.....260
Assembling Selenium Rectifiers.....232	Chassis-Holding Fixture.....264
Electric Punch for Plug-Nuts.....234	Draining Setup for Dipped Rectifiers.....266
Automatic Aluminizer for TV Tubes.....236	

NEW PRODUCTS 268

LITERATURE 328

PLANTS AND PEOPLE 342

NEW BOOKS 372

THUMBNAIL REVIEWS 379

BACKTALK 382

INDEX TO ADVERTISERS 427

WHAT EDITORS DO—The author of this month's opening feature article, about computers for the businessman, started gathering material last November when he wrote to 63 companies that were suspected of having models available or planned.

Of the 63 companies, 29 replied they were not in the business, 24 furnished information and 10 didn't answer several requests for data. The tables in the article list 38 computers made by 24 firms.

On subsequent visits to eight plants, four special demonstrations, three seminars and a number of trade shows Jack Carroll saw one-third of the machines in actual operation. He just about lived with his subject for nearly three months, while simultaneously carrying on many other routine yet demanding duties.

TALE OF AN ARTICLE—The road from author's research to published feature article is a long, and often tortuous one. Our departmental editors are particularly proud of their functions as literary Samaritans, helping a technical tale along the way.

A case in point is the story of Alfenol, the high-permeability nickel-iron alloy that first saw the light of print in *Electrons At Work* (p 222, Aug. 1953) with a follow-up on p 210, Nov. 1954.

While the departmental editor was busy answering inquiries for procurement details (a half dozen

electronics

JUNE, 1955

Vol. 28, No. 6



Member ABC and ABP

TALK

from foreign countries, included) he carried on negotiations with potential authors through our Washington editor.

The result is the article by Lucy and Heath that appears on page 137 of this issue. We are proud to have helped bring our readers information on a new material that is already finding a place in high-quality recording and reproducing of tape signals.

INDUSTRY PROGRESS — One sign of healthy engineering activity is the number of new products that reach the market. Musing about this aroused curiosity so we asked assistant editor Bill O'Brien for some data.

Companies in the field supplied us with 781 items for NP and Lit in the first six issues of this year. During the same period of 1954, the score was 650.

Last year's designs are this year's products, and there are more of them.

DOUBLE TALK—Many years ago **ELECTRONICS** adopted certain abbreviations for common technical terms and some simple rules for abbreviating new phrases when they were coined by engineers in the industry.

Having used these abbreviations for so long we were positive that there could never be confusion with other meanings, particularly with such terms as a-c and d-c.

But computer engineers are now

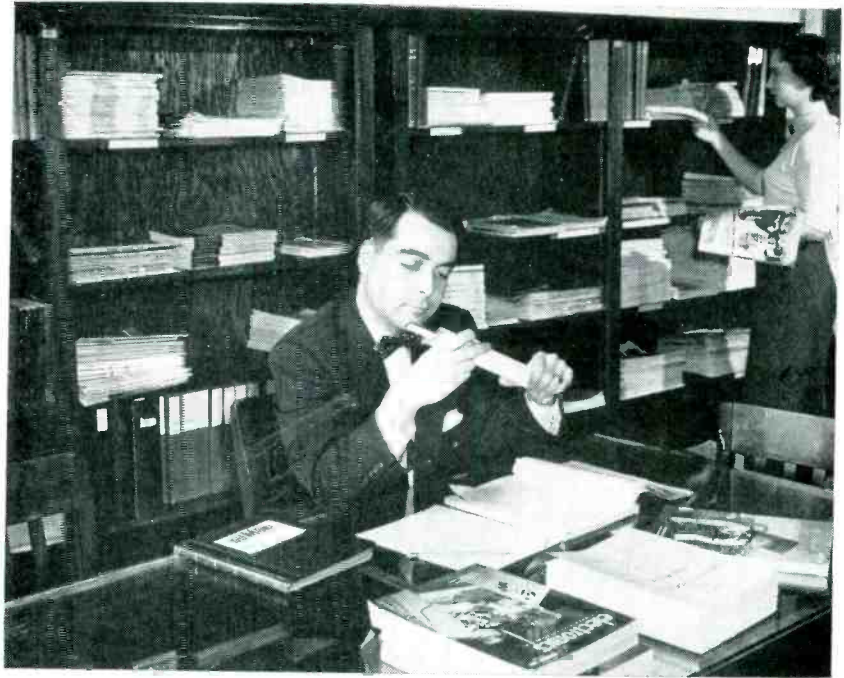

OUR COMMENT on the eleven feet of shelf space that 25 years of **ELECTRONICS** takes up (March Shoptalk) brought in this view of part of the technical library in the Du Mont Research Division plant, Passaic, N. J. Engineer Jesse Haines checks through a television engineering article in a recent issue while a librarian replaces copies in the extensive file maintained for engineers and technicians

tilting our apple cart. They talk about a-c input, meaning analog computer input, and d-c output for digital computer output.

FOR JULY—Those familiar with modern pipe organs tell us that "full organ" operation employs couplers that permit playing all stops from one manual and also automatically provide a multiplicity of notes. Sixty ranks of pipes when played with all the couplers produce a tremendous

ensemble, bringing into play thousands of individually blown pipes. To match such an effect electronically is indeed a difficult task and some experts have been of the opinion that it is next to impossible.

How it was accomplished by engineers at one company will be described in a feature article next month. To whet your curiosity, we can reveal that one of the techniques involves rotating the loudspeakers!

Published monthly with an additional issue in June by McGraw-Hill Publishing Company, Inc., James H. McGraw (1860-1948), Founder, Executive, Editorial and Advertising Offices: McGraw-Hill Building, 330 W. 42 St., New York 36, N. Y., Longacre 4-3000. Publication Office, 99-129 North Broadway, Albany 1, N. Y., Donald C. McGraw, President; Paul Montgomery, Executive Vice-President; Joseph A. Gerardi, Vice-President and Treasurer; John J. Cooke, Secretary; Nelson Bond, Executive Vice-President, Publications Division; Ralph B. Smith, Vice-President and Editorial Director; Joseph H. Allen, Vice-President and Director of Advertising; J. E. Blackburn, Jr., Vice-President and Circulation Director.

Subscriptions: Address correspondence to **Electronics**—Subscription Service, 330 W. 42nd St., New York 36, N. Y. Allow one month for change of address. Subscriptions are solicited only from persons engaged in theory, research, design, production, maintenance and use of electronic and industrial control components, parts and end products. Position and company connection must be indicated on subscription orders.

Single copies 75¢ for United States and possessions, and Canada; \$1.50 for Latin America; \$2.00 for all other foreign countries. Buyers' Guide \$3.00. Subscription rates—United States and possessions, \$6.00 a year; \$9.00 for two years. Canada, \$10.00 a year; \$16.00 for two years. Other western hemisphere countries and the Philippines, \$15.00 a year; \$25.00 for two years. All other countries \$20.00 a year; \$30.00 for two years. Three-year rates, accepted on renewals only, are double the one-year rate. Entered as second-class matter August 29, 1936, at the Post Office at Albany, N. Y., under act of Mar. 3, 1879. Printed in U.S.A. Copyright 1955 by McGraw-Hill Publishing Co. Inc.—All Rights Reserved.

BRANCH OFFICES: 520 North Michigan Avenue, Chicago 11, Ill.; 63 Post Street, San Francisco 4; McGraw-Hill House, London, E. C. 4; Washington, D. C. 4; Philadelphia 3; Cleveland 15; Detroit 26; St. Louis 8; Boston 16; 1321 Rhoads-Haverty Bldg.; Atlanta 3, Ga.; 1111 Wilshire Blvd., Los Angeles 17; 738-9 Oliver Building, Pittsburgh 22. **ELECTRONICS** is indexed regularly in The Engineering Index.

NEW! NEW! NEW!
250VA & 500VA units now available!

MAGNETIC VOLTAGE REGULATORS

These Magnetic Voltage Regulators, or Regulating Transformers, are the first units in a comprehensive line of equipment of this type being developed by Sorensen. They are primarily intended for incorporation into other equipment, where performance becomes more effective when the incoming line voltage is stabilized. However, they can be used as auxiliary line stabilizers.

~~The units now available have capacities of 15, 30, 60, and 120 VA. Soon to be added will be units of 250, 500, and 1000 VA capacities.~~

WRITE FOR NEW CATALOG MVR2

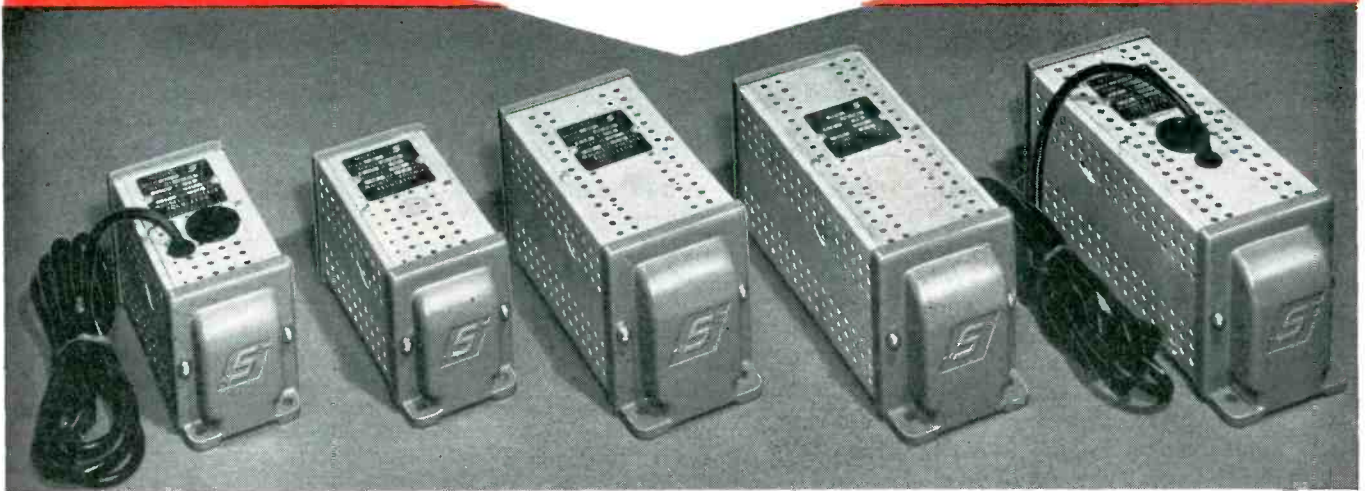

ELECTRICAL SPECIFICATIONS

Input voltage range	95-130 VAC, 1 ϕ , 60 cycles.
Output range	115 VAC, RMS, 1 ϕ .
Regulation accuracy	$\pm 0.5\%$ against line changes.
Load conditions	$\pm 0.5\%$ against line at any given load from 0 to full load.
Time constant	From 2 to 6 cycles for line changes.

MECHANICAL SPECIFICATIONS

Model MVR15	Length	6 $\frac{1}{2}$ "	Width	2 $\frac{7}{8}$ "	Height	3 $\frac{1}{2}$ "
Model MVR30	Length	6 $\frac{1}{2}$ "	Width	2 $\frac{7}{8}$ "	Height	3 $\frac{1}{2}$ "
Model MVR60	Length	8 $\frac{1}{8}$ "	Width	3 $\frac{1}{2}$ "	Height	4 $\frac{1}{4}$ "
Model MVR120	Length	9 $\frac{3}{8}$ "	Width	3 $\frac{1}{2}$ "	Height	4 $\frac{1}{4}$ "
Model MVR250	Length	11 $\frac{3}{4}$ "	Width	4 $\frac{7}{8}$ "	Height	6 $\frac{1}{2}$ "
Model MVR500	Length	14 $\frac{1}{8}$ "	Width	4 $\frac{1}{8}$ "	Height	6 $\frac{1}{2}$ "

Since Sorensen is now offering a new type of line voltage regulator, your inquiries regarding special requirements in magnetic voltage regulators will be welcomed. Write to the Sales Engineering Department, Sorensen & Co., Inc., 375 Fairfield Avenue, Stamford, Conn.

SORENSEN

SORENSEN & CO., INC., 375 FAIRFIELD AVENUE, STAMFORD, CONN.

A HIGH FREQUENCY HYSTERESIS MOTOR

—WITH BUILT-IN GEAR BOX



The practical uses of a hysteresis motor designed for high frequency operation have hitherto been restricted by the high rotor speed of this type of motor. The Muirhead D-565-G Hysteresis Motor employs an integral gearbox so that although the rotor speed is 10,000 rev/min when operating from a 1000 c/s supply, the output spindle speed is only 720 rev/min — a convenient speed for many applications.

The motor may be supplied from a single-phase push-pull amplifier using a phase splitting capacitor in the output. The tuning may be adjusted to vary the relationship between the pull-in and the pull-out torque.



Power supply	- - - - -	- 50V, 0.4A at 1000 c/s	Output spindle speed	-	720 rev/min
Maximum pull-out torque	-	Not less than 9 oz in (650 gm cm)	Full load efficiency	- -	30%
Maximum pull-in torque	-	Not less than 2.5 oz in (180 gm cm)	Weight	- -	1¼ lb (0.6 kg)



PRECISION ELECTRICAL INSTRUMENTS

WRITE UNDER YOUR BUSINESS LETTERHEAD FOR PUBLICATION 7717

MUIRHEAD & CO. LIMITED • BECKENHAM • KENT • ENGLAND

Sales and Service U.S.A.

MUIRHEAD INSTRUMENTS INC • 677 FIFTH AVENUE • NEW YORK 22, • N. Y.

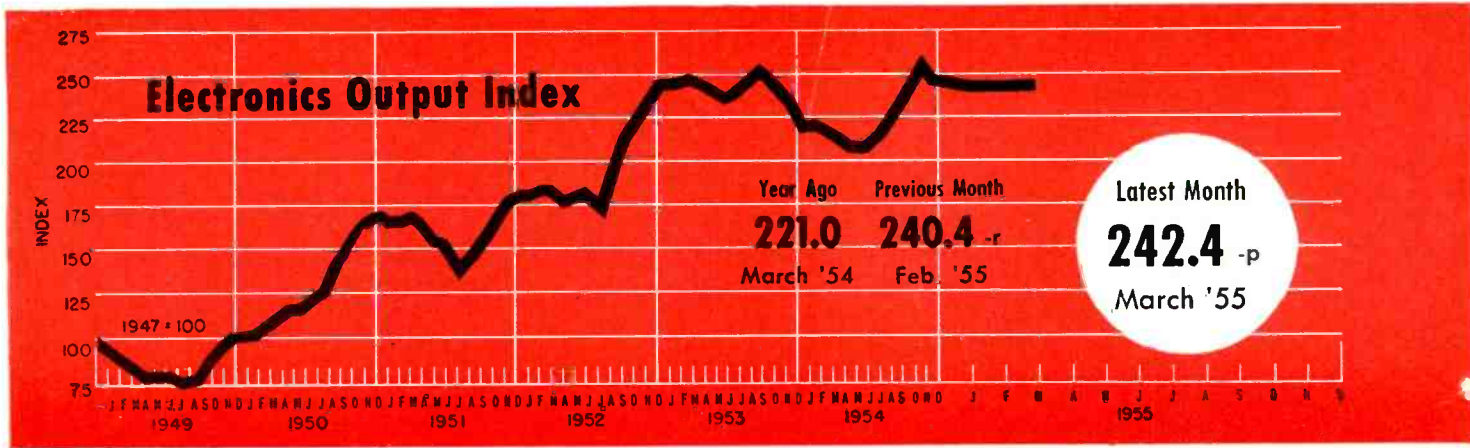

FIGURES OF THE MONTH

	Latest Month	Previous Month	Year Ago		Latest Month	Previous Month	Year Ago
RECEIVER PRODUCTION				TV SETS INSTALLED			
(Source: RETMA)				(Source: NBC Research Dept.)			
Television sets, total	831,156	702,514	599,606	Total sets	35,028,000	34,364,000	29,125,000
With UHF	115,726	101,217	124,855	BROADCAST STATIONS			
Color sets	nr	nr	nr	(Source: FCC)			
Radio sets, total	1,482,274	1,089,724	940,352	TV stations on air	453	451	387
With F-M	23,859	17,751	19,693	TV stations CPs—not on air	121	122	190
Home sets	300,840	232,831	244,110	TV stations—new requests	18	20	52
Clock radios	173,944	150,031	119,863	A-M stations on air	2,717	2,703	2,563
Portable sets	233,465	109,120	206,130	A-M stations CPs—not on air	98	103	112
Auto sets	774,025	597,742	370,249	A-M stations—new requests	201	194	158
RECEIVER SALES				COMMUNICATION AUTHORIZATIONS			
(Source: RETMA)				(Source: FCC)			
Television sets, units	669,794	626,613	512,861	Aeronautical	40,991	42,048	43,324
Radio sets (except auto)	451,049	320,042	486,034	Marine	49,212	48,977	44,598
RECEIVING TUBE SALES				Police, fire, etc.			
(Source: RETMA)				Industrial			
Receiv. tubes, total units	41,080,881	38,526,796	29,063,484	Land transportation	7,453	7,318	6,758
Receiv. tubes, value	\$29,922,192	\$28,107,186	\$22,130,627	Amateur	132,959	130,642	118,750
Picture tubes, total units	882,268	859,529	759,468	Citizens radio	10,557	9,916	5,612
Picture tubes, value	\$17,246,843	\$17,119,568	\$15,904,687	Disaster	313	312	259
SEMICONDUCTOR SALES				Experimental			
(Source: SEMA)				Common carrier			
Germanium diodes, units	1,649,126	1,403,940	815,824	EMPLOYMENT AND PAYROLLS			
Silicon diodes, units	nr	nr	nr	(Source: Bur. Labor Statistics)			
INDUSTRIAL TUBE SALES				Prod. workers, comm. equip.			
(Source: NEMA)				Av. wkly. earnings, comm.			
Vacuum (non-receiving)	\$9,338,181	\$8,803,740	\$9,467,331	Av. wkly. earnings, radio			
Gas or vapor	\$3,498,123	\$3,570,586	\$4,854,222	Av. wkly. hours, comm.			
Phototubes	nr	nr	\$405,000	Av. wkly. hours, radio			
Magnetrons and velocity modulation tubes	\$15,249,651	\$13,112,244	\$13,073,095	STOCK PRICE AVERAGES			
Gaps and T/R boxes	\$1,788,780	\$1,476,407	\$1,707,730	(Source: Standard and Poor's)			
Quarterly Figures				Radio-tv & electronics			
Latest Quarter	Previous Quarter	Year Ago		Radio broadcasters			
4th '54	3rd '54	4th '53		p—provisional; r—revised			
				nr—not reported			

FIGURES OF THE YEAR

Television set production	2,188,252	1,447,110	+ 51.2	7,346,715
Radio set production	3,640,144	2,581,565	+ 41.0	10,400,530
Television set sales	1,943,992	1,780,795	+ 9.2	7,317,034
Radio set sales (except auto)	1,246,038	1,059,336	+ 17.6	6,430,743
Receiving tube sales	117,557,439	76,385,978	+ 53.9	385,089,458
Cathode-ray tube sales	2,608,753	1,962,864	+ 32.9	9,913,504

TOTALS FOR FIRST THREE MONTHS

	1955	1954	Percent Change	1954 Total
Television set production	2,188,252	1,447,110	+ 51.2	7,346,715
Radio set production	3,640,144	2,581,565	+ 41.0	10,400,530
Television set sales	1,943,992	1,780,795	+ 9.2	7,317,034
Radio set sales (except auto)	1,246,038	1,059,336	+ 17.6	6,430,743
Receiving tube sales	117,557,439	76,385,978	+ 53.9	385,089,458
Cathode-ray tube sales	2,608,753	1,962,864	+ 32.9	9,913,504

INDUSTRY REPORT

electronics—June • 1955

Bankers Pronounce Industry Healthy

Returns on net assets and net sales take an upturn for the first time since 1950

INCREASED profits enjoyed by many manufacturers in 1954 due to expiration of excess profits taxes, tax-law changes and good business during the last quarter, helped to reverse a downward trend of sales margins and returns on net assets that had been evident since 1950.

► **Assets Rise**—The chart, based on the tabulation of 78 companies in radio-tv electrical equipment field by First National City Bank of New York shows a trend to even better returns. In 1953 total income was \$457.7 million compared to \$516.5 in 1954, a 13-percent gain. Total book net assets rose to \$3.3 billion in 1954 compared to \$3.0 billion in 1953.

In percent margin on sales, all manufacturing earned an average profit of 5.9 percent of sales in 1954. In the electronics field the percentage was 5.0.

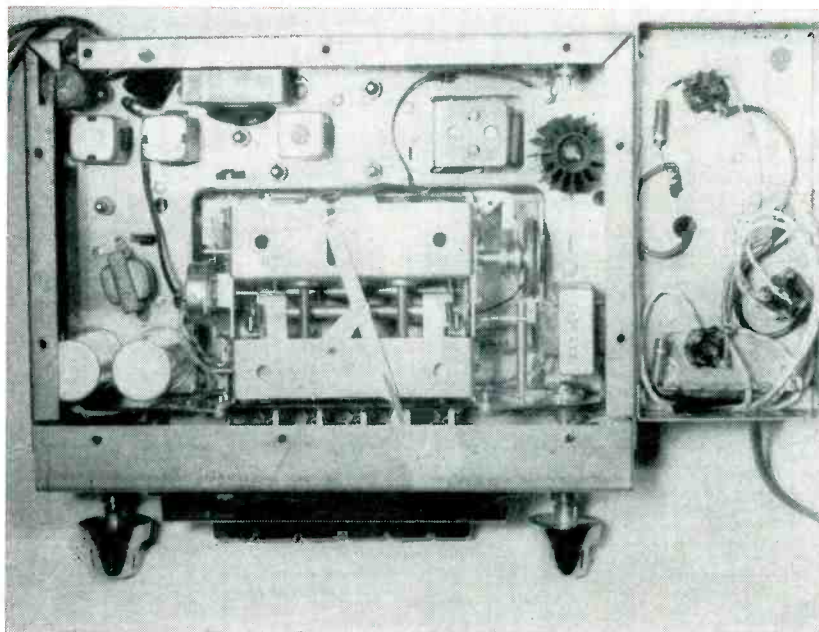
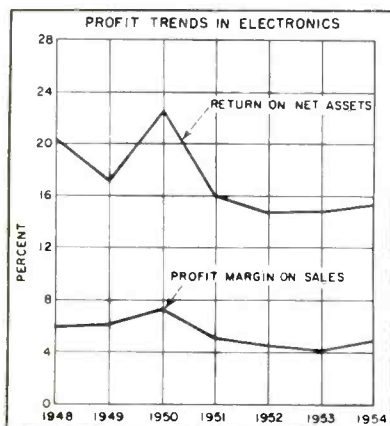

AUTO RADIO utilizing 11 transistors promised by Philco as . . .

New Transistor Radio Hits Market

Three more companies announce plans for producing commercial models

A POCKET radio containing two transistors and three vacuum tubes that weighs less than a pound and is priced at \$44, has been introduced by Emerson.

Motorola plans to announce its first transistor car radio models early in 1956.

A transistor auto radio, jointly developed by Philco and Chrysler, will be available in limited quantities as special optional equipment on 1956 model Chrysler and Imperial automobiles.

► **Auto**—The Philco set, in which 11 surface-barrier transistors will go into

production as soon as tooling has been completed at the firm's plant in Sandusky, Ohio. The set requires less than one tenth of the battery power used by its predecessors. Reduction in size is accomplished not only by the use of transistors but also by the elimination of the vibrator, power transformer and rectifier. These parts are said to account for 85 percent of car radio failures.

► **Volts**—Whereas in conventional auto sets a B voltage of about 250 is required, the new transistor auto radio requires only 12 volts, battery voltage of the cars in which it will be installed. Current drawn by the radio is 90 percent less than by conventional tube sets. The unit, drawing between 0.2 and 0.3 ampere, will run continuously for

140 hours on a 12-volt battery such as Chrysler uses without recharging. Conventional sets which draw four amperes perform only about 10 hours under identical conditions.

Chrysler reports that the new radio is 20 percent smaller than the equivalent tube set. Eventually it expects these transistor sets to be only one-fifth as large as present

sets. It is reported that the new set will sell for approximately \$150 and that it may become available for Chrysler's other car lines by 1957.

Tape Used For Color TV On Network

Closed-circuit demonstration with prototype magnetic recorder opens new market

A TAPE-RECORDED color program transmitted over commercial microwave network facilities gave guests at Minnesota Mining's research center dedication a preview of practical color programming across the time zones, for hourly repeats as the sun rolls westward.

The 15-minute telecast came from a reel of half-inch tape on RCA's new color recorder at NBC studios in New York, and traveled by closed-circuit microwave to the new 3M laboratory in St. Paul, Minn., for viewing on six 21-inch receivers.

► **Progress**—After Brig. General David Sarnoff congratulated 3M "over the ribbons of vinyl" for developing the magnetic tape that helped make the video demonstration possible, Dr. Harry F. Olson gave a progress report on electronic photography. Tape speed has been reduced to 20 feet per second, permitting storage of an entire 15-minute program on a 20-inch reel.

An improved servo system holds tape speed variations down to less than one part in five million to minimize line jitter in the picture. Multiple magnetic heads and amplifiers have been improved to reproduce a bandwidth of over 3 mc at the new reduced speed. However, still further improvements were promised both in the machine and in tape resolution before the commercial version is brought out.

► **Future**—Developments to date point to the feasibility of merchandising 3-minute tapes of popular song hits, with performers in full color, for playing on a color tv set through an attachment selling for less than \$500.

In all tv tape recorder applica-

tions, cost savings could result from re-use of tape after erasing to make it sufficiently advantageous in comparison to film.

It is expected that the motion picture industry will make greater use of magnetic tape, eventually recording both picture and sound on the medium.

From this RCA recorder at NBC studios came the tape-recorded color tv program sent over commercial network facilities, for closed circuit showing at the dedication of the new 3M research center



Industry Stresses Reliability

DESPITE substantial gains in component reliability, the need for more reliable military electronic equipment is continuing to grow. At a symposium conducted in Los Angeles by the Radio Technical Commission for Aeronautics and the IRE it was revealed that one

complex airborne electronic equipment required 3 hours of maintenance for every hour it was operable. The average annual cost of electronics maintenance in the armed forces is twice the original cost of the equipment.

► **Why**—Department of Defense studies on causes of unreliability show that about 1/3 of the failures are due to operational conditions, 1/3 to manufacturing defects and 1/3 to design deficiencies.

► **Complexity**—Effect of complexity on the reliability of military electronics was discussed by W. A. MacDonald, board chairman of Hazeltine Electronics. In 1940 the reliability factor of a simple one-tube electronic circuit and its related elements was 82 percent and in 1955, 98 percent (upper chart). But during the same period the increase in the number of circuits in a typical piece of military equipment has been substantial, as indi-

(Continued on page 10)

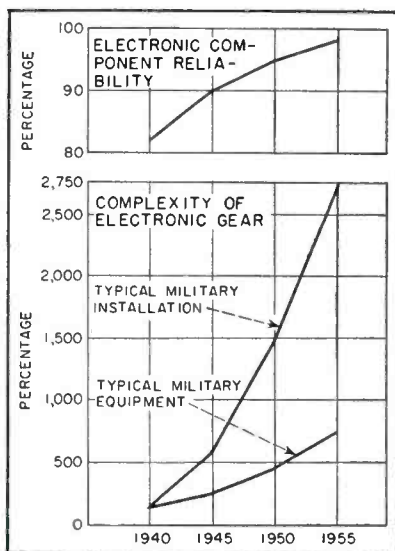

For
maximum flexibility
 in your equipment
 design and layout

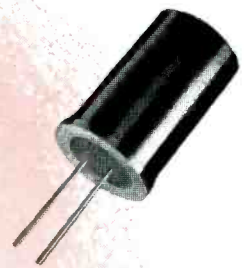

SINGLE-ENDED
 with leads
 clipped for
 socket mounting



DOUBLE-ENDED
 for soldered-in
 applications

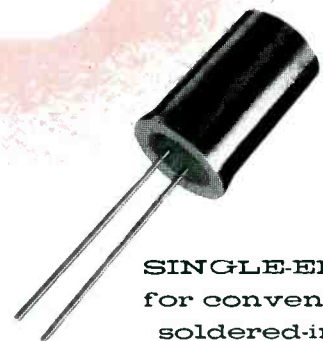

SINGLE-ENDED
 for conventional
 soldered-in use

Sylvania offers you a choice in **Silicon Junction Diodes**

featuring

- high back resistance
- high rectification ratios
- sharp breakdown in saturation voltage region
- ambient operating temperature to 150°C.

Chassis layout call for conventional soldering-in of diodes? Sylvania offers double-ended package design. Or you can choose the single-ended diode package which can be socket-mounted as well as soldered-in. Broad-

range diodes and narrow-range diodes are available in both packages.

Broad-Range Diodes—back resistance of 1000 to 10,000 megohms. Low capacitance and moderate forward conductance make them highly useful in general and computer applications as rectifiers, end gates, restorers, and clippers.

Single-ended
 IN137
 IN138A

Double-ended
 IN409
 IN410

Narrow-Range Diodes—controlled breakdown voltages from 2 to 600 volts. These general-purpose diodes

feature superior rectification ratios and an ability to function at elevated ambient temperatures. They have a very low impedance in the saturation voltage region. Low-voltage types make good voltage regulators for transistor power supplies. All types are applicable in magnetic amplifiers.

Single-ended
 IN200 to IN222
 IN401 to IN408

Double-ended
 IN370 to IN400

For complete data on all Sylvania Junction Diodes, address Department F20R.



SYLVANIA[®]

SYLVANIA ELECTRIC PRODUCTS INC.
 1740 Broadway, New York 19, N. Y.
 In Canada: Sylvania Electric (Canada) Ltd.,
 University Tower Building, Montreal

LIGHTING • RADIO • ELECTRONICS • TELEVISION • ATOMIC ENERGY

cated in the lower chart. In addition, the number of items of electronic equipment used in a typical military installation such as an aircraft, tank or ship has increased greatly. Thus, despite substantial improvement in the average reliability of components,

there has been such an increase in the complexity of both a typical piece of military electronic equipment and of a typical electronic installation that today there is something not much better than half the systems reliability that was prevalent in 1940.

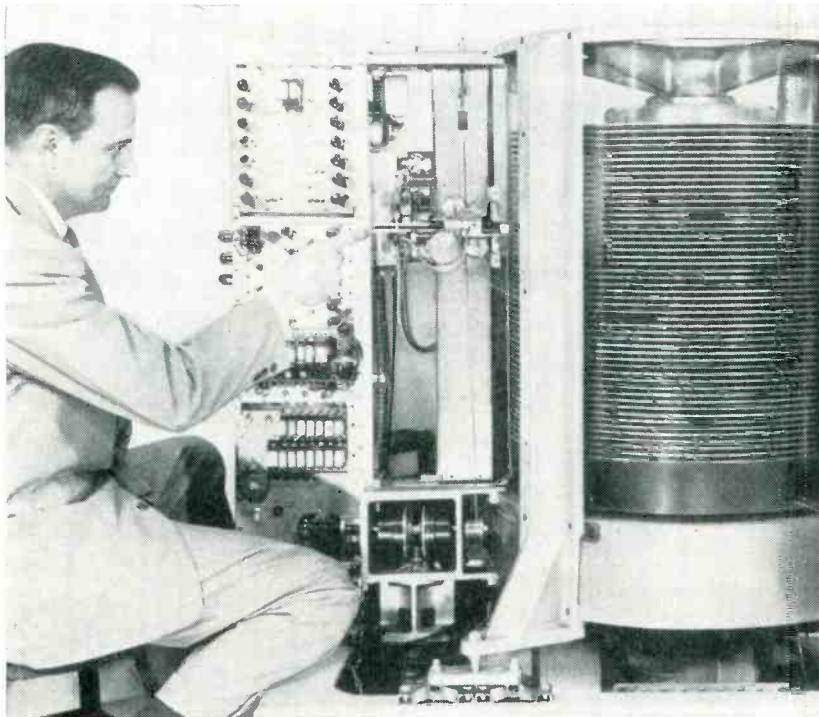

BUSINESS data is recorded on stack of special platters, as . . .

Magnetic Memory Goes Juke Box

Feature provides immediate access to five million stored characters

RESEMBLING a record player mechanism, the IBM 305 magnetic disk memory provides random access to five million stored characters (ELECTRONICS, p 26, May 1955).

The memory is designed to work with punched-card or magnetic-tape accounting machines. Several magnetic-disk storage units can be connected in parallel to provide almost unlimited storage capacity. The unit will comprise the heart of a new IBM line of electronic data processing machines.

► **How It Works**—The disk mem-

ory not only looks like a juke box; it works like one. The information is stored in concentric bands on the top and bottom surfaces of the disks. A reading and writing head actuated pneumatically but controlled electronically operates from the side and locates data by disk-side and band. Air escaping from the head under pressure provides a protective cushion for the magnetic surface.

This type of memory may alter the way in which electronic business machines are used. With many types of storage systems the data must be accumulated and processed in batches. The memory permits filing transactions as soon as the data is received thus keeping balances current.

Manufacturers Eye Selling Costs

Competition and other factors are forcing companies to spend more to keep sales high

SALES costs in the electronics industry have fluctuated between 9 and 13 percent of net sales in the past five years, according to an analysis of the selling, general and administrative expenses of 13 companies in the field. Last year the percentage rose to a little over 10 percent from 9.9 in 1953.

► **Examples**—Despite the similarity of total expense ratios for the companies surveyed, the amount spent by individual companies varied widely, depending on the character of products, distribution channels, competitive condition and sales volume. The amount spent by these firms has fluctuated from year to year.

One company with a net sales volume of \$123 million in 1954 had a \$5.2 million selling expense and \$6.5 million in general and administrative expenses. In 1953, with net sales of \$87.7 million, this company spent \$4.7 million on selling and \$4.0 million on general and administrative expenses.

Another firm with net sales of \$42.6 million in 1954 had advertising expenses of \$1.0 million, selling expense of \$896,201 and administrative expenses of \$1.8 million. In 1953 it had net sales of \$50.4 million, and spent \$1.9 million on advertising, \$1.0 million on selling

(Continued on page 12)

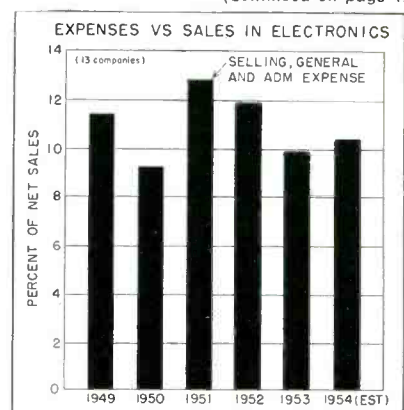

Vitamin Q® News

SMALL DRAWN RECTANGULAR CASE CAPACITORS FOR 125°C

EXCEED REQUIREMENTS OF MIL-C-25A (CHARACTERISTIC "K")

FOR MANY YEARS Sprague Vitamin Q Capacitors have proven their ability to operate at high temperatures. Continued improvement in processing techniques and closer control of the materials used have permitted Sprague Engineers to design capacitors which exceed the performance requirements for Characteristic "K" of Military Specification MIL-C-25A.

Of particular importance to equipment designers specifying 125°C capacitors is the proven chemical inertness and stability at high temperatures of the Vitamin Q impregnant used. Consequently there is no degradation experienced in electrical characteristics following storage at high temperatures for long periods.

All Type 93P, 94P, and 95P Vitamin Q capacitors are, of course, hermetically sealed. The terminal bushings and mechanical case closure have been designed to withstand low barometric pressures at high ambient temperatures.

Complete information on these new Vitamin Q capacitors is provided in Engineering Bulletin 231, available on letterhead request to Sprague Electric Co., 35 Marshall Street, North Adams, Mass.

Sprague, on request, will provide you with complete application engineering service for optimum results in the use of Vitamin Q capacitors

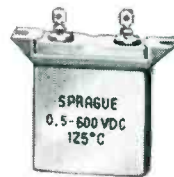

Type 95P capacitors are interchangeable with MIL case styles CP67 and CP69

Here is another new series of reliable, conservatively rated Sprague capacitors.

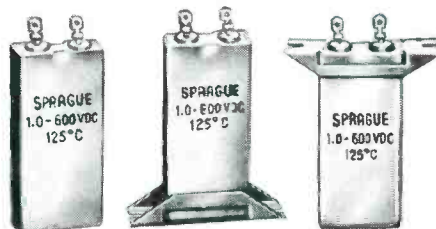

Type 94P units are equivalent in size to MIL styles CP61, CP63, and CP65.

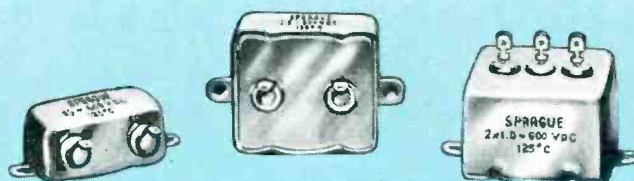

Type 93P Vitamin Q capacitors correspond in size to MIL styles CP53, CP54, and CP55.

SPRAGUE®

World's Largest Capacitor Manufacturer

and \$1.5 million on administration.

► **Survey**—The National Industrial Conference Board has found that

selling and distribution costs in the electrical machinery field, which includes electronics, averaged 8.5 percent of sales with 5.3 percent for

direct selling expense, 0.6 percent for warehousing and delivery expenses, 1.4 for advertising expense and 1.5 percent for other expenses.

A-M and Television Broadcasters Make Progress

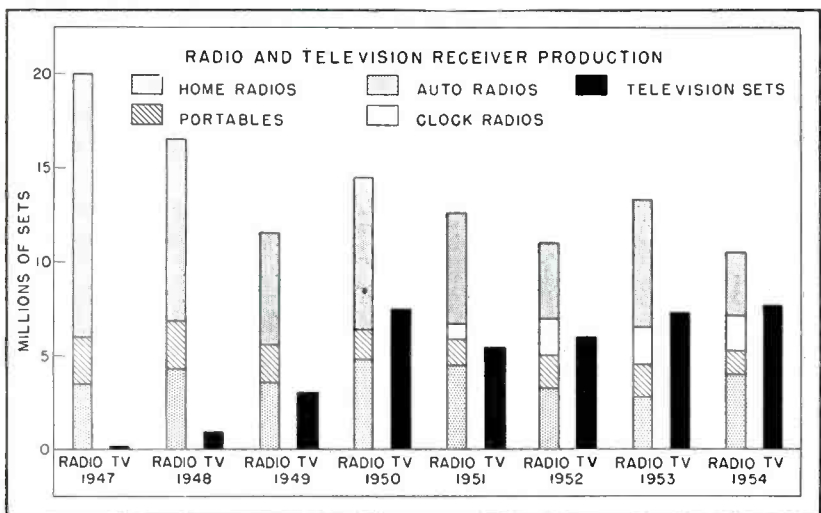
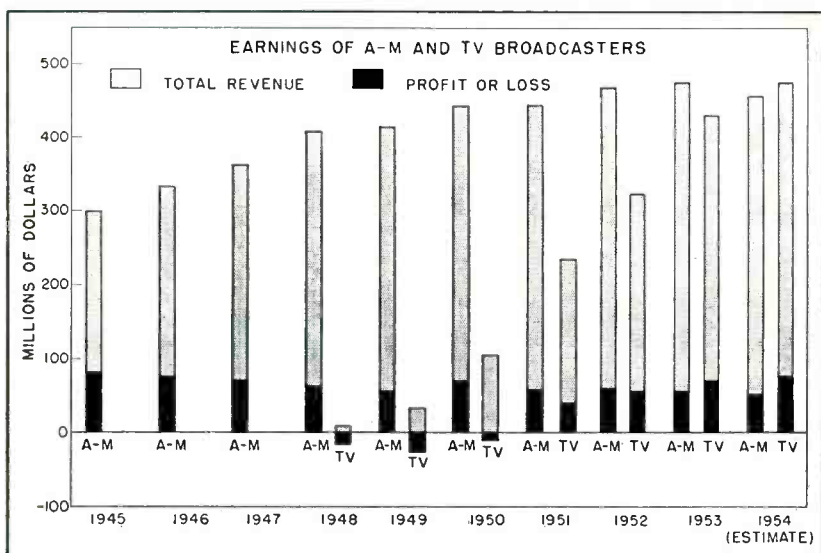
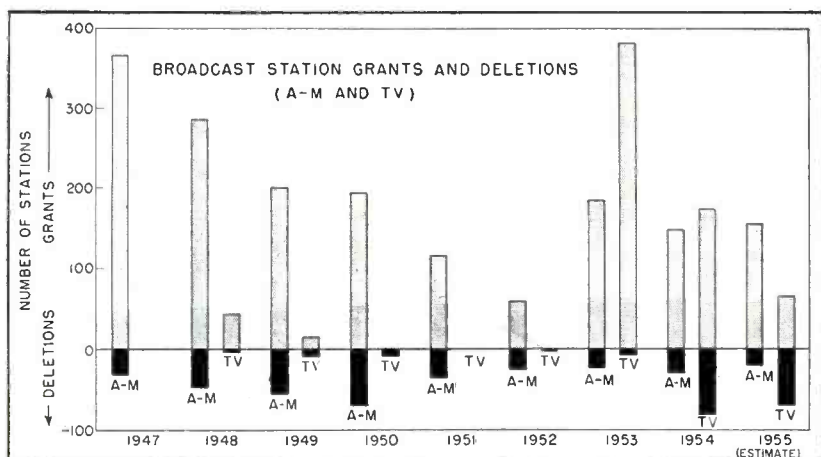

Station grants, broadcasters' revenues and set production give industry profile

TELEVISION and a-m radio have shared most broadcasting business for nearly eight years now and the charts show how the two media stack up.

Despite FCC requirements that prospective broadcasters show a high degree of financial responsibility before going into business, broadcasting can be quite hazardous.

Although all the deletions are not necessarily business failures still the comparison of grants versus deletions shows that broadcasting is no foolproof touchstone for wealth.

► **Station Grants**—In recent years the number of television deletions has risen sharply. Many of these are uhf. However, the high number of tv deletions in 1954 and 1955 can be attributed to a normal shaking down of the heavy post-freeze rush to get on the air that occurred in 1953. A-m station building continues at a high level with considerably fewer deletions than for tv.

► **Station Revenue**—The record of broadcasters' revenues illustrates that a-m is a relatively mature industry with revenues steady in the neighborhood of \$450 million annually. Television is still in its growth phase. Income before taxes for television broadcasters is somewhat higher than for a-m and the trend seems to be continuing in that direction.

► **Set Production**—The set production figures show a stable market both ways. In the radio field the rapid drop in so-called home radio production was offset only slightly by the advent of the clock radio. The clock radio business is holding

(Continued on page 14)

For all your Tape Wound Core Requirements, specify **"CORES by ARNOLD"**

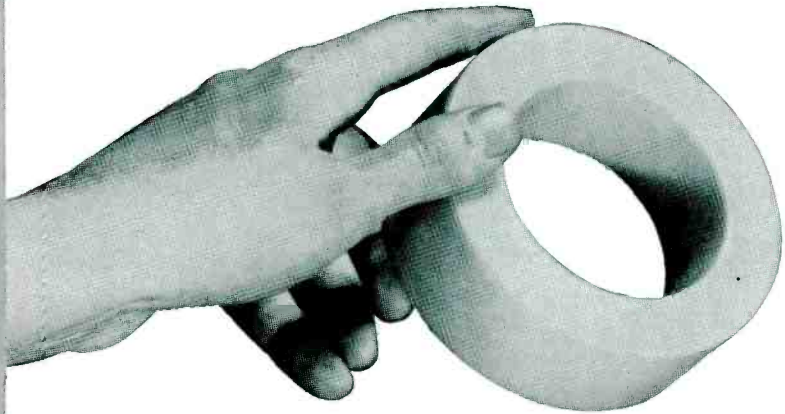

You'll be *assured* of the performance and uniformity you want, when you use Arnold Cores as magnetic components in your amplifier, transformer and reactor assemblies.

Our facilities for production and testing are highly modern and complete. Arnold is a fully integrated company, controlling every manufacturing step from the raw material to the finished core, and therefore best able to maintain high quality control. You'll have at your command the most complete line in the industry . . . containing every type, shape or size core you may require to meet design needs or electrical characteristics.

Many sizes of Arnold Tape-Wound Cores are carried in stock for immediate delivery. • *Write for additional information*, and let us quote on your requirements and help solve your problems.

HERE'S DATA YOU NEED . . . Write for these Booklets

1 BULLETIN TC-101A . . . "Properties of Deltamax, 4-79 Mo-Permalloy and Super-malloy"—28 pages of technical data on Arnold Tape-Wound Cores of high-permeability alloys.

2 BULLETIN SC-107 . . . "Arnold Silectron Cores"—round, square, rectangular, or C and E cores; 52 pages of data on shapes, sizes, properties, etc.

ADDRESS DEPT. E-56

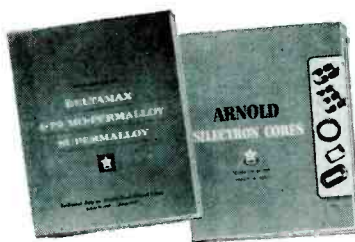

W&D 5648

THE ARNOLD ENGINEERING COMPANY

SUBSIDIARY OF ALLEGHENY LUDLUM STEEL CORPORATION

General Office & Plant: Marengo, Illinois

DISTRICT SALES OFFICES . . . New York: 350 Fifth Ave.

Los Angeles: 3450 Wilshire Blvd.

Boston: 200 Berkeley St.



firm at around two million sets. Auto-set production remains around four million sets.

Television set production rose rapidly in 1948 but seems to have settled at around 7 million. Re-

placement sales constitute about 40 percent of total. About one half of these sales are to get away from poor performance of a present set. There are still relatively few second-set homes.

Electrolytic Capacitor Makers To Up Output

Some manufacturers are pushing production expansion in anticipation of higher demand

OUT OF roughly 125 capacitor manufacturers in the U. S. only 25 companies make electrolytic types. One of the reasons for the relatively small number is the large capital outlay that is necessary to establish a plant. At least \$180,000 to \$200,000 is necessary to establish pilot operation.

Electrolytic capacitors accounted for only about 10 percent of total fixed capacitor production compared to over 50 percent for paper capacitors, 20 percent for ceramic and 15 percent for mica types. However, in dollar volume, electrolytics represent nearly 40 percent of the total and rank second only to paper capacitors. In 1952, government figures indicated volume to be \$108 million. Dollar volume for 1954 is estimated at \$120 million.

► **Expansion**—Pyramid Electric, whose total capacitor production is about 75 percent in electrolytics, has experienced a marked increase in sales in the past year. Its net sales in 1954 were \$7.7 million compared to \$5.7 million in 1953, a 35-percent increase. The firms sales are approximately 10 percent to jobbers, 15 percent to the industrial market and the remainder to set manufacturers. This year the firm estimates that its total sales will reach \$10 million. Sales for the first quarter of this year are 10 percent above the period in 1954.

► **Growth**—GE expanded in the electrolytic capacitor field with a \$6.4-million plant to be built in South Carolina. Limited production is scheduled for early in 1956 and the plant will eventually employ 700 people. It will have 90,000 sq ft of production area. According to the company, the expansion is mainly in anticipation that the rapid

(Continued on page 16)

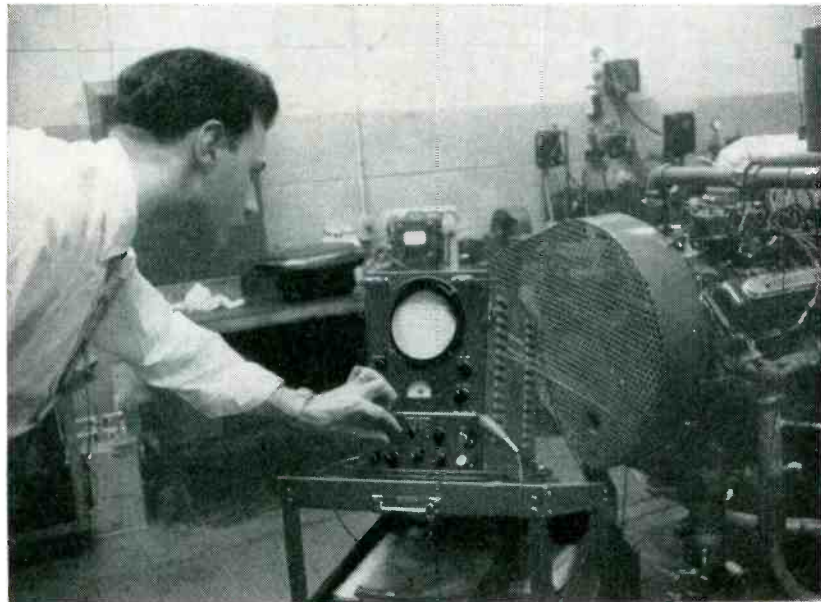

INSTRUMENTS like this Socony engine analyzer are reasons why . . .

Oil Firms Team With Electronics

Three electronic manufacturers to sell instruments developed by petroleum companies

IN THE past few months, three electronic manufacturers have entered into agreements to make and market electronic equipment developed by major oil companies.

Consolidated Engineering will shortly, probably in midsummer, begin marketing four plant analysis and control instruments developed by Phillips Petroleum Company for petroleum and processing industries. They include an infrared gas analyzer, a differential refractometer, an ultraviolet analyzer and an oxygen analyzer. The instruments have been designed and built by the oil firm during the past five years. A number of them have been in service for three years.

Phillips will supply Consolidated with the technical know how on typical refinery and chemical plant applications.

► **Sun**—Licensing arrangements have been entered into by Sun Oil and the Fielden Instrument Division of Robertshaw-Fulton Controls Co. The agreement permits the manufacture and sale by Fielden of electronic devices used to control the levels in processing of petroleum products. Such devices have been operating in the oil firm's refinery located at Delaware, Pa.

An engine analyzer developed by Socony Vacuum Oil will be manufactured and sold by DuMont Labs under a licensing agreement. The instrument can diagnose auto ignition faults in less than one minute and also locate preignition faults. It can picture the behavior of all cylinders simultaneously. Oscilloscope patterns depicting about 65 engine ailments have been identified.

Power for the engine analyzer may be supplied by the battery of the automobile being tested or from any ordinary 115-volt source.

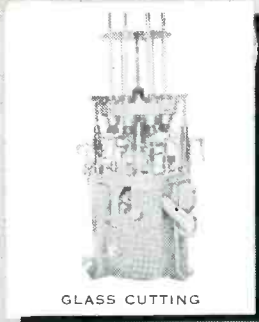

GLASS CUTTING

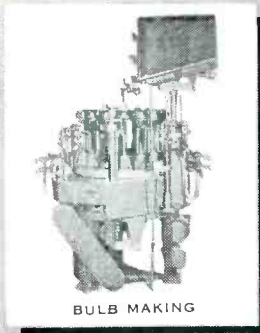

BULB MAKING

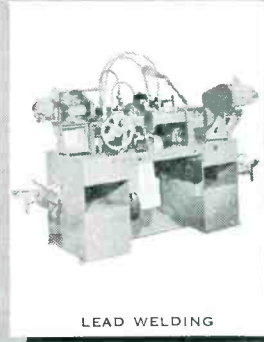

LEAD WELDING

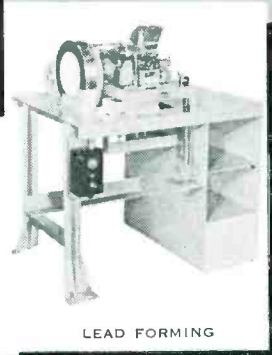

LEAD FORMING

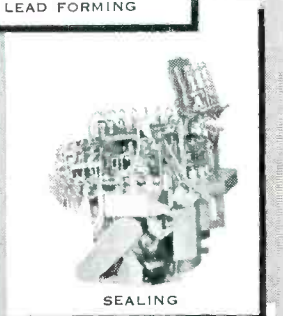

SEALING

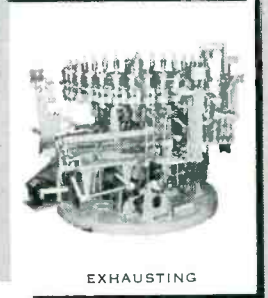

EXHAUSTING

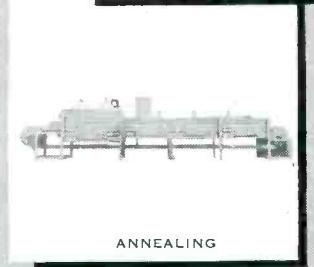

ANNEALING

Kahle Automation

speeds production
for ^{MINNEAPOLIS} Honeywell

mercury switch production doubled
by KAHLE machines for MICRO-SWITCH division

For the first time in history, delicate mercury switches are now being mass produced by automation. Fully automatic machines, engineered and precision-built by Kahle, produce better quality switches approximately *twice as fast* as previous methods! The resulting labor costs are so much lower they are expected to revolutionize the sales of mercury switches for home and industry. Kahle Automation has dramatically increased production for large and small manufacturers in many industries... at minimum equipment cost! Write *today*—tell us your requirements or problems.

Kahle ENGINEERING COMPANY
1307 SEVENTH STREET NORTH BERGEN, N. J.

Designers and builders of special automatic and semi-automatic equipment for all industrial operations.

growth of color tv will greatly expand the market for electrolytics.

It is estimated that by 1960 yearly production of tv sets will reach 9 million with 90 percent color receivers. Estimates are that the average color set will use twice as many capacitors as a monochrome model.

Another company, P. R. Mallory, is completing a \$1.5-million electrolytic capacitor plant in Alabama with 70,000 sq ft of space and Cornell-Dubilier is completing a plant on the west coast. In the past year electrolytic capacitor manufacturers have added over 700,000 sq ft of space.

Arizona Wants Electronics Plants

More companies are establishing plants in the state near the Army's electronic center

SIGNS that the Air Force seeks to slow up further concentration of the aircraft industry in any one place has given the state of Arizona cause to hope for further growth in its aviation and electronic industries. General Lenzner, commanding general of Army's electronic proving ground, Fort Huachuca, Ariz. recently stated that an electronics company having facilities on the West Coast or in the east, and also in Arizona, likely would be in a more favorable position contract-wise.

► **Growth**—According to the Valley National Bank of Phoenix, six major additions to the electronic manufacturing and research facilities in the state have been announced in recent months. Companies such as AiResearch, Douglas Aircraft, Goodyear Aircraft, Hughes Aircraft, Inflico, Motorola, Precision Products, Phemco, Savage Manufacturing and Thunderbird Engineering have plants in the area. These plants now employ a total of about 8,000 people.

Motorola, which has had a laboratory in Phoenix, is building a new \$1.5-million facility there for manufacturing transistors. The firm has been producing the devices in pilot quantities at the present Phoenix plant for two years. The first section of the new building is expected to be completed early in 1956 and initial employment will be 500.

► **Army**—One major reason for growth of the industry in Arizona is Fort Huachuca, the Army's electronic proving ground southeast of Tucson. General Lenzner recently announced that between \$20 and \$30 million in government contracts will be let next fiscal year for electronic equipment to be tested at the Fort.

At the proving grounds, estab-
(Continued on page 20)

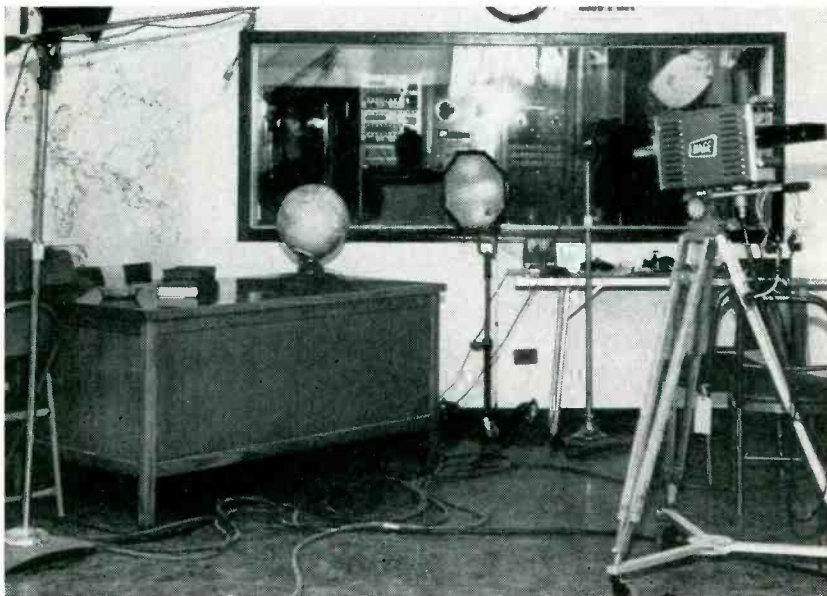

MORE stations like this one in Iceland are installed as . . .

Armed Forces TV Comes of Age

Stations are now budgeted by the Defense Department as an official service

IN LITTLE more than a year since its first station went on the air the Armed Forces Television Service has grown to five operating stations. Locations are at military bases in Maine, Iceland, Azores, Tripoli and Greenland.

A station in Saudi Arabia is expected to be on the air on June 15 and another station in Okinawa is being installed for operation by July 3. Two more stations are planned for Greenland and another on Johnson Island in the Pacific.

The stations are so valued as a morale builder for isolated troops that now the cost of the stations is budgeted by the Defense Department. Previously equipment was

paid for out of unappropriated funds such as Post Exchange profits.

► **Potential**—Every isolated area in the world where U. S. military personnel are located is a potential site for an Armed Forces TV station. Some 50 to 75 stations could conceivably be established. However, each location is evaluated on its individual merits and requirements.

► **Equipment**—Average cost of the stations now installed is about \$50,000. There has not been as yet any formal standardizations for equipment although such standards are forthcoming. The stations are all low-power vhf outlets with below 100 watts erp and do not require an FCC license. Most of the equipment has been supplied as a complete package.

NEW!

R-F Bridge

400 Kc to 60 Mc

The Type 1606-A Radio-Frequency Bridge is a new, improved model of the popular Type 916-A R-F Bridge which has served the communications field for well over a decade.

This G-R instrument reads both resistive and reactive components of impedance directly on separate dials. All variable elements are precision capacitors making possible highest accuracies in measurements, particularly at the upper radio frequencies. For direct impedance measurements of antennas, transmission lines, circuit elements and other low impedances, this versatile r-f tool is invaluable. With an external parallel capacitor, tuned circuits and other high impedances also can be measured.

The new General Radio R-F Bridge has greater sensitivity, uses new variable capacitors whose rotors and stators are milled from solid blocks of aluminum for minimum loss, is less than one-half the volume of its predecessor and contains only one bridge transformer for coverage of the whole frequency range. Dial locks are provided to prevent accidental movement of the initial balance control, and a simplified system of connection to the unknown is made available.

Those who have worked with the first G-R Radio-Frequency Bridge will find the new model an even more convenient and useful instrument. New materials, techniques and operating improvements, many suggested by customers, make this the finest R-F Impedance Bridge yet made available.



Transmission Line Measurements

The General Radio R-F Bridge is an invaluable communications-engineering tool. Indicated at right are input resistance and reactance of a transmission line with characteristics and termination indicated. Solid lines are obtained from detailed computations; circles from measurements with the new Type 1606-A R-F Bridge.

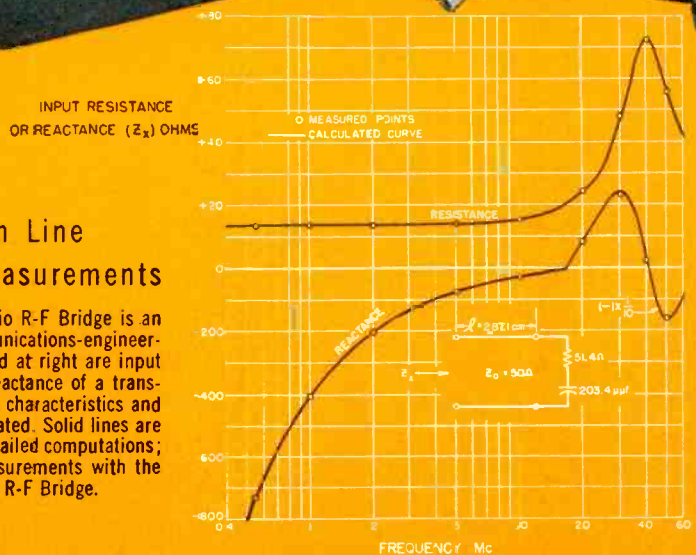

NEW!

- Type 1606-A Radio-Frequency Bridge \$535
- Type 1606-P1 Luggage-type Carrying Case . . . facilitates transportation and insures safe storage..... \$15

- Frequency Range:** 400 kc to 60 Mc
- Resistance Range:** 0 to 1000 ohms
- Reactance Range:** ± 5000 ohms direct reading at 1 Mc — range varies inversely as frequency
- Basic Accuracy:** ± (1% + 0.1 ohm) for Resistance and ± (2% + 1 ohm) for Reactance; slightly less accurate at higher frequencies — high-frequency corrections provided
- Accessories Supplied:** Coaxial cables for connecting generator and detector, two leads of different lengths for connecting unknown impedance to bridge, Type 874-PB58 Panel Connector
- Dimensions:** 12½ x 9½ x 10¼ inches **Net Weight:** 23 lbs (29 lbs with carrying case)

GENERAL RADIO Company

275 Massachusetts Avenue Cambridge 39, Massachusetts, U. S. A.

90 West Street NEW YORK 6
8055 13th St., Silver Spring, Md. WASHINGTON, D. C.
York Road & Guernsey Avenue, Abington, Pa. PHILADELPHIA
920 S. Michigan Ave. CHICAGO 5
1000 N. Seward St. LOS ANGELES 38



1915-1955

40 Years of Pioneering

in Electronics

New Information OF INTEREST TO COMPUTER ENGINEERS AND DESIGNERS

on the **NEW**



RF TRANSISTORS

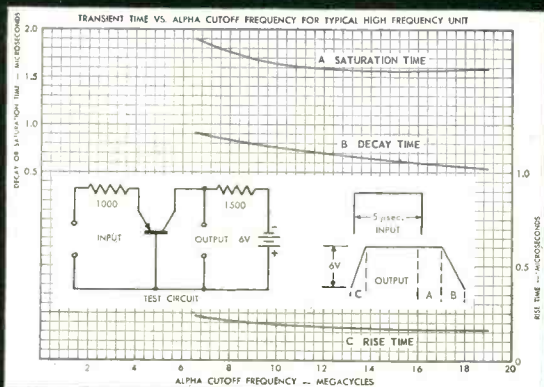

RAYTHEON RF TRANSISTORS ARE

- completely interchangeable without selection of components
- successfully field tested for an entire year. In mass production for several months.
- made by the Raytheon perfected fusion process that has already produced nearly two million transistors

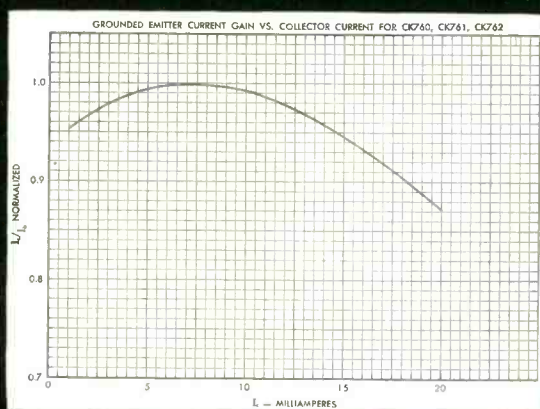
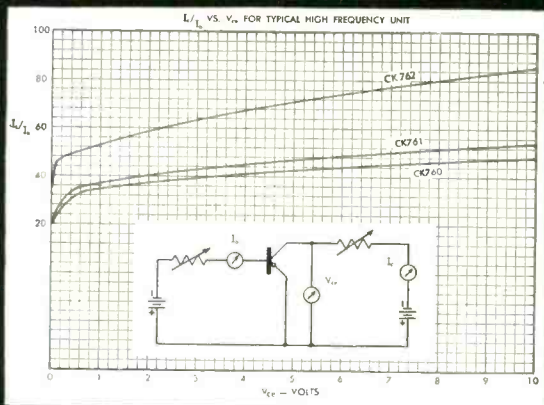

HIGH FREQUENCY TRANSISTORS — HERMETICALLY SEALED CASE

Type	Collector		Emitter		Extrin. Base Resis. ohms	Base Current Ampl. Factor	Alpha Freq. Cutoff mc.	Max. Junc. Temp. °C	Temp. Rise °C/mW	Coll. Capac. μμf
	Volts	Cutoff μA	mA	Cutoff* μA						
2N112/CK760	-6	1	-1.0	0.5	75	40	5	85	0.62	14
2N113/CK761	-6	1	-1.0	0.5	75	45	10	85	0.62	14
2N114/CK762	-6	1	-1.0	0.5	75	65	20	85	0.62	14

*Cutoff current measured at $V_c = -12$ volts

Note: above characteristics are average except where noted

RAYTHEON TRANSISTORS
more in use than all other makes combined



RADIATION COUNTER TUBES

CK1020 Thin wall beta, gamma counter, 900 volt
CK1021 Thin wall beta, gamma counter, 900 volt
CK1026 Halogen quenched, gamma counter, 900 volt
CK1049 Halogen quenched beta, gamma counter, 900 volt

Other counter types can be made to your order.



VOLTAGE REGULATOR TUBES

OA2 150 volts, 5-30 ma.
OB2-OB2WA 108 volts, 5-30 ma.
CK5787-CK5737WA 98 volts, 1-25 ma.
CK6542 150 volts, 5-25 ma.



VOLTAGE REFERENCE TUBES

CK5651-CK5651WA 85 volts, 1.5-3.5 ma.
CK5783-CK5783WA 85 volts, 1.5-3.5 ma.
CK6213 130 volts, 1-2.5 ma.

GAS Filled TUBES

PERFORMANCE TESTED and backed by over THIRTY YEARS OF EXPERIENCE in the manufacture of gas tubes

COLD CATHODE RECTIFIER TUBES

CK1042 2800 volt inverse, 8 ma. dc.
CK5517 2800 volt inverse, 12 ma. dc.
CK6174 2800 volt inverse, 3 ma. dc.

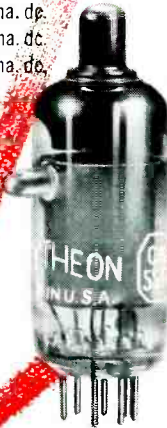

CORONA VOLTAGE REGULATOR TUBES

CK5962 700 volts, 2-55 μ a
CK6437 (CK1037) 700 volts, 5-100 μ a
CK1038 900 volts, 5-100 μ a
CK6438 (CK1039) 1200 volts, 5-100 μ a
500 to 3000 volt ratings! available on special order.



Listed are representative tubes in each group. All are stable, rugged, reliable — worthy of your complete confidence.

All except Radiation Counter Tubes shown actual size.



Excellence in Electronics

RAYTHEON MANUFACTURING CO.

RELIABLE SUBMINIATURE AND MINIATURE TUBES
SEMICONDUCTOR DIODES AND TRANSISTORS
NUCLEONIC TUBES • MICROWAVE TUBES
RECEIVING AND PICTURE TUBES

Special Tube Division — Home Office: 55 Chapel St., Newton 58, Mass., Bigelow 4-7500

For application information write or call the Home Office or: 9501 Grand Avenue, Franklin Park (Chicago), Illinois, TUxedo 9-5400
589 Fifth Avenue, New York 17, New York, PLaza 9-3900 • 622 South La Brea Ave., Los Angeles 36, California, WEbster 8-2851

lished last year, the Signal Corps is performing technical and engineering tests on communications and electronics systems and equipment, developing experimentally the requirements to be met in research and development establishments and formulating new techniques for signal organizations. At the Fort, the Army can lay out in full scale the electronic operations of an entire field army.

► **Not Temporary**—About \$900,000 in permanent construction is budgeted for the fiscal year of 1956 and \$16 million is being asked for permanent construction in fiscal 1957. About 9,300 people, civilian and military, are employed at the Fort.

Taxi Radio Continues As A Top Market

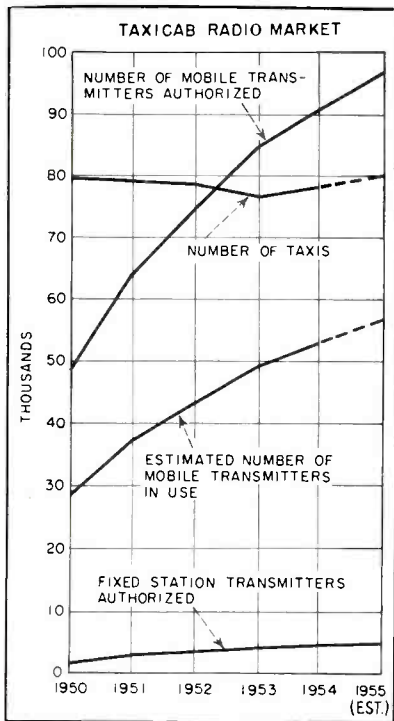

Saturation is high but replacement sales and growth keeps potential up

TAXICAB radio has accounted for more two-way radio sales than any other field except the police radio service.

► **Market**—There are approxi-

mately 78,000 cabs in regular operation in the U. S. Approximately 52,000, 66 percent, of these have been equipped with two-way radio. Of the remaining 26,000 cabs a good number operate in areas where radio is not used. For example in New York where over 11,000 cabs operate, the majority do not use the two-way radio.

The replacement market has grown along with initial equipment sales. The normal life of two-way radio for cabs is from 5 to 8 years.

As shown in the chart, the 95,000 transmitters authorized for taxicab radio far exceeds the number of transmitters in use. The FCC estimates that about 58.5 percent of authorizations are in use.

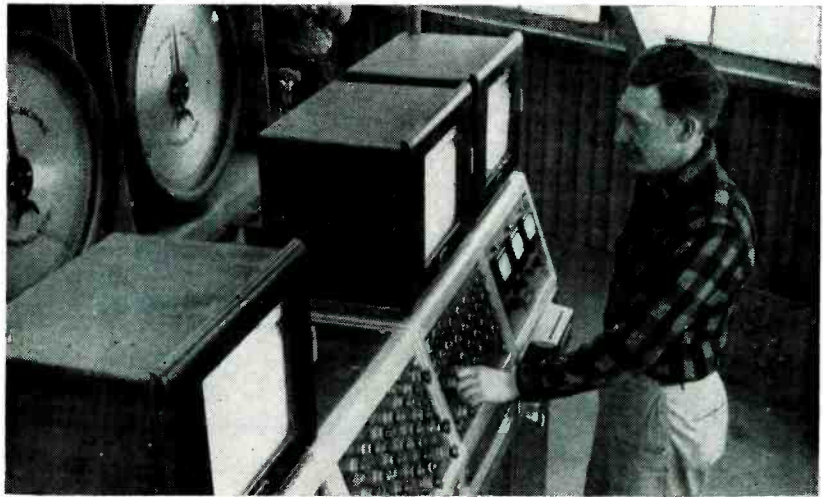

READY-MIXED concrete is prepared in half the time with closer weight control when . . .

Punch Cards Batch Concrete Mixer

Electronic weighing and two-way truck-to-plant radio cut waiting time at peak periods

INSTALLATION of a punch card controlled batching system at a new plant of the Cleveland Builder's Supply Co. increased efficiency and accuracy of concrete mixing by an estimated 100 percent.

Using one of over a thousand punched cards available for various mixes, the operator can prepare a batch of concrete in about half the time required by manual operation. Weighing of ingredients is better too—coming with ± 2 lb of cement in a 600-lb batch. This compares with ± 25 lb for manual-controlled systems.

► **Recipe Card**—Each card carries punched information giving the bin location and weight of each ingredient such as cement, sand, gravel and water. Initiating the weighing cycle, the required

amounts of ingredients are dumped into auxiliary bins. When all of the auxiliary bins contain the required weights the operator can route their contents into the mixer.

Interlocking controls prevent the operator from initiating the mixing cycle until all the weights are correct. A control setting on the instrument panel allows compensating the amount of water to be added for the moisture content of the sand. The system was designed and installed by the Fairbanks-Morse Co. for the Butler Bin Co.

► **Rush-Hour Radio**—The busy period for a concrete plant is the early part of the morning. Use of two-way radio communications permits a returning truck driver to notify the plant as he approaches.

His next delivery can be weighed out and held in the auxiliary bins while the batch for the previous truck is being mixed.

(Continued on page 22)

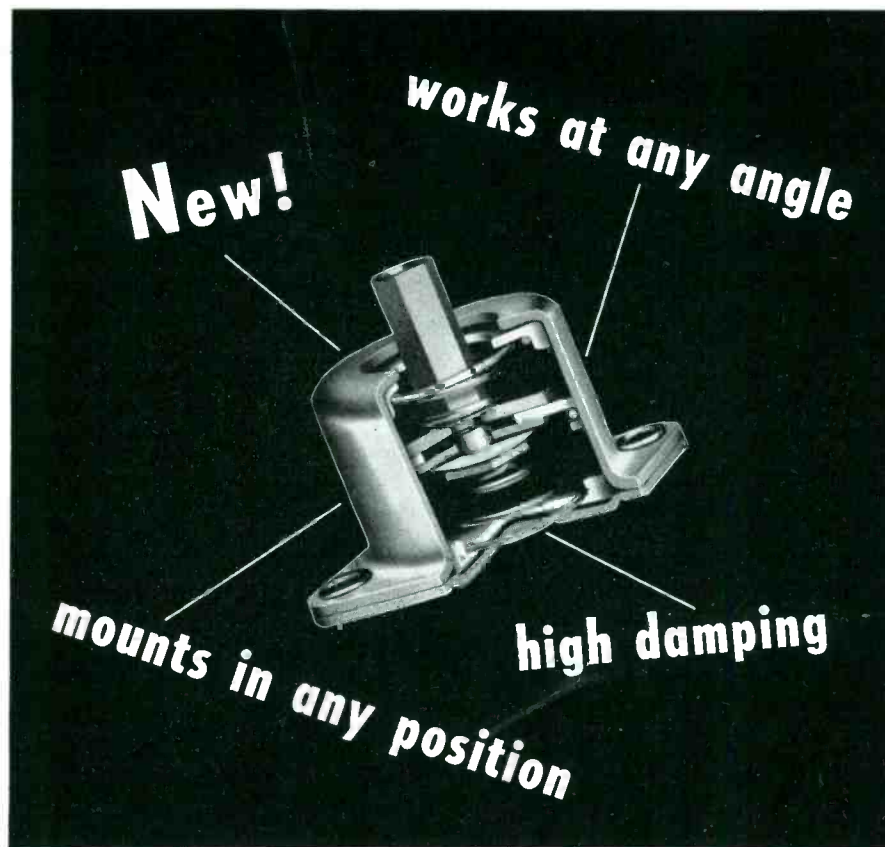

Nothing Less than this ALL-ANGL Mount gives sure protection in JETS and MISSILES

WHY? Because this Barry mount is independent of operating or mounting position. Through every operational maneuver of jets, VTO's, and missiles, the ALL-ANGL gives the same effective shock and vibration protection as in level flight.

These are the vital performance characteristics of the ALL-ANGL Mount:

- Equal stiffness in all directions
- Equal damping in all directions
- Low transmissibility at resonance — less than 3
- Isolation under superimposed steady state accelerations up to 5 g

Maximum load ratings of Size 0 ALL-ANGL mounts now available are 0.5 to 3.0 pounds per mount, in four ranges.

Write today for Data Sheet W5. For specific recommendations, call your nearest Barry Sales Representative.

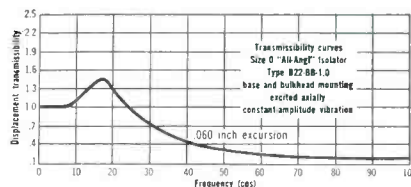

Typical transmissibility curve for ALL-ANGL mount, both base and bulkhead mounting, excited axially at constant amplitude.

BARRY CONTROLS

INCORPORATED

Formerly The Barry Corporation

707 PLEASANT STREET WATERTOWN 72, MASS.

SALES REPRESENTATIVES IN ALL PRINCIPAL CITIES

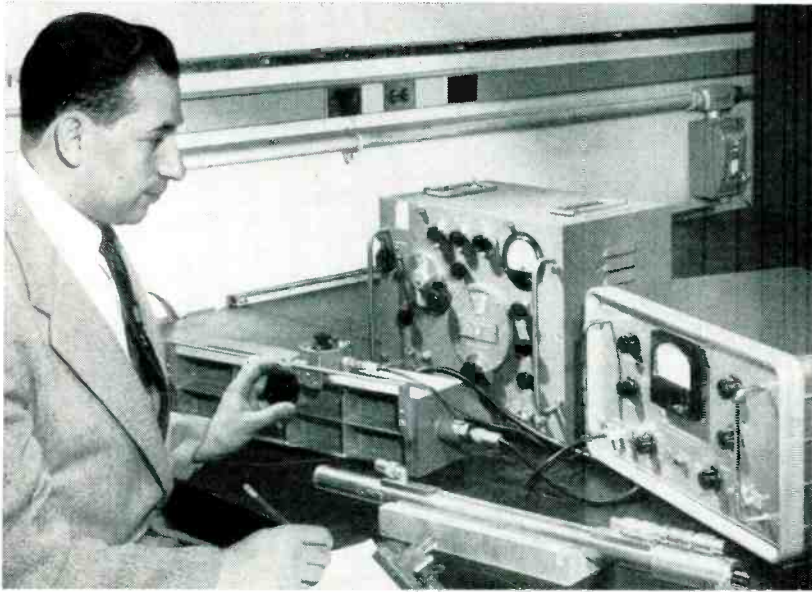

RESEARCH and development work is stepped up as . . .

Traveling Wave Tubes Grow Up

Number of tubes in use is numerically small but output and improvements are increasing

ALTHOUGH less than 1,000 traveling wave tubes are now in use in the U. S., interest in and production and development of the items is growing fast. Nearly every major tube manufacturer has the tubes under development although few are actually producing them for commercial sales.

Huggins Laboratories in California, which has been devoted almost exclusively to traveling wave tube development and production, began producing the tubes in late 1951 and since that time has doubled its space three times.

► **Market**—About 75 percent of traveling wave tube production has been sold for laboratory use and for building prototypes. Military use of the equipment has also been substantial and is growing.

The tube gives high amplification over a wide frequency range without mechanical tuning or variation of any voltages or currents applied to it. Power amplification of greater than 10,000 (40-db gain) over a 2:1 frequency range has been obtained. An operating bandwidth of 2,000 mc has been obtained in one

typical tube type and 7,000 mc has been obtained in another.

► **Types**—Because of the custom-made characteristics of the equipment in which the tubes have been used so far, there is a great variety of traveling wave tube types. Sylvania has eight models plus two backward wave oscillators and shortly will have eight more models available in the C and X bands. Sperry has made approximately 25 different traveling wave tube types.

Federal Telephone and Radio which has been working on the tubes since 1946 recently introduced a metal traveling wave tube with a plug-in feature. It has improved performance and life due to its metal construction and design, according to the company. Also known to be at work in the field, although not necessarily offering tubes for sales are Bell Lab, Roger White Electronics, RCA and Stanford Labs. GE and Raytheon have the tubes under development and are planning to put them into commercial production.

► **Navy**—Through the use of Bismanol, a high coercive magnetic material developed at Naval Ordnance Labs traveling-wave tube use may move ahead faster. Bismanol

magnetic focusing elements exceeded requirements of an Air Force development contract for a new traveling wave tube.

The use of Bismanol magnetic focusing elements, an inch and a quarter in diameter and weighing 3½ pounds, eliminates the need for a solenoid and a power supply and makes possible a weight reduction of over 100 pounds in the finished assembly.

Fire Alarms Go Radioactive

Electronuclear detector will spot smoke from fire before it flames

DEVICES using electronic techniques to measure heat and detect presence or lack of flame have long been accepted by industry. Most recent variation in this field is a fire detector that rings a bell when it smells the first traces of invisible smoke from an incipient blaze.

Based upon the principle of the ionization chamber (technical details on page 200) the new detector depends upon change of resistance in an electronic circuit, which is caused by relatively large smoke particles.

► **Advantages**—Marketers of the new device, Pyrene—C-O Two, point to the lesser expense of installation as compared with another of their systems in which air is pumped back through perforated pipes to a sensing unit. Only standard electrical wiring is needed for the new system.

F-M Subsidiaries May Subsidize F-M

New class of FCC authorization permits use of multiplexed beep music by the broadcaster

LATE BUT WELCOME is a species of economic relief implicit for f-m

(continued on page 24)



ONLY THE LEADER

*always
sets
the
pace*

FIRST-



high voltage mica capacitors.

In harness racing as in capacitors you pick the leader by looking at the record. That's why at Cornell-Dubilier, we're mighty proud of our record of new capacitor designs, consistent dependability and outstanding field performance—a record no other company can even come close to approaching. That's the record of

FIRST-



super-power tank circuit mica capacitors.

C·D...45 YEARS OF FAMOUS FIRSTS

Typical of these "Famous Firsts" are the examples shown here... just three of the hundreds of money-saving answers in capacitors a C-D engineer can show you. Write to Cornell-Dubilier Electric Corp., Dept. K-65 South Plainfield, N. J.

FIRST-



carrier current coupling capacitors.



CORNELL-DUBILIER CAPACITORS

PLANTS IN SO. PLAINFIELD, N. J.; NEW BEDFORD, WORCESTER AND CAMBRIDGE, MASS.; PROVIDENCE AND MORE VALLEY, R. I.; INDIANAPOLIS, IND.; SANFORD AND FUQUAY SPRINGS, N. C.; SUBSIDIARY, RADIART CORP., CLEVELAND, OHIO.

THERE ARE MORE C-D CAPACITORS IN USE TODAY THAN ANY OTHER MAKE

broadcasters in a recent FCC ruling. Under a Subsidiary Communications Authorization (SCA), which is not available apart from an f-m broadcast license, the licensee is permitted to engage in types of nonbroadcast service. Among these are functional music (for stores, institutions and factories) news, time, weather and similar programming.

Although f-m stations are licensed for unlimited time operation, it is required that they broadcast a minimum of 36 hours a week during the hours 6 am to midnight and not less than 5 hours in any one day. Under an SCA grant, and only until next June, the broadcaster will be allowed to send out special programs on the same frequency after he has fulfilled his quota of regular programming.

► **Simplex-Multiplex**—In the language of the Commission, transmission of the SCA program by the same means as the regular broadcast is called simplex. But at any time, an f-m station may send out SCA programs by multiplex. Listeners with ordinary receivers hear only the regular broadcasts.

Airline Radar Folds Into Floor



Radarscope on one of TWA's new Super-G Constellations folds into the floor of the plane's cockpit when not in use. The RCA radar sees weather a hundred miles ahead to help pilots plot a course around and above surface storms

Tubes Moving Underground

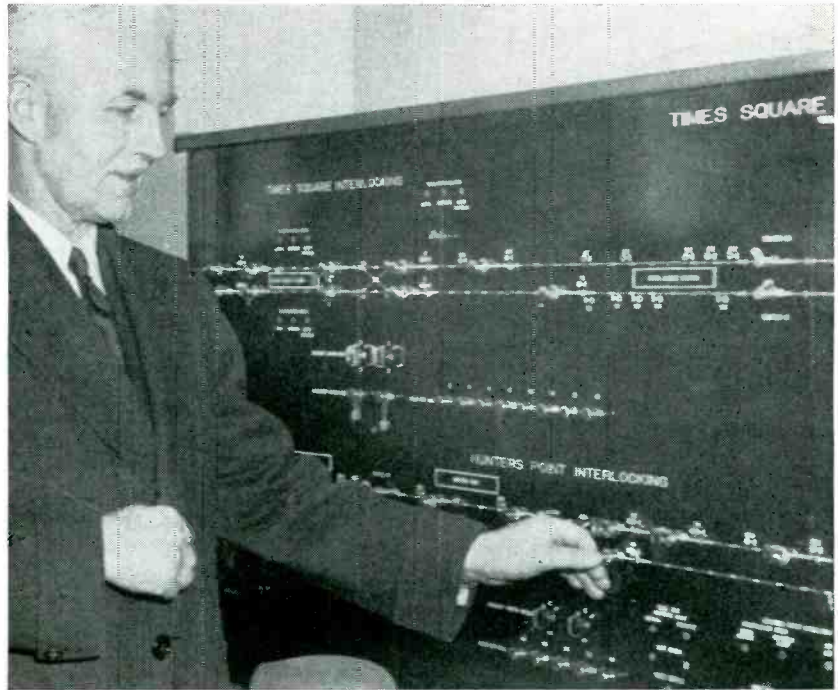

Major General Hugh J. Casey, chairman of New York City Transit Authority, pushes the button to start remote subway train signal and switch control

Pushbutton operations of New York subways will cost million dollars a mile

INCREASING use of electronics in railroading is forecast by recent installation of pushbutton controls for a portion of New York City's complex underground train system—the subway.

With 2.3 miles of the Interborough Rapid Transit system under control from Times Square, Union Switch & Signal is pushing to complete pushbutton switching on the entire IRT Flushing line by the end of 1955. Control for the 9.43-mile stretch will cost over a million dollars a mile. Further extension of the new controls is estimated to result in annual savings of \$3 million.

Auxiliary equipment to supplement signal and switch controls includes electronic train identification that will automatically throw track switches into position, classify on the control machine the trains entering and leaving terminals and

announce the class of train by means of signs.

► **Train Intercom**—A train carrier-radio system that will enable voice communications between control center and every train on the line is planned for eventual installation.

Purpose of the complex interlocking control system is greater safety and economy. For example, during night hours safe single-track operation will speed cleaning and maintenance that must otherwise be confined to short time intervals between trains.

Financial Roundup

First quarter profits for many companies are substantially higher than in '54

CALLED the best first quarter ever in net profits by some electronic manufacturers, the first three months of this year have been lucrative ones for many firms. This

(Continued on page 26)

Centralized Operations Control...

Economical with Modular Design Multi-Gate®

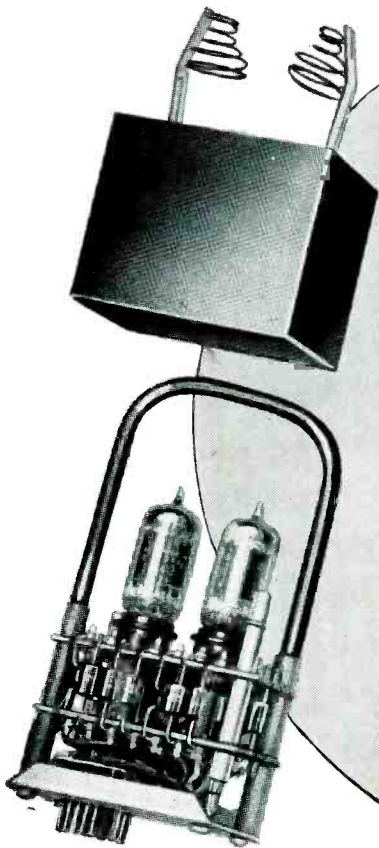

Plug-in Tone Transmitter
(Cover Removed)

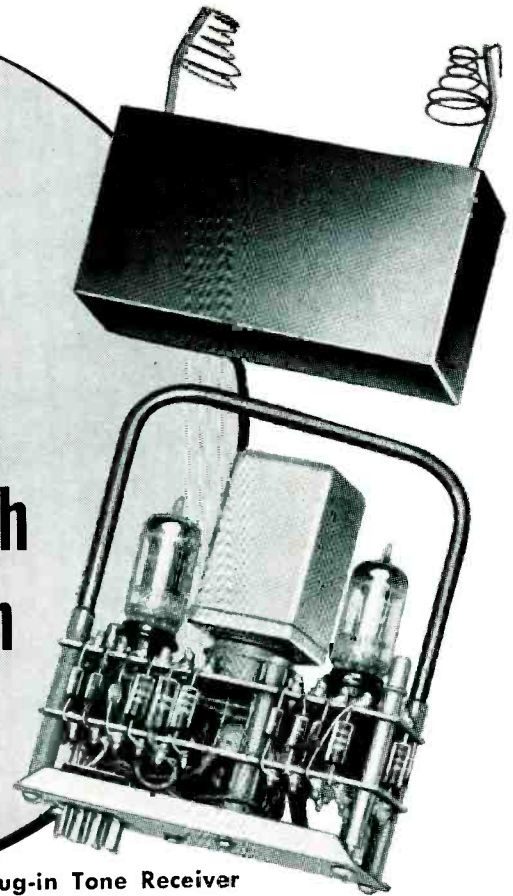

Plug-in Tone Receiver
(Cover Removed)

When planning a system to operate apparatus at a remote location from a central master station, it is important not only that the equipment perform as required, but also that it be easy and economical to install and service. On the first count, Hammarlund Multi-Gate equipment assures fast-acting, fail-safe operation of a practically unlimited number of control functions over a single circuit. On the second count, it's a snap to install and maintain because of its new modular construction. And that means lower operating and maintenance costs.

Each rugged, compact standard audio tone generator and receiver unit, as well as each relay section, is designed for simple plug-in. While easily removed, it is positively secured in service.

To provide complete protection against interruption, it is only necessary to have one spare of each of the basic components. That's because frequencies of the tone receivers and transmitters are determined by completely separate packages. As a result of this design, maintenance of these plug-in units is a simple operation and does not disturb the control system.

Because of its modular design, a complete system of any size is quickly assembled. Also, after installation, it may be easily expanded at any time by the addition of the required modular sections.

Your modern centralized control system will be low in initial cost, provide highly reliable performance, and be most economical in maintenance as a result of the many fine design features in Multi-Gate equipment.

You can get full details by writing to The Hammarlund Manufacturing Company, Inc., 460 West 34th Street, New York 1, N. Y. Ask for Bulletin E-6.

Typical Multi-Gate Receiving Terminal

This unit takes little space and is readily accessible when mounted in a standard 19" rack. Special window covers protect all relays from dust. Control of ventilation maintains conservative temperature levels throughout the equipment.

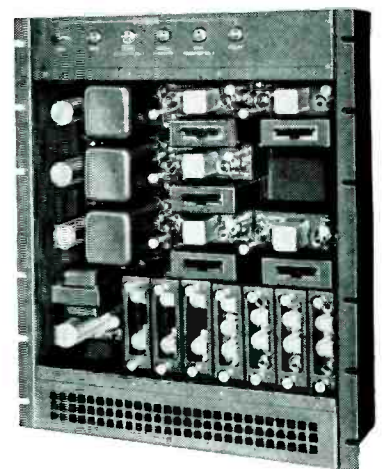

HAMMARLUND

EQUIPMENT FOR COC — CENTRALIZED OPERATIONS CONTROL

can be seen in the following net profit reports for companies in the field in the fiscal periods indicated:

Company	Net Profit	
	1955	1954
Am. B'dcasting 3m	\$1,950,000	\$1,110,000
Avco 3m	579,445	1,695,699
Burroughs 3m	2,459,419	2,315,935
GE 3m	50,569,000	48,029,000
Globe Union 3m	245,976	118,743
Hoffman 3m	309,906	470,238
IBM 3m	11,401,947	10,134,429
Minn.-Honeywell 3m	3,728,240	3,950,339
Minn. Mining 3m	7,452,170	5,259,281
Standard Coil 3m	116,599	406,306
Stewart Warner 3m	1,116,000	801,469
Stromberg Carlson 3m	604,577	571,533
Texas Inst. 3m	391,000	369,000
RCA 3m	12,568,000	9,426,000
Tung Sol 3m	756,714	450,304
Zenith 3m	2,074,960	827,521
	1954	1953
Consolidated Eng. 12m	\$842,862	\$510,406
Eitel McCullough 12m	622,761	
Electronic Engineering 12m	47,842	98,360
Garrett Corp 9m	2,707,309	2,405,928
Servomechanisms 12m	503,900	305,100

► **Securities**—General Precision Equipment is considering the issue of \$10 million of non convertible preferred stock and increasing term debt by an additional \$6.5 million. Purpose would be to retire all of the presently outstanding preferred stock and increase working capital.

Trav-Ler Radio Corp. registered with SEC covering \$1,250,000 of 12-year 6-percent sinking fund debentures, due May 15, 1967, with detachable 12-year common stock purchase warrants. Some of the proceeds will be for reduction of short-term loans and other loans and the balance for working capital.

National Co. obtained \$2 million additional capital for expansion of its engineering research activities, and its development of new electronic products. The new capital was provided by Easy Washing Machine Corp. and S. W. Richardson and P. R. Bass of Fort Worth, Texas. Through their stockholdings in Easy, Murchison Brothers of Dallas, Texas have a major interest in the financing.

Texas Instruments registered with SEC covering 165,945 shares of cumulative preferred stock, series A, \$25 par. Outstanding common stock is to be offered to stockholders at the rate of one share of preferred for each 18 shares of common held on May 2, 1955.

FUTURE MEETINGS

- JUNE 2-3: IRE Materials Symposium, U. of Penn. Physics Bldg., Philadelphia, Pa.
- JUNE 3-5: ARRL Hudson Division Convention and Amateur Radio Equipment Show, Hotel Adelon, Long Beach, N. Y.
- JUNE 6-8: Fourth Annual Convention and Trade Show, National Community Television Association, Park Sheraton Hotel, New York, N. Y.
- JUNE 14-16: First Magnetics Conference and Exhibit, AIEE, APS, AIMME, William Penn Hotel, Pittsburg, Pa.
- JUNE 20-25: Symposium on Electromagnetic Wave Theory sponsored by URSI and the University of Michigan, Ann Arbor, Mich.
- JUNE 23-25: Eleventh Annual Meeting of the Institute of Navigation, Air University, Maxwell Field Air Force Base, Montgomery, Ala.
- JUNE 27-29: Radome Symposium, Ohio State University and Wright Air Center, Columbus, Ohio.
- AUG. 22-23: Symposium on Electronics and Automatic Production sponsored by Stanford Research Institute and NICB, San Francisco, Calif.
- AUG. 24-26: 1955 WESCON, Civic Auditorium and Fairmount Hotel, San Francisco, Calif.
- AUG. 26-28: Sixteenth Annual Summer Seminar, Emporium Section IRE, Emporium, Pa.
- AUG. 26-SEPT. 4: Great German Radio, Gramophone and TV Exhibition, Dusseldorf, Germany.
- SEPT. 12-16: Tenth Annual Instrument Conference & Exhibit, ISA, Shrine Exposition Hall and Auditorium, Los Angeles, Calif.
- SEPT. 26-27: RETMA Symposium, Electronics For Automation and Automation For Electronics, Philadelphia, Pa.
- SEPT. 28-29: Industrial Electronics Conference, AIEE, Rackham Memorial Auditorium, Detroit, Mich.
- OCT. 3-5: National Electronics Conference, Hotel Sherman, Chicago, Ill.
- OCT. 24-25: First Annual Technical Meeting, IRE Professional Group On Electron Devices, Shoreham Hotel, Washington, D. C.
- OCT. 28-29: 1955 Symposium of Philadelphia ISA, Penn Sherwood Hotel, Philadelphia, Pa.
- OCT. 31-Nov. 1: 1955 East Coast Conference on Aeronautical and Navigational Electronics, IRE, Lord Baltimore Hotel, Baltimore, Md.
- Nov. 1-5: World Symposium on Applied Solar Energy sponsored by SRI, Assoc. for Applied Solar Energy and University of Arizona, Westward Ho Hotel, Phoenix, Arizona.
- DEC. 10-17: Atomic Exposition sponsored by AICE and Joint Nuclear Congress, Cleveland, Ohio.

Industry Shorts

- **Successful** airplane flights with all-transistor-equipped automatic navigation and landing systems in place of vacuum tubes have been announced by Bendix Aviation.
- **Commercial** production of a new film and slide system for tv stations, designed primarily for color programming, has been started by GE.
- **Airborne** combat information center in four-engine WV-2 plane has the most powerful airborne search radar yet developed, according to GE. It relays combat information to fighter planes.
- **More than 75 percent** of all amplifiers for Webcor products in 1955 and 1956 will utilize printed circuits.

- **White Alice** is the nickname applied to the initial phase of an Air Force project designed to strengthen and improve the vital communications links in Alaska's extensive radar network. Prime contractor for the project is Western Electric.
- **Facsimile** equipment made by Air Associates is now being used by the Tennessee Valley Authority over a Federal Telephone microwave system.
- **Portable** receiver sales will jump 10 percent this year, rivaling the clock radio as the second most popular type, according to CBS-Columbia.
- **One hundred and nineteen** different receiving tube types are used in 150 different 1954 and 1955 tv sets, according to a survey by GE.

KAY Sweeping Technique

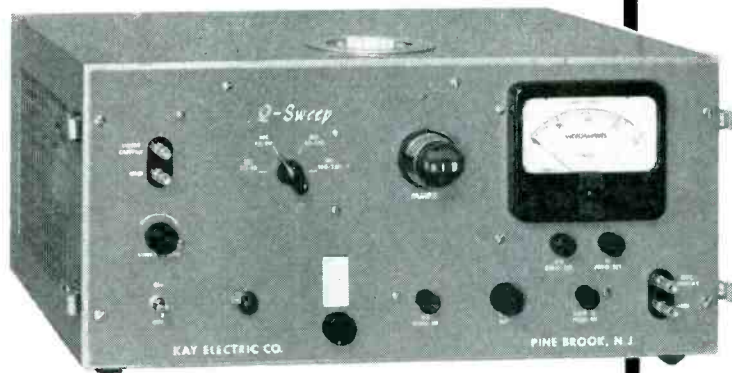

New KAY *Q-Sweep*

SPECIFICATIONS

Frequency Range: 20—220 MC, continuously variable
 Frequency Accuracy: Approx. 2% total deviation
 Range of Q Measure: 0-125, 0-250, 0-500
 Resonating Capacitor Ranges: 7.5—100 mmf—displayed on digital dial for ease of reading
 Resonating Capacitor Accuracy: $\pm 1\%$
 Power Supply: 105—125 v., 60 cycles, electronically regulated. Consumption, 100 watts.

PRICE: \$990. F.O.B. Plant.

The Kay Q-Sweep provides visual or meter display of Q over a 5% swept frequency range.

The Q-Sweep eliminates the need to continually reset the oscillator control for each component test—makes it possible to measure large numbers of components visually, or by meter reading, without readjustment of any control. The unit may be used as a conventional Q-Meter by turning off the sweep.

Provides Quick, Accurate Q Measurement

- XQ setting made with AVC circuit
- Reduces manual calibration adjustment with frequency changes—speeds up operational checks
- Sweep allows visual observation of Q characteristics with scope and/or meter
- Reduces operational errors
- Sweep allows work on narrow band tuned circuit or filter
- Digital display of capacitance value to eliminate dial reading error

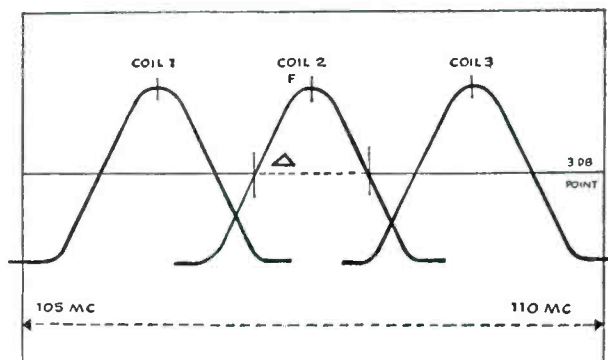

Visual observation of Q measurement showing typical 5% swept frequency.



SPECIFICATIONS

Oscillator Frequency Range: Variable 20 CPS to 1 MC in five steps
 Range of Q Measurement: 0—500
 Range of Calibrating Capacitance: 60 mmf to 0.1 mf. Triaxial tuning capacitor switch continuously variable on direct reading dial. Accuracy of reading to 5 places. (Additional capacitance may be added to terminals on front panels.)
 Calibration Capacitance Accuracy: Main dial tuning, 1%; vernier control, .1%
 Power Supply: 105—125 v., 60 cycles electronically regulated. Consumption, 70 watts.

PRICE \$695. F.O.B. Plant

LOW FREQUENCY Q METER COVERING RANGE OF 20 CPS TO 1 MC

Kilo-Q

The new Kay Kilo-Q provides a measure of component quality over a broad range of inductance and capacitance. It combines a direct reading dial over this range, accurate to 1%, for ease of operation.

Two positions are provided on the Q Range Control with full scale Q readings of 0 to 125 and 0 to 250, respectively. For reading Q values between 250 and 500, it is necessary to set the lever control to the X2 position on the dial and double the reading on the 250 scale.

The instrument provides a tuning capacitor range of 60-1200 mmf. A vernier capacitor control in shunt is provided to facilitate tuning of sharp "Qs".

KAY ELECTRIC COMPANY
 14 MAPLE AVENUE PINE BROOK, N. J.

THE MOST COMPLETE LINE OF FREQUENCY METERS!

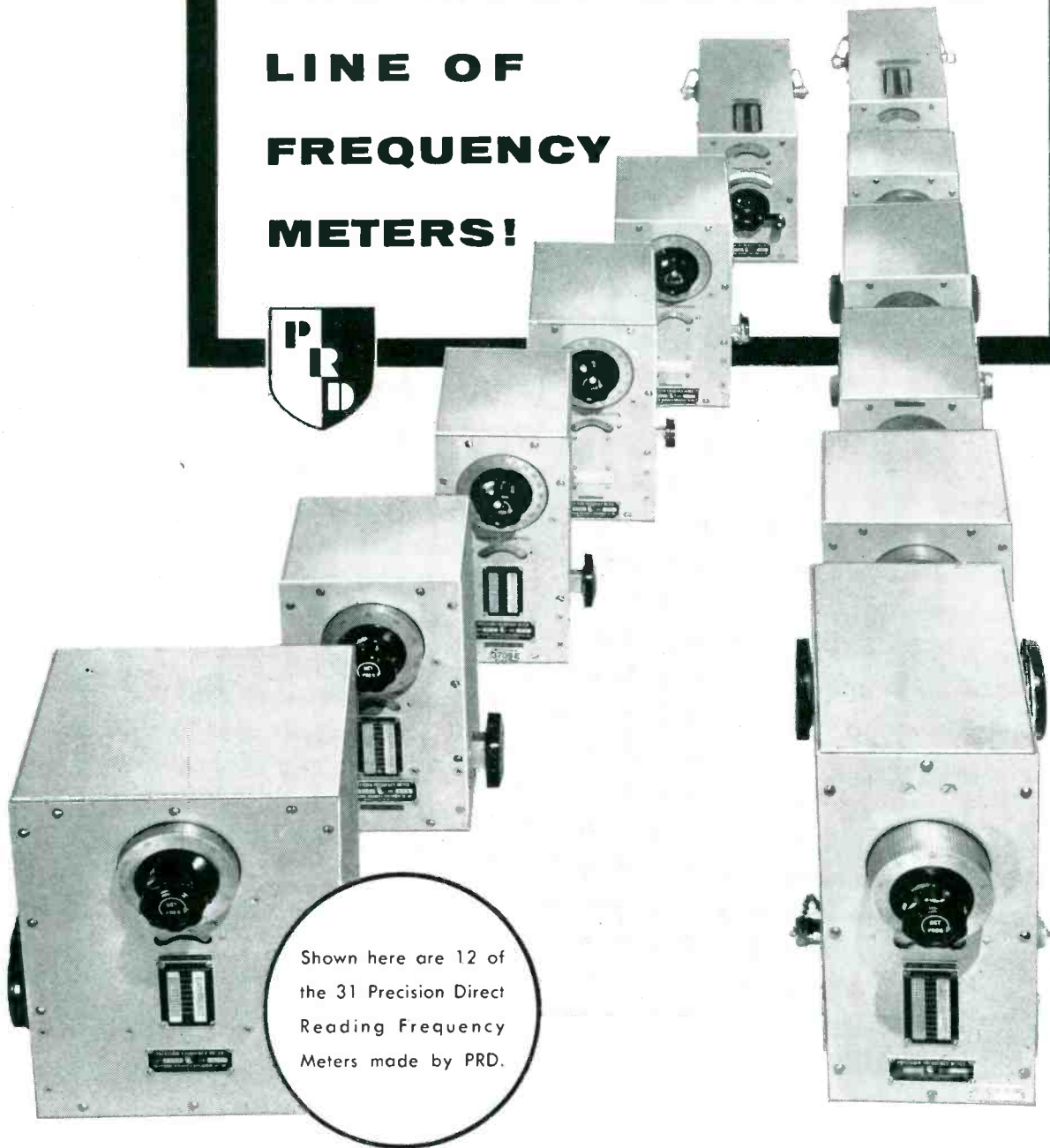

Shown here are 12 of
the 31 Precision Direct
Reading Frequency
Meters made by PRD.

Also Available...

- ✓ Calibrated Precision Frequency Meters
- ✓ Drum Dial Direct Reading Frequency Meters
- ✓ Frequency Standard Multiplier
- ✓ Custom Designs

PRD offers 44 different models.
Coverage from 400 to 40,000
mc/s. Request 1955 catalog.

Polytechnic **RESEARCH**

& DEVELOPMENT CO., INC.

202 TILLARY STREET
BROOKLYN 1, N. Y.

Telephone:
ULster 2-6800

Midwest Sales Office:
1 SOUTH NORTHWEST
HIGHWAY, PARK RIDGE, ILLINOIS — TAlcot 3-3174
Western Sales Office:
741½ NORTH SEWARD STREET, HOLLYWOOD 38, CAL. — HOLLYWOOD 5-5287

*here's the Vinyl Glass Sleevings
with unequalled
HEAT-AGING properties*

**BH
VINYL-SIL
8000**

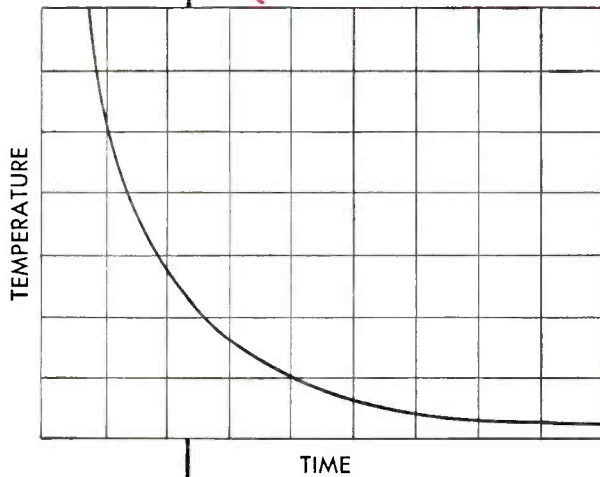

BH Vinyl-Sil 8000 Fiberglas Sleevings offers outstanding resistance to heat-aging, a major factor in insulation breakdown. It retains adequate flexibility, and its minimum guaranteed dielectric strength of 8000 volts even after these exposures:

2000 hours at 130°C., with tests still continuing.
5 hours at 232°C. 130 hours at 180°C. 825 hours at 150°C.

Here's Class B protection at Class A cost . . . plus these additional advantages:

- High Flow Resistance
- Unequalled Non-corrosiveness
- Excellent Low Temperature Flexibility (-50°F.)
- High Chemical and Oil Resistance
- No Capillary Attraction to Water

Here are increased electrical insulating properties that mean highest possible product protection—the greatest improvement in Vinyl Glass Sleevings in five years. Get complete details today — send for free testing samples and data sheet.

Bentley, Harris Manufacturing Co.
1306 Barclay St.,
Conshohocken, Pa.
Telephone: Conshohocken 6-0634

BENTLEY, HARRIS *Fiberglas**
SLEEVINGS

*BH Non-Fraying Fiberglas Sleevings are made by an exclusive Bentley, Harris process (U.S. Pat. Nos. 2393530; 2647296; and 2647288). "Fiberglas" is Reg. TM of Owens-Corning Fiberglas Corp.



Spotlighting
**a NEW AIRBORNE
 NAVIGATIONAL
 COMPUTER**

- **Miniaturized Ground Position Indicator for Navigation and Radar Stabilization**

NEW in CONCEPT! DESIGN! SIZE!

- ✓ 71.1% weight reduction
- ✓ 78.8% size reduction
- ✓ 81.8% area reduction
- ✓ increased accuracy under all service conditions!
- ✓ increased operational flexibility!
- ✓ improved resolution!



Imprint of Integrity

- A complete self-contained system utilizing airspeed pitot pressure, aircraft compass heading, and wind data in polar form. Computes and indicates ground displacement of aircraft in rectangular coordinates, from an initial fix.

LORAL—Specializing in development and production of AIRBORNE EQUIPMENT—devoted to the evolution of new concepts, miniaturization and peak accuracy.

LORAL—Serving the Aircraft Industry in the fields of:

- **AIRBORNE NAVIGATIONAL EQUIPMENT**
- **COMMUNICATIONS SYSTEMS**
- **RADAR EQUIPMENT**
- **TEST EQUIPMENT**

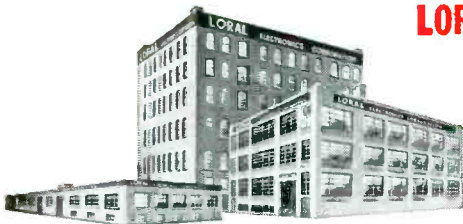

Dept. E-6

LORAL ELECTRONICS CORPORATION
 794 EAST 140th STREET • NEW YORK 54, N. Y.

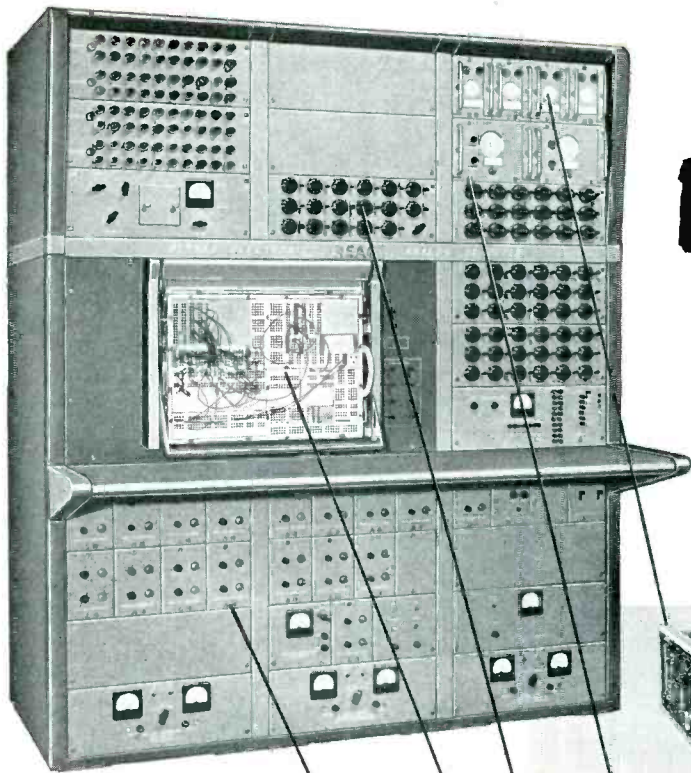

announcing the
New REEVES
REAC HIGH SPEED **400**
ANALOG COMPUTER

New
BUILDING-BLOCK
CONSTRUCTION

... an exclusive Reeves design principle that permits assembly of computer elements in any desired combination to form exactly the computer necessary to do a particular job or to expand an existing installation. REAC 400 can be assembled, component by component, to fit specific requirements at minimum cost, time, space and effort. REAC 400 is completely adaptable to the scope and complexity of your control problem, now or in the future.

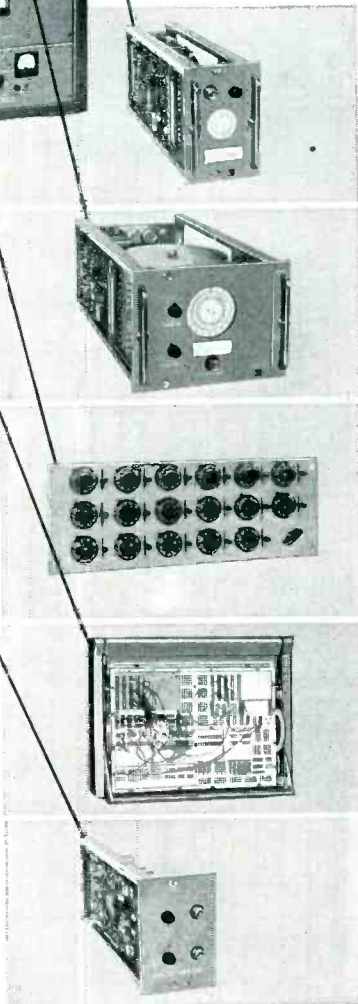

New HIGH SPEED SERVOS

Servo multipliers have bandwidth over 50 cps. Velocity 1500 v/sec; acceleration 60,000 v/sec². Six gang pots; two tapped with front panel plug-in turrets for function generation.

New HIGH SPEED RESOLVERS

Vastly improved dynamic performance ... 35-cycle bandwidth. Rectangular and Polar operation; Full AGC either mode. Front panel plug-in turrets for easy patching for function generation.

New PROBLEM CHECK

New Reeves development permits verification of problem solution directly from equations before problem is run.

checks { Operation of all components used
 Patching of problem from diagram
 Diagramming of problem from equations

New CONVENIENT PATCHBAY

Available in units of 1632, 3264 or 4891 holes for maximum flexibility. Color-coded mask aids in patching. Patchboard changes possible during operation.

New POWERFUL AMPLIFIERS

New dual amplifier chassis, individually chopper-stabilized. Noise less than 3 mv rms in cabinet. Phase shift 0.025° @ 100 cps. Bandwidth 10KC under cabinet conditions.



REEVES INSTRUMENT CORPORATION

A Subsidiary of Dynamics Corporation of America
 201 East 91st St., New York 28, N. Y.

REAC
 Analog
 Computers

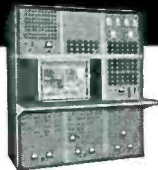

Precision
 Floated
 GYROS



Precision
 RESOLVERS and
 PHASE SHIFTERS



SERVO
 MECHANICAL
 PARTS

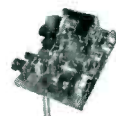

IRV55

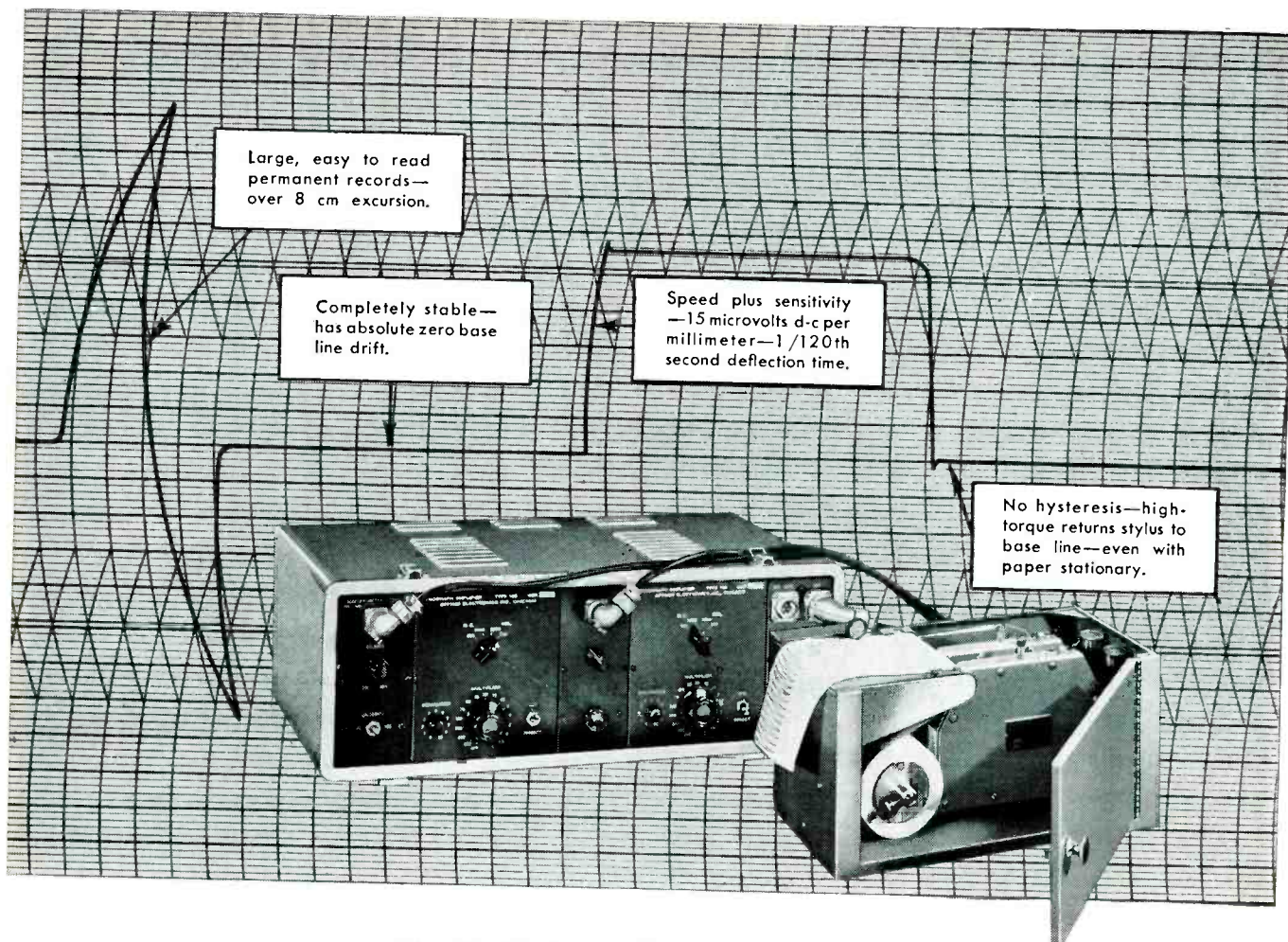

NEW...OFFNER PORTABLE DYNOGRAPH

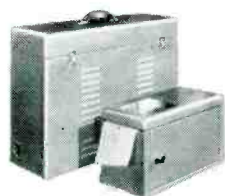

This high speed, direct writing oscillograph recorder provides exceptionally high, absolutely stable, d-c or a-c amplification. It may be used with reluctance type gauges without auxiliary equipment.

The exceptional stability, sensitivity, and versatility of the Dynograph are made possible by the exclusive, patented chopper amplifier. It is used for recording a wide variety of transient variables, such as strain, vibration, temperature, analog computer write-out, etc.

The performance specifications of the Type P Portable Dynograph are identical with those of the Type M Console model, but it is mounted in two convenient carrying cases as illustrated. The Type P is available with one or two channels.

Write for your copy of Bulletin L-742. It gives you complete details and application information on both portable and console models of the Offner Dynograph.



Check these exclusive features:

Speed plus sensitivity. The Dynograph gives you the maximum in speed and sensitivity—15 microvolts d-c per millimeter deflection with a response speed of less than 1/120th second.

Large easy-to-read records. Over 8 cm excursion, permitting the recording of large dynamic variations. Chart speeds 1 to 100 mm per second.

Absolute non-drifting stability. The Dynograph is absolutely stable and non-drifting—it is stable when it starts working and has absolutely zero base line drift.

No Hysteresis. The high-torque movement always returns the stylus to the base line—even with the paper stationary. Linearity is within one percent for four cm.

OFFNER ELECTRONICS INC.

5324 N. Kedzie Avenue, Chicago 25, U. S. A.

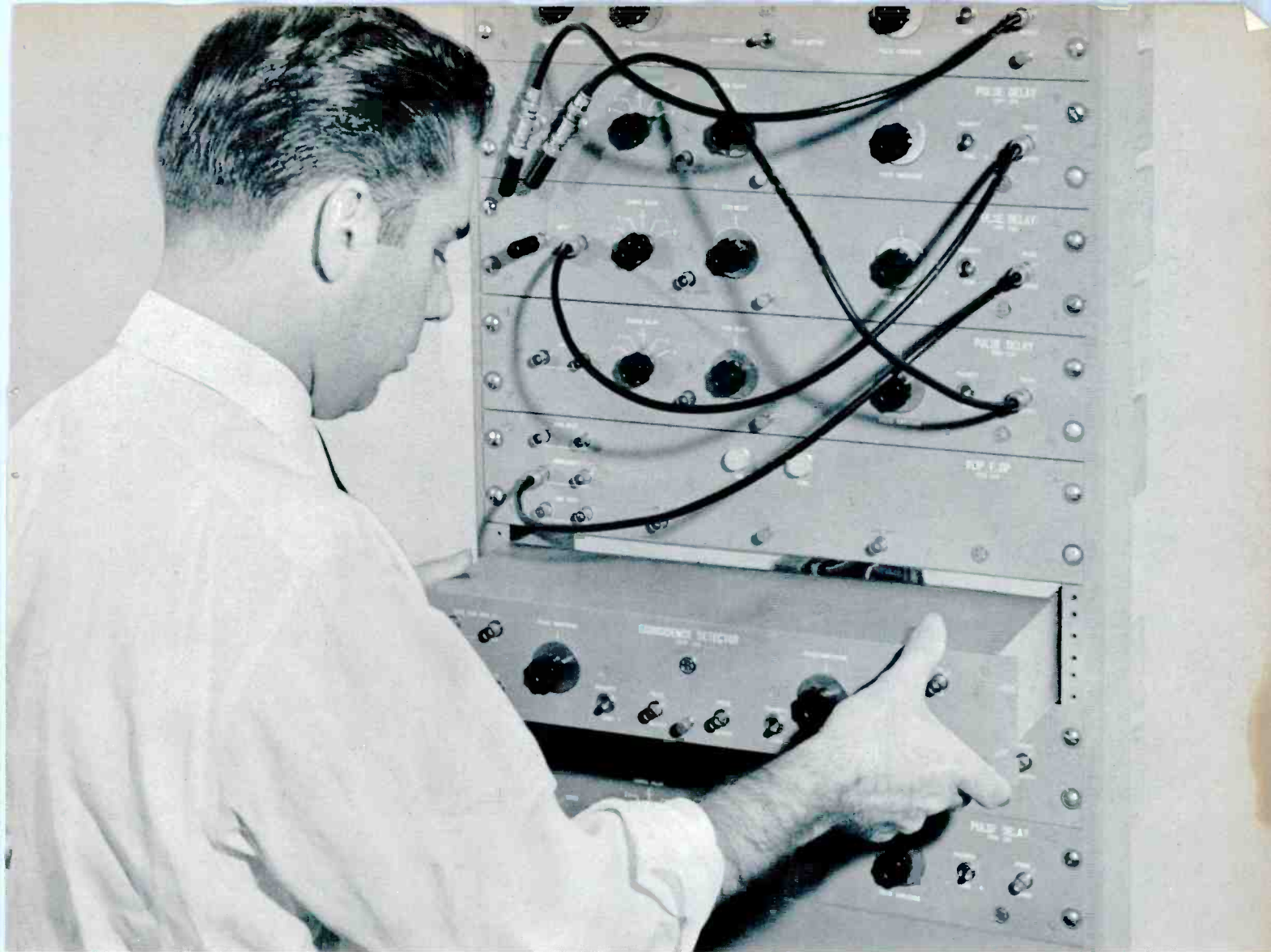

A simple pulse system. Engineer sets up and connects Burroughs Pulse Units to produce a pattern of pulses used in testing magnetic cores.

Every engineer who works with pulses should read this news from **BURROUGHS**

New packaged pulse handling units performing basic functions connect together to form a virtually unlimited variety of pulse systems

Now you can assemble any kind of pulse system you need from the simplest to the most complex—usually in a matter of minutes. All you do is connect together Burroughs Pulse Units, using standard plug-in cables.

Speed of set-up is one of the chief advantages of this equipment. There's no soldering required. Systems can be set up or radically changed with no tools except possibly a screw driver.

Since Burroughs Pulse Units are complete within themselves and matched to each other, you're relieved of the problem of detailed circuit design. You work with simple block diagrams and basic ideas only . . . concentrate your efforts entirely on the logic of the system.



UDEC II, a complex pulse system. The giant Burroughs Unitized Digital Electronic Computer is built entirely from Burroughs Pulse Units connected together with standard cables.

READ MORE →

Burroughs Pulse Test Units Help

No time lost building test equipment

Simple 3-step set-up builds a complete pulse system

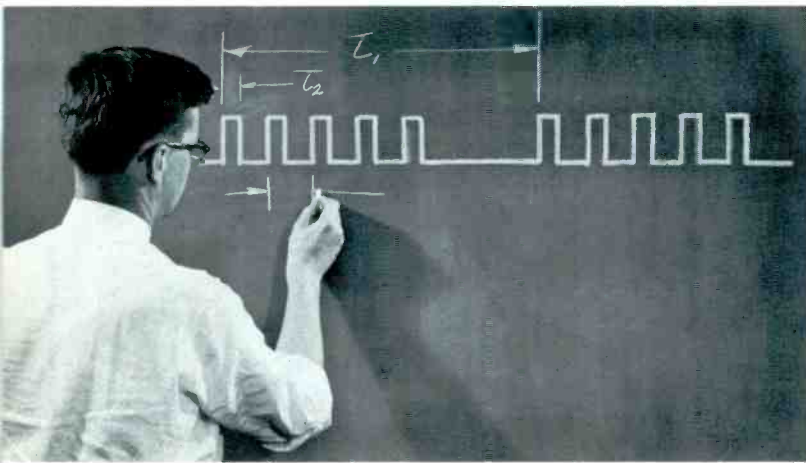

1. Study the pulse sequence

This is the time chart of the desired pulse output from the pulse system. It shows pulse height, pulse width, pulse frequency, and pulse separation. Usually, the pulse sequence is worked out as part of your preliminary planning prior to beginning actual engineering with the equipment.

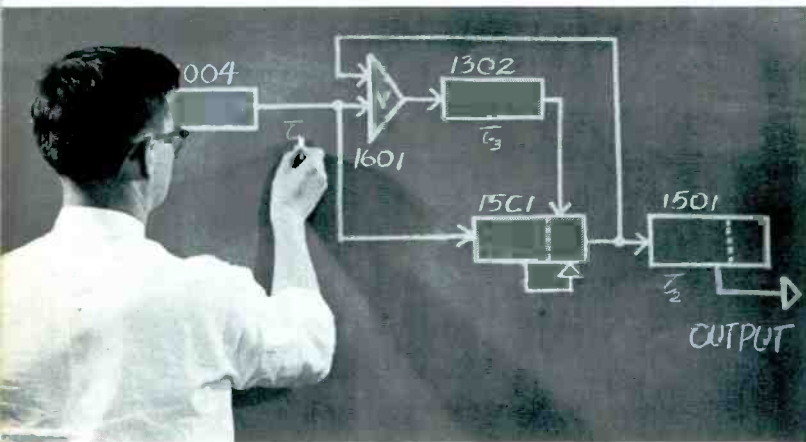

2. Draw the block diagram

This is the first step in planning the actual pulse system. Using standard block diagram symbols, you can plan your complete system within a matter of minutes. And you needn't worry about circuit details within the units themselves, because all units are complete and matched to each other.

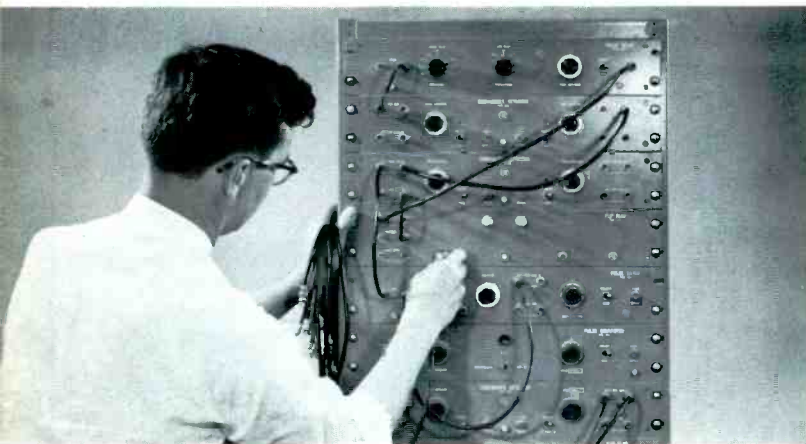

3. Connect the units together

From the block diagram you can determine which Burroughs units you need in your rack. Connect them together with standard cables, and there's your pulse system. Convenient front-panel controls add further flexibility—enable you to make frequency changes over a wide range as easily as turning knobs.

INDIVIDUAL UNITS PERFORMING BASIC FUNCTIONS CONNECT TOGETHER



Pulse generators



Flip-flops



Mixers



Coincidence detectors



Pulse delays

Engineers Save Time to Do More

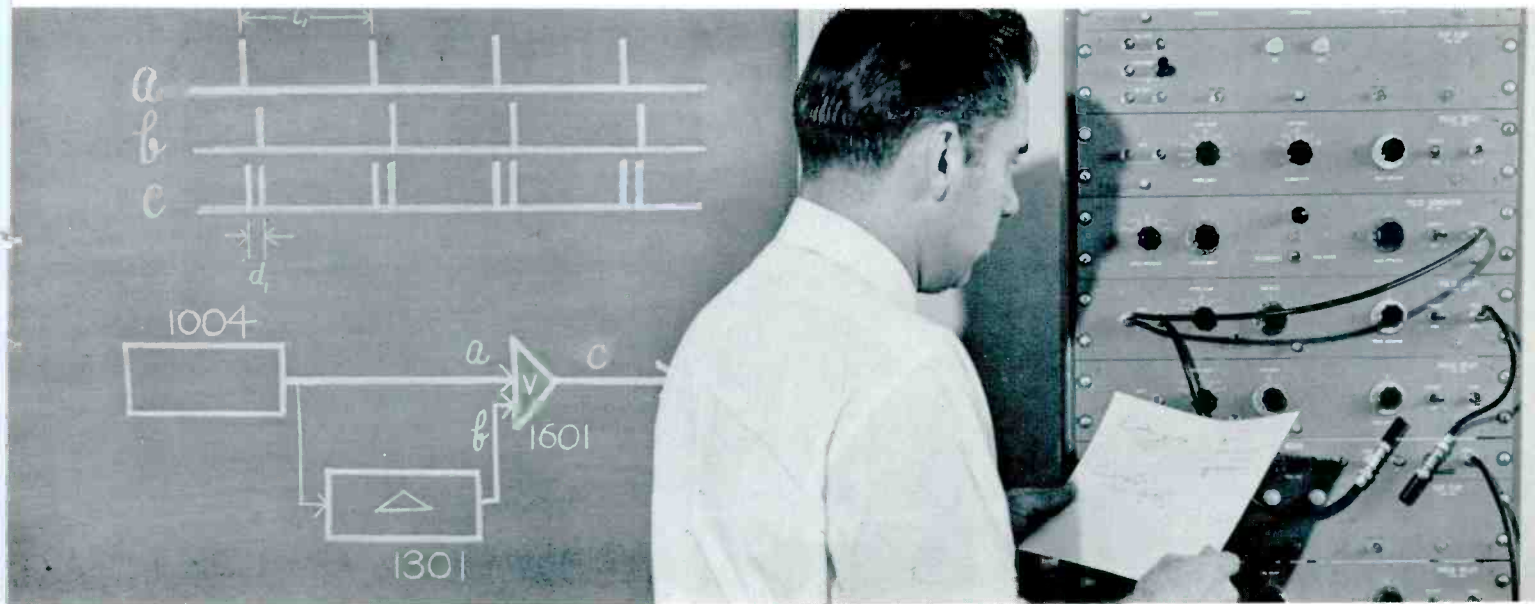

Try new ideas—Burroughs Pulse Units are so easy to use they make it possible for you to try many new ideas that you might otherwise never find time for. Think of it. No breadboard engineering. No designing special test equipment before you begin on a new project. Consider how many more new ideas you can try when you have this convenient, flexible equipment at your finger tips. If you work with pulses, you need these new engineering tools.

Correct errors fast—Before Burroughs Pulse Units were developed, errors in pulse system planning meant a serious economic loss—in equipment as well as time. Not so now. When you discover an error in planning your system, simply reconnect the cables and correct the error. It only takes minutes. Often you can't be sure how a system should be connected. With Burroughs units, you can try different ways—at no loss. You can experiment without losing engineering time.

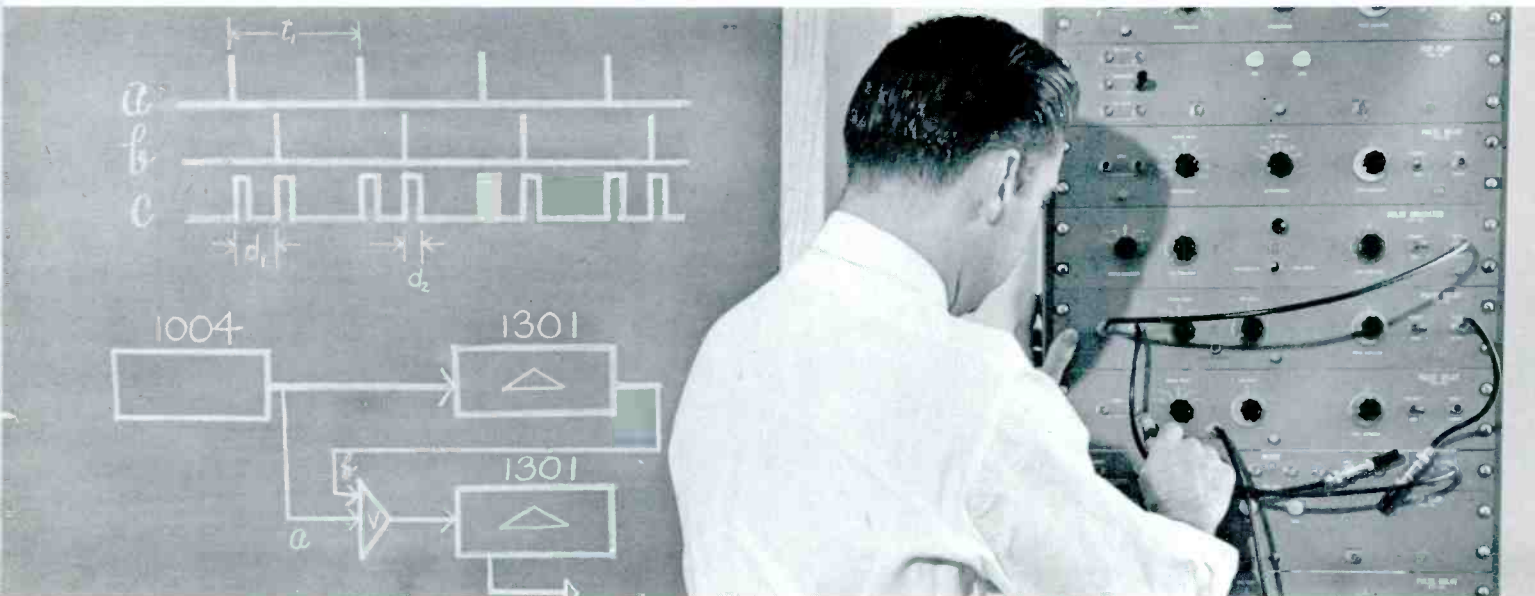

Speed completion of engineering—Every day lost in the engineering phase of product development postpones product delivery. So you're the loser when you take time to build your own test equipment. How much easier it is to make deadlines when you can simply connect Burroughs pre-engineered units together. Leading laboratories engaged in all phases of electronics research are now benefiting from the time-saving advantages of Burroughs Pulse Units.

Use equipment over and over again—This is where the real economy comes in. But first let us say a word about original cost. Burroughs Pulse Units usually cost less than you would otherwise have to spend in engineering time and equipment to design and build your own pulse system. Beyond that, they can be used over and over again on different future jobs—saving additional cost in every application. The total savings can be incalculable.

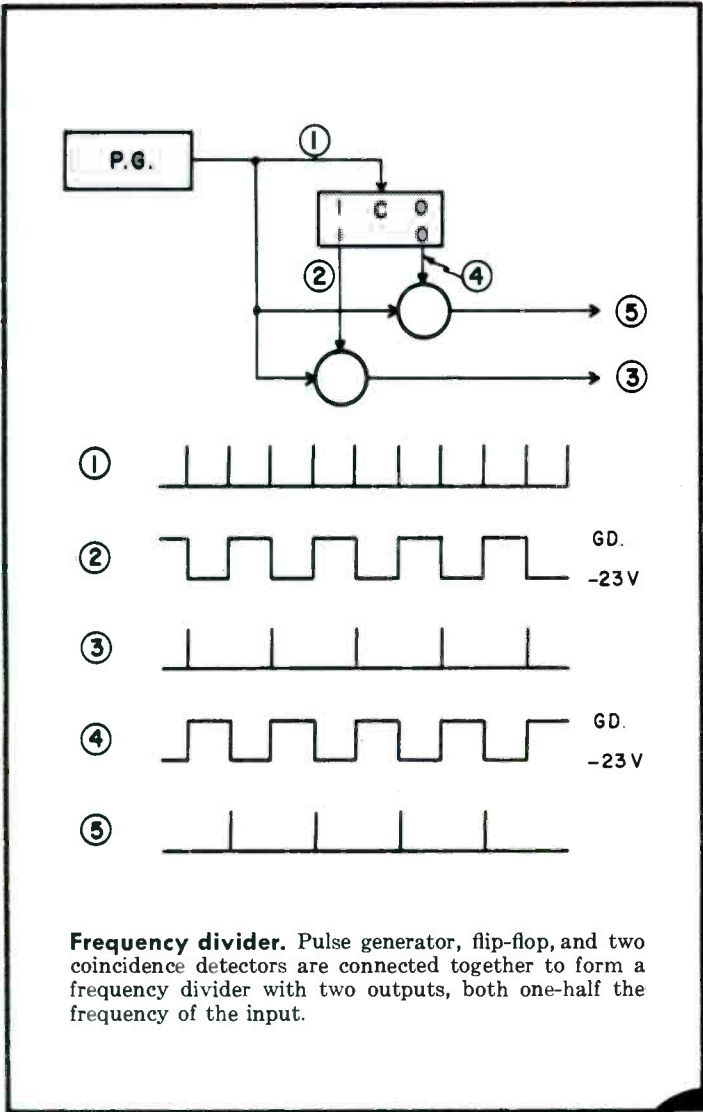

Typical Applications for Burroughs Pulse Units

Pulses are being used so widely today in information handling and control systems that it would be impossible to list fully the many fields of application for Burroughs Pulse Units. Generally, however, they are being used in research engineering, development engineering, and even product test applications in connection with such products as:

- Radar
- Telemetry
- Computers
- Electronic control
- Television
- Test equipment

Can Burroughs Help You?

If you have an engineering problem involving pulses, write Burroughs. Without charge, we'll engineer a system for you showing which Burroughs Pulse Units you need and how much they cost. Prove to your management just how much you can save in engineering time and equipment cost. Deliveries can be made immediately from stock. For detailed brochure, just send the coupon.



Send coupon

Burroughs Corporation
Electronic Instruments Division, Dept. 3F
1209 Vine St., Philadelphia 7, Pa.

Yes, I want the detailed brochure on Burroughs Pulse Units.

NAME

TITLE

COMPANY

STREET

CITY ZONE STATE





Here rectifiers are automatically tested and inspected in mass quantities.

Rectifiers in mass-production lots are placed in Life-Test Equipment and are tested to 10,000-hour life standards.

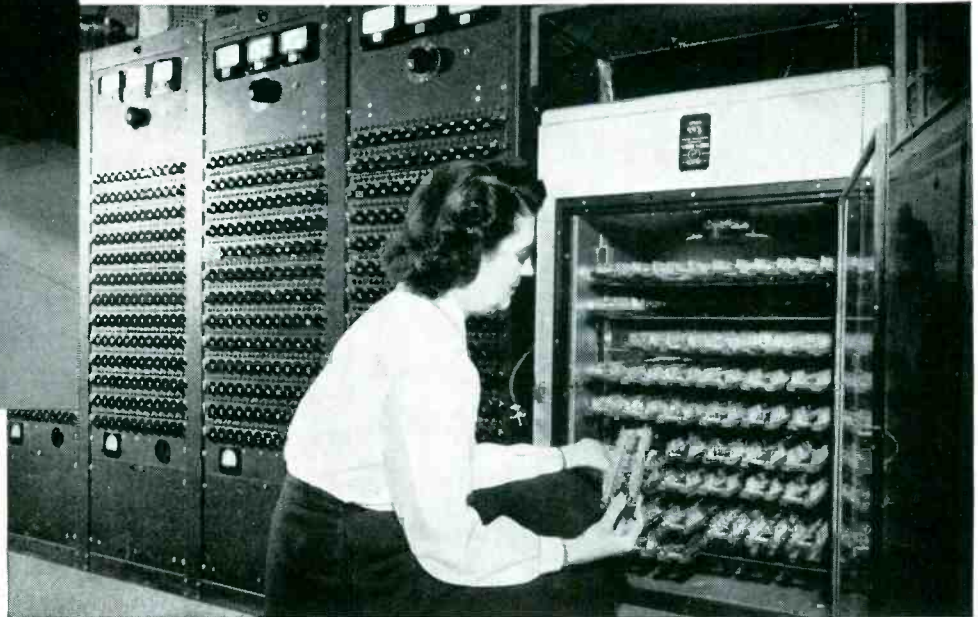

How G.E. assures 85°C operating reliability of the new 1N315 Germanium Rectifier

This array of testing equipment mass-checks individual germanium rectifiers to 10,000-hour standards under *maximum voltage and current* conditions and at 85°C. Each rectifier is electrically connected to a testing circuit and any unit which falls below guaranteed limits is automatically rejected.

This life test is only one of the many severe quality checks imposed on General Electric Semiconductor products. Precision mass production coupled with precision mass testing assures uniform, reliable quality at low, mass-quantity prices.

G.E.'s new 1N315 rectifier operates efficiently and with long life at 85°C because of new germanium crystal growing techniques developed by the General Electric Research Laboratory and improved junction forming methods. Controlled characteristics are assured by accurate machines which reproduce assemblies to extremely close tolerances. The high reverse resistance and low forward resistance characteristics make it specially adaptable for use in magnetic amplifiers or other circuits where high temperature and extremely low leakage current are required.

Full details are available on request. Write or wire today to: *General Electric Company, Section X465, Semiconductor Products, Electronics Park, Syracuse, New York.*

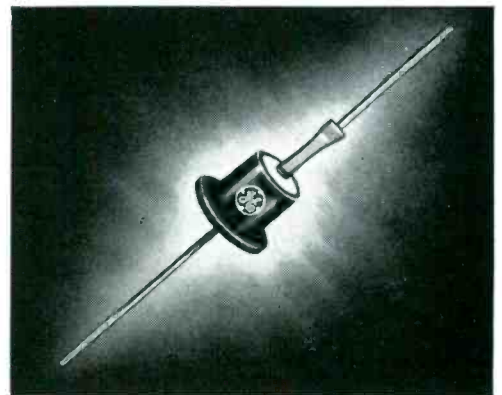

SPECIFICATIONS 1N315 and 1N315A (Resistive or Inductive Load)

	55°C	71°C	85°C	
Maximum allowable peak inverse voltage	200	200	100	V
Maximum allowable D-C output current	100	100	100	ma
Maximum full load forward voltage drop	.48	.46	.44	V
Continuous reverse working voltage	150	100	50	V
1N315 minimum forward to reverse current ratio (average forward/average reverse at full load)	700	300	200	
1N315A minimum forward to reverse current ratio (average forward/average reverse at full load)	1600	750	400	
Maximum operating frequency (70% rectification efficiency)	50	50	50	KC
Storage temperature	95	95	95	°C

Progress Is Our Most Important Product



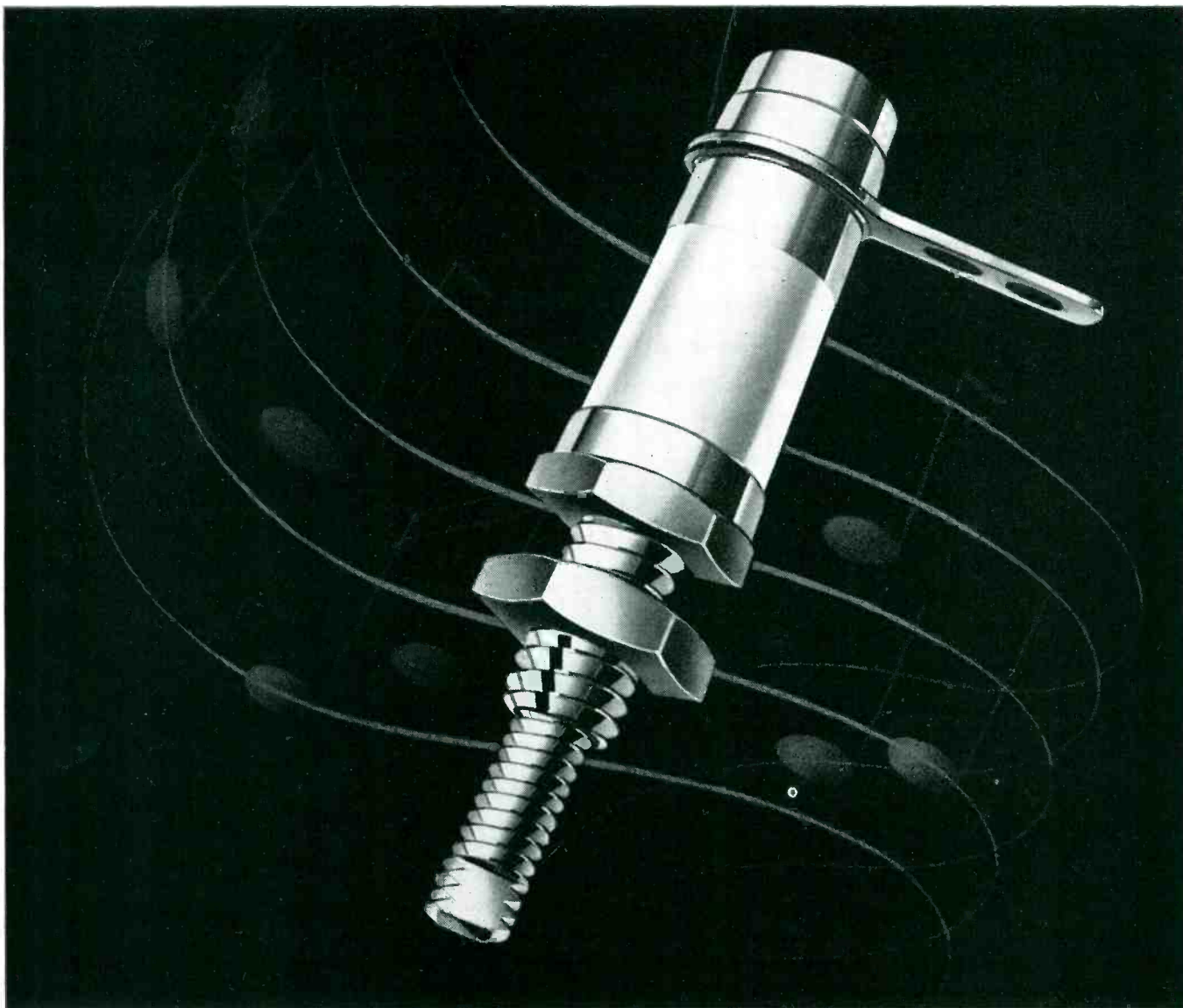

Mighty midget "tunes up" for major performance

This miniaturized CST-50 variable ceramic capacitor outperforms capacitors several times larger. C.T.C.'s unique design includes a *tunable element* which virtually eliminates losses due to air dielectric. This results in wide minimum to maximum capacity range of 1.5 to 12 MMFD.

This tuning sleeve is at ground potential and can be locked firmly to eliminate undesirable capacity change. Each CST-50 is provided with a ring terminal with two soldering spaces.

This is *but one* of a versatile family of C.T.C. ceramic capacitors of this type, built to C.T.C.'s *quality control* production standards for guaranteed performance.

All C.T.C. components — standard or custom — are subject to this precision manufacture. Other C.T.C. components include coil forms, coils, terminal boards, terminals, diode clips, insulated terminals and hardware. C.T.C. engineers are glad to consult on *your* component problem. Write *now* for sample specifications and

prices to Sales Engineering Department, Cambridge Thermionic Corporation, 437 Concord Ave., Cambridge 38, Mass. On West Coast, contact E. V. Roberts, 5068 West Washington Blvd., Los Angeles 16 or 988 Market St., San Francisco, Calif.

C.T.C. Capacitor Data: Metallized ceramic forms.

CST-50, in range 1.5 to 12.5 MMFDs.

CST-6, in range 0.5 to 4.5 MMFDs.

CS6-6, in range 1 to 8 MMFDs.

CS6-50, in range 3 to 25 MMFDs.

CST-50-D, a differential capacitor with the top half in range 1.5 to 10 MMFDs and lower half in range 5 to 10 MMFDs.

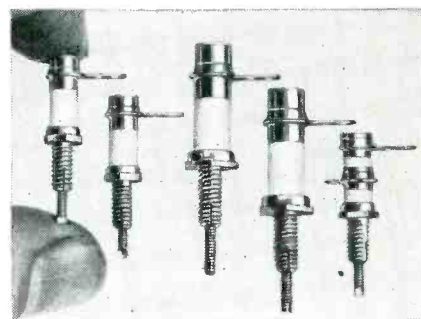

CTC

CAMBRIDGE THERMIONIC CORPORATION

*makers of guaranteed electronic components,
custom or standard*

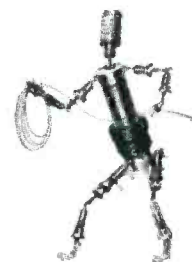

**PLUG
IT
IN**



Airpax Series 300 choppers are available in three mounting styles. The popular plug-in style, Type 300, fits a 7-pin miniature tube socket. It can be locked in place by a tube shield.

**BOLT
IT
DOWN**



For permanent mounting, Airpax supplies you with Type 303. The Series 300 chopper withstands shock and vibration, commending it to such rigid mounting.

**OR
STRAP
IT ON**



Or, for mounting parallel to a chassis, Type 302 is available. These choppers, rated for 2,000 hours life, can be soldered advantageously into many equipments.

THIS RUGGED LONG-LIFE CHOPPER CAN TAKE IT!

Airpax Series 300 choppers operate at 400 CPS. The SPDT contacts are rated for 2 MA at 100 V MAX.

For complete specifications write to



MIDDLE RIVER

BALTIMORE 20, MD.

New, low cost, INDUSTRIAL



MEASURES FREQUENCY, SPEED,
RPM, RPS, RANDOM EVENTS

MEASURES WEIGHT, PRESSURE,
TEMPERATURE, ACCELERATION*

WIDE RANGE, 1 CPS TO 120 KC
DIRECT NUMERICAL READINGS

HIGH ACCURACY, SIMPLE TO USE
COMPACT, RUGGED, DEPENDABLE

-hp- 521A ELECTRONIC COUNTER — \$475.00

SPECIFICATIONS

- Range:** 1 cps to 120 KC.
Accuracy: ± 1 count \pm accuracy of timing frequency. (Approximately $\pm 0.1\%$ when power line used, $\pm 0.01\%$ with crystal standard installed.)
Registration: 4 places. Total count capacity 9,999.
Input Requirements: 0.2 v rms. minimum above 10 cps; 0.3 v 1 cps to 10 cps.
Input Attenuator: Adjusts sensitivity from 0.2 v to 100 v rms.
Input Impedance: Approximately 1 megohm, 50 μf shunt ($1/2$ megohm on "Phototube" jack).
Gate Time: 1/10 and 1 second. Panel neon lamp indicates that gate is open.
Manual Gate: Controlled by "Open-Closed" switch or external contacts.
Display Time: Variable from 1/10 to 15 seconds; or display can be held indefinitely.
Reads In: Cps or directly in rps or rpm with -hp- 506A or 508A/B Tachometer Accessories.
Self-Check: Counts line frequency for any selected gate time.
External Standard: Can be operated from any multiple of 10 cps, 10 cps to 100 cps.
Phototube Input: Supply voltage for 1P41 (or equal) phototube provided at phone jack on rear.
Power Supply: 115v $\pm 10\%$, 50/60 cps, 170 watts.
Size: Cabinet Mount: 9 $\frac{3}{4}$ " wide, 13 $\frac{7}{8}$ " high, 13 $\frac{3}{8}$ " deep. Weight: 25 lbs. net; shipping weight 40 lbs.
Accessories Available: -hp- 521A-95B Crystal Controlled Time Base for field installation, \$100.00.
Price: \$475.00.
 *With transducers

The new -hp- 521A measures frequency, speed, rpm, rps, and counts random events within a selected time interval. With transducers, it measures weight, pressure, temperature, acceleration and many other phenomena which can be converted to frequency. Operation is so simple the instrument can easily be used by non-technical personnel. Readings are direct in cps, rpm and rps. Period of count is 0.1 or 1 second; display time can be varied. A convenient internal check circuit is provided. There are accessory power supplies of —150 volts dc, +300 volts dc and 6.3 volts ac. Connections are also supplied for photocells and an external standard.

Model 521 uses the 50/60 cycle power circuit as a time base. For most applications, the accuracy of this power frequency is adequate. Where higher precision is required, a plug-in crystal controlled electronic time base is available at extra cost.

In measurements of speed, rps and rpm, the 521A is particularly useful with -hp- Optical Tachometer Pickups and Tachometer Generators shown on the opposite page.

Your -hp- field representative will gladly demonstrate the compact, portable 521A in your plant or laboratory. Or, write direct for complete details.



ELECTRONIC MEASURING INSTRUMENTS

versatile

COUNTER

OTHER -hp- COUNTERS



**-hp- 524B Counter with
-hp- 525A Frequency Converter**

Frequency 10 cps to 220 MC, interval 1 μ sec to 100 days, and period 0 cps to 10 KC—all are measured instantly, automatically and directly by the revolutionary -hp- 524B and its plug-in units. You buy just the instrumentation you need now; later add inexpensive plug-ins to double, triple the usefulness of this versatile, complete coverage counter. -hp- 524B without plug-ins, \$2,150.00^Δ.

-hp- 524B Electronic Counter
with plug-in units to fit your exact measuring need

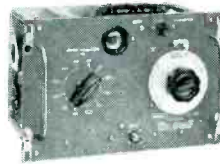

-hp- 525B
Frequency Converter

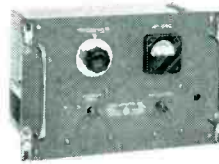

-hp- 526A
Video Amplifier

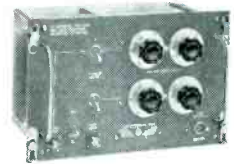

-hp- 526B
Time Interval Unit

Instrument	Primary Uses	Frequency Range	Characteristics	Price
-hp- 524B Electronic Counter	Wide range highly accurate frequency, period measurements	10 cps to 10 MC	Without plug-in units measures frequency 10 cps to 10 MC, and period 0 cps to 10 KC, 1 volt rms minimum input	\$2150.00 ^Δ
-hp- 525A Frequency Converter	Extends -hp- 524B range to 100 MC	10 cps to 100 MC	10 mv rms minimum input 10 MC to 100 MC .1 volt from 10 cps to 10 MC	250.00
-hp- 525B Frequency Converter	Extends -hp- 524B range 100 to 220 MC	100 MC to 220 MC	.1 volt rms minimum input	250.00
-hp- 526A Video Amplifier	Increases sensitivity of -hp- 524B	10 cps to 10 MC	App. 10 millivolt rms minimum input	150.00
-hp- 526B Time Interval Unit	Used with -hp- 524B to measure time interval	Range: 1 μ sec to 10 ⁷ seconds	Start and stop channels separately adjustable for triggering from -192 v to +192 v	175.00

-hp- 522B ELECTRONIC COUNTER

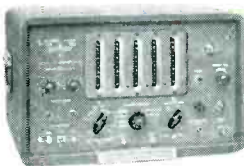

Compact, moderately-priced, versatile instrument for frequency, period or time measurements. Range 10 cps to 100 KC. Reads direct in cps, KC, seconds or milli-seconds. Count automatically reset, action repetitive. Stability of time base 5/1,000,000. Display length variable. Easily used by non-technical personnel. \$915.00^Δ.

Data subject to change without notice. Prices f.o.b. factory.
^Δ Rack mounted instrument available at slightly lower price.

HEWLETT-PACKARD COMPANY

3333A PAGE MILL ROAD • PALO ALTO, CALIFORNIA, U.S.A.

Cable "HEWPACK"

Field representatives in all principal areas

-hp- TRANSDUCERS

-hp- 506A OPTICAL TACHOMETER PICKUP

Versatile, flexible light source and pickup for measuring rotational speeds 300 to 300,000 rpm. Ideal for use on moving parts which have small energy or can not be connected mechanically to measuring devices. Output voltage at least 1 v rms, 300 to 100,000 rpm, into 1 megohm or greater impedance. 21 candlepower, 6 v bulb; type 1P41 phototube. \$100.00.



-hp- 508A/B TACHOMETER GENERATORS

Transducers for use with electronic counters or frequency meters in making direct reading rpm measurements, 15 to 40,000 rpm. Relationship of shaft speed to output voltage is linear to 5,000 rpm. -hp- 508A produces 60 cycles output frequency per shaft revolution. (-hp- 508B is identical, except produces 100 cycles output frequency per revolution.) -hp- 508A or 508B, \$100.00.



QUALITY, VALUE, COMPLETE COVERAGE

Here's the Complete "Package" for Counting Electrically...

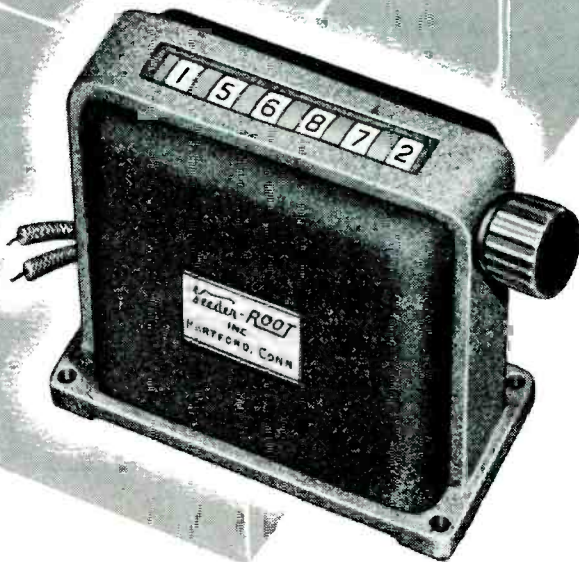
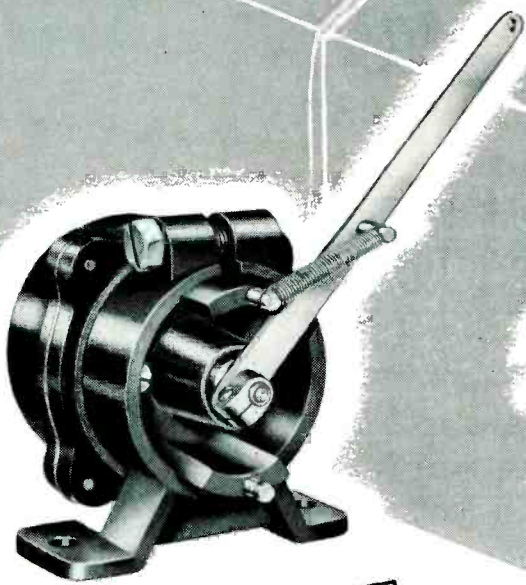

*Added Evidence
that —*

Everyone Can Count on **VEEDER-ROOT**

This Veeder-Root Reset Magnetic Counter (AC or DC) is actuated through electromagnets. And it may be connected in series with any device having a contact arrangement . . . like the specially designed Veeder-Root Electrical Contactor at the left, which insures positive operation of the counter, either in oscillation or connected directly to a revolving shaft . . . with the counter placed at

any distance from the machine or process on which the count is required.

This is another one of the hundreds of Veeder-Root Standard and Special Counting and Computing Devices developed for every conceivable counting duty, in every field from atomics to electronics.

What do you need to count? Just write:

VEEDER-ROOT INCORPORATED
HARTFORD 2, CONNECTICUT



Chicago 6, Ill. • New York 19, N. Y. • Greenville, S. C.
Montreal 2, Canada • Dundee, Scotland
Offices and Agents in Principal Cities
"The Name that Counts"

Adjustoroid®

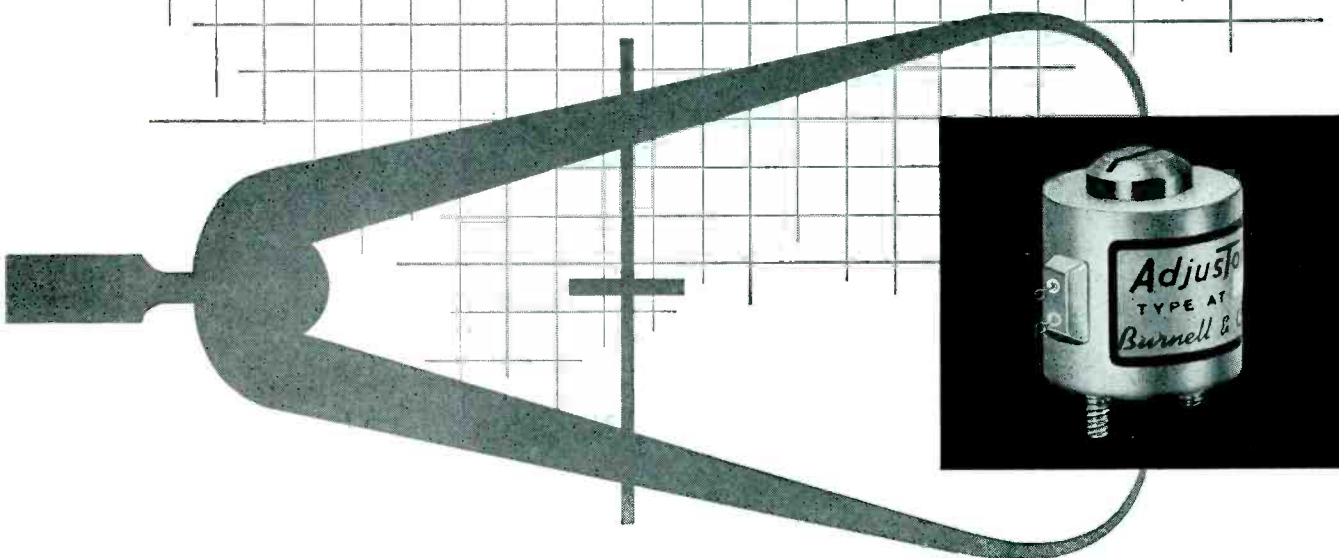

Introducing **A LOW-COST ADJUSTABLE TOROID**

- precise, instant adjustment
- inductance variation of 10%
- eliminates critical close tolerance capacitors
- high Q
- no external power supply
- truly hermetic sealing
- temperature coefficients same as fixed toroids
- no increase in case diameter
- developed by Burnell, creators of the Rotoroid®

Write for Adjustoroid
Technical Brochure A 55

LET BURNELL ENGINEERS SHOW HOW USE OF ADJUSTOROID REDUCES EQUIPMENT COSTS



Teletype: Yonkers, N. Y. 3633

BURNELL & CO., INC.

45 Warburton Avenue
Yonkers 2, New York

Pacific Division: 720 Mission St., S. Pasadena, Calif.

Copyright patent applied for

BUILDING BLOCKS

serving industry through coordinated precision technology

	● Manufacturing	●● Manufacturing and product development	●●● Manufacturing, product development and research	□●● Pilot manufacturing, product development and research
PRECISION MECHANICS, OPTICAL DEVICES, CERAMICS	●●●	●●	●●	□●●
ELECTRICAL EQUIPMENT and COMPONENTS	●●●	●	●	
ELECTRONICS	●●●	●●	●●	
HYDRAULICS, LIQUIDS PROCESSING, HEAT EXCHANGE		●●	●●	
TELEVISION <i>Studio, Theatre, Educational, Business, Industrial</i>	●	●	●●●	
INSTRUMENTS, SERVOS, CONTROLS <i>Hydraulic, Pneumatic, Magnetic, Electronic</i>	●●●	●	●●	□●●
AIRCRAFT and MISSILE GUIDANCE, CONTROL, SIMULATION	●●●	●	●●	
AUTOMATIC COMPUTERS and COMPONENTS	●●●	●	□●●	
RADAR, MICROWAVE, ULTRASONICS	●●●	●	●●	
MOTION PICTURE and AUDIO EQUIPMENT		●●●	□●●	
NUCLEAR POWER COMPONENTS and CONTROLS	●●●		●●	
SYSTEMS ENGINEERING <i>Aeronautical, Naval, Industrial</i>	●●●		●●	
KEARFOTT COMPANY, INC.				
INTERNATIONAL PROJECTOR CORPORATION				
BLUDWORTH MARINE DIVISION				
GENERAL PRECISION LABORATORY INCORPORATED				
THE GRISCOM-RUSSELL COMPANY				
LINK AVIATION, INC.				
THE HERTNER ELECTRIC COMPANY				
THE STRONG ELECTRIC CORPORATION				
J. E. MCAULEY MFG. CO.				
ASKANIA REGULATOR COMPANY				
AMPRO CORPORATION				
LIBRASCOPE, INCORPORATED				

THE GPE PRODUCING COMPANIES

One of a series telling
how the producing companies of
General Precision Equipment Corporation
are contributing to America's progress.

advanced techniques & resources

The producing companies of General Precision Equipment Corporation are engaged in the development, production and sale of advanced technological products. Each of these companies specializes in particular areas of advanced competence and possesses highly developed techniques and resources in its particular field or fields. These are the building blocks of GPE Coordinated Precision Technology, through which GPE serves more than a dozen important industries.

The chart at the left shows the areas in which each GPE Producing Company works. But it cannot show the high degree of specialization and the important position each GPE Company occupies in its field or fields.



Take **TELEVISION**, for instance, and the work of General Precision Laboratory Incorporated, the GPE leader in the field. GPL's research, development and manufacturing activities

in TV are concerned with quality equipment for theatre, studio, business, industrial, institutional and military TV and do not relate to the home TV field. In all the areas in which GPL operates it has played an important part in the making of television history.

- ☐ GPL equipment was used for all video recording of the Coronation, both U. S. and Canadian. It is used by 90% of the studios equipped for video recording.
- ☐ The first appearance of a President on closed-circuit TV—President Eisenhower speaking from the White House to distinguished guests at the dedication of the Ford Research Center in Dearborn—was projected via GPL equipment.
- ☐ High quality portable projection equipment, newly developed by GPL, enabled guests assembled in several separate ballrooms of the Waldorf-Astoria to see and hear the Queen Mother at two New York dinners last Fall; made possible the historic 53-city TV hook-up which was a feature of GM's fifty-millionth car celebration. This equipment played a key role in the recent nationwide "heart-video-clinic"—the largest meeting of its kind ever held—attended by over 20,000 heart specialists in thirty-five cities. It is rapidly making closed-circuit TV a practical, everyday business and institutional meeting medium.
- ☐ Many broadcast studios, including CBS's famous TV 61—the largest in the East, are exclusively equipped with GPL cameras and control equipment.
- ☐ New uses are developing steadily for GPL's "Bullet," the new, portable, easily operated, industrial television camera: in banks to speed service, eliminate congestion and reduce personnel costs; in railroads to better control and speed train make-up and freight car loadings; in industry to monitor and improve manufacturing processes, for surveillance and security, and to view hazardous operations.

GPL is a leader in military TV with its special and exacting requirements for airborne, shipboard and under-water uses and is also at work on color TV. A color film camera chain of high quality, for studio use, is in production and additional color equipment will be announced in 1955.

A broad description of the work of GPL and the other GPE Companies is contained in the GPE brochure, "Serving Industry Through Coordinated Precision Technology." For a copy, or other information, address:

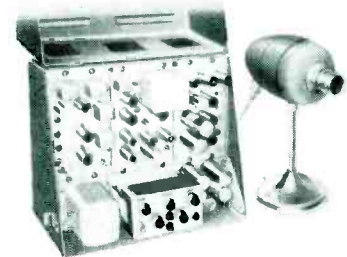

The "Bullet" TV Camera; for industrial, institutional and educational use. Produces useful pictures under conditions of poor light; feeds any TV receiver or monitor; unique packaging permits placement in ordinarily inaccessible areas; unitized construction with plug-in component chassis minimizes maintenance requirements.

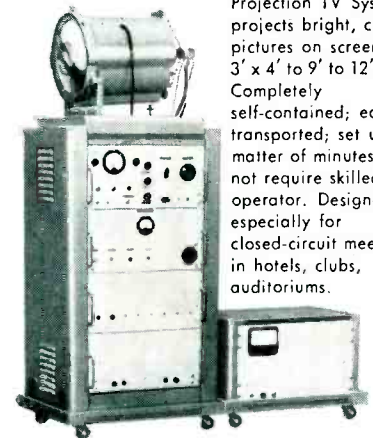

Projection TV System; projects bright, clear pictures on screens from 3' x 4' to 9' to 12'. Completely self-contained; easily transported; set up in matter of minutes; does not require skilled operator. Designed especially for closed-circuit meetings in hotels, clubs, auditoriums.



Remote Control TV Camera; for broadcast and industrial use. Pre-set control permits memory of 6 different shots. Mounted on servo-operated pedestal, provides complete remote control of lens selection, iris, pan and tilt. Highly useful for observing dangerous phenomena; permits broadcasting without use of camera man.

General Precision Equipment Corporation

92 GOLD STREET, NEW YORK 38, NEW YORK

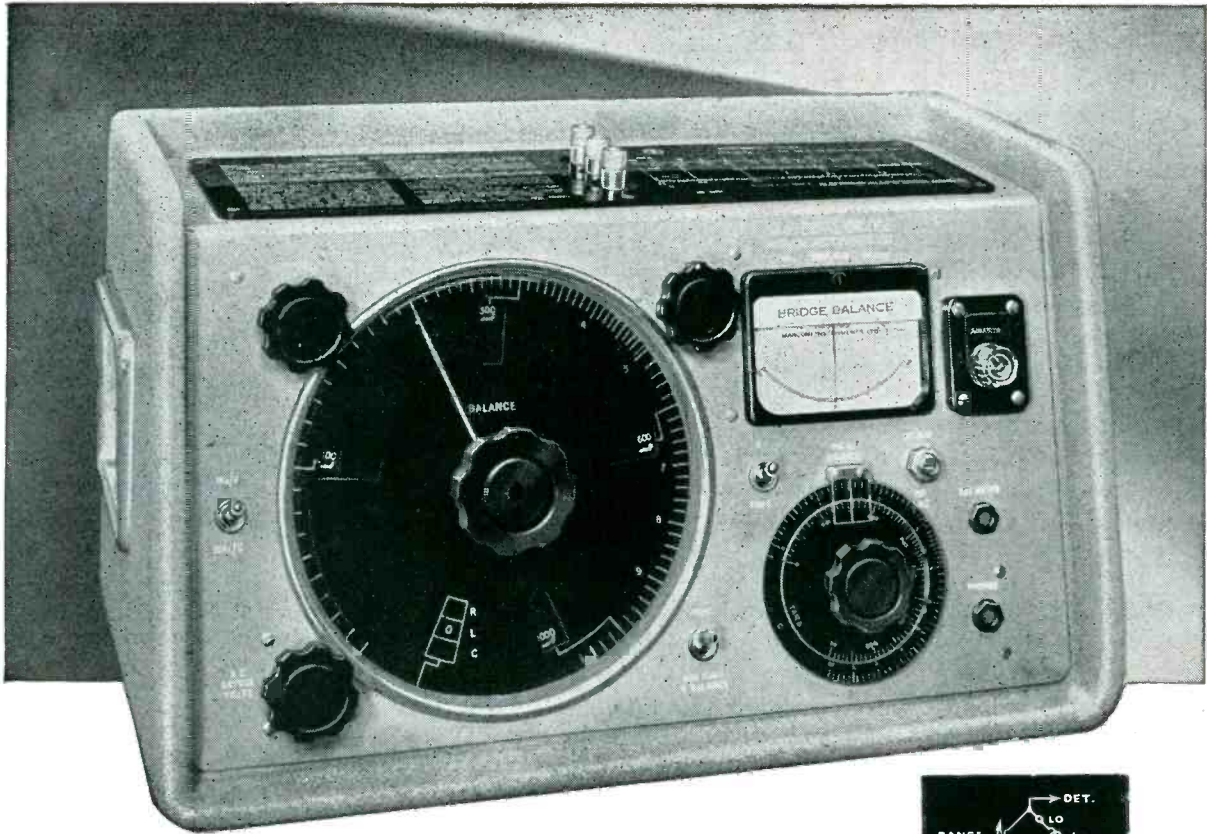

ACCURATELY MEASURED

L - AT 1 OR 10 kc

C - AT 1 OR 10 kc

R - AT D.C.

INDUCTANCE, CAPACITANCE, RESISTANCE and power factor measured quickly and accurately on this self-contained and robust instrument. Its industrial-designed appearance fits well in modern surroundings and partners its outstanding electrical performance.

UNIVERSAL BRIDGE TYPE TF 868/I

Inductance from 1 μ H to 100H, Capacitance from 1 μ F to 100 μ F, and Resistance from 0.1 Ω to 10M Ω .

Single direct reading L.C.R. dial — no multiplying factors involved.

Continuously variable a.c. bridge voltage and automatic detector sensitivity control.

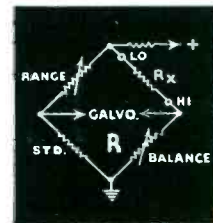
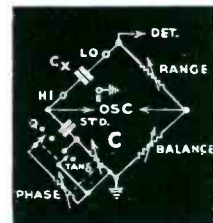
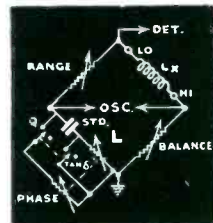

MARCONI INSTRUMENTS

23-25 BEAVER STREET · NEW YORK 4

CANADA: CANADIAN MARCONI CO., MARCONI BUILDING, 2442 TRENTON AVENUE, MONTREAL
 ENGLAND: Head Office: MARCONI INSTRUMENTS LIMITED, ST. ALBANS, HERTFORDSHIRE

Managing Agents in Export: MARCONI'S WIRELESS TELEGRAPH COMPANY LIMITED, MARCONI HOUSE, STRAND, LONDON, W.C.2

TC 39R

that **SPECIAL RECTIFIER**
might be a **STANDARD**

at

Bradley
LABORATORIES, INC.

In addition to our regular line, we have been manufacturing special vacuum processed rectifiers for almost fifteen years. During that time we have made more different kinds of rectifiers than anyone else. Consequently, there is greater possibility of duplicating a special application at Bradley than anywhere else. You can count, in all events, upon more experience in handling unusual problems — just as you can depend upon Bradley standard vacuum processed rectifiers to perform more dependably.

RECTIFIER HANDBOOK

Complete information for product designers. Most comprehensive manual available and kept up to date. Costs only \$2.00.



VACUUM PROCESSED FOR PERFORMANCE AS RATED

BRADLEY LABORATORIES, INC.

168E Columbus Avenue, New Haven 11, Connecticut

Bradley
LABORATORIES, INC.

TAYLOR

Laminated Plastics
Vulcanized Fibre

Shop Talk

TAYLOR FIBRE CO.

Plants in Norristown, Pa. and La Verne, Calif.

PHENOL—MELAMINE—SILICONE—EPOXY LAMINATES • COMBINATION LAMINATES • VULCANIZED FIBRE • POLYESTER GLASS ROD

Tips for designers

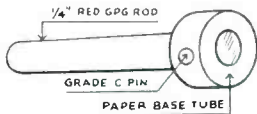

Reset cam button is made of Taylor Polyester Glass Rod. Colored all the way through, it needs no painting or machining. Color never wears off.

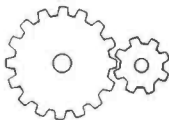

Strong, silent gears are readily machined out of Taylor fabric base phenol laminates . . . noted for high mechanical strength.

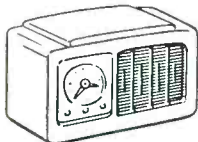

Perforated sheets of Taylor Vulcanized Fibre or Taylor Phenol Laminates make economical, high-strength speaker grilles for radio and TV sets.



Pop-up toaster switch and relay insulation was changed from laminated mica to Taylor G-5 Laminate . . . for easier fabrication and excellent heat resistance.

TAYLOR FABRICATING FACILITIES

Your production can be simplified . . . schedules safeguarded . . . inventory headaches cured . . . and overall costs reduced by having Taylor fabricate finished parts to your specifications. Efficient, modern facilities are ready to serve you. Get in touch with Taylor about your specific requirements.

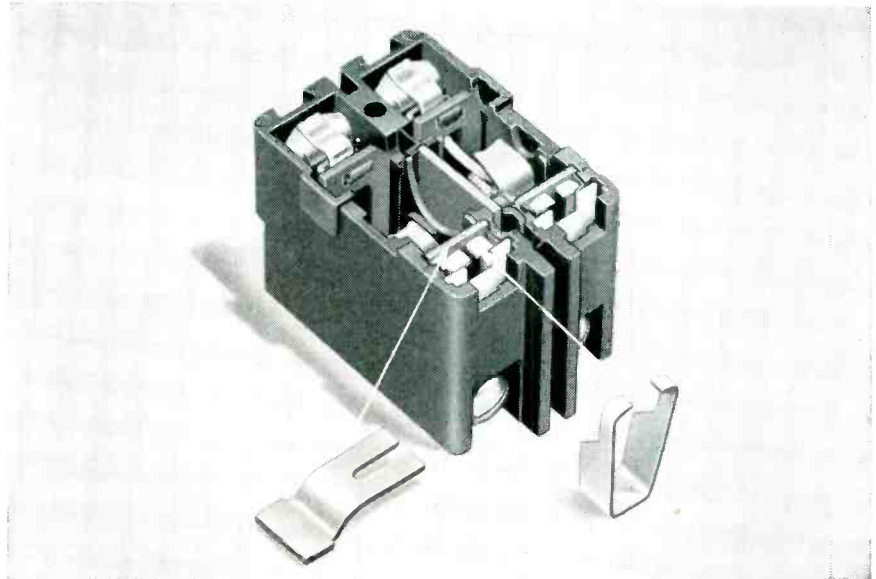

Arc chutes in this circuit breaker are made of Taylor Vulcanized Fibre . . . noted for its arc resistance and electrical insulating properties.

Versatile properties, reasonable cost — try Taylor Vulcanized Fibre

Next time you tackle a materials problem in product design take a look at Taylor Vulcanized Fibre. A time-proved material with thousands of known applications, Taylor Vulcanized Fibre is finding new uses every day. Why? Because it offers a wide range of properties at low cost, places at your disposal a unique combination of performance and economy characteristics.

It's an excellent insulator . . . widely used in electric motors, transformers, appliances and scores of like products.

It's arc-resistant . . . does not readily carbonize and form arc paths, won't track due to air arcs. Use it in arc chambers and chutes in circuit breakers and switches.

It's strong . . . has excellent tensile and compressive properties, resists wear and abrasion. Use it in gaskets, washers, cams, workbench tops, sanding discs, and other structural parts.

It's resilient . . . takes severe shock

without permanent deformation. Use it for inserts in golf clubs, for bumper blocks . . . anywhere you need high impact resistance.

It machines to high finish . . . produces smooth, long-wearing surfaces. Use it in textile shuttles and bobbins and other parts.

It bonds readily . . . to itself, to wood or to other materials. Use it in luggage, receptacles and mill boxes.

It's economical to fabricate . . . provides real cost savings in punching, stamping, drilling, cutting and forming.

Actually, these are only a sample of the applications that keep developing for Taylor Vulcanized Fibre. It comes in a choice of eight different grades, and in a variety of colors. It is supplied in the largest sheet size in the industry . . . also in rolls, strips and turned rods. A Taylor representative near you will be glad to discuss ways that you can put this material to work in your products.

1,000 mc. ← VOLTAGE TUNABLE → 16,000 mc.

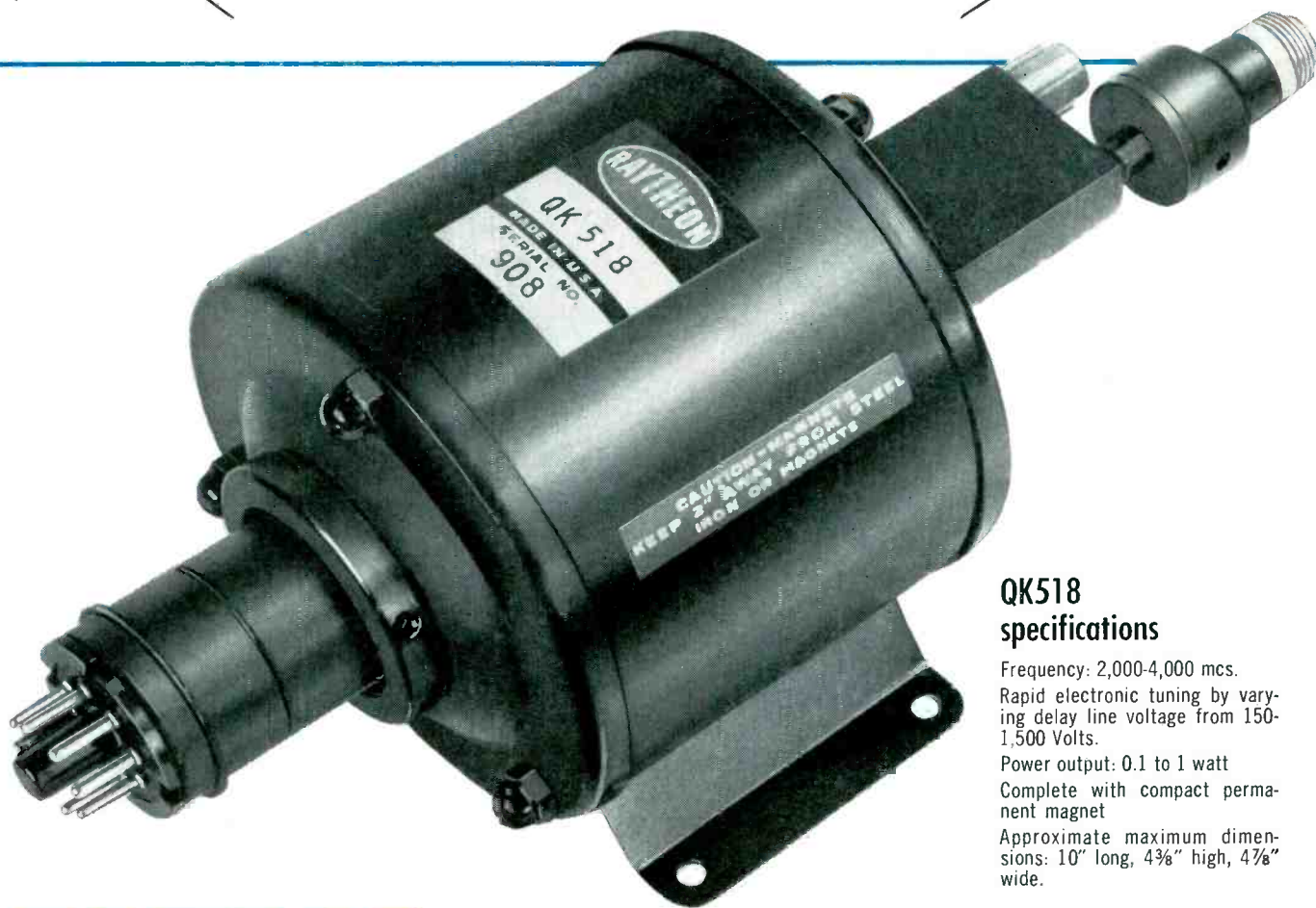

QK518 specifications

Frequency: 2,000-4,000 mcs.
Rapid electronic tuning by varying delay line voltage from 150-1,500 Volts.
Power output: 0.1 to 1 watt
Complete with compact permanent magnet
Approximate maximum dimensions: 10" long, 4 $\frac{3}{8}$ " high, 4 $\frac{7}{8}$ " wide.

NEW

Raytheon Backward Wave Oscillator Series

for wide, rapid electronic tuning — 1,000 mc. to 16,000 mc.

The tubes in this revolutionary new line of Raytheon Backward Wave Oscillators give you four outstanding performance advantages:

1. Electronically tunable over an *extremely* wide range of frequencies
2. Frequency insensitive to load variations
3. High signal-to-noise ratio
4. Can be operated under conditions of amplitude or pulse modulation

These new tubes are finding fast-growing applications in microwave equipment, including radar and signal generators.

Write today for free Data Booklet on the QK518 (above) which is available for delivery. We'll also be happy to answer any questions you may have on this new line.

RAYTHEON MANUFACTURING COMPANY



Microwave and Power Tube Operations, Section PL-22, Waltham 54, Mass.

Excellence in Electronics

Raytheon Makes: Magnetrons and Klystrons, Backward Wave Oscillators, Traveling Wave Tubes, Storage Tubes, Power Tubes, Receiving Tubes, Transistors



versatile

Multi-channel --
telegraph A1 or
telephone A3.

FROM GROUND TO AIR OR POINT TO POINT

STABLE

High stability (.003%) under
normal operating
conditions.

RUGGED

**Components
conservatively
rated. Completely
tropicalized.**

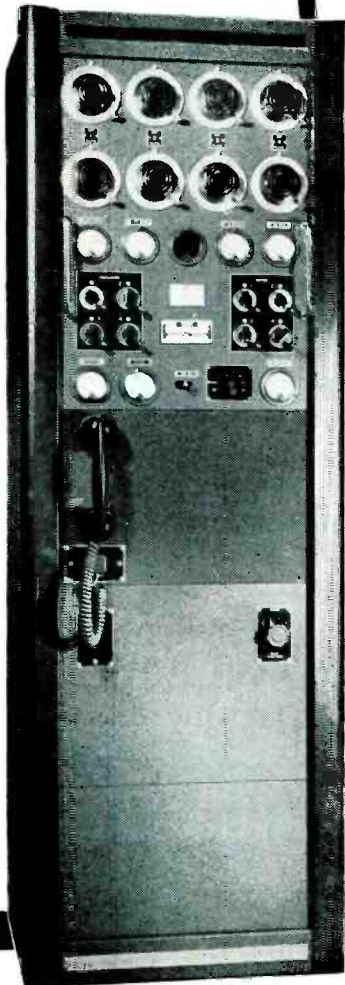

Model 446 transmitter operates on 4 crystal-controlled frequencies (plus 2 closely spaced frequencies) in the band 2.5-24.0 Mcs (1.6-2.5 Mcs available). Operates on one frequency at a time; channeling time 2 seconds. Carrier power 350 watts, A1 or A3. Stability .003%. Operates in ambient -35° to 45°C. Nominal 220 volt, 50/60 cycle supply. Conservatively rated, sturdily constructed. Complete technical data on request.

Here's the ideal general-purpose high-frequency transmitter! Model 446... 4-channel, 6-frequency, medium power, high stability. Suitable for point-to-point or ground-to-air communication. Can be remotely located from operating position. Co-axial fitting to accept frequency shift signals.

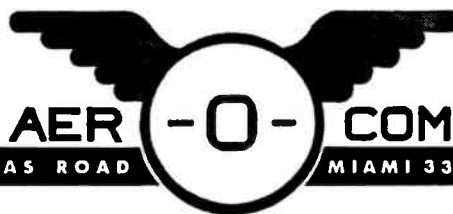

3090 DOUGLAS ROAD

MIAMI 33, FLA.

ALSiMAG[®] CUSTOM MADE
 Manufactured by
AMERICAN LAVA CORPORATION
 SUBSIDIARY OF MINNESOTA MINING AND MANUFACTURING COMPANY
 Telephone 3-3411 • Chattanooga 5, Tennessee

TECHNICAL DATA
 ALSiMag 624
 Date April 13, 1955
 Supersedes 11/10/54
 Subject Microwave attenuator
 Ceramic material

TECHNICAL DATA
 ALSiMag 555
 Date April 13, 1955
 Supersedes None
 Subject Magnesia Ceramic

TECHNICAL DATA
 ALSiMag 550
 Date April 13, 1955
 Supersedes None
 Subject Magnesia Ceramic

ALSiMag 624 is a member of a series of similar ceramic compositions for absorbing and dissipating microwave energy at a relatively high power level.

APPLICATIONS:
 ALSiMag 624 has been used successfully in microwave attenuator shapes whose attenuation and VSWR at 9000 to 9500 mc/s and 2 watts of power remained unchanged. It represents a relatively low loss end member of a series of similar compositions under development and capable of absorbing energy at a much higher level.

TYPICAL PROPERTIES OF ALSiMAG 624 BODY

Property	A.S.T.M. Test No.	Unit
Water Absorption	D116-42(A)	%
Specific Gravity		lbs. per cu. in.
Density	D687-42T	
Dielectric Constant		

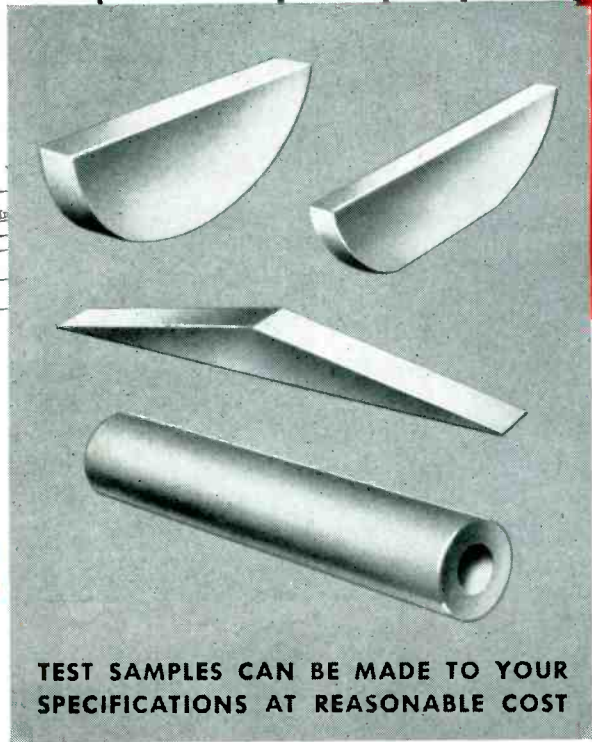

TEST SAMPLES CAN BE MADE TO YOUR SPECIFICATIONS AT REASONABLE COST

ALSiMAG[®]

SPECIAL PURPOSE

CERAMIC MATERIALS

Most of our customers find the exact ceramic for their needs on property chart No. 551. This handy chart (sent free on request) gives mechanical and electrical data on the most frequently used ALSiMag materials. But this is by no means the full selection. ALSiMag offers the widest choice of ceramic materials in the industry. It isn't practical to list them all on one chart. If you need a ceramic with unusual characteristics, tell us your requirements. We'll be glad to send you specification sheets (like those shown above) on the special purpose ALSiMag

material that most nearly fills the bill. If we don't have the right material, perhaps we can develop one. Laboratory records from over 50 years of specialized experience often enable us to produce promptly a new composition "tailor made" for your needs.

Remember, the right ceramic can make all the difference in your product's performance. And, the best source for the right special purpose ceramic is AMERICAN LAVA CORPORATION. Write us today for detailed information on your requirements.

54TH YEAR
 OF CERAMIC
 LEADERSHIP

**AMERICAN LAVA
 CORPORATION**

CHATTANOOGA 5, TENNESSEE
 A Subsidiary of
 Minnesota Mining and Manufacturing Company

Branch offices in these cities (see your local telephone directory): Cambridge, Mass. • Chicago, Ill. • Cleveland, Ohio • Dallas-Houston, Texas • Indianapolis, Ind. • Los Angeles, Calif. • Newark N. J. • Philadelphia-Pittsburgh, Pa. • St. Louis, Mo. • South San Francisco, Calif. • Syracuse, N. Y. • Tulsa, Okla.
 Canada: Irvington Varnish & Insulator Div. Minnesota Mining & Mfg. of Canada, Ltd., 1390 Burlington Street East, Hamilton Ontario, Phone Liberty 4-5735.

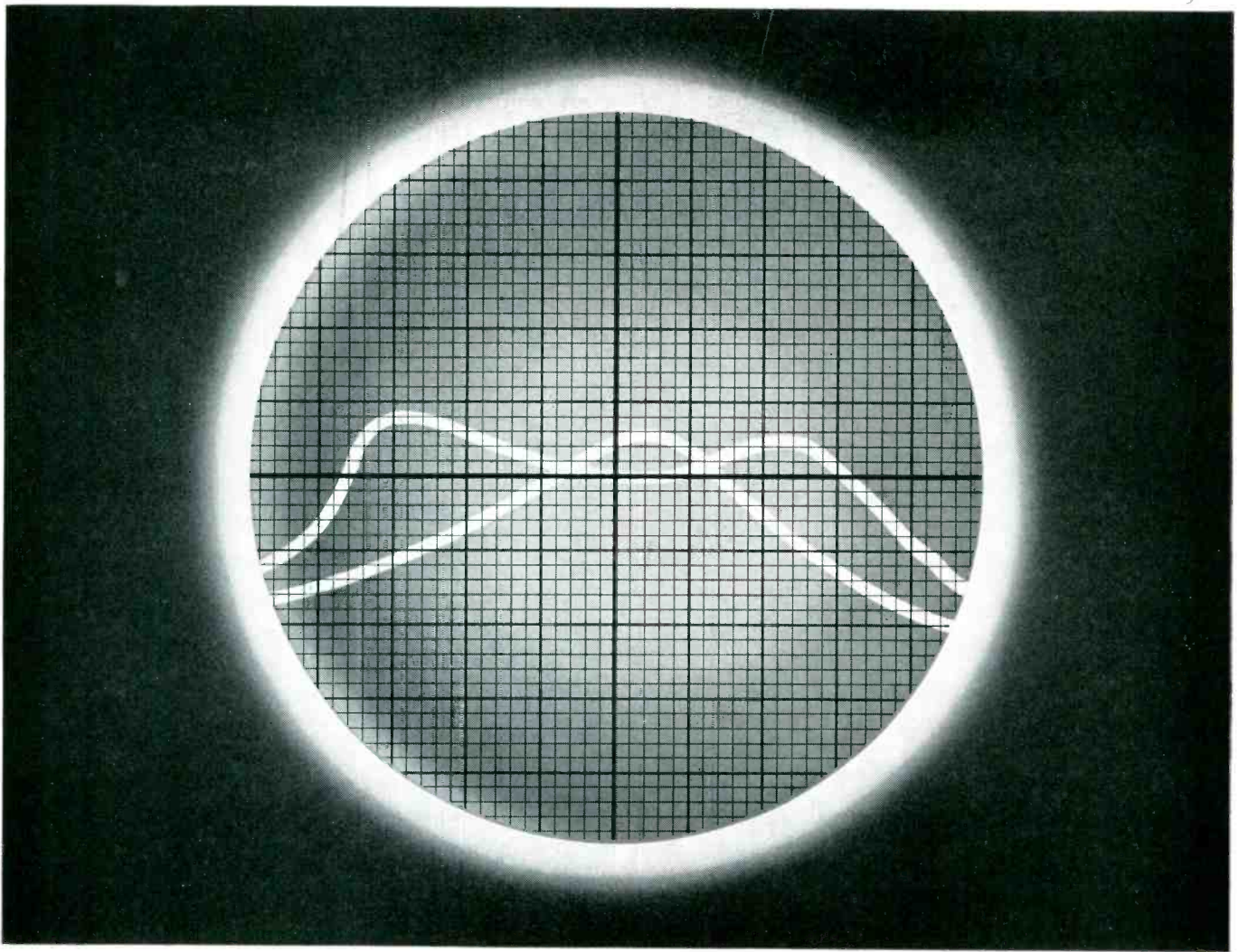

how can vacuum-melted metals help the electronics industry?

When a metal is melted and cast in a vacuum, the gaseous impurities are literally sucked out. The result is an important improvement in many critical properties.

For example, cathode nickel alloys, iron, and alloys for metal-glass seals — are all produced to extremely close standards of composition and uniformity. Soft magnetic alloys exhibit improved permeability, both initial and saturation. Copper shows marked increase in purity and soundness.

Vacuum-melted components greatly increase

vacuum tube life and reliability. That's because the vacuum-melting process degasses these metals *before they are placed in the tube.*

Vacuum Metals Corporation, pioneer in development and leading producer of vacuum-melted metals and alloys, can now offer you a wide range of metals for electrical or electronic applications. If you would like to see how these remarkable new materials can fit into your own production, write on your company letterhead, describing the application in which you are interested. *Vacuum Metals Corporation, P.O. Box 977, Syracuse 1, New York.*



VACUUM METALS CORPORATION

Jointly owned by Crucible Steel Company of America and National Research Corporation

Available
NOW!

New CLARE Type 11 Springdriven Stepping Switch

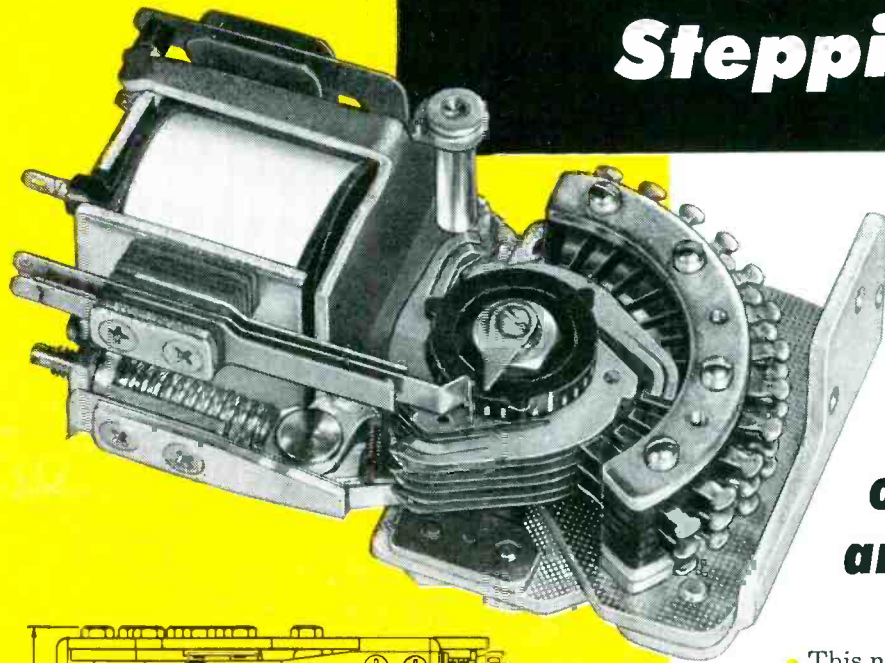

**Small,
compact design
provides millions
of steps without
any readjustment**

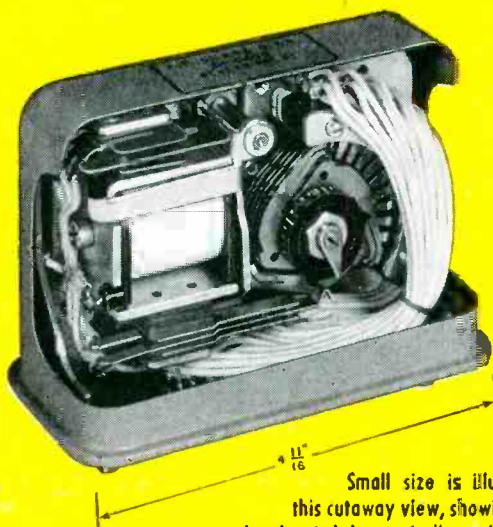
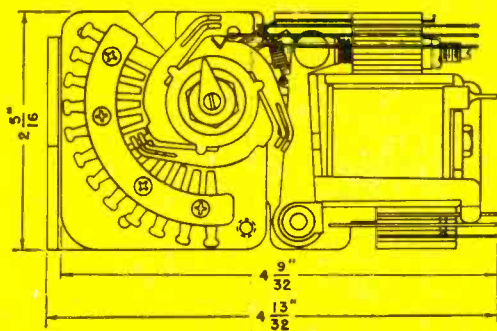
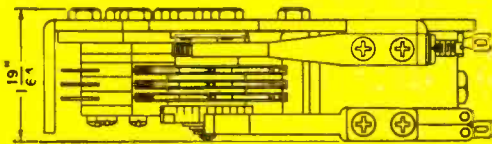

Small size is illustrated by this cutaway view, showing a three-level switch hermetically sealed in a can commonly used to enclose one CLARE Type C Relay

• This new CLARE Type 11 Springdriven Stepping Switch is the latest in the CLARE line of uniselectors, or rotary switches, for completing, interrupting, or changing the connections in a succession of electric circuits in response to momentary impulses of current.

Like the larger and older switches in the CLARE line—Types 20, 26, 40 and 52—this sturdy, fast-stepping little switch is capable of many different applications, such as:

- *Selecting any desired point in a series*
- *Selecting the first unoccupied point in a series*
- *Sequence controlling: automatically controlling a series of operations in a predetermined manner*
- *Counting and totalizing*
- *Generating timed pulses*
- *Monitoring*

The CLARE Type 11 Switch is designed to be free from critical adjustments. The few adjustment points are unusually easy to reach when required, but choice of materials and design provides millions of steps without any readjustment.

Send for Engineering Bulletin No. 121 for complete information on the new CLARE Type 11. Address: C. P. Clare & Co., 3101 Pratt Blvd., Chicago 45, Ill. In Canada: Canadian Line Materials Ltd., Toronto 13. Cable Address: CLARELAY.

**FIRST
in the
industrial
field**

CLARE RELAYS

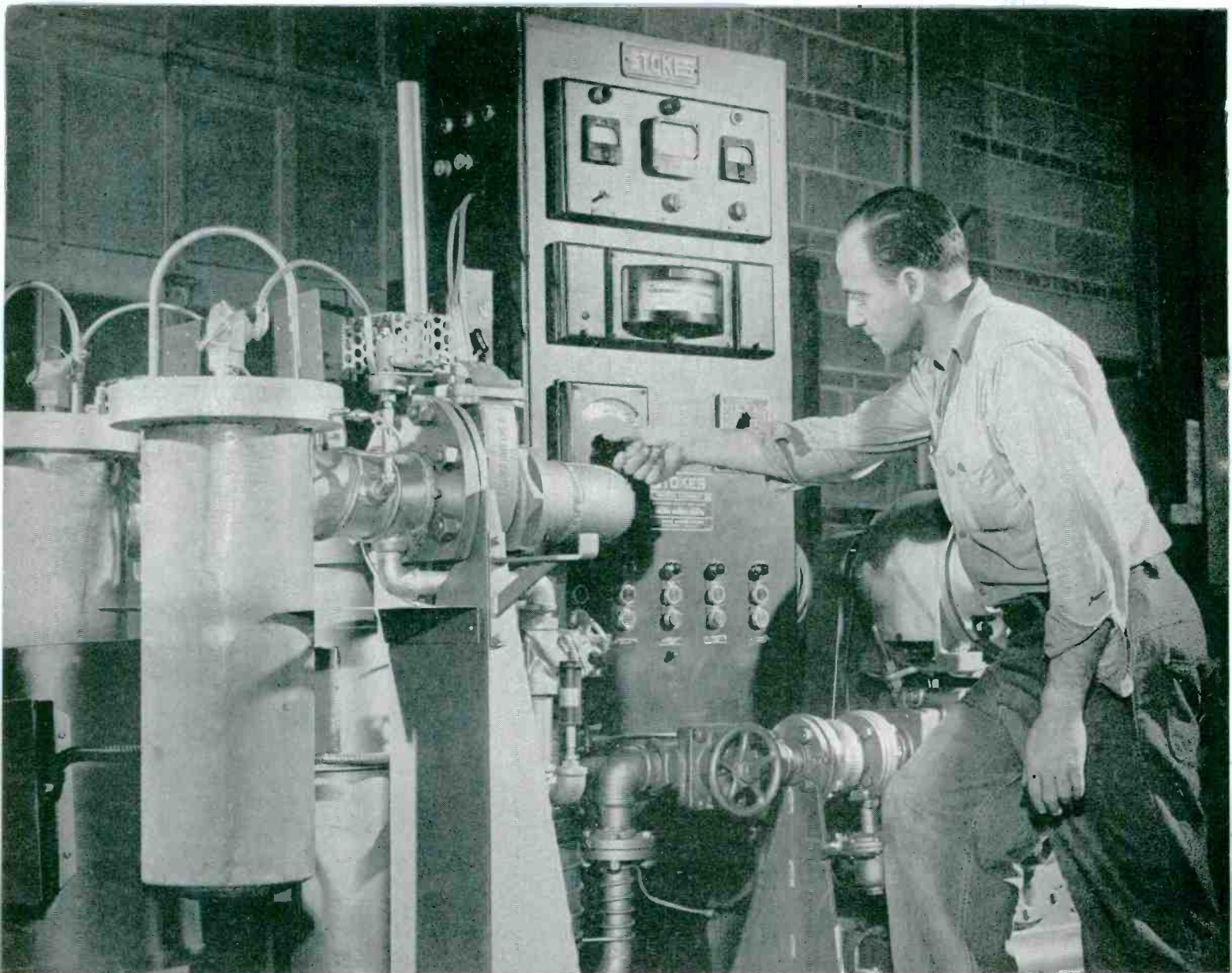

Operator checks pyrometer control of a standard Stokes dual-retort high-vacuum furnace.

THE COMPLETE LINE OF STOKES

Stokes manufactures a complete line of vacuum pumping equipment. This includes mechanical vacuum pumps, diffusion and booster pumps, vacuum valves and gages, and complete vacuum instrumentation. In engineered high vacuum equipment, Stokes builds vacuum metallizers, vacuum furnaces and other vacuum processing equipment.

Stokes has for many years been active in vacuum research. Vacuum experience among our engineers covers the range from laboratory equipment to some of the largest vacuum equipment in service. This experience is available to help solve your vacuum problems.

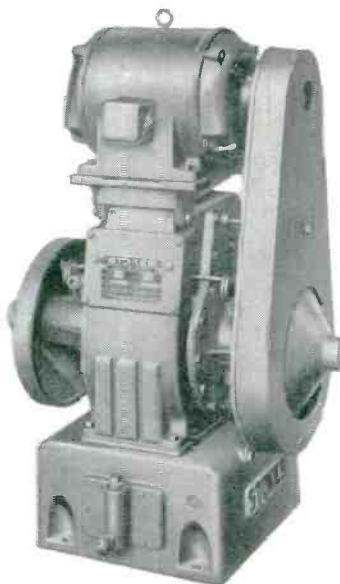

STOKES MECHANICAL VACUUM PUMPS

For vacuum processing systems and for maintaining low forepressures in high-vacuum systems, the Stokes Microvac pump provides efficient, economical operation. Designed with fully automatic lubrication and a long-lasting exhaust valve assembly, every Microvac pump is assured of smooth, trouble-free operation. Six sizes give capacities from 15 to 500 cfm. Send for catalog listed at right.



Production vacuum furnaces now available for the Electronics Industry

You can now buy specially designed Stokes vacuum furnaces for all phases of heat treating and outgassing. They are compact . . . give maximum capacity for minimum floor area. Sequence-operated grouped controls permit even unskilled personnel to handle furnace operations.

The basic problems of vacuum design and engineering have been a Stokes specialty for many years. Stokes vacuum furnaces for commercial production have proved their efficiency and earned the respect of manufacturers in numerous fields of technology. Stokes is the leading supplier of vacuum furnaces for industry.

The new Stokes Ring-Jet pumps described below are incorporated in Stokes vacuum systems to assure pumping cycles of maximum speed.

Stokes vacuum furnaces of numerous basic types are made in sizes and with modifications to fit users' requirements.

If you are interested in heat treating, degassing or melting of metals, you'll want to know more about Stokes high-vacuum furnaces. Write for your free copy of Stokes Catalog No. 790, "High-Vacuum Furnaces".

F. J. STOKES MACHINE COMPANY
5503 TABOR ROAD
PHILADELPHIA 20, PA.

SEND FOR TECHNICAL LITERATURE:

- Microvac Pumps—Catalog 750
- Diffusion and Booster Pump Specification sheets and performance curves
- The Story of the Ring-Jet Pump Complete Vacuum Processing Systems—Catalog 730
- How to Care for Your Vacuum Pump—Booklet 755
- Vacuum Impregnation — Catalog 760
- Vacuum Drying—Catalog 720
- Vacuum Furnaces — Catalog 790
- Vacuum Metallizing — Catalog 780
- Vacuum Calculator Slide Rule



VACUUM EQUIPMENT

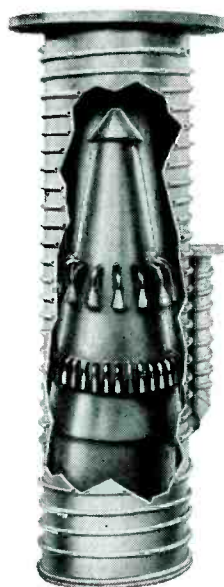

STOKES RING-JET DIFFUSION AND BOOSTER PUMPS

The new Stokes Ring-Jet Pumps embody a new concept of the diffusion principle. Size for size, they have pumping speeds of 10% to more than 100% above any other diffusion pump for a given heat input. Ring-Jet Diffusion Pumps are available in sizes of 4, 6, 10, 14 and 16 inches; Booster Pumps in sizes of 4, 6, 10 and 16 inches. Send for information listed.



STOKES VACUUM VALVES

To control vacuum safely and surely, Stokes vacuum valves are available in 4, 6, 10 and 16-inch standard flange sizes.

STOKES-McLEOD VACUUM GAGES

For measuring vacuums from fractions of a micron up to 50 mm, Stokes-McLeod gages are the standard of reference. Four sizes available.

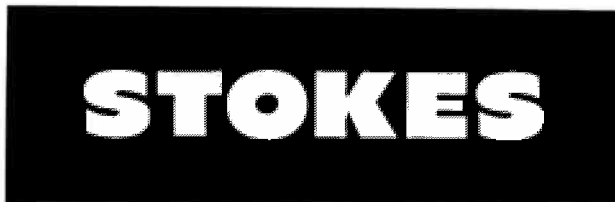

OFFICES IN PRINCIPAL CITIES, REPRESENTATIVES THROUGHOUT THE WORLD

New Simpson Core Meter Movement

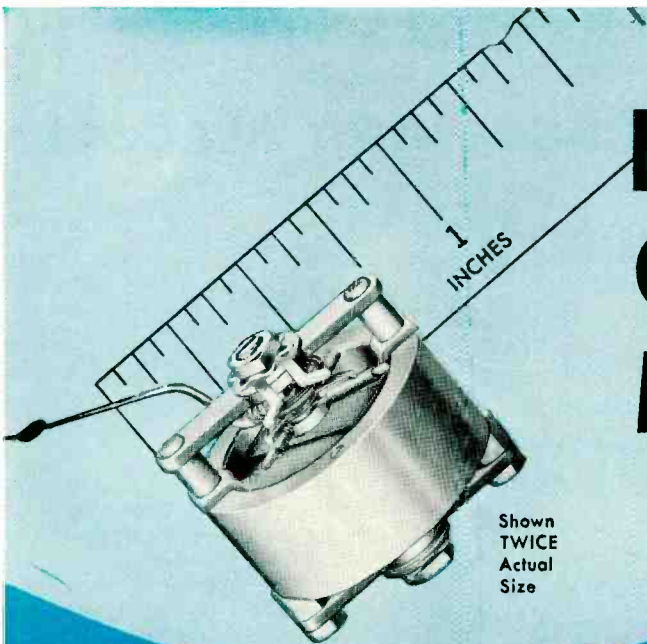

Shown
TWICE
Actual
Size

Rugged... yet built like a fine watch!

Here's the new Simpson **Core-Type Meter Movement**. It's a more compact, more sensitive, **self-shielding** movement that gives electrical measurements with laboratory accuracy, yet has the ruggedness to withstand severe shocks. Its accuracy specifications are so rigid that Simpson engineers had to devise unusual production techniques.

Let Simpson engineers design panel meters using the new core movement to your special instrument requirements. Simpson continues to maintain its large stock of standard panel meters in over 700 sizes and ranges, available through distributors.

RUGGEDIZED METERS

Simpson's 2½" and 3½" Panel Meters are available in **sealed, ruggedized** models to meet specifications MIL-M-10304-(Sig. C). Movements are sealed against moisture and other adverse atmospheres, and are spring-mounted to absorb excessive vibration.

SEND FOR NEW CATALOG 17

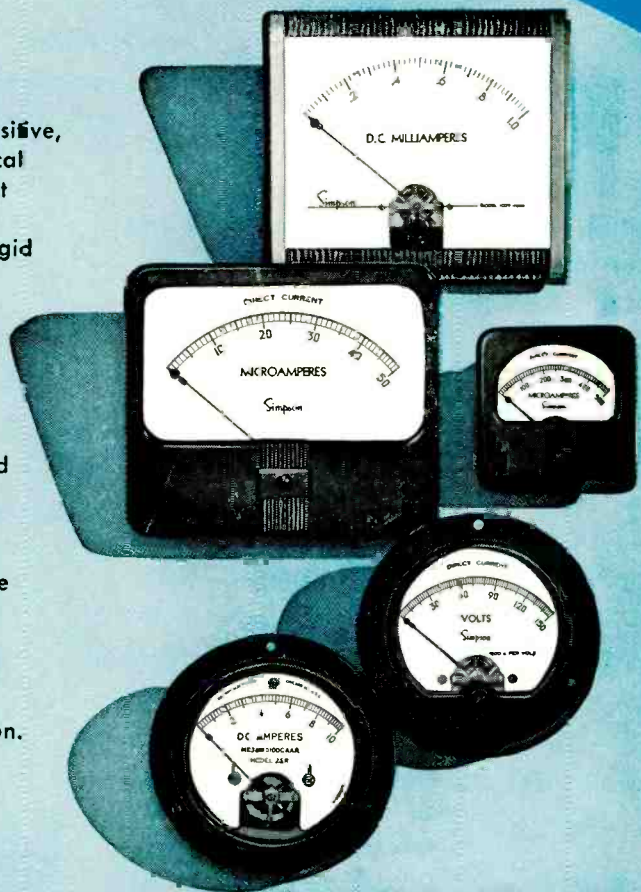

INSTRUMENTS THAT STAY ACCURATE

Simpson ELECTRIC COMPANY

5217 W. Kinzie St., Chicago 44, Illinois, Phone: EStebrook 9-1121
In Canada: Bach-Simpson, Ltd., London, Ontario

"Eimac 450TH in excellent operating condition after 49 months of dependable service"

The 450T power triode first designed and produced by Eimac in 1937 is still a standard Eimac product widely acclaimed by the communications industry. It symbolizes the uncompromising quality, performance and reliability that has made Eitel-McCullough, Inc. the world's largest manufacturer of transmitting tubes.

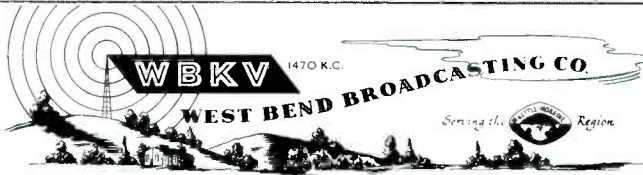

TELEPHONE 1640 WEST BEND, WISCONSIN

December 6, 1954

Eitel-McCullough, Incorporated
San Bruno, California

Gentlemen:

On November 30, 1954 I retired from service an Eimac 450TH, Serial Number C9-2416.

This tube was used as the Power Amplifier in the Gates BC-500D transmitter operated at this station.

It was installed in the transmitter and put into operation on November 1, 1950. The total hours of operation obtained before replacement amounts to 17,892.

Now to further explain the reason for this letter I must tell you that the tube is still in excellent operating condition as far as I am able to tell by its daily performance. It was replaced just on general principles after 49 months of dependable service.

Very truly yours,
Paul J. Ripple
Paul J. Ripple
Chief Engineer

PJR/ps



Mr. Paul J. Ripple, chief engineer, Station WBKV, West Bend, Wisconsin, holds Eimac 450T that he retired, "just on general principles after 17,892 hours of dependable service."



EITEL-McCULLOUGH, INC.
SAN BRUNO · CALIFORNIA

"Shake" tests add extra margin of reliability at **BELL** Aircraft

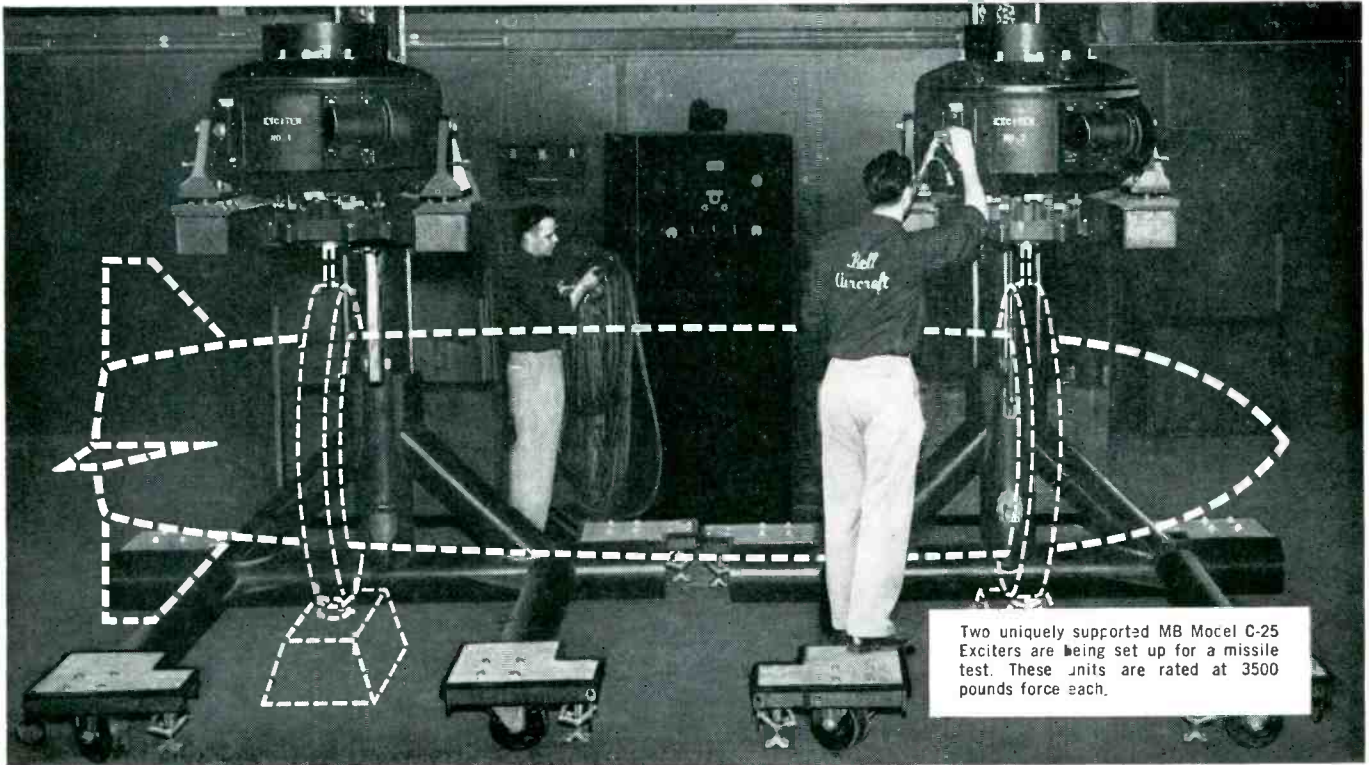

Two uniquely supported MB Model C-25 Exciters are being set up for a missile test. These units are rated at 3500 pounds force each.

Operation and quality quickly checked on

M B VIBRATION EXCITERS

Engineers of Bell Aircraft Corporation take advantage of the unusual help provided by shake testing — with a specially mounted setup of two MB Model C-25 Exciters for vibrating missiles.

BENEFITS OF SHAKE TESTING

Because small vibrations can be magnified in a complex missile structure, and because interactions

of components are important, such testing checks vital systems. The MB shakers permit Bell engineers to produce conditions more severe than expected in service. In effect, a margin of safety can thereby be added to increase reliability of operation.

Moreover, vibration tests afford a quick, versatile means for checking quality of components.

Defective and malfunctioning components are quickly detected.

To cap it all, substantial savings in manhours and fuel costs have been effected by substituting shake tests for hot firing of missiles prior to flight tests.

WHY MB VIBRATION EXCITERS?

Engineered by vibration specialists to deliver maximum performance, MB Shakers can be counted on for pure table motion and dependable operation to full rated capacity. MB's line of vibration testing "tools" is complete — from small specialized-duty shakers to the largest in existence today.

Prompt servicing provided by a special staff of MB engineers. For more information on shakers, send for Bulletin 1-VE-5

*the **MB** manufacturing company, inc.*

1060 State Street, New Haven 11, Conn.

HEADQUARTERS FOR PRODUCTS TO ISOLATE VIBRATION...TO EXCITE IT...TO MEASURE IT

"TOP" CHARACTERISTICS



FILM-X CAPACITORS

WITH **"MYLAR"***
Metal enclosed, hermetically sealed,
Extended foil or tab construction,
Miracle X impregnated.

- ★ Exceptionally High Insulation Resistance.
 Example—2.0 mfd.—600 V FILM-X displayed a minimum insulation resistance of 5000 megohm-microfarads at 85°C.
- ★ High operating temperature.
 Standard series may be operated at 85°C at full rated voltage and at higher temperatures with de-rating.
 HT Series (High Temperature) operated to 125°C at full rated voltage and to 150°C with de-rating.
- ★ Low Power Factor of .005.
- ★ Low Capacitance Change over a temperature range of -55°C to +150°C.

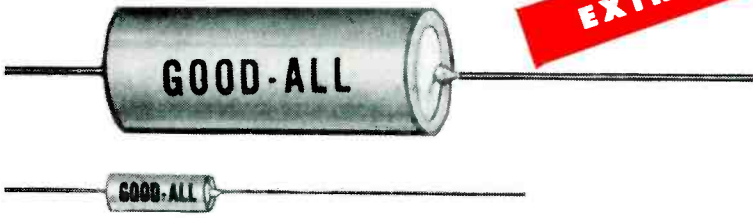

Sizes smaller than other miniaturized brands—approximately 1/2 the size of equivalent paper dielectric capacitors.
 Example: —.01 mfd.—600V as small as .173 dia. x 1/2 inch.

We invite sample orders for your evaluation.

EXTREME ADAPTABILITY

PRINTED CIRCUIT
 Style PCF—Flat plate mount. Designed to withstand shock in excess of 50,000 g's

SCREW MOUNT
 Style S3DL—with double eyelets and lug terminals for mobile and airborne application.

PILLER TERMINAL
 Style PT— for high voltage and high altitude operation

We build to your specifications in many other case styles. Designed to fit exacting physical or electrical requirements

No. 612G and 613G
 extended foil construction

No. 614G and 615G
 tab construction

GOOD-ALL ELECTRIC MFG. CO. 120 First St., OGALLALA, NEBR.

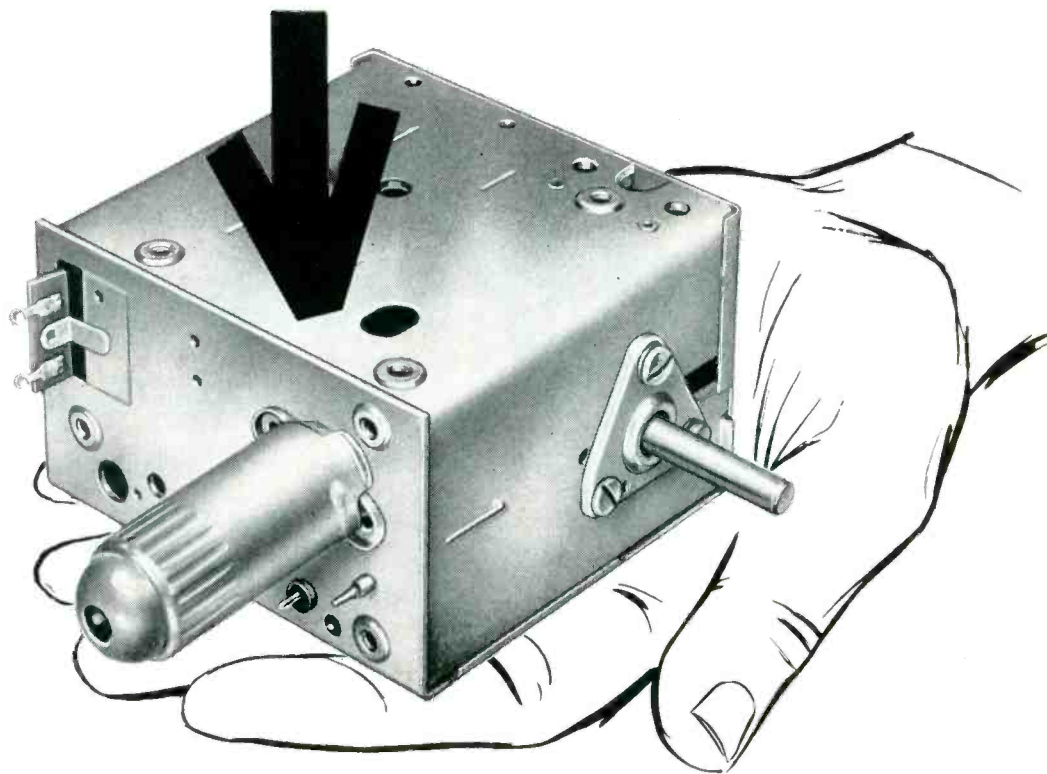

NEW

low cost UHF tuner

FEATURES OSCILLATOR RADIATION FIXES

Here's famous R/C quality at the lowest price ever! The new T-90 Series uhf t-v tuner meets all RETMA spurious radiation requirements. Yet it costs less than any previous Radio Condenser uhf tuner.

The double-circuit tuned T-90 Series has excellent i-f and image rejection, giving remarkably high selectivity. As indicated by R/C statistical quality control, the noise figure of the new tuner exceeds most requirements, and the drift characteristics are equally good. Field results to date have been uniformly excellent.

If you want information fast on the T-90 Series, we'll be happy to have one of our engineers call at your convenience.

Get Complete Engineering and Performance Data.
Write Radio Condenser for your free copy of Bulletin T-90.

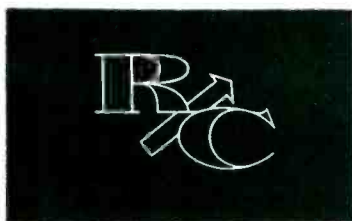
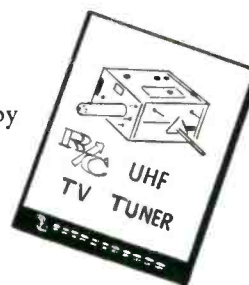

RADIO CONDENSER CO.

Davis & Copewood Streets • Camden 3, New Jersey
EXPORT: Radio Condenser Co., International Div., 15 Moore St., N.Y. 4, N.Y. CABLE: MINTHORNE

NEW BULLETIN P355G

There's a **Powerstat** to meet your **Every Need!**

CONTENTS

design	2
features	3
manual operation	4
motor drives	5
circuitry	6, 7, 8
types 10, 10-2, 10-3	9
types 20, 20-2, 20-3	10
types 116, 216	11
types 116-2, 216-2	12
types 116-3, 216-3	13
types 136, 236	14
types 136-2, 236-2	15
types 136-3, 236-3	16
types 1156, 1256	17
types 1156-2, 1256-2	18
types 1156-3, 1256-3	19
types 1156-4, 1256-4	20
types 1156-6, 1256-6	21
oil cooled powerstats	22
explosion proof powerstats	23
powerstat line correctors	24
voltbox a.c. power supplies	25
powerstat ratings	26
line corrector ratings	27
voltbox ratings	27
explosion-proof ratings	27
oil-cooled ratings	27
how to order	28
other products	28

powerstat

variable transformers

Bulletin P355G

a product of
THE SUPERIOR ELECTRIC COMPANY
Bristol, Connecticut

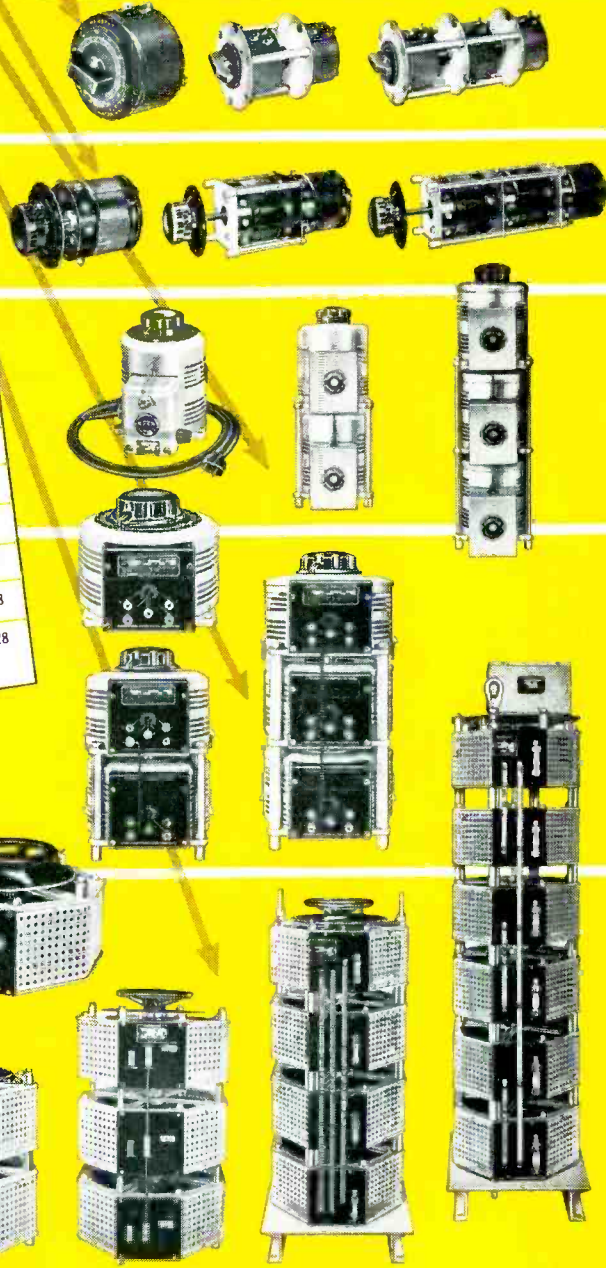

Send for this New
Bulletin Today

The Superior Electric Company

206 Reynolds Avenue, Bristol, Conn.

Please send me POWERSTAT Bulletin P355G

Name.....

Position.....

Company Name.....

Company Address.....

City..... Zone..... State.....

SALES OFFICES: The Superior Electric Company

1436 N. Serrano Avenue
Hollywood 27, California
P. O. Box 946, 1246 Junipero Ave.
Redwood City, Cal.
453-A Eglinton Ave. West, Rm. 202
Toronto 12, Ontario, Canada

P.O. Box 48, 721 So. Boulevard
Oak Park, Illinois
P.O. Box 132, 250 So. Court St.
Medina, Ohio
4515 Prentice St., Rm. 202
Dallas 6, Texas

REPRESENTATIVES

Beryl R. Hill Company
19481 James Couzens H'wy.
Detroit 35, Mich.

Fred H. Haight Company
3212 Eastlake
Seattle 2, Washington

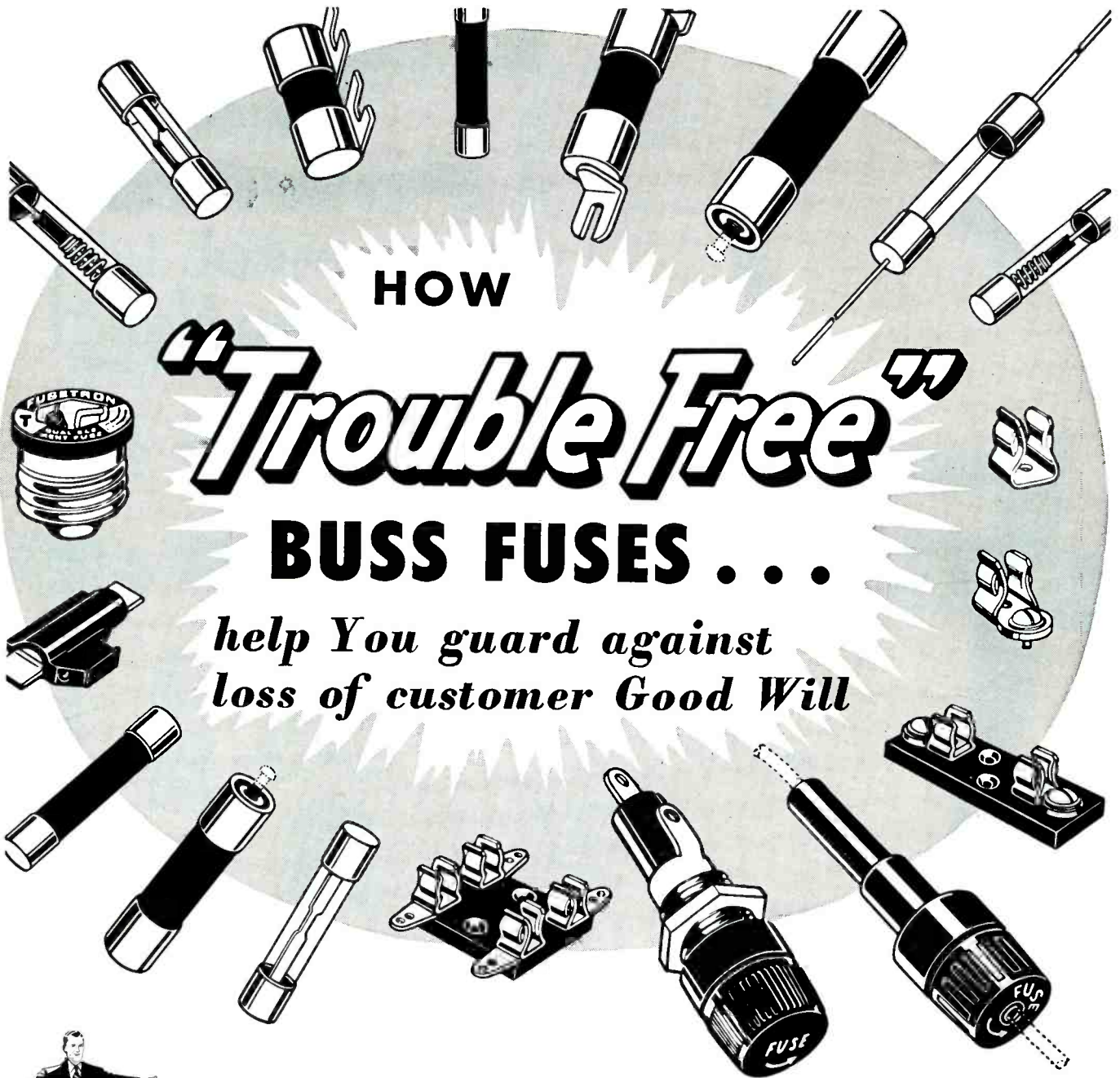

HOW
"Trouble Free"
BUSS FUSES . . .

*help You guard against
 loss of customer Good Will*



Dependable BUSS fuses can help safeguard your product or service against loss of user satisfaction because . . .

When there is trouble on the circuit, BUSS fuses open and prevent further damage to equipment—saving users the expense of replacing needlessly burned out parts.

However, BUSS fuses won't give a "false alarm" by blowing when trouble doesn't exist. Users are not annoyed with shutdowns caused by needless blows.

To make sure of unflinching dependability — every BUSS fuse, normally used by the Electronic Industries, is tested in a sensitive electronic device that rejects any

fuse not correctly calibrated, properly constructed and right in all physical dimensions.

**Save engineering time
 on new products**

The BUSS fuse research laboratory and its staff of engineers are at your service to help you with problems involving electrical protection. They can help you select the right fuse for the job . . . if possible, a fuse available in local wholesalers' stocks, so that your device can easily be serviced.

BUSSMANN MFG. CO.

(Div. McGraw Electric Co.)

University at Jefferson St. Louis 7, Mo.

MAKERS OF A
 COMPLETE LINE
 OF FUSES . . .



FOR HOME,
 FARM, COMMERCIAL,
 ELECTRONIC,
 AUTOMOTIVE AND
 INDUSTRIAL USE.

ELRC

655

10 kw Klystron carriage (826); Eimac Series 3K50,000L Klystron

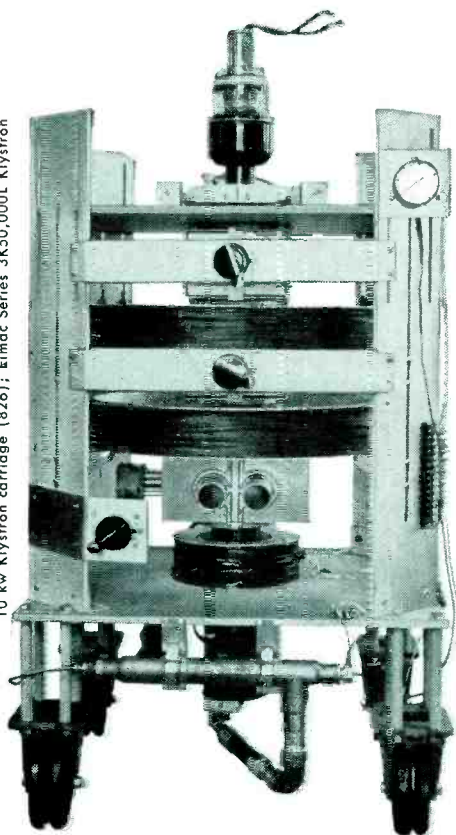

GIANT STEPS

More beyond-the-horizon FM multiplex relay equipment by REL is in operation than that of all other manufacturers *combined*. No need to wait for time-consuming developmental engineering; Type 826 and 827 Terminals are standard items in the REL line of point-to-point communications gear. Each terminal includes an exciter, a dual diversity receiver with combiner or switch, as determined by application, and a Klystron power amplifier: 10 kw for the 826 and 1 kw for the 827.

Carrier frequencies are available for both systems from 400 to 1050 mc, with base band options from 30 to 600 kc. Associated receivers have noise figures from 5.5 to 9 db, depending on frequency. Descriptive specifications may be obtained upon request.

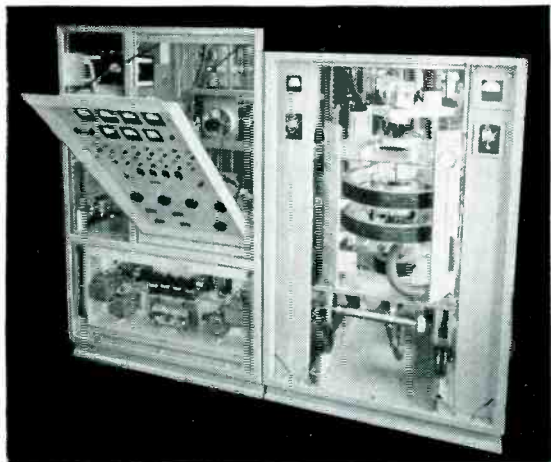

Power amplifier and control panel (826)

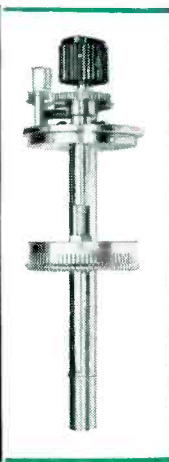

Receiver tuning assemblies (826 and 827)

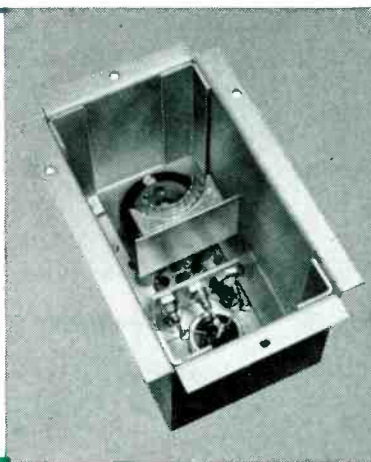

Beam supply (826)

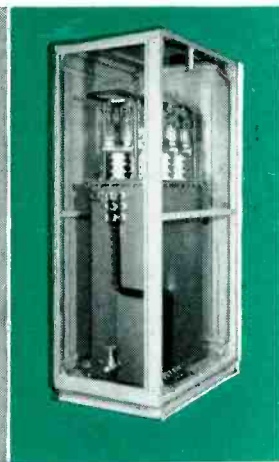

Fourth in a series describing REL versatility



RADIO ENGINEERING LABORATORIES · INC.

36-40 37th St. · Long Island City 1, New York

Telephone: STillwell 6-2100 · Teletype: NY 4-2816

Canadian representative: *Ahearn & Soper Co.*, P. O. Box 715, Ottawa

International representative: *Rocke International Corp.*, 13 E. 40, N.Y. C. 17

WIRE AND CABLE FOR EVERY ELECTRONIC PRODUCT

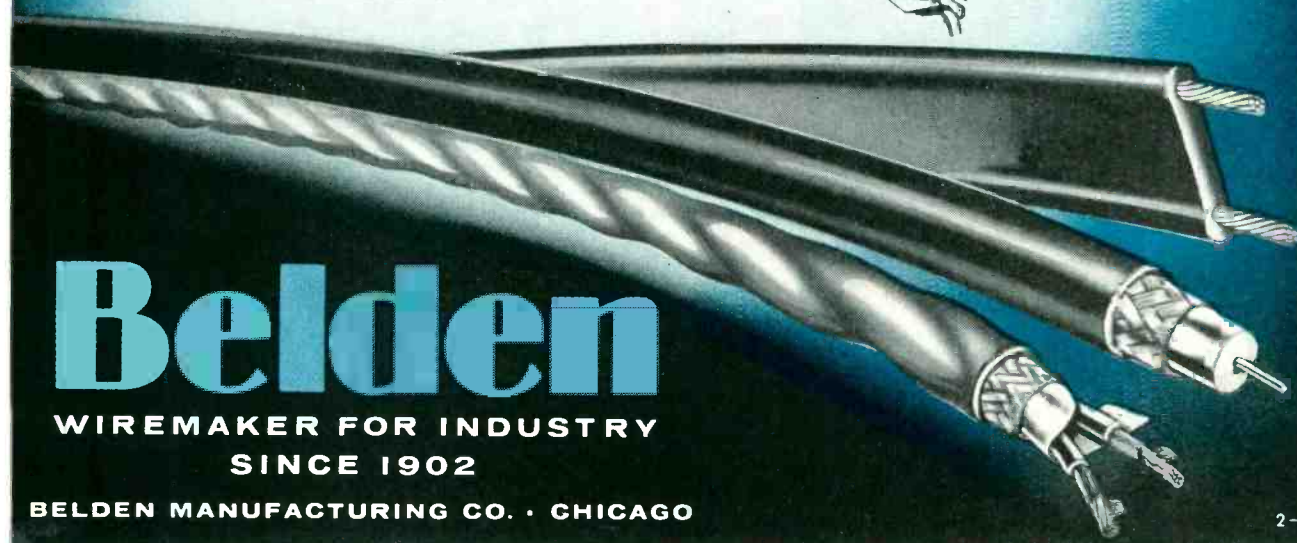
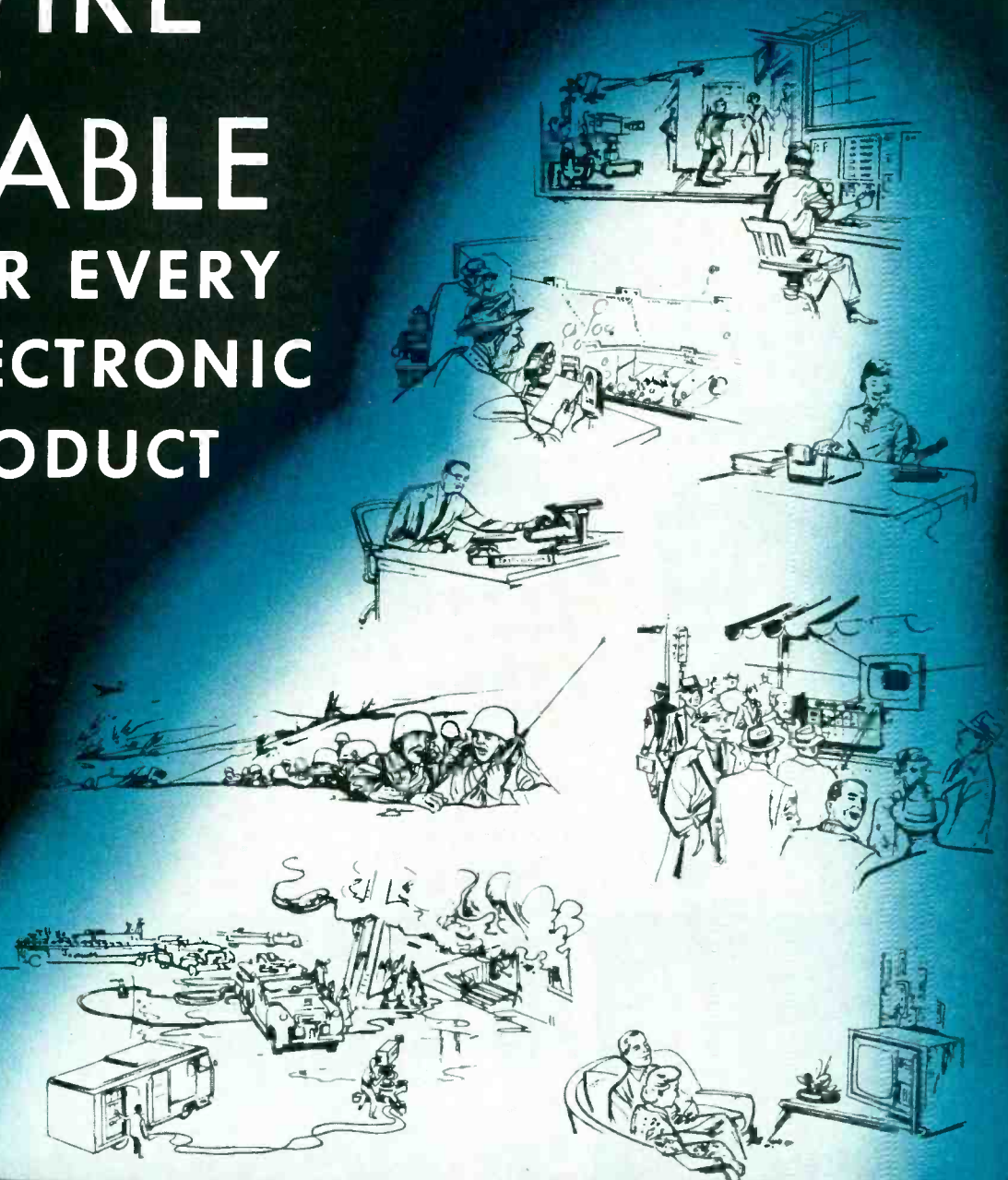

Belden

WIREMAKER FOR INDUSTRY
SINCE 1902

BELDEN MANUFACTURING CO. • CHICAGO

2-8



ACCURACY AT A GLANCE

WITH THE NEW E-I

FOUR-DIGIT

VOLTMETER



MODEL DV40A

ELECTRO INSTRUMENTS' Model DV40A four-digit voltmeter combines in one convenient package all requirements for automatically measuring voltage with utmost reliability and accuracy. A precision instrument designed and built to the exacting requirements of telemetry, computing, data reduction, automatic testing, plus many other instrumentation and automation applications.

Only Electro Instruments offers all these outstanding advantages:

- Direct-reading, four-digit, in-line display of DC voltages from ± 0.001 to ± 999.9 .
- Accuracy within \pm one digit. Absolute calibration insured by nine internally-mounted standard cells.
- $\frac{3}{4}$ second average reading time.
- Completely automatic polarity indication and range switching.
- Machine-recording output for automatic operation of printers, electric typewriters, IBM punch equipment.
- Rugged unitized construction with highest quality components.

- Dependability attested by aircraft, industrial and government laboratories.
- Calibration, switching circuits and bridge resistors mounted in a sealed compartment for thermal isolation and dust prevention.

SPECIFICATIONS: Input impedance: 11 megohms. Calibration: 9 internally-mounted certified standard cells. Size: 7 x 19 x 16 in. (rack and panel mounting). Color: instrument grey. Weight: 35 pounds. Power: 115v., 60 cps ac, 50 w.

Precision



Instrumentation

ELECTRO INSTRUMENTS, INC.
3794 ROSECRANS ST. · SAN DIEGO 10, CALIF.

For complete information and specifications, write Dept. 2 for the new Bulletin 30.

ENGINEERING REPRESENTATIVES THROUGHOUT THE UNITED STATES AND CANADA

Electro Instruments' family of direct-reading, in-line instruments include 15 standard digital voltmeters for precision laboratory and production measurements, as well as digital

read-outs that provide unambiguous numerical indication for a variety of instrumentation applications. Complete literature, optional specifications available upon request.

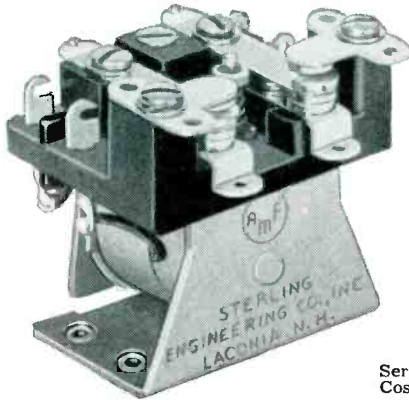

Series PS—Heavy Duty Power—Low Cost—High Quality AC or DC Relay.

SIMPLE OR COMPLEX DESIGN

Sterling
has the answer

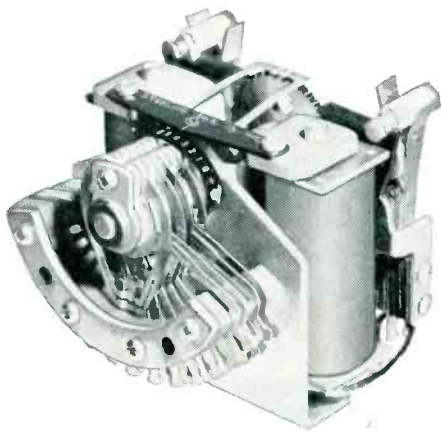

Series SS—Bi-Directional Stepping Switch—Direct Current Actuated.

Sterling Engineering is daily designing and producing products from *Simple Single Spring* relays to *Complex Multi-Spring Bi-Directional Stepping Switches*.

The PS Series of relays—one of the many built to the high quality standards of all Sterling products is *priced lower* than competitive relays and are in stock for *immediate shipment*.

The Series PS heavy duty power relay, is small in overall dimensions, only $1\frac{5}{8}$ " x $1\frac{7}{8}$ " x $1\frac{11}{16}$ " high, yet has a contact capacity up to 20 amperes. Available in any operating voltage to 230 AC or 220 DC.

Type SS Bi-Directional Stepping Switch is a new conception in magnetically actuated devices. The output shaft may be operated in either direction to drive the wipers or as a Stepping motor to drive potentiometers, servo mechanisms or other control devices. In computer applications it is a converter from digital to analog or vice versa.

The contact banks can easily be removed from the driving unit without disturbing the switch adjustments, thus making easy bench wiring or field service.

Type SS can be equipped with up to 4 switch banks, each with up to 12 positions and each set of contacts will carry up to 3 amps.

Write:
Sterling Engineering Co., or
Potter & Brumfield Mfg. Co.,
Princeton, Indiana

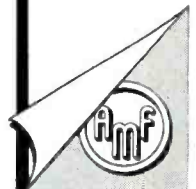



Better Things for Better Living
... through Chemistry

ELECTRONIC DESIGN

PROPERTY AND APPLICATION DATA ON THESE
VERSATILE ENGINEERING MATERIALS: "ZYTEL,"
"ALATHON," "TEFLON," "LUCITE."

NEWS

No. 2

1955

Smaller capacitors for RF equipment with TEFLON® as dielectric

A new line of capacitors, using Du Pont "Teflon" tetrafluoroethylene resin as the dielectric, has achieved an 80% reduction in size under comparable mica capacitors. Designed for RF tank circuits, airborne radio and radar equipment, these capacitors of "Teflon" operate to 100°C. and meet all electrical specifications of JAN C-5, types E, F, and G.

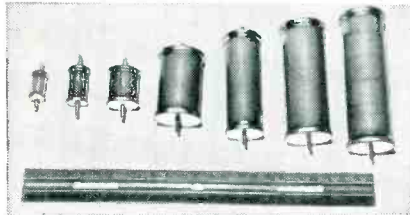

Capacitors of "Teflon" ranging in size from .0004 microfarads with 6,000 effective working volts to a .001-microfarads unit with 24,000 effective working volts. (Manufactured by Condenser Products Company, Division of New Haven Clock and Watch Company, New Haven, Connecticut.)

Installation of these units is easy. End terminals serve as mounts, and the capacitors can be installed in parallel groupings. The glass cases require no insulation between them.

Are you acquainted with the exceptional dielectric and mechanical properties of Du Pont "Teflon"? Use the coupon below for complete information.

Superior properties of Du Pont "Zytel" nylon resin utilized in tip jacks

Tip jacks molded of Du Pont "Zytel" nylon resin are used on aircraft radar equipment because of the many useful properties of "Zytel" nylon.



The 105-600 miniature tip jack shown uses Du Pont "Zytel" nylon for the dielectric. "Zytel" is mechanically strong. It is molded inexpensively in a variety of colors. (Manufactured by E. F. Johnson Company, Waseca, Minnesota.)

"Zytel" proved itself the best engineering material for the tip-jack application because of such dielectric characteristics as low-loss, high-voltage breakdown, and excellent insulating properties. Mechanical strength is excellent. For this application, coloring is important, and "Zytel" can be molded in color, or dyed easily, with inexpensive dyes.

Parts molded of "Zytel"† nylon resin solve air-filter design problem

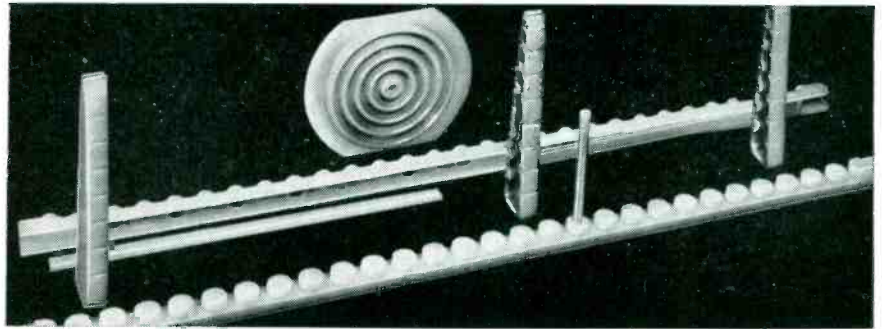

Sixty parts of Du Pont "Zytel" are used in the electrostatic air-filtering unit manufactured by American Air Filter Company, Inc., Louisville,

Kentucky. "Zytel" is lightweight and strong. Plastics Department, General Electric Company, Pittsfield, Massachusetts, molds the parts.

Molded "Zytel" nylon resin has been successfully applied by design engineers in an electrostatic air-filtering unit functioning at a 12,000-volt potential. While the actual current flow is on the order of only 20 milliamps, materials previously tested were charred by occasional arcing. The resulting carbon deposit formed a path for short circuits, making replacement necessary. The resistance of "Zytel" nylon resin to corona dis-

charge completely eliminated this short-circuit problem.

The filter parts molded of "Zytel" are much lighter in weight and much more resistant to breakage than filter parts (of comparable capacity) which use conventional materials.

Sixty parts in six different designs are molded of Du Pont "Zytel" nylon resin for each unit of the filter. Parts are complex in shape, but injection molding makes production easy.

New black "ZYTEL" has increased weather resistance

Black "Zytel" 105 nylon resin is a tough material with excellent weatherability. Results of accelerated weathering tests and exposure, in Florida, indicate that excellent outdoor life can

be expected. Toughness, abrasion resistance, and form stability at high temperatures are combined with lightness of weight to make "Zytel" ideal for many outdoor applications.

NEED MORE INFORMATION?

CLIP THE COUPON

for additional data on the properties and applications of these Du Pont engineering materials.

E. I. du Pont de Nemours & Co. (Inc.), Polychemicals Department Room 226, Du Pont Building, Wilmington 98, Delaware
In Canada: Du Pont Company of Canada Limited, P. O. Box 660, Montreal, Quebec.

Please send me more information on the Du Pont engineering materials checked: "Teflon"* tetrafluoroethylene resin; "Alathon"* polyethylene resin; "Zytel"† nylon resin; "Lucite"* acrylic resin. I am interested in evaluating these

materials for _____

NAME _____

POSITION _____

COMPANY _____

STREET _____

CITY _____ STATE _____

TYPE OF BUSINESS _____

*"Teflon," "Alathon" and "Lucite" are registered trade-marks of E. I. du Pont de Nemours & Co. (Inc.)

†"Zytel" is the new trade-mark for Du Pont nylon resin.

MICRO SWITCH Precision Switches
A PRINCIPLE OF GOOD DESIGN

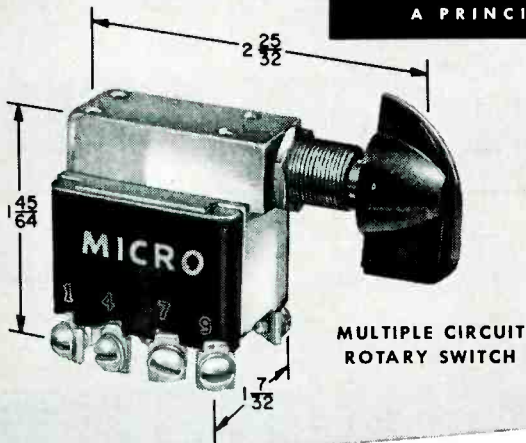

MULTIPLE CIRCUIT ROTARY SWITCH

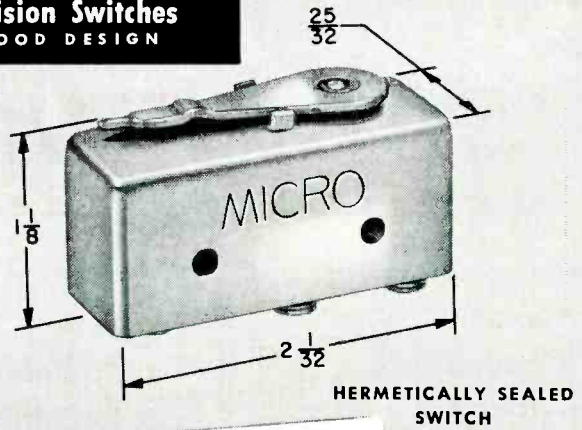

HERMETICALLY SEALED SWITCH

New MICRO SWITCH products meet exacting electronic requirements

Keeping pace with the ever-changing needs of the electronics industry has always been an important consideration of MICRO SWITCH engineering development.

New switches and new switch assemblies are always on the drawing boards and on test at MICRO SWITCH. Often designers find these switches fit, without change, the particular service at hand. At other times consultation with MICRO SWITCH engineering results in modification of an old design or development of one entirely new.

Whatever the task, MICRO SWITCH components either are or can be made available to give the utmost in reliable

service performance. Does your current problem involve any switches like these?

A Multiple Circuit Rotary Switch—Will handle up to 8 circuits at 20 amperes at 115 volts a-c.

New Hermetically Sealed Switch—Provided with split contact arrangement.

Sealed Subminiature Switch—Completely environment-proof, has high electrical capacity and long life.

High Temperature Switch—Designed to operate perfectly in temperatures up to 1000° F.

MICRO SWITCH field engineers are conveniently located at 20 branch offices. Consultation with them involves no cost. It can save you much time and money.

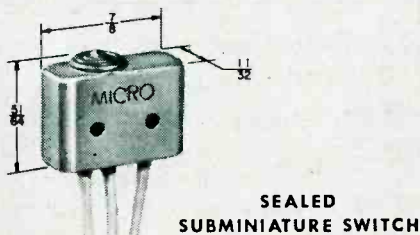
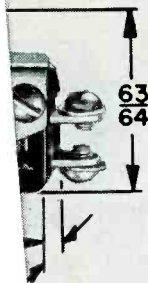

SEALED SUBMINIATURE SWITCH

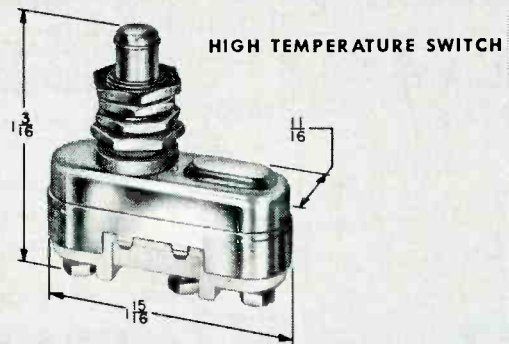

HIGH TEMPERATURE SWITCH

A complete line of snap-action and mercury switches



MICRO SWITCH provides a complete line of extremely reliable, small-size, high-capacity, snap-action precision switches and mercury switches. Available in a wide variety of sizes, shapes, weights, actuators and electrical characteristics. For all types of electrical controls.

MICRO SWITCH

A DIVISION OF MINNEAPOLIS-HONEYWELL REGULATOR COMPANY

In Canada, Leaside, Toronto 17, Ontario • FREEPORT, ILLINOIS



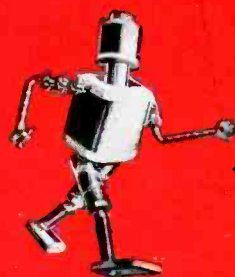

Investigate!

The New



Pay-As-You-Profit
Plans

*Two plans for purchasing or leasing modern
COIL WINDING MACHINERY*

Presented by **UNIVERSAL WINDING COMPANY**
PROVIDENCE, RHODE ISLAND

Full details on the other side . . .

NOW! Two quick, practical ways to Modernize and Economize!

2 NEW LEESONA Pay-As-You-Profit Plans

Why let lack of adequate coil winding machinery cost you money — in lost production and higher operation and maintenance expenses? Universal's two new Pay-As-You-Profit Plans provide the benefit of modern coil winding machines — without jeopardizing cash, capital position or borrowing power. Take your choice of two Plans.

I. LEESONA LONG-TERM PURCHASE PLAN

Advantages of Plan I include:

Your Cash Position Safeguarded. Purchases under this plan need not impair your company's cash position.

Immediate Operating Economies. You get the most up-to-date equipment on the market, thus assuring operating economies at once — without waiting until the complete purchase price has been accumulated out of earnings.

Immediate Expansion Opportunities without bringing in outside capital, which would dilute the equity of present ownership.

Simplified Procedure. The Universal Winding Company handles the entire transaction for you. You need not enter into extended negotiations with any money-lending organization.

Under the Long-Term Purchase Plan you may extend your payments over any period up to five years — depending on the amount involved. Terms include an initial down payment, with the balance paid quarterly over the desired period. Five percent interest is charged *on the unpaid balance only.*

II. LEESONA LONG-TERM LEASE PLAN

Advantages of Plan II include:

You Conserve Your Cash. As under Plan I, you put new, cost-reducing machinery to work for you immediately — with little immediate outlay in cash.

No Impairment of Working Capital. Your company's financial statement shows no increase in liabilities.

Freedom From Debt, through leasing, assures that your business can be operated without the restrictions ordinarily imposed by creditors. Your company's future borrowing power is unaffected and its financial structure is simplified.

You avoid the risk of the obsolescence factor.

Under the Long-Term Lease Plan you pay the first year's rental upon date of shipment and the remainder in quarterly installments. At the end of five years, if you wish to keep the machinery you may either lease it for an additional period, at a small percentage of its original value, or purchase it outright at its then fair market value.

Adding up, here's a real opportunity to get the up-to-date, cost-cutting coil winding machinery you need — and get it fast, with practical, simplified financing!

Take advantage of the Pay-As-You-Profit Plan that best meets your needs. Contact your Universal Representative or write direct to UNIVERSAL WINDING COMPANY, P. O. Box 1605, Providence 1, R. I., or 9 South Clinton St., Chicago, Ill.

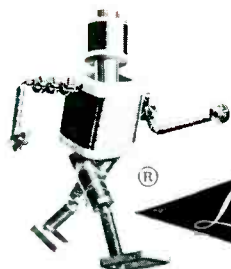

UNIVERSAL WINDING COMPANY

P. O. BOX 1605, PROVIDENCE 1, RHODE ISLAND

Sales Offices: Providence • Chicago • Los Angeles • Philadelphia

For Timeless Protection

HUMID-TROL

LONG TERM STORAGE SEAL
Maintains Any Desired Moisture Level
from 1% to 90% RH-ALWAYS!

In the search for better packaging for our own electronic devices, Lavoie research scientists have developed a combination of material and method that has given us a long term storage container in which moisture is reduced to the unprecedented low of 1%... and maintained, without variation, over long periods of time. Once attaining the desired results for our own purposes, further tests indicated a much broader latitude in which the HUMID-TROL method maintained, indefinitely, a specified degree of relative humidity for long term storage of a variety of products.

We now offer Lavoie HUMID-TROL to industry seeking long term protection against unstable humidity, dehydration, corrosion, fungi and other causes of deterioration. HUMID-TROL has no size limitations and may be used to protect small components as well as large assemblies, including engines, missiles and even heavy tanks. HUMID-TROL withstands submersion; altitude up to 100,000 feet. Re-sealable and re-usable for storage at -80°F or $+180^{\circ}\text{F}$... withstands thermal shock and it may be customized to meet special requirements of various industries. A built-in hygrometer is optional equipment.



In ARCTIC COLD



In DESERT HEAT



HUMID-TROL

will preserve, ready for instant use:

FILM • DRAWINGS • DRUGS
SURGICAL INSTRUMENTS
TOOLS • DIES
ELECTRONIC EQUIPMENT
RIFLES AND SMALL ARMS
ENGINES • MISSILES
NAVIGATION EQUIPMENT
RESCUE EQUIPMENT

Get the facts on HUMID-TROL; write for complete data or consult with our engineers regarding your requirements.

Lavoie Laboratories, Inc.

MORGANVILLE, NEW JERSEY

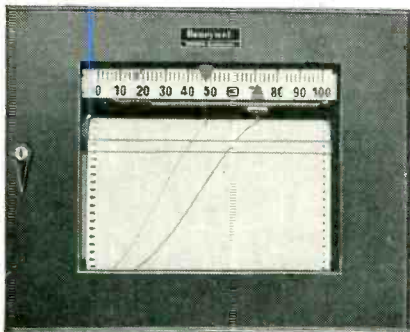

DUPLEX RECORDER

Simultaneously plots two continuous data curves vs. time. Has two independent measuring systems, each with any desired range.

See Data Sheet 10.0-6.

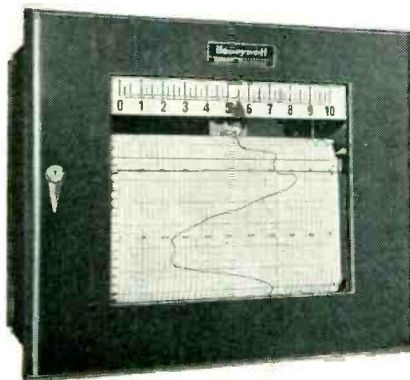

1/2 SECOND PEN SPEED RECORDER

Pen traverses full 11-inch calibrated width of chart in only 1/2 second. Precise recording of variable changes without overshoot or hunting. Full accuracy, even on spans as narrow as 3 millivolts.

Request Data Sheet 10.0-13.



BROWN-RUBICON PRECISION INDICATOR

Combination of high-precision potentiometer and automatic *ElectroniK* indicator, for highly accurate small voltage measurements and for calibrating meters, bridges and similar equipment . . . with minimum operator fatigue.

See Data Sheet 10.0-2.

Get better
test data
quicker – with
ElectroniK
research
instruments

Research men everywhere are finding that specialized *ElectroniK* instruments can save them many precious hours of lab time, by automatically taking over much of the routine burden of gathering, recording and plotting data.

In addition to the models pictured here, Brown instruments for research include *ElectroniK* Function Plotters, in single pen and double pen types . . . *ElectroniK* Extended Range Recorder and Adjustable Span Recorder . . . the *ElectroniK* Null Indicator, modern successor to the galvanometer . . . and a family of precision-made servo components. For a discussion of how these can help in your own research program, call your nearby Honeywell sales engineer.

MINNEAPOLIS-HONEYWELL REGULATOR Co., *Industrial Division*, Wayne and Windrim Avenues, Philadelphia 44, Pa.—in Canada, Toronto 17, Ontario.



MINNEAPOLIS
Honeywell
BROWN INSTRUMENTS

First in Controls

... from field-testing harvesters
to checking jet starter performance ...
**SANBORN OSCILLOGRAPHIC
RECORDING SYSTEMS**
prove their versatility

**FOR INTERNATIONAL HARVESTER'S
ENGINEERING TEST AND DEVELOPMENT DEPT.**

A specially housed and shock-mounted Sanborn 2-channel recorder provides dynamic strain measurement data on a field forage harvesting machine, during actual field use. In the photographs, rotor shaft torque and RPM are being recorded, one of several uses International Harvester has found for the Sanborn System in field testing their farming equipment.

AT ARCH GEAR WORKS, QUINCY, MASS. . . .

A record of tooth regularity of various types of precision gears is obtained on a single-channel Sanborn Model 141 System, used in conjunction with a special gear checking instrument devised by Arch Gear Works. The equipment permits visual spot checking of gears, helps maintain a high rate of acceptability and provides a permanent record of tests often required by customers.

AT G. E.'S AIRCRAFT GAS TURBINE DIV. . . .

Engineers record performance data such as temperatures, pressure, RPM and starting time of jet engine starters, using a modified Sanborn Model 67 System. Six channels of information are recorded in this four-channel unit, equipped with three DC amplifiers, one Triplexer, a four-channel DC Converter, two-channel zero suppression network and two modified strain gage amplifiers. The data also provides G. E. engineers with an indication of the performance of all production units.

These typical applications indicate the scope of usefulness of standard and modified Sanborn Recording Systems. Wherever accurate, permanent, graphic registration of electrical phenomena in the 0-100 cps range is required, the versatility and flexibility of Sanborn one-, two-, four-, six- and eight-channel systems will prove invaluable. A wide variety of readily interchangeable, plug-in preamplifiers enable one basic system to meet many recording requirements. Standard instrument features include inkless recording in true rectangular co-ordinates, high torque galvanometer movement, time and code marking, and a choice of nine chart speeds.

*Research
and
Development*



*Production
Testing*



*Research and
Production Testing*

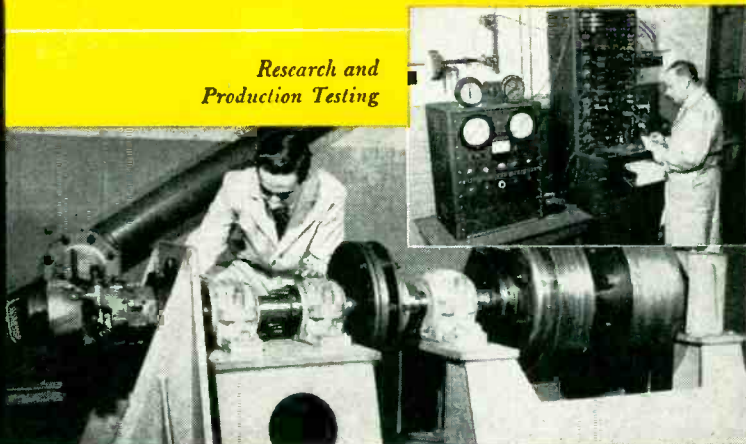

CATALOG AND TECHNICAL DATA
AVAILABLE ON REQUEST



**SANBORN
COMPANY**

INDUSTRIAL DIVISION
CAMBRIDGE 39, MASS.

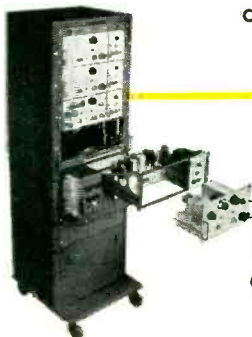

ANNOUNCING



H-300
(300 Watts)

H-500
(500 Watts)

H-225
(225 Watts)

H-750
(750 Watts)

H-1000
(1000 Watts)

5 NEW HIGH- WATTAGE H-H Rheostats

Now the full Hardwick, Hindle line includes H-50, H-75, H-100, H-150, H-225, H-300, H-500, H-750 and H-1000.

Our H-50 -75 -100 and -150 watt models have established in the field a great reputation for unusual ruggedness under abnormal conditions. They have proved themselves to be thoroughly dependable in service.

Their many improvements are all incorporated in these 5 new models, together with

added new features including our recently patented contact arm.

All are designed to comply with current standards of:—

- Military Specifications MIL-R-22
- R.E.T.M.A. • N.E.M.A.
- Underwriters' Laboratories, Inc.

Write today for Rheostat Bulletin 355

HARDWICK, HINDLE, INC.

Rheostats and Resistors • NEWARK 5, N.J., U.S.A.

The mark of quality for more than a quarter of a century



FINANCIAL AID TO HIGHER EDUCATION

Business Help for Our Colleges A Job for All Business Firms

IN recent months, individual business firms have announced the adoption of a variety of plans, both imposing and ingenious, for financial aid to higher education in the United States. In doing so, they have taken a lead in dealing with a problem of transcendent importance both to the business community and to our nation as a whole.

Previous editorials in this special series have shown that:

1. Our colleges and universities, and particularly the independent, privately endowed institutions, are in grave financial difficulties.
2. These difficulties promise to become much more acute in the years immediately ahead unless extraordinary steps are taken to relieve them.
3. A financially crippled system of higher education is a major national menace.

If, however, the business community is to play an adequate part in helping our colleges and universities financially, the plans adopted by business firms thus far constitute merely a beginning and a set of guide posts. What is required is a general movement on the part of business firms to go to the financial aid of higher education. Such a movement would involve a myriad of individual company plans which, in the nature of the case, cannot be expected to bring great renown or publicity to their sponsors.

Rescue Operation Is Feasible

For the business community as a whole it is feasible to make a major and possibly a decisive contribution to putting our colleges and universities back on their feet financially. One percent of business profits before taxes would do it. In 1954 business profits before taxes were about \$35 billion. If one percent of these profits, or \$350 million, were contributed to our independent, privately endowed colleges and universities it would enable these institutions (1) to increase the salaries they pay by \$200 million a year, and (2) to provide \$150 million more for modernization and maintenance of their establishments. In the opinion of competent authorities, this would put these institutions in relatively good working order financially, a process to which a matching grant of \$50 million by the Ford Foundation for the improvement of faculty salaries will make a large contribution. It would add about one-fourth to their present annual outlay of about \$1.4 billion.

Such a contribution from business would not meet the needs of the independent institutions for new buildings and equipment required to accommodate the great increase in college enrollment anticipated in the years immediately ahead. Neither would it relieve the financial problems of our tax-supported colleges and universities. As a group these institutions have fared better financially in recent years than the

independent institutions. But they also face grave financial problems, particularly in the provision of adequate faculty salaries. It would be far simpler, however, to solve the financial problems of the tax-supported institutions if the independent colleges and universities were back on their feet financially.

One Dollar Does Work of Two

The federal government exempts 5 percent of business profits from the tax imposed upon them if the 5 percent is devoted to religious, charitable or educational purposes. (Most profits are taxed 52 percent.) A contribution of one percent of business profits to higher educational institutions would exhaust only one-fifth of this allowance. It would bring to about two percent the total share of business profits going to both educational and charitable purposes.

In 1953, business firms contributed about \$400 million, or slightly more than one percent of profits before taxes to educational and charitable purposes of all kinds. Of this total about \$75 million went to educational institutions, mostly colleges and universities.

For some companies it is feasible to contribute more than the average contributed by business generally. Indeed, some companies not only utilize their full 5 percent of tax-deductible funds for charitable and educational purposes but go beyond it. For other companies in financial difficulties no contribution at all is possible.

If, however, those business firms for which it is financially feasible contributed one percent of their profits before taxes to our colleges and universities, the problem of adequate support for the crucially important business of higher education would be far along the way to successful solution. **In 1954 a contribution of one percent of their profits before taxes, or about \$350 million, would have reduced business profits after taxes by only about half that amount. This would have meant a reduction of about \$175 million, out of a total of about \$17.8 billion of profits after taxes.**

Attractive plans to channel financial aid from business to higher education have been abundantly demonstrated recently. These plans, for the most part the creation of large corporations, have included not only a broad array of schol-

arship grants, but such ingenious arrangements as that by which a company matches with its funds the gifts its employees make to the colleges of which they are alumni.

A full array of these plans, some of which were discussed in an earlier editorial in this series, has been prepared by The Council for Financial Aid to Education (6 East 45th Street, New York City 17) and is available for the asking. Also, colleges and universities have established in most states and regions cooperative associations to help business help them. The Commission on Colleges and Industry (912 Kahn Building, Indianapolis 4, Indiana) distributes a directory of these associations. And, of course, the colleges themselves are always eager to discuss their financial problems with business people and suggest constructive solutions.

Only Small Start Made

The plans for business aid to education which have recently attracted national attention constitute the conspicuous sort of leadership which it is the privilege and opportunity of our great corporations to provide. But the job is too large to be handled by a small number of business firms, no matter how bold or ingenious their programs.

To put our colleges and universities back on a firm footing financially the help of the great rank and file of business corporations is required. All of them, large and small, have a crucial stake in seeing that this job is done. The future of America will be decisively shaped by what happens in and to our college classrooms.

This message is one of a series prepared by the McGraw-Hill Department of Economics to help increase public knowledge and understanding of important nationwide developments that are of particular concern to the business and professional community served by our industrial and technical publications.

Permission is freely extended to newspapers, groups or individuals to quote or reprint all or parts of the text.



PRESIDENT

McGRAW-HILL PUBLISHING COMPANY, INC.

featherlight

**HIGH STRENGTH
AIRCRAFT QUALITY STEEL
AN364 THREAD HEIGHT
.062 THREAD RELIEF**

Series 12600 self locking, sheet metal nuts are designed as the *ultimate answer for light weight AN362F-AN366F series anchor nuts.*

The thread relief design eliminates the need for the first shim, thereby making the *lightest assembly possible.*



COMING SOON. Other styles and types in this basic design.

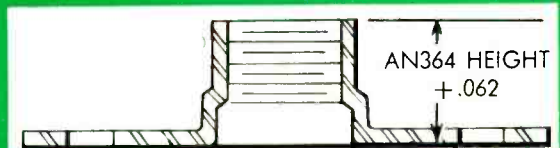

These high strength, low height anchor nuts are fabricated from A.I.S.I. 4130 aircraft quality steel. They exceed requirements of Spec. AN-N-5 and AN-N-10 and are designed to meet requirements of MIL-N-25027 (ASG).

Self locking, sheet metal nuts in Series 12600 withstand temperatures up to 550° F and employ the *triple lock* locking method.

Nutt-Shel

811 A rway, Glendale 1, California. Telephones: CHapman 5-3693 and Citrus 4-4191
MANUFACTURERS OF SELF LOCKING NUTS AND BOLT & NUT RETAINERS.

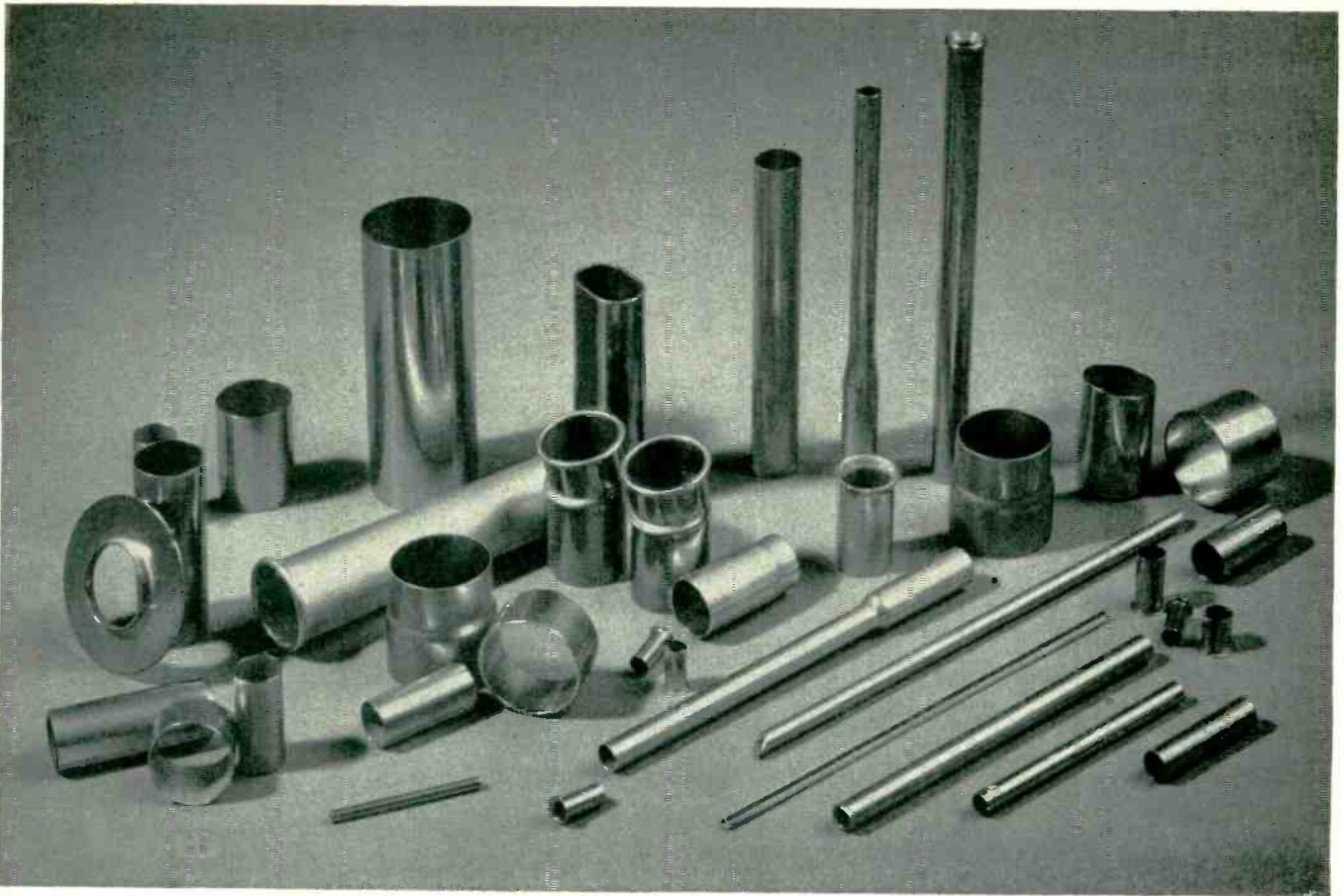

Need close-tolerance tubular parts like these? Just send drawing

Superior Tube has special facilities for doing complete job — efficiently, fast

Save handling costs. When you need special close-tolerance tubular parts, let Superior Tube make them for you complete. Engineering assistance is available. Or just send drawing, indicating size, shape, metal analysis, temper and degree of finish desired.

Superior Tube's special facilities provide for flaring, cutting, deburring, expanding, bending, rolling ends, grooving, beading, coiling, flattening, punching, deep drawing, reducing, drilling, chamfering, shearing, slotting. A wide choice of different alloys of closely controlled analysis is available.

For prices and complete information on fabricated tubular parts on glass sealing alloys, write Superior Tube Company, 2500 Germantown Ave., Norristown, Pa.

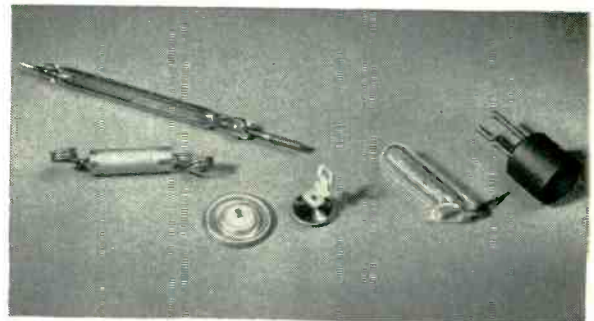

GLASS SEALING ALLOYS

Glass-to-metal seals for conductor leads into vacuum tubes, hermetically sealed chambers, or controlled atmospheres. Typical uses are shown above, left to right: voltage regulator, capacitor, capacitor cap, button terminal, recording pen, refrigeration sniffer. Superior offers six standard uniform-expansion alloys cold drawn to close tolerances in Seamless or WELDRAWN* tubing.

*TM Superior Tube Co., Reg.-U.S. Pat. Off.

Superior Tube

The big name in small tubing

All analyses .010" to 1/4" Q.D. Certain analyses in light walls up to 2 1/2" OD.

LOOK TO **Transitron**

SILICON RECTIFIERS AND DIODES

designed for specific applications

SILICON POWER RECTIFIERS

Rated for 125°C operation, Transitron's silicon rectifiers provide high power handling ability and reliability at high temperature. They are specifically designed for magnetic amplifier and power supply applications. Send for Bulletin TE-1321.

Specifications and Ratings at 125°C					
HIGH POWER TYPES			MEDIUM POWER TYPES		
TYPE	P.I.V.* (volts)	I _{dc} ** (amps)	TYPE	P.I.V.* (volts)	I _{dc} ** (amps)
1N411	50	10	1N332	400	0.4
1N412	100	7	1N334	300	0.4
1N413	200	5	1N336	200	0.4
			1N338	100	1.0

* Peak Recurrent Inverse Voltage at full load
 ** Maximum Average Forward Current at full load



SILICON JUNCTION DIODES

Transitron's silicon junction diodes are characterized by superior forward conductance and reliable operation up to 150°C. They are specifically designed for applications requiring extremely high inverse resistance at high temperatures. Send for Bulletin TE-1322.

TYPE	Forward Current at +1 V (ma)	Inverse Current at Specified Voltage (ua)		Maximum Working Voltage (volts)
		at 25°C		
		at 20V	at 125°C	
1N137A	3	.03 at 20V	—	36
1N138A	5	.01 at 10V	—	18
1N137B	20	.03 at 20V	5 at 20V	36
1N138B	40	.01 at 10V	2 at 10V	18
1N350	20	.03 at 60V	5 at 60V	70
1N351	8	.03 at 100V	5 at 100V	120
1N352	5	.05 at 150V	10 at 150V	170
1N353	3	.10 at 200V	20 at 200V	225
1N354	1	.10 at 300V	20 at 300V	325



ACTUAL SIZE

SILICON BONDED DIODES

Transitron's silicon bonded diodes are specifically designed for high frequency and very fast switching applications at high temperatures. They are particularly useful in detector, discriminator and pulse circuitry. Send for Bulletin TE-1308.

TYPE	Forward Current at +1 V (ma)	Inverse Current at Specified Voltage (ua)	Inverse Breakdown Voltage
S4	1	1 at 10V	15
S5	1	.1 at 10V	20
S6	4	.5 at 5V	10
S7	2	1 at 10V	20
S8	1	1 at 10V	10

Operating frequency range 0-500 mc. Average Shunt Capacitance 0.8 uufd



ACTUAL SIZE

Transitron's special engineering group is available to assist you with specific applications. Inquiries concerning your particular design problems are invited.

Transitron electronic corporation • melrose 76, massachusetts



Glass Diodes



Silicon Diodes



Germanium Diodes



Transistors



Silicon Rectifiers



DATA FOR



NEW TRIODE-PENTODE FOR VARIETY OF TV RECEIVER APPLICATIONS

RCA-6AZ8 . . . general-purpose, 9-pin miniature type containing a medium-mu triode and semiremote-cutoff pentode in one envelope. Triode section is useful in low-frequency oscillator, sync-separator, sync-clipper, and phase splitter circuits. Pentode section which features high trans-conductance, and semiremote-cutoff characteristics to minimize cross-modulation effects and overload distortion in picture-if stages, may be used as an if, video, or agc amplifier, and as a reactance tube.

For technical information on all products shown here call your RCA Representative:

EAST _____ HUmboldt 5-3900
744 Broad St.
Newark 1, N. J.

MIDWEST _____ WHitehall 4-2900
Suite 1181,
Merchandise Mart Plaza
Chicago 54, Ill.

WEST _____ MADison 9-3671
420 S. San Pedro St.
Los Angeles 13, Calif.

Or write RCA, Commercial Engineering,
Section F19R, Harrison, N. J. using this
coupon. Circle types you are interested in.

2N77 2N109 5604-A 6521 6655
2N104 3B2 6AZ8 6570 6694
2N105 5AYP4

Name _____

Position _____

Company _____

Address _____



NEW POWER TRIODE FOR INDUSTRIAL HEATING AND GENERAL COMMUNICATION SERVICES

RCA-5604-A . . . a forced-air-cooled power triode with improved heat-radiation design that reduces forced-air requirements. Well suited to "on-off" industrial operations. Features include: single-phase, multi-strand tungsten filament; sturdy Kovar anode, grid, and filament seals; heavy-wall copper anode. RCA-5604-A has a plate dissipation rating of 10 kw—can be operated with full ratings at frequencies as high as 25 Mc. When operated in unmodulated class C service at a plate voltage of 12 kv, a single 5604-A can deliver 22.5 kw approx.

VACUUM PHOTOTUBE FOR INDUSTRIAL SERVICE EQUIPMENT

RCA-6570 . . . especially useful in industrial applications critical as to microphonics and sensitivity gradient. Features high sensitivity to red and near-infrared radiant energy and is, therefore, suitable for use with an incandescent light source. Has maximum anode-supply voltage rating of 500 volts; maximum average cathode-current rating of 5 μ amperes; and average luminous sensitivity-30 μ amperes per lumen.



NEW VIEW-FINDER KINESCOPE FOR PORTABLE TV CAMERAS

RCA-5AYP4 . . . electrostatically focused and magnetically deflected, this 5-inch cathode-ray tube offers high resolution and good uniformity over the entire picture area. It has a high-efficiency, aluminumized white fluorescent screen which eliminates need for an ion-trap magnet and improves contrast and brightness.

**ELECTRON TUBES—SEMICONDUCTOR DEVICES—BATTERIES—
TEST EQUIPMENT—ELECTRONIC COMPONENTS**

DESIGNERS



NEW MULTIPLIER PHOTOTUBE FOR GAMMA-RAY SPECTROSCOPY AND SCINTILLATION COUNTERS

RCA-6655 . . . a 10-stage, flat-face, head-on type with 1-11/16" diameter cathode; focusing electrode for optimizing magnitude, uniformity, or speed of response; 3000 to 6500 angstroms spectral-response range (max. at approx. 4400); cathode luminous sensitivity of 50 μ amp/lumen; short pulse resolving time at relatively low supply voltage of 1000 volts; and sturdy structure to withstand the rigors of field use.



NEW HALF-WAVE VACUUM RECTIFIER FOR PULSED-RECTIFIER SERVICE

RCA-3B2 . . . a glass-enclosed, high-voltage rectifier of the heater-cathode type for use in the scanning systems of modern black-and-white and color-TV receivers. Rated at a maximum peak inverse plate voltage of 35,000 volts (absolute), maximum peak plate current of 80 ma., and maximum average plate current of 1.1 ma.

FOUR NEW ALLOY-JUNCTION TRANSISTORS

Hermetically sealed, germanium, p-n-p types offering extreme stability and uniformity of characteristics—initially and during life. RCA-2N104 for low-power, audio-frequency applications; RCA-2N109 for large-signal applications, such as class B audio service; RCA-2N77 and -2N105 for hearing-aids.

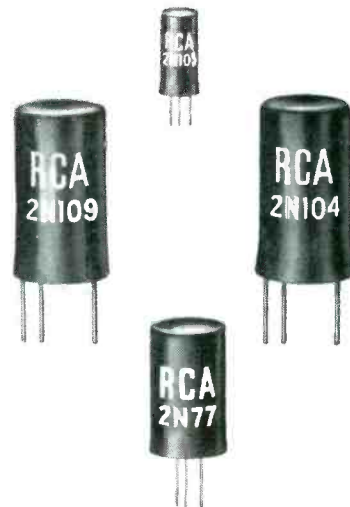

New RCA Transistors shown twice actual size

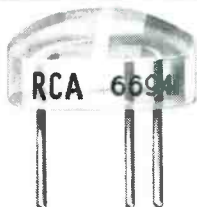

NEW PHOTOCONDUCTIVE CELL FOR LIGHT-CONTROLLED RELAYS, COMPUTERS, AND LIGHT METERS

RCA-6694 . . . very tiny, cadmium-sulfide, head-on type featuring high luminous sensitivity, very low dark current, extremely low background noise, and signal output directly proportional to incident light intensity. Characteristics not substantially affected by wide temperature changes. Spectral response covers range from 3500 to 5500 angstroms with peak at about 5000. Luminous intensity sensitivity is 3 μ amp/ft-c at 90 volts.

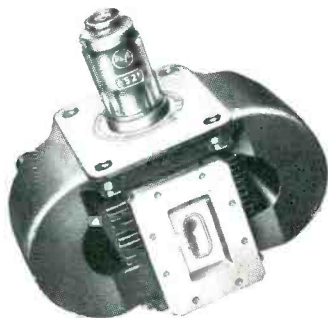

NEW "C" BAND MAGNETRON FOR AIRCRAFT WEATHER RADAR

RCA-6521 . . . for service as pulsed oscillator at fixed frequency of 5400 \pm 20 megacycles. It is designed and conservatively rated to insure long, reliable performance. Operates with high efficiency at pulse durations up to 2.2 microseconds. Has peak input power rating of 25.6 kw, peak anode voltage rating of 16 kv, and peak anode current rating of 10 to 16 μ amperes. Peak power outputs up to about 100 kw may be obtained.



RADIO CORPORATION of AMERICA
TUBE DIVISION

HARRISON, N. J.

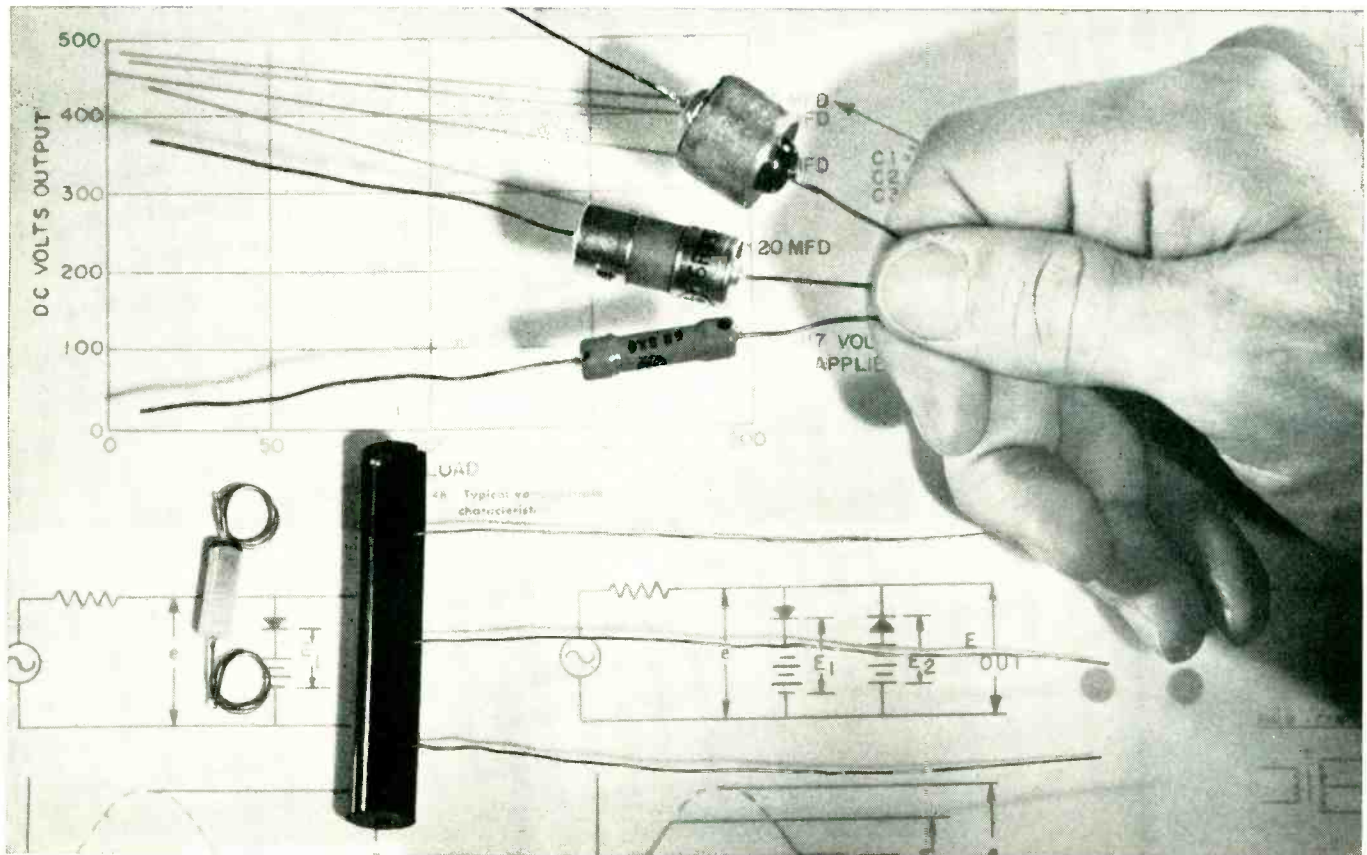

G-E Miniature *Vac-u-Sel** Rectifiers Provide 60,000 Hours Life; -65C to 130C Ambient Range

General Electric miniature Vac-u-Sel rectifier stacks provide outstanding advantages in the areas of:

- Long life expectancy—60,000 hours at 35 C
- Broad ambient temperature range—-65 C to 130 C
- Wide adaptability—variety of stack ratings to 9250 volts peak inverse.

Vac-u-Sel is the G-E trade-mark for a new line of metallic rectifiers with outstanding electrical characteristics.

LONG LIFE EXPECTANCY—Applications requiring 60,000 hours of life and more can be handled with assurance of highly dependable performance with these top-quality rectifier stacks. Long life is an inherent characteristic of these rectifiers. Aging (increase in forward drop) is exceptionally low.

BROAD AMBIENT TEMPERATURE RANGE—All G-E miniature Vac-u-Sel rectifier

cells are specially processed to maintain a high stability of characteristics over an ambient temperature range from -65 to 130 C. Full voltage ratings may be used in all high-temperature applications, and current need not be derated in cases where shorter life is acceptable.

WIDE ADAPTABILITY—Miniature Vac-u-Sel rectifiers are available in individual stacks rated up to 9250 volts peak inverse (6500 volts RMS). Higher voltages may be obtained by using two or more stacks in series. Basic cell ratings are 2.5 ma, 8 ma, and 25 ma (half wave).

Vac-u-Sel rectifiers are available in a variety of housings. The ceramic-tube and metal-tube housings are hermetically sealed. Military specifications on protective coatings are met by applying a special finish to the Textolite* tube stacks at additional cost, and by potting (seal-

ing). Special housings can be offered for large-quantity applications.

PROMPT SERVICE—Immediate attention to any proposition can be obtained by contacting your nearest G-E Apparatus Sales Office, or by writing Section 461-37, General Electric Co., Schenectady 5, N. Y.

*Reg. Trade-mark of the General Electric Co.

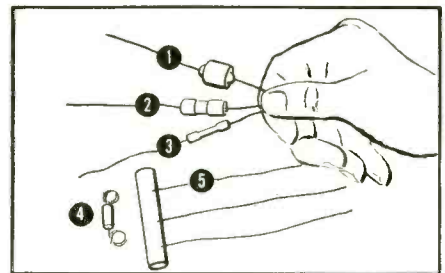

VARIETY OF HOUSINGS available for Vac-u-Sel rectifiers. 1) Metal-clad casing, 2) Textolite tube, 3) Ceramic tube, 4) Nylon tube, 5) Slotted Textolite tube.

Progress Is Our Most Important Product

GENERAL  ELECTRIC



Over the twelve years that Fairchild has been making precision potentiometers — from our first unit (Type 736), on through the more than eighteen different types now in production — we have established and are carrying out a research and development program on new designs and materials, techniques and equipment that is constantly improving our potentiometer reliability. The results of this program are quickly applied to production units and these improved methods and designs are maintained by comprehensive quality control and type testing programs.

MAXIMUM RELIABILITY...

how do you get it?

Reliability in precision potentiometers resolves itself into three basic factors; longer shelf life, longer rotational life, and longer environmental life. Fairchild has increased the average shelf and rotational life expectancy of precision potentiometers far beyond usually expected life cycles, in one way, by compounding and using special potentiometer lubricants. Life expectancy and stability under abnormal operating conditions have been vastly increased through the use of precision-machined aluminum alloy case construction. Epoxy resin insulation, one-piece Paliney conductive springs and contacts, and precious metal alloy resistance elements, for certain applications, also contribute to increased life and functional reliability. Whether one or all of these factors of reliability are important to you, you'll do better to choose Fairchild Precision Potentiometers. For specific facts, write Fairchild Camera and Instrument Corporation, Potentiometer Division, 225 Park Avenue, Hicksville, Long Island, New York, Department 140-64A.



FAIRCHILD
PRECISION POTENTIOMETERS

"WE LIKE THE CONSISTENT QUALITY OF RICHARDSON PLASTICS"

SAYS....



CHICAGO TELEPHONE SUPPLY
Corporation



Exploded view shows a CTS control—a concentric shaft tandem variable resistor with switch. Arrows indicate laminated parts made with Richardson plastics.

SIX PLANTS



MELROSE PARK, ILL.



NEWMAN, GA.



OGDEN, UTAH

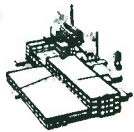

NEW BRUNSWICK, N. J.



INDIANAPOLIS, IND.



TYLER, TEX.

**RICHARDSON
LAMINATED
and MOLDED
PLASTICS**

Chicago Telephone Supply Corporation is the world's largest producer of variable resistors. To achieve this position, they have stressed *quality*—both in their manufacturing operations and in their sources of supply. For many years, The Richardson Company has supplied the Chicago Telephone Supply Corporation with laminated and molded plastic products which meet their high standards for insulating and electrical properties—a testimonial to Richardson's own quality-mindedness.

If you are looking for a plastic supplier who can give you what you need, contact Richardson. Their complete laminating and molding facilities permit volume production with consistent high quality and accuracy. Write or phone today for complete information.

The **RICHARDSON COMPANY**

FOUNDED 1858

2797 Lake St., Melrose Park, Illinois (Chicago District)

SALES OFFICES IN PRINCIPAL CITIES

if you need signs like this

**DANGER
NO SMOKING**

because of explosion hazards...

it'll pay you to look into

Adlake

mercury relays

Adlake relays require no maintenance whatever
...are quiet and chatterless...free from explosion hazard.

Dust, dirt, moisture and temperature changes
can't affect their operation. Mercury-to-mercury
contact gives ideal snap action, with no burning,
pitting or sticking. Time delay characteristics
are fixed and non-adjustable.



The Adams & Westlake Company
Established 1857 • ELKHART, INDIANA • New York • Chicago

the original and largest manufacturers of mercury plunger-type relays

REVOLUTIONARY NEW DEVELOPMENT PHELPS DODGE

offers greatly

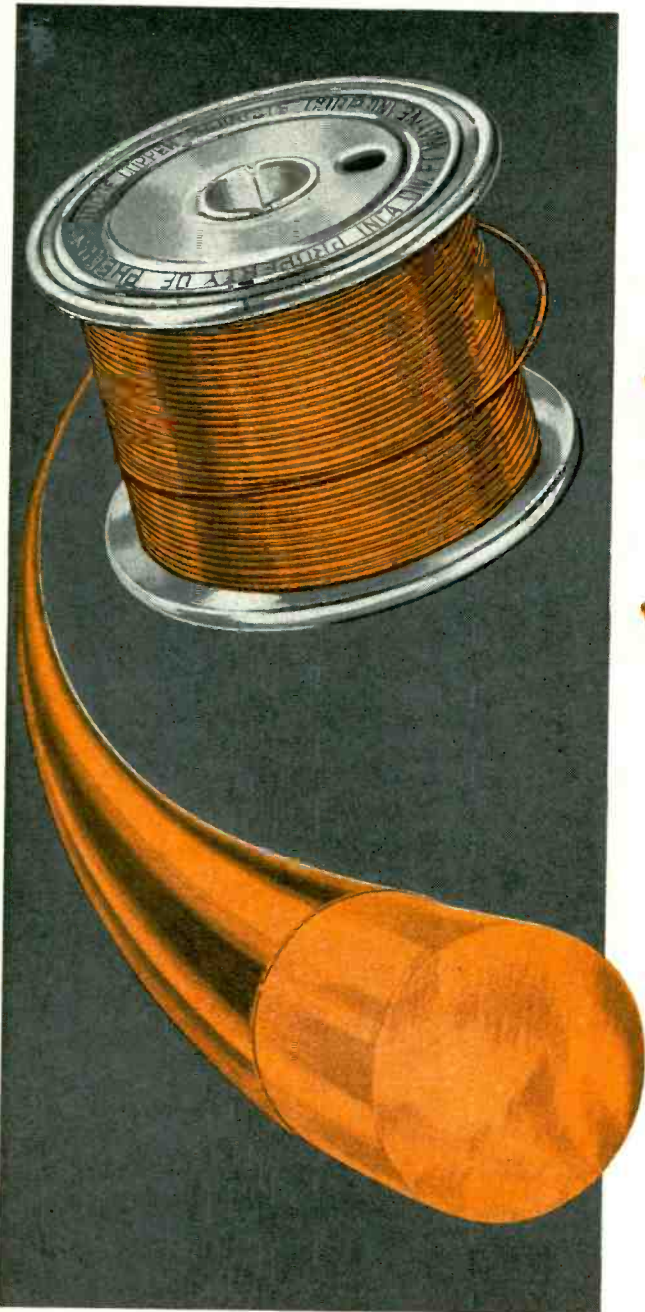

✓ **ASSURES IN EXISTING
DESIGNS INCREASED MARGINS
OF SAFETY FOR OVERLOADS**
—means greatly prolonged thermal life

✓ **MAKES NEW DESIGN
ECONOMIES POSSIBLE AT
HIGHER TEMPERATURES**

Thermaleze, Phelps Dodge's new film magnet wire, provides greatly improved heat resistance for short time, high temperature performance. For Class A windings, where unusual heat conditions prevail, it offers a greater safety factor against overloading. Good abrasion properties, excellent solvent and moisture resistance and good film flexibility readily permit Thermaleze to be substituted for conventional film wires.

*Any time magnet wire is your problem, consult
Phelps Dodge for the quickest, easiest answer!*

First for Lasting Quality—from Mine to Market!

IN CLASS "A" FILM MAGNET WIRE . . .

THERMALEZE®

improved heat stability!

Comparative Heat Stability—Dielectric Twist—150° C.

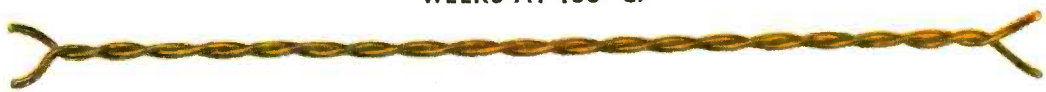
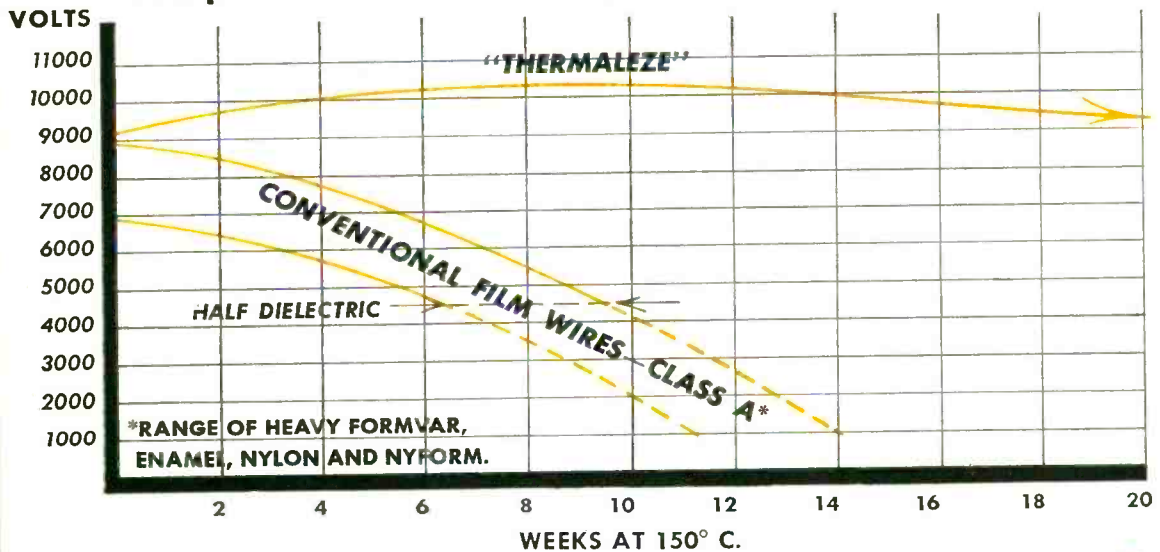

NEMA twist samples aged in air oven at 150° Centigrade. Samples taken periodically for dielectric breakdown—an excellent measure of thermal life.



PHELPS DODGE COPPER PRODUCTS CORPORATION

INCA MANUFACTURING DIVISION
FORT WAYNE, INDIANA

a message

to Original Equipment Manufacturers Who Use Permanent Magnets

May we have 1 minute and 2 seconds to tell you why Indiana Steel Products Company can do the best job, and the most thorough job, of supplying your permanent magnet requirements?

HERE ARE 5 REASONS:

FIRST . . . we're specialists. Indiana Steel Products Company has concentrated on manufacturing permanent magnets for more than 45 years! Attention and interest are not spread over many different and unrelated products.

SECOND . . . all Indiana salesmen are trained *engineers*. In many cases, they can give on-the-spot assistance with immediate problems . . . no delay while they check with the home office.

THIRD . . . Indiana sales engineers draw on our company's 45 years' experience in designing and producing permanent magnets for every conceivable type of application. More often than not, he has *already* encountered problems similar to yours.

FOURTH . . . competently staffed local offices, with direct communication with the home office, assure you of the best possible service . . . expedite rush and emergency deliveries, when necessary.

FIFTH . . . Indiana salesmen are backed by the World's largest engineering staff devoted solely to the design and application of permanent magnets . . . and the World's largest and most complete magnetic research and production facilities.

DO YOU ANTICIPATE a need for magnets in your experimental work, or for use around the plant? Catalog #11-A6 lists a wide assortment. Drop us a line . . . we'd like to send you a copy.

**INDIANA
PERMANENT
MAGNETS**

THE INDIANA STEEL PRODUCTS COMPANY
World's Largest Manufacturer of Permanent Magnets
VALPARAISO, INDIANA

Want more information? Use post card on last page.

June, 1955 — ELECTRONICS

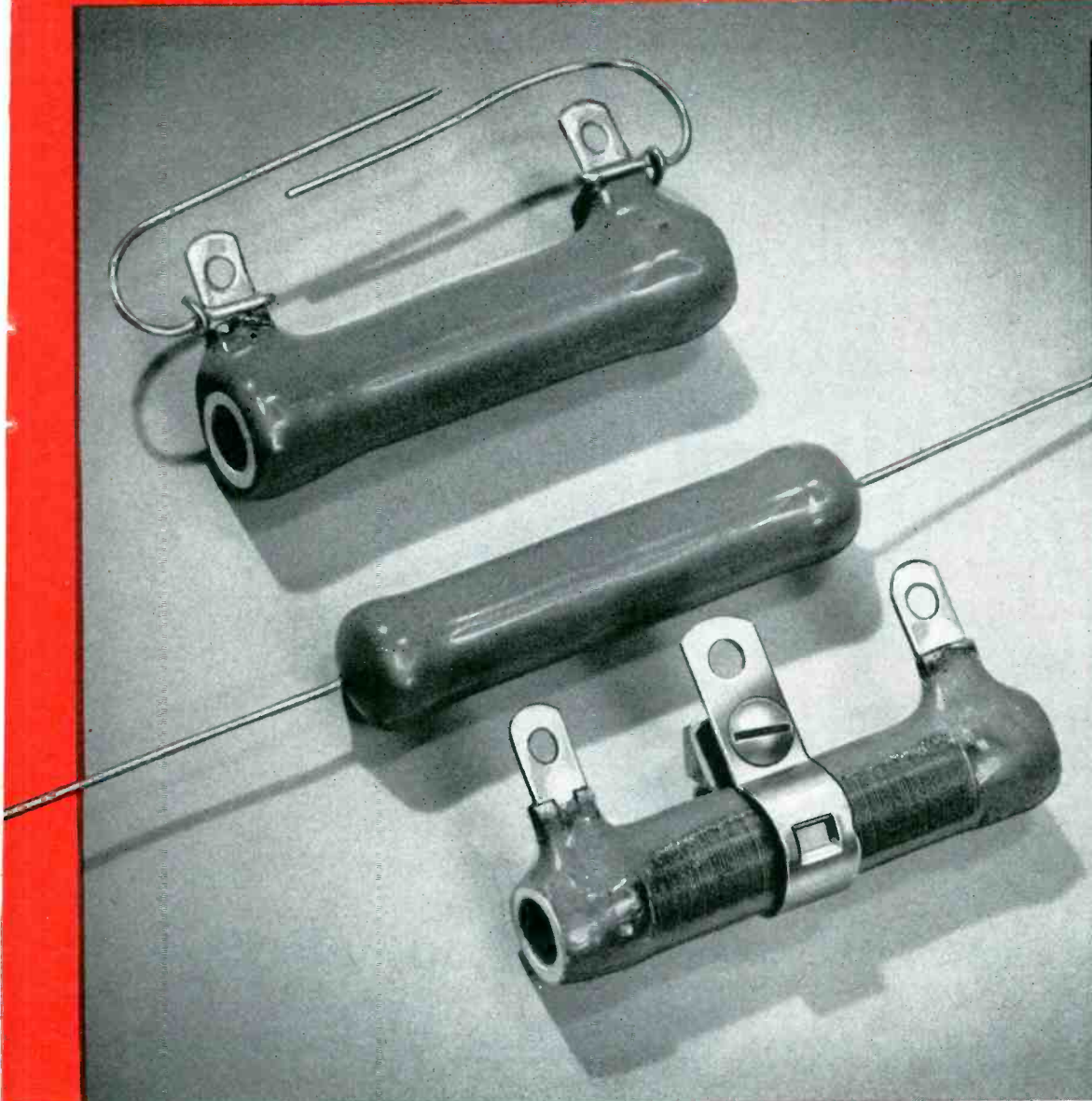

NOTE all diameters and lengths are identical. Photo twice actual size.

How do you want your 10-watt resistors?

Here are a few of the variations you can get in basic design, terminals and mountings on a standard 10-watt Vitrohm resistor.

It's this tremendous variety (we make a wider range of resistors than anybody else) that enables Vitrohm resistors to do so many jobs so well — and save you installation costs at the same time.

Add to this Ward Leonard's performance standards — insured by the 19 separate

inspection tests we run on every single resistor we make — and you see why you get more resistor for your money in a Vitrohm.

Prompt delivery, too, by the way.

Our engineers will be glad to show you which Vitrohm design best meets your specific needs. A line or call to Ward Leonard Electric Company, 450 South Street, Mount Vernon, N.Y. is all it takes. 5.4

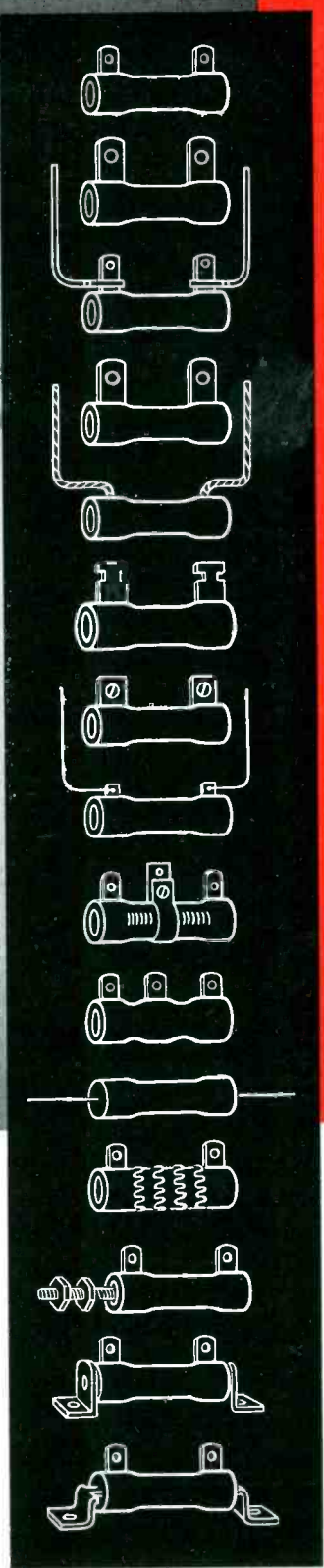

**WARD LEONARD
ELECTRIC COMPANY**
MOUNT VERNON, NEW YORK



Result-**E**ngineered Controls Since 1892



Don't give up! Here's all you need  in order to get
 the whole story of how these  MPB's 
BALL BEARINGS ACTUAL SIZE
 are solving problems in the design
 of precision instruments

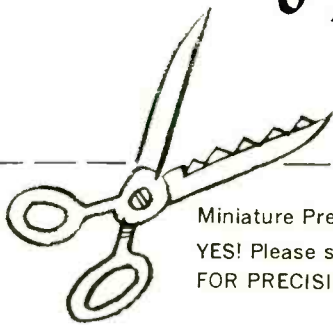

CUT THE CALAMITY AND CUT OUT THE COUPON

Miniature Precision Bearings, Inc., 6 Precision Park, Keene, N. H.
 YES! Please send me the reprint of the article, MINIATURE BALL BEARINGS
 FOR PRECISION INSTRUMENTS

name	title	company	
street	city	zone	state

* MINIATURE PRECISION BEARINGS, INC., KEENE, N. H.

Get this 56-page Guide to

STACKPOLE ELECTRONIC COMPONENTS

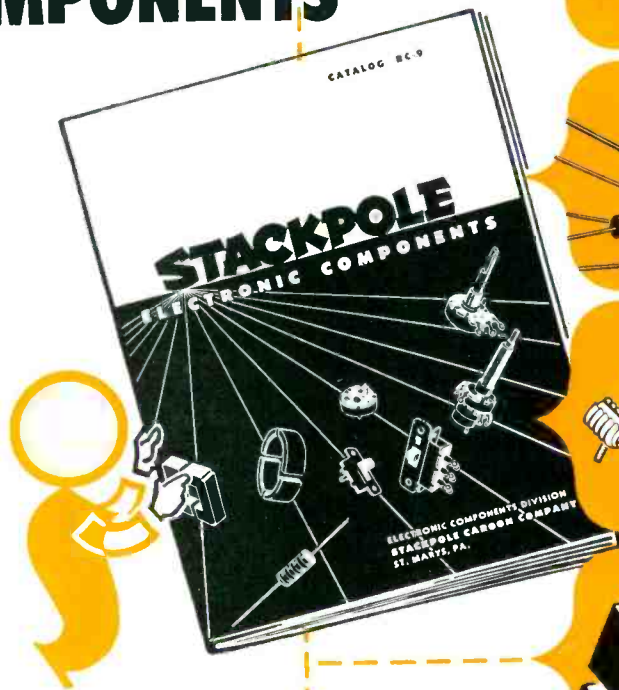

Electronic Components Division
STACKPOLE CARBON COMPANY
St. Marys, Pa.

AVAILABLE THROUGH PARTS DISTRIBUTORS:

For name of nearest distributor stocking Stackpole resistors, switches and "EE" iron cores write Distributors Division, Stackpole Carbon Co., 26 Rittenhouse Place, Ardmore, Pa.

FIXED RESISTORS

RETMA and special types

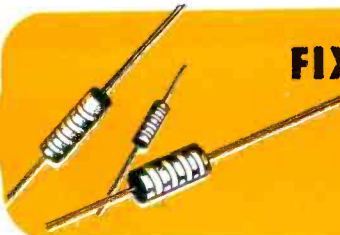

VARIABLE RESISTORS

0.5 and 0.6 watt bushing, tab mounting, printed circuit, and special types



LINE SWITCHES

10 types—circuit arrangements and current capacities for every need



SLIDE SWITCHES

Over 22 low-cost miniature styles for radio and TV receivers, small motors, toys, etc.

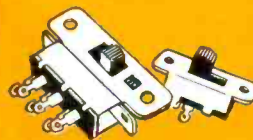

LOW-VALUE CAPACITORS

46 stable values in fixed composition types from 0.10 to 10.0 mmf with RETMA 4-band color code

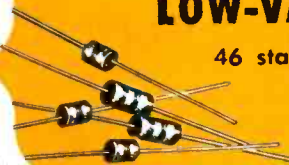

POWDERED IRON CORES

Standard, cup, sleeve, side-molded, and screw core types in any grade



Ceramag[®] FERROMAGNETIC CORES

Samples and production runs to your exact specifications



MOLDED COIL FORMS

Molded phenolic types with or without iron core sections; powdered iron choke cores





Get out of the Magnetic Doghouse with **MUMETAL** Shields



**Write for
your copy**

"MAGNETIC MATERIALS"

This 32-page book contains valuable data on all Allegheny Ludlum magnetic materials, silicon steels and special electrical alloys. Illustrated in full color, includes essential information on properties, characteristics, applications, etc. Your copy gladly sent free on request.

ADDRESS DEPT. E-66

Mumetal shields will give instant relief to interference caused by extraneous magnetic fields. This material can cure many troubles—solve many a problem for you.

Use it where high permeability is required at low flux densities, such as in input and microphone transformers, hearing aid diaphragms, instruments, wire and tape recorders, etc. For properly heat treating Mumetal, we can also offer commercial hydrogen annealing facilities.

A fund of technical data on

shields and other applications for Allegheny Mumetal is available—let us help with your problems.

In addition to Mumetal and other high-permeability alloys, we offer a range of magnetic and electrical alloys and steels that is unmatched in its completeness. Our services also include the most modern facilities for lamination fabrication and heat treatment. ● Let us supply your requirements. *Allegheny Ludlum Steel Corporation, Oliver Building, Pittsburgh 22, Pa.*

STEELMAKERS to the Electrical Industry
Allegheny Ludlum

W&D 5379



Save Money, Maintenance and Man-hours!

GET YOUR **DC** FROM AC

with dependable, long-life

Federal

SELENIUM RECTIFIER

Power-Converting EQUIPMENTS

NO costly, bulky, moving equipment to buy ... no expendable parts to replace frequently ... virtually no maintenance! No wonder Federal's compact, rugged, always-dependable Selenium Rectifier Equipments are the growing answer to DC output requirements ... for industrial power, battery charging and hundreds of other DC applications.

Federal Equipments are ready to connect to your AC source ... ready to deliver uninterrupted DC power wherever you need it and whenever you need it!

Powered by Federal's completely inert selenium rectifiers, the life of Federal Equipments is practically *unlimited*. All are conservatively rated ... with a wide margin of safety to withstand momentary heavy overloads.

If the DC output you need is not in Federal's line of standard power supply equipment, Federal will design and build to meet your specific requirements. Tell us the rating you need ... write today to Dept. E213B.

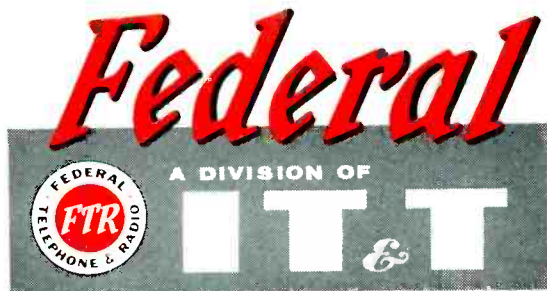

Federal Telephone and Radio Company
A Division of INTERNATIONAL TELEPHONE AND TELEGRAPH CORPORATION
COMPONENTS DIVISION • 100 KINGSLAND ROAD • CLIFTON, N. J.

In Canada: Standard Telephones and Cables Mfg. Co. (Canada) Ltd., Montreal, P. Q.
Export Distributors: International Standard Electric Corp., 67 Broad St., New York

POWER SUPPLIES— Industrial, Military, Laboratory

Chucks, brakes, clutches, screens, separators, drums, pulleys, lifting magnets, relays, circuit-breakers, solenoids, DC motors—these are only a few of the wide variety of applications now being successfully served by Federal Power Supplies.

Federal's FTR-3152-AS

Typical of the many standard types ready for shipment

Rated:

115/230 volts, 4.4/2.2 amps.

AC Input: 220/440 volts

2-phase, 50/60 cycles



REGULATED POWER SUPPLY

The FTR-3128-BS is designed to meet the exacting requirements of the aviation industry for a regulated and filtered DC power supply used for laboratory and testing purposes. Front panel control knob enables continuous selection of any DC output voltage between 22 and 30 volts.

Federal's FTR-3128-BS

Typical of the many standard types ready for shipment

Rated:

22/30 volts, 0.7/10 amps.

AC Input: 105/125 volts

1 phase, 58/62 cycles



MAGNETIC AMPLIFIERS

Presently used in a wide range of successful applications for industry and the Armed Forces, such as:

- Voltage Control
- Current Control
- Speed Control
- Position Control
- Temperature Control
- Photoelectric Control
- Counting
- Automatic Regulation

Federal Selenium Rectifiers, in partnership with the right magnetic components, provide Magnetic Amplifiers outstanding for

Stability • Accuracy • Long Life
High Gain • Fast Response • Low Cost Operation

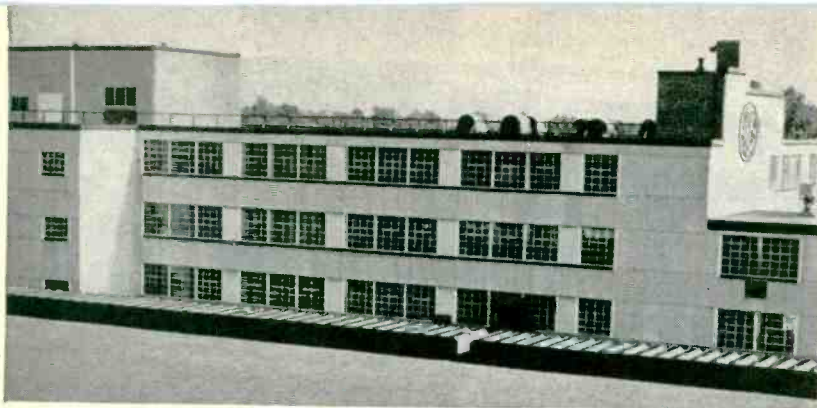

SEPARATE LARGE G-E FACTORY BUILDING at Owensboro, Ky., is devoted to the production of 5-Star miniature and subminiature tubes for military, communications, and industrial uses. Dust control and air-conditioning during assembly and inspection help to assure G-E 5-Star Tube reliability.

AT G.E., FURTHER



AIR-LOCKS AT ALL DOORS. Employees and other persons entering, pass through air-locks, with a grating underfoot through which powerful suction removes any loose dirt from their shoes. All outer garments, lunches, and personal articles are left outside, in a separate cloak-room. Traffic is closely controlled, and those permitted to enter must wear lint-free clothing. Incoming mail is left in the air-locks, for pick-up and delivery later on by employees who work inside the "Snow White" area.

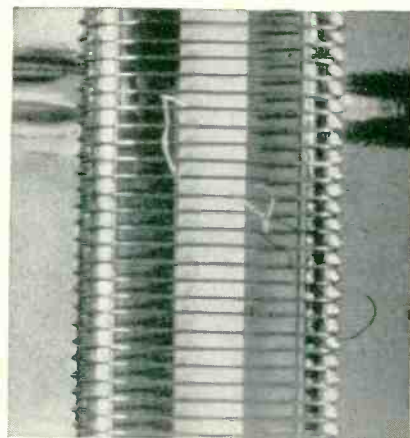

LINT CAUSES GRID SHORT This unretouched photograph of a tube grid magnified some 40 times, shows a stray particle of lint which can easily cause an inter-electrode short-circuit. Dust often causes a similar conductive path to form between closely-spaced tube elements.

LINT, DUST ARE SEALED OFF FROM 5-STAR PARTS. G-E tube grids are given a special cleaning, and then are rinsed, dried, inspected, and sorted. Afterwards G-E employees enclose them in treated paper bags, and fold and staple the ends of the bags so no lint or dust can enter.



"OPERATION SNOW WHITE" INCREASES TUBE RELIABILITY

5-Star Tube inoperatives are greatly reduced by ridding assembly and inspection areas of lint and dust!

Optimum cleanliness during manufacture has resulted in a two-thirds drop in G-E 5-Star Tube inoperatives—mainly caused by intermittent short-circuits from lint. 100% factory tests prove this gain in dependability.

G-E "Operation Snow White" shields the work of 750 skilled employees from lint, dust, and dirt; involves the operations of a whole tube factory; helps assure the reliability of 5-Star types—both miniatures and subminia-

tures—in many million critical military, communications, and industrial tube sockets.

The extensive and important story is told briefly in the pictures and text on these pages. Ask for additional 5-Star Tubes information!

Learn why G-E 5-Star Tubes—specially designed, built, and performance-tested—are the most dependable tubes you can specify and install! *Tube Department, General Electric Company, Schenectady 5, New York.*



WHITE LINT-FREE UNIFORMS of Nylon and Dacron are worn by the 750 selected, trained employees who assemble and inspect G-E 5-Star Tubes. The entire working area, a part of which is shown above, is pressurized to keep out dust, with air that first has been thoroughly filtered, then dehumidified, and cooled.



ASSEMBLY, INSPECTION UNDER GLASS. G-E 5-Star Tube assembly and microscope inspection are carried out under special protective hoods that are glass-paneled for work observation. Employees wear rubber finger cots—changed every hour—to avoid contaminating the tube parts with any dirt or moisture.

Progress Is Our Most Important Product

GENERAL  **ELECTRIC**

162-1B3

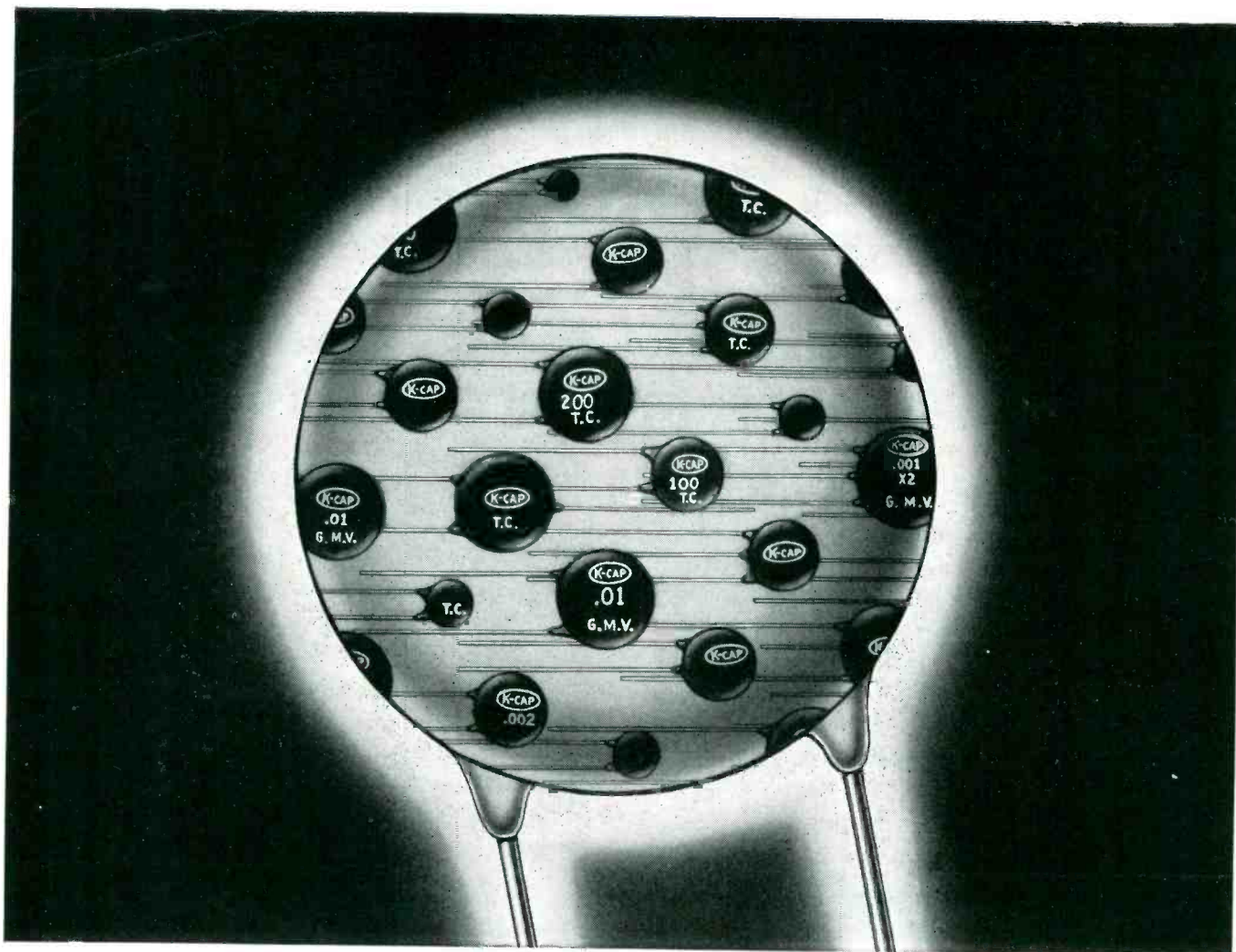

Did you know that only **AUTOMATIC** makes K-CAP Ceramic Disc Capacitors?

K-CAP* Ceramic Disc Capacitors are another mass produced electronic product made by Automatic Manufacturing Corporation, originators of the famous K-Tran* and J-Tran* I.F. Transformers...the first standardized I.F.'s in the industry.

K-Cap capacitors, like K-Tran and J-Tran, are manufactured completely within our own plant from the basic powders to the completed capacitor. The high K ceramic bodies are developed in our own modern laboratory and produced under the exacting supervision of our quality control engineers. The silvering process is done by men with more than 20 years experience in silvering trimmers and condensers.

K-Cap Ceramic Capacitors are distinguished by their black, wax impregnated, phenolic coating, stamped with red markings. All bear the registered trade mark K-Cap.

They are made in 4 standard types:

GUARANTEED MINIMUM VALUE
for bypassing, etc.

GENERAL PURPOSE
for coupling, etc.

TEMPERATURE COMPENSATED
in a range of T.C. from N.P.O. through N2200

HIGH STABILITY
for elimination of drift

Available in either single capacitor, dual capacitor unshielded, and dual capacitor shielded, in a range from 2. uuf to .02 uf.

☆ ☆ ☆

For more information about K-Cap, K-Tran and J-Tran, write for a copy of the K-Tran-K-Cap Manual—56 pages of engineering information, most valuable to you in Electronic designing.

*T.M. Reg. U.S. Pat. Off.



MASS PRODUCERS OF ELECTRONIC COMPONENTS

63 GOVERNEUR ST., NEWARK 4, N. J.

Every part Automatic uses... Automatic makes!

5 Waldes Truarc rings eliminate parts, speed assembly, in light, compact dictating machine

Edison's "V. P." Voicewriter



Edison engineers built this new dictating instrument for small size, light weight, and rugged performance. Waldes Truarc rings replace old fashioned fasteners, cut production costs; keep unit light, compact, and achieve faster more economical assembly.

Disc Lever Cover Assembly

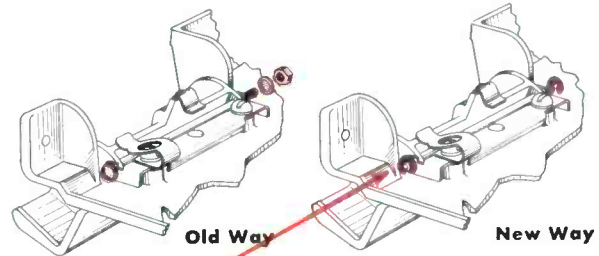

Two Waldes Truarc E-Rings (Series 5133) replace nut, bolt, washer assembly, eliminate one component and assure precise alignment of parts. Truarc rings facilitate pivoting without binding. Production assembly time is decreased.

Lift Bracket and Fork Assembly

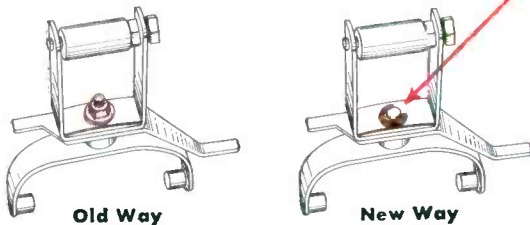

A single, easily assembled Waldes Truarc E-Ring (Series 5133) replaces nut-bolt-washer fastening. Free pivoting is assured, one component eliminated, labor and material costs reduced.

Clutch Plate Assembly

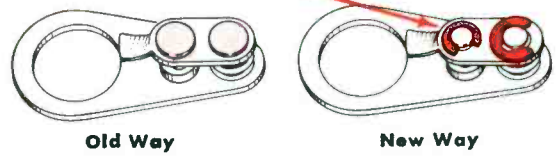

Two Truarc E-Rings eliminate staking operation, prevent damage to spring coil. Simple assembly operation speeds production, eliminates rejects, reduces labor and material costs.

Whatever you make, there's a Waldes Truarc Retaining Ring designed to improve your product... to save you material, machining and labor costs. They're quick and easy to assemble, and they do a better job of holding parts together. Truarc rings are precision engineered and precision made, quality controlled from raw material to finished ring.

36 functionally different types... as many as 97 different

sizes within a type... 5 metal specifications and 14 different finishes. Truarc rings are available from 90 stocking points throughout the U. S. A. and Canada.

More than 30 engineering-minded factory representatives and 700 field men are available to you on call. Send us your blueprints today. Let our Truarc engineers help you solve design, assembly and production problems, without obligation.

For precision internal grooving and undercutting... Waldes Truarc Grooving Tool!

Send for new catalog supplement

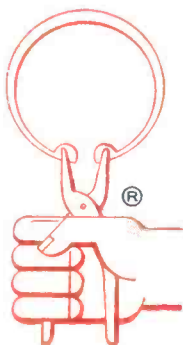

WALDES
TRUARC[®]
RETAINING RINGS

Waldes Kohinoor, Inc., 47-16 Austel Place, L. I. C. 1, N. Y.
Please send the new supplement No. 1 which brings Truarc Catalog RR 9-52 up to date.
(Please print)

Name.....
Title.....
Company.....
Business Address.....
City..... Zone..... State.....

EO67

WALDES TRUARC Retaining Rings, Grooving Tools, Pliers, Applicators and Dispensers are protected by one or more of the following U. S. Patents: 2,382,948; 2,411,426; 2,411,761; 2,416,852; 2,420,921; 2,428,341; 2,439,785; 2,441,846; 2,455,165; 2,483,379; 2,483,380; 2,483,383; 2,487,802; 2,487,803; 2,491,306; 2,491,310; 2,509,081; 2,544,631; 2,546,616; 2,547,263; 2,558,704; 2,574,034; 2,577,319; 2,595,787, and other U. S. Patents pending. Equal patent protection established in foreign countries.



Admiral has built COMMUNICATIONS for a sky-ful of planes

Standard communications equipment for nearly all military aircraft is the famed AN/ARC-27. This complex all-channel transmitter-receiver can be tuned to 1,750 VHF and UHF channels. Containing 56 tubes and upwards of 3,000 parts, this unit is being produced in vast quantities to keep pace with America's expanding air power. Approximately one out of every three transceivers completed to date has come out of Admiral plants.

This particular assignment provides ample evidence of Admiral's ability to produce in quantity...and to maintain the strictest quality standards. Production capacity has now been further augmented by means of the new automation equipment, designed and built by Admiral's own engineering staff. Address inquiries to:

Admiral

CORPORATION

**Government Laboratories Division
Chicago 47, Illinois**

**LOOK TO *Admiral* FOR
RESEARCH • DEVELOPMENT • PRODUCTION**

in the fields of:

COMMUNICATIONS, UHF and VHF, air-borne and ground.
MILITARY TELEVISION, receiving and transmitting, air-borne and ground.

RADAR, air-borne, ship and ground.

RADIAC • MISSILE GUIDANCE • TELEMETERING
• DISTANCE MEASURING • TEST EQUIPMENT
• CODERS and DECODERS



Send for Brochure

...complete digest of Admiral's experience,
equipment and facilities.

ENGINEERS! The wide scope of work in progress at Admiral creates challenging opportunities in the field of your choice. Write Director of Engineering and Research, Admiral Corporation, Chicago 47, Ill.

NEW COLOR TV MONITORS

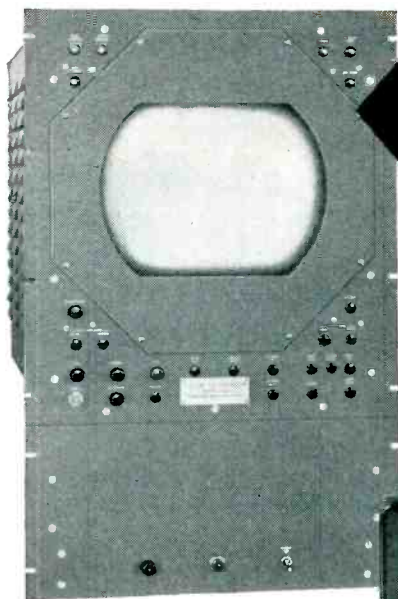

Sierra 162 Picture Monitor

COLOR OR BLACK-AND-WHITE • HIGH STABILITY,
LINEARITY • AUTOMATIC CHROMA CONTROL
SEPARATE POWER SUPPLY

Sierra 161 Waveform Monitor

CONVENIENT WAVEFORM ANALYSIS AND
AMPLITUDE MEASUREMENT • HIGH SENSITIVITY,
WIDE FREQUENCY RESPONSE

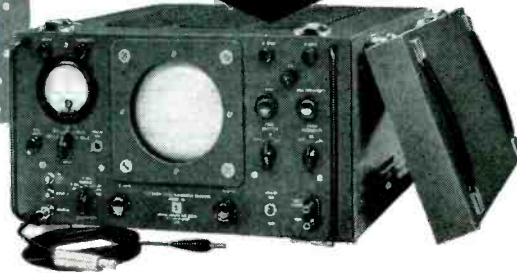

Together, new Sierra 161 and 162 TV Monitors provide convenient, dependable and complete monitoring of NTSC Standard Color Transmissions or black-and-white video signals.

Model 162 consists of a picture unit and a separate power supply. Features include high-level triode demodulators for linearity and stability, automatic chroma control, numerous test jacks to simplify circuit adjustment, and a regulated high voltage supply for the picture tube.

Model 161 provides convenient video signal waveform analysis and amplitude measurement. Vertical amplification is available to either 2, 4 or 6 mc. Also included are a high impedance, low capacitance probe, an input attenuator and a 60 cps calibrating signal simultaneously displayed on screen and voltmeter. Horizontal sweep may be expanded 12 or 20 tube diameters with return trace blanked.

Write for Data Sheets

SPECIFICATIONS — MODEL 162

- Input Video Signal:** 0.25 to 2.0 volts peak to peak, black negative.
- Input Impedance:** 72 ohms, coaxial (BNC connector).
- Resolution:** 250-300 lines (Full NTSC color signal bandwidth is used).
- Picture Tube:** 15" tri-color type.
- Operating Power Requirements:** 105 to 125 volts, 50/60 cps, 4 amperes (approx.).
- Mounting:** 19" relay rack.

Cabinet Dimensions: Picture Unit 17 $\frac{1}{4}$ " wide, (19" panel), 21" high, 29" deep. Power Supply Unit 17 $\frac{1}{4}$ " wide (19" panel), 8 $\frac{3}{4}$ " high, 8 $\frac{1}{2}$ " deep.

SPECIFICATIONS — MODEL 161

- Input Signal Level:** .05 to 300 volts peak to peak.
- Deflection Sensitivity:** 2 mc bandwidth: 0.05 peak to peak volts per inch. 4 mc and 6 mc bandwidth: 0.10 peak to peak volts per inch.
- Frequency Response:**
 - Vertical Amplifier:** 2 mc I.R.E. —3 db down. 4 mc Normal —3 db down. 6 mc Line Test —3 db down.
 - Square Wave Response:** Less than 5% tilt at 60 cps.
 - Horizontal Amplifier:** 35 kc —3 db down.
- Input Impedance:** Vertical amplifier without probe 470 k ohms 40 μ mf. Vertical amplifier with probe 1 megohm. 14 μ mf. Horizontal amplifier (external sweep) 100 k ohms 200 μ mf.
- Sweep Frequencies:** Low range 18 to 80 cps continuously variable. High range 4,000 to 16,000 cps continuously variable.
- Horizontal Expansion:** Low frequency sweep 20 tube diameters. High frequency sweep 12 tube diameters.
- Operating Power Requirements:** 105 to 125 volts 50/60 cps 1.8 ampere.
- Cabinet Dimensions:** 17" wide, 9" high, and 20" deep.

Data Subject to Change Without Notice

sierra



Sierra Electronic Corporation

San Carlos 2, California, U. S. A.

Sales representatives in major cities
Manufacturers of Carrier Frequency Voltmeters, Wave Analyzers, Line Fault Analyzers, Directional Couplers, Wideband RF Transformers, Custom Radio Transmitters, VHF-UHF Detectors, Variable Impedance Wattmeters, Reflection Coefficient Meters.

3226

HERE'S HOW GENERAL PLATE COMPOSITE METALS

**Cut Scrap, Increase Production, Reduce Costs
and Provide Superior Performance**

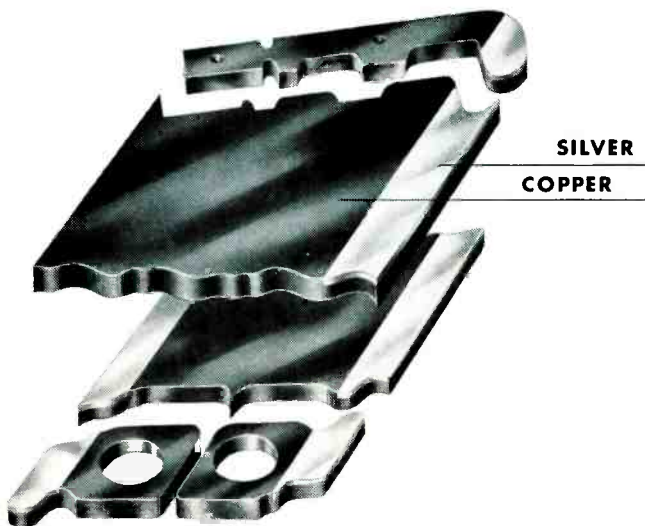

General Plate reduces fabrication and assembly costs of electrical switch contacts.

20" DIAMETER
3500 FT. LONG CONTINUOUS LENGTH



General Plate composite metal, coin silver clad to phosphor bronz, reduces material waste and manufacturing costs of electrical contact spring clips.

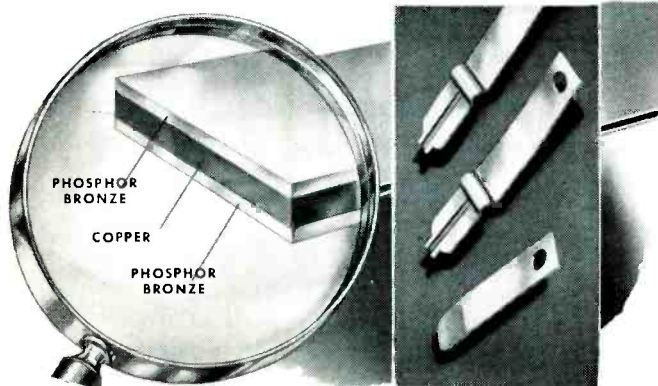

General Plate BRONCO* provides higher electrical conductivity without increasing cross-sectional area of spring blades.

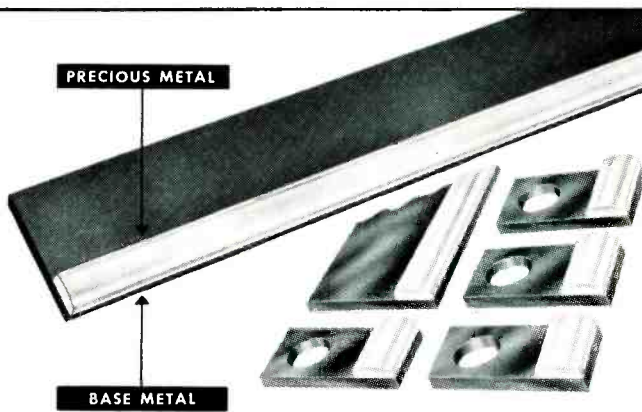

General Plate TOP-LAY® provides quicker fabrication and longer wearing qualities in contact assemblies.

General Plate Composite Metals are improving performance and cutting costs for manufacturers of many types of products.

Made by metallurgically bonding one metal to another, they are available in sheet, strip, tubing or wire in various widths, thicknesses and diameters.

Composite base metals provide a new group of engineering material with properties not available in solid metals. Their use frequently results in lower production costs as compared to solid metals.

In many applications further economy results when General Plate supplies fabricated parts ready for assembly into your product. General Plate makes an infinite variety of fabricated parts,

such as electrical contacts, collector rings and TRUFLEX® Thermostat Metal elements to customers' exact specifications.

General Plate Engineers will gladly help you with your design details. Write for Catalog PR700.

*Trademark

**You can profit by using
General Plate Composite Metals!**

**METALS & CONTROLS CORPORATION
GENERAL PLATE DIVISION**

36 FOREST STREET, ATTLEBORO, MASS.

Another Brush First!

NEW 1- AND 2-CHANNEL OSCILLOGRAPHS RECORD AT 8 OR 16 SPEEDS!

Now for the first time, you have a choice of 16 recording speeds in single and dual-channel direct writing oscillographs. The chart drive is electrically-controlled, permitting speed to be changed instantaneously from either local or remote locations. The chart drive system is highly accurate, providing a linear time base at all speeds. You can select the lowest speed that gives desired resolution of signal with economy of paper.

When used with Brush Amplifiers, these oscillographs give you an extended frequency response from d.c. to 100 cps. The same basic unit can be obtained for either single or dual-channel recording; you have a choice of ink or combination ink and electric writing.



New Dual-Channel Oscillograph Model BL-262 provides internal chart take up; time and event markers can be mounted.



Oscillographs can be mounted in a mobile instrument cart or used on a test bench. Oscillograph has 7" x 19" panel, 10½" overall depth.

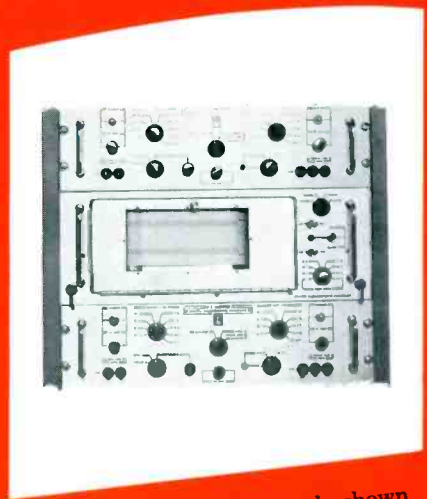

Dual-Channel Oscillograph shown rack mounted; also available in Single-Channel (Model BL-261).

Brush now offers a complete series of 1, 2, 4, or 6-channel Recording Systems. They can simplify your testing and analysis, save valuable engineering time. Send coupon for complete information.

SEND COUPON



BRUSH ELECTRONICS

INDUSTRIAL AND RESEARCH INSTRUMENTS
PIEZOELECTRIC MATERIALS • ACOUSTIC DEVICES
MAGNETIC RECORDING EQUIPMENT AND COMPONENTS

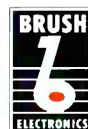

COMPANY

Division of
Clevite Corporation

Sound Measurement

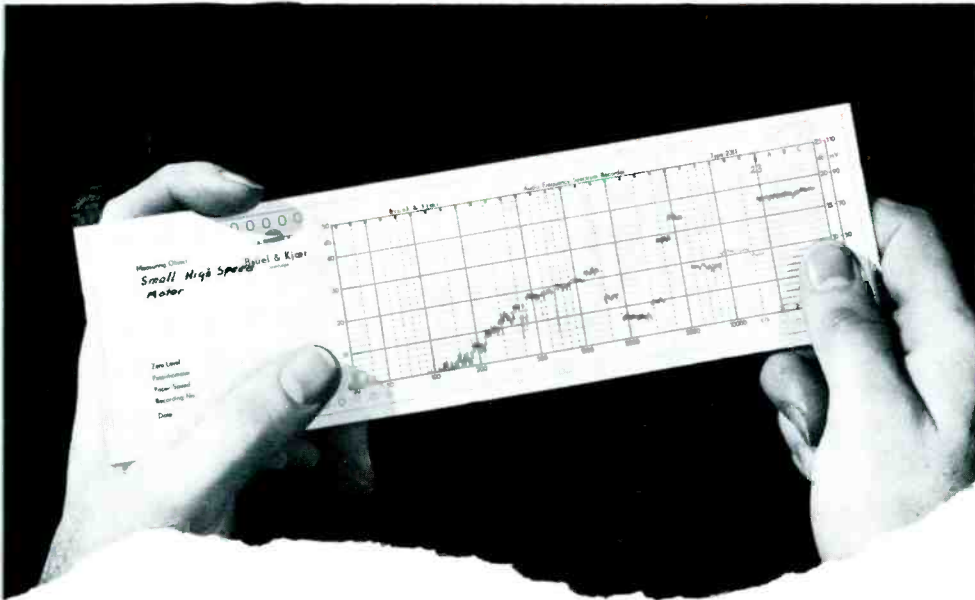

BRUSH INSTRUMENTS RECORD FREQUENCY-AMPLITUDE DATA; SIMPLIFY SOUND ANALYSIS

This chart record was produced by the Brush Third-Octave Spectrum Recorder. It presents a complete frequency and noise level analysis for an electric motor, showing noise levels in each one-third octave band from 35 cycles to 18,000 cycles per second. This chart is typical of the graphic presentation of either complete frequency analysis or frequency response measurement data. The Third-Octave Spectrum Recorder can operate unattended for 24 hours or more, to record all sounds in noise control programs.

Brush offers a completely integrated line of precision equipment, developed by Bruel & Kjaer, for analysis of sound, noise, vibration. These versatile instruments can also be used in data reduction, or recording of electrical quantities. Send coupon for complete information.

BRUSH ELECTRONICS COMPANY, Dept. 666
3405 Perkins Avenue, Cleveland 14, Ohio

- Send booklet on new single and dual-channel oscillographs.
- Send booklet on "Sound Measurements".
- Have representative call.

Name _____
 Title _____
 Company _____
 Address _____
 City _____ State _____

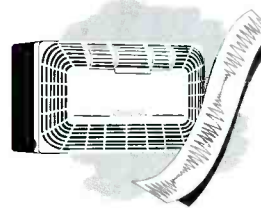

CARRIER CORPORATION . . . uses Spectrum Recorder for production quality control checks of noise levels of room air conditioning units. In 30 seconds, the instrument automatically checks the cooler throughout the eight octaves of audible sound.

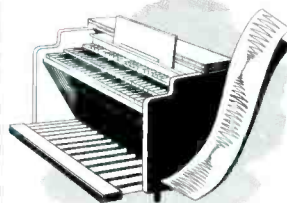

HAMMOND ORGAN . . . uses Frequency Response Recorder to test ringing time of tone generating circuits. This instrument combines a test signal source and a graphic recorder for automatically plotting frequency response curves.



BELTONE . . . uses Frequency Response Recorder to perform entire frequency and sensitivity measurements on high-quality hearing aids.

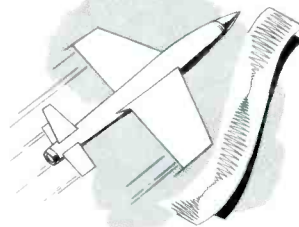

LOCKHEED . . . uses Spectrum Analyzer in a non-audio application — for data reduction of telemetered information. Instrument records data after magnetic tape playback, with band pass filters isolating each frequency band.

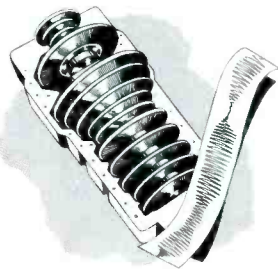

GENERAL ELECTRIC . . . uses Frequency Response Recorder to check mechanical resonance points of turbine blades for both steam and jet turbines. Instrument plots frequency against amplitude when blades are magnetically vibrated.

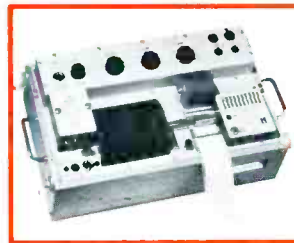

High Speed Level Recorder is the basic instrument in the Bruel & Kjaer line. Used in conjunction with other equipment for recording acoustic or electro-acoustic measurements.

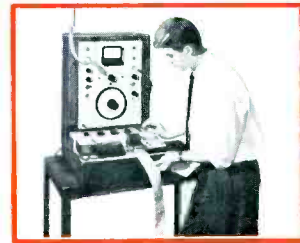

One-Third Octave Spectrum Recorder consists of Spectrum Analyzer and Level Recorder. Self-contained system for noise analysis and recording.

BRUSH ELECTRONICS COMPANY

INDUSTRIAL AND RESEARCH INSTRUMENTS
 PIEZOELECTRIC MATERIALS • ACOUSTIC DEVICES
 MAGNETIC RECORDING EQUIPMENT AND COMPONENTS



Division of
 Clevite Corporation

NO INTERACTION

*Identical Amplifiers
20 mV/cm at 4 Mc/s*

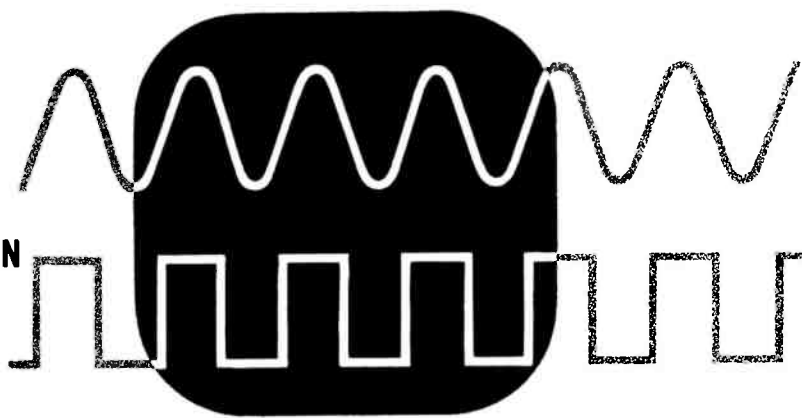

dual-trace oscilloscope

**BY MULLARD
OF
ENGLAND**



INTERNATIONAL ELECTRONICS proudly offer the new L.101 oscilloscope—a well-engineered and reliable instrument with dual trace facilities, and accurate time and voltage calibration.

Two separate amplifiers and a high speed electronic switch operating during the fly-back cycle are used to display two input signals on a conventional cathode ray tube. This arrangement provides a complete uninterrupted sweep on each channel alternately, and ensures freedom from interaction between the two amplifier channels.

The two amplifiers are identical and have a constant bandwidth of 4 Mc/s irrespective of sensitivity. They are aligned for good transient response and have a rise time of 0.1 μ sec. Each amplifier has a maximum sensitivity of 20 mV peak-to-peak/centimetre.

A Miller time base is employed, which may be free-running, synchronised or triggered. Its velocity is continuously variable between 0.1 μ sec/cm and 10msec/cm. Both time and voltage may be measured by the nul method and the well-regulated power supply preserves calibration accuracy.

Further information on the operation and performance of this new oscilloscope and other Mullard instruments is readily obtainable from the address below.

International Electronics Corp.,
81 SPRING STREET • NEW YORK 12, N. Y.

BAKELITE

BRAND

A major advance in fluorocarbons that benefits electrical industries

6 WAYS...

Manufacturers of electrical and electronics equipment are discovering many benefits among the exceptional service properties of BAKELITE Brand Fluorothene. This rigid thermoplastic polymer

offers such a combination of good dielectric properties, corrosion resistance, and physical toughness over a wide temperature range that it can function successfully where most other materials fail.

- 1 BAKELITE Fluorothene's electrical properties** include outstanding volume resistivity that remains over 10^{14} ohm-cm. even at 390 deg. F. The material also has a low dielectric constant and high dielectric strength.
- 2 BAKELITE Fluorothene shows no measurable moisture absorption** after long periods of submersion. This factor is instrumental in maintaining its high electrical values, even under extremely humid conditions.
- 3 BAKELITE Fluorothene's working temperature range** extends over 710 deg. F.—from -320 to +390 degrees.
- 4 BAKELITE Fluorothene has high compressive strength**, making it excellent for strong, tough parts. Hammer blows on a solid piece seldom scar the surface.
- 5 BAKELITE Fluorothene has outstanding chemical resistance**, enabling it to function in extremely corrosive atmospheres. Furthermore, fuming nitric acid can be piped through fluorothene tubing.
- 6 BAKELITE Fluorothene will not support combustion.**

BAKELITE Fluorothene can be fabricated by compression or injection molding or by extrusion, with conventional plastics forming equipment. Typical products include tubing and rod stock, seals, gaskets, and insulation for printed circuits. Film

and sheeting produced from BAKELITE Fluorothene is strong and tough and possesses excellent clarity. For information on the forms, properties, and applications of BAKELITE Fluorothene, write Dept. HC-50.

FLUOROTHENE

(GENERIC TERM FOR POLYMERS OF MONOCHLOROTRIFLUOROETHYLENE)

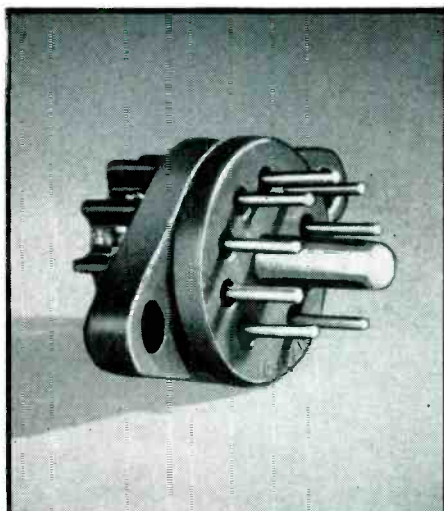

Intricately shaped electronic parts are readily molded from BAKELITE Fluorothene. They have excellent dielectric properties, zero moisture absorption, and high resistance to chemical attack. This male connector used in aviation electronic equipment has pins and center post molded in place.

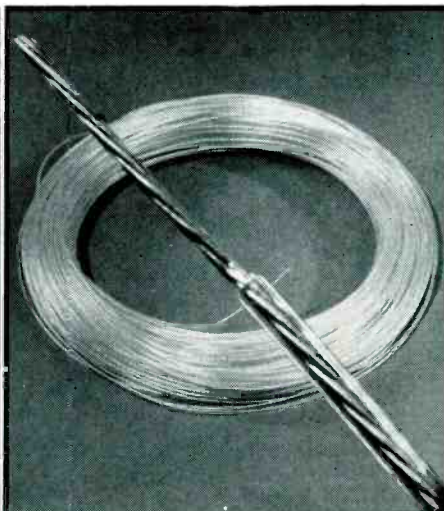

Extruded wire covering of BAKELITE Fluorothene protects against corrosion, fungus, weathering, and impact, in addition to providing good dielectric properties over a broad temperature range. It is excellent for instrumentation control in chemical plants or wherever corrosive atmospheres are encountered.

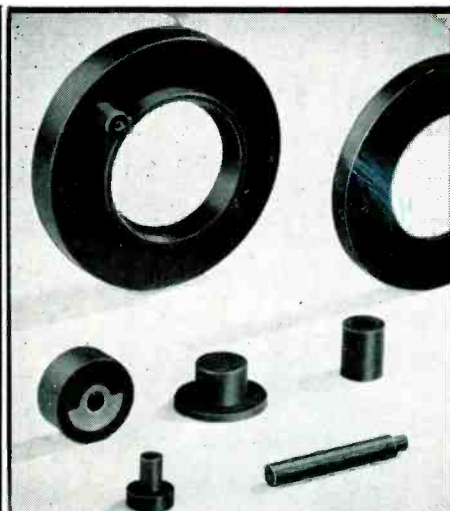

Superior dielectric properties of BAKELITE Fluorothene at elevated temperatures make it an ideal material for these insulators and other parts used in high-frequency radio circuits. Excellent molding properties make it possible to produce these variously shaped parts to close tolerances.

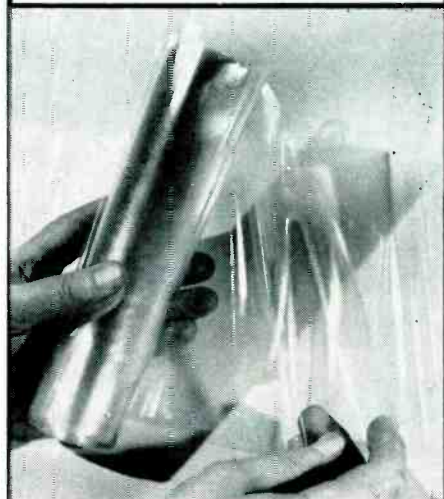

Film made from BAKELITE Fluorothene, used as a wrapping for wire and electrical parts, provides excellent dielectric properties in combination with toughness and chemical resistance over a broad temperature range. It is also resistant to weather and corrosive atmospheres and will not absorb moisture.



BAKELITE COMPANY, A Division of Union Carbide and Carbon Corporation  30 East 42nd Street, New York 17, N. Y.
 In Canada: Bakelite Company, Division of Union Carbide Canada Limited, Belleville, Ontario
 The term BAKELITE and the Trefoil Symbol are registered trade-marks of UCC

A tough job for any plastic but



PLASKON® Alkyd

The magneto coil case in the rugged, one-man McCulloch power saw is made of PLASKON Alkyd Molding Compound 422. After investigating a number of possible materials, McCulloch found that only PLASKON Alkyd was able to meet their rigid requirements . . . for critical dimensional stability, arc resistance, good strength over a wide range of temperatures, and maximum electrical insulation performance.

PLASKON Alkyd is a high-quality molding compound designed specifically for electrical and electronic applications. If you require greater insulation values in the products that you manufacture, you will do well to contact your nearest PLASKON Man. He will give you complete data on all of our alkyds and assist you in applying the right one to your products.



For further information on PLASKON Plastics and Resins, address
BARRETT DIVISION, Allied Chemical & Dye Corporation,
40 Rector St., New York 6, N. Y., HANover 2-7300 



This is the magneto coil case used in the McCulloch power saw.



PLASKON ALKYD may be able to help you reduce production costs. It can be used in a one-piece molding in place of other materials that must be assembled.



ALKYD BASES, sockets and casings have found wide acceptance in electronic and electrical applications in fields as diversified as television, (tube sockets) and aviation, (controls, magneto housings, etc.). Molders appreciate PLASKON Alkyd's rapid cure-rate, general moldability and handling characteristics.

ALLEN-BRADLEY QUALITY COMPONENTS for PRINTED CIRCUITS

FIXED MOLDED RESISTORS

Stable characteristics, uniform size, accurate lead wire dimensions, special uniform solder coating of leads, and mechanical strength are essential requirements for components used for printed circuit applications. It is on these features that the Quality reputation of Allen-Bradley molded resistors was established. Made in 1/10, 1/2, 1, and 2 watt sizes, meeting all applicable RETMA and MIL-R-11A specifications, and rated at 70C ambient temperature, these resistors do not require the derating usually necessary on plastic board assemblies.

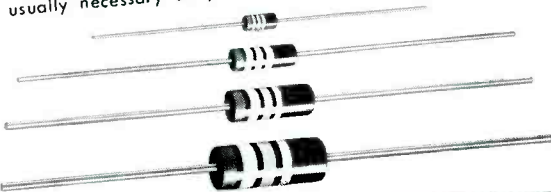

SMALL POTENTIOMETERS

Allen-Bradley Type GP and Type T adjustable molded resistors are designed for printed circuits where quality—not price—is the important requirement.

They are available in resistance values from 100 ohms to 5 meg-ohms in standard tapers.

Both are rated at 1/2 watt.

The Type GP potentiometer is 1/2 inch in diameter and is supplied with gold-plated lugs.

The Type T potentiometer is 1 inch in diameter and has round, solder-coated leads.



Type GP



Type T

CERAMIC CAPACITORS

Type CE and Type DS ceramic capacitors are available for printed circuit assemblies in all commercial characteristics. These units were developed for operation at above normal ambient and are impervious to moisture.

Type DS resin-enclosed capacitors have a new lug adapted for insertion in a round hole. The lug is so designed as to properly space the capacitor above the printed board.



Type DS



Type CE

OTHER MINIATURE COMPONENTS

Type FT feed-thru and Type SO stand-off discoidal capacitors incorporate the maximum performance characteristics together with extreme ruggedness and small size. They are available in standard nominal values from 5 to 1,000 mmf.

Allen-Bradley Type FC Ferri-Cap feed-thru filter is a new, unique device consisting of a discoidal feed-thru capacitor combined with ferrite material to provide internal impedances in series with both ends of the feed-thru electrode.

Investigate these truly superior miniature components.



Type FT



Type FC



Type SO

COMPONENT PACKAGING

To keep step with the automatic trends of industry, small components, such as the molded fixed resistors and the ceramic capacitors, are now offered by Allen-Bradley in reel packages wherein the components are attached to a pressure-sensitive tape, ideally adapted for automatic assembly or preassembly operations.



Carton packaging
(Standard)

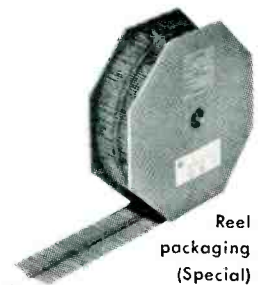

Reel packaging
(Special)

Allen-Bradley Co.
110 W. Greenfield Ave.
Milwaukee 4, Wis.

In Canada
Allen-Bradley Canada, Ltd.
Galt, Ont.



Hughes Diodes

FIRST OF ALL FOR

STABILITY

You can depend on Hughes Diodes to stay within their published rating and specifications. In the field, they have long maintained an extraordinary record of failure-free service under varied and severe operating conditions. Such reliability is possible because

ALL DIODES MADE BY HUGHES ARE:

THOROUGHLY TESTED—Diodes are tested 100% for electrical and mechanical characteristics. They retain stability, operate faithfully over wide ambient temperature ranges.

MOISTURE-PROOF—Fusion-sealed in the famous one-piece glass envelope developed at Hughes. This construction eliminates one major cause of diode failure.

RUGGED—Internal elements are completely isolated from damage or contamination, are undisturbed by physical shock and vibration.

SUBMINIATURE—You can achieve phenomenal component density with Hughes Diodes, even in miniaturized circuitry.

HUGHES SILICON
JUNCTION
DIODE
Maximum dimensions,
standard diode glass
envelope: 0.265 inch long
by 0.105 inch diameter.

The Hughes line of semiconductor devices is being steadily expanded. It now comprises a wide selection of Germanium Point-Contact and Silicon Junction Diodes, and Photocells.

When you need diodes with High Temperature . . . High Forward Conductance . . . High Back Resistance . . . Computer Type . . . JAN-Approved . . . General Purpose, or other special characteristics, be sure to investigate Hughes Diodes. They are first of all—for STABILITY.

Hughes

SEMICONDUCTOR SALES DEPARTMENT

Aircraft Company, Culver City, California



New York Chicago
Los Angeles



DESIGNER'S

New G-E drawn-rectangular capacitors with seamless cases have standard dimensions to fit existing circuit designs

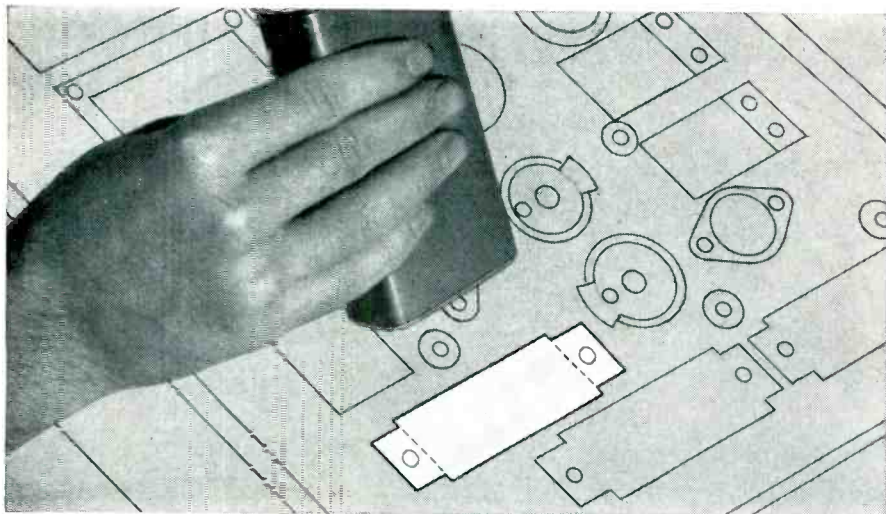

First on the market, G-E drawn-rectangular capacitors can now save you up to 20% in costs, yet are the same size and have the same mounting dimensions as fabricated units. These fixed paper-dielectric capacitors come in seamless,

solderless cases, and in all standard dimensions.

Drawn construction offers three big features: (1) a big saving in production cost is passed on to you, (2) the seamless case is leakproof, and (3) a double rolled

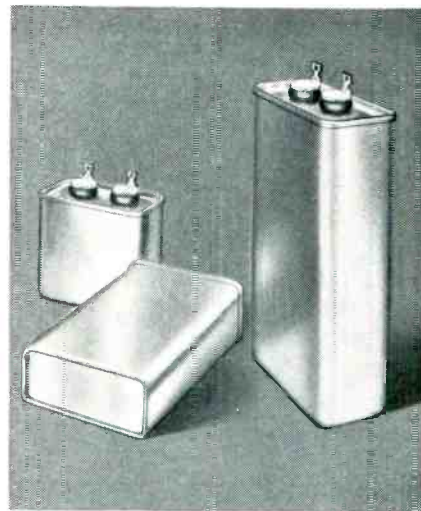

seam between case and cover makes a true hermetic seal.

In addition, suitable bushings for a wide range of design applications are available. For superior performance at lower cost, get the details. Send for Bulletin GEC-809A.

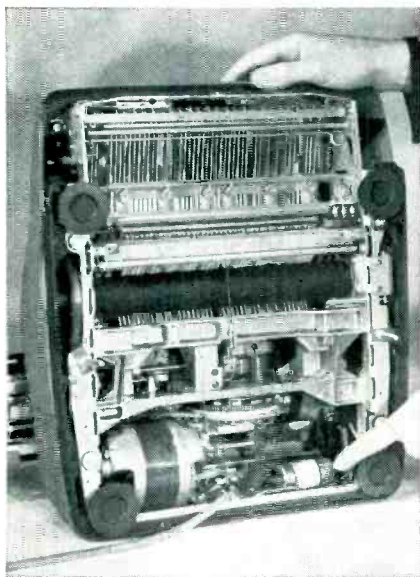

Save space and weight with G-E drawn-oval capacitors

Besides offering cost reductions up to 20%, G-E drawn-oval capacitors can save as much as 20% of precious space and weight. Their drawn construction offers seamless, leakproof cases, and the covers are hermetically sealed with tough, double rolled seams. All add up to top quality performance in minimum space.

The hot solder-dipped terminals are easy to solder and are welded to the stud for permanent attachment. Both fork-type and quick-connect terminals are available. Silicone bushings maintain effective sealing and high insulation resistance through long operation and temperature variation.

Each drawn-oval capacitor is automatically tested before it leaves the factory for further assurance of maxi-

mum reliability.

Photo at left shows G-E drawn-oval capacitor tucked in minimum space of electric typewriter. For complete list of ratings and data, see Bulletin GEA-5777B.



— GENERAL ELECTRIC —

DIGEST

TIMELY HIGHLIGHTS ON G-E COMPONENTS

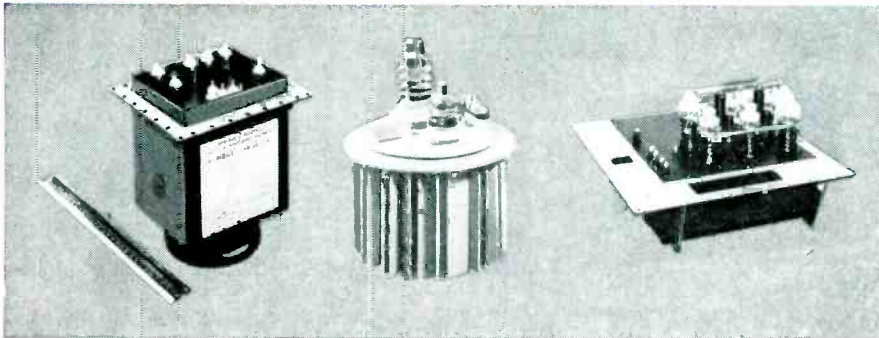

G-E oil-filled radar components save space, weight

Extremely versatile, G-E high-voltage radar components offer to designers characteristics and features to meet a wide range of requirements. All units are designed to conform to MIL-T-27 specifications. A few examples of the large G-E oil-filled line are shown above.

The "packaged" unit at left combines a rectifier and filament trans-

former, a filter inductor and a resonant charging inductor in the same tank. This unit measures 6 x 6 x 7 inches and weighs only 8 pounds. Any combination of components can be packaged corona-free in one tank; the number of components is restricted only by your installation limitations. This method of

packaging units often reduces installation expenses.

Pulse transformers such as the one shown at the center are manufactured in ratings from 5 to 300 kilovolts or more, up to 40 megawatts peak power. These units are designed for either magnetron or klystron oscillators and their pulse lengths range from 0.1 to 50 microseconds or longer, with repetition rates up to 10,000 pulses per second.

Complete d-c power supplies like the one shown at right are manufactured in ratings from 5 to 25 kilovolts, with current ratings up to 4 amperes. This unit contains a rectifier transformer, filament transformers and a filter inductor making a complete power supply packaged in one oil-filled tank. The sturdy tank is designed with extra bracing to more than withstand shock and vibration tests called for in MIL-T-27 specifications. Your G-E Apparatus Sales office has details.



Speed soldering of tiny joints with pencil-weight G-E midget iron

As electronics designers work with more and more restricted spaces, G-E midget soldering irons help reduce rejects on assembly work. With a pencil-fine tip, the iron solders delicate joints with little danger of damage to adjacent parts. A G-E Calrod* heater located in the tip provides fast heat transfer. The copper tip is iron-clad to eliminate need for filing, and to reduce maintenance costs. Weighing only 1 3/4 ounces, the iron has a heat efficiency of 90 per cent. Bulletins GED-2263, GEC-1318.

*Registered trade-mark of General Electric Co.

G-E enameled resistors adapt easily in countless designs

Extremely simple control is possible in electronics design with General Electric resistors. These "Blue Sticks," so-called because of their blue vitreous coating, can be ordered unmounted, mounted on a base with a perforated cover, or in perforated, cage-type enclosures. Moisture-resistant enamel forms an airtight case and aids in heat dissipation. Silicate-compound body withstands sudden and extreme temperature changes. Standard $\pm 5\%$ resistance tolerance makes them adaptable, and nickel alloy wire wound around the ceramic cylinder maintains its consistent resistance characteristic. For the complete story, see Bulletin GEC-817.

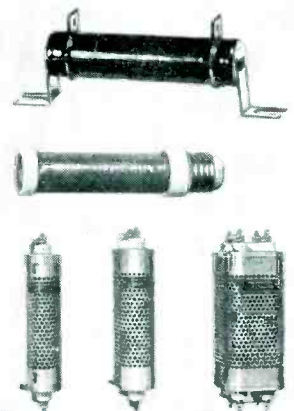

General Electric Company, Apparatus Sales Division,
Section A667-31, Schenectady 5, New York

Please send me the following bulletins:

- GEC-809A Drawn-Rectangular Capacitors GEA-5777B Drawn-Oval Capacitors
 GEC--1318 Industrial Soldering Irons GED-2263 Midget Soldering Iron
 GEC-817 Enameled Resistors

NAME _____
 COMPANY _____
 CITY _____ STATE _____

TURN PAGE FOR MORE G-E COMPONENT HIGHLIGHTS

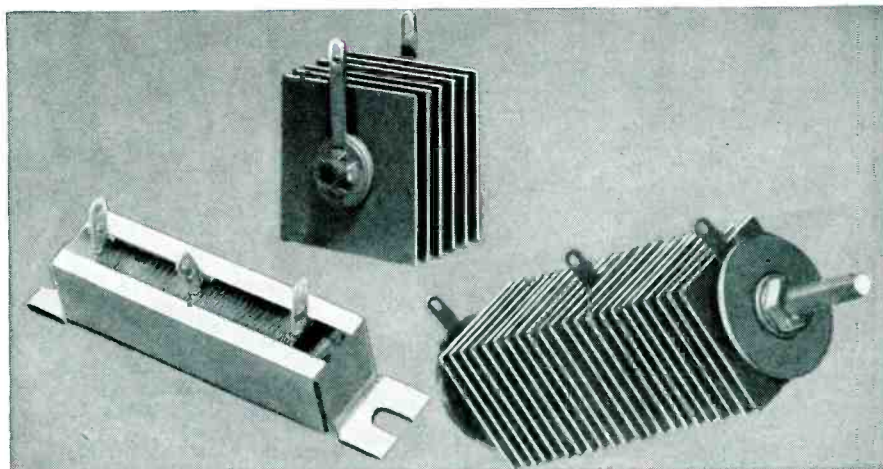

New *Vac-U-Sel** component rectifiers with 3 exceptional performance features

The new Vac-U-Sel trade-mark stands for General Electric's new line of component rectifiers which permit matching performance requirements for life expectancy, ambient temperature, and atmospheric protection, as well as electrical characteristics. *First*, 26-v low-temperature cell has 60,000 hour life

expectancy at normal current rating. Use it in ambient temperatures to 55 C. *Second*, 26-v high-temperature cell meets demands up to 130 C at full voltage. *Third*, 45-v high-temperature cell has a 63-volt peak inverse rating, and a 40,000 hour life. It can be used at ambients up to 110 C. Bulletin GEA-6273.

*Reg. Trade-mark of General Electric Co.

New 400-cycle servo motor weighs only 1.2 ounces, develops 21,000 rpm

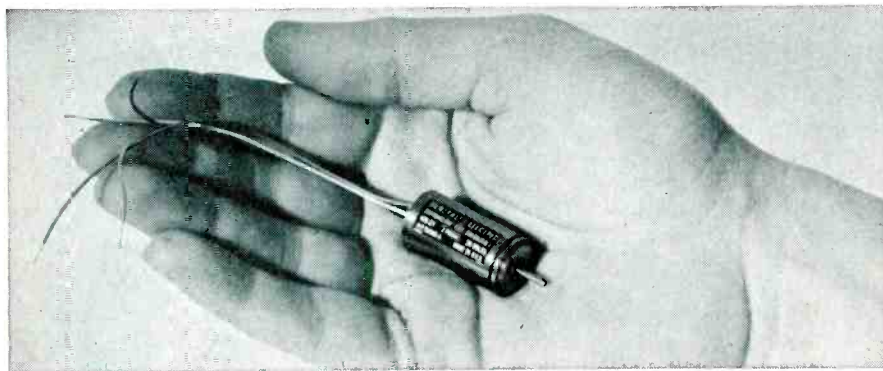

This tiny General Electric induction motor for aircraft applications operates in ambients from -55 C to 90 C, and in altitudes up to 60,000 feet. Two-pole-wound, with a standard squirrel-cage rotor and precision ball bearings, it features high acceleration, stall torque, and operating efficiency. Some uses: null-method measurements, control power, power failure indication, power-operated brakes. The 1.2-ounce motor has a stainless steel housing 1.2 inches long. For more data contact your nearest G-E Apparatus Sales office.

Apply G-E specialty heaters when electronic equipment needs thermal conditioning

General Electric engineers have designed and developed a wide variety of specialty heating devices to assure that electronic equipment will operate correctly at low temperatures, and to quickly raise the temperature of equipment to operating levels. These heaters are made in many sizes, shapes and forms. In operation, they are wrapped around electronic equipment, connected to power source. Generally, these de-

vices operate from standard 110-v or 24-v, ac or dc, and can produce thermal conditioning from a watt or two up to 20 watts per square inch. They weigh as little as 4 ounces per square foot, seldom exceed $\frac{3}{8}$ inch in thickness. They are custom made for servos, gyros, accelerometers, batteries and measuring instruments. Bulletin GEA-6285 gives complete information.

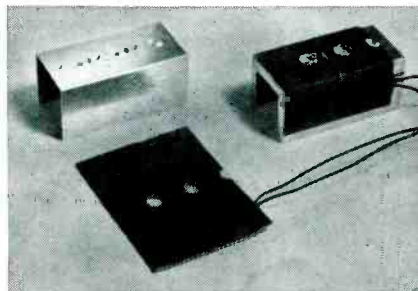

GENERAL ELECTRIC

New high-temp. micro-miniature aircraft relay

Two models of General Electric's new micro-miniature aircraft relay are available, standard and current-sensitive. The standard model weighs a third of an ounce, measures .34 x .781 x .81 in. The new relay meets the demand for small size and greater reliability. Materials used assure that no significant amount of gassing occurs inside the enclosure.

The standard model will operate at only 250 milliwatts and the current-sensitive model at only 100 milliwatts. Operation is quick: approximately 1.5 milliseconds with rated voltage on coil. Contact rating is high: 2 amperes resistive load at 30 volts direct current or 115 volts alternating current.

Shock and vibration resistance is also high. Both models will take over 50 G's shock, and vibration of 10-500 cps at 20 G's acceleration. This is achieved

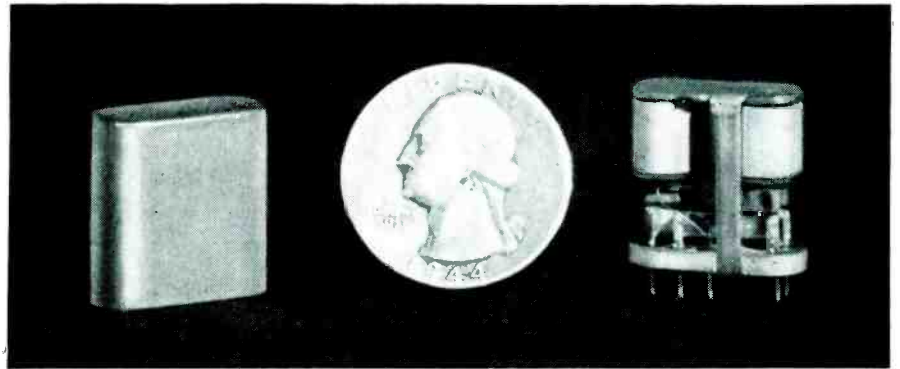

with balanced armature design combined with high tip forces.

The new G-E relays are simply designed, providing easy installation and adjustment for ease of manufacture. This makes it easier to control quality of your product and assures extra reliability. The coil and lead insulation

is Teflon† and the coil spool body is nylon. Contact material is fine silver for low contact resistance and long life. Contact springs are beryllium copper which means they will hold their adjustment indefinitely during temperature cycles or storage. All G-E Apparatus Sales offices have details.

†Reg. Trade-mark of duPont.

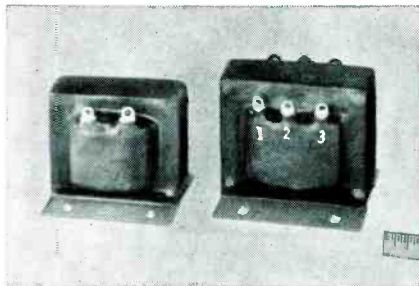

Encapsulated control transformer resists solvents, shock, humidity

These General Electric control transformers and reactors are encapsulated to provide reliable, long-life operation in corrosive atmospheres. Small, lightweight, and economical, they can be furnished with an epoxy-polyester resin coating to meet humidity, salt spray, thermal shock, and anti-fungus requirements of many government specifications. Equipment designers will appreciate this resin coating because it is impervious to most solvents, oils, greases, and acids encountered in many commercial applications. Sealed-in solder type terminals give added protection wherever they are used. For data, contact your nearest G-E Apparatus Sales office.

New standard G-E voltage stabilizers save weight and space

Now equipment designers can choose from a complete new line of *standard* G-E automatic voltage stabilizers, rated from 15 va through 10 kva. Because, in many cases, equipments have been installed *before* it was found that stable or "constant" voltage was needed for them, designers are now building automatic voltage correction into voltage sensitive devices *at the design stage*. You, too, will find that usually, a standard, G-E voltage stabilizer, available immediately, will solve your voltage problems. However, special units up to 50 kva can also be designed to your specifications. Your nearest G-E Apparatus Sales Office has details.



General Electric Company, Apparatus Sales Division
Section A667-31, Schenectady 5, New York

Please send me the following bulletin:

✓ for reference only X for planning an immediate project

GEA-6273 Vac-U-Sel Rectifiers

GEA-6285 Specialty Heating Equipment

For information on other products contact your nearest General Electric Apparatus Sales office.

NAME _____

COMPANY _____

CITY _____

STATE _____

a family of
door fasteners
with

BIG ADVANTAGES

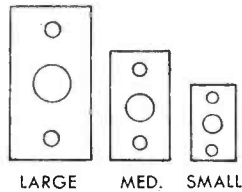
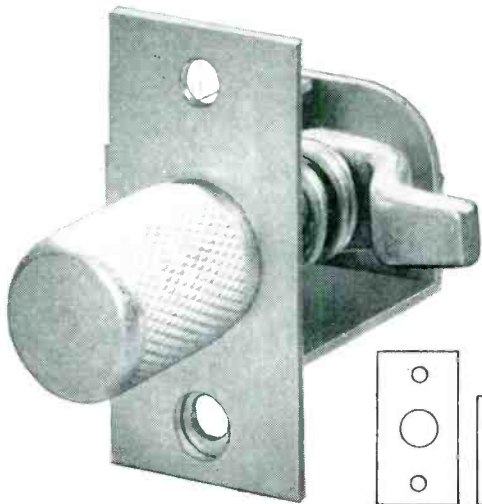

Get the complete story of Southco Pawl Fastener advantages. Write today for your copy of the Southco Fastener Handbook. Southco Division, South Chester Corporation, 233 Industrial Highway, Lester, Pa.

© 1954

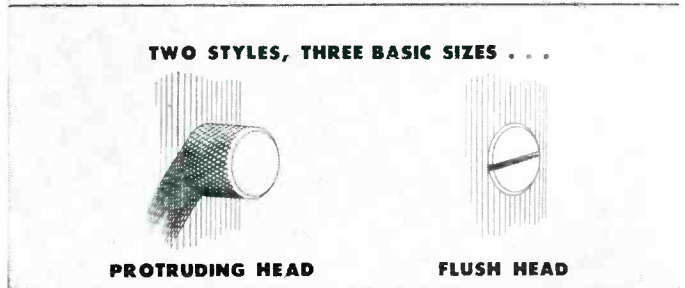
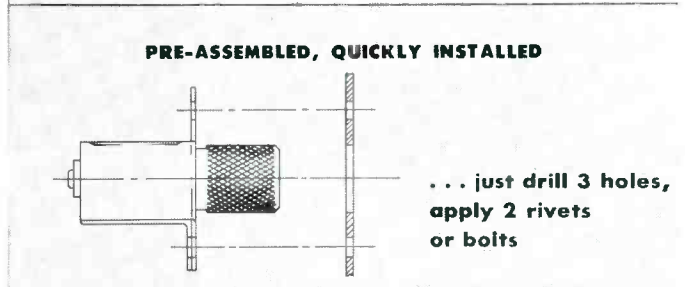
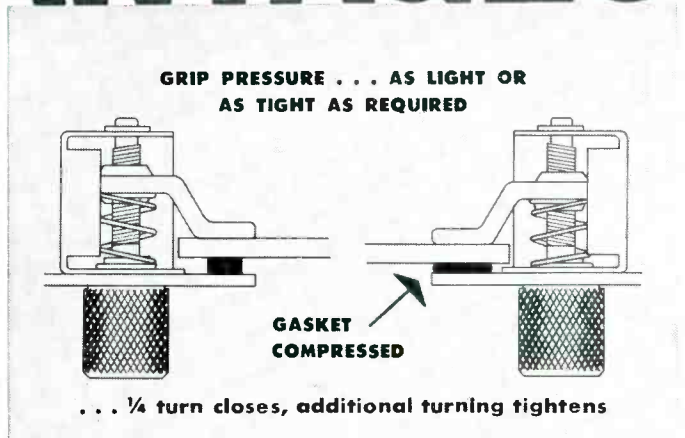
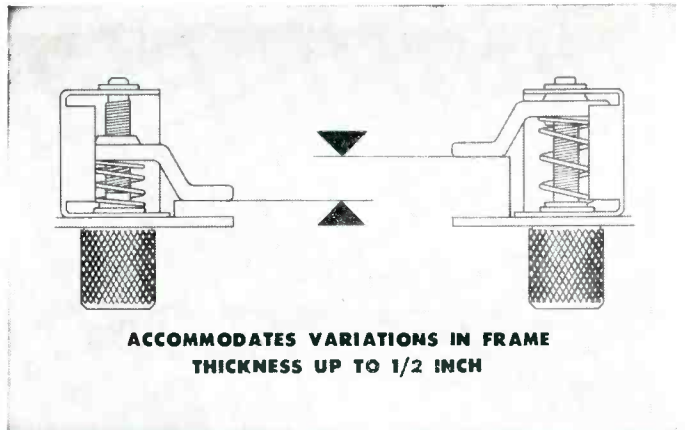

**PAWL • SCREW AND SPRING •
DRIVE RIVETS • ANCHOR NUTS •
ENGINEERED SPECIALTIES**

O F F I C E S I N P R I N C I P A L C I T I E S

WHEREVER TWO OR MORE PARTS ARE FASTENED TOGETHER; STANDARD AND SPECIAL DESIGNS FOR IMPROVED PERFORMANCE AND LOWER PRODUCTION COSTS

VISION... BEYOND THE RANGE OF SIGHT

Farnsworth 

Since the beginning of time man has sought to escape the limitations of the known. Though his feet are planted on the ground, his vision goes beyond the range of sight to limitless space . . . dwelling place for a hundred million universes.

Exploring these realms of the unknown . . . wresting the electron's secrets from Nature has been Farnsworth's sole function for over a quarter of a century . . . the last ten years continuously participating in the design, development and production of guided missile systems such as Talos, Terrier, Sparrow and others.

We hope our contributions to this country's defenses act as deterrents to aggression and help influence the peaceful settlement of differences between nations.

The next decade, added to this vast storehouse of electronic knowledge, will bring man's age-old vision of reaching the stars into closer focus.

Farnsworth Products and Activities include:

Research—Applied Physics, Circuit Research, Solid State Physics, Low Temperature Physics.

Radar—Transmitters and Receivers, Computers, Microwave Components, Pulse-Coding and Circuitry.

Electron Tubes—Photomultipliers, Storage Tubes, Image Tubes, Infrared Tubes.

Missile—Guidance and Control Systems, Test Equipment.



**ELECTRONICS . . .
THE KEY
TO AMAZING TOMORROWS**

FARNSWORTH ELECTRONICS COMPANY ★ FORT WAYNE, INDIANA
a division of International Telephone and Telegraph Corporation

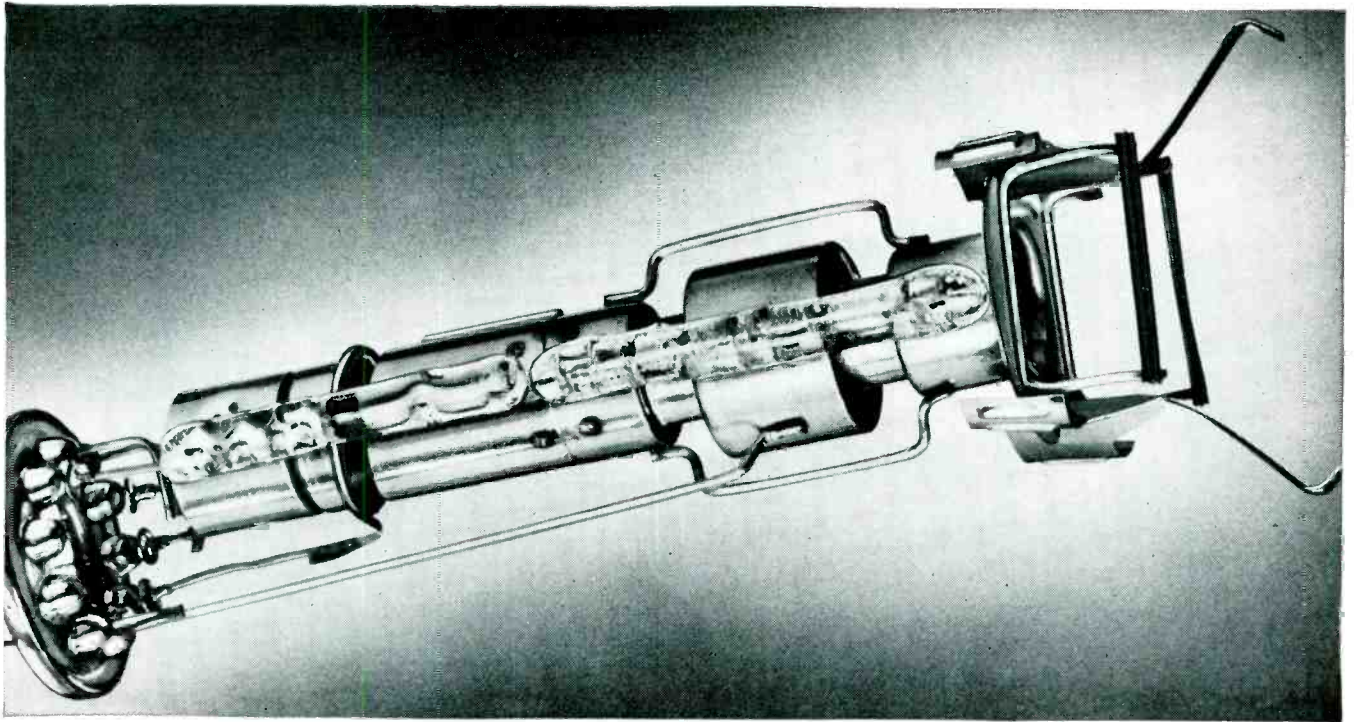

The new Westinghouse electrostatic gun improves picture tube focus, extends tube life, eliminates arcing at high voltages. That's why you can . . .

Now...Get Safe, Reliable 20 KV Picture Tube Operation

With the new Westinghouse electrostatic gun, *reliable* high voltage operation is now a reality. Westinghouse design engineers have successfully developed a new electrostatic gun capable of withstanding extreme voltages, without arcing. For *your* equipment this means improved picture tube performance, extended picture tube life, better focus.

Check These Advantages:

YOU GET . . .

- Arc-free high voltage operation
- Better focus over a wider range of anode voltages.
- More uniform spot shape
- Extended life
- Possible Leakage Paths reduced by 50%

FROM . . .

- Increased focus electrode to anode spacing
- (see graph)
- Use of split ring positioning between gun parts
- Use of new cathode base metal and broadening of active getter area
- Elimination of 2 Glass Beaded side arms

This new Westinghouse electrostatic gun is presently available in Westinghouse equipment picture tubes. Be sure your sets give *top picture tube performance*. See your Westinghouse representative or write to the address below — today.

Focus Voltage vs. Anode Voltage

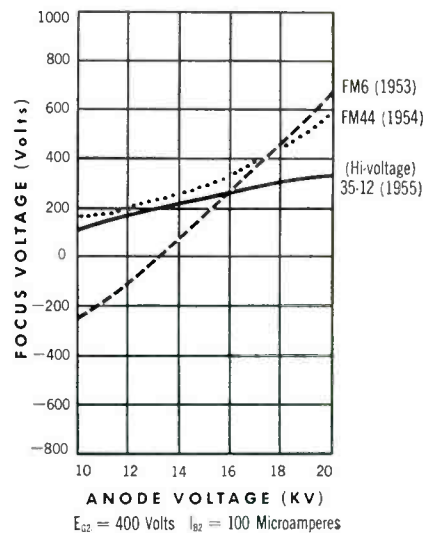

YOU CAN BE SURE...IF IT'S
Westinghouse

RELIATRON® TUBES

WESTINGHOUSE ELECTRIC CORPORATION, ELECTRONIC TUBE DIVISION, ELMIRA, N. Y.

ET-95071

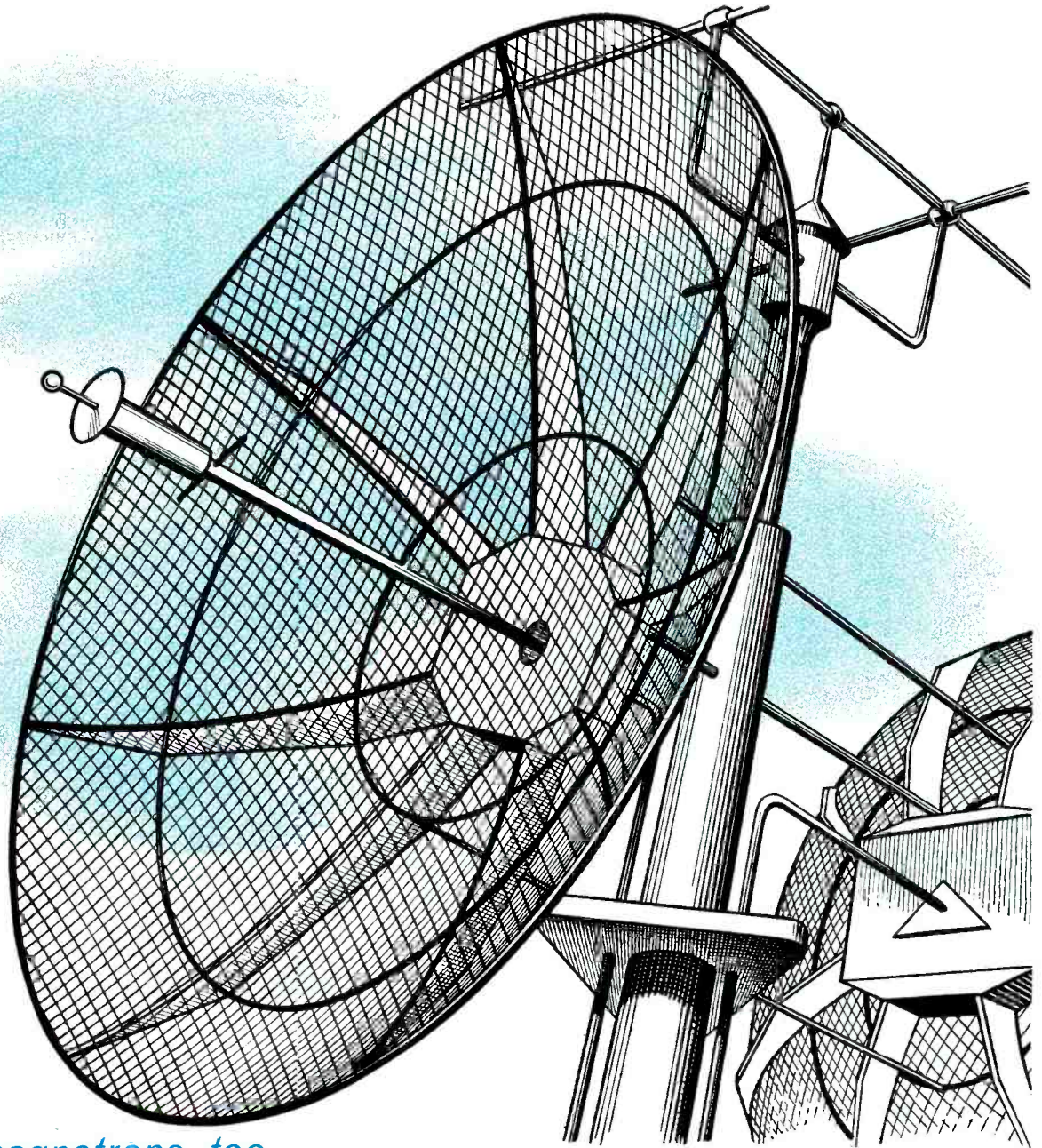

In magnetrons, too

CRUCIBLE PERMANENT MAGNETS *provide maximum energy... minimum size*

In designing magnetrons for radar systems — or any very high-frequency oscillator application — you can be sure of a *consistently higher* energy product with Crucible alnico magnets. *This means more power from a minimum size magnet!*

Crucible alnico permanent magnets are made to meet practically any size requirement from a fraction of an ounce to several hundred pounds. And they're sand cast, shell molded

or investment cast to the exact size, shape, tolerance and finish you need.

Crucible has been one of the largest producers of permanent magnets since the development of alnico alloys. Its unsurpassed magnet experience is backed by over 50 years of fine steelmaking. That's why the best solution to magnet problems starts with a call to Crucible. *Crucible Steel Company of America, Henry W. Oliver Building, Pittsburgh 22, Pa.*

CRUCIBLE

first name in special purpose steels

Crucible Steel Company of America

E-I*presents*

LINE OF HERMETICALLY SEALED

NEW EXPANDED

*PATENTS
PENDING—
ALL RIGHTS
RESERVED**COMPRESSION
TYPE
END SEALS****FOR HERMETICALLY SEALING
CONDENSERS, RESISTORS AND
OTHER TUBULAR COMPONENTS**

E-1 standardization now makes it possible to offer designers and engineers the economy of standard components in a wide selection of types and sizes. These rugged compression type end seals are available in a broad range of dimensions, in either flared tube or pierced terminals, with single or multiple lead terminations. Inquiries invited.

-here's how

**COMPRESSION
CONSTRUCTION
PROVIDES THE
TIME-PROVEN
LASTING SEALS**

In this exclusive E-1 compression construction, the glass remains under constant compression and is therefore extremely strong. These seals possess extraordinary immunity to shock, vibration and pressure changes. For all practical purposes E-1 Compression Seals are indestructible. No special skill is required to apply and assembly is rapid as all metal parts are tin dipped for easy soldering.

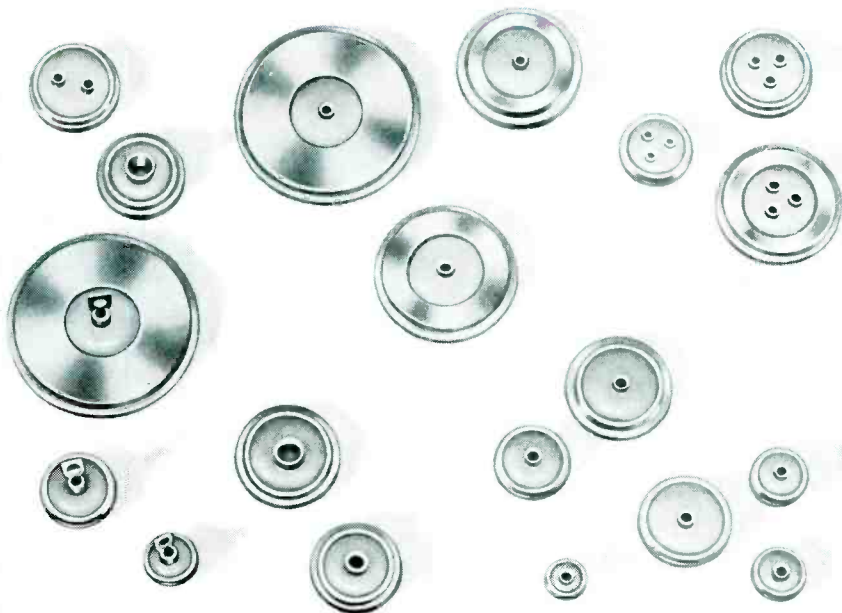

E-1 Leadership — in the field of hermetic sealing assures dependability, economy and fast delivery . . . specify E-1 for multiple headers, octal plug-ins, transistor bases and closures, sealed terminals, end seals and color coded terminals.

**ELECTRICAL INDUSTRIES**

Division of Amperex Electronics Corporation • 44 SUMMER AVENUE, NEWARK 4, NEW JERSEY

NEW

CHARACTERISTIC-CURVE TRACER.. Type 570



Pictures Dynamic

Vacuum-Tube Characteristics

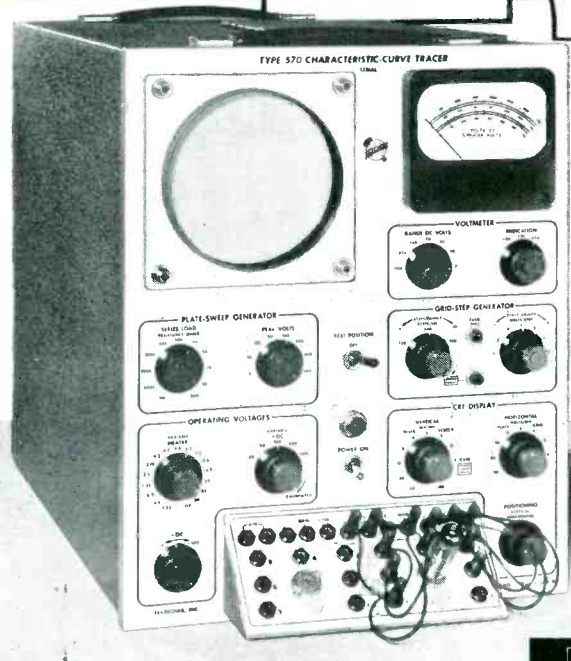

The Tektronix Type 570 Characteristic-Curve Tracer presents an accurate graphic analysis of vacuum-tube characteristics under almost any conceivable operating conditions. Circuit design can now be tailored to more closely fit the operating characteristics of available tubes. Tubes can be selected faster and more accurately for circuits requiring other than average vacuum-tube operating characteristics. Two-socket arrangement with front-panel switching permits rapid comparisons between any two tubes, or two sections of the same tube. You can also make rapid comparisons with preselected curves outlined on a crt mask. Patch-cord connector system with socket-adaptor plates gives you complete control of operating-condition setup. Various socket-adaptor plates furnished and wide range of heater voltages available fit the requirements of practically all receiving-type vacuum tubes.

Displays Families of Curves on CRT Screen

Choice of four to twelve characteristic curves per family—with as many as eight positive-bias curves per family.

Plots All Important Characteristics

- Plate current against plate voltage.
- Plate current against grid voltage.
- Screen current against plate voltage.
- Screen current against grid voltage.
- Grid current against plate voltage.
- Grid current against grid voltage.

Calibrated Controls

Accurate current and voltage readings directly from the crt screen.

Wide Display Range

- 11 current ranges from 0.02 ma/div to 50 ma/div.
- 9 voltage ranges from 0.1 v/div to 50 v/div.
- 11 series-load resistors from 300 ohms to 1 megohm.
- 7 grid-step values from 0.1 v/step to 10 v/step.

Price—\$925

f.o.b. Portland (Beaverton), Oregon

Tektronix, Inc.

P. O. Box 831A, Portland 7, Oregon

CYpress 2-2611

Cable: TEKTRONIX

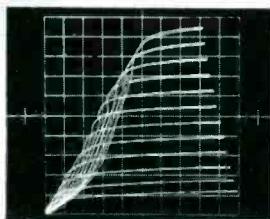

Fig. 1
Plate current—plate voltage

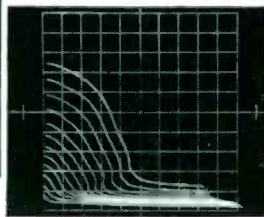

Fig. 2
Screen current—plate voltage

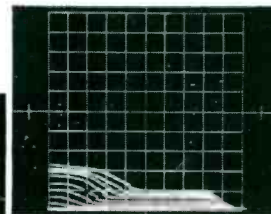

Fig. 3
Grid current—plate voltage

Series of pentode characteristic curves with grid voltage changing 2 volts/step from +16 v to below zero, illustrating Type 570 operation with eight positive-bias curves per family. Vacuum tube is a 6AQ5, under these conditions: Plate load... 300 ohms, peak plate voltage... 100 v, screen-grid voltage... 100 v, vertical scale... 10 ma/division, horizontal scale, fig. 1, 2, and 3... 10 v/division, fig. 4, 5, and 6... 2 v/division.

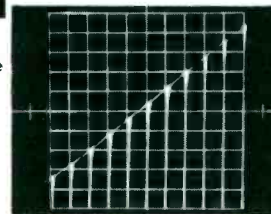

Fig. 4
Plate current—grid voltage

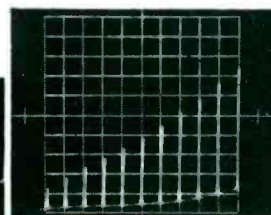

Fig. 5
Screen current—grid voltage

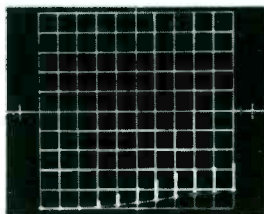
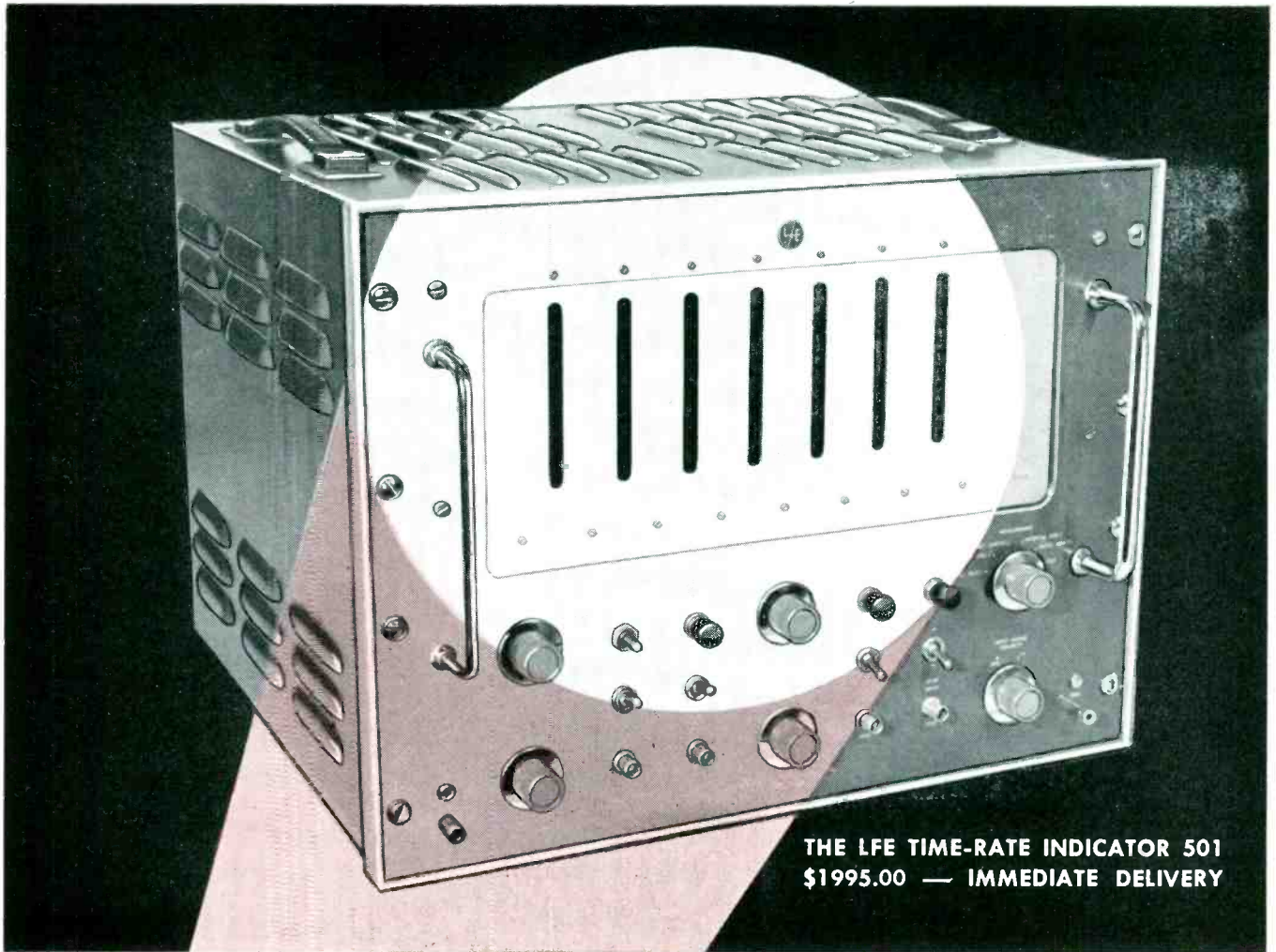

Fig. 6
Grid current—grid voltage

Please call your Tektronix Field Engineer or Representative for complete specifications, or write to:



**THE LFE TIME-RATE INDICATOR 501
\$1995.00 — IMMEDIATE DELIVERY**

Digitized research or control!

LFE's model 501 Time-Rate Indicator brings the advantages of high speed electronic counting to both *instrumentation and automation*. The broad applications of the 501 include research in the fields of frequency measurements, data recording, and process control. This unique counting tool will do more for less money than any similar device on the market.

Write to Laboratory for Electronics for their informative folder "From Instruments to Automation".

Check these features.

Ability to count pulses up to the rate of 10,000,000 per second with a relative accuracy up to ± 1 count.

Ability to measure frequency in megacycles up to 10 mc with accuracy up to 1 part in 10 million with ability to totalize measurement.

Ability to measure periodic functions in decade units from 0.1 μ sec to 100 sec.

Ability to make time interval measurements in the range from 1 μ sec to 0.1 μ sec.

Ability to do frequency ratio measurements between two input frequencies.

Built-in temperature compensated crystal controlled timing pulse generator.

Built-in wide band, high gain amplifier covering a bandwidth of 10 cps to 10 mc and with a sensitivity of 20 mv rms.

Decade Scalers from \$30.00 Plug-in counter units including decade scalars from 20 kc to 10 mc, binary scalars that double the range of any particular unit, or pre-set scalars from 20 to 100 kc.

Creative developments in the field of electronics . . .

LABORATORY FOR ELECTRONICS, INC.

75 Pitts Street

Boston 14, Mass.



the Wescon Show.....

Very Important to You!

NOW important electronic exhibits are bi-coastal. The WESCON Show has assumed tremendous significance, approaching the importance of the IRE show in New York. Nearly 23,000 studied the exhibits of 440 exhibitors last year. The 1955 show will be held in the Civic Auditorium, San Francisco, August 24th, 25th and 26th. There are 550 booths offered and it looks like a sell-out.

Here will be a concentration of the designers and builders of nuclear equipment, guided missiles, aircraft electronic gear and others of the more than 300 West Coast manufacturers of strictly electronic equipment plus representatives, parts jobbers and wholesalers in this vastly growing territory. The rich West Coast has reached an industry billing of more than one billion dollars per year.



CIVIC AUDITORIUM
SAN FRANCISCO

and the August Issue of Electronics

Where Manufacturers Show Their Products in the Electronics "Preview in Print"

Approximately 8,000 of the 40,000 paid-for copies of the August issue of ELECTRONICS will carry your printed selling into the West, Mountain and West South Central states – to every important man who serves this industry in that booming country.

The August issue is a "last chance" before the show for those who plan to exhibit and announce products and *booth numbers* and for those who do not plan to be in the show, to do "an exhibit in print."

There is no more forceful way of telling the Dynamic West about yourselves and what you've got to offer than to use forceful advertising in the August "Wescon, Preview in Print" issue of ELECTRONICS.*

You will be welcome at ELECTRONICS' Booth 1115.

* Closing date for advertising, July 1.



For Current Limiting Applications

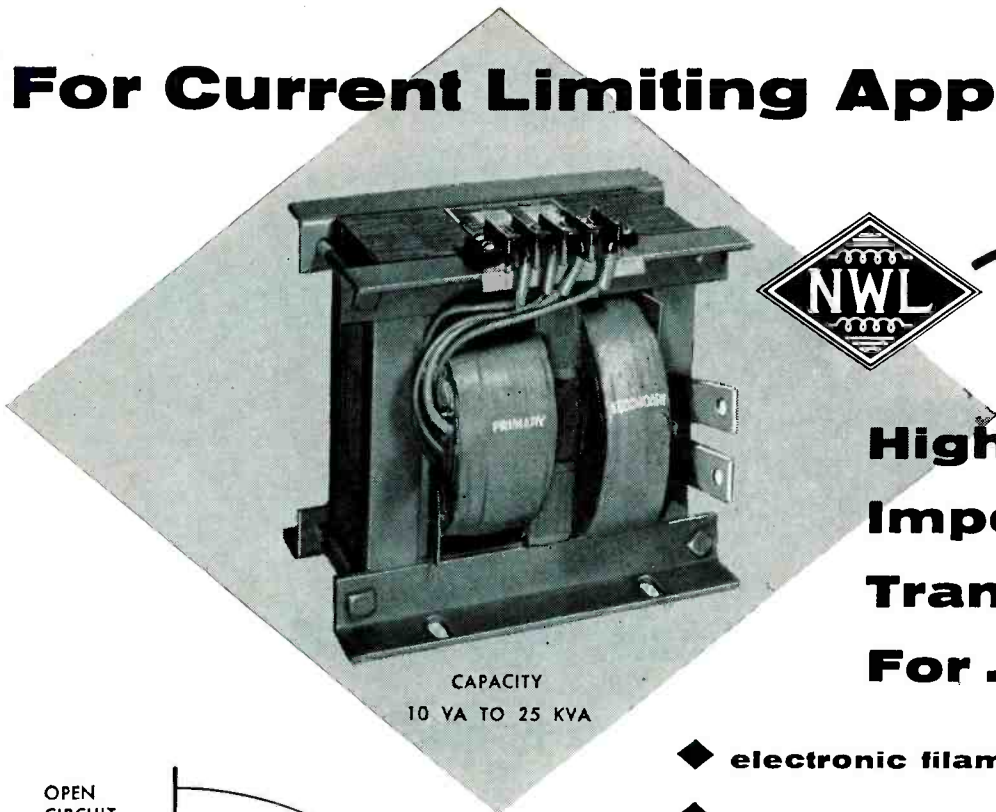

CAPACITY
10 VA TO 25 KVA



Notkefer

High Impedance Transformers For . . .

- ◆ **electronic filament tubes**
- ◆ **lamps**
- ◆ **arc welders**
- ◆ **high impedance tube circuits**
- ◆ **neon signs**



any application where current limiting is needed

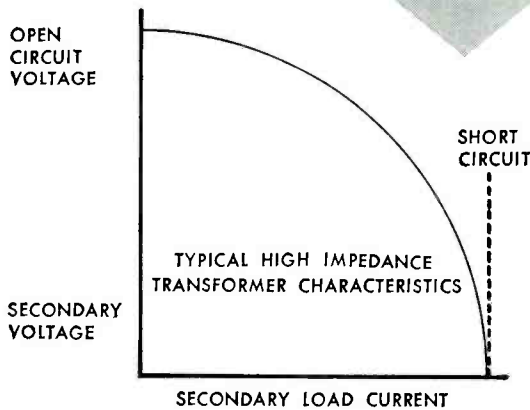

Electrical equipment that requires a high starting voltage, but low operating voltage must be protected against the high initial current that is drawn at starting voltage.

This is done by reducing the starting voltage automatically through the use of a current-limiting or High Impedance Transformer, which has shunts between primary and secondary windings. These shunts carry very little flux at no load; as the load increases, the secondary ampere-turns force more flux into the shunts until at a given current a short circuit is caused. At short circuit current half of the total flux flows through each set of shunts.

For over 30 years NWL has designed and manufactured custom transformers for every application. Only high standard materials and most reliable manufacturing methods are used. NWL coils are vacuum impregnated with the best of varnishes. Joints over 10 amperes are silver soldered and bus leads over 100 amperes are silver plated. All laminations and grain-oriented core steels, and most silicon steels are annealed in controlled nitrogen atmosphere electric furnaces.

We are proud to have built our business by manufacturing one product — reliable custom transformers.



ESTABLISHED 1920



Notkefer

Write for complete information

WINDING LABORATORIES, INC.

P. O. Box 455, Dept. 102 TRENTON, N. J.

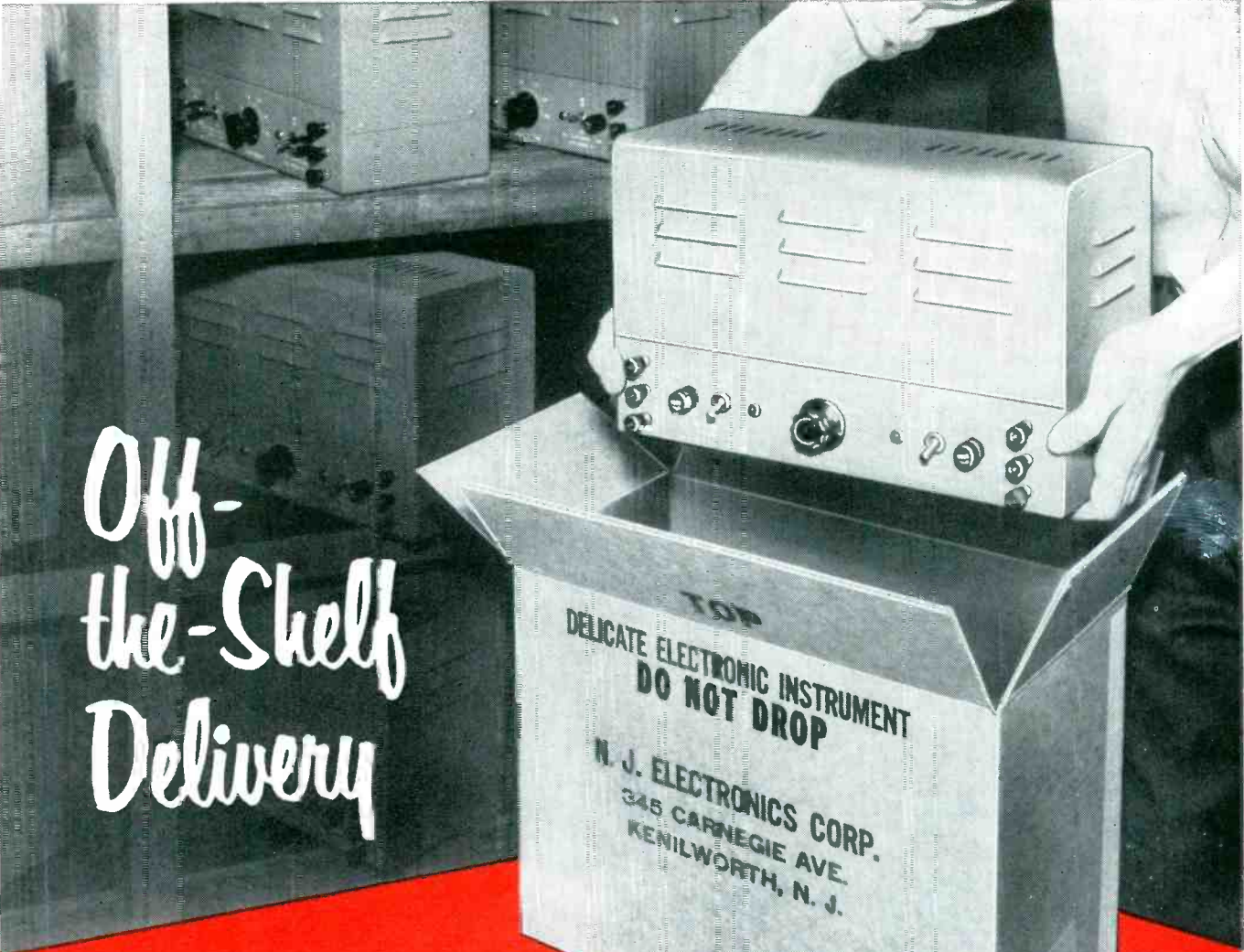

*Off-
the-Shelf
Delivery*

of Regulated Power Supplies

**64 models
available
from stock!**

Within 48 hours after we receive your telephone call, wire, or purchase order, your power supplies are en route!

For a nominal extra charge, you may specify multiple meter ranges, non-standard finishes, relocated terminals, "bias" output, vernier controls, small changes in range, etc. These variations rarely add more than a week to delivery time.

Send for your copy of "A Sensible Approach to Regulated Power Supply Design". Full price and performance data on the industry's most complete line of regulated plate supplies.



NEW JERSEY ELECTRONICS CORP.

345 Carnegie Avenue, Kenilworth, New Jersey

COMPETENT ENGINEERING REPRESENTATION EVERYWHERE

Rapid, complete, competitive custom quotes from 1000 Amperes (low voltage) to 250 KV (low current).

How do your contacts measure up to their jobs?

Are they under-designed...

or over-designed?

To be *right* for your needs, contact materials and contact designs must be evaluated in terms of *all* characteristics of the job they are expected to perform. Current and voltage in the interrupted circuit . . . nature of the electrical load . . . number and frequency of operations . . . contact gap and pressure . . . ambient temperature and atmosphere . . . and many other factors must be thoroughly considered, if contacts are to match both the performance and cost requirements of the application.

By consulting with Mallory engineers, particularly during the engineering and design stages of a contact application, you will add to your own facilities the full scope of Mallory's specialized experience in contact research and manufacturing.

- **The wide selection of materials** developed by Mallory metallurgical research encompasses practically every kind of contact service condition.
- **Standard designs** can often be recommended for standard application conditions . . . at sizable savings to you.
- **Special designs** are engineered by a staff which has the knowledge gained during thirty years of contact development.
- **Economical fabrication** of contacts and complete contact assemblies, in Mallory's manufacturing department, can save you money and simplify your own production.

For a consultation on your own contact problems, or for a copy of the Mallory Contact Catalog, write or call Mallory today.

Expect more...

Get more from



*In Canada, made and sold by Johnson Matthey & Mallory, Ltd.,
110 Industry Street, Toronto 15, Ontario.*

Serving Industry with These Products:

Electromechanical—Resistors • Switches • Television Tuners • Vibrators
Electrochemical—Capacitors • Rectifiers • Mercury Batteries
Metallurgical—Contacts • Special Metals and Ceramics • Welding Materials

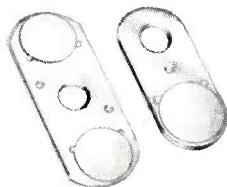
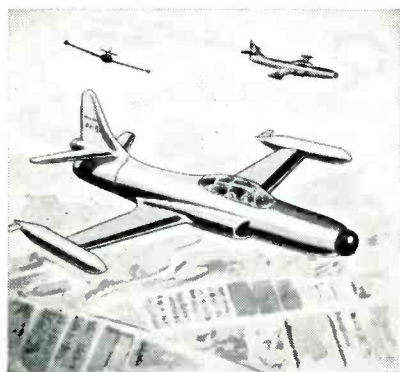
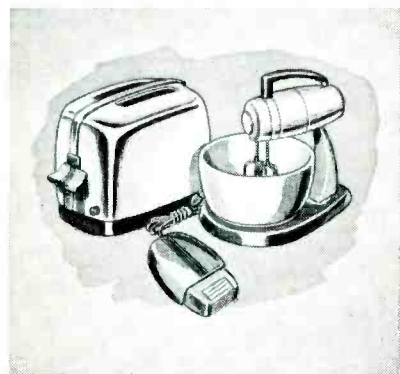
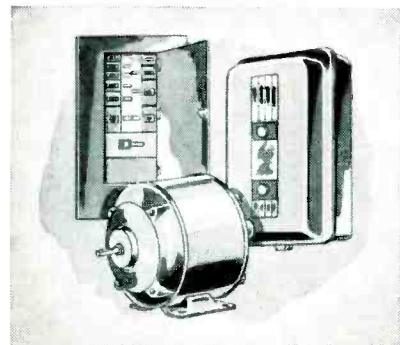

CROSS TALK

► ACROSS THE BOARDS . . .

Almost from the beginning of our industry certain electronic products have seemed to show particular promise in the period immediately ahead. At the moment the promotional pressure is on such things as the automatic factory, the businessman's computer, guided-missile controls, transistorized equipment and color television.

Now all of these do indeed show much promise, but there is some danger that because of their very flashiness it will be assumed that they will progress at the expense of other products.

Such is not the case. The entire electronics industry continues to be a growth industry and just about everything it produces will move ahead, with the usual number of things having a particular appeal to the imagination hogging much of the limelight.

► ROUGH BUT REALISTIC . . .

The devil's advocate, one who presents arguments against a candidate for sainthood, apparently has a place in electronics.

One manufacturer now employs an engineer-lawyer team that does nothing else but look for even minor loopholes in employee patent suggestions. Another maintains a department whose only purpose is to raise every possible consumer objection to prototypes of proposed

new test instruments. And countermeasures experts attack suggested radar and missile-guidance systems with every means at their command.

This is a year, apparently, in which manufacturers feel it particularly necessary to introduce new equipment that is right.

► **FIGURES . . .** For some time we have subconsciously assumed that variation in estimates on the size of the electronics industry between, say, \$6 billion and \$9 billion, merely distinguished the pessimists from the optimists.

Now we have had occasion to study two such figures closely and reach the conclusion that both may

be right; if you add to the lower figure estimated annual dollar volume in replacement parts and service charges, wholesale and retail markups and broadcast and tv-station revenue you come up near the higher figure.

The trouble is that figures are often loosely banded about sans breakdowns.

► **STILL A ROSE . . .** Industry continues to become more and more receptive to electronics but resistance is still not entirely dead.

A friend of ours says his company recently had to redesign some electronic equipment so that it looked pneumatic in order to sell it to an oil refinery.

LOOKING AHEAD . . .

Work on intercontinental guided missiles leads naturally to speculation about space stations and we get the impression that the speculation is now quite serious

High-power transistors may be the answer for designers who have long sought to operate automobile radios from car storage batteries without rotating or vibrating parts

Traveling-wave tube is about to stride out of the laboratory. It is ideally applicable to countermeasures equipment and could play a major role in transcontinental tv relaying

Electronic business machines may soon talk back. Tomorrow's businessman might dial a computer's extension, then an account number, and listen to the answer via magnetic recording

Electronic Computers

COMPUTER STORAGE SYSTEMS



FIG. 1—Tape-handling mechanism

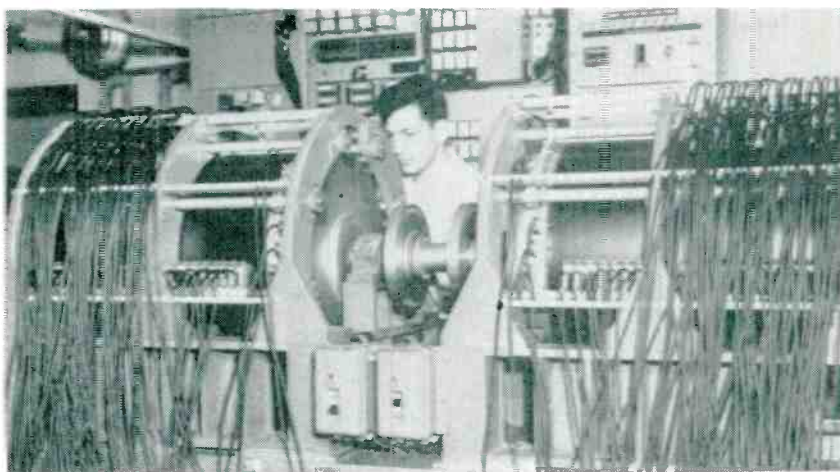

FIG. 2—Twin magnetic drums of custom-designed computer

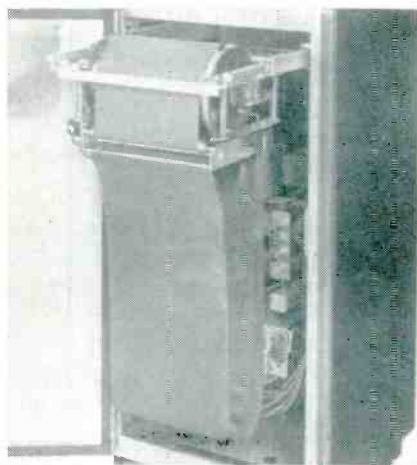

FIG. 3—Rotating drum reads wide tape

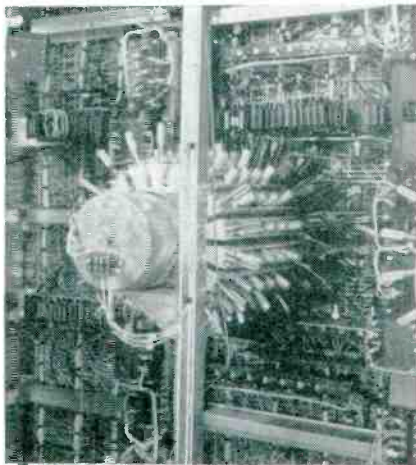

FIG. 4—Mercury tank memory

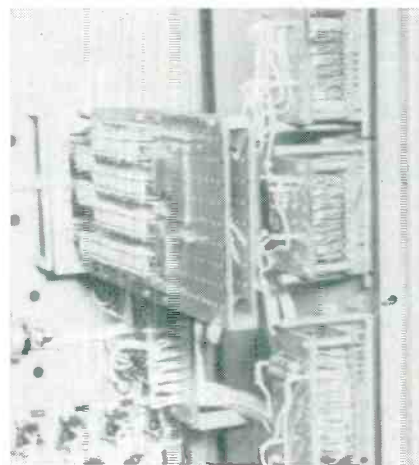

FIG. 5—Fused-quartz delay lines

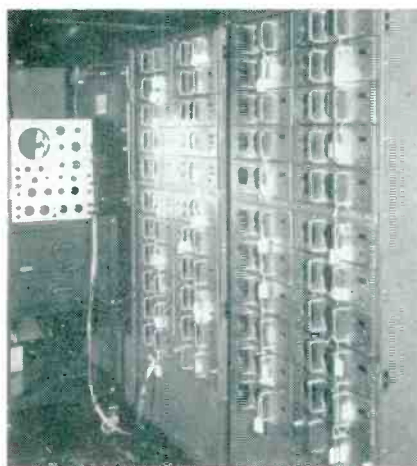

FIG. 6—Electrostatic storage tubes

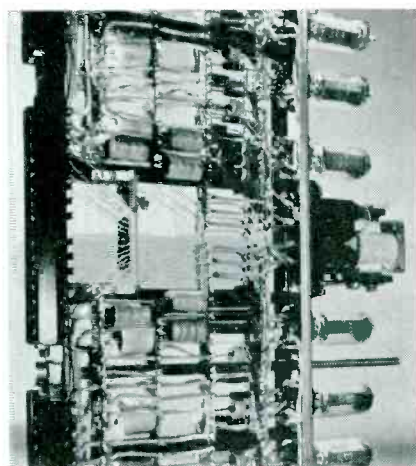

FIG. 7—Ferrite-core memory

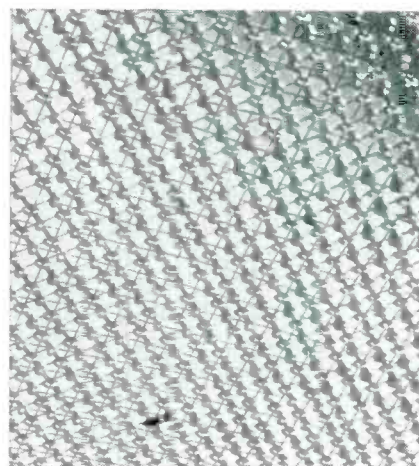

FIG. 8—Closeup of ferrite-core matrix

for the Businessman

SUMMARY — Although the electronic office is yet to come, digital computers are already a valuable aid in business. Survey of manufacturers reveals price, sales record and characteristics of 38 modern computers. Users disclose their actual operating experience

By **JOHN M. CARROLL** *Associate Editor*
ELECTRONICS

MORE THAN 200 years ago John Kay's flying shuttle triggered the first industrial revolution. Soon power-driven machinery altered basically the manufacturing of textiles. The revolution spread to the iron-and-steel industry and within a few decades many products were machine-produced.

Despite early abuses in the factory system, the long range effect was to free men's hands from drudgery and increase a thousand fold the productive capacity of the individual worker. Machine-made products were sold at prices within the means of the working class—opening vast new markets.

Toward the end of World War II a second industrial revolution began. This movement promises to free men's minds from the drudgery of routine computation. Key to the second industrial revolution is the electronic computer.

Nearly 2,800 electronic digital computers are now installed and performing work related to business operations. These machines represent an investment of over \$227 million. About 1,700 computers of various sizes are on order. This constitutes a \$186-million backlog. The tables presented in this article contain information furnished by 24 computer manufacturers and describe 38 models which the makers indicate are useful to the businessman. The survey is not intended to be all inclusive. The computer field is growing rapidly, with new companies con-

stantly entering it, and new machines being introduced in rapid succession.

Table I lists availability, price and application information for machines described in response to *ELECTRONICS'* survey of manufacturers. Technical characteristics and performance for many of the machines are given in Table II.

Types of Computers

Not all electronic computers are useful in the business office. Even among those types useful for handling business-type data there are differences in design based upon application. A computer to calculate premium rates for an insurance company may vary considerably from a computer to tally sales in a department store.

Basically electronic computers are either analog or digital. An analog computer measures, while a digital computer counts. Prototype of the analog machine is the slide rule or automobile speedometer. The analog computer consists of summing amplifiers, differentiating and integrating circuits and feedback loops.

The digital computer works on the principle of the abacus or mechanical calculator. However, it counts electrical impulses. Its heart is a master oscillator and its arithmetic unit is usually derived from the Eccles-Jordan multivibrator circuit or flip-flop.

A digital computer includes also a memory or means for storing

electrical impulses. This storage can take the form of acoustical delay lines, electrostatic storage tubes, banks of capacitors, a rotating magnetic drum, magnetic tape or a matrix of ferrite cores.

A rapid-access internal memory is required for storing numbers, alphameric words (*alphabetical + numeric*) or instruction words used in a problem. An external memory of slower access time may be used to store other programs, that is, sequences of machine instructions to be used in problem solving, and numeric or alphameric data to be processed.

A magnetic tape unit for the IBM 702 is shown in Fig. 1. The computer has provision for as many as 100 such units. The tape unit can read or write 15,000 numerical or alphabetical characters per second. Each reel of tape can hold more than 5 million characters.

Raycom, a large general-purpose computer designed by Raytheon, utilizes a 3-in. tape that provides 31 transverse channels. Characters of a word are recorded serially, that is, longitudinally in one channel of the tape. A reel of tape 2,800 ft long contains 34,000,000 decimal digits. Data can be read and recorded at 56,000 decimal digits per second.

For rapid access many machines use a rotating magnetic drum. The information storage method is similar to that used with tape. Storage capacity depends on the

length and diameter of the drum. Access time depends upon the drum's angular velocity. Storage capacities of various drums vary from 100 to 10,000 words. Access time is usually in milliseconds.

The magnetic drums of the Reservoir, a custom-designed machine used by American Airlines to keep track of available passenger space, are shown in Fig. 2. The drums revolve at 1,200 rpm. The machine operates 22 hours a day with 2 hours down time each night for routine maintenance.

The TapeDRUM developed by Cleveite-Brush Development Co. records data on a wide stationary tape wrapped around half of a rotating drum. The drum carries a large number of magnetic recording and playback heads. Each page of tape, or semicircumference of the drum, may contain up to 200,000 binary digits. Figure 3 is a photograph of the TapeDRUM with the cabinet open.

Acoustical delay lines operate by converting electrical pulses to sonic pulses which are allowed to circulate in a sonic medium. Univac utilizes seven mercury tanks as the circulating media. Its rapid access memory stores 1,130 words with an access time between 0.0404 and 0.404 milliseconds. One of Univac's delay tanks is illustrated in Fig. 4. Each of the channels in the tank stores 10 words—910 pulses.

The Elecom 125 file processor

uses five acoustical quartz delay lines. Maximum item length of 200 digits is standard but greater capacity is available. Information transfer time is 0.888 milliseconds. Three delay lines of this type are shown in Fig. 5.

Electrostatic storage tubes provide rapid access in a high-speed memory unit. Information is stored checkerboard fashion on the faces of special cathode-ray tubes. Each location on the checkerboard corresponds to one bit of information. Presence or absence of a charge spot represents a pulse. Each cathode-ray-tube face stores 1,024 binary digits. Sixty electrostatic storage tubes can store 10,000 decimal digits with an access time of 0.05 millisecond or less. The bank of cathode-ray tubes in the IBM 702 high-speed memory unit is illustrated in Fig. 6.

Raycom and the IBM 705 computers use ferrite-core matrices for rapid-access memory. The cores are tiny doughnuts of sintered ferrite material (combination of iron and other metallic oxides). A ferrite has the property of reversing its polarity of magnetization when pulsed electrically. A matrix of ferrite cores is about the size of a postage stamp. The ferrite-core storage system of the IBM 705 stores 20,000 characters with an access time of about 0.017 milliseconds. The Raytheon Raycom computer has 104,000 ferrite cores which store 2,000 words with an

access time of 0.01 millisecond.

A ferrite-core matrix and associated circuits from the IBM 705 are shown in Fig. 7. A close-up photograph of the ferrite-core matrix, Fig. 8, shows how the many ferrite doughnuts are wired together to provide an information-storage device.

Table III lists the various storage systems used in several computers and gives some of their operating specifications.

Input-Output Devices

Important adjuncts to the computer are the units that feed information in and out. Single action devices include electric typewriters, ten-key office-machine keyboards (input only) and teleprinters. The speed of single-action devices is about ten characters per second. The teleprinters accept punched paper tape and provide a page-printed or punched-tape output.

Line-at-a-time printers such as those made by Remington-Rand and IBM provide speeds of 122 to 300 characters per second and work usually from the intermediate medium of punched cards, although faster units may be hooked directly to the computer.

So-called on-the-fly printers, such as those made by Univac, Potter, Shepard and Anelex provide speeds up to 1,200 characters per second. Some models work from either punched cards, punched paper tape,

LARGE GENERAL-PURPOSE MACHINES



FIG. 9—Operating console of IBM 702

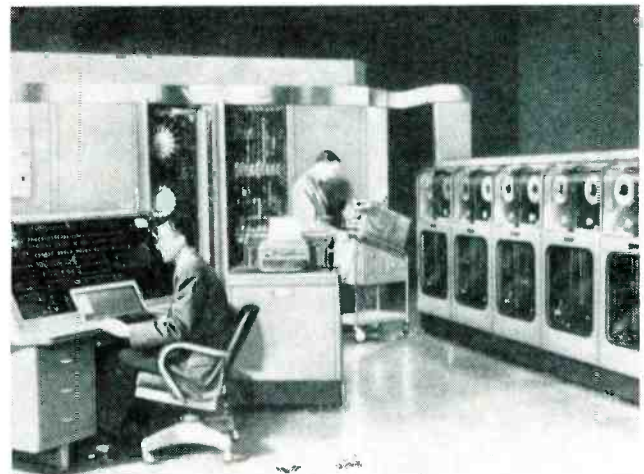

FIG. 10—Overall view of Univac

Table I—Cost, Availability and Use of Computers for the Businessman

Manufacturer	Model	Price	Number of Installations	On Order	Production time	First Delivery	Power	Floor Area in Sq Ft	Cabinets	Personnel Required	
Birkbeck College University of London	APEXC	\$27,900	3		6 mo.		2 kw	6	3	1 mathematician, 1 operator, 1 clerk	
Bendix Computer Div. Bendix Aviation Corp.	D-12	\$51,650	1	3	6 mo.	8-54	7.5 kva	25	2	1 mathematician, 1 operator	
" "	G-15A	\$45,000	0	2	6 mo.	1-55	3 kva	5.6	1	1 mathematician, 1 operator	
Campagne des Machines Bull, Paris	Gamma 3	\$40,000- \$40,000	over 100	70		2-53	3 kva		1	1-2 mathematicians, 1 operator	
Burroughs Corp.	UDEC	\$175,000- 250,000	2		4-6 mo.	11-53	32 kw		31	5 mathematicians, 1 operator, 2 maintenance men, 1 clerk, 1 dept. mgr.	
" "	E101	\$32,500 or \$350/no.	0			6-55	3 kw	17	1	1 operator, 1 programmer	
Clevite-Brush Development Co.	TapeDRUM	\$20,000			8 mo.	9-55		6	1		
ElectroData Corp.	Datatron	\$119,200	7				19 kva	875	16 (max)	2-10 mathematicians, 1 operator, 2 maintenance men, 1 clerk	
Electronics Corp. of Amer.	Magnefile	\$20,000- \$60,000	4		6 mo.	5-1-52	1 kw	10	1	1 mathematician, 1 operator	
Elliott Brothers Ltd.	402	\$69,750	0	2	12 mo.	1-55	6 kva	30	7	2-10 mathematicians, 1 operator, 1 maintenance man	
Hogan Laboratories	Circle 1	\$50,000	1			1-54	3 kw	16	1	2 mathematicians, 1 coder- operator, 1/2 maintenance man	
" "	Circle 2	\$60,000		1		12-54	3.5 kw	16	1	" "	
" "	Circle 3	\$70,000					3.5 kw	20	2	" "	
International Business Machines Corp.	CPC		235	52		12-49	10.2 kva	42	3	Variable	
" "	601		2,100	750		12-48	6.9 kva	19.37	2	"	
" "	607		100	160		12-53	9-11 kva	23.02	2	"	
" "	650		1	over 400		12-54	16.8 kva	37	3	"	
" "	702		1	15		2-55	75 kva	250	22	3 operators	
" "	705		0	over 50		12-55	87 kva	250	22	"	
International Telemeter Corp.	Special purpose equipment										
Librascope, Inc.							1 kva	25	1	1 operator	
Logistics Research, Inc.	Alvac III	\$60,000	2	3	6 mo.	2-51	5 kw	28	3	2 mathematicians, 1 operator, 1 maintenance man	
Marchant Research, Inc.	Miniac	\$85,000	2	0	6 mo.	9-53	5 kw	16	1	4 mathematicians, 1 program- mer, 1 operator, 1 mainte- nance man, 1 clerk	
Monrobot Corp. Subsidiary of Monroe Calc. Mach. Co.	Monrobot	\$85,000 to \$500,000	4	12	12 mo.	3-53	3 kw to 75 kw	16 to 200	1 to 20		
Mountain Systems, Inc.						1955					
National Cash Register Co.	CRC 102-D	\$99,500				8 mo.	1-55	7 kw	23	2	2 operators, 1 maintenance man, 1 analyst programmer
Radio Corp. of Amer.	Bizmac			1							
Raytheon Mfg. Co.	Raycom		0	1		7-56	Variable	Variable	Variable	Variable	
Remington Rand	Univac 60	From \$75,000	over 100	over 50	Variable	12-51	10 kva	43.6	2	1/2 operator, 1 maintenance man, 1 1/2 programmer	
" "	Univac 120	From \$95,000	over 100	over 50	"	6-51	10 kva	43.6	2	" "	
" "	Univac	From \$1,000,000	15	7	"	3-51	120 kva	1,250	2	Variable	
" "	Univac Scientific	From \$1,000,000	8	6	"	9-53	45 kw	300	6	"	
" "	Univac file computer	From \$300,000	0	8			10 kw	50	5	"	
Technitrol Eng. Corp.	180	Approx. \$500,000	1		18 mo.	3-55	35 kw		10		
Telecomputing Corp.	Point O'Sale Recorder										
Teleregister Corp.	Custom designed	Variable	2	10	Variable	7-52	Variable	Variable	6	7 maintenance men, over 200 clerks	
Underwood Corp.	Elecom 125	\$250,000	0	1	9 mo.	3-55	15 kva	29	5	1 operator, 1 maintenance man	
" "	Elecom 50					1-56	2 kw	16	1	1 operator	

Table II—Technical Characteristics and Performance of Electronic

magnetic tape or directly from the computer circuits themselves.

Other high-speed printing devices include matrix printers operating at 350 characters per second.

A recording process recently introduced by Burroughs uses an electrographic printing process. Characters are imprinted on coated paper as a pattern of electrostatic charges created by a 7 × 5 matrix. The image is formed in 3 microseconds. The pattern is made visible by passing the paper through a dry ink bath and to a hot plate which fixes the ink. Paper moves at 44 ft per second and characters are printed at 5,000 a second.

Characteristics of the input-output devices for several computers are given in Table IV.

General-Purpose Machines

Large general-purpose machines cost up to \$1,000,000. They require 100 kva or more and occupy upwards of 250 sq ft of floor space. Their performance is characterized by rapid computation and great flexibility and versatility in programming.

The speeds at which some modern computers perform some of their operations are given in Table V.

The Remington Rand Univac, the IBM models 702 and 705 and the Raytheon Raycom are examples of large general-purpose digital computers, designed for processing business data. Figure 9 is a view of the IBM 702 from the operator's console. An overall view of Univac, Fig. 10, shows the control console, central computer and bank of tape handling units.

Bizmac is a large general-purpose computer developed by RCA. The first model is presently being installed at the U.S. Army Ordnance Corps Detroit Arsenal.

To illustrate the electronic complexity of large general purpose computers: Univac contains 5,600 electron tubes and 18,000 diodes while the IBM 705 contain 6,259 electron tubes and 11,549 diodes. Raycom uses 2,000 tubes.

Applications for large machines include calculation of insurance premiums, serving insurance policies, public utility rate studies, cus-

Model	Number Base	Word Length	Instruction Type
APEXC	2	32 bits incl sign	2 address, 32 bits
D-12	10	7 digits	Special
G-15A	2	29 digits incl sign	2 address, 29 digits
Gamma 3	10	1 to 12 digits, sign optional	1 address coded plugboard 1 inst equals 16 bits
UDEC	Binary coded decimal	10 incl sign	1 address 2 inst per word, 5 digits per inst
E 101	10	12 sign additional	1 address—externally stored
Tape DRUM			
Datatron	10	11 incl sign, 2 inst digits	1 address, 11 digit word, 2 inst, 4 address
Magnetile	10	15-42 decimal digits excl sign	1, 2, 3 & 4 address models 8 digit word
402	2	32 digits incl sign	one + one address (operand & next inst)
Circle 1	Binary internal, decimal or sexadecimal external	44 binary digits incl sign & 6 binary inst digits	1 address, 5 sexadecimal digits per instruction
Circle 2	Binary internal, decimal or sexadecimal external	48 binary digits incl sign & 6 binary inst digits	1 address, 5 sexadecimal digits per instruction
Circle 3	Binary internal, decimal & sexadecimal external	44 binary digits incl sign & 7 binary inst digits	1 address, 5 sexadecimal digits per instruction
CPC	Binary coded decimal	±10 excl sign	2-3 address, 7 inst digits if 3 address
604	Binary coded decimal	Variable	20-60 program steps (control panel)
607	Binary coded decimal	Variable	40-140 program steps (control panel)
650	±10 (biquinary representation)	10 excl sign	2 address, 2 operation, 4 data address & 4 inst address digits
702	Binary coded decimal	Variable 1-10,000 incl sign	1 address, 5 digits per instruction
705	Binary coded decimal	Variable 1-20,000 incl sign	1 address, 5 digits per instruction
Librascope	2	31 incl sign	1 address, 16 digits per inst word
ALWAC III	2	32 excl sign	1 address, 2 instructions per word
Mimiac	Binary coded decimal & pure binary	10 decimal or hexadecimal digits plus sign (41 bits)	1 address, 20 bit inst word, 2 inst digits for command, 4 for address
Monrobot	Binary coded decimal	20 decimal digits (instructions 10 decimal digits)	4 address
CRC 102-D	10	9 excl sign	3 address, 14 octal digits per instruction word
Raycom	Binary coded decimal—alphanumeric	11 plus sign	3 address
Univac 60 & 120	10	10	Prewired on plugboard
Univac	10 (excess-3 code) alphanumeric (6-bit code plus check bit)	12 incl sign (instructions 6 characters)	1 address, 2 per word
Univac Scientific	2	36 binary digits	2 address
180	2	45 incl sign	4 address, 45 digits
Teleregister	2	8 & 11 bits	1 address
Elecom 125	Binary coded decimal	10 plus sign	2 address, automatic address sequence
Elecom 50	Binary coded decimal	10 plus sign	2,400 operating steps on program tape

Digital Computers

Operations Performed	Clock Freq. (kc)	Computing Element	Active Components
Add, subtract, multiply, $l(n)$, $r(n)$, Cc, cA, transfer to & from drum, read & write tape	65	6J6	230 electron tubes 90 crystal diodes
Solution of different equations by numerical integration	228		720 electron tubes 2,400 crystal diodes
Add, subtract, multiply, divide, decision	100		400 electron tubes 2,800 crystal diodes
Add, subtract, multiply & divide (11 digit capacity), multiply & divide (23 digit capacity), compare, transfer, branch	230		400 electron tubes 7,100 crystal diodes
Add, subtract, multiply, divide, auto. address modification, sign modification, shift, complete input-output control including format, movable decimal point, 4 transfer instructions	125		3,000 electron tubes 15 relays
Add, subtract, multiply, divide, read & write in storage, 3 transfers, auto. address mod., sign mod., complete input-output control with format, read from tape, decimal shift	75	Flip-flops & diodes	160 electron tubes 1,500 crystal diodes
Large capacity, rapid-access information storage system			
55 operations including division, address mod., by B register, block transfer to & from quick-access storage, branch, auto. storage of return address in main routine	142	Flip-flops & blocking oscillators	1,200 electron tubes 3,000 crystal diodes
	30-50		130-300 electron tubes 50-600 crystal diodes 40-90 relays
Add, subtract, multiply, divide, collate, etc.	333	Germanium diodes	590 electron tubes 3,500 crystal diodes
8 add & subtract, 2 multiply, divide, unconditional, conditional, overflow & subroutine transfer, 2 memory to register, 2 register to memory, substitute address, shift, convert, transfer to tape, read in, print out, ignore, stop	83	Vacuum tubes	700 electron tubes
8 add & subtract, 2 multiply, divide, unconditional, conditional, overflow & subroutine transfer, 2 memory to register, 2 register to memory, substitute address, shifts, on net decimal to binary convert binary to decimal & print, transfer to address on tape, ignore, stop	91	Vacuum tubes	900 electron tubes
8 add & subtract, 2 multiply, divide, unconditional, conditional, overflow & subroutine transfer, 2 memory to register, 2 register to memory, substitute address, shifts, convert binary to decimal and print, convert decimal to binary, transfer to address on tape, ignore, stop, locate block on mag tape, read & write mag tape, input, output	84	Vacuum tubes	1,000 electron tubes
Add, subtract, multiply, divide, repetition, zero check, suppression, shift, wired subroutines for power series expansion of basic transcendental functions	55	Flip-flop	1,400 electron tubes 123 relays
Add, subtract, multiply, divide, zero check, positive or negative test, repetition, shift	50	Flip-flop	1,103-1,245 electron tubes 96 relays
Add, subtract, multiply, divide, zero test, balance test, suppression, skip, repeat	50	Flip-flop	1,272-2,419 electron tubes 91 crystal diodes 123 relays
Add, subtract, multiply, divide, input, output, branch, table look up, shift & count, shift right or left, alter instruction address, normalize	125	Series-parallel diode matrix adder capacitor to hold data	2,218 electron tubes 3,960 crystal diodes 600 relays
32 operations including add, subtract, multiply, divide, read & write tape, compare, branch, shift right or left, alter instruction address, normalize	1,000	Crystal diodes	5,562 electron tubes 9,574 crystal diodes
36 operations including add, subtract, multiply, divide, read & write tape, compare, branch, shift right or left, alter instruction address, normalize	1,000	Crystal diodes	6,259 electron tubes 11,549 crystal diodes
Add, subtract, multiply, divide, conditional & unconditional transfer, extract, hold, clear, address modification, stop, transfer orders in & out of memory, type	120	Diodes	100 electron tubes 1,000 crystal diodes
76 commands including multiply, divide, add, subtract, count down, compare, shift, transfer, extract	64	Flip-flops	240 electron tubes 6,000 crystal diodes
47 operations of which 25 may be coded for decimal or hexadecimal arithmetic	300	Static flip-flop registers	700 electron tubes 1,400 crystal diodes
Add, subtract, multiply, divide, print, stop, increase and instruction address by unity, read tape, punch tape, conditional transfer, operations on absolute values	10	Tubes	650 electron tubes 200 crystal diodes
Add; subtract; multiply and divide round & double length; shift magnitude & logically; scale factor; extract; test magnitude, algebraic, overflow, bit search & switch; add & subtract binary; buffer load & out; back search; read & write magnetic tape; read punch & print paper tape; punch paper tape (hi speed); read & punch cards, halt	107		400 electron tubes 5,000 crystal diodes 36 relays
32 basic orders including 8 calculating orders, 8 transfer orders, 6 tape control orders, 5 comparison orders, 3 control orders, 2 special printing orders for direct access to intermediate results	2,220	Dynamic flip-flops & logical diode circuitry	2,000 electron tubes
Shifting decimal, alignment, transfer & intermediate functions, add, subtract, multiply, divide		22 ring counters	1,500 electron tubes 200 relays
Add, subtract, multiply, divide, branch, input, output, tape orders, logical multiplication, store program-counter contents	2,250	Flip-flops	5,600 electron tubes 18,000 crystal diodes 300 relays
General arithmetic & logical operations including multiplication, scale factor, logical shift, repetition, memory search (threshold & equality), input-output operations	500	Flip-flops	4,500 electron tubes 6,000 crystal diodes 150 relays
Add, subtract, short & double precision multiplication & division, variable shift & selective replacement, halt, compare provisional & final stop, print upper & lower case, read magnetic or paper tape, automatic accumulation & repetition	1,000	Diode logical circuits	2,500 electron tubes 40,000 crystal diodes 200 relays
Add, subtract, test zero, test negative	20		1,500 electron tubes 50 crystal diodes
Add & subtract with or without clearing accumulator and with or without storing results, multiply & divide with or without roundoff	132	Delay-line registers using lumped parameter electrical delay lines with ferrite cores	600 electron tubes 6,000 crystal diodes
Add, subtract, multiply, input, output, skip, back, check data; add, subtract or clear simultaneously any or all number registers	66	Dynamic flip-flops	160 electron tubes 2,000 crystal diodes

Table III—Characteristics of Storage Devices for Computers

Model	Storage Media										Other Media	
	Magnetic Drum				Electrostatic Tubes			Magnetic Tape				
	Dimensions (in.)	Speed (rpm)	Capacity (words)	Access Time (millisec)	No. of Tubes	Capacity (words)	Access Time (millisec)	Length	Capacity (words)	Access Time (millisec)		
APEC	5 (dia) 8 (length)	4,000	8,000	0.35-16								
D-12	11 (dia)	4,700										
G-15A	12	1,300	2,176	29 (max.)								
Gamma 3												Lumped parameter delay lines 48-84 decimal digits, internal — up to 372, external. Max access —0.17 millisec.
UDEC	8.5	3,500	5,300	0.3-17.0								
E 101	6	3,600	100	1.67-16.7								
TapelDRUM	12-30	1,000	200,000 digits per page									
Datatron	12	3,600	4,080	17.0 (max.)				2,400 ft	200,000	6.5 min (max.)		
Magnefile	8	1,200- 3,600 ft./min.	10,000	0.5-4 sec								
402	9	4,600	2,914	13.0 (max.)								Plug-in nickel delay line—15 word capacity, immediate ac- cess
Circle 1	8	3,450	1,024	0.5-16								
Circle 2	8	3,450	4,096	0.5-16								
Circle 3	8	3,450	4,096	0.5-16				2,400 ft	390,000	16 millisec-8 min (locate block) 22-80 (read/ write word)		
CPC												Vacuum tubes—50 positions electromech relays—160 posi- tions—400 msec access accum register relays—80 posi- tions—400 msec access Up to 5 aux storage units
604												Vacuum tube registers—50 deci- mal digits
607												Vacuum tube registers 66-162 decimal digits
650	4 (dia.) 16 (length)	12,500	1,000 or 2,000	0.098-4.8								
702			60,000 char.	0.04-16		10,000 char.	0.023 cycle time	2,400 ft		speed 75 ft./sec		
705			60,000 char.	0.04-16				2,400 ft		speed 75 ft./sec		Ferrite cores—20,000 char. 0.017 millisec cycle time
Librascope	6.5	3,600	4,096	0.25-17								
Alvac III	7.5	3,500	4 128 32 4,096	0.5 (computing storage) 0.5-7.5 (working storage) 0.5-15.5 (storage of constants) 96 (main storage—32-word block transfer time)								
Miniac	6.5	6,000	3,840 256	1.25-10 1.25-2.5 (fast access)								
Monrobot	10	3,600	100 numbers 200 inst	16								
CRC 102-D	12	2,400	1,024 8	0.4-25 0.5-3.2 (fast access)				1,200 ft	115,000	170 millisec to 160 sec		
Raycom								2,800 ft 3" wide	34 million digits	reading rate 56,000 dec. digits/sec		104,000 ferrite cores, 2,000 word capacity, 0.01 millisec access
Univac 60 & 120												Relays—10 digit capacity
Univac								1,500 ft	96,000	3 min max		Mercury delay lines—1,000 words 0.0404-0.404 millisec access
Univac Scientific	17×10	1,725	16,384	0.004-34	3.6	1,024	0.006- 0.01	4 units	200,000	45 in./sec		
180												Acoustic—128 elements, 1,024 words, 0.048-0.384 millisec access
Teleregister	20	1,200	71,000	0.1-50								
Elecom 125	9.5	3,600	1,000 to 10,000	1.7 (rapid) 8.3 (average)								Sorter—5 acoustic quartz delay lines
Elecom 50	8×2	1,800	50									

tomer billing, payroll accounting, production control in manufacturing plants and various operation analysis studies.

Medium-Price Machines

Where the speed and versatility of a large general-purpose computer are not required, there are several less expensive machines either on the market or under development. Although the machines are quite versatile they do not provide the speed or flexibility in programming available with million-dollar general-purpose models.

Applications of medium-sized machines include inventory and payroll accounting. A large automobile manufacturing concern is considering purchase of more than 30 medium-sized machines to handle parts inventory accounting at each of its regional warehouses.

The Datatron shown in Fig. 11 illustrates three input-output systems: paper-tape handling mechanism, decimal keyboard and automatic typewriter. The input-output equipment of the Miniac is illustrated in Fig. 12. The French-designed Bull machine, Fig. 13, has a unique mechanical arrangement for access to its electronic circuits. Figure 14 shows the magnetic drum of the IBM 650. The drum revolves at 12,000 rpm and provides access to any of 20,000 numbers in less than 3 milliseconds.

Small Machines

Machines costing less than \$50,000 with power requirements of 3 kva and less are sometimes referred to as small machines.

The Burroughs E101 has a six-inch, 3,600-rpm drum which stores 100 words with a maximum access time of 16.7 milliseconds. Its clock frequency is 75 kc and it utilizes 160 electron tubes and 1,500 crystal diodes. Programming is accomplished by a wired plugboard.

The Elecom 50 uses an 8-in., 1,800-rpm drum, with a capacity of 50 words. Its clock frequency is 66 kc and it uses 160 electron tubes and 2,000 diodes.

The Elecom 50 can add to, subtract from or clear, simultaneously, any or all of its 50 registers. The machine is programmed by a 6-in. wide, 2-mill thick Mylar tape with

MEDIUM-SIZED COMPUTERS

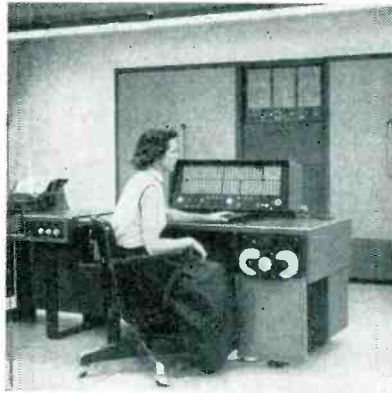

FIG. 11—View of Datatron from console



FIG. 12—Input-output systems for Miniac

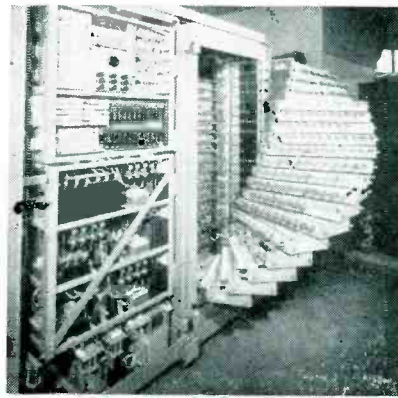

FIG. 13—Design of Gamma 3



FIG. 14—Memory drum of IBM 650

an aluminum flash coating of 200 ohms per sq in resistivity. Data is written on to the tape by passing current at low power through the tape to vaporize the aluminum where desired without making a hole in the plastic base. The tape is stepped through up to 2,400 program steps and read electrostatically. A 5-mc carrier passes through the spots where the aluminum coating has been removed from the tape and 72 electrostatic reading probes are used to sense the program signal.

Tailor-Made Computers

Where essentially the same operation must be performed over and over, a computer tailored to that specific job can often save both in capital investment and personnel training expenses. Tailor-made computers cost from \$20,000 to \$500,000 depending upon their data-handling capacity.

A figure of merit for computers has been given as speed times stor-

age capacity, times reliability, times simplicity equals figure of merit. This figure for computers has increased by 10 or more each year for the last several years. During the past 10 to 12 years speed has increased 10,000 times, storage capacity 50 to 100 times and reliability about 1,000 times. Simplicity has roughly remained constant.

Recent Developments

An all-transistor computer, the IBM 608, was recently announced. The machine performs the same functions as the model 604—a computer using about 1,250 electron tubes. The machine employs more than 3,000 junction transistors mounted on about 700 printed wiring boards. The machine achieves a 50-percent saving in space, and a 90-percent saving in power. The transistor computer consumes a little over 300 watts against 6.2 kw for the electron-tube model. A much smaller

Table IV—Performance of Input-Output Systems

Model	Type of Input		Type of Output	
	Device	Speed (Char/min)	Device	Speed (Char/min)
APEXC	Magnetic tape	24,000	Magnetic tape	24,000
D-12	Paper tape	400	Paper tape Typewriter Incremental plotter	400 600
G-15A	Typewriter Paper tape	600 12,000	Typewriter Paper tape	600 900
Gamma 3	Punched card	10,800	Printer Card punch	7,200 5,750
UDEC	Photoelectric tape reader Teleprinter	6,000 360	Teleprinter	360
E101	Keyboard Paper tape	manual 1,200	12-digit semiganged page printer	1,440
Datatron	Paper tape Keyboard Punch cards Magnetic tape	32,100 manual 100 cards/min 300,000	Paper tape Flexowriter Punched cards Magnetic tape	800 600 100-150 cards/min 300,000
Magnetile	Keyboard, paper tape or punch card		Electric typewriter	600
402	Paper tape	2,400	Electric typewriter tape-punch and page printer	600 960
Circle 1 & 2	Flexowriter	600	Flexowriter	600
Circle 3	Ferranti reader Flexowriter Magnetic tape Punched card	1,800 600 9,000 900	Flexowriter Magnetic tape Punch card	600 9,000 900
CPC	Card reader	150 cards/min	Card punch Printer (numeric) (alphabetical)	30 cards/min 100 lines/min 150 lines/min—80 ch/line
604	Card reader	100 cards/min	Card punch	100 cards/min
607	Card reader	100 cards/min	Card punch	100 cards/min
650	Card reader	200 cards/min	Card punch	100 cards/min
702 & 705	Card reader Card to tape	250 cards/min 250 cards/min	Card punch Tape to card Printer Tape to printer	100 cards/min 100 cards/min 150 lines/min—120 ch/line 150 lines/min—120 ch/line
Librascope	Flexowriter	600	Flexowriter	600
Alvac III	Flexowriter Summary gang punch	540 8,000	Flexowriter Summary gang punch	540 8,000
Miniac	Flexowriter Paper tape Magnetic tape Internal keyboard	500-600 55,000 41,000	Flexowriter Magnetic tape Internal keyboard	500-600 41,000
Monrobot	Keyboard Flexowriter Paper tape	manual 600 600	Flexowriter Paper tape	600 600
CRC 102-D	Electric typewriter Paper tape reader Magnetic tape Punched cards	600 12,000 36,000 4,000	Electric typewriter Paper tape punch Magnetic tape Punch cards	600 3,600 36,000 4,000
Raycom	Punched cards	900 cards/min	Line printer	150 lines/min
Univac 60 & 120	Punch cards	150 cards/min	Punch cards	150 cards/min
Univac	Magnetic tape	255 words/sec	Magnetic tape Typewriter	255 words/sec 660
Univac Scientific	Photoelectric tape reader	1,440	Electric typewriter Tape punch	600 3,600
180	Paper tape Magnetic tape	12,000 600,000	Paper tape Magnetic tape High-speed printer Typewriter	300 600,000 36,000 600
Teleregister	Keysets		Relays—lamps Teleprinter	25,000 300
Elecom 125	Magnetic tape Punch card Punched tape Punched tape (hi-speed) Typewriter	120,000 15 cards/min 600 24,000 600	Magnetic tape Punch cards Punch cards high speed Punched tape Punched tape (hi-speed) Line printer Typewriter	120,000 15 cards/min 150 cards/min 600 3,600 150 lines/min or 300 600
Elecom 50	10 Key	manual	2 ganged acctg. machines	1 word/sec

power supply is employed and no cooling blowers are required by the machine.

Automatic equipment has been developed by General Mills that will permit printed wiring boards upon which transistors may be mounted to be produced in a continuous automatic operation. A printed wiring board for the all-transistor computer is shown in Fig. 15. Figure 16 illustrates the operation of an automatic assembly machine. Completed assemblies are shown coming off the conveyor. The machine has inserted 11 components. It can insert from 1 to 24. Assemblies are completed at the rate of 20 a minute.

The reason for interest in transistors for computer work is evident upon considering the experience of a major insurance company which recently installed a large-scale, general-purpose computer. The computer and its supporting equipment required 4,000 sq ft of floor area and a 40-ton capacity air-conditioning unit for cooling. Total cost of moving in the equipment and of preparing the site was about \$220,000. This included running heavier electrical wiring to supply more than 120 kva.

Most computers include some type of self-checking provision. However, even without self-checking computers have an exemplary record for reliability. A first-rate clerk will make an average of one error in 100 operations. Par for present-day computers is one error for every 10,000,000 operations and machines currently under development may make only one error in every 100,000,000 operations.

Operating Experiences

One of the largest electrical and gas utility companies has been studying the application of electronic computers in their customer-billing operations. But this company estimates that it will require 40 man-years of work to program their customer accounting for running on a large general-purpose computer.

One of the first problems the utility ran on a machine was a rate frequency analysis. The problem required, 740 man-hours of programming and an additional 64

hours on the computer for debugging. The actual running of the problem, however, required only ten minutes. In the course of the operation there was only one error due to mechanical failure.

A large insurance company estimated that 15 man-years would be required to program its operations. However, once they had begun the work of programming, this estimate was revised downward to ten man-years.

Despite relatively high costs, firms that have installed electronic computers have in general found that the computers pay for themselves. For example, multiplication can be performed at a cost of \$30,000 per million operations by a clerk using a desk calculator. On present-day electronic computers, cost is \$3 per million operations and possibly in the future this cost may be reduced to 30 cents per million operations.

BIBLIOGRAPHY

ENIAC Computer Demonstrated, *ELECTRONICS*, p 308, Apr. 1946.
 Computer Survey, *ELECTRONICS*, p 194, Apr. 1947.
 F. J. Murray, Theory of Mathematical Machines, *ELECTRONICS*, p 284, May 1947.
 Mercury Memory Tanks for EDVAC Computer, *ELECTRONICS*, p 116, Oct. 1947.
 T. K. Sharpless, Design of Mercury Delay Lines, *ELECTRONICS*, p 134, Nov. 1947.
 F. R. Micheal, Tube Failures in ENIAC, *ELECTRONICS*, p 116, Oct. 1947.
 Selective Sequence Digital Computer for Science, *ELECTRONICS*, p 138, Apr. 1948.
 C. H. Page, Digital Computer Switching Circuits, *ELECTRONICS*, p 110, Sept. 1948.
 EDSAC Computer, *ELECTRONICS*, p 124, Oct. 1949.
 Gate-Type Shifting Register for Computers, *ELECTRONICS*, p 186, Dec. 1949.
 Time-Data Alignment System, *ELECTRONICS*, p 126, May 1949.
 Electrostatic Cathode-Ray Memory for Computers, *ELECTRONICS*, p 123, Aug. 1949.
 SEAC Computer, *ELECTRONICS*, p 120, Sept. 1950.
 M. Kincaid, J. M. Alden & R. B. Hanna, Static Magnetic Memory for Low-Cost Computers, *ELECTRONICS*, p 108, Jan. 1951.
 E. M. McCormick, Computer for Tick-Tack-Toe, *ELECTRONICS*, p 154, Aug. 1952.
 A. A. Gerlach, Test Pulse Generator for Digital Computers, *ELECTRONICS*, p 158, Nov. 1952.
 H. Koppel, Digital Computer Plays NIM, *ELECTRONICS*, p 155, Nov. 1952.
 H. Kenosian, Unitized Pulse Circuits Speed Computer Design, *ELECTRONICS*, p 156, Oct. 1952.
 Ferrites Speed Digital Computers, *ELECTRONICS*, p 146, Apr. 1953.
 Magnetic Memory for ENIAC Computer, *ELECTRONICS*, p 198, May 1953.
 Ferroelectric Memory Circuits for Computers, *ELECTRONICS*, p 204, July 1953.
 A. W. Holt and W. W. Davis, Computer Memory Uses Conventional C-R Tubes, *ELECTRONICS*, p 178, Dec. 1953.
 J. H. Felker, Arithmetic Processes for Digital Computers, *ELECTRONICS*, p 150, March 1953.
 E. G. Wilby, Intermittent-Feed Computer Tape Reader, *ELECTRONICS*, p 115, Feb. 1953.
 Balanced D-C Supply for Computers, *ELECTRONICS*, p 212, Jan. 1954.
 FOSDIC Computer Input System, *ELECTRONICS*, p 236, Feb. 1954.
 Memory for Whirlwind Digital Computer, *ELECTRONICS*, p 226, Aug. 1954.
 J. W. Brian, Magnetic Matrix Switch Reads Binary Output, *ELECTRONICS*, p 157, May 1954.

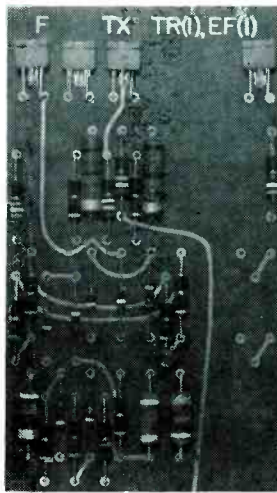

FIG. 15—Transistor board

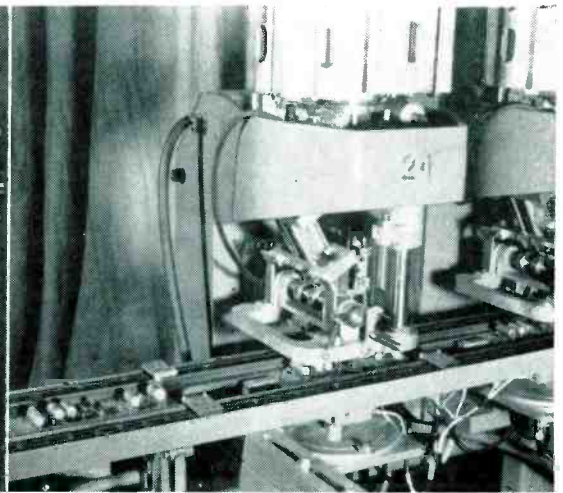

FIG. 16—Automatic assembly of printed wiring boards

B. Moffat, Saturable Transformers as Gates, *ELECTRONICS*, p 174, Sept. 1954.
 C. W. Fritze, Tape Recorder Stores Computer Output, *ELECTRONICS*, p 166, July 1954.
 S. G. Lutz, Welded Joints on Diodes Reduce Computer Bulk, *ELECTRONICS*, p 154, Nov. 1954.
 Tube Failure in SEAC Computer, *ELEC-*

TRONICS, p 212, Mar. 1954.
 Flip-Flop Counter Has Extended Range, *ELECTRONICS*, p 149, Jan. 1955.
 Thomas A. Prugh, Junction Transistor Switching Circuits, *ELECTRONICS*, p 156, Jan. 1955.
 William N. Papian, New Ferrite-Core Memory Uses Pulse Transformers, *ELECTRONICS*, p 194, Mar. 1955.

Table V—Computer Operating Speeds

Model	Computing Time Inclusive of Access, in Milliseconds			
	Transfer	Addition and Subtraction	Multiplication	Division
APEXC	0.350-16	0.350-16.0	0.350-16.0	
G-15A		0.54-15.0	16.7-31.2	16.7-31.2
Gamma 3	0.680 (max.)	0.850 Add 1.020 Subtract	0.510 plus 1.7 per digit	multiplier or quotient
UDEC	0.5-17.0	0.7-17.0	60.0 (max.)	60.0
E 101	33-1,530	50-67	233-433	233-433
Datatron		2.0	8.5 (ave.)	12.0
402	0.2-6.7	0.2-6.7	3.3-9.8	3.3-9.8
Circle 1	16	25	45	45
Circle 2	16	25	45	45
Circle 3	16 (internal) 52 (external)	25 & 52	45 & 60	45 & 60
CPC	0.48	0.48	2.4-24	4.8-26.4
604	0.5	0.5	2.4-24	4.8-26.4
607	0.52	0.52	2.4-23	5.1-25.8 Suppress—0.08 Skip—0.08
650	0.67-10.18	0.67-10.18	2.21-24.29	6.04-28.13
702	0.023	0.253	1.213	2.559
705	0.017	0.119	0.799	1.818
Librascope	2.0-19.0	2.0-19.0	19.0-36	19.0-36
Alwac III	1.0-9.0	1.0-9.0	17-25	17-25
Miniac	1.6-6.1	1.8-6.2	14.9-26.7	16.1-28.2
Monrobot	135	135	600	600
CRC 102-D	9.8-84.8	9.8-109.8	17.2-117.2	17.2-117.2
Raycom		0.25	1.0	compare—0.21
Univac	0.404	0.525	2.15	3.89 compare—0.365
Univac Scientific	0.042	0.048	0.126	0.480
180		0.192-1.536	2.4-3.408	2.4-3.408
Teleregister	0.1-50			
Elecom 125	0.888 (sorter)	3.5	20	20
Elecom 50	50-100	50-100	50-100	50-100

Directly Coupled

SUMMARY — Surface-barrier and certain alloy-junction transistors have characteristics that permit direct coupling between stages. Computer circuits designed to take advantage of these characteristics reduce considerably the number of capacitors and resistors required for operation

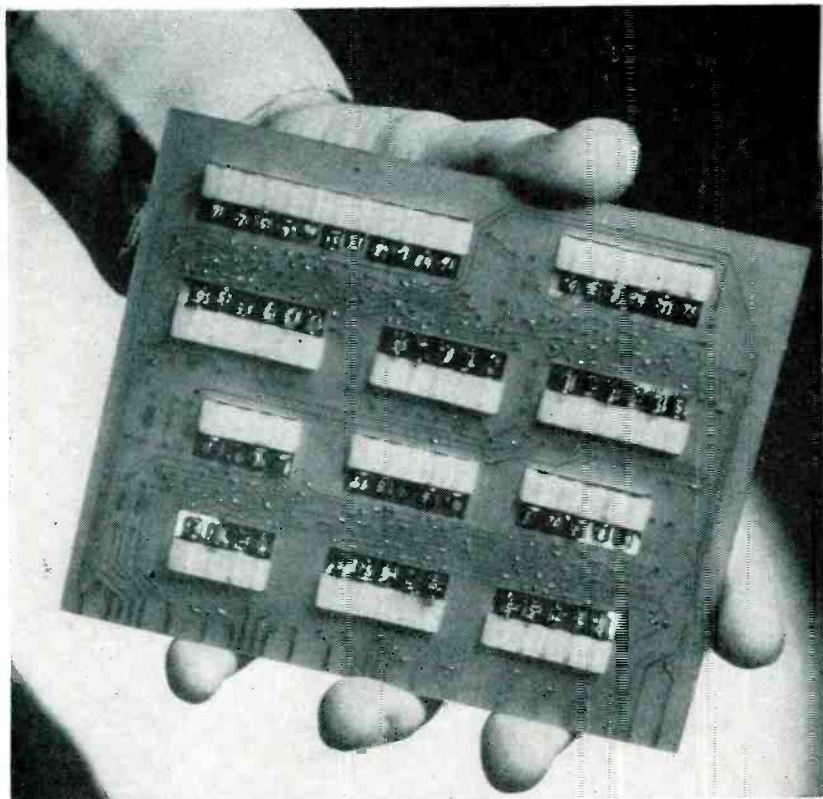

Printed circuit module for Philco Transac (Transistor Automatic Computer) which uses the circuits to be described.

BOTH SURFACE BARRIER and alloy-junction transistors have inherent characteristics that enable them to operate almost like true relays, rather than like equivalents of electron tubes. These characteristics permit new, simpler switching circuits to be used. Surface-barrier transistors, because of their short response time, make these circuits suitable for high-speed digital computers.

In digital computer work, only

two states or conditions of a transistor need be considered in switching circuits. These are the off and on states. The off state is one of effective, if not complete cutoff. The on state is operation at saturation or beyond.

For certain types of transistors used in the common-emitter configuration, the voltage at the collector of an off transistor is high enough to cause saturation at the base of a following transistor. The

collector voltage of an on transistor is low enough to hold a following transistor in the off condition. Operation of bases and collectors in the same voltage region permits direct coupling between output and input terminals of transistor amplifier stages. Inasmuch as a common-emitter transistor amplifier furnishes current gain, it is practicable to connect more than one base to a single collector.

Satisfactory two-state operation with direct-coupled circuits can be obtained with surface-barrier transistors and with many alloy-junction transistors. With the surface-barrier transistors state-to-state transitions can be effected in a tenth microsecond or less.

Circuit Simplification

The family of switching circuits to be described has been developed and tested with transistors of both the surface-barrier and the alloy-junction types. These circuits require only a single supply voltage, which was negative for the *npn* transistors tested. It is possible to use these circuits also for suitable *npn* transistors with a positive power supply voltage.

With few exceptions, the individual circuits are made up of only transistors and resistors. Furthermore, a single resistor may be shared by several transistors, so that a given network is likely to have fewer resistors than transistors.

In a twenty-bit computer, the circuits for controlling and performing all the usual arithmetic

Transistor Circuits

By RALPH H. BETER, WILLIAM E. BRADLEY, RALPH B. BROWN

Senior Engineers
Philco Corporation

Government and Industrial Division
Philadelphia, Pennsylvania

and MORRIS RUBINOFF

Associate Professor, Moore School
University of Pennsylvania
Philadelphia, Pennsylvania

operations may require 1,700 transistors, 500 resistors and 20 capacitors. The capacitors are needed in the control circuits only and are not used in the circuits that handle data. All the circuits in the arithmetic control section can be packaged within a volume of less than 300 cubic inches. A part of such a package is shown in the photo.

Another feature of these circuits is their low power requirements resulting from use of low-power surface-barrier transistors. The complete arithmetic and arithmetic control section for a large-scale computer may require no more than 8 watts at -3 volts.

Direct Coupling

The collector and base characteristic curves of the transistor to-

gether with a conventional load line are shown in Fig. 1.

The collector characteristic curves show the output performance of a grounded-emitter transistor amplifier. There is a knee in each of the curves for a constant base current. Beyond the knee in the direction of decreasing negative V_c , the collector curves become almost parallel to the current axis. This is the region of saturation in which the ratio of collector to base current is a minimum.

Any transistor operating in the region of saturation will have high base and collector currents. It must have also a low or near-ground collector voltage. A conventional load line may be drawn on the plot of collector characteristics, crossing the voltage axis at the power-

supply voltage $-V_{cc}$.

The base or input characteristic curve is plotted for the same power supply voltage and for the same value of load impedance. The value $R_L = 200$ ohms was chosen only for the purpose of illustration and does not restrict the circuits to that value of R_L .

The combination of characteristics can be used to determine the operations of a direct-coupled chain of amplifiers shown in Fig. 2A. The voltage and current at the base of TR_1 are defined by the intersection X in Fig. 1 of the load line and the base characteristic. The collector characteristic for that value of base current crosses the load line at point Y in Fig. 1. A projection to the voltage axis from point Y defines the collector voltage

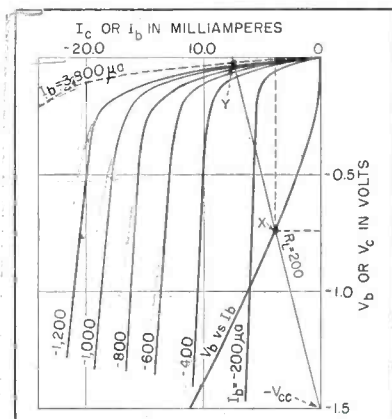
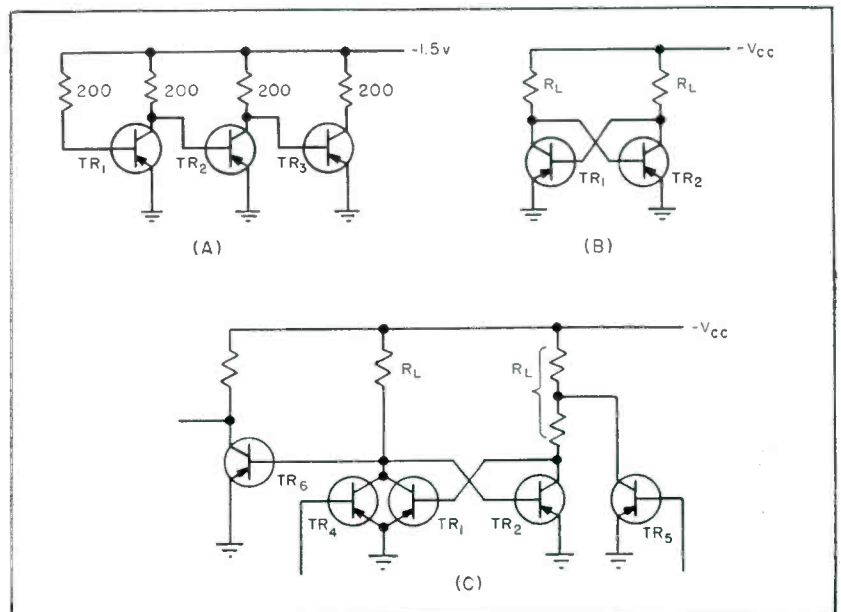

FIG. 1—Combined collector and base characteristics

FIG. 2—Chain of direct-coupled amplifiers (A), saturation flip flop (B) and flip-flop triggering and sensing (C)



for TR_1 . Transistor TR_1 is in the condition of saturation.

The collector voltage for TR_1 is also the voltage at the base of TR_2 . From the base characteristic it can be seen that the base current corresponding to this TR_2 base voltage is essentially zero. Transistor TR_2 is practically cut off, having no appreciable current in either its base or its collector. The voltage at the collector of TR_2 is determined entirely by the base characteristic of TR_3 . The determination of the TR_3 base voltage and hence the TR_2 collector voltage can be carried out by the method already used for the base of TR_1 .

In the family of switching cir-

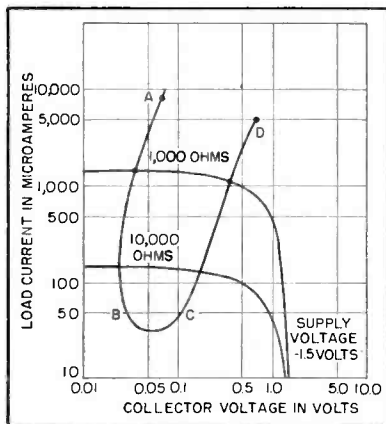

FIG. 3—Flip-flop characteristics

uits transistor bases and collectors operate at voltages determined by points X and Y in Fig. 1 or for other figures drawn to correspond to the load impedances and supply voltages used. The two voltages thus defined are the limits of the signal-voltage swings. The current in each collector also varies over the range defined by points X and Y.

The current in the load impedance of a saturated transistor is almost entirely collector current. The load current for a cut-off transistor is almost entirely the base current for the following transistor or transistors. During a state-to-state transition, the load current will be made up of varying ratios of collector current and base current.

The transistor operating condition, either of saturation or cutoff, is the same for every alternate

stage in the amplifier chain of Fig. 2A. The voltage and current in the base of TR_3 are of the same magnitude as for the base of TR_1 . The TR_2 collector could be connected to the base of TR_1 instead of to the TR_3 base. The resulting closed two-stage chain of direct-coupled amplifiers shown in Fig. 2B is a binary memory circuit called a saturation flip flop.

In the saturation flip flop, the collector voltage for the cut-off transistor will be negative, corresponding to point X in Fig. 1. This voltage is the same as the base voltage of the saturated transistor. The collector of the saturated transistor will be low or near ground corresponding to point Y in Fig. 1. This same voltage appears also at the base of the cut-off transistor.

Flip Flop

The variation of collector voltages with load impedance is shown in Fig. 3. The X-signal voltage will range along the curved line from C to D and the Y-signal voltage from B to A. Figure 3 depicts the relationship between collector voltage-to-ground and collector load impedance for the two stable states of a saturation flip flop. Both load impedances were of the same magnitude when each pair of points was determined for this curve. As the load impedances were increased from a value of about 100 ohms to about 50,000 ohms, the pairs of calculated points established the U-shaped curve. The region of the curve from A to B corresponds to essentially all collector current and the region from C to D corresponds to mainly base current.

The saturation flip flop can be triggered to the opposite state by dropping the base voltage of the saturated transistor to or near ground. This causes its collector voltage to rise, energizing the transistor that was previously cut off. Two slightly different methods of triggering a saturation flip flop are shown in Fig. 2C.

Assume that TR_1 is cut off. A negative signal of sufficient magnitude applied to the base of TR_1 will saturate TR_1 , pulling its collector voltage toward ground. The TR_1 collector is tied directly to the TR_2

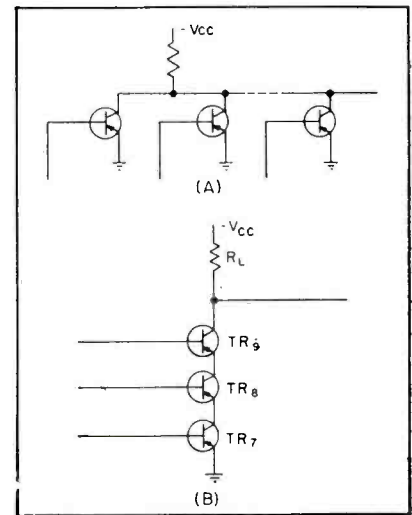

FIG. 5—Relay diagram (A) and schematic (B) of odd parity checker

collector and the TR_2 base. When TR_1 saturates, TR_2 will be cut off. The collector voltage of TR_2 will rise, driving TR_1 into saturation. This will hold TR_2 cut off and the saturating signal to the TR_1 base may be removed. The triggering signal to TR_1 must be maintained for a minimum of about 0.2 microsecond for reliable triggering. The minimum amplitude of the triggering signal to TR_1 is -0.15 to -0.25 volt, depending upon the value of R_L used in the flip flop. Higher values permit lower minimum triggering voltages because they involve lower currents that must be switched.

Assume that TR_2 is cut off. A negative signal of sufficient amplitude applied to the base of TR_2 will saturate TR_2 , cutting off TR_1 , saturating TR_2 and holding TR_2 in saturation even though TR_1 may become cut off. The connection of the TR_2 collector to a tap on the TR_1 load impedance rather than directly to the TR_2 collector permits the use of TR_2 in triggering other flip flops at the same time by sharing the load impedance between the TR_2 collector and the power supply among all the flip flops to be triggered simultaneously.

The state of a saturation flip flop can be sensed by connecting the input of a sensing element such as TR_3 in Fig. 2C to the appropriate base-collector-load tie point in the flip flop.

Figure 4A shows a basic or circuit. In switching networks the or

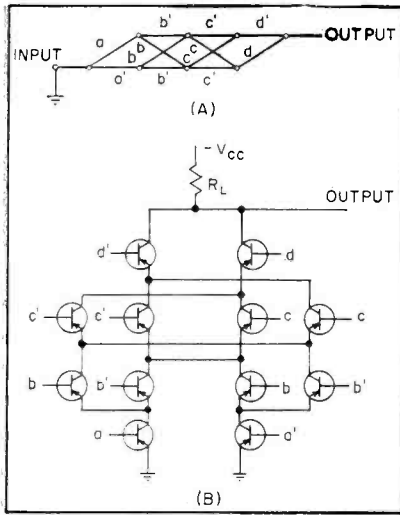

FIG. 5—Relay diagram (A) and schematic (B) of odd parity checker

circuit may appear to be only a soldered connection or a tie point because the or circuit transistors may be parts of other circuits and the or circuit resistor may be the load resistor for a flip flop. An or circuit can be identified in Fig. 2C. Notice that if either TR_1 or TR_4 or both are saturated the voltage at their collector tie point is brought near ground.

The output signal from any of the gating circuits in this new family will be a positive or toward-ground signal whereas the input signals will all be negative signals used to drive transistor bases.

And Circuit

A basic and circuit is shown in Fig. 4B. The and circuit takes advantage of the low collector-to-emitter voltage that exists in saturated transistors of certain types. This voltage can be much less than the voltage from base to emitter.

Saturation current can flow in the cascoded emitter-collector path of an and circuit only if each of the transistor bases is driven sufficiently negative. The series path through the transistors becomes a low impedance, a saturation current flows through the transistors and load impedance and the output voltage drops to nearly ground potential.

Assume that the three-input and gate of Fig. 4B is to be used to trigger a flip flop whose load resistors are 1,000 ohms each and the supply voltage is -1.5 v. Assume

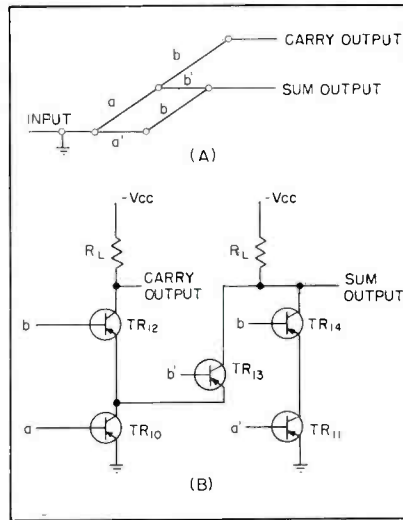

FIG. 6—Relay diagram (A) and schematic (B) of half adder

that the and output signal should bring the collector of TR_8 to within -0.10 volt with respect to ground.

Resistor R_L in Fig. 4B is now one of the flip-flop resistors, with a value of 1,000 ohms. This resistor must have 1.4 volts across it when the flip flop is being triggered which means that it must carry 1,400 microamperes at that time. This current must pass through each of the and gate transistors.

Assume, in this example, that an effective current gain of 10.0 can be realized from base to collector in each of the and gate transistors. Then the transistor currents in Fig. 4B will be: TR_8 —collector, 1,400 microamperes; base, 140 microamperes; and emitter, 1,540 microamperes; Transistor 8—collector, 1,540 microamperes; base, 154 microamperes; and emitter, 1,694 microamperes. Transistor 7—collector, 1,694 microamperes; base, 170 microamperes; and emitter, 1,864 microamperes.

The three bases in the and gate may be energized from sources having the same voltage levels. However, there is a slight decrease in the effective base-to-emitter voltage in going from TR_7 to TR_8 to TR_9 . Part of the base-to-ground voltage for TR_8 is used up as collector-to-emitter voltage drop across TR_7 . On the other hand TR_7 which needs the most drive because it handles the most current automatically is furnished the most drive because its emitter is directly at ground potential.

The number of transistors that may be included in a cascoded circuit is limited only by the base voltage versus collector voltage characteristic exhibited by the transistors when they are in saturation.

In present practice five transistors may be cascoded easily if no special biasing is provided.

Odd Parity Checker

The application of the circuits to the mechanization of Boolean algebraic expressions is similar to mechanization by relay circuitry. The relay diagram can be used to advantage as an intermediate step.

The problem may arise as the design of an odd parity check circuit which senses whether the number of ones in a four-digit register is odd or not. The Boolean expression would be

$$\text{odd} = a(bcd' + bc'd + b'cd + b'c'd') + a'(bc'd' + b'cd' + b'c'd + bcd)$$

The next step would be the construction of the relay diagram for the expression. The result is shown in Fig. 5A.

The transistor circuit is constructed directly from the relay diagram by considering the transistors analogous to single-pole single-throw relays which are normally open. A transistor is inserted in the relay diagram for each con-

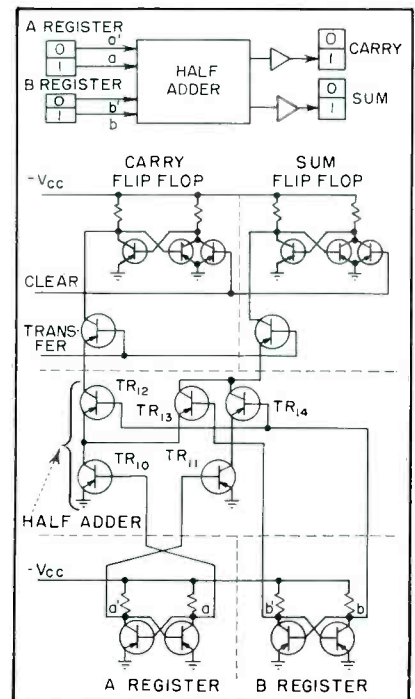

FIG. 7—Complete half-adder circuit

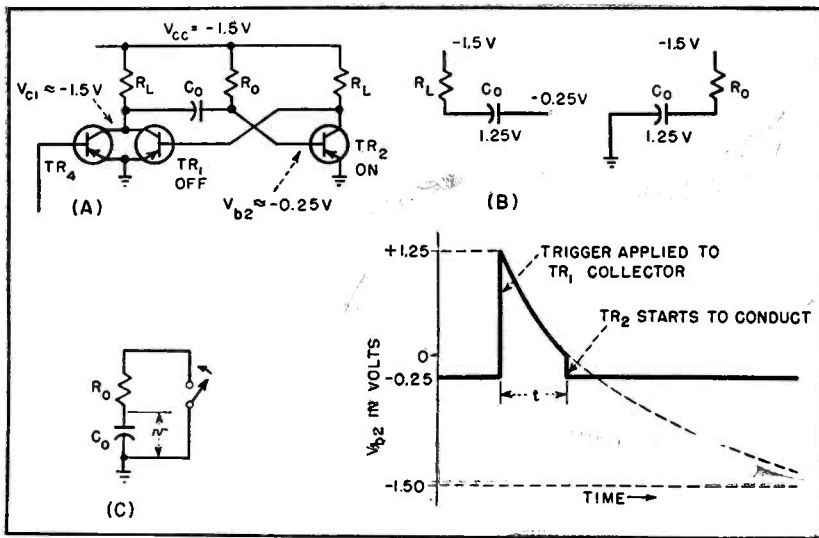

FIG. 8—One-shot multivibrator (A), operation in normal state and at instant of triggering (B), capacitor discharge circuit (C) and discharge waveform

tact. The transistor circuit constructed for odd parity checking is shown in Fig. 5B.

The operation of this circuit is similar to the and gating circuits. The output line remains essentially at $-V_{cc}$, unless restricted to a lower value by the next circuit, until the appropriate bases are energized to provide a low impedance path from the load resistor to ground. The driving requirements are also similar to the and gating circuit.

Half Adder

The development of a half adder circuit follows a similar procedure. The Boolean expressions are

$$\begin{aligned} \text{sum} &= ab' + a'b \\ \text{carry} &= ab \end{aligned}$$

The relay diagram is shown in Fig. 6A. The transistor circuit is shown in Fig. 6B. The operation is similar to the and gate circuit. The signals required to operate this circuit can be obtained directly from flip-flop registers and the output can set another flip-flop register directly as shown in Fig. 7.

If a one is stored in flip flop A (A register), the a' line will be essentially at ground potential and the a line will be negative, providing drive to the base of TR_{10} but not to TR_{11} . A zero stored in A will provide drive to the base of TR_{11} but not to TR_{10} . Similarly, a one in B will provide drive to the bases of TR_{12} and TR_{14} , and no drive to TR_{13} . A zero in the B register will reverse

this condition.

When A and B have been set in the appropriate zero or one state and the sum and carry flip flops cleared, the transfer gate is energized. A sum or carry will be read into the appropriate flip flop.

One-Shot Circuit

The one-shot circuit is a monostable flip flop, useful in control circuits of digital computers. The one-shot circuit has only one stable state, but it can be triggered to the other state which it maintains until some time later when it returns automatically to the stable state.

A one-shot circuit can be considered as a saturation flip flop with an R-C circuit inserted in one of the collector-to-base circuit paths. A one-shot circuit is shown in Fig. 8A.

In the one-shot circuit, TR_2 is normally maintained in the saturated state by the base current supplied through R_0 . The collector of TR_1 is normally near supply voltage, because normally only a negligible amount of I_{cc} flows through it from TR_1 and TR_4 . A negative signal applied to the base of TR_4 triggers the one-shot circuit in a manner already discussed for the flip flop.

Circuit voltages are given in Fig. 8A and the normal-state condition is shown in Fig. 8B (left).

At the instant the one-shot circuit is triggered, resistor R_0 in

Fig. 8A has impressed across it the sum of the stored voltage in C_0 and the supply voltage. This situation is shown in Fig. 8B (right). The resulting current through R_0 commences to discharge C_0 , as shown in Fig. 8C.

Astable or free-running operation of the one-shot circuit of Fig. 8A can be obtained if the value of R_0 is such that TR_2 is not given sufficient base drive to produce collector saturation. For astable operation both TR_1 and TR_2 must be biased so that their operating points are in the active or high-gain region. Then, any slight circuit disturbance will produce a condition of sustained oscillation.

Applications

The family of circuits makes use of transistors and resistors only, except that some capacitors may be incorporated in control circuits. The data-handling speed capabilities of these circuits is largely dependent upon the rise and fall times of the transistors used in the circuits.

Surface-barrier transistors in switching service exhibit rise times of the order of 0.08 microsecond and fall times around 0.10 microsecond. These transistors, used in a twenty-bit arithmetic unit, have performed satisfactorily when the following control-signal durations have been allowed for the separate operations that make up an addition time: clear a row of flip flops, 0.25 microsec; transfer a data word, 0.25 microsec; clear and allow carry propagation, 2.00 microsec; and transfer the result, 0.25 microsec.

The maximum total add or subtract time in this twenty-bit arithmetic unit is 2.75 microseconds and the multiply, divide or square root time is no more than 55 microseconds. The carry propagation time is proportional to the number of bits in a word so that a sixteen-bit arithmetic unit is somewhat faster in operation, being capable of about 425,000 additions or subtractions per second. Changes in the circuits or in the logic can increase the operating speeds still further, but these changes tend to increase the number of circuit components.

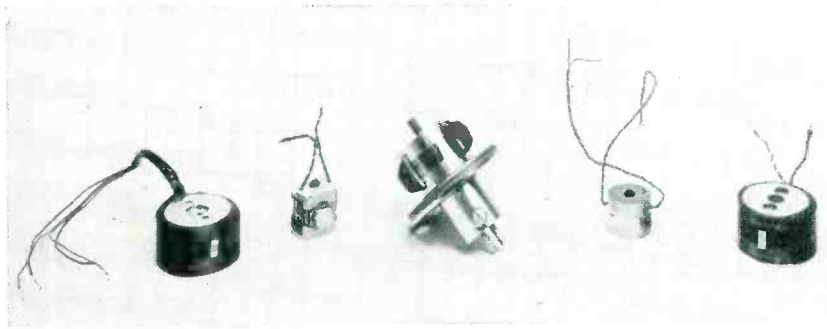

Experimental units used to evaluate magnetic materials in record and reproduce heads. Comparisons indicate that . . .

By **CARROLL W. LUFKY**

*U. S. Naval Ordnance Lab.
White Oak, Md.*

and

WESLEY T. HEATH

*Heath Electronics Co.
Washington, D. C.*

Alloy Improves Magnetic Recording

SUMMARY — High-aluminum-content iron alloy possesses good soft magnetic properties yet is physically hard. Recording and reproducing heads using the new Alfenol have advantages of wear resistance, increase in resolution and decrease in core losses

A MATERIAL that is magnetically soft and physically hard is unusual. This is evidenced by the fact that a physically soft material is used in practically all applications of magnetic recording and reproducing. Ferrites employed in an effort to circumvent the head wear problem^{1, 2} have not, despite their physical hardness, had entirely suitable magnetic properties. In addition, other problems of physical and magnetic nonuniformities lead to fabrication or other difficulties that may result in inferior units.

Alfenol, a binary alloy of between 10 and 16 per cent aluminum with the balance iron, is one of the first high-aluminum content aluminum-iron alloys to be produced in a thin, ductile cold-rolled sheet form³. That such alloys possess good soft magnetic properties has been known for many years.^{4, 5} However, owing to their extremely hard and

brittle character, they could not be produced in sheet form suitable for fabrication into laminations for magnetic structures.

Figure 1 shows the hysteresis loops of 16-Alfenol and 4-79 molybdenum Permalloy, a commercial alloy commonly used in record and

reproduce units. That Alfenol has magnetic characteristics similar to molybdenum Permalloy is clearly shown by the similarity of their respective *B-H* loops. Table I gives a comparison of some of the magnetic and physical characteristics.

On the basis of both electrical

Table I—Alfenol and Permalloy Properties

	Max Permeability μ_{max}	Initial Permeability (μ_i at $B = 20$)	Coercive H_c	Saturation B_m	Remanence B_r	Electrical Resistivity micro-ohm-cm	Hardness	
							Rockwell	Brinell
Alfenol (16% Al, 84% Fe)	116,000	3,450	0.025	7,825	3,800	150	25R _c	256
Moly-Permalloy (4-79) commercial grade	112,600	16,600	0.023	8,490	5,200	45	60R _b	100

resistivity and hardness, the new material possesses exceptional properties, particularly for an application such as record and reproduce heads. The extremely high electrical resistivity gives a low eddy-current loss value. Hardness of 25 (Rockwell C scale) approaches that of tool steel. Because of the material's extreme physical hardness it resists degradation of its magnetic properties through strain induced in processing and handling.

In the as-rolled sheet form, Alfenol has a very thin, tightly adherent film of aluminum-oxide on its surface. This film in turn forms an excellent surface insulation when laminations punched

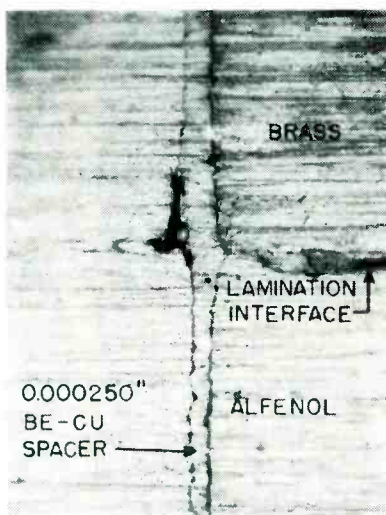

Microphotograph shows widening of beryllium-copper insert at boundary with brass (upper half) compared with Alfenol (lower half). Lamination interface is clearly visible at right center

from the sheet stock are stacked.

Several experimental units used in this investigation are illustrated. Both single and multichannel units were studied. The heads were fabricated from 0.006-in. cold-rolled sheet stock using conventional fabrication techniques. To measure accurately the physical-vs-electrical gap spacing, high-precision, hard-temper beryllium-copper foil was utilized as a spacer material. Foil thicknesses varying from 1,000 to 230 microns were used in establishing the physical gaps.

To eliminate the problems that normally attend the use of high-

impedance heads, such as low resonant frequencies, the inductance of all experimental units was kept below 20 millihenrys. To maintain a symmetrical magnetic structure the rear gap in all cases was the same dimension as the front. The units having small gaps were potted to maintain dimensional stability.

Although several core configurations were made, most of the data here reported were taken on units having a core 0.7 inch inside diameter and 1 inch outside diameter.

Resolution

The electrical resolution of the units was measured at a tape speed of 3.75 in. a sec by determining the frequency at which the first null appeared. This null in head output occurs when the recorded wavelength on the tape is equal to the electrical gap dimension of the reproducing head.

In all new alloy units measured it was observed that the electrical resolution and physical gaps were practically the same. Table II shows the physical-vs-electrical gap measurements. The physical measurements were made by directly measuring the gap under an optical microscope using a Filar-type eyepiece that had been calibrated by a precision ruled stage. Comparison of the two shows a close correlation for the Alfenol units.

The excellence of Alfenol in holding an electrical resolution nearly the same as the physical resolution is accounted for, in part, by the fact that during the lapping of the gap faces little loss in magnetic properties is incurred. It is known that a lapped surface is severely cold-worked. This cold-working results in virtually complete loss of high permeability in the material. However, due to the new material's extreme hardness, the depth of the cold-worked permeability loss is apparently small.

A softer material has a tendency to flow or smear, resulting in a much deeper penetration of the cold-worked surface. Thus a limitation is established on electrical resolution that is caused by the loss of magnetic properties of the inner surface of the gap. This permeability boundary creates an apparent air gap with poorly defined

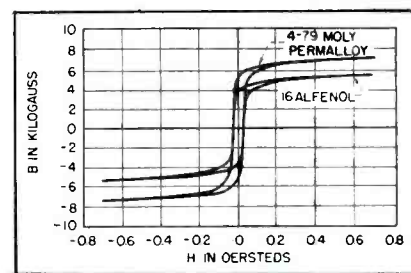

FIG. 1—Hysteresis loops for two magnetic materials

limits. This effect is illustrated in Fig. 2. Here curve A represents the ideal case where the core material permeability remains high and abruptly drops to a value of 1 (that of air) at the gap insert.

Curve B shows the effect of a slight permeability boundary at the core material surface, while curve C illustrates a more severe or deep boundary that would result from excessive cold working. From such a comparison as is given in Table II it may be concluded that Alfenol shows this effect only slightly and would be represented by a curve like that of B.

A second factor that accounts for the improved resolution obtained with the test units was observed in the course of taking precision optical measurements. It was noted that although spacer material from the same beryllium-copper foil was used in fabricating both types, the optical measurements from the new units were consistently lower than those from the others. To check this, an experimental head was constructed with a special brass lamination sandwiched in with the standard laminations of the new material. This brass lamination was chosen from stock that had approximately the same hardness as Permalloy.

Lapping Problem

The unit was then carefully lapped and the interface between the Alfenol and brass at the spacer insert was measured. It was found that where the Alfenol was in contact with the spacer, the spacer thickness was essentially the same as the original foil. However, where the softer brass was in contact with the spacer, the lapping

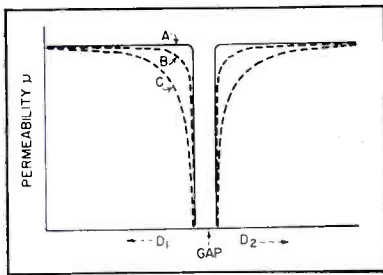

FIG. 2—Effect of permeability boundary in record head gaps

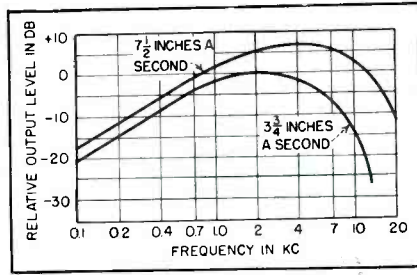

FIG. 3—Frequency response of 230-micronch gap reproducing units

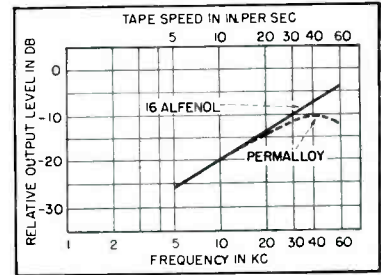

FIG. 4—Comparison of losses for two types of reproducing heads

had apparently caused the spacer foil to flow into the soft material. This resulted in an apparent thickening of the beryllium-copper spacer.

The photograph shows clearly the widening of the beryllium spacer insert at the boundary between the Alfenol and the soft brass lamination. A soft nonmagnetic brass was used in place of a Permalloy lamination for this test since a magnetic lamination would have introduced errors in subsequent tests on the unit. It is assumed, however, that physically the brass and Permalloy behave in a similar manner since they both possess similar hardness characteristics.

Figure 3 shows the frequency response curves for an Alfenol unit with a 230-micronch physical gap. That the electrical resolution of this unit approaches very closely the physical gap is apparent from these curves.

Head Losses

High electrical resistivity should result in a considerable decrease in core losses for record and reproduce units employing this material. To check this a single frequency of 5,000 cycles was recorded at a tape speed of 5 in. a sec using a standard head. The tape was then played back, using an Alfenol reproduce head, at speed increments to obtain playback frequencies of 5, 10, 20, 30, 40, 50 and 60 kc. For comparison a duplicate set of measurements was made using a conventional playback head.

Results of these tests are shown in Fig. 4. Up to a playback frequency of 60 kc (the limit of the measuring equipment used) the new unit showed no deviation from

the normal 6 db per octave rise, as compared to a drop of approximately 7 db in the other unit at 60 kc. As a further check, the bias power required in the new record head was measured and compared to the power required in a conventional head to produce the same results.

The reactive and resistive components of each head were measured on a precision bridge at a level low enough that further decrease in the level caused no change in bridge balance. The results of this experiment showed that the required power into the new head was 0.0312 watt, while that to the old head was 0.0718 watt. The comparative power required was therefore 43.5 per cent.

An advantage of the new head is its increased wear resistance. Direct substitution of reproduce units in actual theater equipment using magnetic sound tracks on film has resulted in an increase in usable life of the heads by a factor of 5 to 10 times. The new units had electrical properties so nearly the same as the standard units that only minor adjustments of preamplifier gain were required in the substitu-

tion. This increased head life represents a marked saving in operating cost.

In instrumentation uses where high calibration accuracy and constancy of calibration are required, experience has been excellent. For example, field tests utilized a recording system designed around multi-channel heads of the new material. This system was employed to record information contained in the audio components of the subcarrier of an f-m/f-m telemetering system used for vibration analysis of projectiles.

This system had an amplitude-vs-frequency characteristic of ± 1 db over the range of 30 to 10,000 cycles, with a 40-db signal to total system noise and crosstalk (at the 1-percent point). Although not required in the original specifications, the heads gave a frequency response and signal-to-noise ratio only slightly reduced over these values for frequencies in excess of 15,000 cycles.

The three advantages of wear resistance, increase in resolution and decrease in core losses of the new material all combine to make its use extremely promising for video recording on tape. Here high tape speeds, the need for high-frequency reproduction at low losses and especially the requirement for high resolution in the reproduce head all fall in line with available properties.

Table II—Measurements of Gap Interface

Core Material	Measurements in inches	
	Physical (Optical With Filar Eyepiece)	Electrical (First Null Method)
Alfenol	0.000250	0.000259
Alfenol	0.000223	0.000240
Alfenol	0.000430	0.000452
Permalloy	0.000430	0.00055

REFERENCES

- (1) Robert Herr, *ELECTRONICS*, p 124, Apr. 1951.
- (2) R. J. Youngquist and W. W. Wetzel, *Proc Department of Defense Symposium on Magnetic Recording*, Mar. 1954.
- (3) J. F. Nachman and W. J. Buehler, *Jour of App Phys*, p 307, Mar. 1954.
- (4) C. Sykes and J. W. Bampfyde, *Jour Iron and Steel Inst (London)*, 130, p 389, 1934.
- (5) H. Masumoto and H. Saito, *Scientific Report*, Research Institute, Tohoku University, 4, No. 4, 1952.

How to

By **ELBERT ROBERSON**

Port Washington, New York

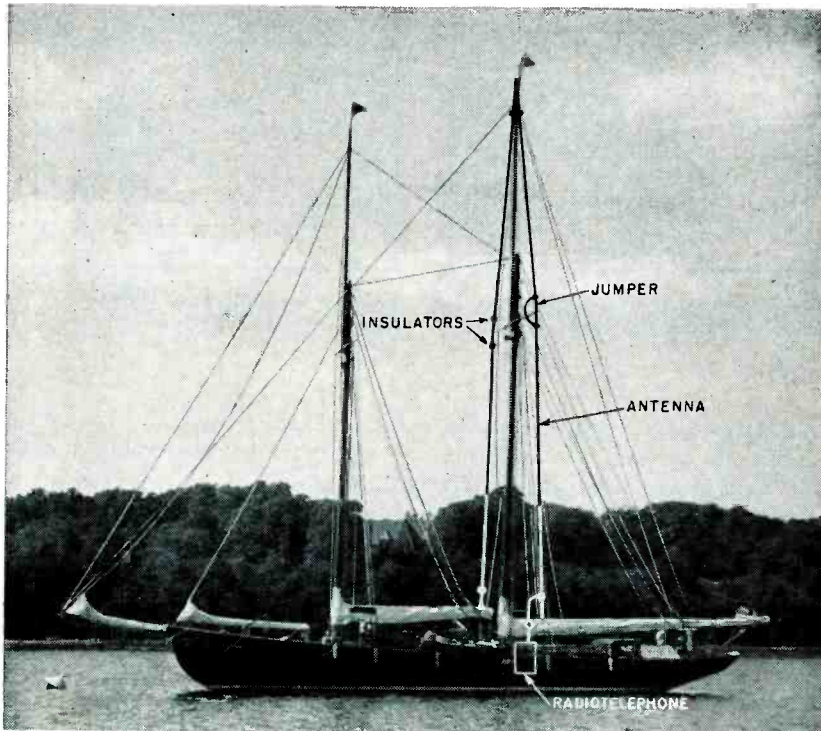

FIG. 1—Insulating main shrouds with 20,000-lb pole-line compression insulators provides antenna system for schooner *Sea Gypsy*

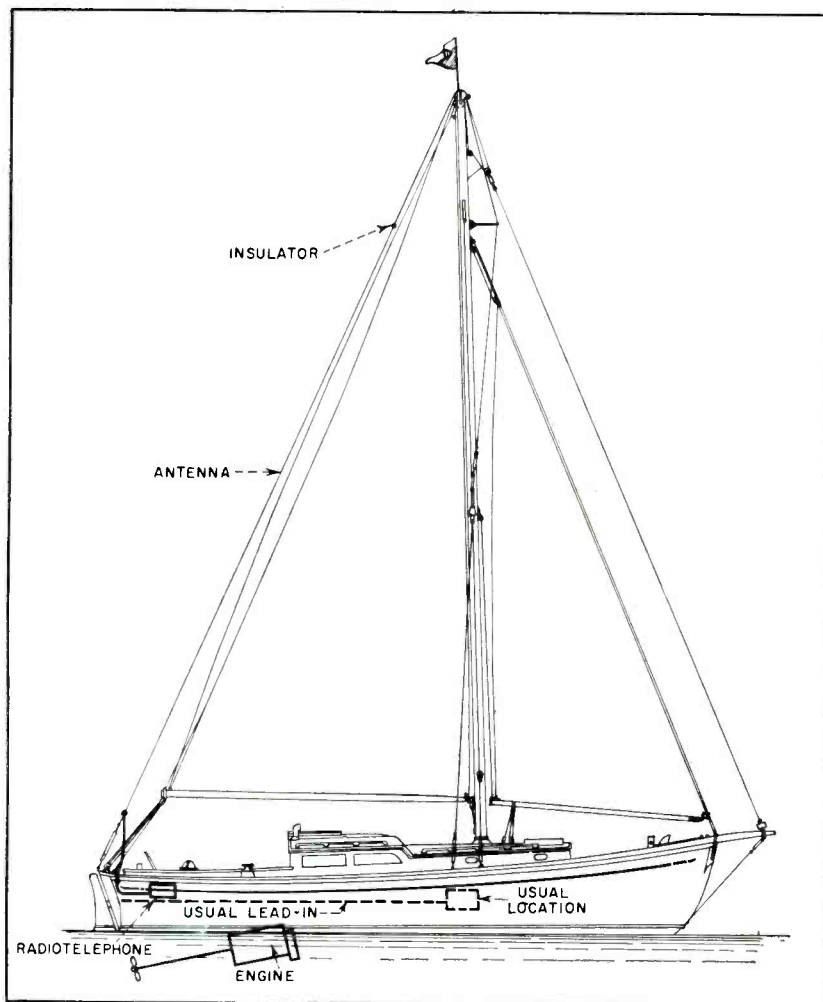

FIG. 2—Auxiliary cruising sloop *Eventide* uses insulated backstay as antenna radiator

THE DESIGN of medium-frequency transmitting antennas that will function in the maze of masts and rigging of a pleasure sailboat is one of the most difficult problems facing the marine electronics engineer. Three methods of attack have been found to be effective: insulate, isolate or incorporate. The one to use will depend upon the rig of the boat—whether sloop or schooner etc, upon whether the rigging is inboard or outboard and upon the existence of open areas that will not be interfered with by the working of the booms and sails.

Marine-radiotelephone channels lie between 2.110 and 2.198 mc. Transmitters are designed to operate on several channels within this range with tuning for the various stages accomplished by multiwafer band switches selecting pretuned elements. Power output runs from 10 to 100 watts.

The transmitters are designed to operate directly into capacitive (shorter than $\lambda/4$) antennas having resistances from 3 to 100 ohms. Optimum effective antenna height is 85 feet, $\lambda/4$ at 2.738 mc. Maximum communication range is desired. Circumstances may require spanning several hundred miles with less than 100 watts of power. Since vessel's headings may be any point of the compass, the antenna radiation pattern should be as omnidirectional as possible.

Insulating the Rigging

A proper selection of rigging wires themselves can be bonded and used as a broadband radiator. High

Design Sailboat Antennas

SUMMARY — Antenna systems installed on sailing vessels present unusual problems for medium-frequency radiotelephone communications. The techniques described are applicable also to oil rigs and other objects having extensive superstructure

frequencies can be accommodated through harmonic operation and the lowest marine frequencies can be reached by using a suitable loading coil. The installation illustrated (Fig. 1) on the schooner *Sea Gypsy* shows how the principle may be applied.

When the vessel is underway there is no clear space aloft in which an antenna could be hung so as not to interfere with sails, rigging or booms at some point of sailing. Yet a permanently installed and highly efficient antenna was an absolute requirement due to the extended voyaging of the vessel. The only practical solution was to insulate part of the rigging for use as an antenna. The outer main shroud on the port side was chosen.

Layout of the vessel permitted installation of the transmitting equipment in the main cabin almost under the foot of the shroud. Allowing 20 feet for lead in and ground connection left 65 feet required to make up the optimum length.

Shipyard riggers removed each of the $\frac{3}{8}$ -in. steel-cable shrouds one at a time and eye spliced a 20,000-pound porcelain compression insulator into each end. Twenty feet of the upper and 42 feet of the port main shroud were then bonded by a 3-foot phosphor-bronze jumper. Remaining main shrouds were insulated similarly but not connected.

The remaining rigging was of such a length or occupied such an angle that it did not interfere seri-

ously. During subsequent cruises of the vessel no directional effects were noted and successful communications at extreme ranges were common. The New York marine operator could easily be reached from as far away as Trinidad with the vessel's 75 watts.

Isolating the Antenna

On most vessels extensive alterations to the rigging cannot be made. At the most, only one wire

may be broken with insulators. Using one of the shrouds for an antenna with the remainder of the shrouds not insulated results in excessive absorption and variable loading as adjacent wires move or work.

With vessels having a standing backstay, the backstay is usually isolated enough to be insulated top and bottom and this makes an effective radiator.

The upper insulator must be

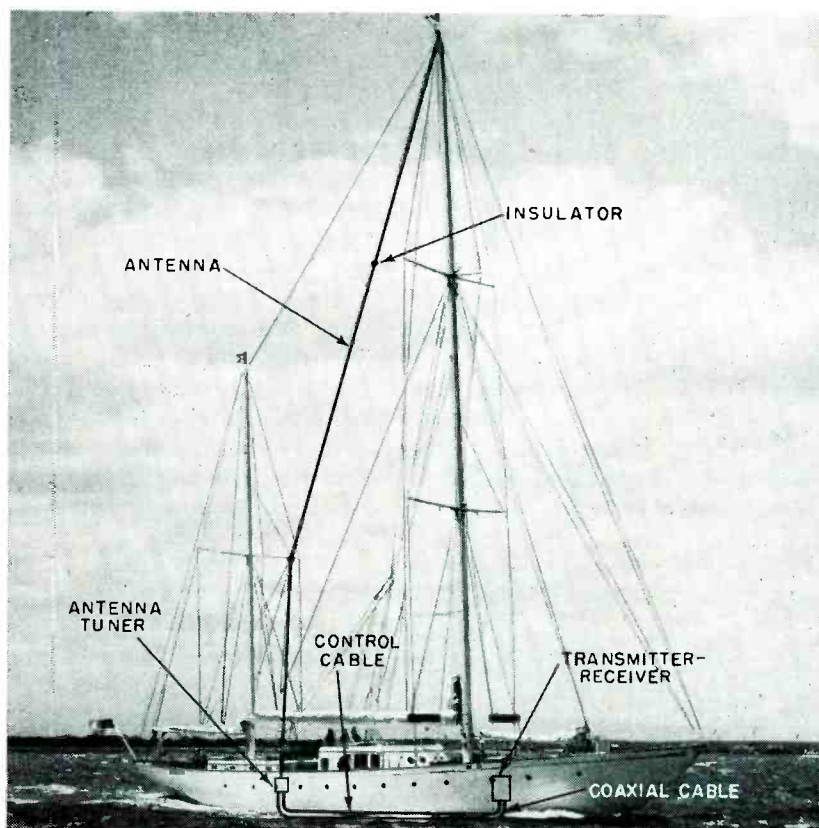

FIG. 3—Coaxial lead-in reduces antenna system loss in installation aboard steel-hulled yacht *Mercury V*

placed so it does not foul the boom lift and the lower insulator must be kept as close to the turnbuckle or transom fitting as possible. Care must be taken that the lead-in insulator is not a physical hazard to the crew, that it will not snag sheets or lie in water on one tack.

Overall length of antenna and lead in should not exceed the optimum figure. Capacitive loading often reduces the usable length to the neighborhood of 65 feet instead of the free-space value of 85 feet.

Even if antenna length is ideal, there are several disadvantages to the simplest utilization of the backstay some of which can greatly reduce both the efficiency and reliability of the equipment.

The sail plan of the *Eventide*, Fig. 2, illustrates the important points. The normal location of the radiotelephone transmitter would be in the main cabin near the mast or in the dog house further aft. The lead-in from the bottom of the backstay to the equipment would be in excess of 25 feet. A low-level horizontal run with the high-current portion of a Marconi antenna is undesirable under the best conditions. On a boat this horizontal run may be below the waterline and at best is surrounded by soggy wood and other wiring. It must pass directly by the auxiliary propulsion engine, picking up noise which may obliterate all signals.

Transmitter Location

From the standpoint of antenna efficiency, the transmitter should be as far aft as possible. In the *Eventide*, dry space was provided in a locker at the stern of the cockpit. The equipment can be operated from on deck or with a remote-control unit from the cabin.

On some vessels an ideally iso-

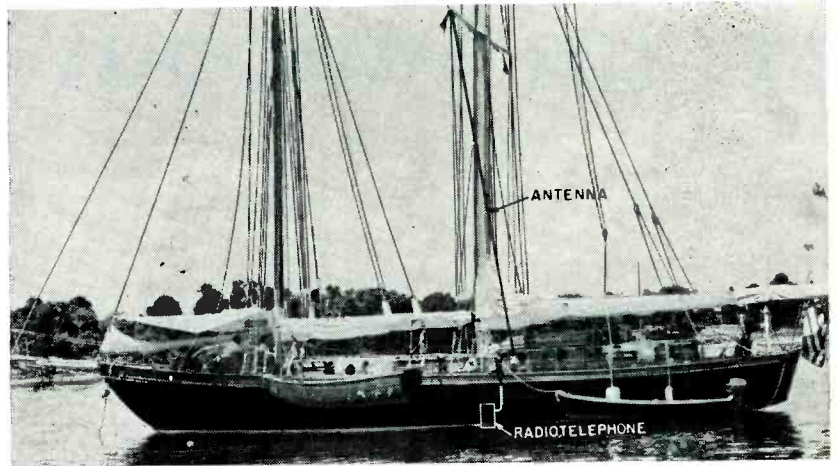

FIG. 5—Racing schooner *Mistress* uses permanently rigged antenna near lower main shrouds

lated wire may exist, but it may be located at such a distance that a directly-connected antenna circuit cannot be used. An excellent example is the 110-foot steel-hulled yacht *Mercury V*, illustrated in Fig. 3. The area above the main backstay was sufficiently in the clear for hanging an antenna which gave excellent performance. However, to reach the radiotelephone equipment which was installed in the main cabin near the mainmast a 75-foot lead in was required.

To avoid the extreme loss which would have resulted in running the first half of the antenna through the steel hull, the transmitter was altered to feed a low-impedance coaxial line using standard fittings and RG-8/U cable. The antenna-loading coil was removed and output taken from the antenna-coupling taps in the tank circuit.

At the base of the antenna, inside the hull and just forward of the mizzenmast, a line-to-antenna-matching and antenna-resonating network was installed. The proper amount of inductance for antenna resonance on each channel was

chosen by a relay actuated by voltage provided by the rewired transmitter antenna-tuning switch and fed aft by a multiconductor control cable. A telephone-talking circuit to aid in tuning was also provided in the control cable. The system is shown in Fig. 4.

In other vessels of approximately the same layout it has been possible to obtain almost equal results with only one relay in the antenna-tuning unit since the marine transmitting frequencies are roughly divided into two groups—one around 2.6 mc and the other around 2.1 mc. Two compromise adjustments will give satisfactory operation over the two frequency ranges in any antenna of reasonable proportions.

This simplification permits the use of only one cable between transmitter and antenna tuner since by separating r-f and d-c circuits with chokes and capacitors, the d-c current for the tuning relay can be supplied through the r-f transmission cable.

Other Arrangements

A further possibility in this direction is the use of a saturable reactor for remote antenna tuning. Direct current for operation of the reactor can be provided through the r-f line.

Attractive, but usually impractical is the often-projected use of the top stay between mastheads of larger vessels. Unfortunately, there is the problem of getting power to the antenna without excessive loss as in the case of back-

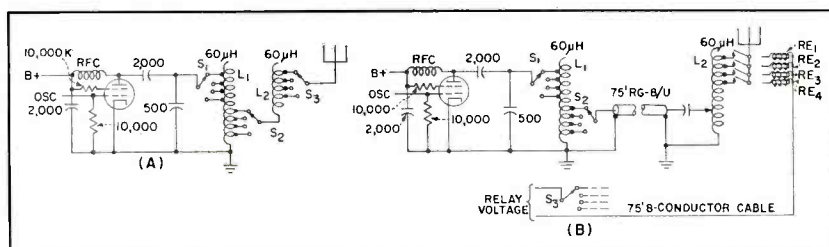

FIG. 4—Original tuning circuit for *Mercury V* antenna (A) and modified circuit (B) using 8-conductor control cable

stay antennas. In addition, such wires aloft cannot be worked against ground except through the use of a half-wave ground line which adds tuning complications. Work on scale models shows upper stays can be used when use of loading coils or a counterpoise transforms the antenna to a half-wave system which can be fed by a non-radiating coaxial line. The same tuning arrangements as illustrated in the case of the *Mercury V* are applicable.

On the ocean-racing schooner, *Mistress*, adequate coverage was obtained with an antenna permanently rigged near the lower main shrouds from deck level to a spreader tip. See Fig. 5. By bringing the base end of the antenna inboard with the wire at the greatest angle to the shrouds, intercoupling was low enough for satisfactory operation.

The operations of some sailboats which have no permanently available space for an efficient antenna, do not call for a heavy outlay for communications. In these cases a temporarily rigged antenna is often best. On each tack, clear space will exist somewhere aloft. When communications are desired a flexible, stranded antenna wire is simply hoisted into the clearest available space by a signal halliard.

Incorporation of Rigging

On some vessels it is desirable to incorporate the standing rigging into the antenna system. With the entire structure aloft acting as a radiator, shadows are entirely eliminated. Using the configuration of a fat folded monopole permits the use of the standing rigging without the introduction of insulators and requires only the bonding aloft and

the grounding at the bottom of the main rigging elements. The folded form of fat monopole may be fed by one or more wires arranged to control the feed impedance. Advantages to be gained are: more uniform directivity; decreased ground loss due to the impedance step up of the form; and automatic lightning protection.

In contrast to antennas consisting of one thin conductor, the fat form described by the usual sailboat rig has broadband characteristics which in some cases may equal the folded fan antenna frequency range of 4 to 1'. Approximate low-frequency cutoff length is $142/\text{frequency}$ in mc. The rigging of a vessel with a mast height of 65 feet should be adaptable for incorporation in a folded antenna that will cover not only the medium-frequency marine channels but also most high-frequency long-distance bands.

In the usual folded-antenna design, a fairly strict relation exists between the size and number of conductors and the impedance step up. However, due to the irregularities inherent in the many various boat rigs, the number of conductors in the system is not as convenient a gage as the area described by the conductors.

Figure 6 illustrates measurements made on a system of this design. If the transmitter can accommodate a fairly high resistance nonreactive load it is possible to feed a folded system with one conductor of reasonably large cross section.

The fact that the usual marine radiotelephone has a limited output-impedance range does not prevent the use of this form of antenna. By increasing the effective

area of the feed conductor in the monopole system through the addition of wires in a fan or cage configuration, the feed-point impedance can usually be reduced to a level which can be accommodated by the transmitter output circuit. In transmitters having extremely limited accommodation a simple L net may be used for impedance matching.

Noise

Any antenna system is likely to pick up electrical noise generated aboard. Not only does the auxiliary-engine ignition system and electrical equipment act as noise sources but any variable contacts aloft or below deck do also. Engine and motor noise can be eliminated by the usual means but special treatment is often required to reduce contact noise. In one case noise was thought to come from the engine, since the receiver rattles had the same period as the firing of the engine cylinders. Electrically silencing the engine showed that the interference was coming from variable contacts aloft which were rattling from the engine's vibration.

Conditions such as this can also affect transmission, so chance contacts should be minimized with any antenna system either by isolating the elements, insulating them or incorporating them into the system by bonding. Noise is also generated by electrolytic and static currents below deck.

Important installations should be worked out on a scale model. So many unknowns and variables are found aboard sailboats that it is virtually impossible otherwise to prepare accurate plans or predict operation.

A simple wire model, having the main rigging features and using a frequency to scale, will show the best layout, the feed impedance, radiation pattern and efficiency. Measurements which compare acceptably with those aboard ship can be made on a rigging model built over several feet of screening laid in any clear space.

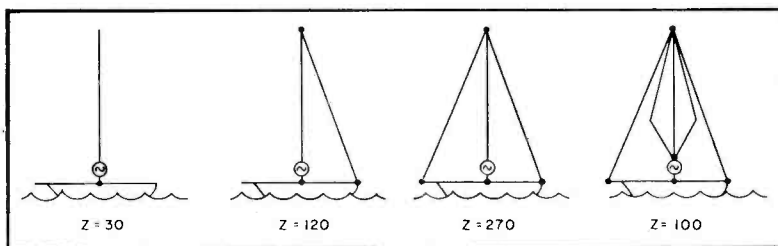

FIG. 6—Use of standard rigging simple isolated monopole, folded monopole using backstay, thin-fat folded monopole using back and forestays with thin feeder, and fat folded monopole using all rigging and cage feeder

REFERENCE

- (1) Linton, *Proc IRE*, p 1,436, Nov. 1951.

By RALPH C. KENNEDY

and HUBERT FRENCH

National Broadcasting Company
New York, New York

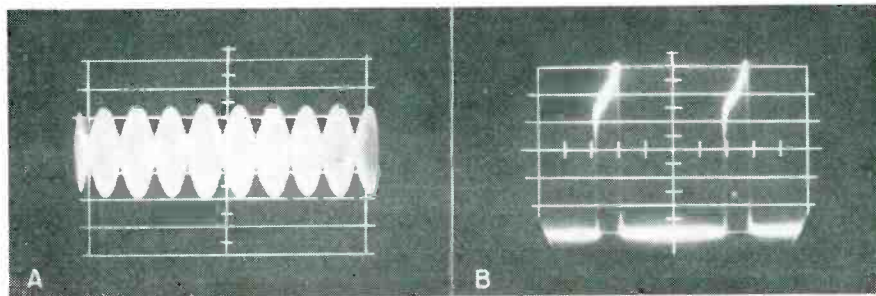

Output waveform of balanced modulator in transmitter when properly balanced (A); pulse output of multivibrator V_{12} (B)

Color-Video Envelope-

SUMMARY — NTSC specifications set up stringent phase-shift requirements for color television transmission. Phase shift is determined directly by measuring so-called envelope or group delay using measuring set consisting of transmitter and calibrated receiver separated by miles of circuits

COLOR-TELEVISION TRANSMISSION requires that envelope-delay measurements be made to a high degree of sensitivity. These measurements must be made on through systems, that is, those having input and output terminals widely separated. Finally these systems must be assumed to have clamper amplifiers located somewhere throughout their extent.

A specification for a system must include at least a steady-state response and phase requirement. The phase requirement is, when reduced to its simplest terms, the transmission time. All frequencies in the band of interest must travel through the system in the same

time. If the transmission time is longer for high frequencies than for low frequencies (series-capacitance shunt-resistance differentiating network) there is a piling up of the faster-traveling low-frequency information on top of the slower-traveling high-frequency information. This appears as an overshoot on a square wave or ringing on the trailing edge of a \sin^2 pulse.

Conversely, if the transmission time is shorter for high frequencies than for low frequencies (shunt capacitance-resistance integrating network) there is a pulling away of the faster traveling high-frequency information from the slower-traveling low-frequency in-

formation. This appears as an under-shoot on a square wave or a ringing on the leading edge of a \sin^2 pulse.

Phase Angle

The phase characteristic of a system is related to transmission time by the expression $\phi = \omega t$, where ϕ is phase angle in degrees, ω is angular velocity and t is time in seconds. If time is a constant the phase angle ϕ is proportional to frequency. This leads to a linear or constant-slope plot of ϕ versus f . If the differentiating circuit cited earlier is considered, its effect produces a curvature in the ϕ -versus- f characteristic which has increasing slope when frequency is plotted as abscissa. The integrating circuit causes the ϕ -versus- f characteristic to have decreasing slope.

The measurement of relative phase usually refers to the ratio of complex voltage at the output terminals of a system to the complex voltage at the input terminals. This requires some secondary path for the transmission of the input signal for comparison purposes at

COLOR SIGNAL—FCC DELAY SPECIFICATION

A sine wave, introduced at those terminals of the transmitter which are normally fed the color-picture signal, shall produce a radiated signal having an envelope delay, relative to the average envelope delay between 0.05 and 0.20 mc of zero μsec up to a frequency of 3.0 mc; and then linearly decreasing to 4.18 mc so as to be equal to $-0.17 \mu\text{sec}$ at 3.58 mc. The tolerance on the envelope delay shall be $\pm 0.05 \mu\text{sec}$ at 3.58 mc. The tolerance shall increase linearly to $\pm 0.1 \mu\text{sec}$ down to 2.1 mc, and shall remain at $\pm 0.1 \mu\text{sec}$ down to 0.2 mc. The tolerance shall also increase linearly to $\pm 0.1 \mu\text{sec}$ at 4.18 mc

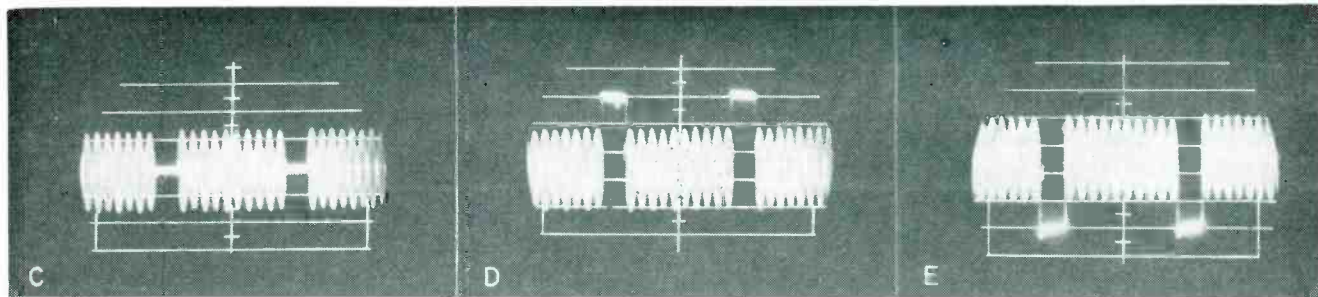

Possible variations in output of pulse-inserting circuit by adjusting output potentiometer. Waveforms show blanking pulse canceled and signal with only an a-c axis (C). Adjustment of potentiometer either side of center causes blanking to appear (D) and (E)

Delay Measurement

the output terminals when system measurements are attempted. This may be realized by using a low frequency for transmission over the secondary path and frequency multiplication at the receiving end. For spot frequencies this is not difficult but for a continuously variable frequency input is rather complex. Further complications arise when attempting to put the signal through clamper amplifiers. Therefore, while straight phase measurements are perfectly satisfactory for closed circuit measurements, they are not desirable in system measurements.

Envelope Delay

Envelope delay is the measurement of the slope of the ϕ -versus- f curve, also called group delay. It is the first derivative of the phase angle with respect to angular velocity. If the time of transmission is constant for all frequencies, that is, if the ϕ -versus- f curve is perfectly linear, the derivative is a constant. However, variations in the slope of the phase curve will produce variations in the envelope-delay curve. The complete expression for envelope delay is obtained by differentiating $\phi = \omega t$. From this it can be seen that the envelope-delay characteristic consists of undulations about transmission time.

Measurement Theory

If ϕ and ω are made larger, we have instead of the derivative the

ratio $\frac{\Delta\phi}{\Delta\omega}$. Practical considerations dictate the value of $\Delta\omega$. As the value of $\Delta\omega$ is made smaller, the accuracy of scanning the phase characteristic increases.

Envelope delay may be measured in two different ways. Either $\Delta\phi$ is kept constant and the corresponding $\Delta\omega$ is measured or $\Delta\omega$ is fixed and $\Delta\phi$ is measured. The latter method is used in this system.

Accuracy

The basic theory involved in the measurement of envelope delay relates to the phase shift produced in a signal consisting of two frequencies spaced $\omega = 2\pi\Delta f$ apart. If such a signal is passed through a system, the two frequencies will appear at the output with their phases shifted according to the phase shift at each frequency caused by the system. It is possible to show that the envelope delay time

$$T_e = \frac{d\phi}{d\omega} = \frac{\Delta\phi}{2\pi\Delta f} = \frac{\phi_2 - \phi_1}{2\pi(f_2 - f_1)} \quad (1)$$

where ϕ_1 and ϕ_2 are the phases of the frequencies f_1 and f_2 respectively.

The expression above indicates the limit of accuracy of envelope-delay measurement. Suppose that a cable circuit is being measured which is mismated causing a reflection or echo to appear on the line. If the period of Δf used in making the envelope delay measurement is equal to the period of the

reflection on the line the envelope delay will appear to be perfect, since the two frequencies will ride along on identical points of the standing wave, but will be 360 deg apart. Thus phase variations will be completely lost to envelope-delay measurement. The only way to circumvent such a condition is to choose a smaller Δf .

The lower limit for Δf is dictated by another consideration. If Δf is small, phase variations, unless large, are hard to detect in conventional phase detectors. This problem may be eliminated by multiplying the two frequencies forming Δf after they have passed through the unknown. This produces a greater phase difference at the higher frequency.

As an example, the time for 1 deg at 100 kc is 0.0278 μ sec. If the 100 kc is multiplied to 1 mc, 0.0278 μ sec is equal to 10 deg.

Referring to Eq. 1, the actual determination of T_e reduces to the measurement of $\phi_2 - \phi_1$, since $f_2 - f_1$ can be measured.

Using a square-law detector for recovering the output signal yields for the envelope delay

$$T_e = \frac{\Delta\phi}{2\pi\Delta f} \quad (2)$$

To get the delay at some other frequency it is necessary to change both f_1 and f_2 keeping their difference (Δf) constant. Then $T_{e1} = \Delta\phi_1 / (2\pi\Delta f)$

One way to measure $\Delta\phi$ is to feed

the sine wave at frequency Δf of unknown phase into a comparator along with a sine wave of Δf but with constant phase. The output of the comparator is then proportional to $K \sin \Delta\phi$. If the indicating meter has a zero center and reads ± 90 deg for full scale, I is current for 90 deg deflection and $2I$ is current for full-scale deflection. Then $2I = \sin \phi$ or $\Delta\phi = \sin^{-1} 2I$. Thus

$$T_e = \frac{\sin^{-1} 2I}{2\pi\Delta f} \quad (3)$$

allows the determination of envelope-delay time by knowing Δf , ($f_2 - f_1$), and reading I from a meter.

Reference Signal

A reference signal must be fed into the phase comparator. This signal should be taken at the input terminals of the system under test and sent to the receiving end for comparison purposes. It should also arrive there in a non-phase-shifted condition compared to the Δf information. This requirement means that the reference signal cannot be sent over a secondary channel which may have a different transmission time.

Since a fundamental requirement is to be able to make measurements on circuits having clamper amplifiers, some type of pulse information must be included in the test signal for development of clamp pulses. The presence of such pulses points to a base frequency which may be used at the receiving end as a reference signal for the comparator. Such an approach is used in the present set.

The use of the blanking pulse as a reference frequency dictates the lowest value of Δf which may be safely used. The magnitude of the higher order components is sufficient to create errors unless the value of Δf is large enough.

Since energy distribution is a $\sin x/x$ function, the components have amplitudes less than 4 percent down to a frequency of about 100 kc. Therefore, the value of Δf must be larger than 100 kc if serious errors are to be avoided.

The signal blanking-pulse generator and the source for the Δf must be tightly locked in frequency and instantaneous phase variations between the two kept to a minimum. This requirement is so stringent

that a local oscillator having very high stability is used to generate a frequency of $\Delta f/2$ or 100 kc. This frequency is divided by six in a circuit which maintains a high degree of phase constancy between the 100-kc and 16.66-kc frequencies. The 16.66 kc is used as a blanking or synchronizing-pulse frequency.

Transmitter

In the circuit diagram of the transmitter shown in Fig. 1 the input to V_1 is fed a signal generator having a continuously variable frequency range from about 200 kc to 10 mc.

The grid and plate signals of V_1 are supplied to diagonal arms of a crystal bridge which acts as a balanced modulator. Oscillator V_2 provides a 100-kc output. This output is amplified in V_3 after which the phase is split in V_4 and fed to the remaining diagonal arms of the balanced modulator.

The two potentiometers and variable capacitor associated with the modulator as well as the potentiometer at the input are used to adjust the balance of the modulator output. When operating properly,

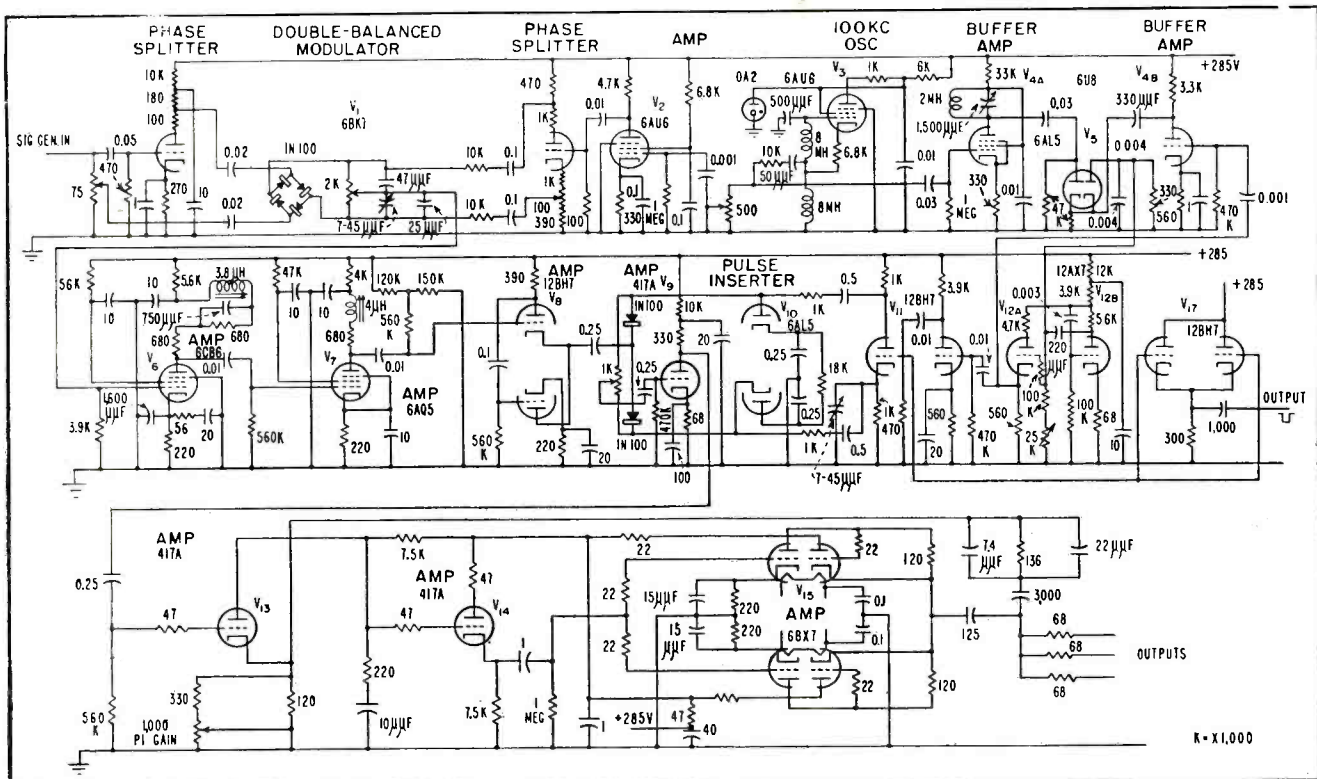

FIG. 1—Circuit diagram of transmitter in envelope-delay measuring system. Input to transmitter from signal generator is kept below 0.3 volt peak to peak

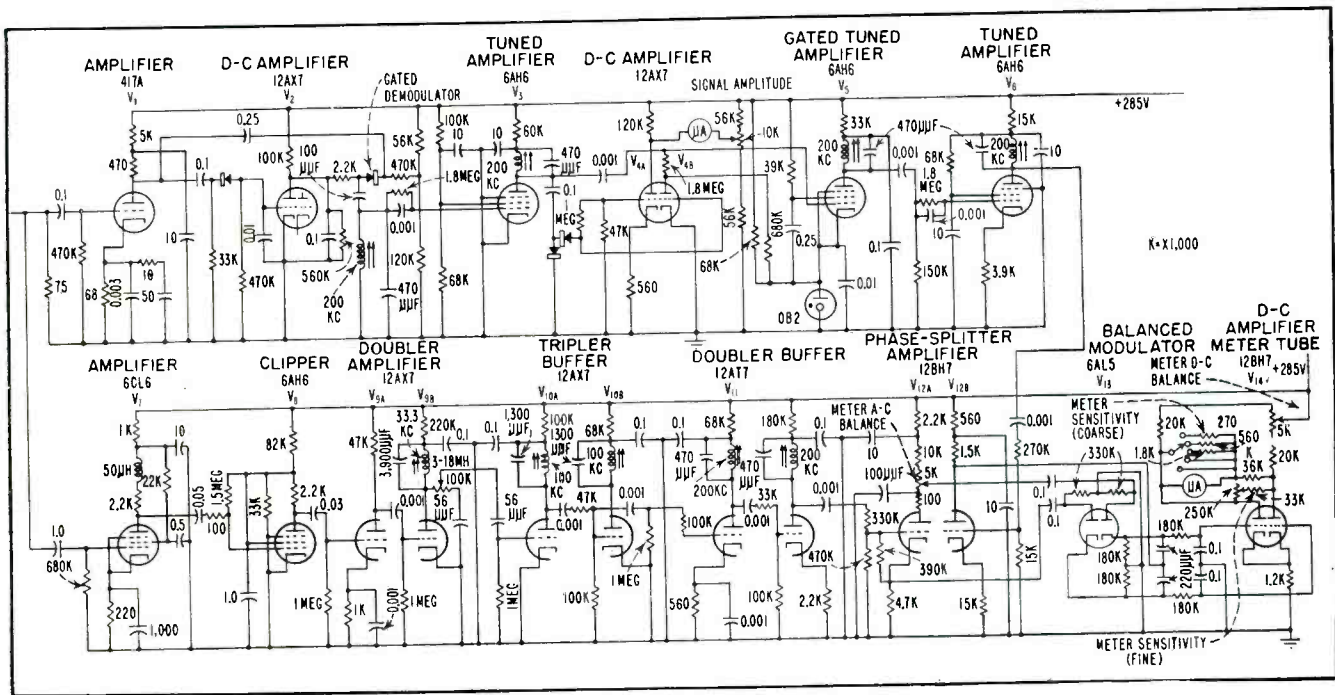

FIG. 2—Signal from unknown system is split at output of V_3 and fed to two different circuits in the receiving unit of the envelope-delay measuring set

this output should consist of two frequencies f_1 and f_2 which are 200 kc apart. They represent the products resulting from the modulation of the signal generator input by the 100-kc signal generated by oscillator V_3 . In a doubly balanced modulator the modulating frequency is suppressed as is the carrier frequency. Frequencies f_2 and f_1 represent the upper and lower sideband components of modulation respectively.

As an example, if the signal generator is set to 2.0 mc the values of f_2 and f_1 are respectively 2.1 and 1.9 mc so that $\Delta f = f_2 - f_1 = 2.1 - 1.9 = 0.2$ mc.

The local oscillator also supplies energy to the pentode section of V_1 , which acts as a tuned buffer amplifier. The amplified signal goes to V_5 which produces a saw tooth at the cathode. The d-c component is used to control the firing time of multivibrator V_{12} . The pulse generated at the output of the multivibrator is amplified in the triode section of V_4 and coupled to the cathodes of V_5 for comparison purposes.

Tube V_{11} amplifies the pulse, splits its phase and then supplies the pulse-inserting circuit of V_{10} .

Returning to the balanced modulator, its output is amplified by V_6 , V_7 and V_8 . The output of V_8 also

feeds the pulse-inserting circuit mentioned above.

Operation of the pulse-inserting circuit provides means for controlling not only the amount of pulse inserted into the signal but the magnitude as well.

The pulse-inserting circuit is followed by amplifier V_6 , which in turn is followed by a straight one-to-one line amplifier utilizing V_{13} , V_{14} , V_{15} and V_{16} . This amplifier has low differential gain and phase distortion, flat frequency response well beyond 10 mc, envelope delay to $+0.01 \mu\text{sec}$ and delivers 1.73-volts peak-to-peak composite signal from a 75-ohm impedance into a 75-ohm load.

The output of the line amplifier is ready for application to the system under test. This can be any circuit or device operating at a 75-ohm impedance level, a-c or d-c coupled, with or without clampers. This includes switching systems, lap-dissolve and effects amplifiers, cable or microwave circuits and transmitters.

Receiver

Tube V_1 in Fig. 2 amplifies the signal and passes it to the first of two amplitude-gating circuits. Part of the signal is passed through a crystal diode which rectifies the signal and provides a d-c potential for bias on d-c amplifier V_2 . The

magnitude of this bias is a function of the amplitude of the wave-packet portion of the signal.

Connected to the plate is another crystal, the cathode end of which receives its signal through the second path from V_1 . This crystal is non-conductive until the wave-packet information of the input to V_1 is high enough to produce a large enough bias on V_2 to raise its plate voltage.

The plate voltage is raised to unbias the signal-path crystal to pass only the wave-packet information but not the pulses. This provides positive gating action, in the sense that the circuit passes no information when the signal level is reduced below a certain minimum value. However, no amplitude compression occurs at this point.

Crystal Rectifier

The crystal in the signal path has another function in addition to being a gate. It is also a rectifier for detection of the 200-kc Δf component from the r-f envelope. The detected information is now in the form of an intermediate frequency and is selectively amplified by V_8 .

The output of V_8 feeds two circuits. One is a crystal doubler circuit which provides d-c bias for the grids of V_4 . The negative bias increases as the signal across the plate impedance of V_8 increases.

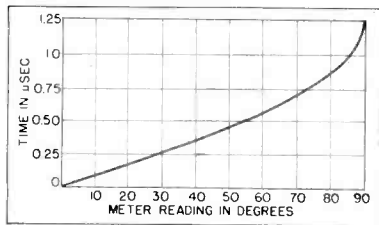

FIG. 3—Calibration curve of envelope-delay set

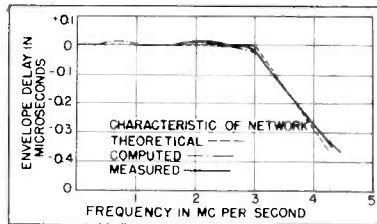

FIG. 4—Envelope-delay (NTSC) for equalizer network for color transmitters

Tube V_{4A} is a d-c amplifier with a meter in the plate circuit for indicating relative transmission.

Tube V_{4B} is also a d-c amplifier whose output provides bias for the grid of V_5 .

Tube V_5 is the second amplitude gating circuit. When no signal is present across the plate impedance of V_3 , no bias appears on the grids of V_4 ; both halves draw maximum plate current and therefore have minimum plate voltage. This causes the grid of V_5 to be negative with respect to its cathode and the tube is cut off. As signal at the plate of V_3 increases, V_4 which is a sharp-cut off tube, suddenly stops conducting causing a rapid rise in the grid potential of V_5 . The result is that at the plate of V_5 the signal is either present or absent, with only a small change required at V_3 .

Final sine-wave purity of the signal is realized by the tuned circuit in the plate of V_6 . The output of this stage is fed to V_{12} whose operation is considered later.

Returning to the input of the unit, a second feed appears at the grid of V_7 . This stage is a straight high-gain wide-band amplifier. The signal is clipped and further amplified in V_8 so that all the wave-packet information is removed and only pulses appear at the plate.

Further amplification occurs in V_9 . Frequency multiplier V_{9B} has an output of 33.33 kc. Tube V_{10} is a tripler producing a sinusoidal output of 100 kc. Buffer amplifier V_{10B} reduces the harmonic content.

Tube V_{11} is a doubler and buffer. Thus one grid of V_{12} receives the 200 kc reference sine wave while at the other grid of the same tube the 200 kc Δf of the signal appears.

The output of V_{12} , which acts as a phase splitter, is balanced for application to V_{13} . This tube acts in

conjunction with the associated bridge circuit, as a balanced modulator. Tube V_{12B} is an amplifier for the signal voltage prior to application to the balanced modulator.

The balanced modulator operates V_{14} which has the envelope-delay meter in its plate circuit.

Transmitter Operation

A source of sine wave at 400 to 500 kc is introduced at the input terminals. The oscillator frequency is first checked against a frequency standard. At this point the signal should be a pure sine wave. Operation of the pulse-generating multi-vibrator is checked by comparing the frequency of the pulses at the cathode of V_{12A} with the 100-kc oscillator frequency. It should be 1/6. The pulse width at the cathode is about 11 μ sec.

The gain control in the cathode of V_{13} is adjusted to give 1.73-volts peak-to-peak signal into 75-ohm terminations at the outputs of V_{15} and V_{16} . The signal is then ready for use in adjusting the receiver unit.

Receiver Operation

The signal input to the transmitter is reduced to zero. The transmitter output is connected directly to the receiver input with as short a cable as convenient (not over a foot of 75-ohm coaxial cable). The polarity of the pulse in the transmitter output is adjusted to be negative.

Remove the transmitter signal completely and adjust the METER D-C BALANCE in the plate of V_{14} for zero center of the meter. Check balance by increasing meter sensitivity.

Reapply the pulse signal from the transmitter to the receiver and adjust the METER A-C BALANCE CONTROL in the plate circuit of V_{12A} to

again produce zero on the meter.

Apply a 400 to 500-kc signal to the input of the transmitter. The signal level of 200 kc at the cathode of V_{12B} should not exceed 10 volts peak to peak. If this value is not realized, check tuning of circuits in grid of V_3 ; plates of V_3 , V_5 and V_6 .

The METER PHASE CALIBRATION potentiometer in the plate of V_{14} is adjusted for a maximum on the meter. Adjust the meter-sensitivity controls for exact full-scale meter deflection. Readjust the METER PHASE CALIBRATION for equal and opposite meter indication. If this condition is not realized re-check previous zero settings. Now reset meter to exact zero by readjusting METER PHASE CALIBRATION.

The envelope delay set is ready for use. By inserting an unknown between the transmitter output and receiver input, the envelope-delay characteristic can be determined as the frequency of the signal input to the transmitter is varied between about 350 kc and 10 mc.

The envelope delay is given by Eq. 3. With $\Delta f = 200$ kc and $I = 50$ microamperes the envelope delay is $T_p = 0.796 \times 10^{-6} \sin^{-1} 20 I_m$ sec.

The meter is calibrated in degrees from -90 to $+90$. At 200 kc 90 deg is equivalent to 1.25 μ sec. Thus the meter reads from -1.25 to $+1.25$ μ sec (Fig. 3.)

Additional sensitivity is realized by changing the resistance shunting the meter with the METER-SENSITIVITY COARSE control.

Several types of apparatus were checked, among them an equalizer intended to produce the envelope-delay characteristic specified by the NTSC for color transmitters. The results are shown in Fig. 4.

BIBLIOGRAPHY

- H. Nyquist and S. Brand, Measurement of Phase Distortion, *BSTJ*, 9, p 522, July 1930.
- A. Schroeder, A Sweep Method for Measuring Envelope Delay, *PTR-251*, May 1952.
- Heinz E. Kallmann, Equalized Delay Lines, *Proc IRE*, p 646, Sept. 1946.
- P. Mertz, Influence of Echos on Television Transmission, *Jour SMPTE*, 60, p 572, May 1953.
- R. C. Kennedy, Cable Equalization for Television Studio Circuits, *RCA Review*, 15, p 581, Dec. 1954.
- H. A. Wheeler, The Interpretation of Amplitude and Phase Distortion in Terms of Paired Echos, *Proc IRE*, 27, p 359, June 1939.
- G. L. Fredendall, Delay Equalization in Color Television, *Proc IRE*, 42, 1, p 258, Jan. 1954.
- R. C. Kennedy, Sine-Squared Pulses Test Color-TV Systems, *ELECTRONICS*, p 138, Dec. 1954.

Waveform Generator Uses Pulse Techniques

SUMMARY — Flying-spot scanner type of function generator for use with analog computers is made insensitive to phototube output level or drift in the d-c amplifiers by a pulse-sampling technique that uses the phototube only as an indicator making its output level relatively unimportant

By **E. E. NEWHALL** *University of Toronto
Toronto, Canada*

MANY RELATIONSHIPS such as rectifier characteristics or magnetization curves that must be simulated in analog computers are known only in graphical form. The analog function generator is a device that accepts a specified input voltage and delivers an output voltage determined by the characteristic of the device to be simulated in the computer.

The function generator to be described is at least as accurate as devices currently used for this purpose. It provides the advantages that stable operation is easily obtained without critical adjustment of oscilloscope controls and that the

system is free from drift problems. It is helpful to discuss the standard type of photoelectric waveform generator¹ as a basis for development of the improved version. The standard setup is shown in Fig. 1A.

Standard Technique

The phototube is in a lightproof box mounted so as to pick up the light from the trace of an oscilloscope and the output of the phototube is fed back to the Y amplifier of the oscilloscope. The input is a voltage to the X amplifier of the oscilloscope, and this voltage is proportional to some known function.

Suppose the input voltage is proportional to the magnetomotive force in a magnetic amplifier, and it is desired to obtain a voltage proportional to the flux in the core of the magnetic amplifier. A mask, as shown in Fig. 1B, is cut to the same shape as the flux-magnetomotive force characteristic of the material in the magnetic-amplifier core. The mask is then fitted on the face of the oscilloscope. With the Y amplifier disconnected, the spot is centered on the vertical center line of the tube face close to the top of the tube face.

When the Y amplifier is connected, the output from the photo-

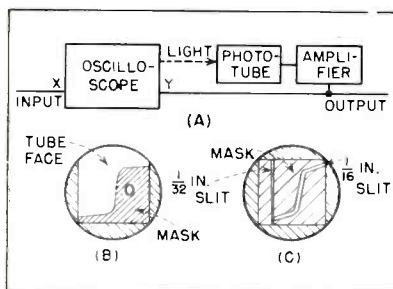
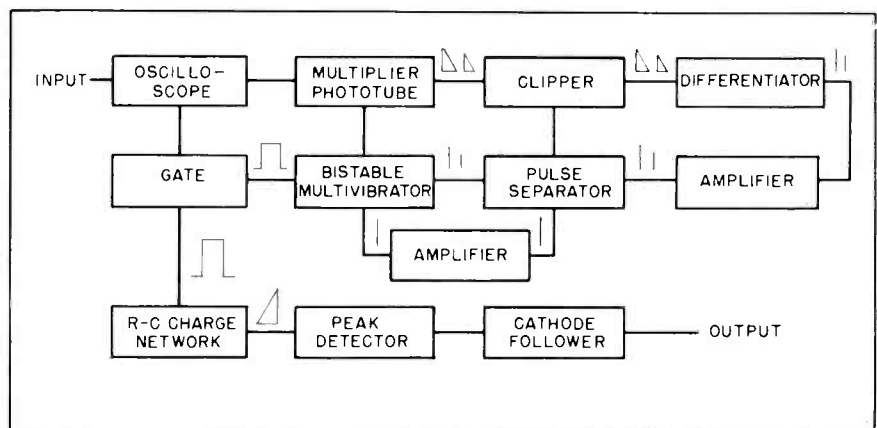

FIG. 1—Basic function generator (A), standard mask (B) and modified mask (C)

FIG. 2 (right)—Modified function generator illustrating relationship of major circuits



tube is of polarity such that when fed back to the Y amplifier it causes the spot to move down. The spot will move down until it starts to go behind the mask on the tube face. The output of the phototube decreases and the spot will come to equilibrium partly obscured by the edge of the mask.

For any X signal displacing the spot from the vertical center line of the oscilloscope the same procedure takes place with the spot coming to equilibrium at the edge of the mask. The signal to the Y plates of the oscilloscope varies in accordance with the way in which the edge of the mask is cut. Thus if the X signal is a continuously varying signal the spot will follow the contour of the mask and the Y signal voltage will be proportional to the desired output.

The equilibrium of the spot on the edge of the mask depends upon the settings of the Y-gain, intensity, focus, Y-position and X-position controls. The system requires careful adjustment of these controls if spot equilibrium is to be maintained. Otherwise the spot may fail to move all the way down to the mask or may move well below it. The careful adjustment required is the main disadvantage.

Setting up the function generator

requires the use of d-c amplifiers in the oscilloscope, thus any drift in the amplifiers causes a change in average spot position which often disturbs the spot equilibrium on the edge of the mask. The ability of the spot to follow exactly the contour of the mask will depend on the gain at the amplifiers between the phototube and the Y plates. However, as the gain these intervening amplifiers is increased to obtain greater accuracy the system is more likely to drift.

Improved System

To obtain a system which is relatively insensitive to the settings of the intensity and focus controls, the phototube is used only as an indicating device, the level of output being relatively unimportant. To eliminate drift problems in the d-c amplifiers, a sampling technique is used.

The mask was changed to that shown in Fig. 1C. When the spot crosses the vertical slit a pulse is developed by the phototube and is used to trigger a multivibrator. Although in crossing the slit the trailing edge is not well defined the leading edge is sharp and accurate timing is attained. Similarly, when the spot crosses the second slit the resultant pulse also triggers the

multivibrator. It is then possible to obtain an accurate measure of the desired time interval. The output pulse, when the spot crosses the Y axis, must be different from the pulse obtained when the spot crosses the curve so that the sequence of operation of the multivibrator is correct insuring proper interval timing. The interval between Y axis and curve must be timed, and not the interval between curve and when the spot again returns to the Y axis. To distinguish between pulses the slits are slightly different in width, the resultant pulses vary in height and may be separated by an amplitude separation method.

The modified circuit is shown in block diagram form in Fig. 2. The clipper is necessary as the triggering of the bistable multivibrator is sensitive to large changes in pulse amplitude. The trigger output of the phototube when the spot crosses the Y axis will be independent of the Y position providing the slit width is uniform. However, large variations in trigger output occur when the spot crosses the curve as the horizontal width of the slit will depend on the Y position. When the curve is almost horizontal the spot will be in the slit an appreciable time and a large output will

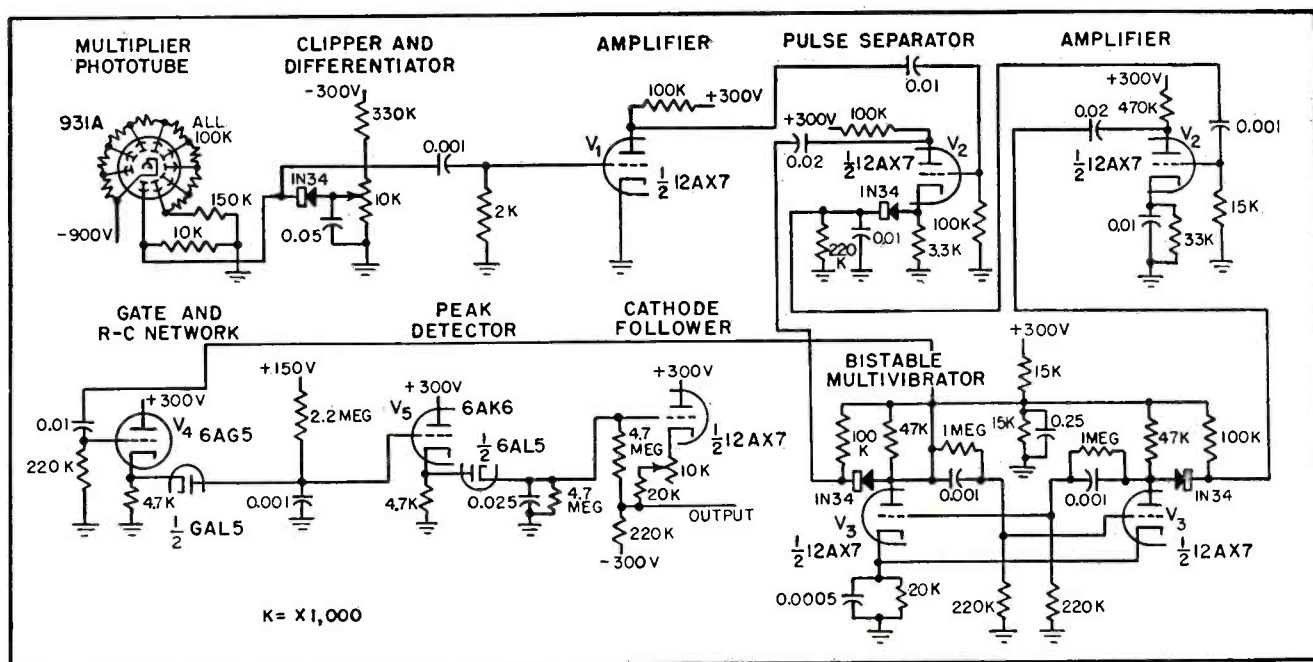

FIG. 3—Circuit details of modified function generator. Pulse separator and gate incorporate novel features

result. This variation in trigger output amplitude with input signal caused the multivibrator to misfire and a clipper was necessary to limit the peak trigger amplitude. The clipping level is set so that when the spot is crossing the part of the curve with the steepest slope the peak amplitude is on the verge of being clipped.

The pulse separator is necessary to establish the proper sequence of the multivibrator, as described previously, and the pulse duration of the output of the multivibrator is proportional to the unknown quantity. The most satisfactory way to obtain a voltage proportional to the output pulse duration was to allow a capacitor to charge linearly through a resistor for the pulse duration. The R-C time constant was large compared to the pulse duration. The peak voltage reached was proportional to the pulse duration and the peaks were retained by a peak detector.

The above process involves sampling the distance between the Y axis and the curve continuously and at a fast enough rate so that there is little change in this distance between successive sweeps. Thus the sweep frequency must be high compared to the frequency of the input signal. In the circuit shown here the sweep frequency is set to 5,000 cps and a signal frequency of 5 cps used in the analog computer.

Circuit Details

The circuit diagram of the modified function generator is shown in Fig. 3. The circuits are conventional with the exception of the pulse separator and the gate.

The grid of the pulse separator receives a series of pulses—alternately a large and a small pulse. The large pulse will charge the capacitor in the cathode circuit through the diode to the peak value of the large pulse retaining the sharp leading edge of this pulse. The capacitor will then discharge slowly through the 220,000-ohm resistor, such that the small pulse which follows the large pulse will not cause the diode to conduct. The R-C network following the 220,000-ohm resistor and 0.01-microfarad

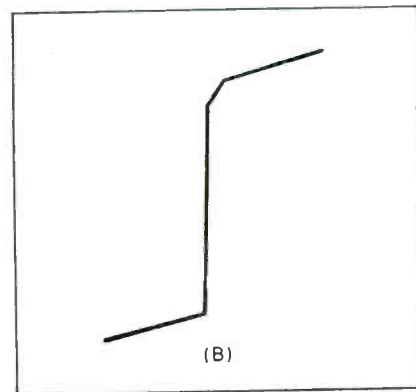
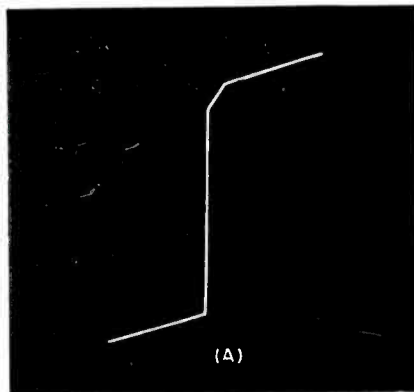

FIG. 4—Reproduction of characteristic by the function generator (A) and same curve as cut on mask (B) which overlays the oscilloscope face

capacitor differentiate the output retaining only the sharp leading edge of the large pulse. Thus the proper sequence of the multivibrator is established.

The gate tube will normally be conducting if the bistable multivibrator is inoperative. If a negative pulse cuts the gate tube off then the 0.001-microfarad capacitor will discharge through the diode until the potential across it is small. When a positive pulse turns the gate tube on, the diode is cut off and the 0.001-microfarad capacitor charges linearly through the 2.2-megohm resistor until the gate tube is again turned off. The charging time of the 0.001-microfarad capacitor is never long enough to cause the diode to conduct before the gate tube is turned off. The peak voltage from this R-C network is proportional to the desired output and the peaks may be retained by a peak detector.

A photograph of the output of this device is shown in Fig. 4A when the mask was cut as in Fig. 4B. A sine wave was applied to the Y axis of the function generator and also to the Y-deflection plates of a second oscilloscope. The output of the function generator was applied to the X plates of the second oscilloscope so that the figure seen should be a reproduction of the curve cut in the mask of the function generator. The scale of the photograph is such that any discontinuities in the output caused by a finite sampling rate would be difficult to see. However, on a normal oscilloscope it is impossible to see

the discontinuities when the oscilloscope gain is adjusted so that the output fills the tube face.

The main disadvantage of this system is the limit set on the upper frequency of operation of the analog computer. The highest frequency of input signal must be small compared to the sampling rate. The highest sampling rate is limited by the rate at which the bistable multivibrator can be successfully triggered.

Because the system relies on a sampling technique it is suited for the generation of double valued functions such as hysteresis loops. The hysteresis loop should be cut as a mask in the standard manner with slits on both sides of the loop. The phototube will then produce a pulse to begin the timing interval when the spot crosses the reference slit. This pulse will be followed by two other pulses either of which can terminate the timing interval. The pulse chosen for termination of the timing interval can be determined by a suitable gating technique.

This work was done during the summer of 1953 and supported by Defence Research Board of Canada under extramural grant DRB-66. The writer is grateful for the support extended by Defence Research Board.

The writer also acknowledges the guidance and assistance of J. M. Ham in supervising the work.

REFERENCE

- (1) D. E. Sunstein, Photoelectric Waveform Generator, *ELECTRONICS*, p 100, Feb. 1949.

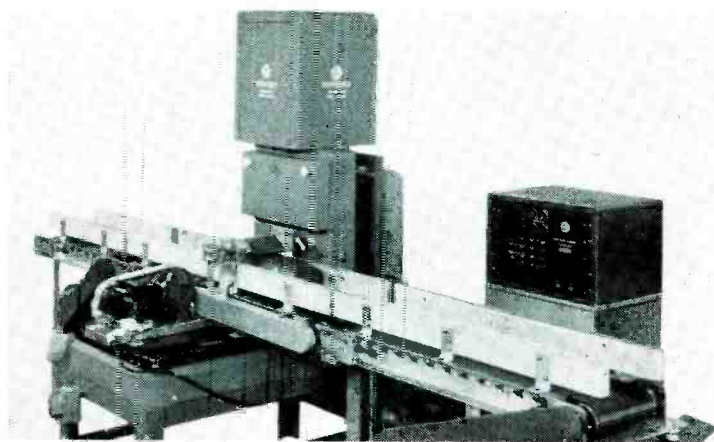

Weighing system for 100-pound projectiles. Accuracy of weight indication is within 0.02 pound

Electronic Weighing

By R. E. BELL
and J. A. FERSTLE

*Toledo Scale Company
Toledo, Ohio*

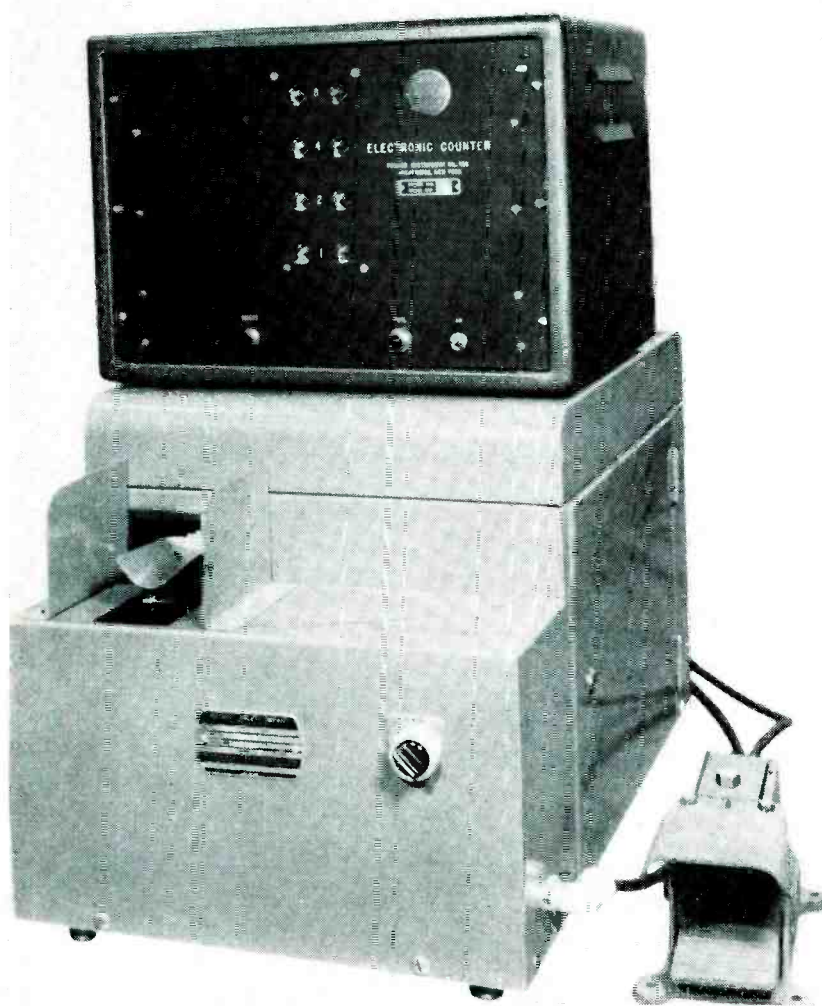

Scale for determining moment of inertia of jet-engine impeller blades provides weight indication on binary counter at top

AUTOMATIC PRODUCTION in industry has brought increasing need for high-speed weighing. Weight information for selection or control should be available at a rate that will not retard the flow of the product on the assembly line. The electrodynamic scale provides a means for obtaining weight rapidly and accurately.

Two methods of measuring weight are in common use. In the first method, as in a beam balance or pendulum scale, a known weight is balanced against the unknown weight with a manually or automatically adjusted lever arm giving the ratio of the two weights. In the other method, as in a spring scale, the weight is determined by measuring the displacement of a calibrated spring directly or indirectly supporting the unknown weight.

Spring Scale

The balance-type scale is inherently more accurate but is slower

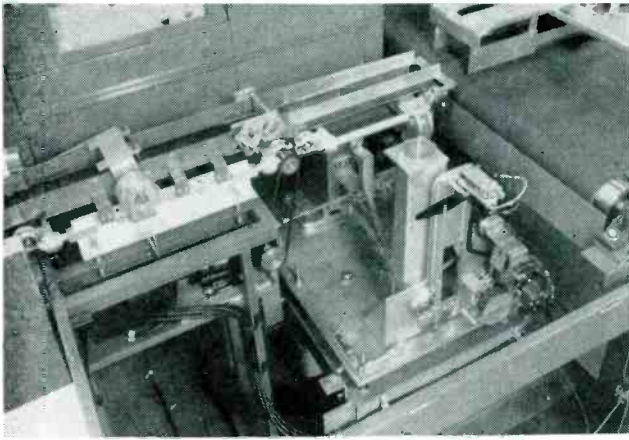

Conveyor-belt scale sorts automobile connecting rods into nine weight categories at rates up to 3,000 an hour

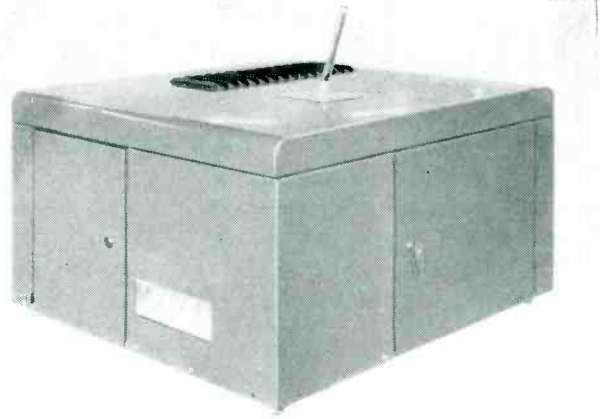

Twenty-millimeter shells inserted through tube at top of scale are weighed accurately within a few grains

on the Production Line

SUMMARY — Electrodynamic scales automatically sort parts into as many as 60 weight categories with an accuracy of better than 1/10 percent at rates up to 3,000 per hour. Predetermined counters provide weight reading and control signal for sorting gates

than the spring scale because a mass, in addition to the unknown weight, must be added to the system. The accuracy of a spring scale is limited by the basic characteristics of springs. Errors in spring scales may be due to hysteresis, creep, zero drift and change of spring modulus with temperature or from other causes.

Spring materials are now available that greatly reduce temperature effects. Hysteresis and related errors can be minimized by using the dynamic weighing principle. Normally, hysteresis effects in spring scales depend both upon the sequence in which the load is applied and upon the length of time the load is applied. Time-dependent errors are minimized in the dynamic scale by the short period of the load cycle. Errors are further reduced by the repetition of a uniform loading sequence.

Figure 1A illustrates the operation of the dynamic scale. There is no damping in this system. In

fact, care must be exercised to eliminate incidental damping due to friction. The characteristic equation of this type of system is

$$M \frac{d^2 X}{dt^2} + KX = W$$

where M = total mass of system, K = spring constant, W = weight and X is scale deflection.

A solution of this equation is

$$X = \frac{W}{K} (1 - \cos \omega t)$$

whose maximum value is

$$X_m = \frac{2W}{K}, \text{ when } t = \frac{\pi}{\omega}$$

Weighing time is the time required for one cycle of oscillation.

$$T = 2\pi \sqrt{\frac{M}{K}}$$

The weight platform is locked during the time weight is being placed on it or removed. When the weight is in position, the lock is released so the platform falls and the system goes through one cycle

of free oscillation. The maximum excursion of the system is twice the distance from the locked platform position to the equilibrium position that would be reached by an equivalent damped system. The maximum excursion is linearly proportional to the weight and can be used to measure the weight.

The requirement for measuring motion on the fly suggests the use of electronics. An electronic measuring method which is both accurate and flexible has been developed.

A lightweight arm or paddle is mechanically coupled to the platform so that it moves with the scale platform. Slots corresponding to equal increments of weight are cut in the paddle. As the paddle moves, these slots interrupt a light beam falling on a lead sulfide photocell. The output pulses from the photocell are fed to counter where they are added and stored. Weight can then be read directly from the counter or the counter can be used for control of other devices. A

block diagram of the system is shown in Fig. 1B.

Zone Weighing

In industrial weighing, it is often necessary to classify articles into several weight categories or zones. The electrodynamic scale can be adapted readily to this application by the use of a predetermined counter. The zones are set up by adjusting the predetermined count selector switches so the desired count will fill the counter and produce a read-out signal or zone indication. The counter circuits can also be arranged so the read-out signal resets the counter to a second zone. Any reasonable number of zones can be chosen in this manner. A set of selector switches is used for each zone.

The block diagram of Fig. 2 shows an arrangement for obtaining three zones of acceptable weight and an under and over zone. A two-decade counter has been chosen for purposes of illustration.

The lower limit for weight in acceptable zone A is set by counterbalancing the load with a tare beam or similar device so weights less than this limit produce no pulses into the counter. When the scale is

cycled under this condition no pulses are generated. The under zone control flip-flop is turned on by a reset pulse from the scale at the beginning of the weigh cycle. All the other zone-control circuits are reset to the off position.

If the weight is in zone A, then one or more pulses are received from the scale. The first of these pulses turns the under control circuit off. An output pulse from the under circuit turns on zone A control and presets the counter through preset switches to the predetermined value for A.

If the weight is great enough to produce enough pulses to fill the counter when preset at A, a counter-filled pulse will be fed to all zone controls. This pulse will momentarily turn all the zone-control circuits off. Since the A circuit has been on, it will then produce an output pulse when it is turned off that will turn on zone-control circuit B. This output pulse will also preset the counter again through preset switches B. A similar sequence of events will occur for weights in zone-range C.

The thyatron output control circuits are keyed off for a short interval at the end of each weigh cycle.

When they are again turned on, the circuit which is connected to the on zone control is energized. The thyatrons usually operate solenoid mechanical gates for directing the articles being weighed into their respective classification bins or conveyor belts.

A weight zone for a system illustrated in the photograph can be divided into one to one-hundred weight increments merely by setting the preset switches. A single decade counter would be used if only ten weight increments a zone were required and a three-decade counter would provide one thousand increments.

The accuracy and linearity of this type of weighing system can be held to better than 0.1 percent under most conditions. Since it is essentially a digital system, its accuracy is not dependent on the stability of the electronic equipment. The photocell amplifier is designed to have a large gain margin so aging of the photocell or the amplifier tubes will not result in faulty operation. A shaping circuit is employed between the photocell amplifier and the counter such that the correct pulse for positive counting will be fed to the counting stages even if the pulses from the photocell are distorted.

Applications

The automotive industry has been the first to use this weighing technique. In automobile engines, balance of the component parts has been found to be of increasing importance. Connecting rods, for example, should be uniform in weight and should have centers of gravity located at the same point. One automobile manufacturer accomplishes this by weighing and sorting all connecting rod forgings, before any machining is done on them. Subsequent machining is then so adjusted that each connecting rod is machined to the same weight and has its center of gravity located at the same point.

When the scale shown in the photograph was placed in operation, it replaced four operators with manual scales or a system of four semiautomatic scales. This scale was designed to handle the entire production of connecting rods of

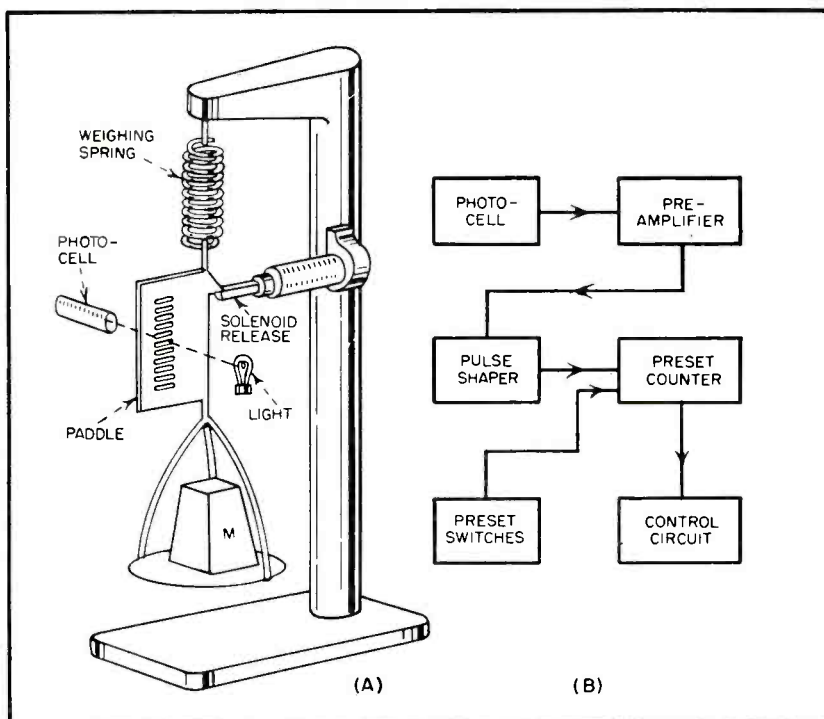

FIG. 1—Principle of electrodynamic weighing (A). Slotted plate interrupts light to photocell providing pulses to counter through preamplifier and pulse shaper (B)

one engine plant, about 3,000 rods an hour. The sorted rods emerge from the scale through nine separate channels. One channel contains those rods that are either too heavy or too light to be economically processed, while each of the other eight channels or zones contains a group of rods that are within the specified weight range of each other. Since the scale is completely automatic, no operator is required, and measurement is accomplished without interrupting the normal production line flow.

Many other objects have been handled successfully on the electrodynamic type scale. Both automatic and semiautomatic scales have been built to weigh automobile engine pistons. In the machining process, all the essential dimensions of the piston have been established without regard to weight. It is then necessary to weigh the piston and determine how much additional material must be removed to bring it to a specified weight. After the operator places a piston on the scale, it automatically goes through a weighing cycle. The operator then reads the electronic counter and translates this information to a vertical milling or boring machine for the final operation. Such information can also be automatically read into milling machines or any such device using digital type control devices.

A 100-percent check weighing of the finished pistons is the last step before they are assembled into the automobile engines. This operation may be conveniently located in the same area with automatic gaging machines, thus insuring that the group of pistons that goes into each engine is both dynamically and dimensionally suited for the task it must perform.

The one scale shown was developed in co-operation with the U.S. Army and one of its suppliers of 20-mm ammunition. The small tube at the top of the scale cabinet serves as the loading point and storage hopper for the scale. A feeding mechanism inside the cabinet extracts one round of ammunition at a time from this tube and places it in weighing position. The vented section in the rear of the

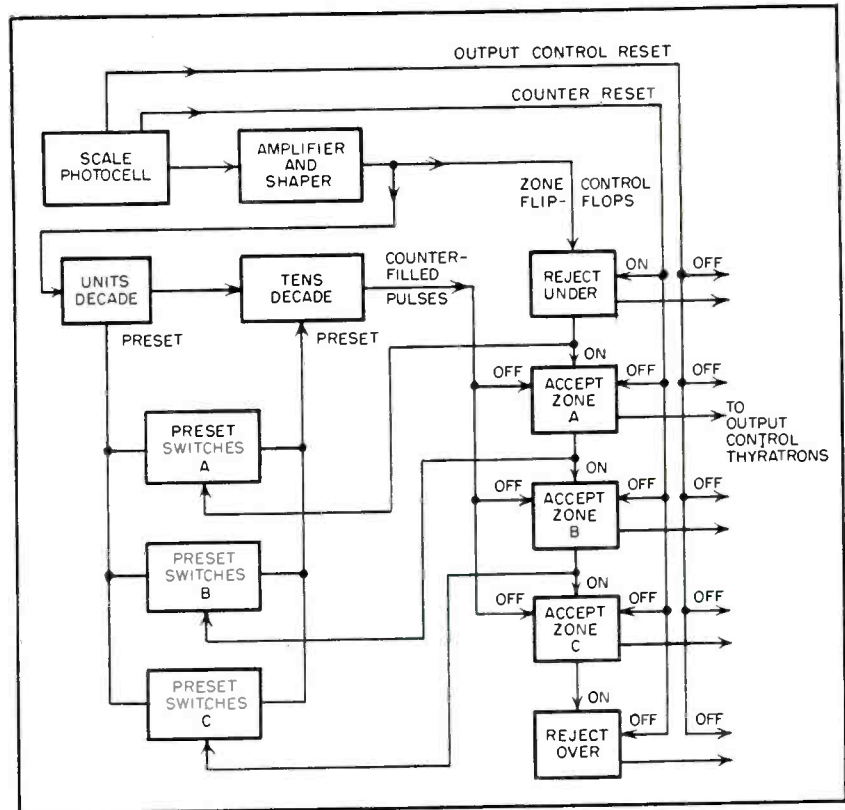

FIG. 2—Automatic weighing system provides two reject zones and three classifications of acceptable weight

cabinet contains the electronic counter-controller.

The controller operates rotary solenoids to divert the object into the proper output channels at the lower front section of the cabinet. A typical contract for this size ammunition might be for 2 to 3 million rounds, so that it is impossible to hand weigh each round without greatly increasing manufacturing cost. The electrodynamic scale allowed 100-percent inspection of these parts to an accuracy of a few grains (1 grain = 1/7,000 lb) and at the same time eliminated the need for an operator.

Jet Engine Blades

Aircraft jet-engine impeller blades must have a constant moment of inertia with respect to the center of rotation. It is necessary accurately to locate each blade on the scale and then measure its moment of inertia. An impeller blade is shown in position on the electrodynamic scale in the photograph. The operator releases the scale by means of the foot switch and reads the zone number corresponding to a value of moment of

inertia from the electronic counter located on top of the scale. An engine is then assembled with all blades from any one of the 60 zones.

All of the objects so far mentioned are relatively small in size and weight, none weighing more than 2 pounds. However, the electrodynamic scale principle can be applied to larger objects. An automatic scale of this type shown in the photograph is used to sort projectiles weighing as much as 100 lb, the scale being graduated to a resolution of 0.02 lb. For this application, a conventional static scale base and lever system was used with the dashpot or damping device omitted and the system was terminated in an explosion-proof housing that contained the electrodynamic scale. The basic scale unit is capable of check-weighing cartons and detecting off-weight units within the carton. It is also useful in checking total production weight for a period of time since its controls can be arranged to totalize the number of cartons in each of 20 or more weight zones passing over the scale, at rates up to 25 or 30 cartons per minute.

Getting the Most

SUMMARY — Comparison of legal and economic factors for several types of service. Circuits used in receiver for one-way signaling, selective calling and garage-door opener are described

MOBILE RADIO communications can be defined as exchange of signals and messages between land vehicles or between a land vehicle and a fixed station. Although similar radio transmitters and receivers may be used in many different applications, the use of any given frequency (or equipment applicable thereto) depends upon regulations of the Federal Communications Commission governing the class of service involved.

Mobile radio is generally two-way radio with equipment owned and maintained by the company or municipality using it. Equipment is occasionally rented. Full two-way communications may sometimes be unnecessary or undesirable. A more economical means, such as one-way signaling without voice modulation, may be sufficient.

In addition, there are other variables. For example, the owner of a taxicab company may elect to use conventional equipment in the region of 150 mc and share the band with several other competing com-

panies. Or he may decide to avoid present interference by spending somewhat more money on equipment for the region near 450 mc. However, there is no assurance that this region will forever remain uncluttered. Operations are on a developmental basis.

If he so desires, the taxi owner can obtain authorization to use developmental frequencies in the band 2,450–2,500 mc. Commercial equipment is not yet available here and use is sometimes subject to interference from industrial or medical devices in this band.

Best choice of frequency and type of equipment is based upon these and other considerations.

Types of Services

For purposes of rule making and frequency assignment, the mobile users are classified by FCC into three categories: Public Safety (Part 10), Industrial (Part 11) and Land Transportation (Part 16).

Public Safety includes police, fire, forestry-conservation and like

services. Industrial Radio takes in services like forest products, relay press, special industrial and low-power industrial. Land Transportation encompasses highway truck, railroad, taxicab, automobile emergency and other similar services.

While there may be few choices for a fire or police department to make in adopting two-way radio, this situation is not true for a large number of individuals or industries that are not specifically covered by the rules. For example, although those concerned with oil-well drilling are provided with communications and radiolocation frequencies, the oil delivery service in the local community is ineligible for Petroleum Radio Service.

The individual or industry seeking mobile communications facilities must consider the requirements and choices summarized in Table I. He must understand first, however, that radio cannot ordinarily be used wherever there are wire lines available, or where they can be economically provided.

Comparative Costs

Of lively interest to the prospective user of mobile radio equipment or service is the matter of costs. Should he buy his own system and provide for its maintenance or should he rent his system from the Telephone Co.? Perhaps an answering-service type system will be adequate, or even one-way signaling. Although each specific communications problem must be considered on its own merits, an example can be set up to show a number of the major points upon which

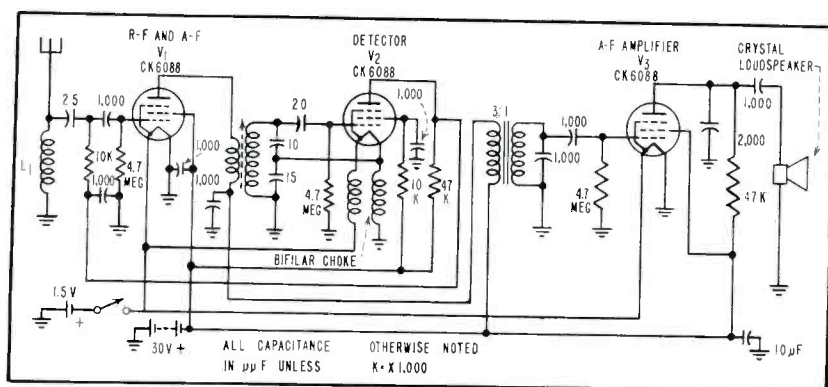

FIG. 1—Budelman miniature paging receiver uses three tubes in reflex circuit giving effect of four tubes

From Mobile Radio

By

ALEXANDER A. MCKENZIE

Associate Editor

a judgement must be based.

A hypothetical case for which dollar values are assigned in Table II is considered. Suppose a garage with three tow trucks wishes to use radio communications to speed its operations. It is assumed that a total of 300 messages a month will pass from the garage to the vehicles.

If the garage owner buys his own system, installing transmitter and antenna three miles from the garage in space rented in a suitably high building he will be required to lay out about \$2,772 and total cost per year may come to around \$1,400. His monthly charges will be essentially fixed, so that any messages in excess of 300 will cost him no more. Or, in other words, the cost per message decreases with the number of messages.

If limited common carrier service is available, in which a central operator handles messages to a large number of mobile units, the garage owner can relay each call through such an operator, but he may not talk directly with the tow trucks. In this case, his capital outlay will be about half, or \$1,500, to equip three trucks with transmitter-receivers and the total yearly cost will be nearly \$1,360. Greater use of the system will reduce the per-message cost of his equipment, but message charges and telephone calls continually increase the cost of use to some point of diminishing returns for the overall system.

Depending upon availability of radio service and the organization of the tow-truck system, the garage owner might be able to make use of



Typical two-way installation in highway tow truck speeds service and cuts down unprofitable mileage that might otherwise run up

Table I—Systems of Radio Communication Available

A license will be granted by the Federal Communications Commission:

- (1) For single-company operation on frequencies provided for special industries. These are described in the text and in Parts 11 and 16 of FCC Rules;
- (2) For operation on a cost-sharing, nonprofit basis in which several companies of a single industry co-operate in solving their mobile communications problems
- (3) If no other frequencies are provided for a given service, for use of the Citizens Radio band
- (4) For use of common carrier. In this service, the license is held by the company operating the communications service and the mobile station is subject to the licensee's control. This is like extension of telephone service, even to interconnection with wire lines. It is often operated by the telephone company
- (5) For use of limited common carrier. This system is like a radio secretarial service in which an operator relays messages to and from the mobile unit. The operating company, often an adjunct to a telephone-answering service, holds the basic license under which mobile units are authorized
- (6) No license is required by the listener-user of one-way signaling, which is a variation of common carrier systems. He listens to a small receiver at intervals. When he hears his code number he calls for his message from the nearest telephone. Other receivers that operate a buzzer or light when they receive the code are also becoming available
- (7) Included among services described in (1) above is the low-power industrial radio service. Here low-power transmitters could be used for one-way signaling (as from ground to overhead crane). Any person engaged in a commercial activity or industrial enterprise is eligible for a license

one-way signaling in which hand-held units are used to listen for radio calls from a central operator. Upon receiving a coded signal, the tow-truck driver calls in to the garage from the nearest telephone. It is then necessary for the garage to phone the radio dispatcher and ask that the call be taken off the air. This accounts for the 900 telephone charges—one to put the radio signal on, one to take it off, and one from driver to garage.

One-way signaling is attractive in that no license is required, there is no capital outlay and no maintenance. The service is unlimited. While the cost per message decreases with use of the radio system, the attendant telephone message costs increase with use.

Because of the many factors involved, it can be fairly said that costs, on the basis of 300 messages, are essentially equal for all three types of service. Actual cases may make use of alternatives that reduce costs or enhance the service. For example, the garage telephone

line could be tapped to intercept calls at the radio control point. The additional charge for this service might offset the time of a person at the garage to answer calls and dispatch tow trucks.

It should also be noted that in the specific case of company owned tow-truck radio service, all operations of both the base and mobile units are on the same radio frequency of 35.70 mc. This means that service is enhanced by mobile units being able to talk among themselves. In this way, signals might be relayed from garage to one mobile unit and then to another on the fringe of reception or in a shadow area.

Paging Receiver

Growth of one-way signaling systems has depended upon development of small receivers with minimum battery requirements and reasonably good rejection of undesired signals. Such equipment can be fixed tuned to either 35.58 or 43.58 mc, the frequencies assigned

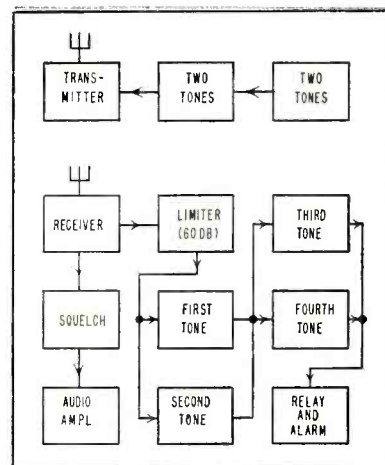

FIG. 2—Selective calling system used by Motorola in land mobile and aircraft signalling systems

to this service by the FCC.

Equipment so far produced uses the superregenerative circuit, which requires amplitude modulation of the associated transmitter for optimum system performance. The receiver described here is built into a steel case about 1 x 2 x 5 inches with a flexible antenna about 5 inches long protruding from the top end. A miniature loudspeaker, which is held near the ear, is built into the front of the case. A push-button turns the receiver on during the listening period.

The circuit of the Budelman Radio Corp. vhf receiver is shown in Fig. 1. Three subminiature pentodes are used in a four-tube circuit. The radio-frequency amplifier V_1 is employed in a reflex circuit as the first audio amplifier also. The r-f amplifier, broadly tuned by L_1 provides gain and eliminates detuning effects of body capacitance on the antenna. It likewise permits optimum coupling to the small, inefficient antennas that must be used.

When receivers are used within a few feet of each other, interference from radiation may result. Complete shielding of the detector and use of the r-f stage eliminates interference in this design. Sensitivity in the order of 2 to 3 microvolts is obtained at the grid of the first tube. A field strength of about 25 μ v per meter is required for satisfactory service.

Bandwidth is approximately 50

Table II—Three Ways to Call a Tow Truck

1. Privately owned radio system operating in Automobile Emergency Radio Service			
Capital Outlay		Monthly Charges	
Base station	\$800	Remote control line	\$7.50
Remote control	200	Talk line (3 mi)	15.00
Antenna and line	72	Space rental	5.00
3 mobile units @ \$475	1,425	Base station maintenance	7.50
Base station installation	100	Mobile maintenance	15.00
Mobile installations	75		
Remote control installation	100	Total	\$65.00
Total capital expense	\$2,772	Yearly charges (65 x 12) =	\$780.00
Interest and amortization (4% on 5-year basis) per year	\$621.00		
TOTAL YEARLY COST OF SYSTEM		\$1,401.00	
2. Using Limited Common Carrier Two-Way Radio on Subscription Basis			
Capital Outlay		Monthly Charges (300 Messages)	
3 Mobile units @ \$475	\$1,425	First 100	\$17.50
Mobile installations	75	Second 100	13.00
Total capital expense	\$1,500	Third 100	10.00
Interest and amortization	\$332	Telephone calls (300)	30.00
Yearly charges	\$1,026	Mobile maintenance	15.00
TOTAL YEARLY COST	\$1,358	Total monthly charges	\$85.50
3. Using One-Way Signaling (Hand-Held Receiver in Tow Truck)			
Monthly Charges (300 Messages)			
First 2 receivers and service	\$24		
Third receiver and service	11		
Telephone calls (900)	90		
Total monthly charges	\$125		
TOTAL YEARLY COST (12 X \$125)	\$1,500		



Announcing machine for one-way radio paging uses magnetic tape affixed to numbered Nylon block. Experimental tone-coded keyer at upper right

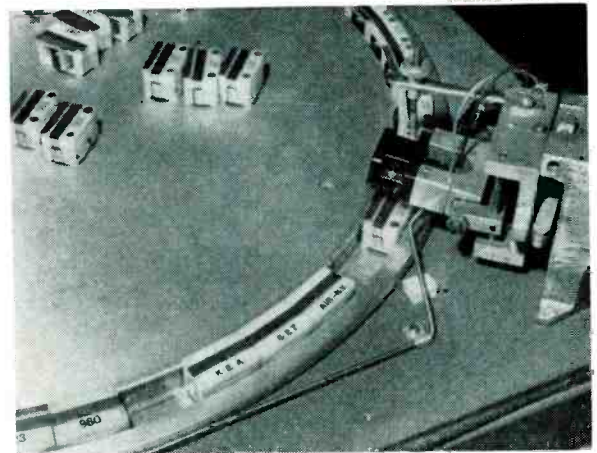

Close up of announcing machine turntable with station call letters (KEA627—Aircall New York) on three blocks in foreground. Pickup to right

kc, but almost complete rejection of strong signals occurs at about 40 kc from the desired carrier signal. Audio output is 1 milliwatt from the third pentode V_3 , which is driven by the reflex audio output of V_1 .

In normal intermittent use the batteries last a minimum of six months. As the receivers are generally used, a subscriber is given one and allowed to return it for new batteries or repairs whenever necessary, this service being covered as a part of the monthly charge.

Paging Announcer

The nature of a radio paging system is such that desired calls must be quickly placed on the air and be capable of many repetitions. When the called subscriber answers, the paging must be terminated instantly to make radio space for other calls. Since human means of repeating calls is not practicable, electronic devices are used.

One successful device in operation at Aircall, Inc. in New York City uses magnetic tape recordings. After the principle of the revolving drum, the recordings are placed near the periphery of a large turntable. For convenience, Nylon blocks, each engraved with a number or other designation and color coded, carry short strips of tape.

When a call is to be initiated, the appropriate block is inserted into the groove, as shown in the photo-

graph, where it remains until the calling is to be terminated. The speed of the tape under the pickup is about 1 inch a second. Each tape is good for more than 25,000 playings. When the operator wishes to insert or remove a block, she removes power from the driving motor (allowing the turntable to be moved by hand) and automatically lifts the pickup that rides above the tape recording.

Automatic Alarm

The paging system so far described requires that the subscriber listen occasionally by placing the receiver to his ear to hear if his

number occurs. Experiments now in progress may result in a system in which the subscriber turns on a small receiver and places it in his pocket. When actuated by a coded signal, unique for each separate receiver, a tiny buzzer warns that there is a message. The subscriber does not listen to the radio signal itself.

Although full technical details are not yet available, the general method of operation is known. At the transmitter, four audio tones are sent out in sequence. Time required is only 0.8 second and a bandwidth of only 1,000 cycles is sufficient. The receiver, one model

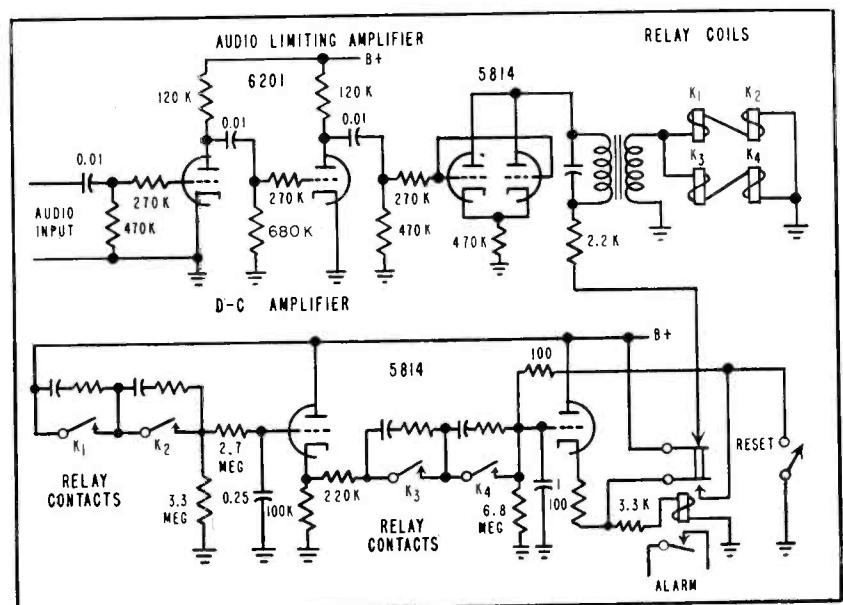

FIG. 3—Detail of vibrating-reed-type selective decoder requiring four tones for operation. Coils are shown upper right and respective contacts below

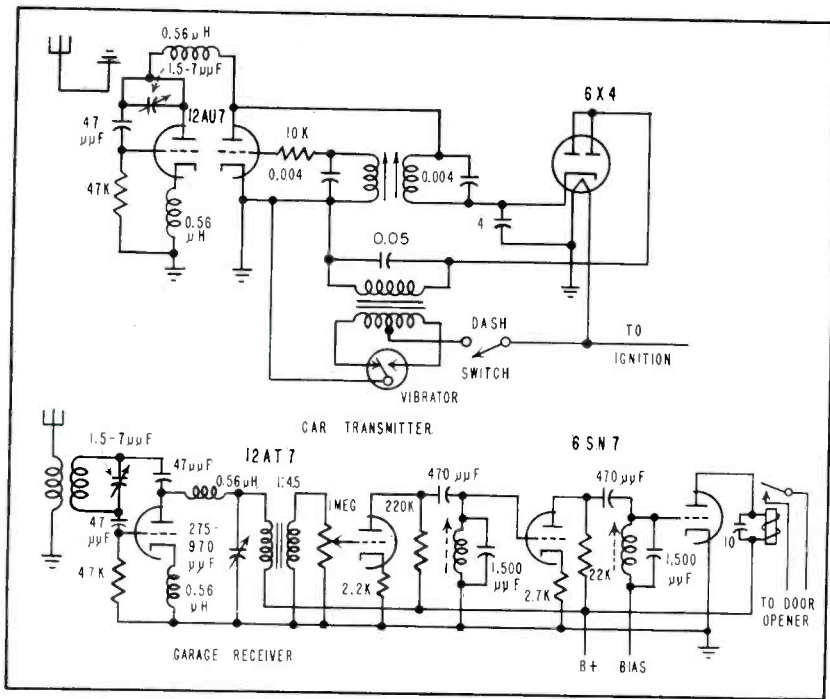

FIG. 4—Garage-door opener operating in 250-mc range requires transmitter in car. Receiver controls motor that opens door

of which measures about $1 \times 2\frac{1}{2} \times 3\frac{1}{2}$ inches, in addition to r-f and tuning circuits contains four small reed-type relays. If the tones to which the receiver responds are picked up in proper sequence, the reed relays close in series to operate the warning buzzer.

In the control center, an operator sets up desired tones by dial number. After this has been done, a toggle switch connects the encoder unit into the paging system and a stepping switch sends the four-tone signals one after another, as many times as desired. Any subscriber's number can be set up in a matter of seconds and a new number can be reset immediately after the answer to a call, thereby reducing the demands upon multiple terminal equipment.

A relay rack containing 24 tone senders in use on an experimental basis can be seen to the right of the Aircall paging announcer in the photograph. Industrial paging equipment that will handle 100 receivers in a hospital or plant is available for operation on the Citizens Radio frequency of 27.255 mc. The type of selective paging described is designed by J. R. Scantlin Electronics of Los Angeles, Calif.

The weight and relatively high

current consumption of conventional mobile radio communications equipment makes added selective calling equipment practicable even in areas where signals are weak. Particularly here, in high noise levels or within range of undesired signals, selective systems are sometimes used to reduce operator fatigue or insure reception of desired signals. Selective calling has also been applied to airways communications.

One system in general use is that of Motorola, shown in the block diagram, Fig. 2. Four tones are transmitted for each call; a pair of tones (each of 1-sec duration) is followed 0.2 second later by a second pair. Tones are generated by tuning forks operating in the range between 300 and 1,000 cycles. Twelve separate tones are available in a complete system. The equipment is so arranged that the calling operator can produce the tone pairs, separated by a short silent interval, at the push of a button. Auxiliary circuits shortcircuit the microphone during the tone period.

In the receiver, vibrating-reed relays are actuated only by the tones used to call the particular station. As shown in the diagram, the selective-calling decoder is connected to the receiver independ-

ent of the squelch and audio circuits. Input goes to a limiter that compensates variations in tone level up to 60-db.

Output from the limiter connects to the first pair of tone-discriminating circuits. If the reed relays resonate with the incoming signals, connection is made to the second pair. If these, too, respond, a conventional relay closes either a visual or audible alarm circuit, warning of an incoming call.

A simplified circuit diagram of the Motorola Quik-call tone decoder is shown in Fig. 3. The first two tubes comprise an audio limiter that actuates the coils of the vibrating reed relays K_1 , K_2 , K_3 and K_4 . When the proper actuating tones are received the relay contacts (shown separately as a part of the d-c amplifier) close momentarily. Capacitors in the grid circuits of the d-c amplifier tube sections charge with resultant closing of the alarm relay. Separate sets of contacts disconnect B+ from the plate of the upper type 5814 tube; the alarm relay is locked up through a contact that maintains conduction in the right-hand section of the lower 5814 tube.

Auxiliary Devices

Radio-frequency remote controls have long been in use; frequencies in the Citizens Radio band are set aside for further experimentation and actual operation. One practical device for users of mobile radio communications is a garage-door opener made by The Alliance Manufacturing Co. For the uses presently envisaged, it requires no license.

One version of the radio control operated from a car or truck employs frequencies in the order of 150 to 270 kc with modulation frequencies of 15, 17, 19, 22 and 25 cycles. Vibrating-reed techniques furnish selection. The various combinations give 25 different characteristics. Another version of the technique, shown in Fig. 4, has carrier frequencies in the range 245 to 285 mc modulated at 8, 10, 12 or 15 kc. Tuned circuits in the garage receiver furnish the tone discrimination. A vacuum-tube oscillator is used to modulate the transmitter.

Capacitive Transducer Has Low Impedance

SUMMARY — Push-pull capacitor formed by moving stylus between two metal plates has low mechanical impedance and good frequency response when used as a phonograph pickup. Low-capacitance rectifier integral with assembly provides transducer with low-impedance output and high signal-noise ratio. Condenser microphone is possible using similar techniques

By **HENRY P. KALMUS**

Chief, Supporting Research Laboratory
Diamond Ordnance Fuze Laboratories
Washington, D. C.

A NEW CIRCUIT for capacitive transducers transforms impedance to a low value with a low-capacitance rectifier. When the principle is applied to the design of phonograph pickups or microphones, the resulting structure has very low mechanical impedance and good frequency response.

New Circuit

It is assumed for the peak-rectifier circuit shown in Fig. 1 that the rectifier has zero resistance in one direction and infinite resistance in the other. Let Z_{A-C} be a real impedance for alternating current only, and a short-circuit for all harmonics and for direct current. If bypass capacitor C is large enough to short-circuit the alternating current and all its harmonics, $E_{D-C} = E_2/\sqrt{2}$ and $i_{D-C} = i_{A-C}/\sqrt{2}$ when i_{A-C} is the effective value of the fundamental component of the current and i_{D-C} is the d-c component.

In a peak rectifier, the current

consists of short pulses as shown in Fig. 2. Fourier analysis indicates the fundamental component of this current has a peak value twice the d-c component independent of the shape of the pulses. The relations in Fig. 1 are

$$E_2 = E_1 - i_{A-C} Z_{A-C}$$

$$E_2 = E_{D-C} / \sqrt{2} \quad i_{A-C} = 2i_{D-C} / \sqrt{2}$$

$$E_{D-C} = E_1 \sqrt{2} - 2i_{D-C} Z_{A-C}$$

$$Z_{D-C} = \frac{dE_{D-C}}{di_{D-C}} = -2Z_{A-C}$$

This means that the circuit behaves like a d-c generator with an in-

ternal impedance equal to twice the a-c impedance.

Capacitive Transducer

Figure 3 shows the application of the theorem for a simple capacitive transducer, E_1 , R , L and C representing a high-frequency oscillator with an internal a-c impedance $Z_{A-C} = L/CR$. Capacitor C_1 is the parallel capacitance of the diode. Choke K has high r-f impedance. Assume that C_2 is the variable capacitance formed by the armature of the

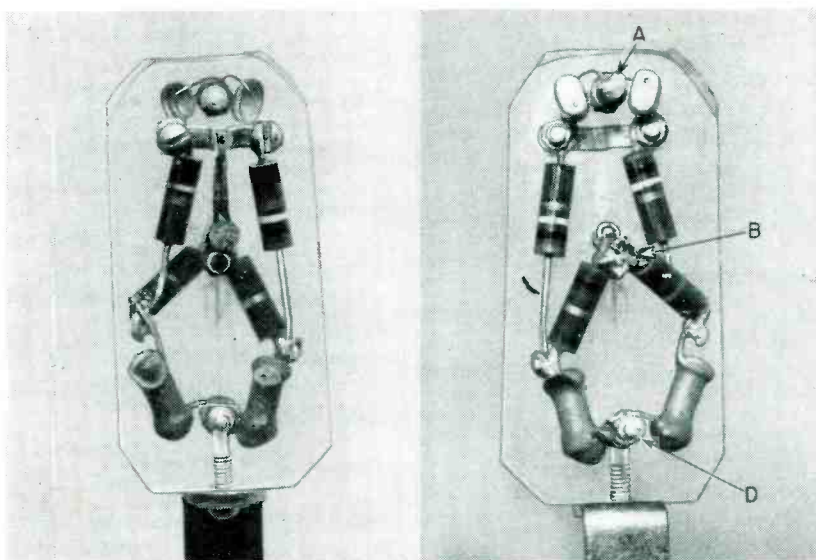

Transducer in form of phonograph pickup. Bottom view (left) shows stylus at top center. Top terminals (right) are marked to correspond with Fig. 5, indicating r-f input and audio output

transducer, with a value near $1 \mu\mu\text{f}$ and being modulated by about 1 percent.

If the diode capacitance C_1 is also $1 \mu\mu\text{f}$, a voltage $E_{D-c} = E_2\sqrt{2}/2$ is developed across C_2 . If C_2 is varied by 1 percent, the a-c voltage across the diode is modulated by 0.5 percent so that E_{D-c} is changed by 0.5 percent at the modulation rate.

Capacitances C_1 and C_2 form an a-c voltage divider such that the effective internal a-c impedance of the device is $Z_{A-c}/4$. Using the theorem, the internal d-c impedance of the device is $Z_{D-c} = Z_{A-c}/2$.

Assuming a direct voltage of $E_{D-c} = 50$ v, a 1 percent mechanical modulation produces $\Delta E = 250$ mv voltage change. Assuming an internal a-c impedance of $Z_{A-c} = 10,000$ ohms, the d-c impedance of the device is $Z_{D-c} = 5,000$ ohms. Hence, the device is equivalent to an audio generator with an open-circuit voltage of 250 mv and with an internal impedance of 5,000 ohms as shown in Fig. 4A.

Conventional D-C Operation

The equivalent circuit of the conventional d-c operation of a capacitive transducer is shown in Fig. 4B. Assuming the same voltage $E_{D-c} = 50$ v across the transducer, there is, again, an open-circuit voltage of 250 mv for a 1 percent change of capacitance. The internal impedance, however, is now the impedance of a $2 \mu\mu\text{f}$ capacitor and at 100 cycles $Z = 1/\omega C = 800$ megohms. For lower frequencies the impedance is correspondingly higher.

Special input tubes with low grid current must be used. Either input capacitance must be low or negative feedback employed to reduce capacitance. The high internal impedance makes the device sensitive to hum and humidity, requiring extensive shielding.

These drawbacks are avoided by the impedance transformation method although conditions are idealized. The rectifier has definite forward and backward resistance so the real internal d-c impedance is higher than the calculated impedance.

In an experimental model of the new transducer, a measured value of 7,000 ohms was obtained as against the theoretical value of

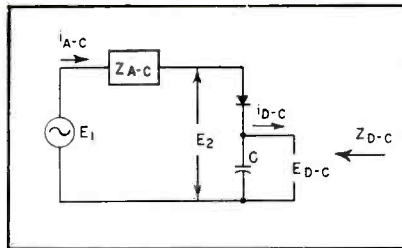

FIG. 1—Peak rectifier circuit used as the basis of the capacitive transducer

5,000 ohms, a negligible increase when compared with conventional transducer impedance of hundreds of megohms.

Balanced Circuit

The balanced circuit shown in Fig. 5 is used to cancel oscillator noise. Rectifier noise is likewise reduced and the internal oscillator impedance is eliminated, minimizing audio-output impedance.

The transducer comprises a balanced capacitor C_2C_2' , the center conductor of which is movable so while C_2 is increased, C_2' is decreased. Distortion is reduced by cancellation of even harmonics.

Each diode is terminated by two resistors $R + R_1$ in series; R is much smaller than R_1 and serves as choke for r-f voltage. Terminating resistor for the diode is R_1 . A value of 2 megohms keeps the r-f load as high as possible, 500,000 ohms in this case, thereby minimizing the power required from the high-frequency generator. The audio voltages are fed to the output terminal through capacitors C_3 .

The a-c impedance terminating the rectifiers is smaller than the d-c impedance. In general, such an arrangement produces audio distortion resulting from diagonal clipping. In the present application, however, the modulation percentage is much less than 1 percent so no measurable distortion exists.

It is assumed the circuit is symmetrical so a given deflection of the center conductor causes the same ΔE to be produced by both rectifiers. Hence

$$\begin{aligned} E &= E_{AV} + \Delta E \\ E' &= -(E_{AV} - \Delta E) \end{aligned}$$

At the same time, noise voltages E_D and $E_{D'}$ are generated by the diodes. Using the equivalent circuit shown in Fig. 6, the resulting signal and noise voltages E_s and E_N

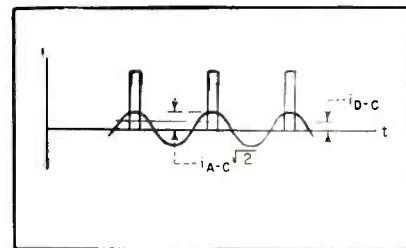

FIG. 2—Current in peak rectifier consists of short pulses

can be calculated, $E_s = (E + E')/2 = \Delta E$. The signal voltage is the same as that obtained from the circuit in Fig. 3. Any undesired amplitude modulation of the oscillator E , however, is now almost canceled.

To find the resulting noise voltage, the root mean square values of the individual voltages must be added; thus $E_N = \sqrt{(E_D^2 + E_{D'}^2)}/2$, whereby E_D and $E_{D'}$ are the noise voltages produced by the diodes. For $E_D = E_{D'}$, $E_N = E_D/\sqrt{2}$. If the oscillator in Fig. 3 were noise free and if its impedance were zero, the signal-to-noise ratio would be improved by 3 db.

In reality, the noise reduction is much greater because oscillator noise in the circuit of Fig. 3 can be considerable. In addition, the internal oscillator impedance increases the noise created by the diode. This noise is produced by fluctuations in the value of the internal diode back-resistance so that the rectifier circuit represents a fluctuating load for the oscillator. Hence, a low internal oscillator impedance results in a more stable oscillator voltage. In the balanced circuit, the effective oscillator impedance is zero and the remaining diode noise results only from the unavoidable forward resistance of the diode and the r-f impedance of capacitors C_2 and C_2' .

In computing the audio-output impedance, the diode forward resistance and the r-f impedance of C_2 can be neglected in comparison with the value of the filter resistor R . (If chokes were used instead of the filter resistors, the audio output impedance would be reduced to a few hundred ohms).

The output impedance is thus approximately $R/2$ or 50,000 ohms. This value is so low that shielding of the lead from transducer to amplifier is not critical. Microphonics of the oscillator tube and beat

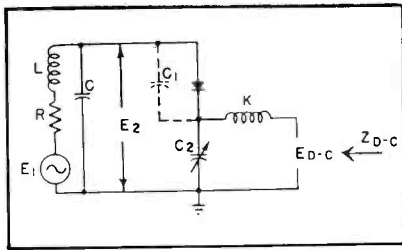

FIG. 3—Development of transducer in which capacitance of C_2 is varied

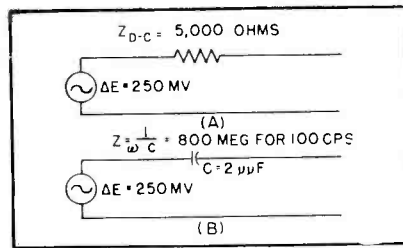

FIG. 4—Capacitive transducer (A) and conventional high-impedance type (B)

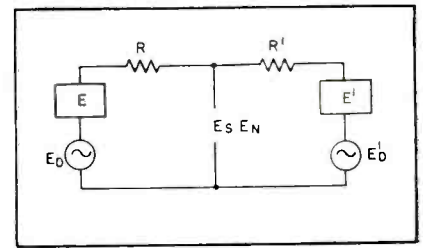

FIG. 6—Equivalent circuit of balanced transducer representing voltages

notes produced by interference between the oscillator and spurious signals are rendered harmless by the balanced design.

Phonograph Pickup

The phonograph pickup shown in the photographs is based on the balanced circuit of Fig. 5. Radio-frequency voltage at 5 mc is delivered to terminals A and B. Audio voltage is derived from D and B.

Capacitance variation of C_2 should be as high as possible compared with the values of C_3 and C_1 . It is necessary to mount diodes and resistors R as close as possible to the stylus. Stray capacitances of the leads are then reduced to a minimum. The rectifiers employed are silicon-junction diodes with low noise and a Zener voltage of 50 volts. Capacitances C_1 and C_2 are not equal in this design so it becomes necessary to compute developed audio voltage.

Assume the resistive impedance of R high enough to be neglected in comparison with C_1 and C_2 . The stray capacitance of R is assumed to be a part of C_2 and R_1 is high so peak rectification occurs. Direct voltage developed across C_2 equals peak r-f voltage E .

$$E = E_1 \frac{C_2}{C_1 + C_2}$$

$$\frac{dE}{dC_2} = E_1 \frac{C_1}{(C_1 + C_2)^2}$$

$$\Delta E = nC_2 \frac{dE}{dC_2} = E_1 \frac{nC_1 C_2}{(C_1 + C_2)^2} \quad (1)$$

where n is the modulation factor of C_2 . Capacitance C_1 , near $2 \mu\text{mf}$, is internal to the diode. Capacitance C_2 is about $1 \mu\text{mf}$, formed by the pickup armature and internal capacitance of resistor R as shown in Fig. 5.

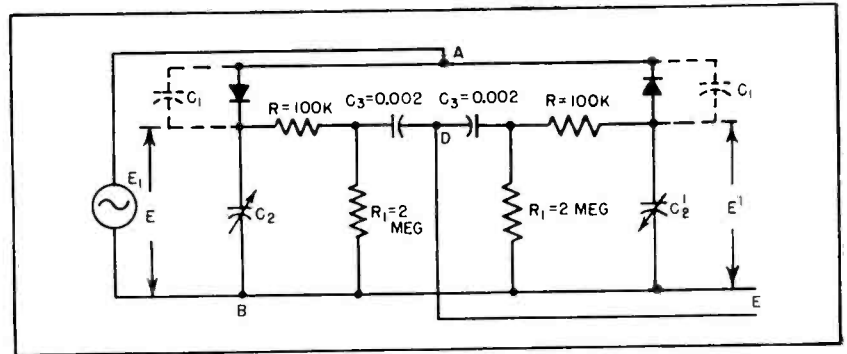

FIG. 5—Balanced circuit cancels oscillator noise, reduces rectifier noise and eliminates internal oscillator impedance

Assuming a recording velocity $v = 6$ cm per sec and frequency $f = 1,000$ cycles, maximum stylus deviation is $a = v/2\pi f = 10^{-3}$ cm. For a stylus gap $d = 30 \times 10^{-3}$ cm and for capacitance $C_a = 0.06 \mu\text{mf}$ between stylus and pole piece, a capacitance change of $\Delta C = C_a (a/d) = 0.002 \mu\text{mf}$ is obtained. The modulation factor is $n = \Delta C/C_2 = 2 \times 10^{-3}$.

Employing a high-frequency voltage $E_1 = 75$ v and using Eq. 1, an audio voltage $E_s = 30$ mv is obtained. This corresponds to an effective voltage of 21 mv and is high enough to override the noise produced in the amplifier. With the particular diodes used, a noise output voltage of $10 \mu\text{v}$ was measured when the output was passed through a filter having a uniform amplitude response from 40 to 10,000 cycles.

For a peak recording velocity of 14 cm per sec, a signal-to-noise ratio of more than 70 db is obtained. If a correction network is employed to obtain constant amplitude for an RIAA recording characteristic, an attenuation of 6 db at 1,000 cycles must be accepted. This network can be simple because output of the capacitive transducer is proportional to amplitude and not to the velocity of stylus deviations.

The balanced circuit is likewise suitable for a condenser microphone. It is advantageous, in this case, to replace the semiconductor rectifiers by vacuum diodes to reduce noise voltage to a few microvolts.

Condenser Microphone

Signal-noise ratio is increased in comparison with conventional circuits in which the capacitor is terminated with a resistor of hundreds of megohms. The noise produced in a space-charge-limited diode is equal to the noise produced by a resistor ρ at about two-thirds the cathode temperature, whereby ρ is the differential resistance of the diode. Low output impedance makes it possible to place the amplifier far from the capacitor.

The diodes should be d-c heated. Cathode-to-filament capacitance is not critical because the active capacitor in a microphone has a value of about $10 \mu\text{mf}$ and not $0.06 \mu\text{mf}$ as in the phonograph pickup. Hence a parallel capacitance of 1 or $2 \mu\text{mf}$ can be tolerated.

The author acknowledges the help of Irwin D. Stein, who produced the mechanical design and also performed the measurements.

Antenna System for

SUMMARY — Dual helical antennas, low-noise preamplifier and multi-coupler form antenna system for receiving signals telemetered from guided missiles. Overall gain exceeds 30 db. Antennas track missile in overwater flight from Florida to Puerto Rico

By **GARTH E. BOWER*** and **JAMES B. WYNN, JR.**

Project Engineer *Manager Telemetry Engineering*
RCA Service Co., Inc.
Missile Test Project
Air Force Missile Test Center
Patrick Air Force Base, Florida

The Front Cover



Installation of dual seven-turn remotely tracked helical antennas on 50-ft tower

THE AIR FORCE Missile Test Center, one of nine centers under the Air Research and Development Command, has a test range extending more than 1,000 miles. From the launching site, Cape Canaveral, Florida, instrumentation sites are scattered throughout the Bahama Islands to Puerto Rico. This article describes development of the r-f portions of the receiving system for signals telemetered from missiles in flight. The assigned frequency range for missile telemetering extends from 216 to 235 mc.

For many flight test programs, a receiving antenna system of 30-db gain with low noise was necessary. Primary breakdown of the system was into two components: an improved helical antenna with at least 10-db gain and capable of being tracked; a wide-band low-noise preamplifier and associated multi-coupler contributing at least 20-db gain. Actually higher gains were realized from both together with a good noise figure.

The antenna helix consists of 7 turns of 1/4-in. copper tubing wound

in a clockwise direction looking through the ground plane. Since the wavefront is not circularly polarized, the screw, or direction of rotation of the helix is of little importance. Copper tubing was selected because it may be sweated securely to the coaxial connector at the ground plane. The tubing is either silver or cadmium plated and given several coats of clear lacquer. The front and side views of the antenna are shown in Fig. 1.

Since the antenna is working in its axial or beam mode, the diameter of a single turn is 15 1/4 in. Spacing between successive turns is 5 3/4 in. with 5 1/4 in. being used for terminating the helix to the coaxial fitting. Overall helical length as measured from the ground plane is 3 ft 9 in. Four 1-in. polystyrene rods spaced 90-deg apart within the helix form the supporting structure. Two spreaders are used to position the rods uniformly throughout the length of the helix with a pyramid support from the outer spreader to the ground plane for axial rigidity.

Ground-Plane

A 4-in. aluminum U beam, 6 ft long forms the main support for the antenna ground plane. This beam was formed in the shop from 0.125-in. aluminum stock. The beam size was determined, or more appropriately limited, by two distinct requirements: It must provide the main support for the antenna when

* Now Chief Engineer, Century Electronics, Cocoa, Florida.

Missile Telemetry

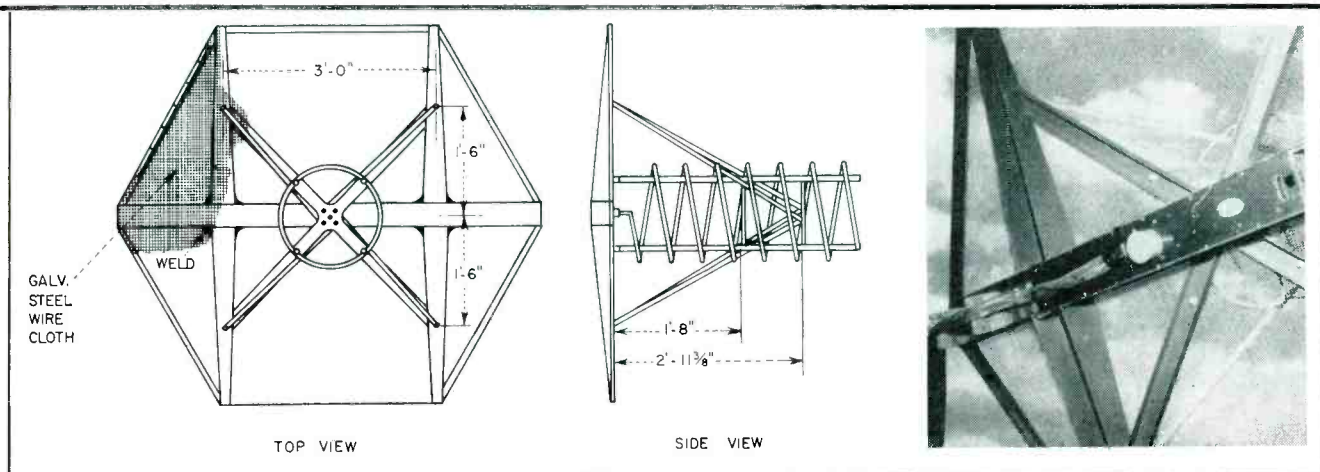

FIG. 1—Plan and side views of helical antenna and its ground plane. Detail, right, shows housing for r-f preamplifier

mounted in a yoke for remote tracking and it should be adequate to house an r-f amplifier directly at the helix termination. For the latter reason the center portion of the beam has been boxed in to form a weatherproof compartment. Four truncated U beam support arms are welded onto the main beam to form the basic structure of the ground plane. All structural members have dimpled holes wherever practical to reduce the wind loading and weight.

The ground plane consists of wire cloth. This material, procured in rolls 6-ft wide avoids splicing problems. The galvanized-steel wire of the screen is 0.063 in. in diameter with $\frac{1}{2}$ -in. openings. Although this wire weighs 0.59 lb per square yard, it is desirable rather than aluminum since it can be sweated directly to the coaxial connector and thus provide an electrical connection that will not easily deteriorate due to corrosion or the many other ill effects of a salty, damp atmosphere.

The UG-352/U coaxial connector was selected for the antenna termination although the fitting is designed to be used with $\frac{3}{8}$ -in. coaxial connectors and the smaller RG-63/U coaxial cable is used at this point. Actually, the fitting is modified so that the cable connects by solder lugs rather than using a mating connector.

Many of the losses occurring in

antennas after they have been in use for sometime occur at points of termination or support. For this reason insulation quality and leakage paths have been given much consideration. This particular coaxial fitting was found to have the greatest surface distance between the inner and outer connecting surfaces. The insert material used in this connector is Teflon.

Antenna Evaluation

The electrical characteristics of the new 7-turn helical antenna were established by an independent laboratory. The power gain above an isotropic radiator ranges from 11.4 to 12.0 db of average measured gain. Table I lists antenna gain characteristics.

The results indicate that the sensitivity to an illuminating angle of polarization is fairly constant between the limits of vertical to horizontal wavefront. The circularity of polarization was plotted for the principal axes of the polarization

ellipse and tabulated in decibels. The axial ratio remained approximately 2.75 db throughout the band. The nominal magnitude of the impedance of the helical antenna under investigation is approximately 150 ohms. Since the antenna exhibited a minimum vswr of 3.1 over the frequency band, it was necessary to fabricate an impedance transformation section. A 6.5-in. length of RG-63/U coaxial cable, which exhibits a characteristic impedance of 125 ohms, provided a satisfactory impedance transformer. Between the frequency range of 216 to 235 mc a maximum vswr of 1.24 was achieved. This low voltage standing-wave ratio is important for the long transmission line feeding a receiver.

The directivity of the 7-turn helical antenna has been increased compared with the previously used 2 $\frac{1}{2}$ -turn helical antenna. Beamwidth has been decreased from 60 to 70 degrees to between 42 to 56 degrees at the half-power level. Antenna

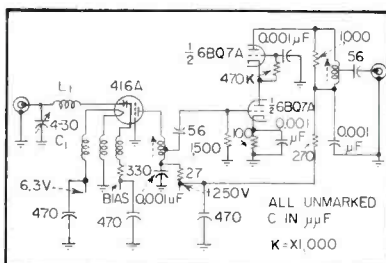
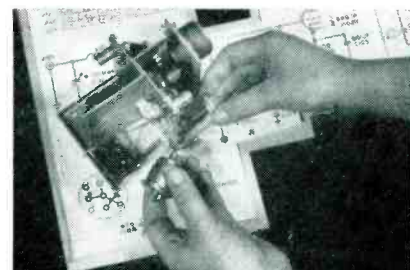
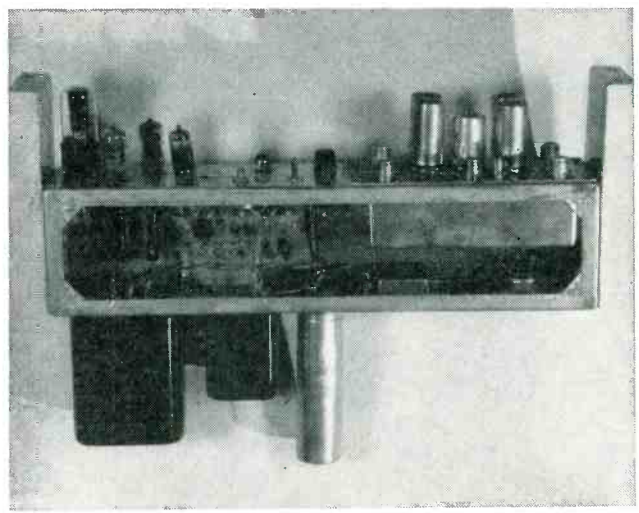
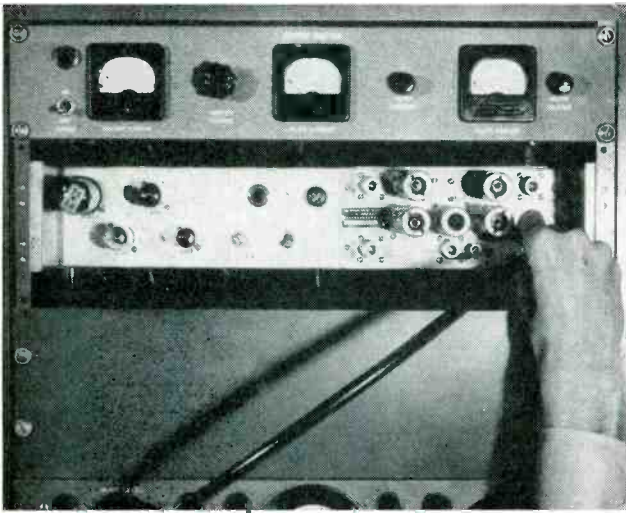

FIG. 2—Circuit of r-f preamplifier



Low-noise r-f amplifier



Recessed rack-mounted multicoupler, left, and multicoupler removed from rack, right used for isolation

radiation patterns show that the minimum front-to-back ratio is approximately seven decibels.

A Houston-Fearless remote-control parabola assembly was used as the basic tracking pedestal. The system comprises a pedestal for positioning the antenna and a control unit for remotely driving as well as indicating the antenna position.

The pedestal was modified to provide 730-degrees rotation before contacting the electrical limit switches instead of the usual 365 degrees. Approximately 48-degrees travel in elevation was possible and no modification was required in this respect. The antenna is positioned both in elevation and azimuth by $\frac{1}{2}$ -hp motors which provide a torque of 10,500 inch-pounds at 1 rpm. The pedestal assembly has been stressed for a wind velocity of 120 mph. Magnetic brakes on the motors prevent the antenna from coasting so that both azimuth and elevation may be positioned with reasonable accuracy.

A control panel 14 in. high is mounted in a standard relay rack in the telemetry receiver room. Correct antenna position is indicated by observing the relative signal strength of a receiver connected to the antenna. Both azimuth and elevation position of the antenna are indicated on large 8-in. dials by synchro repeaters.

Since some of the receiving antennas are located from 75 to 150 feet from the receivers, it was necessary to install the preamplifier within a small enclosure adjacent to

the ground plane of the helix, thereby overcoming losses and noise normally encountered in the coaxial cable. The unit is housed in a case approximately $3\frac{1}{2} \times 4 \times 4\frac{1}{2}$ in. with a blower and mounted on a $\frac{1}{8}$ -in. panel designed to cover the enclosure or for rack mounting.

Preamplifier

The preamplifier has input and output impedances of 52 ohms, 15-db gain, 20-mc bandwidth from 215-235 mc and a noise figure of approximately 2.5 db.

As shown in Fig. 2, the first stage consists of a grounded-grid Western Electric 416A planar triode. Because of its low transit time and high transconductance, this tube has excellent low-noise characteristics. This stage is coupled to the amplifier input by a pi-matching network consisting of C_1 , L_1 , the cathode-to-grid capacitance and the shell-to-cathode capacitance of the 416A.

The second stage of the amplifier is a direct-coupled cascode amplifier employing a 6BQ7A dual triode. Interstage and output coupling both are accomplished by single-tuned,

tapped coil circuits. The 416A is cooled by a small blower driven by a 115-v squirrel-cage motor. The power supply for the amplifier is electronically regulated, designed for standard rack mounting and is installed within the receiver building. Three meters are provided on the front panel to indicate plate voltage, filament voltage and 416A cathode current.

Multicoupler

The multicoupler is designed for standard rack mounting and couples an antenna or r-f preamplifier to four receivers. This equipment occupies $3\frac{1}{2}$ in. of a 19-in. relay rack and is recessed approximately 2 in. from the front of the rack to allow connection of input and output coaxial patches. Two of these units are installed at each station making possible the simultaneous operation of eight telemetry receivers from only two receiving antennas.

The multicoupler provides input and output impedances of 52 ohms, gain of approximately 9 db, bandwidth of 20 mc and 34-db minimum isolation between input and outputs and between the four outputs.

The input connection, shown schematically in Fig. 3, is coupled by an L-section matching network to a 6AJ4 triode connected as a grounded-grid amplifier. The four output stages are cascode-connected 6BQ7A's and are identical in nature. Interstage coupling is accomplished by a double-tuned circuit involving a pi-network of inductors rather than the usual magnetically coupled transformer. In-

Table I—Helical Antenna Gain Characteristics

Frequency (mc)	Gain (db)*	Average Gain (db)
216	12.5 9.8	11.4
226	13.1 10.1	11.8
236	13.4 10.3	12.0

* Spread illustrates polarization effects.

ductor L_1 acts as the primary, L_2 provides mutual coupling and the secondary is made up of L_3 , L_4 , L_5 and L_6 in parallel. Each output of the unit is connected by a single-tuned network to its respective output connection. A self-contained electronically regulated power supply is incorporated into the unit.

Equipment Evaluation

Part of the equipment evaluation was devoted to a series of tests to determine the improvement or degradation of signal-to-noise ratio experienced when using the preamplifier, multicoupler or combination of the two. Although it is not planned to use the multicoupler without the preamplifier, information on its performance under this condition was considered important since failure of a preamplifier might necessitate operation in this manner. All measurements were made by radiating a known signal and measuring signal-to-noise ratio with reference to the measured signal-to-noise ratio of the normal receiving system, namely 7-turn helix, RG-8/U coaxial cable and the telemetry receiver.

Measurements were made with various transmitted signal intensities and modulation deviations of ± 5 kc to ± 125 kc. In general, the results were the same under all conditions except for signals of level sufficient to reach maximum signal-to-noise ratio in the receiver. This condition was reached at about 500-microvolts input to the receiver and no improvement could be made beyond that point. Figure 4 presents the results of these measurements.

Performance

Addition of the multicoupler alone to the system caused a loss of about 2-db signal-to-noise ratio. Addition of the preamplifier alone to the system improved signal-to-noise ratio about 7 or 8 db and addition of the multicoupler in series with the preamplifier degraded this value only about $\frac{1}{2}$ db. An improvement in signal-to-noise ratio of 7 or 8 db is equivalent to multiplying the missile transmitter power by more than five.

A further check was made to determine what improvement could be made in a noisy pulse-duration

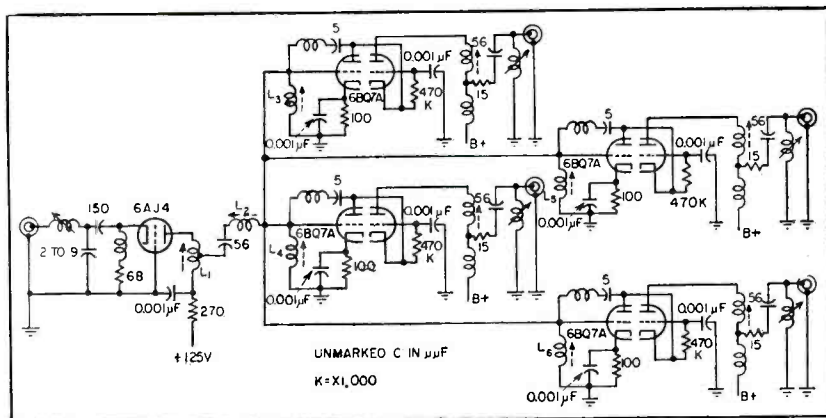

FIG. 3—Multicoupler permits operating four telemetering receivers from a single antenna installation without mutual interference

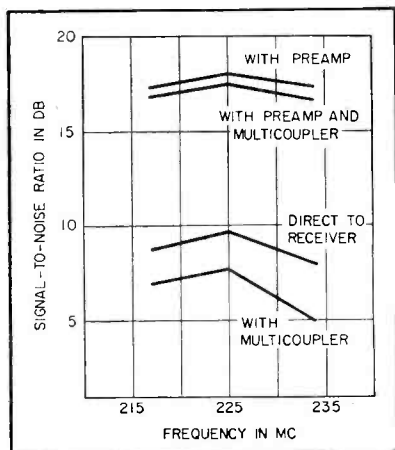

FIG. 4—Antenna system performance characteristics with different inputs



FIG. 5—Noise level with (top) and without (bottom) preamplifier

telemetry signal by adding the preamplifier to the normal receiving system. Figure 5 shows the transmitted pulse signal with (top) and without (bottom) preamplifier.

Design of the antenna system is based in part upon work done by R. Lowell of NRL and by the J. P. Seeburg Co. Other developmental work was done by the Applied Science Corp. of Princeton under AF contract 08(606)-605.

The preamplifier is manufactured commercially as the ASCOP model APA-1 and the multicoupler as the ASCOP model AMC-1. The telemetry receivers are Raymond Rosen model 842-C or 842-C1. The wire cloth used in the ground plane was obtained from Kentucky Metal Products.

A telemetry receiving antenna and distribution system has been designed and tested that provides a gain in excess of 30 db over the frequency range 216 to 235 mc.

The antenna characteristics are as follows: Beam width of the an-

tenna varies between 42 and 56 degrees. Remote tracking is provided by a modified Houston-Fearless pedestal. By the use of an impedance matching section, a vswr of less than 1.24 to 1 is maintained throughout the 20-mc band. The gain of the 7-turn helical antenna is approximately 12 db.

The performance of the r-f amplifier and multicoupler may be summarized as follows: The r-f preamplifier and multicoupler provide an additional gain of approximately 24 db. Noise figure of the preamplifier is approximately 2.5 db. Addition of the preamplifier to the receiving system gives an improvement in signal-to-noise ratio of 7 or 8 db; equivalent to a five times increase in transmitted power. Operation of four receivers from one antenna is satisfactory.

It is believed that these new components will considerably enhance the accuracy and capability of the telemetry receiving system at the Air Force Missile Test Center.

Industrial Microwave

SUMMARY — Secondary standard of frequency, continuously compared with standard frequency broadcasts, operates at 100 kc and can be adjusted to better than 1 part in 5 million. Microwave checkpoints derived from variable frequency oscillator calibrated by the 100-kc standard

By **H. E. STINEHELPER, Sr.** and **J. G. VOGLER**

Chief Engineer

*Frequency Standards
Asbury Park, N. J.*

Project Engineer

ACCURATE FREQUENCY checkpoints over the microwave spectrum can be derived from a low-frequency source utilizing a carefully designed crystal oscillator. For long term stability this oscillator is usually temperature controlled. Its output is multiplied and drives a harmonic generator that establishes checkpoints over the vhf and uhf bands.

The harmonics are then mixed in a heterodyne circuit with the output of a stable, variable oscillator tunable over the range in which direct crystal harmonics are available. This makes it possible to set the vfo accurately to frequencies that are multiples of the input to the harmonic generator by zero-beating the two frequencies.

This comparison is made very accurate when both visual and aural indication of the beat note is

used. The unit employed in this laboratory to compare the two signals is shown in the photograph. It uses standard components except for the crystal mixer. The cap of the crystal mixer is removed, showing the 1N21B crystal.

Incoming signals to be compared are fed into the crystal through the capacitor blocks located beside the crystal mount. The audio beat note is taken from the tip end of the crystal which is facing downward and is amplified by the low-noise audio amplifier circuit. The beat note is presented on the 2-inch crt and audio output is available through earphones. The unit has two independent channels making it possible to compare several signals simultaneously. One channel is used for comparing the crystal harmonic with the vfo fundamental; the other channel is used to

compare the vfo harmonic with the microwave signal. Details are shown in the circuit diagram. Harmonics in the output of the vfo, which can be increased by use of a crystal diode multiplier, now establish accurately known checkpoints in the microwave spectrum. The harmonics of the vfo can be used to zero-beat with a c-w microwave oscillator or to give markers when sweeping techniques are employed.

The accuracy of these checkpoints depends upon absolute accuracy of the crystal fundamental, stability of the crystal output and stability of the vfo.

The absolute accuracy of the fundamental is the most important factor since errors are multiplied all the way up to microwave frequencies and can reach considerable magnitude. The crystal fre-

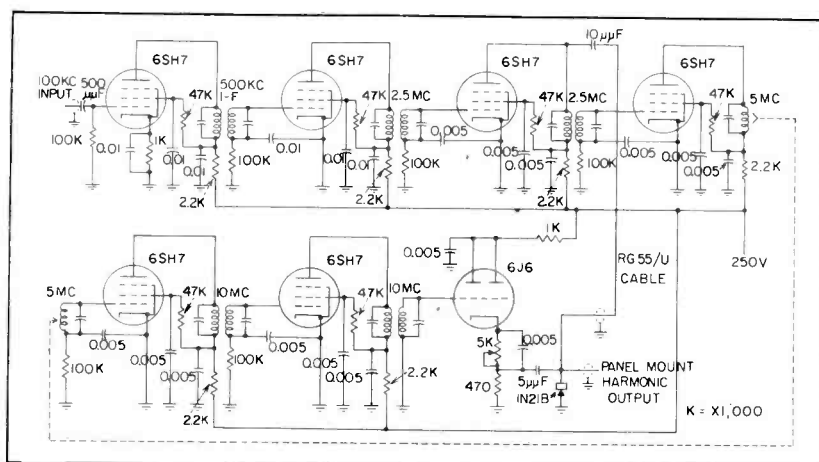

Frequency multiplier and harmonic generator provides 2.5-mc checkpoints up to 1,000 mc. Unit is fed from 100-kc crystal standard

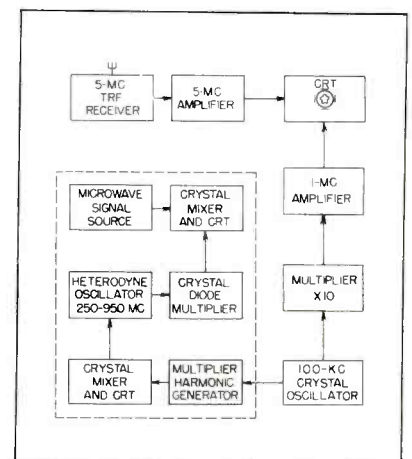
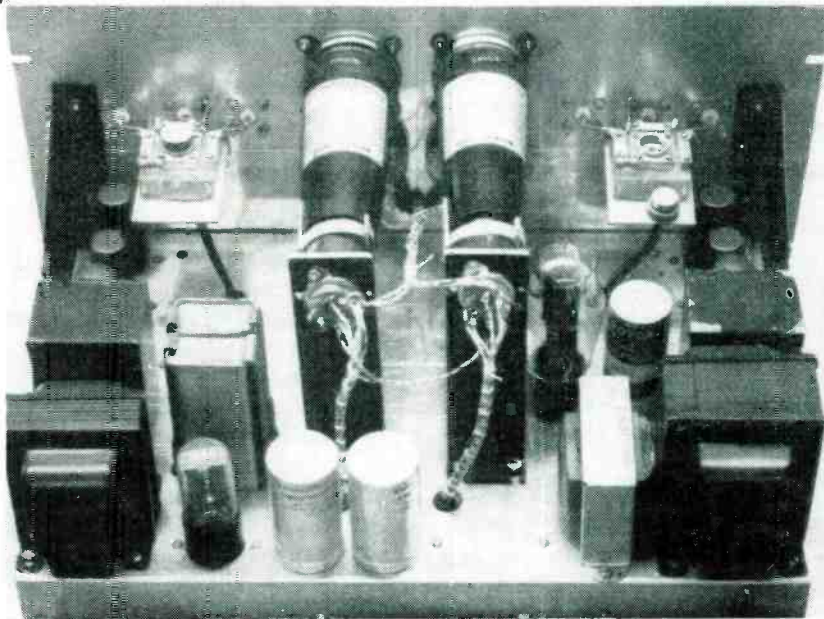
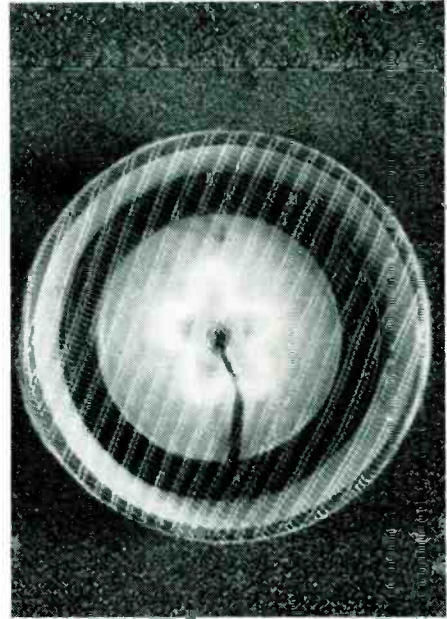

FIG. 1—Basic system permits calibration of microwave signals against WWV

Calibrator



Photograph shows c-r monitor tubes. Crystal mixer assembly at right is open with screw cap resting on shelf. Unit is complete with power supplies



Five-pointed star rotates when crystal standard is not in step with WWV

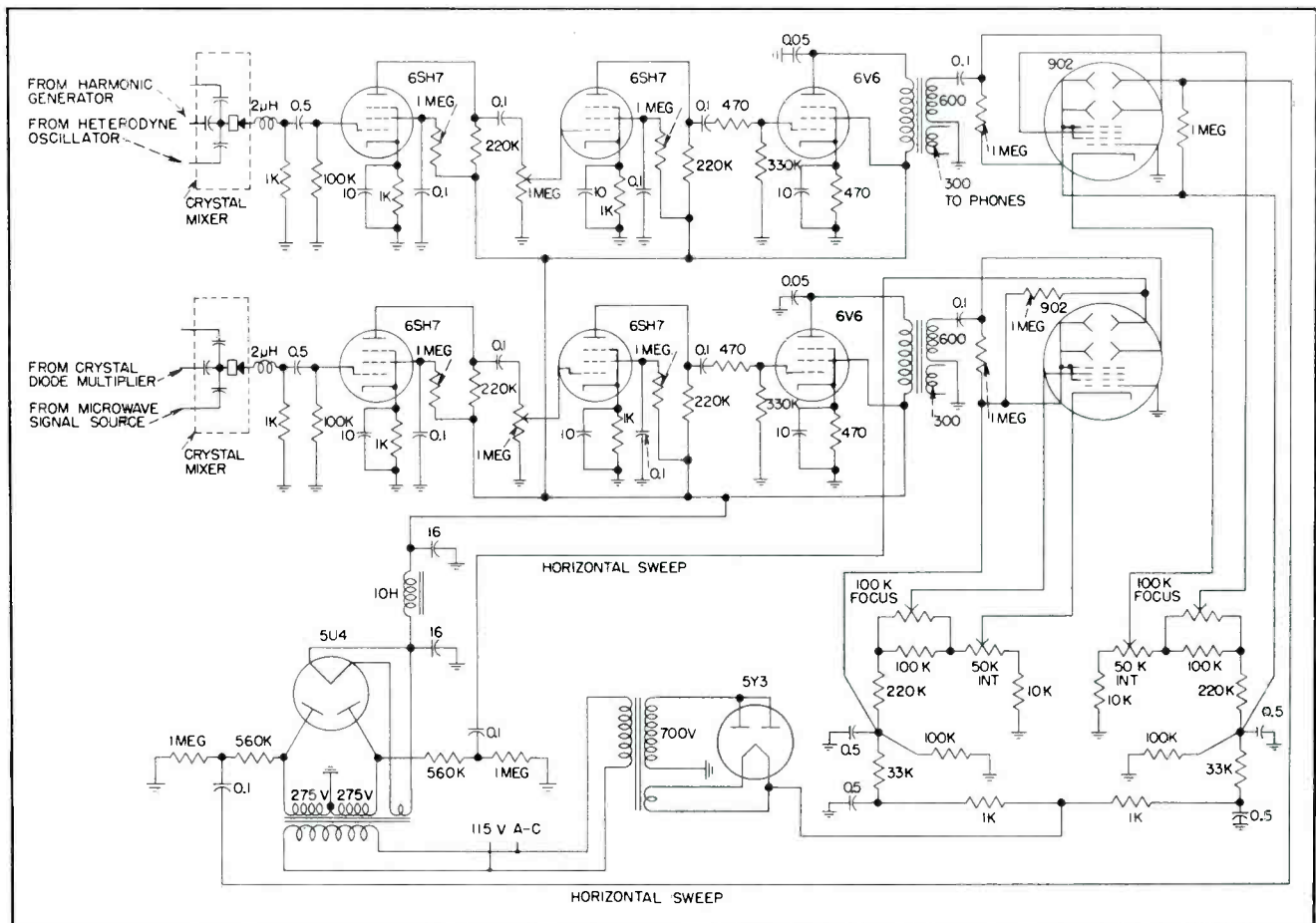

Crystal mixer and cathode-ray indicators are mounted in one unit as shown in the photographs above

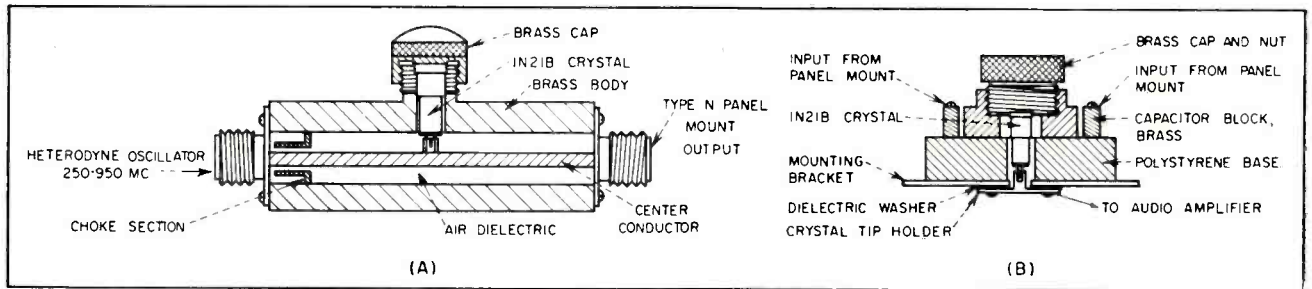

Cross-section of crystal diode multiplier (A) and crystal mixer assembly (B) used in the microwave calibrator

quency, therefore, is usually set by beating one of the crystal harmonics with a standard signal transmitted by WWV. The stability of the crystal determines how frequently these comparisons and adjustments have to be made.

The stability of the vfo determines for how long the vfo harmonics will be accurate. Usually it is necessary to observe the beat-note between crystal harmonic and vfo fundamental during measurements.

Crystal Oscillator

The most critical component in this system is the crystal oscillator. If a crystal of 100 kc is used, an error of 1 cps is multiplied to an error of 100 kc at 10,000 mc.

Unless a crystal oscillator of exceptional stability is used, almost continuous comparison with a WWV signal will be necessary to insure the accuracy of the microwave checkpoints.

These comparisons can be made using almost any short-wave receiver. However, an audio beat-note can be quite disturbing in a laboratory when frequent checks are required. Also, it is possible to beat the crystal harmonic with one of the sidebands generated by the modulation of the WWV signal, which could introduce a considerable error.

To eliminate these difficulties, the following setup is used for calibration as shown on the block diagram, in Fig. 1. Figure 2 shows an arrangement for using the cavity Q method of calibration.

Output from a 100-kc crystal oscillator (Fig. 1) is multiplied to 1 mc, amplified and applied to a 3-inch crt to generate a circular trace. A 5-mc signal from WWV is picked up with a trf receiver. This receiver has a 5-mc r-f output and incor-

porates two crystal filters to remove most of the modulation from the carrier. The 5-mc output from the receiver is amplified and applied to the radial deflection of the crt.

This signal puts five lobes into the circular trace as illustrated in the photograph. The signal will rotate clockwise or counterclockwise depending on the difference between the two frequencies. The pattern is stationary when the 1-mc signal from the crystal is exactly one-fifth the received WWV signal.

In this arrangement, one revolution per second of the pattern corresponds to an error due to the crystal frequency of one part in one million. It is easy to adjust a good crystal oscillator so that less than one lobe rotates past a given point in one second and the checkpoints will then be accurate to one part in five million. This accuracy can be obtained even from simple crystal oscillators without temperature control for short periods. However, if frequent adjustments of the oscillator are to be avoided, it is necessary to control the temperature of the crystal.

Complex thermistor bridge circuits have been described in the literature. However, a relatively simple arrangement works satisfac-

torily. The crystal oscillator uses a conventional circuit and incorporates a variable capacitor that allows small frequency adjustments. This capacitor is made of Invar and is placed with other circuit components in a chamber where the temperature is held constant to 55 C plus or minus 1 deg. The crystal itself is wrapped in glass wool and mounted in a vacuum flask. A thermostat set to 55 C and adjusted for plus or minus 0.5 C change is located outside the flask to hold the temperature of the medium surrounding the flask to this value. Thermal inertia holds the temperature of the crystal constant.

The oscillator usually requires only one adjustment a day. Even after one week without adjustment the 1-mc signal is seldom off more than two or three cycles. This slow drift is always towards higher frequencies and seems to result from aging of the crystal. Using continuous comparison of the crystal frequencies with WWV eliminates the possibility of introducing an error in the crystal oscillator. The WWV signal can be off frequency a small amount owing to Doppler shift.

During several years of continuous use of this frequency standard, it has been found that this method of comparison gives accurate frequency indications even during times of atmospheric electrical disturbances when the signal from WWV is received for only a few seconds. A small amount of Doppler shift, in the order of 3 cps of the 5-mc signal can be observed during morning and evening hours.

BIBLIOGRAPHY

- L. A. Meacham, The Bridge Stabilized Oscillator, *Proc IRE*, Oct. 1938.
- W. P. Mason, A New Quartz-Crystal Plate, Designed the GT, Which Produces a Constant Frequency Over a Wide Temperature Range, *Proc IRE*, May 1940.
- H. Nyquist, Regeneration Theory, *BSTJ*, Jan. 1932.

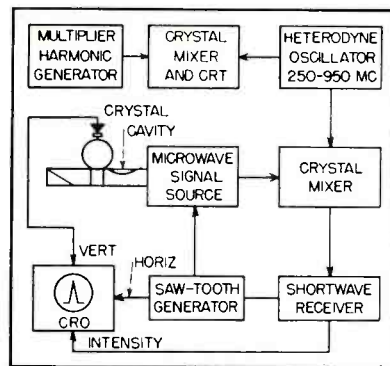
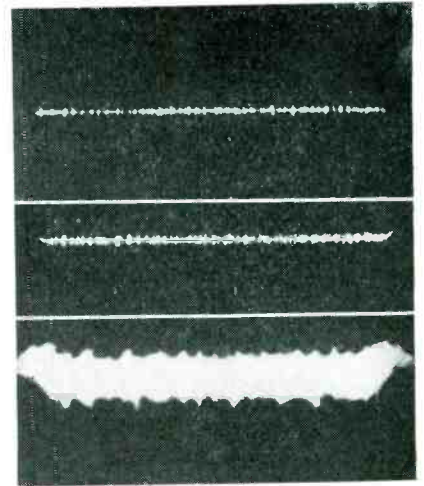
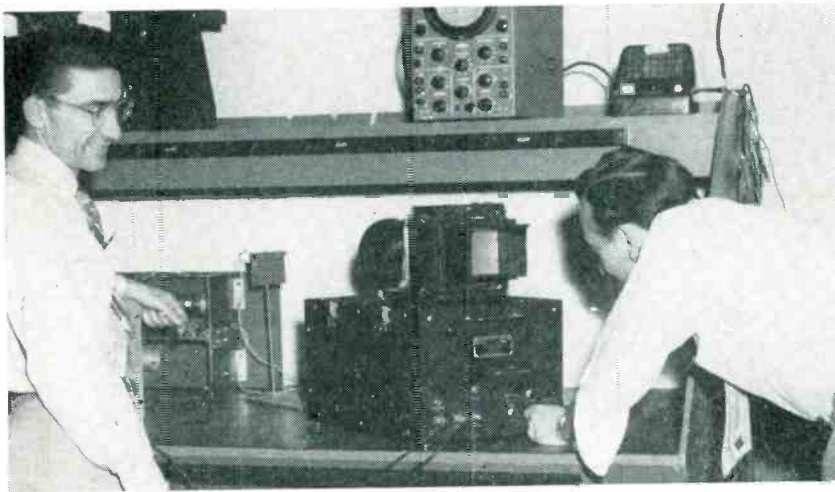

FIG. 2—Simplified arrangement for calibrating high-Q resonators



Laboratory setup for photographing wire vaporization with camera using Kerr-cell shutter. Resulting photographs, shown at right, are for delays of 8, 15 and 20 μ sec after application of vaporizing current to wire supported by binding posts on panel in front of camera

Kerr-Cell Shutter Has Submicrosecond Speed

SUMMARY — Photographic exposures of 0.1 microsecond with effective aperture of f/7 are achieved by using Kerr-cell shutter with standard press camera. Shutter is opened and closed by narrow 45-kv pulse from network-transformer combination

By **WILLIAM Q. NICHOLSON** and **IRVING ROSS**
Engineering Section Head Hycon Manufacturing Company Pasadena, California *Senior Electronics Engineer*

NCESSITY for more quantitative information concerning rapidly changing physical phenomena has brought about the development of several high-speed shutters for photographic purposes in the microsecond region.

A further increase in speed to extend into the submicrosecond region has been achieved with the development of an electro-optical shutter suitable for photography of short-duration luminous phenomena, such as in explosion and ballistic studies.

The Kerr-cell shutter incorporates an exposure time of 0.1

microsecond, a geometric aperture of f/4.5, an effective aperture of f/7 and a view angle of 20 degrees. It may be repetitively pulsed at a 60-pps rate to check cell operation with a synchroscope.

Electro-Optical Effect

Basically, a Kerr cell is a transparent container with two electrode plates immersed in a fluid such as nitrobenzene. Polaroid sheets are mounted at either end and oriented as shown in Fig. 1.

Nitrobenzene is normally an optically isotropic material. The index of refraction and therefore the

velocity of propagation is independent of the electric vector orientation of light passing through it. When nitrobenzene is subjected to an electric field, it becomes anisotropic or birefringent for light passing normal to the electric field. The velocity of propagation depends upon the orientation of the electric vector of the light.

The propagation velocity is different for light with the electric vector parallel to the field than for light perpendicular to the field. This difference is proportional to the square of the field strength. The constant of proportionality is de-

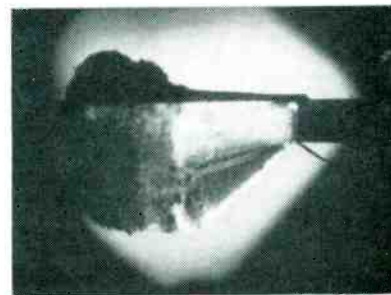
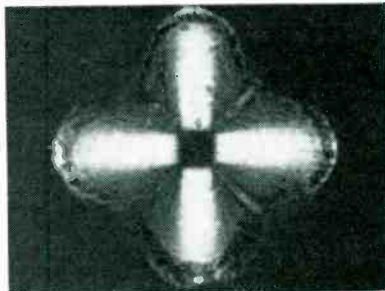
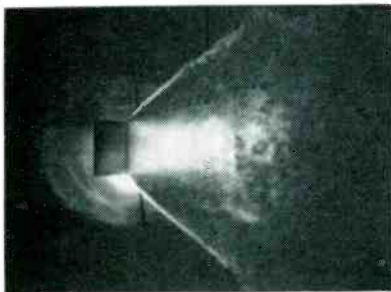

One-tenth-microsecond exposures of detonating pentolite stick. At left is side view, partially back-lighted. Center—front view, showing rays due to square stick. Photograph at right shows shock transmitted through horizontal metal sheet by contact detonation of pentolite

1-microsecond duration.²

Breadboard tests of a hydrogen-thyratron and capacitor combination feeding the primary of a pulse transformer showed that a 45-kv pulse could be generated, but shaping would be necessary to achieve desired width.

An experimental cell was constructed using the above parameters as a design basis. At the same time a development program was undertaken to design and build the pulse transformer and pulse-forming network. Since the secondary pulse fidelity was not of great importance, no attempts were made to achieve theoretical impedance match. Five-thousand-ohm load resistors were found to be adequate to prevent a long trailing edge on the pulse.

Circuits

A block diagram of the modulator or pulse unit is shown in Fig. 2, the schematic diagram in Fig. 3. The shutter is opened by discharging the 0.2-microsecond pulse-forming network which is charged to 14 kv through the primary of pulse transformer T_2 . The pulse forming network is discharged by the 5C22 hydrogen thyratron.

For adjustment and test of the pulse circuits and of cell operation a train of firing triggers is obtained for the 5C22 by clipping the 60-cps voltage at one plate of the rectifier for the +325-v supply. This clipped signal is differentiated and fed to a plasma circuit using a 2D21W. This miniature thyratron repeatedly discharges C_1 producing a set of fast-rise triggers. These triggers are fed to the 5687 blocking oscillator. Transformer T_1 then provides pulses of microsecond duration at 250-volts amplitude to fire the 5C22.

The network in the grid circuit of the 5C22 isolates the blocking-

oscillator stage from the pulse present at the grid of the 5C22 during ionization buildup.

The input impedance of T_2 is kept low to provide wide response and fast rise time on a 0.2-microsecond pulse. This is particularly necessary in a pulse transformer having a high voltage stepup.

When the pulse-forming network charges to 14 kv and the shutter is tripped, the network discharges into the pulse-transformer primary.

The 7-kv voltage across the primary is stepped up to 42 kv across the Kerr cell. The 10-ohm resistor in series with the 5,000-ohm damping resistors provides a low-level pulse-monitor output voltage, which may be observed on a synchroscope.

For photographic purposes the select trigger switch is placed in the internal or external position. When the camera shutter is tripped, the camera sync contacts ground the junction of the two 33,000-ohm resistors. This applies a positive-going step to C_2 , which in turn triggers the 2D21W and the high-level circuitry. The external switch position provides a connection for externally delaying the trigger so that a picture may be obtained at any time after initiating the phenomena to be photographed.

Operation

To verify the predicted exposure time, a multiplier phototube was used in place of a photographic plate. With the unit operating at the 60-pps rate and an incandescent light source placed in front of the cell, the actual light transmission pulse, shown in Fig. 4, was observed on a synchroscope.

Actual photographic tests were made by exploding 1-mil diameter resistance wire with a capacitor bank. The photographs show a

series of pictures taken at various delays. An external delay device was used to delay the trigger pulse until the desired time interval had elapsed. The nonuniform characteristic of localized heating of a presumably uniform homogeneous wire is attributed as one of the causes for incipient filament failure due to generation of hot spots during filament warmup.

This instrument was developed at Hycon Manufacturing Company under contract with the Ballistics Research Laboratory, Aberdeen, Md.

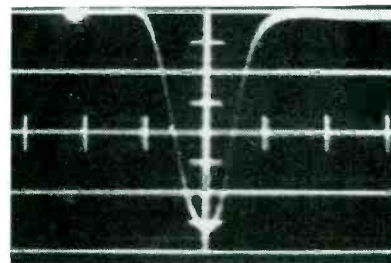

FIG. 4—Actual light transmission pulse through electro-optical shutter. Horizontal scale divisions are 0.1 microsecond

F. R. Marshall of Naval Ordnance Test Station, Thompson Laboratories and A. M. Zarem of the Stanford Research Institute assisted in the original optical and geometric cell configuration and made many helpful suggestions during this development.

The assistance of W. A. Stewart and W. L. Ahrens of Hycon in solving the many optical and mechanical problems contributed to the success of the project.

REFERENCE

- (1) A. M. Zarem, F. R. Marshall and F. L. Poole, An Electro-Optical Shutter for Photographic Purposes, NavOrd report 1,016.
 - (2) B. J. Ley and P. Greenstein, Electro-Optical Shutters for Ballistic Photography, *ELECTRONICS*, p 123, Sept. 1952.
- M. Sultanoff, A 0.1-Microsecond Kerr-Cell Shutter, *Photographic Engineering*, 5, No. 2, 1954.

Tracing Electron Paths

SUMMARY — Straight edge across nomograph shows directly the angle of reflection of an electron when angle of incidence and ratio of potentials for adjacent areas are known. Electromagnetic waves through several media are similarly traced

By **WILLIAM J. SPAVEN**

*Fada Radio and Electric Co., Inc.
Belleville, N. J.*

THE PATH of an electron through an electrostatic field may be readily determined by the repeated application of Snell's law, given the initial electron potential, the angle of incidence and the ratio of electron potential for two areas.

A simple procedure using a nomograph is outlined here. Determine the initial velocity of the electron entering the field in terms of potential V_1 . Obtain a plot^{1,2,3} of the equipotential lines of the field. Determine the angle θ_i at which the electron enters the field. This angle is measured from a line perpendicular to the boundary line at the point of entry.

Determine the average potential for the area between the first and second equipotential lines, as $V_1 = \frac{1}{2}(V_a + V_b)$. Determine the ratio of the two potentials. Referring to the nomograph, draw a straight line between the point corresponding to the angle of incidence θ_i and the point corresponding to the ratio of the two voltages. Extend the line to θ_r on the nomograph. The point of intersection gives the angle of refraction.

Repeated application of the process for succeeding areas will yield the path of the electron through the electrostatic field.

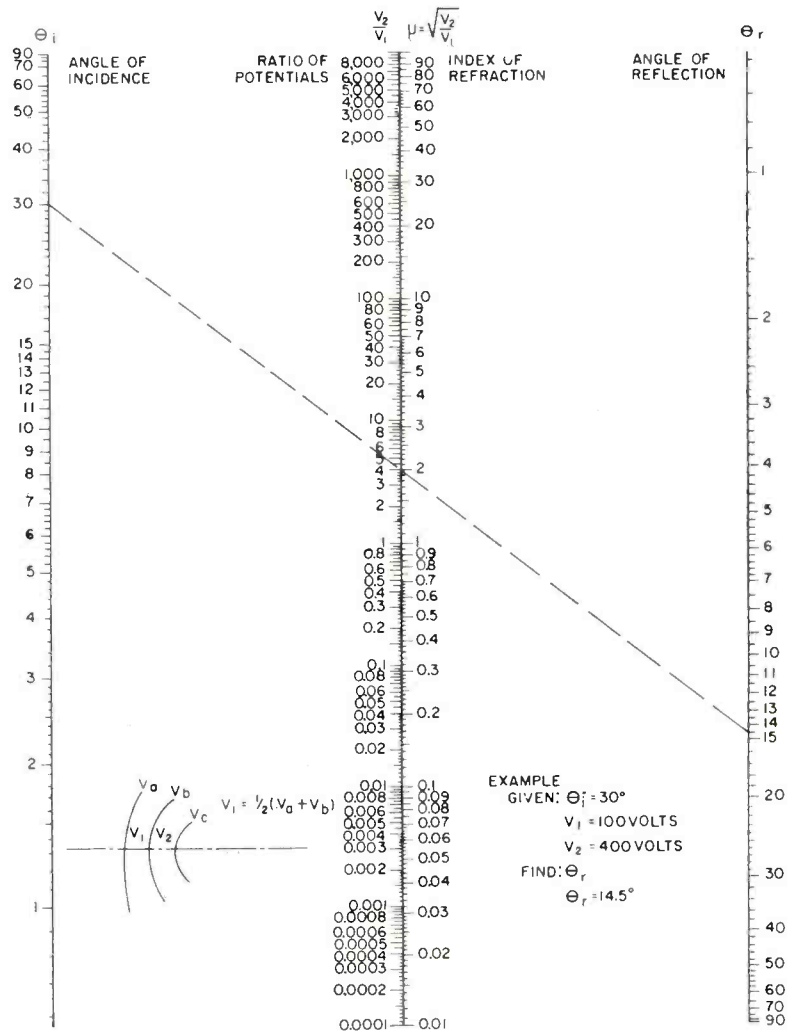

Although developed to aid in tracing electron paths and therefore useful in solving electron optics problems, the nomograph may also be used to trace paths of electromagnetic waves through several media with different wave velocity characteristics.

REFERENCE

- (1) Zworykin, Morton, Ramberg, Hillier and Vance, "Electron Optics and the Electron Microscope," John Wiley and Sons, Inc., New York, N. Y.
- (2) Spangenberg, "Vacuum Tubes", McGraw-Hill Book Co., Inc., New York, N. Y.
- (3) Klemperer, "Electron Optics", Cambridge University Press, London, England.

...FOR 'POSITIVE ELECTRICAL CONTACTS'... CINCH SUB-MINIATURE SOCKETS:

The CINCH Sub-miniature socket insures positive electrical contact, holds tubes securely in place, permits easy maintenance and replacement, yields maximum insulation resistance and minimum high frequency loss. And provides manufacturers of electrical controls, transmitters, receivers, transceivers, airborne equipment, etc., and hearing aids... a labor saving chassis installation which serves terminal board functions while permitting designers to obtain maximum shelf space afforded by the standard flat base tubes. For mounting perpendicular tubes, retainer rings and saddles are available, when socket cannot be staked. Contacts silver plated beryllium copper. For the Standard sub-miniature socket in quantity, quickly—

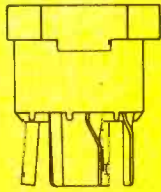
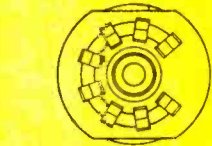

Sub-miniature for small button sub-minor 8 pin base T3 tubes mounted perpendicular to chassis.



Five pin stem type for mounting tubes parallel to chassis for printed circuits.

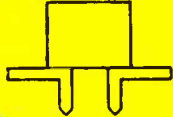
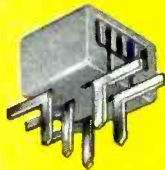

Seven pin stem type for tubes vertically mounted; also available in five and six pin.

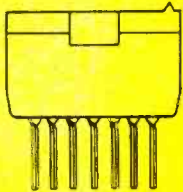

CINCH components are available at leading electronic jobbers—everywhere.



CONSULT CINCH CINCH MANUFACTURING CORPORATION

1026 South Homan Ave., Chicago 24, Illinois

Subsidiary of United-Carr Fastener Corporation, Cambridge, Mass.



Retaining rings, subminor 8 pin socket with saddle (right) and all sub-miniature sockets within yellow area (above) are shown enlarged twice.



Exclusively CINCH; quantity production of low loss mica components, quickly. CINCH constantly demonstrates ability to hold tolerances on Mica moldings... to meet the most exacting requirements in small metal plastic assemblies for components of higher quality materials held to closer tolerances.

Delay-Line Design

SUMMARY — Simulating networks to replace delay lines may be designed from nomograph that relates time delay to inductance, capacitance and impedance of line. Expanded scales determine additional significant figures

By **JOSEPH F. SODARO**
Los Angeles, California

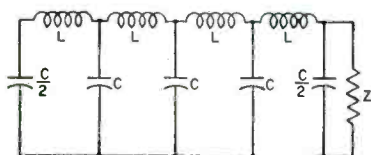

FIG. 1—Simulated time-delay network

DELAY-LINES may be either a coil of transmission-line or an artificial line or simulating network as shown in Fig. 1.¹

The time delay in seconds for n unit lengths of line is

$$t = n \sqrt{LC} \quad (1)$$

and the characteristic impedance in ohms is

$$Z = \sqrt{L/C} \quad (2)$$

in which L is the inductance per unit length in henrys and C is the capacitance in farads.

When long delays are required from a small component, the delay network is used. In this case n is the number of sections.

The nomograph evaluates Eq. 1 and Eq. 2 for either transmission-line or lumped-constants networks. Select the desired time delay on the t scale. Pivot a straightedge about this point and read combinations of inductance and capacitance on adjacent L and C_1 scales, which give the required time delay. Next, place the straightedge on the same values on the L and C_2 scales. Read characteristic impedance in ohms where the straightedge crosses the Z scale. This procedure may be reversed if Z is the independent variable.

Each scale stem has two sides. The right-hand scales are expanded left-hand cycles. Use the left-hand scales for decimal-point location. Use the right-hand scales for significant figures.

As an example, design a 10-section line having a total delay of 5 μ sec. Since the delay per section is 0.5 μ sec, place a straightedge on 0.5 on the t scale. Pivot the straightedge about this point selecting 400 μ uf on C_1 as a value of shunt capacitance. Estimate

630 μ h where the straightedge intersects the left-hand L scale. Repeat on right-hand scales to obtain 625 μ h.

Place the straightedge on the same values on left-hand L and C_2 scales. Estimate 1,300 ohms on the left-hand Z scale. Repeat on right-hand scales to read 1,250 ohms.

REFERENCE

(1) Allen A. Barco, Measurement of Phase Shift in Television Amplifiers, *RCA Review*, Apr. 1939.

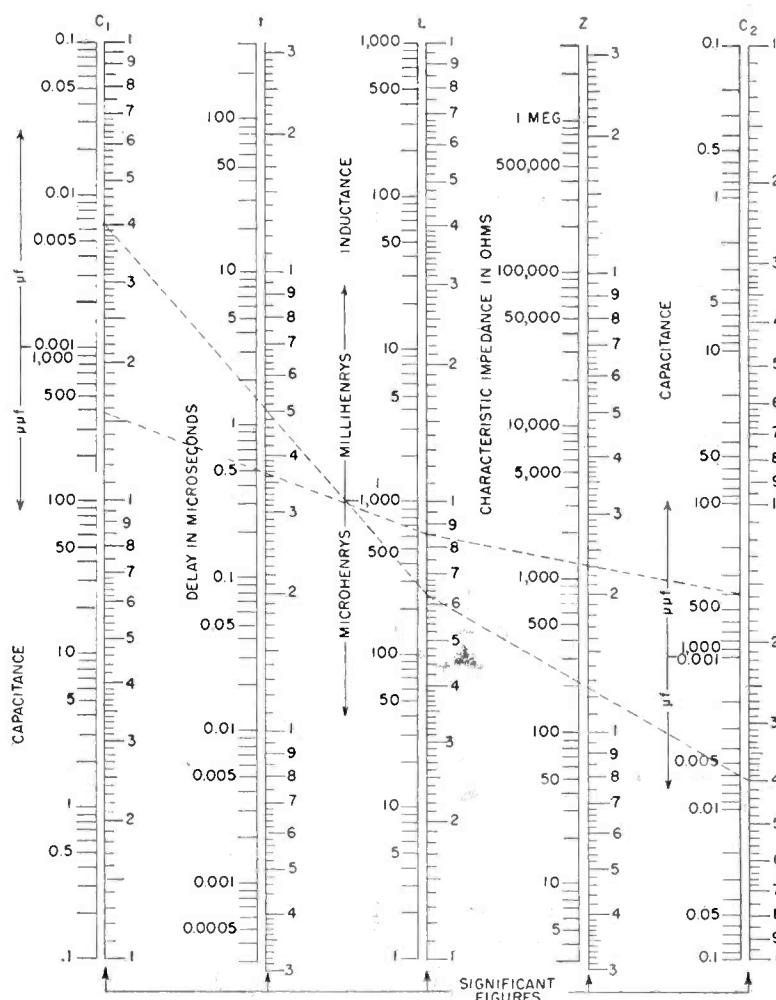

Save Space and Assure Dependability in Transistor Circuits

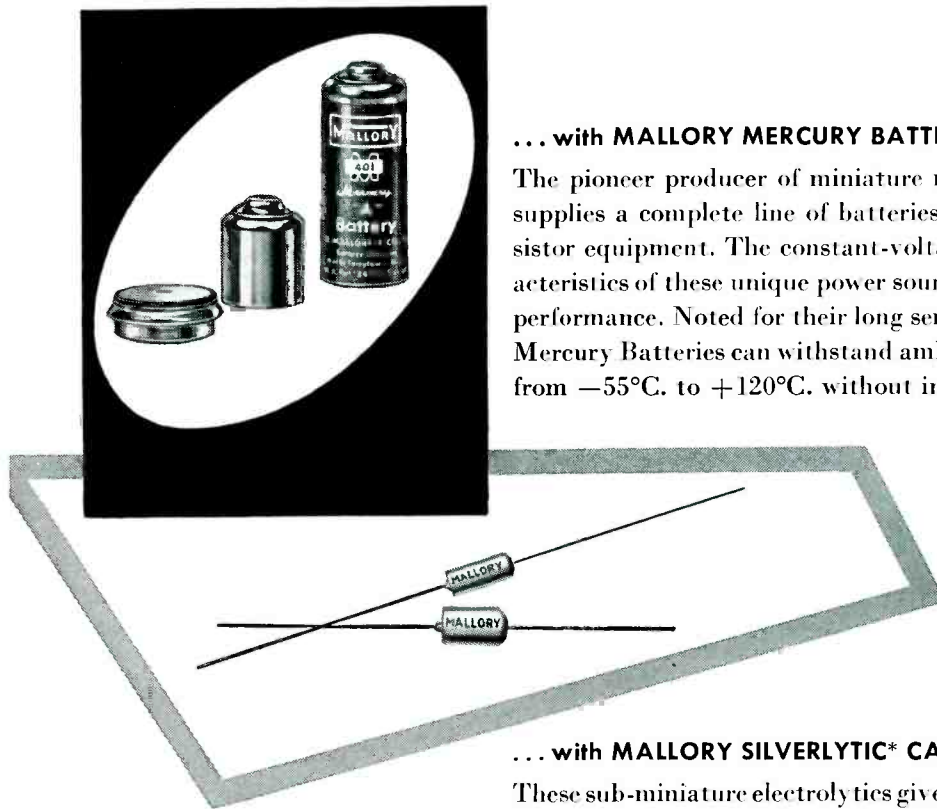

... with MALLORY MERCURY BATTERIES

The pioneer producer of miniature mercury batteries, Mallory supplies a complete line of batteries and Power-Paks for transistor equipment. The constant-voltage, constant-current characteristics of these unique power sources provide peak transistor performance. Noted for their long service and shelf life, Mallory Mercury Batteries can withstand ambient temperature extremes from $-55^{\circ}\text{C}.$ to $+120^{\circ}\text{C}.$ without impairment of output.

... with MALLORY SILVERLYTIC* CAPACITORS

These sub-miniature electrolytics give you the largest capacitance and voltage ratings in the smallest case size. Two different types are available. Type TAP, rated for $-55^{\circ}\text{C}.$ to $+85^{\circ}\text{C}.$, comes in values up to 30 mfd. at 6 volts, and in higher voltages as well. This unit is only $\frac{7}{32}$ " in diameter by $\frac{3}{8}$ " long. Even smaller is Type TAW, just 0.145" in diameter and $\frac{3}{8}$ " long, in ratings of 4 and 6 mfd. at 4 volts.

Expect more...

Get more...

from **MALLORY**

Plan to utilize the excellent electrical performance of these Mallory miniature components in your transistor equipment ... or in any low-voltage electronic circuits where space must be conserved. For complete technical data, write or call Mallory today. Your nearby Mallory distributor can give you prompt service on orders for experimental and pilot-run use.

Parts distributors in all major cities stock Mallory standard components for your convenience.

Serving Industry with These Products:

Electromechanical—Resistors • Switches • Television Tuners • Vibrators
Electrochemical—Capacitors • Rectifiers • Mercury Batteries
Metallurgical—Contacts • Special Metals and Ceramics • Welding Materials

*Trade Mark



Navigating By Carrier-Based TACAN Beacons

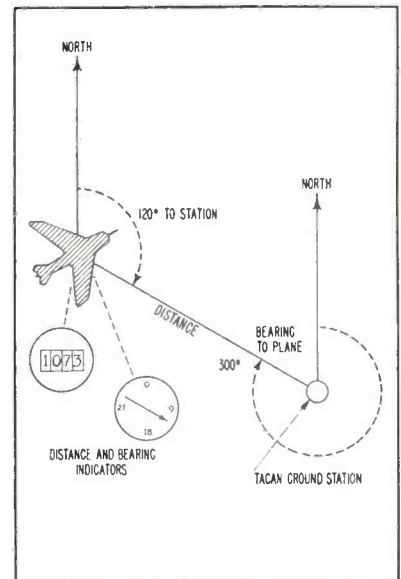

System of tactical air navigation (TACAN) not yet completely declassified by the military is said to be accurate within 0.2 mile and have a bearing accuracy better than ± 1 deg. Siting problem for TACAN is said not to be so critical as that for other bearing-dis-

tance systems and it can therefore be used to guide aircraft back to a naval aircraft carrier. It is being considered as possible replacement of existing VOR/DME system now in use by Civil Aeronautics Administration

Automatic Blood Pressure Recorder Will Sound Alarm

BY PRESETTING a desired pressure for which an alarm is to be sounded, the nurse of a post-surgery or cardiac patient can be summoned to the patient if pressure falls to that level.

In application, a blood pressure cuff is wrapped around the patient's arm and inflated by automatic opening of a valve in the air-storage supply. The device can be programmed for selected intervals from 30 seconds to one hour.

A microphone is strapped over the arm at the point where the physician holds his stethoscope ordinarily. Sound impulses detected by the microphone are amplified and thereby actuate a printing device that records air pressure in the system at the time it is equal to blood pressure. Special circuits discriminate against nonarterial noise.

Based upon the design of a

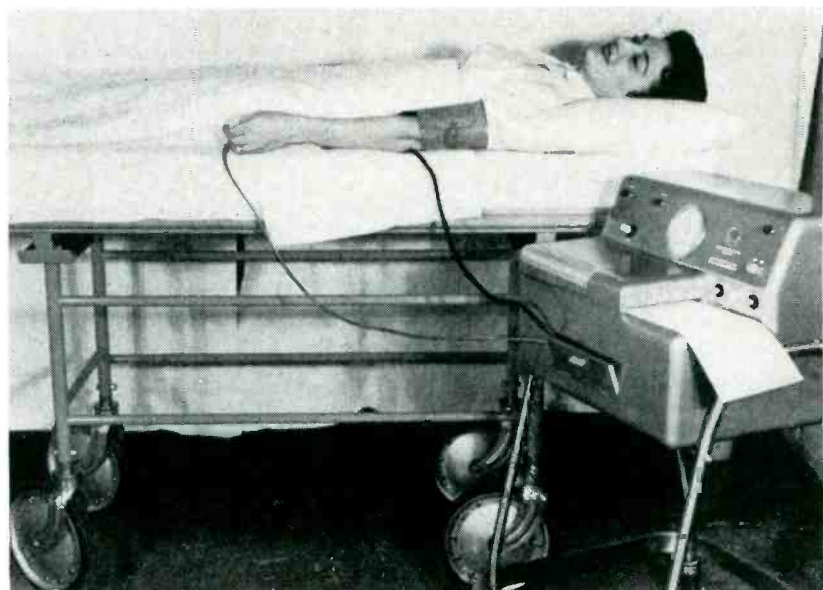

Machine plots patient's blood pressure and sounds alarm for preset limit

medical electronic device initially developed at National Bureau of Standards, the equipment is manu-

factured by the Colson Corp., Elyria, Ohio.

(Continued on Page 180)

KEPCO

Presents 2 New VOLTAGE REGULATED POWER SUPPLIES

KEPCO Voltage Regulated Power Supplies are conservatively rated. The regulation specified for each unit is available under all line and load conditions within the range of the instrument.

REGULATION: As shown in table for line fluctuations from 105-125 volts and load variations from minimum to maximum current.

SPECIAL FEATURE: Provision is made for picking up the error signal directly at the load, compensating for the voltage drop in external wiring.



Model 2600

OUTPUT	VOLTS	CURRENT	REGULATION	RIPPLE
1	0-60	0-2 Amp.	5 Mv.	1 Mv.

Model 2650

OUTPUT	VOLTS	CURRENT	REGULATION	RIPPLE
1	0-60	0-5 Amp.	5 Mv.	1 Mv.

30 MODELS
AVAILABLE FROM
STOCK. COMPLETE
CATALOG ON REQUEST

WRITE DEPT.1



KEPCO LABORATORIES

131-38 SANFORD AVENUE • FLUSHING 55, N.Y. • INDEPENDENCE 1-7000

Data Processor Prepares Computer Input On Ram Jets

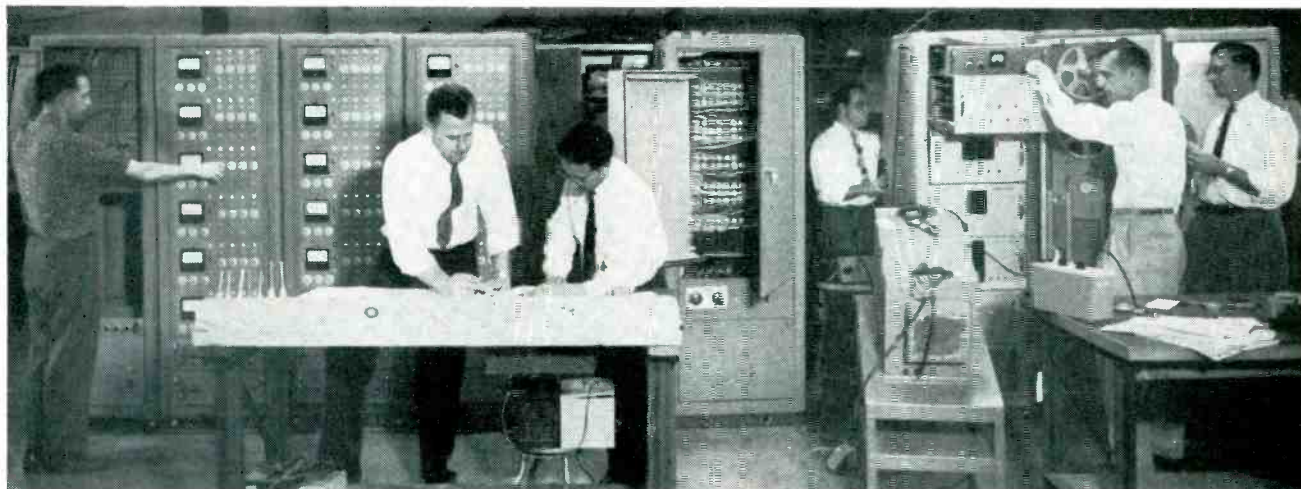

Consolidated Engineering Corp. high-speed data processing system built for Marquardt Aircraft Co. tests ram-jet engine pressures, temperatures and fuel flows. Information is transmitted in electrical form through an amplifier and balancing system and converted

to numerical values. Resulting figures are recorded on magnetic tape for direct input to an electronic digital computer or card punch. Besides cutting cost of test instrumentation more than 60 percent, it will reduce by 65 percent time lag in obtaining results

Spider Antenna Can Beam Signals In Six Directions

A UNIQUE ANTENNA structure 50 feet across and 20 feet high is being operated by Von R. Eschleman and Thomas V. Harroun of Stanford University in a study of meteoric dust in the upper atmosphere. Operating as corner reflectors, any one of the six sections can be employed to detect and chart the paths of dust by means of echoes reflected and recorded at the ground.

Although visible meteors are rare and shooting stars are not plentiful, about 10 billion particles, many no larger than dust, hit the earth's atmosphere each day. Propagation of radio signals over long distances by bouncing them from the ionized air in the wake of meteor particles appears entirely possible.

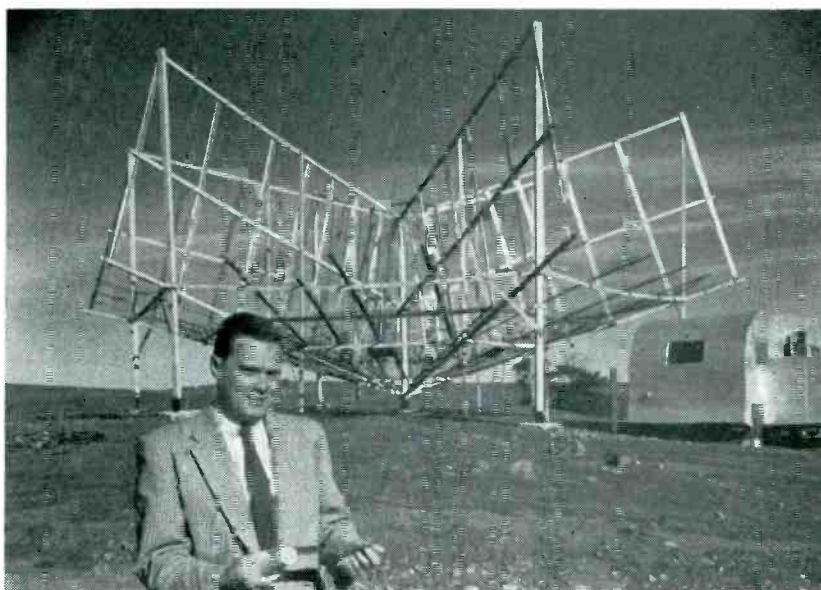

Dr. Eschleman of Stanford Radio Propagation Laboratory and the Spider antenna

Table Model Receiver Uses AFC For F-M Tuning

ALTHOUGH automatic frequency control circuits have little novelty in themselves, recent models of f-m receivers manufactured by Zenith require a somewhat different circuit approach from those of other manufacturers.

The reactance tube uses a capacitive reactance circuit, necessitated

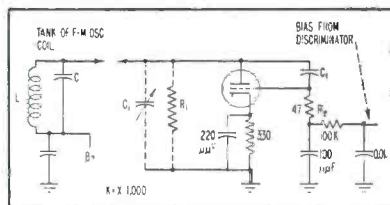

Representation of the capacitive reactance circuit described in the text

because the receiver employs a variable inductance tuner. The reason is that with a fixed capacitance C across the tuned circuit, the ΔC of the reactance tube will have the same afc range across the entire f-m band.

For the circuit diagram shown, it was found that when R_2 was 47

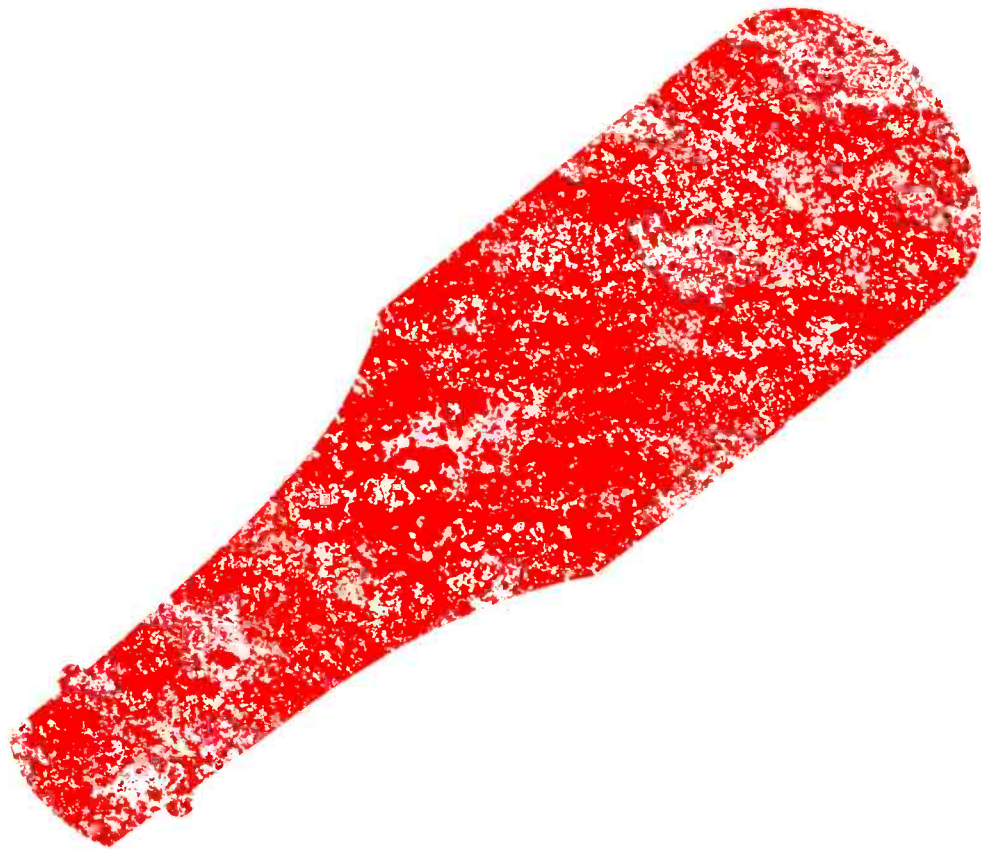

no ketchup needed



When a predestined steer meets a dedicated chef . . . man, that's steak!
If steer or chef is bad (and double trouble if both) . . . ketchup can't help.
Now comes the commercial.

Take the best available materials (sifted by unrelenting research).
Season with the same inventiveness used by Dr. A. O. Beckman to develop
the precision potentiometer in 1940 (we've never switched brands).
Add assembly-line economies without compromising quality. Test and
retest in the industry's most complete lab. Inspect a dozen times
(too many cooks can't spoil *this* broth). Pack well. Ship on schedule.
Man, that's a HELIPOT precision potentiometer . . . no ketchup needed!



first in precision potentiometers
Helipot Corporation / South Pasadena, California
Engineering representatives in principal cities
a division of BECKMAN INSTRUMENTS, INC.



536 *REG. U.S. PAT. OFF.

*Helipot makes precision potentiometers . . .
linear and non-linear . . . in the widest choice
of sizes, mounting styles and resistances.
Many models are stocked for immediate
shipment . . . our engineers will gladly adapt
standard models to your requirements . . .
or design entirely new HELIPOT* precision
potentiometers for you.
For information and specifications . . .
write for data file 601.*

ohms, about 800 kc of afc holding was obtained on either side of center.

An afc disabling switch is also provided in the receiver to allow for perfect centering for recording purposes. The receiver can then be switched to afc for maximum frequency stability. Switching out afc is also desirable on weak signals

when there is a strong station one channel away. Similarly, frequency pulling by a strong local f-m receiver oscillator can thus be eliminated.

For the simplified circuit shown, when $R_2 \ll X_{C1}$, $C_1 \approx g_m C_1 R_2$. The value of R_1 is approximately $1/g_m (\omega C_1 R_2)^2$. The component C_1 is the capacitive reactance across the

plate of the reactance tube and varies with g_m , which in turn varies with the grid bias applied to the reactance tube; R_1 is a resistive component that also appears across the plate of the reactance tube.

This item is abstracted from material furnished by Virgil R. Beck of the Zenith engineering department.

Solar Battery Efficiency Doubled in Year

CONVERTING SUNLIGHT into electricity using specially prepared silicon wafers is a technique announced by Bell Telephone Laboratories in April 1954 (ELECTRONICS, p 196, June 1954). Within a year, the efficiency of the solar battery has been increased from 6 percent to 11 percent. This efficiency compares with that of the best gasoline engines and is more than 20 times higher than that of photovoltaic devices.

Developed by G. L. Pearson, C. S. Fuller and D. M. Chapin, the battery has been improved by K. D.



Bell Labs engineer, D. F. Ciccolella compares solar battery with Eppley pyrheliometer that measures total solar radiation available

Smith, E. J. Stansbury, C. J. Frosch and D. F. Ciccolella. The battery wafer comprises a thin slice of arsenic doped silicon into which boron has been introduced in the microscopic layer near the surface. The boron reaches a depth of less than 1/10,000 inch.

Trial batteries will be used this summer as part of the experimental subscribers' line system near Americus, Ga. that uses transistor amplifiers on rural circuits.

The improved battery can deliver power from the sun at 100 watts per square yard of silicon surface.

Canadian Observatory Broadcasts Talking Clock

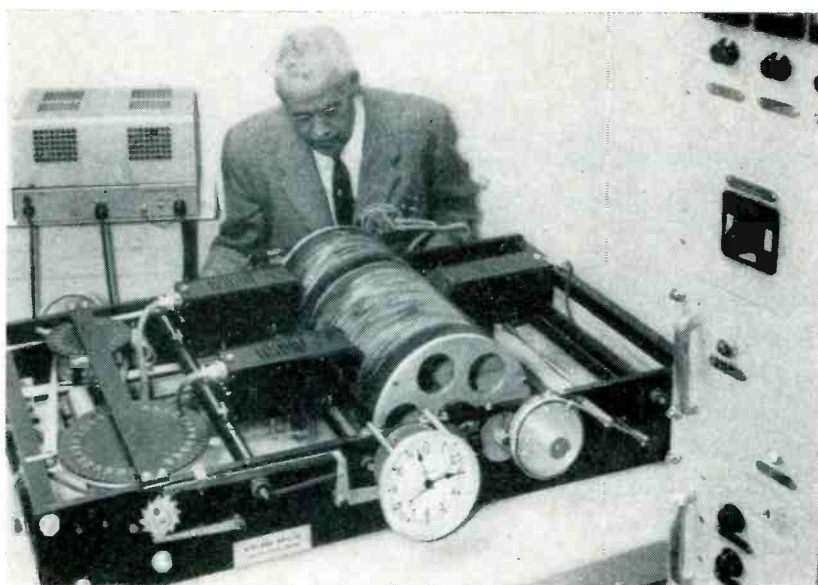

Voice announcement of the hour and minute is made automatically each minute by the photoelectric machine recently put into service at the Dominion Observatory

SINCE January 1, 1955, the Dominion Observatory, Ottawa, Ontario, has been transmitting voice-announced time-signals each minute on the following frequencies; 3,330 kc, 7,335 kc and 14,670 kc.

These time announcements are obtained from either one of two machines constructed in France by Atelier Brillé Frères of Paris.

The voice is produced from sound track cut from 35-mm film, mounted in grooves on a drum, which is revolved at 30 rpm by a synchronous motor. Power for the motor comes from an amplifier controlled by the 60-cycle multivibrator output of one of the five crystal clocks comprising the Dominion Observatory time standard.

Three readers, each containing an exciter lamp, photocell and matching transformer, are mounted on tracks parallel to the drum and are made to move from groove to groove by cam action between announcements.

A point of light from each reader is focused on the sound track and

Table I—Coding of CHU Time Signals

Minutes	Second	50	51	52	53	54	55	56	57	58	59	60
1st		—	—	—	—	—	—	—	—	—	—	—
2nd		—	—	—	—	—	—	—	—	—	—	—
3rd		—	—	—	—	—	—	—	—	—	—	—
4th		—	—	—	—	—	—	—	—	—	—	—
5th		—	—	—	—	—	—	—	—	—	—	—



Kodak
TRADE-MARK

Announcing . . .

*a portable, bench-type comparator for
either horizontal or vertical projection . . .*

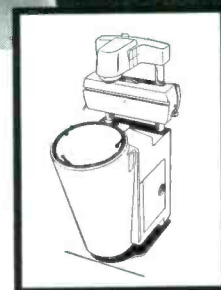

the KODAK CONTOUR PROJECTOR, Model 8

Here's how Kodak brings you new economy in checking small parts by projection gaging:

Two-way staging: Parts can be staged in simple holding fixtures for horizontal projection on the Model 8. Or you can turn the machine on end for vertical projection and simply lay the workpiece on an easily mounted plate-glass stage. Only Kodak provides this choice to simplify your staging.

Choice of magnification: Six precision projection lenses (10×, 20×, 31¼×, 50×, 62½× and 100×) are quickly interchangeable, seat positively for precise rated magnification.

Large work area: Kodak's unique relay lens system gives you uniform, ample working distance at all magnifications.

Easily portable: The cast-aluminum Model 8 is easily portable, designed for use on bench or table.

Bright screen image: Coated lenses which increase light transmission—plus a special Fresnel lens back of the screen—yield a bright image, permitting you to use the Model 8 anywhere in the plant.

Optical stability: Kodak's famed Ektar Projection Lenses and rigidly built lens mounts and housings insure accurate performance year after year, provide precision equal to that of large toolroom projectors.

Easy to use: Operators learn inspection procedures quickly, using optical gaging on the Model 8. Erect, right-reading image with both vertical and horizontal projection cuts down training time. Air-cooled lamp-house and handy controls assure operator ease.

EASTMAN KODAK COMPANY

Special Products Sales Division
Rochester 4, N. Y.

the KODAK CONTOUR PROJECTOR

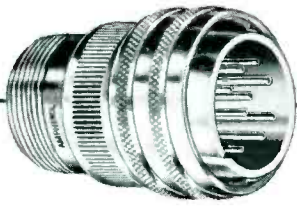

AN CONNECTORS

make



MINIATURE AN-types

contact



RF CONNECTORS

with

SUB *Minax*

Amphenol

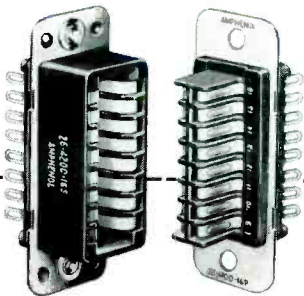
BLUE *Ribbon* CONNECTORS

Quality

Six individual catalogs present the AMPHENOL products. If you will give us a list of the AMPHENOL literature you now have we will bring this important reference material up-to-date in accordance with your designated product interest.

is reflected back to the photocell by a bright surface underlying the film. Modulation is effected by the variable-width sound track reflecting varying degrees of light intensity as it is rotated on the drum at the rate of 90 feet a minute.

Cam-operated snap switches select each reader in turn to give the proper sequence to the announcements such as station identification, hours and minutes.

Suitable amplifiers, controls and meters, an independent set for each machine, are mounted on a rack adjacent to the table-mounted drum mechanisms. Alarm circuits alert the operator if trouble develops.

Table I showing how time ticks (sent out independently of the voice-announcing machine) are coded, is common to Dominion Observatory and U. S. Naval Observatory standard time signals. The method is described in greater detail beginning on page 196.

Small Airport ADF

THE AUTOMATIC direction finder illustrated comprises two units—the rotating-goniometer antenna and the receiver-indicator to which it is connected by cables. The antenna is an H-type Adcock with four vertically polarized dipoles symmetrically disposed about the central housing that serves as sense antenna.

The directional pattern has a cardioid shape. The goniometer couples energy from the dipoles to the rotary transformer, rotating the pattern at 1,800 rpm. A signal arriving from any particular direction is amplitude modulated at



Compact adf comprises receiver and indicator dial

AMERICAN PHENOLIC CORPORATION
CHICAGO 50, ILLINOIS
In Canada: AMPHENOL CANADA LTD., Toronto

AMPHENOL

June, 1955 — ELECTRONICS

RF VOLTAGE STANDARD

A Micropotentiometer supplying a Standard source of RF Voltage for calibrating Signal Generators



TYPE 245-A

- Operates over a wide frequency range. Useful to 1000 MC.
- Standard calibration signals available at levels of 0.5, 1.0 and 2.0 microvolts.
- Output impedance 50 ohms. VSWR less than 1.03 to 500 MC.
- Measures high level output of Signal Generators at one frequency.
- Calibrates all Signal Generators, with 50 ohm output impedance and maximum output of 50,000 microvolts into 50 ohms, in its frequency range.

The RF Voltage Standard, Type 245-A consists of an attached, well shielded, input cable for connecting from a Signal Generator to a voltage monitoring system across the input to a "T" type attenuator. The output of the attenuator connects to a coaxial connector intended for a cable which is connected to an RF receiver. The voltage monitoring system includes a semi-conductor diode used at a constant bias value, set from the front panel. The diode output is matched to a very sensitive meter by a transistor. The monitoring system indicates the RF voltage across a voltage divider consisting of a 50 ohm impedance in series with a 0.002 ohm disc resistor to ground. The voltage existing at the junction of the divider is connected through a 50 ohm resistor to the output. This system takes approximately the full output of an average signal generator, precisely monitors this output at a proper level, and accurately attenuates this precisely measured voltage to the micro-

volt region. The now accurately known signal at microvolt level appears in the output circuit in series with a 50 ohm resistive impedance.

In use the Signal Generator to be calibrated is connected to the input cable and a receiver with a d.c. meter across its detector is connected to the output of the "RF Voltage Standard" Type 245-A as shown at "A" below. The output of the Signal Generator is advanced to a reference line on the meter of the "RF Voltage Standard" and the reading on the d.c. meter across the receiver noted. The "RF Voltage Standard" is then removed from the circuit, as at "B" below, and the same reading established on the receiver d.c. meter by varying the attenuator of the Signal Generator. The Signal Generator attenuator is now set for an output of 0.5, 1.0 or 2.0 microvolts depending on choice of reference line.

The "RF Voltage Standard", Type 245-A, is housed in a small, portable, sloping-panel cabinet. The indicating meter is a very sensitive movement in a clear plastic case arranged for rear panel mounting. The micropotentiometer attenuator is a coaxial system including a 50 ohm resistive concentric line terminated in a 0.002 ohm disc resistor to ground. Connected to the other side of the disc is an additional 50 ohm concentric line connecting to the output. The voltage at the input is monitored by a UHF Crystal Diode in a specially designed coaxial mounting. The d.c. output current of the diode is connected through an RF filter and matching transistor to the indicating meter. An internally mounted battery, supplies necessary d.c. voltages.

CW Signal Generator is shown connected to RF Voltage Standard which is connected to receiver. Note coaxial micropotentiometer and voltage monitoring system.

CW Signal Generator connected directly to temporarily calibrated receiver.

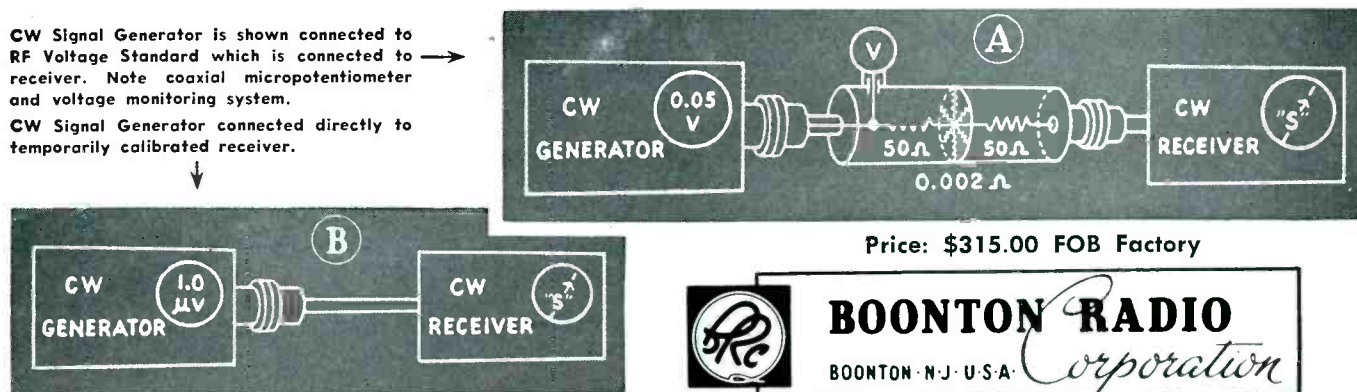

Price: \$315.00 FOB Factory



TWIN POCKETSCOPE

by

Waterman

MODEL S-15-A

TWO IDENTICAL
INDEPENDENT
OSCILLOSCOPES
WITH COMMON
TIME BASE



Size:
12" x 6" x 7"
16 1/4 Pounds

ANOTHER EXAMPLE OF **Waterman** PIONEERING ...

The WATERMAN TWIN POCKETSCOPE, model S-15-A, presents a new concept in multiple trace oscilloscopy with independent vertical channels each having a sensitivity of 10 millivolts rms/inch, and a response within -2 db from DC to 200 KC—a pulse rise time of 3 microseconds. These features combined with the provisions for intensity modulating either, or both, traces, results in greater flexibility. The sweep generator is operated either in the repetitive or triggered mode from 0.5 cycles to 50 KC with synchronization polarity optional. All attenuators and gain controls are of the non-frequency discriminating type. Remember that portability has not been overlooked! The amazing small size of the S-15-A tips the scales of opinion heavily in its favor. Imagine, all of these essential characteristics in an instrument weighing only 16 1/4 lbs. You can carry it to any job, anywhere!

WATERMAN PRODUCTS CO., INC.

PHILADELPHIA 25, PA.
CABLE ADDRESS: POKETSCOPE

WATERMAN PRODUCTS INCLUDE

S-4-C SAR PULSESCOPE®
S-5-A LAB PULSESCOPE
S-6-A BROADBAND PULSESCOPE
S-11-A INDUSTRIAL POKETSCOPE®
S-12-B JANized RAKSCOPE®
S-14-A HIGH GAIN POKETSCOPE
S-14-B WIDE BAND POKETSCOPE
S-15-A TWIN TUBE POKETSCOPE
RAYONIC® Cathode Ray Tubes
and Other Associated Equipment

MEMO
Write
for
details
today!

WATERMAN PRODUCTS

30 cps. Phase of the modulation depends upon direction of arrival. The synchronous motor also drives a 30-cps diphas generator that serves as phase reference for the indicator.

The modulated wave is amplified and detected in the receiver, which is capable of being tuned over the range from 118 to 148 mc. Constant phase shift is maintained as a function of tuning and signal strength. After detection, the 30-cps wave is limited to insure constant voltage input to the phase detector.

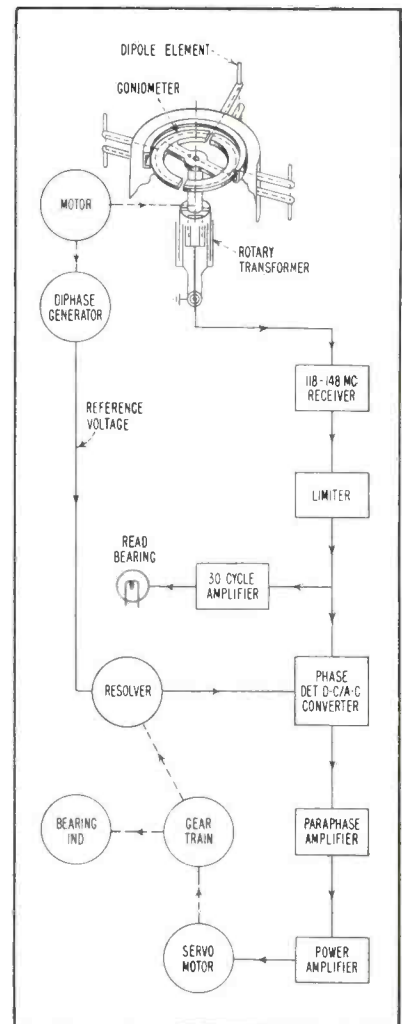

Block diagram of the automatic direction finding system

The detector has two inputs, one from the resolver, which acts as a phase shifter and the other from the limiter. Its output is a d-c error signal of reversible polarity that is converted to a-c and amplified in the paraphase and power amplifier to drive the servomotor;

make sure you get the most important
TAPE WOUND CORE IMPROVEMENT
 in 6 years



revolutionary **ALUMINUM CORE BOX[†]** construction

withstands HIGH TEMPERATURE • VACUUM IMPREGNATION
 HEAVY WINDING STRESSES • SHOCK and VIBRATION

This is a development which calls for immediate changes in purchasing specifications for Tape Wound Cores, because introduction of the Aluminum Core Box means designing your toroids around four important new advantages:

1. Use of an aluminum core box means the new Magnetics, Inc. tape wound cores will withstand temperatures of *at least* 450° F.
2. Because of the unusual seal provided by forming the aluminum over the silicone glass seal, true vacuum impregnation of your coils is now possible. Varnish cannot penetrate the core box and affect magnetic properties of the tape.
3. The strong aluminum construction absolutely prevents deflection of the core box when coils are wound—a distortion-free construction which means no change of magnetic properties.
4. Cushioned with an inert material, the tape winding in the core box is protected against vibration and shock. In most cases it is so completely minimized that it is no longer a problem.

Because of the many advantages of these new Magnetics, Inc. Tape Wound Cores, it will pay you many times over to specify "Aluminum Core Boxes" on your next order.

[†]PATENT PENDING

Immediately available in 109 standard sizes, using all commercially available magnetic materials.

ALL *Performance - Guaranteed*

For full details, write for
 Bulletin TWC-200
 Catalog TWC-100

MAGNETICS inc.

DEPT. E-21, BUTLER, PENNSYLVANIA

PERKIN... HAS A STANDARD POWER SUPPLY FOR YOUR EVERY NEED
IMMEDIATE DELIVERY!!



PERKIN
TUBELESS!!
MAGNETIC AMPLIFIER
REGULATED DC
POWER
SUPPLIES

MODEL
 MR 532-15
 5 TO 32 V.
 @ 15 AMP.
 (CONT.)



REGULATION: $\pm 1\%$ (a) from 5-32V DC (b) from 1.5 to 15 amps. (c) from 105-125V AC. (single phase, 60 cps.)
RIPPLE: 1% rms @ 32V and full load, increases to max. of 2% rms @ 5V and full load. **RESPONSE:** 0.2 sec.
METERS: 4 1/2" AM and VM; 2% accuracy.
MOUNTING: Cabinet or 19" rack panel.
FINISH: Baked Grey Wrinkle.
WEIGHT: 150 lbs.
DIMENSION: 22" x 17" x 14 1/2"

MODEL
 M60 YMC
 0 TO 32 V.
 @ 25 AMP.
 (CONT.)



REGULATION: $\pm 1\%$ * (a) at 28V DC; increases to 2% max. over the range 24-32V; does not exceed 2V regulation over the range 4-24V DC (b) from 1/10 full load to full load (c) at a fixed AC Input of 115V.
RIPPLE: 1% rms @ 32V and full load; 2% rms max. @ any voltage above 4V.
AC INPUT: 115V, single phase, 60 cps.
FINISH: Baked Grey Wrinkle.
WEIGHT: 130 lbs.
DIMENSIONS: 22" x 15" x 14 1/2"

MODEL
 MR 1040-30
 10 TO 40 V.
 @ 30 AMP.
 (CONT.)



REGULATION: $\pm 1\%$ (a) from 10 to 40V DC (b) from 100 to 130V AC (c) from 3 to 30 Amps DC. **RIPPLE:** 1% rms.
AC INPUT: 100-130V, 1 phase, 60 cycles.
RESPONSE: 0.2 sec. **METERS:** 4 1/2" AM and VM.
MOUNTING: Cabinet with 19" rack panel.
FINISH: Baked Grey Enamel.
WEIGHT: 200 lbs.
DIMENSIONS: 22" x 15" x 23"

MODEL
 MR2432-100X
 24 TO 32 V.
 @ 100 AMP.
 (CONT.)

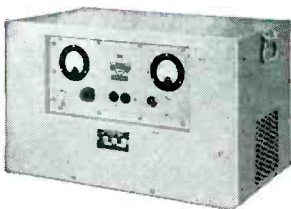

REGULATION: $\pm 1/2\%$ (a) from no load to full load. (b) from 24-32V DC. (c) for 230* (or 460) V $\pm 10\%$.
DC OUTPUT: 24-32V @ 100 amps.
AC INPUT: 230 or 460V $\pm 10\%$, 3 phase, 60 cycles.
RIPPLE: 1% rms. **RESPONSE TIME:** 0.2 sec.
MOUNTING: Cabinet or 19" rack panel.
WEIGHT: 250 lbs.
DIMENSIONS: 25" x 15" x 15"
 *This unit will be supplied for 230V AC Input unless 460V is specified.

ALSO AVAILABLE: Standard 6 and 115 volt models; Ground and Airborne Radar and Missile Power Supplies.—Write for Perkin Bulletins.

PERKIN
ENGINEERING CORP.

345 KANSAS ST. • EL SEGUNDO, CALIF. • ORegon 8-7215 or EAsgate 2-1375



resolver and bearing indicator.

The motor rotates until the phase of the resolver output and the incoming signal are 90 deg. This corresponds to detector zero output. At this point, the indicator reads bearing of the incoming signal. The phase detector, operating on a cross-correlation principle, gives output even when noise is as high as 20 db above the signal. The servomotor can accurately shift as much as 180 deg in 1 second of time. However, under normal field conditions, response time is closer to 1 1/2 sec.

A 30-cps amplifier lights an indicating lamp when the preset level of signal that will insure reliable readings is reached. Normally the control of this level is set for a microvolt signal at the receiver input terminals.

Low-Frequency Sound Reducer

ELECTRONIC SOUND ABSORPTION reduces sound by means of a transducing system, as contrasted to conventional absorption by direct conversion from acoustical energy to heat energy. The system is ca-

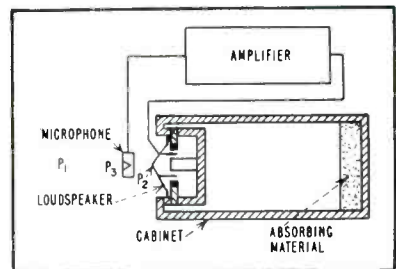
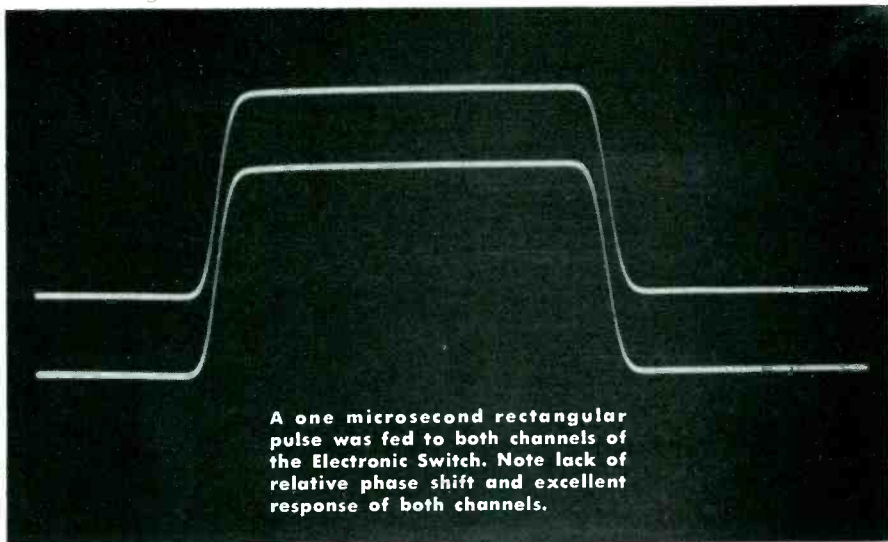

FIG. 1—System for local sound reduction uses loudspeaker to cancel sound waves in area of microphone

pable of absorbing, to a high degree, sounds in a range of many octaves in the low-frequency range. The absorber consists of a microphone, amplifier and speaker arranged as shown in Fig. 1. The sound picked up by the microphone is amplified and fed to the loudspeaker in a phase relationship that tends to cancel out soundwaves in the vicinity of the microphone.

To obtain a flat response in the low-frequency region, an electronic microphone is used. The microphone diaphragm is connected di-

Convert to
Dual Channel
Operation in
the Range of
DC to 15 MC



...using any Single-Channel Oscillograph
with the

NEW DU MONT TYPE 330 ELECTRONIC SWITCH

The new Du Mont Type 330 Electronic Switch is a self-contained accessory for oscillography that permits . . .

1. Converting *any* single-beam oscillograph into a dual-channel instrument.
2. Adding a channel to any multi-channel instrument.
3. As a chopper, converting an a-c oscillograph for d-c measurement.

Within the range of DC to 15 MC, the Type 330 is limited only by the characteristics of the cathode-ray oscillograph being used.

This is the answer to those studies requiring comparison between two or more functions. Maximum time shift between the channels of the Type 330 is within one millimicrosecond. Both channels may be adjusted for unity gain making it a simple matter to superimpose two phenomena for very precise time, phase or amplitude comparison.

Three free-running switching rates, 1KC, 10KC and 100KC, or triggered operation allow selection for best presentation on the cathode-ray oscillograph. The Type 330 can be connected into a test setup or disconnected as the need arises.



MAJOR SPECIFICATIONS

SIGNAL CHANNELS

- I. Sinusoidal Frequency Response: with an output load of 60 uuf, either channel, flat to d.c. and down not more than 3 db at 15 mc.
- II. Amplifier Rise Time: with external load of 60 uuf, no greater than 0.022 usec.
- III. Variable Attenuator: Each channel has two series stepped attenuators with attenuation ratios of 1, 2, 4, 10,

20, 40, 100, 200, and 400; accuracy of attenuators $\pm 2\%$.

- IV. Output: Level is zero volts d.c. with no signal or positioning voltage; positioning controls provide ± 1 volt of d.c. positioning voltage.

SWITCHING

- I. Recurrent: Free-running, fixed frequencies of approximately 1 KC, 10 KC and 100 KC; Triggered, rate may be triggered at 0 to 100 KC rates.

DU MONT

PRICE \$295

WRITE FOR COMPLETE INFORMATION

ALLEN B. DU MONT LABORATORIES, INC.
INSTRUMENT DIVISION

760 BLOOMFIELD AVENUE • CLIFTON, N. J.

What is YOUR RELAY PROBLEM?

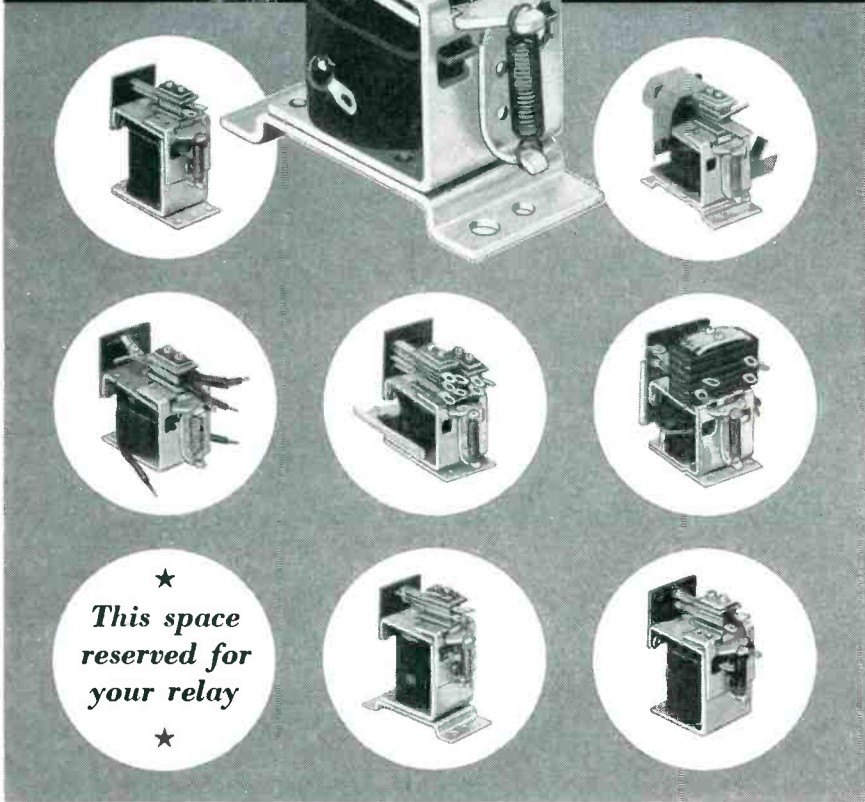

★
This space reserved for your relay
★

R·B·M General Purpose Relays..

have solved many specific relay problems with no development or tooling cost to the customer. RBM has produced hundreds of thousands of magnetic relays from standard parts—designed and initially produced over seven years ago—to fulfill the need for dependable relays at low cost.

The many variations of contact form and ratings, as well as ter-

minial arrangements and mounting brackets, may well provide just the right relay for you. WRITE FOR BULLETIN 570—or better yet, tell us your requirements. Bulletin 570 shows only a few of the many variations.

Whether a single relay or a relay panel complete with wire assemblies and cord sets, RBM may help you lower your costs.

R-B-M DIVISION
ESSEX WIRE CORPORATION
Logansport, Indiana

Controls for Electronic, Refrigeration, Industrial, Appliance, Communication and Automotive Industries



rectly to the anode rod of a movable-anode tube as shown in Fig. 2. Output of the tube is proportional to the movement of the anode rod.

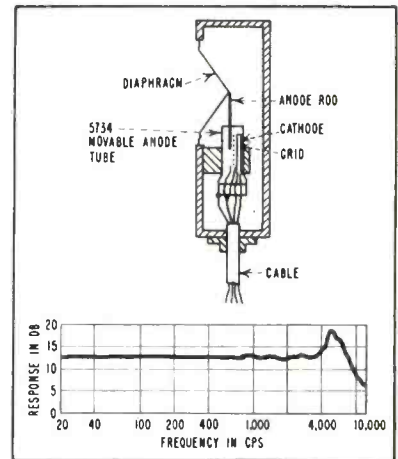

FIG. 2—Movable anode tube microphone has flat low-frequency response characteristic

Uniform response extends down to zero cps. Since the impedance of the microphone is about 10,000 ohms, the problem of obtaining uniform phase and response characteristics is simplified.

The loudspeaker unit, Fig. 3, has a high-impedance voice coil coupled directly to the amplifier output tube. This eliminates phase-shift problems involved in the use of coupling transformers. In this application the back of the loudspeaker must be entirely enclosed. For a speaker diaphragm three inches in diameter a cabinet volume of one-half cubic foot is required.

The speaker cone is suspended

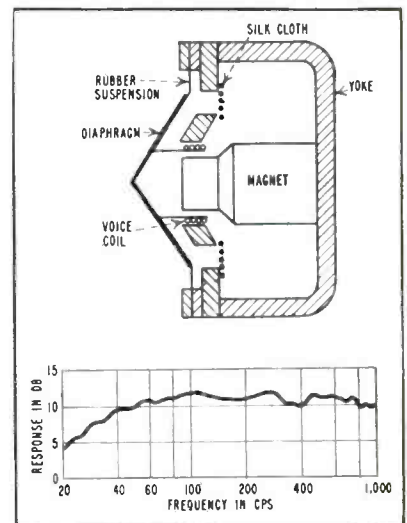

FIG. 3—Loudspeaker diaphragm carried on circular rubber disk to eliminate center mounting has response shown

IN TOP QUALITY CORES

FOR HIGHER FREQUENCIES

FROM 20 TO 300 MC.

TYPES SF, J AND W

GA&F® CARBONYL IRON POWDERS

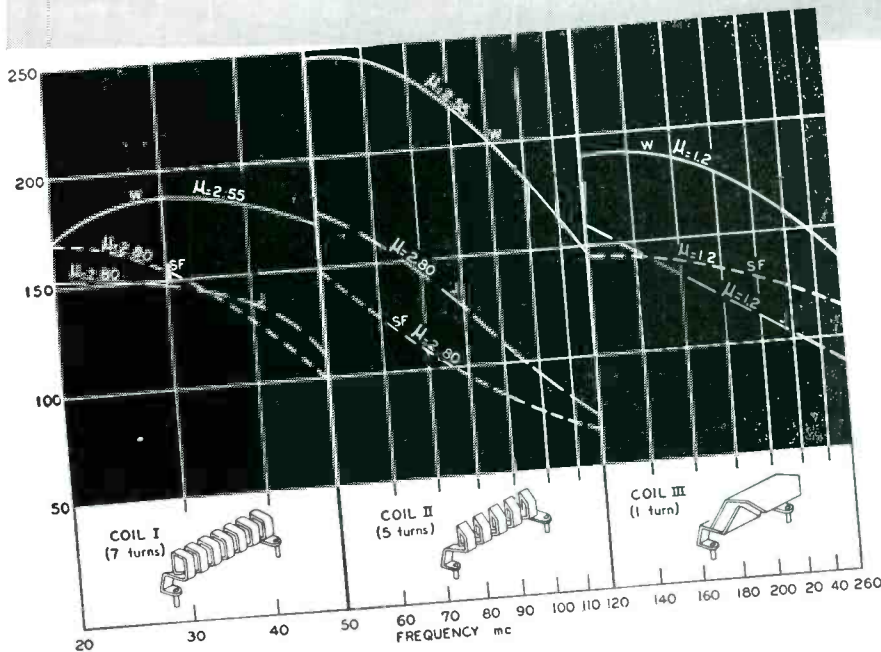

Three types of G A & F Carbonyl Iron Powders are particularly satisfactory in cores designed for use at the higher frequencies. To assure low losses and good magnetic and temperature stability at 20 mc. to 300 mc., we invite you to test Types SF, J and W. These powders are microscopic, almost perfect spheres—ranging from 3 to 9 microns in diameter—with the same rigorous uniformity that characterizes all G A & F Carbonyl Iron Powders.

Today, Carbonyl Iron Powders—a total of ten types—are widely used in the production of cores for transformers and inductor coils—to increase Q values, to vary inductances, to reduce coil size, to confine stray fields or to increase the coupling factors.

We urge you to ask your core maker, your coil winder, your industrial designer, how G A & F Carbonyl Iron Powders can increase the efficiency and performance of the equipment or product you make, while reducing both the cost and the weight.

We offer you two books—one covering SF, J and W Powders only—the second covering the other seven types. In both books, characteristics and applications are given with diagrams, performance charts and tables. For either or both books, address Department 37.

PHYSICAL CONSTANTS	W	J	SF
Percent retained by 325 mesh screen.....	trace	trace	trace
Weight-average particle diameter (Roller Analyzer) $d = \sum d_i^4 / \sum d_i^3$ (microns).....	3	9	3
Surface-average particle diameter (Fischer Sub-Sieve-Sizer) $d = \sum d_i^3 / \sum d_i^2$ (microns).....	2.5	4.5	2.5
Density of particles, g/cm ³	7.35	7.35	7.81
Apparent density, g/cm ³	2.6	2.8	3.0



ANTARA® CHEMICALS

A SALES DIVISION OF GENERAL ANILINE & FILM CORPORATION
435 HUDSON STREET • NEW YORK 14, N. Y.



From Research to Reality...



BALLANTINE Model 300

STILL THE FINEST IN
ELECTRONIC VOLTMETERS

Featuring a Logarithmic
Voltage Scale and
Uniform Decibel Scale

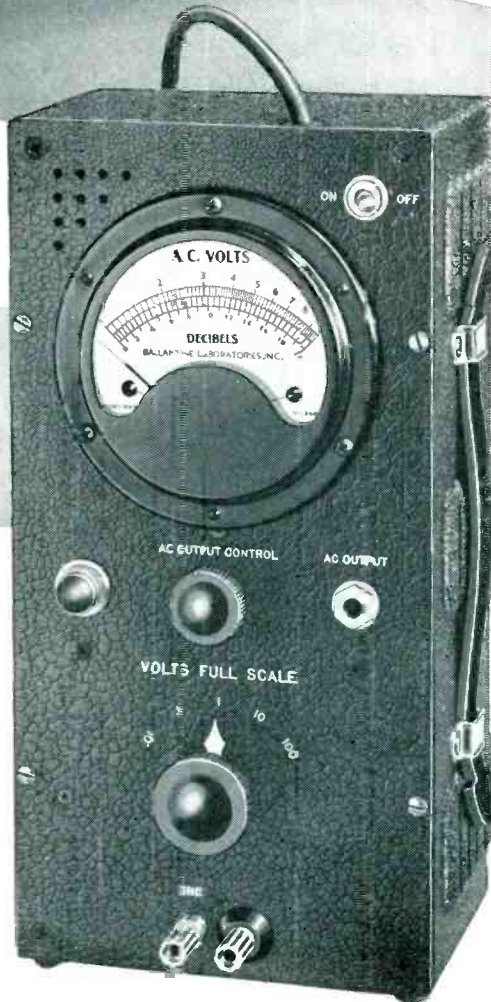

PRICE \$210.

VOLTAGE RANGE001v to 100v
 FREQUENCY RANGE 10 cps to 150 kc
 ACCURACY 2% ENTIRE RANGE
 INPUT IMPEDANCE 1/2 meg shunted by 30 uuf

- Stability insured by the exclusive use of wire-wound resistors in the attenuator and feedback network.
- Same accuracy of reading at ALL points on the logarithmic voltage scale and linear decibel scale.
- Only ONE voltage scale to read with decade range switching.
- No "turn-over" discrepancy on unsymmetrical waves.
- Accessories available to extend the range to 20 μ v and to 42,500 volts.
- Available Precision Shunt Resistors convert voltmeter to microammeter covering range from 1 microampere to 10 amperes.
- Provides 70 DB amplifier flat within 1 DB from 10 cps to 150 kc.

For further information on this and other Ballantine instruments
write for our new catalog.

BALLANTINE LABORATORIES, INC.



100 FANNY ROAD, BOONTON, NEW JERSEY

on a sheet-rubber disk around the outer edge, making center suspension unnecessary. Resonant frequency of the cone is about 30 cps. Silk cloth covering the holes in the top plate of the magnet structure provides acoustical damping.

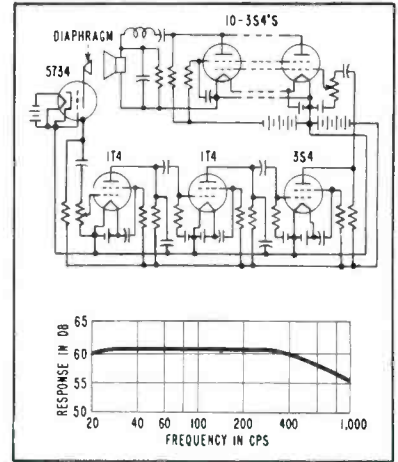

FIG. 4—Sound absorber amplifier has three voltage-amplifier stages feeding ten paralleled 3S4's in power stage

The amplifier circuit shown in Fig. 4 consists of ten 3S4 tubes connected in parallel to the voice coil of the speaker. The output of the type 5734 movable-anode tube is fed to the paralleled output stage through a three-stage voltage amplifier. Separate filament supplies were used on each of the amplifier stages and separate plate supplies were used for power and voltage stages to reduce regeneration problems. Positive feedback and an L-C network between the amplifier and loudspeaker reduce high-frequency response.

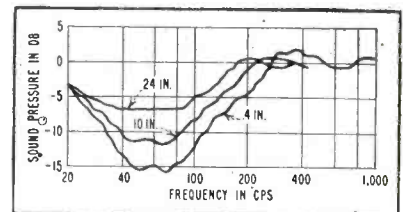

FIG. 5—Sound pressure reduction at three distances from the microphone

The system is connected and equalized for frequency response and phase so that sound pressure will be reduced at the microphone. The loudspeaker driving pressure p_s is given by $Bl i/S$, where B is flux density, l is length of voice coil conductor, i is the current in the voice coil and S is the area of the cone.

The amplitude and phase rela-

When No Other Material Can Meet Your Electrical Requirements

In case
after case

KEL-F[®]
PLASTIC
WILL

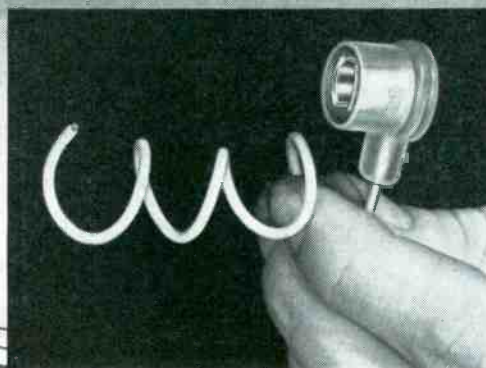

New tube cap connector made of KEL-F Plastic insures high insulation resistance, and excellent dimensional stability over a wide temperature range (-320° to 390° F.) for critical installations.

KEL-F[®] PLASTIC IS UNIQUE. A polymer of trifluorochloroethylene, its molecular construction produces a combination of outstanding properties headed by excellent electrical characteristics, resistance to chemical attack and negligible deformation under load.

KEL-F Plastic is dense, tough, and readily moldable. It has an operational temperature range of approximately 710° F. (-320° F. to 390° F.) KEL-F Plastic is non-wettable, and moisture absorption is zero! In electrical applications it can be used structurally as well as dielectrically—particularly in the

critical electronic applications encountered in sub-miniaturization, automation, servo-mechanisms, etc. And, as wire insulation, KEL-F Plastic offers outstanding abrasion resistance, so important in aircraft and other critical installations.

KEL-F Plastic is available as a molding compound, or in extruded film, sheeting, rods and tubing from independent fabricators. KEL-F Dispersions for bake-coating of metallic surfaces are also obtainable. The complete story of KEL-F Plastic should be in your "ready" file. Write for special bulletins.



THE M. W. KELLOGG COMPANY
Chemical Manufacturing Division, P. O. Box 469, Jersey City, N. J.
SUBSIDIARY OF PULLMAN INCORPORATED

® Registered trademark of The M. W. Kellogg Company's fluorocarbon polymers.

More Engineers on A-N and civilian projects are proving—

It pays to specify AMPERITE DELAY RELAYS and BALLAST REGULATORS

... they're finest



... cost less!

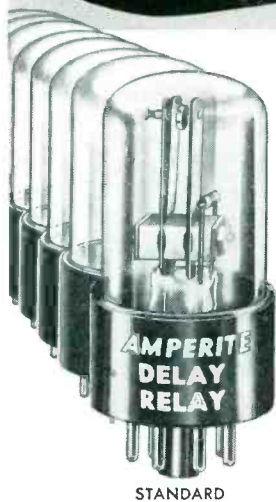

STANDARD

Thermostatic DELAY RELAYS

MOST COMPACT, HERMETICALLY SEALED

Provide delays ranging from 2 to 150 seconds.

- Actuated by a heater, they operate on A.C., D.C., or Pulsating Current.
- Hermetically sealed. Not affected by altitude, moisture, or other climate changes.
- Circuits: SPST only — normally open or normally closed.

Amperite Thermostatic Delay Relays are compensated for ambient temperature changes from -55°C . to $+70^{\circ}\text{C}$. Heaters consume approximately 2 W. and may be operated continuously. The units are most compact, rugged, explosion-proof, long-lived, and — inexpensive!



MINIATURE

TYPES: Standard Radio Octal, and 9-Pin Miniature.

PROBLEM? Send for Bulletin No. TR-81

Also — a new line of Amperite Differential Relays — may be used for automatic overload, over-voltage, under-voltage or under-current protection.

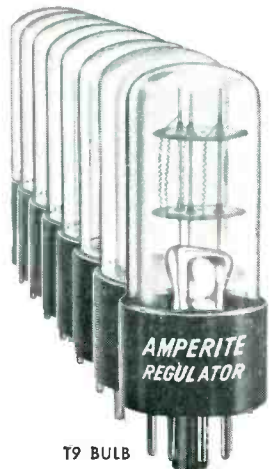

T9 BULB

BALLAST REGULATORS

- Amperite Regulators are designed to keep the current in a circuit **automatically regulated** at a definite value (for example, 0.5 amp).
- For currents of 60 ma. to 5 amps. Operates on A.C., D.C., Pulsating Current.
- Hermetically sealed, light, compact, and most inexpensive.

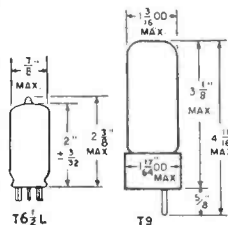

Amperite Regulators are the simplest, most effective method for obtaining automatic regulation of current or voltage. Hermetically sealed, they are not affected by changes in altitude, ambient temperature (-55°C . to $+90^{\circ}\text{C}$.), or humidity. Rugged; no moving parts; changed as easily as a radio tube.

Write for 4-page
Technical Bulletin No. AB-51

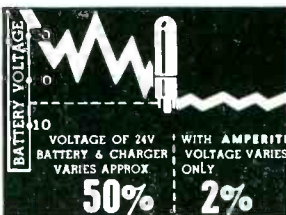

AMPERITE CO. Inc., 561 Broadway, New York 12, N. Y.

In Canada: Atlas Radio Corp., Ltd., 560 King St. W., Toronto 2B

tionships between sound pressures p_1 of Fig. 1 and p_2 are such as to make p_2 as small as possible over a wide frequency range. Under these conditions of operation the system acts as a pressure reducer. The sound-pressure reduction characteristic is shown in Fig. 5. A high order of reduction is obtained over a range of more than three octaves.

This article has been abstracted from information previously published by H. F. Olsen and E. G. May of RCA Laboratories, Princeton, N. J.

Radio Control Gives Right-of-Way

CONTINUAL INTEGRATED cycling of traffic signals by radio from a central control point has been installed in Greeley, Colorado. The system is described in a communication from Roy R. Newsom, Colorado Electronics Corp., designers of the technique.

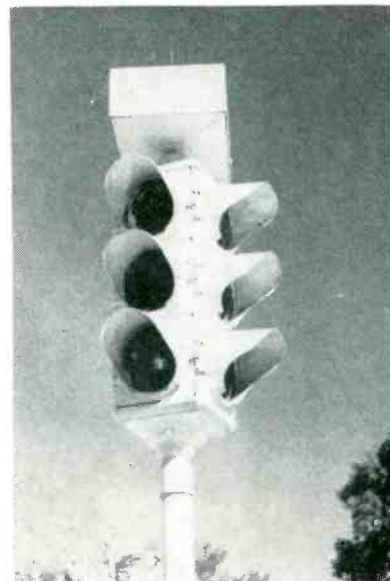

Intersection radio control unit mounted above traffic signals

For a small city such as Greeley, a tape recorder is used as storage mechanism for coded signal voltages, which are recorded on the tape and then reproduced continually for broadcast. Signals are processed through a premodulation unit and then fed into a conventional transmitter.

At each intersection there is a conventional receiver. Output is connected to a unit that decodes the

**ADVANCED DESIGN
CUSTOM - SUBMINATURE**

Toroids

WESTERN UNION
Western Electric
MELPAR, INC.
KELLOGG SWITCHBOARD
WILCOX ELECTRIC COMPANY
RADIO CORPORATION OF AMERICA
COLLINS
HUGHES

Bendix
AVIATION CORPORATION
UNION PACIFIC RAILROAD

SANGAMO ELECTRIC COMPANY
GENERAL ELECTRIC

Westinghouse
Motorola
CROSLLEY

Air Associates
Santa Fe

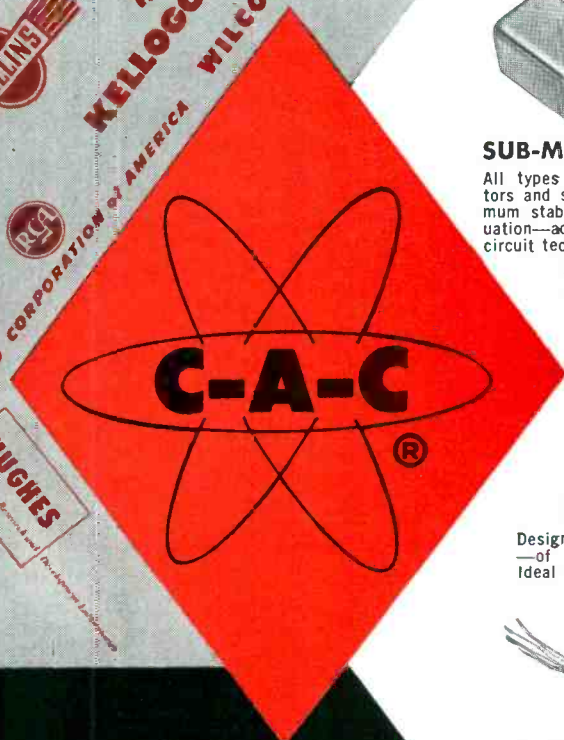

Why is it? . . .

In 7 short years, CAC has reached a dominant position as an exclusive toroidal coil winding and component producer.

Why?

We believe it is due to meticulous care, advanced research—and to the specialized skill of our people.

Thankful for the trust important customers have placed in us, we are ever mindful of a growing responsibility—YOU CAN DEPEND ON CAC!



UNCASED TOROIDS

Basic inductor component. Plain, wax, or plastic dip with flex-leads. Hi Q values up to 10 mc. Complete range of sizes: subminiature, wedding ring, etc.



STEEL CASED TOROIDS

Hermetically sealed to MIL-T-27 specifications—mounting area minimized—lo-hum pickup—hi-perm cases—standard inductances in stock.



SUB-MINIATURE FILTERS

All types of filters—toroidal inductors and special capacitors for maximum stability, sharpness, and attenuation—advanced design and printed circuit techniques make possible high degree of miniaturization—hermetically sealed construction.



DELAY LINES

Designed to your specifications—of lumped constant type. Ideal for sonar applications.



SATURABLE REACTORS

Transformers: Up to 12" OD x 5/8" ID x 4 1/2" high—handling 16 to 38 wire on largest units—miniature transformers to 48 AWG.



HI-CYCLE TRANSFORMERS

- Range—400-6000 cps
- Efficiency—up to 95%
- Wattage—6 mw—200 watts
- Temperature —55° to +155° C
- Depicted—6 KC 100 Watt Unit
- Less than 1.65 cubic inches



PLASTIC CASED TOROIDS

CAC compression molded toroids have become the standard of the industry. Incorporated in most advanced military and domestic applications. Stocked units for immediate shipment.



TUNED CIRCUITS

- For Printed Circuit Applications
- Multiple Tuned Transformers
 - Delay Lines
 - Tuned Circuits
- W—1"
L—4 1/4"
H—7/16"

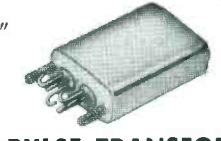

PULSE TRANSFORMERS

Customized toroidal units. Blocking oscillator and pulse coupling transformers for specific applications. Nth degree miniaturization.



MAGNETIC AMPLIFIERS

Toroidal construction and quality materials provide: high gain per stage—fast, stable response. Multiple, electrically isolated input and output windings—line frequencies 60 cycles, 400 cycles and higher—operating temperatures —55° to +100° C—hermetic sealing to MIL specs.

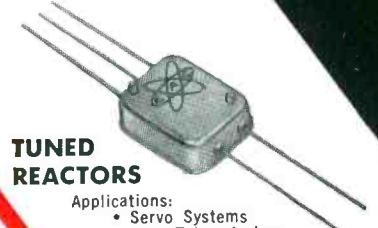

TUNED REACTORS

- Applications:
- Servo Systems
 - Data Telemetering
 - Remote Frequency Control
- Illustrated—High Frequency Reactor Tuned by Varying D.C. Current.
- W—1"
L—1 1/4"
H—15/32"

DISCRIMINATORS

Linear frequency sensitivity and temp. compensated. May be packaged with MAG AMPS to produce control functions from small signals.

Precision
Delivery
Quality

FOR ADDITIONAL INFORMATION CONTACT

COMMUNICATION ACCESSORIES Co.

HICKMAN MILLS, MISSOURI • PHONE KANSAS CITY, SOUTH 5528

**Factory
pre-setting assures
high accuracy . . .
eliminates costly
pre-installation
adjustments**

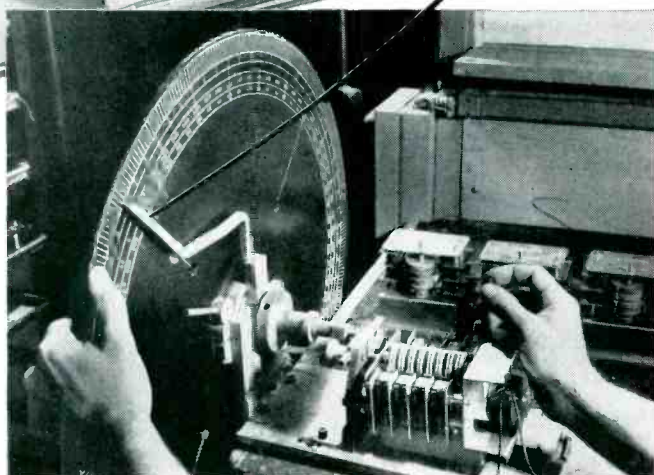
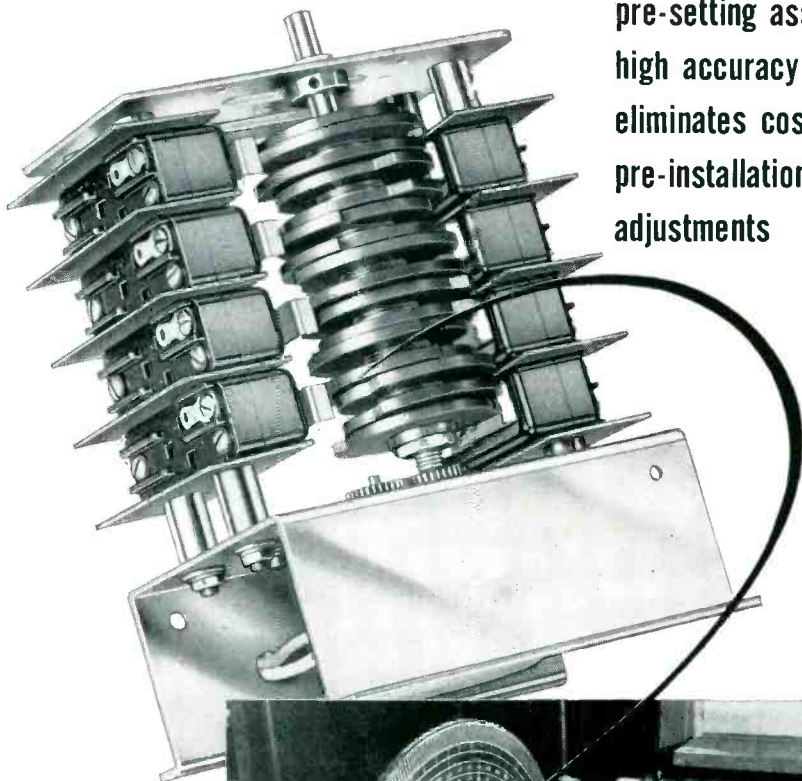

Cramer CYCLING TIMERS

The accuracy of a cycling timer depends on the exactness of the cam settings. If any one of the driving cams is incorrectly set, even to the minutest degree, the over-all program pattern or sequence of operations is changed.

Cramer cycling timers are normally supplied with all cams pre-set to customer specifications on special calibration equipment like that shown above. This pantographic principle, in effect, produces a sixteen-time enlargement of the cam, permitting extremely close setting accuracies.

While these timers can be adjusted in the field, factory setting assures highest accuracy and eliminates costly pre-installation adjustments.

This is but one of the many Cramer customer services designed to provide greater product usefulness and satisfaction at lower cost.

For full information about Cramer Cycling Timers, write for new Bulletin PB-510.

signals and selects those intended for that particular intersection. Operations are at 454.15 mc using a transmitter with 18 watts output and having a 30-kc bandwidth.

The standard mobile-type receiver, despite its relatively narrow-band design, permits putting several systems in the band with overlapping radiation patterns and operating them without interference. This feature is necessary to accommodate systems in neighboring cities.

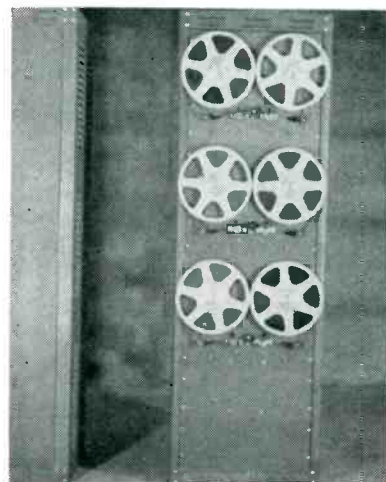

Three tape mechanisms with automatic continuous cycling suitable for a large city with complex traffic patterns

The intersection unit includes a synchronous motor that is turned on and off by radio. If the radio signal fails, the motor automatically assumes cycling of the traffic lights.

Successful operation of traffic signals by radio is not new. A microwave system used in France to permit passage of emergency vehicles is reported in the Dec. 1937 issue of *Wireless World*, a British publication. An advantage of the present equipment is that it may be sold for about \$800 an intersection, whereas cable-controlled lights are said to cost an average of \$3,300.

Dominion Time Signals

CORRECT time for Canada is derived from star observations by photographic zenith tube. Primary clocks are quartz frequency standards.

Three observatory transmitters at Ottawa are on the air continuously with the call sign CHU and frequencies 3,330 kc, 7,335 kc and



SPECIALISTS IN TIME CONTROL

The R. W. CRAMER CO., Inc.

BOX 3, CENTERBROOK, CONNECTICUT

13CR55

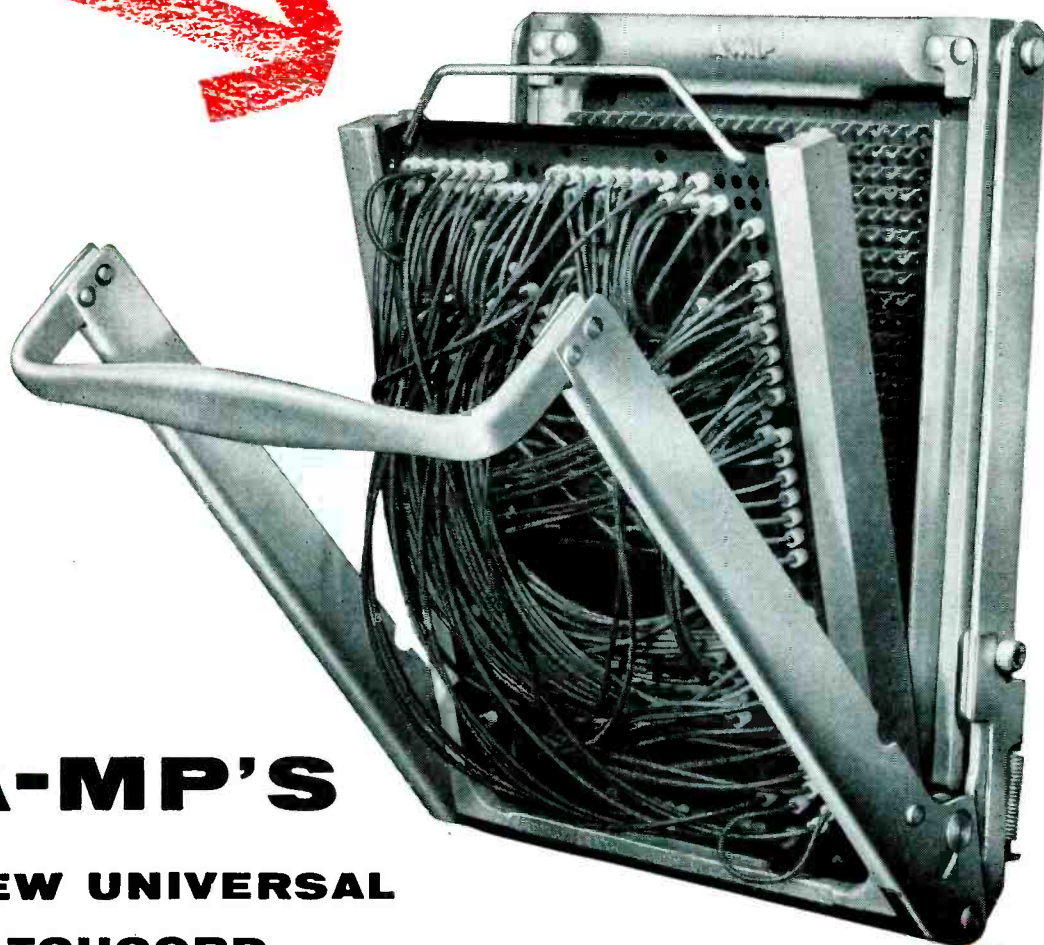

**A-MP'S
NEW UNIVERSAL
PATCHCORD
PROGRAMMING
SYSTEMS** are designed especially for programming required on

- Analog Computers
- Digital Computers
- Data Processing Equipment
- Test Equipment
- Automatic Control Equipment and similar devices

These units incorporate many new design features that assure reliable programming for the most critical applications. They are now available with 240, 815 and 1632 contacts.

A-M-P

© A-M-P ®

AIRCRAFT-MARINE PRODUCTS, INC., 2100 Paxton Street, Harrisburg, Pa.
In Canada: AIRCRAFT-MARINE PRODUCTS OF CANADA, LTD., 1764 Avenue Road, Toronto 12, Ontario, Canada

I tol 'em and I tol 'em!

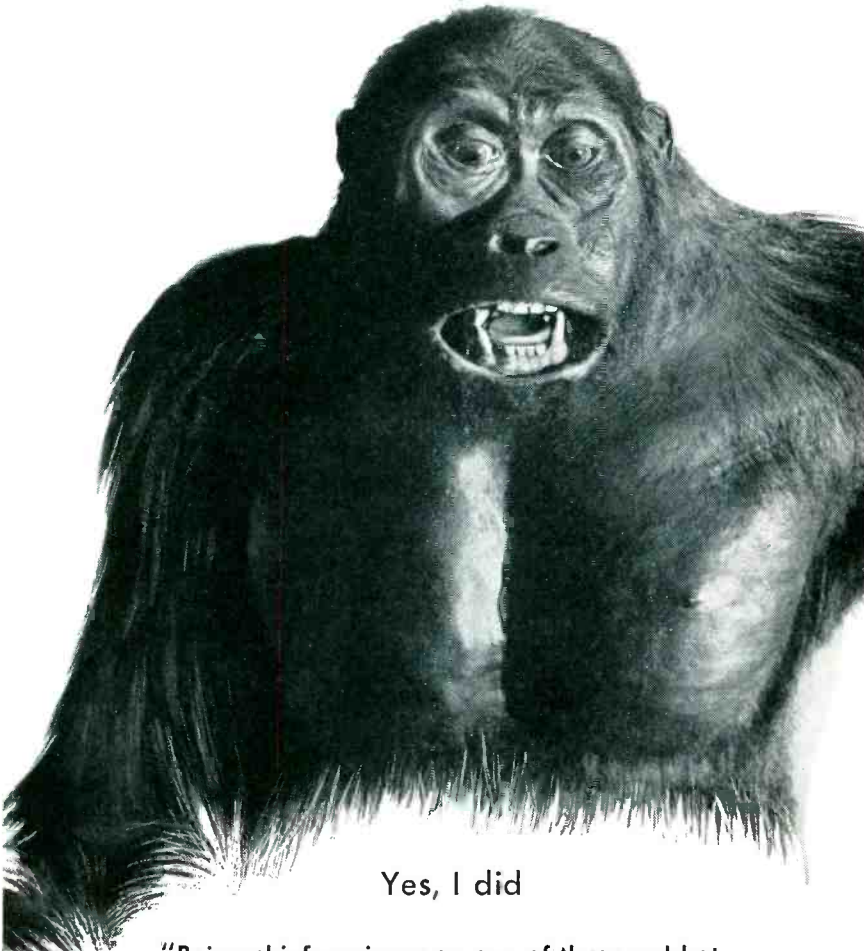

Yes, I did

"Being chief engineer on one of these red hot projects ain't hay and the big gripe is that no matter what goes wrong I can't fix it. That's why at the start when the confusion is still gently confined to the breadboard you should call in Sigma. Confusion is an old story to those boys." — actual unsolicited testimonial by L. M. A. Ape, Sc. D., chief engineer, Simian Products Company, Kivu Heights, Africa.

OK, now that you've had the hard-sell, we do have a relay that we'd like to talk about. It does some difficult jobs very well. Here are the basic specifications:

SIGMA SERIES 22

Miniature (not sub-miniature) sensitive double pole sensitive relay.
Excellent combination of small size and high performance.

22KN

Sensitivity . . . SPDT: 20 milliwatts (e.g., with 8000 ohm coil, operate 1.6 ma.)
DPDT: 40 milliwatts (e.g., with 8000 ohm coil, operate 2.3 ma.)

Contact Rating . . . 2 amp., 115 V AC or 28 V DC, 100,000 operations
Vibration . . . 10 g from 10-2000 cps

Shock and Acceleration . . . 100 g non-operating
50 g operating with additional margin

Size . . . 22RJ: 1" square x 1 3/4" high
22RJ2, 22KN: 1" square x 2" high
Weight . . . 3 ounces max.



If you are interested, we'll be glad to send you a bulletin sheet on the Series 22, or a complete catalog if you prefer.

SIGMA

SIGMA INSTRUMENTS, INC.
62 Pearl St., S. Braintree, Boston 85, Mass.

14,670 kc. The musical pitch of 1,000 cycles, which is characteristic of these signals, is derived from the primary crystal clock.

The voice announcement that occurs between 50 sec and 60 sec of each minute refers to the next beat. The beginnings of the beats mark the exact seconds and are reliable to a few hundredths of a second of true time. Seconds' beat are approximately 0.25-second duration. Intervals between seconds' beats are correct to better than one-thousandth of a second. The beginning of each minute is the first beat following the long pause.

Radio station CFH at Halifax, N. S. (115 kc and several high-frequency bands) customarily broadcasts Dominion Observatory time signals at 10 and 22 hours EST each day. This service is temporarily discontinued.

Canadian time signals are broadcast according to the 5-minute period coding established originally by the Naval Observatory, Washington, D. C. The identification of each minute of a 5-minute group is determined by the omission of seconds' beats at the end of each minute as shown in the table on page 182.

Hence, when the 51st second is omitted and 4 more beats are sent, it indicates that there will be 4

Bovine Gyration Measured Electronically



Complex harness on steer transmits signals from transducers to moving paper tape. The number of times a grazing animal stretches its neck to chew grass and even the number of tail twitches is recorded. According to British Information Services, scientists in England are using these electronic devices to study means of improving milk production and find how to produce tenderer beef for the market

ANOTHER... CASCADE RESEARCH FERRITE "FIRST"

POWER

+ .3 MEGAWATT PEAK
+ 300 WATTS AVERAGE



MODEL HL86-96



for inclusion between the output of microwave power source and load

to provide . . . substantial isolation with very low V.S.W.R. and with negligible loss in transmitted microwave power . .

to eliminate "pulling" or long-line effect normally present where antennas are separated from magnetron or klystron microwave generators by a transmission line of appreciable length

The desirable properties of ferrites at microwave frequencies have been applied uniquely in this new series of Power Unilines. Here the design objective has been to obtain maximum heat dissipation without the requirements of forced air or liquid cooling. Utilization of the resonant absorption properties of ferrites at microwave frequencies makes possible the use of internal ferrite elements with substantial surface area. This in turn permits adequate cooling by conduction since the ferrite elements can directly contact the inner wall surfaces of the waveguide

section. The required transverse magnetic field is supplied by heavy-duty permanent magnets which are an integral part of the assembly. No external power supply is required.

The power ratings listed on the accompanying chart are realistic and practical. They take into account the probability that V.S.W.R. of any practical load will usually be considerably greater than unity. Ratings therefore are predicated upon test conditions where the load connected to the output of the Power Uniline is adjusted for a 1.8:1, V.S.W.R.

SPECIFICATIONS

MODEL	FREQUENCY RANGE	PEAK POWER	AVERAGE POWER	MIN. INSERTION LOSS Reverse direction	MAX. INSERTION LOSS Forward direction	V.S.W.R. Either direction
H16-17,	16.0-17.0 KMC	100 KW (Calculated)	100 W (Calculated)	12 DB	≤ 0.5 DB	≤ 1.05
HL86-96,	8.6-9.6 KMC	300 KW	300 W	10 DB	≤ 0.4 DB	≤ 1.05
H86-96,	8.6-9.6 KMC	150 KW	125 W	10 DB	≤ 0.8 DB	≤ 1.10
H28-32	2.8-3.2 KMC	150 KW	150 W	10 DB	≤ 0.8 DB	≤ 1.20

All Cascade Power Unilines will meet military environmental specifications including those applying to temperature, shock and vibration.



OTHER CASCADE RESEARCH PRODUCTS: Ruggedized Unilines, Gyraline the direct microwave amplitude modulator, Gyraline audio driver, phase shifters.

WRITE FOR DETAILED TECHNICAL LITERATURE

CASCADE RESEARCH 53 VICTORY LANE LOS GATOS, CALIF.
CORPORATION

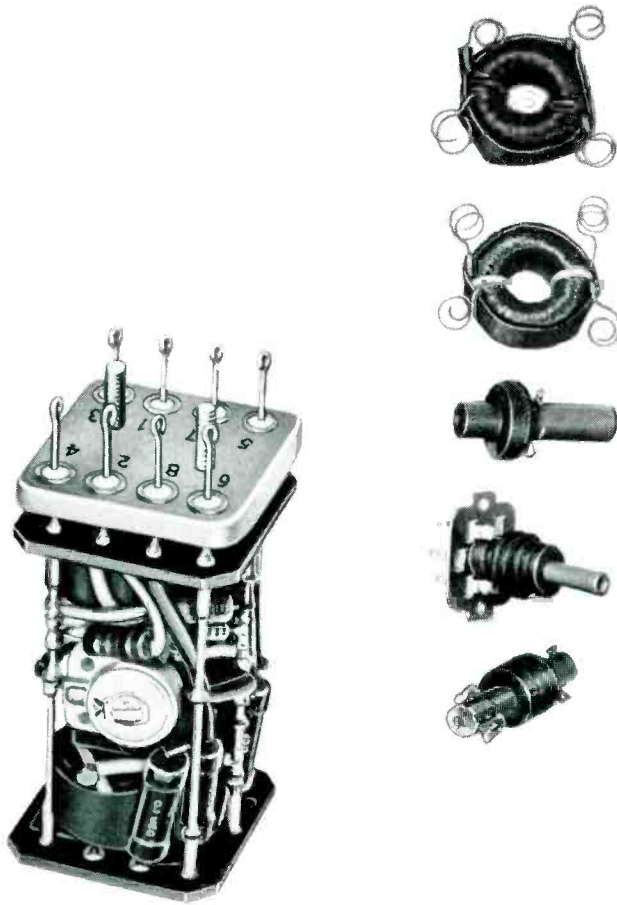

Your filters can be no better than the engineering and winding of the coils with which they are made.

And Barker & Williamson has had longer experience in the engineering and winding of coils than *any other manufacturer*

. . . dating back to B & W's introduction of the world's first Air Inductor.

Single layer solenoid coils . . . universal units with single, multiple pie, or progressive windings . . . r-f, i-f, and oscillator coils . . . traps, discriminators, toroids, filters, r-f and delay line chokes.

B&W

Barker & Williamson, Inc.
237 Fairfield Ave., Upper Darby, Pa.

more minutes to the 5-minute interval and so on. The end of the 52 is omitted and 3 more beats are sent, indicating that there are 3 more minutes to a 5-minute interval. At the end of the 2nd minute, 5th minute has a long gap from the 51st to the 59th beats. During the first minute of each hour the call CHU CANADA CHU is sent in Morse code twice in place of the seconds.

Ionization Chamber Detects Fires Quickly

FLAME AND HEAT, manifestations of fire that are customarily used to actuate detecting devices, may be poorer criteria than combustion gases and smoke to sound an early alarm for conflagrations.

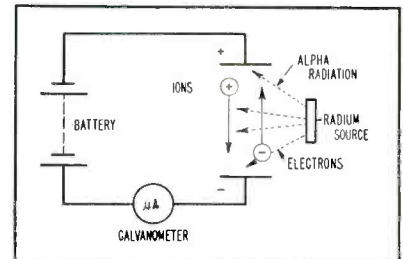

FIG. 1—Principle of the ionization chamber

A detecting system demonstrated by Pyrene—C-O-Two makes use of a modified ionization chamber that reacts to invisible combustion gases. Smoke from a paper held near the predetector head and scorched by a match held beneath it is sufficient to trigger the alarm. In competitive tests with other types of equipment manufactured by the company, the new device operated many times as quickly—in a matter of seconds.

Alpha particles given off from a radioactive source have the property of ionizing air. Air molecules are dissociated into positive ions and negative electrons. A current arises when ionized air is introduced into an electric field as shown in Fig. 1.

Potential from a battery is applied to the plates and the air between is ionized by the radium source. The charged particles move in the directions indicated by the arrows. A sensitive meter

Get better printed circuits . . . lower costs . . . fewer rejects

with NEW C-D-F METAL CLADS

All manufacturers of metal clad stock for printed circuitry have made considerable progress in improving their product—a material with a metal foil surface bonded to a non-conducting base. How this has been done by one leading manufacturer, the Continental-Diamond Fibre Company, illustrates some of the problems involved in buying this type of material and in understanding its design potentials.

C-D-F CONSOLIDATED GRADES

At first, small test lots of Dilecto laminated plastic with copper surfaces were made. Almost every core material was used. Finally the number of practical grades for printed circuit work narrowed down to these few grades which retained to a large degree the inherent electrical qualities of their base material and resin at high temperatures:

XXXP-26 COPPER CLAD—PAPER BASE WITH PHENOLIC RESIN

A laminate with excellent electrical and mechanical properties. High moisture resistance and dimensional stability. Recommended for applications where high heat and high insulation resistance plus low dielectric loss under high humidity is needed. Low cold flow characteristics. Can be hot punched to 1/8". Good flexural strength. Natural green color.

This is one of the *improved C-D-F Dilecto laminates*. Advances in resins and manufacturing techniques make this grade almost homogeneous, with improved impregnation of the filler. Thorough impregnation eliminates entrapped moisture and air, giving greater moisture resistance and better dielectric properties.

Any metal clad is no better than its base and the care taken in laminating. With the cost of material high, compared to labor and inspection, the purchase of a *uniform* metal clad material, like this C-D-F grade, becomes vital.

XXXP-24 COPPER CLAD—PAPER BASE PUNCHING GRADE WITH PHENOLIC RESIN

Similar to grade XXXP-26 in electrical and moisture resistance properties, but not quite as strong mechanically. Equal cold flow and punching characteristics. Natural brown.

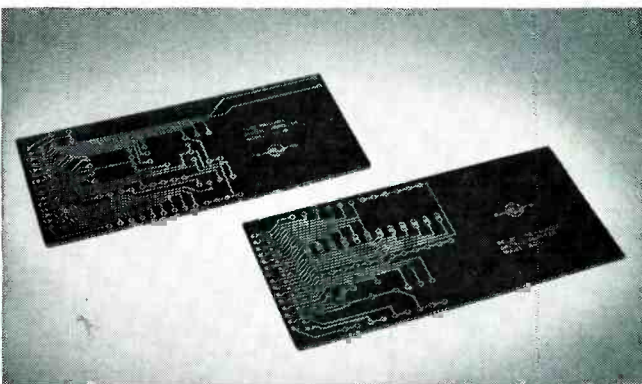

GB-181E COPPER CLAD—GLASS FABRIC WITH EPOXY RESIN

The new C-D-F epoxy grade uses a glass fabric laminate with a copper foil surface on one or both sides. Epoxy resin laminates possess very high mechanical strength (tensile and flexural), along with good dielectric strength, both perpendicular and parallel to laminations. Used in

government and commercial equipment, epoxy metal clads are superior to phenolic laminates in moisture absorption and temperature resistance. Both bond and hot solder tests are rated excellent.

GB-116T COPPER CLAD—GLASS FABRIC WITH TEFLON RESIN

A glass base laminate using duPont's tetrafluoroethylene resin, Teflon, for outstanding resistance to high heat with extremely low dielectric loss properties. A fine weave continuous filament glass fabric cloth is used for superior mechanical strength and good machining qualities. In spite of its high cost, this C-D-F grade has demonstrated that it can save money and do a job that no other single material can in microstrip high-voltage, high-frequency circuit elements. Remember, C-D-F is a major supplier of sheets, tapes, rods, tubes of Teflon, has valuable experience in its manufacture and fabrication. Write for samples.

C-D-F INCREASED BOND STRENGTH

By developing a special thermo-setting adhesive particularly suited for metal clads, C-D-F was able to increase the bond strength of their laminates considerably above their original figures. Bond or peel strength, the amount of pull required to separate the foil from the core material, is one of the most important physical properties. Therefore, the purchaser should compare his source of supply with these C-D-F average test values:

BONDING STRENGTH—FOIL TO LAMINATE	
MATERIAL	Average or Typical Value Lbs. pull per 1" width of foil to separate
XXXP-24 or XXXP-26 plus 0.0014" copper	5 to 8
XXXP-24 or XXXP-26 plus 0.0028" copper	7 to 9
GB-181E plus 0.0014" copper	15 to 18
GB-116T plus 0.0014" copper	6 to 9

These values are based on tests at prevailing room temperature (20-30°C.)

C-D-F INCREASED HEAT RESISTANCE

Special efforts by C-D-F technicians to increase the heat resistance of all C-D-F Metal Clads have resulted in certain special grade variations able to withstand higher soldering temperatures without damage. As production methods change, C-D-F offers materials to meet your requirements.

NOW . . . HOW ABOUT YOUR STORY?

Notice how we have talked about C-D-F and what we have done to improve quality and uniformity of metal clad products. Much of this has been accomplished with the guidance and cooperation of leading users of printed circuit stock. No one company knows all the answers . . . but C-D-F, a big reliable source of supply, can help you get better printed circuits . . . lower costs . . . fewer rejects. Look up the address of your nearest C-D-F sales engineer in Sweets Design File, write us for samples you can test in the lab and on the production line, technical bulletins, help on your specific project. We want to work with you!

WRITE FOR NEW C-D-F DILECTO CATALOG

 *Continental-Diamond Fibre*

CONTINENTAL-DIAMOND FIBRE COMPANY
NEWARK 16, DELAWARE



- 1.** Tough, durable molded nylon sleeve—won't chip or crack.
- 2.** New, simplified solderless connection—up to 16 gauge wire held securely with positive electrical contact.
- 3.** No exposed metal surfaces—pin assembly is recessed, providing positive insulation.

Completely insulated, this rugged tip plug is the perfect "mate" to the Johnson nylon tip jack. Sleeve is molded of tough, durable nylon and will not chip or crack even when subjected to rapid or extreme temperature changes. Recessed construction prevents the exposure of metal surfaces when plug is engaged with any standard tip jack. These new Johnson nylon tip plugs are available in 11 bright colors to match the Johnson nylon tip jack series. Standard .081" diameter pin projects, 9/16"; sleeve length, 7/8"; sleeve diameter, 3/8".

ALSO NEW!



NYLON INSULATED BANANA PLUGS

New nylon insulated banana plugs are also available. Made of high grade, nickel plated brass with nickel-silver springs and a rugged nylon insulating sleeve. Designed for solderless connection—accommodates up to 16 gauge stranded wire.

NYLON TIP JACK AND INSULATING SLEEVE

Complete assembly includes standard nylon tip jack with threaded nylon insulating sleeve. This assembly may be used for patch cords or sleeve may be used instead of a nut to mount tip jack on panels, providing insulation for the rear connection.

For complete information on these or other Johnson quality components write for your free copy of Components Catalog 976.

E. F. JOHNSON COMPANY

2323 Second Avenue Southwest • Waseca, Minnesota

measures the current, the value of which depends upon the strength of the radioactive source and, to some extent, upon the voltage of the battery.

At low ionizing potentials, only part of the ions reach the electrodes. The rest collide with electrons and they neutralize each other. At a given potential, all the ions formed reach the electrodes. Beyond this saturation point current remains constant, regardless of increase in potential.

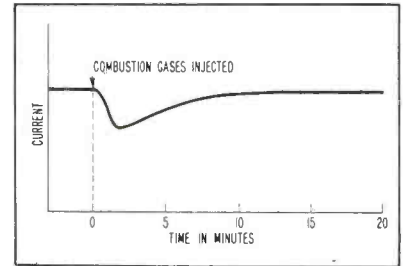

FIG. 2—Current vs time for an ionization chamber containing aging combustion gases and smoke

Current also depends upon the gas between the electrodes according to the number and size of gas molecules. Rate of drift of the ions is related to their size and mass, but there is little difference between gases. When products of combustion are introduced into the ionization chamber, there is a sharp drop in current. The reason is that although they are often too small to be seen, their size is many times that of an air molecule. The larger particles slow down production of ions by increased absorption of alpha rays and by slower movement in the electric field.

Current is therefore decreased

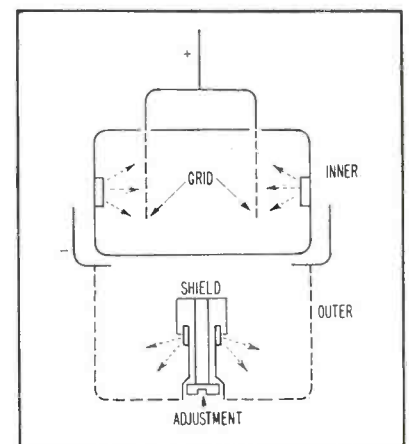

FIG. 3—Arrangement of inner and outer chambers

*Superior
in every way*
**Moldite
Core
"Standards"**



FERRICORES

They are precision mixed, precision made, and precision controlled for every electronic use.

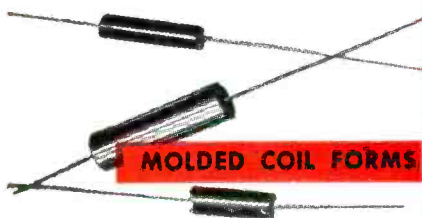

MOLDED COIL FORMS

Give your products the advantages of MOLDITE Core Standards that offer you . . .

- | | |
|---------------------|---------------------------------|
| ECONOMY | INTERCHANGE-
ABILITY |
| AVAILABILITY | HIGH QUALITY |
| UNIFORMITY | FLEXIBILITY |



MAGNETIC IRON CORES

**NATIONAL
MOLDITE
COMPANY**

**MOLDITE
"WROTE THE BOOK"
for IRON CORES**



MOLDITE'S record of performance for the past ten years in producing millions of cores, coil forms and ferrites has contributed substantially to the accomplishments of the electronic industry.

To check with MOLDITE is a Must, because only MOLDITE leads in all three . . . iron cores, coil forms and ferrites.

MOLDITE iron cores, ferrites and molded coil forms (iron and phenolic) are being selected for use in high quality equipment by all leading television, radio and electronic manufacturers as well as all branches of the Armed Forces. Only MOLDITE makes them all . . . for your service and convenience. One source for all three — iron cores, ferrites and molded coil forms.

We are particularly proud of a Certificate of Cooperation awarded us by the U. S. Foreign Operations Administration for furnishing technical assistance.

Our success is measured by the ever increasing number of loyal satisfied customers. MOLDITE'S quality, service and spirit of progress sets the keynote for tomorrow. No specifica-

tion is too difficult, no order too small, no requirement too rigid. The MOLDITE label is your guarantee of complete satisfaction.

MOLDITE'S world-wide reputation is a result of . . .

1. Creative research and engineering.
2. Specialized materials processing techniques.
3. High quality mass production facilities
4. Modern core manufacturing facilities for precision molding.
5. Exclusive, specially designed, press controls.



Send for our Catalog NM #110

1410 CHESTNUT AVE., HILLSIDE 3, N. J.

- | | | | | | |
|--|--|--|---|---|--|
| Bill Franklin
3 Holly Road
North Syracuse, N. Y. | Robert T. Murray Co.
614 Central Avenue
East Orange, N. J. | Jerry Golten Co.
2750 W. North Ave.
Chicago 22, Ill. | Perlmuth-Coleman Assoc.
2419 So. Grand Ave.
Los Angeles 7, Calif. | Jose Luis Ponte
Cardoba 1472
Buenos Aires | John S. Plewes Co.
52 Humbercrest Blvd.
Toronto 9, Ontario |
|--|--|--|---|---|--|

through the chamber in two ways. Being much less mobile than air molecules, the heavy particles, when being ionized, are likely to be almost completely neutralized by free electrons before they reach an electrode. When combustion gases enter an ionization chamber, its resistance value is therefore increased.

These phenomena have nothing to do with the fact that a flame and the air immediately surrounding it are conductive. Such ions recombine quickly, so that a few inches above a wood or candle flame conductivity falls off to nothing.

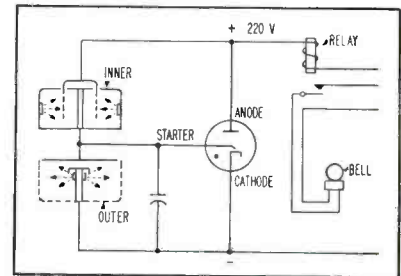
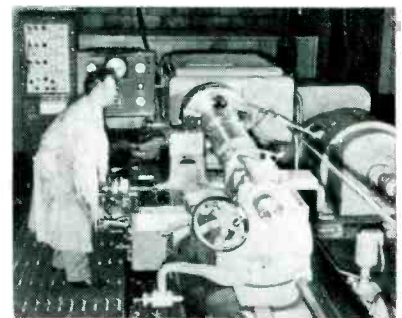

FIG. 4—Simplified circuit of the predetector

Although there is a sharp drop in current after the injection of smoke, current returns to normal with aging smoke as shown in Fig. 2. This fact is useful since the predetector type of alarm must often experience an atmosphere of accumulated cigarette smoke without false indication. On the other hand, the same amount of smoke produced in a much shorter time must sound the alarm.

The practical detector uses two

Lathe Speed Constant



Electronic feedback system maintains speed of 125 hp, 32-in. lathe at General Electric laboratory in Detroit with less than 1-percent variation when full load is applied. Tests of machinability require accurate knowledge of speed and feed for various metals



Comar Relays

— made **better**
to work **better**

- ✓ JOB-FITTED
- ✓ JOB-TESTED
- ✓ JOB-PROVED

Relays tailor-made for the job perform better, last longer. It costs no more to have Comar custom-design and manufacture relays to exactly

fit your requirements. Comar gives you

the exact electrical characteristics, the exact size

and the exact mounting necessary for top efficiency and

easy installation. Precision made of highest quality materials

to insure maximum operating dependability. Send for

details on how to get more relay for your money from Comar.



3349 ADDISON STREET
CHICAGO 18, ILLINOIS

RELAYS • SOLENOIDS • COILS • TRANSFORMERS • SWITCHES • HERMETIC SEALING

ASTOUNDING... the insulating ability of this thin plastic film

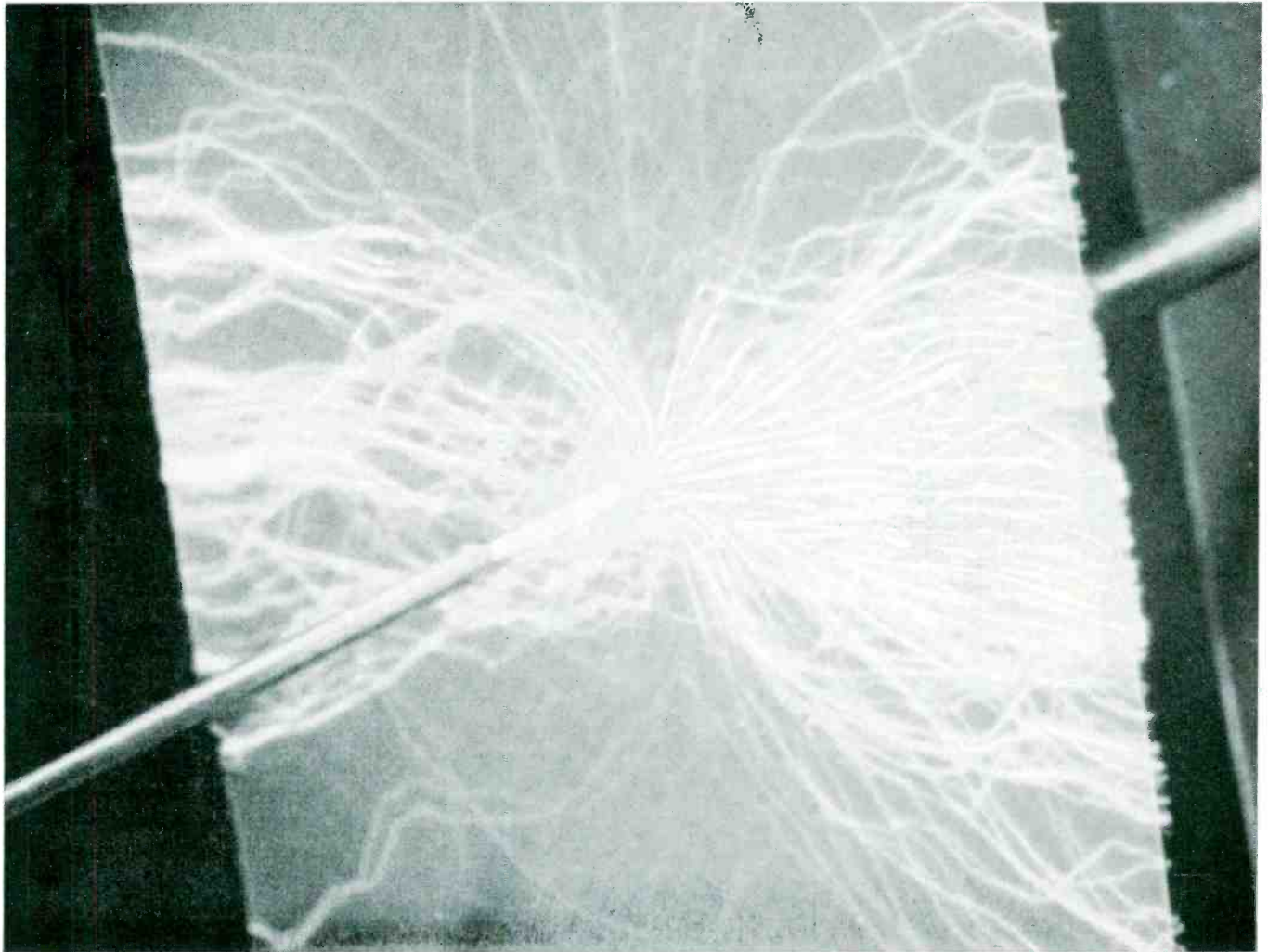

CHALLENGING to industry... the combination of remarkable properties offered by Du Pont MYLAR*

The photograph above can mean something to you even if your product has nothing to do with electricity. A high-voltage blast passes around, rather than through, a thin sheet of new Du Pont "Mylar" polyester film. High dielectric strength—essential for any insulating purpose.

But that's just *one* of the many unusual properties offered by this new film.

"Mylar" is the strongest of all plastic films available. Important if you want to design miniaturized equipment, or need extra toughness and thinness for any purpose.

"Mylar" keeps its remarkable properties over a wide temperature range. Vital if your product operates

under extremes of heat or cold.

"Mylar" resists the attack of many acids, bases, organic solvents. You can use it where many other materials would break down.

"Mylar" can be slit into yarn; metalized; it can be bonded to other substances to make vapor barriers, protective and decorative laminates. This opens a whole new range of applications.

DU PONT

MYLAR®



POLYESTER FILM

Better Things for Better Living... through Chemistry

What about *your* product? It may pay you to find out about the amazing variety of products in which "Mylar" has already cut costs and increased efficiency. Send for your copy of a new fact-filled booklet and samples of this versatile new film. Mail the coupon below.

"Mylar" is a registered Du Pont trade-mark for its brand of polyester film

E. I. du Pont de Nemours & Co. (Inc.)
Film Department, Room 5E, Nemours Bldg.
Wilmington 98, Del.

Please send me sample and further information on "Mylar" polyester film.

Name _____

Firm _____

Street Address _____

City _____ State _____

MAGNETIC RECORDING

ELECTRONS AT WORK

(continued)

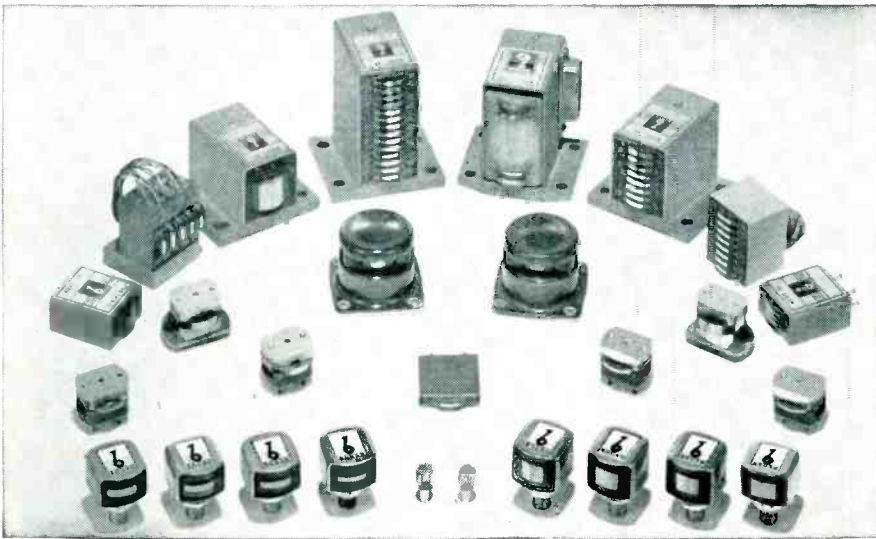

Brush offers complete line of precision magnetic heads

• Brush heads perform the functions of recording, reproducing, and erasing — where accuracy is vital to the performance of the magnetic recording system.

Brush heads utilize a unique laminated pole structure to provide uniformity of track width. Assembled poles are ground and lapped perfectly flat to provide a straight, accurate gap. This precision gap alignment assures time-phase accuracy. Thus data can be recorded on one machine and played back on another, with all signals remaining in perfect time-phase relationship.

You can fill all your requirements from Brush's complete range of single and multi-channel heads. For information write Brush Electronics Company, Dept. K-6A, 3405 Perkins Avenue, Cleveland 14, Ohio.

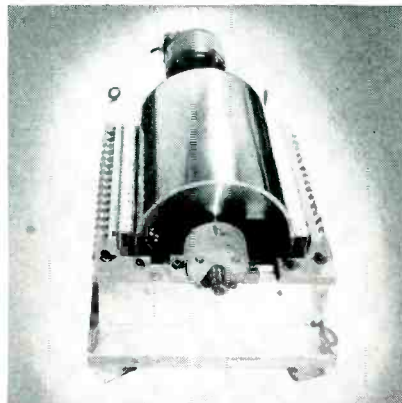

Pulse recording heads used on magnetic memory drum. Interlaced arrangement provides 150 recording tracks.



Data recording equipment uses two multi-channel Brush heads to record 25 data channels on a 1-inch tape.

ionization chambers, one of which is nearly sealed off from the atmosphere. The unit thus constitutes a constant-current device with high dynamic resistance. Smoke introduced into the outer chamber increases its resistance and produces a large change in voltages at the electrical junction of the two chambers, which are arranged as shown in Fig. 3.

The sensitivity of the detector unit can be adjusted by a mechanical movement of the shield over the radium source in the outer chamber. Radioactivity is roughly equivalent to that produced by several watches with illuminated dials and the unit is generally inaccessible to all but authorized personnel.

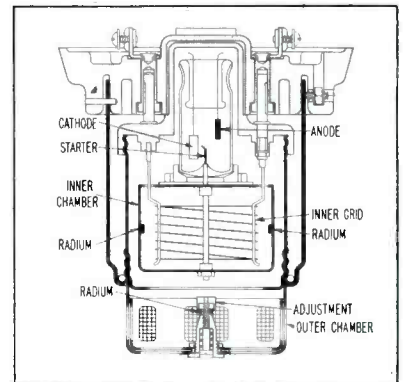

Cross-section of the detector head used to sense fire from its smoke

A special cold-cathode gas discharge tube converts the voltage change into a current of sufficient magnitude to operate a relay. Breakdown in the tube developed for the purpose is greater than 270 volts so that no breakdown occurs at 220 volts (the circuit diagram is given in Fig. 4). Breakdown voltage between the starter electrode and cathode ranges between 100 and 130 volts, or about 110 volts. The control section of the gas triode will not trigger if a potential difference of about 80 volts occurs between cathode and starter. When the difference is raised above 110 volts discharge takes place and a heavy current is permitted to pass between anode and cathode, energizing the relay.

The value of the current depends upon exterior resistance and sustaining voltage over the main gap of the tube, which is about 90 volts. The tube will not ignite unless the

BRUSH ELECTRONICS

INDUSTRIAL AND RESEARCH INSTRUMENTS
PIEZO-ELECTRIC MATERIALS • ACOUSTIC DEVICES
MAGNETIC RECORDING EQUIPMENT
ULTRASONIC EQUIPMENT



COMPANY

formerly
The Brush Development Co.
Brush Electronics Company
is an operating unit of
Clevite Corporation.

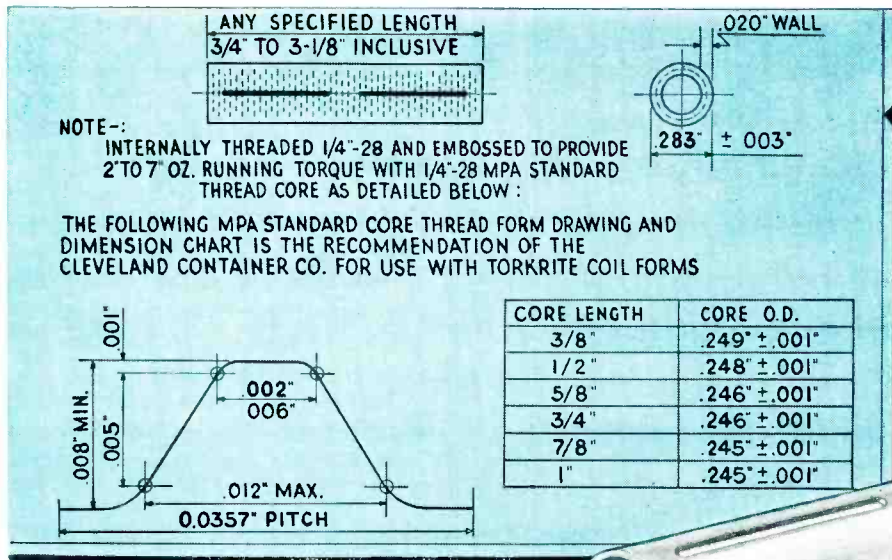

NOTE--: INTERNALLY THREADED 1/4"-28 AND EMBOSSED TO PROVIDE 2" TO 7" OZ. RUNNING TORQUE WITH 1/4"-28 MPA STANDARD THREAD CORE AS DETAILED BELOW:

THE FOLLOWING MPA STANDARD CORE THREAD FORM DRAWING AND DIMENSION CHART IS THE RECOMMENDATION OF THE CLEVELAND CONTAINER CO. FOR USE WITH TORAKRITE COIL FORMS

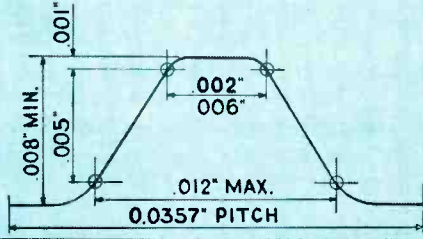

CORE LENGTH	CORE O.D.
3/8"	.249" ± .001"
1/2"	.248" ± .001"
5/8"	.246" ± .001"
3/4"	.246" ± .001"
7/8"	.245" ± .001"
1"	.245" ± .001"

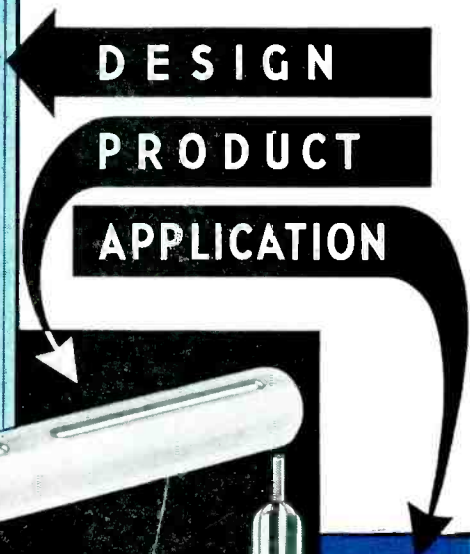

**DESIGN
PRODUCT
APPLICATION**

TORAKRITE

BY THE MAKERS OF CLEVELITE* PHENOLIC TUBING

IMPROVED PERFORMANCE . . . LOWER PRICE!!!

Torakrite coil forms eliminate torque and stripping problems and are rapidly replacing other coil forms because Torakrite:

- withstands more than required stripping pressure.
- requires no revision other than reduced winding arbor diameter.
- is round and concentric; winds coils at higher speed without wire breakage or fallen turns.
- permits use of lower torque since it is completely independent of stripping pressure.
- recycling ability is unmatched.
- is stronger mechanically because of heavier wall.
- provides 2-7" oz. running torque when used with MPA standard thread core.
- has no holes or perforations thru tube wall which eliminates cement leakage locking cores.
- has smooth adjustment of core without lubricant.
- torque increases less after winding as heavier wall reduces any tendency to collapse and bind core.
- maximum stability results as core cannot move in relation to winding after peaking as it is engaged in internal threads.
- embossings are evenly spaced, with a lead at each end of the form to permit easy insertion of core.

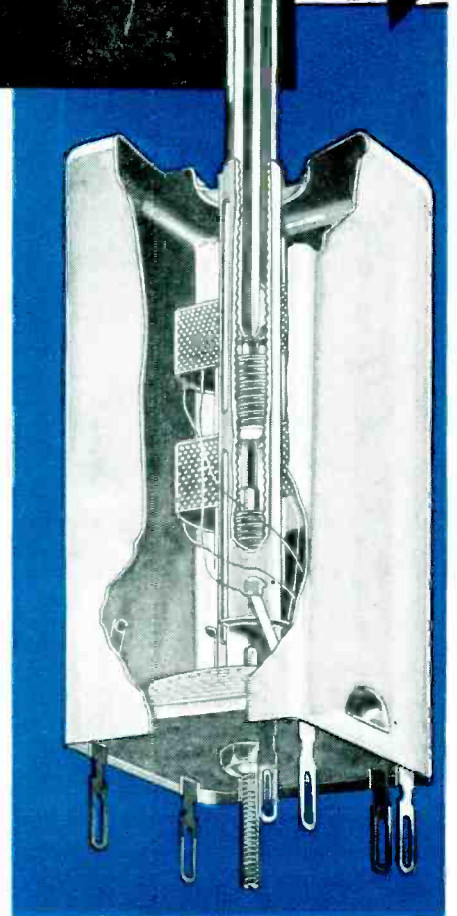

Why pay more? For good Quality . . . Call CLEVELAND!

Improved Torakrite is now available in various diameter tubes. Lengths from 3/4" to 3-1/8" are made to fit 8-32, 10-32, 1/4-28 and 5/16-24 cores.

*Reg. U. S. Pat. Off.

THE
CLEVELAND CONTAINER
COMPANY

6201 BARBERTON AVE. CLEVELAND 2, OHIO

PLANTS AND SALES OFFICES:

CHICAGO • DETROIT • MEMPHIS • PLYMOUTH, WIS. • OGDENSBURG, N.Y. • JAMESBURG, N.J. • LOS ANGELES

ABRASIVE DIVISION at CLEVELAND, OHIO
Cleveland Container Canada, Ltd., Prescott and Toronto, Ont.

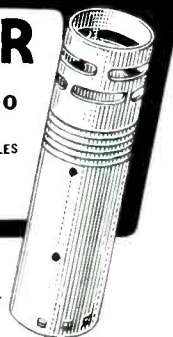

Representatives:
 NEW YORK AREA: R. T. MURRAY, 604 CENTRAL AVE., EAST ORANGE, N. J.
 NEW ENGLAND: R. S. PETTIGREW & CO., 62 LA SALLE RD., WEST HARTFORD, CONN.
 CHICAGO AREA: PLASTIC TUBING SALES, 5215 N. RAVENSWOOD AVE., CHICAGO
 WEST COAST: IRV. M. COCHRANE CO., 408 S. ALVARADO ST., LOS ANGELES

Lapp



TUBE SUPPORTS

for forced-air-cooled
power tubes

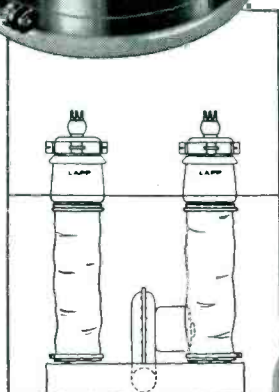

• No longer is it necessary for equipment manufacturers to design supports for forced-air-cooled tubes. After producing many such special designs, Lapp has engineered and built a complete series of insulating supports for air-cooled tubes. Use of these supports facilitates design of transmitter and other high-power circuits. Simple, compact, efficient and attractive in appearance, they make for economical production, easy interchangeability, and availability of replacement units. Write for Bulletin 301, with complete description and specification data. Lapp Insulator Co., Inc., Radio Specialties Division, 238 Sumner St., Le Roy, N. Y.

Lapp

anode voltage is higher than a certain minimum value. This value is dependent upon intensity of the primary discharge and to this end a small capacitor is connected between starter and cathode. Minimum anode voltage for reliable discharge is less than 200 volts. The gas tube envelope is especially treated to insure a surface leakage greater than 10^{12} ohms.

This article has been abstracted from information furnished by the Pyrene—C-O-Two Co., Newark, N. J.

Alfenol Sources

MAGNETICALLY soft and physically hard, Alfenol, an alloy of aluminum and iron, may find great usefulness in the fabrication of recording heads for magnetic tape recording. (ELECTRONICS, p 210, Nov. 1954).

Alfenol is known to be available in sample or token quantities from Hamilton Watch Co., Allied Products Div., Lancaster, Pa. and Magnetics, Inc., Butler, Pa.

A similar alloy containing molybdenum in addition and called Ther-

Radar Cane Guides Sightless



Radio inspector measures field intensity of transmitter used as blind aid. A. A. McCollum (right) uses a four-pound transmitter mounted on a cane to serve as radar-like device that indicates obstructions. Built with the help of a fellow amateur radio operator, the set is said to have cost \$35. Echo indications are converted to an audio frequency that is sensed by the user wearing a hearing-aid receiver



INTEGRATED ELECTRONICS

THE IMAGINATION FOR RESEARCH PLUS THE SKILLS FOR PRODUCTION

Hoffman Laboratories maintains a highly specialized group of engineers whose entire efforts are devoted to the complex problem of developing and producing specialized tactical test equipment for airborne navigation radar, fire control, missile guidance systems, and other advanced electronic gear. To meet the high standards of quality and reliability set by Hoffman Laboratories, this test equipment group is an integral part of the engineering staff.

For the past 13 years Hoffman Laboratories has been successfully solving advanced design and development problems in electronics.

During this time Hoffman Laboratories has never undertaken a development program that has not successfully gone into production.

Write the Sales Department for your copy of "Report From Hoffman Laboratories."



Radar, Navigational Gear
Missile Guidance & Control Systems
Noise Reduction
Countermeasures (ECM)
Computers
Communications
Transistor Application

A SUBSIDIARY OF HOFFMAN ELECTRONICS CORPORATION

Challenging opportunities for outstanding engineers to work in an atmosphere of creative engineering. Write Director of Engineering, Hoffman Laboratories, Inc., 3761 S. Hill St., Los Angeles 7, California.

menol is available in cast form only from The Duraloy Co., Scottsdale, Pa.

Other companies from which Alfenol may now or eventually be available include Vacuum Metals Co., Box 977, Syracuse 1, N. Y.; and Thompson Products, Inc., Cleveland 17, Ohio.

The Roxy Theater in New York City is using Alfenol playback heads for stereophonic sound on film.

Evaporated Magnetic Materials

By MARSDEN S. BLOIS, JR.

*U. S. Naval Ordnance Laboratory
Corona, Calif.*

HOPE of yielding an improved magnetic material through change in form has resulted in an examination of the possibilities of producing useful magnetic materials through a vacuum evaporation process.

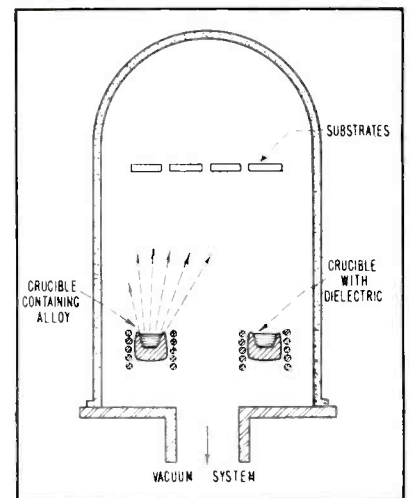
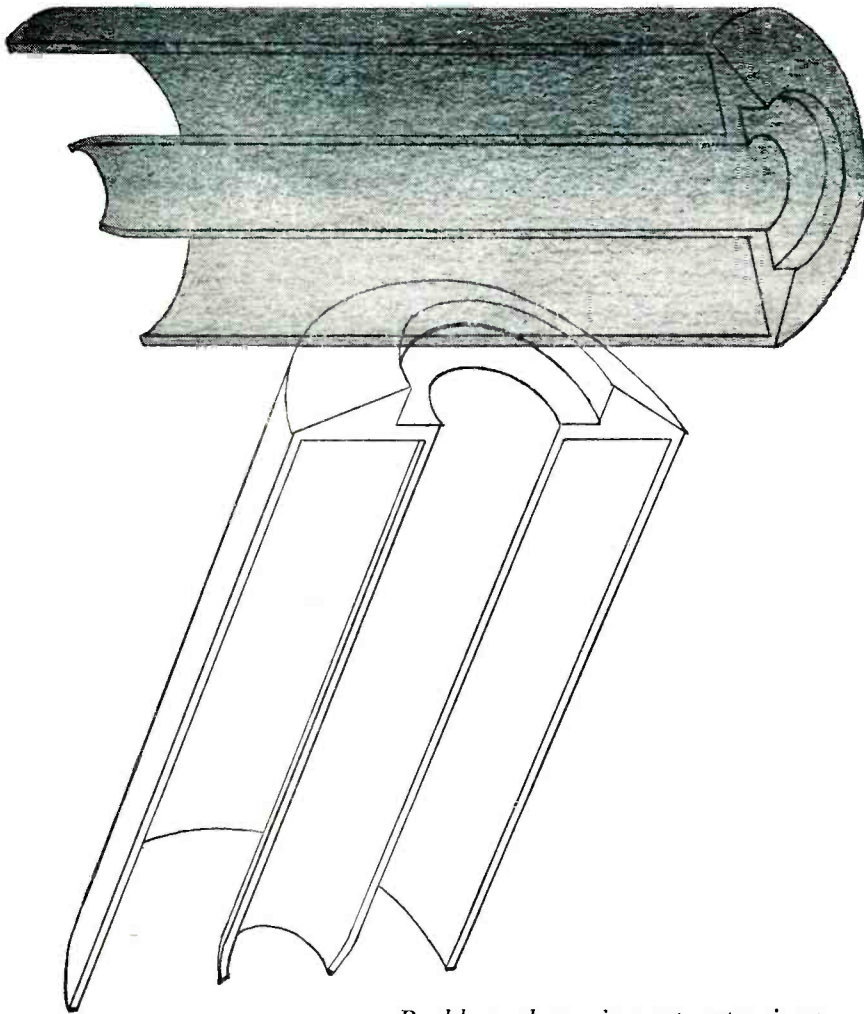

FIG. 1—Cross-section of vacuum chamber for depositing alternate layers of magnetic materials and dielectric

This general approach was made with three distinct possibilities in mind: nearly complete elimination of eddy-current losses, improved control over hysteresis loop form and the inherent economy associated with vacuum-coating techniques as a production method.

The preparation of the evaporated materials is conducted in a vacuum chamber as shown in Fig.



Problem shape impact extrusions.

Shells for the electronic industry.

*A source . . . with sure deliveries
and a 30 year old reputation . . .*

SunTube
CORPORATION
HILLSIDE, NEW JERSEY

IMPACT EXTRUSIONS • CONDENSER CANS AND SHELLS

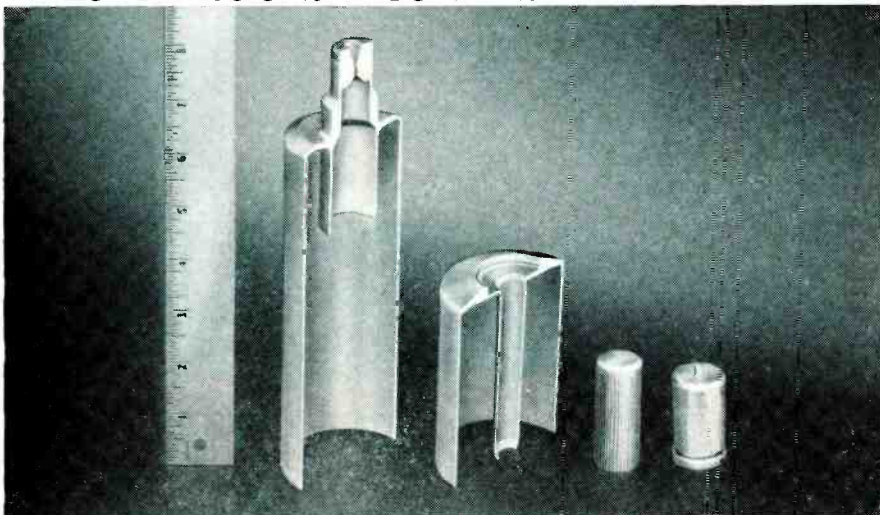

ALUMINUM • ZINC • LEAD • TIN • SILVER

Transducers that can take it!

EXCELLENT REPEATABILITY... CONSTANT RELIABILITY

BY

Greenleaf...

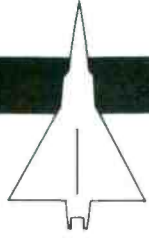

Whatever your needs for accurately measuring or transmitting motion or forces, we are interested in working with you to solve your problems.

ACCELEROMETERS:

- Ranges— ± 1 G to ± 50 G
- natural frequencies to meet your needs
- oil or air damped
- repeatability as low as $\pm 0.1\%$... linearity, resolution and hysteresis are $\pm 2\%$ throughout the entire operating range
- operating temperature range between -55°C . and $+70^\circ\text{C}$.

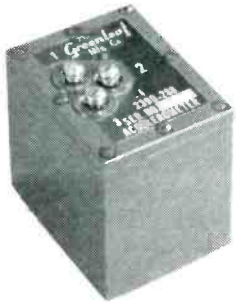

PRESSURE TRANSMITTERS:

- for altitude, absolute or differential pressures
- range from 3.4 to 30 inches Hg absolute
- DC coil resistance—7500 ohms $\pm 10\%$, -0%
- linearity, repeatability, resolution and hysteresis are within $\pm 2\%$ throughout the entire operating range



FOR INFORMATION on the many modification possibilities of these transducers, write, wire or phone today.

ENGINEERING • DEVELOPMENT • PRODUCTION

THE *Greenleaf*

MANUFACTURING COMPANY

7814E MAPLEWOOD INDUSTRIAL COURT, SAINT LOUIS 17, MISSOURI

Where quality control works on the production line ... producing the new HIG-3 and the HIG-4 Gyros, Rate Gyros, Differential Pressure Switches, Synchros, Air Speed Indicators, Actuators and many other precision-built components.

How well our detection and warning services will function in time of emergency will depend upon the performance of each individual component. Imaginative engineering, selected materials, careful inspection and constant quality control make Freed products the ultimate in the industry.

Send for further information and catalog

FREED TRANSFORMER CO., INC.

1722 Weirfield St., Brooklyn (Ridgewood) 27, N. Y.

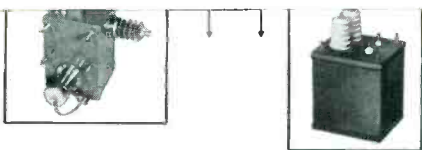

- TRANSFORMER PRODUCTS**
- High Fidelity
 - High Level Pulse
 - High Q Toroids
 - Power
 - Slug-Tuned
 - Hermetically Sealed
 - Step-down
 - Magnetic Amplifiers
 - Miniature Transistor
 - High Q Reactors
 - High Temperature
 - Miniature Audio
 - Charging Reactors
 - Sub-Miniature
 - Precision Reactors
 - Precision Filters
- INSTRUMENTS**
- Comparison and Limit Bridges
 - Low Frequency "Q" Indicators
 - Incremental Inductance Bridges
 - Universal Bridges
 - Null Detectors and V.T. Voltmeters
 - Power Supplies
 - A.C. Bridges and Accessories
 - Differential Voltmeters
 - Harmonic Distortion Meters
 - Wide Band Amplifiers
 - Decade Amplifiers
 - Decade Inductors
 - Decade Capacitors
 - Megohmmeters
 - Filters
 - Magnetic Voltage Regulators

• For production or laboratory use, units with performance characteristics similar to those shown below can be furnished to your configurations and frequency requirements.

KEARFOTT MAGIC TEE #W 122-1A

A broad band impedance-matched hybrid junction, engineered and produced to exacting tolerances in RG 52/u, or RG 67/u. This Magic Tee provides a maximum VSWR of 1.20 over a 10% band width... has isolation of better than -35db from any arm with output balance of 0.1% or better.

Available in aluminum or brass.

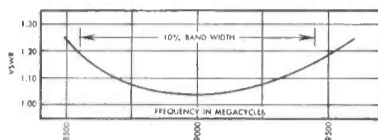

TYPICAL CURVE

Write for brochures on Microwave Components Test equipment

KEARFOTT SPECIALIZED MICROWAVE COMPONENTS

IMPEDANCE-MATCHED
MINIMUM VSWR

1. The air is exhausted to a pressure of about 10^{-4} mm Hg to reduce the possibilities of contamination by gas and to increase the mean free path of the metallic atoms. The substrate, which may be a highly glazed ceramic or glass form or a sheet of plastic material, is suitably mounted above a crucible containing the magnetic metal.

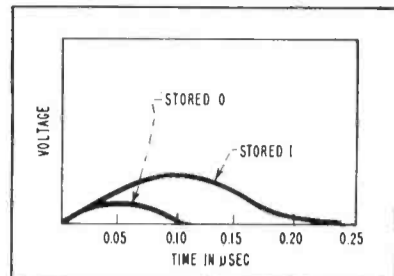

FIG. 2—Output voltages for signals parallel to and across original direction of magnetization

When residual pressure has been reduced to an operating vacuum the metal-filled crucible is heated by high-frequency induction. The metal then melts and evaporates. Under these conditions the metal

say nothing of employing it as a circuit element. To build up a reasonable volume of magnetic material and still keep eddy-current losses within practical limits, multilayered films must be deposited with a layer of insulation between the metallic layers. This too can best be done by evaporation, so a second crucible containing a dielectric material is placed in the chamber as shown.

After a metal layer has been laid down, the crucible containing the dielectric is heated and an evaporated layer of the dielectric is deposited. This process may then be repeated until the necessary metallic cross-section has been deposited.

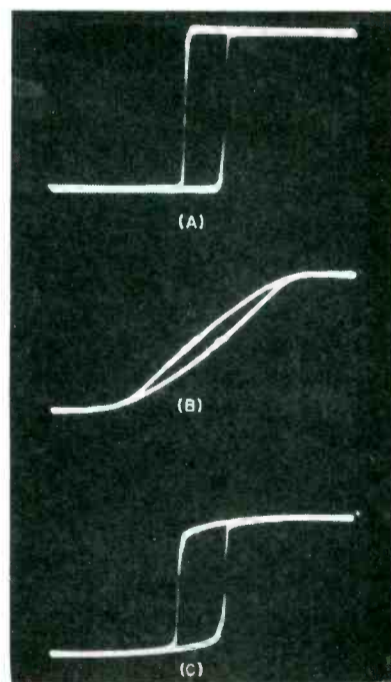
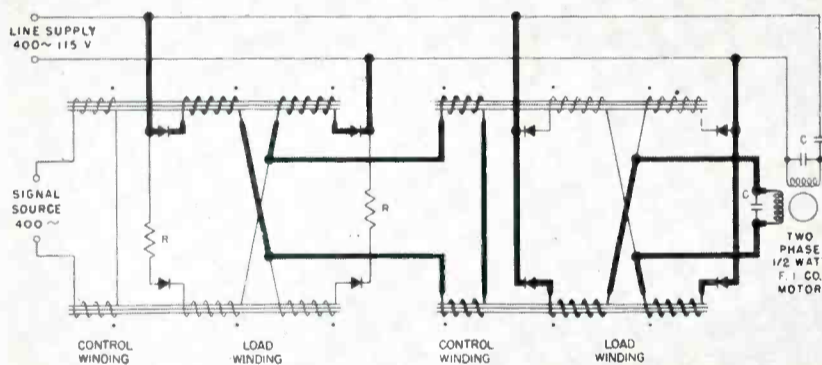

FIG. 4—Hysteresis loops for single layer of deposited 80-Permalloy 1,850-A thick with magnetizing field parallel (A), normal (B) and at a 45 deg angle (C) to the axis of orientation

Up to the present time some of the best results have been obtained using Permalloys with composition in the neighborhood of 80 percent nickel and 20 percent iron, and using magnesium fluoride as the evaporated dielectric.

The magnetic response rate of these materials is measured in a somewhat indirect manner associated with their use as digital storage elements for computers. A magnetic field having a time distribution like a step function is applied and the elapsed time is

An important requisite of any practical amplifier is that it should be possible to cascade several units if more amplification is required than a single stage can offer. In usual magnetic amplifiers, this creates some practical difficulties because the inherently long time constants of each stage add up, and the cumulative time constant of the several stages may become excessive for practical applications.



Ford Instrument Company has perfected and holds the basic patents on circuits which allow cascading magnetic amplifiers with stages operating on successive half-cycles of the a-c supply.

In the circuit shown here, amplification in (each) stage of the amplifier is accomplished by pre-setting the core fluxes with the control-winding signal during one half-cycle of the applied load-winding voltage. During the next half-cycle, when the load-winding conducts, the control winding contribution is negligible. In this mode of operation the control winding of each stage of the amplifier receives its signal during the reset or non-conducting half-cycle of that stage of amplification. The effect of this signal occurs during the next half-cycle, thus the time constant in the stage is at a minimum of $\frac{1}{2}$ cycle.

The amplifier uses half as many elements (cores and rectifiers) as the conventional bridge (full-wave circuit), and has a constantly higher figure of merit (power gain per cycle of time constant).

In amplification problems it will pay you to talk to the engineers of Ford Instrument Company. For forty years this company has specialized in designing and manufacturing special computers and controls. Send your problem to Ford.



FORD INSTRUMENT COMPANY
DIVISION OF THE SPERRY CORPORATION
31-10 Thomson Avenue, Long Island City 1, N.Y.

ENGINEERS

of unusual abilities can find a future at FORD INSTRUMENT COMPANY. Write for information.



THIS IS IT

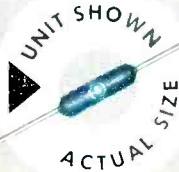

NEW 3-WATT Blue Jacket[®] miniaturized axial-lead wire wound resistor

This power-type wire wound axial-lead Blue Jacket is hardly larger than a match head *but it performs like a giant!* It's a rugged vitreous-enamel coated job—and like the entire Blue Jacket family, it is built to withstand severest humidity performance requirements.

Blue Jackets are ideal for dip-soldered sub-assemblies . . . for point-to-point wiring . . . for terminal board mounting and processed wiring boards. They're low in

cost, eliminate extra hardware, save time and labor in mounting!

Axial-lead Blue Jackets in 3, 5 and 10 watt ratings are available without delay in any quantity you require. ★ ★ ★

SPRAGUE TYPE NO.	WATTAGE RATING	DIMENSIONS L (inches) D		MAXIMUM RESISTANCE
151E	3	1½	1¾	10,000 Ω
27E	5	1½	¾	30,000 Ω
28E	10	1½	¾	50,000 Ω

Standard Resistance Tolerance: ±5%

SPRAGUE



WRITE FOR ENGINEERING BULLETIN NO. 111B



SPRAGUE ELECTRIC COMPANY • 35 MARSHALL ST. • NORTH ADAMS, MASS.

precision plumbing for microwave transmission

With unequalled experience in all of the accepted waveguide metals, Technicraft's thorough, stage-by-stage inspection and measurement policy assures delivery of only the most precise plumbing, both electrically and mechanically.

Technicraft employs the most advanced attaching techniques, including dip brazing. Manufacturing standards under constant supervision of experienced microwave engineers. Extensive lab facilities available for development and production tests.

For complete details and characteristics ask for our specification sheets.

TECHNICRAFT LABORATORIES

INCORPORATED

1550 THOMASTON RD. • THOMASTON, CONNECTICUT

Designers and Manufacturers of Rigid and Flexible Waveguide Assemblies, Microwave Test Plumbing and Components, Waveguide Systems.

measured until the material is magnetized in the direction of the applied field. This response time is the quantity that describes the rate at which information can be put into or read out of magnetic elements.

In Fig. 2 the waveform of the output voltage as a function of time is shown for the two cases in which the applied field is either parallel or antiparallel to the direction of the original magnetization. The ratio of these curves at any particular time is referred to as the zero-to-one ratio and is a kind of signal-to-noise ratio in an information sense.

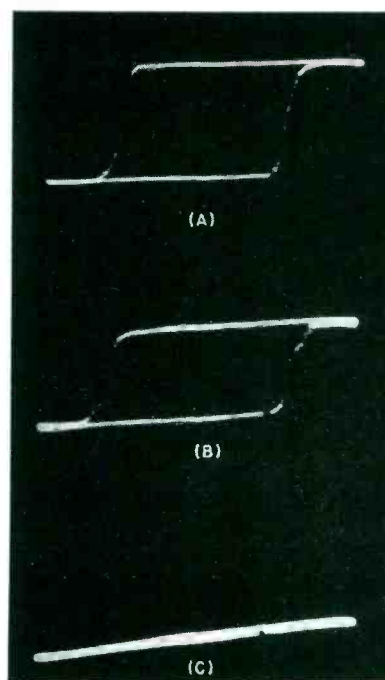
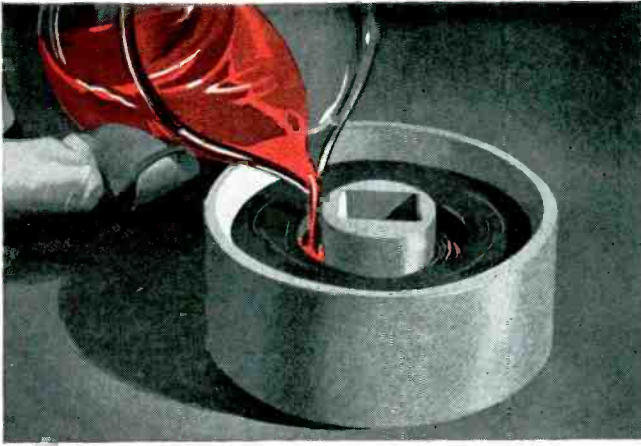

FIG. 5 — Characteristic curves for oriented film of 80-Permalloy 6,000-A thick deposited on $\frac{1}{2}$ -mil Mylar with magnetizing field parallel (A), at a 45-degree angle (B) and normal (C) to the axis of orientation

A comparison of the response time of an evaporated material with that of a wound-ribbon toroidal core and a ferrite core is shown in Fig. 3. It will be seen that once a metal lamination has been reduced to $\frac{1}{4}$ to $\frac{1}{8}$ mil there is little further increase in speed of response for still thinner layers. That is, at this thickness the eddy-current losses are small compared to the power requirements of the fundamental magnetic processes.

From a study of the shape of the curve of voltage-output versus time



**POURED
AS A LIQUID**

BAKELITE Epoxy Resin, mixed with hardener, is poured into place, without harm to fragile elements in the assembly. The mixture will cure with excellent adhesion to metal, ceramics or glass, bonding them firmly in position.

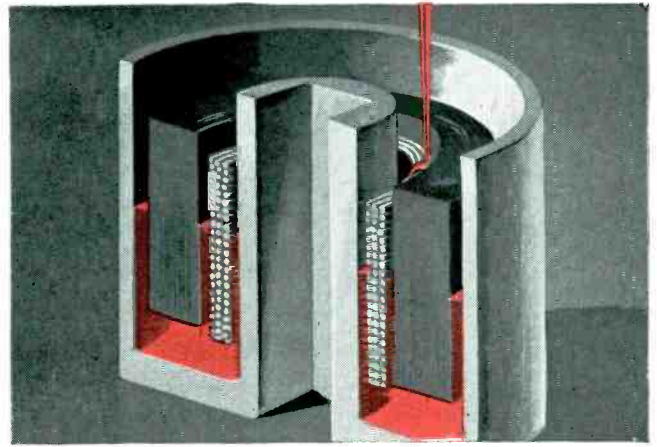

**FILLS EVERY
CREVICE**

Low viscosity permits BAKELITE Epoxy Resin—hardener combination to penetrate extremely minute cavities. Air entrapment is minimized. Vibration or centrifugal casting reduces it further, aids in filling, and eliminates bubbles.

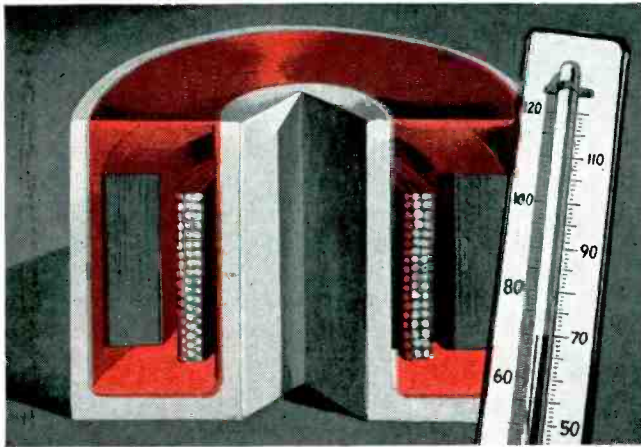

**HARDENS
WITHOUT
HEAT**

BAKELITE Epoxy Resins can cure at room temperature—another advantage where parts would be damaged by high temperatures needed to set other potting materials. Oven curing at low temperatures may be used for more complete reaction.

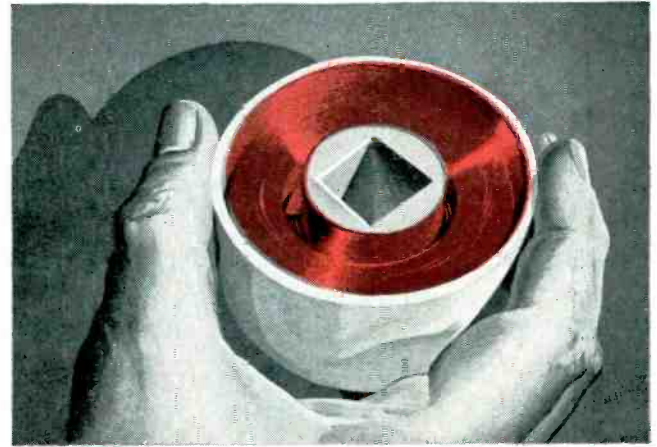

**KEEPS
ASSEMBLY
SAFE**

Cured BAKELITE Epoxy Resin resists shocks, chemicals, moisture. It keeps the assembly solidly embedded, safe from external hazards. Resin shrinkage is so slight as to be unimportant for most applications, but can be further reduced by use of fillers.

Potting and encapsulating with BAKELITE Epoxy Resins make delicate electrical assemblies stronger, easier to handle

Many electrical assemblies seem to grow more fragile as they become more efficient. But BAKELITE Brand Epoxy Resins are making them more serviceable than ever. Three different types of these resins are available for potting and encapsulating techniques. They can be cured by any of four specially formulated BAKELITE Epoxy hardeners designed to give a variety of viscosities and curing speeds, or by several conventional catalysts. We can help you pick the combination with the best set of properties for your product. In addition, there are BAKELITE Phenolic and Polyester Resins ideally suited to give you the widest selection of materials available. Find out what all these resins can do. Write Dept. BL-50.



BAKELITE COMPANY, A Division of Union Carbide and Carbon Corporation  30 East 42nd Street, New York 17, N. Y.
The term BAKELITE and the Trefoil Symbol are registered trade-marks of UCC

Lamination users can now correlate va. and core loss figures with applications

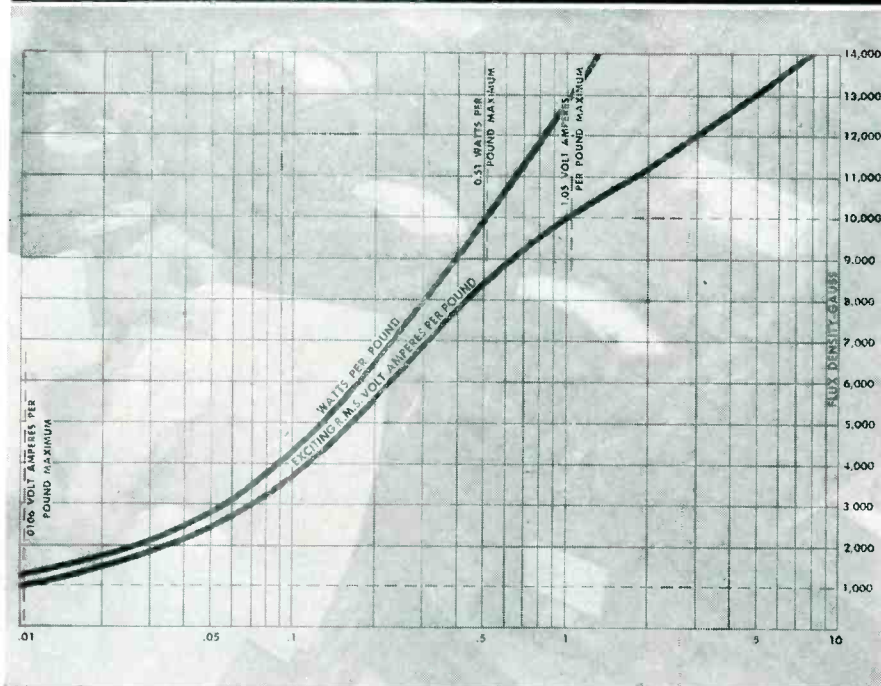

The above curve shows the maximum va. and watt loss of EI 1 1/4" 29 gauge Orthosil 3X laminations.

As a lamination user, you will want to know that guaranteed maximum va. and core loss is available for standard EI transformer laminations and that you can correlate the figures for your own applications.

This valuable information is offered exclusively by Thomas & Skinner. For several years, Thomas & Skinner has accumulated data on standard EI laminations. Based upon an analysis of this information, T&S has established maximum va. and maximum core loss values of each EI lamination at 1,000 and 10,000 gauss, 60 CPS.

A MATERIAL CERTIFICATION is furnished with each shipment of T&S laminations, and gives test figures for both core loss and exciting current on each heat annealed.

This CERTIFICATION attests that each shipment meets the specifications set by the customer.

To you — as a lamination user — these test figures mean elimination of need for retesting, adding up to important savings in your production.

WRITE TODAY for Technical Bulletin DMF-1 giving test details and tables showing core loss and maximum va. Also request new 40-page Bulletin No. L-355 (illustrated below), on special and standard laminations.

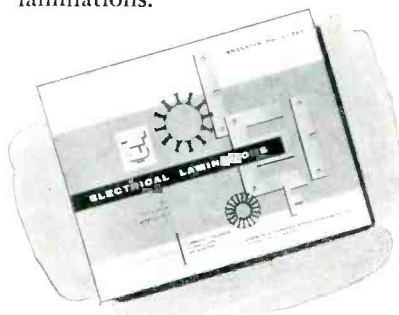

SPECIALISTS IN MAGNETIC MATERIALS . . .

Permanent Magnets  Laminations  and Wound Cores 



THOMAS & SKINNER Steel Products Company, Inc.

1122 E. 23rd Street—Indianapolis 7, Indiana

Experimental Radio Link

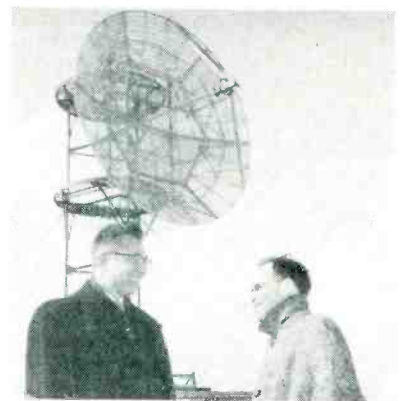

Samuel Seely and Stanford Goldman pose beneath antenna reflector to be used in Air Force-sponsored study of radio propagation on 915 mc. Signals sent from Lexington, Mass. to the station operated by Syracuse University, about 250 miles away, are thought to be scattered by the ionosphere or the troposphere whence they are reflected to receivers well beyond the line of sight

International

Selenium Rectifiers



high voltage cartridges



selenium diodes



hermetically sealed cartridges



industrial power rectifiers



selenium tv and radio rectifiers



selenium color tv rectifiers

The **WIDEST RANGE** in the **INDUSTRY**

- ★ Power Ratings from Microwatts to thousands of Kilowatts!
- ★ Efficiency to 87%

The most widely used Industrial Power Rectifiers in industry today.

International Rectifier

C O R P O R A T I O N

EXECUTIVE OFFICES: 1521 E. GRAND AVE., EL SEGUNDO, CALIFORNIA • PHONE OREGON 8-6281
New York Office: 501 Madison Avenue, Phone PLaza 3-4942 • Chicago Office: 205 West Wacker Drive, Phone FRanklin 2-3889
In Canada: Atlas Radio Corp., Ltd., 50 Wingold Ave. W., Toronto, Ontario • Phone RU 1-6174

WORLD'S LARGEST SUPPLIER OF QUALITY INDUSTRIAL RECTIFIERS

Miniaturize...
and maintain reliable
performance characteristics

with **ERIE**
DISC CERAMICONS®

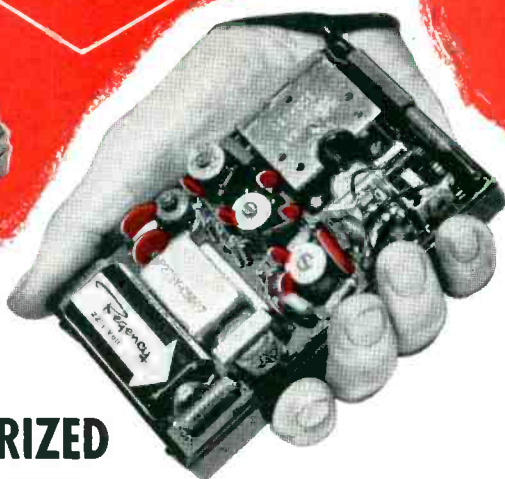

**AS SHOWN
HERE IN THE
FIRST TRANSISTORIZED
COMMERCIAL RADIO**

Nine ERIE DISC CERAMICONS are used in the Regency pocket radio.

- Standard ERIE DISC CERAMICONS are small. Their reliable performance characteristics are not sacrificed for size.

- Leads of ERIE DISC CERAMICONS are tinned with a coating of .001" minimum thickness to assure ease of soldering even after long storage. This allows trouble-free dip-soldering assembly.

**GENERAL PURPOSE
TEMPERATURE
COMPENSATING**

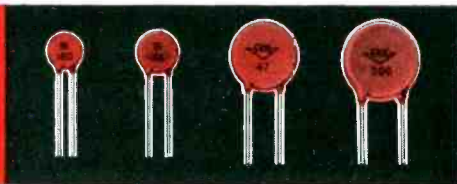

For miniaturization, ERIE DISC CERAMICONS are made in sizes from $\frac{5}{16}$ " max. to $\frac{3}{4}$ " max. diameter and .156" max. thickness. They are available in the following values:

GENERAL PURPOSE DISC CERAMICONS in values from 5.0 MMF to .02 MFD. Rated at 500 volts D.C. working.

TEMPERATURE COMPENSATING DISC CERAMICONS in capacity values from 2 to 2000 MMF at 500 V.D.C.W.

Erie's Sales Engineers will gladly furnish complete descriptions and specifications for your capacitor miniaturization problems.

ERIE
electronics

ERIE ELECTRONICS DIVISION

ERIE RESISTOR CORPORATION

Main Offices and Factories: ERIE, PA.
Manufacturing Subsidiaries

HOLLY SPRINGS, MISSISSIPPI • LONDON, ENGLAND • TRENTON, ONTARIO

that of the bulk material to within the experimental error.

For use in a matrix-type memory unit, magnetic materials must have a reasonably rectangular hysteresis loop and the squarer the loop, the less noise will be introduced into the computing system by those magnetic cores that undergo half-amplitude magnetization.

One means of evaporating rectangular-loop magnetic materials is to place the substrate in a fairly strong magnetic field of about 400 oersteds. This preferentially orients the film during its formation with the result shown in Fig. 4, which shows three hysteresis loops, all measured at 60 cycles but with the magnetizing field at different angles to the preferential axis of the film.

Oriented Permalloy

Another oriented-Permalloy deposit evaporated onto a 0.0005-in. thick Mylar film is shown in Fig. 5. These were prepared for use in evaluating the possibilities of this material for binary magnetic recording on tape or drum surfaces.

Since the evaporation of a mixture of elements suggests the process of fractional distillation, close checks have been made on the chemical composition of the resulting films. It was expected that change of composition would take place, but that this would occur in a reproducible manner, and allow films of a desired composition to be formed by proper choice of starting materials.

Chemical analysis of Permalloy films in the 80 Ni and 20 Fe vicinity, using micromethods, have shown that the separation is considerably less than predicted by current theory for the behavior of such mixtures. For one particular sequence of nine films, the crucible charge was found to have a mean composition of 83.5 percent Ni and 16.5 percent Fe and the mean composition of the films was 81.5 percent Ni and 18.5 percent Fe. This two-percent iron enrichment in the deposit is quite small, though in the direction predicted by theory.

The composition of the films was uniform to within the experimental error of the chemical analysis,

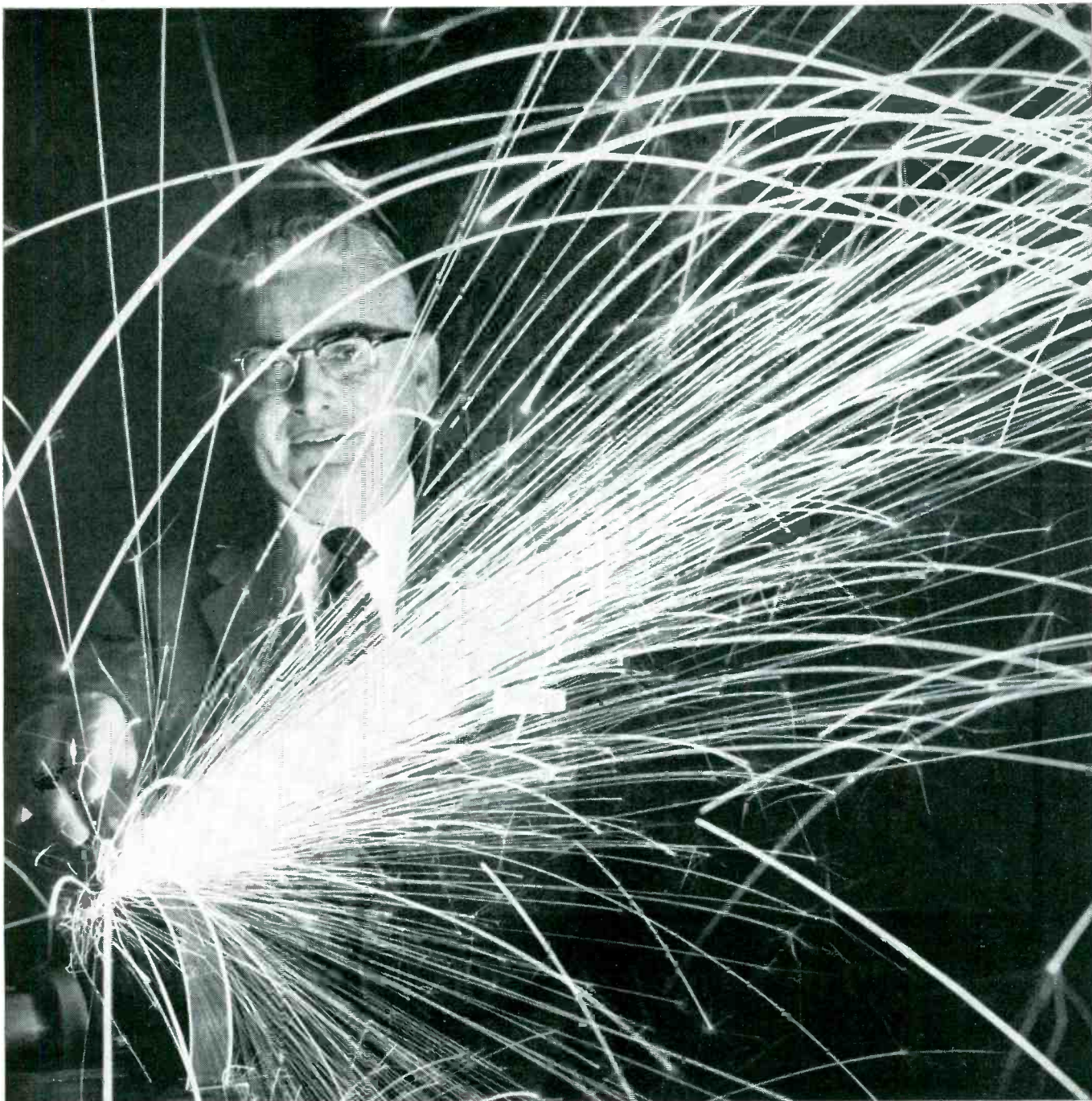

General Traffic Manager Douglas Dawson of Norton Company tells

“How Norton makes the sparks fly!”

“When a plant’s grinding operations break down, their production lines may grind to a halt, too. *We* have to make the sparks fly!” says Doug Dawson.

“The abrasive that can meet specifications — and *gets there first* — gets the order.

“We win those races time after time from our one big plant in Worcester, Mass.

“How? With on-the-ball engineering — and Air Express!”

To us, Air Express is like a full warehouse in every community; we can deliver anywhere in the U.S. in a few hours.

“Yet, we actually save money when we use Air Express instead of other air carriers. A typical 25-lb. shipment from Worcester to Chicago, for example, costs \$8.85. That’s \$3.55 cheaper than any other direct air service!”

“Those savings add up when you ship as much as 1,000 pounds a day by Air Express, as we do!”



Air Express



GETS THERE FIRST via U.S. Scheduled Airlines

CALL AIR EXPRESS . . . division of RAILWAY EXPRESS AGENCY

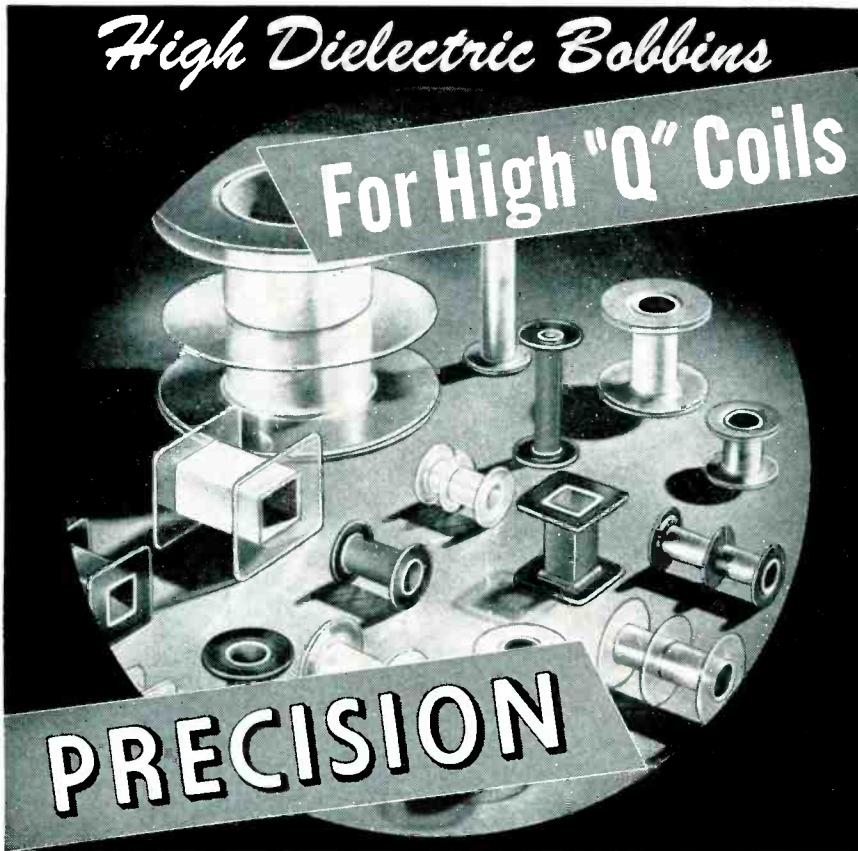

**MADE TO YOUR EXACT SPECIFICATIONS
IN ANY SIZE • SHAPE • QUANTITY**

Precision coil bobbins are fabricated from high dielectric materials and quality controlled to the most minute tolerances . . . Yet, because they are made on special high production equipment, they're available to you for prompt delivery at low unit cost.

Cores are spirally wound dielectric kraft, fish paper, acetate, phenol impregnated or combinations. Flanges are cut to any specification for all types of mountings.

Request illustrated bulletin. Send specifications for samples.

High Strength Low Cost Paper Tubes

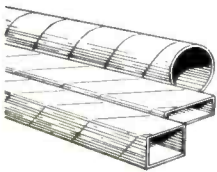

Accurately fabricated in any size, shape, ID or OD. Spirally wound from select dielectric materials. Crush resistant, with excellent dimensional stability. Subject to rigid control and inspection for tolerance and uniformity.

Ask for samples and Arbor List of over 2000 sizes.

Sales Representatives in:

New England:

Framingham, Massachusetts, Trinity 3-7091

Metropolitan New York, New Jersey:
Jersey City, New Jersey, Journal Square 4-3574

Upstate New York:
Syracuse, New York, Syracuse 4-2141

Northern Ohio, Western Pennsylvania:
Cleveland, Ohio, Atlantic 1-1060

Indiana, Southern Ohio:
Logansport, Indiana, Logansport 2555

Missouri, Southern Illinois, Iowa:
St. Louis, Missouri, Sterling 2318

Maryland:
Baltimore, Maryland, Plaza 2-3211

Philadelphia, Camden:
Philadelphia, Pa., Chestnut Hill 8-0282

California:
Pasadena, California, Sycamore 8-3919

Canada:
Montreal, Quebec, Canada, Walnut 0337



PRECISION PAPER TUBE CO.

2041 W. CHARLESTON ST.

CHICAGO 47, ILL.

Plant No. 2: 79 Chapel St., Hartford, Conn.

± 0.75 percent and it appears that the chemical problems of reproducibility require only nominal control methods.

For applications in which a small volume of magnetic material can be employed in an electronic circuit such as computer memories, register or counter stages, and magnetic recording surfaces it appears that evaporated magnetic materials may play a useful role. As a production technique, vacuum evaporation is singularly well adapted to processes in which a large number of small, simple pieces are involved and this is primarily the case of computer memory units.

The present status of research indicates that these materials can be made with satisfactory values of coercive force and good loop rectangularity. It appears that individual layer thicknesses can be achieved in the range 0.1 to 10 microns, with coercivities from 0.1 to 10 oersted.

Control of chemical composition in the case of evaporated alloys appears straight-forward.

**Facsimile Speeds
Plant Messages**



Renewed interest in facsimile, spurred by need of television stations for quick transmission of photographic copy, has spread to industry. Continuous-copy machine using electrolytic paper at receiver cuts operator requirement. Receiver shown in Highland Park mail room of Chrysler Corp. is connected to transmitter at the central records department in Detroit

STANDARD flexlab

**IN INDUSTRY and RESEARCH
IN GOVERNMENT
IN VOCATIONAL and
TECHNICAL SCHOOLS
and UNIVERSITIES**

Why not send for Flexlab Catalog #187—"Laboratory Equipment for Industry and Government"... or for Flexlab Catalog #216—"Laboratory Equipment for Vocational and Technical Schools."



"Custom Designed and Built"

IN GOVERNMENT



Naval Research Laboratory



Los Alamos Physics Laboratory

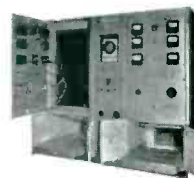

McClellan Air Force Base



Aberdeen Proving Grounds

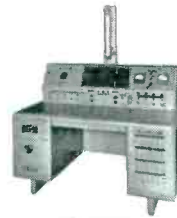

Naval Air Development Station

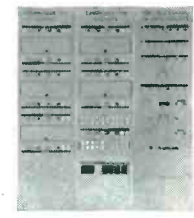

Frankford Arsenal



Pensacola Naval Air Station

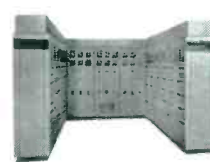

White Sands Proving Grounds



Naval Research Laboratory

IN SCHOOLS and UNIVERSITIES



Bell Vocational School



Bell Vocational School

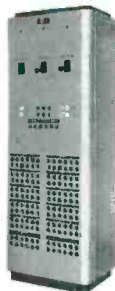

Iowa State College

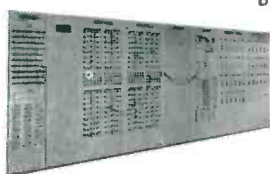

Princeton University



Bergen County Vocational School

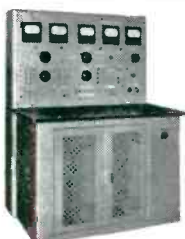

Technical School

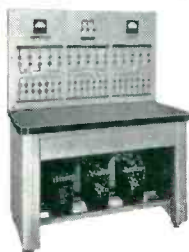

Bell Vocational School

IN INDUSTRY and RESEARCH



Westinghouse Electric Co.



Monsanto Chemical Co.



Ford Motor Co.



Radio Corp. of America

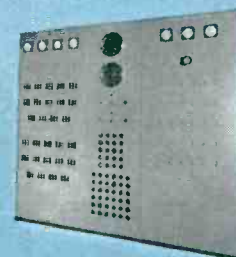

Glenn L. Martin Co.



Commonwealth Edison



Packard Motor Co.



General Electric



Since 1884

THE STANDARD ELECTRIC TIME COMPANY

97 Logan Street • Springfield 2, Massachusetts

**ELECTRIC CLOCK AND PROGRAM SYSTEMS • FIRE ALARM SYSTEMS • HOSPITAL SIGNAL SYSTEMS
PRECISION TIMERS • CHRONO-TACHOMETERS • PIPELINE NETWORK ANALYZERS**

Silk-Screen Machine Places Insulating Paint on Selenium Rectifiers

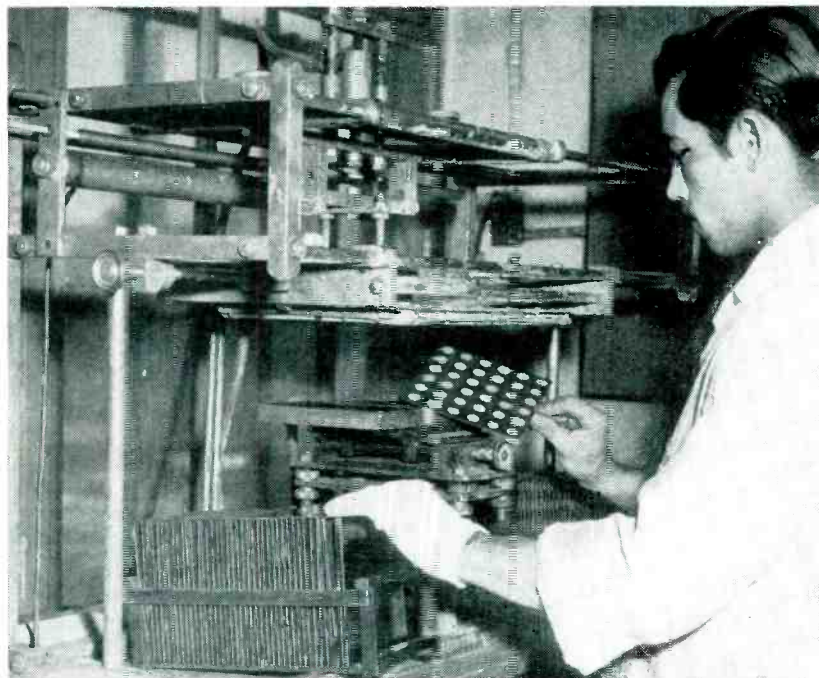

Removing painted plate from automatic silk screen machine. Unpainted plates are in rack at left. Painted plates are placed in rack at right to dry

LARGE DOTS of insulating paint are applied to 6-inch-square selenium-coated sheets by a special automatic silk screen printing machine in the Brooklyn, N. Y. plant of Radio Receptor Co., in preparation for later punching of mounting holes and

cutting into individual selenium cells for rectifiers. The operator merely loads, unloads and operates the pedal-type air valve on the floor to initiate the printing operation.

The paint serves to minimize

shorting of the cells when punching holes for mounting studs. The paint has good insulating qualities so as to withstand a 500-volt test, sufficient elasticity to give required protection during punching and dries fast enough in air so that it does not slow up the production line.

When the blank sheet is slipped into position between the guides on the platen of the press, the operator pushes the foot pedal. This initiates action of interlocking valves that bring up the platen against the silk screen, bring the squeegee down on the silk screen, then move it across the screen for forcing paint through and onto the selenium plate. Air cylinders connected to the valves produce all these motions.

When the operator releases the foot pedal, the squeegee is pulled up by spring loading, then pulled back to the left of the machine by a longer spring working against the horizontal air cylinder that moved it across initially. Simultaneously the platen drops down so the operator can remove the printed plate. The machine was constructed by Dependable Compressor Co., 157 W 21st St., New York, N. Y.

Limit Bridge Tests Finished Ceramic Capacitors Ten-at-a-Time

A MOTOR-DRIVEN ten-position rotary switch with an operating cycle of 1 second is used in the Metuchen, N. J. plant of Gulton Mfg. Corp. in connection with a 1-kc capacitance-limit bridge and a simple d-c breakdown test circuit to check finished ceramic capacitors.

The tiny capacitors are taped to wood sticks in groups of ten for ease of handling during the coating, baking, imprinting, testing and final waxing operations. After imprinting, the operator at the test

position picks up a stick of capacitors and pushes it down between two rows of contacts in one easy motion to make all the required connections simply and automatically.

Each set of contacts consists of a wedge-shaped insulating upright that goes between the leads of a capacitor, mounted between vertical phosphor-bronze contact strips that go outside the leads. The ten sets of these contacts in the front row serve for the capacitance test and

an additional set in the back row serve for the shorts test. Two sets of contacts were used to minimize switching requirements in the test circuits, it being just as easy to bring the stick of capacitors down into two sets of contacts as for just one set.

Two sets of ten neon lamps in front of the contacts serve as capacitance indicators. The row of red lamps indicates units below tolerance, and the row of yellow lamps (yellow paint on neon lamps) glows

While You're Reading This



...Kester '44'

Resin-Core Solder Has

Done Its Job!

KESTER SOLDER

COMPANY 4204 Wrightwood Avenue, Chicago 39, Illinois; Newark 5, N. J.; Brantford, Canada

for units above tolerance. An R-C circuit connected to each lamp keeps it on for about 1½ sec, which is amply long for the operator to mark the tape over the leads of the corresponding capacitor with either a red or yellow crayon pencil.

The operator next presses a lever at the left of the machine to close a snap-action switch that connects the rear set of contacts into the circuit for a shorts test. As the rotary switch goes through another cycle she watches the red neon lamps, which now come on bright only for a shorted unit. These get an extra red crayon mark on the tape.

After testing, the stick of capacitors is lifted out for transfer to the next operation. Here the units marked for rejection are pulled out and the others are put through a final waxing operation.

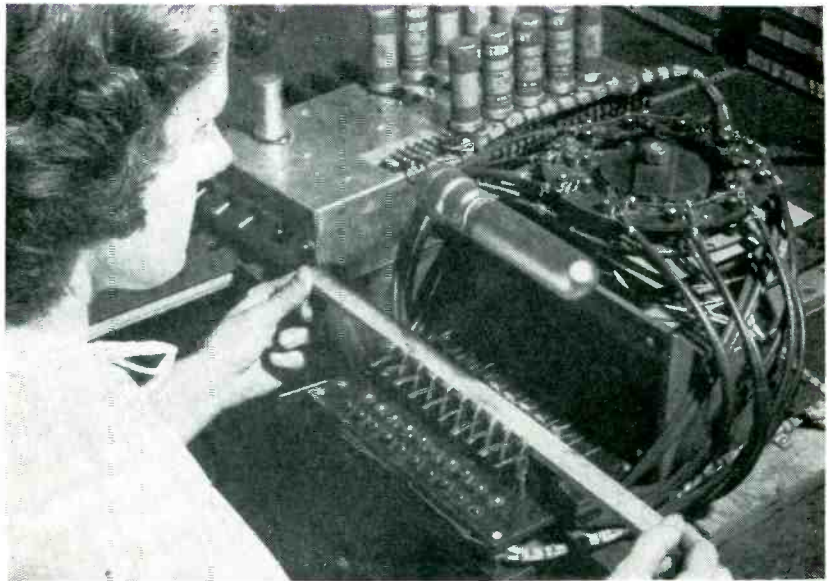

Method of placing stick of ten capacitors in position on test contacts. Normally the tape side of the stick is facing up, so that the operator can mark appropriate check marks with crayon on the expendable tape

Mechanized Line Inspects and Tests Speaker Magnets



ALL MATERIALS HANDLING, mechanical inspection and magnetic testing functions for speaker magnets are centralized in a 16-foot line built around two new electronically controlled machines in the Edmore, Mich., permanent magnet plant of Carboly Department of General Electric Co.

The mechanical inspection unit processes 2,100 speaker magnets per hour, a production pace three times faster than any technician can possibly work. It provides facilities for visually inspecting for defects, then automatically checks the magnets for length, outside diameter, end squareness and parallelism. The machine holds both length and outside diameter to plus or minus 0.001 inch and end squareness under 0.002 inch.

Steady travel of the speaker magnets through the machine is controlled by a control switch in-

Mechanical inspection machine (left) and magnetic testing machine (right) on new mechanized inspection line for speaker magnets. Filled bins of magnets passing tests at first machine are carried to second machine and dumped into hopper for pickup by conveyor belt rising into air at top center

The Only COMPLETE Line...



Model SS
3-speed, 2-pole motor

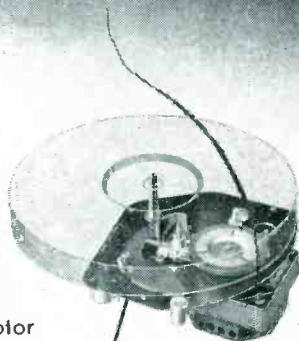

Model DSS
3-speed, 4-pole motor

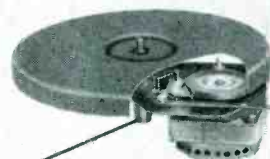

Model DR
2-speed,
4-pole motor



Model LC
Single speed,
2-pole motor



Model RM 4
Single speed,
4-pole motor

Model D-10
4 pole, shaded pole AC
Induction type for
tape, wire or disc
recorders



Smooth Power PHONOMOTORS

- FOR PORTABLE PHONOS
- FOR HI-FI UNITS
- FOR COMBINATIONS
- FOR RECORD CHANGERS
- FOR TAPE RECORDERS
- FOR REPLACEMENT USE
- FOR EVERY PHONO APPLICATION

Follow the lead of America's foremost manufacturers - Specify GI for all your phonomotor needs. A complete range of speeds and types to meet every requirement - backed by over half a century of design leadership!



THE GENERAL INDUSTRIES CO.

DEPARTMENT GA • ELYRIA, OHIO

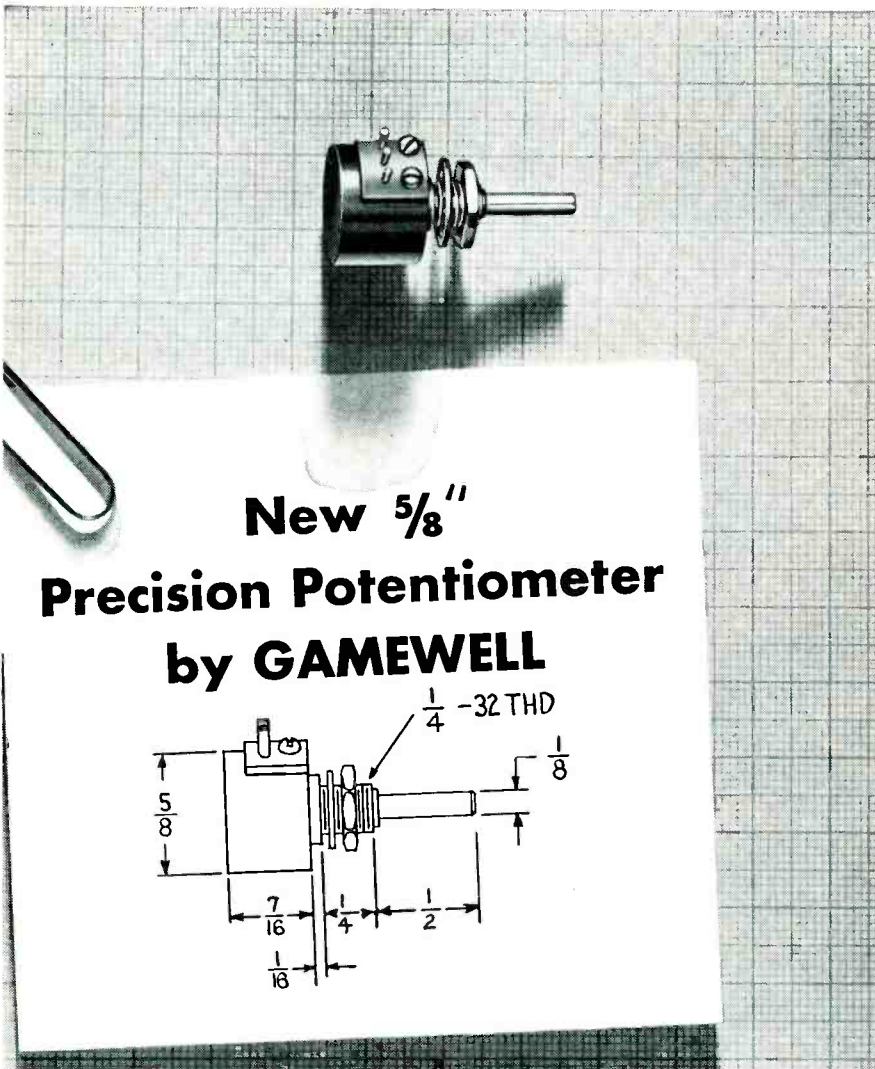

New 5/8"
Precision Potentiometer
by GAMEWELL

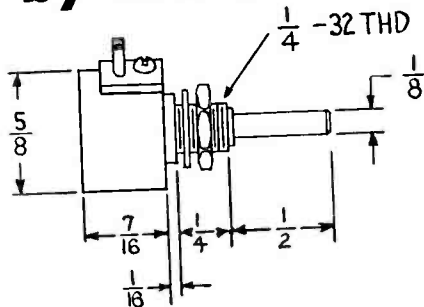

Here is a 5/8" potentiometer that offers you the extreme precision found in larger sizes of Gamewell Potentiometers.

Body is of anodized aluminum and the shaft is made of stainless steel. Kohlrausch type winding provides excellent linearity and the unit meets MIL-E-5400 specifications as they apply.

The unit can be modified for special mounting, Multiple gangs, higher operating temperatures, and other special features upon request. Write for additional information about this miniature precision potentiometer.

CONDENSED TECHNICAL DATA:

- Resistance.....*30K ± 5%
- Min. Resistance..... 20 ohms
- Linearity.....*0.25
- Electrical Angle......345°
- Resolution..... *0.09% (1100T)
- Test Voltage.....1000 RMS
- Temperature......105°C
- Watts......1
- Size......5/8" OD
 1/16" long
- Torque......0.2 oz.-in.

*Maximum Values

THE GAMEWELL COMPANY
 NEWTON UPPER FALLS 64, MASS.



PRECISION POTENTIOMETERS

Manufacturers of Precision Electrical Equipment Since 1855

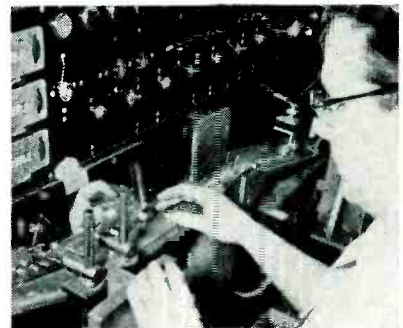

Magnetic tester. Magnets drop off conveyor belt into chute to rotating work feeder, which lines them up for passage through feed wheel of magnetic tester directly in front of operator

side the hopper, located at the left of the machine. So long as the hopper is full and the switch steadily actuated by the tumbling magnets in the hopper, no additional magnets are conveyed to the machine. Additional magnets are conveyed to the hopper automatically when the switch is no longer actuated.

During the checking sequence

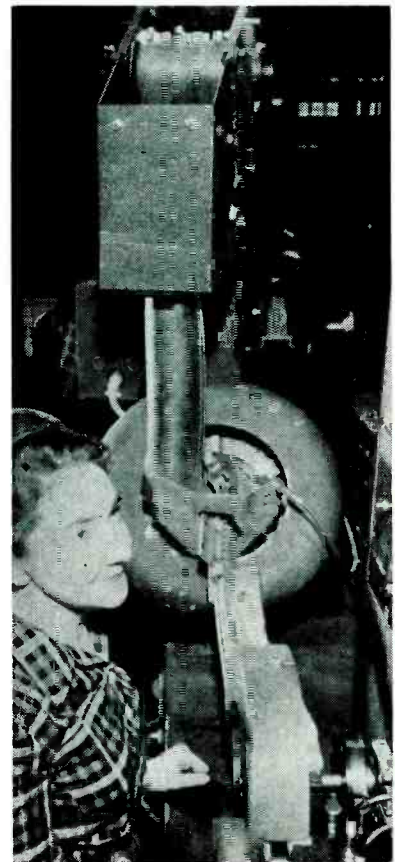

At mechanical inspection machine, magnets roll down chute by gravity, past mirror for visual inspection of both ends, then through sensing gates for dimensional checking. Switches on rotating hoppers start conveyor feed belt when magnet supply gets low



← this mark
means: "Registered
U.S. Patent Office."

SINTERCOTE



← placed
after a
word, like this,
it identifies a
registered trademark.



← these
marks together
mean Los Gatos

Electron Tubes, the
finest you can get. They
have Sintercote [®] black-body
anodes and give truly
amazing service life. Get
them from your jobber or
Lewis and Kaufman Ltd., Los
Gatos, California. Radio Valve Co.
distributes them in Canada,
Minthome International Co. of
New York exports them.

VHF

... Very High Frequencies



• **RADIO INTERFERENCE**
 • **and FIELD INTENSITY***
 • **measuring equipment**

• **Stoddart NM-30A • 20mc to 400mc**

• **Commercial Equivalent of AN/URM-47**

PRINTED CIRCUITRY... Modern printed circuits offer many advantages over conventional wiring, lighter weight, more compact units and freedom from many of the troubles normally encountered in conventionally-wired electronic equipment. Vibration becomes even less of a problem with printed circuits, adding to the many portable features already available with Stoddart equipment.

ADVANCED DESIGN... Specialized engineering and modern production techniques have produced one of the most advanced instruments for the accurate measurement, analysis and interpretation of radiated and conducted radio-frequency signals and interference ever manufactured. Designed to laboratory standards, rugged, and with matchless performance, the versatile NM-30A is an outstanding example of modern instrumentation. Its frequency range includes FM and TV bands.

SMALLER SIZE... A wider frequency range and higher standard of performance is incorporated into an equipment whose size is one-third that of any similar equipment ever manufactured.

SENSITIVITY... Sensitivity ranges from one to ten microvolts-per-meter, depending upon frequency and antenna in use.

APPLICATIONS... Field intensity surveys, antenna radiation pattern studies, interference location and measurement for checking radiation from virtually any mechanical or electrical device capable of generating or radiating radio-frequency signals or interference.

Stoddart RI-FI* Meters cover the frequency range 14kc to 1000mc

VLF
 NM-10A, 14kc to 250kc
 Commercial Equivalent of
 AN/URM-6B. Very low frequen-
 cies.

HF NM-20B, 150kc to 25mc
 Commercial Equivalent of
 AN/PRM-1A. Self-contained
 batteries. A.C. supply optional.
 Includes standard broadcast
 band, radio range, WWV, and
 communications frequencies.
 Has BFO.

UHF
 NM-50A, 375mc to 1000mc
 Commercial Equivalent of
 AN/URM-17. Frequency range
 includes Citizens band and
 UHF color TV-band.

only those magnets that measure up to all specifications pass entirely through the machine for eventual shipping. The others are automatically rejected at the stations where they fail to meet size specifications.

The electronically controlled magnetic testing unit processes about 1,600 speaker magnets per hour and tests the magnetic output of individual magnets. In the magnetizing fixture of the machine, magnets are first magnetized, then tested by comparing them with a standard magnet of known value. They are then partly demagnetized and electronically segregated. As in the mechanical tester, several drop chutes are used in segregating them into proper containers located at the bottom of the machine.

Transparent Covers For Quality Control Charts

CHANGING of production output or quality control charts at daily, weekly or monthly intervals can be eliminated by placing glass or transparent sheet plastic over the basic chart form and plotting the points and curves with china marking crayon. When a chart is filled, it can be cleared in readiness for the next time period by wiping off the crayon markings with a soft cloth. Holidays can be encircled and other pertinent data for any

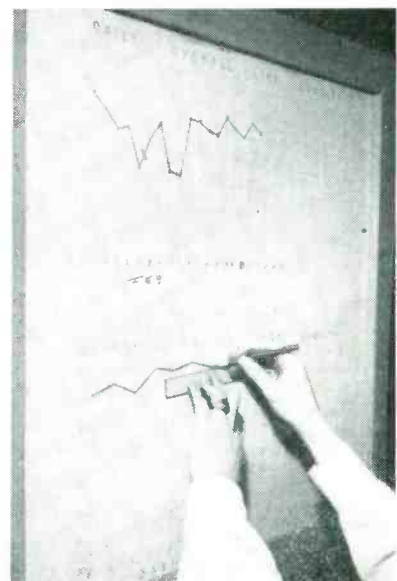

Extending curve on glass-covered chart with crayon guided by straight edge

STODDART AIRCRAFT RADIO Co., Inc.

6644-A Santa Monica Blvd., Hollywood 38, California • Hollywood 4-9294

CPPC OFFERS HIGH QUALITY SYNCHROS Consistently!

By Customer's Testing—
REJECTION RATE .00095



ACTUAL SIZE

Out of 9000 synchros recently supplied a customer for a single job, the rejection rate by his testing of some 20 characteristics was .095% on each test. Nearly $\frac{3}{4}$ of the rejections were on minute differences of calibration measurements.

According to the customer, "this is far below rejection rates of 20% and 30% which we have experienced with regard to other sources of supply for like items."

A second customer reports that he has found CPCC synchros to have the next to the lowest rejection rate out of 500 suppliers. The only vendor having a lower rejection rate was a resistor manufacturer. (Names of both customers available on request.)

It costs no more to have the best! For highest consistent quality and accuracy, specify CPCC.

For full engineering information on size 10, 11, 15 and 22 synchros of virtually every type and available for 3 weeks or less delivery, write or phone, T. W. Shoop, Sales Mgr. Phone (Suburban Phila.) MADison 6-2101.

West Coast Rep Wm. J. Enright, 988 Kensington Rd., Los Angeles. MUtual 6573

Direct Export Sales inquiries to: Andrew S. Szucs, Inc., 50 Broad St., New York 4, N. Y.

LOOK TO CPCC FOR **cppe** SYNCHRO PROGRESS
CLIFTON PRECISION PRODUCTS COMPANY, INC.
CLIFTON HEIGHTS PENNSYLVANIA

HIGH RESOLUTION LABORATORY STANDARD DC VOLTMETERS

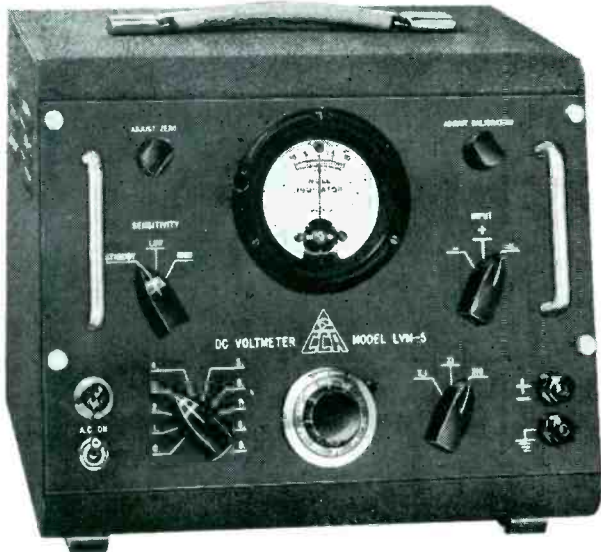

For most applications these rugged portable, self-contained nulling voltmeters replace a potentiometer, voltbox, galvanometer and standard cell combination. They are suitable for laboratory use, production line testing and field service.

Model LVM-5

Voltage Range: 0-100 Volts DC
 Resolution: At least 50 microvolts between 0 and 1 volt
 500 microvolts between 1 and 10 volts
 5 millivolts between 10 and 100 volts
 Absolute Accuracy: $\pm 0.1\%$ of reading
 Input Impedance: Infinite at null

Model PVM-4

Voltage Range: 0-600 Volts DC
 Resolution: At least 5 millivolts between 0 and 10 volts
 50 millivolts between 10 and 600 volts
 Absolute Accuracy: $\pm 0.1\%$ of reading
 Input Impedance: Infinite at null

Computer Company of America, Division of Bruno-New York Industries Corp. also manufactures the IDA analog computers and accessories. Their usefulness in the field of dynamics has been proven over the years. A complete line of standard computers, instruments and regulated power supplies is supplemented by the ability to design and manufacture specialized equipment for your particular applications. Your inquiries are invited.

The Model LVM-5 may also be used as a deflection potentiometer, a sensitive null indicator and a precision millimicroammeter. Write for catalog PL which describes these instruments completely. Address Dept. E&D

COMPUTER COMPANY OF AMERICA
 Division of BRUNO-NEW YORK INDUSTRIES CORP.
 460 WEST 34th STREET • NEW YORK 1, N. Y.



particular period can be written on the chart in the same manner.

This technique is used in a great many plants, but is of course applicable only where there is no need to preserve the completed charts.

Assembling Cartridge-Type Selenium Rectifiers



Loading pellets on assembly fixture

A TILTING LOADING FIXTURE is used in the Brooklyn, N. Y. plant of Radio Receptor Co. to aid in loading eight disk-shaped selenium cells into a tubular Bakelite housing. The operator places eight of the pellets in position above the plunger in the semicircular groove of the fixture, all facing the same way, then adds dummy pellets as required to fill the housing.

The first step involves placing a housing upside down between the studs at the upper end of the fixture, with the pigtail lead up. The lead and end cap were previously pushed in with an arbor press.

The operator now pushes the



Bringing up plunger to push pellets into tubular cardboard housing. Fixture is then tipped backward so that housing can be removed without spilling

"PIG-TAILORING"

... a revolutionary new mechanical process for higher production at lower costs. Fastest PREPARATION and ASSEMBLY of Resistors, Capacitors, Diodes and all other axial lead components for TERMINAL BOARDS, PRINTED CIRCUITS and MINIATURIZED ASSEMBLIES.

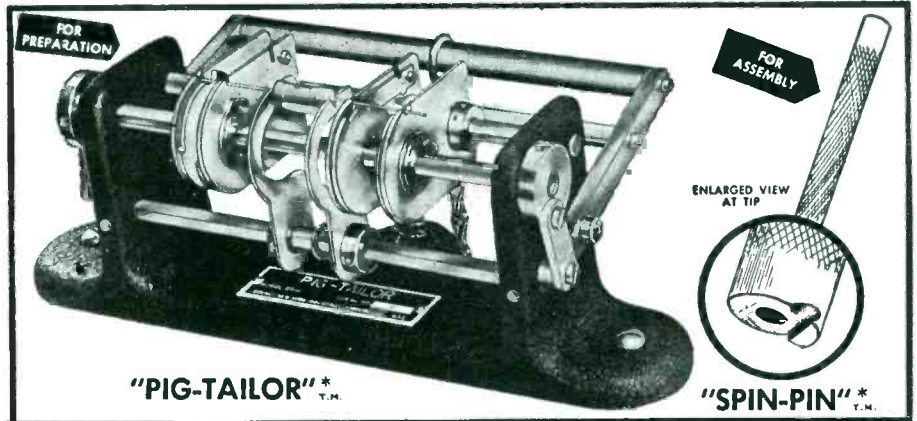

The "PIG-TAILOR" plus "SPIN-PIN" — Accurately Measures, Cuts, Bends, Ejects and Assembles both leads simultaneously to individual lengths and shapes — 3 minute set-up — No accessories — Foot operated — 1 hour training time.

PIG-TAILORING provides:

- | | |
|-------------------------------------|-------------------------------------|
| 1. Uniform component position. | 6. Individual cut and bend lengths. |
| 2. Uniform marking exposure. | 7. Better time/rate analysis. |
| 3. Miniaturization spacing control. | 8. Closer cost control. |
| 4. "S" leads for terminals. | 9. Invaluable labor saving. |
| 5. "U" leads for printed circuits. | 10. Immediate cost recovery. |

PIG-TAILORING eliminates:

- | | |
|--------------------------------|-----------------------------------|
| 1. Diagonal cutters. | 6. Broken leads. |
| 2. Long-nose pliers. | 7. Short circuits from clippings. |
| 3. Operator judgment. | 8. 65% chassis handling. |
| 4. 90% operator training time. | 9. Excessive lead tautness. |
| 5. Broken components. | 10. Haphazard assembly methods. |

* PATENT PENDING

Write for illustrated, descriptive text on "PIG-TAILORING" to Dept. E6-P

BRUNO-NEW YORK INDUSTRIES CORPORATION
 DESIGNERS AND MANUFACTURERS OF ELECTRONIC EQUIPMENT
 460 WEST 34th STREET • NEW YORK 1, N. Y.



Broadband RF Power Meters

THE CHOICE OF ALL ARMED SERVICES
 FOR MICROWAVE POWER MEASUREMENTS

POWER: PULSE and CW — $5\mu W$ to 5W average
FREQUENCY: 20MC — 10,000MC
ACCURACY: 5% Absolute at all ranges, frequencies, temperatures

- INDICATIONS: Direct Reading
- CALIBRATION: Compensates for All Variables
- R-F COMPONENTS: 3, 6, 10 and 20db Attenuators, Bolometer Mount and Elements, R-F Cable
- BOLOMETER: Broadband, High Overload Capacity
- PLUMBING: $\frac{3}{8}$ " and $\frac{7}{8}$ " 50-ohm Coaxial
- POWER SOURCE: 115VAC $\pm 15\%$, 50-1000 cps
- CONSTRUCTION: Rugged, meets all JAN, MIL requirements

TYPICAL APPLICATIONS

Microwave Links . . . Television . . . Communications . . .
 Radar . . . Telemetry . . . Signal Generators . . .
 Laboratory Standards.

Write for descriptive literature to Department E6-M

Bruno - New York Industries Corporation
 DESIGNERS AND MANUFACTURERS OF ELECTRONIC EQUIPMENT
 460 WEST 34th STREET • NEW YORK 1, N. Y.

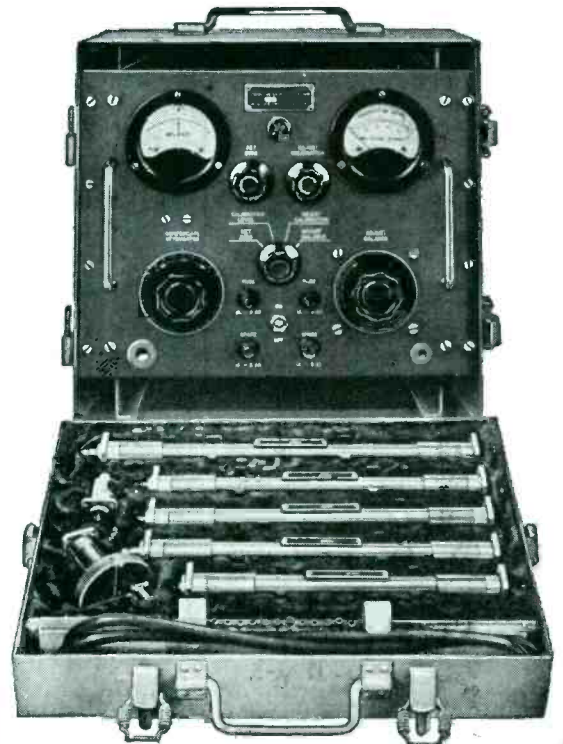

LET THIS CATALOG BE YOUR GUIDE



Preparing to operate press after placing loaded housing on bed of press and inserting other lead in die of press

plunger at the bottom of the fixture, so as to move the pellets up into the housing without disturbing their alignment. The fixture is tilted upward, the plunger removed and the filled housing taken out and set into a holding tray. This tray is simply a square of plywood having drilled holes large enough for the leads but too small for the housing to slip through. Long bolts at the four corners serve as feet for the tray.

The final step in assembly involves inserting the second lead and cap in the upper die of the arbor press, then placing a loaded housing on the bed of the press. The operator places a spring and blank disk on top of the pellets already in the housing, then operates the press to force in the other pigtail lead and thereby complete the assembly.

Electric Punch Speeds Insertion of Plug-Nuts

A CHUTE for feeding plug nuts to a punch for insertion in prepunched holes in aluminum brackets for carrier communication equipment has been designed by the Lenkurt Electric Co. of San Carlos, Calif.

The chute is fastened to a vibratory feeder made by the Syntron Co. of Homer City, Pa. Approximately 45 plug nuts are held in the chute at a time. At the end of the chute is a spring jaw which guides and centers each plug nut for driving into a prepunched hole in the aluminum part.

It was necessary to design a

microwave

AND

uhf

ELECTRONIC TEST EQUIPMENT

THE **NARDA** CORPORATION

HIGH POWER
Impedance Meters
Variable Reactances
Terminations

•
COAXIAL
Slotted Lines
Attenuators
Terminations
Couplers

•
Bolometers
Thermistors
Frequency Meters
Terminations
Couplers
Attenuators
Detectors
Mixers
Tuners and Shorts
Tee Sections
Stands and Clamps

*high-specs
low-cost*

WRITE FOR YOUR COPY OF THE NARDA CATALOG, and use the NARDA advisory services without obligation.

Narda manufactures a complete line of Microwave Test Equipment, Thermistors and Bolometers.

NARDA

THE NARDA CORPORATION
66 MAIN STREET • MINEOLA, NEW YORK
Pioneer 6-4650

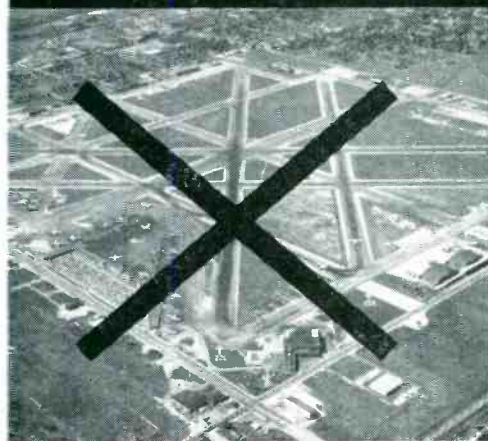
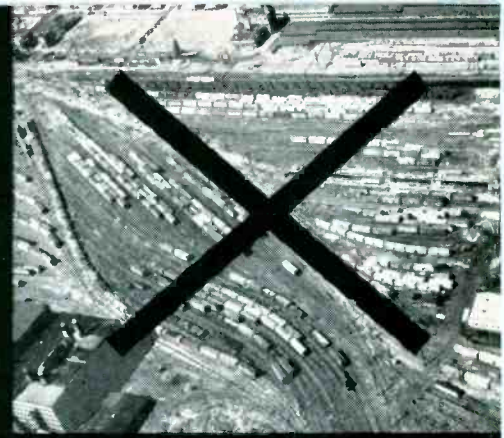

tic 'tac' toe!

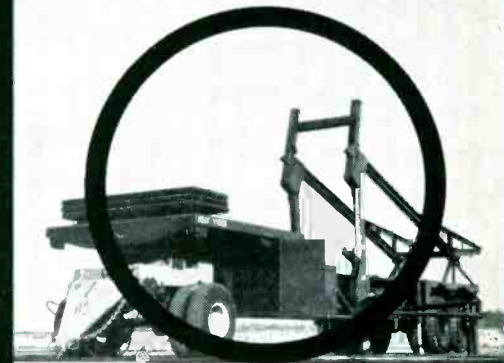

In the event of surprise attack, today's new and more powerful USAF Tactical Air Command can now carry war to the enemy anywhere in the world—around the clock and in any weather.

Here at a glance are some of the elements that might be used in such an attack and which are contributing to Tac Air's new mobility and striking power.

In modern warfare, major fixed bases are certain to become targets for initial enemy action. The Martin zero-length launcher makes possible swift mobility and advance-area operation of the TM-61 Matador tactical missile and—if need be—of piloted jet fighters.

In addition, new versions of U.S. Air Force's B-57 bomber, a major tactical weapon, are now being developed for service.

And for tomorrow's Tactical Air Command arsenal, new and more powerful Martin weapons systems are on the way.

MARTIN
BALTIMORE · MARYLAND ·



high performance **SHAKER** in **CALIDYNE'S** new 100 pound force system

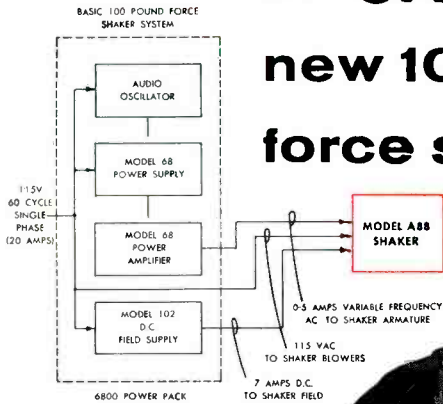

HIGHER USEFUL OUTPUT, IMPROVED SHAKER DESIGN

Calidyne's new Model A88 Shaker, rated at 100 pounds force output continuous duty over the 40 to 3000 cps frequency range, incorporates several important design changes and refinements. A lightweight, extremely rigid armature of cage-type construction greatly increases the useful portion of total force output. MIL-E-5272A Procedure I requirements, for example, can be met with mass loads up to 7.3 pounds. Also, a new flexure system insures truly *linear* motion of the armature, and trunnion mounting of the Shaker allows forces to be exerted in any direction. And for monitoring amplitude of vibratory motion, a calibrated velocity signal generator has been built into the Shaker.

SINGLE CONSOLE CONTAINS CONTROLS AND POWER PACK

The 6800 Control and Power Pack unit includes the Power Amplifier, Audio Oscillator, and Shaker Field Supply, as well as all controls and indicators, for operation of the complete system. Accessories for monitoring Shaker vibratory levels and performing automatic cycling tests required in many MIL and JAN specifications may be added to the basic system at any time, by rack mounting in the cabinet.

*Complete System Specifications and Details
Available on Request*



THE CALIDYNE COMPANY

120 CROSS STREET, WINCHESTER, MASSACHUSETTS

SALES REPRESENTATIVES:

WALTHAM, MASS.
Robert A. Waters, Inc.
Waltham 5-6900

NEW HAVEN, CONN.
Robert A. Waters, Inc.
Fulton 7-6760

NEW YORK CITY AREA
G. C. Engel & Associates
Rector 2-0091

RIDGEWOOD, NEW JERSEY
G. C. Engel & Associates
Gilbert 4-0878

PHILADELPHIA, PA.
G. C. Engel & Associates
Chestnut Hill 8-0892

NORTHERN NEW YORK
Technical Services Co., Boston
Capital 7-9797

CLEVELAND, OHIO
M. P. Odell Co.
Prospect 1-6171

DAYTON, OHIO
M. P. Odell Co.
Oregon 4441

WASHINGTON, D. C.
F. R. Jodan, Inc.
Woodley 6-2615

SOUTHEAST
W. A. Brown & Assoc.
Alexandria, Va.
Overlook 3-6100

CHICAGO, ILLINOIS
Hugh Marsland & Co.
Ambassador 2-1555

INDIANAPOLIS, INDIANA
Hugh Marsland & Co.
Glendale 3803

MINNEAPOLIS, MINN.
Hugh Marsland & Co.
Coffax 7949

DALLAS, TEXAS
John A. Green Co.
Dixon 9918

HOLLYWOOD, CALIFORNIA
G. B. Miller Co.
Hollywood 9-6305

SAN FRANCISCO, CALIF.
G. B. Miller
LYtch 3-3438

ALBUQUERQUE, NEW MEXICO
G. E. Miller Co.
Albuquerque 5-8606

SEATTLE, WASH.
G. B. Miller Co.
Lander 3320

CANADA
Measurement Engineering Ltd.
Amprior, Ont. Phone 400

Toronto, Ont. Mayfair 8860
EXPORT
Rocke International Corp.
13 East 40th St., N.Y. 16, N.Y.
Murray Hill 9-0200

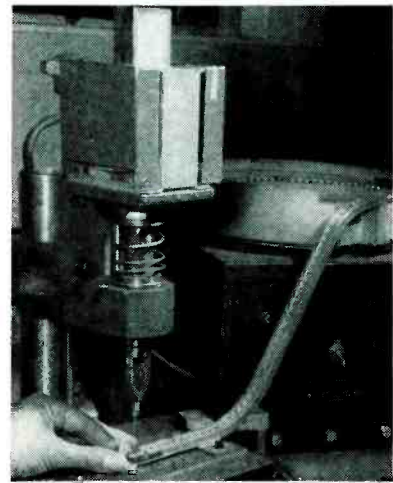

Holding aluminum bracket in position for automatic punching of plug nut coming down chute from work feeder

spring pickup tongue for the punch and a spring-loaded pilot for the anvil. When actuated electrically by a foot treadle, the punch picks the plugnut off the spring jaw of the chute and drives it into the aluminum part. This part is guided into exact position for the operation by utilizing the pilot button on the anvil.

The chute feeds the plug nuts into position more rapidly than could be done by hand and positions them more accurately for punching.

The chute, punch and die were designed by Lenkurt's Industrial Engineering Department. Black and Webster, Inc. of Newton, Mass. manufacture the Electropunch used in this operation.

Automatic Aluminizer for Television Picture Tubes

COMPLETELY automatic continuous-production aluminizing equipment for television picture tubes has been designed and placed in production by F. J. Stokes Machine Co., Philadelphia, Pa. The 22 self-contained mobile units travel around an oval track in endless procession. RCA's Tube Division has installed one of these 22-unit systems at its plant in Marion, Indiana. Speed of the aluminizing equipment is here synchronized with the rest of the picture-tube production line. Only one operator is needed to load and unload the tubes, for aluminizing up to 120 tubes per hour.

The overhead conveyor line from

Now Puerto Rico Offers 100% Tax Exemption to New Industry

"We don't want runaway industries" says Governor Muñoz. "But we do seek new and expanding industries." Federal taxes do not apply in Puerto Rico, and the Commonwealth also offers full exemption from local taxes. That is why 300 new plants have been located in Puerto Rico, protected by all the guarantees of the U. S. Constitution.

by BEARDSLEY RUMI

In a dramatic bid to raise the standard of living in Puerto Rico, the Commonwealth Government is now offering U. S. manufacturers such overwhelming incentives that more than three hundred new factories have been established in this sun-drenched island 961 miles off the Florida Coast.

First and most compelling incentive is a completely tax-free period of ten years for most manufacturers who set up new plants in Puerto Rico.

For example, a recent analysis for one Ohio firm revealed that due to tax exemption and operating economies it will increase its net profit from \$187,000 to \$442,000 a year by locating its new plant in Puerto Rico.

The Commonwealth will leave no stone unturned to help you get started. It will



Aerial view of the modern city of San Juan, capital and financial center of Puerto Rico.

CORPORATE TAX EXEMPTION	
If your net profit after U. S. Corporate Income Tax is:	Your net profit in Puerto Rico would be:
\$ 17,500	\$ 25,000
29,500	50,000
53,500	100,000
245,500	500,000
485,500	1,000,000

DIVIDEND TAX EXEMPTION*	
If your income after U. S. Individual Income Tax is:	Your net income in Puerto Rico would be:
\$ 3,900	\$ 5,000
7,360	10,000
10,270	15,000
14,850	25,000
23,180	50,000
32,680	100,000
70,180	500,000

*Dividends are tax-free only if paid to residents of Puerto Rico by a tax-exempt corporation. Examples are based on Federal rates (Jan. 1, 1954) for single persons.

build a factory for you. It will help you secure financing. It will even screen job applicants for you—and then train them to operate your machines.

Puerto Rico's labor reservoir of 650,000 men and women has developed remarkable levels of productivity and efficiency.

Twenty-eight factories are now producing delicate electronic equipment.

Among the U. S. companies already manufacturing in Puerto Rico are Sylvania Electric, Carborundum Company, Remington Rand, Univis Lens, Shoe Corporation of America and Weston Electric.

"Close to Paradise"

Listen to what L. H. Christensen, Vice President of St. Regis Paper, says: "The climate is probably as close to paradise as man will ever see. I find Puerto Ricans in general extremely friendly, courteous and cooperative. This plant in Puerto Rico is one of our most efficient operations, in both quality and output. Our labor has responded well to all situations."

Six steamship companies and four airlines operate regular services between Puerto Rico and the mainland. San Juan is just 5½ hours by air from New York City. There is no duty on trade with the mainland.

Are You Eligible?

Says Governor Muñoz: "Our drive is for new capital. Our slogan is not 'move something old to Puerto Rico,' but 'start

something new in Puerto Rico' or 'expand in Puerto Rico'."

The Commonwealth wants to attract all suitable industries to Puerto Rico—especially electronics, men's and women's apparel, leather, plastics, costume jewelry, small electrical appliances, and pharmaceuticals.

To get all the facts, and to find out whether you and your company would be eligible for *complete* tax exemption, mail the coupon below for your free copy of "Facts for Businessmen."

MAIL THIS COUPON

Economic Development Administration
Commonwealth of Puerto Rico, Dept. V-3,
579 Fifth Avenue, New York 17, N. Y.

Mail me "Facts for Businessmen," your report of the advantages of Puerto Rico for plant location.

Name _____

Company _____

Product _____

Address _____



Your source for 2K50 REFLEX KLYSTRON TUBES

The new Bendix Red Bank 2K50 is the perfect answer for those who want a thermally-tuned Reflex Klystron tube for K-band operation.

The 2K50 has two primary applications—first, as a local oscillator in small, compact, lightweight, high definition radar and, second, as an oscillator in microwave spectrometers, signal generators and spectrum analyzers.

Because of its thermal feature, the 2K50 may be tuned automatically. Thus, it is ideally suited for difficult locations . . . in aircraft, for example . . . where direct or mechanical tuning is not practical.

Perfection of the complex, ultra-precision 2K50 . . . one of the most difficult electron tubes to manufacture . . . is a tribute to the unique talents of our engineers and production men. It demonstrates why you can depend on Bendix Red Bank for the answer to *any* special-purpose electron tube problem you may have.

MAXIMUM RATINGS

Resonator Voltage	330 volts D.C.
Reflector Voltage	—150 volts D.C.
Tuner Grid Voltage	—50 volts D.C.
Filament Voltage	6.3 ± 8% volts
Gun Cathode Current	28 ma. D.C.
Tuner Cathode Current	10 ma. D.C.

ELECTRICAL CHARACTERISTICS

Heater Voltage (A.C. or D.C.)	6.3 volts
Heater Current755 amps.
Thermal Tuning Range	23216 to 24751 Mc/Sec.
Min. Power Output at 23504 Mc/Sec.	8.5 mW.
Min. Power Output at 23984 Mc/Sec.	10.0 mW.
Min. Power Output at 24464 Mc/Sec.	8.5 mW.
Min. Electronic Tuning at Mid-Band	55 Mc/Sec.

PHYSICAL CHARACTERISTICS

- Dimensions: Maximum seated height 2 1/4" • Base: Small Octal 8-Pin, B8-21, Low Loss Phenolic Wafer • Coupling to Wave Guide: Direct, by means of an insulating fitting • Cooling: Convection • Mounting Position: Any • Cavity: Silver Plated Steel (integral within the bulb) • Bulb: Metal • Output Window: Low loss glass

Manufacturers of Special-Purpose Electron Tubes,
Inverters, Dynamotors, AC-DC Generators, Voltage
Regulators and Fractional H.P. DC Motors.



DIVISION OF



EATONTOWN, N. J.

West Coast Sales and Service: 117 E. Providencia Ave., Burbank, Calif. • Export Sales: Bendix International Division, 205 East 42nd St., New York 17, N. Y.
Canadian Distributor: Aviation Electric Ltd., P.O. Box 6102, Montreal, P. Q.

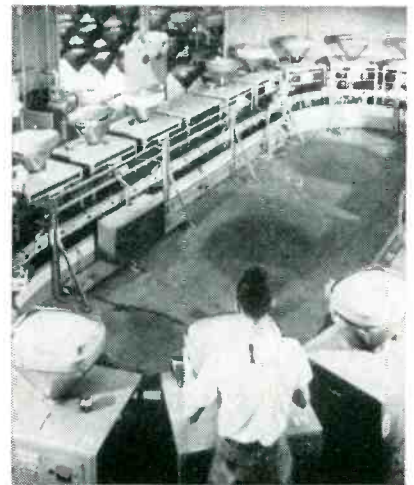

Installation of Stokes 22-unit continuous aluminizing equipment at RCA's plant in Marion, Indiana. Man in foreground handles both loading and unloading

previous production stages delivers the uncoated tubes to the immediate vicinity of the operator. He loads the tubes one at a time, neck down, into the metallizing dollies as they pass in front of him. The rest of the metallizing operation then proceeds automatically as the dollies travel around the loop.

As the finished tubes arrive in front of the operator, he unloads them and places them back in the main overhead conveyor. He then

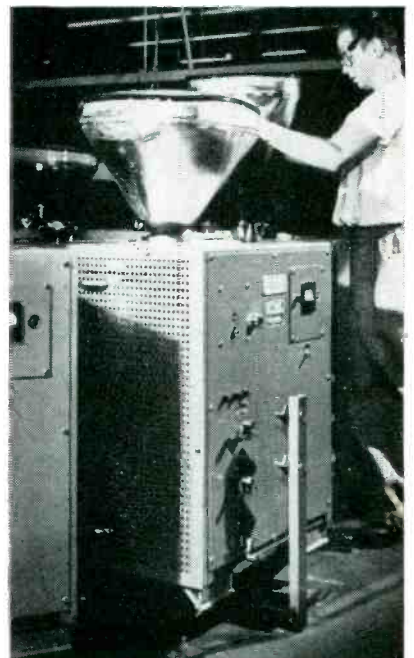

Dolly nearing end of cycle, showing one of the fixed angle-iron ramps used to trip switch levers on the moving dolly. The ramp here cuts out the cooling-water pump, just before another ramp trips the vacuum-break lever to release the finished tube for unloading



can "hush-hush" be overdone?

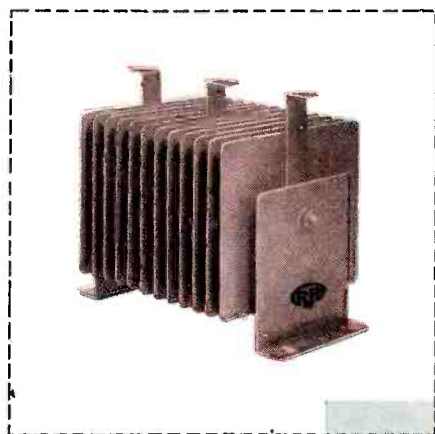

As semiconductor specialists we often receive such sketchy material from companies engaged in classified work that *no* one can help them much.

This might possibly hoodwink an enemy but it certainly delays design and manufacturing progress on guided missiles or whatever the defense project may be.

Naturally, occasional circuits are dead giveaways from which competent engineers could design a complete assembly — just as paleontologists might reconstruct a dinosaur from a single bone. Yet this is remote.

We at Radio Receptor don't suggest anyone violate security. Just see that when you present us with a problem requiring skillful use of semiconductors, you supply *all* the background information necessary for our proper understanding of it . . . even though that might mean getting special clearance. *Then*, we can go to town on your problem!

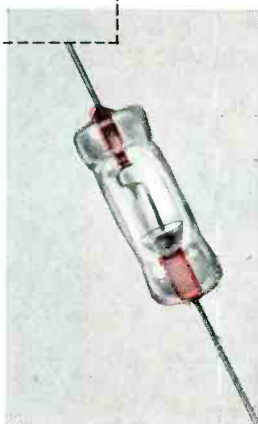

- ▶ **GLASS DIODES**
Gold bonded germanium types.
Silicon alloyed junction types.
- ▶ **HERMETICALLY SEALED PNP JUNCTION TRANSISTORS**
- ▶ **SILICON AND GERMANIUM POWER DIODES**
- ▶ **SELENIUM RECTIFIERS**

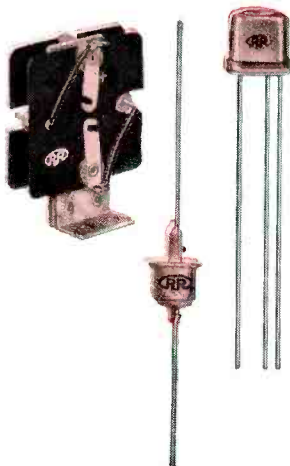

Semiconductor Division

RADIO RECEPTOR COMPANY, INC.

In Radio and Electronics Since 1922

SALES OFFICES: 251 WEST 19TH STREET, NEW YORK 11, N. Y., WATKINS 4-3633, FACTORIES IN BROOKLYN, N. Y.

OTHER PRODUCTS OF RADIO RECEPTOR FOR GOVERNMENT AND INDUSTRY
RADAR, NAVIGATION AND COMMUNICATIONS EQUIPMENT • THERMATRON
INDUSTRIAL ELECTRONIC HEAT SEALING GENERATORS AND PRESSES

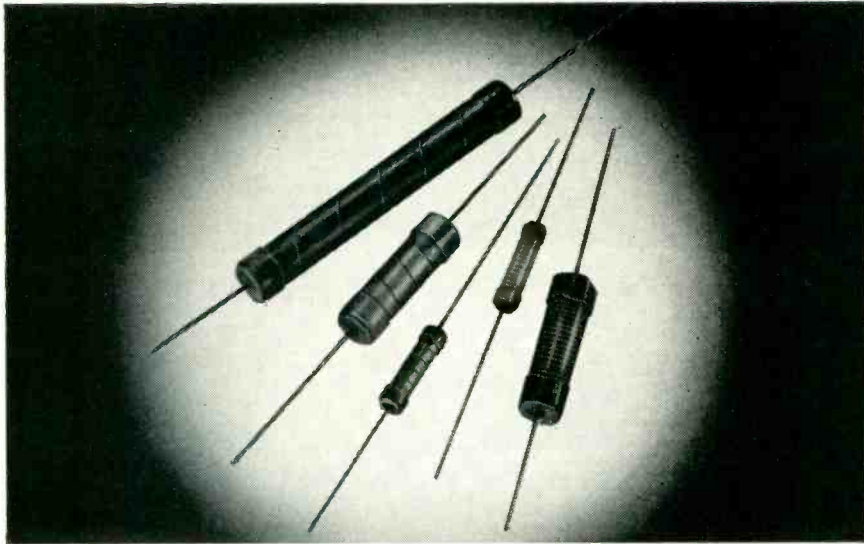

Corning Type N Precision Resistors. Rugged. Stable. And Economical.

For critical accuracy, extreme stability

... Rugged Corning Type N Film-Type Resistors

When you need a precision resistor for really hard work, our Type N accurate grade is a likely job candidate.

We make it to a standard tolerance of 1%, but we can tighten up if you wish. You can operate Type N's at ambient temperatures up to 140°C. with derating. Their noise level is so low, you'll have difficulty measuring it.

They have a negligible voltage coefficient averaging less than .001% per volt. You needn't worry about moisture because both core and film are absolutely impervious.

Stability means that the average change of resistance after 500 hours at maximum dissipation is less than 0.5%. A standard 5-second overload of 6.25 times rated power causes a permanent resistance change of less than .75%. Type N resistors are non-inductive.

These accurate grade resistors overcome the inadequacies of convention-

al resistors in many advanced circuits. We recommend them to you for use in circuits where other resistors aren't up to the task or cost too much.

Specifically, you'll find these resistors most useful for radio and TV equipment, HF circuits, test equipment, and low-signal, hi-gain amplifier stages. Their stability and ruggedness make special handling unnecessary. Made to MIL-R-10509A Specs.

Fine as they are, Corning Type N Resistors cost remarkably little. For complete technical information and price lists, use the coupon.



Corning Type R High-Power Resistors—Range from 25 to 1,000,000 ohms, ratings from 7 to 115 W, are non-inductive. Exceptionally good noise and frequency characteristics. Excellent moisture resistance and overload capacity recommend them for stable long-life service under adverse conditions. Meet MIL-R-11804A Specs.

places a fresh supply of aluminum on the filament and loads the next uncoated tube in the dolly.

As the dollies pass along the track, the vacuum pumping system in each self-contained unit is cut in and evacuates the tube to a pressure of about 0.5 micron. Then, as the dollies pass in front of two

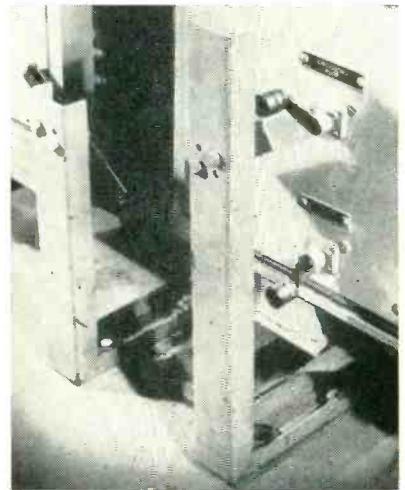

Angle-iron pieces bolted at angles to vertical channel serve to trip crank arms of switches as dollies move past

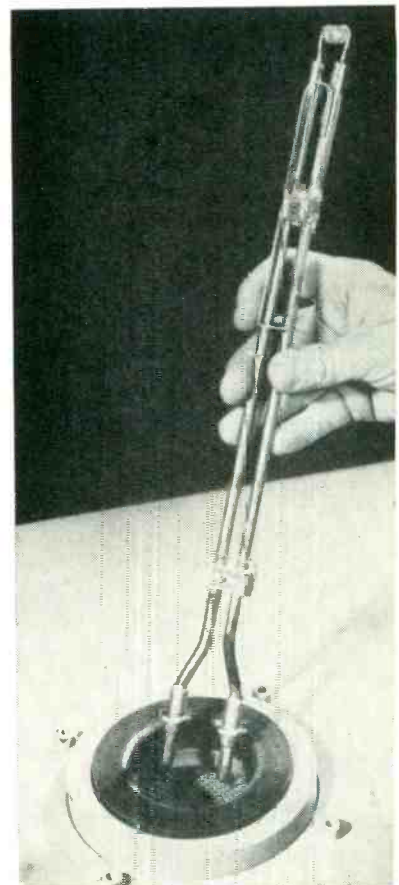

Plug-in filament structure of dolly is easily replaced when it breaks or burns out



Corning means research in Glass

CORNING GLASS WORKS, 36-6 Crystal St., Corning, N. Y.

New Products Division

Please send me descriptive catalog sheet on Corning Type N Film-Type Resistors.

Name..... Title.....

Address.....

Company.....

City..... Zone..... State.....



TMHF—Horizontal front opening



TMUT—Upright top opening

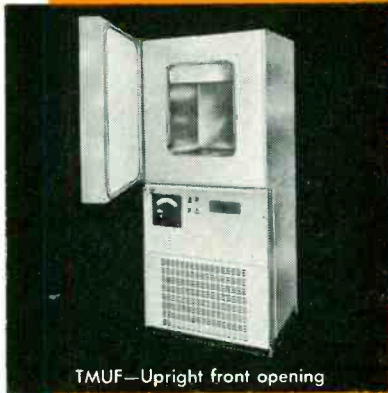

TMUF—Upright front opening



TMHT—Horizontal top opening



TMO—Oven; TMB—Bath

NEW! ... a complete testing and cold treating unit —

In less space than a desk!



Here's what the versatile new Tenney-Mite means to labs, testing departments, and metal working shops:

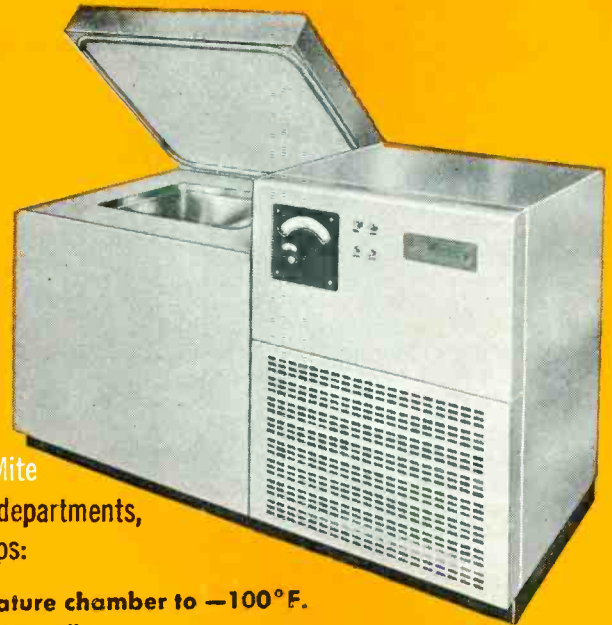

- Low temperature chamber to -100°F. (-120°F. optional)
- Mechanically refrigerated
- $1\frac{1}{2}$ cu. ft. capacity — perfect for labs, small component testing, tool chilling
- Occupies little floor space — only $2\frac{1}{2}' \times 2\frac{1}{2}'$ for vertical unit, $4' \times 2\frac{1}{2}'$ for horizontal
- Low original cost — no installation charges
- Pulls down to -100°F. in approx. 60 minutes
- Dissipates 400 BTU's/hr. at -100°F. in fluid
- Available as a bath, or an oven to elevated temperatures
- Low cost puts the Tenney-Mite within reach of every lab and shop

Plug the new Tenney-Mite into a regular 110 volt line, and any bench top or corner instantly becomes a complete test center, oven, or metal chilling and treating unit.

This versatile new chamber gives your shop or lab top testing facilities ... at an exciting new low price!

Three low temperature ranges available ... -40°F. , -100°F. , and -120°F. Five handy arrangements for maximum flexibility. Simple to operate and maintain. Variable setting indicating controlling instrumentation standard equipment, with recording instruments optional.

GET THE FULL STORY ON HOW THE NEW TENNEY-MITE AND OTHER TENNEY ENVIRONMENTAL EQUIPMENT CAN WORK FOR YOU...



Tenney

ENGINEERING, INC.

1090 SPRINGFIELD ROAD, UNION, N. J.
DEPARTMENT E-6 Plants: Union, N. J. and Baltimore, Md.

Member of Environmental Equipment Institute

Engineers and Manufacturers of Refrigeration and Environmental Equipment

Tenney maintains the largest specialized staff in the industry for engineering consultation on environmental and refrigeration installations. Contact Engineering Department for complete details.

New HIGH INSERTION LOSS NOISE FILTERS

Now Sprague brings you a complete series of miniaturized, bulkhead-mounting interference filters for aircraft and mobile electrical and electronic equipment in ratings from 0.1 ampere to 20 amperes for both 125 volt dc and 125 volt ac, 400-cycle service. These filters meet all pertinent MIL and AN requirements for operation at temperatures from -55°C to $+85^{\circ}\text{C}$. All designs are hermetically sealed with glass- or ceramic-to-metal solder seal terminals.

These filters are available to meet your production schedules from the West and East coast plants of a reliable, old-line manufacturer. For Engineering Data Sheets on the units in which you are interested, write today to the Technical Literature Section, Sprague Electric Company, 11325 West Washington Blvd., Los Angeles 66, California, or 35 Marshall St., North Adams, Massachusetts.

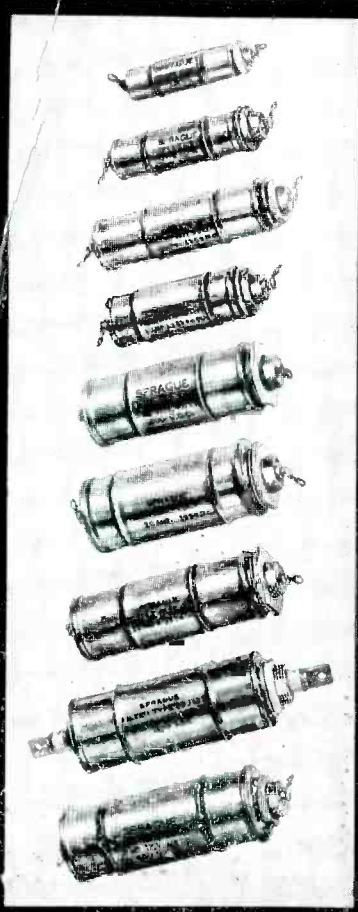

SPECIFICATIONS

RATING		CATALOG NUMBER	WEIGHT (OZS.)	SIZE (DIA. X LENGTH)	CHARACTERISTICS					
CURRENT (AMPS)	VOLTAGE FREQUENCY				INSERTION LOSS (DB) AT GIVEN FREQUENCIES (MC) (50 OHM SYSTEM)					
					.15	.5	1	10	100	400*
0.1	125VDC	11X54	1.5	$\frac{5}{8} \times 1\frac{1}{8}$	63	100	100	112	>84	>80
1	125VDC	11X36	2	$2\frac{3}{32} \times 2\frac{1}{4}$	56	81	>100	86	>90	>73
1	125V/400CY 400VDC	11X42	5	$2\frac{1}{32} \times 2\frac{1}{32}$	50	79	96	97	80	>56
5	125V/400CY 400VDC	51X15	6.5	$1\frac{1}{2} \times 3$	60	90	>112	100	>70	>70
5	125VDC	51X18	3.7	$2\frac{1}{32} \times 3\frac{1}{8}$	59	89	>95	>105	>90	>73
10	125V/400CY 400VDC	101X15	8.5	$1\frac{1}{2} \times 3\frac{1}{32}$	59	88	>100	87	>80	>79
10	125VDC	101X16	7.5	$1\frac{1}{2} \times 3\frac{1}{4}$	74	106	>109	>113	>93	>81
20	125VDC	201X14	9	$1\frac{1}{2} \times 2\frac{1}{8}$	57	88	>103	>99	>90	>83
20	125V/400CY 400VDC	201X15	10	$1\frac{1}{2} \times 3\frac{1}{32}$	56	88	>100	>114	>83	>60

* Beyond the range of measurement

you can depend on

SPRAGUE[®]

WORLD'S LARGEST CAPACITOR MANUFACTURER

copper bus bars supported on up-rights inside the track, leaf spring contacts on the dollies make contact with these bus bars and conduct the 25-ampere vaporizing current into the tube through two electrodes which extend up into the neck to the beginning of the flare. This current heats the stranded tungsten filament and thereby vaporizes the aluminum slug. At the very low pressure now existing in the tube, the molten aluminum evaporates and coats the whole of the inner surface of the tube, including the rear surface of the screen. After aluminizing, vacuum is broken automatically, releasing the tube so that it can be unloaded.

The duration of the flashing current is controlled by the length of the track contacts, not by a timer.

An electronic device developed by RCA checks the thickness and completeness of coverage of the coating. This device is used for periodic quality-control tests.

Applying Selenium to Rectifier Cells

AN AUTOMATIC CONVEYOR setup serves for sprinkling powdered selenium uniformly on 6-inch-square metal base plates in the Selenium Rectifier Division of Radio Receptor Co., Brooklyn, N. Y. The entire operation of preparing the plates



Loading nickel-plated aluminum plates on flexible stainless steel conveyor belt for passage through selenium-sifting box



He's Proteus, Neptune's son, a highly versatile character—hence the adjective *protean*. You never knew whether next you'd see him as a lion, a raging fire, a reptile, or an angry bull.

Here at Driver-Harris, we do protean marvels too . . . with *metals*. For instance, Nichrome*, the unique heat-resistant, corrosion-resistant, electrical-resistance alloy known the world over, has long been the engineer's yardstick of comparison not in one, but *in at least 3 widely different applications*.

TO GENERATE HEAT: In all applications of producing heat by electricity, particularly to temperatures above 1700°F., Nichrome and Nichrome V set the quality standard. From simple electrical appliances such as ranges, broilers, toasters, etc. to giant industrial furnaces, no other alloys enjoy such widespread recognition and use.

TO RESIST HEAT: Because of its unsurpassed resistance to heat and corrosion, Nichrome is used for making massive furnace muffles and

retorts often weighing tons, and work-loading fixtures of all shapes. The outstanding property of Nichrome here is its extremely long life, which results in low heat-hour costs.

TO RESIST ELECTRICITY: The greatest contribution to outstanding stability and miniaturization of resistors is made by Nichrome wire. Drawn to sizes as small as .0005 and finished in a variety of insulations, Nichrome is a boon to electronics in the manufacture of high tolerance resistance units of all types.

Added to the nickel and chrome of Nichrome and Nichrome V is always one exclusive ingredient—the supreme mastery of the Driver-Harris specialists, gained in their 57 years of melting and drawing experience.

In recognition of its unique properties, the United States Patent Office in August, 1908, granted solely and exclusively to us the trademark NICHROME. There is *only one* Nichrome, and it is made only by Driver-Harris.

*T. M. Reg. U. S. Pat. Off.



Driver-Harris Company HARRISON, NEW JERSEY

BRANCHES: Chicago, Detroit, Cleveland, Louisville, Los Angeles, San Francisco
In Canada: The B. GREENING WIRE COMPANY, Ltd., Hamilton, Ontario

MAKERS OF THE MOST COMPLETE LINE OF ELECTRIC HEATING, RESISTANCE, AND ELECTRONIC ALLOYS IN THE WORLD

Do you have source spots?

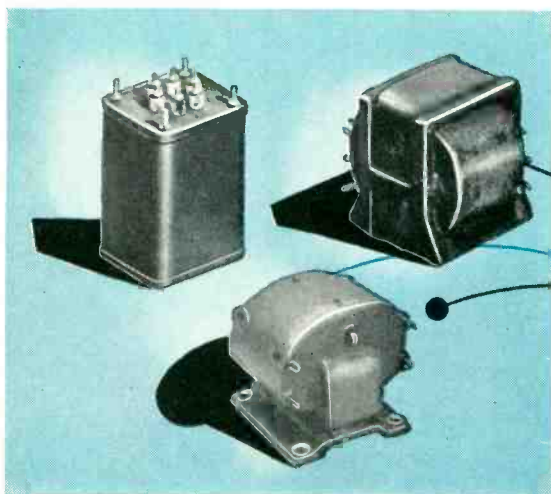

Every design engineer or production man we ever met makes mental notes of good places to get quick aid on needs out of the ordinary.

You might like to know, therefore, that a great deal of the work we do here at Wheeler on transformers, coils, harnesses, custom-built electronic assemblies, and communications components is just that kind of assignment.

We publish no catalog of the everyday standard items . . . they present no problem to anyone. We do serve an increasing group of engineering and production departments that require competent help . . . backed by ample manufacturing facilities . . . in producing components that are "a little (or a lot) different." Call or write us for an interesting story.

TRANSFORMERS • COILS • AMPLIFIERS
CUSTOM ELECTRONIC AND WIRING ASSEMBLIES
COMMUNICATIONS EQUIPMENT • MAGNET WIRE

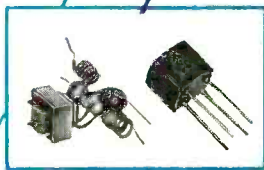

Wheeler is constantly adding to its staff of engineers. If you are available and quality in this field, call us now.

THE WHEELER
INSULATED WIRE COMPANY, INC.

Division of The Sperry Corp.
1101 EAST AURORA STREET
WATERBURY 20, CONNECTICUT



Output of sifting conveyor, showing how plates are arranged in groups of four on cardboard-covered aluminum tray in preparation for fusing the selenium powder

is carried out in an air-conditioned room, with workers wearing gloves and smocks to prevent contamination of the selenium.

The plates are loaded on an endless stainless steel conveyor belt for transport through the sifting box. Here powdered selenium drops through vibrating screens and deposits uniformly on the plates.

At the output of the conveyor, another operator carefully transfers the plates to sheets of cardboard backed by metal trays to permit four-at-a-time handling.

The aluminum pressing trays are then carried one at a time to the hot press and carefully slid in. Each press holds six trays contain-



Inserting tray of rectifier plates in hot press

*Tuning Fork Resonators,
the ultimate in precision audio
frequency control...*

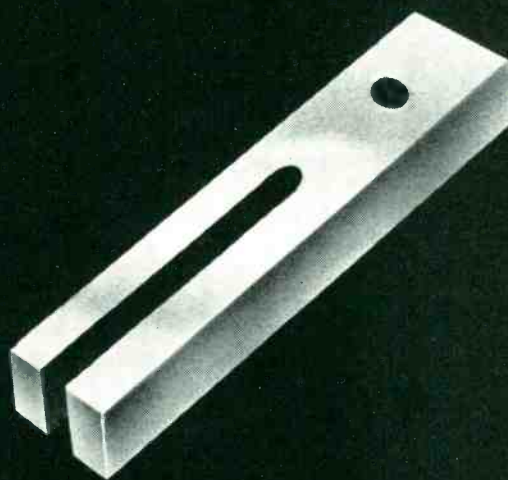

... phone or write

for complete information regarding component type
Tuning Fork Resonators, or variously pack-
aged **Tuning Fork Frequency Standards**.



Philamon Laboratories Inc.

90 HOPPER STREET, WESTBURY, LONG ISLAND, N. Y.

EDgewood 3-1700

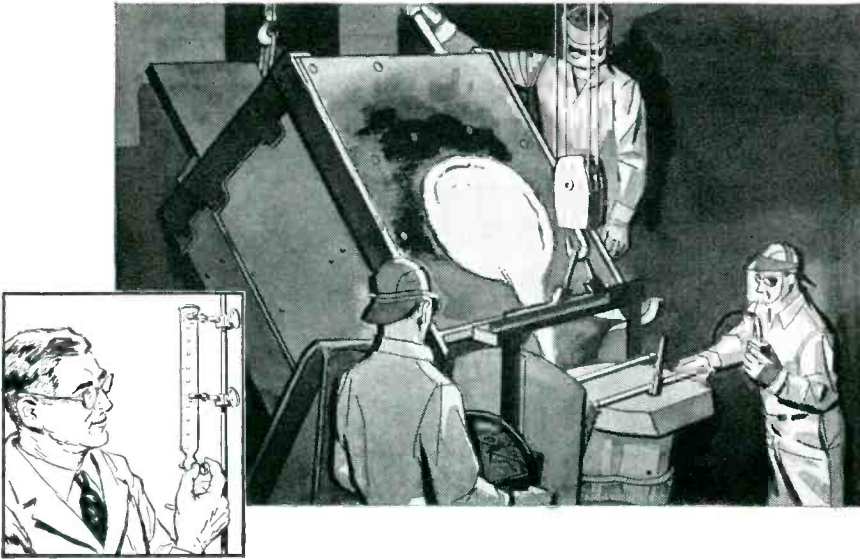

ing a total of 24 rectifier plates. After loading, the press is closed to apply a pressure of 1,500 lb per square inch at 125 C for fusing the selenium to give a mirror-bright surface. To achieve this result, the press platens that come in contact with the selenium are made from air-hardened tool steel, lapped to a mirror finish, then chromium-plated, lapped again and polished. The press is made by Chas. E. Francis Co., Huntington, Indiana.

Value-Averaging Device



Operator moves right-hand slider up to each of five values in turn and down again, then reads average immediately on left-hand indicator

PLOTTING of life test charts in the quality control department of Tung-Sol's Bloomfield, N. J. plant is expedited with the aid of a simple sliding indicator device that gives the average of five values automatically. Basically it consists of two dial-cord belts, each running over two pulleys, with a 1:5 gear train coupling the two belt systems in such a way that the left-hand belt moves exactly one-fifth as fast as the right-hand belt.

The belt system is mounted in a small wood box. Fixed wood sliders, each permanently fastened to its own belt, project up through longitudinal slots in the cover of the box. A cardboard scale between the indicators on the cover encompasses the range of values to be averaged.

In use, both indicators are reset to the lowest point, closest to the operator. The right-hand indicator is then moved up to the first value and moved back to the lowest point. This operation is repeated for the

It pays to insist on

MASTERMET CERTIFIED ALLOYS

STAINLESS • HIGH TEMPERATURE • SPECIAL ANALYSIS

Make Cannon-Muskegon your source of custom and standard high alloy metals — and be sure of exactly predictable metallurgical control

NO matter what alloys you use, it pays to have the exact physical, chemical and electrical characteristics you want. That's why the leading firms in your industry insist on MasterMet certified alloys. With each heat, you receive a notarized analysis as a guide for remelt or processing. And, close laboratory control assures constant uniformity to one or more heats of the same alloy.

Look into the great versatility of Cannon-Muskegon's complete MasterMet alloy service — and the opportunity it affords for improving present quality, for experimental or new production. MasterMet alloys are available in shot, ingots and cast billets, bars and special shapes.

Typical Regular-Production Alloys Certified for Scores of Applications

STAINLESS STEELS	SUPER ALLOYS	ALLOY STEELS	SPECIAL ALLOYS
300 SERIES	High Temperature	SAE 4130	*NI RESIST CU-NI
400 SERIES	AMS 5382B	SAE 52100	*MONEL NI-CR
ACI TYPES	AMS 5385B	SAE 6150	*INCONEL NI-FE
17-4-PH†	AMS 5388	SAE 8630	INVAR CR-FE
	PWA 651A	SAE 3140	

†ARMCO Steel Corp.

TOOL and DIE STEELS
*International Nickel Co.

Cannon-Muskegon CORPORATION

2885 LINCOLN STREET • MUSKEGON, MICHIGAN



Cannon-Muskegon is your only source of MasterMet certified alloys — that's why it pays to have the complete story. Write for NEW catalog today.



CAPACITY	DIELECTRIC	SIZE	AVAILABLE CAPACITY TOLERANCES	
2-KV				
5-15	N-750	1/4"	5-10-20%	GMV
16-47	N-750	3/16"	5-10-20%	GMV
48-72	N-750	1/2"	5-10-20%	GMV
73-200	N-750	3/8"	5-10-20%	GMV
201-250	N-750	3/4"	5-10-20%	GMV
251-330	N-750	7/8"	5-10-20%	GMV
3-KV				
5-15	N-750	3/16"	5-10-20%	GMV
16-28	N-750	1/2"	5-10-20%	GMV
29-56	N-750	5/8"	5-10-20%	GMV
57-68	N-750	3/4"	5-10-20%	GMV
69-180	N-750	7/8"	5-10-20%	GMV
181-240	N-750	7/8"	5-10-20%	GMV
4-KV				
5-56	N-1500	5/8"	5-10-20%	GMV
57-180	N-1500	7/8"	5-10-20%	GMV
5-KV				
5-30	N-1500	5/8"	5-10-20%	GMV
31-60	N-1500	3/4"	5-10-20%	GMV
61-130	N-1500	7/8"	5-10-20%	GMV
6-KV				
5-20	N-1500	3/4"	-10-20%	GMV
21-100	N-1500	7/8"	-10-20%	GMV

POWER FACTOR: .1% Max. @ 1M C (initial)
INSULATION: Durez phenolic—vacuum waxed

for exacting design...

RMC HIGH VOLTAGE DISCAPS

As a supplier of many types of ceramic capacitors to practically every major television manufacturer RMC can offer you high voltage DISCAPS that will consistently meet and exceed the most exacting design specifications.

Rated at 2000, 3000, 4000, 5000, and 6000 V.D.C., RMC high voltage DISCAPS provide the safety factor necessary in yoke and other critical voltage applications. They are the proved answer to problems encountered in the design of standard or special purpose electronic equipment.

Write today on your company letterhead about your specific requirements.

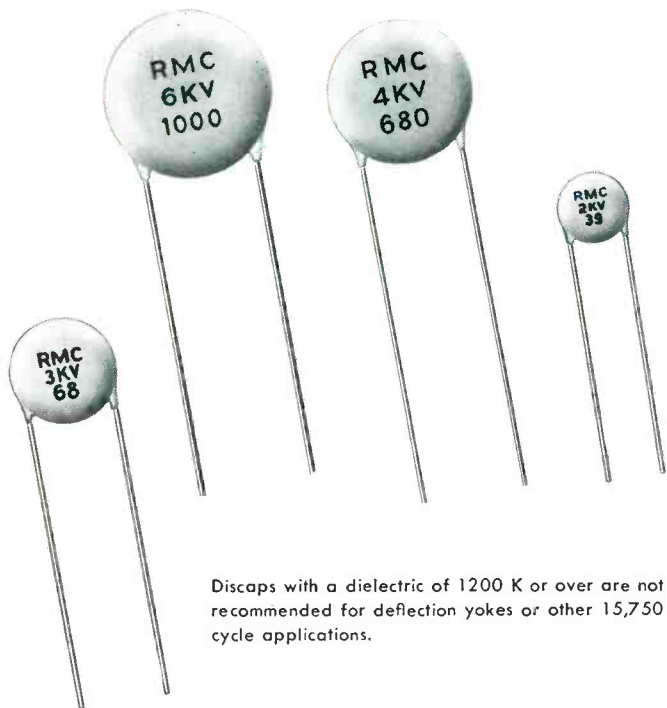

Discaps with a dielectric of 1200 K or over are not recommended for deflection yokes or other 15,750 cycle applications.

CAPACITY	DIELECTRIC	SIZE	AVAILABLE CAPACITY TOLERANCES	
2-KV				
331-470	1200-K	3/16"	± 20%	GMV
471-1000	1200-K	5/8"	± 20%	GMV
1001-2700	HI K	3/16"		GMV
2701-5000	HI K	3/4"		GMV
5001-10000	HI K	3/4"		GMV
3-KV				
241-500	1200-K	5/8"	± 20%	GMV
501-1000	1200-K	5/8"	± 20%	GMV
1001-5000	HI K	3/4"		GMV
4-KV				
181-680	1200-K	3/4"	± 20%	GMV
681-1000	HI K	5/8"		GMV
5-KV				
131-330	1200-K	7/8"	± 20%	GMV
331-1000	HI K	7/8"		GMV
6-KV				
101-220	1200-K	3/4"	± 20%	GMV
221-470	1200-K	7/8"	± 20%	GMV
221-1000	HI K	7/8"		GMV
471-1000	HI K	7/8"		GMV

POWER FACTOR: 1.5% Max. @ 1 KC (initial)
INSULATION: Durez phenolic—vacuum waxed

DISCAP
CERAMIC
CAPACITORS



RADIO MATERIALS CORPORATION

GENERAL OFFICE: 3325 N. California Ave., Chicago 18, Ill.

FACTORIES AT CHICAGO, ILL. AND ATTICA, IND.

Two RMC Plants Devoted Exclusively to Ceramic Capacitors

WHICH IMPROVEMENT DOES YOUR PRODUCT NEED?



**ELECTRONIC
ELECTRICAL
MECHANICAL**

I.E. offers all three on a reasonable contract basis

INLAND ELECTRONICS brings a basic *plus* to any phase of your design or development program: I-E engineers solve the toughest problems first . . . by keeping *production* and *cost* firmly in mind as they create your improved design!

This bed-rock approach is solidly based on years of successful specialization—in design, engineering and manufacture—on high volume production at low unit cost.

For the electronic, mechanical or electrical solution to your immediate problem, consult your best source for creative and cost-conscious service . . . I-E, that is!

INLAND ELECTRONICS OFFERS YOU THESE PRODUCT SERVICES

DESIGN—I-E is ready to assume complete creative responsibility

PRODUCTION—from a simple part to thousands of complex mechanisms

TESTING—through production, assembly and final inspection

WRITE for **FREE**
booklet on



I-E Electronic, Mechanical,
Electrical Product Develop-
ment Facilities

*Product Design,
Engineering
and Contract Manufacturing*

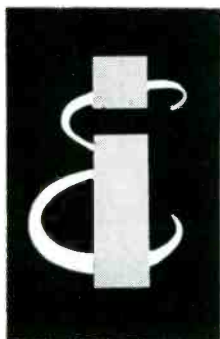

INLAND ELECTRONICS CORPORATION
500 RATHBONE AVE., AURORA, ILLINOIS

Telephone: AUrora 6-7745

PRODUCTION TECHNIQUES (continued)

other four values. Each time the right-hand indicator is moved up, the left-hand indicator moves up precisely one-fifth of the distance. The left-hand indicator thus reads the average of the five numbers immediately at the end of the fifth operation. The entire procedure takes only about five seconds.

The right-hand belt does nothing on the up stroke, but engages the pulley on the down stroke. This is accomplished by using an idler ball bearing which jams the upper pulley so that it stands still and the belt slips on the up stroke. A spring is used in each dial-cord belt. The left-hand belt is considerably looser than the other so that it will slip when pushed back for resetting the device.

The entire device can be built for only a small fraction of the cost of

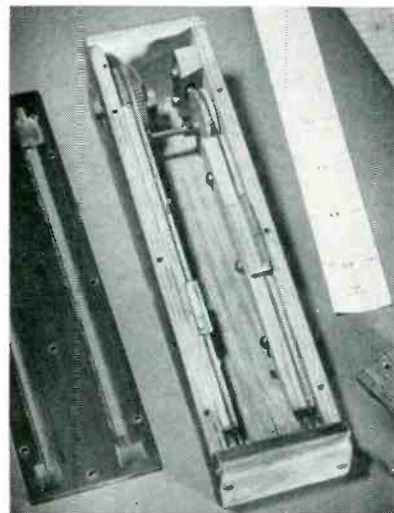

Construction of averaging device. Cover is at left, and interchangeable scales are at right. Mahogany plywood is used for box to minimize warping

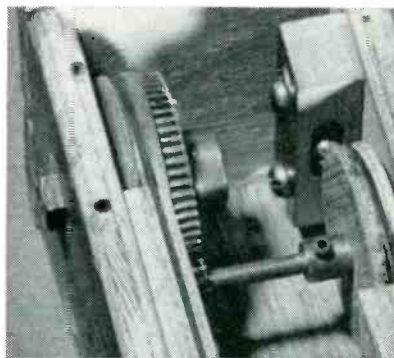

Construction of clutch. Ball bearing moves freely up and down in slot of wood at upper right inside box. When right-hand slider is moved up, ball drops and jams pulley so that cord slips. When slider is moved down, ball rises and pulley turns with belt



Improve quality, cut costs of high-volume TV output with G.E.'s new 600-Series Tubes 6BH8 and 6CN7!

General Electric, originator of 600-Series Tubes for series-string circuits, announces the new 6BH8 and 6CN7, which bring to 50 its line of uniform-warm-up types. Use these new G-E miniatures for higher TV quality—you will have fewer production-line rejects, more reliable performance in set-owners' homes!

Use them for lower TV costs! Each of the new tubes will replace two single-purpose types—is in itself a low-price tube. Use them to reduce plant tube inventory . . . the 6BH8 and 6CN7 can be applied in either series-string or transformer sets!

Use the new G-E tubes for design versatility! The triode sections of both types can do a number of different circuit jobs.

Wire or write for description, ratings, and prices! *Tube Department, General Electric Company, Schenectady 5, New York.*

NEW G-E 6BH8 . . . Medium-mu triode-pentode, for use as general-purpose triode, and video amplifier or i-f amplifier. Has 600-ma heavy-duty heater with series-string warm-up time.

NEW G-E 6CN7 . . . Duplex-diode high-mu triode, with a separate cathode for the two diodes. Triode section is useful in many circuit applications. The tube has a 600-ma heavy-duty heater with series-string warm-up time.

NOW 50 G-E 600-SERIES receiving tubes with uniform series-string warm-up time. And *all* G-E picture tubes have heaters with series-string warm-up! For top performance, specify G-E tubes throughout your circuit!

Progress Is Our Most Important Product

GENERAL  **ELECTRIC**

162-1A3

an adding machine, takes far less room on a desk and requires no training in its use. A new scale can easily be slipped in between the indicators at any time to accommodate a different range of values.

Drill-Press Extrusion of Grids for Tubes

INTRICATE THIN-WALL electrode structures for vacuum tubes are being produced rapidly and at low cost on a drill press by an unusual metalworking process known as Uniskan extrusion, at the RCA tube plant in Lancaster, Pa.

One recent tube design called for a tubular electrode support having a seamless foil-like wall of Kovar alloy only 0.001 inch thick, for use as a heat-isolating support for an indirectly heated cathode in an electron tube. The thicker end portions of the part strengthen the foil-like cylinder and permit it to be joined to the cathode by r-f induction welding.

Fabrication consists of several simple steps. A short tubular work blank is slipped over a mandrel in the chuck of the drill press. Mandrel and work blank are rotated between rollers mounted on the bed of the press, and the rollers are fed into the work blank to within 0.001 in. of the mandrel. Spacing of the rollers from the mandrel determines the thickness of the thin wall. A small downward axial force is next applied to the rotating work

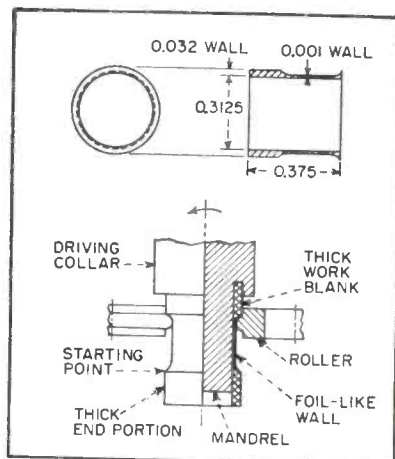

Foil-like wall of this heat-isolating support is formed in a single pass on drill press. Rollers are run in at bottom of work blank, and mandrel is then moved down

H *First in Controls*

First in Opportunity for ENGINEERS

With E.E. or M.E. Degree & Work Background in DESIGN · DEVELOPMENT · RESEARCH on Industrial Recording & Control Instruments!

Today, more than ever before, industry needs men who know how to interpret the future . . . project plausible solutions . . . and, when the time comes, handle them with confidence and dispatch. We are no exception. With 50,000 plants in the world spending a half-billion dollars annually for industrial instruments, we, as the leader in this field for more than 60 years, must ALWAYS have the right answer ready for every situation.

To keep pace with today's need and ahead of tomorrow's foreseeable demands in the field of automation, the BROWN INSTRUMENT DIVISION has more than doubled the size of its Engineering Department since 1942. Further enlargement of this department is essential . . . the science of instrumentation is in its infancy. Truly, the opportunities are unlimited . . . and while our policy is to promote from within, our selections for advancement are made on a merit basis.

In the BROWN INSTRUMENT DIVISION, in Philadelphia, more than 400 engineers are engaged in design, development and research on industrial measuring and control instruments. These men know their business, but they can't carry today's growing work-load.

**They need help—YOUR HELP!
Can You Help Them . . .
Can You Help Us?**

Our requirements: skilled men with backgrounds in Physics, Mechanical, Industrial and Chemical Engineering . . . with a particular stress on ELECTRICAL ENGINEERS with E.E. Degree and preferably two to four years experience in design, development and research projects related to our field.

The Rewards: Recognition, advancement and pay, based on your ability and potential executive capacity. Better than average company benefits —

But, Why Not Get All the Facts First-Hand

. . . write us a letter about yourself, asking specific questions, or just send the coupon below for a copy of: YOUR OPPORTUNITY TO HELP MAKE POSSIBLE THE AUTOMATIC FACTORY OF TOMORROW.



MINNEAPOLIS
Honeywell

BROWN INSTRUMENTS
Wayne & Windrim Aves., Phila. 44, Pa.

Mail this Coupon NOW...

Mr. Don Whiteley, Employment Manager
MINNEAPOLIS HONEYWELL, Brown Instruments Division
Wayne & Windrim Aves., Philadelphia 44, Pa.

By return mail, please send me free copy of YOUR OPPORTUNITY TO HELP MAKE POSSIBLE THE AUTOMATIC FACTORY OF TOMORROW.

NAME _____

ADDRESS _____

CITY _____

ENGINEERING DEGREE _____

**Over 60
Different
Types of
Industries
Use More
Than 8000
Minneapolis
Honeywell
Products**



POWER PACKED CONTROL

for bulls-eye accuracy

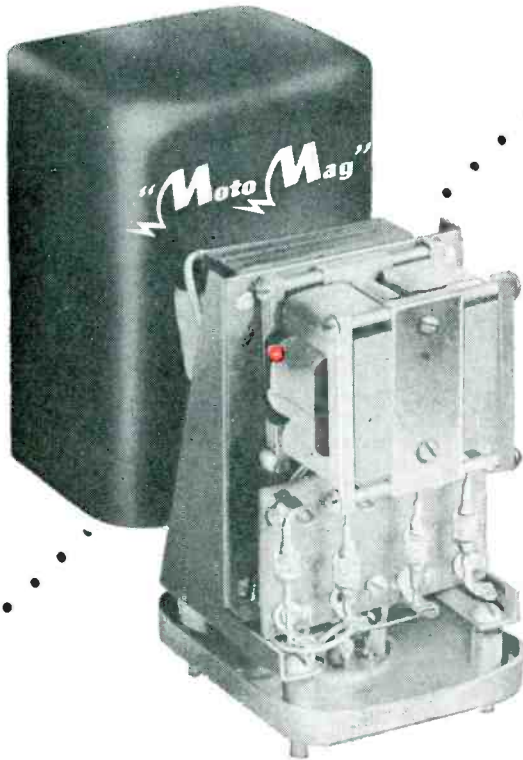

Military and industrial control systems—from guided missiles to computers—demand absolute control accuracy in the smallest, lightest, most rugged units that can be made.

To meet these requirements, Keystone developed the MOTO MAGS*—small, light weight, hermetically sealed magnetic amplifiers, custom engineered for high amplification, excellent linearity, absolute dependability even under extreme operating conditions.

MOTO MAGS are available as two-stage magnetic amplifiers...as saturable transformers...and with vacuum tube phase detector completely self-contained. Outputs from 2.5 to 18 watts.

Seven basic types available immediately; custom-made units supplied promptly.



*Trademark

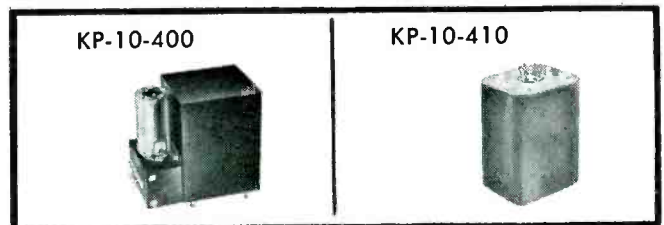

Write for new illustrated MAGNETIC AMPLIFIER catalog

Gives complete specifications and performance data for MOTO MAGS covering a wide range of special requirements. Send for your copy today.

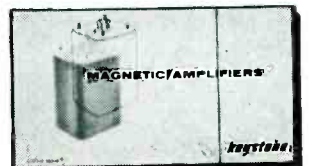

keystone 
PRODUCTS COMPANY

904 23RD STREET UNION CITY 2, N. J.

...an outstanding source
for all types printed circuit connectors

INTRODUCING NEW MINIATURE EC COAXIAL CONNECTOR

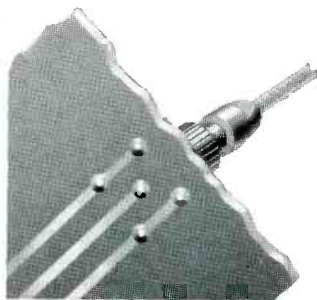

HHB Miniature EC Coaxial Connector in mounted position on card.

MORE THAN 75 PRINTED CIRCUIT CONNECTOR DESIGNS AVAILABLE

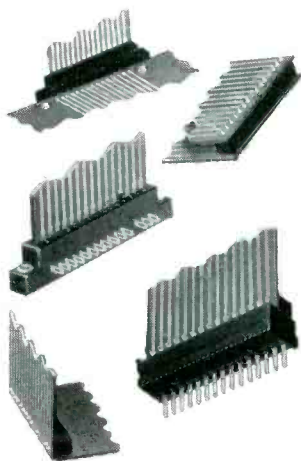

Every prospect and user of printed circuitry can rely upon the vast background of research and design-engineering experience of H. H. Buggie, Inc., regarding connectors for this specialized field. Since the introduction of printed and etched circuit methods, HHB personnel have worked closely with company engineers to develop connectors for special applications.

Today these designs include latest engineering advancements, such as the new HHB miniature connector for coaxial cable, featured above.

If you are a user of printed circuits, or contemplate the use of printed circuit designs in the future, H. H. Buggie, Inc., invites your inquiry regarding connector needs.

Write—for HHB EC Series Printed Circuit Connector bulletin.

Skilled in

- RESEARCH • DESIGN
- ENGINEERING • MANUFACTURING

of Electronic Components and Connectors
for Communications and Industry



H. H. BUGGIE, Inc.

726 STANTON STREET

TOLEDO 4, OHIO

Sales-Engineers in All Principal Cities

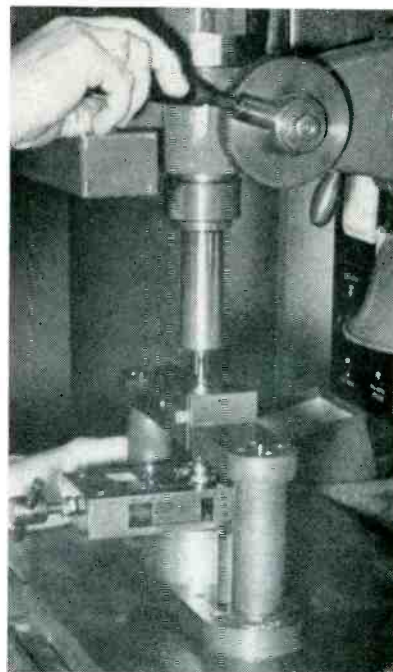

Tubular blank on mandrel is rotated between rollers. Pressure on drill press feed lever extrudes the part in a single pass

blank with the press feed lever, forcing the metal through the rollers to form a foil-like tube closely fitting the mandrel. When the thin wall is the desired length, axial force is removed, rollers backed off, rotation stopped and the finished part is slipped off the mandrel.

The mandrel rotates in a separate bearing on the press and has a toothed collar to drive the end of the work blank. The frame carrying the rollers is self-centering and has an adjustable screw for determining the wall thickness of the thin-walled tubing. Three rollers are used, two fixed and one adjustable; all are mounted on precision needle bearings.

All forces required to accomplish forming are applied through the relatively thick upper end of the work blank. After the material has been thinned, it need transmit no forces whatsoever. This is in sharp

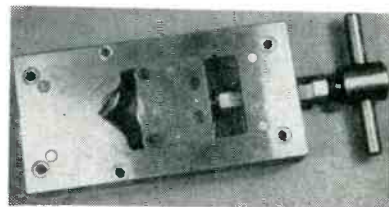

Self-centering frame carries two fixed rollers and a third which may be adjusted during operation by a feed screw

El-Menco

provides

*Positive Proof
of Performance*
of the powerful new...



Dur-Mica DM 15

world's smallest mica capacitor

First Miniature Dipped Mica Capacitors with Parallel Leads.

El Menco's Dur-Mica DM15 provides assurance of peak performance in a variety of transistor circuits and other miniature electronic equipment in military and civilian applications. A new, tougher phenolic casing provides assurance of long-life and stability through wide ranges in temperature. Parallel Leads provide greater versatility—allow efficient, safe use of the El Menco Dur-Mica DM15 in applications heretofore impractical. Saves Money—El Menco's Dur-Mica DM15 costs even less than the famous El Menco CM15. Provides economy of size.

CAPACITIES AVAILABLE:

- DM15—Up to 510 mmf at 300vDCw
- Up to 400 mmf at 500vDCw
- DM20—Up to 5100 mmf at 300vDCw
- Up to 3900 mmf at 500vDCw

Available in 125°C operating temperature. Minimum capacity tolerance available—± 1/2% or 0.5 mmf (whichever is greater).

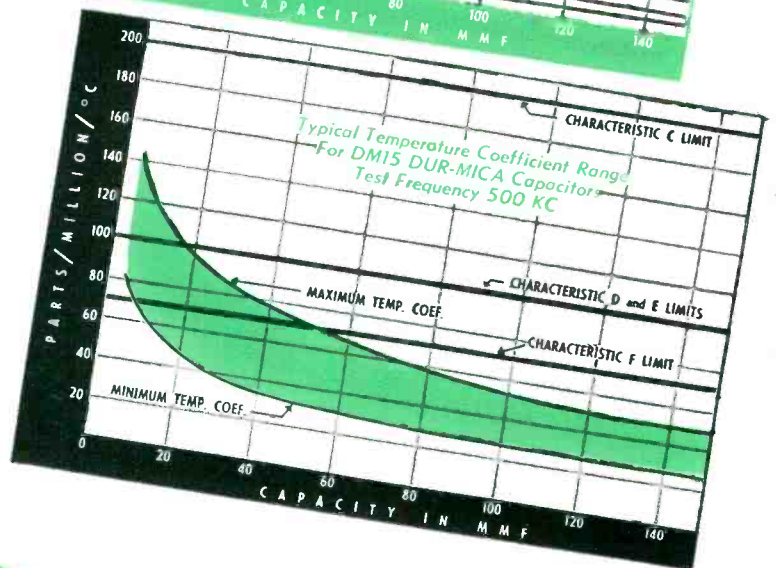

Test El Menco "Dur-Micas" For Yourself!

For your special requirements—we are pleased to offer information and assistance. Write for free samples and catalog on your firm's letterhead.

El-Menco

Capacitors

THE ELECTRO MOTIVE MFG. CO., INC.

WILLIMANTIC CONNECTICUT

- molded mica • mica trimmer
- tubular paper • ceramic

Jobbers and distributors write to Arco Electronics, Inc., 103 Lafayette St., New York, N. Y.

How REMINGTON RAND uses

3-D

Micro-Vision to maintain peak shaver production

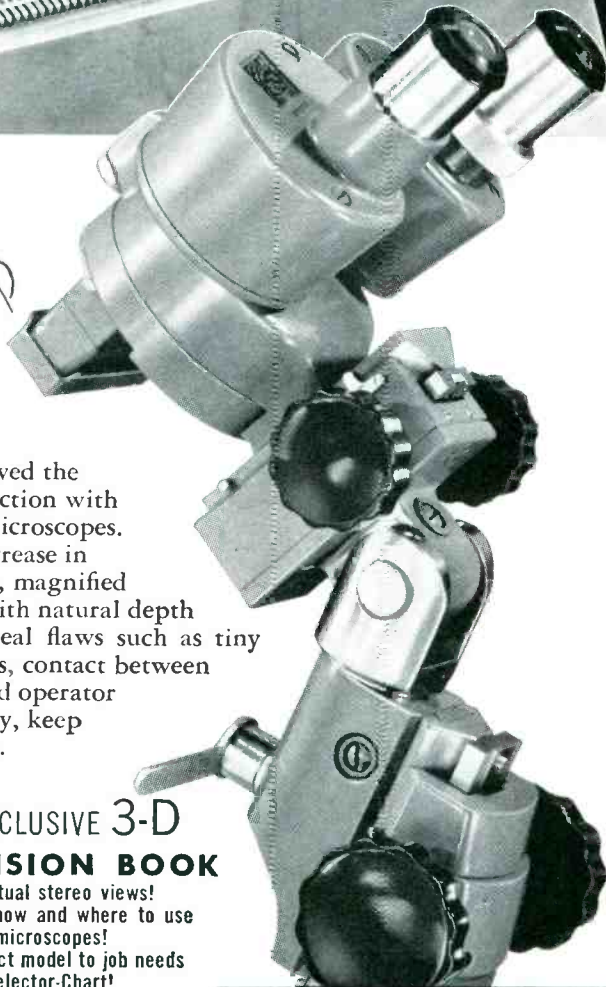
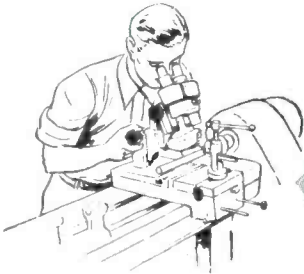
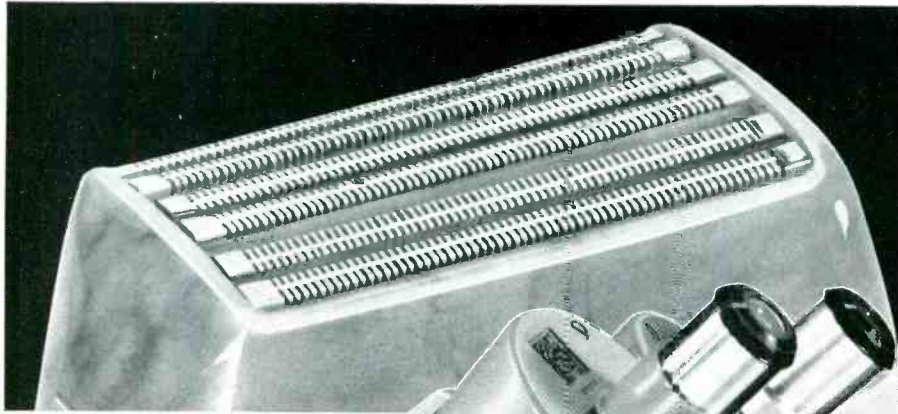

Remington Rand has solved the problem of critical inspection with Bausch & Lomb Stereomicroscopes. And it's done with an increase in production. Clear, sharp, magnified views of shaver head—with natural depth perception—quickly reveal flaws such as tiny cracks, bent blades, burrs, contact between cutter and head. Increased operator comfort, higher efficiency, keep peak production rolling.

Write for NEW! EXCLUSIVE 3-D MICRO-VISION BOOK



- See actual stereo views!
- Know how and where to use Stereomicroscopes!
- Fit exact model to job needs with Selector-Chart!

WRITE FOR FREE COPY. Ask for Manual D-15. Bausch & Lomb Optical Co., 61442 St. Paul Street, Rochester 2, N. Y.

BAUSCH & LOMB

SINCE 1853

STEREOMICROSCOPES

America's only complete optical source... from glass to finished product.

PRODUCTION TECHNIQUES

(continued)

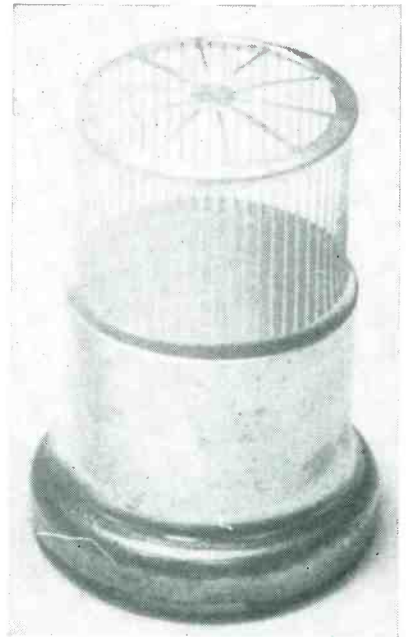

Complete one-piece copper grid having sixty 0.005-inch wires formed integrally with thicker end supports. Accurate jiggling cylinder is also formed

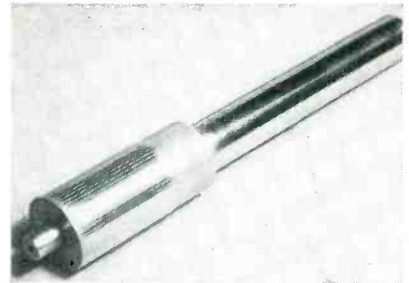

Grooves ground in polished mandrel determine number, size and shape of strands in grid made by Uniskan extrusion

contrast to metal-spinning, in which practically all driving forces are transmitted through material which has already been thinned. It is relatively easy to obtain tubular members several inches long having wall thicknesses of less than 0.001 in.

Extrusion of Grids

Grid structures are made by forming a cylindrical array of straight, fine strands integrally with relatively heavy tubular end support members. Elimination of welds or other joints materially aids conduction of heat away from the grid strands.

First the mandrel must be provided with longitudinal grooves which determine the number, size and shape of the grid strands. During the pass through the rollers, material is forced into these

AMERICA'S NO.

1

LINES

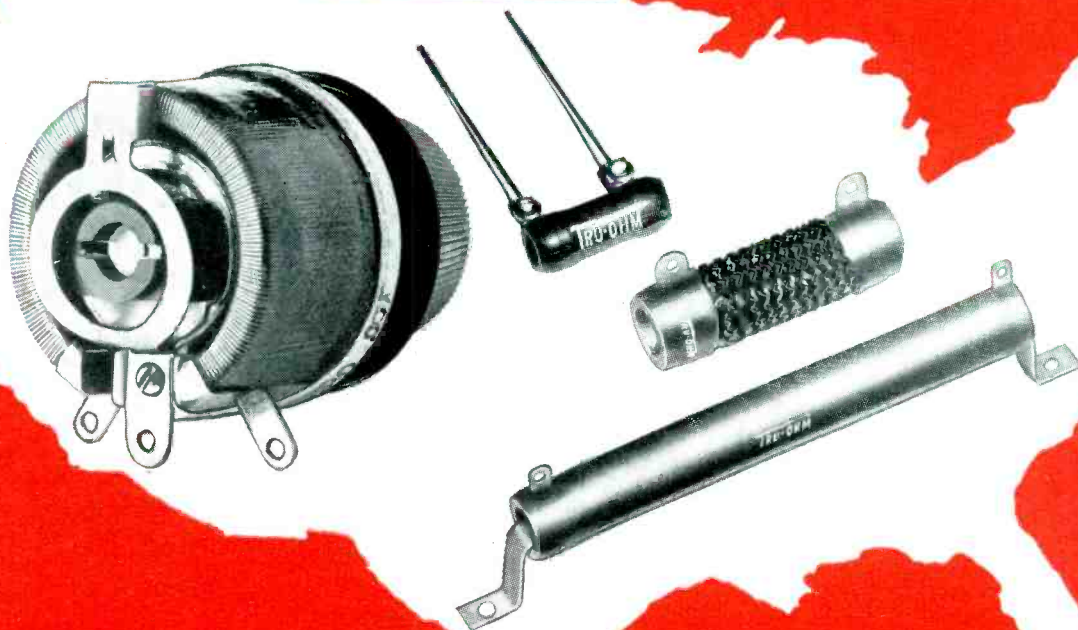

POWER RHEOSTATS

The finest power rheostats...
 UL approved rheostats . . .
 25 watt . . . 50 watt . . . 75 watt
 . . . 100 watt . . . 150 watt.
 We maintain a large stock for
 ready shipment or can design
 a rheostat with many special
 features for your particular
 need. Our rheostats are in-
 terchangeable. Prompt engi-
 neering service is available.



VITREOUS ENAMELED RESISTORS

Because we are the world's
 largest producers of wire-
 wound resistors, we have
 the production facilities to
GUARANTEE best delivery
 and finest quality . . . from
 stock or to your specifica-
 tions.



Division of Model Engineering & Mfg., Inc.

MANUFACTURERS: Power Rheostats, Fixed Resistors, Adjustable Resistors, "Econohm" Resistors, "Tru-rib" Resistors

We invite your inquiry on RHEOSTATS and RESISTORS . . . Have you seen our latest catalog?

General Sales Office: 2800 N. Milwaukee Ave., Chicago 18, Ill.

Factory: Huntington, Indiana

"Largest producers of wire-wound resistors in the U. S. A."

American Electric Model EPM-1123

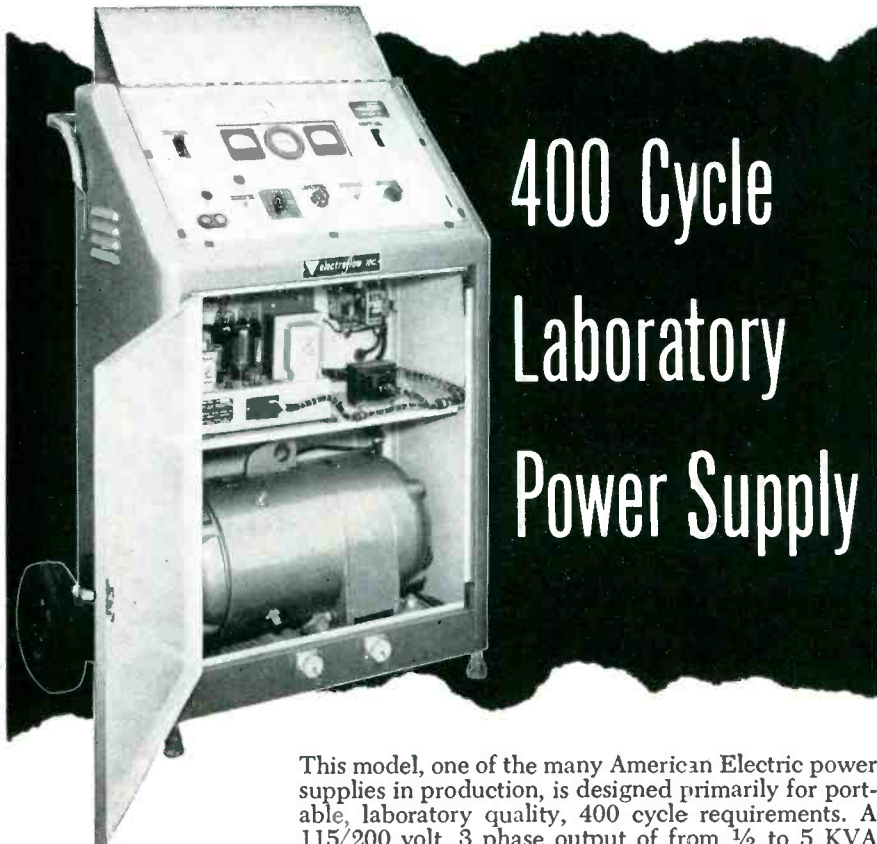

400 Cycle Laboratory Power Supply

An Electroflow product.

ALL CIRCUITS PROTECTED

Input circuit is equipped with a 60 cycle circuit breaker and motor starter. Output circuit is protected against both current and voltage surges with a circuit breaker and over-voltage relay.

METERING

400 cycle instrumentation includes a voltmeter, ammeter, frequency meter and a selector switch by which each phase may be checked individually.

COMPLETE INTEGRATION

This rubber tired unit contains the complete system—American Electric Inductor-type Alternator (no wearing parts), electronic exciter and voltage regulator, complete instrumentation and two output connectors for multiple loads.

MANY OTHER SIZES

American Electric Power Supplies are available in many high cycle variations... from 1/2 to 75 KVA, fixed or variable frequency, portable or stationary designs.

WHATEVER YOUR HIGH CYCLE POWER REQUIREMENTS

There's an American Electric model for your immediate needs. *Ask for details!*

Atlanta, Boston, Buffalo, Chicago, Dayton, Dallas, Kansas City (Mo.), Los Angeles, Minneapolis, Memphis, New Orleans, New York City, Rochester, San Francisco, Seattle, St. Louis, Syracuse, Silver Spring (Md.), Tampa, Montreal, Toronto.

American Electric Motors, Inc.

Electric Machinery & Equipment Division of



2112 Chico Avenue, El Monte, Calif.



Partially completed grid is foil-like cylinder having thicker longitudinal ribs along inner surface. Ribs become grid strands when web is etched out

grooves. The part as taken from the mandrel consists of a cylindrical array of ribs connected by a foil-like webbing. Removal of the webbing yields the desired grid.

The web is removed by dipping the part in an etching bath for a few seconds. The interconnecting web disappears, leaving an accurately formed grid structure free from stresses which might later cause deformation.

In spite of the delicate nature of this grid structure, the part may be readily handled by means of the

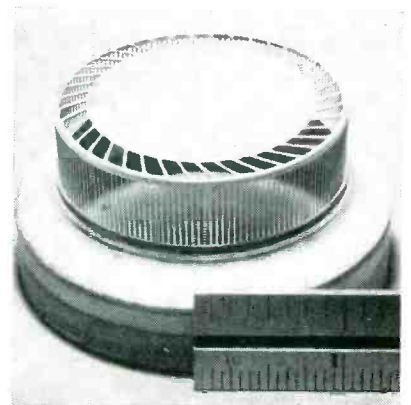

Large-diameter one-piece screen grid for high-frequency power tetrode, also made by extrusion, has 120 strands each 0.010 inch wide. Strands are exactly straight and accurately indexed on entire production run, as required to provide exact registry with other parts of tube structure

CHATHAM advance-designed yesterday

- in
industry-wide
use today!

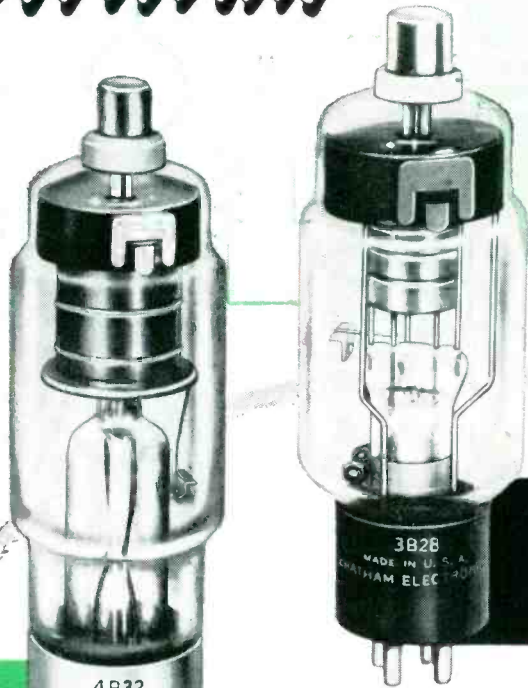

**AMPLIFIERS • REGULATORS • INERT GAS
AND MERCURY RECTIFIERS • MERCURY,
INERT GAS AND HYDROGEN THYRATONS**

**CHATHAM
SPECIAL-PURPOSE
TUBES**

3828 RECTIFIER

Rugged half-wave Xenon filled rectifier. Operates in any position. Ambient temperature range -75° to $+90^{\circ}\text{C}$. Inverse peak anode voltage 10,000, average current .25 amps. Filament 2.5v., 5 amp.

4832 RECTIFIER

Ruggedly built, half-wave Xenon filled rectifier. Ambient temperature range -75° to $+90^{\circ}\text{C}$. Inverse peak anode voltage 10,000, average anode current 1.25 amp. Filament 5v., 7.5 amp.

**VC-1258 MINIATURE
HYDROGEN THYRATRON**

for pulse generation. Handles 10 kw peak pulse power.

6336 TWIN TRIODE

for voltage regulation. Features high plate dissipation, hard glass envelope.

6394 TWIN TRIODE

Similar to 6336 except 26.5 volt heater instead of 6.3 volt heater.

5594 XENON THYRATRON

Operates over wide ambient temperature range -55°C to $+90^{\circ}\text{C}$.



6336



5594



VC-1258



6394

STANDARD TYPES DIRECT FROM STOCK
PLUS SPECIAL DESIGNS BUILT TO REQUIREMENTS

Chatham specializes in the development of general and special purpose tubes for both electronic and industrial applications. Many of the tubes originally developed by Chatham to fill a specialized need, now number among the most widely used tubes in the industry. For complete information on Chatham tubes — either stock items or types built to your requirements — call or write today.

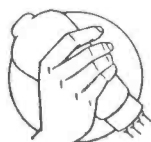

Chatham Electronics
DIVISION OF GERA CORPORATION—LIVINGSTON, NEW JERSEY

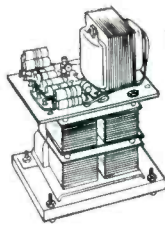

Thompson's
Magnetic
Amplifier

How to "borrow"

... ideas
... facilities
... experience

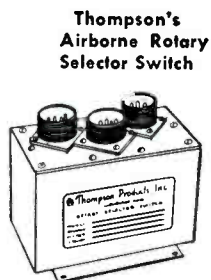

Thompson's
Airborne Rotary
Selector Switch

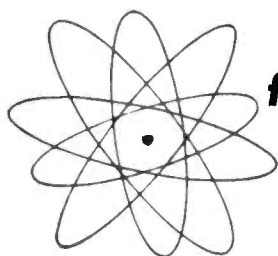

from Thompson

FOR help in untangling knotty electronics problems, many manufacturers have learned to "count on Thompson".

Ideas? To Thompson electronics engineers, no research, development or production problem is "unsolvable". Given the opportunity, they'll come up with sound ideas to solve *your* electronics problems. "Borrow" those ideas!

Facilities? Complete development and testing laboratories . . . plus the most modern production equipment . . . are available to Thompson's electronics engineering staff. "Borrow" these facilities!

Experience? Thompson has had 53 years of successful problem-solving for the automotive, aircraft and general industries of America. The highly developed skills and combined experience of the entire Thompson organization are available to you for all your electronics problems. "Borrow" this experience!

One of the
many
Thompson
Coaxial
Switches

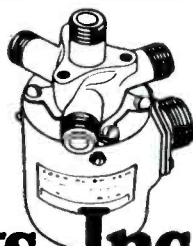

Electronics Division

Thompson Products, Inc.

2196 CLARKWOOD RD., CLEVELAND 3, OHIO

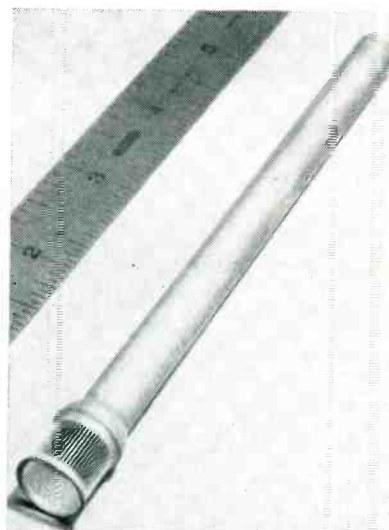

Electrodes may be formed integrally with other functional parts. This grid is made on one end of a copper tube used to evacuate the electron tube



Tapered slats of this extruded grid are obtained by using a mandrel with tapered grooves

heavier supporting portions. The portion of the support just below the grid strands is formed into an accurate cylindrical jiggling surface by an additional step in the rolling procedure. After the desired length of grid strands has been rolled, the rollers are partially backed off and the axial feed continued for a short distance.

The work blank for this grid is a drawn cup consisting of two sections of different diameter. The spoke-like end is formed by fabrication and the chemical removal of the web between the spokes. Grids

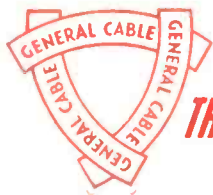

THE GREATEST NAME IN ELECTRICAL WIRE AND CABLE



Modern methods assure product uniformity.

It takes a unique combination of modern production facilities, rigid quality control techniques and skilled workers to make *consistently* top quality magnet wire...and General Cable has it! That's why General Cable magnet wire is noted throughout industry for its extraordinary uniformity...providing the ultimate in high level performance.

Important, too, General Cable can always supply you with *exactly* the magnet wire you want...when you want it! They make every type, shape and size:

Formvar, Plain Enamel, Nylon Enamel, Silicone, and other synthetic enamels, with light, intermediate or heavy coatings.

Cotton, Paper, Silk, Nylon, Glass and Special High Temperature Covering with single and double wrappings, similar and dissimilar materials.

Plus bonded paper and glass, or other specialized types. You name it and General Cable makes it... and makes it *right!* So look to General Cable for *all* your electrical wire and cable needs!

GENERAL CABLE CORPORATION

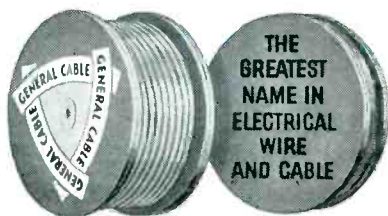

BARE, WEATHERPROOF, INSULATED WIRES and CABLES FOR EVERY ELECTRICAL PURPOSE

GENERAL CABLE CORPORATION
Executive Offices: 420 Lexington Ave., New York 17, N. Y.

SALES OFFICES: Atlanta • Baltimore • Boston • Buffalo
Chicago • Cincinnati • Cleveland • Dallas • Denver • Detroit
Erie (Pa.) • Greensboro (N. C.) • Houston • Indianapolis
Kansas City • Lincoln (Neb.) • Los Angeles • Memphis
Milwaukee • Minneapolis • New Haven • Newark (N. J.)
New York • Philadelphia • Pittsburgh • Portland (Ore.)
Richmond (Va.) • Rochester (N. Y.) • Rome (N. Y.)
St. Louis • San Francisco • Seattle • Springfield (Ill.)
Syracuse • Tampa • Tulsa • Washington, D. C.

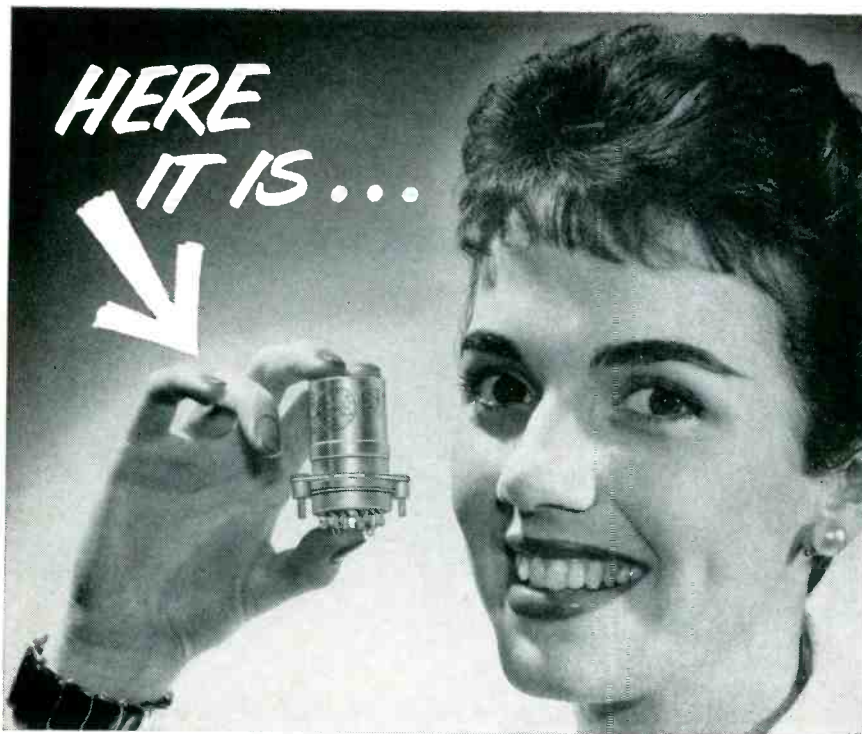

THE NEW UNION

Miniature **A-C** Relay

Now you can get UNION A-C Miniature Relays. They're new but they are backed up with four year's intensive research and development and are adapted from our well-known line of D-C Relays. They are especially designed for vital applications in 115 volt, 60-400 cycle airborne A-C circuits.

To assure utmost reliability the contacts are made from gold alloy or palladium. The sealed-bridge rectifier is of our own design and manufacture . . . made of top quality selenium cells housed in nylon.

UNION A-C relays have been thoroughly proved in rigid tests. They have the same reliable construction as our D-C Miniature Relays, and meet or exceed all requirements of

Mil-R-5757. They withstand shock up to 50G's, vibration through 1500 cycles at 15G's and have a life expectancy of 1,000,000 operations. They are rated at -55°C to $+85^{\circ}\text{C}$.

The relays are available in either 6-pole or 4-pole double-throw models, plug-in or solder-lug connections and all the usual mountings.

The operating advantages of this A-C relay lie in its construction. All parts are precision made—assembly is quality controlled. It is hermetically sealed to improve contact performance and to preclude the possibility of internal contamination. For complete information, call our nearest sales representative listed below or write for descriptive literature.

GENERAL APPARATUS SALES

UNION SWITCH & SIGNAL

DIVISION OF WESTINGHOUSE AIR BRAKE COMPANY

PITTSBURGH 18  PENNSYLVANIA

NEW YORK, IVanhoe 3-2424 (Hempstead)

HARTFORD, JAcKson 9-3122 (Wethersfield, Conn.)

BALTIMORE, VAIlley 5-3431

ST. LOUIS, JEFFerson 5-7300

CHICAGO, LOnGbeach 1-3042

LONDON, OHIO, LOnDon 1555

LOS ANGELES, VAndyke 8731



Loading 6-inch-square sheets of aluminum on plating rack

made by this method cost only a fraction of older types made by hand-threading and spotwelding molybdenum wire to nickel tubular supports.

Materials suitable for use with the extrusion process range from soft copper to harder materials like molybdenum. A suitable etchant for copper is a 30 to 50 percent solution of nitric acid in distilled water. Other metals require different etchants. For example, tantalum requires hot hydrofluoric acid with a trace of nitric acid added.

Mandrel and roller machining details were given in the complete paper presented before the American Society of Tool Engineers at the 1954 convention in Philadelphia by W. N. Parker, as well as in a previous article in the Mar. 5, 1953 issue of Iron Age.

Automatic Electroplater for Selenium Rectifier Sheets

ALUMINUM SHEETS used in the fabrication of selenium rectifiers are automatically plated with nickel in the plant of Radio Receptor Co., Brooklyn, N. Y. with a machine made by Hanson-Van Winkle-Munning Co. of Mattawan, N. J. The 26-position machine operates on a 35-second cycle per position, with 15 seconds transfer time between positions, so that the complete plating operating takes approximately 20 minutes.

Tanks range from one to four



“OUR BEST PORTABLE RECORDER YET”

says Richard Parks, Asst. Chief Engineer, ABC, San Francisco

“This new Ampex 600 really fills a need. We like it. It’s light. It’s compact. And its fidelity and timing accuracy leave nothing to be desired. Now no matter how important the program material, we can send the 600 out after it. The results that come back are as good as we could have recorded inside our studio on Ampex 350s. For program protection the 600’s third head is an excellent feature. The engineer monitors as he records. There’s no guesswork. The recording is always right.”

“The photo shows Bill Adams, our farm reporter. He has made extensive use of the 600 for farm interviews.”



Model 600

NOW THERE'S AN AMPEX FOR EVERY BROADCAST NEED

The new 600 completes the Ampex line. In any station it’s an ideal portable, and for many it’s an all purpose machine. The Ampex 600 fits limited space and limited budgets, but does an unlimited job. Base price is \$498. In portable case it’s \$545. The Ampex 620, a portable amplifier-speaker unit in matching case is a superb quality monitoring unit, usable inside or out; price is \$149.50.

The Ampex 350 is the versatile broadcast studio machine. It has a remote control plug-in, two speeds, 10 1/2-inch reels, easy editing and quick accessibility for service. Its durability defies time and hard usage.



Model 350

Bulletins on the low cost Ampex 600, the versatile 350, the 450 eight-hour reproducer and the Ampex Tape Duplicator are available on request. Write today to Dept. E-1881.



Signature of Perfection in Sound

934 CHARTER STREET • REDWOOD CITY, CALIFORNIA
Distributors in principal U. S. cities; Canadian distribution by the Canadian General Electric Company.

**SUPERIOR TO
CERAMIC BUSHINGS**

**HV CONNECTION
COMPLETELY RECESSED**

**HV
CONCEALED-DISCONNECT
BUSHINGS**

60 KV — 100 KV

Pronouncedly superior to ceramic bushings: connection between HV source and output lead is deeply within unit — corona completely eliminated, maximum safety provided operator.

Molded of tough, flexible resin of high impact and dielectric strength. High dielectric and assembly method permit increased performance and reduced size — advantageous where restricted space precludes internal bushing. A copper sleeve at contact point curtails breakdown from bombardment.

- HVD-60 (60 KV) and HVD-100 (100 KV) handle 1.5 KW • Height 5 3/4" (2 3/4" above base of mounting flange), base diameter 3 1/2"
- Operating temperature —50°C to 150°C • Two feet of HV lead with each unit — longer leads available.

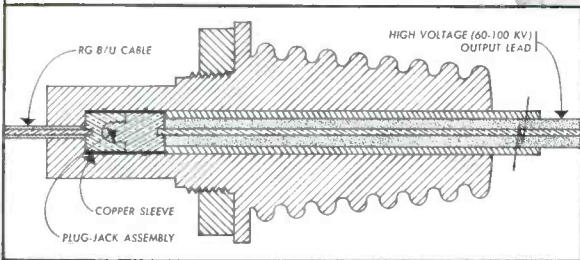
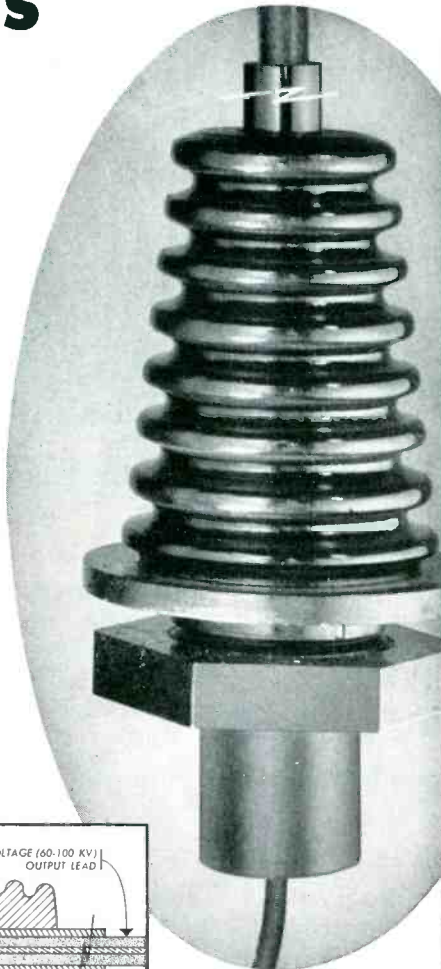
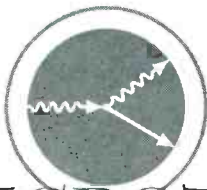

Diagram showing completely recessed HV connection.

Special assemblies available for your higher wattage requirements

MTL produce HV components such as Power Supplies, Pulse Transformers, Capacitors, etc., developed for their instrumentation for the radiographic recording of ultra speed phenomena but applicable to unrelated fields. They invite extraordinary commissions.



MICROTIME LABORATORIES

7247 ATOLL AVENUE, NORTH HOLLYWOOD, CALIFORNIA

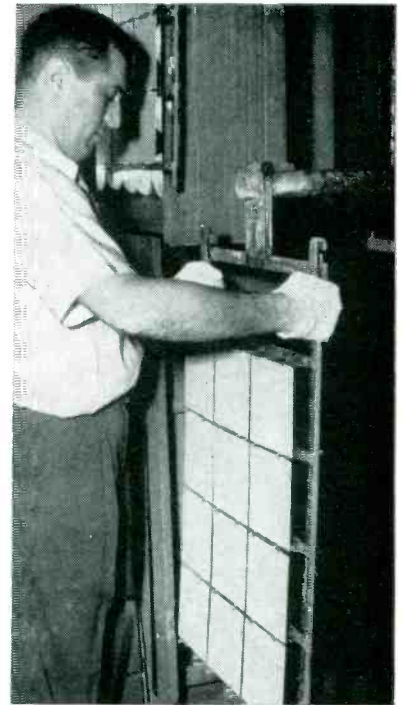

Removing plated sheets from machine at unloading position. Rack of empty sheets is easily hooked in position during the 35 seconds of down time at each position

positions in width, depending on the length of time needed. The racks rise and then come down again farther along in the same tank where longer immersions are required.

The first step involves loading the bare aluminum plates on special racks. These racks have spring clips so positioned that different

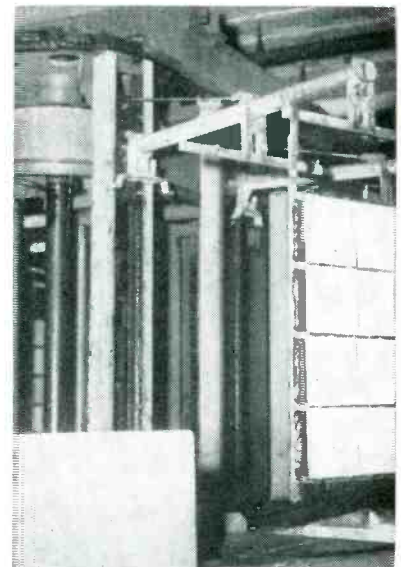

Rack coming around the bend at the half-way point on the automatic plating machine. In next few seconds it will be lowered automatically into cold water spray rinse tank at lower right

GUARDIAN®
Endurance Tested
 MULTIPLE CONTACT
RELAYS
 BREAKING ALL RECORDS

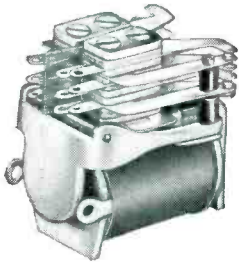

Guardian Series 595
 Up to 4 Pole, Double
 Throw—3 Amps.

120 million operations
 at 30 pulses per second

This test is equivalent to 100 YEARS of continuous operation in many applications! No visible signs of wear. Ideal for business machines and computers.

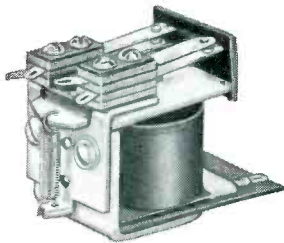

Guardian Series 615
 Up to 4 Pole, Double
 Throw—10 Amps.

90 million operations
 at 10 pulses per second

A low cost, midget relay with practically unlimited applications. Trouble-free operation! Excellent high quality!

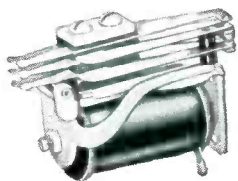

Guardian Series 415
 Up to 8 Pole, Double
 Throw—3 Amps.

60 million operations
 at 11 pulses per second

Sturdy construction to withstand constant operation at extremely high speed. Meets standard Navy and Signal Corps specifications.

write FOR NEW CATALOG NO. 11
 Switches — Steppers — Solenoids — Complete Control Assemblies
GUARDIAN  **ELECTRIC**
 1625-G W. WALNUT STREET CHICAGO 12, ILLINOIS
 A COMPLETE LINE OF RELAYS SERVING AMERICAN INDUSTRY





Nickel-plated sheets are handled with gloves to maintain cleanliness while being placed in airlock for transfer to adjacent air-conditioned room for coating with selenium

lengths of plates can be put in provided they are all 6 inches wide. The loaded rack is hooked over the carrying frame of the automatic plating machine, which moves down at the loading and unloading position just as it does at all other positions. The plates then go through the following operations, numbered according to position:

1. Degrease in trichlorethylene.
- 2, 3, 4. Clean in hot caustic solution.
5. Cold water spray for rinsing.
- 6, 7, 8, 9. Etch in muriatic acid.
10. Cold water spray rinse.
11. Etch in hot caustic at 100 F.
12. Cold water spray rinse.
- 13, 14. Desmut in nitric acid to remove surface dirt.
15. Cold water spray rinse.
16. Clean in mild alkali solution to eliminate residual effect of nitric acid.
17. Cold water spray rinse.
18. Immerse in cold water.
19. Cold water spray rinse.
- 20, 21, 22, 23. Plate with nickel in Watts-type solution at 15 amperes per square inch.
24. Cold water spray rinse.
25. Cold water spray rinse.
- 26, 27. Dry by moving between two banks of forty 250-watt infrared lamps.
28. Unload and reload.

The nickel is plated on the sheets to isolate the subsequent selenium coating from the aluminum, thereby preventing contamination of the selenium.

Chassis-Holding Fixture

A METAL FIXTURE in use on assembly lines in the Paramus, N. J. plant of Avion Instrument Corp. enables women to rotate a heavy chassis easily and lock it at any desired position.

One end plate of the fixture slides on horizontal metal rods. This permits changing the spacing between supports to accommodate various

There'd be no "blip" without power control by the
A.W.HAYDON CO.

*Blip — Reflected Radar Signal

DESIGNED for AIRBORNE RADAR . . .

double delayed reset time delay relay

To Provide Faster Response While Preventing Costly and Dangerous Tube Damage The A. W. Haydon Company's Double Delayed Reset Time Delay Relay delays application of plate power to vacuum tubes until filaments reach operating temperatures. Initial delay of 4 minutes is obtained after closure of "time" switch before closure of the load circuit. Reset is controlled by a double escapement which provides a rapid reset rate from the "time out" position to the point where the load switch opens; and a slow reset rate for the balance of the reset time. Current interruptions of eight seconds or longer will introduce a delay after power is restored, up to the full reset interval of six minutes. Interruptions of six minutes or longer will result in a four minute delay before reclosure. Motor Operates at 400 cycles from 115 volt and clutch coil from 26½ volt DC supply. Temperature range -55°C to +85°C — Motor pull-in voltage 85 volts — drop-out voltage 65 volts or less — Clutch coil pull-in voltage 18 volts — drop-out voltage 13 volts or less. — Hermetically sealed

WHEN TIMING POSES A PROBLEM CONSULT . . .

(General Catalog Sent on Request)

The **A.W. HAYDON Company**
 235 NORTH ELM STREET, WATERBURY 20, CONNECTICUT
 Design and Manufacture of Electro-Mechanical Timing Devices



5 millimeter*
Precision Waveguide Test Equipment
50.00 to 75.00 kilomegacycles
with FULL SPECIFICATIONS

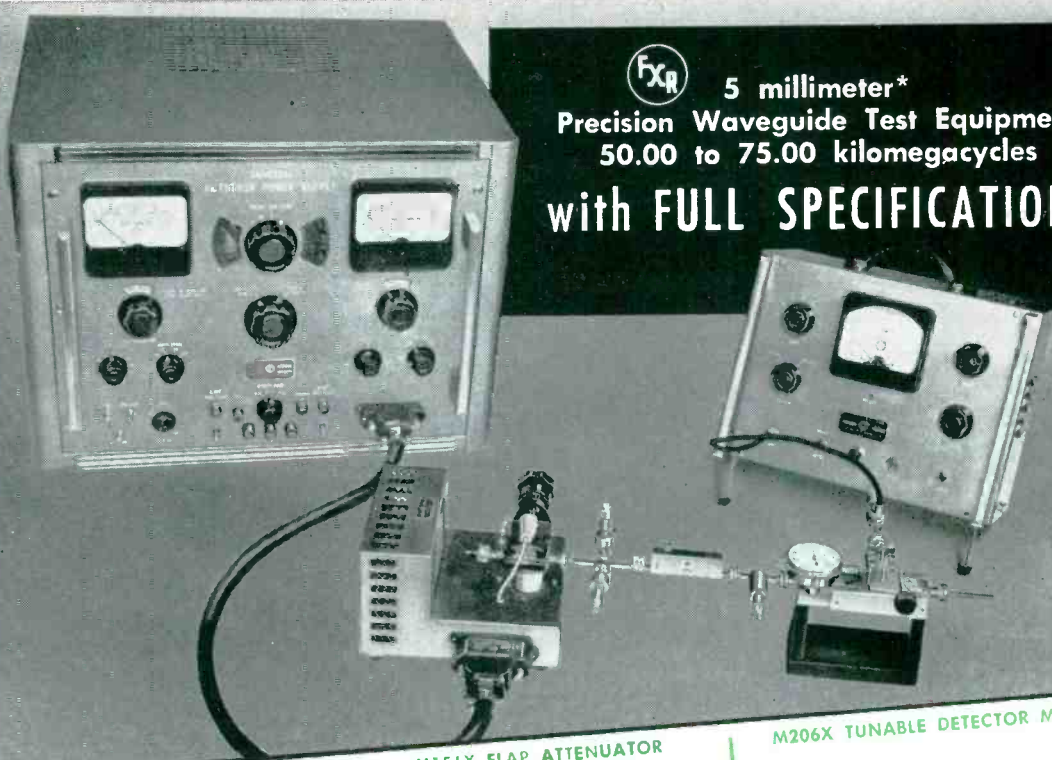

M103X SLOTTED SECTION



Slope and Irregularity—1.02 vswr, max.
 Dual Tuned Pickup Probe**
 Tapered Slot
 Dial Indicator—0.01 mm graduations
 Milled Coin Silver Construction
 Ball Bearing Carriage
 Friction Drive

M151X FLAP ATTENUATOR

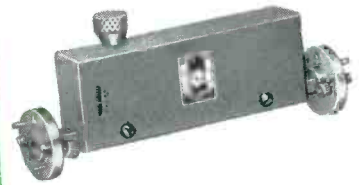

Attenuation—0 to 40 db
 Approximate calibration
 Max. vswr—1.20

M206X TUNABLE DETECTOR MOUNT



IN53 Crystal
 Tunable for low vswr
 Micrometer Driven Choke Tuning

M312X E/H TUNER

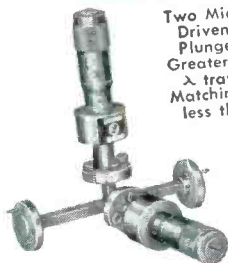

Two Micrometer
 Driven Choke
 Plungers
 Greater than 1/2
 λ travel
 Matching—20:1 to
 less than 1.02:1

M410X FREQUENCY METER



Absolute Accuracy—0.1%
 Resonant Dip—approx. 20%
 Micrometer Drive

M501X TERMINATION



Max. vswr—1.05

TRANSMISSION LINE COMPONENTS

- M620X Series Tee
- M621X Shunt Tee
- M622X E/H Tee

- M623X 90 Deg. E-Bend
- M624X 90 Deg. H-Bend
- M631X Micrometer Sliding Short
- M638X Horn
- M780X Harmonic Generator
- X910X Transmission Line Stand

- Z815A Universal Klystron Power Supply
- Z762A Klystron Tube Mount
- B830A Universal Power Meter

ACCESSORIES:

Will operate tubes (not supplied) thru the frequency range of 18 to 60 Kmc; with harmonic generation up to 90 Kmc; min.

- B810A Standing Wave Amplifier

*RG-98/U Waveguide. RG-97/U and RG-99/U waveguide test equipment information also available.

**FXR M206X Tunable Detector Mount not included.



Write for catalog of complete line of
FXR PRECISION MICROWAVE TEST EQUIPMENT

Electronics & X-Ray Division

F-R MACHINE WORKS, Inc.

26-12 BOROUGH PLACE, WOODSIDE 77, N. Y. • ASTORIA 8-2800



Designed for



Application

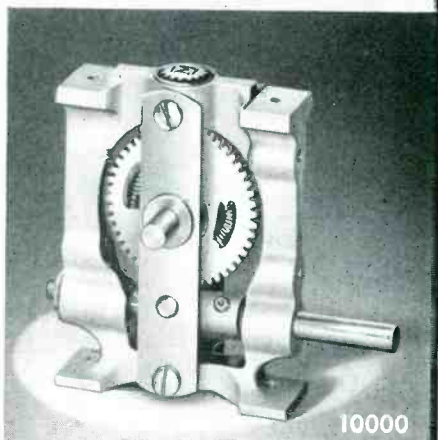

The No. 10000 WORM DRIVE UNIT

One of our original *Designed For Application* products, tried and proven over the years. Rugged cast aluminum frame may be panel or base mounted. Spring loaded nickel plated cut brass gears work with polished stainless steel worm to provide low back lash. $\frac{1}{4}$ " diameter stainless steel drive and driven shafts. Available in two ratios, 16:1 and 48:1. Specify ratio in ordering.

JAMES MILLEN MFG. CO., INC.

MAIN OFFICE AND FACTORY
MALDEN
MASSACHUSETTS



PRODUCTION TECHNIQUES

(continued)

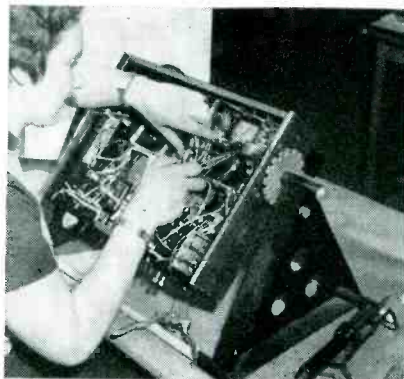

Working on chassis mounted in universal holding fixture

chassis lengths. Each chassis in turn is bolted to the rotating plates of the fixture, since relatively long assembly cycles are employed in this plant. A toothed wheel on one end support engages with a spring-loaded detent to lock the chassis at the desired angle.

Draining Setup for Dipped Rectifier Stacks

AFTER DIPPING a basket-load of radio stacks in clear glyptal, the basket is hung over the glyptal pan on an angled support. This insures that surplus coating will drain neatly from the sharp corners of the stacks rather than collect on flat surfaces.

The support is made by bolting metal side plates to a wood strip cut to the width of the basket handle. Metal straps and a metal rod hold this rack at an angle over the tray. This technique is used in the Selenium Rectifier Division of Radio Receptor Co., Brooklyn, N. Y.



Placing basket on angle support for quick draining after dipping in clear glyptal

MICROWAVE MULTI-PULSE SPECTRUM SELECTOR

for use with Polarad
Spectrum Analyzers



The Polarad Multi-Pulse Spectrum Selector increases the versatility of Polarad Spectrum Analyzers by displaying and allowing selection for analysis a specific train of microwave pulses as well as any one pulse in the train.

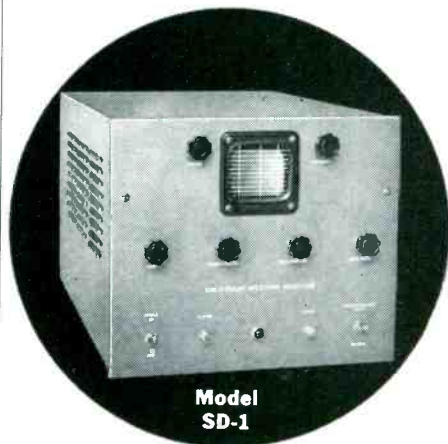

Model
SD-1

It will select and gate a group of pulses up to 100 μ sec. in length; is designed to work with fast, narrow pulses; and can be adjusted to gate any pulse including the first at zero time. Special circuitry discriminates automatically once pulses have been selected. The Model SD-1 has been designed to operate with all Polarad Spectrum Analyzers at any of the frequencies they will accept.

- Completely self-powered portable unit.
- High intensity, flat-face CRT for accurate display with:
 - Continuously variable sweep widths; 10 to 100 μ sec.
 - Continuously variable gate widths for pulse selection; 0.2 to 10 μ sec.
 - Continuously variable gate delays for pulse selection; 0 to 100 μ sec.
 - Automatic gating of spectrum analyzer during time of pulse consideration.
 - Intensified gates (brightening) to facilitate manual pulse selection.
 - Triggered sweep on first pulse in any train. No sweep in absence of signal.

SPECIFICATIONS:

Maximum Pulse Train Time.....100 μ sec.
Pulse Rise Time.....0.5 μ sec. or Less
Minimum Pulse Separation.....1 μ sec.
Repetition Rate.....10 -10,000 pps.
Minimum Pulse Width.....1 μ sec.
Input Power.....95 to 130 volts,
50/60 cps., 350 watts

Input Impedance . . . 50 ohms (to match TSA)
Output Impedance . . . 50 ohms Spectrum Analyzer

AVAILABLE ON EQUIPMENT LEASE PLAN

FIELD MAINTENANCE SERVICE AVAILABLE
THROUGHOUT THE COUNTRY



ELECTRONICS
CORPORATION

43-20 34th STREET
LONG ISLAND CITY 1, N. Y.

Want more information? Use post card on last page.

June, 1955 — ELECTRONICS

PORTABLE DIRECT READING SPECTRUM ANALYZER

10 TO 44,000 mcs

5 RF HEADS

UNI-DIAL TUNING



MODEL TSA

Now, a new Polarad spectrum analyzer only 21 inches high that covers the entire frequency range 10 to 44,000 mcs with 5 interchangeable RF tuning heads. The model TSA operates simply—single dial frequency control—with utmost frequency stability. It provides highest accuracy, and reliability for observation and true evaluation of performance over the entire RF spectrum—saving engineering manhours.

This instrument is designed for maximum utility and versatility in the laboratory and on the production line providing an easy-to-read 5 inch CRT display of the RF spectrum.

Model No.	Equipment
Model DSA.....	Spectrum Display and Power Unit
Model STU-1.....	RF Tuning Unit 10-1,000 mc.
Model STU-2A.....	RF Tuning Unit 910-4,560 mc.
Model STU-3A.....	RF Tuning Unit 4,370-22,000 mc.
Model STU-4.....	RF Tuning Unit 21,000-33,000 mc.
Model STU-5.....	RF Tuning Unit 33,000-44,000 mc.

SPECIFICATIONS:
 Frequency Range: 10 mc to 44,000 mc.
 Frequency Accuracy: $\pm 1\%$
 Resolution: 25 kc.
 Frequency Dispersion: Electronically controlled, continually adjustable from 400 kc to 25 mc per one screen diameter (horizontal expansion to 20 mc per inch)

Input Impedance: 50 ohms—nominal
 *Sensitivity:
 STU-1 10-400 mcs —89 dbm
 400-1000 mcs —84 dbm
 STU-2A 910-2,200 mcs —87 dbm
 1,980-4,560 mcs —77 dbm
 STU-3A 4,370-10,920 mcs —75 dbm
 8,900-22,000 mcs —60 dbm
 STU-4 21,000-33,000 mcs —55 dbm
 STU-5 33,000-44,000 mcs —45 dbm
 Overall Gain: 120 db
 Attenuation:
 **RF Internal 100 db continuously variable, IF 60 db continuously variable
 Input Power: 400 Watts
 *Minimum Discernible Signal
 **STU-1, STU-2A, STU-3A

The model TSA Spectrum Analyzer has these exclusive Polarad design and operating features:

- Single frequency control with direct reading dial. No klystron modes to set. Tuning dial accuracy $\pm 1\%$.
- Five interchangeable RF tuning units for the entire frequency range 10 to 44,000 mcs.
- Temperature compensation of Klystron Oscillator.
- Swept IF provides 400 kc to 25 mc display independent of RF frequency setting.
- Internal RF attenuator.**
- Frequency marker for measuring frequency differences from 40 kc to 25 mc.

AVAILABLE ON EQUIPMENT LEASE PLAN

FIELD MAINTENANCE SERVICE AVAILABLE THROUGHOUT THE COUNTRY

NEW! Write for Handbook of Spectrum Analyzer Techniques



ELECTRONICS CORPORATION 43-20 34th STREET, LONG ISLAND CITY 1, N. Y.

REPRESENTATIVES: • Albuquerque • Atlanta • Baltimore • Bayonne • Bridgeport • Buffalo • Chicago • Dayton • Fort Worth • Los Angeles • New York • Newton • Philadelphia • San Francisco • Syracuse • Washington, D. C. • Westbury • Winston-Salem • Canada, Amprior, Toronto—Export: Rocks International Corporation

New Products

Edited by WILLIAM P. O'BRIEN

66 New Products and 62 Manufacturers' Bulletins Are Reviewed
. . . Control, Testing and Measuring Equipment Described and
Illustrated . . . Recent Tubes and Components Are Covered

LONG LIFE CHOPPER

rated for 2,000 hours

AIRPAX PRODUCTS Co., Middle River, Baltimore 20, Md., has developed a miniature 6.3-v, 400-cps mechanical modulator rated for a life of 2,000 hr. Contacts of this spdt chopper are rated for a maximum of 1 ma for signals from 0.1 mv to 100 v. Tests indicate that life in excess of 2,000 hr can be expected. Type 300 chopper is constructed to operate in ambient temperatures from -65 C

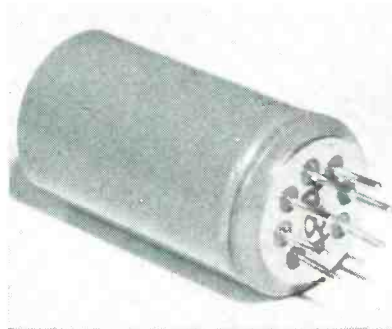

to $+100\text{ C}$, is hermetically sealed for use in humid atmospheres and at altitudes to 50,000 ft. It withstands mechanical shocks of 100 g and vibrations of 0.06 in. total travel from 10 to 55 cps. Switching phase angle is 65 ± 15 deg; dwell time on each pole is 145 ± 20 deg; balance between dwell times is 0 ± 15 deg. Required driving frequency is 400 ± 20 cps; required coil voltage is 6.3 ± 0.6 v. Coil impedance is 230 ± 60 ohms at 400 cps with 6.3 v rms applied at 25 C .

OSCILLOGRAPH

with 2 chart-drive systems

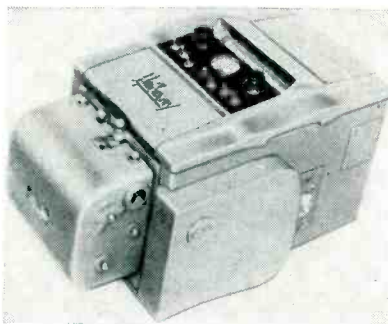

HATHAWAY INSTRUMENT Co., 1315 S. Clarkson St., Denver 10, Colo. The S14-E oscillograph has added important improvements in the chart-drive mechanism of the S14. Two kinds of chart-drive systems are now available, both simple and reliable at all speeds. One employs miniature V belts, and the other a continuously-variable transmission. Standard chart speeds with either

system are 40, 20, 10, 4, 2, 1, 0.4, 0.2 and 0.1 in. per sec. Chart speeds up to 400 ips are possible. Standard accessories include drum-type record magazine, time coordinate device, and automatic transient-recording equipment capable of starting in 2 milliseconds. Novel optical system improvements produce traces of unusual sharpness and contrast, and galvanometers are available for the high sensitivity of 40 mm per μa , to the high natural frequency of 10,000 cps.

CONTACT TERMINALS

simplify connector wiring

WINCHESTER ELECTRONICS, INC., Willard Road, Norwalk, Conn. Two new styles of contact terminals that facilitate assembly wiring or increase the operating current of electrical connectors are now available in the miniature, quick-disconnect and small power connector class. Ideal for higher currents, the turret terminals (shown at left) enable wrap around wiring of two or more wires per contact, or,

if preferred, allow the use of larger Awg wire than that formerly permitted by conventional solder cup

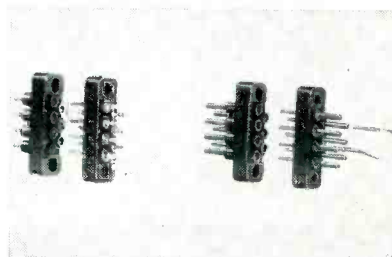

terminals. Internally-tapered terminals (right) are designed for use with No. 53 AMP taper pins to speed individual wire attachment and permit selective engagement or disengagement of wires.

GATING PACKAGE for digital computation

COMPUTER CONTROL Co., INC., 92 Broad St., Wellesley 57, Mass., has announced the 3C-PAC gating



Peak performance from every color!

SYLVANIA is your dependable
source of **ALL** picture tube phosphors

Whether you need phosphors for black-and-white or color picture tubes, Sylvania's long experience, highly developed production facilities and exacting quality control add up to *dependability*.

All Sylvania tube phosphors are rigidly inspected for purity, particle size, brightness and uniformity of color. There is a full range of phosphor formulations available to meet your requirements, including special blends for maximum cross-burn resistance. All Sylvania phosphors can be supplied in 1000-lb. lots to eliminate color-matching problems.

To help you secure long-lasting screen brightness and good color, Sylvania also manufactures high-purity *potassium silicate*. Exact control of potassium-to-silica ratio assures maximum wet-screen strength.

For complete information about high-performance Sylvania phosphors and TV Picture Tube components, write to:

SYLVANIA ELECTRIC PRODUCTS INC.,
1740 Broadway, New York 19, N. Y.

In Canada:

*Sylvania Electric (Canada) Ltd.,
University Tower Bldg., St. Catherine St.,
Montreal, P. Q.*

SYLVANIA 

Lighting • Radio • Electronics • Television • Atomic Energy

package, a universal logical package for utmost digital system flexibility. These high-speed digital building blocks, operating at a 1-mc repetition rate, can be made to perform an endless variety of logical operations and computations. The gating package is particularly use-

ful for digital computation, control and data handling. It consists of two 4-leg gates and two 3-leg gates joined by a 4-leg buffer, a lumped delay, and an amplifier that produces both positive and inverted pulse trains. Components of the 3C-PAC are mounted on an etched

circuit panel to form a rugged, compact unit measuring only 7 in. sq and less than 1 in. thick. The low output impedance of 93 ohms matches into conventional coax cable and minimizes the capacitive effects of wiring. Total power consumption is approximately 4 w.

VISUAL MONITOR

displays 24 signals



CENTURY GEOPHYSICAL CORP., 1333 No. Utica, Tulsa, Okla. Model 20 dynamic visual monitor combines 24 moving-spot, light-beam galvanometers in one package, 8½ in. × 8½ in. × 6 in., weighing less than 13.5 lb, to permit simultaneous display of 24 separate electrical signals on a single 3 in. × 4 in. ground-glass screen. It represents

the ideal way to view the outputs of a series of thermocouples, pressure transducers, strain gages or other similar signal sources. Use of low period galvanometers and a long-path optical system permits presentation of electrical signals up to 120 cps with only 0.24 ma required for full-scale deflection. Spot intensity is sufficient to permit photography in photo panel displays or for viewing under conditions of high incident light.

POWER SUPPLY

features stackability

NEW JERSEY ELECTRONICS CORP., 345 Carnegie Ave., Kenilworth, N. J., has developed a new compact, economical, stackable power supply—the S-100-R. Although the basic output range is 200-325 v at 0-100 ma, two, three or four units can be stacked in parallel to furnish 0-200 ma, 0-300 ma or 0-400 ma. While stacked, hogging of the load by one supply is prevented by a different circuit feature. The junction be-

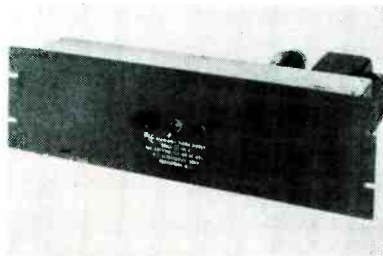

tween the pass-tube grids and the error-amplifier plate is brought to the rear terminal strip, permitting

several units to be interconnected so that one error amplifier controls all the pass-tubes in use while the other error amplifiers remain inactive. This setup permits the use of one voltage control to set all the supplies to the desired output. Load division is uniform to 10 percent. The S-100-R is specifically intended for permanent or semipermanent inclusion in low and medium power rack assemblies of equipment such as computers, test fixtures, telemetering, radar, tv and a-f amplifiers.

FAST TOTALIZERS

for high volume output

ATOMIC INSTRUMENT Co., 84 Massachusetts Ave., Cambridge 39, Mass., has introduced the model

8003 fast industrial counter. The instrument is readily applied to the rapid counting of high speed, high volume outputs; studies of plant and machine operations; efficiency analyses, and quality control. This counter with register is designed to tally count of continuous, discontinuous, random or cyclic succession of events or passage of linear or liquid flow. Maximum counting rate of 4,000 counts per sec is achieved through a combination of low heat, cold cathode glow transfer counting tubes and an

electromechanical register. Pulse pair resolution is 250 μsec and total count capacity is seven digits (9,999,999). Counters are built from the unitized functional plug-in strips.

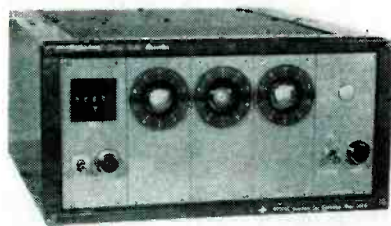

STORAGE TUBE for computer systems

RADIO CORP. OF AMERICA, Harrison, N. J. Type 6571 storage tube is designed primarily for use in binary-digital computer systems. Features include a storage surface providing relatively uniform secondary emis-

**INSTRUMENT CORPORATION
OF AMERICA**

slip ring & commutator assemblies

**One-piece construction*
assures high accuracy and
super-dependability to the
most rigid specifications.**

*Proven for
performance in
precision instruments
and equipment including
SYNCHROS, GYROS, RADAR,
FIRE CONTROL, TEST TABLES
and other CRITICAL APPLICATIONS*

Specify Instrument Corporation of America Slip Ring and Commutator Assemblies for closer tolerances, absolute uniformity and the ultimate in miniaturization. Wherever extreme dimensional precision, accurate concentricity and high dielectric qualities, are required, Instrument Corporation of America assemblies are specified with confidence. One-piece, unitized construction eliminates dimensional variation due to accumulated errors, provides jewel-like finish, uniform ring hardness and reduced weight. Engineering "know-how" resulting from years of specialization and continuous collaboration with leading manufacturers all over the world is at your immediate service.

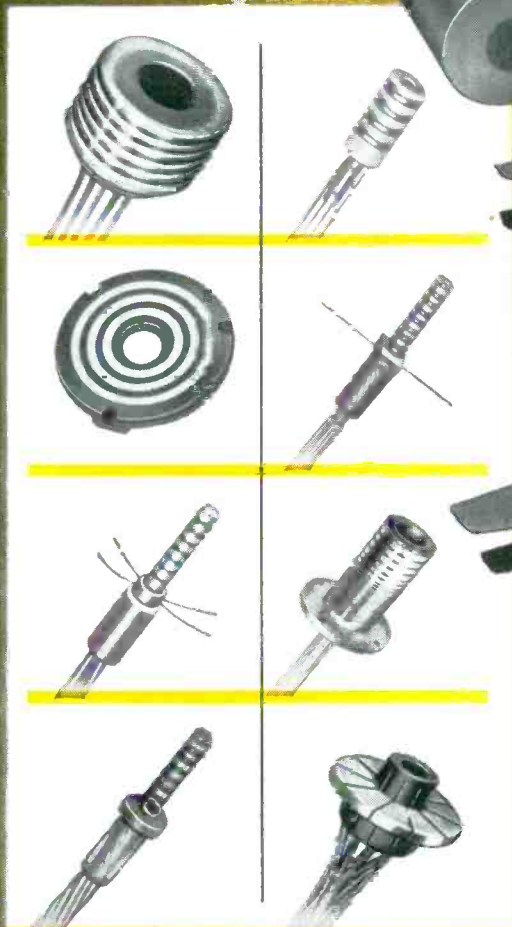

**TYPICAL
SPECIFICATIONS**

- SIZES: .035" to 36" Diameter, Cylindrical or Flat
- CROSS-SECTIONS: Ring Thickness .005" to .060" or More
- FINISH: 4 Micro-Inches or Better
- BREAKDOWN: 1000 V or More Hi-Pot Inter-Circuit
- RING HARDNESS: 70 to 95 Bhn ± 1
- SURFACE PROTECTION: Palladium and Rhodium, or Gold Prevent Tarnish, Minimize Wear & Noise

INSTRUMENT CORPORATION OF AMERICA

BLACKSBURG · VIRGINIA

*ELECTRO DEPOSITION PROCESS AVAILABLE UNDER EXCLUSIVE LICENSE AGREEMENT WITH ELECTRO TEC CORP.

COST-SAVING IDEAS  FOR DESIGN ENGINEERS

S.S. WHITE FLEXIBLE SHAFTS OFFER BASIC ECONOMIES IN DESIGN... PRODUCTION ... AND ASSEMBLY

For example, consider the case of the small flexible shaft used in this color TV receiver to connect the hue control to its control knob. The shaft permits a direct connection between the two components despite an intervening 90° turn, thereby saving parts and simplifying assembly operations. What's more, since the shaft needs no alignment it can be installed faster and with less difficulty.

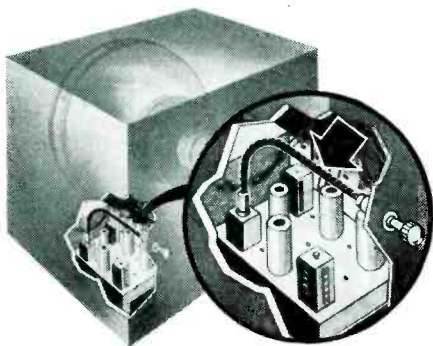

WITH AN S.S. WHITE FLEXIBLE SHAFT you reduce to a *single* element the number of parts needed to transmit power or remote control between two points. You can often eliminate gearing, universals and many other similar parts which complicate manufacturing and assembly operations and add unnecessary bulk and weight. Also a flexible shaft gives you greater freedom in placing connected members wherever desirable to secure higher equipment efficiency, easier assembly, greater compactness and more convenient servicing.

BULLETIN 5306 has basic information and data on flexible shaft application and selection. Send for a free copy. Address Dept. E.



R-8

THE S.S. White INDUSTRIAL DIVISION
DENTAL MFG. CO.

10 East 40th Street
NEW YORK 16, N. Y.

Western District Office • Times Building, Long Beach, California

sion to prevent bad spots on which information cannot be stored, and a focused beam having an exceptionally small effective area and a well defined boundary. The latter feature is significant whenever a single storage element is addressed several times before neighboring elements are regenerated. A third feature is a separate external connection for the collector to serve as an effective shield to prevent cross-coupling between the electron gun and the external signal-output electrode. The 6571 is of the single-beam type with electrostatic focus and deflection and has its storage surface on the inner surface of the faceplate. It is 3 in. in diameter with an overall length of 11½ in.

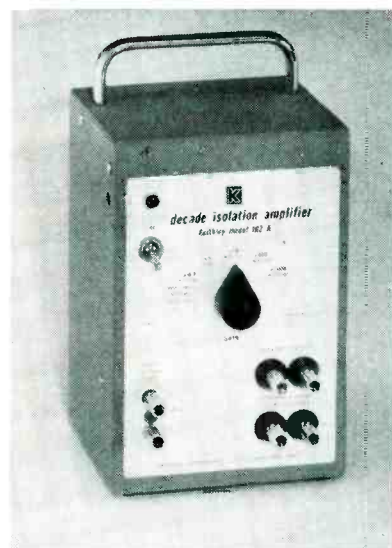

A-C AMPLIFIER is decade isolation type

KEITHLEY INSTRUMENTS, 3868 Carnegie Ave., Cleveland 15, Ohio. Model 102A decade isolation amplifier has an input impedance of 250 megohms shunted by 3 μf, gains of 0.1, 1, 10, 100 and 1,000 accurate within 2 percent, and a frequency response of 3 cps to 300 kc. Other features include an accessory double-shielded low-capacitance probe, printed wiring, and optional cabinet or rack panel mounting—up to 3 units may be mounted on a 5¼ × 19-in. panel. The instrument may be used as a compact general purpose preamplifier or as an isolation amplifier ahead of vtvm's and oscilloscopes. By giving indicating instruments

COMMON CHARACTERISTICS OF ALL TYPE 2131 GEARED MOTOR GENERATOR UNITS

O.D. of Case.....1.000 inch
 Case Length.....3.301
 Weight.....7.5 ounces
 Frequency.....400 cycles

No. of Poles (Motor).....6
 *No Load Speed (Min.).....6500 rpm
 Rotor Inertia.....1.1 gram-cm²

*Motor Speed at input to gear train



NEW

integral gear head in small servo motors

OUTSTANDING FEATURES OF TYPE 2131 GEARED MOTOR GENERATOR

- New methods of manufacture result in high efficiency
- High torque to inertia ratio to give fast response
- Available for 115 volt—115 volt two phase or single ended tube operation
- High impedance winding for direct plate to plate operation available
- High generator output voltage with excellent signal to noise ratio
- Zero degree phase shift in generator
- All metal parts corrosion resistant
- Extremely wide operating temperature range

*Other models
of one inch O.D. units*

TYPE NO.	DESCRIPTION
2103	Induction Motor
2101	Geared Induction Motor
2028	Motor Generator

Latest catalog and/or complete specification drawings will be sent upon request.

A new line of units has been added to the Kollsman "Special Purpose Motors" family combining precision machining, advanced electrical design and the latest in new materials. An unusual feature of the new line is the integral gear head unit. Contained within a single case is the gear train and motor; or gear train, motor and generator. Gear ratios as high as 300:1 can be supplied.

This new line consists of Induction Motors and Induction Generators supplied separately or combined in a single case one-inch in diameter. The new motors have been designed to give the maximum torque per watt ratio with the minimum rotor inertia. The generators have been designed to give the maximum output voltage with the minimum residual voltage and phase shift.

One of the principal features of the Kollsman "Special Purpose Motors" is the interchangeability of parts which permits numerous electrically different combinations of motor and generator windings within the same case.

INPUT PER PHASE ONLY 1.8 WATTS ELECTRICAL CHARACTERISTICS OF TYPICAL TYPE 2131 GEARED MOTOR GENERATORS

TYPE NO.	EXCITATION		INPUT PER PHASE	MOTOR			GENERATOR	
	FIXED	CONTROL		STALL TORQUE	Theoretical Acceleration At Stall	EXCITATION FIXED	INPUT	OUTPUT PER 1000 rpm
2131-0411110	26	26	2.3	0.4	25600	26	1.8	.51
2131D-0412120	26	26	4.0	0.6	38500	26	2.2	.68
2131D-0413120	26	26	1.8	0.3	19200	26	2.2	.68
2131-0460600	115	115	4.0	0.6	38500	115	2.6	1.00
2131-0463600	115	55	4.0	0.6	38500	115	2.6	1.00
2131-0470600	115	P-P	4.0	0.6	38500	115	2.6	1.00
	volts	volts	watts	Oz-n	rad/sec ²	volts	watts	volts



kollsman INSTRUMENT CORPORATION

80-10A 45th AVE., ELMHURST, NEW YORK • GLENDALE, CALIFORNIA • SUBSIDIARY OF *Standard* COIL PRODUCTS CO. INC.

POWER

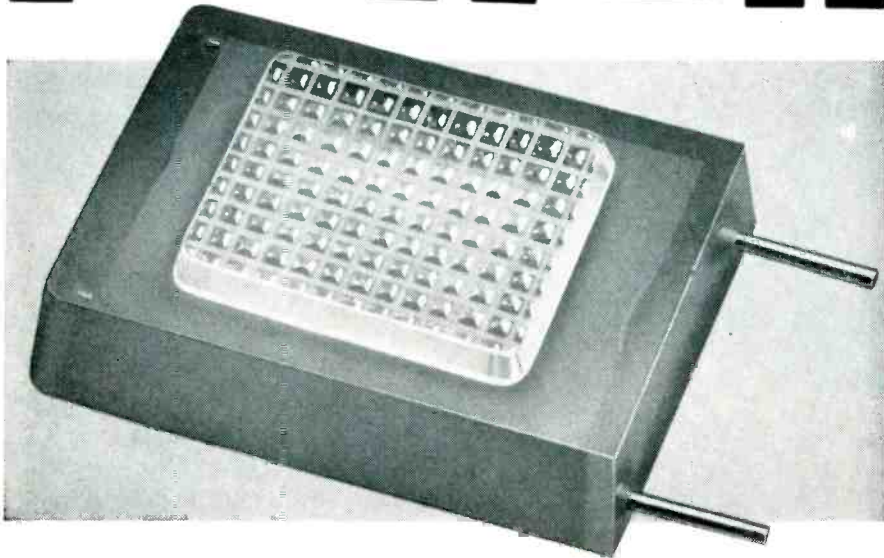

IN PHOTOCELLS

The superiority of Canadian Marconi Photoconductive Cells is shown in this review of its characteristics.

- Dissipation 0.3 watts max.
- Voltage 1.5 to 120 max. volts
(a.c. or d.c.)
- Current 20 ma max.
- Temperature -70°C. to 75°C. ambient
- Spectral Response approximates that of the eye.
- Wavelength at max. response 5100 angstroms
- Dark resistance 10 to 1000 megohms
- *Sensitivity at 1 ft. candle (100 volts) . . 0.15 to 0.4 amp/lumen
- Capacitance 20-30 mmfd
- Rise-time at 50 ft. candles 5 m. sec
- Decay-time at 50 ft. candles 10 m. sec

*Measured with a 2854°K colour temperature tungsten lamp.

NOW AVAILABLE

For further information contact **F. HASELL**

CANADIAN MARCONI COMPANY

2442 TRENTON AVENUE, MONTREAL 16, P.Q., CANADA

NEW PRODUCTS

(continued)

and mirror galvanometers an effective 250-megohm input impedance, it sharply reduces circuit loading errors in a broad range of applications.



VIDEO PHASE METER provides direct readings

TECHNOLOGY INSTRUMENT CORP., Acton, Mass. Type 324-A video phase meter provides direct readings of phase angles from 0 to 360 deg without ambiguity. The frequency range of 20 kc to 4.5 mc may be extended down to 20 cycles on special orders. Angular accuracy is ± 4 deg for either sine or complex waves having no more than one positive-going zero-axis crossing per cycle. A pair of input probes are provided for extreme ease in making point-to-point checks of phase relationships in experimental circuitry. Input impedance of the 324-A is represented by 10 megohms in shunt with 14 μf . The video phase meter is especially valuable in measurements of phase delay, broad-band feedback, chromaticity signals, oscillator or reactance tube circuits, phase equalizers and ssb systems.

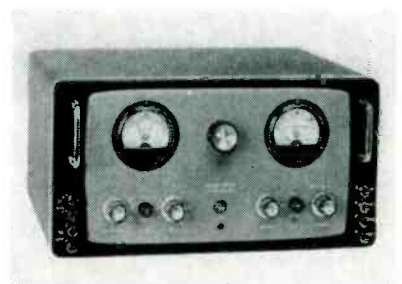

POWER SUPPLY for ultrahigh regulation

KROHN-HITE INSTRUMENT Co., 580 Massachusetts Ave., Cambridge 39, Mass. Model UHR-240 regulated

TELNIC[®] BRONZE!

**Works hot, works cold...
machines easily!**

Telnic Bronze, developed and patented by Chase, might very well be called the "all purpose" alloy. It has *excellent* machinability, hot and cold workability, high strength and conductivity, high fatigue strength and superior corrosion resistance.

Chase Telnic Bronze is available in round or hexagonal rod. Find out more about this amazing alloy—check the coupon for Chase's free Telnic Bronze booklet.

GET FORGINGS FROM CHASE!
Non-ferrous forgings of all types made to your specifications. Write for details.



Chase



BRASS & COPPER CO.

WATERBURY 20, CONNECTICUT • SUBSIDIARY OF KENNECOTT COPPER CORPORATION

The Nation's Headquarters for Brass & Copper

Albany†	Chicago	Detroit	Los Angeles	New York	St. Louis
Atlanta	Cincinnati	Grand Rapids†	Milwaukee	Philadelphia	San Francisco
Baltimore	Cleveland	Houston	Minneapolis	Pittsburgh	Seattle
Boston	Dallas	Indianapolis	Newark	Providence	Waterbury
Charlotte†	Denver	Kansas City, Mo.	New Orleans	Rochester†	(sales office only)

FREE

Chase Brass & Copper Co.
Waterbury 20, Connecticut
Dept. 655

Gentlemen:

Please send me your free Telnic Bronze booklet.

Name _____

Position _____

Firm _____

Street _____

City _____ State _____

Bliley

CRYSTALS IN

AERONAUTICAL ELECTRONICS

Frequency control in guided missiles and in airborne communications requires an advanced degree of design and craftsmanship. That's why Bliley crystals, crystal ovens, and custom built oscillator assemblies are first choice for both prototypes and production. If you want it built better, call in Bliley.



Bliley crystals fly with the famous "Matador" pilotless bomber built by the Martin Company, Baltimore.



BLILEY ELECTRIC COMPANY
UNION STATION BUILDING • ERIE, PENNSYLVANIA

NEW PRODUCTS

(continued)

power supply provides up to 0.5 ampere of d-c at 0 to 500 v with 0.001-percent regulation and less than 100 μ v of ripple. Stabilization for \pm 10-percent change in line voltage is better than 0.003 percent. The d-c and l-f impedance is less than 0.005 ohm. The a-c impedance is less than 0.05 ohm in series with 0.1 μ h (4 inches of wire). Transient response is 0.001 millisecond. Typical 10-hr drift is 300 ppm + 20 mv. The ultrahigh regulation applies over the entire operating range. For line voltages between 105 and 125 v, the full maximum current can be drawn continuously at any output voltage. Price is \$550.

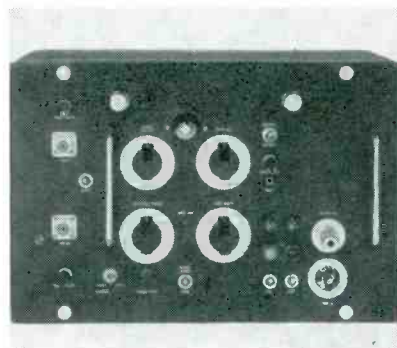

RADAR MONITOR operates automatically

MILLER ASSOCIATES, Lakeville, Conn., has developed an automatic patented, radar monitoring device, known as the Raytector, which operates in conjunction with any radar search equipment to provide visual and audible alarms whenever an object appears in a predetermined zone. The equipment also contains built-in test and monitoring circuits which initiate an alarm signal in the event of failure of either the radar equipment or the Raytector. In the event of such a failure, built-in simulated radar signals, which are controlled by front panel controls, can be employed to quickly localize trouble to either the radar set or the Raytector.

PANEL SEAL for toggle switches

PANSEAL INC., 10 Main St., Little Ferry, N. J. Model 3268 panel seal

ELECTRONICS MANUFACTURERS— put your shipment in our hands!



No other airline holds such leadership:



MORE EXPERIENCE—First with scheduled airfreight, American Airlines today has the largest, most experienced personnel force in carrier service.

GREATER SCHEDULE FREQUENCY—With *more* scheduled service to more key industrial areas than any other airline, American is your best assurance of dependable on-time deliveries.

MORE MAJOR MARKET COVERAGE—*Only* American serves two-thirds of the top 30 retail markets—all 23 of the top industrial states.

GREATER CAPACITY—With the greatest cargo capacity of any airfreight system, American is better able to provide direct one-carrier service without delay.

MOST RELIABLE SERVICE—Superiority in coverage, capacity and experience make American better qualified *than any other carrier* to solve shipping problems. For information, wire collect to American Airlines, Inc., Cargo Sales Division, 100 Park Avenue, New York 17, N. Y.

**AMERICAN
AIRLINES
AIRFREIGHT**

PRESSURIZE ELECTRONIC EQUIPMENT

with
Eastern
UNITS

The extensive line of Eastern Pressurization Units for airborne electronic equipment accommodates a broad range of requirements, and meets appropriate government standards.

Units can be modified to meet your specific requirements. These modifications usually consist of: 1) Different compressors; 2) Motor change to meet your requirement; 3) Change in pressure switch settings; 4) Different mounting provisions. Eastern welcomes the opportunity to discuss and quote on your particular application problem.

MODEL E/AP-100 TYPE 202

- Maintains a system pressure of 25 P.S.I.A. minimum.
- Motor is .03 H.P.—10,000 R.P.M., 208 V., 3 ph., 400 cy.
- Current draw is .7 amperes/phase maximum under normal operating conditions
- Unit operates continuously
- Weight is 4¾ lbs. maximum

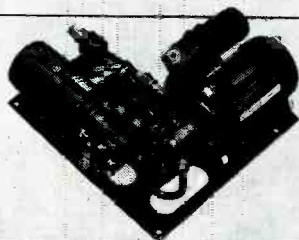

MODEL E/AP-150 TYPE 205

- Operating pressure switch maintains a system pressure of 17 P.S.I.A.
- Motor is 1/25 H.P. 7,500 R.P.M., 27 volts D.C. — T.E.B.B.
- Current draw is 2.0 amperes maximum under normal operating conditions
- Life is 500 operating hours
- Weight is 8 lbs. maximum

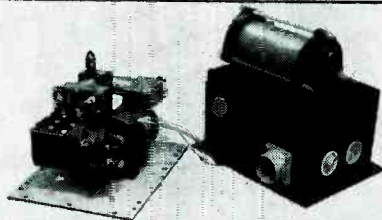

MODEL E/AP-1500 TYPE 203

- Operating pressure switch maintains a system pressure of 30 P.S.I.A.
- Motor is 1/15 H.P. nominal 24-28 volts D.C., 5,000 R.P.M., continuous duty, shunt wound
- Current draw is 3.4 amperes maximum under normal operating conditions
- Life is 500 operating hours
- Weight is 12 lbs. maximum

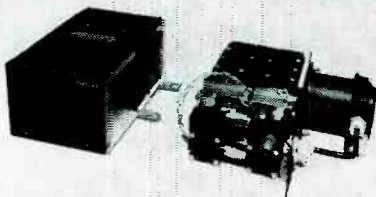

MODEL E/AP-2400 TYPE 201B

- Maintains system pressure of 31 P.S.I.A.
- Motor is 1/10 H.P., 24-28 volts D.C., 5,000 R.P.M. continuous duty
- Current draw is 5.5 amperes maximum
- Life is 500 operating hours
- Weight is 10-3/4 lbs. maximum

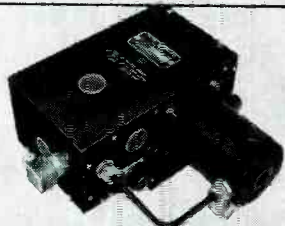

MODEL E/AP-3600 TYPE 200

- Maintains system pressure of 31 P.S.I.A.
- Motor is 1/7 H.P., 10,000 R.P.M. { 208 V., 400 cy., 3 ph. } continuous operation 24-28 V.D.C.
- Current draw is { 1.3 amp./phase } amperes maximum under normal operating conditions { 7.1 on D.C. }
- Life is 1,000 operating hours
- Weight is 8-1/2 lb. maximum

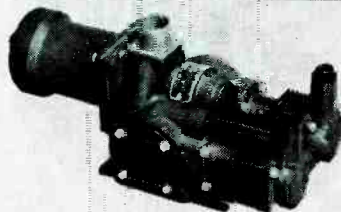

Eastern
INDUSTRIES, INC.



100 SKIFF STREET
HAMDEN 14, CONN.

COMPLETE
AVIATION
CATALOG #330-P
ON REQUEST.

is designed for positive waterproofing, dust-proofing, moisture-proofing and explosion-proofing of panel-mounted toggle switches. Panseal is a precision-molded seal comprising and explosion-proofing of panel-a threaded metal insert. It secures toggle switch to panel without danger of loosening under shock and vibration. The elastic member is of silicone base rubber configured to grip the toggle lever firmly, yet allow its full movement. Lateral ridges in the internal wall secrete a silicone grease (inserted prior to installation) and provide a continuous source of lubrication during normal operation of the switch lever. A flyer listing industrial applications is available.

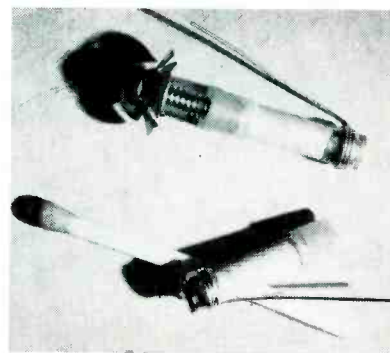

GLASS TRIMMER is only ¾ in. long

CORNING GLASS WORKS, Corning, N. Y., announces a new low-cost, glass midget rotary trimmer capacitor that measures ¾ in. in overall length. It is available in two sizes: 0.5-3.0 μf and 1.4-4.5 μf . Q is 500 at 50 mc. Temperature coefficient of the body of the trimmer is 200 ppm.

CERAMIC for microwave attenuation

AMERICAN LAVA CORP., Cherokee Blvd. & Mfgs. Rd., Chattanooga 5, Tenn. AlSiMag 624 is a member of a new series of ceramics for use as power absorbers. It is recommended where 10 w or more of power must be handled and where organic materials are unstable. The maximum wattage absorbed depends on provisions for dissipation of heat. This ceramic material can be fabricated

Pipes of Progress

Hundreds of thousands of telephone conversations or hundreds of television programs may one day travel together from city to city through round waveguides—hollow pipes—pioneered at Bell Telephone Laboratories.

Round waveguides offer tremendous possibilities in the endless search for new ways to send many voices great distances, simultaneously, and at low cost. Today, Bell Laboratories developments such as radio relay, coaxial cable and multivoice wire circuits are ample for America's needs. But tomorrow's demands may well call for the even greater capacity of round waveguides.

Unlike wires or coaxial, these pipes have the unique property of *diminishing* power losses as frequencies rise. This means that higher frequencies can be used. As the frequency band widens, it makes room for many more voices and television programs. And the voices will be true, the pictures faithfully transmitted.

These studies illustrate once more how Bell Telephone Laboratories scientists look ahead. They make sure that America's telephone service will *always* meet America's needs, at the lowest possible cost.

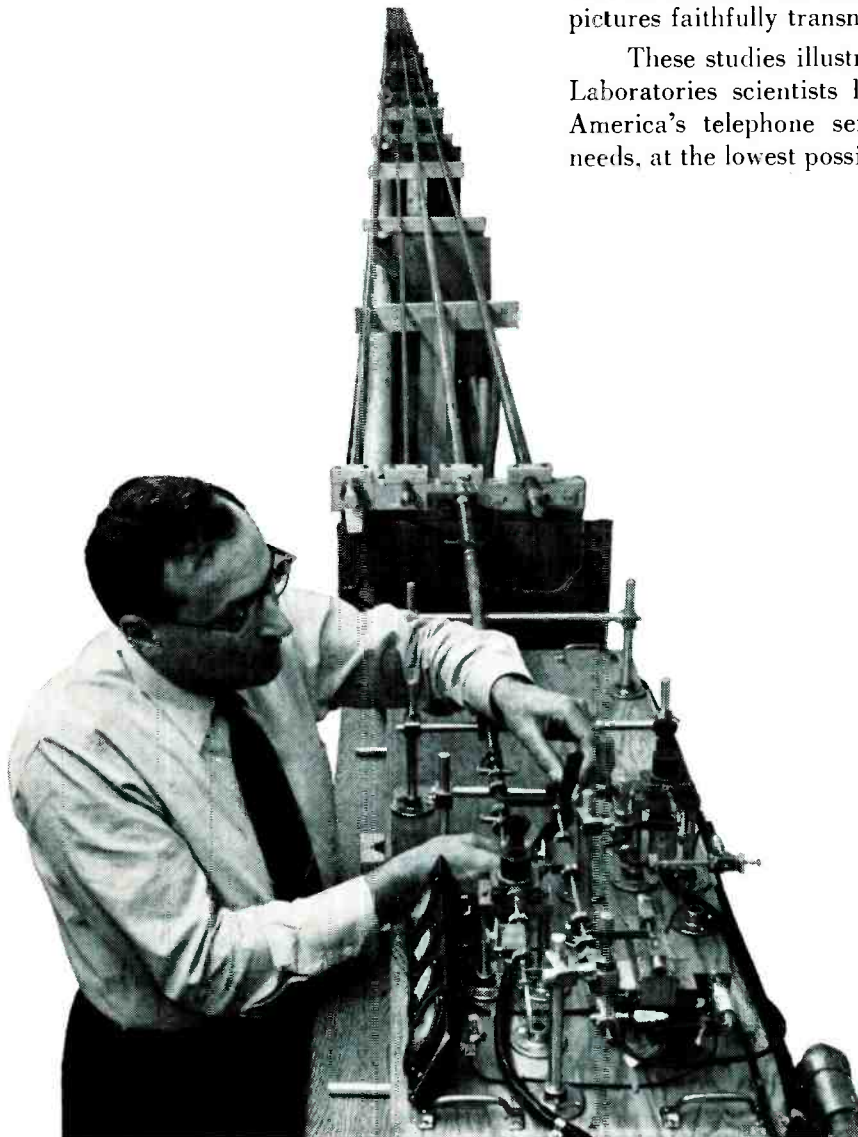

Testing round waveguides at Bell Telephone Laboratories, Holmdel, New Jersey. Unlike coaxial cable, waveguides have no central conductor. Theoretically, voice-capacity is much greater than in coaxial cable.

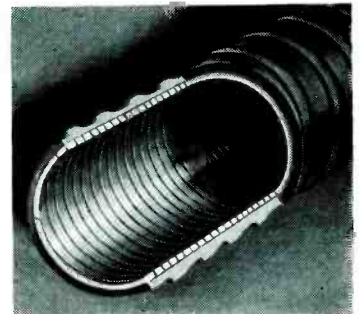

New type of waveguide pipe formed of tightly wound insulated wire transmits better around corners than solid-wall pipes.



New type waveguide is bent on wooden forms for study of effect of curvature on transmission. The waveguide itself is here covered with a protective coating.



Bell Telephone Laboratories

Improving America's telephone service provides careers for creative men in scientific and technical fields.

HOMELITE

Gasoline-Engine-Driven Generators

designed and built to meet
toughest specifications

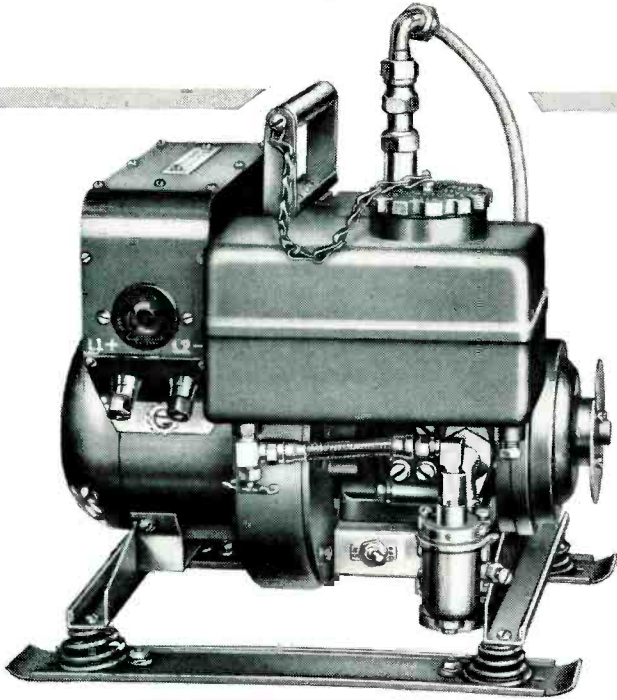

Another Typical Homelite Example

This is the first generator of this size procured to meet the requirements of MIL-G-10286A(CE) and the requirements of the reference engine specification MIL-E-11275A(CE). Only 22 pounds complete, it has a military rating of .15 KW, 120 V., 60 cycle, 1 Phase, 1.0 P.F. reconnectable to 120 V. DC. One gallon of fuel will operate this generator more than 11 hours at full load.

What's your problem? If it involves meeting MIL specifications for lightweight generators, get in touch with Homelite.

With more than thirty years' experience in designing and building hundreds of thousands of lightweight, dependable gasoline-engine-driven units, Homelite's engineering and manufacturing facilities are in a position to find the best solution to your toughest problem, quickest.

Write and you will receive prompt, competent and confidential service.

Homelite builds generators in sizes from .15 KW up to 5 KW in all voltages and frequencies . . . with either gasoline engine or electric motor drive.

Manufacturers of Homelite
Carryable Pumps
Generators • Blowers
Chain Saws

PERFORMANCE • DEPENDABILITY
HOMELITE
CORPORATION
SERVICE

6806 RIVERDALE AVENUE • PORT CHESTER, N. Y.

Canadian Distributors: Terry Machinery Co., Ltd., Toronto, Montreal, Vancouver, Ottawa

in a wide variety of shapes and sizes. The manufacturer can formulate ceramic materials to meet a wide range of dissipation factors and volume resistivities for specific attenuation requirements. Test samples and condensed data sheet will be sent on request.

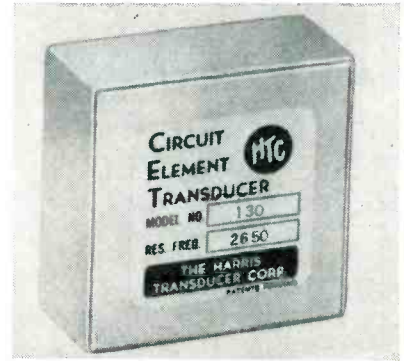

TRANSDUCERS have variety of uses

THE HARRIS TRANSDUCER CORP., Woodbury, Conn. Circuit element transducers (CET's) are simple symmetrical electromechanical devices. Small in size, they are efficient as high-impedance, narrow-band, interstage coupling filter elements, or as low-level oscillator circuits. In groups they provide comb filtering, band-pass filtering or spectrum analysis. Where it is desirable to have matched sets, units can be provided to within a cps in center frequency. They are available in a range of frequencies from 100 cps to 7 kc. They can be supplied to a specified frequency with Q's of 100 or 250. The elements are temperature compensated and are operable to 130 F.

TRIODE-PENTODE is miniature 9-pin type

SYLVANIA ELECTRIC PRODUCTS INC., 1740 Broadway, New York 9, N. Y. The 6BA8 is a miniature, 9-pin, medium- μ triode and sharp cut-off pentode. It is intended for service in tv receivers employing a series heater string. The pentode section has a plate dissipation rate of 3.25 w and is designed to serve as a video amplifier. The triode section has a μ of 18 and is suitable for applications where a low-

Output vs. Input Voltage

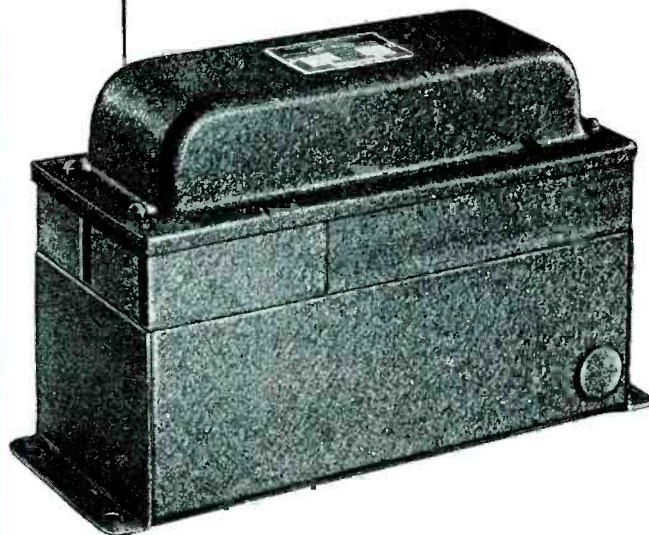
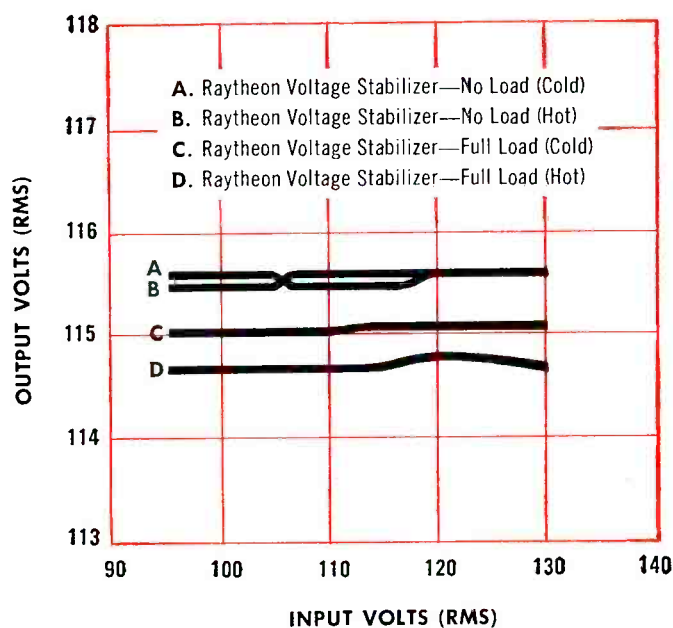

Why Raytheon Voltage Stabilizers mean satisfied customers for you

When you incorporate a Raytheon Voltage Stabilizer in your equipment, you help assure complete customer satisfaction—for these important reasons:

1. Your equipment will operate as it was designed to, regardless of voltage variations of your customers' electrical source.
2. Since most components have maximum life when operating at their designed voltage, a Raytheon Voltage Stabilizer prolongs the life of components—and your equipment. A plus feature is provided by the short-circuit protection inherent in Raytheon Voltage Stabilizers.
3. Because Raytheon Voltage Stabilizers are superior to any other static type stabilizer under virtually all operating conditions, your equipment will work better and longer—characteristics your customers really appreciate.

Check these important points of Raytheon

Voltage Stabilizer superiority

Raytheon Model VR-6113 (120 watts) chosen at random and compared with a similarly rated competitive model.

- Guaranteed to deliver accurate AC voltage within $\pm\frac{1}{2}\%$ (competitive model 1%)
- 14% lighter, 22% smaller
- Three times more accurate no-load to full-load regulation
- 17% less change in voltage output as frequency varies
- 28% closer regulation as temperature changes

For full information see your electronic supply house
or write Dept. 6120

RAYTHEON MANUFACTURING COMPANY

Equipment Marketing Division, Waltham 54, Mass.



Excellence in Electronics

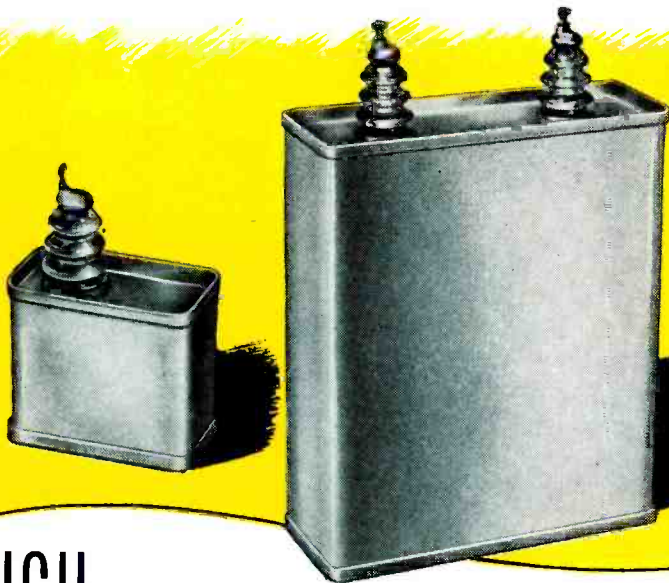

HIGH INSULATION RESISTANCE...

LOW POWER FACTOR

wherever these properties are required—

AEROVOX

Polystyrene

CAPACITORS



Designed to take full advantage of the unusual properties of **polystyrene**, for applications such as computing devices, tuned circuits demanding highest Q standards, capacitance bridges, timing circuits, laboratory standards, circuits requiring low dielectric absorption, and so on.

AeroVox polystyrene-dielectric capacitors are generally available in such standard case designs as cardboard-case tubulars (Type L84), glass end-seal metal tubular-case (Type L123XG), metal-case bathtubs (Type L30), and rectangular-can (Type L09).

Available in other special designs and uncased units

Get the FACTS!

Technical data, including performance curves, sent on request. Let us collaborate on your standard or special capacitance requirements.



AEROVOX CORPORATION

NEW BEDFORD, MASS.

HI-Q DIVISION, Olean, N. Y. • ACME ELECTRONICS, INC. Monrovia, Calif. • CINEMA ENGINEERING CO., Burbank, Calif. • HENRY L. CROWLEY & CO., West Orange, N. J.

In Canada: AEROVOX CANADA LTD., Hamilton, Ont. JOBBER ADDRESS: 740 Belleville Ave., New Bedford, Mass. Export: Ad. Auriema, Inc., 89 Broad St., New York, N. Y. • Cable: Auriema, N. Y.

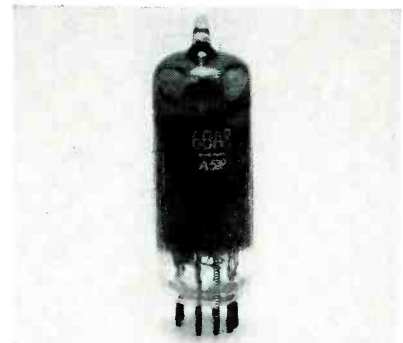

mu triode is desirable, such as sync amplifiers. The 6BA8 contains in addition a 600-ma heater with controlled warmup ratings. With the 6.3-v heater rating it can be used in conventional transformer sets.

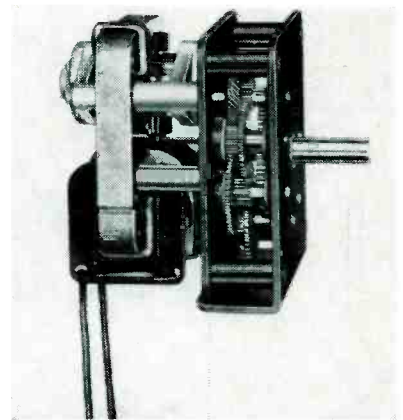

GEARMOTOR

is versatile combination

NEW ENGLAND GEAR WORKS, 2027 South End Rd., Southington, Conn. Model MD gearmotor is a versatile gear train and motor combination. It can be had with ratings from 1/300 hp to 1/35 hp with any single speed from $\frac{1}{2}$ rpm to 426 rpm, for clockwise or counter-clockwise operation. The unit employs a shaded pole motor with an internal cooling fan and self-aligning oilless bearings. It operates on 115 v, 60 cps. Torques range from 60 lb in. at 1 rpm to 5 lb in. at 10 rpm, available with either open or enclosed gear train.

TEST CHAMBER

with dry ice compartment

TENNEY ENGINEERING, INC., 1090 Springfield Road, Union, N. J. A new high and low temperature en-

Winco dynamotors qualify

for Signal Corps Reduced Inspection Plan

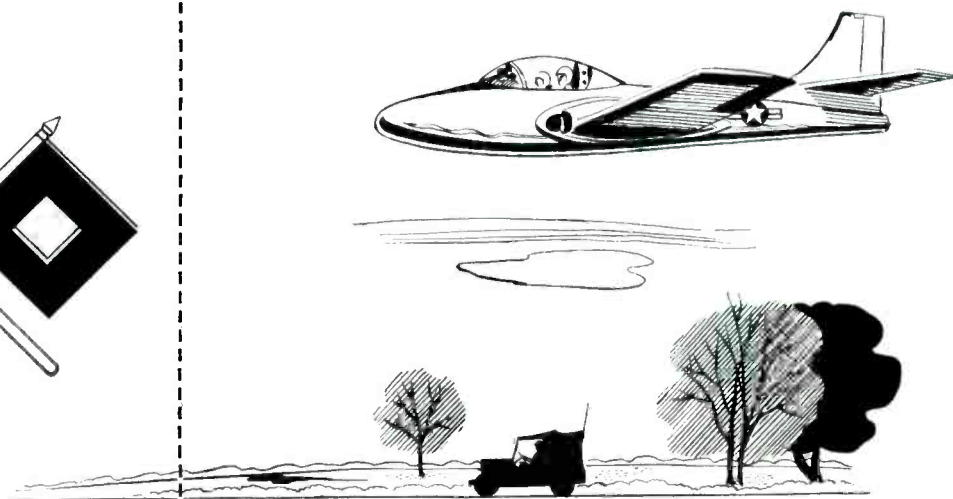
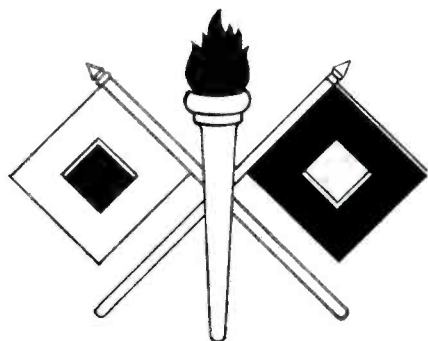

The Wincharger Corporation's long history of producing dynamotors "equal to or better than the Acceptability Quality Level established by the government" has resulted in the Signal Corps' selection of Winco dynamotors for its Reduced Inspection Quality Assurance Plan.

As of this writing, Wincharger is the only manufacturer of dynamotors qualified under RIQAP. Only those suppliers who have consistently furnished material of the highest quality level and who maintain quality control and inspection methods and procedures acceptable to the Signal Corps are considered for this honor.

This new Signal Corps plan places more responsibility for maintenance of quality on the manufacturer by reducing the amount of government inspection. It is an honor inspection program.

What does Wincharger qualification for RIQAP mean to you — further evidence that you can depend on Winco Products.

WINCO®

**Power for the nation's
mobile communications**

WINCHARGER CORPORATION

Sioux City 2, Iowa

Subsidiary of Zenith Radio Corporation

marion
 advancement
 in instrument
 design

WHAT
 HAPPENED
 ?

SCHEDULE
 MAINTENANCE
 STUDY
 PRODUCTIVITY

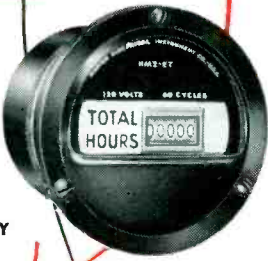

Glass-to-metal sealed
 ELAPSED TIME
 indicators. Compact, low
 cost, tamper-proof. Standard
 ASA-MIL dimensions, 2½" and
 3½" sizes. Easy to read standard
 size counter registers 1/10 hour
 steps to 9999.9 or hour steps to
 99999. Hermetically sealed. Shielded.
 Starts, operates continuously from
 -55° C. to +85° C. For 110-125
 or 220-250 volt 50 or 60 cycle A.C.



marion electrical instrument co.

401 Canal St., Manchester, N. H., U. S. A.
 Manufacturers of Ruggedized and "Regular"
 Panel Instruments and Related Products.

copyright 1955 M. E. I. Co.

marion meters
MOLYBDENUM

**PURE and THORIATED
 TUNGSTEN**

For ELECTRONIC APPLICATION

RIBBONS

STRIPS

FORMED PIECES

Your special metals
 rolled to thin sizes
 - close tolerances

H. CROSS CO.
 15 BEEKMAN ST., N. Y. 38, N. Y.
 Worth 2-2044 and COrtlandt 7-0470

NEW PRODUCTS

(continued)



Environmental testing chamber incorporates a removable dry ice compartment as a source of cold air. Model TDI-8 chamber was developed for small cold metal treating shops, electronic component and instrument manufacturers, laboratories and other testing organizations which require low cost test facilities. Temperature range of the chamber is from -100 F to +200 F, meeting a broad range of MIL testing specifications. Reported pull-down is from ambient to -100 F in about 60 minutes, while +200 F can be reached in about 30 minutes. Cubic interior of the test chamber is 8 cu ft.



DYNAMIC MICROPHONE
 is highly sensitive

TURNER Co., 905 17th St. N. E., Cedar Rapids, Iowa, is producing a slender-type, high-fidelity dynamic microphone for use in broadcasting, telecasting, recording and public address. Users may select either high or low impedance by making connection to the proper pair of connectors at the terminal

LARGEST VARIETY

of
SIZES and
TYPES

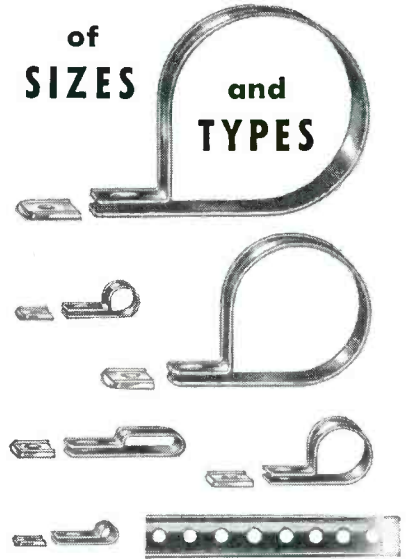

PLASTIC CABLE CLIPS
 and **PERFORATED STRAPPING**

Hold open wiring, fragile components, tubing, etc. with these safe, light weight supports.

Free samples and complete information.

WECKESSER CO.

5267 N. Avondale Ave., Chicago 30, Ill.

For consistently high purity...

"LINDE" M.S.C. RARE GASES
 Trade-Mark
 (Mass Spectrometer Controlled)

- Helium
- Argon
- Neon
- Krypton
- Xenon

In radar electronic equipment, nuclear radiation counters, cosmic ray cloud chambers, and thyratrons, where the purest rare gases are demanded, LINDE M.S.C. Grade gases meet the specifications. They are produced under continuous mass spectrometer control to assure you of gases of known purity and consistently high quality. LINDE, the world's largest producer of gases from the atmosphere, can meet your individual needs of volume, mixture, and container.

For information on the physical, chemical, and electrical properties of these gases, send for the booklet, "LINDE Rare Gases."



LINDE AIR PRODUCTS COMPANY

A Division of
 Union Carbide and Carbon Corporation
 30 E. 42nd Street **UCC** New York 17, N.Y.

In Canada:
 Dominion Oxygen Company, Division
 of Union Carbide Canada Limited, Toronto
 The term "Linde" is a registered trade-mark of Union Carbide and Carbon Corporation.



Puts your business on a cash basis

If you are an electronics manufacturer wholesaler with annual or potential sales of \$1,000,000 or more you can profitably use our kind of banking service to provide increased working capital without increased indebtedness or dilution of profits.

Why not investigate this modern approach to your money problems and learn how you can put your business on an all-cash basis, with wider opportunities for sales and profits.

More than four hundred companies in various industries are now profitably using our banking services.

Textile Banking Co., Inc.

Providing operational financing for manufacturers and distributors of furniture, apparel, electronics, plastics and textiles.

55 Madison Avenue, New York 10, N. Y.

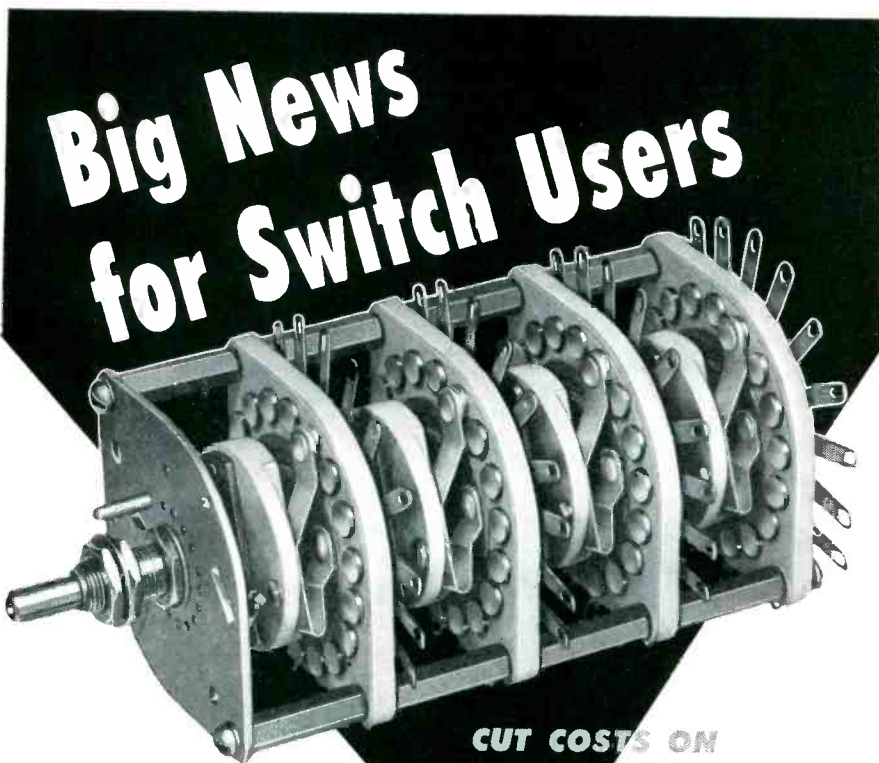

Big News for Switch Users

**CUT COSTS ON
INSTRUMENT SWITCHES**

**SHALLCROSS
"12000 SERIES"
OVER 275 TYPES
FROM STOCK**

New Shallcross "12000 Series" Oval Ceramic Switches offer "custom-built" quality — without the delay and cost of specials.

With only a few basic interchangeable parts, constantly stocked by Shallcross, over 1000 different switch types can be quickly assembled. Delivery is immediate. Your specifications are matched exactly.

The use of solid silver contacts and collector rings, low-loss steatite decks, and silver plated beryllium-copper wiper pressure springs assures uniformly low contact resistance and exceptional durability for a wide variety of instrument switching applications.

For complete information on "12000 Series" Switches, write, wire, or phone for Shallcross Engineering Bulletin L-32 which catalogs 275 of the most popular types. SHALLCROSS MFG. CO., 522 Pusey Avenue, Collingdale, Pa.

Shallcross 12000 Series Oval Ceramic Switches

NON-SHORTING ACTION—40° or 60° indexing

SHORTING ACTION—20° or 30° indexing

DETENT—Optional. Positive-acting star wheel type.

POLES PER DECK—1, 2, or 3

NUMBER OF DECKS—Up to 10 decks may be ganged.

ADJUSTABLE STOP—Available on order

SHAFT—Completely isolated

CONTACT RESISTANCE—0.0025 ohm, ±0.0002 ohm

RATINGS—110 v., 1a., 60 cy.-nominal.
2500 v., 60 cy.-de-rated current.
40 amps—de-rated voltage.

Complete specifications in Bulletin L-32.

end of the 20-ft, 3-conductor shielded cable. Another feature is the rugged, sensitive Dynaflex high-fidelity diaphragm. Frequency response is 50 to 13,000 cps. Output level is 55 db below 1 v per dyne per sq cm.

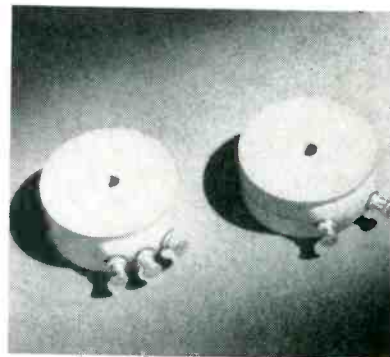

TOROIDS are hermetically sealed

DIETZ DESIGN AND MFG. Co., Grandview, Mo., has available a new line of encapsulated toroids. The outstanding feature of the new line is a molding technique which permits (1) relief of mounting strains to permit absolute physical and electrical uniformity of product; (2) guaranteed accuracies as great as 0.1 percent or one turn of winding where required; (3) hermetic sealing—meeting MIL-T-27 requirements; (4) low cost low due to techniques which result in low rejection rates even at high accuracies. Toroids described are available wound on standard or temperature stabilized cores of 125, 60, 26 or 14 permeability and with threaded or oversize hole mounting.

TUNING FORK is plug-in unit

VARO MFG. Co. INC., 1801 Walnut St., Garland, Texas, is producing a highly miniaturized precision tuning fork. The fork, 0.875 in. in diameter × 2.75 in. high, is designed to plug into a standard 9-pin miniature tube socket. Frequency range is from 300 to 3,000 cycles. Accuracy is 0.1 percent. Rugged construction prevents loss of accuracy during exposure to extremes of shock, vibration and temperature. Designed for use as a frequency or

▶ Shallcross

NEW VARIAN KLYSTRONS

ADD SEVEN LEAGUE BOOTS

to microwave transmission...

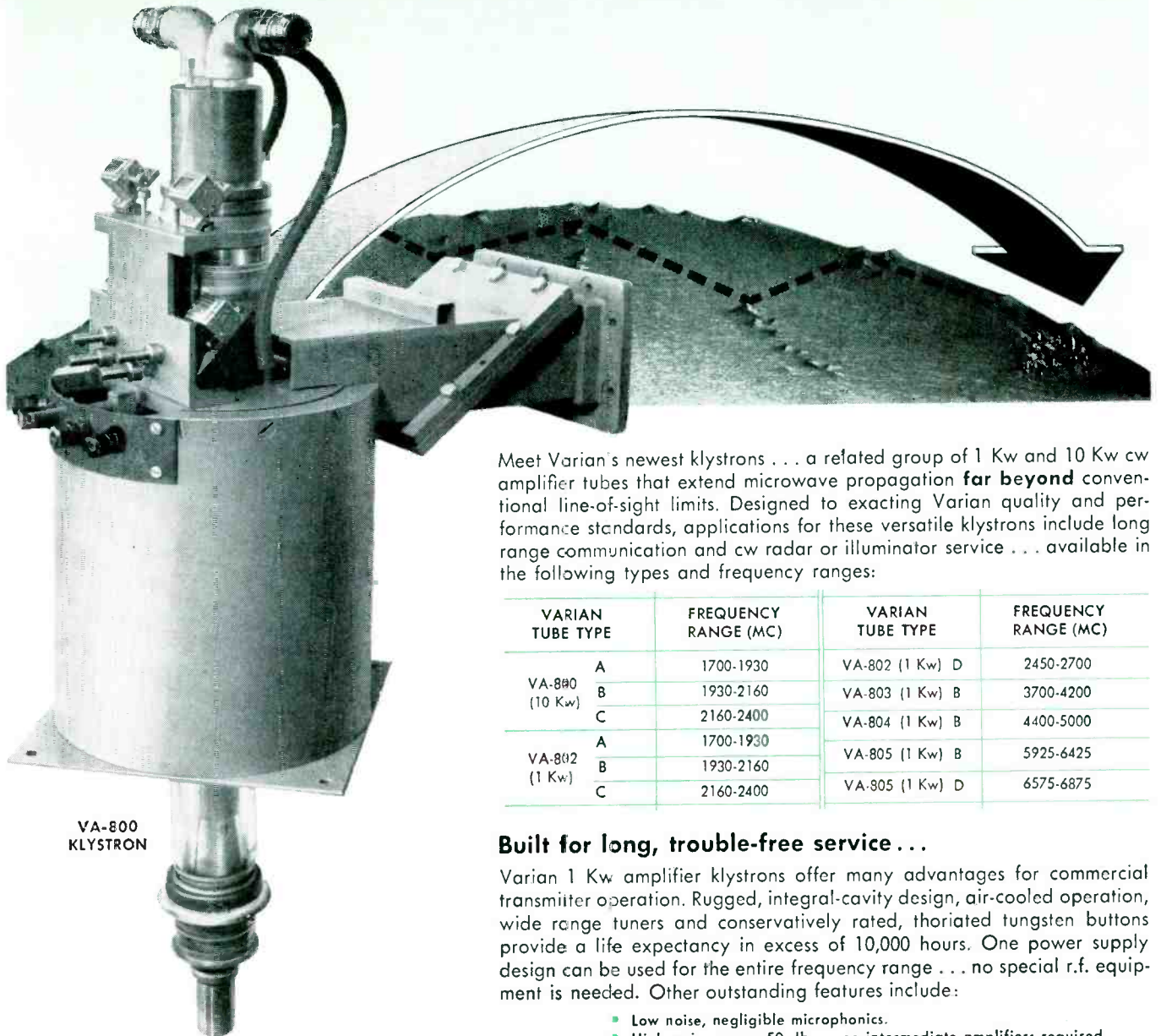

VA-800
KLYSTRON

Meet Varian's newest klystrons . . . a related group of 1 Kw and 10 Kw cw amplifier tubes that extend microwave propagation **far beyond** conventional line-of-sight limits. Designed to exacting Varian quality and performance standards, applications for these versatile klystrons include long range communication and cw radar or illuminator service . . . available in the following types and frequency ranges:

VARIAN TUBE TYPE	FREQUENCY RANGE (MC)	VARIAN TUBE TYPE	FREQUENCY RANGE (MC)	
VA-800 (10 Kw)	A	1700-1930	VA-802 (1 Kw) D	2450-2700
	B	1930-2160	VA-803 (1 Kw) B	3700-4200
	C	2160-2400	VA-804 (1 Kw) B	4400-5000
VA-802 (1 Kw)	A	1700-1930	VA-805 (1 Kw) B	5925-6425
	B	1930-2160	VA-805 (1 Kw) D	6575-6875
	C	2160-2400		

Built for long, trouble-free service . . .

Varian 1 Kw amplifier klystrons offer many advantages for commercial transmitter operation. Rugged, integral-cavity design, air-cooled operation, wide range tuners and conservatively rated, thoriated tungsten buttons provide a life expectancy in excess of 10,000 hours. One power supply design can be used for the entire frequency range . . . no special r.f. equipment is needed. Other outstanding features include:

- Low noise, negligible microphonics.
- High gain — over 50 db . . . no intermediate amplifiers required.
- Standard waveguide output — permits direct coupling.
- High efficiency and simplicity of installation.

EXTEND YOUR MICROWAVE HORIZONS . . . Write today for complete specifications and technical information on the new Varian 1 Kw and 10 Kw amplifier klystrons . . . data on the Varian V-42 and other high power klystrons is also available. Address our Applications Engineering Department or contact your nearest Varian representative.

THE
MARK OF
LEADERSHIP

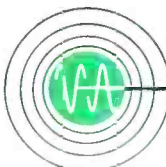

VARIAN associates
PALO ALTO 1, CALIFORNIA

KLYSTRONS, TRAVELING WAVE TUBES, BACKWARD WAVE OSCILLATORS, R.F. SPECTROMETERS, MAGNETS, STALOS, UHF WATERLOADS, MICROWAVE SYSTEM COMPONENTS, RESEARCH AND DEVELOPMENT SERVICES



CHICAGO
HERMETICALLY
SEALED
TRANSFORMERS
 that meet the full
 requirements of
MIL-T-27

A complete range of MIL-T-27 units is available for quick delivery from your Chicago Standard distributor.

- POWER
- AUDIO INPUT
3 frequency ranges
- 400 CYCLE
Power
Filament
Chokes
- FILAMENT
- AUDIO OUTPUT
3 frequency ranges
- MS (Military Standard)
Power,
Filament
- BIAS
- PULSE

Ask for the free CHICAGO catalog, listing detailed electrical and physical specifications on all these transformers. Available from your electronic parts distributor or from Chicago Standard Transformer Corporation.



CHICAGO STANDARD TRANSFORMER CORPORATION

ADDISON AND ELSTON • CHICAGO 18, ILLINOIS

Export Sales: Roburn Agencies, Inc., 431 Greenwich Street, New York 13, N.Y.



timing reference of high accuracy, or as a signal filter, the tuning fork meets all applicable military aircraft specifications.

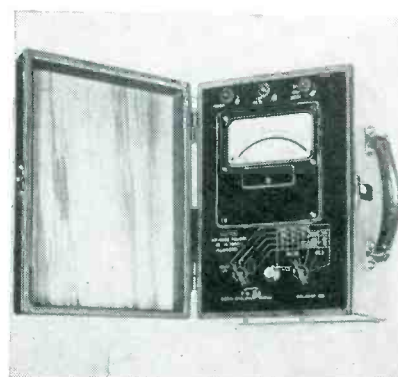

VTVM is a multirange unit

DUBROW DEVELOPMENT Co., 235 Penn St., Burlington, N. J., has developed a multirange precision a-c voltmeter-milliammeter, the Multipac model 392, which covers 12 voltage ranges and 6 ma ranges with 0.5 percent accuracy. Voltage ranges are from 0.5 v to 2,000 v; current ranges are from 50 ma to 2 amperes. Sensitivities range from 1,000 ohms per v to 4,000 ohms per v on voltage ranges and 500 mv on all current ranges. No thermocouples or meter rectifiers are employed; true rms values are obtained by employing a Weston model 455 electro-dynamometer type meter. Frequency range is from 25 to 1,000 cps.

JUNCTION TRANSISTOR for hearing-aid use

CBS-HYTRON, a division of Columbia Broadcasting System, Inc., Danvers, Mass. A *pnp* junction transistor for hearing-aid applications has been announced. Type

DO YOU HAVE A

SEALING PROBLEM, too?



When it comes to *static* sealing you can depend upon the specialized experience and know-how of the Franklin C. Wolfe Company.

Nearly every leading industrial producer in America uses at least one Wolfe sealing design.

In fact, many companies have found that it pays to take advantage of our free sealing design consultation service. This service saves many hours of design-engineering time and effort by helping to "*seal the entire assembly at the design stage.*" If your designs require sealing why not use this free service yourself?

For full particulars just drop us a line on company letterhead.



LOCK-O-SEAL



RIV-O-SEAL

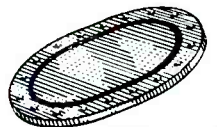

GASK-O-SEAL

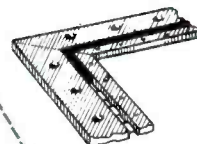

STRIP-O-SEAL



STAT-O-SEAL



BOLT-O-SEAL

To seal fasteners, flanges, or fittings one of the "O-seal" family is your assurance of safe, sure, zero-leakage sealing.

"It pays to cry WOLFE for sealing!"



FRANKLIN C. WOLFE CO., INC.

3644 Eastham Dr.

Culver City, Calif.

"Sealing design specialists"

AMONG IMPORTANT
ACTIVITIES AT HUGHES
IS A PROGRAM INVOLVING
COMPREHENSIVE
TESTING AND EVALUATION
IN CONNECTION WITH
HUGHES-DEVELOPED
RADAR FIRE CONTROL
AND NAVIGATION SYSTEMS
FOR LATEST TYPE
MILITARY ALL-WEATHER
INTERCEPTORS.

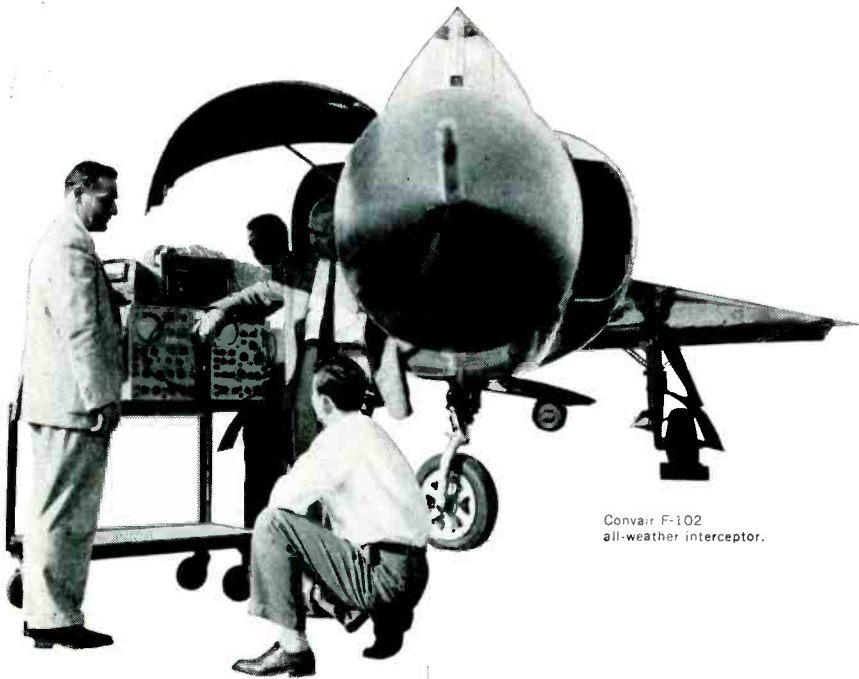

Convair F-102
all-weather interceptor.

System Test Engineers

SCIENTIFIC AND ENGINEERING STAFF

Hughes

There is need on our Staff for qualified engineers who thoroughly understand this field of operation, and who have sufficient analytical and theoretical ability to define needed tests; outline test specifications; assess data derived from such tests, and present an evaluation of performance in report form.

Engineers who qualify in this area should have **1** a basic interest in the system concept and over-all operation of test procedures; **2** experience in operation, maintenance, "debugging," development, and evaluation testing of electronic systems, and knowledge of laboratory and flight test procedures and equipment; **3** understanding of basic circuit applications at all frequencies; **4** initiative to secure supporting information from obscure sources.

RESEARCH AND
DEVELOPMENT LABORATORIES
Culver City, Los Angeles County, California

NEW PRODUCTS

(continued)

2N38A is especially designed and tested for low noise operation. Peak maximum noise rating is 27 db per μv at a frequency of 1,000 cps, with load resistance of 20,000 ohms and input resistance of 1,000 ohms. Its nickel silver can, 0.330 in. long by 0.225 in. in diameter, is hermetically sealed against surface contamination, light excitation and humidity.



MULTI-SCALE METER provides up to 5 scales

DEJUR-AMSCO CORP., 45-01 Northern Blvd., Long Island City 1, N. Y. Series HD-647 sealed multimeters provide up to 5 scales in all sensitivities, a-c or d-c, within the compact areas of a single 2½-in. panel instrument. The instruments conform to JAN-1-6 mounting dimensions. Screw-lock terminal connectors provide quick installation and disconnect for replacement or service. The meter is also available in 3½-in. diameter on special order.

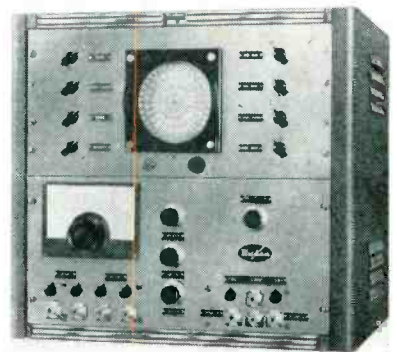

PHASE DISPLAY UNIT ideal for transistor studies

WICKES ENGINEERING AND CONSTRUCTION Co., 12th St. and Ferry Ave., Camden 4, N. J. Model PDE-1

If you have

VIBRATION

PROBLEMS ... install

HUBBELL

Interlock PLUGS

TRADE-MARK

for Dependable
Wiring Connections

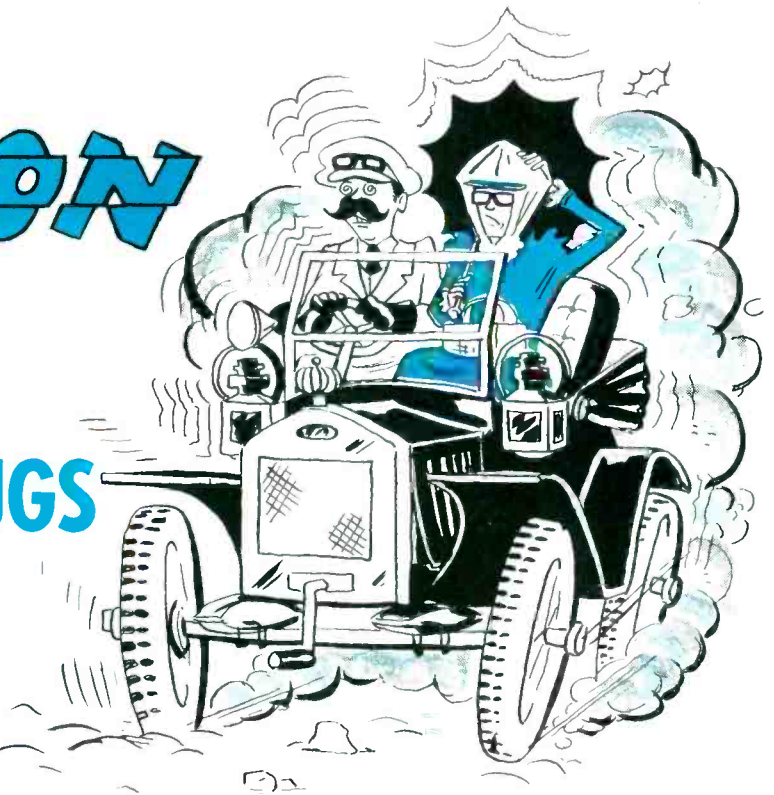

There's nothing new about vibration problems, and actually, little can be done to prevent vibration in many of today's electronic and electrical systems. It is possible, however, to make wire connections secure enough to withstand

tremendous vibrational stress. Hubbell *Interlock* Plugs are designed to provide a dependable, locked connection, even when subjected to the most severe conditions.

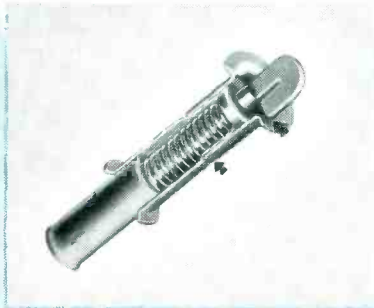

Automatic Lock . . . Quick Disconnect

Always be sure of a positive, low contact resistance connection with *Interlock* Plugs. Note how contact head locks securely and automatically in its eyelet. Contact is made on two surfaces maintained by coil spring pressure even during extreme temperature changes, impact and vibration.

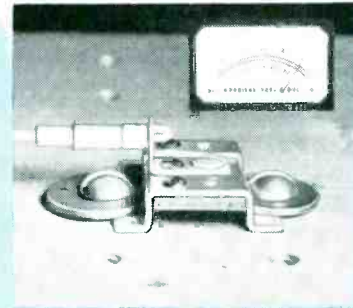
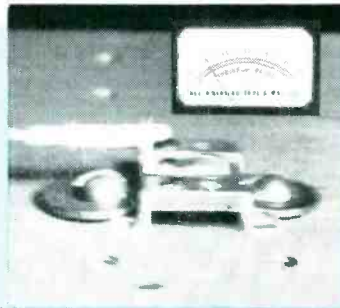

Tests Prove It!

Left: With *Interlock* Plug and Jack securely mounted, test begins with platen vibrating at 10 cycles per second. Right: at 50 cycles per second, camera stops motion to show plug still locked in its jack! Tested for 18 hours at an amplitude of .06 inch and at a varying frequency from 10 to 50 to 10 cycles per second, there wasn't a single failure!



For Further Information, Write Dept. A:

HARVEY HUBBELL, INC.

Interlock Electronic Connector Dept., Bridgeport 2, Conn.



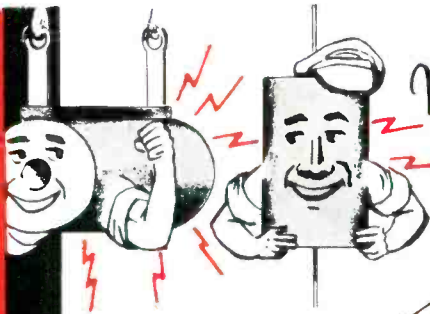

We're **DALOHM**...
miniature but
mighty!

You can depend on



TYPE WWA & WWL PRECISION ENCAPSULATED RESISTORS

For critical applications. Non-inductive, Pi-wound, encapsulated in chemically inert compounds for complete protection.

Superior performance is assured through thorough testing, temperature cycling, salt water immersion, humidity, and overload tests.

- Temperature coefficient 0.00002/Deg. C
- Ranges from 1 ohm to 3 megohms
- Tolerances as low as 0.05%

Built to Surpass MIL-R-93A

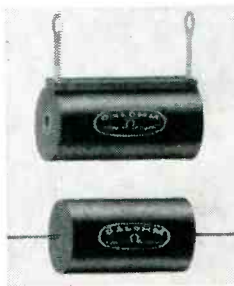

WRITE FOR BULLETIN No. R-26

DALE PRODUCTS, Inc.

1300 28th AVE., PHONE 2139 Columbus, Nebraska, U. S. A.

Export Dept.:
Pan-Mar Corp.,
1270 Broadway,
New York 1, N.Y.

NEW UHF MEGACYCLE METER

With the Widest
Frequency Coverage
in a Single Band

FEATURES

- Excellent coupling sensitivity.
- Fixed coupling point.
- Small grid current variation over band.
- Calibration point every 10 Mc.
- Uses split-stator tuning condenser with no sliding metal contacts.
- Standard camera socket for tripod fixtures.
- Octagonal case for convenient positioning.
- Useful in television transmitting and receiving equipment.

\$198.00
F. O. B. FACTORY



MODEL 59 UHF

SPECIFICATIONS

FREQUENCY RANGE: 430-940 Mc in a single band
FREQUENCY ACCURACY: $\pm 2\%$ (Individually calibrated)
OUTPUT: CW or 120-cycle modulation
POWER SUPPLY: 117 volts, 60 cycles, 30 watts
DIMENSIONS: Oscillator Unit 4 $\frac{3}{8}$ " x 2 $\frac{1}{2}$ "
Power Unit 5 $\frac{1}{8}$ " wide x 6 $\frac{1}{8}$ " high x 7 $\frac{1}{2}$ " deep



ROTOR BALANCER shows vibrational unbalance

M. TEN BOSCH, INC., 80 Wheeler Ave., Pleasantville, N. Y. The unit illustrated detects and measures small vibrational unbalance in rotary devices. Rotor vibrations arising from static and dynamic unbalance are applied to mechano-electronic transducers, whose outputs are fed to an electronic computer. By measuring the unbalance signal and comparing it with a photoelectric signal derived from the spinning rotor, precise production balancing is achieved. The instrument is capable of rapidly balancing all types of rotors including gyroscopes, high speed grinding heads, motors and turbines. Completely assembled units can be balanced. Spin axis may be

Laboratory Standards



**MEASUREMENTS
CORPORATION**
BOONTON • NEW JERSEY

SCATTER

ANDREW Parabolic Antennas for this exciting new method of communication are available in standard sizes of 15, 30 and 60 ft. diameter.

The 30 ft. Type P-30-1 illustrated has a gain of 36 db at 800 MC and the Dual feeds have 40 db isolation. Antenna is adjustable in both elevation and azimuth. Construction is of sectionalized sheet steel, field welded. Type 16607 tower supports antenna center 50 feet above ground.

Look to ANDREW for your complete antenna system, including transmission line. Specify HELIAX[®], a truly flexible air-dielectric coaxial cable.

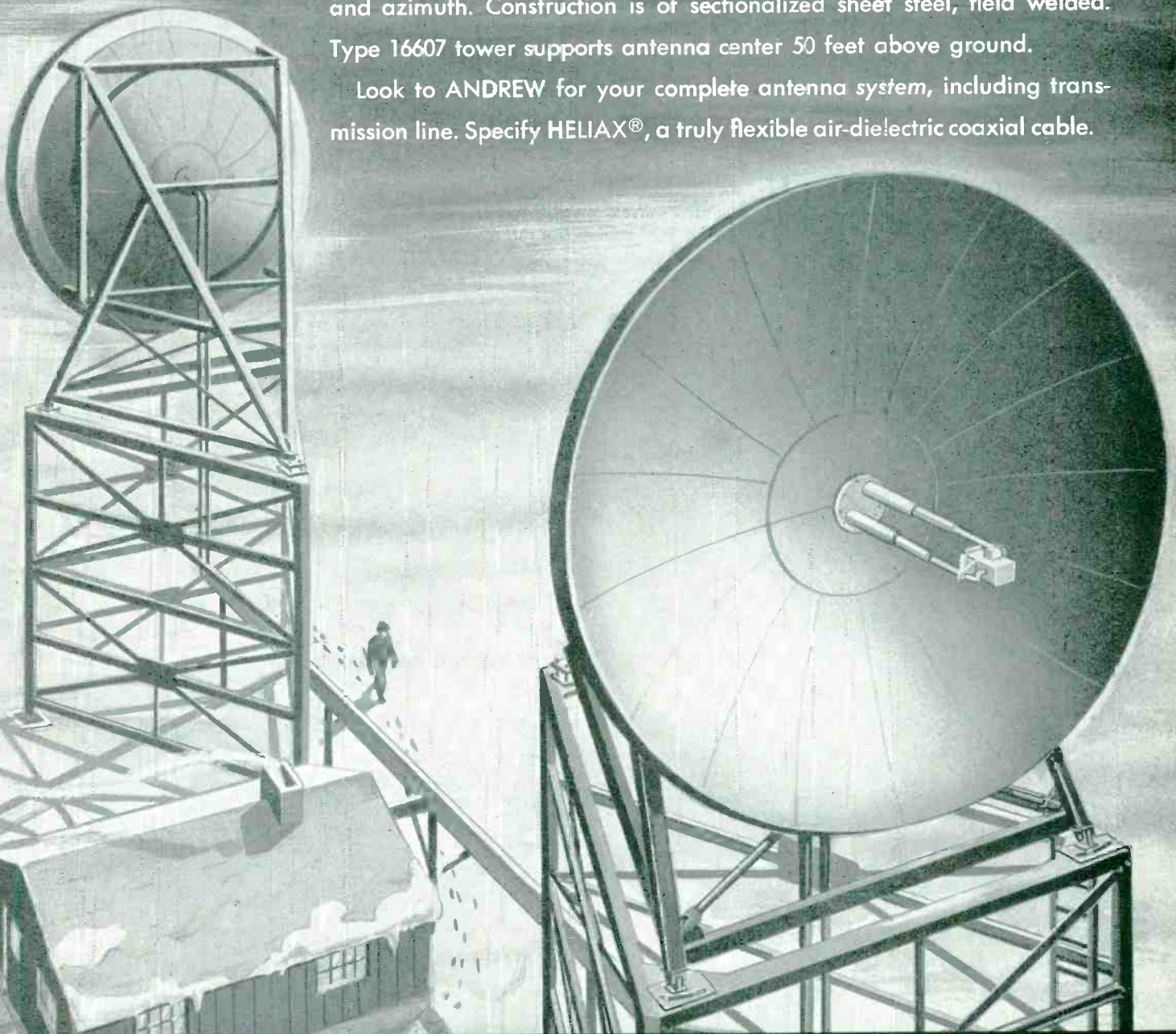

Andrew
CORPORATION
363 EAST 75th STREET • CHICAGO 19

TRANSMISSION LINES • ANTENNA EQUIPMENT



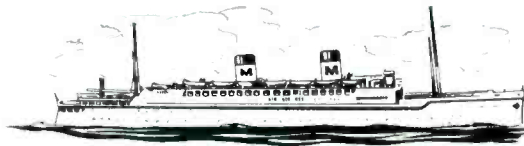

HYSOL 6000

goes to sea with RAYTHEON RADAR



The S. S. Lurline, one of the largest U. S. passenger liners, is the first big ship in the world to install Raytheon's new Model 1500 small boat radar. Scheduled for use as "standby" equipment, it will be used in conjunction with the regular 16-inch big ship "Mariners' Pathfinder" radar, shown in foreground and demonstrating comparative size. Chief Officer R. McKenzie inspects scope reading of the Model 1500.

HYSOL 6000 Epoxide Resins Used in Component Parts . . .

Complicated internal component parts of Raytheon radar equipment are formulated from HYSOL 6000 Series epoxide compounds because of their outstanding electrical and mechanical properties. In addition, HYSOL 6000 Series compounds provide a material which is economically molded into intricate shapes, including complicated inserts.

HYSOL 6000 Series compounds are made from the new epoxide resins and include a complete selection of room temperature and heat curing potting and casting compounds, easily machined sheets, rods and tubes, and coating and laminating varnishes.

The Raytheon application of HYSOL 6000 may suggest to you other plastic uses now posing a problem in your design or production departments. Houghton Laboratories, Inc., is ready to assist you with these problems through the experienced services of our skilled research laboratory, design and production departments. Your investigation will be welcomed at no obligation. Write, wire or phone today!



houghton laboratories, inc.

100 BUSH STREET

OLEAN, NEW YORK

NEW PRODUCTS

(continued)

horizontal or vertical. Rotors can be balanced at all speeds from 1,000 to 200,000 rpm and unbalance indications are independent of speed.

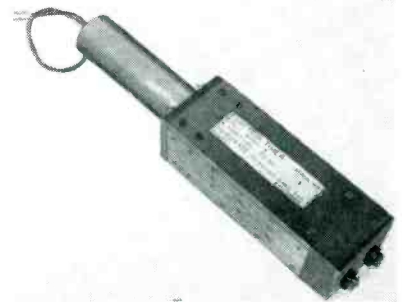

FUNCTION TIMER

designed for precision

HUBBARD SCIENTIFIC LABORATORIES, INC., 1292 E. Third St., Pomona, Calif. Type 1, model A function programmer is designed for minimum functional accuracy of 0.1 sec under extreme environmental conditions. By using a controlled voltage and under laboratory conditions, accuracy of 0.01 sec is possible. Time of travel is 50 sec nominal. The time may be varied above and below the nominal by changing the gear ratio, motor rpm or leadscrew pitch. The programmer incorporates four resistance and two switch functions nominal, and it is possible to incorporate any combination of switches and resistances up to six. Nominal operating voltage is 27 v d-c although provisions may be made for 400-cycle a-c operation.

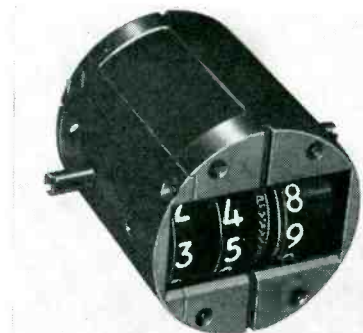

ANGLE COUNTER

for high-speed operation

BOWMAR INSTRUMENT CORP., 2415 Pennsylvania St., Ft. Wayne, Ind. Model 1502 angle counter features a reduced number of moving parts, aiming toward high speed operation.

A uniquely **NEW** Oscillograph from **Midwestern Instruments**

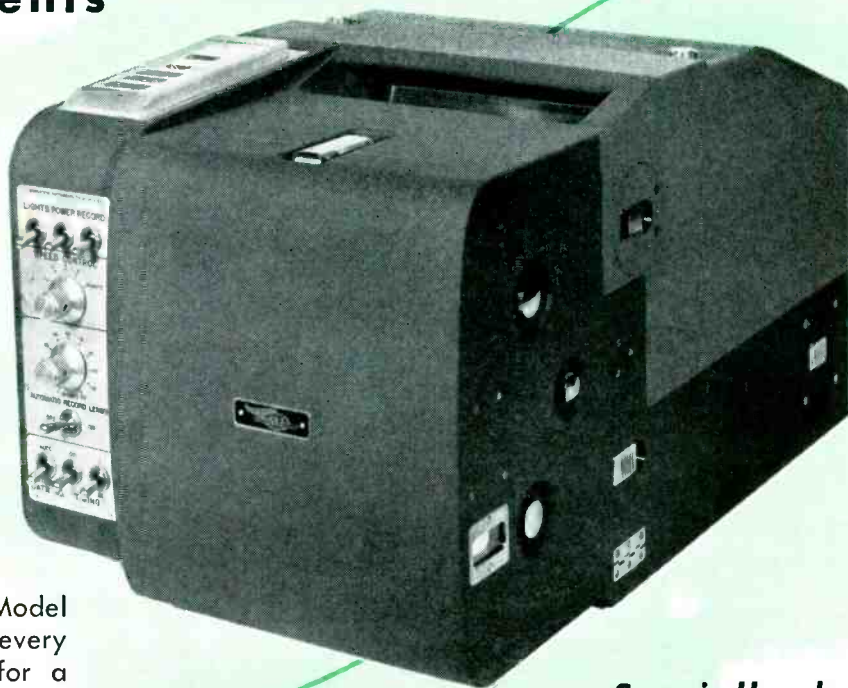

Midwestern's New Model 590 incorporates every feature necessary for a successful flight-test instrument.

**Specially designed
for remote control***

**If desired the instrument can be supplied with no controls on it. All control then originates at a remote location.*

Here's another great development in Midwestern's series of famous flight-test instruments. It is based on extensive experience applying other Midwestern oscillographs to many combinations of environmental conditions. One of the many features is a remotely-controlled jump-speed system. Speed may be changed at any time by simply positioning a rotary switch to the required setting. 20 recording speeds are possible with this electrically-actuated system and change gears within the oscillograph. Lamp intensities are automatically adjusted to a previously-set value for recording at the new speed. The single aluminum alloy casting is ribbed for the strength and rigidity needed under high acceleration conditions.

Write for Complete Details and Specifications

products

- OSCILLOGRAPHS
(LABORATORY AND FLIGHT TEST)
- MAGNETIC STRUCTURES
- GALVANOMETERS
- AMPLIFIERS
- HYDRAULIC SERVOVALVES
- TORQUE MOTORS
- SERVOAMPLIFIERS
- DATA REPEATERS
- WATERPROOF CONNECTORS
- GEOPHYSICAL EQUIPMENT



MIDWESTERN INSTRUMENTS

41st and Sheridan Road

Tulsa, Oklahoma

Save Time, Reduce Errors... Determine and Record Data Automatically with These Two Versatile **Berkeley** Instruments

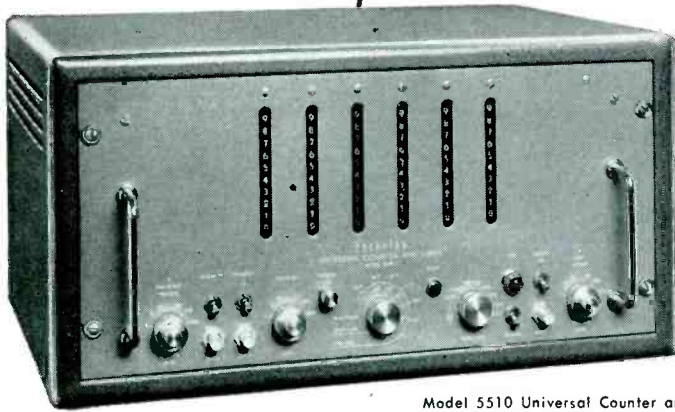

Model 5510 Universal Counter and Timer offers direct-reading digital display of count, frequency or microsecond time interval. Time bases from 1 mc. to 1 cps; gate times from .00001 to 10 sec. Accuracy ± 1 count, \pm crystal stability (1 part in 10^6). Price \$1,100.00 f.o.b. factory.

1. UNIVERSAL COUNTER AND TIMER, Model 5510, combines the functions of four instruments in one single, compact unit. It will:

- a. Count at speeds to 1 million per second.
- b. Count events occurring during a selectable, precise time interval.
- c. Measure time intervals in 1 microsecond increments, from 3 microseconds to 1 million seconds.
- d. Determine frequencies or frequency ratios from 0 cps to 1 megacycle.
- e. Operate directly the BERKELEY printer (below), BERKELEY digital-to-analog converter, or BERKELEY data processor to drive IBM card punches, typewriters or teletype systems.

2. BERKELEY DIGITAL RECORDER, Model 1452, combines scanner and high speed printer in a single unit; prints up to 10 digits on standard adding machine tape. Can be modified to print "Time" or "Code" information simultaneously with count data on same tape.

Model 1452 prints 6 digits (8 or 10 on special order) on standard adding machine tape. Is only 19" wide x 10 1/2" high x 14" deep, weighs 60 lbs. Price, \$750.00 f.o.b. factory.

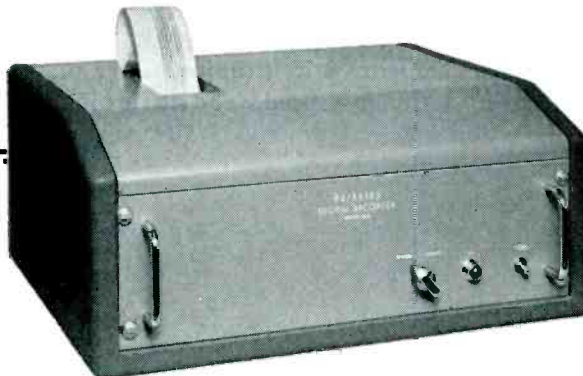

Write for complete specifications and data; please address Dept. G-6

M-43

Berkeley

division

BECKMAN INSTRUMENTS INC.
2200 WRIGHT AVE., RICHMOND, CALIF.

INDUSTRIAL INSTRUMENTATION AND CONTROL SYSTEMS • COMPUTERS • COUNTERS • TEST INSTRUMENTS • NUCLEAR SCALERS

extended life under adverse conditions, and relatively low cost. It indicates angular changes from 0 to 359 deg and back to 0, in 1-deg divisions. One revolution of the input shaft is equal to one revolution of the unit drum. The counter is equally useful in clockwise, counterclockwise or reversible applications. Input speed is rated at 500 rpm. The 1502 generally conforms to Navy BuOrd specifications for Counter MK3 Mod 0. Typical applications include fire control devices, radar indicators and the positioning of servomechanisms.

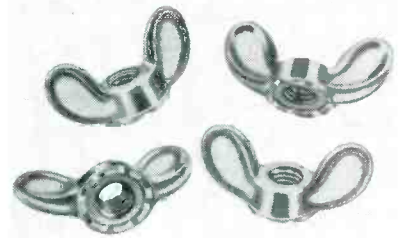

WING NUT is self-locking

GRIES REPRODUCER CORP., 400 Beechwood Ave., New Rochelle, N. Y., has introduced a new serrated base wing nut which frequently eliminates the need for a lock washer and speeds assembly. These nuts have been in use for some time by tv antenna manufacturers, and, after successful testing, are being added to the company's line of standard wing nuts to meet every industrial need and requirement. Available in a full range of popular sizes they are made of rust-proof zinc alloy and feature a patented recessed thumb grip.

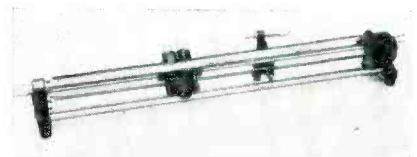

SLOTTED LINE is convenient and accurate

GENERAL RADIO Co., 275 Massachusetts Ave., Cambridge 39, Mass. Operating over the frequency range from below 300 to 5,000 mc, the

Exciting New Development

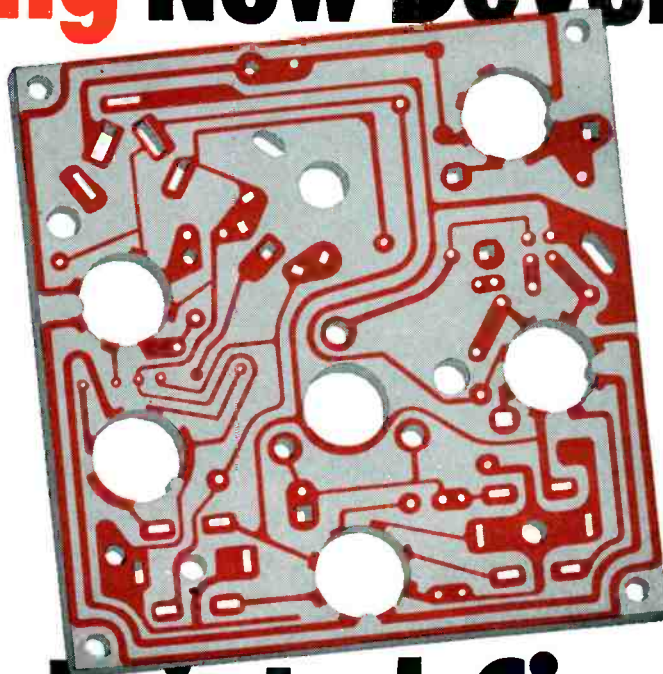

Photo courtesy
Methode Manufacturing Corp.
Chicago, Ill.

in Printed Circuits!

New CuCLAD* copper-clad laminate offers unequalled bond strength, heat resistance, solderability, punchability, electrical performance!

Here's the foil-clad laminate you've been waiting for! It's CuCLAD LAMICOID®—made possible by an entirely new concept in bonding material, specially designed equipment developed exclusively by Mica Insulator Company. This new bond and unique bonding method give you unequalled performance that's consistent and dependable from sheet to sheet, lot to lot.

*Trade-mark

You get all these advantages:

- A STRONGER BOND WHICH IMPROVES WITH AGE AND HEAT**
- BETTER HEAT RESISTANCE**
- BETTER REACTION TO HOT SOLDER**
- BOND ELECTRICALLY EQUAL TO LAMINATE**
- IMPROVED ARC RESISTANCE**
- SUPERIOR PUNCHABILITY**
- UNIFORMITY**

and CuCLAD LAMICOID is competitively priced!

CuCLAD LAMICOID is available *NOW*, in several grades. Tell us your requirements or problems—or ask to have a Mico Sales Engineer call.

LOOK AT THESE TYPICAL PRODUCTION RUN VALUES ON 6028 XXXP CuCLAD LAMICOID:

BOND STRENGTH —Guaranteed min: 6 lb.; avg. 9 lbs. (90° peel at 2 lbs./min.)	
SOLDER TEST —Guaranteed no blisters @ 230-240° C. for 10 seconds, 1" square floated on molten solder	
HEAT RESISTANCE —Guaranteed no change at 150° C. for ½ hour in air-circulated oven, air flow parallel to specimen	
PUNCHABILITY —Excellent	
SURFACE RESISTIVITY, megohms	
C-96/35/90	7.3 x 10 ⁴
VOLUME RESISTIVITY, megohm cm.	
C-96/35/90	3.7 x 10 ⁵
WATER ABSORPTION	
1/16" th., E-1/105 + D-24/23 copper on	0.1%
1/16" th., E-1/105 + D-24/23 copper removed	0.7%



MICA *Insulator* **COMPANY**

Schenectady 1, New York

Offices in Principal Cities

In Canada—Micanite Canada, Ltd., Granby, Quebec

LAMICOID • (Laminated Plastic) • MICANITE • (Built-up Mica) • EMPIRE • (Coated Fabrics and Papers) • FABRICATED MICA • ISOMICA •

**MORE STAYING POWER
FOR YOUR
TEST SET DOLLAR**

Hycon

**LABORATORY
ACCURACY
... FIELD-SERVICE
RUGGEDNESS**

Buy right today and know you're ready for tomorrow's requirements. Hycon test instruments defeat obsolescence by anticipating — and surpassing — future standards of quality. In addition to the three basic instruments shown, the Hycon line will soon include a 5" oscilloscope, sweep generator, and color bar/dot generator. Write the factory or contact your local parts jobber for additional product information.



MODEL 614 VTVM

Convenience at unprecedented low cost sums up this rugged, serviceable instrument. Hycon plus features include: 21 ranges (28 with peak-to-peak scales); large 6½" meter; 3% accuracy on DC and ohms, 5% on AC; frequency response to 250 mc with accessory crystal probe. Test probes stow inside case, ready to use.

Ideal for production-line testing and laboratory work, this new VTVM provides direct readings without interpolation. Features illuminated digital scale with decimal point and polarity sign; 12 ranges (AC, DC, ohms); frequency response to 250 mc with auxiliary probe; accuracy: 1% on DC and ohms, 2% on AC. Cuts multiple scale confusion and learning curve error.



MODEL 615
DIGITAL VTVM

Designed for both field servicing and laboratory requirements. Features high deflection sensitivity (.01 v/in rms); 4.5 mc vertical bandpass; flat ±1 db; internal 5% calibrating voltage. Small, compact — but accurate enough for the most exacting work. Special flat face 3" CRT provides undistorted trace edge to edge.

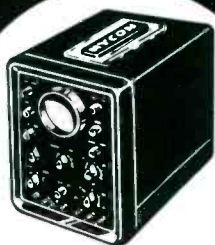

3" OSCILLOSCOPE
MODEL 617

**ALL INSTRUMENTS
IN MATCHING,
BENCH-STACKING CASES**

Hycon Mfg. Company

2961 East Colorado Street
Pasadena 8, California

"Where accuracy counts"

GO NO-GO MISSILE TEST SYSTEMS • AERIAL CAMERAS
BASIC ELECTRONIC RESEARCH • AERIAL SURVEYS
ELECTRONIC TEST INSTRUMENTS • ORDNANCE
ELECTRONIC SYSTEMS

NEW PRODUCTS

(continued)

type 874-LBA slotted line is a convenient and accurate instrument for measurements of impedance, swr and attenuation. The unit has an improved mechanism for driving the electrostatic pickup probe, a more constant probe coupling along the line (within ±1.5 percent along the entire 50 cm of travel), a sturdier supporting structure, negligible backlash, improved center conductor and probe support, and adaptability to motor drive. The unit is illustrated with the type 874-LV micrometer vernier attachment.

OSCILLOGRAPH for c-r recording

HATHAWAY INSTRUMENT Co., 1315 South Clarkson St., Denver 10, Colo. A writing rate of 5,000,000 ips and chart speeds up to 6,000 ips are features of the type SC-16B c-r recording oscillograph. Frequency responses is 0 to 200 kc. New, improved camera-type lenses increase trace definition. Several different methods of recording are possible with this new oscillograph. Records may be taken on continuously driven 6-in. or 35-mm width film or paper at speeds up to 600 ips or on drum-type charts at speeds up to 6,000 ips.

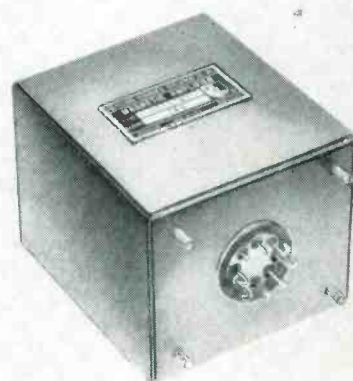

SERVO AMPLIFIER is transistor-magnetic

POLYTECHNIC RESEARCH & DEVELOPMENT Co., INC., 202 Tillary St., Brooklyn 1, N. Y. The PRD R40-G7W6 is a combination silicon transistor-magnetic servo amplifier. The unit will deliver full power to

Progress is always
an uphill climb

And We've been Climbing For Over 30 Years
Setting the Pace In—
**ENGINEERED
SHEET METAL
FABRICATION** — — —

Karp "Know-How"
plus Karp
*“One-Stop” Service
Can Make Your Climb
To The Top Easier Through

- Experienced engineering design
- Expertly designed tools and dies

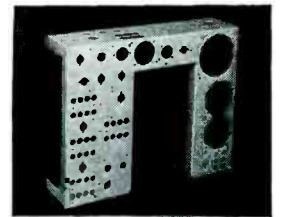

- Proven production methods
- Latest shop equipment



- Highly skilled craftsmanship
- Rigid inspection

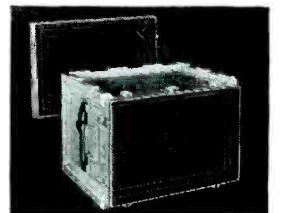

To produce quality controlled sheet metal products, at rock bottom prices, regardless of size or quantity. Send us your models, sketches, blue prints. See how you can profit by Karp's practical experience in fabricating sheet metal *Enclosures, Housings and Chassis*. Send for your free copy of the Karp Engineering Data Booklet No. 1.



METAL PRODUCTS CO. • 215 63rd STREET, BROOKLYN 20, N. Y.

Division of H. & B. American Machine Company, Inc.

- FACILITIES FOR ENGINEERED SHEET METAL FABRICATIONS:** in aluminum or steel • long run or short • spot, arc, gas or heliarc welding • any type finish
- Modern plant—3 city blocks long
 - Thousands of dies available
 - Most modern of sheet metal fabricating equipment
 - U. S. Air Force Certified Welding Facilities
 - Air-conditioned spray room... complete baking facilities
 - Complete sub-assembly facilities

marion new
advancement
 in instrument
 design
MEDALIST*
 meters



Greater readability and modern styling in minimum space. Interchangeable with ASA/JAN 2½ and 3½ inch sizes. Up to 50% longer scale in same space as ordinary type. Available in various colors. Complete data on request.

*Trade Mark
 Patents Pending



marion electrical instrument co.
 401 Canal St., Manchester, N. H., U. S. A.

Manufacturers of Ruggedized and "Regular" Panel Instruments and Related Products.

copyright 1955 M.E.I. Co.

marion meters

NEW PRODUCTS (continued)

the parallel connected control windings of the 400 cps BuOrd MK7 or MK14 servo motors. Overall voltage gain, when driving the MK7 motor, is greater than 2,000. This high gain, coupled with the wide bandwidth of 0 to 70 cps, makes the unit a very useful component in instrument servo systems. The use of silicon type transistors for the preamplifier allows operation at ambient temperatures up to 85 C. Internal means of stabilization is available by utilizing the d-c component present in the amplifier output. The low cost, lightweight unit will add ruggedness, reliability and simplicity to any closed loop control system where high performance is of prime importance.

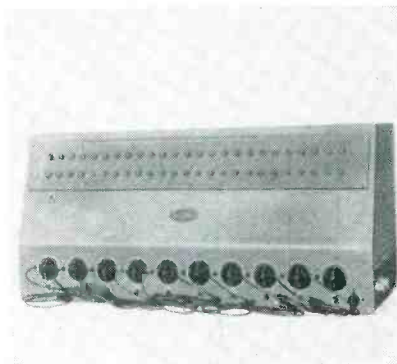

NETWORK SYNTHESIZER
 and laboratory filter

WICKES ENGINEERING AND CONSTRUCTION Co., 12th St. and Ferry Ave., Camden 4, N. J. The NS-1 is a network synthesizer and universal laboratory filter designed for experimental circuits or systems evaluation, particularly in the tv field. The equipment will synthesize any selectivity curve expressible by a Fourier cosine series, or any transient response function. It accelerates network design procedures by eliminating time-consuming design calculations. A 50-section delay line permits rapid synthesis of any filter characteristic over the entire video range. Voltages are picked off the line by means of 10 cathode followers, each having an attenuator and polarity (algebraic sign) selector switch. Any 10 voltages can be selected and combined, so that either 10 terms of a Fourier series can be obtained, or any 10-step approximation to a

FOR PUBLIC ADDRESS, RADIO, and kindred fields, JONES 400 SERIES PLUGS & SOCKETS

of proven quality!



P-406-CCT



S-406-AB

Socket contacts phosphor bronze cadmium plated. Plug contacts hard brass cadmium plated. Insulation molded bakelite. Plugs and sockets polarized. 2, 4, 6, 8, 10, 12 contacts. Steel caps with baked black crackle enamel. Catalog No. 20 gives full information on complete line of Jones Electrical Connecting Devices — Plugs, Sockets and Terminalstrips. Write

Jones HOWARD B. JONES DIVISION
 CINCINNATI MANUFACTURING CORPORATION
 CHICAGO 24, ILLINOIS
 SUBSIDIARY OF UNITED-CARR FASTENER CORP.

Sales Promotion Expert

FOR

ELECTRONIC SYSTEMS

• Must have scientific degree (preferably in electronics) or heavy background in complex electronic systems. Minimum 5 years experience.

To prepare advertisements, news releases, sales promotion copy, brochures, and proposals for new electronic computers and systems. Write Personnel Manager.

REMINGTON RAND, INC.

ENGINEERING RESEARCH ASSOCIATES DIVISION
 1902 W. Minnehaha Avenue
 St. Paul W4, Minnesota

Earn Extra Income
 in MOBILE-RADIO MAINTENANCE!



It's now a big business (650,000 installations) . . . fast-growing (70% increase just last year) . . . specialized . . . and high-paying!

Learn how to turn this opportunity into cash—write today for free booklet "HOW TO MAKE MONEY

IN MOBILE-RADIO MAINTENANCE!" It's published as a service to radio engineers by Lampkin Laboratories, Inc., manufacturers of the well-known 105-B Micrometer Frequency Meter and 205-A FM Modulation Meter.



LAMPKIN LABORATORIES, INC.
 Instruments Div., Bradenton, Fla.

At no obligation to me please send "HOW TO MAKE MONEY IN MOBILE-RADIO MAINTENANCE."

Name _____
 Address _____
 City _____ State _____

Where can you use **VARFLO?**

(the highly flexible Class B Sleeving and Tubing that licks Class A in performance — equals it in price)



- **MORE FLEXIBLE** — can be bent, even tied in knots, without cracking or crazing.

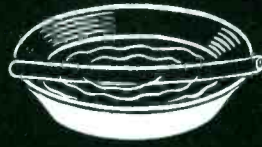

- **MORE RESISTANT** to water, alkalis, mild acids, common solvents, oils and greases.

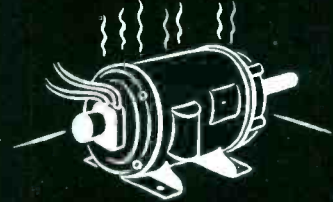

- **LONGER LASTING** at high temperatures — withstands hundreds of hours at 300° F.



- **INHERENTLY STRONGER** — stands up under vibration, varnishing, baking. Good shelf life, too.



- **MORE STABLE** — retains dielectric value when pulled back during soldering.

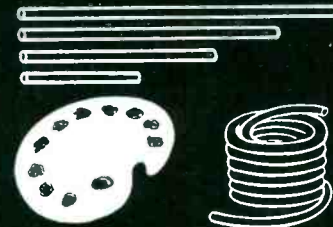

- **WIDER RANGE** — available in 4 NEMA grades, 10 colors, coils, 36" — lengths or short lengths.

Cuts inventory, too!

Superior to Class A insulation in performance—yet on a par with it in price—Varflo Sleeving and Tubing can be used economically for all Class A and Class B installations. This low-cost adaptability of Varflo enables many of our customers to achieve substantial savings in inventory. Available in NEMA Grades A-1 and B-1 tubing and Grades C-1 and C-2 sleeving.

Perhaps Varflo can solve *your* insulating problems. Describe them in a letter—no cost or obligation for our recommendations.



**FREE
TEST
SAMPLES**

Mail coupon
for yours



VARFLEX CORPORATION 506 W. Court St., Rome, N.Y.

Please send me free folder containing description and test samples of Varflo Sleeving and Tubing. I am particularly interested in insulation for

.....

Name

Company

Street

City..... Zone..... State.....

where
QUALITY
is a
MUST

and **COST** a PROBLEM

IT'S **TIC'S** NEW
P-SERIES
PRECISION
POTENTIOMETERS

Typical production line application of TIC's "P" series potentiometers is shown at the plant of Massa Laboratories, Hingham, Mass. These units have enabled Massa Laboratories to economically achieve and hold the critically accurate gain control calibration and wide band frequency response required in their Model M-105 60db Laboratory Amplifier widely used in high intensity sound and vibration research. Production savings arise from the low first cost and from economy of assembly brought about by the precision linearity of these potentiometers which permits use of pre-engraved attenuator dials without elaborate circuit padding or adjustment.

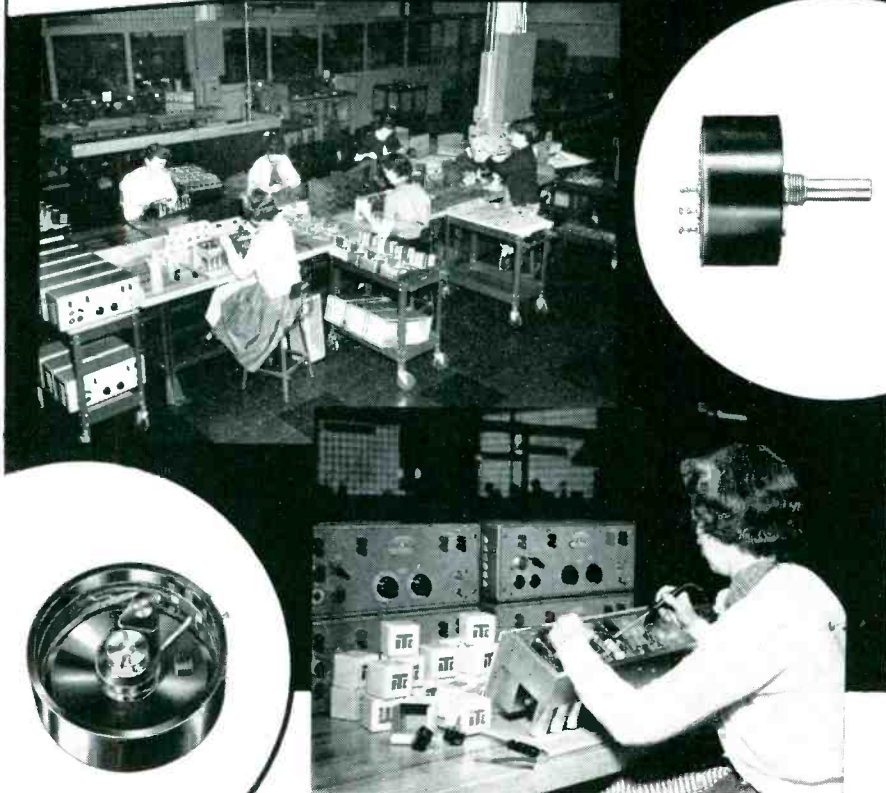

New, low-cost P-series precision potentiometers meet growing demand for economical precision potentiometers in commercial instrumentation.

Precision features developed for stringent military applications have been retained in the new, low-cost P-Series.

The P-Series potentiometers are available in three sizes: 3-inch (P-3) . . . 1 5/8-inch (P1 5/8) . . . and 1 1/4 (P1 1/4). Resistance ranges are from 100 ohms to 200,000 ohms. Threaded bushing . . . tapped hole . . . or precision pilot mounts are available. Single or ganged assemblies as required.

For complete specifications write for **FREE** brochure No. P-103.

Unique, dual, precious metal wiper provides low-noise operation . . . long life . . . and low torque. Precision-bored, phosphor-bronze sleeve bearing further reduces torque. Moulded bakelite housing minimizes distributed capacitance providing wide frequency response. Patented* resistance — element design permits greater variety of nonlinear functions. Low temperature coefficient of resistance wire produces stability in extremes of temperature . . . minimized distributed capacitance provides stability in extremes of humidity.

*U.S. Patent No. 2511807

TECHNOLOGY INSTRUMENT CORP.

533 Main Street, Acton, Mass. COlonial 3-7711
West Coast Plant — Box 3941, No. Hollywood, Calif. POplar 5-8620

transient response function can be made. Synthesis can be in either the frequency or the time domain.

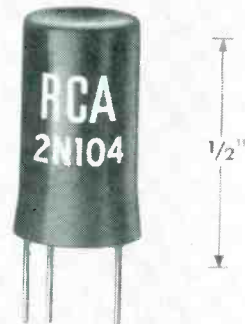

JUNCTION TRANSISTOR for low-power audio use

RADIO CORP. OF AMERICA, Harrison, N. J., has announced the 2N104 alloy-junction transistor intended for low-power audio applications in communications and other types of electronic equipment. The tiny semiconductor device has exceptional stability and excellent uniformity of characteristics, together with numerous design features which permit its use in most low-level a-f applications. The new transistor is a *pn-p* germanium type, hermetically sealed in an insulated metal envelope. It is 1/4 in. in diameter and 1/2 in. in overall length. The device is a plug-in type which will fit a linotetrap three-pin base. On the basis of usual transistor ratings, the collector dissipation is in the order of 35 mw.

ELECTRONIC MESSENGER for exact-copy transmission

AIR ASSOCIATES, INC., 511 Joyce St., Orange, N. J. An electronic communications device, the Electronic Messenger, transmits exact, permanent copies of any printed or written original, including graphs, maps, drawings, sales orders, vouchers—in any shape and size up to 8 1/2 in. × 14 in.—over telephone, microwave or closed circuits . . . to one or more companion machines in other offices, plants or stations. It includes transmitter and receiver in a single unit pack-

At WICO... Leesonas coil winders have long been standard equipment

*Years of efficient,
economical performance
result in new
installation of No. 107
machines*

For many years the Wico Electric Company has enjoyed an enviable reputation for its manufacture of magnetos, distributors, complex ignition systems and other allied precision products. During that time the company has found Leesonas Coil Winders to be thoroughly satisfactory in every respect, meeting every need for fast, accurate, low-cost winding on a wide range of jobs.

So when the time came to expand their coil winding production, Wico made certain that their new machines would be Leesonas.

These new machines are Leesonas No. 107 Automatic Coil Winders, the last word in automatic coil winder design, which produce 4 to 30 compact, uniform paper-insulated coils simultaneously — in fastest time — with minimum operator attention.

Investigate

how Leesonas No. 107's in your own production can eliminate human error, reduce wire breakage to a minimum and cut production time to its shortest. The coupon will bring you complete details, together with other helpful coil winding information. Why not check and mail it today?

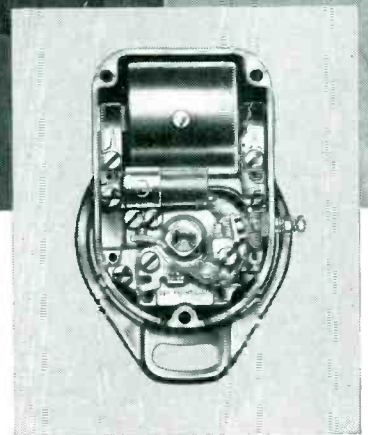

New Leesonas No. 107 Automatic Coil Winders, shown in the plant of Wico Electric Company, West Springfield, Mass., were selected because of this firm's long, satisfactory experience with Leesonas machines. Leesonas No. 107 Winders, featuring speed and accuracy in automatic winding, are enabling many plants to boost production and cut costs. Inset shows a cutaway of a Wico Model XH Magneto. Coil at top of it is precision wound on Leesonas No. 107's.

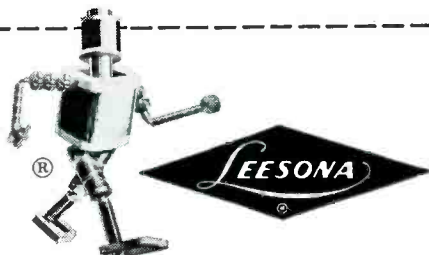

FOR WINDING COILS
IN QUANTITY... ACCURATELY
... AUTOMATICALLY... USE
UNIVERSAL WINDING MACHINES

UNIVERSAL WINDING COMPANY

P. O. BOX 1605, PROVIDENCE 1, RHODE ISLAND, Dept. 16

Please send me

- Bulletin on the Leesonas No. 107 Automatic Coil Winder.
- Condensed catalog of Leesonas Winders.
- Bulletin on the new Leesonas Pay-As-You-Profit Plans for purchasing or leasing modern coil winding machinery.

Name.....Title.....

Company.....

City.....Zone.....State.....

new...
precision

Continental Connectors

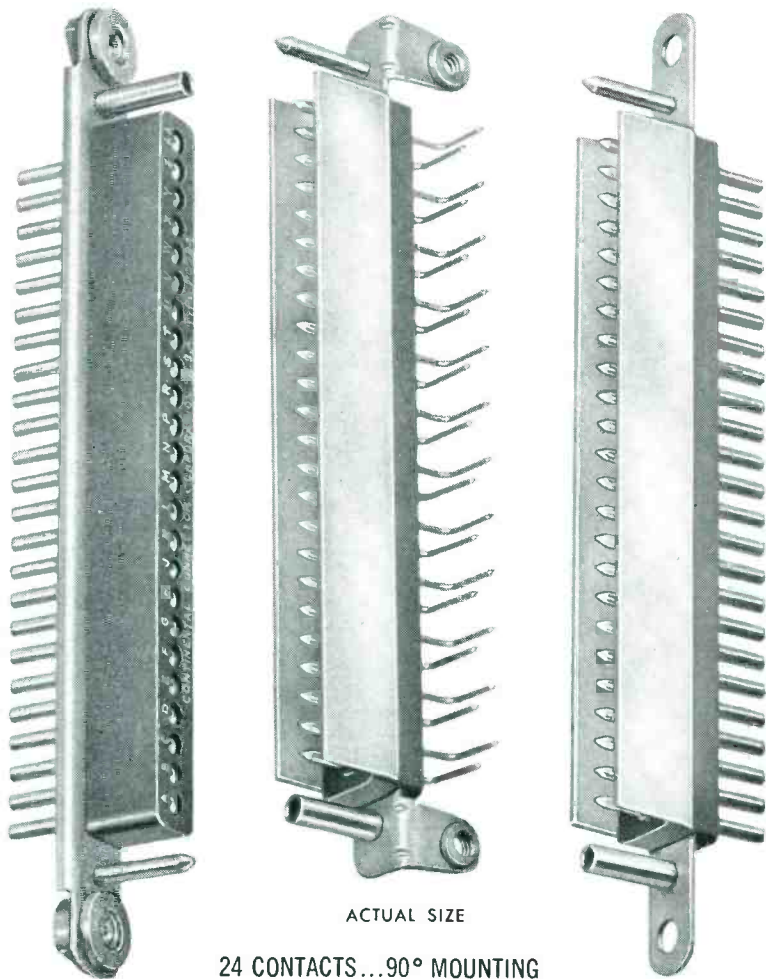

ACTUAL SIZE

24 CONTACTS...90° MOUNTING

SPECIAL DESIGN PRINTED CIRCUIT CONNECTOR

This new, unusual design connector was developed primarily for digital computer applications. Stainless steel brackets are an integral part of the construction and also act as supports for the printed circuit assembly. The 90° printed circuit plug (center) is dip soldered to the printed circuit board.

Polarization is positive with a reverse guide pin and guide socket arrangement. The terminal end of the contacts receive an "AMP 53" taper pin. A straight plug is also shown on the right.

Technical data on this connector, PLUS other special designs and applications requiring the use of sub-miniature, printed circuit, hermetic seal, pressurized, high voltage or power connectors, are available on request.

Electronic Sales Division

DeJUR-Amsco Corporation,

45-01 Northern Boulevard, Long Island City 1, N. Y.

DeJUR

NEW PRODUCTS

(continued)



age, weighs less than 100 lb and is slightly larger than a typewriter. Design and operating data are given in a recent 4-page folder.

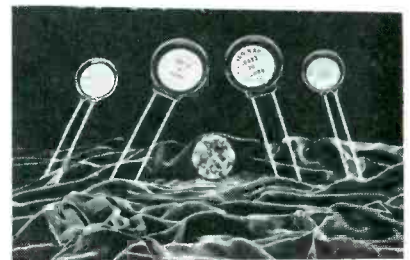

DISK CAPACITOR has temperature stability

CENTRALAB, a division of Globe-Union Inc., 900 E. Keefe Ave., Milwaukee 1, Wis. The ISO-KAP disk capacitor features temperature stability and completely insulated molded case. Capacitance is within -9.8 percent average of nominal value from -55 C to +85 C. Made with a completely molded polyethylene case, it has a case breakdown voltage rating of 3,000 v d-c, an insulation resistance of 10,000 megohms minimum. The capacitors are a little smaller than $\frac{1}{2}$ in. and $\frac{1}{16}$ in. in diameter. They are rated at 500 v d-c, flash tested at 1,500 v d-c and are available in values from 5 μ f to 0.0022 μ f.



VIDEO AMPLIFIER is a versatile unit

AMERICAN ELECTRONIC LABORATORIES, INC., 641 Arch St., Philadelphia 6, Pa. Versatile, low video

Why we can supply the timer that will do your job best



Time Delay Timers



Interval Timers

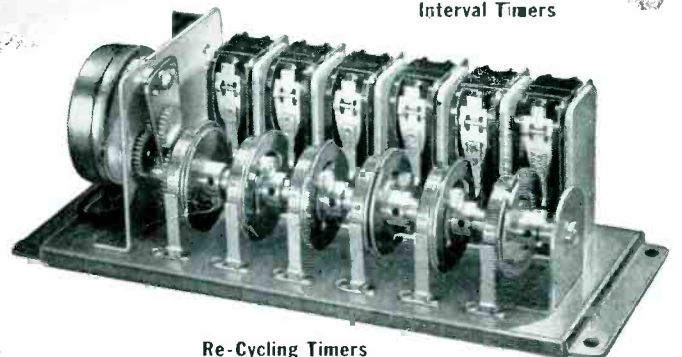

Re-Cycling Timers

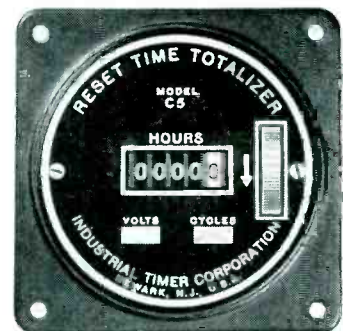

Running Time Meters

To meet the widely different requirements of our customers, we work with 17 basic types, from which we have so far developed 721 combinations. 19 years of successfully "timing" these customers has equipped us with a breadth of practical experience that you can draw on. The timers we manufacture comprise a complete line in 4 broad classifications.

- TIME DELAY TIMERS
- INTERVAL TIMERS
- RE-CYCLING TIMERS
- RUNNING TIME METERS

That's why you can depend on us to meet your needs. If we can't do it with one of the 721 combinations already developed, we'll have our engineers get on it at once and develop the combination that's right for you.

Our deliveries are extra good because we maintain large stocks of our 17 basic types, and even if your order is very "special" you'll be more than satisfied with our service. Send us your specifications; you'll get a prompt reply.

*Timers that Control
the Pulse Beat of Industry*



INDUSTRIAL TIMER CORPORATION
131 OGDEN STREET, NEWARK 4, N. J.

Standard H.F. R.T.

STR.18B2 24-Channel Pilot Controlled Airborne Communication Equipment

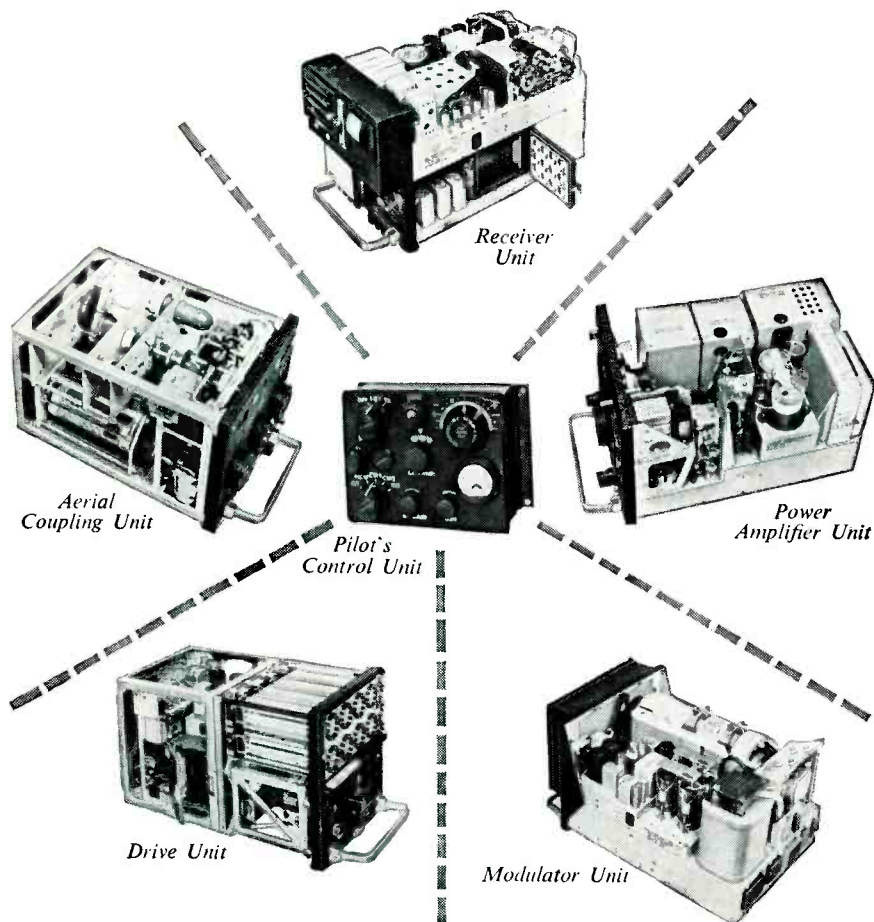

Suitable for use in civil or military aircraft, the STR.18B2 is now in quantity production for the British Ministry of Supply.

- ★ Frequency Band 2.8-18.1 Mc/s.
- ★ 24 Crystal-Controlled Channels
- ★ Full Pilot Remote Control
- ★ Single Knob Selection of both Transmitter and Receiver Channel
- ★ Ample Transmitter Power — 100 watts R.T.
- ★ Receiver Sensitivity less than 1 Microvolt
- ★ Standardized Units for Compact Installation



Standard Telephones and Cables Limited

Registered Office: Connaught House, Aldwych, London, W.C.2

RADIO DIVISION · New Southgate · London · N.11 · England



NEW PRODUCTS

(continued)

amplifying units, manufactured in two models are offered for use in distribution systems, color tv systems, computer development, nucleonic circuits and pulse control systems. They have a bandwidth of less than 1 cps to 10 mc (3 db). Model 119A has an output of 150 v peak-to-peak into capacitive load at 25 μ f. Overshoot is less than 5 percent and compression less than 3 percent at maximum output. A continuously variable gain control is included. Model 119 differs, with an output of 10 v peak-to-peak into 75 ohms. Both units take up to 1.5 v. peak-to-peak input and are supplied with input impedance of 50,000 ohms and 10 μ f, 90 ohms, 75 ohms, or 50 ohms at option of user.

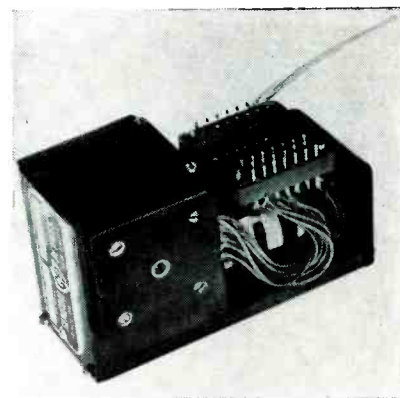

SAMPLING SWITCH is lightweight and durable

GENERAL DEVICES, INC., Princeton, N. J., has announced the model 1205 high speed sampling switch for telemetering, data recording and related application. It has the following specifications: 2 synchronized poles; 30 contacts per pole; 15 alternate contacts and collector rings per pole tied to individual plugs; a self-contained 5-cps motor; and measurements— $3\frac{1}{8}$ in. high by $1\frac{3}{8}$ in. wide.

CAMERA suitable for various uses

GRASS INSTRUMENT Co., 101 Old Colony Ave., Quincy, Mass. Model C-4 camera features precision for both intermittent and continuously moving film advance. The camera is suitable for c-r oscilloscope,



These tubes died young; a G-E Inductrol might have saved them

Fluctuating voltage killed these electronic tubes off young. Over-voltage murdered most . . . a five percent overvoltage cuts tube life by almost 50 percent (see chart below). Undervoltage, which resulted in cathode bombardment of gas or mercury-filled types, ruined more. Even while in use, poor voltage regulation made these tubes perform erratically. And when they died, downtime costs and replacement costs ran high.

Good voltage gives you maximum tube performance. General Electric Inductrols—dry-type induction voltage regulators—are the answer for circuits up to 600 volts, 520 kva. They automatically maintain constant output voltage, assuring accuracy and peak performance of electronic equipment. There are no steps, no brushes to maintain. Wave form distortion is negligible. Regulation is done magnetically, with $\pm 1\%$ band width. Manufacturers are building Inductrols into induction heating equipment, radar gear, radio and TV transmitters, computers—to get consistent performance wherever voltage is critical.

TUBE-LIFE AND PERFORMANCE VS VOLTAGE

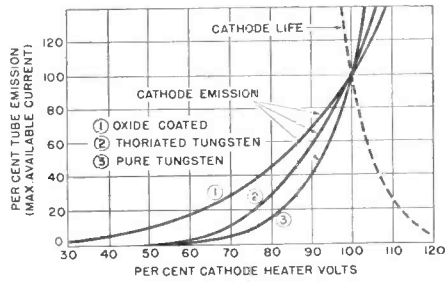

3 TYPES AVAILABLE
G-E Inductrols come with manual, motor-operated, or completely automatic controls. See your G-E Apparatus Sales Office or Agent. Or, send us the coupon. General Electric Co., Schenectady 5, N. Y.

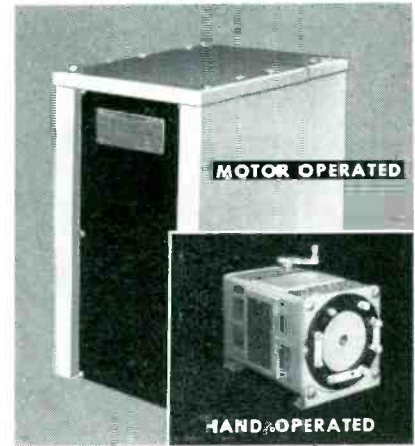

Progress Is Our Most Important Product



TELL ME MORE! I'm interested in G-E Inductrols. Please send me these bulletins:

- Voltage Deviation on Electronic Tubes and the Use of Inductrols.....GEA-5936
- Single-phase Inductrols, indoor service, 600 volts and below on circuits up to 240 kva.....GEC-795A
- Three-phase Inductrols, indoor service, 600 volts and below on circuits up to 520 kva.....GEA-5824

General Electric Company
Section A423-211, Schenectady 5, N. Y.

Name

Company

Address

City State

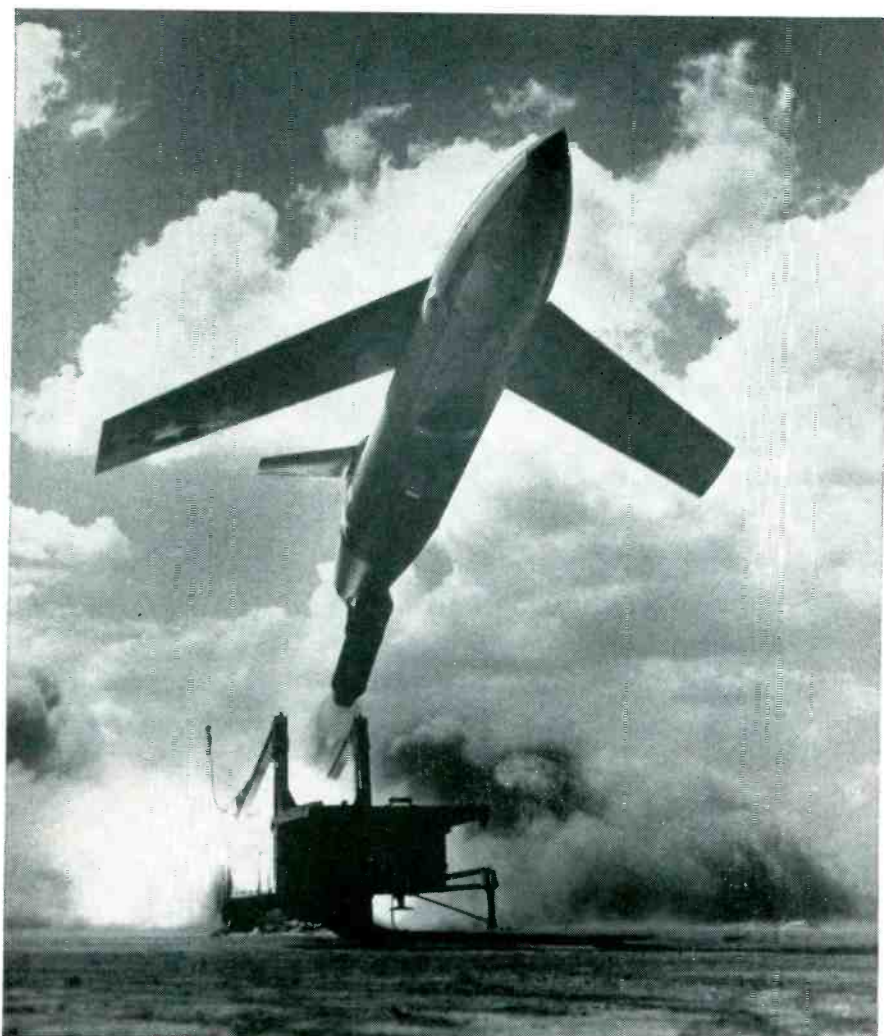
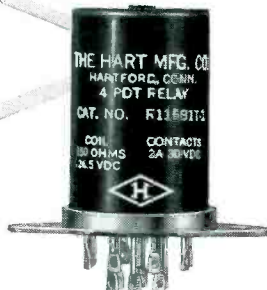

Photo courtesy the Martin Company

Relays for the Matador

by "DIAMOND H"



Matadors, surface-to-surface tactical missiles now deployed with USAF operational squadrons in Germany, are products of the Martin Company, Baltimore.

The relays, developed to help control its near speed-of-sound flight, are products of The Hart Manufacturing Company.

They're 4 PDT hermetically-sealed relays with a previously unobtainable combination of dependable characteristics engineered into remarkably small space and weight.

A new bulletin gives complete data on the wide range of performance characteristics which can be obtained with "Diamond H" Series R relays for critical jobs in the *Matador* and other missiles, jet aircraft controls, computers, high-speed cameras and other vital applications. Write for a copy today.

The Hart Manufacturing Company

202 Bartholomew Ave., Hartford 1, Conn.

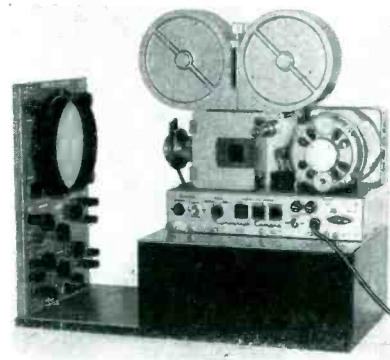

photoflash, sequence and time-lapse photography. The control system allows it to drive synchronously or to be driven by associated equipment or subject material. Twelve continuously moving film speeds range from 0.25 to 1,000 mm per sec; accurate to 0.5 percent. Full recording speed and full stop are reached in only 20 milliseconds. Total running time may be preset. Control may be by remote signal or by an internal switch.

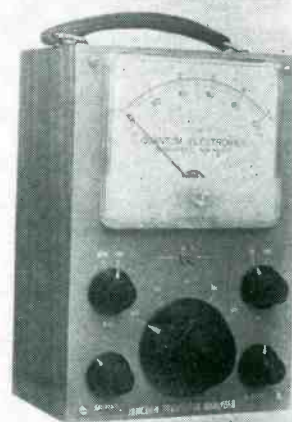

TRANSISTOR ANALYZER is completely portable

QUANTUM ELECTRONICS, 1921 Virginia St. NE, Albuquerque, N. M., announces a new transistorized, portable, junction transistor analyzer that features self-calibration and direct reading measurements. It weighs only 3 lb and is powered by standard flashlight cells. Two parameters, I_{co} and common emitter short-circuit current gain, are measured at a constant collector voltage and adjustable emitter bias. True dynamic small signal current gain is measured at a guaranteed accuracy of 5 percent or better over wide ambient temperatures. Speed and simplicity of use are additional

PYRAMID SOLID DIELECTRIC GLASSEAL® CAPACITORS FOR 6 POINT PREFERENCE

Burton Browne / New York

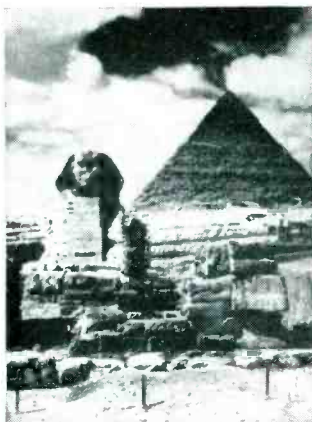

1

Especially sturdy capacitors capable of withstanding vibrational stresses of high acceleration and frequency, and severe shock conditions encountered in guided missiles and airborne equipment.

2

Utilize new, rugged compression-seal type, glass-to-metal solder-seal terminals. Terminals will not work loose or rotate under any operating condition.

3

Functional operating range from -55°C to $+125^{\circ}\text{C}$.

4

Operates normally under severe humidity conditions.

5

Production tests for voltage breakdown, capacitance, power factor, insulation resistance and seal are performed on a 100% basis.

6

Capacitance range: .001 mfd. to 1.0 mfd.; voltage range: 100 to 600 V.D.C. operating; can be provided to standard tolerance of $\pm 20\%$ or to closer tolerance, if desired.

1. Hermetically sealed in metallic cases.

2. Power factor less than 1%.

3. Subminiature in size.

4. Available in both inserted tab and extended foil constructions.

For complete engineering information contact your local Pyramid representative or write to—

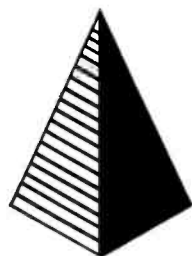

CAPACITOR DIVISION

PYRAMID ELECTRIC COMPANY

1445 Hudson Blvd. • North Bergen, N. J.

+ FACTORS



Detectron

PRESET COUNTERS

Automatically count and control to 1,000,000 events.



Model DS-8600 Series (5 Models)

Designed to control any operation after a preselected total count has been reached. Used to count pills, bottles, cans, machine parts, etc. for automatic packaging.

If an event can be converted to an electrical impulse—it can be counted and controlled with a Detectron Preset Counter.

Dual models available which provide output signals at any two preset totals. Write for catalog or contact nearest representative.

FEATURES

- Absolute Accuracy
- High Speed
- Reliable
- Automatic
- Rugged
- Economical
- Small Size

NEW PRODUCTS

(continued)

features which make the analyzer a valuable instrument for incoming inspection, production screening and circuit development.

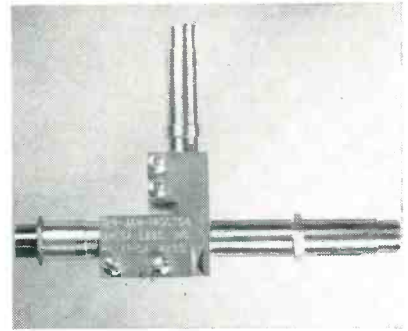

COAXIAL MIXER for S-band use

OMEGA LABORATORIES, INC., Box 466, Billerica, Mass. The Sharpless type coaxial mixer for S band has been manufactured to the exacting specifications of the Armed Forces Electro Standards Agency. Intended for use in the precision measuring of coaxial crystal diodes, IN21 types, the Omega 124 may be used for a front end of a microwave receiver operating in the microwave region centered on 3,060 mc. For this service a local oscillator coupling block is required and can be supplied on order.

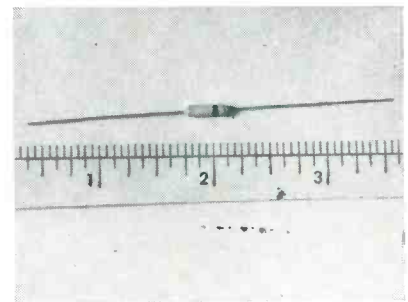

SOLDER SEAL DIODE is small and rugged

GAHAGAN, INC., 11 W. Fourth St., Bethlehem, Pa. The GC-100 series of germanium diodes is exceptionally suited to high temperature operation. Available in a wide variety of electrical types, the series competently operates in computer, communications, radar, television, and special circuits. Dimensions of the ceramic body are 0.110 in. diameter by 0.305 in. long. The copper-clad tinned lead wire

SPECIFICATIONS	DS-8602	DS-8603	DS-8604	DS-8605	DS-8606
Decades	2	3	4	5	6
Count Capacity	100	1000	10,000	100,000	1,000,000
Counts Per Second	0-100,000				
Input Sensitivity	0-10 counts per second: 1 volt RMS 10-20 counts per second: 0.5 volt RMS 20-100,000 counts per second: 0.1 volt RMS				
Input Impedance	1 megohm., 0.05 mf.				
Output Signal	50 volt positive pulse				
Recycling Rate	35,000 per second				
Relay Hold Time	Automatic: 0.01 to 0.1 seconds 0.1 to 1.0 seconds 1.0 to 10 seconds		Manual: Until reset		
Power Requirements	117 volts \pm 10%, 50-60 cycles				

Dept. 78-F



Computer-Measurements Div.

THE DETECTRON CORP.

5528 Vineland Ave., North Hollywood, California

TECHNICAL REPRESENTATIVES:

NEW YORK & NO. NEW JERSEY
Gerard G. Lewis Company
Great Neck, N.Y. HUinter 2-7784

SO. NEW JERSEY & EAST PENNSYLVANIA
Louis A. Garten & Associates
Montclair, N.J. MO. 3-0257

MARYLAND, D.C., VIRGINIA, NO. CAR., TENN.
S. S. Lee Associates
Washington 8, D.C. EM. 2-8626

Branch Office:
Baltimore 29, Md. AR. 3742

Branch Office:
Winston-Salem, N.C. 5-3460

OHIO, SO. MICH., W. VIR., W. PA.
Michael J. Cudahy Company
Chicago 40, Ill. SU. 4-5858

NO. ILLINOIS, INDIANA, SO. WIS., E. IOWA
Warren B. Cozzens Company
Evanston, Ill. DA. 8-4890

COLORADO, WYO., E. IDAHO, UTAH, NEBR.
Allen I. Williams Co.
Denver 4, Colo. MA 3-0343

NEW MEXICO & EL PASO COUNTY, TEXAS
Allen I. Williams Company
Albuquerque, N.M. AL. 5-9632

WASHINGTON, OREGON, W. IDAHO, MONTANA
Testco
Seattle 8, Wash. MO. 4895

CALIFORNIA, ARIZONA, NEVADA
Koessler Sales Company
Los Angeles 38, Calif. YO. 6271

Branch Office:
San Francisco 18, Calif. JO. 7-0622

MINN., NO. WIS., NO. MICH., NO. & SO. DAK.
Industrial Representatives Company
Minneapolis 16, Minn. WE. 9-9019

SO. CAR., GA., ALA. & FLA.
Southeastern Industrial Instruments
Atlanta, Ga. EX. 7801

SO. ILL., MO., KANS., W. IOWA
Engineering Services Company
St. Louis 5, Mo. VO. 3-3661

Branch Office:
Kansas City, Mo. JE. 7765

CANADA
Electromechanical Products
Agincourt, Ontario. 493-R-2

EXPORT
Frazier & Hansen, Ltd.
301 Clay St., San Francisco, Calif.

New TRANSISTORIZED MINIATURIZED

**TYPE
2007T**

SPECIFICATIONS

INPUT

20 to 35V DC
at approx. 5 m.a.

OUTPUT FREQUENCY

400 or 500 cycles

Type 2007T

+ \pm .02% from -65° to $+85^{\circ}$ C.

Type R2007T

+ \pm .002% from $+15^{\circ}$ to $+85^{\circ}$ C.

Type W2007T

+ \pm .005% from -65° to $+85^{\circ}$ C.

OUTPUT VOLTAGE

5 volts, sine wave.

Substantially uniform
from -65° to $+85^{\circ}$ C.

LIFE EXPECTANCY

several times that of vacuum tubes

INTERNALLY SHOCK MOUNTED

on Silastic

MAGNETICALLY SHIELDED

HERMETICALLY SEALED

OCTAL BASE

SIZE

$4\frac{1}{2}$ " x $1\frac{1}{2}$ " diameter

WEIGHT

7 ounces



Precision

FREQUENCY STANDARDS

These units, which are the result of several years of development and testing, offer a new standard of simplicity and reliability. Particularly noteworthy is the uniformity of output signal voltage with temperature change. Small size and light weight make them ideal for airborne and portable use.

For applications where only higher B voltages are available, a simple voltage reducing circuit may be used.

COMPLETE INFORMATION ON REQUEST
PLEASE SPECIFY TYPE 2007T

American Time Products, Inc.

580 Fifth Avenue

New York 36, N. Y.

MANUFACTURING UNDER PATENTS OF WESTERN ELECTRIC COMPANY

is butt welded to the internal nickle stud, which in turn is soldered to the vitreous ceramic body, thus completing the hermetic seal. Diodes are made to JAN or customer electrical specifications.

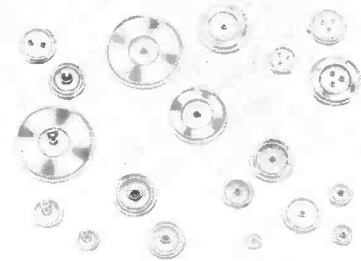

END SEALS are compression type

ELECTRICAL INDUSTRIES, Division of Amperex Electronic Corp., 44 Summer Ave., Newark 4, N. J., has available new super-rugged terminations that are widely used for hermetically sealing capacitors, resistors and other tubular components. In this compression construction the glass remains under constant compression and is therefore very strong and difficult to put under stress. For all practical purposes the compression seals are indestructible. All metal parts are tin-dipped for easy soldering.

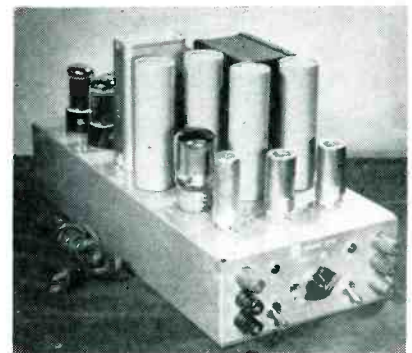

POWER SUPPLY is super-regulated unit

LABORATORY OF ELECTRONIC ENGINEERING, INC., 413 L St. N.W., Washington 1, DC. Model R-10 super-regulated power supply combines extremely low noise level with super voltage regulation at low cost. Under most conditions of operation, the noise is less than 150 μ v. Ultralow internal impedance

Airflex[®]
PRECISION RIVETERS

**TAKE THE
TOUGH
JOBS**

**High Frequency
IMPACT
with Spinning**

Airflex[®] Riveters bring an entirely new technique to the field of fastening. Riveting now becomes feasible under conditions that previously made it impractical.

Wherever tolerances or riveting pressures are critical, or assemblies and materials are apt to distort or fracture, the Airflex[®] cold-flow principle has provided the solution. Selective tolerances as close as .002" between peened end of the rivet and the material are being maintained even on volume production. Materials impose no limitations—glass, ceramics and plastics can also be riveted economically. Capacity for steel rivets range from 3/32" to 1". Silver, aluminum, brass, copper, titanium rivets also—hollow or solid—from 1/16".

Airflex[®] Riveters can give you faster, better riveting on routine jobs—and the economy of riveting on the "impossible" jobs. Write now for complete information.

AIRFLEX[®] PRINCIPLE combines high frequency blows with a spinning action to cold-flow the rivet. Force and rate of impacts, duration of impacts and spinning speed are independently controlled. Operator training is cut to a minimum.

LEMERT ENGINEERING CO., INC.
185 E. JEFFERSON ST., PLYMOUTH, IND.

Airflex[®]
RIVETERS DIMPLERS

JUST LOOK at the watt-hour rating of

Centralab's New, Exceptionally Small, Military-Quality Model 3 Radiohm®



Less than 1/16" diameter



The model 3 has many other desirable characteristics:

Designed for high operating temperatures.

Closed case construction readily lends itself to sealing and potting, (even though we believe that a control should "breathe").

Available in 1/8" diameter shaft, standard or locking-type.

Order a quantity of Model 3's for pilot testing. Call in your Centralab representative or write directly to the office.

DON'T look further for a high-quality variable resistor that you can use at exceptional wattage for short periods of time with minimum resistance change. Centralab's new Model 3 Radiohm is your answer. Tests prove it.

Take the 10,000 Ohm value for example. It stacks up this way:

ONLY 10% MAXIMUM CHANGE

- when used at . . . 1 watt for 1 1/2 hours
- . . . 3/4 watt for 35 hours
- . . . 1/2 watt for 80 hours
- . . . 1/3 watt for 300 hours
- . . . 1/4 watt continuous rating

This is just one of a complete selection of values for all miniature applications, guided missiles, geophysical equipment, etc., etc.

Technical bulletin EP-63 gives you complete engineering data. Write for it.

**More proof that
if it's a job
for electronic components,
it's a job for Centralab**

Centralab's advanced engineering continues to create the prototypes of the components industry



Volume Controls



Capacitors



Switches

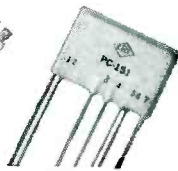

Printed Electronic Circuits



Ceramics

Like to win a library of high-fidelity records of your own choosing? Enter this month's

Electroni-Kwiz†

Answer this question in 50 words more or less:
What qualifications do you consider most important when specifying electronic components?
A leading editor will pick the winner of this month's major prize.
Mail your entry to us before June 30.

† Nothing to buy. Employees of Centralab and their advertising agency not eligible. Duplicate prizes awarded in case of tie.

D-556

Centralab

A DIVISION OF GLOBE UNION INC.

914F E. Keefe Avenue • Milwaukee 1, Wisconsin
In Canada: 804 Mt. Pleasant Road, Toronto, Ontario

*Trademark

SINCE 1922, INDUSTRY'S GREATEST SOURCE OF STANDARD AND SPECIAL ELECTRONIC COMPONENTS

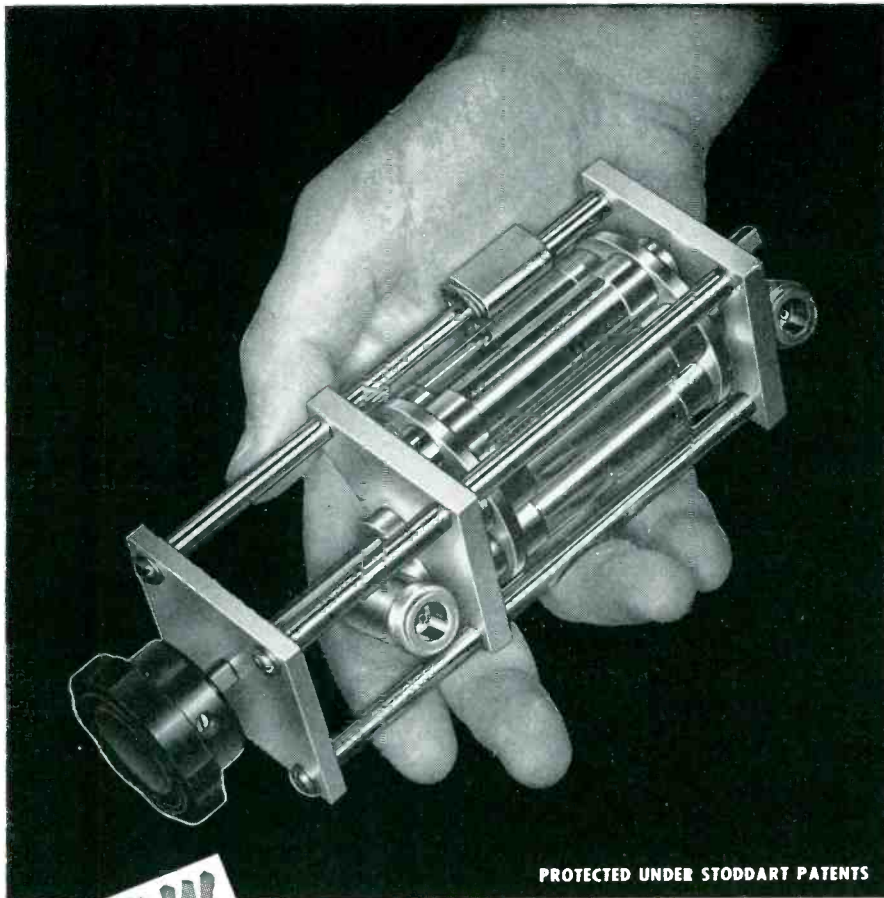

PROTECTED UNDER STODDART PATENTS

NOW

Precision Attenuation to 3000 mc!

TURRET ATTENUATOR featuring "PULL-TURN-PUSH" action

SINGLE "IN-THE-LINE"
ATTENUATOR PADS
and
50 ohm COAXIAL
TERMINATION



FREQUENCY RANGE:
dc to 3000 mc.

CHARACTERISTIC IMPEDANCE:
50 ohms

CONNECTORS:
Type "N" Coaxial female fittings each end

AVAILABLE ATTENUATION:
Any value from .1 db to 60 db

VSWR:
<1.2, dc to 3000 mc., for all values from 10 to 60 db
<1.5, dc to 3000 mc., for values from .1 to 9 db

ACCURACY:
±0.5 db

POWER RATING:
One watt sine wave power dissipation

*Send for free bulletin entitled
"Measurement of RF Attenuation"*

*Inquiries invited concerning pads or
turrets with different connector styles*

STODDART AIRCRAFT RADIO Co., Inc.

6644-A Santa Monica Blvd., Hollywood 38, California • Hollywood 4-9294

over the audio band eliminates need for usual decoupling circuits. Other features are: very low ripple and noise; no electrolytic capacitors; a pentode series tube with separate screen power supply; and separate plate and filament transformers.

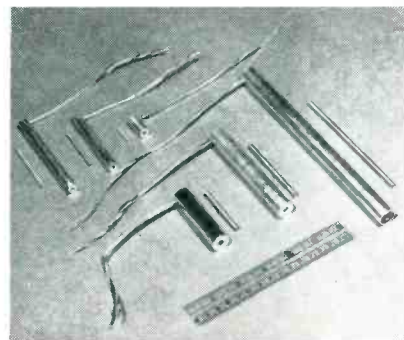

VELOCITY PICKOFFS are extremely stable

CONTROL COMPONENTS Co., 1 Holden St., Brookline 46, Mass., announces linear-motion velocity pickoffs known as the LV syn. It is designed for ease in coupling to linear-motion elements and generating an electrical signal which is accurately proportional to the velocity of the elements. The impedance characteristics of the device are readily modified so that the pickoff can be used with vacuum-tube, transistor, or magnetic circuits in control or instruments systems. No external electrical excitation is required, resulting in a very stable instrument.

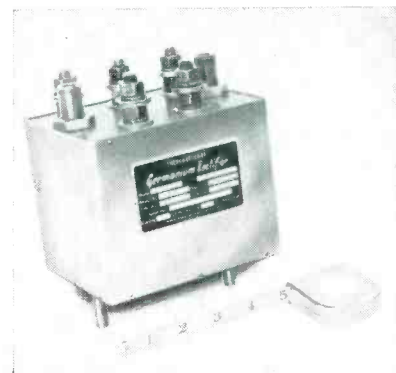

POWER RECTIFIER is liquid-cooled type

INTERNATIONAL RECTIFIER CORP., El Segundo, Calif., has available a 35-kw liquid-cooled germanium

he's working for you



THIS FELLOW IS TRAINED IN YOUR BUSINESS. His main duty is to travel the country — and world — penetrating the plants, laboratories and management councils . . . reporting back to you every significant innovation in technology, selling tactics, management strategy. He functions as your all-seeing, all-hearing, all-reporting business communications system.

THE MAN WE MEAN IS A COMPOSITE of the editorial staff of this magazine. For, obviously, no one individual could ever accomplish such a vast business news job. It's the result of many qualified men of diversified and specialized talents.

AND, THERE'S ANOTHER SIDE TO THIS "COMPOSITE MAN," another complete news service which complements the editorial section of this magazine — the advertising pages. It's been said that in a business publication the editorial pages tell "how they do it"—"they" being all the industry's front line of innovators and improvers — and the advertising pages tell "with what." Each issue unfolds an industrial exposition before you—giving a ready panorama of up-to-date tools, materials, equipment.

SUCH A "MAN" IS ON YOUR PAYROLL. Be sure to "listen" regularly and carefully to the practical business information he gathers.



McGraw-Hill PUBLICATIONS



What's Your Angle?

says she . . . WHAT ANGLE? says he . . . EVERYONE'S GOT AN ANGLE . . . says she . . . and SERVO HAS DEVELOPED A LINE OF EQUIPMENT TO MEET YOUR NEEDS NO MATTER WHAT YOUR ANGLE!

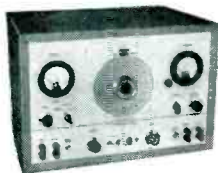

IF IT'S YOUR PHASE ANGLES that need analyzing, the **SERVOSCOPE**[®] will accurately and rapidly measure them. Just a few turns of the dial will give you the values for plotting magnitude and phase curves. The **SERVOSCOPE** generates modulated carrier, low frequency sine, and square waves. So, whether you're developing new designs or de-bugging production testing, let **SERVOSCOPE**, the only equipment of its kind, save you man-hours and prevent costly errors. [®]T.M.



IF IT'S DESIGN ANGLES — the **SERVOBOARD**[®] provides a flexible experimental electro-mechanical assembly that allows you to mock-up your intended designs and test them. No longer must you wait for an overloaded breadboard shop to come through. Developed as an aid to the design of servo-mechanisms and computers, the **SERVOBOARD** will quickly provide the standard precision parts needed to set a preliminary design into mechanical form.



IF IT'S AZIMUTH ANGLES for direction finding, **SERVO**'s VHF Receiver will do the job. Its directly calibrated 72° bandspread dial speedily locates the frequency region of interest. This precision constructed receiver provides all custom features needed for communication and laboratory work. In addition, special outputs are provided for the receiver to be used as a component in complete communication, telemetering or direction finding systems.

SERVO'S PRECISION CONSTRUCTED EQUIPMENT IS AN EXAMPLE OF SOUND ENGINEERING AND UNEXCELED CRAFTSMANSHIP. BEHIND SERVO PRODUCTS STANDS A RECORD OF OUTSTANDING PRACTICAL ENGINEERING ACHIEVEMENTS.

SERVO CORPORATION of AMERICA



New Hyde Park
Long Island, N. Y.

FOR FURTHER INFORMATION WRITE:

SERVO CORPORATION OF AMERICA
New Hyde Park, N. Y.

Please send further information and details on the following:

SERVOSCOPE SERVOBOARD VHF RECEIVER

Name _____

Title _____

Company name _____

Address _____

City _____ Zone _____ State _____

EL6

power rectifier, type 53-0075-0. It is a 3-phase bridge unit, rated for a maximum of 450 amperes d-c continuous output and can be supplied for input voltages of 26 v, 36 v, 52 v, and 66 v rms maximum. It has a volume of approximately 220 cu in. as compared to 1,650 cu in. for a comparable selenium unit (fan cooled) and 14,000 cu in. for a copper oxide unit (fan cooled). The new unit requires liquid coolant at a maximum inlet temperature of 25 C and a volume of $\frac{1}{2}$ gallon per minute minimum.

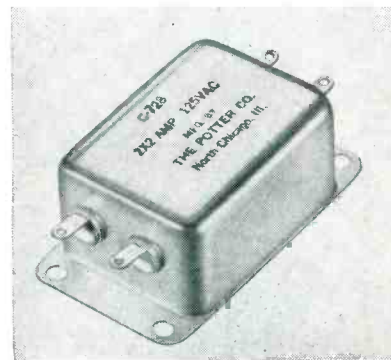

LINE FILTER for h-f units

POTTER Co., 1950 Sheridan Rd. North Chicago, Ill., has announced its new C-728 filter. Intended as a component in h-f units such as diathermy and ultrasonic oscillators, its use enables units of this type to meet FCC radiation requirements of 15 μ v per meter at 100 ft. It meets UL requirements of 5 ma current to ground, and is for 115-120 v a-c operation. It is available for any current rating and in a wide variety of shapes and mounting arrangements. Complete information is given in bulletin ELN.

PULSE TRANSFORMERS in ferrite and steel core

VALOR ELECTRONIC COMPONENTS Co., 5808 Marilyn Ave., Culver City, Calif. The new F series ferrite core, and L series ribbon steel core pulse transformers feature unusual compactness of construction. Blocking oscillator transformers which can be used to develop pulse widths from 0.1 to 8 μ sec, and

TUNG-SOL "Magic Mirror"

ALUMINIZED

PICTURE TUBE

**BRIGHTER-SHARPER
MORE DETAIL
MORE CONTRAST**



The "Magic-Mirror" Aluminized Picture Tube produces the brightest, most realistic picture ever seen in the American home. The "Magic-Mirror" tube effectively utilizes *all* the light generated by the phosphor screen.

Tung-Sol has developed a unique "fogging" method of backing up the phosphor screen with a mirror-like aluminum reflector. This reflector prevents light radiating uselessly back into the tube. It brings out all the detail of which the receiver circuit is capable. So smooth and true is the Tung-Sol aluminum reflector that mottling, streaks, swirls, "blue-edge", "yellow center" and other objectionable irregularities are eliminated.

Tung-Sol pin-point-focused electron gun assures a steady, brilliant picture—free from alternate fading and overlighting. Tung-Sol's exacting standards of quality control, manufacture and testing further guarantee the high uniformity and maximum performance of the "Magic-Mirror" TV Picture Tube.

Let the superior qualities of "Magic-Mirror" Picture Tubes add selling advantages to your set.

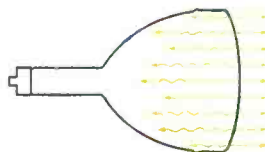

ORDINARY TUBE—Only *half* the light produced by the phosphor screen is utilized in the picture. Other half radiates wastefully back into tube.



RESULT—A light background within the tube which reduces picture contrast.

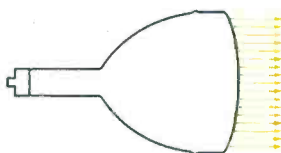

MAGIC-MIRROR ALUMINIZED TUBE—Aluminized reflector allows electron beam through. Blocks wasted light from backing up into tube. Reflects *all* the light into picture.



RESULT—Pronounced increase in contrast to make a bright, clear, more realistic picture.

TUNG-SOL ELECTRIC INC., Newark 4, N. J.

Sales Offices: Atlanta, Chicago, Columbus, Culver City (Los Angeles), Dallas, Denver, Detroit, Montreal (Canada), Newark, Seattle.

Tung-Sol makes All-Glass Sealed Beam Lamps, Miniature Lamps, Signal Flashers, Aluminized Picture Tubes, Radio, TV and Special Purpose Electron Tubes and Semiconductor Products.

Kearfott RDF Loops Exceed 41,000 Hours Operation

*Test Made with Equipment
Exposed to Full Range of
Weather Conditions.*

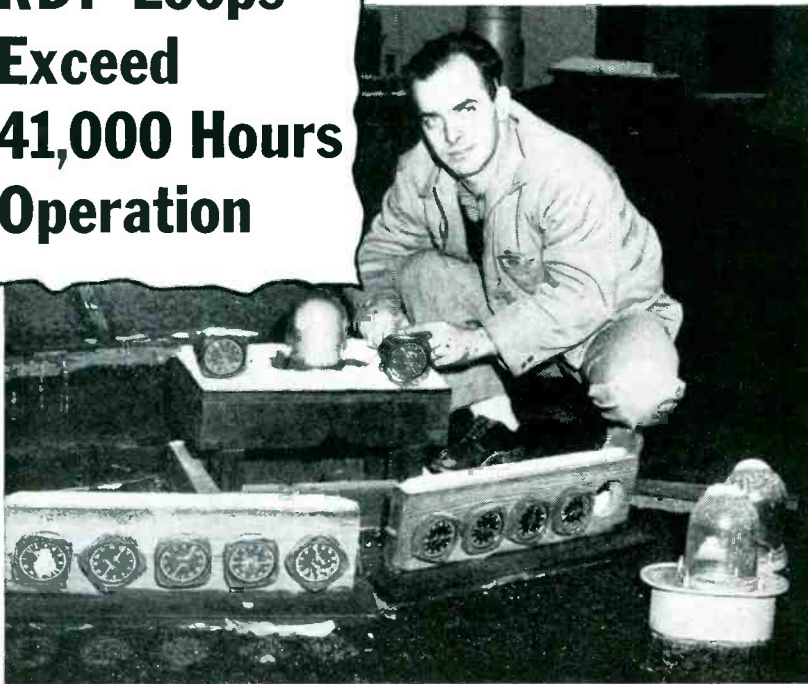

The Kearfott AS-313 Radio Direction Finder Loop and the ID-90 Indicators withstood continuous operation for 41,977 hours. This is over 40 times the 1,000 hours required by Air Force specifications for Sealed Aircraft instruments.

The ability of Kearfott equipment to operate long beyond requirements is significant. The same hermetic seal principle employed in the construction of Kearfott Loops is also used to impart dependability and long life to Kearfott Gyros, Computers and Packaged Servo Systems.

The Kearfott organization is available to you to aid in meeting instrumentation requirements of modern airborne equipment.

—Send for Technical Data Sheets

KEARFOTT COMPONENTS INCLUDE :

Gyros, Servo Motors, Synchros, Servo and Magnetic Amplifiers, Tachometer Generators, Hermetic Rotary Seals, Aircraft Navigational Systems, and other high accuracy mechanical, electrical and electronic components. Send for bulletin giving data of components of interest to you.

ENGINEERS :

Many opportunities in the above fields are open. Please write for details today.

A SUBSIDIARY OF GENERAL PRECISION EQUIPMENT CORPORATION



KEARFOTT COMPANY, INC., LITTLE FALLS, N. J.

Sales and Engineering Offices: 1378 Main Avenue, Clifton, N. J.
Midwest Office: 188 W. Randolph Street, Chicago, Ill. South Central Office: 6115 Denton Drive, Dallas, Texas
West Coast Office: 253 N. Vinado Avenue, Pasadena, Calif.

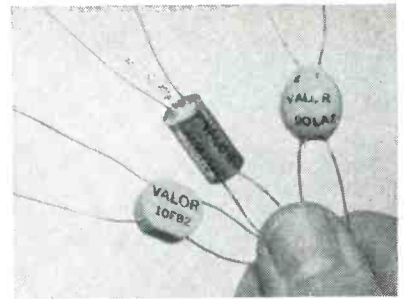

high-Q pulse coupling transformers of 0.1 to 10-mh inductance are available. As coupling transformers the ferrite units have rise times in excess of 0.005 μ sec. Both types are available in 2 and 3-winding in a variety of case configurations including epoxy encapsulated, molded, and hermetically sealed in metal cases. They conform to the requirements of MIL specifications.

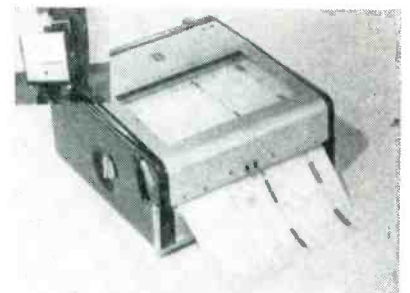

OSCILLOGRAPHS are lightweight, portable

BRUSH ELECTRONICS Co., 3405 Perkins Ave., Cleveland 14, Ohio. The new lightweight portable oscillographs are designed for either 4 or 6-channel recording. The 4-channel unit weighs 36 lb and the 6-channel recorder is 48 lb. Designed for flexibility, each unit offers a range of 16 chart speeds with the travel variation of from 10 in. per day to 10 in. per sec to simplify the testing problems of electrical variables, vibration, torque, stress, strain and other desired measurements. Engineered into the models are a control selector that will permit either a local or remote control setup.

VACUUM PHOTOTUBE for industrial service

RADIO CORP. OF AMERICA, Harrison, N. J. Type 6570 vacuum phototube

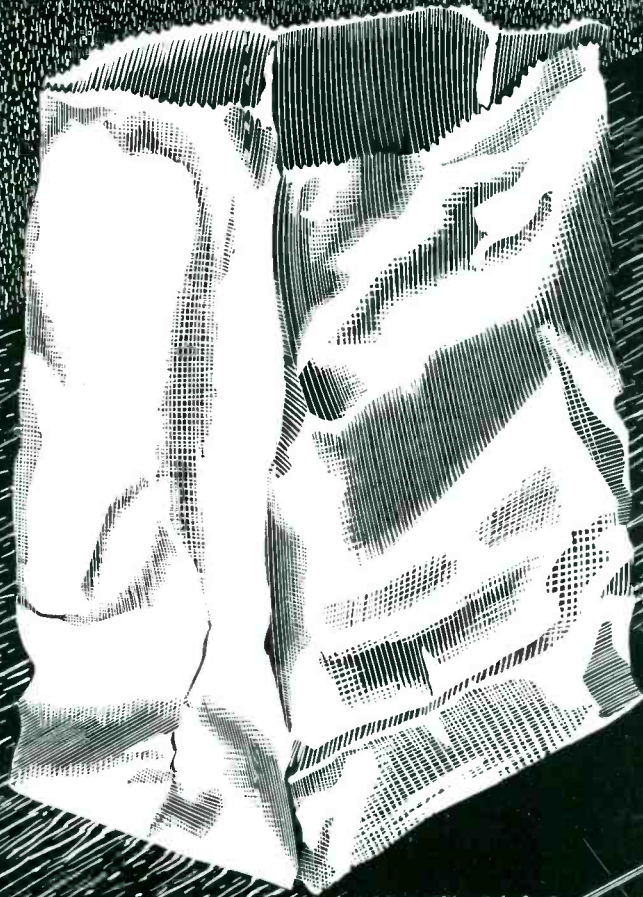

...and a pound of precision, please

Those who shop for precision in mixer crystal testing, look for accurate measurement of these characteristics: Relative Noise Figure . . . Relative Sensitivity . . . Crystal Pair Matching . . . Conversion Loss . . . Noise Temperature.

Ail's Type 390A-3 Microwave Crystal Test Set achieves this at the highest standard of operating efficiency. But more important, all this precision comes delivered in a one-pound package, RFU* Field or Laboratory. Priced at \$97.00, the unit has been repeatedly selected by those who recognize in all Ail products the individuality of advanced design, which receives universal acceptance.

Literature available on request.

*Ready For Use

 **AIRBORNE
INSTRUMENTS
LABORATORY**
I N C.

160 OLD COUNTRY ROAD, MINEOLA, L. I., N. Y.



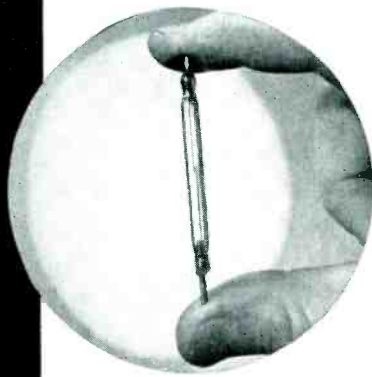
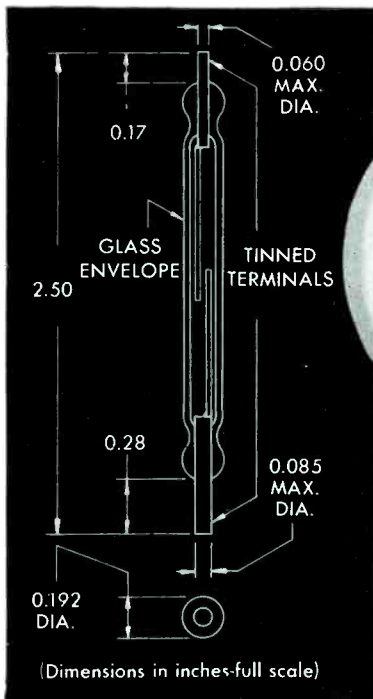

the mighty little glaswitch*

LIGHTNING RESPONSE . . . SEALED IN GLASS

The magnetically actuated reeds in this tiny Revere GLASWITCH make contact in just 1 millisecond . . . at rates up to 400 cycles per second. Hermetically sealed in an inert, dry atmosphere, with lightning fast snap action, both shelf and contact life are extremely long. Smaller than a cigarette, the GLASWITCH can be located anywhere . . . in any position . . . even in explosive atmospheres . . . individually or in multiples for multi-contact use.

Whenever you need faster, more positive response . . . where extreme sensitivity is a must . . . where light weight is important . . . investigate the Revere GLASWITCH. Write today for complete specifications and suggested uses.

CHARACTERISTICS:

Type—Single pole single throw—normally open—snap action
Enclosure—Hermetically sealed glass tube containing inert dry atmosphere

Operating Time—1 millisecond

Operating Rate—Up to 400 cycles per second

Contact Surfaces—Electroplated Rhodium

Contact Resistance (measured terminal-to-terminal)

Closed Circuit—0.050 ohms maximum

Open Circuit—500,000 megohms minimum

Contact Ratings

D.C. Loads at 28 volts

0.5 amps resistive

0.5 amps inductive (L/R—0.026)

A.C. Loads at 115 volts, 60 cycles

10 watt lamp load

Ambient Temperature Range— -85°F to $+500^{\circ}\text{F}$

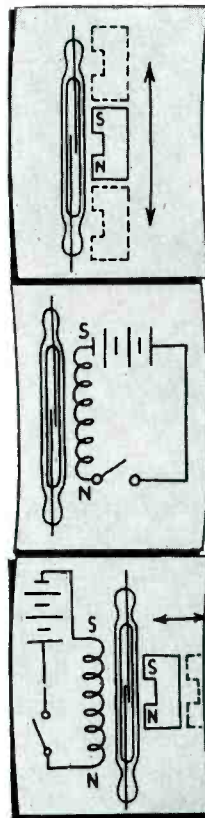

METHODS OF ACTUATION:

A moving permanent magnet or controlled external electromagnetic field are all you need . . . and the sky's the limit on imagination!

* Trademark



Revere CORPORATION OF AMERICA

WALLINGFORD, CONNECTICUT A subsidiary of Neptune Meter Company

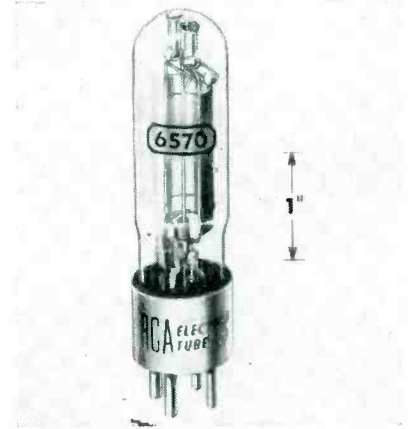

is designed for use in industrial applications critical as to microphonics and sensitivity gradient. Among such applications are electronic beverage-inspection equipment and ampul-inspection equipment. Spectral response of the 6570 is characterized by high sensitivity to red and near-infrared radiant energy. The tube is especially suitable for use with an incandescent light source. It has a maximum anode-supply voltage rating of 500 v, a maximum average cathode-current rating of $5 \mu\text{a}$ and an average luminous sensitivity of $30 \mu\text{a}$ per lumen.

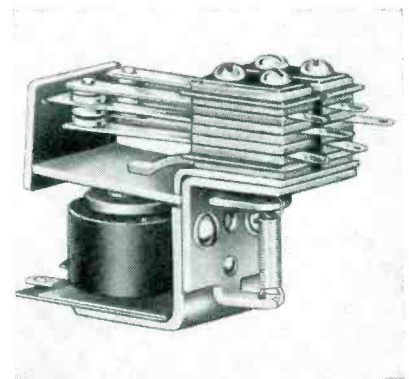

CONTROL RELAY carries full UL approval

GUARDIAN ELECTRIC MFG. Co., 1621 Walnut St., Chicago 12, Ill. Series 210-UM magnetic motor controller relay series carries full UL approval. This sturdy a-c relay is available in any standard arrangement of contact combinations from spst, normally open, to dpdt. Coil voltage is 115 v, 60 cycles. Contacts are rated at 115 v, a-c, 60 cycles, single-phase, $\frac{1}{2}$ hp. Standard coil and contact terminals are lug type, tinned for easy soldering. Bakelite

insulation of the contacts is tested at 1,500 v, 60 cps. The standard dpdt unit weighs 4.3 oz.

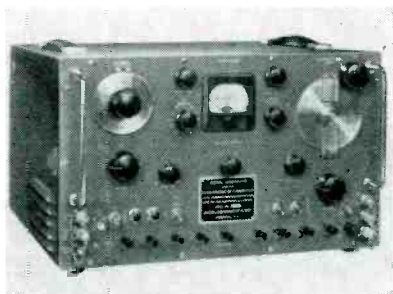

SIGNAL GENERATOR
for testing i-f amplifiers

AVION INSTRUMENT CORP., 299 State Highway No. 17, Paramus, N. J., has developed a new signal generator, model 131, for testing i-f amplifiers and other circuits operating in the 7 to 70-mc range. Capable of c-w, pulse or standard operation, with a built-in 5,000-mc crystal frequency standard, a completely electronic linear frequency sweep and a continuously tunable frequency marker, the signal generator weighs 99 lb and is housed within a cabinet 11 in. high x 16 3/4 in. deep x 18 1/4 in. wide.



T-W AMPLIFIERS
for a variety of uses

ROGER WHITE ELECTRON DEVICES, INC., Route 17 and Erie R. R., Ramsey N. J. The TWA series of t-w amplifiers comprise a group of broadband amplifiers operating in the frequency ranges above 800 mc. A single beam control permits the output power level to be adjusted or maximized. A helix control is also provided to permit additional peak-

Pacific rate gyros

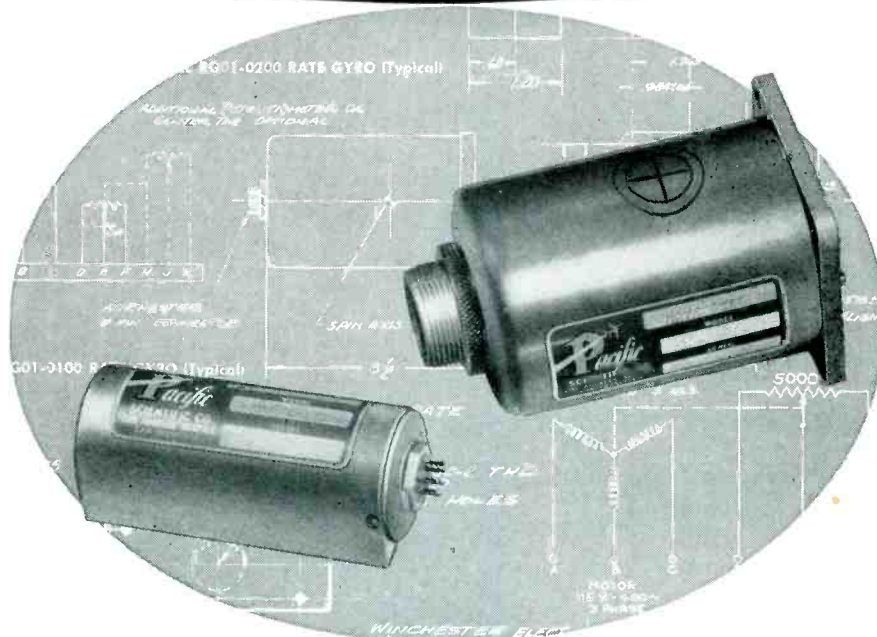

... advanced wheel design
gives higher natural frequency
over any rate range!

Now in production, an entirely new concept in wheel design provides Pacific Rate Gyros with unusually accurate and dependable performance. Combined with a special precision potentiometer, this advanced design Rate Gyro gives greater resolution and shock resistance...lower power consumption...light weight...and a higher natural frequency with any rate range!

A wide variety of Pacific Rate Gyros are built for any application. Production models from sub-miniature designs for use in stabilization or damper systems, to gyros for precision computer applications. Special models can be custom designed to your own specifications by Pacific's large staff of experienced gyro engineers.

For any Rate Gyro, Pacific's creative designs, complete manufacturing facilities and experience are backed by fully approved quality control. You're assured precision performance and rugged dependability in every unit.

**PACIFIC SCIENTIFIC—PIONEERS IN AIRCRAFT
INSTRUMENTATION AND ACCESSORIES SINCE 1919**

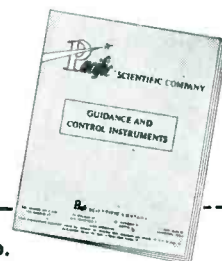

Pacific SCIENTIFIC CO.
LOS ANGELES • SAN FRANCISCO • SEATTLE • ARLINGTON, TEXAS
REPRESENTATIVES:
Aero Engineering Co.
Atlanta, Ga. • Baltimore, Md.
Indianapolis, Ind. • Mineola, L.I., N.Y.
Columbus, Ohio • St. Louis, Mo.
GARRETT MFG. CORP., Toronto, Canada

PACIFIC SCIENTIFIC CO.
1422 Grande Vista Ave.
Los Angeles 23, Calif.
Please send me your new catalog and specification sheets on:

Rate Gyros Free & Vertical Gyros
 Accelerometers Potentiometers

name _____
company _____
address _____
city _____ state _____

* TRADE MARK

Fansteel

TANTALUM CAPACITORS

Four basic advantages

1. Greatest Capacity in Small Space
2. Practically Unlimited Life
3. Maximum d-c leakage 0.00008 amp.
4. Stable Characteristics over Wide Temperature Range

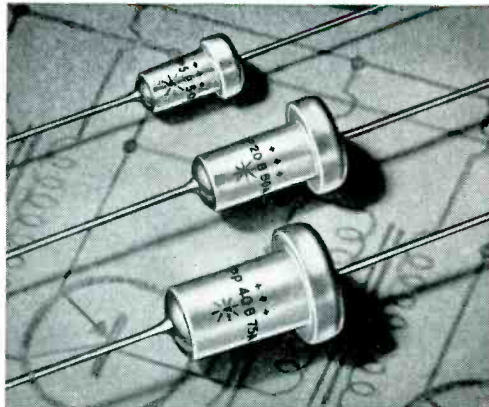

Incorporating a porous tantalum anode assembly, tantalum capacitors derive their unusual stability from the characteristics inherent in tantalum itself—the most stable of *all* anodic film forming metals. During twenty years of ever increasing use, these important advantages have become accepted: No important changes of characteristics occur, even in long periods of operation. No shelf aging. Large capacity in extremely small size. Maximum stability and temperature range.

Fansteel offers Tantalum Capacitors in 58 sizes and ratings. All sizes are available from stock. Write for current technical bulletins.



FANSTEEL METALLURGICAL CORPORATION
North Chicago, Illinois, U. S. A.

C552A

TANTALUM CAPACITORS . . . DEPENDABLE SINCE 1930

NEW PRODUCTS

(continued)

ing if desired. The unit is operated from a 115-v, 60-cycle power line. Front panel control information, operating instructions and specifications are found in bulletin TWA 12-54.

CATHODE-RAY TUBE for view-finder service

RADIO CORP. OF AMERICA, Harrison, N. J. Type 5AYP4 direct-viewing 5-in. crt was designed for use as a view-finder on portable tv cameras. It provides a 3 $\frac{3}{8}$ in. \times 2 $\frac{1}{2}$ in. image of the televised scene. Focused electrostatically and deflected magnetically, the 5AYP4 has an electron designed to provide high resolution and uniform focus over the entire picture area. The face of the new tube is practically flat and has an aluminized white fluorescent screen that not only improves picture contrast and brightness but also eliminates the need for an ion-trap magnet. An external conductive coating on the tube, combined with the internal conductive coating, forms a supplementary filter capacitor. Maximum design-center rating for the ultor is 10,000 v and for the focusing electrode 1,500 v.

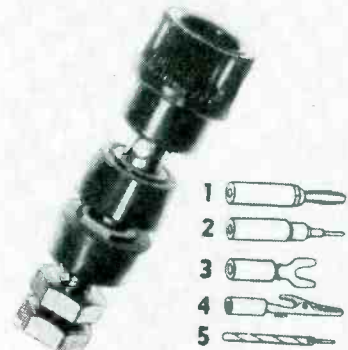

BINDING POST is compact, 5-way unit

HERMAN H. SMITH INC., 2326 Nostrand Ave., Brooklyn 1, N. Y., has available a new compact 5-way binding post. Model 260 all-molded binding post is designed to accept standard phone tips, banana plugs, spade lugs, alligator clips and most wire sizes. Mounting in a $\frac{5}{16}$ -in. hole this unit locks securely in

panels from $\frac{1}{16}$ in. to $\frac{1}{4}$ in. thick, and assures complete insulation from all surfaces at 3,000 v a-c. Ask for catalog No. 55A.

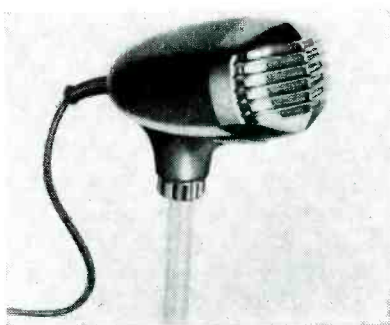

MICROPHONE is general purpose type

TOKYO TELE-TECH Co., 3475 Knox Place, New York 67, N. Y., representatives of the firm of Tokyo Tsushin Kogyo K.K., has entered the American electronic field with the model F-6 general purpose moving coil microphone. Inexpensive enough to be a replacement for a crystal microphone, this product has a frequency response of 60 to 10,000 cps, ± 5 db, at an output level of -55 db over 40,000 ohms. Manufacturers' inquiries are invited.

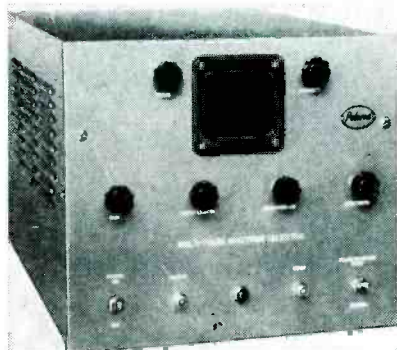

SPECTRUM SELECTOR for gating pulses

POLARAD ELECTRONIC CORP., 43-20 34th St., Long Island City 1, N. Y., has announced a new multipulse spectrum selector to display and select, for spectrum analysis, a specific train of microwave pulses as well as any one pulse in a train. Model SD-1 will select and gate a group of pulses up to 100 μ sec in length. It will work with fast narrow pulses and can be adjusted to gate any pulse including the

Fansteel

SELENIUM RECTIFIERS

a 31 year record of DEPENDABILITY!

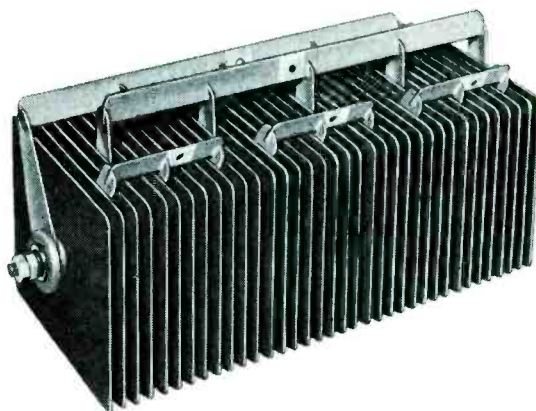

Whatever your rectifier requirements, you can depend on Fansteel's experience and facilities to meet them...exactly! From standard Fansteel selenium cells, more than 400,000 different rectifier stack combinations are available. Since 1924, Fansteel's continuing research and development program has paced American Industry's growing demand for selenium rectifiers engineered to fill specific needs.

Fansteel High Temperature Rectifiers

Designed for continuous operation at ambient temperatures up to 100°C. with no derating whatsoever. About one-third the size and one-quarter the weight of a standard rectifier rated at 45°C. *Another "First by Fansteel"!*

Write for current bulletins



FANSTEEL METALLURGICAL CORPORATION
North Chicago, Illinois, U. S. A.

E554A

DEPENDABLE RECTIFIERS SINCE 1924

Stupakoff

Kovar **HARD GLASS** Seals

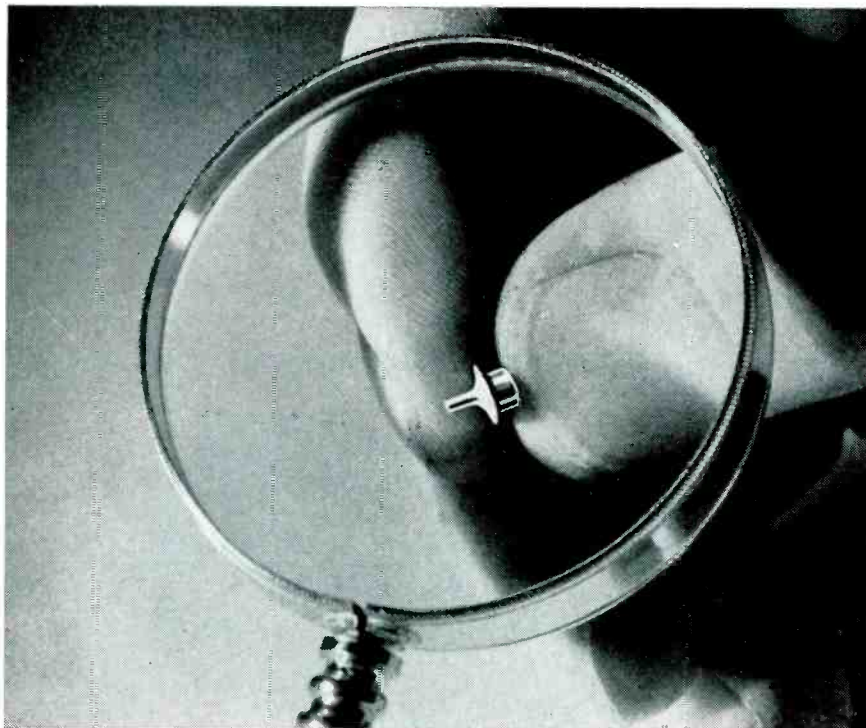

No "Leakers" in 52 million!

Over 52 million of the seals illustrated above are in use; and not a single "leaker" has been discovered!

In their manufacture, Kovar metal and *hard borosilicate glass* (Pyrex) are permanently bonded together, forming a fused-oxide seal that is vacuum- and pressure-tight, and corrosion-proof at the interfaces.

Borosilicate glass, matching perfectly the thermal expansion of Kovar, gives to Stupakoff seals thermal endurance, weather resistance, and high electrical insulating properties over the full temperature range of the glass.

Complete data of hundreds of sizes, styles and ratings of standard Stupakoff Kovar **HARD GLASS** hermetic seals is given in this catalog. Send for a free copy of Bulletin 453A. Write Dept E



Stupakoff

CERAMIC & MANUFACTURING COMPANY • LATROBE, PA.

DIVISION OF *The CARBORUNDUM Company*

NEW PRODUCTS

(continued)

first, at zero time. Special circuitry discriminates automatically once pulses have been selected. The unit operates at all microwave frequencies that can be accepted by the company's spectrum analyzer.

NICKEL OVERLAY for electronic applications

AMERICAN SILVER Co., 36-07 Prince St., Flushing 54, N. Y., is now making available an ultrathin, high precision tolerance nickel clad steel strip. It is produced in thicknesses down to 0.003 in., to tolerances as close as ± 0.0001 in., in widths down to 0.093 in. The nickel overlay possesses high-temperature oxidation resistance. It has been used for lead-in wires for electronic tubes, grid support rods, and other applications where a surface of pure nickel is necessary.

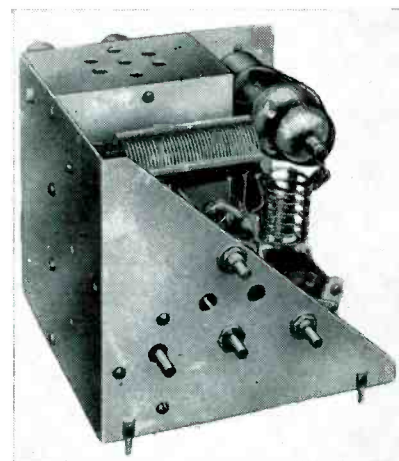

FREQUENCY MULTIPLIER for instant band selection

BARKER & WILLIAMSON, INC., 237 Fairfield Ave., Upper Darby, Pa., has announced a new exciter unit that makes transmission on any band available at the flip of a switch. Model 504C multiband frequency multiplier covers the 80 through 10 meter bands with a nominal power output of 25 w from its 807 amplifier stage through its flexible pi-network output circuit. It requires no tuning, and comes equipped with four 6AQ5's which make up its multiplier string. An external vfo or crystal oscillator (80 meter fundamental) is required, as is a suitable power sup-

ply. Complete information is given in bulletin 504C.

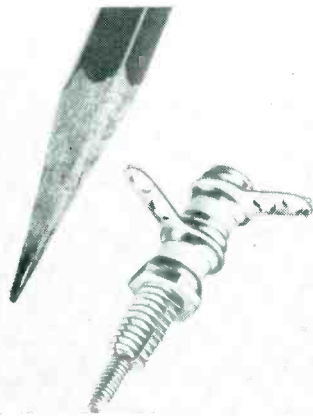

TINY CAPACITOR
with single tuning element

CAMBRIDGE THERMIONIC CORP., Cambridge, Mass., announces its new CST-50-D miniaturized differential capacitor for circuits where balancing is required. It features a single tuning element of unusual design to minimize air dielectric loss. Mounted, the capacitor stands $\frac{1}{8}$ in. high. It is under $\frac{1}{4}$ in. in diameter and has an $\frac{8}{32}$ thd mounting stud. Range of top half of the unit is 1.5 to 10 $\mu\mu\text{f}$; of bottom half, 5 to 10 $\mu\mu\text{f}$. Terminals have two soldering spaces. Locking nut affords stability with no capacitance change.

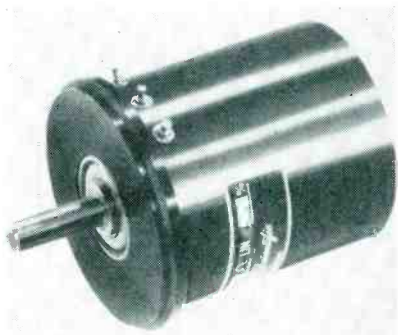

POTENTIOMETER
is extremely accurate

GENERAL SCIENTIFIC CORP., North Hollywood, Calif., has announced the M10-3000HT precise potentiometer. This 10-turn, high-resolution potentiometer is recommended for applications where extreme accuracy is required, such as fire control equipment and analog com-

Stupakoff

Kovar HARD GLASS Seals

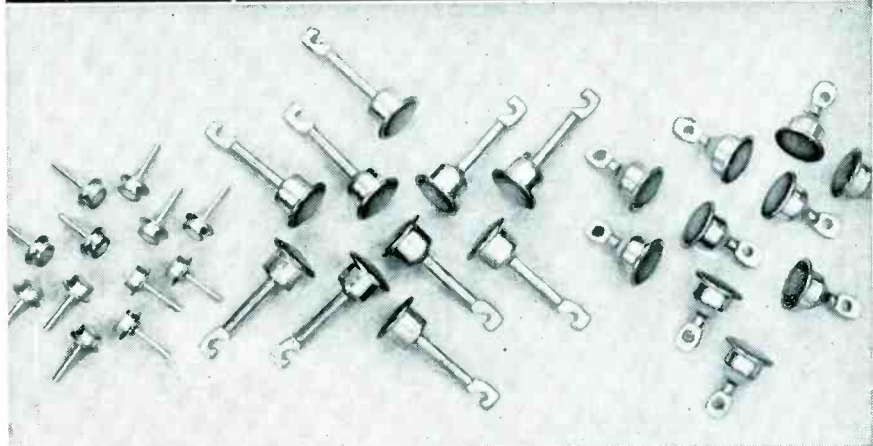
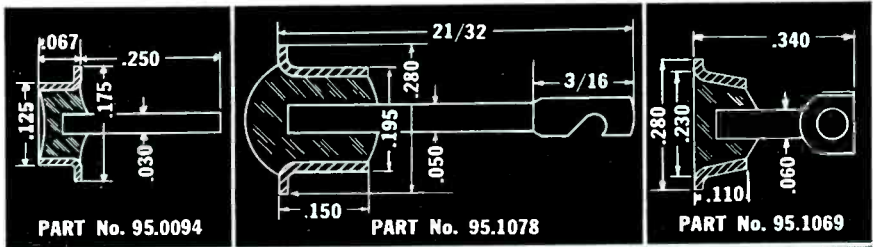

Kovar HARD GLASS Stand-offs for test or connection points.

Fused oxides guarantee
TRUE HERMETIC SEALING

Stupakoff Seals are made by bonding together Kovar metal and hard borosilicate (Pyrex Brand) glass, through a heating process which fuses the oxides of these materials. The strain-free bond thus formed guarantees true hermetic sealing over a wide range of temperatures.

The smooth glazed surface of these compact, light weight seals has high insulating value, and minimizes accumulation of moisture and foreign materials. High thermal endurance permits operation at elevated temperatures, and maximum efficiency is retained even at minus temperatures.

Proper design of a Kovar HARD GLASS stand-off or lead-through terminal insures incorporation of these advantages in your product to provide the desired safety factor. See the "Design Information" section of Catalog 453A, on pages 29 and 30.

Complete data of hundreds of sizes, styles and ratings of standard Stupakoff Kovar HARD GLASS hermetic seals is given in this catalog. Send for a free copy of Bulletin 453A. Write Dept E

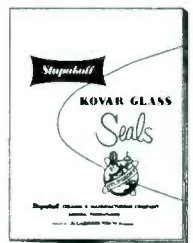

Stupakoff

CERAMIC & MANUFACTURING COMPANY • LATROBE, PA.

DIVISION OF *The CARBORUNDUM Company*

NOW

adjustable

POLYSTYRENE CAPACITORS

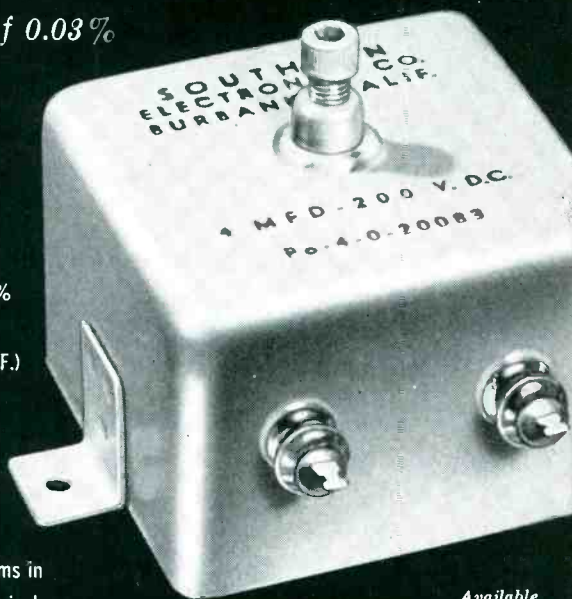
*with Accuracy**in the order**of 0.1% or better**and Long Time**Stability in**the order**of 0.03%*

Check these

outstanding features:

- I. R. - @ 25° C - 10¹² OHMS
- Dielectric Absorption - .015%
- Dissipation Factor - .0002
- Temp. Coeff. (-20° to 140° F.)

100 P.P.M. per °C

Excellent for

Computer Integration,
Test Equipment

or Secondary Standards.

Join these other leading firms in

specifying Southern Electronics' precision polystyrene capacitors

for your most exacting requirements: Reeves Instrument Corp.,

Electronic Associates, Inc., Convair,

Berkeley Scientific, M.I.T., Calif.

Inst. of Tech., and many others.

Write for complete catalog -

SOUTHERN ELECTRONICS



Corporation

239 West Orange Grove Ave., Burbank, Calif.

Available
from 0.1 M.F.D.
to 8 M.F.D.

puters. It is provided with servo mountings and will function in ambient temperature up to 200 C. The unit is very compact and rugged.

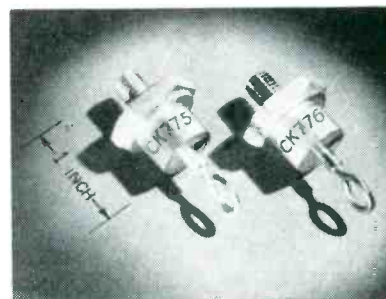
POWER RECTIFIERS
in two new silicon types

RAYTHEON MFG. Co., 55 Chapel St., Newton 58, Mass., announces two new silicon power rectifiers, types CK775 and CK776, capable of handling up to 15 amperes and 200 v peak. Operation at 5 amperes and 170 C is permissible. The ratio of reverse to forward resistance is over 100,000. The rectifiers are small (about 0.6 cu. in.), hermetically sealed and usable to over 100,000 cycles.

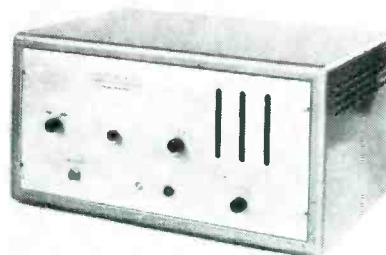
DIGITAL VOLTMETER
is a high-speed unit

FRANKLIN ELECTRONICS INC., 415 W. Pike St., Philadelphia 40, Pa., has available a new high speed analog to digital converter using radar type measuring circuits. The equipment is packaged as a convenient general purpose voltmeter providing for both manual reset and periodic measurements at adjustable rates. Readings as frequent as 20 three-digit numbers per second can be made. Voltage measurements from 100 mv to 999 v of

either polarity can be made with an accuracy of 1 digit. Applications of the model 310 digital voltmeter in process instrumentation and data reduction are anticipated when combined with time division multiplex equipment for scanning and with a peak detector for transient studies. Chopper stabilized d-c amplifiers are also available for applications requiring high measuring sensitivity.



PRESSURE GAGE for adverse condition use

PHOTOCON RESEARCH PRODUCTS, 421 N. Foothill Blvd., Pasadena 8, Calif., has announced a new Dynagage for measuring static and dynamic pressures and displacements under the most adverse temperatures and vibrations. The new model DG-400 with its integral power supply has a size and weight reduction of over 75 percent. It may be used with a complete new series of pressure pickups for measuring pressures up to 75,000 psi. Features include: a stable output of ± 15 v into a high impedance load; frequency response from 0 to over 20,000 cps; cable lengths up to 1,000 ft for remote applications, and simplified tuning controls.

GLASS TUBING for diode manufacturers

CORNING GLASS WORKS, Corning, N. Y., has available precut, ready-to-use glass tubing for hermetically sealed, all-glass diodes. This will aid diode manufacturers by eliminating the waste and breakage that can occur in transporting, handling

Dormeyer Mixers



Get a
**POWERFUL
SALES BOOST**
from

PHALO *Cords*
TRADE MARK

The power supply cord is much more than the life line of the appliance today. It is an integral part of the quality and dependability of the appliance . . . and it should complement the appearance of the appliance.

Phalo cords in black, brown or Phalo Color "Cord-O-Nates" in a selection of fashionable decorator colors are giving powerful sales boosts to nationally famous appliances in every appliance field.

Before you order your next power supply cords or cord sets, ask the Phalo man for the details on quality Phalo cords.

Phalo Custom Builds Cords, Cord Sets, Plugs and Strain Reliefs to Specification.

PHALO PLASTICS CORPORATION
CORNER OF COMMERCIAL STREET, WORCESTER, MASSACHUSETTS

Southern Plant: Monticello, Miss.

Insulated Wire and Cables — Cord Set Assemblies

How SECON Fine Wire is used in critical Government end-use items

SECON'S HIGHLY ENGINEERED FINE WIRE IS BEING USED TO MEET CRITICAL SPECIFICATIONS BY MANUFACTURERS OF IMPORTANT DEFENSE AND MILITARY END USE ITEMS. OUR TIGHT QUALITY CONTROL ON PRECISION FINE WIRE AND RIBBON IS AN IMPORTANT CONTRIBUTION TO THE SATISFACTORY PERFORMANCE OF COMPLETED INSTRUMENTS.

A few examples are listed below . . .

In supplying Precious Metal Alloy Wire for PRECISION WIRE WOUND POTENTIOMETERS, all physical and electrical characteristics are measured to conform to the manufacturers' specifications and blueprints. Also, SECON winds a prototype potentiometer from each melt which is tested for life, noise, and other characteristics which cannot be specified on the wire. Roundness of so small a magnitude that it cannot be measured is a carefully controlled characteristic which receives our continuous attention.

Wire and Ribbon for use as Direct Heated Cathodes in ELECTRONIC VACUUM TUBES are individually prepared for each manufacturer, in order to insure satisfactory operation. Melts are set aside until a manufacturer has ascertained the emission and life characteristics of the melt. Approved melts are then used exclusively to supply the manufacturer who made the tests.

Precious Metals used in ELECTROPLATED GRID WIRE for ELECTRONIC VACUUM TUBES are carefully selected to insure high purity. Only high purity Gold, Rhodium, Silver, and other metals are used.

STRAIN GAUGE WIRES are most carefully selected, both in Precious Metals and Base Metals. Samples of melts are tested by the manufacturer of the strain gauge for Temperature Coefficient of Resistance, Gauge Factor, and other important characteristics. In order to assure uniformity, approved melts are set aside for the exclusive use of the manufacturer who made the tests.



The foregoing are only a few of the fields in which SECON Wire, Ribbon, and manufacturing techniques are used to insure satisfactory performance of the finished item.

Secon specializes in the development, research and production of special alloys and pure metals, processed to very small diameter wire—in all shapes—round, oval, flat, ribbon, grooved—for highly engineered applications in electronics, instrumentation, ordnance, aviation, nuclear physics, atomic energy, guided missiles, automotive industry, and other fields.

Close tolerances and controlled specifications can be held on many important characteristics such as: resistance, tensile strength, elongation, surface appearance, special spooling, purity, torque, linearity, composition, cross section, weight per unit length, uniform plating, dependable insulation, temperature coefficient of expansion and of resistance, and strain sensitivity.

In its Research and Development Section Secon is constantly making new melts and alloys to be tested for new and improved characteristics, as well as perfecting techniques employed on wire and ribbon being currently supplied.

Many companies avail themselves of our offer to discuss their metallurgical problems with our Research and Development Departments. This offer is made to any company who may have a problem which falls within the scope of our activities. For further information write for Pamphlet E-6 to:

Secon end-products include:

- Fine Wire drawn to 0.0003" diameter
- Ribbon rolled to 0.0001" in thickness
- Electro-Plated Wire and Ribbon
- Special Solder
- Enameled and Insulated Wire
- Pirani Gauge Wire
- Electric Primer
- Ignition Wire
- Galvanometer Suspension Strip
- Etched Wire
- Precision Potentiometer Wire
- Transistor Wire Components
- Electronic Vacuum Tube Wire Components
- Experimental Melts

SECON METALS CORPORATION

7 Intervale Street, White Plains, N. Y.
White Plains 9-4757

and cutting long tubing lengths. Bead and case diameters are being produced to a tolerance of ± 0.002 in. Length tolerances are ± 0.004 in. on the bead and $+0.005$ in. on the case. Length of the standardized glass case is 0.275 in. Outside diameter is 0.095 in.; and inside diameter, 0.060 in. The sealing bead is available with these dimensions: length, 0.062 in.; outside diameter, 0.053 in.; inside diameter, 0.023 in.

Literature

Precision Electrical Instruments. Electro-Measurements, Inc., 4312 S. E. Stark St., Portland 15, Oregon. A recent 8-page brochure has been divided into 3 major parts. The initial spread features impedance bridges and accessory null bridge amplifiers. It consists of pictures, circuit diagrams and specifications, and a special description of the L-R-C Dekastat using a direct-reading coaxial dial. The middle section of the catalog is devoted to laboratory instruments, namely Dekaviders and Dekaboxers. Circuit diagrams and Dekadial sketches pertinent to all of the Deka instruments and components are shown.

Transistors. Transitron Electronic Corp., Melrose 76, Mass. A recent folder illustrates and describes *pnp* alloy junction transistors. Maximum ratings and characteristics are given for high-power, medium-power, standard and sub-miniature types.

Potentiometer. Helipot Corp., 916 Meridian Ave., South Pasadena, Calif. The single-turn, high precision Helipot series G potentiometer is the subject of data sheet 54-36. Compact, rugged and long-lived, yet low-priced, the series G unit's construction, specifications and linear coil characteristics are described in detail in the sheet.

Q Meter and Q Sweep. Kay Electric Co., 14 Maple Ave., Pine

Brook, N. J. A single sheet bulletin covers two new instruments. Illustrated and described are the Kilo-Q, a low-frequency Q meter covering the range of 20 cps to 1 mc in 5 steps; and the Q-Sweep which displays Q by means of a 5-percent swept frequency. Major features and technical specifications for both instruments are given.

Microwave and Uhf Test Equipment. The Narda Corp., 66 Main St., Mineola, L. I., N. Y., has just issued its new 28-page catalog. New features include high power impedance meters, variable reactances, and terminations, as well as coaxial slotted lines, attenuators, terminations and couplers.

Flexible Laminates. Oliver Tire & Rubber Co., 4341 San Pablo Ave., Oakland 8, Calif., has available a data sheet on its line of copper clad silicone rubber flexible laminates. Information is given on constructions, sizes, physical properties and state of cure. Prices on 16 different styles are listed.

Waveform Monitor. Allen B. DuMont Laboratories, Inc., Clifton, N. J. Bulletin TR839 illustrates and describes the type 5034-B waveform monitor which measures r-f directly. The instrument discussed features no nonlinearity from video detectors and video amplifiers; provides direct reading of percent modulation on a 4-in. meter; measures modulation percent to within ± 2 percent; and provides 3-in. deflection on the crt.

Glass Enclosed Switch. Revere Corp. of America, Wallingford, Conn. The magnetically operated, glass enclosed, Glaswitch, a sensitive control element for general industrial applications, is described in engineering bulletin 1057. The 20-page booklet covers operation, performance and characteristics of the 2½ in. long, hermetically sealed switch, which is designed to operate in any position in one millisecond or less at rates as high as 400 cps. Methods are illustrated for effecting closure of the rhodium-plated switch contacts, which are rated

What's
Your Use for...

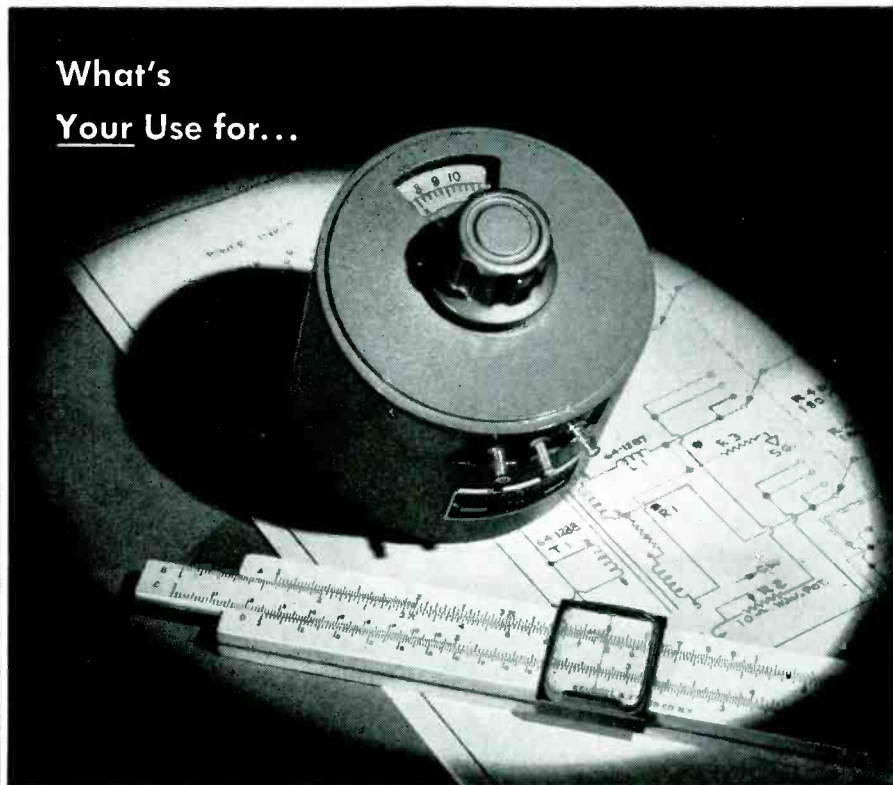

vernistat... The Revolutionary New Precision Variable-Ratio Transformer

Analog Computers? Servos? Control Systems? Vernistat is a completely different type of voltage divider combining **low output impedance with an inherently high resolution and linearity** not ordinarily attainable by precision potentiometers.

The Vernistat consists of a tapped auto-transformer which provides the basic division of voltage into several discrete levels. These levels are selected and further sub-divided by a continuous interpolating potentiometer that moves between 30 transformer taps.

Because of its unique operating principles, electrical rotation is held to close tolerances eliminating the need for trim resistors. In many applications there is also no need for impedance matching amplifiers.

Specifications of the standard model Vernistat are shown below. Other versions are under development to meet specific end uses.

What are your requirements for this unique precision voltage divider? Fill in the coupon now.

vernistat division PERKIN-ELMER CORPORATION
NORWALK, CONNECTICUT

SPECIFICATIONS

Linearity Tolerance
better than $\pm .05\%$

Resolution better than $.01\%$

Output Impedance
130 ohms (max.)

Max. Output Current 50 ma

Frequency 50-3000 cps

Other models including a miniaturized 400 cps version will be available in the near future.

vernistat division  PERKIN-ELMER CORPORATION
885 Main Avenue, Norwalk, Connecticut

Send me more information on the Vernistat.
The application I have in mind is as follows:

NAME

TITLE

COMPANY

ADDRESS

MISSILE SYSTEMS PHYSICISTS

Research and development in the technology of guided missiles is not confined to any one field of physics. Broad interests and exceptional abilities are required by the participants. Typical areas at Lockheed Missile Systems Division include:

- Neutron and reactor physics
- Advanced electronics and radar systems
- Applied mathematics such as the numerical solution of physical problems on complex computers
- Analytical systems analysis of guidance and control problems
- Ballistics and the integration of ballistic type missiles with vertical guidance
- Electromagnetic properties of the upper atmosphere
- RF propagation in microwaves as concerned with antenna and radome research
- Experimental laboratory instrumentation

Continuing developments are creating new positions for those capable of significant contributions to the technology of guided missiles.

Lockheed MISSILE SYSTEMS DIVISION

| *research and engineering staff*

LOCKHEED AIRCRAFT CORPORATION • VAN NUYS, CALIF.

at 0.5 ampere resistive or inductive at 28 v d-c or 10-w lamp load at 115 v a-c, and are hermetically sealed to permit safe operation even in explosive atmospheres. Calibration data, temperature, life and vibration characteristics and installation information are included in the booklet.

Hermetic Seals. Hermetite Corp., 702 Beacon St., Boston 15, Mass. A recent catalog sheet illustrates and describes a line of quality controlled and engineered hermetic seals. Included are product data on end seals, multiple-pin headers, single terminals, feed-through terminals, transistor and diode bases, crystal holders and custom units. The company's engineering service is also discussed.

Automatic Noise Generator. Kay Electric Co., 14 Maple Ave., Pine Brook, N. J. A recent flyer gives an illustrated description and technical specifications for the Auto-Node, an automatic noise generator for development and production-line noise measurement. It features an automatic measure of noise figure from 5 to 26,500 mc allowing continuous interpolation over vhf, uhf and microwave frequencies.

Electric Motors. Bristol Motor Div., Vocaline Co. of America, Inc., Old Saybrook, Conn. A recent flyer illustrates and describes the series 430 high torque reversible synchronous motors. Wiring and dimensional diagrams and chief features are given.

Regulator. Electric Regulator Corp., 604 Pearl St., Norwalk, Conn. Bulletin 6.04 gives complete details and instructions for the use of the size 4 Regohm, a new direct-action, finger-type electric circuit control regulator. The unit described brings finger-type regulation techniques into higher direct-control power ranges.

Silicon Power Rectifiers. Transi-tron Electronic Corp., Melrose 76, Mass., has available a folder on high temperature silicon power rectifiers for magnetic amplifiers and power supplies. Included are bulletins showing technical speci-

fications and typical temperature characteristics for power supply types and magnetic amplifier types.

Tube Components. Superior Tube Co., Germantown Ave., Norristown, Pa. Basic data on the company's cathodes and other vacuum tube components have been assembled into a single catalog. The 20-page catalog completely illustrates and describes a line of products including cathodes for receiving type tubes, electronic parts for crt's, tubing and tubular parts for transmitter and special purpose tubes and semiconductor devices, and special tubular parts fabricated to customers' blueprint specifications.

Transistor Booklet. Hydro-Aire, Inc., 3000 Winona Ave., Burbank, Calif., has published a booklet entitled "The Transistor And You." It contains instructions and circuit diagrams for the following transistor applications: three-stage transistorized regenerative radio receiver; low-cost broadcast receiver; dynamic microphone preamplifier; radiophone monitor; electronic timer; relay control circuit; electronic time generator; audio oscillator; and field strength meter.

Instrument Catalog. Allen B. DuMont Laboratories, Inc., 760 Bloomfield Ave., Clifton, N. J. A quick-reference catalog lists the salient points of the company's c-r oscillographs and accessory instruments. The 8-page catalog is divided into three sections devoted to l-f, h-f and accessory instruments. A picture of each instrument is provided together with a brief description of its features and some of the fields in which it has applications. Additional technical information is provided in tabular form.

Precistor. International Resistance Co., 401 N. Broad St., Philadelphia 8, Pa., has available catalog data bulletin B-9 dealing with the type MDC $\frac{1}{2}$ w Precistor, which combines the advantages of the company's molding techniques with its experience in de-



NEW DEVELOPMENTS

NEW Fixed Pad Attenuators

FROM 0-1000 MCS.



Pat. Pend.

Here is another major advance in the continuing development, by ARI, of inexpensive, electronic components that measure-up to the most exacting specifications. It's the brand new HFA-50, and HFA-75 fixed pad attenuators for the 0-1000 Mc. frequency range. Important: BNC connectors are used so that the attenuators can be incorporated in virtually all equipment and test set-ups without the need for auxiliary adapters.

CHARACTERISTICS

	HFA-50	HFA-75
Input and Output Impedance	52.5 ohms	75 ohms
Nominal Attenuation	3, 6, 10 or 20 db.	3, 6, 10 or 20 db.
Accuracy	$\pm .5$ db.	$\pm .5$ db.
Max. VSWR	1.2	1.2
Frequency Range	0-1000 Mcs.	0-1000 Mcs.
Connectors: As specified	UG-88/U and/or UG-89/U	UG-260/U and/or UG-261/U
Polarity	None	None

NEW Matching Coaxial Termination

FROM 0-1000 MCS.

The HFT-50 and HFT-75, ARI coaxial terminations are designed for use with the new ARI fixed pad attenuators. Here too, BNC connectors are used.

The unit costs of the ARI fixed attenuators and coaxial terminators have been kept within the practical price range of the large and small equipment producer, as well as the research and experimental user.



CHARACTERISTICS

	HFT-50	HFT-75
Impedance	52.5 ohms	75 ohms
Connectors	UG-88/U	UG-260/U
Max. VSWR	1.2	1.2
Frequency Range	0-1000 Mcs.	0-1000 Mcs.
Power Rating (CW)	1 Watt	1 Watt

Applied  Research
163-07 DEPOT ROAD, FLUSHING, N. Y.

WRITE TODAY for full information, and latest prices.

MANUFACTURERS OF: BNC Attenuators and Coaxial Terminations; Bandpass and Bandreject Filters; Broadband Sweep Generators; Community TV Components; Crystal Mode Indicators.

ADJUSTABLE CAPACITORS

by FCI

for circuits requiring close tolerance of large capacitance

Film capacitors, Inc. has designed a series of polystyrene capacitors to attain the exact value of capacitance in ultra precise circuits where the capacitance cannot be predicted in advance due to second order effects in the circuitry.

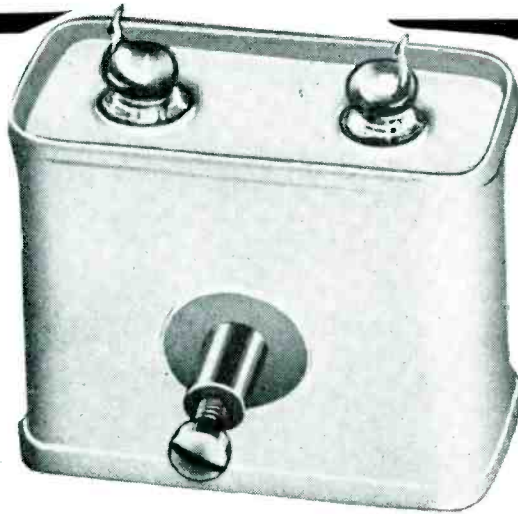

Capacitance Value May Be Adjusted Over A Range of 1% of nominal value.

These capacitors employ a self-rigid type of winding which is inherently stable without external pressure. The extra pressure necessary to adjust the capacitor is a small fraction of the total pressure in the assembly, thus assuring high capacitance stability. The windings are completely non-inductive, thus minimizing power factor and soakage.

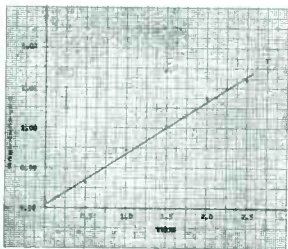

An extremely important advantage of F-C-I adjustable capacitors is the fact that the capacitance is changed instantaneously. There is no slow drifting into a final capacitance value hours after an adjustment has been made. The change of capacitance with rotation is linear to better than $\frac{1}{2}\%$, as shown by the graph which was taken from a stock 1 MF unit. Furthermore, the unit will track its own curve weeks or months after a setting has been made, if it

should be necessary to make another adjustment. Once set, a unit will maintain its value within 0.1% for approximately 1 year. Stray capacitance from capacitor to adjustment screw is on the order of 100 mmf, and has no effect on adjustments. Other electrical values of these capacitors are the same as for fixed polystyrene capacitors.

Standard values rated at 200 WYDC: 0.1, 0.25, 0.50 and 1.00 mfd. Other values and Adjustable Teflon Capacitors supplied to order.

ELECTRICAL CHARACTERISTICS*	Specify F-C-1 for precise, stable industrial capacitors	
	Rated Voltage	200 d-c
Test Voltage	500 d-c	
Power Factor	.02%	
Soakage	.01—0.02%	
Insulation Resistance	10 ⁹ meg-mfd @ 20° C	
Capacitance Stability	0.1% change/year	
Operating Temperature	-40° C to +160° F	
Temperature Coefficient	-100 ppm/°C	

* For complete technical data, write for catalog



film capacitors, INC.

3400 Park Avenue, N.Y., N.Y. • Telephone CYpress 2-5180

posited and boron-carbon resistor production. Included are illustrations, applications, specifications and characteristics.

Aviation Products Catalog. Eastern Industries, Inc., 100 Skiff St., Hamden 14, Conn., has announced a new aviation products catalog covering aircraft pumps, electronic tube cooling units, refrigeration-type cooling units, pressurization units and dehydrators. Bulletin 330 gives complete engineering data covering performance and operating temperature ranges, weights and sizes of all models, and appropriate performance curves.

Airborne TV System. The Davies Laboratories Inc., 4705 Queensbury Rd., Riverdale, Md., has published a single-page leaflet on its closed circuit airborne tv system that features semiminiaturized cameras, automatic illumination control, and reliable operation from conventional aircraft power supplies over a wide range of service conditions. The complete system described includes up to 7 cameras and a monitor station. Complete details are given in bulletin 55-A.

Autopositive Paper. Eastman Kodak Co., Rochester 4, N. Y. How Kodagraph Autopositive paper is being used for engineering drawing reproduction in business and industry is told in a new brochure. Suggested uses for the paper described are to protect original engineering drawing, reclaim old drawings, improve legibility of prints, reproduce unprintable originals, speed revision of drawings, combine standard designs and simplify print distribution.

Beryllium Alloy Wire. Little Falls Alloys, 194 Caldwell Ave., Paterson, N. J. A descriptive folder is available on a new high conductivity beryllium copper alloy wire. The wire discussed, Silvercote No. 10 alloy, is composed of 0.5-percent beryllium, 2.5-percent cobalt and the balance of copper. It has 65 to 70-percent conductivity of

copper and will resist fatigue from flexing and vibration and withstand higher temperatures than ordinary copper wire. It comes with a light silverplating which makes it easy to solder.

Klystron Data. Eitel-McCullough, Inc., San Bruno, Calif. "Klystron Facts—Case No. 2" is a new booklet discussing klystron power amplifier applications, as well as new Eimac developments in the klystron field. It is a continuation of "Klystron Facts," published in 1954, which covers the theory and principle of klystrons. Both pamphlets are available on request.

Polar Pattern Recording System. Airborne Instruments Laboratory, Inc., 160 Old Country Road, Mineola, N. Y., has repackaged and redesigned the components of the AIL 116 and 105 antenna pattern recording system. Complete details pertaining to the equipment, principles of operation and descriptive specifications are enclosed in a recent 4-page brochure.

Panel Instruments. Pace Electrical Instruments Co., Inc., 70-31 84th St., Glendale 27, L. I., N. Y., has published a 4-page folder discussing a line of panel meters for manufacturers serving the fields of communications, industrial control, production-testing and scientific investigation. Illustrations, dimensional diagrams, ranges and electrical specifications are given.

Communications Receiver. Hammarlund Mfg. Co., 460 W. 34th St., New York, N. Y. A 4-page brochure describing the Pro-310 amateur and professional communications receiver is now available. It describes in detail the specifications, design and performance characteristics of this receiver. The instrument described makes use of a rotary turret and has continuously calibrated bandspread from 550 kc to 35.5 mc.

Electromagnetic Components. Heppner Mfg. Co., Round Lake, Ill., has released a new catalog of electromagnetic components for tv and radio applications. Illustrated

SIE

MODEL R-1

VOLTMETER

*Designed and Engineered
for Design Engineers*



FEATURING:

- ★ **DC Volts & Millivolts**
Accurate to 1½% of full scale
- ★ **AC Volts & Millivolts**
Accurate to 3% of full scale
- ★ **Balanced D-C Amplifier**
Flat ±½ db. to 100 KC
- ★ **Ohmmeter**
with Expanded Scales
- ★ **Regulated Power Supply**
unaffected by line transients
- ★ **Illuminated Weston Meter**
accurate to 1% of full scale

... and the SIE Distended DC Scales, the most useful feature ever incorporated in a vacuum-tube voltmeter, enabling changes as small as one part in 10,000 to be read accurately.

The new rack-mounted version of the R-1 includes all of these features in a unit specially designed for this application.



SPECIFICATIONS:

AC & DC Volts Ranges: 1 mv. to 1000 v., full scale
Ohmmeter Ranges: zero ohms to 500 megohms
Maximum Gain, D-C Amplifier: 200
Drift (after warm up): less than 3 mv./hr.
Tube complement: 13
Weight: 34 lbs.

SIE

Price, f.o.b. Houston: **\$620.00**rack mounted: **700.00****SOUTHWESTERN INDUSTRIAL ELECTRONICS CO.**

P. O. Box 13058

2831 Post Oak Rd.

Houston, Texas

SEND FOR FREE LITERATURE.

REPRESENTATIVES THROUGHOUT THE WORLD.

54-1

**BRINGS A NEW CONCEPT INTO
THE FIELD OF SIMULTANEOUS
MULTIPLE MEASUREMENT**

direct writing

**TYPE 550-A
OSCILLOGRAPHIC
RECORDER**

DC TO 900 CYCLES

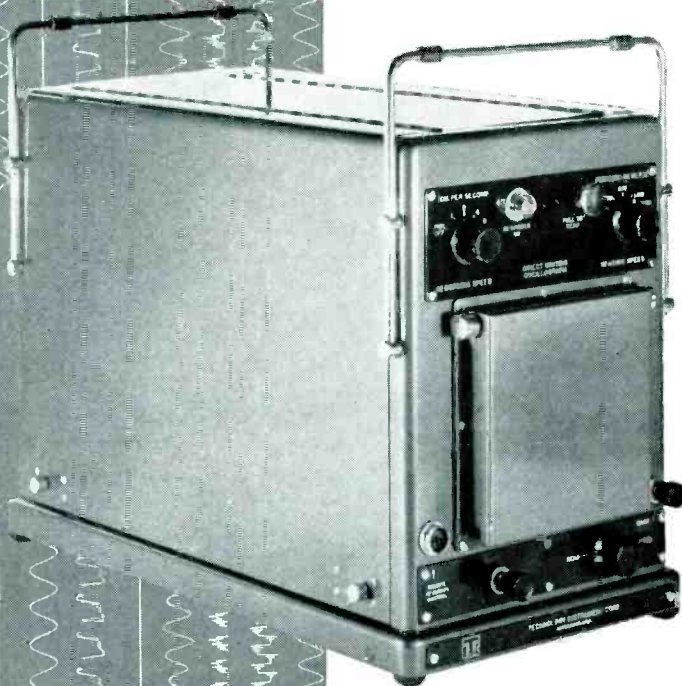

**A New High in Frequency
Response For Direct Writing
Oscillographs**

applicable to inquiry info:

- BLOW-DOWN TUNNEL WORK
- HYDRODYNAMIC TESTING
- ACCELERATION TESTING
- STRAIN EVALUATION
- WELDING ANALYSIS
- VIBRATION STUDIES

Write today for your copy
of our Bulletin 1-102

MULTI-CHANNEL:

**EIGHT
SIMULTANEOUS
TRACES**

- EVENTS SEQUENCE RECORDING
- PERCENT FACILITY UTILIZATION
- SHOCK TUBE INVESTIGATIONS
- DETONATION MEASUREMENTS
- GEOPHYSICAL EXPLORATION
- MEDICAL AND BIOLOGICAL
RESEARCH

and completely described are a full line of ion traps, centering devices, speakers, flybacks, tv focusing magnets, field neutralizing assemblies, purity ring, blue beam bender and Barkhausen oscillation eliminator.

Temperature Indication Systems. Avien, Inc., 58-15 Northern Blvd., Woodside 77, N. Y. High-accuracy temperature indication systems for aircraft jet engines are described in a 4-page brochure. The servo-driven, self-balancing bridge design discussed uses the company's k-volt standard to provide a stable reference voltage that maintains system accuracy of ± 0.5 percent, without recalibration, for a minimum of 1,000 operating hours. System design also permits use of light gage lead wire, offering significant savings in installation weight.

Vibration and Shock Control. Lord Mfg. Co., 1635 W. 12th St., Erie, Pa. The 6-page technical bulletin No. 700 provides complete data on Temproof mountings for vibration isolation. The mountings described are resistant to temperature over the range from -80 F to 250 F. They are extensively used on airborne electronic equipment and also assure excellent vibration isolation for stationary industrial equipment.

Control System. Weston Electrical Instrument Corp., 614 Frelinghuysen Ave., Newark 5, N. J., has issued a catalog illustrating and describing its Inductronic system for measurement and control. The catalog gives technical information, as well as application data, on the basic Inductronic d-c amplifying unit as well as on its companion models such as multirange d-c amplifiers, sensitizing amplifiers, integrating fluxmeters, limit and knife-edge control units, and product resolvers.

Precision Connector. DeJUR-Amesco Corp., 45-01 Northern Blvd., Long Island City 1, N. Y. A 4-page brochure in color gives actual size illustrations and outline drawings on the new series 1300 AN-type connectors with one-

TECHNOLOGY INSTRUMENT CORP.

530 Main St., Acton, Mass., Colonial 3-7711

West Coast Mail Address: P.O. Box 3941, North Hollywood, Calif., POplar 5-8620

piece molded inserts. Electrical and mechanical specifications are included.

Multiple Scale Meters. DeJUR-Amsco Corp., 45-01 Northern Blvd., Long Island City 1, N. Y. Bulletin MHD-155 covers the HD-647 multimeters. One page in color describes the new 2½-in. meter series that provides up to 5 scales in all sensitivities, a-c or d-c. The reverse side of the sheet deals with 3½-in. elapsed time indicators.

Nuclear Batteries. Patterson, Moos Research Division, Universal Winding Co., Inc., 90-28 Van Wyck Expressway, Jamaica 18, N. Y. A single-page flyer discusses nuclear batteries which convert nuclear energy into electrical energy. Suggested applications of the batteries described are: timing circuits, transistor power supplies, constant current reference sources, constant voltage reference sources, control circuits, polarizing elements, power supplies for radiation measurement instrumentation, biasing elements and so on.

Teflon Terminals. Seaelectro Corp., 186 Union Ave., New Rochelle, N. Y., has published an 8-page illustrated folder describing Press-Fit Teflon terminals. Applications, and electrical, mechanical and chemical properties are given. Dimensional diagrams and tabular data are included for stand-offs, feed-throughs, connectors, miniature and subminiatures.

Cooling Devices. Rotron Mfg. Co., Woodstock, N. Y., has available an 8-page brochure entitled "What We Make". It describes in editorial and picture content the complete line of cooling devices for the electronics industry manufactured by this company, as well as indicating applications in which these devices find use.

Coil Forms. Precision Paper Tube Co., 2035 W. Charleston St., Chicago 47, Ill., has published a 4-page brochure containing technical data and other important information on square and round

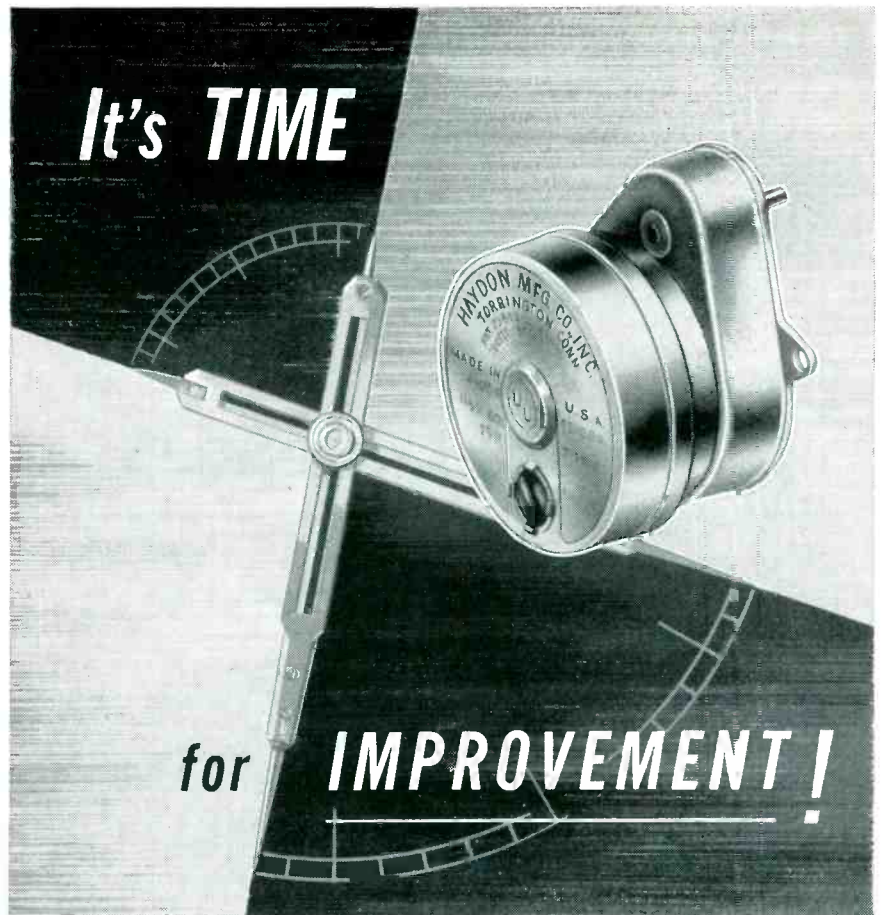

when you specify

HAYDON* TIMING MOTORS

TIME — and its accurate measure — are vital factors in today's designs. And whatever your timing requirements, you'll find there's a HAYDON Timing Motor that does the job better . . . opens the way to important improvements and advances in your designs.

Take very slow shaft speeds for example. HAYDON 4400 Series Timing Motors offer speeds from 6 hours to 1 week with totally enclosed gearing and at comparatively low cost. You save the extra bulk and expense of external reduction gears . . . achieve greater compactness, dependability and economy.

When it's time for design improvement it's HAYDON every time. Take advantage of our complete Timing Services. HAYDON'S manufacturing facilities and engineering counsel are at your disposal through the nearby HAYDON Field Engineer.



CLIP AND MAIL THE COUPON FOR HIS NAME — AND FOR AN INFORMATIVE CATALOG — TODAY!

A SUBSIDIARY OF GENERAL TIME CORPORATION

HAYDON Manufacturing Company, Inc.
2430 ELM STREET, TORRINGTON, CONN.

- Send me the name of the nearby HAYDON Field Engineer.
- Send me catalog, "Electric Timing Motors."

NAME _____
 POSITION _____
 COMPANY _____
 CO. ADDRESS _____
 CITY _____ ZONE _____ STATE _____



* Trade Mark Reg. U.S. Patent Office

physicists and physical chemists

... with baccalaureate or advanced degrees and those with basic experience in these sciences now are offered an unusual opportunity to enter the new semiconductor field and at the same time become associated with General Motors.

The scope of the semiconductor field is virtually limitless, and our new permanent program is to explore wide areas of it and engage in research and development—starting with a power transistor suitable for automotive use and continuing on toward basic research and the development of semiconductor types suitable for military and other commercial uses. The work is independent of Government support.

The most up-to-date research facilities for this type of work are provided, with leadership by a physicist with an outstanding record in this field. You also obtain the advantages of being among the first to join this new and vital General Motors activity.

Location is the Midwest. Expenses for arranged interviews and relocation allowed. Unusual employe benefits of General Motors are included.

If you find this of interest or if you wish further information, write, wire or telephone Mr. H. J. Claypool, Executive Engineer, Delco Radio Division, General Motors Corporation, Kokomo, Indiana (phone 2-8211).

Delco Radio



DIVISION OF **GENERAL MOTORS**

tubes, Resinite coil forms, bobbins and mandrel services for electronic and related applications.

Motors. John Oster Mfg. Co., Avionic Division, 1 Main St., Racine, Wis., has released a new data sheet. Technical information and illustrations are given on typical units in the company's line of synchros, servo torque units, a-c drive motors, d-c motors, a-c servo motors, tachometer generators, actuators, and motor driven blowers and fan assemblies.

VHF Communications Receiver. Stratton & Co., Ltd., Eddystone Works, West Heath, Birmingham 1, England. A 4-page brochure covers the model 77OR vhf communications receiver which features continuous coverage from 19 to 165 mc in 6 tuning ranges. An illustration, chief features and complete technical information are included. The receiver described is a 19-tube superheterodyne for a-c operation. It weighs 60 lb; measures 16 $\frac{3}{4}$ in. wide, 15 in. deep and 8 $\frac{3}{4}$ in. high.

Electron-Power Tubes. Eitel-McCullough, Inc., San Bruno, Calif. "What's New with the Electron?", a discussion of the company's developments during the past year, is now being offered. The booklet covers new and improved Eimac tubes in the triode, tetrode, klystron and rectifier fields, including the 4x5000A, the first Eimac all ceramic and metal radial-beam power tetrode.

VHF Signal Generator. Kay Electric Co., 14 Maple Ave., Pine Brook, N. J. A single-page bulletin covers the Xtalator, a decade switched, direct reading, crystal controlled vhf signal generator. Chief features, specifications and price are included.

Miniaturized Power Packs. Electronic Research Associates, Inc., 67 E. Centre St., Nutley, N. J. A new 2-sided catalog sheet covers the company's line of Transpac miniaturized power packs. The catalog includes many new models covering both 60 and 400 cycle types as well as a new series of

models which supply a combination of constant voltage and constant current specifically for transistor application.

Industrial TV Housings. Radio Corp. of America, Camden, N. J. Catalog E. 55 contains descriptions, chief features, illustrations, applications and specifications for the company's dust and explosion-proof type and the weatherproof type industrial television housings.

Spurious Emission Filters. Allen B. Du Mont Laboratories, Inc., Clifton, N. J. Bulletin TR-787 covers types 5391-A, 5392-A, 5393-A and 5394-A spurious emission filters. The filters described, when inserted in the output transmission line of any tv transmitter, will effectively attenuate all second and higher order harmonics so as to satisfy FCC requirements. Included are specifications, power ratings, attenuations and installation information.

General Parts Buying Guide. Electro Sonic Supply Co., Ltd., 543 Yonge St., Toronto, Canada, has published its 1955 general parts catalog. Containing 284 pages plus an 8-page index, it is packed with the latest in tv components, radio parts, amateur gear, industrial devices, high-fidelity equipment and test instruments. Write for catalog No. 551.

Tubing and Sleeving. Alpha Wire Corp., 430 Broadway, New York 13, N. Y., has published an engineer's cross-reference tubing and sleeving chart. It enables the engineer to spot the specific tubing and sleeving he needs for any particular application, in just seconds. Full technical specifications such as dielectric strength and temperature rating are included.

Transistor Packaged Circuits. Electronic Research Associates, Inc., 67 E. Centre St., Nutley, N. J., has available a new catalog sheet covering its line of Transamp transistor packaged circuits. It deals with additional new models including transistor audio ampli-



EPIC FAST PULSE AND COUNTING EQUIPMENT

10 MC SCALERS

(Model 4000 Series)

available with:

- Predetermined count
- Predetermined time
- Regulated 500-2.5kv high voltage power supply
- Automatic reset
- Decade or binary systems
- Scale of 1000 or 4096
- 0.1 microsecond resolution
- Preamplifiers and pulse height discriminators

A wide range of choice makes it possible to select the exact high-speed counting equipment desired, from the basic manual models to the most fully automatic and complex counting systems.

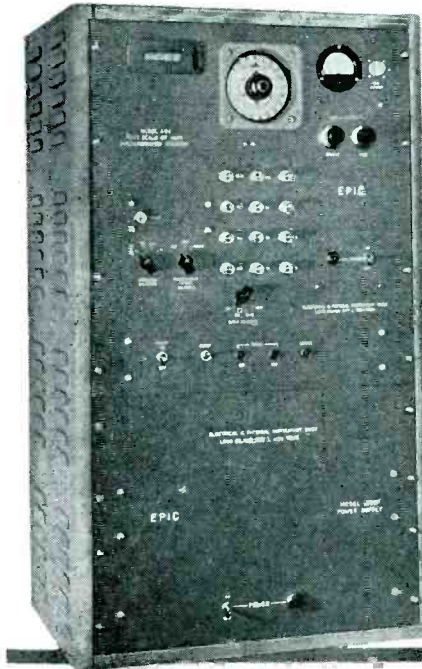

MILLIMICROSECOND

Square Pulse Generators

with single or multiple pulse-outputs: ▶

Rise Time: .001 μ sec. from 10% to 90% amplitude.

Pulse Width: .001 μ sec. to several μ sec.

Pulse Amplitude: From 100 volts to .006 volts in one db steps.

Output Imp: Matched to any impedance for standard coax lines. Multi impedance outputs also available.

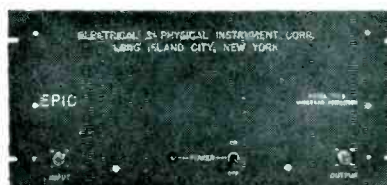
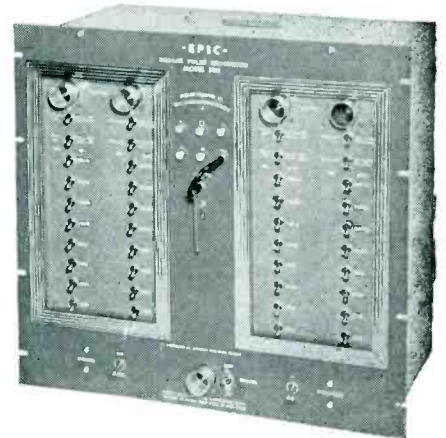

PULSE GENERATORS • 0-10MC COUNTING SYSTEMS • PLUG-IN COUNTING SYSTEMS • 0.1 MICROSECOND RESOLUTION COUNTER CHRONOGRAPHS

WIDE BAND AMPLIFIERS

(Model 700 Series)

Band Width: 2000 cycles to above 10 MC
Gain: 40 db or 60 db (Higher Gains Also Available)

Gain Control: Coarse and Fine Gain Controls Permit a Continuous Gain Variation by a Factor of 100 on Some Models.

Output Limit Level: To 50 Volts for Positive Pulses on Some Models.

Input: Positive or Negative Pulses, or Sine Wave Discriminator: 0-50 Volt Positive Amplitude Discriminator for Fast Pulses Also Available.

ALSO CUSTOM DESIGNED EQUIPMENT TO MEET YOUR INDIVIDUAL REQUIREMENTS!

Write for detailed engineering bulletin No. 206

ELECTRICAL & PHYSICAL INSTRUMENT CORPORATION

42-19 27th Street, Long Island City 1, N. Y.

A CALORIMETRIC TYPE RF WATTMETER

0-3000 MCS.

0-300 WATTS

MODEL 641N—an instrument designed to measure RF power with the precision of a Primary Standard.



at last!



►►► **DESIGNED FOR USE** wherever extremely accurate RF Power measurements are needed, the 641N Wattmeter serves as a Primary Standard for such measurements. As such, it can be used to check the accuracy of other types of RF wattmeters, and to determine the actual power output of an RF power source, the approximate magnitude of which is known. Over the entire frequency range of 0 to 3000 megacycles this instrument has an accuracy of better than plus or minus 2 percent of full scale, using the calibration curve supplied. For more accurate measurements, the 641N Wattmeter may be calibrated by the user at DC or 60 cycles. AC-DC wattmeters with an accuracy of $\frac{1}{4}$ of 1 percent may be used in this calibration, and the resulting RF power level may be established to an accuracy of better than 1 percent.

SPECIFICATIONS

Impedance: 52 ohms
 Frequency Range: 0 to 3000 mcs.
 Power Range: 0 to 300 watts
 Power Scales (5):
 0-3 watts
 3-10 watts
 10-30 watts
 30-100 watts
 100-300 watts

VSWR (max. over frequency range): 1.1 to 1000 mcs.
 1.2 to 3000 mcs.

RF Connector: Type N, mates with UG21B/U.

Accuracy: Plus or minus 2% of full scale on any scale, using the supplied calibration curves.

This instrument can be calibrated by the user at DC or 60 cycles for more precise measurement at a particular power level.

Repeatability: Within 1%

Time Required for One Reading: 2 minutes.

Recycling Time between Readings: 20 minutes.

Power Required: 3 watts 105-125V 60 C.

Size:
 Indicator 5 $\frac{1}{2}$ " x 6" x 13 $\frac{1}{2}$ "
 Load 5 $\frac{1}{2}$ " x 6" x 14 $\frac{1}{4}$ "

Weight:
 Indicator 8 pounds
 Load 16 pounds

fiers, transistor controlled magnetic amplifiers, and other packaged circuits such as transistor oscillators and transistor photo-sensitive amplifiers.

Precision Potentiometers. Helipot Corp., 916 Meridian Ave., South Pasadena, Calif. Series T precision potentiometers—extremely compact, low torque, continuous rotation units—are described in data sheet 54-51. The data sheet details the construction, specifications and coil characteristics of these $\frac{3}{8}$ -in.-diameter units.

Monitor Equipment. Allen B. Dumont Laboratories, Inc., Clifton, N. J. Bulletin TR-838 discusses the type TA-154-A 12-in. monitor equipment, which includes the type 5112-B 12-in. monitor and type 5108-D power supply. Illustrations, features and specifications are included.

Resistance Strips & Concentric Disk Resistors. International Resistance Co., 401 N. Broad St., Philadelphia 6, Pa. Comprehensive data on construction, dimensions, machining technique, tolerances, resistance values, power and voltage ratings, temperature coefficient, voltage coefficient and the like. Charts and graphs are included in the 4-page folder.

Equalizers and Wave Filters. Cinema Engineering Co., Div. of Aerovox Corp., 1100 Chestnut St., Burbank, Calif., has issued a 16-page catalog, No. 12E, completely illustrated with response charts, for its equalizers and wave filters. It covers all applications of this type of equipment in sound and sound recording with more than a score of items outlined. The section devoted to case studies gives concrete problems with solutions. The data were selected from actual case histories furnished by the company's customers.

Process Control. Barber-Colman Co., Rockford, Ill. The 16-page educational bulletin No. 9 discusses conventional millivoltmeter construction and its application to a control instrument. Also described is the function of an

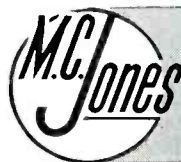

M. C. JONES ELECTRONICS CO., Inc.
 BRISTOL, CONNECTICUT

Developers
of the
Corporal
Guided
Missile.

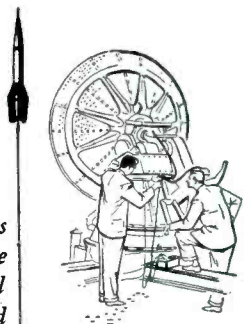

JET PROPULSION LABORATORY

CALIFORNIA
INSTITUTE OF
TECHNOLOGY

*Active in all phases
of electronics and physics
related to guided missiles
and jet propulsion.*

The nation's foremost guided-missile research and development facility, established in 1940, offers exceptional opportunity for engineers and research scientists in the fields of guidance and control, information theory, computers, electro-mechanical devices, instrumentation, and related aspects of electronic research. The Laboratory offers an ideal blend of academic and industrial environments and maintains a high level of technical competence. Attractive salaries are offered.

*A brochure describing
opportunities and activities
at the Laboratory will be
sent upon request.*

JET PROPULSION LABORATORY



California Institute of Technology
4800 OAK GROVE DR.,
PASADENA 3, CALIFORNIA

NEW PRODUCTS

(continued)

oscillator circuit in a pyrometer controller, along with various control forms which can be developed from this type circuit. Of particular interest to control engineers is the detailed description of saturable core reactor control for electric loads.

Tube Handbook. General Electric Co., Schenectady 5, N. Y. A new edition of "Essential Characteristics", a handbook on receiving tubes, picture tubes, special purpose tubes and germanium diodes is now off the press. The 192-page book (ETR-15F) gives the characteristics of some 2,000 tube types of which over 150 are new. Other new features include a classification chart on receiving tubes which permits selecting a tube by the type of application; characteristic curves of representative types; a thumb index; and a table of contents.

Audio Mixing Panel. Allen B. DuMont Laboratories, Inc., Clifton, N. J. Bulletin TR-831 covers the type 5305-A audio mixing panel which may be used for audio control at either transmitter or studio control positions to provide switching, mixing, cueing and monitoring facilities for up to 8 audio input signals. Chief features, power requirements, input signals, output signals, external amplifiers required and physical dimensions are listed.

Delay Line. Helipot Corp., 916 Meridian Ave., South Pasadena, Calif. The passive, jitter-free, continuously variable Helidel delay line is the subject of technical paper 266. Entitled "A Precise, Wide-Band, Continuously Variable Delay Line", it was written by N. W. Gaw, Jr. and D. Silverman of Helipot Corp., and M. B. Kline of DuMont Laboratories.

Variable Frequency Generator. Communication Measurements Laboratory, Inc., 350 Leland Ave., Plainfield, N. J. A recent 4-page catalog illustrates and describes among other units the model 1455, a new variable frequency generator featuring an exceptionally wide frequency range, excellent

DC-AC CHOPPERS

0-500 cycles
DEPENDABLE



All military specifications met. Liberal factors of safety to meet emergency conditions.

1. Production sampled daily and life tested to check 1,000 hour rating.
2. Every Chopper given not only one but two tests over the full range of military temperatures before shipment.
3. Only gold contacts used for superior operation in the vital 0-1 1/2 volt d-c range.
4. Liberal safety factors to meet emergency conditions.
 - a. 0-500 cps.
 - b. Input voltage $\pm 30\%$.

WRITE FOR THESE
CATALOGS:
No. 371 0-500 CPS.
No. 370 60 CPS.

**STEVENS
ARNOLD
INCORPORATED**

22 ELKINS STREET
SOUTH BOSTON 27, MASS.

S/A-11

full load-no load regulation, low distortion and low dynamic output impedance. Specifications and prices are included.

Temperature Indicating Products. Tempil° Corp., 132 W. 22nd St., New York 11, N. Y., has available a brochure covering its temperature indicating products—Tempilstiks°, Tempilaq°, and Tempil° pellets. The brochure contains concise directions for use; indicates the choice of temperature indicating product for the intended application; and lists the various temperature ratings available in each of the product-types, including newly developed items in the 400 to 550 F interval.

Voltmeter Multipliers. International Resistance Co., 401 N. Broad St., Philadelphia 8, Pa. Comprehensive data on moisture-proof construction, temperature coefficient, terminations, wiring, voltage rating and dielectric strength are shown. Charts and graphs are included.

Carrier-Telegraph Terminal. Radio Engineering Products Ltd., 1080 University St., Montreal 3, Canada, has available a data sheet on type F3B carrier-telegraph terminal. The system described provides an economical and trouble-free method of obtaining up to 3 full-duplex 100 word-per-minute telegraph channels at the upper end of a broadband telephone channel, and still retain a 2,950-cycle voice circuit. Midchannel carrier frequencies of 3,120, 3,240 and 3,360 cycles are employed. The 4-page folder illustrates and describes the unit, and also includes specifications.

Colloidal Graphite. Acheson Colloids Co., Port Huron, Mich. Bulletin No. 433 contains information, photographs and charts pertaining to colloidal graphite applications in the industry. The bulletin describes how dag colloidal graphite is used for coating the insides of crt's to prevent stray electrons from reflecting back into the electron beam. Also mentioned is the use of graphite films for increasing thermal radiation and

GLASS WORKING LATHES

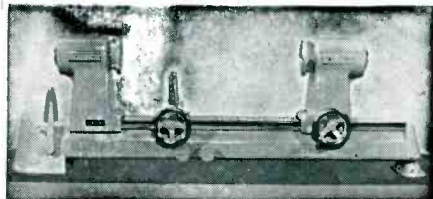

MODEL HSA

\$1695.00 f.o.b. Grass Valley, Calif.

GENERAL SPECIFICATIONS

Maximum length overall	63½"
Maximum width overall	18½"
Maximum length spindle nose	36½"
to spindle nose	20½"
Height	9"
Radial clearance above apron	2½"
Spindle hole diameter	550 pounds
Approximate shipping weight	Approx. 400 pounds
Net weight	

STANDARD EQUIPMENT

- Variable speed pulley assembly
- Two face plates
- One collet draw-in bar
- One twelve-fire single jet adjustable oxygen-gas or oxygen-hydrogen burner
- Hand carburetion control
- Foot pedal control of air or nitrogen supply and of oxygen-gas volume
- Main air valve controlling air in either or both spindles
- ½ h.p. Motor, 110 volt, single phase, single speed, 60 cycle, AC
- Face plate wrench
- Two motor belts
- One motor pulley

DO YOU KNOW?

- That a first class glassblowing job requires accurate alignment of rotational axes between the headstock and footstock?
 - That variable spindle speed gives another dimension to your technique?
 - That simple chucking attachments supply versatility for wide varieties of applications?
 - That special chucking for your industrial procedures, or laboratory practices are available?
 - That Litton jet-mix fires are universally used in glassblowing to prevent reducing conditions?
 - That Litton Lathes have been the standard of the vacuum tube industry for 22 years, and have been constantly improved?
 - That you can get these precision tools at reasonable cost, in eight sizes, with swing from 8" to 42", and working length from 20" to 75½"?
- Let us send you complete specifications and prices on our line of equipment and tools for the Vacuum Tube industry and for general research and development laboratory use.

3238

Litton Engineering Laboratories
Grass Valley, California • P. O. Box 949

which of these
CLEANING PROBLEMS
are yours?

CHECK*

- | | |
|--|--|
| <input type="checkbox"/> Insulating coatings | <input type="checkbox"/> Radio-active oxides |
| <input type="checkbox"/> Amorphous metal | <input type="checkbox"/> Dirt |
| <input type="checkbox"/> Discoloration | <input type="checkbox"/> Grease |
| <input type="checkbox"/> Lacquer | <input type="checkbox"/> Oil |
| <input type="checkbox"/> Plastic flash | <input type="checkbox"/> Rust |
| <input type="checkbox"/> Rubber flash | <input type="checkbox"/> Varnish |
| <input type="checkbox"/> Glass flash | <input type="checkbox"/> Paint |
| <input type="checkbox"/> Enamel flash | <input type="checkbox"/> Plate |
| <input type="checkbox"/> Imbedded metal | <input type="checkbox"/> Core sand |
| <input type="checkbox"/> Lead deposits | <input type="checkbox"/> Silicate coatings |
| <input type="checkbox"/> Carbon | <input type="checkbox"/> Excess solder |
| <input type="checkbox"/> Brazing flux | <input type="checkbox"/> Ceramic deposits |
| <input type="checkbox"/> Weld spatter | <input type="checkbox"/> Graphite |
| <input type="checkbox"/> Stains | <input type="checkbox"/> Slag |
| <input type="checkbox"/> Heat treat scale | <input type="checkbox"/> Polishing compound |

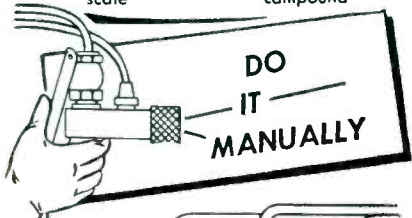

OR

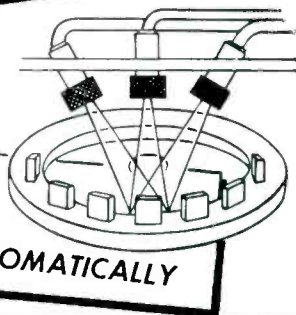

WITH PRESSURE BLAST WET BLASTING

TWO SPEED

* This ad is your coupon. Check off your problem(s) and mail today for free illustrated literature . . . application data . . . case history information!

CRO-PLATE COMPANY INC.
747-A WINDSOR STREET
HARTFORD 5, CONNECTICUT

for decreasing secondary emission, back emission and undesirable photoelectric effects in vacuum-tubes. Ways of improving efficiency of copper oxide rectifiers, improving connections between graphite coatings and ground wires, and attaching filaments to lead-in wires of various types of carbon filament lamps by means of colloidal graphite dispersions, are shown. Many other electronic applications are cited.

Subminiature Switches. Micro Switch, a division of Minneapolis-Honeywell Regulator Co., Freeport, Ill., has published a 12-page catalog covering subminiature snap-action precision switches, auxiliary actuators, and toggle and pushbutton switch assemblies. Three pages of catalog 75 are devoted to groups of single-hole bushing-mounting subminiature toggle switches. Panel mounting subminiature pushbutton switches are shown, including the spdt 1PB4 switch. Many other pushbutton switches are covered, and the 1SL1 slide switch and a line of rotary selector switches are described.

Distribution Amplifier. Allen B. DuMont Laboratories, Inc., Clifton, N. J. Bulletin TR-825 deals with the type 5437-A distribution amplifier. Illustrations, chief features and technical specifications are included.

Vibration Control. MB Mfg. Co., Inc., New Haven, Conn., now offers a revised 12-page bulletin No. 616 on vibration. It contains basic, helpful information on vibration, useful charts, and concise data on standard, special performance vibration isolators produced by the company.

Indicating Instruments. DeJUR-Amsco Corp., 45-01 Northern Blvd., Long Island City 1, N. Y. A 4-page color bulletin covers the 2½-in. and 3½-in. ruggedized or sealed meters. It shows features, technical specifications and schematic drawings on the new meter series which is available in either sealed or ruggedized (MIL-M-10304) models.



★ ULTRA LOW capacitance & attenuation

TYPE	μμF/ft	IMPED.Ω	O.D.
C 1	7.3	150	.36
C 11	6.3	173	.36
C 2	6.3	171	.44
C 22	5.5	184	.44
C 3	5.4	197	.64
C 33	4.8	220	.64
C 4	4.6	229	1.03
C 44	4.1	252	1.03

WE ARE SPECIALLY ORGANIZED TO HANDLE DIRECT ORDERS OR ENQUIRIES FROM OVERSEAS
SPOT DELIVERIES FOR U.S.
 BILLED IN DOLLARS—
 SETTLEMENT BY YOUR CHECK
CABLE OR AIRMAIL TODAY



NEW 'MX and SM' SUBMINIATURE CONNECTORS
 Constant 50Ω-63Ω-70Ω impedances

TRANSRADIO LTD. 138A Cromwell Rd. London SW7 ENGLAND CABLES: TRANSRAD, LONDON

for service and lab. work

Heathkit
 PRINTED CIRCUIT
OSCILLOSCOPE KIT
 FOR COLOR TV!

① Check the outstanding engineering design of this modern *printed circuit* Scope. Designed for color TV work, ideal for critical Laboratory applications. Frequency response essentially flat from 5 cycles to 5 Mc down only 1½ db at 3.58 Mc (TV color burst sync frequency). Down only 5 db at 5 Mc. New sweep generator 20,500,000 cycles, 5 times the range usually offered. Will sync wave form display up to 5 Mc and better. Printed circuit boards stabilize performance specifications and cut assembly time in half. Formerly available only in costly Lab type Scope. Features horizontal trace expansion for observation of pulse detail—retrace blanking amplifier—voltage regulated power supply—3 step frequency compensated vertical input—low capacity nylon bushings on panel terminals—plus a host of other fine features. Combines peak performance and fine engineering features with low kit cost!



MODEL 0-10
\$695.00
 Shpg. Wt. 27 lbs.

② A new Heathkit sweep generator covering all frequencies encountered in TV service work (color or monochrome). FM frequencies too! 4 Mc—220 Mc on fundamentals, harmonics up to 880 Mc. Smoothly controllable all-electronic sweep system. Nothing mechanical to vibrate or wear out. Crystal controlled 4.5 Mc fixed marker and separate variable marker 19-60 Mc on fundamentals and 57-180 Mc on calibrated harmonics. Plug-in crystal included. Blanking and phasing controls—automatic constant amplitude output circuit—efficient attenuation—maximum RF output well over .1 volt—vastly improved linearity. Easily your best buy in sweep generators.



MODEL TS-4
\$495.00
 Shpg. Wt. 16 lbs.

Heathkit TV
SWEEP GENERATOR KIT
 ELECTRONIC SWEEP SYSTEM

Heath
 COMPANY
 A SUBSIDIARY OF DAYSTROM, INC.
BENTON HARBOR 14, MICH.
 WRITE FOR FREE CATALOG
 ...COMPLETE INFORMATION

Plants and People

Edited by WILLIAM G. ARNOLD

More electronic manufacturers enter merger agreements. Companies continue expansion of plants and facilities through acquisitions or building programs. Engineers move to new positions in the industry, receive honorary awards

General Dynamics And Stromberg-Carlson Plan Merger

THE MERGER of Stromberg-Carlson into General Dynamics Corp., subject to the approval of the share owners of both corporations in June, was voted by the directors of both concerns.

J. J. Hopkins, who will continue as chairman of the board and president of Dynamics, reported that holders of the common stock of Stromberg-Carlson would receive one share of General Dynamics stock for each share of Stromberg-Carlson.

Hopkins stated that this acquisition by Dynamics was a major move in the direction of broadening its base of operations in the electronics field and that anticipated earnings of Stromberg-Carlson for the year 1955 should contribute substantially to the projected earnings base of Dynamics for this year. The current annual dividend rate of Dynamics of \$2.20 per share compares with dividends paid last year to holders of Stromberg-Carlson common stock of \$1.525 per share.

No changes in the management of either corporation are contemplated. Stromberg-Carlson will retain its name, individual identification and organizational structure except that it will operate within General Dynamics as the Stromberg-Carlson division. Robert C. Tait, now president of Stromberg-Carlson, will continue as president of the division and will also become a senior vice-president of Dynamics. Tait, Wesley M. Angle, chairman of Stromberg-Carlson's board, and Bernard E. Finucane, president of Security Trust Company of Rochester and also a member of Stromberg-Carlson's board, will become members of General

Dynamics' board. Tait will also serve on the management committee of the board of directors and Angle and Finucane on the advisory committee thereof.

Tait emphasized the fact that it is the intention of all concerned not only to retain the Stromberg-Carlson operations in its plants in Rochester but to expand them substantially.

General Dynamics, with three divisions and a Canadian subsidiary, employs approximately

55,000. The divisions are Convair, Electric Boat, Electro Dynamic and Canadair.

More than 5,200 are employed by Stromberg-Carlson in its three Rochester manufacturing plants.

In addition, Stromberg-Carlson owns and operates three high-power broadcasting stations in Rochester, New York, namely, WHAM, WHFM, and WHAM-TV. The transfer of licenses of these stations is subject to the approval of the FCC.

Cornell-Dubilier Celebrates 45th Year



Left to right: A. O. Beckman, William Dubilier, Octave Blake, Lee DuBridge

CORNELL-DUBILIER Electric Corp. celebrated its 45th anniversary in the field of radio and electronic development and opened its first West Coast laboratory and plant. The plant occupies 15,000 sq ft of space and cost approximately \$300,000. It will employ about 100 persons.

Lawrence A. Hyland, vice-president of Hughes Aircraft, was keynote speaker at the celebration dinner and C. B. Thornton, chairman of the board of Litton Industries, presided as dinner chairman.

Carl P. Miller, president of the Los Angeles Chamber of Com-

CAPACITORS by General Electric

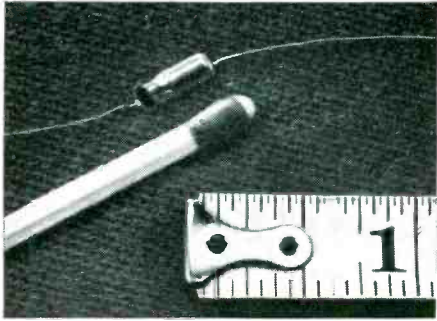

MICRO-MINIATURE

For low voltage d-c miniaturized electronic equipment (hearing aids, walkie-talkies, paging systems). Ideal for transistorized assemblies. **Ratings** 1-8 uf at 4 v. d-c, 1 uf at 8 v. d-c, 0.5 uf at 16 v. d-c. **Tolerance** -0 to +200%. **Temp. range** -20 to +50° C. **BULLETIN** GEA-6065.

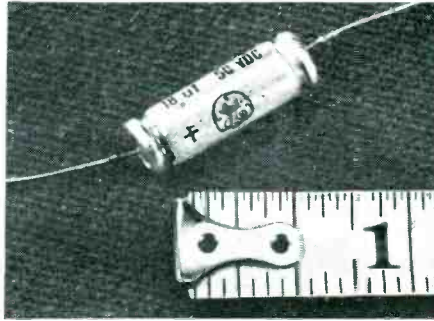

TANTALYTIC*

For electronic equipment requiring small size, low leakage current, long shelf life, wide temperature range. Plain or etched foil, and polar or non-polar types, suitable for a-c or d-c. **Ratings** 0.25-580 uf, 3.75-150 v. **Tolerance** ±20% (plain foil), -15 to +75% (etched). **Temp. range** -55 to +85° C. **BULLETIN** GEC-808.

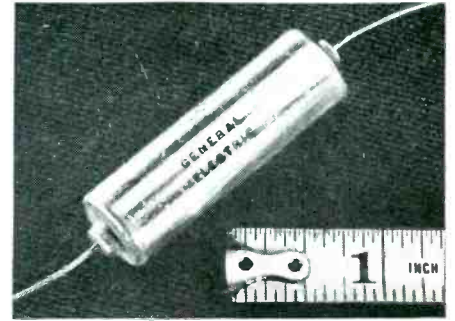

METAL-CLAD TUBULAR

For d-c uses where reliability under severe operating conditions is required (military electronic equipment). **Ratings** 0.001-1 uf at 100, 200, 300, 400 and 600 working v. d-c. (Can be applied to a-c circuits with adequate derating.) **Tolerances** ±5, ±10, or ±20%. **Temp. range** -55 to +125° C. **BULLETIN** GEC-987.



PERMAFIL-IMPREGNATED

Designed to meet requirements of MIL-C-25A, characteristic K specifications, and are suitable for high-temperature operation. **Ratings** 0.05-1 uf at 400 v. d-c. **Tolerance** ±10%. **Temp. range** -55 to +125° C. **BULLETIN** GEC-811.



STANDARD COMMERCIAL

For motors, filters, communication equipment, luminous-tube transformers, industrial control. **Ratings** dual rated units (a-c or d-c) rated at 0.01-50 uf, at 236-660 v. a-c, 400-1500 v. d-c. Single rated units also available. **Tolerance** ±10%. **Temp. range** -55 to +85° C. **BULLETIN** GEC-809.

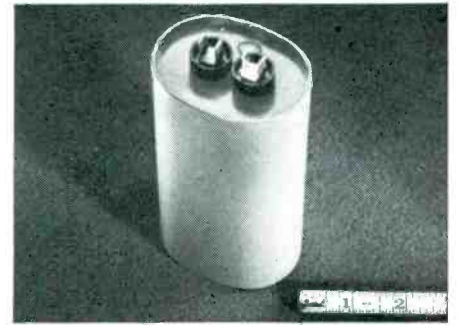

DRAWN-OVAL

For air conditioning and refrigeration equipment, fluorescent lamp ballasts, business machines, voltage stabilizers. Single, dual or triple-section types. **Ratings** 1-20 uf at 236-660 v. a-c, and 1-15 uf at 600-1500 v. d-c. **Tolerance** ±10%. **Temp. range** -30 to +70° C. **BULLETIN** GEA-5777.

*Reg. trademark of General Electric Company.



ENERGY STORAGE

For use in high magnetic fields and high intensity arc discharge. **Ratings:** may be built as high as 2000 joules (watt-seconds). **Tolerance** ±10%. **BULLETIN** GEA-4646.

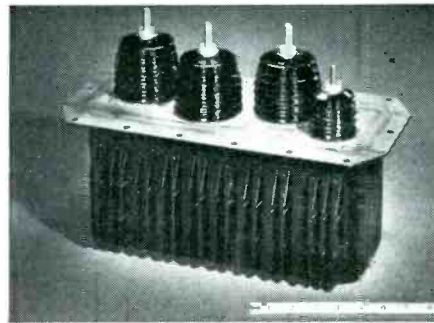

NETWORK

For guided missiles, aircraft, radar equipment. **Ratings:** built to user specifications. **Temp. range** -55 to +125° C, or to user specifications. **BULLETIN** GEA-4996.

NOTE: All capacitance tolerances are given at +25° C.

Progress Is Our Most Important Product

GENERAL ELECTRIC

SEND COUPON BELOW for complete information about G-E capacitors.

General Electric Co.
Section K 442-25
Schenectady 5, N. Y.

Please send me capacitor bulletins checked below.

- | | |
|-----------------------------------|----------------------------------|
| <input type="checkbox"/> GEA-4646 | <input type="checkbox"/> GEC-808 |
| <input type="checkbox"/> GEA-4996 | <input type="checkbox"/> GEC-809 |
| <input type="checkbox"/> GEA-5777 | <input type="checkbox"/> GEC-811 |
| <input type="checkbox"/> GEA-6065 | <input type="checkbox"/> GEC-987 |

Name

Position

Company

Address

City Zone State

merce, delivered the welcoming address.

A. O. Beckman, chief executive of Beckman Instruments, accepted a bronze bust of Dr. Lee de Forest who was honored for his contribution to industry advancement.

A similar bust of the late Dr. R. A. Millikan was accepted by Dr. Lee Alvin Dubridge, president of California Institute of Technology, for placement in the Institute's museum.

The Cornell-Dubilier organiza-

tion was represented by president, Octave Blake; vice-president, William Dubilier; executive vice-president, Haim Beyer; vice-president in charge of plants, Paul Deeley; and vice-president and chief engineer, William M. Bailey.

Honeywell And Raytheon Set Up Computer Firm

MINNEAPOLIS-HONEYWELL Regulator Co. and Raytheon Manufacturing Co. have entered into a joint undertaking to engineer and market new, large, highspeed, electronic data-processing systems for use in business and government.

The project will be carried out through the formation of a jointly-owned corporation, to be known as Datamatic Corp.

Honeywell will have a 60 per cent and Raytheon a 40 per cent interest in the new corporation. Heading the new firm, to be headquartered in Waltham, Mass., will be: president, John J. Wilson (vice-president of M-H); vice president and general manager, Walter W. Finke (who



John J. Wilson

has been assistant to the president of M-H); vice president, J. Ernest

Smith (Raytheon assistant vice-president and director of equipment engineering); treasurer, David T. Schultz (Raytheon's senior vice-president and treasurer); secretary, Paul F. Hannah (Raytheon's secretary and general counsel).

The seven-man directorate of Datamatic will consist of the above-named men, except Hannah, plus B. B. Wishart and C. F. Adams, Jr., presidents of M-H and Raytheon respectively, and Alfred M. Wilson, executive vice-president of Minneapolis-Honeywell.

John Wilson also will continue as president of Honeywell's Doelcam division at Boston.



Sperry Completes Klystron Plant

THE SPERRY electronic tube division's \$900,000 plant building in Gainesville, Florida, has been completed and installation of \$2,000,000 worth of machinery and fixtures has begun.

The plant comprises 60,000 sq ft of working area, and is capable of employing 300 persons with an estimated annual payroll approximating \$1,000,000.

The new plant has been designed

for production of high power klystron and traveling wave tubes. Preparatory to assembly of tubes, parts and raw materials in the amount of \$400,000 are now being shipped in. Production is scheduled to begin in May, undergo a gradual build-up, and reach its peak by Spring of 1956. It is expected that assembly of several types of micro-wave tubes will be under way at that time.

Texas Instruments Acquire Radell Resistor

PURCHASE of the business and assets of the Radell Corp. of Indianapolis, Ind., manufacturer of a line of deposited carbon precision resistors, has been made by Texas Instruments of Dallas, Texas.

The transfer of production operations to the Texas Instrument's Dallas operation is being scheduled so that deliveries to Radell's customers will continue uninterrupted during the change.

J. P. Rodgers, Jr. is general manager of the Texas Instrument components division, which will manufacture and market the Radell resistors.

John R. Pies, former Radell manager, will join Texas Instruments as chief engineer of the components division.

Texas Instruments will continue the production of the Radell precision resistors and will keep them available to the electronics industry at large. It is also anticipated that TI will use these resistors, along

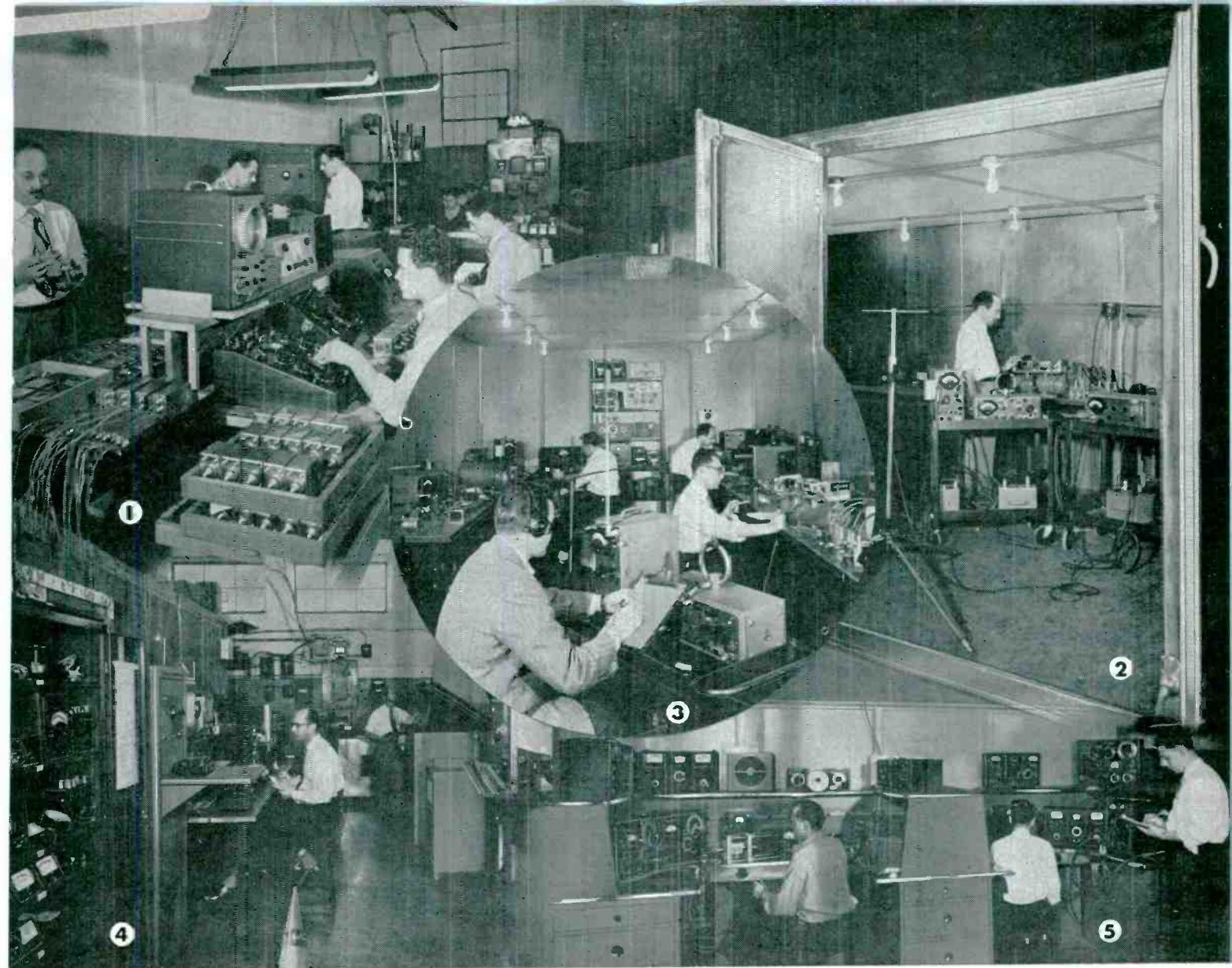

filtered by **FILTRON**
Guided Missile



Jet Aircraft



T-38 Sky Sweeper
Self-Aiming
Anti-Aircraft Gun



Atomic Submarine
U.S.S. NAUTILUS

Main Plant, Flushing, N. Y.

FROM GUIDED MISSILES TO ATOMIC SUBMARINES... FILTRON PROVIDES EXACTLY THE FILTER THEY NEED

- 1 Electrical Test
- 2 Shielded Laboratory Measurements
- 3 Screen Room Interference Testing
- 4 Environmental Testing
- 5 Attenuation Test Consoles (per MIL-STD-220)

From the best equipped Radio Interference Laboratories in the world—staffed with the most experienced Radio Interference Engineers, tomorrow's electric and electronic components and systems are made "Radio Interference Free" today.

FILTRON's exceptional facilities are available for the Radio Interference testing AND filtering of your equipment to meet Military Radio Interference Specifications.

Combining engineering facilities, application experience, and manufacturing ability, Filtron competently handles RF interference problems from start to finish.

FILTRON's four plants, with complete production facilities—capacitor manufacturing, coil winding, metal fabricating and stamping, tool and die department, assembly division—are producing more RF interference filters than ever before.

FILTRON—the most dependable name in RF Interference Filters—is the choice of engineers, manufacturers, and military and commercial laboratories the world over.



Send for our free 20-page RADIO INTERFERENCE FILTER CATALOG.



FILTRON CO., INC., FLUSHING, LONG ISLAND, NEW YORK
PLANTS IN FLUSHING, NEW YORK, AND LOS ANGELES, CALIFORNIA



NOW
AVAILABLE
IN ALL 3 SIZE
RANGES

- Low Temperature Flexibility to -90°F (impact test)
- Flame resistant — all sizes self extinguishing in less than 15 sec.
- High Temperature Stability up to 260°F
- Completely fungus resistant

For use wherever Air Force Specification MIL-I-7444A(1) applies, Resinite EP-93 Vinyl Insulation Sleeving is now available. Here is one outstanding source — one material — to meet the requirements of all 3 size ranges of this specification.

The quality of Resinite sleeving is rigidly controlled through meticulous compounding, precision manufacturing and thorough inspection. Laboratory Test Reports of EP-93 and other Specification Grades of Resinite Sleeving are furnished with each shipment at no extra cost.

One order will show you why more Resinite Specification Vinyl Sleeving than all others is used by the aircraft and electronics industries. Write for samples and performance data.



Want more information? Use post card on last page.

with other components division products, in the assembly of the in-

struments and systems of the TI apparatus and petroleum instrumentation divisions.

Chromatic Promotes TV Engineers



Robert Dressler



Howard R. Patterson

CHROMATIC TELEVISION Laboratories, a 50%-owned affiliate of Paramount Pictures Corp., has elected A. Crawford Cooley, Robert Dressler, and Howard R. Patterson vice-presidents.

Chromatic, a research and development organization, has as its main commercial program, the development of the Lawrence color tv picture tube.

The three newly appointed officers will continue to serve in capacities each has held for several years.

Dressler becomes vice-president and remains director of research and development of the east coast development laboratory in New York, which is primarily engaged in electronic research.

Patterson becomes vice-president and continues as general manager of the west coast development laboratory in Emeryville, Calif. Cooley becomes administrative vice-president, and continues as business manager of the west coast operation, which is developing color cathode ray tubes.

RETMA Selects Muter For Medal of Honor

CLIMAXING a three-day industry conference, the board of directors of RETMA selected director Leslie F. Muter, pioneer radio manufacturer and veteran RETMA treasurer and past president, to receive the 1955 Medal of Honor at the industry banquet on June 16 in Chicago.

The Association also approved proposals designed to broaden its services and activities which will be voted on by RETMA members during the June 14-16 convention. They are:

Realignment of the administrative and top level organizational structure to separate the Association's operations in the radio-TV and electronics fields.

Establishment of a sixth division within the Association to be known as the Military Products Division.

Creation of a new type of membership to be known as Special Member and redefinition of the rights and privileges accorded to all active and associate members.

The selection of L. F. Muter as recipient of the 1955 Medal of Honor was made on recommendation of the Annual Awards Committee. He was president of the Association for four consecutive years between 1934 and 1938 and has served as treasurer continuously since the latter date. In addition, he has participated in many important Association activities since

its founding. He attended the first organization meeting of the Association on April 18, 1924, and the subsequent meeting on June 23 of the same year when the constitution and by-laws were adopted and the first board of directors and officers were elected. He became a member of the board of directors in 1929 and was first elected treasurer in 1931.

In nominating Muter for the Medal of Honor, R. C. Sprague characterized him as "an industry leader who has given of his time and energies effectively for more than 30 years to every type of constructive effort of local or national interest to the industry" and he has been "known and admired by all."

Telefunken Opens Spanish Factory

A NEW FACTORY in which Telefunken Radiotecnica Espanola SA will turn out 57,500 radio receivers a year has been opened in Madrid. Eighty-five per cent of the components will be of Spanish origin. The firm, which started manufacturing radios in Spain in 1940, will also produce television receivers and electronic equipment in the new works.

Erie Forms Assemblies Division

ERIE RESISTOR CORP. formed a new division in Erie, Pa. for the engineering and production of special electrical, electronic and mechanical assemblies.

For several years the firm has had in operation engineering and production departments engaged exclusively in special assembly production. The formation of the new division was made in response to the increased demands from manufacturers for unitized assembly components.

Remington Rand Plans Computer Lab

PLANS have been made for a \$2,000,000 electronic computer laboratory to augment Remington Rand's Engineering Research Asso-

THE NEW WAY TO MARK EQUIPMENT....

with

GRAVOflex

the first chip-proof, flexible engraving stock

on the versatile

Engravograph

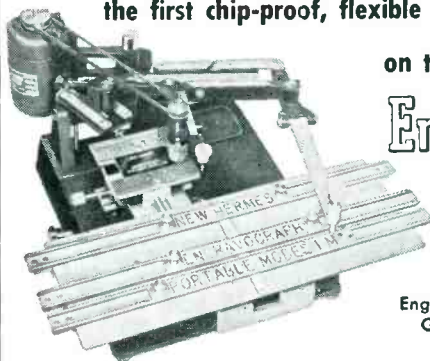

Send for booklets:
Engravograph Booklet 1M-29
Gravoflex Booklet G-29

So simple to engrave Gravoflex. Lettering stands out permanently on contrasting background. No paint needed. 10,000 Engravographs used for engraving on metals and plastics. Only Engravograph has these patented features:

- Adjustable for 15 ratios.
- Self-centering holding vise.
- Automatic depth regulator.
- Adjustable copy holders.

NEW HERMES ENGRAVING MACHINE CORP.

13-19 UNIVERSITY PLACE, NEW YORK 3, N. Y.

shear it



bend it

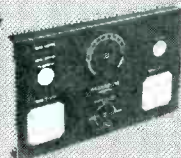

form it

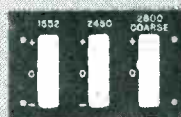

punch it

"INDUSTRIAL"

HIGH VOLTAGE

TUBE SOCKETS

INDUSTRIAL HARDWARE'S deep shell High Voltage Socket provides a new high in safe, reliable, and economical design of high voltage equipment.



- LAMINATED SOCKETS
- TERMINAL STRIPS
- WIRED ASSEMBLIES
- DUO-DECAL SOCKETS
- ANODE CONNECTORS
- ANTENNA CONNECTORS
- TERMINAL BOARD ASSEMBLIES
- METAL AND BAKELITE STAMPINGS
- PRINTED CIRCUIT SOCKETS
- SUBMINIATURE SOCKETS

SPECIFICATIONS:

- 1 Maximum continuous DC Voltage without Arc-over to metal chassis.
- 2 Deep shell is molded of natural mica-filled phenolic material.
- 3 Can be supplied for Octal, Miniature and Noval tubes.

Our extensive design and production facilities are available for developing your special requirements and applications. Representatives in principal cities throughout U.S.A.

Precision engineered electronic components and connecting devices for all your needs.

Write for samples and information.



INDUSTRIAL HARDWARE

Manufacturing Company, Inc.

109 PRINCE ST., NEW YORK 12, N. Y.

Specify



PRECISION QUALITY Components

OF TUNGSTEN,
MOLY, NICKEL CLAD WIRE,
ALLOYS, KOVAR

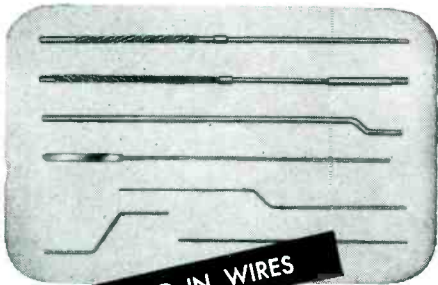

• DKE LEAD IN WIRES

Quality controlled throughout production with Tungsten hard glass leads produced under General Electric Timing Control. Each tungsten lead is micro-specially inspected for flaws. DKE offers highest quality and LOW PRICES now. Send drawings for quotations and let us prove the economy of our prices.

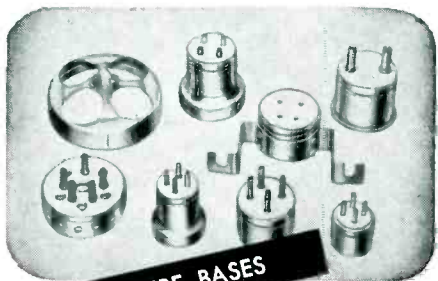

• DKE TUBE BASES

The Engineering Company can give you immediate delivery on following bases: 50 Watt, 3303B, 412 Industrial Base, Giant 7 Pin Bayonet, 4310 Four Pin Jumbo, Tetrode, Hydrogen Thyratron Bases in both Aluminum and Copper up to 6.50 dia etc. All bases to JAN-1A/MIL-E-1B and subjected to weights and strength tests.

DKE HYDROGEN THYRATRON TUBE BASES



CALL OR WRITE FOR QUOTATIONS
ON YOUR SPECIFIC REQUIREMENTS

THE engineering co.

27 WRIGHT ST., NEWARK 5, N.J.

Want more information? Use post card on last page.

PLANTS AND PEOPLE

(continued)

ciates division operations in St. Paul, Minn.

The new facility is expected to lead to the expansion of the division's personnel to 5,000 employees and an annual payroll of \$22,000,000.

The new two-story, 200,000 sq ft building will be devoted to research and light manufacturing.

The ERA division currently employs approximately 1,400 people and has been in operation since 1947. It became a division of Remington Rand in 1951.

IRC Makes New Appointments



Left to right: Benjamin Gerding, Carl Smith, Leo Jacobson, George Williams

INTERNATIONAL Resistance Co. promoted Leo J. Jacobson, to chief engineer; George Williams to group leader of product engineering; Benjamin F. Gerding to manager of manufacturing engineering and Carl Smith to manager of quality control, in its Philadelphia plant.

Jacobson has been associated with IRC since 1949 as manager of the quality control department and was previously quality engineer for Western Electric.

Williams joined IRC in 1952 as

junior engineer. Since then, he has held the positions of associate engineer and product engineer.

Gerding, prior to joining the International organization in 1950, was associated with the United Motor Service division of General Motors as rebuilding operations manager.

Smith has been associated with IRC since June, 1951, in the capacity of senior quality engineer and later supervisor of controls and analysis.

Consolidated Plans Plants, Ups Engineers

A NEW \$1.5-MILLION building is to be constructed this summer for Consolidated Engineering Corp.

The 120,000 sq ft structure will be built on an eight-acre site adjoining CEC's main plant in the Hastings Ranch area of Pasadena, Calif. It will house CEC's research, engineering, and marketing divisions. The firm also announced that James C. Kyle, formerly physi-

cist and research specialist with the Ames Aeronautical Laboratory in Sunnyvale, Calif., has been named technical director of its transducer division.

Kyle will be responsible for administering the transducer product development program.

In addition to his 12 years of instrumentation experience with the Ames Laboratory of the NACA,

Kyle has been consulting physicist in pressure measurements for a number of manufacturing groups, most of them electronic.

He also was partner in the Palo Alto, Calif., firm of Dynamic Measurements from 1951 to 1954.

In Consolidated's affiliate, Electro Data Corp., Glen F. Nielsen, former technical staff assistant to the vice-president, has been named chief development engineer.

Nielsen will be responsible for a research and new product program centering on the company's electronic data processing machines and auxiliary equipment.

Nielsen was formerly associate engineer and group leader in systems planning for large-scale computing equipment at IBM.

Ridenour Leaves International Telemeter

LOUIS N. RIDENOUR, in order that he might adequately fulfill an important function in connection with National Defense, had arranged with International Telemeter Corp. to be relieved as vice-president in charge of engineering and research.

Dr. Ridenour will continue as an active consultant on electronic projects now underway at the firm's laboratories in Los Angeles, Calif. Before becoming an executive of the firm, he was chief scientist of the U. S. Air Force.

General Lanahan Joins IT&T



MAJOR GENERAL Francis H. Lanahan, U. S. A. (Ret.) has been elected vice-president and general

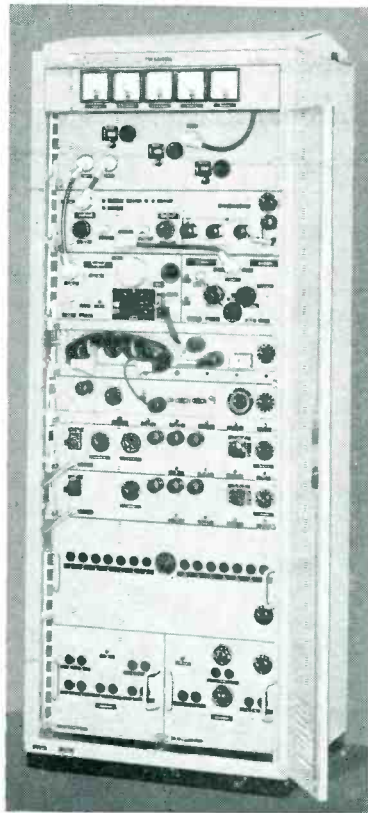

SIXTY-CHANNEL UHF FM RADIO SYSTEM OF ADVANCED DESIGN

Type FM60/2000 Radio System transmits up to 60 voice channels in a frequency range of 1700 to 2300 mc. Transmitting power is 5 watts and a single antenna is employed for both transmitting and receiving. The maximum frequency swing is 0.5 mc, and the transmitted frequency band is 12 to 252 kc. A similar system type FM60/300 operating in the frequency band 235 to 328 mc is also available. These radio systems operate in conjunction with the type F60 carrier-telephone system, which provides up to 60 3400-cycle telephone channels in 5 12-channel groups.

A complete FM60/2000 Radio Terminal requires a single cabinet.

RADIO ENGINEERING PRODUCTS

1080 UNIVERSITY STREET, MONTREAL 3, CANADA

Telephone: UNiversity 6-6887

Cable Address: Radenpro, Montreal

MANUFACTURERS OF CARRIER-TELEGRAPH, CARRIER-TELEPHONE AND BROAD-BAND RADIO SYSTEMS

THE HOTTEST THING IN CARTRIDGE HEATING-UNIT HISTORY

THE NEW WATLOW FIREROD CARTRIDGE

5 TIMES MORE HEAT
than ANY standard cartridge heating unit!

A New high in Watt Densities and temperatures . . . plus l-o-n-g-e-r cartridge life.

For convincing test-proof and other information, write for new FIREROD Bulletin.

WATLOW

ELECTRIC MFG. CO.
1390 FERGUSON AVE.
SAINT LOUIS 14, MO.

ATR
for A. C.
current
ANYWHERE!

*To Expand Your
AC Product Sales!*

**STANDARD and HEAVY DUTY
INVERTERS**

For Inverting D. C. to A. C. . . . Specially
Designed for operating A. C. Radios,
Television Sets, Amplifiers, Address
Systems, and Radio Test Equipment
from D. C. Voltages in Vehicles,
Ships, Trains, Planes and
in D. C. Districts.

ATR

- ✓ NEW MODELS
- ✓ NEW DESIGNS
- ✓ NEW LITERATURE

"A" Battery Eliminators,
DC-AC Inverters, Auto
Radio Vibrators

See your jobber or write factory

AMERICAN TELEVISION & RADIO CO.
Quality Products Since 1931
SAINT PAUL 1, MINNESOTA—U. S. A.

manager of Federal Electric Corp., a subsidiary of IT&T. The company is the field service organization for Federal Telephone and Radio Co.

In 1944, General Lanahan became chief signal officer for the Supreme Headquarters Allied Expeditionary Forces, Europe, and later served as chief signal officer of the American Occupation Forces

in Germany before returning to the U.S. in 1947 as commanding general of the Signal Corps Center at Fort Monmouth, N. J.

In 1951, General Lanahan was again assigned to the European Theatre as first chief signal officer of SHAPE, returning to the U. S. late in 1952 to assume the post of deputy director of logistics of the U.S. Army until his recent retirement.

Bendix Promotes Four Executives



Arthur E. Raabe

ARTHUR E. RAABE, vice-president of Bendix Aviation and general manager of Eclipse-Pioneer division, has been promoted to the corporation staff to coordinate commercial aviation sales for 12 divisions. Roy H. Isaacs was named general manager of the company's



Roy H. Isaacs

Eclipse-Pioneer division in Teterboro, N. J. He was formerly director of sales and service.

Also named to new executive posts are Milo F. McCammon as assistant general manager and Charles A. Wolf as director of sales and service, Teterboro division.

Elgin Buys Advance Relay

ELGIN NATIONAL Watch Co. purchased Advance Electric & Relay Co. of Burbank, California.

It was the watch company's second acquisition in the relay field within the past six months and its third move during that period into the West Coast electronic industry.

Advance, founded in 1915, currently employs about 400 people and maintains a plant with 25,000 sq ft of floor space in addition to leased space. Advance will be under the general direction of A. P. Barton, general manager of Elgin Neomatic.

Marconi Advances Chief Engineer

L. T. BIRD has been promoted from chief engineer to assistant manager of Canadian Marconi's commercial products division.

He has been with Marconi since 1922, and during that time has been engaged mainly in electronic equipment design and development engineering.

In his new duties he will assist in the general management of the division's operations, with special emphasis on all technical phases.

The research functions of the present research and development department will be carried on separately by the research department headed by D. A. Anderson,

chief physicist, and all the other former activities of the research and development department will be maintained by the engineering department, under J. G. Kahan, who has been named chief engineer.

Colson Names Instrument Head

SAUL R. GILFORD has been named director of the medical instrument division of The Colson Corp. of Elyria, Ohio.

The division recently was established to produce a line of electronic hospital instruments.

Gilford had been at the National Bureau of Standards since 1948 as an electronic scientist, group leader.

Andersson Appointed RCA Plant Head

NILS G. ANDERSSON, JR. has been appointed manager of the Camden, N. J., manufacturing plant of the engineering products division of RCA.

Andersson, who joined the firm in 1954 as superintendent at the Camden plant, succeeds to a post which had been under the acting management of S. N. Lev, general plant manager.

The new plant manager will have direct responsibility for all engineering products production and related activities at the local plant which employs more than 7,500 persons.

Previously, Andersson had been vice-president in charge of manufacturing at the five plants of the Lynch Corp. of Anderson, Indiana; vice-president in charge of production for Ware Laboratories of Miami, Fla. and vice-president and works manager in charge of production at the Master Rule Corp. of Middletown, N. Y.

Helipot Plans \$2 Million Plant

HELIPOT CORP. has acquired a 15-acre site in Newport Beach, Calif. for a \$2 million main plant expected to be finished in mid-1956.

Present facilities in South Pasa-

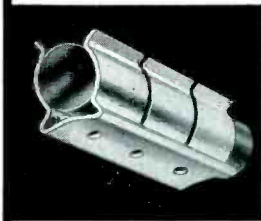

AUGAT Sub-miniature Tube Cradles

- HEAT DISSIPATION
- CUSHION FROM SHOCK AND VIBRATION

Protect the efficiency of your sub-miniature tubes, resistors and capacitors in electronic equipment with Augat Tube Cradles. These mite-sized marvels reduce tube temperature by conducting the heat and dissipating it rapidly. Augat Tube Cradles hold tubes firm and steady regardless of external shock and vibration. Once your tubes are inserted in the cradles, they stay put!

Augat Tube Cradles come in three types as shown on the left and may be obtained in cadmium plated spring steel; beryllium copper, silver plated; or silver magnesium nickel where heat dissipation is desired. The base of cradles is convex shaped to provide additional tension when cradle is fastened to chassis. Where additional conductivity is required, shields are available in copper silver plated with gold flash or in silver magnesium nickel material.

Write for additional information and samples

AUGAT BROS. INC.

31 PERRY AVENUE • ATTLEBORO, MASS.

Electronic Engineers

A NEW CHALLENGING HORIZON!

Unusual opportunities for professional development and recognition

Sperry, a pioneer in many fields for 43 years takes another forward step in its consistent growth and expansion. You are invited to investigate these new openings.

Over 1500 employees have been associated with Sperry for more than 15 years . . . ample evidence of opportunity, good salaries, excellent benefits and fine working conditions that make for a bright future.

Digital Computer Engineers—Positions require familiarity with Digital to analogue data converters, Pulse circuits, Logical design, Sampled data system studies, Memory devices.

Electronic Engineers and Physicists—Interesting, Non-routine assignments in the fields of Radars, Missile test equipment, Microwave ferrites, Solid state devices, U.H.F. receivers and transmitters, Klystron and traveling wave tubes.

Interviews can be arranged on Saturday at our plant and may be arranged in your city.

SPERRY GYROSCOPE CO.

DIVISION OF THE SPERRY CORP.

Great Neck, Long Island, New York

- RELOCATION ALLOWANCES
- LIBERAL EMPLOYEE BENEFITS
- ADEQUATE HOUSING IN BEAUTIFUL SUBURBAN COUNTRY TYPE AREA
- TUITION REFUND PROGRAM (9 graduate schools in area of plant)
- MODERN PLANT WITH LATEST TECHNICAL FACILITIES
- ASSOCIATION WITH OUTSTANDING PROFESSIONAL PERSONNEL





Sub-Miniature PILOT LIGHTS



A. **PLASTIC PLATE LIGHT ASSEMBLIES**

A great aid to miniaturization

Require a single 15/32" hole

All lens colors

All units applicable to Mil Specifications



B. **LIGHT SHIELD ASSEMBLY**



C. **SUB-MINIATURE INDICATOR LIGHTS**

when you're CRAMPED for SPACE



D. **SUB-MINIATURE INDICATOR LIGHTS**



E. **SUB-MINIATURE INDICATOR LIGHTS**

A) No. TT-51; No. TT-51A with No. 327 lamp. For edge lighting. Red or other color filters, black top.

B) No. 8-3730-111; for Mil-7788 panels.

C) No. 4-1930; light shield.

D) No. 8-1930-111; non-dimming.

E) No. 11-1930-111; mechanical dimmer. No. 3-1930-111; polaroid dimmer.

All assemblies accommodate midget flanged base lamps like this one (actual size); easily replaced. Available for voltages of 1.3, 2.7, 6, 14, and 28.



Any assembly available complete with lamp.

SAMPLES ON REQUEST — NO CHARGE

Write for Catalogue L-153

(All illustrations are approx. actual size.)

Foremost Manufacturer of Pilot Lights

DIALIGHT CORPORATION

60 STEWART AVE. • BROOKLYN 37, N. Y.
HYACINTH 7-7600

dena, San Gabriel, Pasadena, and Alhambra will be combined at the new location with an expected employment increase from 600 to 1,000. Helipot's recently established plants at Mountainside, New Jersey and Toronto, Canada are also in the process of expansion.

Helipot also announced that Dean Barton has been promoted to chief production engineer. He has been supervisor of project engineers for the past two years. Before joining Helipot he was with A. C. Spark Plugs.

Western Union Buys Into Microwave Firm

THE WESTERN UNION Telegraph Company has acquired a one-third interest in Microwave Associates of Boston.

Microwave was founded in 1950 and now employs over 150 people. Its annual gross income is approximately \$1,500,000. The company designs and produces microwave equipment, magnetrons, radar components and other electronic devices.

American Broadcasting-Paramount Theatres has been a part owner of Microwave Associates since 1952 and will have a one-third interest in the company.

The company plans to expand its semi-conductor, tube and equipment, research and production facilities and a new modern plant will be built.

Raytheon Builds TV Cabinet Plant

RAYTHEON has begun construction of a 203,874 sq ft plant in Melrose Park, Ill. as the nucleus of manufacturing and warehousing facilities the company expects to later expand on a 624,000 square-foot site.

The building, which is expected to be completed by September of this year, will contain all of the firm's tv metalworking, painting and cabinet construction facilities with a portion of the space used for warehousing.

More units will be added to the building in the future as the company's consolidation program progresses and as the manufacturing

ILSCO CONNECTORS

All these ... and more ... for YOUR BEST CONNECTIONS

U/L AND CSA TESTED	HI-RUGGED STRENGTH
PURE COPPER	RE-USABLE
100% CONDUCTIVITY	ALL WIRE SIZES
COOLER OPERATION	ECONOMICAL

WRITE FOR 80-PAGE CATALOG

ILSCO CORPORATION
5753 Mariemont Ave.
Cincinnati 27, Ohio

MAKE YOUR PRODUCT PERFORM BETTER

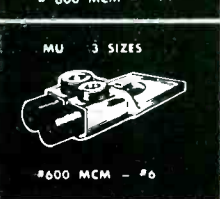
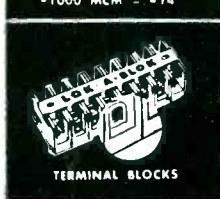

program requires more space.

About 200 of the company's present employees will work in the new building, shifting over from present leased and owned space occupied at various other Chicago locations.

The new unit provides extensive metal-cabinet facilities. All of the firm's 21-inch and 17-inch table model cabinets will originate from the new building where 45,000 sq ft will be devoted to making cabinets.

The factory service department will also be located in the new building.

Raytheon also announced that John R. Cann has been named manager of its Canadian operation.

In 1948, he became radar engineer for Canadian Aviation Electronics and in 1950 he became assistant general manager.

In 1951 he joined the Transducer Corp. of Boston as senior engineer, becoming project engineer until 1953, when he accepted a position as senior systems engineer for Raytheon, in which capacity he has served until his present promotion.

Slaughenhaupt Promoted to Vice-President at Rola

E. C. SLAUGHENHAUPT was promoted to the position of vice-president in charge of manufacturing of the Rola Co. of Cleveland, Ohio.

He has been with the company since 1935 and has served as cost accountant and most recently, plant superintendent.

Electronic Specialty Acquires Three Firms

ELECTRONIC SPECIALTY Company of Los Angeles, Calif. acquired controlling interest in Electromec of Burbank, Calif., and purchased all assets of two other companies.

Electromec, a manufacturer of radar and electro-mechanical units, will operate as an affiliate under its own name with William E. Howe and Charles M. Brown continuing as president and chief engineer, respectively. Sales last year were approximately \$1 million.

The wholly owned companies, Miniature Components Co. of Glendale, Calif., and Audio-Pacific

ITC

AUDIO PULSE POWER TRANSFORMERS...

From low level matching and blocking oscillator to high power Magnetron types. Computer Transformers . . . Zero phase shift, 0.1% accuracy.

QUALIFICATION APPROVAL NEED NOT DELAY DELIVERY FROM ITC SINCE WE HAVE APPROVED QA IN PLANT TESTING FACILITIES.

INDUSTRIAL TRANSFORMER Corporation
 GOULDSBORO PENNSYLVANIA

SHOCK PROOF VACUUM TUBE RETAINERS

These retainers are used to secure Vacuum Tubes and to resist side motion of Vacuum Tubes used in radio equipment which is subject to shock and vibrations. These retainers meet the requirement of all JAN specifications. The insulated portion is made of a melamine base Fibre Glass Phenol which provides 300 volts insulation to ground and withstands a temperature of 350 F. The insulated plate can readily be fastened or released by hand.

Available for envelope types T7, T8, MT8, T9, T12, ST12, T12ZDI, ST14, S14, ST16, T5½, T6½, MT-IC, ST19, T14, ST128CT-9.

Manufacturers of Electronic Components

JAMES IPPOLITO & CO., INC.
 401 CONCORD AVENUE, BRONX 54, N. Y.



Iron Sealing and Kovar Sealing Glass precision molded to the closest tolerances in the industry. Multiforms for your gun mount assemblies. Our laboratory is prepared to assist you in selecting the proper glass for any application.

**Your Supplier of
GLASS BEAD
MULTIFORMS!**

Our consultant will be glad to visit your plant to help adapt our multiforms to your specific needs.

No design too difficult for Mansol Engineers. We're at your service any time to discuss your powder molding problems, whether they be glass for seals, spacers or lead through bushings.

DELIVERY WITHIN 1 WEEK!

Write for 16-page, 2-color catalog of Mansol Multiforms custom-molded to exact specifications.

CABLE ADDRESS:
Mansol - Belleville, New Jersey



of Los Angeles, will operate as divisions. Miniature Components makes capacitors and relays. Audio-Pacific works on amplifiers and speaker enclosures for high-fidelity sound equipment.

Electronic Specialty also started construction last month on an 18,000 sq ft building in Glendale which it expects to occupy this June with Shavex, a subsidiary. The building will contain research and production facilities.

**Transitron Appoints
Chief Engineer**

EDMOND SHERMAN, formerly chief engineer for Teleking Corp., has been appointed chief engineer for Transitron of New York, N. Y.



Edmond Sherman

Prior to his association with Teleking, he served as project engineer on equipment for Hazeltine Electronics Corp.; as project and chief engineer for manufacturers of government electronic equipment and commercial radio and television receivers.

**Holloway Heads
Lincoln Laboratory**

MARSHALL G. HOLLOWAY was appointed director of the Lincoln Laboratory.

The Laboratory, which is concerned with problems of continental defense, is managed by M.I.T. for the Army, Navy and Air Force.

Dr. Holloway came to M.I.T. from the Los Alamos Scientific Laboratory in Los Alamos, New



superior for unsurpassed control of frequency oscillation

REEVES

CRYSTAL UNITS
exceptional as
High-Q elements
in wave filters

Write today for further information. Get your copy of Reeves fact-filled Crystal Unit Brochure.



REEVES - HOFFMAN CORPORATION

a subsidiary of Claude Neon, Inc.

CHERRY AND NORTH STREETS CARLISLE, PENNSYLVANIA

Mexico, where he has served since 1943 and has been actively engaged in nuclear scientific problems, including the development of atomic weapons. He succeeds Dr. Albert G. Hill, who has asked to be relieved of the responsibilities of director of the Lincoln Laboratory to permit him to return to his position as a professor in the department of physics at MIT.

Union Carbide Elects Top Officers

AUGUSTUS B. KINZEL has been elected vice-president—research of Union Carbide and Carbon Corp. Dr. Curme, who is retiring as vice-president, will continue as a director.

Dr. Kinzel has been actively engaged in research work with Union Carbide since 1926, when he joined Electro Metallurgical Co. as a research metallurgist. He became chief metallurgist of the laboratories in 1931, and a vice-president of Electro Metallurgical in 1944. He was appointed director of research of Union Carbide in 1954.

Howard S. Bunn has been elected executive vice-president and member of executive committee of Union Carbide.

He has been a member of the firm since 1922. After serving as manager of Pyrofax gas division and later the plastics division of Carbide and Carbon Chemicals, he became successively vice-president of that company and vice-president and president of Bakelite Co. In April, 1953, he was elected a vice-president and in September, 1954, a director of Union Carbide and Carbon Corp.

TelAutograph Acquires Walsco And Schott

WALSCO ELECTRONICS CORP. and affiliated Walter L. Schott Co., both of Los Angeles, Calif., have become a division of TelAutograph Corp. of New York, through a stock and cash transaction. Both western companies will continue to operate under founder and president Walter L. Schott. Louis R. Kurtin is chairman of the board of TelAutograph. R. G. Leitner has been appointed

NEW SUBMINIATURE METALLIZED PAPER CAPACITORS

NEW LEAD LOCATIONS AVAILABLE

Axial leads • Radial leads
• Single End parallel leads
in all capacitor sizes.

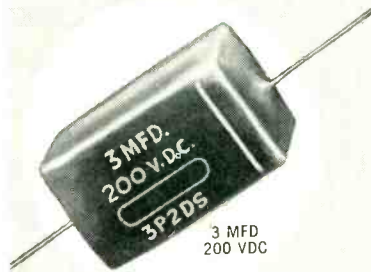

FUNGINERT PLASTIC ENCASED

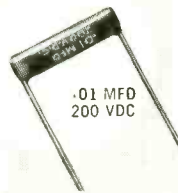
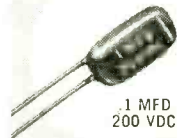

(actual sizes shown)

- ✓ Resin impregnated and rectangular shaped for maximum space conservation.
- ✓ Completely encased in a non-nutrient plastic for maximum fungus and humidity protection.
- ✓ Operating temperature range -55°C to $+100^{\circ}\text{C}$.
- ✓ Temperature coefficient $\pm .07\%/^{\circ}\text{C}$.
- ✓ Excellent capacity retrace.

A variety of sizes are available. Also, special designed units made to exact specifications.

Also, NEW subminiature HY-THERM CAPACITORS

for all applications requiring exceptionally high insulation resistance and unusual stability at high temperature.



Write, wire or phone for details, TODAY!

2082 Lincoln Ave., Altadena, Calif.
SYCAMORE 8-1185 • Offices in WASHINGTON, D. C. and DETROIT



Microwave Assemblies, Radar Components, and Precision Instruments . . . manufactured and designed to your specifications.

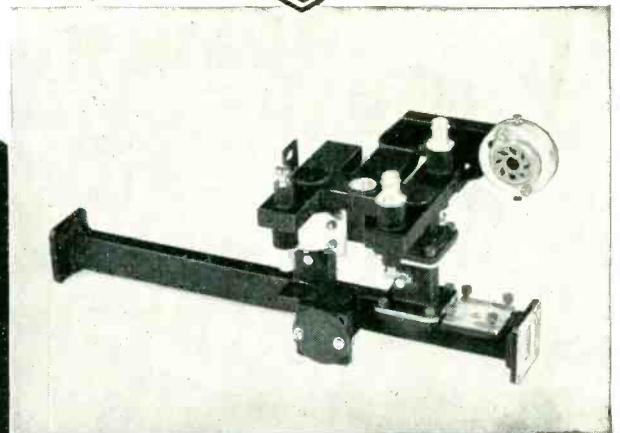

N. R. K. MFG. & ENGINEERING CO.

4601 WEST ADDISON STREET • CHICAGO 41, ILL. • SPRing 7-2970

West Coast Representatives TUBERGEN ASSOCIATES 2232 W. 11th St., Los Angeles 6, Calif.

GLOBE A.C. or D.C. MOTO-MITE* MOTORS

...for MAXIMUM POWER in MINIMUM SPACE!



*Trademark

D.C. MOTO-MITE*
Shown actual size. Length 1 3/4" Diameter 1 3/8"
Weight 3.5 oz. Larger, smaller sizes available.
A.C. MOTO-MITE*
Length 2 1/4" Diameter 1 1/4" Weight 6 oz.
Larger and smaller sizes available.

Miniature, compact, powerful, custom-built and quality controlled motors, characterized by high output and high efficiency. Designed as components for precision airborne accessory equipment, Globe Motors meet all military requirements. Speed governors, gear reducers, radio noise filters, electromagnetic clutches, brakes, etc., are available as standard assemblies. D. C. Motors can be made for various voltage applications ranging from 6 to 100V, and from 5,000 to 22,000 R.P.M. and with power output up to 1/100 H.P., and up to 1/50 H.P. dependent on frame size. A.C. Motors, 400 C.P.S. Hysteresis-Synchronous type, can be made for voltage applications up to 115V, with power output up to 1/200 H.P. for 4-pole types, and up to 1/100 H.P. for 2-pole types. Single phase capacitor-run or two phase windings available. A.C. Motors, 60 C.P.S. also available.

Let Globe's complete engineering facilities investigate and resolve your motor problems. WRITE FOR COMPLETE INFORMATION TODAY!

Globe industries, inc.

MOTORS • GEAR REDUCERS • GENERATORS • GOVERNORS • SERVOS
BLOWERS • FANS • ACTUATORS • SWITCHES • GYROS • VIBRATORS

1793 STANLEY AVE., DAYTON 4, OHIO



Louis R. Kurtin, left, and Walter L. Schott

chief engineer of TelAutograph Corp. He will direct the development of the firm's communication systems and expanded program into the fields of automation, nucleonics and electronic instrumentation.

Leitner has been active in the Southern California electronics industry for the past fifteen years, serving as chief research engineer for Packard Bell since 1951, and in a similar position at Lear, prior to that time. Leitner was chairman of the 1952 Western Electronic Show and Convention and has been a director of the West Coast Electronic Manufacturers Association as well as vice-chairman of the Los Angeles Council.

ECA Leases Headquarters Plant

ELECTRONICS CORP. of America has leased a building in Cambridge, Mass. that provides 208,000 square feet of floor space.

The firm's headquarters, laboratories, administration, and sales offices are to occupy the new site when the changes in the building are completed in late 1955. Under present plans, ECA will retain its present plant in Cambridge, as well as other plants in the area.

The new headquarters will be occupied by about 1,000 persons, including 500 to 750 engineers, physicists, chemists and research specialists.

ECA is planning to add another 100,000 sq ft of manufacturing area to its Cambridge facilities. By the end of 1955, according to the firm, ECA's total personnel will ap-

Mitchell-Rand

THE ONE DEPENDABLE SOURCE FOR EVERYTHING IN ELECTRICAL INSULATION

As part of Mitchell-Rand service to industry, we maintain a research laboratory and staff to solve insulation requirements. If you have an insulation problem send the particulars to Mitchell-Rand for the product to meet your requirements.

Write for Catalogue #20 and wall chart with engineering and electrical tables, symbols, etc.

TAPES
(Cotton, Fibreglas, Asbestos)

TUBINGS
(Fibreglas, Cotton, Plastic)

VARNISHED CAMBRICS

WAXES AND COMPOUNDS

PAPER & MICA PRODUCTS

PRESSURE SENSITIVE TAPES

COMBINED SLOT INSULATION



MITCHELL-RAND
INSULATION COMPANY

51 MURRAY STREET • COrtlandt 7-9264 • NEW YORK 7, N.Y.

Tapes • Twines • Wedges • Mica Products • Fibre • Paper • Varnish Cambrics • Duxseal • Varnishes • Class H Silicone Products

XCELITE Hand Tools
PREFERRED BY THE EXPERTS



No. 51C
LONG
NOSE
SIDE
CUTTER

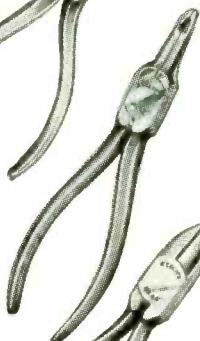

No. 58C
RADIO-TV
PLIER

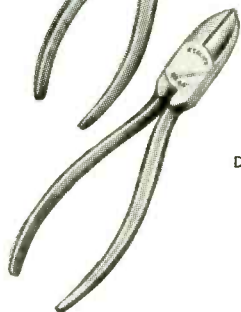

No. 66C
6-IN.
DIAGONAL
PLIER

XCELITE PLIERS
now available
CHROME PLATED
for added years of
rust-free good looks!

You know XCELITE PLIERS have always been a top value for radio and TV jobs of all kinds—but did you know they're available chrome-plated at slight extra cost? This gleaming protection really makes them "lifetime" tools you'll always be proud to own! Shown are just three of the wide selection of specialized XCELITE PLIERS to choose from. Ask your dealer today!

XCELITE, INCORPORATED
(formerly Park Metalware Co., Inc.)
Dept. C, Orchard Park, N. Y.

For Originality
LOOK TO XCELITE

Want more information? Use post card on last page.
ELECTRONICS — June, 1955

proach 1,500 and by the close of 1956 about 2,000.

American Bosch Promotes Three



Clifton T. Foss



Edmund D. Gittens

THREE APPOINTMENTS to higher posts have been made at Arma division of American Bosch Arma Corp. of Garden City, N. Y.

Clifton T. Foss has been named division vice-president and general manager. He had been vice-president-engineering since 1950 and vice-president-engineering and assistant general manager since 1954. He has been with the firm for 21 years.

Edmund D. Gittens was pro-

NEW PRECISION PHASE METER



TYPE 405

- 0.3 VOLT SENSITIVITY
- NO AMBIGUITY AT ZERO DEGREE
- 0.25° RELATIVE ACCURACY
- PHASE READING INDEPENDENT OF SIGNAL AMPLITUDES

Type 405 Phase Meter has a frequency range of 8 cps to 100 kc, phase range 0-36, 0-90, and 0-180 degrees; a switch is provided for 180-216, 180-270, and 180-360 degrees. The accuracy is $\pm \frac{1}{4}$ degree relative and 1 degree absolute in any range. The input impedance is 2.7 megohms shunted with 20 μ f on both channels. The meter scale is $6\frac{1}{2}''$ long, thus a fraction of $\frac{1}{4}$ degree can be read easily. Price \$485. F.O.B., Passaic, N. J. For 0.0001 cps to 1000 cps, use our U-L Phase Counter.

PRECISION PHASE DETECTOR

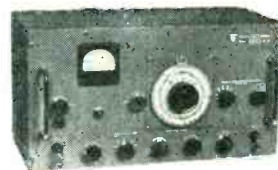

TYPE 205

- MEASURES TIME DELAY WITH 1% ACCURACY
- MEASURES PHASE DELAY WITH 1° ACCURACY
- 10 KC TO 15 MEGACYCLES, 0.01 VOLT SENSITIVITY

SPECIFICATIONS

- ACCURACY: ± 0.1 degree in phase reading of $\pm 1\%$ of the time delay indicated on the dial of the continuously variable delay line.
- RESOLUTION TIME: 5×10^{-10} seconds or smaller; the smallest phase angle in degrees which can be read on the dial is approximately equal to $5 \times 10^{-10} \times 360 \times$ frequency in cps.
- TIME DELAY: Three continuously variable delay lines are supplied with the unit, 0 to 0.45 microsecond, 0 to 0.25 microsecond and 0 to 0.05 microsecond. A step delay line with 3 us delay in steps of 0.25, is also supplied.
- PHASE RANGE: The maximum phase range is equal to the total time delay of the continuously variable delay line multiplied by the frequency of the signals and 360.
- INPUT IMPEDANCE: Two low capacity probes with input capacitance less than 4 mmf are supplied with the unit. The panel binding posts have about 1 megohm shunted with 12 mmf on both input channels.

PRICE \$445.00

WRITE FOR DATA!



ADVANCE ELECTRONICS CO., INC.
451 Highland Ave. • Passaic, N. J.

Want more information? Use post card on last page.

NEW!

Davohm Series 850 Metal Film Resistor

Perfect compromise between precision wire wound—and composition types

This new precision film type resistor is hermetically sealed, highly stable, and has a temperature coefficient independent of resistance value. The Davohm Series 850 is available in 1/2, 1 and 2 watt sizes; to tolerances of $\pm 1.0\%$, $\pm 0.5\%$, $\pm 0.25\%$; and, to any desired value.

Compare these performance figures!

	MIL-R-10509A ALLOWABLE CHANGE	Series 850 TYPICAL CHANGE
Temperature Cycling	1.0%	0.02%
Low Temperature Exposure	3.0%	0.04%
Short Time Overload	0.5%	0.02%
Effect of Soldering	0.5%	0.02%
Moisture Resistance	5.0%	0.08%
Voltage Coefficient	0.002%	0.00%
Load-Life (per 1000 hours)	1.0%	0.20%
Temperature Coefficient (PPM/°C)	± 500	$+370 \pm 20$

Write for complete data.

Available Through: THE DAVEN ELECTRONIC SALES CORP.

Associated with:

THE **DAVEN** CO. 191 Central Ave.
Newark 4, N. J.

WORLD'S LARGEST MANUFACTURER OF ATTENUATORS



Clarence H. Hopper

promoted to vice-president and chief engineer of the division. He has been an Arma engineer for 20 years and chief engineer since 1951.

Clarence H. Hopper was appointed vice-president-manufacturing of the division. He had been works manager since 1954. Previously he served in various manufacturing posts for 19 years at ACF-Brill Motors Co.

GE Names Carrier Current Head

Theron A. Cramer has been appointed manager of GE's carrier current engineering.

He will be responsible for the design, development, and application engineering of the firms carrier current communication equipment.

He joined GE in 1929 on the company's engineer test program.

In 1931, he transferred to the company's transmitter division, vacuum tube application section.

Shortly after, he joined the carrier current section of the transmitter division as a design engineer. Immediately prior to his new appointment, he was an application engineer for carrier current equipment.

Perry R. Roehm Joins Norden-Ketay

Perry R. Roehm has been appointed a vice-president of Norden-Ketay Corp. of New York. He will

tomorrow's OPPORTUNITY today

for experienced

ELECTRONIC ENGINEERS

and

ELECTRONIC TECHNICIANS

If you can develop new computer circuits using magnetic cores, transistors, printed wiring, and other new techniques, we have a good position available for you.

You will work with the outstanding computer men who developed the ERA 1101, ERA 1102, and ERA 1103 Computer Systems, the Univac File Computer, ERA magnetic drum memories, and other equally famous Remington Rand systems.

Computer experience is not necessary. Your proficiency in related fields will be rewarded from the start, and you will work in the fastest-growing organization in the data-processing field. Opportunities for advancement will be numerous.

Positions are also available for new engineering graduates and technicians who want to learn digital techniques and systems. Pay, special benefits, and opportunities for advancement are most attractive.

Please send an outline of your training and experience to
Mr. J. N. Woodbury:

Remington Rand

ENGINEERING RESEARCH ASSOCIATES DIVISION
1902 W. Minnehaha Ave. • St. Paul W4, Minnesota

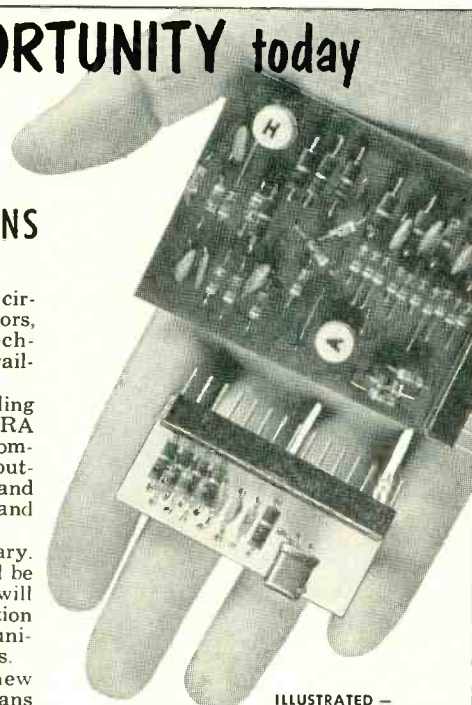

ILLUSTRATED —

Designs for new Remington Rand ERA computers that are now under development.
Upper: general purpose digit register.
Lower: packaged transistor logic element.

be responsible for coordination of sales and product engineering.

Prior to joining Norden-Ketay, he was vice-president and a director of The Barden Corp. of Danbury, Conn., a position he held from 1950 to the present. Before 1950, he was chief production engineer of Carl L. Norden, of New York, and before that, production superintendent of the Navy bombsight facility at Elmira, New York.

Westinghouse Establishes Systems Department

WESTINGHOUSE has formed a director systems department responsible for the engineering, manufacture and sale of specialized automatic control systems.

Director systems are control systems with no moving parts which have been developed by the company for industrial control applications.

Named as manager of the new department is L. W. Golden. He joined the firm in 1946 through the graduate student training course, and has worked on various assignments in the materials engineering department.

Varo Manufacturing Buys Schuttig

VARO MANUFACTURING Co., of Garland, Texas purchased the Schuttig Co. of College Park, Md. Schuttig will move to Garland as a division of Varo.

Varo, established in 1946, is a developer and manufacturer of electronic power supplies in the audio frequency field. Schuttig's activity has been in the area of vhf stations and systems principally for aircraft.

Under a reorganization of Schuttig, Robert L. Jordan, formerly vice-president and general manager, will assume the new position of executive vice-president, and five new vice-presidencies will be created. Leonard A. Schuttig, formerly head of the Maryland concern, will join Varo as vice-president of the new Schuttig division. Thirteen key employees of Schuttig will move to Garland. Before starting his own company in 1940



ALLEN KEYS

New bright finish
New kit
Lower price **

Now the hex keys furnished in Allen key sets have a high luster coating — better looking — rust resistant — makes size markings easier to read.

Available in six sets, all packaged in new red-trimmed plastic envelopes.

No. 603	11 short arm keys	3/32" through 5/8"
*No. 604	7 short arm keys	5/64" through 1/4"
*No. 605	6 short arm keys	.050" through 5/32"
No. 606	11 short arm keys	.050" through 3/8"
No. 614	11 long arm keys	3/32" through 5/8"
*No. 616	9 extra long arm keys	5/64" through 3/8"

**Bright Coated Keys **No. 605*



Order from your Allen Industrial Distributor
or write us for bulletin C38 for your files.

ALLEN

Manufacturing Company, Hartford 2, Connecticut, U.S.A.

Idea to Reality...

Put WHEELER Microwave Experience to Work for You!

Wheeler Laboratories' outstanding achievements in better engineered microwave components for radio and radar place it in a unique position to handle your microwave needs.

Under the direction of Harold A. Wheeler, our competent engineering staff, with complete supporting facilities, is equipped to tackle your toughest design problem . . . and come up with positive results.

Submit your idea for immediate analysis, or arrange a meeting with our engineers. A brief summary of our work is available on request.

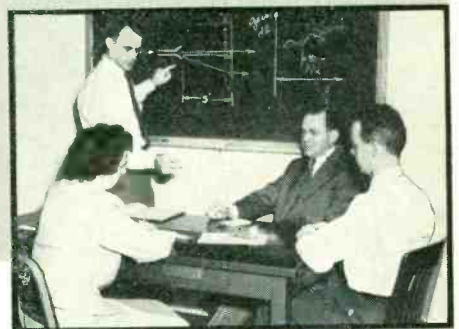

Members of the engineering staff discuss a problem in antenna design with Mr. Wheeler.



WHEELER
Laboratories, Inc.
122 Cutter Mill Road
Great Neck, N. Y.
HUNter 2-7876

VALPEY

Quartz Crystals

symbol of craftsmanship
for over 23 years

Valpey measures each crystal for surface flatness using a Precision Optical Flat with monochromatic light in a Valpey-designed Interferometer. Parallelism and surface flatness are measured to millionths of an inch — another step in the Valpey quality control process.



Manufacturers of ultrasonic transducers and delay lines are assured the ultimate in equipment performance when they specify Valpey. For experimental labs or production runs, Valpey is equipped to provide crystals to 60 Mc., meeting the most rigid specifications.

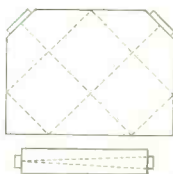

VALPEY Crystal CORPORATION

1249 Highland Street
Holliston, Mass.

Craftsmanship in Crystals since 1931



Austin N. Stanton



Leonard A. Schuttig

Schuttig was chief engineer for Bendix Radio Corp.

The other new vice presidents will be Luther B. Nicholson, vice-president finance; Fred P. Granger, Jr., vice-president customer relations; Jack G. Smith, vice-president engineering and Walter J. Jagmin, vice-president manufacturing. Austin N. Stanton is president of Varo.

Radio Receptor Leases New Plant

THE RADIO RECEPTOR Co., has taken a five year lease on a newly completed \$750,000 factory building in Brooklyn, N. Y.

The new structure consists of three floors and affords 66,000 sq ft of space.

The company leased the new building for its engineering prod-

IN-RES-CO TYPES SM-15 & SM-30 WIRE WOUND RESISTORS

SUB-MINIATURE weather-tested midgets

Type SM-15 and SM-30 Resistors offer three vital advantages — sub-miniature size, weather resistant construction and high resistance. The elimination of center hole mounting and the inclusion of axial leads increases winding area and results in 25% greater resistance value than resistors of standard design. Special coating is moisture and fungus proof and designed to meet JAN-R-93 specifications. Sealed in Bakelite construction affords additional climatic protection. As ratings are conservative, types SM-15 and SM-30 can be specified with confidence for service under rigorous conditions.



TYPE SM-15
5/16" DIA. x 3/8" LG.



TYPE SM-30
5/16" DIA. x 3/4" LG.

ASK FOR THE NEW
RESISTOR HANDBOOK —
Contains complete data on
resistors for every purpose
and their recommended
applications. Please
make request on com-
pany letterhead.



INSTRUMENT RESISTORS CO.

COMMERCE
AVENUE



UNION
NEW JERSEY

APPLICATION-DESIGNED RESISTORS FOR ELECTRONICS AND INSTRUMENTATION

RF Leakage can be

STOPPED!

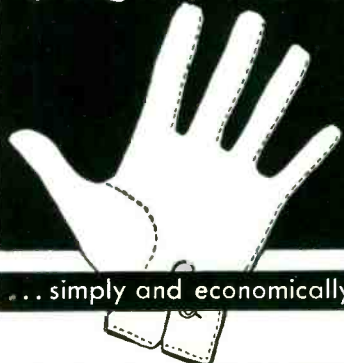

... simply and economically

**A MUST in MILITARY
and MANY COMMERCIAL
EQUIPMENTS**

**YOU CAN IMPROVE
YOUR DESIGNS GREATLY,
THIS SIMPLE, INEXPENSIVE WAY**

The place to stop RF leakage is "on the drawing board." In other words if you design your product so that RF leakage is reduced to a minimum you'll have no difficulty in meeting military radio noise specs and FCC regulations, and you'll have a better product too. In the design of many military equipments during the last 10 years effective sealing in of RF leakage has been accomplished with a simple application of METEX Electronic Weatherstrip and other METEX Shielding Products made from Metal Textile's highly resilient compressed knitted wire. You can achieve comparable results in your own designs. Send today for our new brochure describing METEX Shielding Products in detail with a most helpful section on design.

get your
copy today



METAL TEXTILE CORPORATION

Knitters of Wire Mesh for more than a Quarter Century
ROSELLE, NEW JERSEY

Want more information? Use post card on last page.

ELECTRONICS — June, 1955

PLANTS AND PEOPLE

(continued)

ucts division which produces communications and navigation equipment for the Defense Department and other governmental agencies. It will house approximately 400 engineering, production, executive and clerical personnel.

Beckman & Whitley Promote Engineers

THREE NEW product managers are appointed in an organizational realignment at Beckman & Whitley. Myron Baldwin, former test engineer, becomes product manager for research cameras and pressure recorders. William Place, former assistant chief engineer, becomes product manager for guided missile products. Ernest Stecker becomes product manager for meteorological instruments and heat-flow transducers.

Other changes include the advancement of Joseph R. Greer from project engineer to assistant chief engineer and George H. Bingham, Jr. from chief accountant to plant manager.

Empire Coil Selects Willett

R. F. WILLETT has been appointed general manager of Empire Coil Co. of New Rochelle, New York, manufacturer of flybacks and transformers.

He started with GE as a student engineer in 1937 and spent five years with them working through design engineering, central office sales to district office sales. For the last three years, he was plant manager of Essex Electronics and, prior to that, had spent five years as sales and application engineer with the F. W. Sickles Co.

Physical Research Laboratory Formed

ROTH LABORATORY for Physical Research has been formed by Wilfred Roth in Hartford Conn. as the successor to Rich-Roth Laboratories. Stanley R. Rich, former associate of Dr. Roth, has become technical director of The General Ultrasonics Co., a corporation re-

America's most complete line

Carter ROTARY POWER SUPPLIES

ROTARY POWER IS BEST

The "clop-clop" of "Old Bess" gave Grandma's buggy ride more vibration than the smooth Rotary Power of today's modern automobiles. ROTARY POWER is best for mobile radio, too . . . and for all DC to AC conversion . . . smoother . . . more dependable.



DC TO AC CONVERTERS

For operating tape recorders, dictating machines, amplifiers and other 110-volt radio-audio devices from DC or storage batteries. Used by broadcast studios, program producers, executives, salesmen and other "field workers".

DUO-VOLT GENEMOTORS

The preferred power supply for 2-way mobile radio installations. Operates from either 6 or 12-volt batteries. Carter Generators are standard equipment in leading makes of auto, aircraft, railroad, utility and marine communications.



CHANGE-A-VOLT DYNAMOTORS

Operates 6-volt mobile radio sets from 12-volt automobile batteries . . . also from 24, 32 and 64-volt battery power. One of many Carter Dynamotor models. Made by the world's largest, exclusive manufacturer of rotary power supplies.



BE SAFE . . . BE SURE . . . BE SATISFIED

AC can be produced by reversing the flow of DC, like throwing a switch 120 times a second. But ROTARY converters actually generate AC voltage from an alternator, same as utility stations. That is why ROTARY power is such clean AC, so dependable . . . essential for hash-free operation of recorders from DC power.



MAIL COUPON for illustrated bulletin with complete mechanical and electrical specifications and performance charts. Carter Motor Co., Chicago 47.

CARTER MOTOR CO.
2646 N. Maplewood Ave.
Chicago 47, Illinois

Carter

Please send illustrated literature containing complete information on Carter "Custom" Converters and Dynamotor Power Supplies

NAME

Address

City State

Want more information? Use post card on last page.

Transformers for special applications

Need a transformer for a special or unusual application? Check the qualifications of Caledonia Electronics.

1. **DESIGN EXPERIENCE.** Large staff of design engineers with extensive experience in circuit design — audio, radar, RF, UHF. Engineers who can understand your circuit needs and know how to meet them.
2. **MANAGEMENT EXPERIENCE.** Caledonia's management represents more than 250 years cumulative experience in the electronics industry . . . almost all associated with the manufacture of communications transformers.
3. **PRODUCTION EXPERIENCE.** Production and inspection staffs thoroughly trained in every phase of transformer manufacture and quality control.

This experience has solved successfully hundreds of problems in transformer design. For further information and help with your problems, write to

CALEDONIA

ELECTRONICS AND TRANSFORMER CORPORATION

Dept. E-6, Caledonia, N. Y.



the BEST WAY to SOLVE YOUR PROBLEMS

Specify **MAGNATRAN** TRANSFORMERS

When you are up against a tough problem and need special high voltage equipment consult with us. The 20 KV unitized rectifier illustrated here is only one example of how we helped to solve one problem. The result was a rectifier that did away with long leads to the tubes, yet was compact and ready to hook up.

Write us your problem

MAGNATRAN INCORPORATED
TRANSFORMERS AND ELECTRICAL EQUIPMENT
246 SCHUYLER AVE., KEARNY, NEW JERSEY

TRANSFORMERS FOR THE ELECTRONICS INDUSTRY

cently organized by Rich-Roth. Dr. Roth continues as a director and consultant to General Ultrasonics.

Brown Instruments Names Wilson



JOHN M. WILSON has been named chief engineer of the development and design division of the engineering department of Minneapolis-Honeywell's Brown Instruments division.

Wilson, formerly chief electrical engineer for the parent firm in Minneapolis, joined Honeywell in 1933.

India's ITE Grows

THE INSTITUTION of Telecommunication Engineers, inaugurated in New Delhi, India, in November, 1953, has grown to a membership of over 1,000.

Radio Condenser Appoints Shafer

ALBERT G. SHAFER has been appointed vice-president in charge of the western division of Radio Condenser which includes the company's plants in Watseka and Hoopeston, Ill.

Shafer joined Radio Condenser in 1931 as electrical calibration foreman of the Camden, N. J. plant. He became assistant chief engineer at Camden, and in 1939 was made manager of the company's newly acquired facilities at Watseka, Ill. In 1950 he became general manager of the western division.

The firm also announced the ap-

BASIC PROCESSES OF GASEOUS ELECTRONICS

By Leonard B. Loeb

A discussion of the basic atomic, electronic, molecular, and kinetic mechanisms that lead to the electrical behavior of gases. The latest techniques, and critical evaluations of results are presented. Of interest are most recent values for the physical quantities of gases of known purity, and a summary of material presented at the Seventh Gaseous Electronics Conference, October, 1954. Although directed primarily to the physicist, chemist, or engineer, the book is intelligible to anyone with a knowledge of basic atomic structure and relatively little kinetic theory.

1028 pages, 307 illus. \$13.50

UNIVERSITY OF CALIFORNIA PRESS
Address: Berkeley 4, California

pointment of John W. Crowfoot as manager of the special apparatus division.

He joined Radio Condenser Co. in 1950 as manager of the processing and standards department. Appointed assistant manager of manufacturing in 1952, he was given a special assignment as acting manager of the special apparatus division.

Bell To Research Head at Toledo Scale

ROBERT E. BELL has been appointed manager-research engineering at Toledo Scale Co. He has had full charge of electronics research since coming to the company in 1953. In his new post, he will be responsible for the entire research program including the electronics program and the general research engineering activities.

Sylvania Plans Network, Names Tube Head

SYLVANIA ELECTRIC and Western Union Telegraph plan a nationwide 12,000-mile private electronic communication system, linking 51 cities with Sylvania's data processing center to be constructed at Camillus, N. Y., near Syracuse.

These various installations will feed financial and production information via the leased network to the data processing center, where the data will be instantly summarized for corporate and decentralized management.

The heart of the center will be a Univac computer leased from Remington Rand. The private wire system is said to be the first nationwide network especially designed for automatic transmission of control data.

Sylvania has obtained an option on a site of more than 30 acres in Camillus, and construction work on the building is to start about July 1, while partial operation of the center is scheduled for next January. The Western Union communications system is being leased initially on a two-year basis from next January 1.

Sylvania also announced that Walter A. Weiss has been named

HYCOR TELEMETERING FILTERS

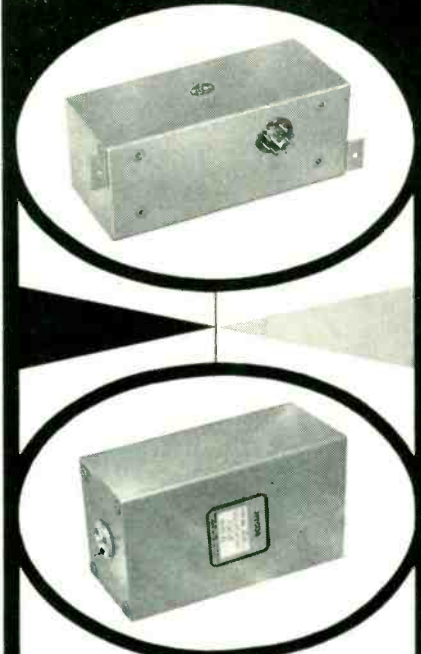

Features...

- HYCOR telemetering filters have excellent characteristics due to the use of high "Q" toroid inductor elements. The filters may be used in low level circuits with negligible hum pickup resulting.
- In addition, only the finest capacitors are employed to assure stability.
- Available in standard RDB frequencies.

GENERAL SPECIFICATIONS Impedance 500/500

TYPE	BANDWIDTH	ATTENUATION	FREQUENCY RANGE
1500	± 7½%	-3 db or less	400 cps to 14.5 kc
	+ 20%	-30 db or more	
4300	± 7½%	-3 db or less	400 cps to 960 cps 1300 cps to 14.5 kc
	+ 20%	-40 db or more	
4000	± 7½%	-3 db or less	400 cps to 960 cps 1300 cps to 14.5 kc
	+ 15%	-45 db or more	
	± 15%	-3 db or less	
	± 28%	-45 db or more	22 kc to 70 kc

Other frequencies and impedances available on request.

Representatives in Principal Cities

HYCOR
Company Inc.

Subsidiary of International Resistance Company
11423 VANOWEN STREET
NORTH HOLLYWOOD 1, CALIF.

VULCAN

ELECTRIC HEATING UNITS

IMMERSION



The most efficient and usually the most convenient method of heating liquids in tanks, urns, boilers, kettles, etc.

FOR WATER
FOR FUEL OIL PRE-HEATING-OIL and WAX HEATING

Single Heat and Three Heat.

Standard sizes usually in stock. Larger and smaller sizes made to order, as well as units to suit special applications.

Bayonet and Bottom Outlet types, too.

Full particulars in the Vulcan catalog.

See 8 page Vulcan catalog in Sweet's Product Design File for 1955.

VULCAN

ELECTRIC COMPANY

DANVERS 10, MASS

Want more information? Use post card on last page.
ELECTRONICS — June, 1955

Want more information? Use post card on last page.

Try **HELIX**

BONDING AGENT R-313

- A thermosetting adhesive that cures at room temperature and needs no pressure. High electrical insulating properties.
- Gives a bonding strength of 3000 psi between metal parts.
- Non-porous — gives high pressure seals between metal and glass, plastics, etc.
- Unaffected by acids, alkalis, fuel and lubricating oils.
- Reduces manufacturing costs by eliminating bolts, screws, rivets.

WRITE FOR LITERATURE TO DEPT. EM-6

A better product for better production

CARL H. BIGGS

COMPANY

2255 Barry Avenue

W. Los Angeles 64, Calif.

An Invitation TO MANUFACTURERS OF ELECTRONIC EQUIPMENT

1. Friendly labor supply.
2. Unusual city, county, and state tax advantages.
3. Industrial sites plentiful.
4. Good banking facilities.
5. Full cooperation guaranteed.
6. Strategic location

for
SMALL
or
MEDIUM
INDUSTRIES

Businessmen of Lakeland, Florida will cooperate fully and furnish complete information to manufacturers who will consider relocating or establishing a branch unit in this fast-growing central Florida city

INDUSTRIAL DEVELOPMENT COMMITTEE OF 100
LAKELAND TERRACE HOTEL

LAKELAND, FLORIDA



Walter A. Weiss

general manager of the radio tube division at Emporium, Pa. Herbert A. Ehlers succeeds Weiss as general manufacturing manager of the same division.

The two appointments followed the recent promotion of M. D. Burns to the positions of vice-president of Operations and general manager in charge of electronic tube operations.

Weiss, who had been general manufacturing manager of the radio tube division since 1952, succeeds Burns as general manager of the division.

Weiss served as a student engineer in the company's radio tube plant while attending Pennsylvania State University and later joined the company on a full-time basis in 1941 as a test equipment engineer. He became supervisor of quality control and served in this capacity until 1947 when he was appointed division manager of quality control, a post he held for nine months before being named manager of the Emporium radio tube plant. In 1951, he was appointed manager of Sylvania's Burlington, Iowa, radio tube plant, and served in this capacity until his appointment as general manufacturing manager.

Ehlers had been manager of the company's Huntington, W. Va., tube plant since 1947. Previous to this assignment, he was manager of product engineering for the radio tube division.

He joined the company in 1933 as a factory engineer at Emporium.

The tube division announced that a 210,000-sq ft facility near Williamsport, Pa., to be used for finishing and packaging operations

on receiving tubes, has been completed for lease to it.

The new plant, which will employ about 300 people, will be used for the most part for bulk tube storage and the branding, testing, packaging and shipping of radio and television receiving tubes. It will also house a renewal tube distribution operation.

Heldor Names Malcolm Taylor

H. J. ELLINGTON, president of Heldor Manufacturing Corp of Paterson, N. J., has appointed Malcolm H. Taylor as his executive assistant. Taylor, who formerly was general manager of Olympic Metal Products, Hillside Fabricators and Alpha Products, will assume the supervision of all Heldor plant operations and production.

He has held supervisory and engineering positions with Day & Zimmerman, consulting engineers of Philadelphia, Pa. and Henry Diss-ton & Sons, also of Philadelphia where he was in charge of all product and process engineering, designing, new products and research. He worked with sub-contractors on tooling and methods for the manufacturing of aircraft parts while at Goodyear Rubber Co in Akron, Ohio.

His industrial background also includes supervisory duties at the Heinemann Circuit Breaker Company, and Thermoid Company where he was in charge of production activities.

Marton Receives Commerce Award

LADISLAUS L. MARTON of the National Bureau of Standards has received the Gold Medal for exceptional service from the Department of Commerce. This award was presented in recognition of his major contributions to science and technology in creating and developing the electron interferometer and the electron optical technique of mapping electrostatic and magnetic fields of extremely small dimensions.

Dr. Marton is chief of the electron physics section of the atomic

YOKE SPECIALISTS



- Military or special yokes and focus coils designed to your specifications.
- Production yokes for TV sets.

For your answer to yoke problems write Dr. Henry Marcy today.

syntronic

INSTRUMENTS, INC.

100 Industrial Road • Addison, Ill. • Phone: Terrace 4-6103

SENSITIVE RELAYS that R-E-S-I-S-T

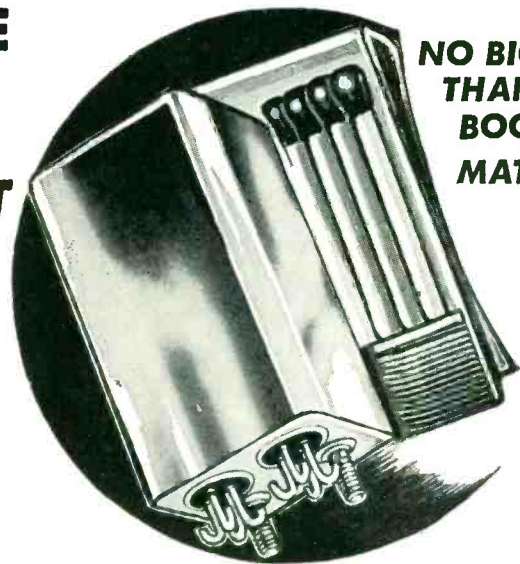

NO BIGGER THAN A BOOK OF MATCHES



SHOCK

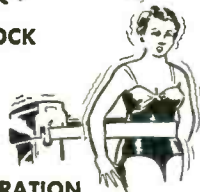

VIBRATION



TEMPERATURE

Here are miniature sensitive relays—single or double-pole types—which fulfill the most rigid requirements of space, shock, temperature and vibration in both commercial and military applications. The Series 100—105—106 relays are hermetically sealed and have a long life expectancy. Write for Bulletin SR— 6

Engineering representatives in principal cities.

Wheelock **RELAYS SIGNAL**
ENGINEERING & MFG. CO.
LONG BRANCH, NEW JERSEY



7 times actual size

Electronic HOOK-UP Wire NYLON-INSULATED

Insulated with ZYTEL (Trade-Mark Registered, by Dupont) this ductile but durable hook-up wire by CONTINENTAL saves time, labor and uncertainty in assembly. Its adaptability to extreme operating temperatures — from minus 50°C to plus 125°C — also means money and space saved from stocking several specialized wires.

Extremely thin—even down to 1 mil — Zytel insulation is efficiently tough against abrasion, and resistant to acids, alkalis and petroleum solvents.

Zytel is also unique for its non-shrinking qualities. For example, the photograph at left — unretouched, but magnified seven times — shows a slipping assembly for electronic motors. Here, Continental Hook-up Wire is soldered to the ring by the iron direct, without any creep-back or shrink-away in the insulation.

Available in AWG sizes 18 to 32; or tell Wallingford your special requirements.

CONTINENTAL WIRE CORPORATION

Heat- and Moisture-Resistant
Wires, Cables and Cords

PLANTS at YORK, PENNA.
and WALLINGFORD, CONN.



Serving 600 to 5000 Volts,
Sizes 18 AWG to 2,000,000 CM
SALES: Box 363, DEPT. L
WALLINGFORD, CONN.
(Phone COLony 9-7718)



TRANSCONDUCTANCE ANALYZER AND CIRCUIT STIMULATOR

MODEL 901

This direct-reading meter measures transconductance under all operating conditions. It has directly calibrated voltage controls and means for connecting components to simulate the circuitry in which a tube will operate. Facilities are provided for measuring both static and dynamic tube characteristics.

Transconductance Range: 0-100, 0-500,
0-1,000, 0-5,000, 0-10,000, 0-50,000 micromhos. Accuracy of measurement: $\pm 5\%$.

Write for Catalog

NEW LONDON
INSTRUMENT

Company INC.

82 Union Street
New London 1, Conn.

WE CARRY IN STOCK ALL SIZES, ALL SHAPES, ALL ALNICO GRADES

When you
need them—
as you need them . . .

HIGH ENERGY, PRECISION
ALNICO PERMANENT **MAGNETS**

Experimental or
production
quantities

Catalog upon request

PERMAG CORP., 210 TAAFFE PLACE, BROOKLYN 5, N. Y. — Phone: MAin 2-0114

24 HOUR
DELIVERY

PERMAG

ENGINEERING
PRECISION CUTTING
PRECISION GRINDING
MAGNETIZING

and radiation physics division, at the Bureau. This section is responsible for the development of methods and techniques for the measurement of electric and magnetic fields by the use of electron optical methods.

Prior to joining the staff of the Bureau in 1946, he was a member of the faculty of Stanford University, 1941-1946, serving as head of the division of electron optics and associate professor of physics.

Gates Radio Promotes Jochem



N. L. JOCHEM was promoted to director of engineering of the Gates Radio Co. of Quincy, Ill. He has been associated with Gates for the past twelve years usually in some phase of engineering work. For many years he was chief audio engineer and for the past two years he has been in charge of the audio division of the sales department.

Daystrom and Weston Sign Merger Pact

DAYSTROM and Weston Electrical Instrument Corp. have signed an agreement of merger under the terms of which Weston would be merged into Daystrom. Stockholders of both firms will vote on the merger.

Terms of the merger call for the issuance of one share of Daystrom stock for each share of Weston.

It is planned that the business

and assets acquired from Weston will be transferred to a wholly-owned Daystrom subsidiary to be named Weston Electrical Instrument Corp. Weston operations will be continued under the same management and personnel as at present, and the Weston name will be retained on its products.

Flight Safety Names Rashkow

BERTRAM R. RASHKOW has been appointed director of the electronics engineering department of Flight Safety.

He was formerly with the atlantic division of Pan American World Airways as communication engineering superintendent and was responsible for the engineering of airborne and ground electronic systems. At Flight Safety he will coordinate operational and technical electronics systems requirements of executive and airline aircraft operators to provide an optimum in safety, reliability and economy for the operator's individual needs.

Webcor Establishes British Company

WEBSTER-CHICAGO Corporation has formed a new British corporation, Webcor of Great Britain, to manufacture and sell Webcor phonographs, tape recorders, and record changers.

Webcor of Great Britain will not confine its selling activities to Britain and the sterling countries, but will sell in any market where conditions are favorable.

Avien Enlarges Plant Space

AVIEN of Woodside, N. Y., manufacturer of aircraft instrument and control systems, broke ground for the construction of a new wing which will add 11,000 sq ft of floor space to the company's engineering and administrative departments.

Present plant of the company has a total of 80,000 square feet. The enlarged facilities, scheduled for occupancy in mid-July, will house engineering test laboratories, and

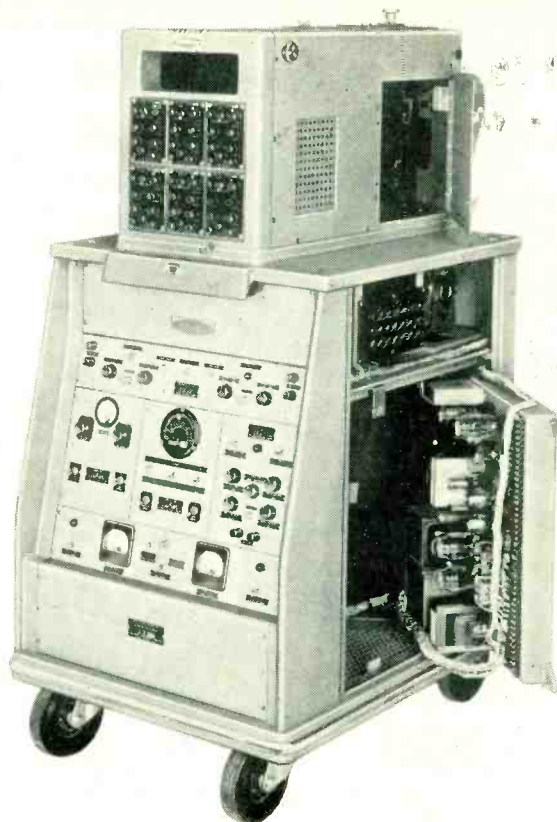

Multi-channel Recording D-C to 200 kc

Hathaway New SC-16B

The SC-16B is a complete oscillograph which records up to 12 signals on a single chart. It produces sharp, well defined records even at the highest frequencies. The SC-16B is useful in research programs requiring multi-channel, high frequency recording of pressure, strain, vibration, and acceleration.

SPECIFICATIONS

Number of Channels: Up to 12 Chart Speed: 1.6 to 6000 inches per second Chart Size: 6 inches x 100 or 200 feet; 6 inches x 15 inches; 6 inches x 10 feet; 35 mm x 400 or 1000 feet
Frequency Response: D-C to 200 kilocycles Writing Rate: 5,000,000 inches per second Chart Speed Change: 16 speed quick-change transmission Voltage Input Level: 1.5 volts r.m.s. per inch on tube screen; 1.5 millivolts r.m.s. per inch on tube screen with type ASC-10 D-C Amplifier Timing Lines: Precision tuning fork controlled at 1/100 or 1/1000 second intervals Synchronization: Transient can be initiated from oscillograph, or transient can initiate oscillograph Record Length Control: For continuously-moving-chart recording, 0.75 to 15 seconds; for drum-type-chart recording, 5 milliseconds to 1 second.

Write for bulletin 2-G1-A

Hathaway

INSTRUMENT COMPANY

DIVISION OF

Hamilton

WATCH COMPANY

1315 SOUTH CLARKSON • DENVER, COLORADO

new designs on the board?

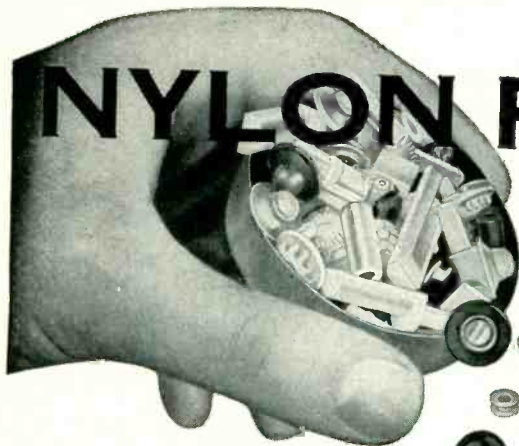

Gries' unique single cavity molding facilities are flexible—provide the practical answer to countless problems of product design and improvement. No matter how tiny, or how intricate, GRC molds nylon parts to meet your exact specifications, with precise tolerances and uniform quality. And, because GRC methods are completely automatic, costs are surprisingly low—GRC tiny nylon parts are produced completely trimmed and ready for use, in one high-speed, money-saving operation!

Write today for Bulletin and Samples.

Send prints for quotation.



GRIES REPRODUCER CORP.

World's Foremost Producer of Small Die Castings
151 Beechwood Ave., New Rochelle, N. Y. Phone: NEw Rochelle 3-8600

GRC TINY MOLDED NYLON PARTS

may be the
difference
between
"problems"
and
profits!

GRC MOLDS ALL
THERMOPLASTICS
SWIFTLY, DEPENDABLY,
ECONOMICALLY!

*Automatic Continuous
and Individual Inserts!
Single Parts!*

Quick deliveries on quantities of 25,000 to millions.

NO SIZE TOO SMALL!

MAXIMUM SIZE
.03 oz.—1 1/4" long.
NO MINIMUM SIZE!
LOW MOLD COSTS!

an expanded materials laboratory. A product display room and a school room, for training of company and customer personnel, will also occupy the new building.

Cogan Elected Victoreen Chairman



DAVID H. COGAN was elected chairman of the board of Victoreen Instrument. In 1927 he worked with Amrad Corp. at Medford, Hillside, Mass. While with Amrad, he invented automatic tube testing equipment. Cyrad Manufacturing, which was set up to produce this equipment, later became a part of Hytron, with Cogan moving up as sales manager and later vice-president and director. He has been an officer and director of many other corporations in the electronic manufacturing and broadcasting fields, such as, Rayvac Electronics, Paramount Industries, Pathe Radio, Air King Products, Columbia Broadcasting System, C. B. S.-Columbia, Inc., CBS-Hytron. Since 1953 he has been a director of Victoreen.

Chief Engineer Joins Bristol

JOHN J. SMITH joined the engineering department at the Bristol motor division of Vocaline Company in Old Saybrook, Conn.

He was formerly with the R. W. Cramer Company in Centerbrook, Conn. manufacturers of synchronous timing motors and electrical

ALUMINUM DOLLIES

SCOPE DOLLY MODEL 1

- Convenient Height and Viewing Angle
- Adjustable to Hold Portable Scopes
- Ball Bearing Swivel Rubber Tired Casters
- Lightweight Aluminum Construction
- Recommended by Laboratories Wherever Used.

\$38.50

FOB Louisville, Ky.

TECHNICAL SERVICE CORP.

1404 W. Market St. Louisville 3, Kentucky



VHF-UHF Noise Source

Long-Lived, Low Cost Tubes
No Balun Requirements
No Tuning Required

This simplified noise source operates between 50 and 900 mc. It's fast and accurate, ideal for testing television tuners and receivers in the laboratory and on the production line.

Noise Figure: 0 to 19 db; Accuracy: ± 1 db max. at 900 mc with equipment having an input impedance of 300 ohms. ± 0.5 db below 400 mc regardless of input impedance.

Write for Catalog



NEW LONDON
INSTRUMENT

Company INC.
82 Union Street
New London 1, Conn.



**Hunting
COILS
For High Temp.
Application**

DANO makes them!

For specifications calling for coils to be used for high temperature applications, Dano will supply the exact coils needed.

Dano, makers of a wide variety of coils, is fully equipped to meet the increasing demand for these special coils. Keeping pace with modern design, Dano offers encapsulated coils with tough, molded covers that spell extra electrical insulation with freedom from moisture.

Every Dano Coil is custom-made to your specific requirements. Call or write today, and Dano's quote will be on the way!

- *Encapsulated Coils • Form Wound*
- *Bakelite Bobbin • Cotton Interweave*
- *Paper Section • Acetate Bobbin*
- *Coils for High Temperature Applications*
- *Also, Transformers Made To Order*

The DANO Electric Co.
MAIN ST., WINSTED, CONN.

When Heat Treating

Stainless Steels

**"KNOW
HOW"**

makes the difference!

A large new plant, ultra-modern equipment*, fast service, plus an interested "know-how" staff make Sargeant & Wilbur stainless steel heat treating services worth money to you.

SAMPLE PROCESSING FREE

Write, Wire & Phone



SARGEANT & Wilbur
Heat Treating Corp.

170 York Avenue, Pawtucket, Rhode Island

*U. S. Air Force Certified

- BRAZING
- ANNEALING
- HARDENING

Want more information? Use post card on last page.

ELECTRONICS — June, 1955

PLANTS AND PEOPLE

(continued)

timers for 17 years. During the last 10 years he held the position of chief engineer.

Vocaline recently underwent re-organization. Management additions at the time of reorganization included the election of Alexander M. Laughlin as chairman of the board and James M. Carlisle as a member of the executive committee. At the same time Charles M. Murphy became sales manager.

Fairchild Camera Buys Freed Electronics

ALL OF THE VOTING stock of the Freed Electronics and Control Corp. of New York has been acquired by Fairchild Camera and Instrument Corp.

Freed will operate as a subsidiary of Fairchild, maintaining its separate corporate identity. It will retain the officers and personnel as heretofore with the exception of the addition of J. A. Hewlett, treasurer of Fairchild who will be treasurer of Freed and C. L. Terrill, vice-president of Fairchild who will be secretary of Freed.

CBS-Columbia Promotes Schulman

HAROLD J. SCHULMAN has been named assistant to the president, for CBS-Columbia, in charge of coordinating all company plans and activities.

He has been director of product service for CBS-Columbia with supervision of all service and field engineering activities. He is chairman of the service committee of RETMA.

Prior to coming with CBS-Columbia in 1954, Schulman was director of service for DuMont Laboratories, a post he held for three years. Prior to that he was an executive for Admiral Distributors in New York City.

New Plant Started For Jordan Electronics

GROUND was broken for a 12,000 sq ft plant in Alhambra, Calif. to house administrative and production facilities of Jordan Electronics of Pasadena, a wholly owned sub-

SPEED UP

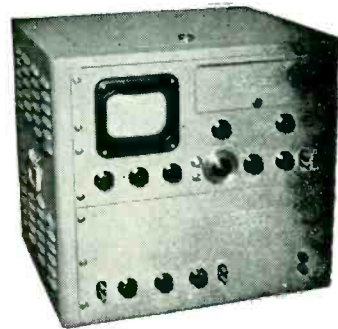

AUDIO WAVE FORM ANALYSIS

PANORAMIC SONIC ANALYZER LP-1

Many engineers find that Panoramic's LP-1 expedites their entire measurements program. LP-1 analyzes sound vibrations and electrical waveforms quickly, conveniently, accurately. Designed to eliminate the tedious problems commonly associated with audio waveform analysis, the Panoramic technique provides valuable visual information in seconds.

- Visualizes frequency and amplitude of waveform components between 40 and 20,000 cps; magnifies small portions of spectrum for detailed analysis; displays easily photographed; scans spectrum in 1-second; analyzes changing and static phenomena.

It will pay you to investigate the many unique advantages of LP-1.

• SPECIAL APPLICATIONS

- Investigations of closely spaced sound and vibration frequencies. Harmonic analysis of waveforms having low frequency fundamentals. Spectrum analysis requiring constant band width.

- Panoramic's LP-1 offers scores of unique advantages; it will pay you to check their application to your problems.

WRITE TODAY for

Complete Specifications



Made by the makers of Panadaptor, Analyzer, Panoramic Sonic Analyzer and Panoramic Ultrasonic Analyzer

10 So. Second Av., Mt. Vernon, N. Y.
Phone: MOUNT VERNON 4-3970

Want more information? Use post card on last page.

NEW! VERSATILE!!

PUSH BUTTON SWITCH with Features Never Before Available

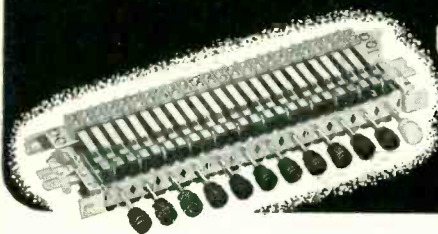

SWITCHCRAFT
INC.
"MULTI-SWITCH"

Easily Adapted
to Individual Requirements

NEW FEATURES

- Flexible tools—2 to 12 stations possible.
- Choice of mounting centers.
- Center to center between buttons— $\frac{3}{8}$ "
- Plungers accept standard Push-On Buttons.
- Up to 4 stack switches can be operated by each button.
- Switches available with fine silver or welded cross bar Palladium contacts.

Be sure to check into the possibility of using the "Multi-Switch". Send details or write for Bulletin No. S-550.

SWITCHCRAFT
INC.

FUNCTIONS TO SUIT YOUR NEEDS

- Interlock. Actuating of a button automatically restores to normal, button previously actuated.
- Non-locking. Each button has momentary action.
- All-lock. Accumulative locking—all buttons restored to normal by actuating release button.
- All-lock and non-lock combination. Choice of functions.
- Interlock and non-lock combination. Various arrangements possible.

1336 N. Halsted Street
Chicago 22, Illinois

Canadian Representative

Atlas Radio Corp., Ltd., 50 Wingold Avenue, Toronto, Canada

CUSTOM-BUILT and MIL-T-27

"In-Plant" Tested Transformers



- Government Pulse • Commercial Aircraft • Toroidal • Class H
- Miniature-Transistor • Molded Grade 1, Class A • Sub-Audio
- Audio • Power • Vibrator • Atlantic-Seal

MODERN FACILITIES

- In-Plant Testing • Complete Pulse Magnetron Test Equipment • Extensive Research and Measurements Laboratory
- RETMA and UL Specifications.

COMPLETE SERVICES

- Design Engineering • Rapid Estimating • Immediate Sample Delivery
- Top quality — at competitive prices
- Production

Write or phone for detailed information

ATLANTIC TRANSFORMER DIVISION

OF NEW LONDON INSTRUMENT COMPANY, INC.
30 Hynes Avenue • Groton 1, Conn.

COILS

YOKES

Industrial Camera
Yokes
Alignment Yokes
Image Orthicon
Yokes
Focus Coils Image
Orthicon
Terminal Board
Assemblies

Variable R.F.
Variable I.F.
Plate Coils
Oscillator Coils
Crystal Heater Units

COIL ASSEMBLIES

Impedance Coils
Peaking Coils
R.F. Chokes
Video Peaking Coils
Transmitter Coils

TELE COIL CO., Inc.

SAMUEL FELDMAN, Pres.

2733 Saunders St.

Camden 5, N. J.

Phone EMerson 5-7528

subsidiary of Panellit, of Skokie, Ill.

Jordan manufactures remote area monitoring systems and portable instruments for radiation measurement. The \$150,000 construction will more than double present production capacity. The new plant is the first of three buildings planned on this site in the near future.

It will consolidate all operations of Jordan Electronics and Panellit, now located in Pasadena. Occupancy is scheduled for mid-June.

Mace to Join Litton Industries

MYLES L. MACE, professor, Harvard University Graduate School of Business Administration, will become vice-president of Litton Industries. Dr. Mace, professor of administrative policy at Harvard, has organized courses for the school in other fields of business management and, for the past four years, has been associated with the Harvard advanced management program for business executives.

Micamold Radio Changes Its Name

MICAMOLD RADIO CORP. has changed its name to Micamold Electronics Manufacturing Corp. to reflect its variety of products and expanded facilities.

No change in company management or organizational structure is contemplated. However Micamold is expanding its manufacturing facilities both in Brooklyn, N. Y. and Tazewell, Va., and a laboratory site has been chosen in the Los Angeles area.

Prodelin Appoints Frizen Works Manager

N. J. FRIZEN has been appointed works manager of Prodelin, Kearny, N. J. television and microwave firm. A mechanical engineer with more than 25 years of production experience, Frizen was formerly associated as plant manager with Hanovia Chemical.

At Prodelin, his duties will in-

clude the supervision and coordination of all matters having to do with the production of the company's products.

Mag-Electric Buys Radar Company

MAG-ELECTRIC PRODUCTS of Hawthorne, Calif., manufacturer of magnetic amplifiers has acquired all of the assets of Mag-Electric Networks, manufacturer of radar components. All engineering and production personnel of Mag-Electric have been retained.

Ampex Names Quality Manager

ROBERT PAPPAS has been appointed quality control manager for Ampex Corp.

He was employed for the last two years as quality control manager at the Schaible Co. of Cincinnati, Ohio. From 1951 to 1953 he was employed with U.S. Time Corp. Prior to that from 1949 to 1951 he was associated with Minneapolis-Honeywell.

Crosley Names Defense Manager

JOHN C. CHRISTAIN, formerly chief, armament staff unit of Boeing Airplane Co., has joined Crosley division of Avco as manager of plans and programs for its defense operations.

Christain will be responsible for planning and programming all activities directed toward future requirements of the military services covering land, sea and air equipments.

Ramo-Wooldridge Names Gen. Saville

MAJOR GENERAL Gordon P. Saville, USAF (ret) has been appointed director of the newly-created office of military requirements of Ramo-Wooldridge Corp. of Los Angeles, Calif. The office will maintain liaison with government agencies served by Ramo-Wooldridge's guided missile and weapons systems programs.



Write today for one or all of Florida's ten new folders which set forth in plain, unvarnished form the basic facts about Florida's opportunities for new industry. These folders have been prepared in convenient individual file-size form for ready reference.

Address: State of Florida, Industrial Development Division, 3410F Caldwell Building, Tallahassee, Florida.

FOLDERS AVAILABLE

- | | |
|-------------------|-----------------------|
| Market | Research |
| Labor | Power |
| Water | Education and Culture |
| Transportation | Government and Taxes |
| Natural Resources | Health and Climate |

{ Plan national sales conventions, sales conferences and state and regional meetings for Florida. Exceptional facilities for any type of meeting. Get double value . . . successful meetings in delightful surroundings plus colorful recreational activities. }

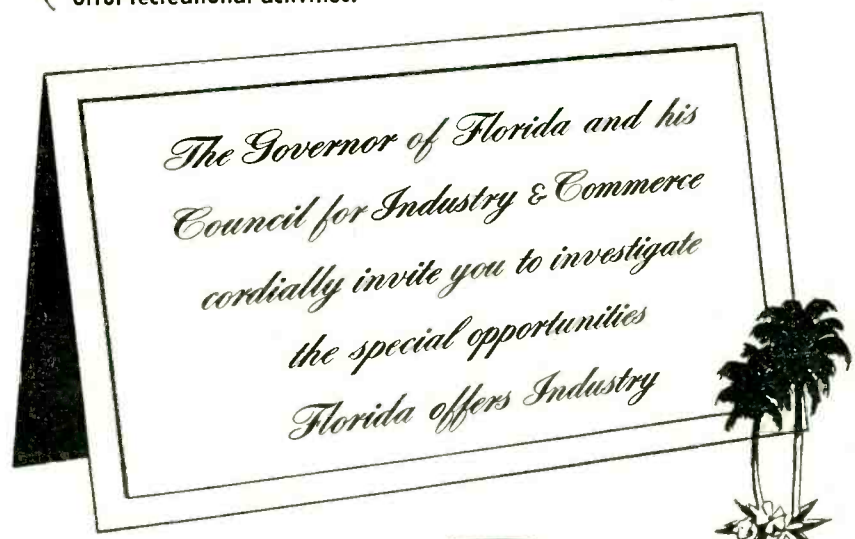

you'll always do better in

Florida

New Books

Advances in Electronics and Electron Physics

By L. MARTON. *Academic Press Inc., New York, volume VI, 1955, 538 p., \$11.80.*

ALTHOUGH the efforts of physicists and electronic scientists in government, college and industrial laboratories may diverge widely from the experience of the practicing engineer, their work constantly broadens the scope of his profession. This book is the latest in a series which appears annually to summarize developments during the year that have increased the breadth of the field. This year's edition comprises contributions by nine experts and covers advances in eight distinct fields.

Content

A section by A. B. Pippard of the Royal Society Mond Laboratory, Cambridge, England describes use of microwave techniques in studying the high-frequency conductivity of metals at extremely low temperatures. Two sections are devoted to ferromagnetic materials, currently gaining wide use in the electronics industry; Elihu Abrahams

physical properties of ferrites.

The behavior of space charge limited currents, important to electron-tube designers, is the subject of a section by Henry F. Ivey of Westinghouse. W. M. Webster of RCA Laboratories makes a comparison of analogous semiconductor devices and gas tubes. Semiconductor devices capable of operating at peak current densities of the order of 1,000 amperes per sq cm, peak voltages of a few thousand volts and internal power dissipations of several watts are seen to be achievable.

Problems in the design of electron microscopes are reviewed by M. E. Haine of Associated Electrical Industries, Ltd, Aldermaston, England. Although the resolving power of the average available electron microscope is worse than 30 A, new commercial instruments should be able to attain 10 A. Current research may establish conditions necessary for resolving powers down to 5 A.

A section on traveling-wave tubes by Rudolf G. E. Hutter of Sylvania covers theory of traveling-wave tubes with and without a slow wave guiding structure and reviews recent advances in tube design. Helix-type tubes have been built to operate from a few hundred mc to 50,000 mc and with power outputs from milliwatts to several hundred watts. Other types have been developed such as the backward-wave tube, velocity jump tube, electronwave tube and the diocotron, in which the electron beam travels through crossed electric and magnetic fields. The final section, by J. Van Den Randel of the University of Leiden, Netherlands deals with paramagnetism.

Application

This book is invaluable to research engineers, particularly those whose work touches on one or more of the eight fields covered. It will be of value to graduate students and teachers as source material and collateral reading in courses in advanced electromagnetic theory,

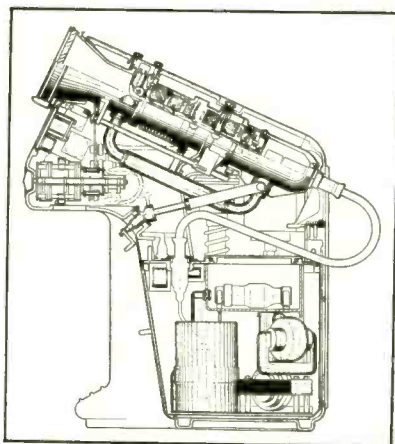

Philips three-stage electron microscope described in "Advances in Electronics and Electron Physics"

of the University of Illinois discusses the theory of relaxation processes in ferromagnetism while a section prepared by J. Smit and H. P. J. Wijn of Philips Research Laboratories, Eindhoven-Netherlands describes the various

536K Multimeter Kit \$12.90
Wired \$14.90
1000 ohms/volt



425K 5" Scope
Kit \$44.95
Wired \$79.95

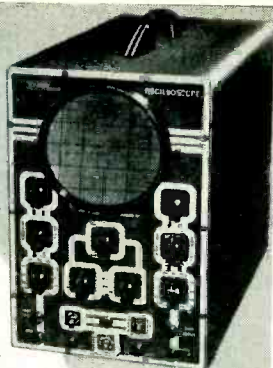

470K 7" Push-Pull Scope
KIT \$79.95. WIRED \$129.50.

YOU BUILD

EICO

KITS IN ONE EVENING-

but they
last a lifetime...
and you
save 50%

38 Kits and 42 Instruments —
the industry's most complete
line of **MATCHED
TEST INSTRUMENTS**

¼-million EICO Instruments are now in use the world over! That's the proof of EICO's leadership in Value.

For latest precision engineering, finest components, smart professional appearance, lifetime performance and rock-bottom economy — see and compare the EICO line at your Jobber before you buy any higher-priced equipment! You'll agree with over 100,000 others that only EICO Kits and Instruments give you the industry's greatest values at lowest cost.



121K VTVM Kit \$25.95
Wired \$39.95



565K Multimeter Kit \$24.95
Wired \$29.95
20,000 ohms/volt



377K
Sine & Square Wave Audio Gen.
Kit \$31.95. Wired \$49.95

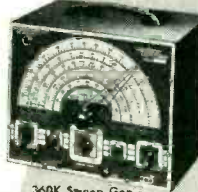

360K Sweep Gen.
Kit \$24.95. Wired \$49.95



1050E Battery Elm.
Kit \$29.95. Wired \$38.95



625K Tube Tester
Kit \$38.95
Wired \$49.95

Write NOW for FREE latest Catalog E-6

EICO

Laboratory Precision at lowest cost

©1954

ELECTRONIC INSTRUMENT CO., Inc.
84 Withers Street, Brooklyn 11, N. Y.

Want more information? Use post card on last page.

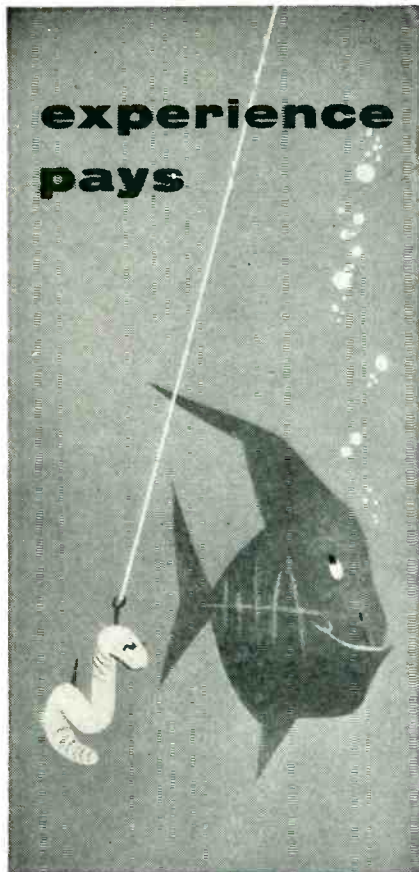

**experience
pays**

Yes, experience does pay in many ways. Our clients know from experience they have a dependable, responsible source for preparation of better industrial and business literature.

Why not do the job right? It saves time, money and produces results. Let us give you a proposal on your next publication.

We'll do the whole job—from planning to printing—or just those parts that you need.

product literature
military manuals
company publications
training material

Call or write for more information.

TECHNICAL WRITING SERVICE
McGraw-Hill Book Co., Inc. • 330
West 42nd Street • N. Y. 36, N. Y.

NEW BOOKS

(continued)

solid state and electron physics. The book may also interest practicing engineers who may find in the developments described an indication of the direction in which their field is progressing.—J.M.C.

Engineering Electronics

BY GEORGE E. HAPPELL AND WILFRED M. HESSELBERTH. McGraw-Hill Book Co., 1953, 508 p., \$7.50.

THIS TEXT is intended for electrical engineering students at the junior level taking a first course in electronics of one year duration. It is based on a course given by the authors for several years at Purdue University.

Introduction

The first four chapters in some 100 pages provide the usual material on electron ballistics, electron emission, space charge and the general characteristics of diodes, triodes, tetrodes and pentodes.

Chapter 5 serves a very useful function by providing a brief and qualitative introduction to the field of use of electronic devices for those students who have no previous background. The topics presented include such things as the outline of an a-m radio-transmission system, the diode as a rectifier and detector and the triode and pentode as various types of amplifiers.

In chapter 6 are grouped together the various methods and techniques pertaining to electronic-circuit analysis. Here for instance the student is introduced to the load line concept, the dynamic tube characteristic, the equivalent-plate-circuit theorem, the determination of the static and dynamic operating points and the various types of distortion.

The main section of the book then follows with chapters on voltage amplifiers, audio frequency power amplifiers, power amplifiers with tuned loads, feedback amplifiers, oscillators, modulation and detection, conduction through gases, rectifiers and photoelectric cells.

In general the coverage is very adequate for the purpose intended. For instance the chapter on voltage amplifiers runs to 89 pages and

WANTED!

We're looking for engineers whose prime responsibility is to seek ways and means to make products or parts better, more efficient and at lower cost. To you, we recommend Frenchtown Engineered Ceramics.

Very possibly you can profit from the many valuable properties of Frenchtown Engineered Ceramics to give you resistance to high temperatures and low thermal expansion; excellent mechanical strength and wear resistance; superior dielectric strength at both high and low frequencies.

This helpful 4-page bulletin contains complete data on electrical and mechanical characteristics of Frenchtown high-performance bodies. Send for a free copy today.



frenchtown

PORCELAIN COMPANY
86 Muirhead Ave. • Trenton 9, N. J.



SPADE BOLTS



Specialists in designing and manufacturing of all-purpose fasteners and wire forms. Tooled to produce over 1000 styles in any screw size, material, finish, quantity, to your specifications.

Serving Industry for Thirty-five Years
— OTHER PRODUCTS —

Simplex

WIRE STRIPPERS & CUTTERS

• TOOLS • DIES • STAMPINGS
Bulletins on complete line upon request

WENCO MANUFACTURING CO.
1133 W. Hubbard St., Chicago 22, Ill., U. S. A.

Want more information? Use post card on last page.

FOR MARKING...



**PLASTIC • METAL
GLASS • PAPER
RUBBER • CERAMIC
CARDBOARD**

**in such products as
Resistors, capacitors,
valves, tubes, labels,
sleeves, spark plugs, car-
tons, etc., etc.**

**THESE PRODUCTS
AND MANY OTHERS
OF ALMOST ANY
MATERIAL AND SHAPE
CAN BE IMPRINTED**

ON THE
REJAFIX
MARKING MACHINE

Why not send us samples of your products? They will be test-printed and returned to you for your examination!

- REJAFIX HAND-OPERATED MODELS FOR SMALL RUNS. FULLY AUTOMATIC MODELS FOR MASS PRODUCTION.

EST. 1922

POPPER & SONS INC. 300 FOURTH AVENUE
NEW YORK 10, N. Y.

**SAVE
MONEY**

**have your electronics engineering
problems solved abroad!**

Only New London offers this unusual (and economical) service: electronics research and development performed by engineers in Israel.

This exceptional facility, located near Tel Aviv, enables you to employ leading specialists in solving your audio, VHF and UHF problems. And doing so actually costs much less. Furthermore, projects are com-

pleted in minimum time, with utmost efficiency, and at no sacrifice of quality.

The engineers employed by the American Eastern Electronics Division are top specialists in circuitry. Many are U.S.-trained, with considerable experience in U.S. industries. They have at their disposal all the advantages of extensive, modern laboratories, and can supply you with complete plans and prototypes to your specifications.

Look into this new service today — proposals on request

NEW LONDON INSTRUMENT COMPANY, INC.

AMERICAN EASTERN ELECTRONICS DIVISION
82 Union Street New London 1, Conn.

deals with the generalized single and multistage amplifier, the R-C amplifier, the video amplifier with high and low-frequency compensation, phase inverters, the cathode follower, the grounded grid amplifier, the transformer coupled amplifier and single and double tuned r-f amplifiers.

For undergraduate use, feedback amplifiers are well covered. The line diagrams employed are excellent aides to understanding. The emphasis on method of analysis is commendable both here and elsewhere in the text.

While only 21 pages are devoted to oscillators, the types presented and the methods of solution have been well chosen to broaden the student's perspective.

The book closes with a short chapter on the more recent developments in the field. Here, semi-conductors and their byproducts, thermistors, point-contact rectifiers and transistors are dealt with as well as magnetic and dielectric amplifiers.

The text makes a good visual impression. The equations have been well arranged. The diagrams are numerous and well drawn. Typographical errors are at a minimum. Each chapter is followed by a bibliography and except for the last chapter by a sizable group of problems. Many sample problems have been worked out in the text. The authors are to be congratulated for the thorough way in which they have discussed the limitations of these solutions.—
HIRAM D. HARRIS, *Professor of Electrical Engineering, Rensselaer Polytechnic Institute, Troy, N. Y.*

Single Sideband Techniques

BY JACK N. BROWN, W3SHY. *Cowan Publishing Corp., New York, N. Y., 1954, 112 p, \$1.50.*

Single Sideband for the Radio Amateur

BY HEADQUARTERS STAFF, *American Radio Relay League, West Hartford, Conn., 1954, 208 p, \$1.50.*

IN THE 1937 edition of a well-known

IT TAKES TWO

DISPLAY ADVERTISING • AROUSES INTEREST • CREATES PREFERENCE
DIRECT MAIL • GETS PERSONAL ATTENTION • TRIGGERS ACTION

After your prospect has been convinced by Display Advertising, he still must act. A personalized mailing piece, is a powerful action-getter. Send for our Industrial Direct Mail Catalogue, 150 lists available.

Direct Mail Division,
McGraw-Hill Publishing Co., Inc.
330 West 42 St., N. Y. 36, N. Y.

Please forward my free copy of the McGraw-Hill "Industrial Direct Mail Catalogue."

Name _____
Company _____
Address _____
City _____ State _____



for Results



Mc GRAW-HILL
DIRECT MAIL LIST SERVICE

radio text there appeared the statement: "Single sideband transmission is . . . used . . . over wire lines, but the difficulty of producing . . . single sideband power at radio frequencies and the difficulty of receiving the signals have prevented single sideband transmission from being standard practice in radio work."

In the 18 years that have since elapsed, use of single sideband transmission has become commonplace, even being suggested as a means of reducing interference and making more economical use of the mobile radio spectrum. While it is by no means commonplace within the amateur fraternity, there is now available a good body of practical knowledge. This information can also be of benefit to the practical radio engineer seeking a groundwork in single sideband practice.

The material contained in these booklets is digested from technical articles that have appeared in the pages of the magazines *CQ* and *QST*. Both the filter method and the balanced modulator method of generating single sideband signals are described. Information is likewise included on operation of linear amplifiers, special speech amplifiers and break-in circuits. For the broad view and because of the low price, it is recommended that the interested neophyte might well purchase both books, particularly since the author of one has contributed to the other.—A. A. MCK.

Alternating Current And Transient Circuit Analysis

BY HARRIS A. THOMPSON. *McGraw-Hill Book Co., New York, 1955, 317 p., \$6.75.*

THIS text book is intended for use in the first electrical engineering courses devoted to a-c circuit analysis. As is true of so many of the modern text books now being published, the material in the books was first developed as a set of class notes (for a two semester junior year E. E. course).

Mr. Thompson's chapter titles show that he is in agreement with the other competent teachers in the

HI-POWER

WATER LOADS AND CALORIMETERS



1 MEGACYCLE
TO
12,000 MEGACYCLES

COAXIAL

self-contained High Power Calorimeters and Water Loads up to 3,500 megacycles.

WAVEGUIDE

High Power Calorimeters and Water Loads—900 to 12,000 megacycles.

Your inquiries for special Water Loads and Calorimeters are invited

ELECTRO IMPULSE Laboratory

208 RIVER STREET • RED BANK, N. J. • Phone: Red Bank 6-0404

GOLD INLAY KNOBS

IN ANY QUANTITY!

... and Never a Tool Charge

NEW GEE-LAR GOLD INLAY KNOBS

You can get beautiful gold inlay knobs, pointers, instrument controls . . . thousands of styles and varieties . . . in any quantity from GEE-LAR—The House of Knobs. They're available in both knurled and spring types, in either walnut or ivory backgrounds. For faster service and lower cost . . . plus the widest selection . . . get your Gold Inlay Knobs from GEE-LAR!

WRITE TODAY for Gee-Lar Catalog IT'S FREE!



THE HOUSE OF KNOBS

GEE-LAR MANUFACTURING COMPANY

821 ELM ST. • Rockford, Illinois



Aerohm

Precision wire-wound Potentiometers



"Lo-TORK" POT

For minimum-torque uses in computer, servo, and selsyn service. Stainless-steel precision ball bearings. Minimum torque is 0.01 inch-ounce. Dissipates one watt at 80°C. Resistances — 100 to 100,000 ohms. Weight is only 1/2 ounce. Ganging to six decks; internal clamps hold 7/8" diameter. Standard linearity 0.5%; on special order 0.25%; toroidal winding allows winding angles to 360°; standard 354°.

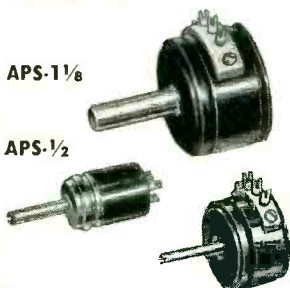

MICRO-MINIATURE and MINIATURE

Series APS-1/2 — 2 watts continuous at 80°C; resistances 10 to 20,000 ohms, 5% tolerance standard; diameter 1/2", depth 1/2", weight 1/4 ounce; sealed well enough for potting.

Series APS-7/8 — 3 watts continuous at 80°C; resistances 10 to 100,000 ohms; diameter 7/8", depth 3/8", weight 1/2 oz.; standard linearity 2%.

Series APS-1 1/8 — 4 watts continuous at 80°C; resistances 10 to 150,000 ohms; diameter 1 1/8", depth 1/2", wt. less than 3/4 oz.; standard linearity 1%.

All precision-machined, with anodized aluminum bodies, line-reamed phosphor bronze bearings, centerless-ground stainless steel shafts, and gold-plated fork terminals. Fully sealed and fungus-proofed. Can be processed, on special order for use at 125°C. Aerohm potentiometers are individually checked for quality and performance.



Write for copy of our new catalog.

WATERS MANUFACTURING, inc.
Waltham 54, Massachusetts

APPLICATION ENGINEERING OFFICES IN PRINCIPAL CITIES

NEW BOOKS

(continued)

field concerning the concepts and tools which should be taught at this introductory level.

Deserving of special mention are chapter 3 on Complex Algebra and Phasors which is clearly written and should be of real help to the student; and chapter 10 on Mathematical Analogies where, among other things, it is clearly shown that duals are present in mechanical systems.

General Concepts

The first two chapters in this text cover general concepts such as phase difference, effective values, etc. However, this reviewer feels that the concepts mentioned in chapter I, Circuit Theory vs Field Theory, etc., are so briefly dealt with that the student will obtain very little help from this chapter. Missing from this chapter is a basic discussion of that universal stumbling block for the sophomore, junior, senior and sad to say many graduate students—algebraic potential difference (i.e. algebraic voltage) and algebraic current, and the reference direction and sign convention which are integral parts of these concepts. Section 4.1 and section 5.2 in chapters 4 and 5 respectively do consider this important subject but in a way which will not clarify this matter for a junior year student.

Chapter 4 logically considers the relationship between the voltage produced across an impedance and the current which produces this voltage, but notably lacking is the dual treatment considering the current produced through an admittance by an applied voltage. The student is helped most if at this point in his learning the admittance concept is given stress equal to (or perhaps greater than) that given to the impedance concept—this chapter unfortunately does not stress this equality.

Network Theorems

Chapters 5 and 6 are clearly written chapters which really contain the meat of an introductory course on steady state a-c circuit analyses: the use of phasors and complex algebra in steady-state a-c analyses; the use of Kirchoff's Laws to

miniature . . . subminiature

Precision Products by
ELECTRO-miniatures Corp.

Insert Molding in ALL Plastics



- Plastic Embedded Voice Coils
- Encapsulated Inductances
- SLIP RING ASSEMBLIES

Miniaturized Electronic Assemblies

- Designs
- Prototypes
- Production

Our Exacting Methods Give You Components at their BEST!

Your Inquiries Invited

ELECTRO-miniatures Corp.

205 LAFAYETTE STREET
NEW YORK 12, N. Y.
Phone: WOrth 6-2346

CADMIUM PHOTOCELLS

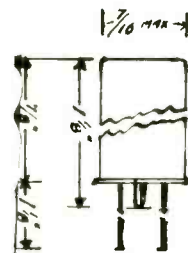

(GLASS)



(PLASTIC)



- Both of these types are extremely sensitive to very low levels of illumination.

PHOTO-CRYSTALS, INC.
15 S. First St. GENEVA, ILL.

Want more information? Use post card on last page.

Want more information? Use post card on last page.

obtain network solutions; and the use of Superposition, Thevenin and Norton's Theorems, etc. As already indicated, section 5.2 discusses the all-important matter of voltage and current directions but in a manner which this reviewer feels to be confusing to students. Part of this confusion is due to the fact that Mr. Thompson (and many other modern text book writers) fail to separate the concept of "the reference direction for an unknown voltage" from the concept of "the polarity of a known voltage." It may also be noted that the title of section 5.14 is incorrect, or at least confusing; I_1 , I_2 and I_3 are not branch-currents; they are loop currents—branch currents are those contained in Eq. 5-90 to 5-93.

The book is clearly illustrated, and a large number of useful problems is given at the end of each chapter. In addition, each chapter contains a number of numerical examples which are worked out in detail.

In general, and in almost all particulars, Mr. Thompson has written a carefully thought out and useful textbook.—M. DISHAL, *Federal Telecommunication Laboratories, New Jersey.*

Control-System Dynamics

BY WALTER R. EVANS. *McGraw-Hill Book Co., New York, 1954, 282 p., \$7.00.*

THIS outstanding new next is designed to demonstrate the techniques for determining the response of linear control systems. It is primarily an exposition of the root locus method invented and developed by the author. The root locus, a tool to factor an algebraic polynomial, is used in analyzing differential equations in feedback control systems. The book is a valuable text or reference book for students and practicing electrical or mechanical engineers.

Analysis

According to the author, "The analysis of a given control system is mathematically identical to the analysis of a mechanical shock mount or an electric circuit. Each system can be solved by a set of

Specialists in the
Unusual

DIRECT TEMPERATURE MEASUREMENT

UP TO **3700°F.**

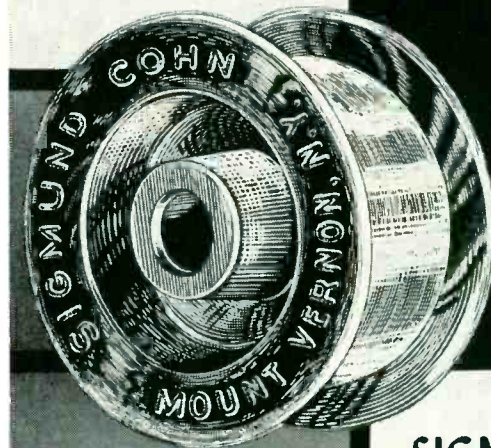

Write for List of Products

IRIDIUM vs. RHODIUM TRIDIUM
THERMOCOUPLE WIRE

The only thermocouple material which may be used at these very high temperatures in an oxidizing atmosphere.

Ductile wire made possible by high purity and our advanced melting and drawing techniques.

Output. Over 10 millivolts at **3700°F.**

UNIFORM • REPRODUCIBLE

SIGMUND COHN CORP.

Metallurgists and Producers of Small Wire

121 South Columbus Avenue
Mount Vernon, N. Y.



A copy of this quick-reading, 8-page booklet is yours for the asking. It contains many facts on the benefits derived from your business paper and tips on how to read more profitably. Write for the "WHY and HOW booklet."

McGraw-Hill Publishing Company, Room 2710, 330 West 42nd St., New York 36, N. Y.

You Name It EISLER Makes it...

GLASS TO METAL

ELECTRONIC GLASS WORKING EQUIPMENT for RADIO, TELEVISION TUBES, INCANDESCENT LAMPS, GLASS LATHES for TELEVISION TUBES

We make Transformers, Spot and Wire Butt Welders, Wire Cutting Machines and 500 other items. Indispensable in your production. Eisler Engineers are constantly developing New Equipment. If you prefer your own designs, let us build them for you. Write to Charles Eisler who has served The Industry over 34 years.

IF YOU NEED ANY SPECIAL CAMS WE MAKE THEM

INDEXING TURNTABLES

Charles Eisler
Eisler Engineering Co., Inc.
Newark 3, N. J., U. S. A.

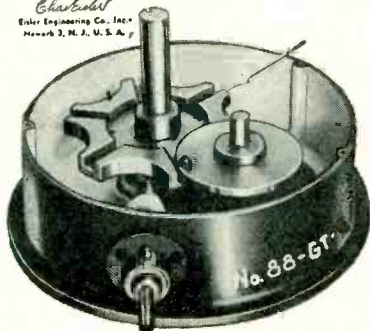

Over
100
Different
Types

Write
for
Catalog

World Famous
for Over 33 Years
Charles Eisler M.E.

CHAS. EISLER JR., PRES.
EISLER ENGINEERING CO., INC.

751 So. 13th St., NEWARK 3, N. J.

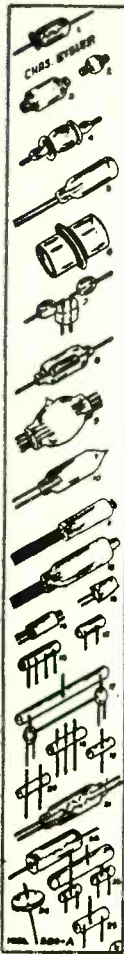

linear differential equations. These equations can be solved by a direct routine for the steady-state response to a sinusoidal input or for the transient response to a step input. The control-system problem differs, however, in that only part of the system is given; the rest of the system must be selected so that the desired response is obtained. This reverse process requires a clear understanding of the problem and many special calculation tricks to be efficient. The purpose of this book is to present these calculation procedures, including the root locus method developed by the author, to permit the reader to select the best method for his problem. It is the author's hope that some of the ideas will help the engineer whose problems are sufficiently complicated that any solution by any method would be welcome."

Problem

The simplest problem presented is the change in the speed of a motor to a suddenly applied voltage, while the most complex is the interaction of the roll and yaw motions of an airplane. Each solution establishes a concept which permits a simpler technique to be applied to the next, more complicated problem. Physical understanding of the problems is emphasized as opposed to memorization of a routine method for solving particular problems. The author first develops the physical picture of a solution and then follows with its mathematical solution. All recent advances in control-system dynamics are covered.

—WILLIAM KES, *Bethpage, L. I., N. Y.*

Engineering Cybernetics

By H. S. TSIEN. *McGraw-Hill Book Co., New York, 1954, 289 p., \$6.50.*

THIS important work aims to establish engineering cybernetics as a new branch of engineering science. A science on which there has, as yet, been a minimum number of books published. From the viewpoint of technical knowledge, this book represents a significant step to conclude basic facts that have direct engineering applica-

CAPACITORS

will help you build

LOW LOSS

into your circuit systems

VITRAMON CAPACITORS

have low dissipation over wide frequency ranges

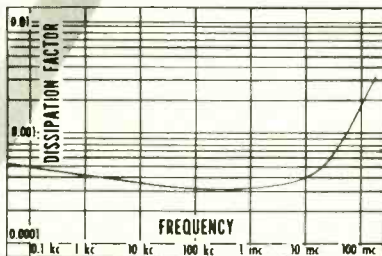

— LOSS vs FREQUENCY



Two materials — a monolithic block of porcelain enamel and fine-silver electrodes — fused into one strong, stable, efficient and effectively homogenous unit.

Vitramon
INCORPORATED
BOX 544 E • BRIDGEPORT 1 • CONN.

Losses are inherent in EVERY capacitor. You can keep them to a minimum with Vitramon . . . the capacitor of purity. Pure porcelain enamel dielectric . . . pure silver electrodes . . . with absolute bonding.

LOW LOSS? YES! PLUS...

STABLE

LOW NOISE

WIDE TEMPERATURE RANGE

RUGGED

MINIATURE

VAPORPROOF

The biggest names in electronics use Vitramon Capacitors in guided missiles, beat-frequency oscillators, jet ignition, interceptor guidance, radar and servo systems, carrier telephone and telemetering systems, proximity fuses, etc.

IF YOUR CAPACITOR PROBLEM IS CRITICAL WRITE TODAY FOR COMPLETE DATA...

tions in designing controlled or guided systems. This book gives a comprehensive treatment of scientific principles of control abstracted out of the entire field of control engineering, from the simple conventional servomechanisms to the very complex controlled and guided systems. A large portion of the book has been devoted to topics which have never been included in any book on servomechanisms, and many of which have never appeared previously in book form.

New Topics

Among the new topics treated are the following: noninteracting controls of many variable systems; linear systems with time lag—Satche diagrams; nonlinear servomechanisms; control design by perturbation theory; control design with prescribed performance; optimizing control; noise filtering and detection; ultrastability and multistability of homeostatic systems; and von Neumann's theory of error control.

Authors Treatment

In the author's treatment of the above topics, he has successfully shown that a wider range of topics is only one difference between engineering cybernetics and servomechanism engineering. A deeper difference lies in the fact that engineering cybernetics is engineering science, while servomechanisms engineering is an engineering practice.

The entire discussion is concise, but nevertheless lucid, logically clear and well-organized. Whereas an engineering science is predominated by theoretical analysis and very often uses the tool of advanced mathematics, the mathematical arguments used in this book are on a level no higher than that required for a research engineer.—WILLIAM KES, *Bethpage, L. I., N. Y.*

Thumbnail Reviews

Inventories of Apparatus and Materials for Teaching Science—Vol. III, Technical Colleges, Part 4 Electrical Engineering. United Nations Educational, Scientific and Cultural Organization, Columbia University Press,

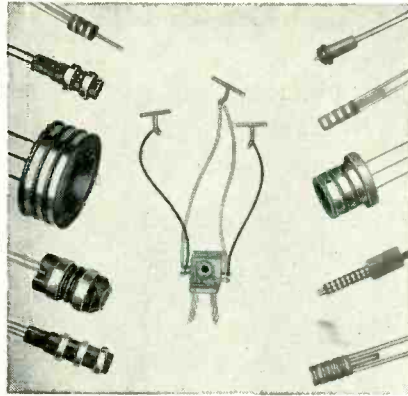

Miniature and Sub-Miniature SLIP RING ASSEMBLIES BRUSH BLOCK ASSEMBLIES COMMUTATORS

and other
Electro-Mechanical Components

**PRECISION MADE
TO YOUR OWN SPECIFICATIONS**

Precision molded products with exacting tolerances in precious and non-precious solid metals of all alloys. All types of Thermo-Plastic and Thermo-Setting materials.

Slip Ring Assemblies fabricated or one-piece precision molded to your specifications in Nylon, Kel-F, Mineral filled Mellamine, Phenolic, and other materials. Rings and leads spot welded or brazed together for positive electrical circuit.

Our Swiss methods and techniques are geared to meet exacting requirements. We invite your inquiries.

COLLECTRON CORPORATION

MUrray Hill 2-8473 • 216 East 45th Street • New York 17, N. Y.

FREQUENCY STANDARD

... with ultra high stability

Determines frequency with exceptional accuracy! This model 701 features a unique method of temperature stabilization that achieves a unique degree of frequency stability.

FREQUENCY STABILITY. After 48 hours of operation: (1) 1 part in 10^7 per 24 hours, (2) 1 part in 10^7 for $\pm 10\%$ line voltage change, (3) 1 part in 10^8 per degree Cen-



MODEL 701

tigrade: **OUTPUT FREQUENCIES:** 10 kc—5 mc at 10 kc or 100 kc intervals, or 1 mc from front output connector through resistive attenuator, 100 kc sine wave from rear connector. **Write for catalog.**

NEW LONDON INSTRUMENT CO., Inc.

82 UNION STREET • NEW LONDON 1, CONN.

Cunningham
ESTABLISHED 1930



CROSSBAR

A truly superior switch for
**MASTER CONTROL AND
MONITOR SWITCHING OF
AUDIO & VIDEO CIRCUITS**
Also
**COMPUTERS • TELEMETERING
TELEPHONY • DELAY LINES
ETC.**

Advantages

Extreme flexibility
Fast quiet switching
Crosstalk down 60 Db at 19 MC
Any group of setups may be held intact while setting up others
Provision for spot or remote control
Strapwiring eliminated
Excellent HF characteristics
Palladium contacts
Reduced cost
Compact design, small size
Low operating power—2.5 watts
Simple "package" installation

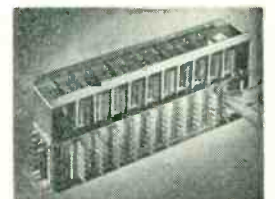

- Individual magnets at each cross-over.
- Maximum, six conductors per circuit
- Life-tested to 100 million operations.

JAMES CUNNINGHAM, SON & CO., INC.

33 Litchfield St., Rochester, N. Y.

Tel: Baker 7240

JUNIOR *Utility* OVENS

- Low cost
- Easy to operate
- Minimum maintenance

4 MODELS
to choose from

Model	Internal dimensions	Temperature range
CA 250	22" w by 20" d by 23" h	up to 250°F
CA 550	20" w by 17" d by 21" h	100° to 550°F
CA 650	20" w by 17" d by 21" h	100° to 650°F
CA 1000	18" w by 15" d by 19" h	100° to 1000°F

Here is a new line (4 models, temperature ranges up to 1000°F) that incorporates every possible advantage of experienced oven design. Use the Jr. Utility Oven for economical manufacturing, product control, sample testing, etc. External dim. 24" x 24" x 34" high. Handsome gray hammertone finish. Write for complete data on new, advanced features. Some territories open for representatives, distributors and resale outlets.

NEW ENGLAND OVEN & FURNACE CO.
POST ROAD, ORANGE, CONN.

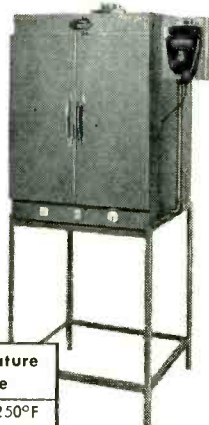

New York, 1954, 147 p, \$2.75 (paper). Information about the organization of the teaching of electricity in France, Sweden and Great Britain

Radio-Control Handbook. Howard G. McEntee, Gernsback Publications, Inc., New York, 1954, 192 p, \$2.25 (paper). Theory, operation and construction of control systems, transmitters and receivers for remote operation of model planes, cars and boats.

Bibliography on Physical Electronics. Wayne B. Nottingham, Addison-Wesley Publishing Co., Inc., Cambridge, Massachusetts, 428 p, \$8.50. List of papers published since 1900 on gaseous electronics; electron emission and surface phenomena; solid state and conduction; phosphors and luminescence; photocells, photovoltaic effect and photoconductivity; techniques (measurements, diffraction and scattering, high vacuum) and miscellaneous metallic properties.

Interior Electric Wiring and Estimating—Part Two, Industrial. Kennard C. Graham, American Technical Society Chicago, 1955, 324 p. Practical approach to industrial wiring including code provisions, cost estimation and specific techniques. Specific subjects include x-rays, electrical heating devices, welders, electric signs and remote control installations.

The Radio Amateur's Handbook American Radio Relay League, West Hartford, Connecticut, 1955, 541 p, \$3.00 (paper). A basic reference for amateurs, experimenters, students and engineers. Subjects covered include: single-sideband, f-m, uhf and microwave communications, tv and mobile work. Vacuum-tube tables list 67 new miniatures, 26 crystal diodes, 19 rectifiers and 17 transistors.

The Changing American Market. The Editors of *Fortune*, Hanover House, Garden City, New York, 1955, 304 p, \$4.50. A collection of articles that appeared in *Fortune* magazine between August 1953 and August 1954 that delineates the social, and economic pressures affecting the domestic market for consumer products. The book discusses the radio and television industry and predicts its outlook for the next five or ten years.

Norwegian-English Technical Dictionary. By John Ansteinesson. Krause Periodicals Inc., 16 East 46th St., New York 17, N. Y., 1954, 327 p, \$7.75. Norwegian terms arranged alphabetically, each followed by English equivalents. Example: elektronikk electronics.

Reliability of Electronic Equipment. Vol. 1, 1952, 20 p, available from OTS, Department of Commerce, Washington, D. C., \$.50. Preliminary finding and recommendations of group set up by the Committee on Electronics of the R&D Board. Gives background for present high rate of failure and makes specific recommendations for improvement.

Temperature Stability of Electrical Insulating Materials. American Society for Testing Materials, 1916 Race Street, Philadelphia 3, Pa. 141 p, 1954, \$2.75. Papers presented at a symposium in Chicago 1954 on measurements of dielectrics, test methods, stabilities of materials.

CONTINUOUS, DIRECT-READING X-BAND VSWR MEASUREMENT

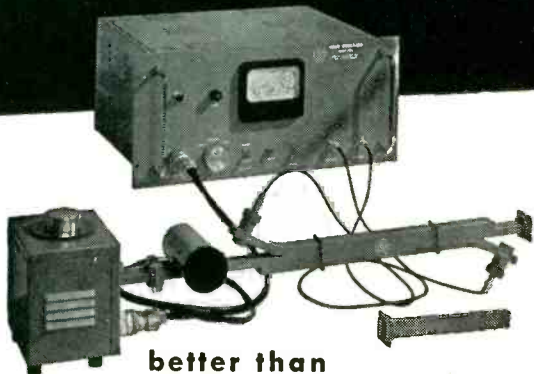

better than
2% overall accuracy!

For speedy and accurate VSWR measurements in laboratory or production use, the CTI Model 110B Measuring System reads directly, is continuously tunable from 8,500 to 9,600 mc.

SPECIFICATIONS

Two VSWR Ranges: 1.02 to 1.2; 1.2 to 2.5
Attenuation Scale: 0 to ∞; 1.5 db midscale
Waveguide Fitting UG-39/U
Directional Couplers, directivity over 40 db

COLOR TELEVISION INCORPORATED

SAN CARLOS 1, CALIFORNIA





HOW ARE YOUR COMMUNICATIONS ?

Do the booklets, pamphlets, and manuals you use really *work* for you? Are these vital publications, that tell the story of your products and your company, as effective, readable, well designed and illustrated as they can be? Today more than ever, your entire operation is judged by each annual report, employee manual, and public relations piece that you produce. Have you examined your communications lately? If you have any doubt as to the impact of your instructional and promotional literature, remember . . .

COMMUNICATION IS OUR BUSINESS

For a good many decades McGraw-Hill has stood for complete coverage in the business literature field. Now the McGraw-Hill **TECHNICAL WRITING SERVICE** offers a new approach to your publication problems — an *integrated* writing, editing, illustrating, and printing service for the *custom* production of: INSTRUCTION MANUALS, PRODUCT BULLETINS, TRAINING AIDS, INDUSTRIAL RELATIONS LITERATURE, ANNUAL REPORTS, COMPANY HISTORIES, PROCEDURAL GUIDES and other collateral literature. More than 150 editorial and graphic experts are at your disposal, ready to prepare high-quality material to your own or government specifications. Save time, save money . . . and make your communications work! Let *our* staff be your staff for technical and business publications.

McGraw-Hill Book Co. TECHNICAL WRITING SERVICE

Write or phone Technical Writing Service, McGraw-Hill Book Co., Inc.
330 West 42nd Street, New York 36, N. Y. • LONgacre 4-3000

This service is available through ad agencies.

Backtalk

More Early Radar

DEAR SIRs:
BELATED SILVER Anniversary Greetings!

The box on page 126 of the April issue on "Early Radar" was of particular interest, since NRL, or NRL scientists, were responsible for each of the items listed. The first item, dated 1922, relating to the fact that metal buildings or passing ships interfered with radio waves was, of course, discovered by Dr. A. H. Taylor and Leo C. Young (he still is at NRL, incidentally) at one of the predecessors of NRL, the Aircraft Radio Laboratory at the Naval Air Station in Anacostia.

The work on pulse radar was begun at the Laboratory by Dr. Robert M. Page, presently associate director of research for electronics at NRL, whom we think of as the "father of radar." He had a set completed and tested in December of 1934.

And so it goes with the rest of the achievements in the field of radar. True, perhaps it is not fair to claim credit for the production of the 20 sets installed in the Fleet by Pearl Harbor Day, but even there, the Laboratory was instrumental in getting production under way by RCA.

This, of course, is history, but it is pleasant, at times, to think that we still have people at the Laboratory who were instrumental in the early development and production of radar; it's grown to be quite an industry in a few short years.

CHAS. DE VORE

*Assistant Technical Information Officer
Naval Research Laboratory
Washington, D. C.*

More Medical Electronics

DEAR SIRs:

AS THE DESIGNER of the first commercially successful direct-writing electrocardiograph in this country (and of electroencephalographs having novel and useful features, an encephalographic analyzer of compact and simple form, etc.) I was interested in the letter of Dr. Harwell G. Davis, Jr., in your January issue, p 360.

About 10,000 of these cardio-

600 BC
1700
1955
TOROIDS!
2,555 YEARS
IN THE
MAKING

Thales . . . Gilbert . . . Oersted . . .

You'll feel their spirit and see the mark of their immortal minds in the modern magnetic cores used to produce toroids with the Boesch Model TW-200-A.

Fully automatic, this BOESCH Toroidal-Coil Winding Machine provides industry with the ultimate in toroidal-winding equipment.

Write today for detailed information on the BOESCH Model TW-200-A and other BOESCH winding machines.

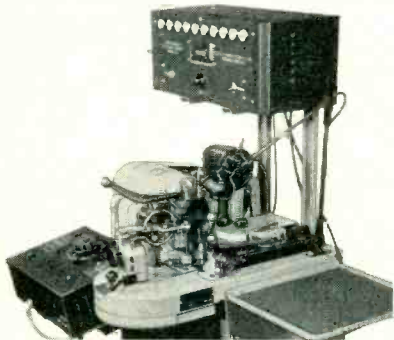

Model TW-200-A

Now — no licensing, no royalties required in the sale and use of BOESCH Machines



Want more information? Use post card on last page.

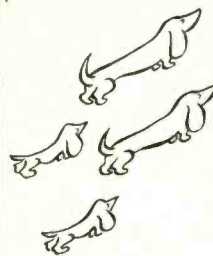

IT TAKES TWO

DISPLAY ADVERTISING

- AROUSES INTEREST
- CREATES PREFERENCE

DIRECT MAIL

- GETS PERSONAL ATTENTION
- TRIGGERS ACTION

After your prospect has been convinced by DISPLAY ADVERTISING, he still must take one giant step. He must act. A personalized mailing piece direct to his desk, in conjunction with a display campaign, is a powerful action getter.

McGraw-Hill has a Direct Mail Division ready to serve you with over 150 specialized lists in the Industrial field.

To get your copy of our free INDUSTRIAL DIRECT MAIL CATALOGUE (1954) containing complete, detailed information about our services, fill in the coupon below and mail it to McGraw-Hill.

Do it now! The best advertising programs are planned well in advance.

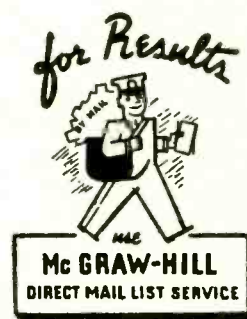

Direct Mail Division,
McGraw-Hill Publishing Co., Inc.
330 West 42nd St., N. Y. 36, N. Y.

Please forward my free copy of the McGraw-Hill "Industrial Direct Mail Catalogue."

Name _____

Company _____

Address _____

City _____ State _____

graphs have been sold since 1942 when they were first introduced; and there are probably at least 7,000 in daily use. . . There are now probably more than 40,000 direct-writing instruments in use. . .

When we first presented the non-photographic electrocardiograph (direct-writing) the opinion then prevailing in supposedly expert circles was that only Einthoven string galvanometers, or the various modifications of them, could provide clinically accurate cardiographs. To demonstrate that this opinion was not essentially valid many hundreds of simultaneous recordings were made, using a carefully designed cathode-ray oscilloscope system as a standard against the string galvanometer machines and the direct-writing machine.

There were never any deviations computed to be clinically significant by consulting cardiographers of long experience. What insignificant deviations were observed were quite frequently found to be greater in the string machines than in the direct-writers. . .

The string machine is a low-impedance device (usually 2,000-4,000 ohms). Its sensitivity is adjusted solely by changing the string tension. For high source (patient) impedances, the string tension is low and vice-versa. The frequency response and damping characteristic of the instrument is therefore different for every source impedance. Since the source impedance changes with every patient and with every lead connection on every patient, and is different even from moment to moment on the same lead on the same patient, it is obvious that it is almost impossible to have the instrument in any "standard" condition.

In practice, this means that a graph made with a patient resistance of 10,000 ohms will show a slightly different waveform, for the same cardiac potentials, from one made with a patient resistance of 1,000 ohms. These resistances are frequently found in practice. . .

There are other things wrong with string machines, too. There are also things wrong with direct-writers; and like the string machines which they have largely superseded, they are hardly suit-

free . . . AGF BURNER CATALOG

AVAILABLE NOW!

The first complete catalog containing technical data on air-gas and oxygen-gas burner equipment is yours for the asking.

Wherever gas burners are used, AGF has been supplying them for 77 years. New Catalog C6A covers:

- Sharp Flame Ribbon Burners
- Fishtail Burners
- Needle Point Glass Fires
- Blowpipes
- Hand Torches
- Mixing Equipment
- Flow Meters
- Fire Checks
- Ball Joints
- Blast Burners
- Oxygen-Hydrogen Burners

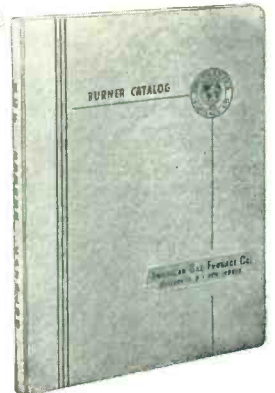

Write for your copy today on your company letterhead.



AMERICAN GAS FURNACE Co.
130 SPRING STREET - ELIZABETH 4, N. J.

MARKEM[®] MACHINES

Solve "IN-PLANT" PRINTING PROBLEMS
- FASTER - NEATER - AT LOWER COST

The Markem Model 45AF Machine prints trade name, trade mark, specifications, etc., on resistors, condensers, capacitors, diodes, triodes, transistors, etc., at production rates. Feeds, prints, and ejects automatically. Quickly insertable type provides easy change in data being printed.

Write for further information. Submit sample of item you wish to mark.

WIRE LEAD
COMPONENT PRINTING

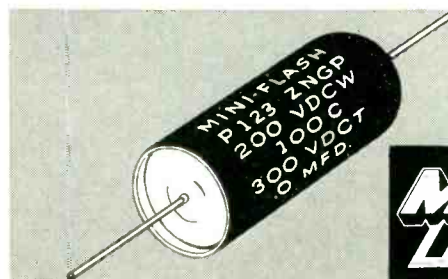
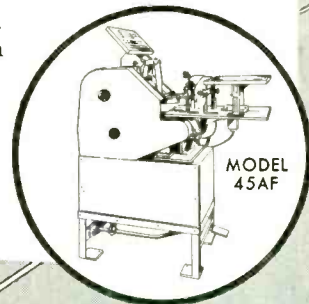

MARKEM MACHINE CO.
KEENE 5, NEW HAMPSHIRE

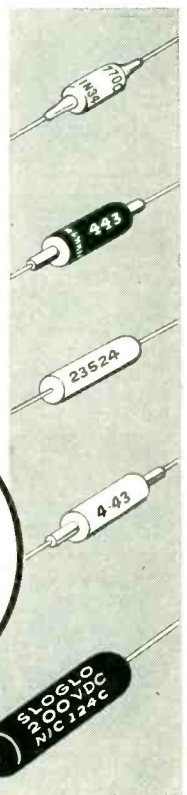

CONTACTS

FOR THE FIELD OF ELECTRONICS

CINEMA'S TAPE AND FILM Degausser

CLEAN ERASURE OF MAGNETIC TAPE & FILM



TYPE 9205 DEGAUSSER

Noise & program erasure. Use the best. Cinema's Bulk-Tank Type Degausser 9205. Economically priced. Buy yours today

CINEMA ENGINEERING CO.
DIVISION AEROVOX CORPORATION
1100 CHESTNUT STREET • BURBANK, CALIF.

• PLATING • Precision

Industrial
GOLD and SILVER
of all Description
GOVERNMENT CERTIFIED

GARREPY PLATERS INC.
11-19 Bartlett St., Worcester, Mass.
PLeasant 3-6472

Complete Service
FOR SMALL PARTS

- TOOLS
- STAMPINGS
- ASSEMBLIES
- SOLDERING
- PLATING
- PORCELAIN ENAMELING
- BRIGHT ANNEALING

Established 29 Years.
ORBER MANUFACTURING CO.
DUNNELL LANE PAWTUCKET, R. I.



EISLER MANUFACTURES COMPLETE EQUIPMENT

WELDERS FOR SPOT & WIRE BUTT
RADIO, TV TUBE EQUIPMENT & REPAIR UNITS
INCANDESCENT, FLUORESCENT MFG. EQUIPMENT
NEON SIGN MAKERS EQUIPMENT, GLASS LATHES
ELECTRONIC EQUIPMENT, VACUUM PUMPS, Etc.
Wet Glass SLICING & CUTTING MACHINES for Lab Use
TRANSFORMERS, SPECIAL & STANDARD TYPES

EISLER ENGINEERING CO., INC.
751-A So. 13th St. Newark 3, N. J.



SAUERISEN CEMENTS

FASTER ASSEMBLY ON
Radio Tubes

Leading electrical manufacturers use Sauerisen Cements for assembling, sealing and insulating.

Send unassembled parts or sketch for technical advice.

Write for Catalog

Sauerisen Cements Company • Pittsburgh 15, Pa.



FLUXES

SOLDERING
BRAZING & WELDING

L. B. ALLEN CO. INC. Chicago 31, Ill.

6751 BRYN MAWR AVE.

World's Only Recorder of its Kind WALKIE-RECORDALL

8-LB SELF-POWERED BATTERY RECORDER

- AUTOMATIC UNDETECTED RECORDING up to 4 hrs
- PICKS UP WITHIN 50 FT. RADIUS
- VOICE ACTIVATED "SELF-START-STOP"
- NO WIRES OR PLUGS

Records noiselessly in or out of closed briefcase, containing hidden mike while walking, riding, flying. Conferences, lectures, dictation, 2-way phone. Permanent, unalterable, indexed recording at only 3c per hr.

MILES REPRODUCER CO., INC.
812 Broadway, N. Y. 3, N. Y. Dept.

One inexpensive modern device . . .

can frequently help speed up operation and maintenance or production.

One product advertised in the "Contacts" Section may be the answer to your problem . . . a real money-saver.

To be informed—and reminded—on modern aids to economical operation, maintenance and production, check "Contacts" advertising regularly . . . every issue.

able for certain kinds of investigative work. I know of nothing adequate for careful research work except the cathode-ray oscilloscope. And there is no point in having greatly extended frequency response unless the chart speed is also greatly extended beyond the American standard of 25 mm per second to provide resolution of the higher frequency components.

The damping problem in the direct-writing machine was never any particular problem. The instruments of my design have always used an auxiliary damping to go with its potential fed back to the amplifier, plus a special network providing other advantages. Patent # 2,439,640 filed by me in 1944 describes the specific application of this method. This type of damping helps to correct deficiencies in the overall electromechanical system, including stylus friction variation.

The Alnico magnets in our machines used to weigh 12 oz.; in the very latest models they weigh about 15 oz. Increasing coil currents "slightly" hardly compensates for less magnet. The heat dissipation in the coil is already a limiting factor; and adequate dynamic design does not permit of much latitude. Less magnet also requires higher power capability in the output stage, and more amplifier gain, with, in turn, more weight.

The drift problem has not precluded the use of d-c amplifiers in our designs. The gain is not very high and drift could always be held to satisfactory limits. We have not wanted to transmit zero frequency, because one of the great advantages of the electronic instruments over the string machines has always been that the almost zero frequency skin voltages are not transmitted and do not have to be compensated as they do in the string machine. A properly phase-shift-corrected capacitance-coupled amplifier provides undistorted reproduction of any low-frequency wave form known in cardiography, and very greatly facilitates the operation of the machine in clinical cardiographic use.

PAUL TRAUGOTT
(Formerly president and chief engineer
Electro-Physical Laboratories, Inc.)
Boston, Massachusetts

PROFESSIONAL SERVICES

Consulting—Patents—Design—Development—Measurement

in

Radio, Audio, Industrial Electronic Appliances

AIRPAX PRODUCTS CO.

Development Division

Specialists in the
Design and Manufacture of
UNUSUAL TRANSFORMERS AND RELAYS

Middle River Baltimore 20, Md.

ERCO RADIO LABORATORIES, INC.

Radio Communications Equipment

Engineering - Design - Development - Production
Our 27th Year in Air to Ground
Communications and Radio Beacons
Garden City • Long Island • New York

PICKARD & BURNS, INC.

Consulting Electronic Engineers

Analysis and Evaluation
of Radio Systems

Research, Development and Production
of Special Electronic Equipment

240 Highland Ave. Needham 94, Mass.

ANALYSIS INSTRUMENT CO.

Consultants on Magnetic Problems

Magnetic Materials Tested
Special Magnetic Devices Designed
Magnetizing & Testing Equipment Supplied

P. O. Box 7 Pequannock, New Jersey

HANSON-GORRILL-BRIAN INC.

Product & Mfg. Development

ELECTRICAL - ELECTRONIC
HYDRAULIC - MECHANICAL

One Continental Hill Glen Cove, N. Y.
Glen Cove 4-7300

ALBERT PREISMAN

Consulting Engineer

Television, Pulse Techniques, Video
Amplifiers, Phasing Networks,
Industrial Appliances

Affiliated with
MANAGEMENT-TRAINING ASSOCIATES
3224-16th St., N. W. Washington 10, D. C.

H. O. BIXBY ASSOCIATES

Consultants to the Electronic Industry

SURVEYS—PROMOTIONS—LIAISON
PERSONNEL PLACEMENT—TECHNOLOGY

238 Main St. Cambridge 42, Mass.
ELIot 4-0401

THE KULJIAN CORPORATION

ELECTRONICS DIVISION

Consulting Electronic Engineers

Research, Development, Production of
Automatic Controls — Special Instrumentation
1200 No. Broad St., Philadelphia 21, Pa.
Stevenson 2-9000

KARL F. ROSS

Registered Patent Agent

(U. S. and Canada)

Specializing in electronic patent matters
305 Broadway, New York 7, N. Y. WOrth 2-3440

THOMAS H. BRIGGS & ASSOCIATES

Electronics Consultants

Electron Tubes - Automation - Product Surveys
Tube Materials & Reliability - Servo-mechanisms
Engineering and production facilities.
Box 185 RD#2 Norristown, Penn. Tel No. 8-7671

ROBERT McCABE

Radio Noise Measurement and Elimination
Field Intensity Surveys

1781 Bide-a-Wee Park Columbus 5, Ohio

THE TECHNICAL MATERIAL CORPORATION

Communications Consultants

Systems Engineering

General Offices and Laboratory
700 Fenimore Rd., Mamaroneck, N. Y.

CROSBY LABORATORIES, INC.

Murray G. Crosby & Staff

Radio - Electronic
Research Development & Manufacturing
Communication, FM & TV

Robbins Lane, Hicksville, N. Y.
Hicksville 3-3191

Measurements Corporation

Research & Manufacturing Engineers

HARRY W. HOUCK MARTIAL A. HONNELL

JOHN M. VAN BEUREN

Specialists in the Design and
Development of Electronic Test Instruments

Boonton, New Jersey

TELECHROME, INC.

Electronic Design Specialists

COLOR TELEVISION EQUIPMENT

Flying Spot Scanners, Color Synthesizers, Keyers,
Monitors, Oscilloscopes and Related Apparatus
J. R. Popkin-Chirman, Pres. & Ch. Engr.

88 Merrick Rd. Amityville, L. I., N. Y.

EDGERTON, GERMESHAUSEN & GRIER, INC.

Consulting Engineers

Stroboscopy — Transient Oscillography
Photoelectricity — Pulse Techniques — Timing
High-Speed and Electronic Flash Photography
Telemetering - Industrial Television Applications
160 Brookline Avenue Boston 15, Mass.

MERCURY ELECTRONIC COMPANY

Power Supplies

Electronic • Magnetic • Static

Red Bank New Jersey

WALSH ENGINEERING CO.

Specialists in design of

ELECTRONIC and MAGNETIC

Apparatus to solve unusual problems.

Complete Model Shop.

34 DeHart Place Elizabeth, N. J.
Elizabeth 2-7600

Eldico of New York, Inc.

Pioneers of Television Interference Elimination from
Transmitters, Induction Heaters, Diathermy and etc.

Donald J. S. Merten & Engineering Staff

72 E. Second St. Mineola, L. I., N. Y.
Pioneer 6-5212

NEW ROCHELLE TOOL CORP.

FOR CERTIFICATION OF INDUCTION
AND DIELECTRIC HEATING EQUIPMENT
IN ACCORDANCE WITH F.C.C. RULINGS

Mobile Test Unit Available Entire U. S.

320 Main St. New Rochelle, New York
Phone NE 2-5555

WHEELER LABORATORIES, INC.

Radio and Electronics

Consulting — Research — Development

R-F Circuits — Lines — Antennas

Microwave Components — Test Equipment

Harold A. Wheeler and Engineering Staff
Great Neck, N. Y. HUnter 2-7876

ELECTRONIC RESEARCH ASSOCIATES, INC.

"TRANSISTORIZE" YOUR PRODUCT!

Complete Service in consulting, research, develop-
ment, and production on Transistor circuitry, prod-
ucts and instrumentation.

87 East Centre Street Nutley, N. J.
NUTley 2-5410

NIAGARA ELECTRON LABORATORIES

CONSULTATION - DESIGN - CONSTRUCTION
MFG. THE THERMOCAP RELAY

Specializing in solution of problems of electronic
and electro-physical instrumentation for the re-
search or analytical laboratory. Industrial plant
problems also invited.

Andover, New York Cable Address: NIATRONLAB

YARDNEY LABORATORIES, INC.

Research-Design-Development

Electro-Chemical Generators of Energy

40-46 Leonard Street Worth 6-3100
New York 13, N. Y.

**KAMAN
AIRCRAFT CORP.***requires
experienced***ELECTRONIC and
AERONAUTICAL
SYSTEMS ENGINEERS**

For responsible positions in the expanding field of
HELICOPTER
Instrumentation and Automatic Controls
Suburban location near Hartford

Forward detailed resume to:
W. M. Tynan, Administrative Engineer

THE KAMAN AIRCRAFT CORPORATION
BLOOMFIELD CONNECTICUT

★ **MANUFACTURERS**

Let us handle technical sales representation of your products

★ **INVENTORS**

We will share the cost of protecting your invention if accepted for commercialization

We Specialize In Electronics, Nucleonics, Instrumentation, Servomechanisms & Cybernetics.

R. W. HODGSON CO.

Technical Sales Representation & Research & Development Engineering

3406 W. Washington Blvd., Los Angeles 18, Calif.
REpublie 2-2851

**COMPONENT
MANUFACTURERS**

*Are Your Sales Stymied in
Greater New York Area?*

We are a growing sales engineering organization with 10 years experience in the Electronic Development Field. We can offer you the finest in engineering liaison between your factory and your potential customers.

CHARLES JASIK

11 Park Place New York 7, N. Y.
BE ekman 3-8338

**ELECTRONICS ENGINEERING
HEADQUARTERS**

A specialized division of America's largest Executive Placement Service.
Representing 400 of the nation's best electronics firms.

Many management, administrative, and executive positions now open.

Salaries: \$6,000 to \$50,000

Completely confidential, present position protected. No contacts made without permission.

**NO CHARGE TO APPLICANT
EMPLOYING CONCERNS PAY OUR FEE.**

Write for application, or send resume to:
Eugene B. Shea, Electronics Division,

CADILLAC EMPLOYMENT AGENCY, INC.
220 S. State St. Chicago 4, Ill.
America's Finest — Since 1930

**STAFF ASSISTANT
TO CHIEF ENGINEER**

New position in television design laboratory of progressive manufacturer. A real challenge and outstanding opportunity for young engineer. Starting salary \$10,000-\$12,000. Co. pays all fees and expenses.

28 E. Jackson Chicago 4, Illinois
Monarch Personnel

REPLIES (Box No.): Address to office nearest you
NEW YORK: 330 W. 42nd St. (36)
CHICAGO: 520 N. Michigan Ave. (11)
SAN FRANCISCO: 68 Post St. (4)

POSITIONS VACANT

Career Opportunities in telephone switching circuit design, both electro-mechanical and electronic, and in the allied fields of apparatus engineering and design. Openings are available for a limited number of men of promising ability who are graduate electrical engineers or who have the equivalent of practical experience. Good starting salaries with excellent opportunities for advancement. Attractive benefit plans and above average business stability. Write giving full details of your educational and work background to: Personnel Director, Automatic Electric Co., 1033 W. Van Buren St., Chicago 7, Ill.

Engineer—Television receiver deflection systems engineers wanted. Development and product design. Both color and monochrome. Send resume to Department RT-E, Technical Employment Office, General Electric Company, Electronics Park, Syracuse, New York.

Florida Positions. Electronic, electrical, mechanical, civil, chemical and industrial engineers. Technicians. Electronic draftsmen and others. Associated Agencies, Box 1324, Orlando, Florida.

POSITIONS WANTED

Engineer B. Eng., profession engineer and senior I.R.E. member. Age 37, married. Fifteen years of diversified experience in the electronic and guided missile field. Capable of project leadership and direction. Desires responsible position with an aggressive company. Present position staff engineer. PW-6326. Electronics.

Manufacturers Representative

Engineer desires newly manufactured electronic and electro-mechanical products for sale to Guided Missile and Aircraft Companies located in Southern California. Reply to:

LEE GRANT SNYDER CO.

Technical Sales & Contract Administrators
1418 N. Highland Ave., Hollywood 28, California
Phone Hollywood 9-6278

ENGINEERING DEGREES

(Under and Postgraduate)

E.E. Major in Electronics,
Earned Through Home Study.

AMERICAN COLLEGE OF ENGINEERING

Affiliated with University of the West
Box 27724(G), HOLLYWOOD 27, CALIF.

GOOD INDUSTRIAL PLANT

available for lease in Winston Salem, N. C., the home of the Electronics Division of Western Electric Company. The building which is in excellent condition has been occupied by Bell Laboratories. Forty thousand square feet floor space, large parking lot.

W. C. WRIGHT, Owner
Robert E. Lee Hotel Winston Salem, N. C.

POSITIONS WANTED

Engineering Executive—Currently engineering manager for national organization. Background of many years in field. Includes diversified experience in radar, communications, radio and TV. Well versed in manufacturing operations and management, purchasing, labor negotiations, contracts and leases, construction, specifications, budget control, standards preparation, client contacts. BSEE and BSME. PW-6287, Electronics.

CONTRACT WORK WANTED

Small electronic units or assemblies to wire, Eastern Electronic Service, Box 213, Maple Shade, New Jersey.

Small electronic units or assemblies to wire. CWW-6102, Electronics.

DRAKE PERSONNEL

National Placement Center for
**EXECUTIVE AND
TECHNICAL PERSONNEL**

*General and Plant Managers
Plant Superintendents—Foremen
Accounting—Staff Personnel
Engineers: Design—Production
Sales Managers—Engineers*

*Please outline briefly your
experience or personnel needs to:*

John Cope
7 W. Madison St., Chicago 2, Ill.
Financial 6-2100

Bendix OFFERS

3 SENIOR ENGINEERING JOBS

WELL WORTH LOOKING INTO...

SYSTEMS PROJECT ENGINEER

6-10 years experience in missile or radar electronic system development. Ability to direct systems engineering at the project level.

Senior Engineer TEST EQUIPMENT DESIGN

7-10 years experience in development and design of electronic test equipment for complete systems involving microwave and pulse techniques, adaptation of commercial instruments to special applications, preparation of proposals and the actual product design of electronic and electro-mechanical devices. Familiarity with problems of maintenance helpful. Supervisory experience and ability required.

Senior Engineer MECHANICAL DESIGN

6-10 years experience in missile or aircraft electronic package design. Familiarity with vibration and other environmental problems essential.

Here are three especially attractive job opportunities for engineers who want to get on the ground floor in the important, interesting, and challenging phase of a new industry—guided missiles.

Qualified men are given real job responsibilities with Bendix and grow with the development of what is not only the nation's most important weapon system, but a project that will undoubtedly lead to new and im-

portant long-range commercial application.

At Bendix you will be associated with top missile authorities and have at your command unexcelled engineering and manufacturing facilities. Salaries for these top jobs and other opportunities are open for discussion. Write today to: Mr. W. L. Webb, General Manager, Missile Section, Bendix Products Division, Bendix Aviation Corporation, 401 North Bendix Drive, South Bend, Ind.

23 OTHER ENGINEERING POSITIONS!

Bendix also offers unusual job opportunities for assistant engineers, junior engineers, and technicians, as well as a score of other assignments. A 30-page book describing in

detail every phase of our guided missile operation will be sent to you on request. If you are interested in guided missiles, this book is bound to interest you. Write for it today.

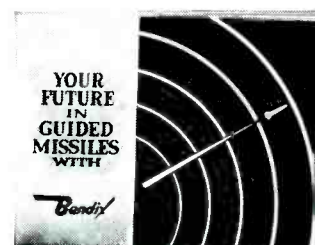

TO THE FINE ENGINEERING MIND
SEEKING THE CHALLENGING PROJECTS IN

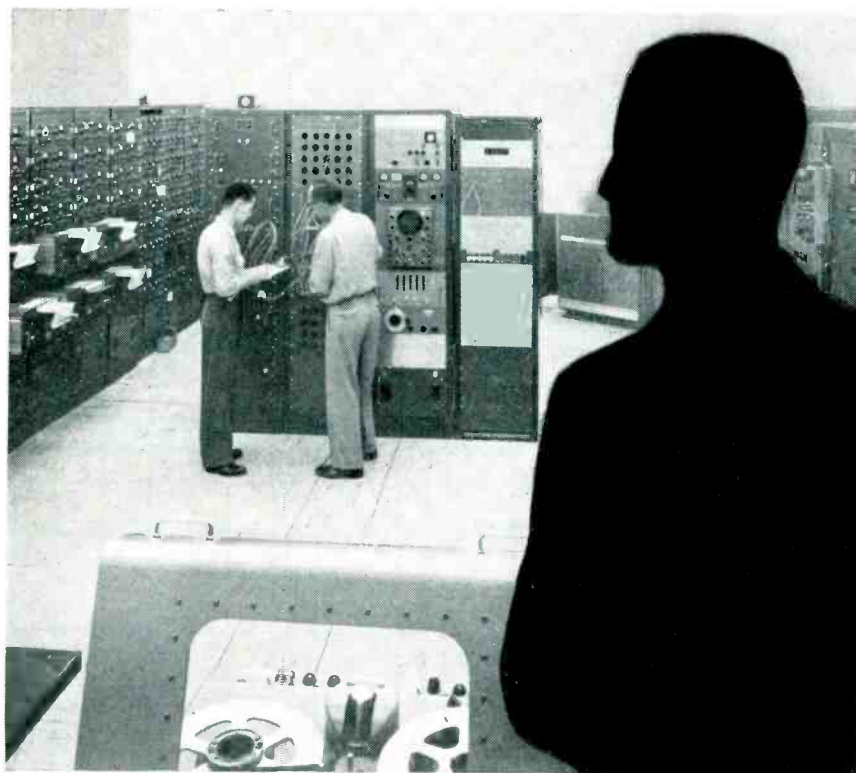

MISSILE TEST

Fine career opportunities in Southern California and Florida exist now within our expanding Convair Engineering Department for engineers experienced in these areas of missile field test operations:

ELECTRONICS ENGINEERS experienced in the installation, check-out and operation of missile guidance systems; installation, check-out, operation and maintenance of ground line and airborne telemetering equipment.

PROPULSION ENGINEERS with experience in liquid rocket engine installation, check-out, operation and maintenance.

HYDRAULICS AND PNEUMATICS ENGINEERS with experience in hydraulic and pneumatic missile control systems (experience in handling liquefied gases advantageous).

CONVAIR offers you an imaginative, explorative, energetic engineering department... truly the "engineer's" engineering department to challenge your mind, your skills, your abilities in solving the complex problems of vital, new, long-range programs. You will find salaries, facilities, engineering policies, educational opportunities and personal advantages excellent.

Generous travel allowances to engineers who are accepted. Write at once enclosing full resume to:

H. T. Brooks, Engineering Personnel, Dept. 906

CONVAIR

A Division of General Dynamics Corporation

3302 PACIFIC HIGHWAY

SAN DIEGO, CALIFORNIA

CORNELL AERONAUTICAL LABORATORY NEEDS

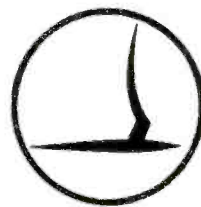

ELECTRONIC ENGINEERS

You can work in the stimulating atmosphere of an applied research and development laboratory where ideas are important, initiative is encouraged and associates are competent. The project areas listed below are typical of our extensive electronics interest; a complete list would include almost every branch of modern electronics.

We are interested in men of all levels with sound training, imagination and potential, regardless of their specialty. B.S. degree and experience required; advanced degree with experience to back it up is even better.

- Communications
- Dynamic Control Systems
- Aircraft Instrumentation
- Radar
- Computers
- Electrical Measurements
- Varied Electronic Circuits
- Servo-Mechanisms
- Missile Guidance
- Microwave

If you are interested in working at your maximum professional level in an organization that combines the most desirable elements of academic and industrial research and development, we invite you to communicate with our Employment Manager.

Hospitalization, surgery; group life, sickness, accident and retirement insurance is available with most of the cost paid by the Laboratory. Salaries are comparable with industry. Merit reviews occur semi-yearly assuring recognition of work well done and expediting advancement. Other personnel policies are very liberal, such as our self-sponsored internal research program. Graduate study at University of Buffalo is encouraged through generous tuition refund program.

CORNELL AERONAUTICAL LABORATORY

Buffalo 21, New York

wholly owned by Cornell University

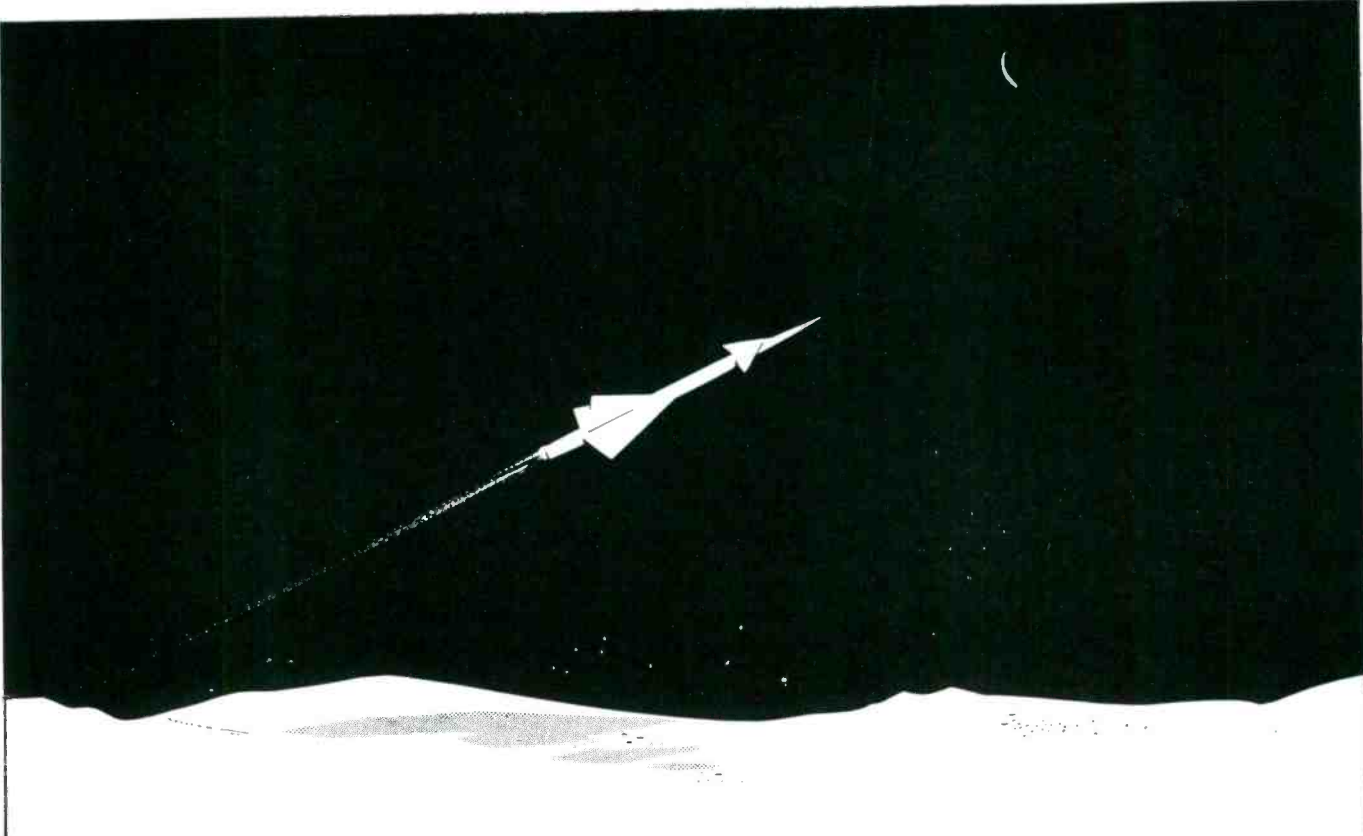

OPPORTUNITY (ɔp' ɔr-tū'nī-tī)

... a time or place favorable for
executing a purpose (Webster)

Opportunity rings clearly at Goodyear Aircraft. Almost from the moment a shadow on the sands of Kitty Hawk startled the world, we've been making visions come true. Engineers with ability and imagination are invited to help us continue the Goodyear tradition of thinking and doing. Opportunities await qualified personnel in research, design, development, and product engineering in these fields:

- ELECTRO-MECHANICAL
- MICROWAVE
- SERVOMECHANISMS
- ELECTRONIC PACKAGING
- WEAPON SYSTEMS
- PULSE TECHNIQUES
- ANTENNA DESIGN
- MINIATURIZATION

Send a resume or write for application forms to

C. G. Jones, Salary Personnel Department

Goodyear Aircraft Corporation

1210 Massillon Road



Akron 15, Ohio

UNIVAC

The FIRST Name

in Complete Electronic Computing Systems

As the UNIVAC takes its place in more and more industries, REMINGTON RAND has greatly expanded its research and development work in order to continue its leadership in electronic computing equipment.

There are many positions recently opened at all levels in all phases of research, design, developments, and application of computing and allied equipment. Even though your training and experience may not be connected with computers, we are willing in many cases to provide the necessary training. Individual cases can be evaluated during interview.

- System Studies
- Logical Design
- New Components
- Solid State Physics
- Semi-conductors
- Magnetic Materials
- Storage Techniques
- Circuit Design
- Pulse Techniques
- Input-Output Devices
- Product Design
- Test Equipment Design
- Computer Development and Design
- High Speed Electro-Mechanical Devices
- System Test and Maintenance

The rapidly expanding engineering program has created many permanent positions paying excellent salaries. These positions offer personal challenge as well as outstanding opportunities for professional development. The possibilities for graduate study in this area are excellent and the company has a liberal plan for reimbursement of tuition expenses. Other company benefits include retirement and group insurance.

Replies Kept Strictly Confidential

FOR INTERVIEW, WRITE TO

Remington Rand

ECKERT-MAUCHLY DIVISION

2300 West Allegheny Ave.

Philadelphia 29, Pa.

Engineers . . .

CAREER OPPORTUNITIES

Expanding design, development and research programs for jet engine controls and other engine accessories will create several ground-floor openings for recent graduate engineers with the Chandler-Evens Division of the Niles-Bement-Pond Company, an important aircraft engine accessory manufacturer located in West Hartford, Connecticut.

These interesting openings will entail analytical and development work on problems of hydromechanical servo devices, mechanical computing systems, fluid metering components, and pneumatic and electronic systems.

Prefer recent graduates with Bachelor's or advanced degrees in either Electrical or Mechanical Engineering or Physics. In addition, should have an interest in problems involving closed loop control or servo theory, analogue computers, or fluid mechanics.

PROJECT ENGINEERS

(Experienced)

To set up and perform system analysis by use of analogue computer equipment. Must have background of servo theory required for dynamic analysis of feedback control systems as applied to Turbojet or Turboprop engines.

PROJECT ENGINEERS

(Experienced)

Execute design and performance analysis for steady state and transient conditions. Require should background in fluid mechanics to work on hydraulic control development and fuel systems for Turbojet Engines.

Excellent working conditions. Ideal suburban location for working and living. Send resume of education, experience, and salary requirements to

Personnel Department

NILES-BEMENT-POND COMPANY

Pratt and Whitney—Chandler-Evens Divisions

West Hartford Connecticut

ELECTRONIC ENGINEERS

Unique opportunity to get in on ground floor of young successful company applying atomic energy to industrial uses (non-government).

Graduate engineers are needed in two major functions: sales and applications engineering, and development and design engineering.

Rapid expansion of company offers promotion opportunities found in few organizations. Only men with top academic and work records who desire and are capable of hard work and rapid promotion will be considered.

INDUSTRIAL NUCLEONICS CORP.
1205 Chesapeake Ave. Columbus 12, Ohio

A leader in Nuclear Instrumentation and Automation Equipment.

EXPAND YOUR HORIZON!

ELECTRONIC ENGINEERS
ELECTRONIC PHYSICISTS

*Bendix Radio has new,
exceptional opportunities for advancement
while working on:*

RADAR
MISSILE GUIDANCE
AIRBORNE COMMUNICATIONS
MOBILE COMMUNICATIONS
AUTO RADIO

Expand the horizon of your future with Bendix Radio—a leader & pioneer in the electronics field, one that has the knowledge, strength and resources to stay out front during the competitive days ahead! Your part is EASY! Wire, phone, write . . . or send us a post card. Simply state your name, address and phone number, your education and experience. We'll carry the ball from there! All replies held in strictest confidence, and we guarantee speedy action!

*Address: Mr. L. H. Naggle
Dept. J
Bendix Radio
Baltimore 4, Md.
Phone: VAlley 3-2200*

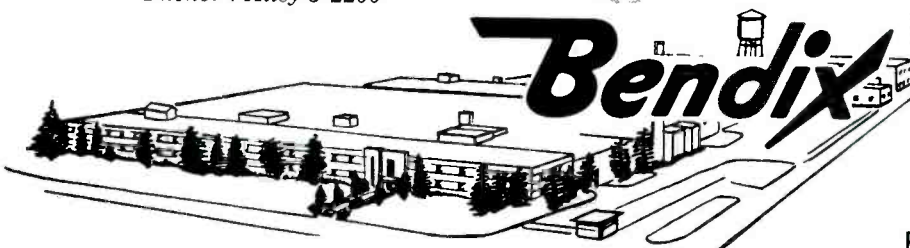

Bendix Radio

DIVISION OF
BENDIX AVIATION
CORPORATION

Baltimore 4, Maryland

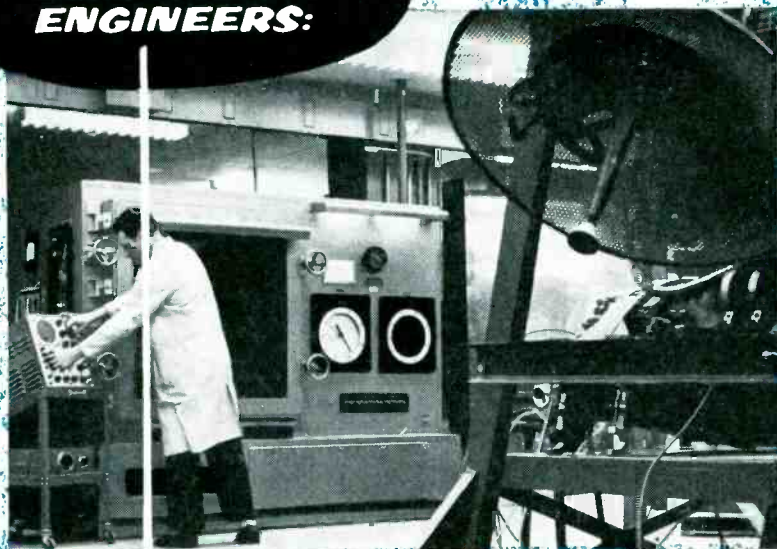
ELECTRONIC ENGINEERS:

READ WHAT HAPPENED WHEN WE PUT OURSELVES IN THE "ENVIRONMENTAL TEST CHAMBER"

Both the Electronics and the Air Arm Divisions of the Westinghouse Electric Corporation are expanding. We need experienced electronic engineers for advanced design and development work . . . so we put ourselves in the "environmental test chamber" to see just what we have to offer the people we need.

We found that we have a professional atmosphere that is ideal for the engineer. We offer advanced study at company expense and merit promotions that assure a good future.

Our income and benefit advantages scored high on this test, too. Finally, there were many "extras," like the Westinghouse Patent Award Program, that make investigation of the current openings worthwhile for all electronic engineers.

APPLY NOW-

Openings exist in the fields of—

COMMUNICATIONS
(Microwave)
FIRE CONTROL
RADAR
COMPUTERS

BOMBER DEFENSE
MISSILE GUIDANCE
FIELD ENGINEERING
TECHNICAL WRITING

TO APPLY-

Send resume outlining education and experience to:

Employment Supervisor
Dept. 156
Westinghouse Electric Corporation
2519 Wilkens Avenue
Baltimore 3, Md.

ENGINEERS

LONG-RANGE,
CONTINUING
OPPORTUNITY
FOR
ELECTRICAL
AND
MECHANICAL

ENGINEERS

AT

Bendix

OPENINGS EXIST FOR—

COMPUTER ENGINEER

Requiring an engineering degree in electrical engineering or math and physics, plus a minimum of three years of computer activity. To handle programming in the simulation and study of jet and reciprocating engine fuel systems. Problems involved would be linear and non-linear in nature and applied to product design as well as research into basic phenomena. No maintenance ability necessary.

**MAGNETIC AMPLIFIER
SYSTEMS ENGINEER**

Electrical engineer supervisory capacity on research and development of magnetic amplifier circuitry, control systems, and component design and testing, supervising other engineers and technicians.

**LIQUID PROPELLANT
ROCKET CONTROLS
ENGINEER**

Mechanical or electrical engineer to supervise the research and development of liquid propellant rocket controls, systems design, component design, development, and testing.

The salary of these positions will be determined by your ability and experience.

Send detailed resume listing education, engineering experience, and salary requirements to:

Technical Employment Department
Box 255-E

Bendix Products Division of
Bendix Aviation Corporation

401 Bendix Drive
South Bend 20, Indiana

We guarantee you an immediate reply.

Lockheed antenna program offers wide range of assignments

Airborne Antenna Design is one of the fastest-growing areas of endeavor at Lockheed. Advanced development projects include work on stub, slot, reflector-type, horn and various dipole antennas.

These diverse antenna activities reflect the full scope of Lockheed's expanding development and production program. For with 13 models of aircraft already in production and the largest development program in the company's history underway, the work of Lockheed Antenna Designers covers virtually the entire spectrum of aircraft, commercial and military.

Lockheed's expanding antenna development has created a number of new positions on all levels for qualified antenna designers. Those interested are invited to write E. W. Des Lauriers, Dept. A-9-6.

Research Specialist Edward Lovick (right) discusses application of experimental slot antenna in the vertical stabilizer of a high-speed aircraft with Electronics Research Engineer Fred R. Zboril and Electronics Research Engineer Irving Alne.

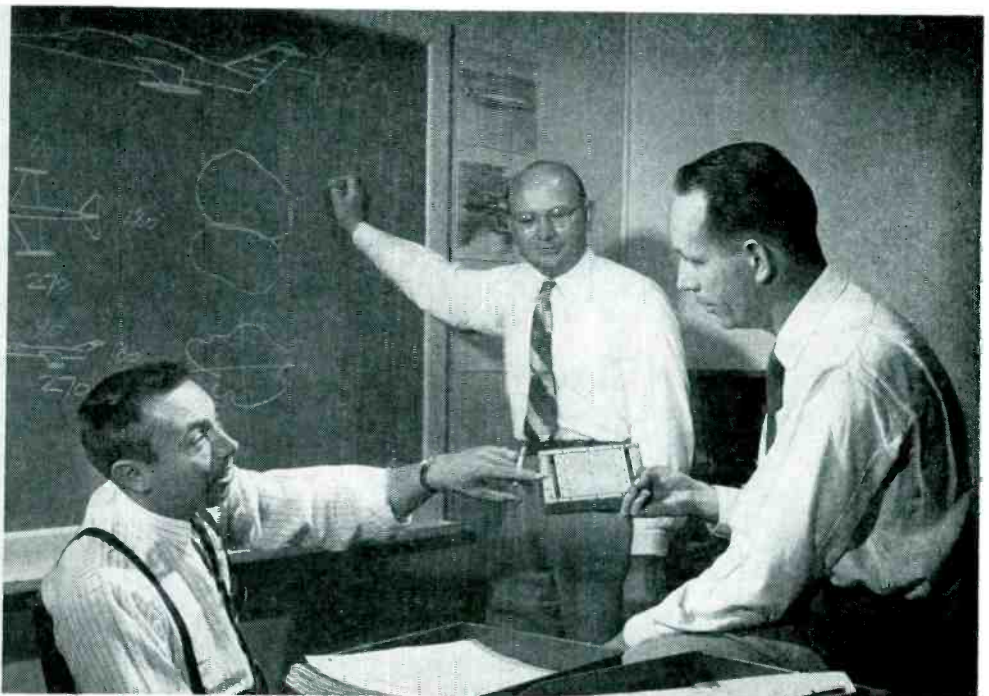

Lockheed increases engineers' salaries

Salaries, rate ranges and overtime benefits have been increased. In addition, employe benefits add up to approximately 14% of each engineer's salary in the form of insurance, retirement pension, etc.

Generous travel and moving allowances enable you and your family to join Lockheed at virtually no expense to yourself.

An address by Edward Lovick on "An Electronic Square-Rooter and Pattern Integrator for use with Antenna Range Systems" is available to interested engineers. Address inquiries to Mr. Lovick.

Lockheed AIRCRAFT CORPORATION

CALIFORNIA DIVISION • BURBANK **California**

CHOOSE A CAREER OF

Achievement
WITH

Admiral

OPPORTUNITIES that offer stability and an assured future. You will work with the most modern electronic equipment and a staff of engineers who are leaders in the field.

To qualify, you must have had previous experience in design and development of communications equipment. Men selected will be given intermediate or advanced level assignments in either a TV, radio or government equipment lab. Positions available for engineers with the following backgrounds:

★ TEST EQUIPMENT

Design of electronic test equipment and associated circuits for TV receivers and government electronic equipment.

★ UHF COMMUNICATIONS

Applied development and design of military communications apparatus for both transmitters and receivers.

★ RADAR INDICATOR SYSTEMS

Development and design to include fire control equipment in the microwave region.

★ TELEVISION SYSTEMS AND COMPONENTS

HV Transformers, coils, amplifiers, deflection yokes and tuners as applied to color and monochrome TV

★ RESEARCH AND DEVELOPMENT

Engineers with ability to apply fundamental principles of engineering to solving original problems of more than average technical difficulty related to communications projects.

To aid our engineers in their progress, Admiral also provides financial support for advanced education as well as other liberal employee benefits. You will have the opportunity to qualify for excellent salaries commensurate with your ability and experience.

Please forward complete resume to Mr. W. A. Wecker, Personnel Division

Admiral Corporation

3800 W. Cortland St.
Chicago 47, Illinois

**DEVELOPMENT &
FIELD SYSTEMS
ENGINEERS**

- ANTENNA
- RADIO COMMUNICATIONS
- RADAR
- MICROWAVE
- NAVIGATIONAL AIDS
- TERMINAL EQUIPMENT
- TELETYPE

With a progressive, expanding, well established corporation. Interviews will be arranged for qualified applicants. Send complete biographical resume, experience and education to

Mr. J. E. Richardson
Personnel Director

MARYLAND ELECTRONIC MFG. CORP.
5009 Calvert Road
College Park 9, Maryland

**Electrical Engineers
and Physicists**

- Radar Simulation
- Advanced Circuitry
- Analog Computers
- Ballistics
- Mapping
- Telemetry

Senior and Junior Engineers

**A Job with
Good "Contacts"**

We offer you the opportunity to come in contact with an entire project, not with just a segment of the overall job. Here is your chance to join a firm with a future . . . to grow with us . . . to gain individual recognition by working closely with technical management. You will live and work in a delightful suburban community . . . associate with other top-notch engineers. If you are looking for a job with *good contacts*, write:

Industrial Research Laboratories

Division of Aeronca Manufacturing Corp.
Dept. A-6, Hilltop & Frederick Rds.
Baltimore 28, Maryland

Planning a New England vacation?

Visit Raytheon

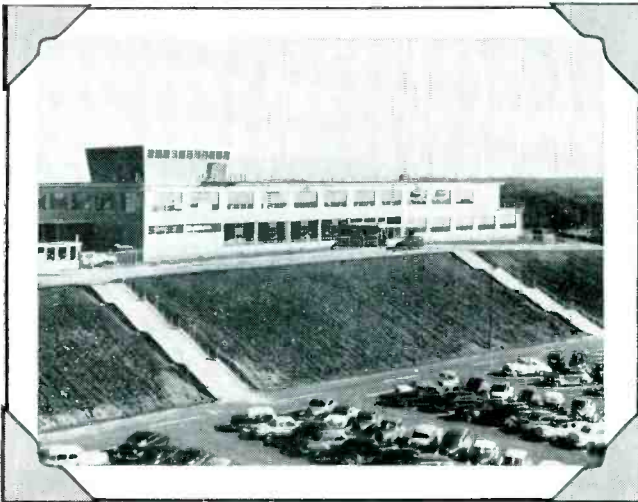

Raytheon Missile and Radar Division's new laboratory next to Hanscom Air Force Base, Bedford, Mass. Another engineering facility nears completion at Wayland, Mass.



Following your visit with us, be our guest for lunch or dinner at the picturesque Wayside Inn, South Sudbury, Mass., immortalized by Henry Wadsworth Longfellow.

If you vacation in New England this summer, we'd like to have you pay us a visit to talk over the interesting things we are doing and see how you might fit into our progressive engineering set-up. You will see some of our engineering and test facilities and your questions will be answered frankly.

Research, development and engineering positions are open in the fields of missiles, radar, communications, semi-conductors, microwave tubes and industrial electronics.

Write for **FREE** map

Visit us at the Administration Building, Willow St., Waltham, Mass. – ask for or telephone L. B. Landall, Professional Personnel Section, Waltham 5-5860, ext. 412. Write him today for simplified map showing you the best routes to Waltham.

You'll find a friendly greeting awaiting you – be sure to drop in and see us.



*Excellence in
Electronics*

RAYTHEON MANUFACTURING COMPANY
Waltham 54, Massachusetts

ENGINEERS

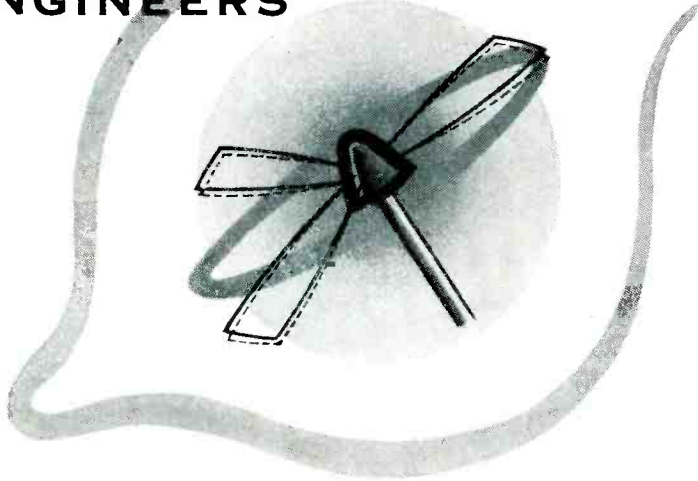

How Would You Like to Tackle this Problem?

To instrument a system for testing propellor blades, measuring to 0.1 degree and 0.1 inch respectively, the angular and lateral deflection of a blade rotating at 8000 rpm — with all equipment OUTSIDE of the wind tunnel.

This is just one example of the wide variety of projects at ECA, and it was accomplished by an ingenious application and modification of a well-known device.

To develop those automatic controls, electronic business machines, digital and analog computers that will best meet the increasing need for automation in business and industry requires engineering skill of the highest order... a well developed professional curiosity... a diversity of personal interests.

Men of this calibre come to ECA — and stay — for more than one reason: there's the freedom which encourages individual approach and initiative, the compensation high on the industrial scale, the stability based on the success of many established commercial products.

And as ECA continues to grow, daily exploring new fields and enlarging its interest in old ones, there's room for more exceptional engineers. Please send full details of your experience and education to Mr. W. F. Davis, Dept. 715.



**ELECTRONICS
CORPORATION
OF AMERICA**

77 Broadway Cambridge 42, Mass.

Bendix needs

**ELECTRONIC
ENGINEERS**

in

SOUTHERN CALIFORNIA

Unusual engineering positions in Radar, Sonar and Telemetry are available at Pacific Division, Bendix Aviation Corporation in North Hollywood, California. These positions, which are directly associated with our long-range projects for industry and for defense, are available at all levels.

Please address inquiries to:

W. C. WALKER

Engineering Employment Manager

Pacific Division
Bendix Aviation Corporation
NORTH HOLLYWOOD, CALIF.

**ENGINEERS
OR
PHYSICISTS**
with
PHOTO-EMISSIVE
EXPERIENCE

Old established firm manufacturing electronic tubes desires services of several engineers or physicists familiar with photo-emissive and photo-conductive devices. Firm is embarking on manufacture of pickup and storage tubes.

Chance to get in at the start of a new operation. Location New England.

State complete qualification, salary desired, citizenship status and references. Reply:

P-5952, Electronics
330 W. 42 St., New York 36, N. Y.

ENGINEERS • *Electronic • Electromechanical*

PHYSICISTS

SALES ENGINEERS

*Enjoy
These Advantages!*

In addition to paid vacations, liberal pension plans and numerous other valuable health and hospitalization benefits for you and your family, we provide cooperative educational aid at one of the many technical schools in the Philadelphia area for qualified applicants who find our center an ideal work-shop in which to secure the desired recognition in their chosen fields.

Your family, too, is important! And, here at Paoli, a delightful suburban community, thirty minutes from Philadelphia, you will find the cultural atmosphere as well as the educational facilities required for your children.

We will pay travel expenses for all applicants invited to visit our NEW Research Center to consider the application of their educational and/or work background to the many challenging problems we are engaged in for industry and the nation's welfare.

If you want the BEST for yourself and your family, consider NOW your qualifications for the openings listed on the right and —

Write **L. E. DICK**, Personnel Manager
BURROUGHS RESEARCH CENTER
Paoli, Pa.

Located on
PHILADELPHIA'S
"MAIN LINE"

Burroughs

Research Center, Paoli, Pa.

Invites You

To Inspect Its Openings on Both
Commercial & Sponsored Projects

If you possess an educational and/or work background in Communications, Data Handling, Electronic, or Electro-Mechanical Business Machines...including such specifics as High Speed Mechanisms, Paper Handling Devices, Magnetic-Tape Transport Mechanisms, Magnetic-Drum or Tape Applications, Radar, Telemetry, Guided Missiles, Process Control Instrumentation, Digital and Analog Computers, Transistor and Magnetic Circuit Design and Analysis, Magnetic Amplifiers, Servo Mechanisms, and Electronic Packaging Design . . .

CONSIDER THESE OPENINGS AS

- **ELECTRICAL ENGINEERS; Junior & Senior**
 - **MECHANICAL ENGINEERS; Junior & Senior**
 - **LOGICAL DESIGNERS ● PHYSICISTS**
 - **PROJECT ENGINEERS**
-
- **SALES ENGINEERS** to sell E-101 electronic desk computers in all sections of the country. Sales & Technical experience in allied lines desirable.

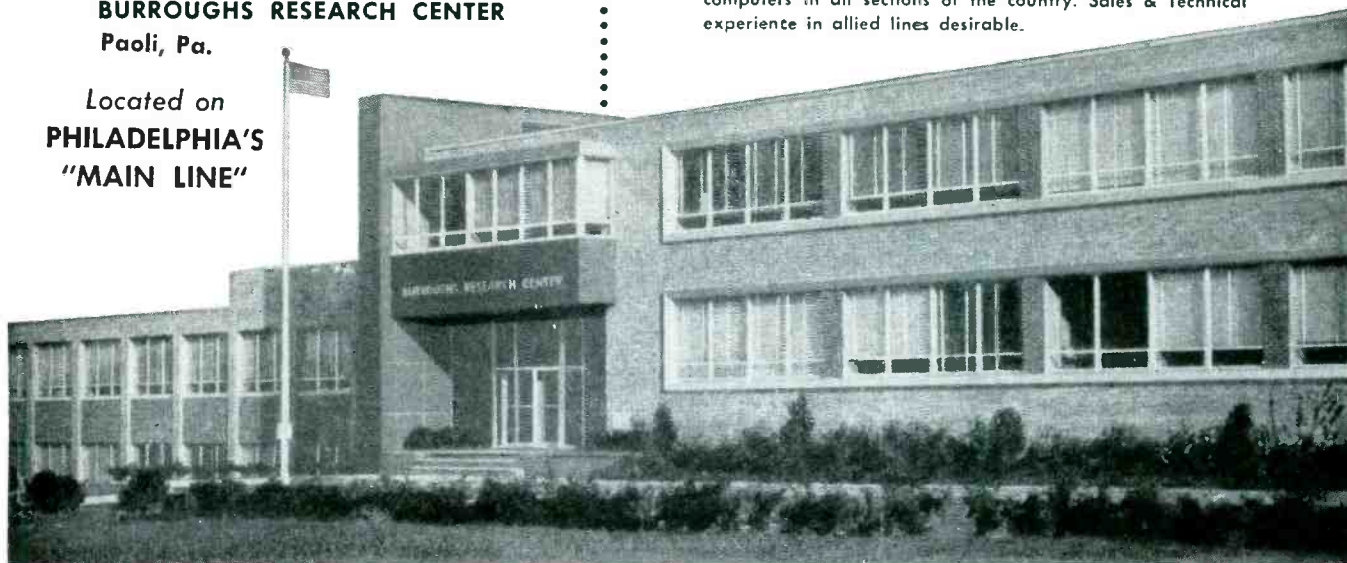

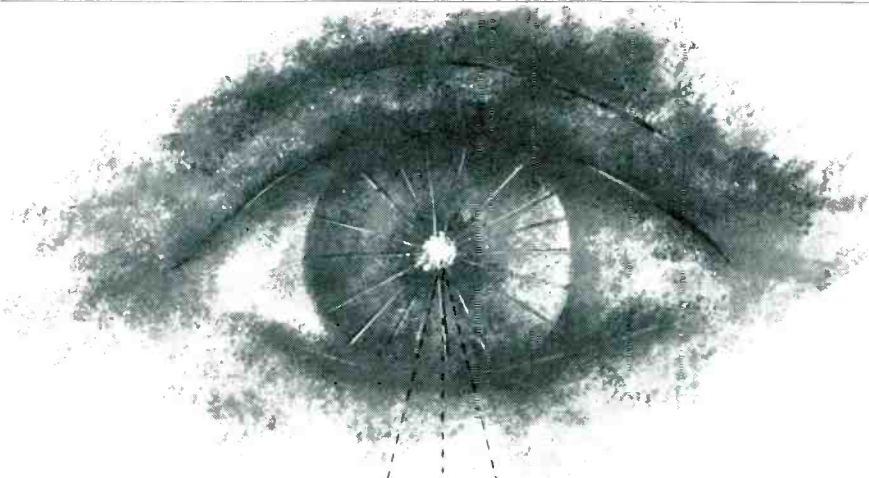

Looking for NEW ELECTRONIC WORLDS to conquer?

Beyond the range of sight lies the vast potential of tomorrow's electronic world. How this new world will affect the scientist, surgeon, farmer, housewife, business man, can only be surmised. But the possibilities are inspiring. The world of the electron is infinite.

Wresting electronic secrets from Nature has been Farnsworth's sole function for over a quarter of a century. Expansive, aggressive diversification into new and challenging fields of activity, implemented by the addition of men with significant capacity for professional growth, marks the direction of the Company's progress. Association with an organization slated for continuing major success can lead to highly satisfying individual responsibility and awards, and result in a stimulating and fruitful career.

To scientists and engineers possessing the professional potential and who are looking ahead to new electronic worlds to conquer, Farnsworth offers worthwhile opportunities in these fields: Pulse Circuitry, Microwave Antennas, Information Theory, Infra-Red Systems and Devices, Mechanical Packaging, Receivers, Optics, Data Recording, Transistor Circuitry, Microwaves, Radar, Electronic Countermeasures, Operations Research, Missile Guidance and Control Systems and Test Equipment.

Farnsworth DIVISION OF IT&T
Address Inquiries to
FARNSWORTH ELECTRONICS CO.,
Technical Employment Dept.
Fort Wayne, Indiana

TECHNICAL REPRESENTATIVES

LEAR, INC. is expanding its top notch Field Service organization to keep pace with increasingly wide-spread military acceptance of LEAR flight control systems and flight reference systems.

Attractive salary, liberal expense arrangements. Assignments may require travel or residence at assigned stations. Company orientation prior to assignment.

Qualifications include:

1. E. E. Degree or equivalent.
2. Knowledge of servomechanisms, gyros, electronics.
3. Tech. Rep. experience.

To Apply, send resume to:
Field Service Manager



LEAR, INC.

110 Ionia Ave., N. W.
Grand Rapids 2, Mich.

ELECTRONIC ENGINEERS

For responsible positions in small, expanding advanced development laboratory. Excellent opportunity for advancement. Experience in the following fields is especially important:

- Television (Flying-spot Scanners)
- Pulse Circuitry
- Digital Coding Systems
- Radar Tracking Equipment
- Electro-mechanical Equipment

Please submit resume, including salary required.

P-6495, Electronics
330 W. 42nd St., New York 36, N. Y.

ENGINEERS FIELD ELECTRONICS

5 yr installation, maintenance, and/or instruction, exp. ECM and/or ground-to-air-navigation ILS, VOR. Ground radar and control—guided missiles.

Dynamic Electronics of New York, Inc.
73-39 Woodhaven Blvd., Glendale, N. Y.
Mr. Schwartz, Illinois 9-7000



**ENGINEERS
PHYSICISTS**

How SYLVANIA Can Help You in the Missiles Field thru its Stability and Diversity

Sylvania has established a Missile Systems Laboratory. New laboratory facilities are nearing completion. This 54 year old company, renowned for its consumer products, and supplying vital "heart" parts to other manufacturers, now brings its research, know-how, stability and diversity to the guided missiles field. Behind this important new Sylvania laboratory stands the versatility, drive and dedication that has seen Sylvania expand to 45 plants and 16 laboratories, while *doubling* its engineering staff and almost tripling sales in the past 6 years.

Permanent positions
are now open in these fields:

ANALYSIS & DESIGN OF
SEARCH RADAR SYSTEMS
ANTENNA THEORY & DESIGN
ANALYSIS OF MISSILE
GUIDANCE SYSTEMS
MATHEMATICAL ANALYSIS &
SYSTEM DESIGN OF FIRE CONTROL
& COMPUTER EQUIPMENT
INERTIAL GUIDANCE OR
INFRA-RED FOR DETECTION
& TRACKING
SERVO SYSTEM
DESIGN & ANALYSIS
AERODYNAMICS
PROPULSION
AIRCRAFT OR MISSILE
STRUCTURES

Relocation and interview expenses will be paid.

Please forward resume to:
Mr. Robert Koller
Supervisor of Professional Placement

missile systems laboratory

 **SYLVANIA**
ELECTRIC PRODUCTS INC.

151 Needham Street, Newton, Massachusetts
(A suburban location just 8 miles from downtown Boston)



ENGINEERING OPPORTUNITIES *for you!*

CONVAIR-Pomona is engaged in development, engineering and production of electronic equipment and complex weapons systems. The Convair-Pomona engineering facility is one of the newest and best equipped laboratories in the country. The work in progress, backed by Convair's outstanding record of achievement, offers excellent opportunities for recent graduates and experienced engineers in the following fields:

**DYNAMICS
AERODYNAMICS
THERMODYNAMICS
OPERATIONS RESEARCH
ELECTRONICS
HYDRAULICS
MECHANICAL DESIGN
LABORATORY TEST ENGINEERING**

Generous travel allowance to engineers who are accepted.

*For further information on Convair and its fields of interest, write at once, enclosing a complete resume to:

Employment Department 3-G



*ENGINEERING
BROCHURE
TO QUALIFIED
APPLICANTS



Convair

A DIVISION OF GENERAL DYNAMICS CORPORATION
POMONA, CALIFORNIA

LINCOLN LABORATORY

MASSACHUSETTS INSTITUTE OF TECHNOLOGY

The Lincoln Laboratory is operated under contract by the Massachusetts Institute of Technology for the Air Force, Navy and Army. The principal task is the development of a system for defense against air attack on continental North America. The work is classified. The Laboratory is housed in new permanent buildings in the town of Lexington, Massachusetts. A member of the M.I.T. family, the Lincoln Laboratory combines academic research with systems and development engineering. Participation in the Laboratory offers association with experienced research men who are leaders in their fields, as well as many opportunities to broaden professional experience, to develop creative ability, and to acquire supervisory responsibilities in research. Salaries closely approximate current industrial levels. Persons with Bachelor's, Master's or Doctor's degrees, regardless of experience, are encouraged to apply.

The Lincoln Laboratory has openings for the following:

PHYSICISTS for

Development and design analysis in radar and communication systems.

Component research and development.

ELECTRICAL ENGINEERS for

Radar and communications circuit design.

Systems engineering, special digital computer design.

Systems engineering, radar installation and maintenance work.

Industrial liaison and production scheduling.

MECHANICAL ENGINEERS for

Development of small primary power plants.

Mechanical and machine design problems.

MATHEMATICIANS for

Analysis of radar and communication data.

Operations analysis for computer applications.

For further information, please write or phone

PERSONNEL DEPARTMENT

LINCOLN LABORATORY

P. O. Box 73

Lexington 73, Massachusetts

WAVE FILTER DESIGN ENGINEER

An excellent opportunity at the senior engineer level, with many job benefits.

Write to

E. A. Gentry, Personnel Manager
Clevite-Brush Development Co.

CLEVITE RESEARCH CENTER

540 East 105th St.
Cleveland 8, Ohio

Division of Clevite Corporation

COMMUNICATIONS ENGINEERS and TECHNICIANS

EXCELLENT SALARIES
MINIMUM PREREQUISITES

ENGINEER EE Graduate with 3 years experience

TECHNICIAN 2 years technical school in communications and 3 years experience.

Require installation adjustment and maintenance experience with communication receivers and associated terminal equipment. Also, men with similar experience with high-powered transmitters, antennas, transmission lines.

Must be willing to travel in United States and Overseas.

Page Communications Engineers, Inc.
710 Fourteenth St., N.W., Washington 5, D.C.

SALES ENGINEERS

We have openings for Sales Engineers in Detroit, Cleveland, and New York

We manufacture industrial instruments and have a complete line of Mechanical and Electronic Recorder & Recorder Controllers

Our resources are second largest in the industrial instrument field and Management is desirous of expanding sales. Excellent opportunities for graduates in Electrical, Mechanical and Chemical Engineering

P-6484, Electronics
330 W. 42nd St., New York 36, N. Y.

Physicists and Engineers

are required for

INDUSTRIAL ATOMIC POWER

PHYSICISTS — in following areas:
Reactor design and analysis, basic reactor physics, shielding problems, instrumentation and control.

ENGINEERS — in following areas:
Response-stability characteristics under transient load conditions, mechanical design of components, thermal and fluid systems analysis, control systems and instrumentation.

WESTINGHOUSE ELECTRIC CORP.
INDUSTRIAL ATOMIC POWER
BOX 355 • PITTSBURGH 30, PA.

ELECTRONIC ENGINEERS

Research & Development
Physicists - Engineers
(SENIORS)

Experienced in research and development of various radar systems including: beacons, missile guidance and counter measures. Advanced training in applied mathematics, noise theory and probability analysis desirable. EE degree or equivalent required.

FIELD ENGINEERS (SENIORS)

Local & Field Assignments

Must have EE degree, with 3-5 years experience in one of the following:

- Flight Simulators
- Radar & Sonar Trainers
- Fire Control Radar
- Electronic installation and maintenance.

• EQUIPMENT ENGINEERS

3-5 years experience with at least 3 years in circuit packaging. EE degree with mechanical background.

• APPLICATION ENGINEERS

5-10 years experience on coil and transformer development.

Salary and advancement commensurate with ability; liberal vacation, sick leave, 9 paid holidays, group life, sickness and accident insurance plans, and a worthwhile pension system.

**STAVID
Engineering, Inc.**

U. S. Highway 22, Watchung, P. O.
Plainfield, N. J.—PLainfield 7-1600

OPPORTUNITY FOR

ELECTRONIC ENGINEERS *and* ELECTRONIC TECHNICIANS

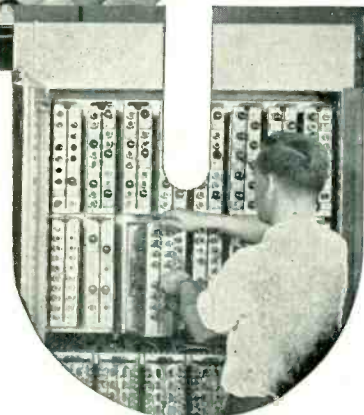
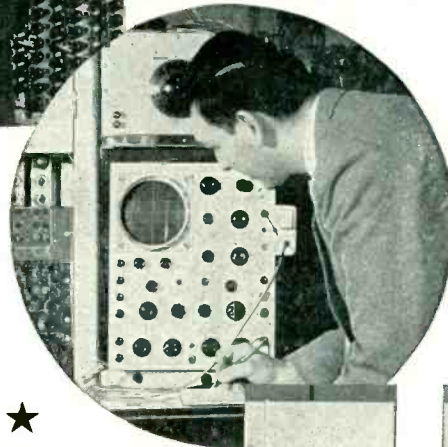

These are
PERMANENT
Positions with a
leader in the dynamic
field of
**ELECTRONIC
COMPUTERS**

Your best chance for increasing responsibility and rapid advancement in the electronic field is in the challenging field service work associated with digital computers. *Computer experience is not necessary.* You will receive extensive training in computer logic and circuitry and specialized training on specific computers. Good salaries start with the training period. After training you will be assigned to one of our large computer installations in continental United States. You will enjoy liberal travel allowances and other employee benefits.

The practical knowledge of computers obtained from actual experience at field installations will aid you greatly in advancement.

Minimum qualifications for
ELECTRONIC ENGINEERS
Bachelor Degree—2 years
electronic experience

Minimum qualifications for
ELECTRONIC TECHNICIANS
High school plus electronic school
(armed forces acceptable)
and four years electronic experience

For further information regarding our computers and training programs, send a brief resumé of your education and experience to Mr. R. A. Nelson, Employment Manager. Interviews at our expense by arrangement. All contacts are held in strict confidence.

Remington Rand

ENGINEERING RESEARCH ASSOCIATES DIVISION
1890 W. MINNEHAHA AVENUE • ST. PAUL W4, MINNESOTA

LET'S FACE IT...

there are thousands of engineering positions open today... *but—*

CROSLEY

DIVISION



✓ New engineering groups being established offering unusual opportunities *NOW* . . . "on the ground floor."

✓ Greater advancement opportunities assured by the continued expansion of this young, vibrant engineering organization.

PRESENT REQUIREMENTS*

Electronics and Mechanical Engineers, Physicists and Mathematicians:

- Advanced Research
- Research
- Project
- Advanced Design
- Senior Design
- Design
- Junior

CROSLEY ENGINEERING GROWTH IN PERSONNEL

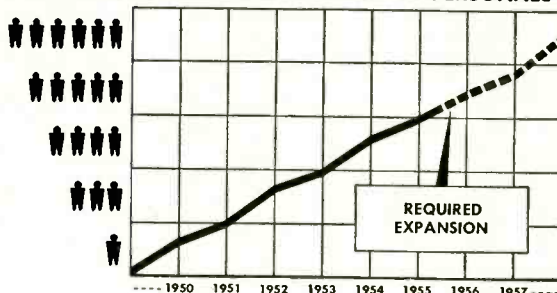

SOME OF THE FIELDS OF INTEREST TO CROSLEY:

Radar — Servo-mechanisms — Fire Control — Digital Circuitry — Navigation — Communications — Countermeasures — Missile Guidance — Microwave Design — Telemetry

SUBSTANTIAL BENEFITS AVAILABLE TO YOU:

Excellent salaries, fully equipped modern laboratories, paid vacations and holidays, subsidized university educational program, group insurance program for you and your family, retirement plan and adequate housing in desirable residential areas.

Investigate these opportunities by sending resume to:

*U. S. Citizenship required

DIRECTOR OF ENGINEERING
Government Products — Crosley Division,
AVCO Manufacturing Corporation
Cincinnati 15, Ohio

EMPLOYMENT PROBLEM?

When you are in need of specialized men for specialized jobs, contact them through an employment ad in a McGraw-Hill Publication.

Management, Engineering, Production, Maintenance, Selling . . . these represent broadly the principal functions in business and industry. And it is principally to the men and executives who fill key jobs in these important divisions that McGraw-Hill publications are directed.

McGraw-Hill Domestic Publications

- AMERICAN MACHINIST
- AVIATION WEEK
- BUS TRANSPORTATION
- BUSINESS WEEK
- CHEMICAL ENGINEERING
- CHEMICAL WEEK
- COAL AGE
- CONTROL ENGINEERING
- CONSTRUCTION METHODS AND EQUIPMENT
- ELECTRICAL CONSTRUCTION AND MAINTENANCE
- ELECTRICAL MERCHANDISING
- ELECTRICAL WHOLESALING
- ELECTRICAL WORLD
- ELECTRONICS
- ENGINEERING AND MINING JOURNAL
- ENGINEERING NEWS-RECORD
- FACTORY MANAGEMENT AND MAINTENANCE
- FLEET OWNER
- FOOD ENGINEERING
- NATIONAL PETROLEUM NEWS
- NUCLEONICS
- PETROLEUM PROCESSING
- POWER
- PRODUCT ENGINEERING
- TEXTILE WORLD

THE MEN YOU NEED ARE THE MEN WHO READ THE

McGraw-Hill Publications

330 West 42nd St.,
 New York 36, N. Y.



OFFERS OUTSTANDING OPPORTUNITIES IN FIELD ENGINEERING

E E graduates or equivalent with field experience in radar will find unequalled opportunities for professional advancement with Raytheon — a world leader in electronics. Foreign and domestic assignments. Excellent salaries. Liberal allowances.

Write

RAYTHEON
GOVERNMENT FIELD ENGINEERING
WALTHAM 54, MASS.

SPECIFICATIONS ENGINEER

- with experience in electro-mechanical drafting and designing in the military field.
- consult with company engineers and recommend standard government approved components for military designs.

*work with one of the finest
laboratories in America*

Clevite-Brush Development Co.

CLEVITE RESEARCH CENTER

540 East 105th St.
Cleveland 8, Ohio

Division of Clevite Corporation

ELECTRICAL ENGINEERS

To work on engineering problems in development of new Regulated AC and DC supplies, transistors, semi-conductor circuitry and magnetic amplifiers. B.E.E. or BS with physics or math major, plus some allied experience.

SORENSEN & COMPANY, INC.
375 Fairfield Avenue Stamford, Conn.

At Your Service . . .

The Searchlight Section is at your service for bringing business needs or "opportunities" to the attention of men associated in executive, management, sales and responsible technical, engineering and operating capacities with the industries served by McGraw-Hill publications.

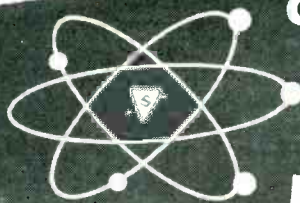

**OPPORTUNITY
DIVERSITY
EXPANSION**

SPEEDY PATHS TO SUCCESS FOR MEN OF TALENT AT SYLVANIA

Career positions with
ELECTRONIC SYSTEMS DIVISION

Between 1947 and 1953, the electronics industry grew 21% . . . Sylvania grew 32%.

That is why Sylvania today offers important paths to quick success for men of talent.

Here, individual achievement is swiftly recognized and rewarded, as witness the fact that the average age of top level executives is only 45. In this stimulating Sylvania atmosphere, original thinkers can and do go far.

BOSTON Laboratory

Majors in E.E., M.E.,
Math, Physics. Research
& Development experi-
ence in —

Countermeasures
Systems Analysis
Transistor Applications
Noise Studies
Antenna Res. & Dev.
Systems Development
Mechanical Design
Miniaturization
Digital Computer
Circuits & Systems
Circuit Design
Shock & Vibration
Technical Writing
Missile Analysis

BUFFALO Engineering

Majors in E.E., M.E.,
or Physics. Experience
in Product Design and
Advanced Develop-
ment in —

Circuit Design
Systems Development
Pulse Techniques
F.M. Techniques
Equipment Specifications
Components
Microwave Applications
Servo Mechanisms
Subminiaturization
Mechanical Design
Shock & Vibration
Heat Transfer

INTERVIEW AND RELOCATION EXPENSES WILL BE PAID BY SYLVANIA

Sylvania provides financial support for advanced education as well as liberal insurance, pension and medical programs.

Please forward resume to:

Professional Placement Supervisor

SYLVANIA ELECTRIC PRODUCTS INC.

Thomas A. Tierney | Randall A. Kenyon
100 First St. | 175 Great Arrow Ave.
Waltham, Mass. | Buffalo 7, N. Y.

SYLVANIA

SYLVANIA ELECTRIC PRODUCTS INC.

Your inquiries will be answered within two weeks

ENGINEERS

for immediate placement

ENGINEERING AT NCR:

1. Immediate, permanent positions in Mechanical and Electrical Engineering Divisions.
2. Engineering project work involving design and development of mechanical, electronic, electromechanical devices, and electronic data processing equipment in Business Machine applications.
3. Some experience in development, design, and application of high-speed, light-weight mechanisms of the intermittent motion type is desirable.
4. Openings also for Mechanical and Electrical personnel for writing technical and application literature describing newly-developed machines.
5. Ample training and indoctrination is available to all employees.

ACT AT ONCE—Send resume of your education and experience to: **EMPLOYMENT DEPARTMENT, TECHNICAL PROCUREMENT SECTION**

THE NATIONAL CASH REGISTER COMPANY

Dayton 9, Ohio

**ELECTRONIC ENGINEERS
ELECTRICAL ENGINEERS
MECHANICAL ENGINEERS
MECHANICAL DRAFTSMEN**

AS AN NCR ENGINEER you, with your family, will enjoy:

1. **UNLIMITED OPPORTUNITY** in the broad, ever-expanding field of Business Machine Engineering.
2. **AN EXCELLENT SALARY**, plus exceptional benefits of life-time value for you and your family.
3. **A RECREATIONAL PROGRAM** for year-round enjoyment of the entire family including a new Country Club with 36 holes of golf, and a 166-acres park for outings with swimming, boating, and supervised play for the children.
4. **LIVING IN DAYTON . . .** considered one of the cleanest and most attractive cities in the Midwest with outstanding school facilities.
5. **YOUR WORK AT NCR** with its friendly, family atmosphere, with its employee morale at a very high level, and with people who, like yourself, have decided to build their professional future with NCR.

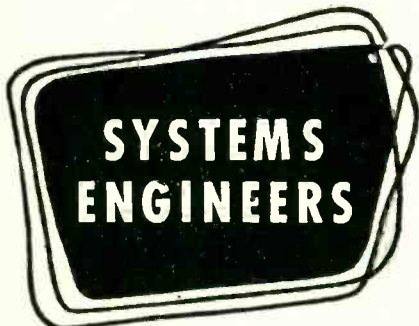

PERMANENT ASSIGNMENTS

IN THE FIELD OF **MILITARY WEAPONS SYSTEMS**

- Missiles
- Reliability Studies
- Fire Control
- Radar
- Sonar
- Underwater Ordnance

REAL CAREER OPPORTUNITIES

You'll enjoy the advantages of a small company atmosphere in the Silver Spring Laboratory . . . along with the stability of being part of the rapidly growing Vitro Corporation of America with 5 diversified operations throughout the United States.

- Suburban Location in residential community adjacent to Washington, D. C.
- Plentiful housing—modern apartments, houses to rent or buy
- Advanced courses available at 4 major universities
- Cultural advantages of the nation's capitol

Similar opportunities also available at West Orange, N. J. and Eglin Field, Florida Laboratories

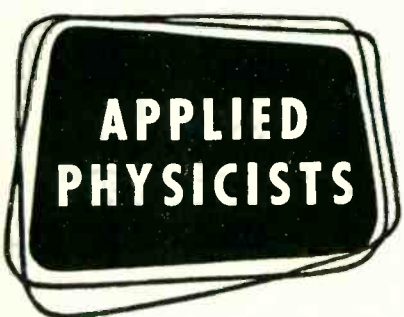

Write to Personnel Manager

VITRO LABORATORIES

962 WAYNE AVE.

SILVER SPRING, MD.



Attention . . .

EMPLOYMENT ADVERTISERS

Effective with the July issue, a new section will start in **ELECTRONICS**. We will head this section: **EMPLOYMENT OPPORTUNITIES**. All Displayed Employment Opportunity advertising will be placed in this new section, with the exception of those advertisers who contract for run-of-book position. Advertisements in the **EMPLOYMENT OPPORTUNITIES** section will be billed at the new open rate of \$21.50 per inch. Contract rates furnished on request. Advertisements are subject to Agency Commission.

For full information write:

ELECTRONICS

CLASSIFIED ADVERTISING
330 West 42nd St.,
New York 36, N. Y.

GENERAL ELECTRIC

**PLANS
FAR INTO THE FUTURE**

The development of new technologies at General Electric has opened the door on a program of advanced electronics work requiring the skills of top engineers and physicists. To engineers this means long-range, continuing opportunity enabling them to build a solid future as they enjoy the vast facilities, stimulating challenges and many incentives and rewards offered by General Electric.

ENGINEERS PHYSICISTS

*Positions available
in the following fields:*

**Advanced Development, Design, Field Service
and Technical Writing in connection with:**

**MILITARY RADIO & RADAR
MULTIPLEX MICROWAVE
MOBILE COMMUNICATION
COMMUNICATIONS
ELECTRONIC COMPONENTS
TELEVISION, TUBES & ANTENNAS**

Bachelor's or advanced degrees in
Electrical or Mechanical Engineering,
Physics, and experience in
electronics industry necessary.

Please send resume to: Dept. 6-5-E, Technical Personnel

GENERAL ELECTRIC

Electronics Park, Syracuse, N. Y.

Engineers

June is
Busting out
all over . . .

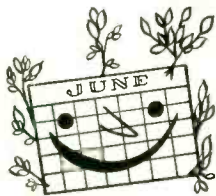

And opportunities are busting
out all over, too,

at the
**NEW EXPANDING
ELECTRONIC TUBE DIVISION OF**

Westinghouse

in Elmira, N. Y.

. . . . Opportunities to advance in your profession
. . . . to receive recognition for your creative talents
. . . . to have a secure financial future.

Openings for:

DESIGN, DEVELOPMENT, and APPLICATION ENGINEERS: Receiving, image orthicon or vidicon tubes; solid state devices.

MICROWAVE TUBE DESIGN ENGINEERS: 2 or more years experience, for designing magnetrons, traveling-wave tubes, TR and ATR tubes, reference cavities, etc.

Above openings are for Engrs and Physicists with Bachelor's, Master's or Doctor's degree. Also:

ELECTRICAL ENGRS for Equipment design: Designing, costing & guiding construction of processing and testing equipment, e.g. atmosphere furnaces, electrical welders, induction heaters, X-ray sequencing & test units, wave-guide apparatus, transistor life test units.

MANUFACTURING ENGINEERS: Electrical & Mechanical Engrs. and Physicists, to work on micro-wave, image orthicon, & other tube types. Exp. in these fields desirable, not mandatory.

Interviews in your area, or travel expenses paid for interviews in Elmira. Send resume:

WESTINGHOUSE ELECTRIC CORP.
Electronic Tube Div., Elmira, N. Y.

ENGINEERS

DESIGNERS-DRAFTSMEN

Electronic

Mechanical

What's *NEW* at Melpar

NEW laboratories

NEW opportunities

NEW projects

Melpar has just opened its new plant at Falls Church, Virginia, in a beautiful suburban location. We have also moved to larger quarters at Watertown, Mass., and opened a new research department at Cambridge, Mass.

Melpar's continued expansion offers new career opportunities for individual growth and recognition. Men of vision and imagination who plan for the future are quick to sense the potential with this growing, dynamic organization.

Continued leadership in electronic research and development is reflected in our current group of projects with long-range military and industrial application.

- Network Theory
- Systems Evaluation
- Automation
- Microwave Technique
- UHF, VHF or SHF Receivers
- Analog Computers
- Digital Computers
- Magnetic Tape Handling Equipment
- Quality Control & Test Engineers
- Radar & Countermeasures
- Packaging Electronic Equipment
- Pulse Circuitry
- Microwave Filters
- Flight Simulators
- Servomechanisms
- Subminiaturization
- Electro-Mechanical Design

*For personal interview send resume to
Technical Personnel Representative,*



melpar, inc.

Subsidiary of Westinghouse Air Brake Co.

3000 Arlington Blvd., Dept. E-18
Falls Church, Virginia
or 11 Galen St., Watertown, Mass.

CIRCUIT ENGINEERS

Why Not Work in Vacationland?

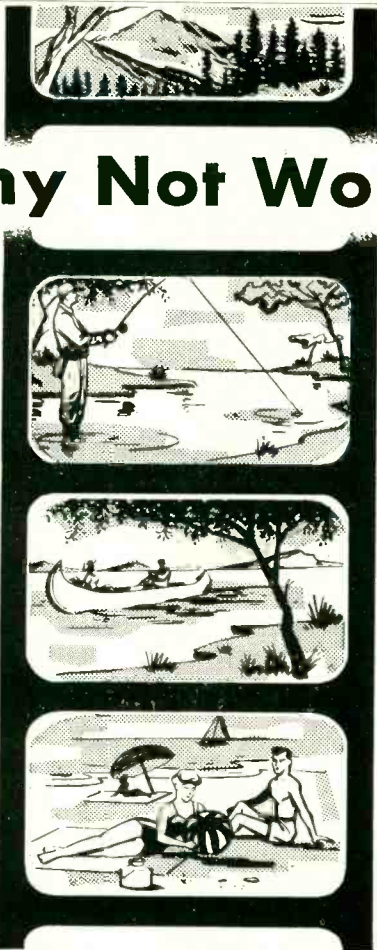

One of the many advantages in working for Sanders Associates, Inc. is the site of the plant itself: Nashua in lovely New Hampshire, New England's most beautiful state. Less than one hour from both the White and Monadnock Mountains, with cool streams, crystal lakes, lush green foliage, Nashua's many natural recreational facilities abound. Or, if you prefer the surf and the sea, you're less than one hour from world-famous Hampton and Rye Beaches.

Of distinct advantage, too, is Sanders' working environment: the small, effective engineering groups working on a variety of projects, the balance of military and commercial work, the realistic management BY engineers FOR engineers make way for quick professional growth and personal advancement.

Noteworthy "firsts" developed at Sanders include printed "strip-line" plumbing, tape resistors, the world's smallest rate gyro. On the staff are some of the top electronics experts in America, and a good many of the most promising junior men — exceptional engineers with the "something extra" that makes the difference between competence and real talent.

To complement this fine team and to permit further expansion, Sanders is adding a few engineers with at least 3 to 5 years experience in missile guidance, pulse and doppler radar, microwave antenna, airborne navigation, printed circuit and component development.

If you are an exceptional engineer — have not only talent, but ambition and drive — Sanders can provide unusual opportunity. Address inquiries to Mr. J. I. Chesterley.



137 Canal St., Nashua, New Hampshire

• • • for those who qualify



offers

ELECTRONIC ENGINEERS

Security

Understanding

Know how

- HEAVY BACKLOGS
- SOUND FINANCING
- TOP BENEFITS
- MANAGEMENT BY ENGINEERS
- EDUCATIONAL AID
- MINIMIZED RED-TAPE
- VARIED SPECIALIZATION
- FLEXIBLE ORGANIZATION
- VERSATILE PERSONNEL

Send resume to

R. F. LANDER

Electronic Engineering Company
of California



180 SOUTH ALVARADO STREET
LOS ANGELES 57 • CALIFORNIA

WANTED ENGINEER WITH EXPERIENCE IN VHF OR UHF

Interesting creative work with the most resourceful and progressive firm in the field of television equipment.

This position is permanent. It will offer every opportunity for unlimited advancement and for developing a successful career. The plant is now housed in a newly-acquired larger building, only 22 miles from downtown New York City. The surroundings and atmosphere are stimulating and congenial.

Attractive Salary

Write stating qualifications.

BLONDER-TONGUE LABORATORIES
526-536 NORTH AVENUE
WESTFIELD, NEW JERSEY

ENGINEERS

Creative Opportunities with Republic Aviation

 Research
Antenna Engineer

To conduct pattern studies, design prototype antennas and supervise flight tests of new antenna installations. College graduate in Physics, Math or E.E.

Electronic Instrumentation Engineer

Three to five years aircraft instrumentation experience required. Knowledge of transducers, amplifiers and recording equipment used in experimental research testing of hi-speed jet aircraft is essential. Knowledge of servo loop theory as applied to aircraft systems coupled with ability to properly instrument, record and

analyze is desirable. Graduate with E.E. degree preferred.

Electronics Engineer

Familiar with airborne electronic equipment (communications, navigation I.F.F., Radar and Autopilots), preferable with 2 to 4 years aircraft experience. Should be a college graduate. Duties will include system investigations, establishing test procedures and conducting environmental tests on airborne electronic equipment and components.

Computer Engineer

To supervise maintenance and to design special circuitry for computers. Experience with either analogue or digital computers required. College graduate preferred.

Senior Power Plant Engineer

Three to eight years aircraft power plant experience. Capable conducting power plant testing in conjunction with jet engine and induction system analysis. B.S. in M.E. or A.E.

Please address complete resume, outlining details of your technical background, to:

Assistant Chief Engineer

Administration

Mr. R. L. Bortner



REPUBLIC AVIATION

FARMINGDALE, LONG ISLAND, NEW YORK

ENGINEERS

The APPLIED PHYSICS LABORATORY of THE JOHNS HOPKINS UNIVERSITY offers an exceptional opportunity for professional advancement in a well-established Laboratory with a reputation for the encouragement of individual responsibility and self-direction.

Our program of

GUIDED MISSILE RESEARCH and DEVELOPMENT

provides such an opportunity for men qualified in:

- Design and Analysis of Pulse Circuits
- Research and Development in Radar and Microwaves
- Electronic Packaging
- Development of Telemetering, Data Processing, and Special Switching Equipment
- Flight Test Conduction and Data Analysis
- Development and Application of Printed Circuits
- Servomechanisms and Control-System Analysis

Please send your resume to
Professional Staff Appointments

**APPLIED PHYSICS LABORATORY
THE JOHNS HOPKINS UNIVERSITY**
8621 Georgia Avenue
Silver Spring, Maryland

UNUSUAL CREATIVE FREEDOM at *Bendix* AVIATION RESEARCH LABORATORIES DIV.

• The center of advanced development activities for the Bendix Aviation Corporation offering excellent opportunities in design, research and development.

SYSTEMS ENGINEERS

To coordinate and supervise a group of engineers and mathematicians in systems analysis and design.

MATHEMATICIANS

Evaluation of servo control and guidance systems and components of a system. Analysis of systems and applications.

MACHINE DESIGNERS

Design of automatic machine tools, machine tool hydraulic servos, and digitally controlled tools.

CONTROLS ENGINEERS

Analyze and synthesize control system and design, develop and package such systems.

COMPUTER ENGINEERS

Development of special purpose digital and analog computers for process and business applications.

MICROWAVE SPECIALISTS

Research and development in advanced microwave techniques.

MECHANICAL ENGINEERS

Develop mechanical and hydraulic components for servo controls. Systems engineering and dynamic analysis of numerically controlled machine tools.

- Staff will participate in the initial exploration of new fields and the development of new commercial products.

All replies confidential—
send brief resume to:

DIRECTOR OF PERSONNEL

**BENDIX AVIATION CORPORATION
RESEARCH LABORATORIES DIVISION**
4855 Fourth Avenue • Detroit 1, Mich.

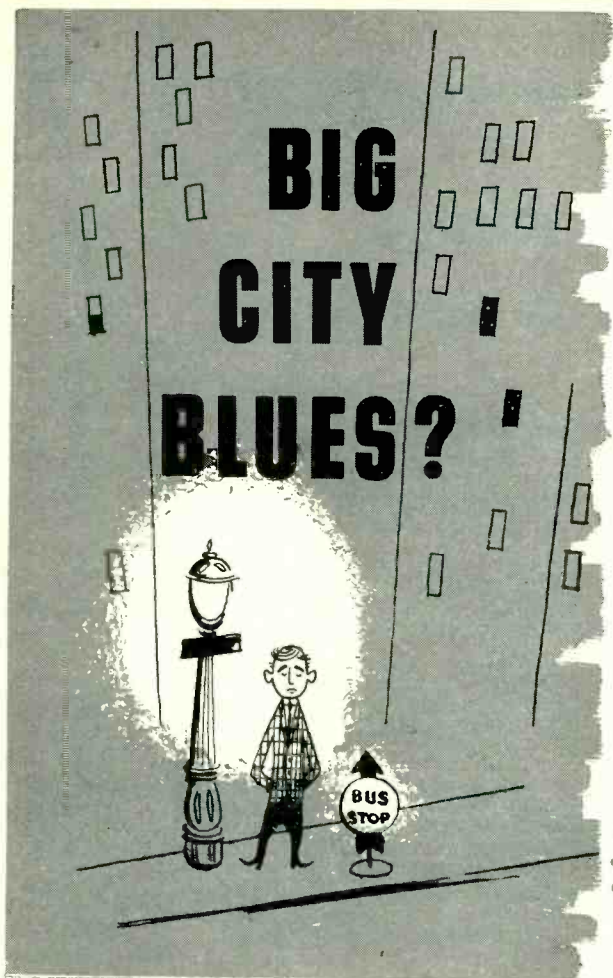

ENGINEERS — PHYSICISTS



friendly
Head for the Southwest

... if you're looking for a better career opportunity ... and the kind of life that lets you enjoy it! Here in the Southwest (incidentally, it's the nation's fastest growing industrial frontier) you'll find friendly people (including the boss), a more relaxed attitude toward the business of living, many cultural and recreational advantages, plus ready and waiting job opportunities in your specialized field. And the climate? Well, it's the best one we know ... for success!

If you're a graduate engineer or physicist (B.S., M.S. or Ph.D) and want to engage in research or development work with transistors, radar, sonar, waveguide and transformer components, or geophysical equipment, send resumé to W. D. Coursey, Personnel Division. We'll be glad to interview qualified applicants to discuss career opportunities at Texas Instruments ... our Profit Sharing and other benefit programs ... and to show you our interesting research and manufacturing activities.



TEXAS INSTRUMENTS
INCORPORATED
6000 LEMMON AVENUE DALLAS 9, TEXAS

PROGRESSIVE ENGINEERS LOOK WEST

Qualified Electronic and Electro-Mechanical engineers find happy association with a Western electronics pioneer and leader.

design
development
production

Commercial and military projects. Radar, DME, Communications, Noise, Test Equipment including color T.V. — Many others with real interest & challenge. Relocation expenses — excellent working conditions — Central location. Scheduled reviews & advances. Fine insurance plan. Move should not disturb urgent military projects.

Send complete resume, income history & requirements to engineering employment mgr.

Hoffman LABORATORIES, INC.

(A SUBSIDIARY OF HOFFMAN RADIO CORP.)

3761 SO. HILL ST.

LOS ANGELES 7, CALIF.

Engineers

with experience in

computers
microwave
pulse techniques
servo-mechanisms
related circuit design

leading designers and manufacturers of electronic instrumentation offer outstanding opportunity, top pay, moving allowance, benefits, plus the charm of san francisco living.

please send resume.

Berkeley *division*
BECKMAN INSTRUMENTS INC.

2200 WRIGHT AVE., RICHMOND 3, CALIF.

SEMICONDUCTOR DEVELOPMENT

Responsible positions are now available with one of the leading and fastest growing manufacturers of semiconductors. These are outstanding opportunities for Physicists and Engineers in research, development or production of advanced

germanium and silicon diodes and transistors.

Experience in semiconductors or other components such as tubes or capacitors is desirable.

Positions are available for:

Physicists
Device Engineers

Metallurgists
Sales Engineers
Production Engineers

Send resume
or call

Transitron electronic corporation
407 Main Street MEIrose 4-9600 Melrose, Mass.



Offers Career-Future in MICROWAVE DEVELOPMENT

We have two openings on our staff for engineers with varied design experience in the microwave field particularly with a background of experience in SHF, SLOW WAVE STRUCTURES and FRONT-END APPLICATIONS. The men who will fill our openings will have an ELECTRICAL ENGINEERING or PHYSICS DEGREE and a minimum of 3 years experience in microwave and related fields. You will have an opportunity to work in the field of ADVANCED DEVELOPMENT of MICROWAVE THEORY and APPLICATION.

PLEASE SEND A COMPLETE RESUME WITH EDUCATION, EXPERIENCE, AND SALARY REQUIREMENTS, TO

T. F. COLLINS

Telephone
SPRING 7-3300

Looking for a Future . . .  . . . Excellence in Electronics

RAYTHEON MANUFACTURING COMPANY

Chicago Division of Equipment Operations

• 4132 W. BELMONT AVE. • CHICAGO 41, ILL.

ELECTRONIC ENGINEERS!

•
• **Big opportunities**
• **await you at**
• **Bendix York!**
•

To the Engineer who is a recent college graduate, as well as to those with experience in all phases of advanced design, Bendix York offers opportunities outstanding in its field. As a young and expanding division, Bendix York provides fascinating and challenging assignments. Good salaries, all employee benefits, ideal living conditions in a beautiful suburban area are yours.

•
• Send resume of Education and Experience to: Mr. L. D. Smith, Employment Supervisor
•
•

Bendix

AVIATION CORPORATION
YORK DIVISION

Phone: York 5521 York, Penna.

Electronic & Mechanical ENGINEERS & PHYSICISTS

Do You Want . . .

Scope for Your Varied Talents

National has pioneered in the research and development of electronic equipment and components for over 40 years.

To Follow Projects Through

At National, you can see the whole picture — share in the development of every project from its inception.

To Win Quick Recognition for Ability

You will work closely with top men, where your individual contributions can be immediately seen and rewarded. And since you have more responsibility, you have greater opportunities for advancement.

A Warm & Friendly Atmosphere

National's steady growth has been PLANNED — it has not been allowed to submerge the individual. If this personal emphasis appeals to you, and you have a B.S. or higher degree, you are cordially invited to send your resume to:

Mr. John A. Bigelow

National

EST. 1914



NATIONAL COMPANY, INC.
61 Sherman St. Malden, Mass.

ENGINEERS NEEDED FOR RESEARCH AND DEVELOPMENT POSITIONS IN THE

Design of electronic instrumentation for underwater ordnance, including high gain amplifiers, conventional filters, power amplifiers, oscillators and detectors in the ultrasonic range.

Analytical and experimental treatment of scientific research problems in the fields of hydrodynamics, acoustics, electronics, network theory, servomechanisms, mechanics, information theory and noise analysis including analogue and digital computations.

Design of transducers, fundamental problems in underwater acoustics involving transmission, attenuation, reflection, etc. Problems in sound control and noise reduction. Acoustical aspects of systems research including operations research and feasibility studies.

Opportunities for graduate study

Liberal Vacation Policies

Excellent Working Conditions

THE PENNSYLVANIA STATE UNIVERSITY
ORDNANCE RESEARCH LABORATORY

University Park, Pennsylvania

Send Resume to ARNOLD ADDISON, Personnel Director

ELECTRONIC ENGINEERS

Field Service

Young E. E. Graduates expd. in Military or Private Industry. \$10 per diem—liberal overseas bonus. Excellent future.

SERVOMECHANISMS

INC.

POST & STEWART AVE'S
WESTBURY, N. Y.

In the "sensory" phase of automatic control Beckman provides equipment and instrumentation for quickly detecting and measuring electric currents as small as 3×10^{-13} amperes. Beckman instruments detect and measure variations in chemical composition, color, acidity and alkalinity (pH), moisture content and other critical functions in chemical analysis and control.

Beckman products that typify major advancement in the field of modern electronic instrumentation are ultraviolet, visible and infrared spectrophotometers, colorimeters, pH meters, aquameters, computers, synchros, and a wide range of special products.

Significant growth in the application of "sensory" devices for process and laboratory control for pushbutton factory operations and atomic research and development has created new positions in our Engineering Department. Engineers and physicists with experience in related fields or exceptional ability are invited to consider joining us.

Particularly Interested in
SPECTROSCOPY
?

A Priority Opening SENIOR ELECTRONIC SPECIALIST

The position calls for the highest creative engineering talent. Duties will include providing electronic know-how to engineering teams engaged in major projects and complete individual responsibility on some highly technical special assignments. Non-supervisory in nature, the position offers unusual promise in interesting work and salary equal to our top engineering and administrative classifications.

Also urgently needed are a solid-state physicist for crystal work and an electronic engineer with data handling experience. Send complete resume to

BECKMAN INSTRUMENTS, INC. 2500 Fullerton Road
Fullerton 1, California

ELECTRONICS ENGINEER OR PHYSICIST

If you have experience or ability in design, construction and evaluation of high voltage, high frequency circuits, we have an exceptional opportunity in which you will be interested. Position requires applicant capable of designing circuits incorporating transistors, magnetic amplifiers and semi-conductors. Write Director of Personnel, The Electric Auto-Lite Company, Toledo 1, Ohio

INSTRUMENTATION ENGINEER

Once in a lifetime opportunity for physicist or electronics engineer with ability to design, construct and install setups used to obtain data on engine ignition and performance. Setups will be diversified so that projects might require mechanical and electronic instrumentation as required to best obtain information. Also included will be design of auxiliary control circuits and writing of operation manual to be used by experimental department personnel. Write Director of Personnel, The ELECTRIC AUTO-LITE COMPANY, Toledo 1, Ohio

PERSONNEL MANAGERS

LOOKING FOR ENGINEERS . . . TECHNICIANS?



Write for free copy of

"RESERVOIR OF ENGINEERS AND TECHNICAL MEN"

The engineers and technicians you want to reach are gathered in convenient, compact groups—as this 12-page booklet points out.

It keys the job titles these men hold to the McGraw-Hill publications they read for on-the-job information. It explains how you can make contact . . . channel, concentrate your employment advertising to just the men with the job qualifications you want.

Write for your free copy to

ELECTRONICS

Classified Advertising Division
330 W. 42nd St., N. Y. 36, N. Y.

RECEIVER ENGINEERS

With Experience in VHF and UHF Frequencies

Career Opportunities
With Old Established
Central Connecticut Firm
Interesting Projects
Top Salaries
Suburban Living

Replies Held in Strict Confidence
Wire or Phone Collect
Personnel Mgr. SHERWOOD 7-2741

THE ALLEN D. CARDWELL ELECTRONICS PRODUCTIONS CORPORATION

Plainville, Connecticut

SENIOR ELECTRONICS ENGINEERS

EE degree or equivalent experience. Background in communications and navigation desirable. Permanent positions in design and development. Citizenship required. Position at Rochester, New York. Excellent living and recreational conditions in this area.

ADDRESS:

Chief Electronics Engineer
STROMBERG-CARLSON COMPANY
ROCHESTER 3, NEW YORK

ENGINEER—TAPE RECORDER PROJECT LEVEL

EXPERIENCED IN ALL PHASES OF
MAGNETIC TAPE RECORDER MFG.
TOP SALARY—PERMANENT POSITION
SEND COMPLETE RESUME TO
FEDERAL MANUFACTURING &
ENGINEERING CORP.
BROOKLYN 5, New York

REPRESENTATIVES WANTED

Manufacturer of electronic test equipment for military and commercial applications needs technically qualified representatives. Write giving qualifications, lines handled, territory covered.

RW-2178, Electronics
1111 Wilshire Blvd., Los Angeles 17, Calif.

REPRESENTATIVES WANTED

Leading manufacturer full line electronic and magnetic amplifier regulated dc power supplies wishes engineering representation in several areas. Ready staffing experience, education, territory covered, other lines. Will consider energetic individuals just starting own office.

RW-6415 Electronics
1111 Wilshire Blvd., Los Angeles, Calif.

REPRESENTATIVES WANTED

Manufacturer of electronic equipment—with open production capacity up to \$5,000,000 annually—needs qualified representatives with established contacts, to solicit sub-contracts from well known electronic manufacturers.

TRAD TELEVISION CORP.
1001 First Ave., Asbury Park, N. J.

ENGINEERS

ELECTRONIC

Experience in research & development of pulse circuitry, computing components and servo systems.

SYSTEMS (E. E.)

For work in the development of airborne navigational equipment.

MECHANICAL

2-3 years' experience in the design of precision instruments.

DESIGNERS

ELECTRONIC ELECTRO-MECHANICAL MECHANICAL

1. Electronic or electrical packaging. Knowledge of sub-miniaturized techniques. Work is associated with servos, amplifiers and computers.
2. Mechanical or electro-mechanical packaging of precision flight instruments.

The modern facilities and congenial atmosphere at Kollsman, designers of America's finest aircraft instruments, provide an environmental conducive to truly creative work.

Please submit complete resumes
to Employment Manager.



kollsman INSTRUMENT CORPORATION

80-08 45th AVENUE, ELMHURST, NEW YORK • SUBSIDIARY OF Standard COIL PRODUCTS CO. INC.

RAYTHEON'S MISSILE and RADAR DIVISION



Bedford
Mass.

CAREER ENGINEERING POSITIONS

• SENIOR RADAR SYSTEMS ENGINEER

Attractive opening for engineer capable of advanced systems engineering for airborne radars. Strong background in electronic circuit design required. Experience in radar systems design and allied fields desirable. Long term developments involve application of interesting new techniques.

• SENIOR MICROWAVE ENGINEER

Must have wide experience in the application of microwave techniques to military radar and a keen appreciation of overall system design problems. Responsibility involves both system and component engineering. Will work with project engineers and department manager's office on a wide variety of microwave problems. Microwave tube design experience desirable but not essential.

• SENIOR SPECIFICATIONS ENGINEER

5 or more yrs. of experience in electronic design, applications or technical writing required. Familiarity with military specifications desirable.

RAYTHEON'S MISSILE AND RADAR DIVISION is a well-established, progressive organization located 20 miles from Boston in an area offering excellent housing, recreational and educational facilities.

Please write, or apply in person, giving full particulars concerning education, experience, and salary to Mr. A. H. Nile, Personnel Section.

RAYTHEON MANUFACTURING COMPANY
190 Willow Street, Waltham, Mass.

ELECTRONIC SURPLUS

SAVE UP TO
85%

400 CYCLE SERVO MOTORS

Kollsman "Teletorque" type 1377-0410	\$ 9.95
Kollsman type 999-0411	15.00
Kollsman type 1515B-0410	22.50
Kollsman type 9416-0110202	15.00
Kollsman type 776-01 Drag Cup	12.50
Kollsman type 775-01 Drag Cup	12.50
Pioneer type 10047-2A Drag Cup	10.50
Pioneer type CK-2 Induction	35.00
Pioneer type CK-5 Drag Cup	22.50
Pioneer type CK 13	25.00
Kearfott type R110-2A-B	20.00
American type 172B	17.50
Western Electric KS 9154	12.50
Transcoil type 2900	15.00



INVERTERS

MG 149F HOLTZER CABOT
OUTPUT: 26 @ 250 VA; 115 V., @ 500 VA;
single phase; 400 cycle; INPUT: 24 VDC @ 36
amps.\$49.50

PIONEER 12123-1-A
OUTPUT: 115 V; 3-phase; 400 cycle; Amps .5;
INPUT: 24 VDC; 12 amp.\$69.50

PIONEER 12126-2-A
Output: 26 volts; 3 phase; 400 cycle; 10 VA; .6
PF; Input: 27.5 volts DC; 1.25 amps.\$24.50

DMP2506M
CONTINENTAL ELECTRIC
24-30 volts input; 5.5-4.5 amps; cont. duty. Out-
put: 115 volts; .44 amps; 400 cyc; 1 phase; RF
1.0 50 watts.\$39.50

10563 LELAND ELECTRIC
Output: 115 VAC; 400 cycle; 3-phase. Output:
115 VAC; 400 cycle; 3-phase, 115 VA; 75 PF.
Input: 28.5 VDC; 12 amps.\$39.50

PIONEER 12117
Output: 26 volts; 400 cycles; 6 volt amperes, 1
phase. Input: 24 VDC; 1 amp.\$19.95

PE 218 LELAND ELECTRIC
Output: 115 VAC; Single Phase PF 90; 380/500
cycle; 1500 VA. Input: 25-28 VDC; 92 amps;
8000 rpm; Exc. Volts 27.5 BRAND NEW \$39.95

PE 109 LELAND ELECTRIC
Output: 115 VAC; 400 cyc; single phase; 1.53
amp; 8000 rpm. Input: 13.5 VDC; 20 amp \$65.00

MG153 HOLTZER-CABOT
Input: 24 VDC; 52 amps. Output: 115 volts—
400 cycles, 3-phase, 750 VA and 26 volt—400
cycle, 250 VA. Voltage and frequency regulated
\$95.00

PIONEER 12130-3B
Output: 125.5 VAC; 1.5 amps. 400 cycles single
phase, 141 VA. Input: 20-30 VDC, 18-12 amps.
Voltage and frequency regulated.\$69.50

12116-2-A PIONEER
Output: 115 VAC; 400 cyc; single phase; 45 amp.
Input: 24 VDC, 5 amp.\$39.95

10285 LELAND ELECTRIC
Output: 115 volts AC; 750 VA; 3 phase, 400 cycle,
.90 PF and 26 volts, 50 VA; single phase, 400
cycle, .40 PF. Input: 27.5 VDC, 60 amps, cont.
duty, 6000 rpm. Voltage and frequency regulated
\$59.50

10486 LELAND ELECTRIC
Output: 115 VAC; 400 cycles; 3-phase; 175 VA;
.80 PF. Input: 27.5 DC; 12.5 amps; cont. duty
\$90.00

PIONEER 10042-1-A
DC input 14 volts; output: 115 volts; 400 cycle,
1-phase; 50 watt.\$39.50

10339 LELAND ELECTRIC
Output: 115 volts; 150 VA; single phase; 400 cyc-
le; .90 PF and 26 volts; 60 VA; 400 cycle, .40
PF. Input: 27.5 volts DC 18 amps cont. duty,
voltage and freq. regulated.\$49.50

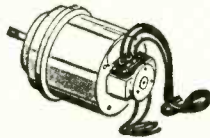

SYNCHRONOUS SELSYNS

110 volt, 60 cycle, brass cased, approximately 4"
dia. x 6" long. Mfd. by Diehl and Bendix

QUANTITIES AVAILABLE
REPEATERS \$20.00 ea.
TRANSMITTERS \$20.00 ea.

SYNCHROS

GENERAL ELECTRIC MOD. 2J15M1; 115-57.5
oils, 400 cycle.\$22.50

KOLLSMAN AUTOSYN MTR TYPE-403; 32
VAC; 60 cycle; single phase.\$9.95

BENDIX AUTOSYN MTR. TYPE-851; 32 VAC;
60 cycle, single phase.\$9.95

MICROSYN UNIT TYPE IC-006A.\$15.00

IF SPECIAL REPEATER; 115 voltage cycle
\$15.00

2J1F3 GENERATOR; 115 volt-400 cycle.\$10.00

5CT CONTROL TRANSFORMER; 90-50 volt; 60
cycle\$45.00

5F MOTOR; 115-90 volt; 60 cycle.\$45.00

5SDG DIFFERENTIAL GENERATOR; 90-94
volts; 400 cycle.\$30.00

BENDIX TRANSMITTER TYPE C-78248; 115
volt; 60 cycle.\$22.50

DIFFERENTIAL TYPE C-78249; 115 volt; 60
cycle\$5.00

BENDIX REPEATER TYPE C-78410; 115 volt;
60 cycle\$37.50

REPEATER, Type C-78663, AC Synchronous 115
volt, 60 cycle\$9.95

DIEHL REPEATER TYPE FJE 22-2; 115 volt;
400 cycle; secondary 90 volt.\$27.50

5G GENERATOR; 115/90 volt; 60 cycle.\$45.00

7G SYNCHRO GENERATOR; 115/90 volt; 60
cycle\$75.00

6G SYNCHRO GENERATOR; 115/90 volt; 60
cycle\$60.00

6DG SYNCHRO DIFFERENTIAL GENERA-
TOR; 90/90 volt; 60 cycle\$50.00

2J5F1 SELSYN CONTROL TRANSFORMER;
105/55 volts; 60 cycle\$22.50

2J5H41 SELSYN GENERATOR; 115/105 volts;
60 cycle\$50.00

2J1F1 GENERATOR 115/57.5 volts; 400 cycle
\$12.50

2J1H1 DIFFERENTIAL GENERATOR; 57.5/
57.5 volts; 400 cycle.\$12.50

2J1G1 CONTROL TRANSFORMER; 57.5/57.5
volts; 400 cycle.\$7.50

2J5H1 SELSYN GENERATOR; Mfr. G.E.; 115/
105 volts, 60 cycle.\$27.50

PRECISION AUTOSYNS

Eclipse Pioneer AY 201- s-B	\$17.50
Eclipse Pioneer AY 202- s-1B	\$17.50
Eclipse Pioneer AY 201- 3B	17.50
Eclipse Pioneer AY 200- 4-B	15.00
Kearfott R-212-1A-A Transmitter	15.00
Kearfott R-200-1-A Control Transformer	15.00
Kearfott R-210-1-A Transmitter	15.00

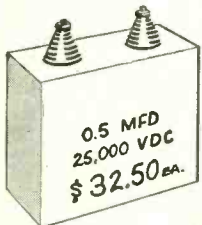

WRITE OR WIRE FOR INFOR-
MATION ON OUR COMPLETE
LINE OF SURPLUS ELEC-
TRONIC COMPONENTS. ALL
PRICES NET F. O. B.
PASADENA, CALIFORNIA.

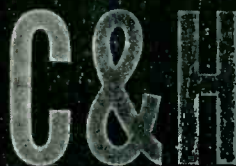

SALES CO.

2176-E East Colorado St.
Pasadena 8, California
RYan 1-7393

ECHO BOX

A hand tuned ring box with an associated dipole
which picks up the RF energy from the radar set.
Frequency range of 3140-3640 MC. Ideal unit for
experimental lab. Wt. 7 lbs. New **\$4.95**
Condition

TS-56A/AP TEST EQUIPMENT

Slotted line test equipment designed for operation
over a frequency of 500-875 MC. Has impedance of
51 ohms. Ideal test set for matching antennas,
measurements of characteristics of transmission
line. With instructions manual. **\$95.50**
New. Shipping wt.: 41 lbs.

RADAR TEST SET

Phantom Target RF4/AP is used for permanent
installation in planes equipped with radar set in
the S hand while plane is in flight. With in-
struction book, new condition. Wt. **\$49.50**
10 lbs.

TS-35A/AP

X band test equipment for measuring power and
frequency of transmitters and receivers. Like new
condition. P. U. R

TS-102A/AP

Range calibration test set for checking radar sets.
Excellent cond. P. U. R

AN/ARD-2

Complete tunable receiver with a frequency range
of 1,000-3,000 MC. This unit has a directional
antenna system, spare parts, and test set for adjust-
ing the receiver. With manual. Brand new. P. U. R

TS-10C/APN

Latest model for testing FM radio altimeters. Com-
plete with cables and indicator. New condi-
tion. P. U. R

NEW CATALOG NO. 114

1955 ISSUE
LISTS LATEST INVENTORY OF AIRCRAFT,
INDUSTRIAL AND MILITARY ELECTRONICS
EQUIPMENT. SEND FOR YOUR COPY TO-
DAY!

ARROW SALES INC.

Western Division
Mailing Address: P.D. BOX 3878-E, N. HOLLYWOOD, CAL.
Office-Warehouse: 7460 VARNA AVE., N. HOLLYWOOD, CAL.
Phones: Stanley 7-6005 • Poplar 5-1810
Sales-Showroom: 2005 EMPIRE AVENUE, BURBANK, CAL.
Phone: Victoria 9-2934
Cable Address: ARROWSALES, NORTH HOLLYWOOD
Telegraph Address: WUX, NORTH HOLLYWOOD

Central Division
Mailing Address & Sales-Showroom:
2441 S. MICHIGAN AVE., CHICAGO 16, ILLINOIS
Phone: CALumet 5-4750

RCA TV CAMERA

NEW Surplus

for Labs! Export!
Industrials!
Medicine!
Closed Circuit
TV!



Ideal for labs, industry, prisons, TV technicians,
swim pools, medics—"mechanical eye" for closed
circuit TV. 1846 Iconoscope, 6-stage video ampli-
fier and clipper. THE REAL THING! Send for
new, free, complete technical data. SOLD AT
FRACTION OF REAL VALUE!
Write today! Note our new address!

Harjo Sales Co.

Mailing Address: Box 1187-E MAGNOLIA PARK STA-
TION, BURBANK, CALIF.
Office-Warehouse: Dept. E, 503 N. VICTORY BLVD.,
BURBANK, CALIF.

ART-13 APR-4 BC-610-E

BC-348, BC-312, BC-342, RAK, RAX.
BC-221, TS-174, #241 Scope, LM
ARC-1, APA-10, DY-17, DY-11

Alltronics, Box 19, Boston 1, Mass.
Telephone: Richmond 2-0048, 2-0916

400-800 CYCLE MOTOR-GENERATOR SETS & ALTERNATORS

FOR SALE OR FOR RENT
1 to 5 KVA—1 PHASE & 3 PHASE
IMMEDIATE DELIVERY
ALL INQUIRIES INVITED
SEND FOR OUR LIST

EDWARD WOLF COMPANY
P. O. BOX 82 MATTAPAN 26, MASS.
BLUEHILLS 8-1254

FAY-BILL DISTRIBUTING CO.

PARTIAL LISTING ONLY

LARGEST SURPLUS TUBE DEALER IN THE COUNTRY
STANDARD BRANDS - TRANSMITTING & RECEIVING

Type	Price	Type	Price	Type	Price	Type	Price	Type	Price	Type	Price	Type	Price	Type	Price
AB-150	\$2.95	2C40	9.99	4-125A	18.99	317A	2.49	718A/BY		955	.29	6A06	.59	7Z4	.69
CEP-220	.94	2C43	14.77	4B36	3.69	317C	6.99	CY/EY	21.99	956	.26	6AR6	2.70	12A6	.59
CEP-120*ZB	.94	2C44	.85	4C27	8.95	311A	2.99	719A	16.95	957	.26	6AS5	.76	12A7	.49
CK-507AX	.99	2C46	9.99	4C28	33.50	321D	2.39	720A/CY		958	.59	6ASTG	2.99	12AU7	.79
CK-521AX	.99	2C51	3.21	4C35	14.99	349C	5.99	EY/DY	29.75	959	1.99	6AX4	.79	12AV7	.99
CRP-72	.79	2D21	.89	4D22	19.95	349C	4.39	721A	1.21	991	.44	6B4G	.99	12AV7	.94
DG-1290	3.99	2D21W	2.85	4D32	19.89	350R	4.99	722	8.95	1500T	84.50	6BA7	.99	12AX4	.83
EF-50	.39	2E22	2.49	4E27	14.99	350TH	19.50	723A/B	10.44	CK1005	.49	6B5	.99	12AX7	.79
E-1148	.39	2E24	3.29	4E27A	29.95	350TL	21.50	724A/B	1.99	CK1006	3.19	6B8	.69	12AX7	1.31
EC1	.39	2E36	1.89	4J22	79.95	353A	7.99	725A	7.50	1608	.99	6B8G	1.99	12BA6	.64
EM3GA	39.99	2G-22	1.19	4J23	79.95	358B	4.49	726A	11.49	1613	1.70	6BH6	.79	12BA7	.64
F123A	5.99	2J-21	2.49	4J24	79.95	359A	6.99	726B	29.99	1614	1.99	6BE6	.69	12C8	.69
F127A	3.99	2J-22	2.99	4J25	82.95	364A	4.19	726C	39.50	1616	.99	6BJ6	.69	12C7	.89
F128A	29.50	2J-26	4.99	4J26	86.95	371A	12.99	730A	12.99	1622	1.55	6BK7A	1.21	12C7	.59
FG-105	14.44	2J-27	6.99	4J27	86.95	374A	1.49	800	.98	1624	1.64	6BL7	1.10	12SR7	.59
HF-100	6.99	2K-22	16.99	4J28	79.50	374B	1.99	801	.44	1625	.19	6BM6	35.99	12SF7	.82
HF-150	15.99	2K-23	17.95	4J29	86.95	282A/B	4.41	801A	.44	1626	.11	6BN6	1.24	12SG7	.85
HF-200	10.99	2K25	12.99	4J30	96.50					1629	.16	6BQ6	1.19	12H6	.65
HF-300	19.99	2K28	28.99	4J31	99.50					1630	.69	6BQ7A	1.19	12H7	.69
HK-24	3.99	2K33A	69.50	5AP1	4.99					1631	.49	6B7	1.24	12J7	.69
HK-54	4.59	2K45	49.50	5BP1	1.96					1632	.49	6C6	1.72	12K8	.69
HY-114B	2.29	2K52	59.50	5BP4	2.99					1633	.59	6CB6	.69	12SK7	.69
HY-615	.29	2K55	39.95	5CP1	2.29					1639	.89	6C4	.40	12SN7	.79
KU-610	4.99	2K55	39.95	5CP1A	10.50					1639	.89	6C5	.49	12SL7	.89
QK-59	41.50	2K55	39.95	5CP7	8.99					1641	2.49	6C6	.49	12Z3	.49
QK-61	63.60	2K55	39.95	5CP11A	15.50					1642	.29	6CBG	.99	14A7	.79
QK-62	69.00	2K55	39.95	5C21	8.49					1644	.69	6D4	2.75	14B6	.69
QK-185	110.00	2K55	39.95	5C21 C6J	8.49					1806P1	3.99	6E5	.79	12B8	.79
RK-34	.29	2K55	39.95	5C22	28.99					1851	1.39	6F5	.49	14N7	.99
RK-38	1.89	2K55	39.95	5D21	7.99					1960	.99	6F6	.99	14R7	.99
RK-59	1.89	2K55	39.95	5BPIA	6.99					2050	1.19	6F6G	.69	14WL	.99
RK-60	2.49	2K55	39.95	5FP7	1.99					2050W	3.49	6G10	3.29	19T8	.99
RK-65	14.99	2K55	39.95	5HP4	3.99					2051	.81	6J6	.72	25L6	.64
RX-21A	8.99	2K55	39.95	5HP1	3.99					1A3	.69	6J7	.94	25Z6	.61
UH-50	1.99	2K55	39.95	5JP1	14.50					1B3	.89	6J8	.96	26D6	1.75
10S-VT-25A	.89	2K55	39.95	5JP5	7.49					1G6GT	.69	6K4	2.69	28D7	1.21
VR-78	.89	2K55	39.95	5RP2	16.50					1LC5	.94	6K5	.79	35L6	.69
VR-90	.89	2K55	39.95	5J29	9.00					1LD5	.94	6K6	.69	35Z3	.69
VR-105	.89	2K55	39.95	5J30	16.65					1L4	.84	6K7	.79	35Z5	.51
VR-150	.89	2K55	39.95	5J33	5.90					1T4	.69	6K8	1.19	35Y4	.69
VT-52	.19	2K55	39.95	5LP1	9.05					1A5	.79	6L6M	1.49	50A5	.69
30S-VT-67	.19	2K55	39.95	5NP1	11.95					1H5	.69	6L6G	.99	50B5	.69
VT-127A	2.99	2K55	39.95	5R4GY	.91					1N5	.89	6L7	.99	50C5	.69
VT-158	15.99	2K55	39.95	5R4WG	2.22					1R5	.69	6N7	1.10	50L6	.69
VU-111	.19	2K55	39.95	434A	8.66					1S4	.84	6R7GT	.69	77	.49
OA2	.84	2K55	39.95	446A	1.49					1S5	.69	6S4	.59	78	.59
O2B	.86	2K55	39.95	446B	2.89					1U4	.69	6S7	.74	80	.49
1B22	1.19	2K55	39.95	464A	1.49					1U5	.65	6S7	.74	83V	.99
1B24	5.99	2K55	39.95	464B	2.89					1X2A	.89	6S7	.69	56S1	1.71
1B26	1.46	2K55	39.95	466A	1.49					1V2	.69	6S7	.79	56S4	1.10
1B29	2.59	2K55	39.95	466B	2.89					2A3	.99	6S7	.64	56T0	3.99
1B32 532A	1.19	2K55	39.95	466A	1.49					2A4	.99	6S7	.79	56B6	1.79
1N21	.69	2K55	39.95	466B	2.89					3B7	.39	6S7	.59	56B7	3.49
1N22	.39	2K55	39.95	466A	1.49					3D6	.39	6S7	.79	5725	2.05
1N23	2.10	2K55	39.95	466B	2.89					3V4	.73	6W4	.69	5751	2.39
1N27	.89	2K55	39.95	466A	1.49					3Q4	.83	6W6	.84	5763	1.59
1P28	11.70	2K55	39.95	466B	2.89					354	.69	6V6GT	.66	5796	7.99
1P30	2.99	2K55	39.95	466A	1.49					5U4	.49	6X4	.49	5814	1.27
2AP1	7.44	2K55	39.95	466B	2.89					5Y3	.50	6X5	.49	5879	1.29
2B22	1.49	2K55	39.95	466A	1.49					5T4	.91	6T4	1.44	5915	1.09
2BP11	7.99	2K55	39.95	466B	2.89					5V4	.89	6T8	.99	5963	1.10
2C22	.36	2K55	39.95	466A	1.49					5Z4	1.19	7A5	.95	5964	1.30
2C26	.22	2K55	39.95	466B	2.89					5W4	.89	7A6	.85	8193	.09
2C30	4.95	2K55	39.95	466A	1.49					6AC7	.89	7A7	.79	8002R	17.49
2C33 RX233 1.69		2K55	39.95	466B	2.89					6AB7	.99	7A8	.79	8005	4.90
2C39A 10.40		2K55	39.95	466A	1.49					6AF4	1.29	7B5	.69	8012	1.94
		2K55	39.95	466B	2.89					6AG5	.84	7C4	.39	8013A	4.69
		2K55	39.95	466A	1.49					6AG7	1.19	7C5	.79	8020	2.50
		2K55	39.95	466B	2.89					6AH6	.89	7F7	.89	8025	2.95
		2K55	39.95	466A	1.49					6AL5	.59	7G7	.89	8022	.69
		2K55	39.95	466B	2.89					6AJ5	1.69	7H7	.69	9001	.79
		2K55	39.95	466A	1.49					6AK5	.74	7N7	.89	9002	.69
		2K55	39.95	466B	2.89					6AK6	.79	7Q7	.99	9003	1.29
		2K55	39.95	466A	1.49					6AN4	1.35	7Y4	.69	9004	.19

WE BUY YOUR SURPLUS TUBES. SEND US YOUR LIST FOR HIGHEST QUOTATION LARGEST BUYERS IN THE COUNTRY

FAY-BILL DISTRIBUTING CO. DEPT. E1
418 Broome St., N. Y. 13, N. Y.
Telephone CAnal 6-8404

All boxed and fully guaranteed. Special quantity discount—10% on 100 or more of same type. Minimum order \$10.00. Thousands of other types in stock . . . Send us your requirements F.O.B. New York 25% deposit with order or if paid in advance save C.O.D. charges. Rated firms net 10 days. Prices subject to change without notice. For fast service ask for Sy.

HELIPOTS
TEN TURNS; 50,000 OHMS
Linearity tolerance 0.05%
Resistance tolerance 1%
3/8" standard bushing mounting
New, clean, original bulk pack. Regular factory cost cut drastically because of contract termination.
\$12.95 each, postpaid in U.S.A.
QUANTITY USERS WRITE FOR QUOTATION ON THESE AND OTHER QUALITY COMPONENTS
G. GREENE
166-04—67th Avenue Flushing 65, N. Y.

AC GENERATORS
6—5 KW, single phase, A.C. generators, 1200 RPM, 110/220 volts, single bearing, with cranking exciters, \$300.00 each, subject to prior sale.
MOTOR GEN. SETS
2—400 Cycle, 30 KVA, Motor Generator Sets.
Several miscellaneous Rotary Converters.
KATO ENGINEERING CO.
1415 First Ave. Mankato, Minn.

OFFERING IN MARINE SPECIALTIES
SONAR DOMES—Navy 60"—Standard all window. CW-177A/U. B. F. Goodrich.
DEAD RECKONING ANALYZERS—Navy Mark VI. Complete with Dummy Log. Arma.
DEAD RECKONING TRACERS—Navy Mark VI. With Auxiliary Plotting. Arma.
ELECTRIC MEGAPHONES—Navy PAE-1. 20-watt audio. With Charge Rack & Spares.
CUNNINGHAM ENGINEERING COMPANY
P. O. Box 707 Beaumont, Texas

COMMUNICATIONS EQUIPMENT CO.

10 CM.—RG48/U Waveguide

POWER SPLITTER for use with type 726 or any 10 CM. Shepherd Klystron. Energy is fed from Klystron antenna through dual pick-up system to 2 type "N" connectors \$12.50

LHTR. LIGHTHOUSE ASSEMBLY. Parts of RT39 APG 5 & APG 15. Receiver and Trans. Cavities w/assoc. Tr. Cavity and Type N CPLG. To Recv. Uses 2C40, 2C43, 1B27. Tunable APX 2400-2700 MCS. Silver Plated. \$15.00
BEACON LIGHTHOUSE cavity p/o UPN-2 Beacon 19 cm. Arg. Bernard Rice. each. \$27.50
MAGNETRON TO WAVEGUIDE Coupler with 721-A Duplexer Cavity, gold plated. \$31.50
721A TR BOX complete with tube and tuning plungers \$12.50
McNALLY KLYSTRON CAVITIES for 707B or 2K28, 2700-2900 MC. \$4.00
HOLMDELL-TO-TYPE "N" Male Adapters. W. E. #D16784 \$2.75
BEACON ANTENNA. AS31/APN-7 in Lucite Ball. Type "N" feed. \$22.50
ANTENNA, AT49A/APR: Broadband Conical. 300-3300 MC Type "N" Feed. \$12.50
"E" PLANE BENDS. 90 deg. less flanges. \$7.50
K-Band, X-Band EQPT. Available. Send for List

I. F. AMPLIFIER STRIPS

Model 15: 30 Mc Center frequency. Bandwidth 2.5 Mc gain figure: 65 db. Uses 2 stages of 6AC7's. Has D. C. Restorer and Video Detector A.F.C. Strip included. Input impedance: 50 Ohms. Less tubes \$17.50
60 MC. Miniature IF strip, using 6AK5's 60 Mc Center Freq. Gain: 95 db at Bandwidth of 2.7 Mc. New. Complete with tubes. \$15.00

400 CYCLE TRANSFORMERS

(All Primaries 115V. 400 Cycles)		
KS13101	6.3V/15A, 6.3V/0.9A, 6.3V/0.4A.	\$ 3.85
KS13104	6.3V/0.2A	7.50
KS9615	145V0VCT/0.283A, 105V0VCT/0.217A.	1.57
KS9318	6.3V/4A, 3V/1A	1.35
KS9608	1233 .35MA, 1140V0VCT/.07A	5.79
352-7102	6.3V/2.5A	1.45
5W-74224	145V0VCT/1.0MA, 2.5V/75A, 6.4V/3.9A, 5V/2A, 6.5V/3A, P/O ID-39/ APG-13	4.95
352-7039	640 VCT @ 380MA, 6.3V/.9A, 6.3V/6A 5V/6A	5.49
702724	9800/8600 @ 32MA	8.95
KS9584	5000V/250MA, 5V/10A	22.50
KS9507	73AVCT/1.77A, 1710VCT/177A	6.79
352-7273	700VCT/350MA, 6.3V/0.9A, 6.3V/25A, 6.3V/.08A, 5V/CA	6.95
352-7070	2x2.5V/2.5A (2KV TEST) 6.3V/2.25A, 1200/100/750V, @ .005A	7.45
352-7196	1140/1.25MA, 2.5V/1.75A, 2.5V/1.5A—5KV TEST.	3.95
352-7176	320VCT/50MA, 4.5V/3A, 6.3V/CT 20A, 2x6.3VCT/6A	4.75
RA6400-1	2.5/1.75A, 6.3V/2A—5KV Test.	2.39
901692	13V9A	2.49
901699-501	2.7V @ 4.25A—10KV Test	3.45
Ux8855C	90VCT/75MA, 100V/.04A	4.29
RA6405-1	90VCT/.067A, 5V/3A	3.79
T-48852	800VCT/65MA, 5VCT/3A	3.69
KS9236	700VCT/806MA, 5V/3A, 6V/1.75A	4.25
352-7098	2500V/6MA, 30VCT/15MA	5.95
KS9336	110V/50MA TAPPED 625V/2.5V/5A	3.95
M-7474319	6.3V/2.7A, 6.3V/.66A, 6.3VCT/21A	4.25
KS8984	27V/4.3A, 63V/2.9A, 1.25V/.02A	2.95
52C080	650VCT/50MA, 6.3VCT/2A, 5VCT/2A	3.75
32332	400VCT/35MA, 6.4V/2.5A, 6.4V/.15A	3.75
68G331	1.0-0-1150V 2MA	21.75
80C198	6VCT/.0006 KVA	1.75
32433A	6.3V/9.1A, 6.3VCT/6.5A, 2.5V/3.5A, 2.5/3.5A	4.85
KS 9445	892VCT/18MA, 6.3V/8.1A, 5V/2A	5.95
KS9685	110V/50MA, 6.4V/3.8A, 6.4/2.5A	4.79
70G30G1	600VCT/36MA	2.65

MICROWAVE ANTENNAS

3 cm. Horn, 1" x 1/2", with twist and 180 deg. bend. With dielectric window. As shown \$22.50
AT49/APR—Broadband Conical, 300-3300 MC, Type N Feed \$8.95
Discone Antenna. AS 125 APR. 1000-3200 mc. Strip supported with type "N" Connector. \$14.50
AS14A/AP. 10 CM pick up dipole assy. complete w/ length of coax and "N" connectors. \$4.50
AS46A/APG-4 Yagi Antenna. 5 element array. \$22.50
30" Parabolic Reflector Spin Aluminum dish. \$4.85
AN/APA-12 Sector Scan adaptor for APS-2 radar. Complete Kit. \$37.50
TPS-3. 10 Ft. Dish. "Chicken Wire" Parabolic. Extremely lightweight, portable. \$125.00
AN-154 3 vertical dipoles working against a rectangular mesh approx. 3'x4'. Freq. 140-200 mc. with lobing switch (115V. 60 cy) and portable slatted crate. Extremely rugged. \$27.95
LP-24 Alford loop, for use with glide-path transmitters (MRN-1, etc.) 100-108 mc. \$32.50
18" PARABOLIC DISHES, spun aluminum. Focus approx. 8 inches. \$4.95

THERMISTORS

D-164699 Bead Type DCR, 1525-2550 Ohms @ 75 Deg. F. Coefficient: 2% Per Deg. Fahr. Max. Current 25 MA AC/DC \$1.00
 D-167332 Bead Type DCR is 2525-2550 Ohms. Rated 25 MA at 925-1175 VDC \$1.00
 D-167613 Disk Type DCR: 955 Ohms @ 75 Deg. F. P.M. 2.5%, 1 Watt. \$1.00
 D-166228 Disk Type 7120 Ohms @ 60° F. 4220 Ohms @ 80° F. 2590 Ohms @ 100° F., 1640 @ 120° F. \$1.00

JAN WAVEGUIDE FLANGES

UG 39/U	\$1.10	UG 51/U	\$1.65
UG 40/U	\$1.25	UG 52/U	\$3.40
UG 40A/U	\$1.85	UG 52A/U	\$3.40

TEST SETS

TS-13/AP-X BAND RADAR TEST SET—Measures power, freq., signal-to-noise ratio, I.F. Bandpass, etc. Input—115/140 800— WRITE
TS-35A/AP-X-BAND—Measures transmitted power & frequency of Radar Transmitters, also used for receiver adjustments. NEW. \$375.00
TS-100/AP—TEST SCOPE, type A, R, J & X indications, gated & ungated sweep, Int. or Ext. trigger. WRITE

TS-56A/AP TEST EQUIPMENT

Storied line test equipment designed for operation over a frequency of 500-675 MC. Has impedance of 51 ohms. Ideal test set for matching antennas, measurement of characteristics of transmission line. With instructions manual. New. Shipping \$1200.00 wt.: 41 lbs.

TEST OSCILLATOR TS-47/APR, 40-2000 + Mc. Fundamental coverage 40-500 Mc in two ranges. Harmonics above 2000 Mc. Provides a calibrated (dial accuracy ± 0.7 per cent) H.F. source for testing receiving equipment. Output 3MW or more up to 400 Mc. Less on harmonics. CW, mod. pulse or sine wave output. Operates on 115/230 60 Cy. or batteries. Part of APR countermeasures equip. \$1650.00

BARGAIN SPECIALS

500 MC. RECEIVERS, Type ASB. Uses lighthouse cavity-tuned RF Amp. and Mixers, plus GL-446 oscillator. I.F. is 60mc. New less tubes. \$7.50
CAPACITOR Sp. H. 30-300 200 MIMF. per section, 6 KV, working, air space—0.168", Mfg. Cardwell. \$14.50
NFI-1 Noise Filters, Rated 100A/.35 volts DC. AAP = 3300-399857005, Mallory. \$9c
POWER SUPPLY and modulator, MP-28, For TA-12 transmitter. Dynamotor rated. Input: 28 VDC/14.8A. Output 540V/450 MA. New. \$21.50
TU-6 Tuning Units for BC 375 transmitter. Brand New. complete with case. \$3.95
RANGE CALIBRATOR, Scales, Mod III. For accurate checking of Sweeps, Markers, and Range Scopes \$185.
PANORAMIC ADAPTER AN/APA-10. A Combined Panoramic Adapter and Scope. Has 3 inputs for feeding in receiver I.F.'s of 455KC, 9.2 Mc or 30 Mc. Designed also to be used as regular scope for testing other equipment. Has both vertical and horizontal push-pull amplifier 3/4 CR tube and instruction manual. \$115.00 for operation on 115V. 400 cycles.
NAVY ADF Receiver OZ-1, made by RCA. Continuous 15 to 1750 kc in 6 bands. gear-train tuning with vernier and coarse scales, broad or sharp band-pass. CW or MCW. All controls on front panel. No headaches of mechanical or electrical control interconnections. Beautifully built with 5-gang tuning capacitor, shielded tubes and coils. 8 tubes: 8-6D6, 2-7B, 2-6C6. Complete with tubes, less power sup. \$2295 only
TYPEWRITER DESK WELLS Mounted on Steel Panel for Standard Rack Mfg. 10 1/2" H x 19" W x 3/4" Thick. Well is 22" Wide, 20" Deep. Affording Full Working Space. Gray \$6.95 ea. Crinkle Finish New.
RECORDING DISKS, Wilcox-Gay, 6-in. paper base with plastic coat. Packed 60 per box \$2.50
SWITCH, MOTOR-DRIVEN 24VDC DPDT Ideal for multiple-indicator oscilloscope. Switch connections are lo-loss 50-ohm connectors. New \$4.50

VACUUM TUBES

1N21	28¢	5J23	\$34.50	700B	\$8.75
1P5GT	45¢	5J30	\$14.50	700D	\$8.75
1P30	\$1.10	5J33	\$4.75	703A	\$1.50
2C21	35¢	5B5/5C30	\$1.10	704A	95¢
2C22/7193	7¢	7C4/1203A	\$1.18	705A	75¢
2C28A	8¢	9CP7	\$3.45	706A	\$9.75
J21A	\$2.25	10Y	10¢	708D	\$14.75
J22	\$2.50	15R	15¢	706EY	\$9.75
J26	\$2.50	39/44	8¢	706CY	\$9.75
J27	\$3.00	QK59	\$39.50	708A	\$2.10
J29	\$18.50	Q50	\$35	709A	\$2.45
J31	\$13.95	QK61	\$50	713A	85¢
J32	\$14.50	QK62	\$54	C-722A	90¢
J38	\$9.00	CEQ-72	59¢	725A	write
J37	\$9.50	ML-100	\$69.50	730A	\$8.50
J39	\$8.25	HY 14B	\$25	800	65¢
J40	\$22.50	52	\$25	817	85¢
J46	\$48.50	258A	\$2.25	817	85¢
J46	\$6.75	316A	50¢	843	19¢
3EP1	\$1.75	355A	\$12.50	851	\$12
3FP7	\$1.10	358B	\$10.50	864	19¢
J434	\$23.50	393A	\$4.50	876	75¢
J438	\$8.85	417A	\$4.50	876	75¢
J442	\$47.50	CL471A	\$2.10	1605	20¢
5FP7	\$1.10	WL531	\$2.75	1619	15¢
5GP1	\$4.50	532/1832	\$1.10	1626	10¢
SHP4	\$3.50	GL559	75¢	1629	10¢
				8012	\$1.75



CERAMIC-CASED MICA CAPACITORS

Cap.	Volts	Amps/KC	Size	Price
.03MFD.	2,000	33/300	G2	\$7.85
.0015MFD.	10,000	—	G2	\$10.95
.004MFD.	5,000	7.5/300	G2	\$7.50
.15MFD.	2,500	40/300	G4	\$17.50

—Special C.D. Case, Cast Al.

PULSE NETWORKS

15A—1400-50: 15 KV. "A" CKT. 1 microsec. 400 PPS, 50 ohms imp. \$22.50
G.E. #3E (3-84-810) (8-2-24-405) 50PIT: 3KV "E" CKT Dual Unit: Unit 1, 3 sections, 0.84 Microsec. 810 PPS, 50 ohms imp.; Unit 2, 8 sections, 2.24 microsec. 405 PPS, 50 ohms imp. \$24.50
7-5E3-3-200-6P: 7.5 KV "E" Circuit, 3 microsec. 200 PPS, 67 ohms impedance, 3 sections. \$7.50
7-5E4-16-60, 67P: 7.5 KV "E" Circuit, 4 sections 16 microsec. 60 PPS, 67 ohms impedance. \$15.00
7-5E3-3200-67P: 7.5 KV "E" Circuit, 3 microsec. 200 PPS ohms imp. 3 sections. \$12.50
H-61 10KV, 2.2 usec. 2.5 PPS, 50 ohms imp. \$27.50
H-615 10KV, 0.85 usec. 750 PPS, 50 ohms imp. \$27.50
KS8865 CHARGING CHOKE: 115-150 H @ .02A. 32—40H @ .08A, 21KV Test. \$37.50
G.E. 25E5-1-350-50 P2T: "E" SKT. 1 Microsec. Pulse @ 350 PPS, 50 OHMS Impedance. \$69.50
KS9623 CHARGING CHOKE: 16H @ 75 MA, 50 Ohms DC. 300V Test. \$14.95
G.E. 6E3-5-2000 50 P2T: 6 KV. "E" Circuit 0.5 usec./2000 PPS/50 ohms/2 sections. \$7.50

PULSE TRANSFORMERS

GE #K2748 A. 0.5 usec @ 2000 Pps. Pk. Pwr. out is 32 Kw. Impedance 40/100 ohm. Pk. volts 2.3 KV Pk. Sec. volts 11.5 KV Pk. Bifilar rated at 1.3 Amp. Fused with magnetron well. \$24.50
K-2745 Primary: 3.1/2.8 KV, 50 ohms Z. Secondary: 14/12.6 KV 1025 ohms Z. Pulse Length: 0.25/1.0 usec @ 600/500 PPS. Pk. Power: 200/150 KW. Bifilar: 1.3 Amp. Has "built-in" magnetron well. \$32.50
K-2461-A. Primary: 3.1/2.6 KV—50 ohms (line). Secondary 14/11.5 KV—1000 ohms Z. Pulse Length: 1 usec @ 600 PPS. Pk. Power Out: 200/130 KW Bifilar: 1.3 Amp. Fitted with magnetron well. \$29.50

PULSE MODULATORS

MIT. MOD. 3 HARD TUBE PULSER: Output Pulse Power 144 KW (12 KV at 12 Amp). Duty Ratio: 001 max. Pulse duration: 5, 1.0, 2.0 microsec. Input voltage: 115 v. 400 to 2100 cps. Uses: 715 B, 4-89 J, 3-72 B, 1-73. New. \$135
ASD Modulator Units, mfd. by Sperry. Hard tube pulser, delivers Pk. pulse of 14 kv. Similar to Mod. 3 unit, but new new tubes. \$85.00
Airborne RF head, model A1A, delivers 50 Kw peak output at 9000 mc. at .001 duty. Complete with pulser unit and all tubes. Used, excel. \$185.00

DYNAMOTORS



TYPE	INPUT		OUTPUT		Price
	VOLTS	AMPS	VOLTS	AMPS	
BDAR83	14	3.8	375	.150	\$6.50
35X-059	19	3.8	405	.095	4.35
PO5X-15	14	2.8	220	.08	8.95
DM33A	28	7	540	.250	3.95
23350	27	1.75	285	.075	3.95
B-19	12	9.4	275	.110	6.95
DA-3A*	28	10	300	.260	3.95
			150	.010	
			14.5	5.	
PE 73CM	28	19	1000	.250	17.50
ED 60	14	2.8	220	.08	8.95
DAG-33A	18	3.2	450	.06	2.50
DM25	12	2.3	250	.05	6.95
BDAR 93	28	3.25	375	.150	6.95

*Less filter.
 *Used, Excellent.
 PE 94, Brand New \$9.95

INVERTERS

800-1B Input 24 vdc, 62 A. Output: 115 V. 800 cy. 7A. 1 phase. Used, excellent. \$18.75
PE-218H: Input: 25/38 vdc, 92 amp. Output 115V 300/500 cy 1500 Volt-ampere. NEW. \$32.50
PE206: Input: 28 vdc, 36 amps. Output: 80 V 800 cy 500 volt-amp. Dim. 13 x 5 1/2 x 10 1/2. New. \$22.50
EICOR—ML 3011-5, Input: 13.75 V; 18.4A. Output: 115 V/400—36, 0.95 PF. New. \$59
PU 7/AOP, Input: 28 vdc/160A. Output: 115 VAC, 400—10, 500 VA. 21.6 Amp. Volt. and Freq. Reg. Used, Exc. \$75

DELAY NETWORKS

D-168184: 0.5 usec. up to 2000 PPS, 1800 Ohms. \$1.00
 D-170499: 0.25/5/75 usec. 8 KV., 50 Ohms. \$8.50
 D-165997 Delay 1.25 usec. \$5.00
 RCA = 255686-502: 1.7 usec. 1400 ohm impedance \$2.00
 D-162311. Delay of 0.5 usec. 72 ohms with 4 MC Bandwidth. \$1.75
 D-168435 Delay 0.5 usec. 555 ohms. 5mc. BW. \$4.50
 D-172578. 416 ohms imp. 0.22 usec. Delay. \$4.75
 D-150979: Oscillating network. Oscillates at 81.955 kc. When normal current of 10ma. is interrupted. Has built-in temperature control for stability. Assembled in shielded can 4" L x 4" Diam. \$4.35

MAIL ORDERS PROMPTLY FILLED. ALL PRICES F.O.B. NEW YORK CITY. M.O. OR CHECK. ONLY SHIPPING SENT C.O.D. RATED CONCERNS SEND P. O. PARCELS IN EXCESS OF 20 POUNDS WILL BE SHIPPED VIA CHEAPEST TRUCK OR RAILX.

131 Liberty St., New York 7, N. Y. Dept E-6 Chas. Rosen Phone: DIgby 9-4124

SEARCHLIGHT SECTION

WANTED
BC-788, T-47A/ART-13,
BC-348R, R-5/ARN-7,
RT-18/ARC-1

RADALAB
 87-17 124th STREET
 Richmond Hill 18, New York
 Phone Virginia 9-8181-2-3

Prices FOB NYC. Rated firms open account. Prices subject to change without notice.
CABLE: Radalab, NY
TELETYPE: NY-4-4361

AN/TXC-1, RC-120 FACSIMILE SETS

Page sending and receiving equipment. These sets will transmit and receive a 12 by 18 inch or a 7 by 8 inch page of written or picture material over a telephone line or a radio circuit in 20 minutes. The copy may be sent on or received on either photographic printing paper or on direct recording paper. Power input is 110v 60 cye. POR.

AN/ASQ-1 and 1A MAGNETOMETERS

This is an airborne magnetometer used to measure the magnetic flux of the earth and to locate submarines and other metallic objects by their distortion of the magnetic field. Sensitivity 2-3 gamma or better. POR.

AN/GSQ1-A SPEECH SCRAMBLERS

Speech scrambler for use on any comm. channel to insure privacy. We can supply complete installations of this equipment 28v DC input. Also 110v 60 cye.

RC-115V 75 MC FAN MARKER

This is a 75 C Marker Beacon Ground Station. This equipment comes mounted in a transporting trunk. The set can emit either inner, outer, or airways signals. The transmitter is crystal controlled and operated from 110 Volts 60 cye. POR.

SCR-291A

Automatic ground direction finder covering 1.5mc-30mc. Provides instant bearings on a C.R. indicator of any signal in its range. This equipment is transportable and can be set up quickly. 110v 60 cye. POR.

AN/ARC-1

100-156 mc. VHF transmitter-receiver. This equip. provides phone operation in 10 crystal controlled automatically selected channels from 100-156 mc. with one guard channel. We can also modify these sets for 20 and 50 channel operation and can supply complete sets for ground operation from 110v 60 cye supply. Normal input 28v DC. POR.

AN/APQ-15

Multiple echo equipment. This set will pick up signals from a ground search radar and re-transmit from making the plane carrying it look like an entire fleet of planes on the ground radar. POR.

SCR-682 A RADAR

10CM high power long range harbor surveillance and early warning RADAR. This equipment is a 3000 mc mobile search radar that can be transported in a truck. The equipment incorporates a 7" PPI for operation up to 240,000 yards. Azimuth accuracy is $\pm 1\%$. Range accuracy is 100 yards at 10,000 yard range and 5000 yards at 240,000 yard range. Trans. output is approx. 225 KW, pulse width is one microsecond. Antenna beam width is 6". Input is 110v 60 cye. Can be supplied with or without operating shelter or antenna tower. POR.

SCR-718C

The SCR-718C is a high altitude radar altimeter to be used in aircraft. 2 ranges are provided in the 0-40000 foot range. The aircraft altitude is read directly on a cathode ray indicator. The set has an output of app. 100 watts pulse at 400 mcs. CAA approved. Input 110v 400 cye. POR.

We can supply many types of radars, test sets, communications equipments, manufactured after 1947. Write us if you cannot find it.

AN/APR-4 38-4000 MC RECEIVER

This is a precision receiver covering 38-4000 mc. The set utilizes 5 tuning units with direct reading dials in megacycles. The receiver has a wide and narrow band-width 30mc. I.F. strip which may be selected at will. An output meter is provided to measure signal strength. Outputs are provided for a pulse analyzer and pan adaptor. Each tuning unit has an automatic sweeping mechanism which enables any portion of the tuning range to be scanned automatically. Input 110v 60 cye. POR.

L-BAND SIGNAL GENERATOR

This is a high precision signal generator covering 500-1300 mc. A precision attenuator is built in providing accurate determination of output from 0-100,000 microvolts. Either CW or pulsed carrier output with the following characteristics are provided. Pulse rate 60-2500 CPS. Pulse length 2-30 microseconds. Output line 50 Ohm impedance. Accuracy better than one percent. Input 110v 60 cye. With calibration charts. Price. \$249.50

U.H.F. SIGNAL GENERATOR

This set covers 90-600 mc. with an accuracy of one percent or better. C.W. or pulse output with the following characteristics are provided. Output from 0-100,000 microvolts 2-30 microseconds long. Pulse rate 60-2500 cye. Pulse delay 3-300 microseconds. Output 50 ohm line. Input 110v 60 cye. Price. \$249.50

CF-3A CARRIER REPEATER

This is a transportable 4 wire carrier telephone repeater. This set amplifies all signals when used in an intermediate position on a carrier system to extend the range. DC signaling and telegraph communications can be performed to the terminal equipments or to other repeaters. Monitoring and transmission circuits are built in. Power input 110 or 220v or 12v DC. This set can be used with all CF terminals and commercial equipments. Brand New in original cases. POR.

AN/APA-17 DIRECTION FINDER

This is an automatic direction finder covering 300-1,000 mc to be used with the APR-1 and APR-4 radar search receivers. The bearing is presented on a cathode ray screen in a cardoid pattern. The set can be used in aircraft or on the ground. Input 110v 400 cye and 28v DC. POR.

S
B
A
N
D

GUIDED MISSILE BEACON FILTER CAVITY F-28/APN-19
 2700-2900mc. Max. 1.5-db loss at ctr. freq. over band, 3db at 15 mc band ends. JAN spec. Ideal as standard reference cavity. Brand new. Guaranteed. \$37.50.
AN/APN-60 Crystal Mounting, \$19.50.
COAXIAL CRYSTAL MOUNT. Type N fittings, tuneable silver plated. Holds any IN21 type Xtal. \$9.50.
LIGHTHOUSE CAVITY. For 2C40 tube. Tuneable 2700-2900mc w/suitable grid cycles. Can be freq. modulated. \$22.50.
FEEDBACK DIPOLE coax. 11 3/4" o.d. \$14.50.
ECHO BOX, TS-207/UP. 2700-2900mc. \$64.50
ECHO BOX, OBU-3. Precision w/detector and meter. \$325.00.

60MC. IF STRIP
 Uses (6) 6AK5 Mfg. Western Electric. Price, \$14.50.

X
B
A
N
D

MITRED BEND. Vy Short Radius. E plane. \$10.00.
TRANSITION, 1"x1/2" to 1/4"x3/8" Lgth 3 3/4". \$6.50
TWIST, 90 DEGREE, UG39 to UG40. Silver plated. \$6.50.
CRYSTAL MOUNT. Hold any IN23 type xtal. 1" x 1/2" guide std coax output. UG40 fig. Input. \$15.00.
DIRECTIONAL COUPLER. Uni. or Bi directional types 20db coax "N" output. UG39 fig. to UG40 clk. \$24.50.
FLEX. SECT. 0". UG39 figs. \$10.00, 12" at \$17.50.
ROTARY JOINT. 3 types available, miniature 180 deg. input output, miniature 90 deg. input output, large 90 deg. input output 360 deg. rotary coupling for lab or high speed scanner VSWR 1.2 or better. \$15.00.
LINE STRETCHER. VSWR matching device for XMSN Lines. \$34.50.

K
B
A
N
D

MAGIC TEE. precision. \$22.50
DIRECTIONAL COUPLER bi-dir. UG-113/U ranges. \$22.50.
KLYSTRON OUTPUT COUPLING for 2K50, RG 66/U guide. \$8.50.
H BEND 90 deg. CG346/U.
E BEND 90 deg. CG345/U. Cplg. UG-117 to UG-116. RG66 guide. \$12.50.
ADAPTERS. 1 1/2" lg UG116 to UG116. UG117 to UG117 ea. \$5.00

W.E. STEPPING RELAY
 44 Step, 2 Levels, Bridging Wipers, Gold Plated Contacts. Oper. Voltage 5.5 to 12 V.D.C. 4.4 Ohms. Inter. Contact 1 Break-Make. Price One to 10 Pieces \$12.00 Each. Brand New. Quan. Discounts.

RADIO-RESEARCH INSTRUMENT Co.
 550 - 5 Ave., N. Y. 36, N. Y. Tel: JU 6-4691
PAUL J. PLSHNER

FOR SALE
Wholesale to Industrials and Dealers Only

RECEIVERS
TRANSMITTERS
MODULATORS
SYNCHRONIZERS
JUNCTION BOXES
CONTROL BOXES
MICROWAVE ACCESSORIES
KLYSTRON MOUNTS
WAVE GUIDE
DUPLEXERS
MAGNETS
I.F. STRIPS
NETWORKS
TRANSFORMERS
TEST EQUIPMENT
METERS
INSTRUMENTS
RELAYS
CONTACTORS
DYNAMOTORS
MOTORS
BLOWERS
SYNCHROS
TORQUE UNITS
SWITCHES
CAPACITORS
RESISTORS
POTS
CONNECTORS
ALL TYPES OF TUBES

WRITE TO
AMBER INDUSTRIAL CORPORATION—Metals Division
 732 E. Monument Ave. Dayton, Ohio
 By Appointment

Specialists in TUBES
All Famous Name Brand Radio and TV Receiving Tubes, Transmitting Tubes, Special Purpose Tubes

You get **immediate delivery** on these high quality, low priced tubes taken from one of the most extensive selection of tubes available. Order now!

We handle such brands as: Hallicrafters, National Union, Zenith, Admiral, Stewart-Warner, Raytheon, RCA, Philco, Sylvania, Crosley, B-E, Motorola, Testron.

SPECIALS: Transmitting Tubes

807 \$1.00	3B28 \$2.00
2X2A90	2C46 \$6.00
2D2165	6A56 \$1.75
6080 \$2.25	HF200 \$6.00

This is just a partial list of types available. Phone or mail your order. Send for our complete tube listing.

B & C DISTRIBUTORS COMPANY
 180 Spring Street • Paterson, N. J.
 MUlberry 4-4010

2K28 Tubes - Fully Guaranteed **\$2850**

Write for Quotations on Any Types
ALLIED ELECTRONIC SALES
 74 COURTLANDT ST.—NY. 7, N.Y.
 BARclay 7-5839

Watch—
the Searchlight Section
for
Equipment Opportunities

SPECIAL PURPOSE TUBES

OA2	7.50	EL-3C	5.50	7BP7	5.00	WE-124A	3.50	WE-347A	3.50	807W	4.75	1629	2.25
OA3	1.00	EL-3CJ	7.50	7CP1	15.00	VT-127A	1.50	WE-348A	5.00	808	1.50	1630	.75
OA5	4.00	3C22	60.00	7EP4	10.00	F-128A	20.00	WE-349A	7.50	809	2.75	1631	1.50
OB2	.75	3C23	3.75	9GP7	5.00	HF-130	1.50	WE-350A	3.00	810	10.00	1632	.50
OB3	.75	3C24	1.50	9LP7	3.50	VR-150	.75	WE-350B	3.00	811	3.00	1633	.75
OC3	.75	3C31	2.50	9MP7	7.50	FG-154	17.50	WE-351A	6.00	811A	4.00	1634	1.35
OD3	.75	3C37	30.00	10Y	.35	HK-154	5.00	WE-352A	10.00	812	2.25	1635	1.50
EL-C1B	2.50	3C45	7.00	CE-11V	2.50	VT-158	10.00	F-353A	2.00	813	12.00	1636	1.25
EL-1C	1.50	3D21A	6.00	12A6	.50	FG-166	25.00	WE-353A	3.50	814	2.00	1641	1.50
1B22	1.50	3D22	9.75	12DP7A	35.00	FG-172	20.00	WE-354A	15.00	815	1.35	1642	.50
1B23	3.50	3DP1	3.75	12GP7	15.00	QK-181	20.00	WE-355A	15.00	816	1.50	1644	1.00
1B24	4.75	3DP1A	7.50	12J5WGT	2.00	FG-190	7.50	WE-359A	3.00	822	10.00	1649	1.00
1B26	1.25	3E29	10.00	12K8Y	.75	HF-200	12.50	WE-368A	3.00	826	1.00	1654	3.50
1B27	10.00	3EP1	2.00	12L8GT	1.00	CE-201	4.00	371A	.75	828	7.50	1655	2.00
1B32	1.00	3FP7	2.00	LM-15	200.00	C-202	7.50	371B	1.00	829	7.50	1656	6.50
1B35	4.75	3FP7A	5.00	NE-16	.35	203A	5.00	F-375A	15.00	829B	10.00	1661	6.00
1B38	30.00	3GP1	2.50	FG-17	3.50	203Z	5.00	WE-388A	1.50	830B	1.00	1846	50.00
1B40	3.50	3HP7	3.00	RK-19	1.00	204A	35.00	WE-393A	5.00	832	4.00	1851	1.75
1B42	4.50	3J21	75.00	RK-20A	9.75	WE-205B	.75	394A	2.50	832A	5.50	1887	100.00
1B51	7.25	3J31	35.00	TZ-20	2.00	207	75.00	WE-394A	3.50	833A	35.00	1904	10.00
1B59	10.00	3JP1	9.50	CE-21C	3.00	211	.75	410R	100.00	834	7.50	1960	.50
1C21	2.00	3KR7	150.00	RK-21	1.00	WE-211C	10.00	WE-417A	15.00	835	10.00	1984	10.00
1P21	30.00	3KP1	7.25	RK-22	3.50	WE-211D	8.00	WL-417A	5.00	836	2.50	2000T	150.00
1P23	2.00	3RP1	7.25	CE-23C	1.50	211W	5.00	GL-434A	3.00	837	1.00	2050	1.25
1P25	75.00	4-400A	40.00	PJ-23	2.00	WE-212E	25.00	446A	.50	838	1.25	2051	.75
1P30	2.00	KC-4	75.00	RK-23	2.75	217A	2.00	446B	2.00	842	2.50	2172	12.50
1P32	1.00	4AP10	3.75	HK-24	3.00	217C	5.00	450TH	50.00	843	.50	2183	5.00
1P34	1.75	4B22	6.50	HK-24G	1.00	WL-218	25.00	450TL	45.00	845	6.50	2252	25.00
1P36	2.50	4B23	15.00	CE-25A/B	2.00	CE-220	.75	451	5.00	845W	8.50	ZB-3200	75.00
1Z2	2.00	4B24	5.50	RK-25	3.00	WE-220B	100.00	WL-460	10.00	846	75.00	R-4100	7.50
VG-2	10.00	4B25	8.00	25T	3.00	220C	150.00	464A	2.25	849	25.00	R-4330	10.00
2AP1	5.00	4B26	3.50	25TG	1.00	CE-221	8.00	WL-468	15.00	850	25.00	5528	3.75
2AP1A	5.00	4B27	4.00	FG-27A	12.00	CE-222	1.50	SS-501	7.25	851	12.50	5550	35.00
2AS15	6.00	4B28	3.00	CE-28D	2.50	CE-224	5.50	RH-507	35.00	852	7.50	5551	40.00
2B21	1.00	4B30	.75	RK-28	2.50	CE-225	3.00	CK-510AX	.75	860	3.00	5553	135.00
2B26	1.50	4B31	35.00	28D7	.75	CE-226	3.00	527	15.00	861	15.00	5556	6.75
2C21	.50	4B32	10.00	28D7W	1.50	WE-231D	2.00	WL-525	10.00	864	.35	5557	3.50
2C22	.35	4C22	7.50	CE-29	1.25	RX-233A	.75	WL-530	15.00	865	.50	5560	17.50
2C24	.75	4C25	3.00	CE-30C	1.25	CE-235A	5.00	WL-531	5.00	866A	1.15	5610	1.25
2C25	.35	4C27	3.50	Twin 30	7.50	235R	50.00	WL-532A	1.00	868	2.00	5625	75.00
2C26A	.50	4C30	1.50	HY-30Z	2.75	WE-242A	5.00	WL-535	10.00	851	12.50	5632	7.50
2C33	.75	4C35	15.00	CE-31V	2.50	WE-242C	8.00	WL-538	.50	852	7.50	5645	6.50
2C34	.35	4E27	9.00	FG-32	6.00	WE-249B	3.25	GL-553	2.00	860	3.00	5651	1.50
2C39A	8.50	4J52	50.00	FG-33	11.50	WE-249C	3.25	559	.75	861	15.00	5656	7.50
2C40	7.50	4X100A	25.00	RK-33	.50	250R	5.00	GL-564	1.50	864	.35	5670	2.00
2C42	15.00	EL-5BHD	15.00	RK-34	.35	250TH	20.00	575A	15.00	878	1.00	5691	5.00
2C43	12.00	EL-5B2.5	6.50	35TG	3.00	250TL	15.00	WL-579B	10.00	879	.35	5696	1.00
2C44	.50	5AP1	2.00	RK-38	6.50	WE-251A	50.00	KU-610	7.50	884	1.25	5703	1.25
2D21	.75	5B21	2.00	RK-39	2.50	WE-252A	10.00	HY-615	.50	885	1.25	5720	11.50
2D21W	1.50	5BP1	2.00	T-40	2.50	WE-253A	5.00	WL-629	1.25	902P1	3.50	5725	2.00
2E22	2.00	5BP1A	10.00	TZ-40	3.50	WE-254A	6.00	WL-630	1.00	905	2.00	5728	10.00
2E24	2.50	5BP2A	10.00	CE-42C	1.50	HK-257B	9.00	631-P1	7.50	913	15.00	5740	44.00
2E26	3.25	5BP4	2.00	RK-44	1.00	WE-257A	2.25	WL-632A	17.50	917	2.50	5801	2.50
2J21A	3.50	5C21	6.50	QK-47	50.00	FG-258A	135.00	WL-655/658	135.00	918	2.00	5820	350.00
2J26	5.00	5C22	30.00	RK-47	1.75	WE-258B	5.00	WL-670A	8.00	919	2.50	5826	375.00
2J27	5.00	5C30	1.50	CE-48	1.75	WE-259A	12.50	WL-681/686	35.00	921	3.00	5827	2.50
2J29	15.00	5CP1	3.00	RK-49	3.00	WE-261A	10.00	WE-701A	3.00	922	1.00	5829	1.50
2J30	25.00	5CP1A	10.00	HY-51B	1.00	WE-262B	7.00	702A	.50	923	1.50	5842	15.00
2J31	15.00	5CP7	7.50	FP-54	44.00	WE-264C	3.00	702B	1.00	923	1.50	5932	4.75
2J32	15.00	5D21	7.00	HK-54	3.00	WE-267B	10.00	703A	2.00	924	1.35	5933	4.75
2J33	15.00	5D23	7.50	T-55	5.00	WE-271A	10.00	WE-704A	1.00	925	2.50	5948	250.00
2J34	15.00	5FP7	1.50	RK-57	2.75	WE-272A	5.00	705A	1.00	926	2.50	5963	1.00
2J36	25.00	5FP14	5.00	RK-58	1.25	WE-274A	4.75	707A	3.50	927	1.00	5981/5650	50.00
2J37	5.00	5GP1	5.00	QK-59	35.00	WE-274B	3.00	707B	4.50	928	2.50	6010	1.25
2J38	10.00	5J26	100.00	QK-60	5.00	274B	.75	WE-708A	1.00	929	1.25	6011	4.75
2J39	10.00	5J29	7.50	RK-60	1.50	WE-275A	5.00	WE-709A	1.00	930	1.25	6013	10.00
2J40	15.00	5J30	7.50	HY-61	1.25	276A	3.00	710A	.50	931A	2.75	6033	7.25
2J50	35.00	5J32	25.00	QK-61	35.00	WE-288A	7.50	713A	5.00	954	.35	R-6160	2.00
2J51	150.00	5JP1	15.00	RK-61	2.00	WE-283A	4.00	714AY	17.50	955	5.00	R-6175B	2.00
2J53	25.00	5JP2	7.50	QK-62	35.00	WE-285A	5.00	715A	2.50	956	.75	R-6200	1.75
2J55	50.00	5JP4	7.50	RK-62	1.75	WE-286A	6.00	715B	5.00	957	3.5	R-6210	15.00
2J56	75.00	5JP5A	7.50	RK-63	20.00	WE-287A	5.00	WE-715C	15.00	958A	7.75	UX-6653	.75
2J61	15.00	5JP11	25.00	HY-65	3.00	WE-295A	8.00	717A	.50	959	1.75	8001	9.00
2J62A	5.00	5LP1	8.00	RK-65	7.50	WE-296A	25.00	WE-719A	10.00	991	.35	8002R	25.00
2J62B	50.00	5LP1A	25.00	FG-67	10.00	HF-300A	17.50	721A	1.00	CK-1005	.35	8005	4.25
2K25	1.00	5MP1	5.00	RK-69	2.00	WE-300B	7.50	721B	7.50	CK-1006	2.00	8008	6.00
2K28	12.50	5R4GY	1.00	RK-72	.75	CE-302	1.00	722A	1.00	CK-1007	.75	8011	.10
2K29	30.00	5R4WGY	1.50	RK-73	.75	EL-302.5	5.00	723A/B	10.00	CK-1009	5.00	8012	1.00
2K30	100.00	5X3	3.00	HY-75	3.00	CE-303	2.50	WE-724A	1.00	CK-1026	3.00	8012A	2.50
2K33A	75.00	EL-C6A	6.00	RK-75	1.00	WE-304B	7.50	WE-724B	1.00	R-1100	5.00	8013	2.75
2K39	135.00	EL-C6J	6.50	VR-75	1.00	304TH	10.00	WE-725A	3.50	R-1130B	10.00	8013A	3.75
2K41	100.00	EL-C6L	3.75	75TL	5.00	304TL	10.00	WE-726A	7.50	HY-1269	5.00	8014A	50.00
2K54	10.00	EL-6C	8.00	VR-78	.50	WE-305A	3.50	WE-726B	7.50	1500T	100.00	8016	2.50
2K55	7.50	6AC7W	1.00	FG-81A	5.00	307A	1.00	WE-726C	25.00	1602	2.25	8020	1.25
2P21 Image		6AJ5	1.25	VR-90	.75	CE-309	3.50	WE-730A	7.50	1603	3.50	8021	.75
2P21 orthicon	100.00	6AJ6	2.00	CV-92	3.50	WE-310A	4.00	731A	1.50	1608	3.75	8022	.75
2V3G	2.25	6AK5W	1.50	FG-95	17.50	WE-310B	5.00	WE-732A	2.00	1609	9.25	8025	2.00
2X2	.35	6AL5W	.85	C-100D	2.00	WE-311A	5.00	WL-735	2.00	1610	2.25	8025A	2.50
2X2A	1.00	6AN5	3.00	HF-100	7.50	WE-312A	3.00	WL-741	1.25	1611	1.50	8026	3.50
3A4	.50	6AR6	2.00	ML-100	75.00	WE-313C	3.00	750TL	45.00	1612	1.25	PD-8365	75.00
3A5	.50	6AS6	1.50	100R	5.00	316A	.50	WL-759	12.50	1613	1.00	9001	1.00
3AP1	5.00	6AS6W	2.00	100TH	6.50	WE-323A	10.00	WL-786	25.00				

BLOWERS:



1-24 VDC—AC CAST ALUMINUM BLOWER (Pictured at left)—100 CFM; 3" intake; 2" outlet. Shunt Motor 4"x2"; 3000 RPM @ 24 VDC. \$5.95

6 VDC SINGLE—100 CFM—No. 6100\$4.95

6 VDC FLANGE—150 CFM—No. 6150\$6.95

24 VDC DUAL—20 CFM—Min.—No. 2420.....\$7.95

10 CFM BLOWER (Pictured—right); 27.5 VDC; 1/100 HP; 7000 RPM; Oster Motor C2BP; 1A; L-R Mfg. Co. Bakelite Blower = 2, overall size: 3-1/4" x 4-1/2". Price\$5.95

Same as above, 12 VDC operation; Price\$5.95

115 V. 400 CYCLE—10 CFM—Eastern Air Devices Motor J31A—7200 RPM, 1/100 HP; L-R #2 Blower Assy. Overall Size: 4-1/2" x 3-1/2". No. 3110.....\$5.95



10 CFM BLOWER (Pictured at left)—28 VDC—.6 A; 5000 RPM; Pioneer Motor SS-2345; Aluminum Blower Housing; Overall Size: 4-1/2" x 3-1/2". Price\$5.95

115 V. 60 CYCLE BLOWERS:

115 VAC 60 cycle SINGLE TYPE—100 CFM; 2-3/4" intake; 2" outlet. Complete size: 5" x 6" No. 1C939\$8.95

115 VAC 60 cycle DUAL TYPE—100 CFM; 4" intake; 2" Dis. Each Side. Complete size: 8" x 6" No. 1C880\$13.95

115 VAC 60 cycle COMPACT TYPE—108 CFM; Motor built inside squirrel cage; 4-1/2" intake; 3 3/8" x 3" Dis. Complete size: 4-1/4" W x 8 3/8" H x 8-1/4" D. No. 2C067\$14.95

115 VAC 60 cycle FLANGE TYPE—140 CFM; 3-1/2" intake; 2-1/2" Dis. Complete size: 7-1/2" W x 7-1/2" H x 6-3/4" D. No. 1C807\$13.95

115 VAC 60 cycle FLANGE TWIN—275 CFM; 4-1/2" intake; 3-1/4" x 3" Dis. Complete size: 11-3/4" W x 3-3/4" H x 8-1/16" D. No. 2C069\$21.95

METERS:

WESTON AC AMMETER



(Pictured) In portable leather case, with Test Leads, 2 1/2", 0-15 AC and 0-3 AC Scale.\$5.95

DC AMMETER HOYT:

In portable metal case, with Test Leads, 4 1/2", Fan, Mirrored Scale—0-15 ADC.\$4.95
0-3 RF AMMETER IS-128—2 1/4" Rd. Flush Mtr. Calibrated F/Non Mag Panel. P/O BC-233 Transmitter NEW: \$2.95
0-8 Amp RF w/Thermocouple IS-89; 2 1/2" Rd. \$4.95
0-15 AC-DC—2 1/2" Rd.; IS-122\$4.95
0-500 Milliamper DC—2 1/2" Rd.; IS-22\$4.95

SELSYN



115 VOLT 60 CYCLE, Synchronous Transmitter C-78414, 5" x 3-1/2". Long Leads w/Bracket. Removed from New Equipment PAIR \$15.00

BC-221 FREQUENCY CASE

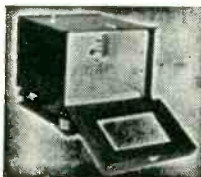

BC-221, FREQ. CASE—Aluminum Case for BC-221 or TS-164, FREQ. METER — W/Voltage Regulator Supply using 1 VR-105 — 2/Ballast Tubes, Relay, Cable, etc. Front Compartment 9-3/4" x 7-1/2" x 7-3/4". Rear Comp. 2" deep. Shock-mounted. NEW: \$4.95

**FM RECEIVER
27 TO 38.9 MC**

Four Preset Channels—Frequency Ranges 27 to 29.5—29 to 32—31.5 to 34.4—and 34.4 to 38.9 MC. Complete with 16 Tubes; 1/12SA7; 3/12SC7; 2/12SG7; 2/12SJ7; 1/VR-150; 1/61H6; 1/6S17; 2/6SL7; 1/6V6; 2/6AC7; 1/NE-20; and DC-14 Crystal 1000 KC; Crystal, Calibrator, and Speaker. Power required: 12 or 24 V. DC and 275 V. DC 150 MA. Size: 6-3/4" x 11-5/16" x 1 1/2".

BC-923 RECEIVER... NEW: \$34.95

TRANSFORMER—115 Volt 60 cycle Input; Output 325-0-325, 150 MA 12 V—2 A; 12 V—2 A; 5 V—3 A\$8.95

CHOKE—15 Hs. 165 MA—125 OHM.\$1.95
PLUG for Rear of BC-923 Receiver\$1.00

**MAGNETRON
MAGNET**



HEAVY DUTY PM MAGNET—Approx. 2000 Gauss. Size: 5-1/2" x 1-1/2" x 1-1/2" gap. 10-1/2 lbs. Removed from New Equipment\$5.95

**6 VDC VIBRATOR
POWER SUPPLY**

RCA MJ-8—6 VDC input; output 275 VDC 80 MA with: 024 Tube, 11 Pt. Battery and Power Cable, Switch, and Fused Line. Size: 4-1/2" x 4" x 6" New\$7.95

**A DEPARTMENT STORE
FOR YOUR
ELECTRONIC SUPPLIES**

WE'RE SELLING YOU RELAYS—
WHAT ARE YOUR OTHER NEEDS?
Our normal Inventory Includes Over
80,000 Different Items in the Electronic,
Radar and Radio Fields

RELAYS



ALLIED • LEACH • TELEPHONE TYPE
MINIATURE AIRCRAFT • GUARDIAN
SIGMA • HERMETICALLY SEALED
and many others



SENSITROLS

**STEPPING
SWITCHES**



SEND FOR OUR LATEST BULLETINS
AND ADD YOUR NAME
TO OUR MAILING LIST
cable address: UNIGENCOR, N. Y.

324 CANAL ST. (Near B'way) N. Y. — WA 5-9642
Universal general corp.

**TELEPHONE
RELAYS**

See our May Ad for
a more complete list-
ing



Chase

ELECTRONIC SUPPLY CO.
105-07 225 St., Queens Village, N. Y. HOllis 4-5033

FOR SALE

Transmitter Tubes
Eimac - Machlett - 750TL
List \$137.00. Our price \$32.50

J. BEEBER CO. INC.
838 Broadway AL 4-3510 New York

PULSE TRANSFORMERS

4-WINDING PLUG-IN TYPES
BERKSHIRE PT-1 8.95
PT-2 8.95
PT-3 (New low price) 5.95
SP-1, set of 1 each of above 18.75
RAYTHEON UX 7307 5.95
AUTOMATION & ELECTRONICS
25 Grant St. Waltham 54, Mass.

**FAIR RADIO SALES • 132 SOUTH MAIN ST
LIMA, OHIO**

SELLING

- Receivers
- Transmitters
- Radar
- Special Purpose Tubes
- Relays
- Meters
- Switches
- Connectors
- Rectifiers
- Transformers
- Motors & Generators
- Wiring Cable
- Instruments
- and
- All Electronic Components

WILL BUY ALL

New or Used

Leach Relay	#5059-R
	#5058
	#5055
	#5053-SM
	#5053
Price Bros. Relay	#10
Relay	#5586
	#5587
Antenna Switching Relay	
Box	# CBY 23049
	# BG-AN-198
	# BC -408
Tubes	#53A
	VT-127A
	35T
	WL-530

Highest prices paid for most all types of aircraft sparkplugs any condition

RADIO & ELECTRONIC SURPLUS

Wholesale Only

13933-9 BRUSH STREET
Detroit 3, Mich. TO 9-3403

Wholesale Only

FOR ALL BEST

RESISTORS
POTENTIOMETERS
CAPACITORS

Phone: Yonkers 9-6000
LEGRI S COMPANY
391 Riverdale Ave. Yonkers 5, N. Y.



FULL-WAVE BRIDGE TYPE

DIRECTRON SELENIUM RECTIFIERS

Max Amps.	18VAC 14VDC	36VAC 28VDC	54VAC 42VDC	72VAC 56VDC	130VAC 100VDC
1	\$1.35	\$2.35	\$3.75	\$4.50	\$7.45
2	2.00	2.75	5.35	5.90	9.15
3	2.95	4.15	5.85	7.85	12.75
4	3.50	6.45	11.35	14.35	21.75
6	4.00	7.75	12.85	17.30	25.75
10	5.90	11.45	19.50	24.80	41.35
12	7.25	14.35	22.10	29.75	44.25
20	13.05	25.05	37.25	48.75	78.50
24	14.25	28.75	44.50	57.65	81.00
30	17.95	34.35	56.50	71.00	109.00
36	22.45	42.35	65.00	86.95	134.00
50	29.50	54.35	105.45	115.75	174.00
100	59.50	119.00			

We build other Selenium Rectifiers, Transformers and Chokes to your specifications. Buy from the Direct Source for Quick Delivery.

NEW RECTIFIER TRANSFORMERS

Pri: 115V, 60 cycles input
SEC: 9, 12, 18, 24, and 36 volts. Continuous

1 Amp	\$5.75
2 Amps	6.75
5 Amps	8.65
12 Amps	16.85
24 Amps	35.65
50 Amps	59.00
100 Amps	108.00

NEW RECTIFIER CHOKES

Continuous Ratings.

1 Amp	.1 Hy	1.5 ohm	\$3.95
2 Amps	.04 Hy	3 ohm	4.95
4 Amps	.07 Hy	6 ohm	7.95
12 Amps	.01 Hy	1 ohm	14.95
24 Amps	.004 Hy	.025 ohm	29.95
50 Amps	.005 Hy	.01 ohm	54.00

FILTER CAPACITORS

Capacity	W. Voltage	Each
500 MFD	200 V.	\$1.95
500 MFD	50 V.	.85
1000 MFD	15 V.	.35
2000 MFD	50 V.	2.25
6000 MFD	15 V.	1.50

NOW AVAILABLE!

WHITE COATED TUBE CARTONS

SIZE	EACH	SIZE	EACH
Miniature	\$.01	LARGE GT.	.015
1"x1"x3"		1 1/2"x1 1/2"x4 1/2"	
6AU6, 6AL5, etc.		1B3, 6BQ6GT, etc.	
GT	.0125	LARGE G.	.02
1 1/2"x1 1/2"x3 3/8"		2 1/2"x2 1/2"	
6SN7W, 64, etc.		5U4C, 6RG6G, etc.	

Also in Super-Gloss Red and Black. Both types with new safety partitions—they meet U. S. Government specifications! Attractive discounts for quantity users. Minimum order 100 of a size. Be sure to specify white or color when ordering.

Consistent Dependable Source for Quality Tubes

- Specialists in Western-Electric, Subminiature, Jan, and Ruggedized Types.
- May new types such as GM Counter, Scintillation, 5000/6000 Series, as well as obsolete types stocked.
- Critical types Lab certified for your extra protection.
- All fully guaranteed, unused, and boxed merchandise.

OA4G	\$1.00	4J21	77.50	311C	2.50	5634	7.00	
OB3	VR90	.85	4J36	75.00	337A	6.50	5641	6.00
OC3	VR105	.85	4J37	75.00	350A	3.00	5642	.95
OD3	VR150	.85	4J63	7.00	WE355A	19.75	5651	1.40
1B26	1.50	4PR60A Surplus	75.00	359A	2.00	5656	7.95	
1B32	2.00	4X150A Surplus	35.00	394A	3.50	5670	2.15	
1B35	6.50	4X500F Surplus	65.00	401A/5590	3.10	5676	1.00	
1B85	9.95	5BP4	3.95	403B/5591	3.15	5678	1.15	
1B86	7.75	5C22	29.95	404A/5847	12.00	5686	2.00	
1P30	2.00	6A7	.85	416A	39.95	5687	3.00	
2C39A Surplus	13.75	6AG5	.60	416B	79.95	5691	5.50	
2C40	12.75	5D21	7.75	417A	4.00	5692	5.25	
2C43	12.75	5JP5	10.00	417A/5842	12.50	5693	4.75	
2C46	6.60	7BP7	4.50	422A	9.95	5696	1.15	
2C51	3.75	7EP4	12.50	429A	8.75	5702	2.00	
2E30	1.75	7GP4	12.50	464A	2.55	5703	.95	
2E31	1.90	8D21	455.00	CK503AX	1.00	5704	1.90	
2E35	1.95	12DP7	10.00	GL673	13.00	5718	4.25	
2J33	10.00					5726/6AL5W	1.10	
2J36	35.00					5732	3.00	
2J32	15.00					5744	1.00	
2J37	10.00					5751	2.50	
2J42	58.50					5762	100.00	
2J49	35.00					5763	1.10	
2J54	35.00					5780	250.00	
2K25	92.50					5795	250.00	
2K45	65.00	15E	1.00	703A	1.25	5812	2.75	
2K59	95.00	FG27A	11.95	705A	.85	5814	1.60	
2K60	95.00	FG41	12.50	707A	4.00	5820	Write	
2K61	95.00	FG67	12.00	707B	5.00	5829	2.00	
2K62	95.00	CRP72	.60	708A	2.00	5840	5.00	
3B24	1.80	FG98A	20.00	709A	1.75	5844	4.00	
3B24/W	5.00	100R Surplus	5.00	715B	3.00	5879	1.40	
3B27	3.50	100TH	6.75	715C	8.00	5881	2.65	
3B28	6.00	100TL Surplus	8.50	717A	.50	5886	2.50	
3B29	6.00	FG105	15.00	721A	.75	5899	5.50	
3C22	58.50	VT127A	2.50	722B	1.00	5963	1.20	
3C23	7.50	VXR130	.75	723A/B	9.50	6021	5.00	
3C24/24G Surplus	1.75	FG172	45.00	725A	4.50	6080	3.25	
3C31/C1B	9.25	QK181	25.00	800	2.00	6080WA	4.25	
3C45	7.95	211	.50	803	1.75	6095	1.25	
3D21A	6.00	249A	3.50	829B	8.75	6096	Write	
3J30	45.00	249B	3.50	838	1.50	6097	1.50	
3J31	45.00	253	5.50	891	125.00	6098	1.90	
3BP1	2.95	274B	1.00	958A	.50	6099	1.50	
3BP11	7.00	275A	3.50	1619	.30	6101	1.50	
3DP1	3.30	276G	8.50	1620	4.75	6113	1.25	
3FP7	9.50	300B	6.00	1851	1.75	6113	1.25	
4B24	5.00	304TH Surplus	8.75	1960	.60	6187	4.00	
4B28	3.00	304TL Surplus	8.75	5514	4.50	6189	3.75	
4E27	9.50	311A	5.50	5516	6.50	8020 Surplus	1.25	

Write For Listings of XMTG Receiving & Special-Purpose Tubes—Over 2,000 Types IN STOCK at Low, Low Prices—

Matched, compact, hermetically-sealed components for KW power supply. Ideal for new Collins KWS-1K, etc.
 • Power xfmr. Pri: 115 v. 60 cy. with taps for 1/2, 1/2, and full power. Sec: 3400 v. @ 400 ma. 39 lbs.—8"x5"x7 3/8"
 • Choke to match above—12 henries @ 400 ma. 34 lbs. 8"x5"x7 3/8"
 • Filament xfmr for 4—866A's in bridge circuit. Pri: 115 v. 60 cy. Sec: 2.5 v. @ 5.0 A, 2.5 v. @ 5.0 A., and 2.5 v. @ 10 A. Complete set only \$45.00.

Many Other Types in Stock
Phone, wire or write for quotations.

Terms: F O B—N Y C—25% Deposit with order—or send full remittance to save C O D charges—D & B Rated Firms (F21/2 or Better) Net 10 days. CABLE BARRYELECT. N. Y. TELEGRAPH BARRY ELECTRONICS. FAX. N. Y.

BARRY ELECTRONICS CORP.

Authorized Distributors of Eimac, CBS-Hytron (CBS), Cetron, Lewis & Kaufman and Penta Tubes.

512 Broadway, New York 12, N. Y. Dept. 6-E PHONE: WALKER 5-7000

SELLING OUT OUR MOTOR INVENTORY

- Delco—Permanent Magnet Alnico Field Motor with Brake #5070200—12 V. 140 RPM. @ \$8.00 each
- Delco—#5072400 with Worm Gear—27V. D. C. @ 7.50 each
- Diehl—#SSFD6-25 with and without Follower—27V. D. C. @ 6.50 each
- Oster—#1/67 HP—27V. D. C.—5000 RPM. @ 1.25 each

RAWAY SALES

4 Forsyth St. Walker 5-8150 New York 2, N. Y.

CLOSE-OUTS

#36 Fahnstock clips: 90-A soldering lugs: Ammeters for 6 ampere battery chargers: 0-15 precision DC (Triplet) #321 ammeters: 6 ampere, 115 volt G-E rectifiers (220 V. input) Nos. 29, 30 & 31 SCE, #31 DCC & #44 HE magnet wire at closeout prices. Special rectifiers, battery chargers & transformers made to order in any quantities.

STRICKLAND ELECTRIC COMPANY
COLUMBUS 41, OHIO

INDUSTRIAL X-RAY INSPECTION EQUIPMENT

General Electric OX-200, XRD Diffraction, Picker, Standard, Westinghouse and Keleket units from 100 KV up. Special inspection booths made to order.

MEDICAL SALVAGE CO., INC.
217 E. 23rd St. N. Y. 10, N. Y.

INDUSTRIAL RF GENERATOR

Westinghouse, style 867885, 20 KW output, 43 KVA input, 460 volts, 3 phase, 60 cycles, equipped with the following:

- a. American Blower (utility set), model 175-A-1
- b. 3/4 HP Westinghouse 1150 RPM motor, 220/440 volt, 3 phase, 60 cycle, frame 203, class 1, style 116B505, 3.1/1.55 amps.
- c. Westinghouse rectifier-transformer, secondary tested 9.6 KV, 3 phase, RMS to primary arch to ground, Rectifier normal output 9600 volt at 3.7 amps, primary volts 480 @ 45 amps., secondary volts 7100 @ 3.5 amps, diagram 8D8961.
- d. Conversion unit 20-30-40 MC.
- e. 2 spare tubes, type 8B9RA with radiators (spare tubes are packed in shock-proof shipping containers).

Used but excellent condition, estimated weight 3000#; 6 1/2' x 4 1/2' x 4 1/2'; located in New York City. Original acquisition cost \$10,156.75

One unit only available. priced @ \$2500.00
ELECTRO SALES CO., Inc.
 50-58 Eastern Avenue
 Boston 13, Mass.

WANTED

VIBRATORS
 Loops LP 21
 Microphones, all types
 Keys J-38
 Keys J-45
 T-17 Mikes
 APN-3
 ARC-1
 ARC-3
 ART-13
 CH 88A
 CH 89A
 CH119A
 CH 120A
 CPN-6
 CPN-8
 CPN 17

FT 107
 IE-17
 Kites
 PE 210 & PE 95
 SCR 211
 JK-55
Boom Mikes
 307A Tubes
 RM52, RM53, RM29
 APN-2 Material
 SCR 720 Material
 SCR 522 Material
 H 4/AR Headsets
 Gibson Girl Material
 Telephone Material
 Control Boxes BC434
 Generators GN 45

CORDS & CABLES

Cable CC 358
 Cords CC 338
 CD335
 CD267
 CC59
 Cable CC 338
 CD1108

FIELD EQUIPMENT

BC788
 BC939
 BC614
 BC348 or parts
 BC221 or parts

FOR SALE!

Antenna Dipole AN 154.....\$25.00
 Antenna AN 104.....1.00
 TS 100/AP.....10 @ \$30.00
 MT 96/APS-3.....150 @ .75¢

TUBES
 2J 21.....200 @ \$ 1.50
 2J 22.....300 @ 1.50
 2J 26 TUBES.....1.75
 707A TUBES.....1.75

TELEPHONE RELAYS:
 W. E 215A RY 20.....\$5.00 new boxed

TELETYPE CAPACITORS:
 3DB-500-7.....50
 3DA 750-1.....50

GENERATORS:
 GN 38B.....\$4.00

TELEPHONES:
 EE 8 Field Phones.....\$20.00
 Coil Repeating W. E. #120.....1.25
 TS 9 Handsets.....3.25
 TS 15 Handsets.....5.50
 Upright Telephones Complete.....1.50
DESK PHONES, Leich #90 with Handset and Dial & Cord.....\$4.50

PE 120 **INVERTERS**.....200 ea. \$5.00
 6-12 or 24 volts
 PE 94 **DYNAMOTOR**.....2.00
 PE 118 **INVERTER**.....5.00
 PE 103 **POWER UNIT**.....15.00
 PE 73 **DYNAMOTOR**.....5.00
 PE 112 **POWER UNIT**.....5.00
 PE 115 **INVERTER**.....5.00

PE 186 **DYNAMOTOR**.....10.00
 DM 42 **MOTOR**.....4.00
 PE 206 **INVERTER**.....12.00
 PE 218 **INVERTER**.....7.50
LIP MIKES......85
THROAT MIKES......15
MODULATOR
 MD 31/TPL-1 New.....7.50
 MR 44A **MOUNT** for TA 2J 24.....3.50
 MT 96/APS-3 New.....1.00

CRYSTALS
 IN 21—Brand new—Sylvania—each in lead Sheath 50,000.....@ .06 ea.
 FT 241
 FT 243—110,000 Misc. Freq. all at .03 Ea.
 FT 500
 Sets of 80 boxed.....3.25
 Sets of 120 boxed.....5.50
 Receiver Radar R 85/TPL-1.....15.00
 Trans-Receiver GP-7.....7.50
 Receiver BC 966.....7.50
 WE Receiver Unit HA-1......75
 WE Transmitter Unit F-1......75
 CA 355 Capacitor F or EE 8......40
 EE 70 Head & Chest Set.....1.25
 Gibson Girl Transmitter S.O.S. 500 K.C. Manual operated. Complete—New.....15.00
 Reflector Corner Radar.....2.50
 Butyl Acetate 1 oz. bottle......10
 CD 1250 Cord with PL 291......10
 VB 8 Vibrators......25
 BC 611 Cover Top. Assy......50

TALLEN CO., INC.

159 CARLTON AVE. BROOKLYN 5, N. Y.
 TRiangle 5-8241

AN/APR-4 LABORATORY RECEIVERS

Complete with all five Tuning Units, covering the range 38 to 4,000 Mc; wideband discone and other antennas, wavetraps, mobile accessories, 100 page technical manual, etc. Versatile, accurate, compact—the aristocrat of lab receivers in this range. Write for data sheet and quotations.

We have a large variety of other hard-to-get equipment, including microwave, aircraft, communications, radar; and laboratory electronics of all kinds. Quality standards maintained.

NEW TS-13/AP X-BAND SIGNAL GENERATORS with manual \$575.00; T-47A/ART-13 Transmitters, \$450.00; H-P, Boonton, G-R, Measurements, many others in stock.

ENGINEERING ASSOCIATES

434 PATTERSON ROAD

DAYTON 9, OHIO

world's largest stock

RELAYS

immediate delivery!



ADJUSTABLE THERMAL TYPE TIME DELAY RELAY

Operates on 115 V.A.C. Continuously adjustable delay from 5 to 20 seconds. 1/4 Inch D.P.D.T. 12 1/2 amp. contacts. Primarily designed for use with radio transmitters but has wide variety of other applications. Catalog No. R 686 Price \$6.10 each

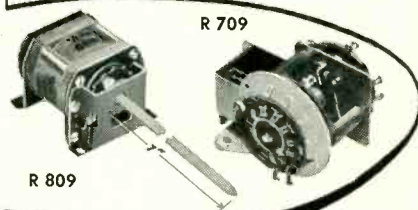

STEPPING UNIT

Operates on 22 to 30 V.D.C. 12 Position driving mechanism operates through 360° in progressive steps. Indexes one position for each momentary current impulse. Attached wafer switch may be used for self interruption. 7 inch flatted shaft will drive pulley, gear or one or more wafer switches. Catalog No. R 809 Price \$2.45 each

SOLENOID OPERATED RATCHET STEPPER

Operates on 6 V.D.C. Operates three 12 position wafer switches. Most standard wafers are interchangeable with those supplied. Rotates 30° with each impulse. Catalog No. R 709 Price \$3.90 each

HUNDREDS OF RELAY TYPES IN STOCK

- | | |
|----------------------------------|-----------------------------------|
| Standard Telephone Relays | Differential and Polarized Relays |
| Short Telephone Relays | Special Relays BK-Series |
| Midget Relays | Antenna and Ceramic Relays |
| Timers | Motor and Control Relays |
| Aircraft Contactors | Relay Assemblies |
| Rotary Relays | Latching and Interlocking Relays |
| Western Electric Type 'E' Relays | Mechanical Action Relays |
| Keying Relays | Ratchet and Stepping Relays |
| Hermetically Sealed Relays | |
| Voltage Regulators and Cutouts | |

All relays are new, individually inspected and unconditionally guaranteed. They are first line products of leading manufacturers. Special attention given to orders of one or more relays. 24 Hour delivery.

Write for new catalog. Phone, write or wire your requirements.



Austin 7-0709
 4717 W. Madison St.
 Chicago 44, Ill.

SURPLUS—SAVE! SAVE! MICROMAX RECORDERS

For Spec. Plat. Thermohm. AC Galvinometer Type.

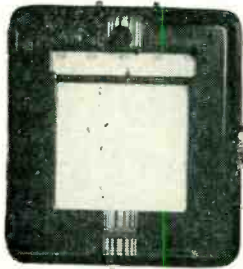

For fast and sensitive recording or controlling one or more points throughout a wide variety of processes. Used originally for temp. ranges of 350-550 Degrees cent. but may be changed for other applications by suitable control units. Control units not incl. with instrument.

Guaranteed to satisfy or money back.

Removed from equip. Sold as used but many have never had ink in pens.



BAILEY METER RECORDER,
as pictured, used and
guaranteed . . . \$65.00

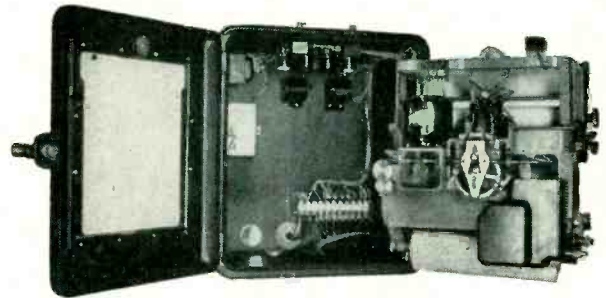

Price - - \$139.50

**BRAND NEW RC-58-B
FACSIMILE SETS \$350.00**
PER PAIR

New in original boxes complete with spare parts box, BC-908-B Amplifier, BC-918-B Recorder-Scanner, writing stand, and 48 rolls recorder tape. Ideal for banks & business to verify signatures, etc. 12 V. DC operated. Operates by wire or radio.

Two sets of above described units \$350.00

BATTERY CHARGERS (ED33511-ED33510)

Output 12 to 35 V. DC at 14 amps. max.

Manufactured by Ward-Leonard Electric Co.

Type 16888.19. 115 V. DC Input. Complete with cord, kit of spare parts. Brand new, perfect condition. Overseas packed.

CHARGING RATES

No. of 2 V. cells	Charging Amps.	
	High	Low
6	14	7
9	13.7	6.8
12	12.1	5.9
15	11.1	5.4

Size approx. 12" wide x 20" high x 10" deep. Weight of unit 45 lbs. Acquisition cost to Government \$300 each. Our price—\$19.95 each, f.o.b. Indianapolis.

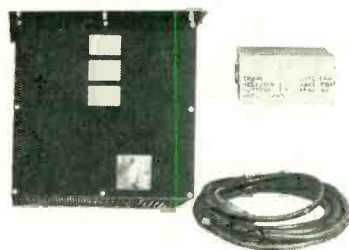
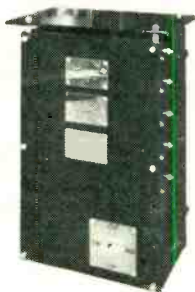

BATTERY CHARGER (ED33510)

Manufactured by Ward-Leonard Electric Co.

Type 16888.23. (Same as above except 30 Amps maximum). 115 V. DC input. Complete with cord, kit of spare parts, metal tool box. Brand new, perfect condition. Overseas packed. Approx. size 20" wide x 20" high x 10" deep. Weight of unit 65 lbs. Our price \$19.95 each, f.o.b. Indianapolis.

All mdse. guaranteed to satisfy or money back if returned prepaid.

ESSE RADIO COMPANY

42 W. South Street

Indianapolis 25, Ind.

WELLS SALES

Large Quantity SPECIALS!



PHOSPHOR BRONZE CABLE

Non-insulated 16 gauge 6x7x0071—200 pound tensile strength—impervious to weather—Spark resistant—New, perfect condition. Packed on 1000 Foot factory packed spools, same on 3000 Foot spools. Mfg by Roebling, same by Hackensack

Per M Foot spool..... \$8.50 ea.
50,000 Foot lots or more..... 7.50 per M



HI VOLT LOW CURRENT TRANSFORMERS

High Reactance Transformer mfg. by Jefferson. Pri. volts 115V-60 cy. Sec. Volts 8300-9000 @ 16 MA. Capacity 250 V.A. Sec. start ground. Pri. has 18" long rubber jacket leads. Sec. has special plug furnished. Ideal for high voltage breakdown tester or adaptable to neon and oil burner application. 10 elongated mtg. holes on base flange. Dim. 6 1/2" x 4 7/8" x 5" H.

Stock No. 969-001..... \$3.50 ea.
Lots of 10..... 3.00 ea.

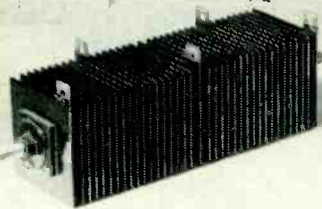

MAGNESIUM COPPER SULFIDE RECTIFIER (H. T.)

30V. A.C. maximum input. 15V. D.C. output @ 7 Amps or 24V A.C. input. 14V. D.C. output @ 7 Amps. Mfg. by Mallory 153687, single phase bridge. 24 Thd. Bolt extends 1" both ends. 5 Terminals on top: No. 2 and 4 for A.C. input, No. 3 D.C. Neg. No. 1 and 5 D.C. (strapped) positive. Dim.: 10" x 1 x 2 1/2" W x 3" H.

Price..... \$4.25 ea.
Lot of 10..... 3.50 ea.

Write to Dept S for our free C55 48-page Catalog of thousands of Electronic Parts.

WELLS SALES, Inc.

833 W. Chicago Ave. Chicago 22, Ill.
5Eley 8-4143

INDEX TO THE SEARCHLIGHT ADVERTISERS

SEARCHLIGHT SECTION (Classified Advertising) H. E. Hilty, Mgr.

EMPLOYMENT

Positions Vacant.....	386-413
Selling Opportunities Offered.....	413
Positions Wanted.....	386
Selling Opportunities Wanted.....	386
Employment Agencies.....	386
Employment Services.....	386

SPECIAL SERVICES

Contract Work.....	386
--------------------	-----

EDUCATIONAL

Schools.....	386
--------------	-----

PROPERTY

For Rent.....	386
---------------	-----

EQUIPMENT

(Used or Surplus New) For Sale.....	414-426
--	---------

WANTED

Equipment.....	
----------------	--

ADVERTISERS INDEX

Admiral Corp.....	396
Allied Electronic Sales.....	418
Alltronics.....	414
Amber Industrial Corp.....	418
American College of Engineering.....	386
Arrow Sales, Inc.....	414
Automation & Electronics.....	420
Avco Mfg. Co., Crosley Div.....	404
Barry Electronics Corp.....	421, 425
B & C Distributors Co.....	418
Beckman Instruments, Inc.....	410, 412
Beeber Co., Inc. J.....	420
Bendix Aviation Corp.....	
Pacific Division.....	398
Products Division.....	387, 394
Radio Division.....	393
Research Laboratories Division.....	409
York Division.....	411
Blan.....	425
Blonder-Tongue Labs., Inc.....	408
Burroughs Research Center.....	399
Cadillac Employment Agcy., Inc.....	386
Cardwell Electronics Prod. Corp., Allen D.....	413
Chase Electronic Supply Co.....	420
C & H Sales Co.....	414
Clevite-Brush Development Co.....	402, 405
Communications Equipment Co.....	417
Convair, A Division of General Dynamics Corp.....	390, 401
Cornell Aeronautical Laboratory.....	390
Cunningham Engineering Co.....	416
Drake Personnel, Inc.....	386
Dynamic Electronics of N. Y. Inc.....	400
Electric Auto-Lite Co., The.....	412
Electro Sales Co., Inc.....	421
Electronic Engineering Co., of Calif.....	408
Electronics Corp. of America.....	398
Engineering Associates.....	422
Esse Radio Company.....	423
Fair Radio Sales.....	420
Farnsworth Electronics Co.....	400
Fay-Bill Distributing Co.....	416
Federal Mfg. & Eng. Corp.....	413
Finnegan, H.....	425
Florida Aircraft Radio & Marine Inc.....	425

General Electric Co.....	407
Goodyear Aircraft Corp.....	391
Graebner's Exchange.....	386
Green, Gould.....	425
Hodgson Co.....	386
Harjo Sales Co.....	414
Hoffman Laboratories, Inc.....	410
Houde Supply Co.....	425
Industrial Nucleonics Corp.....	392
Industrial Research Labs.....	396
Jasik, C.....	386
Johns Hopkins University, The.....	409
JSH Sales Co.....	415
Kaman Aircraft Corp.....	386
Kato Engineering Co.....	416
Kollsman Instrument Corp.....	413
Lear Inc.....	400
Legri S. Co., Inc.....	420
Lockheed Aircraft Corp.....	395
Maryland Electronic Mfg. Corp.....	395
Massachusetts Institute of Technology.....	402
Medical Salvage Co., Inc.....	421
Melpar Inc.....	407
Microwave Equipment Supply Co.....	425
Mogull Co., Alexander A.....	425
Monarch Personnel.....	386
M. R. Co.....	425
National Cash Register Co.....	406
National Company, Inc.....	411
Niles-Bement-Pond Co.....	392
Page Communications Engineers, Inc.....	402
Pennsylvania State University.....	412
Radalab.....	418
Radio Corp. of America.....	388, 389
Radio & Electronic Surplus.....	420
Radio-Research Instrument Co.....	418
Raway Sales.....	421
Raytheon Manufacturing Co., Chicago, Ill.....	411
Waltham, Mass.....	397, 405, 413
Relay Sales.....	422
Remington Rand, Inc. Engineering Research Associates Div.....	403
Eckert-Mauchly Division.....	392
Republic Aviation.....	409
Sanders Associates Inc.....	408
Servomechanisms, Inc.....	412
Snyder Co., Lee Grant.....	386
Sorensen & Co., Inc.....	405
Stavid Engineering, Inc.....	403
Strickland Electric Co.....	421
Stronberg-Carlson Co.....	413
Sylvania Electric Products Inc., Buffalo, N. Y.....	405
Newton, Mass.....	401
"TAB".....	426
Tallen Co., Inc.....	422
Texas Instruments, Inc.....	410
Trad Television Corp.....	413
Transitron Electronic Corp.....	410
Universal General Corp.....	420
Vitro Laboratories.....	406
Wells Sales Inc.....	424
Western Engineers.....	419
Westinghouse Electric Corp., Baltimore, Md.....	394
Elmira, N. Y.....	407
Pittsburgh, Pa.....	403
Wolf Co., Edward.....	414
Wright, W. C.....	386

This index is published as a convenience to the readers. Care is taken to make it accurate but ELECTRONICS assumes no responsibility for errors or omissions.

**SELLING OUT
OUR ENTIRE
"AN" CONNECTOR
INVENTORY**

**OVER 150,000 PIECES
AMPHENOL and
CANNON
(ALL NEW SURPLUS)**

THIS REPRESENTS THE STOCK WE MAINTAINED AND REPLENISHED UP TO DATE.

WE WILL ENTERTAIN ANY REASONABLE OFFER FOR ALL OR PART.

WE WELCOME YOUR INQUIRIES — BUT ACT QUICKLY FOR BEST SELECTION.

A. MOGULL CO.

17 Warren St., N. Y. 7, N. Y.
Phone: WORTH 4-0865

Manufacturers . . . Does your
Experimenters . . . AC Line-
Laboratories . . . Voltage vary?
THEN THIS BARGAIN IS FOR YOU!
The U.S. Air Force required 115.0 V. ± 1% despite line variations (transient or continuous) up to 30% in either 110 V. or 220 V. and either 50 or 60 cycle locations. So this SOLA Constant Voltage Transformer has all 4 inputs by choice of connections per instructions on etched plate. Output is ALWAYS 115.0 V. ± 1% at 17.4 amps (2,000 VA). For smaller loads, input may vary much more than 30%, and output holds to 1%. Secondary is isolated from primary. No moving parts. No service or attention required. Self-protecting against overloads. Response time 1 cycle, or less.
Because the Air Force dropped this project, you get this 4-input unit for \$95.00 less than the regular price of a single-input, 2000 VA unit—plus the added bonus that you can, if you wish, use it as a step-down transformer!
Brand new, in original wood box, 4 cu. ft. Ship. wt. \$149.50
254 lbs. F.O.B. Pasco, Wash.

THE M. R. COMPANY
P. O. Box 1220-B Beverly Hills, Calif.

SURPLUS

BOUGHT & SOLD
GOULD GREEN 252 Greenwich St.
Worth 4-8044—NYC 7

ATTENTION SEARCHLIGHT ADVERTISERS

NEW RATES shown below will be put into effect with the JULY issue to accord with an increase of circulation.

RATES:
Displayed: \$18.50 per inch
Undisplayed: \$2.10 per line

EMPLOYMENT advertising will be excluded from the Searchlight Section. For details see our announcement ad on page 406.

REVERSIBLE GEARED-MOTOR
Delco-PM-Permanent Magnet Alnico Field Motor



#5071895 1/4 SHAFT or 11/16 GEAR... \$17.50
#5069000... \$18.50
Clamps to hold motor: \$1.50 ea.

GRAIN OF CORN LAMPS
10 for \$3.00 — 100 for \$25.00



#328, 6 Volts #326, 2 1/2 Volts #321, 28 Volts

TELECHRON Motors
4 RPM on 50 cycles or 4 3/4 RPM on 60 cycles... 2.85
2 RPM \$2.90
3 RPM 3.90
4 RPM 2.90
3.6 RPM 3.15
1 RPM 3.95
3 R.P. Hr 2.85
1 R.P. 2 Hr 2.80
1 R.P. 12 Hr 3.25
60 RPM 4.85
Laboratory Special 1 of Each Above \$25.00

please include postage

BLAN

BLOWERS 115 Volts A. C. 60 c.
REDMOND 5" 18 watts... \$8.95
DELCO 60 cfm. 40 watts... \$14.50
#5062369 used in 584 RADAR
EASTERN AIR DEVICES 70 watts.
3400 RPM, labeled 80 cfm, but
blows like blazes!... \$17.50

HAND WOUND 10 Sec. to 24 Min. TIMER SWITCH... \$1.25
6 Watt Most POWERFUL TELECHRON 1 RPM 110 volts 60 cy \$6.50
10 for \$60.00

3" Round Elapsed Time Meter \$1375
Square Case \$14.50

MARKTIME 5 HOUR SWITCH
A 10 amp. timing device. Pointer moves back to zero after time elapses. Ideal for shutting off radios and TV sets when you go to bed. Limited supply at this special PRICE... \$4.90
Also available in 15 min., or 30 min. or 1 hr. at \$6.50

HAYDON TIMING MOTORS
110v. 60 cycle 30 RPM... \$2.60
110v 60 cycle 1 RPM... 2.85
230V 51 RPM... 1.00
60C 72 RPM... 1.00

EST. 1932 64K Dey Street New York 7, N. Y.

GLASS TUBING
PYREX - NONEX - URANIUM BULB & CYLINDERS
WRITE FOR FREE MONTHLY LIST
HOUE SUPPLY COMPANY
PHONE KEYPORT 7-1286
M. R. #1 Box 86X Keyport, N. J.

WANTED

WANTED
ART-13 transmitters, parts, and components, DY-12 and DY17 dynamotors, CU-25 etc. Also ARC-1 and ARN-7 material.
Advise price, condition first letter.
FLDRIDA AIRCRAFT RADID & MARINE, INC.
International Airport Branch
P. O. Box 205 Miami 48, Florida

WANTED
Type R19/TRC-1 Receivers
W-8652, Electronics
330 W. 42 St., New York 36, N. Y.

WILL BUY ALL
Art-13 T47A Transmitters \$225.00 BC-348 Rec'r modified \$25.00
Art-13 T-47 Transmitters \$150.00 BC-348 Rec'r unmodified \$50.
BC-788C Altimeters \$150.00 ARC-1 Radio complete \$200.00
RS/ARN7 Radio Compass \$180.00 BC-312 Receiver \$40.00
ARC-3 Complete \$185.00 BC-342 Receiver \$50.00
Ship via Express C.O.D., Subject to Inspection to:
H. FINNEGAN
49 Washington Ave. Little Ferry, N. J.

WANTED VARI-TYPER
Late Model A20 or DSJ & EXTRA TYPE FONTS
W-0460, Electronics
330 W. 42 St., New York 36, N. Y.

Special Purpose Tubes
!! Compare These Prices !!

Tubes listed below are available in quantity from stock. New, in original cartons and fully guaranteed!

1B24 JAN	\$4.75	2K42 SPERRY	\$124.95
1B27 JAN	6.95	2K43 SPERRY	124.95
1B36 JAN Sylvania	3.50	2K44 SPERRY	115.00
1B38 JAN	19.95	2K46 SPERRY	275.00
1B41 JAN	39.95	3K23 SPERRY	325.00
1B42 JAN	12.95	5C22 Sylvania	26.95
1B63-A JAN	35.00	6K1	2.95
1N21-A JAN	1.29	6L6M JAN RCA	1.19
1N21-B JAN	1.95	FG-172 GE RCA	15.95
1N23-A JAN	1.68	300-B WE	7.95
1N23-B JAN	1.99	350-B WE	4.49
1N26 WE JAN	4.95	434-A GE JAN	2.95
1N40 Sylvania	6.49	715-B JAN WE	5.95
1N41 Sylvania	8.95	715C JAN WE	9.95
1N42 Sylvania	15.95	723A/B WE JAN	11.95
1P21 RCA	28.00	804 JAN	9.50
1Q26 GE JAN	52.95	1614 JAN RCA	1.25
2C40 RCA JAN	6.50	2050 RCA	.96
2K25 723A/B WE		5051 RCA	1.35
JAN Orig-sld/ctns	18.95	5051 GE	1.39
2K28 w/mtg JAN	27.95	5070	1.95
2K35 SPERRY	350.00	5087 Tung-Sol	2.49
2K39 SPERRY	129.00	CK-5702	1.75

This is but a partial listing. Call or write if your requirements are not listed. Terms: Net 15 days to rated firms.

Microwave Equipment Supply Co
255 East 78th St. New York City 21
TRatalgar-9-3776

TUBE TESTING LABORATORY
TEST YOUR TRANSMITTING, RECEIVING, AND SPECIAL-PURPOSE TUBES TO JAN, MIL-E-18 AND/OR COMMERCIAL SPECS. LAB. CERTIFICATES SUPPLIED.
BARRY ELECTRONICS CORP.
512 BROADWAY, N. Y. 12, N. Y. Walker 5-7000

INDEX TO ADVERTISERS

Acme Wire Co.	372
Adams & Westlake Company	81
Admiral Corp.	46
Advance Electronics Co., Inc.	357
Aeronautical Communications Equipment, Inc.	282
Aerovox Corporation	319
Airborne Instruments Laboratory	319
Aircraft-Marine Products, Inc.	197
Airpax Products Co.	35
Allen-Bradley Co.	102
Allen Co., Inc., L. B.	359
Allen Manufacturing Co.	359
Allegheny Ludlum Steel Corp.	88
American Airlines, Inc.	277
American Electric Motors, Inc. Electric Machinery & Eqpt. Div. of American Electronics Inc.	256
American Gas Furnace Co.	383
American Lava Corporation	47
American Phenolic Corp.	184
American Television Radio Co.	350
American Time Products, Inc.	311
Antara Chemicals, A Sales Division of General Aniline & Film Corp.	191
Amperite Co., Inc.	194
Ampex Corporation	261
Andrew Corporation	293
Applied Research Inc.	331
Arnold Engineering Co.	13
Augat Bros. Inc.	351
Automatic Manufacturing Corp.	92
Bakelite Co., a Div. of Union Carbide and Carbon Corp.	98, 99, 217
Ballantine Laboratories, Inc.	192
Barker & Williamson, Inc.	200
Barrett Division, Allied Chemical & Dye Corporation	100, 101
Barry Controls, Inc.	21
Bausch & Lomb Optical Co.	254
Belden Manufacturing Co.	60
Bell Telephone Laboratories	279
Bendix Aviation Corporation, Red Bank Div.	238
Bentley, Harris Mfg. Co.	29
Berkeley Division, Beckman Instruments, Inc.	296
Biggs Company, Carl H.	364
Bird Electronics Corp.	430
Bliley Electric Company	276
Boesch Mfg. Co., Inc.	382
Boonton Radio Corp.	185
Bradley Laboratories Inc.	43
Bruno-New York Industries Corp.	232, 233
Brush Electronics Co.	96A, 96B, 206
Buggie Inc., H. H.	252
Burnell & Co., Inc.	39
Burrroughs Corporation, Electronic Instruments Div.	32A, 32B, 32C, 32D
Bussman Mfg. Co.	58

Caledonia Electronics & Transformer Corp.	362
Caldyde Company, The	236
Cambridge Thermionic Corp.	34
Canadian Marconi Company	274
Cannon Muskegon Corp.	246
Carter Motor Co.	361
Cascade Research Corp.	199
Centralab, Div. of Globe-Union Inc.	313
Chase Brass & Copper Co.	275
Chatham Electronics Div. of Gera Corp.	257
Chicago Standard Transformer Corp.	288
Cinch Mfg. Corp.	175
Cinema Engineering Co.	384
Clare & Co., C. P.	49
Cleveland Container Co.	207
Clifton Precision Products Co., Inc.	231
Cohn Corp., Sigmund	377
Collectron Corporation	379
Color Television, Inc.	380
Comar Electric Company	204
Commonwealth of Puerto Rico, Economic Development Administration	237
Communication Accessories Co.	195
Computer Company of America, Div. of Bruno-New York Industries Corp.	232
Continental-Diamond Fibre Co.	201
Cornell-Dubilier Electric Corp.	23
Continental Wire Corp.	366
Corning Glass Works	240
Cramer Co., Inc., R. W.	196
Cro-Plate Company, Inc.	340
Cross Co., H.	284
Crucible Steel Co. of America	111
Cunningham, Son & Co., Inc., James	379

Dale Products, Inc.	292
Dano Electric Co.	369
Daven Company	3rd. Cover
Daven Electronic Sales Corp.	358
DeJur-Amso Corporation	304
Delco Radio Division of General Motors	336
Detector Corporation, Computer-Measurements Div.	310
Dialight Corporation	352
Driver Harris Company	243
Dumont Airplane & Marine Instruments Inc.	429
Du Mont Laboratories Inc., Allen B.	189
DuPont de Nemours & Co. (Inc.) E. I., Film Dept. Polychemicals Dept.	205, 63
Eastern Industries, Inc.	278
Eastman Kodak Company	183
Eisler Engineering Co., Inc.	378, 384
Eitel-McCullough, Inc.	53
Electrical Industries, Div. of Amperex Electronic Corp.	113
Electrical & Physical Instrument Corp.	337

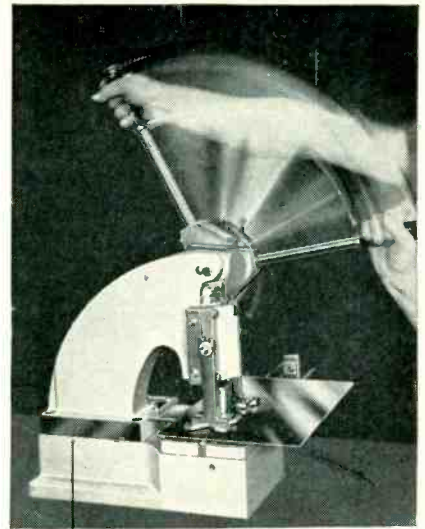

**PUNCH...
BLANK...
EMBOSS...
FORM...**

Quickly, Easily, Accurately with a DI-ACRO* PUNCH PRESS

Deep throats—6 and 12 inches—of Di-Acro Punch Presses make them ideal for many operations impossible to perform on most bench presses.

Holes of various shapes and sizes—as large as 4" in diameter in 16 gauge steel—can be punched. Vee shaped ram controls position of punch head assuring perfect alignment. Turret stripper, of exclusive Di-Acro design, strips material from punches of all shapes. Side and back gauges provide exact work positioning.

*pronounced Die-ack-ro



FOUR HAND AND POWER MODELS AVAILABLE

Di-Acro Power Punch Presses are designed for high speed production. Rated capacity, five tons. 180 strokes per minute. Motor driven flywheel and other moving parts are housed in a welded, steel cabinet.

Hand operated Di-Acro Punch Presses are easy to operate, ideal for short run production and experimental work. Rated capacity, four tons.

PUNCH PRESS ACCESSORIES

Complete line of standard size punches in round, square, notcher, rectangular and oval shapes available in six clearances. Also special sizes.

Send for 32-Page Catalog

Tells all about both hand and power operated Di-Acro Punch Presses, Benders, Brakes, Notchers, Rod Parters, Rollers and Shears. Punch and Die Cost Sheet included.

Creators of "Die-Less Duplicating"

**O'NEIL-IRWIN
MFG. CO.**
321 8th Avenue
Lake City, Minnesota



Want more information? Use post card on last page.

REGULATED HIGH VOLTAGE POWER SUPPLY

Model 810-S



1000 to 2500 Volts
D.C. at 5 Milliamperes
Maximum

This electronically regulated power supply is designed to serve as a d.c. power source at high voltage and low current. An ideal unit for applications requiring greater than usual stability and accurate voltage adjustments.

Especially useful for the operations of photo-multiplier tubes, cathode ray tubes, traveling wave tubes, Geiger-Mueller counters, and similar applications, particularly when more than one of these devices is operated at exactly the same voltage.

No meter is required. Accurate voltage readings are made directly from a 15 turn vernier dial which is calibrated to read 1 volt per scale division.

Write for Literature on
Other High Voltage Regu-
lated Power Supplies.

MODEL 810-S SPECIFICATIONS

- **REGULATION:** Output voltage varies less than .01% per volt change of line voltage and less than .1 volt with variation of output current from 0 to 5 Milliamperes.
- **RIPPLE:** Less than 5 Millivolts r.m.s.
- **STABILITY AND DRIFT:** Output varies less than 0.1% for any setting of the output dial over a period of 72 hours and less than 0.03% per hour.

Either positive or negative terminal may be grounded by a front panel switch.



FURST

ELECTRONICS, INC.

3324 W. Lawrence Ave., Chicago 25, Illinois

MANUFACTURERS and FABRICATORS of
Printed Circuitry,

Acrylics, Ureas, Fabric and Paper Base Phenolics, Poly-
styrenes, P.V.C., Fibres, Butyrates and High Pressure
Laminates USE and RECOMMEND . . .

Radialloy-Tipped* Circular Saw Blades

CHIP-FREE CUTS • CLOSE TOLERANCES • LONG BLADE LIFE

These Super-Finished Blades operate *faster, smoother* and are available for *close tolerance* work, thus eliminating costly trial and error methods. And they *do not vibrate* on "tough sawing" materials. Why? *There's no variation in tooth construction!* They're engineered from the heat-treated shank out as carbide blades—they're not regular saws with carbide tips added!

RADIAL CUTTER 839 Bond Street
MANUFACTURING CORPORATION Elizabeth 4, N. J.

Specialists and Leading Manufacturer of Carbide-Tipped Saw Blades

HERE'S PROOF—
We'll furnish
sample cuts on
your materials to
illustrate their
superior cutting
quality.

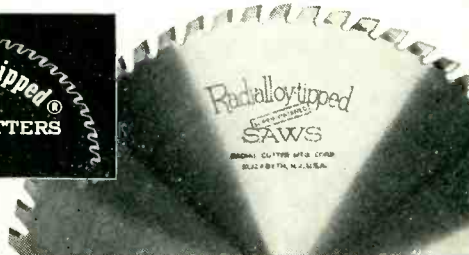

WRITE for prices and brochure
for complete data.

*Reg. U. S. Pat. Office

Electronic Instrument Co., Inc. (EICO)	372
Electro Impulse Laboratory	375
Electro Instruments, Inc.	61
Electro-miniatures Corp.	376
Electro Motive Mfg. Co., Inc.	253
Engineering Co., The	348
Essex Wire Corporation, R-B-M Div.	190
Erie Resistor Corp.	220

F-R Machine Works, Inc.	265
Fairchild Camera & Instrument Corp.	79
Fansteel Metallurgical Corp.	322, 323
Farnsworth Electronics Company	109
Federal Telephone & Radio Company	89
Film Capacitors, Inc.	332
Filtron Co., Inc.	345
Ford Instrument Company	214
Freed Transformer Co., Inc.	213
Frenchtown Porcelain Company	373
Furst Electronics, Inc.	428

Gamewell Company	228
Garrepy Platers	384
Gee-Lar Manufacturing Co.	375
General Cable Corp.	259
General Electric Company Apparatus Dept. 78-104-105-106-107-307-343 Electronics Div.	83
Tube Dept.	90, 91, 249
General Industries Co.	227
General Precision Equipment Corp.	40, 41
General Radio Company	17
Genisco, Inc.	112
Globe Industries, Inc.	356
Good-all Electric Mfg. Co.	55
Greenleaf Manufacturing Co.	211
Gries Reproducer Corporation	368
Guardian Electric Mfg. Co.	263

Hammarland Manufacturing Co., Inc.	25
Hardwick, Hindle Inc.	68
Hart Manufacturing Company	308
Harvey Hubbell, Inc.	291
Hathaway Instrument Company	367
Haydon Company, A. W.	264
Haydon Manufacturing Company, Inc.	335
Heath Company, a Sub. of Daystrom Inc.	341
Helipot Corporation, a Div. of Beckman Instruments, Inc.	181

Hewlett-Packard Company	36, 37
Hoffman Laboratories, Inc.	209
Homelite Corporation	280
Hopkins Engineering Co.	355
Houghton Laboratories, Inc.	294
Hughes Aircraft Company	103
Hughes Research & Development Labs	290
Hycon Mfg. Company	298
Hycor Company, Inc.	363

Ilseco Copper Tube & Products Inc.	352
Indiana Steel Products Company	84
Industrial Timer Corp.	305
Industrial Development Div., State of Florida	371
Industrial Hardware Manufacturing Company, Inc.	347
Industrial Transformer Corp.	353
Inland Electronics Corp.	248
Instrument Corporation of America	271
Instrument Resistors Co.	360
International Electronics Corp.	97
International Rectifier Corp.	219
International Resistance Company	72, 73
Ippolito & Co., Inc., James	353

Jet Propulsion Laboratory	339
Johnson Company E. F.	202
Jones Div., Howard B. Cinch Mfg. Corp.	300
Jones Electronics Co., Inc., M. J.	338

Kahle Engineering Co.	15
Karp Metal Products Co., Div. of H & B American Machine Co.	299
Kay Electric Co.	27
Kearfott Co., Inc.	212-318
Kellogg Company, M. W.	193
Kepeco Laboratories	179
Kester Solder Co.	225
Keystone Products Company	251
Kollsman Instrument Corp.	273

Laboratory for Electronics, Inc.	115
Lakeland, Florida Industrial Development Committee of 100	364
Lampkin Laboratories, Inc.	300



DUMONT

HI-TEMP.

MINIATURES

125-150°C

- ★ HIGHLY MOISTUREPROOF
- ★ HIGH I.R.
- ★ 1-2-5-10% to 1.
- ★ HIGH Q. SUBSTITUTE FOR MICA AND CERAMIC UNITS

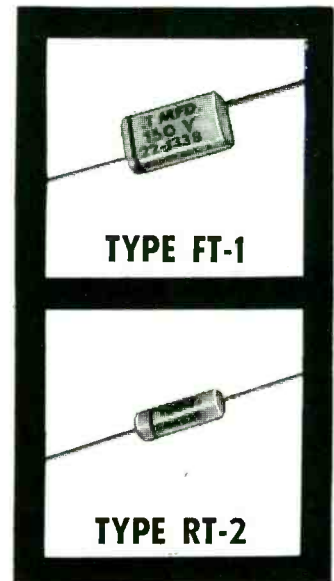

Dumont scores again with the finest small condenser available. A distinctive NEW HI-temp. miniature that will meet all your requirements for HI-temperature performance. (125°-150°C.) For stability they have no equal and will give maximum capacitance in minimum space. There is a complete range of sizes and ratings available.

WRITE FOR
BULLETIN No. 5-55A

DUMONT-AIRPLANE & MARINE INSTRUMENTS, Inc.
OFFICE
 15 William Street
 New York 5, N. Y.
FACTORY
 Clearfield
 Pennsylvania

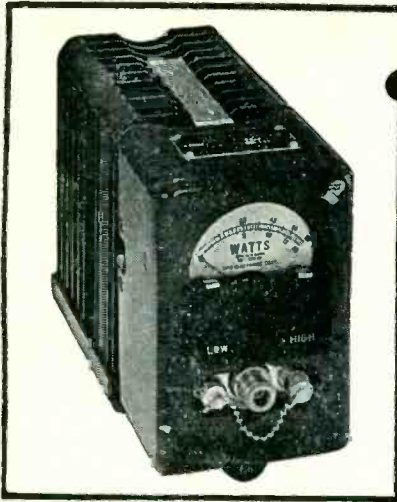

TERMALINE DIRECT READING R. F. WATTMETERS

(DUAL RANGE)

MODEL 611—0-15 and 0-60 Watts

MODEL 612—0-20 and 0-80 Watts

IMPEDANCE—51½ Ohms

Models 611 and 612 are popular instruments in research and design laboratories, vacuum tube plants, transmitter manufacturing plants, and in fixed and mobile communication services.

They are ruggedly built for portable use, and are as simple to use as a D.C. voltmeter. The power absorbing load resistor is non-radiating, thus preventing transmission of unwanted signals which interfere with message traffic in communication services.

Frequency range: 30 to 500 MC (30 to 1,000 MC by special calibration)

Impedance: 51.5 OHMS—VSWR less than 1.1

Accuracy: Within 5% of full scale

Input connector: Female "N" which mates with UG-21 or UG-21B. Adapter UG-146/U is supplied to mate with VHF plug, PL259.

Special Scale Model "61s" are available as low as ½ watt full scale, and other models as high as 5 KW full scale.

Catalog Furnished on Request



BIRD ELECTRONIC CORP.

1800 EAST 38TH ST., CLEVELAND 14, OHIO
TERMALINE Coaxial Line Instruments

NEELY
ENTERPRISES
Hollywood • San Francisco
Albuquerque

RON MERRITT
COMPANY
Seattle

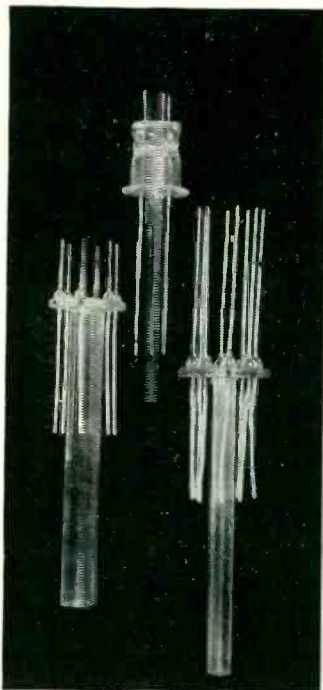

(A)

TUBE COMPONENTS AND HERMETIC SEALS

- (A) Molded Button Stems
- (B) Powdered Glass Molding
- (C) Metal-to-glass Window Seals
- (D) Clear Glass-to-metal Terminals
- (E) Chemical-oxide bonded glass-to-metal seals

We are also equipped for custom glass operations, both hand & machine. Complete facilities available for sealing & evacuation. Write now for immediate quotations on any quantity.



(C)



(E)

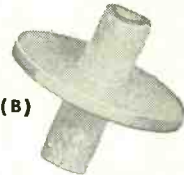

(B)



(D)

Over a Quarter Century of Sealing Experience

SCIENTIFIC ELECTRONIC LABS

866 Bergen St.

Newark 8, N. J.

Bigelow 8-6553

Lapp Insulator Co., Inc.	208
Lavoie Laboratories, Inc.	65
Lemert Engineering Co., Inc.	312
Lewis & Kaufman Ltd.	229
Linde Air Products Company, Div. of Union Carbide & Carbon Corp.	284
Litton Engineering Laboratories	340
Lockheed Missile Systems Div.	330

MB Manufacturing Company, Inc.	54
Magnatran, Inc.	362
Magnetics, Inc.	187
Mallory and Co., Inc., P. R.	120-177
Mansel Ceramics Co.	354
Marconi Instruments, Ltd.	42
Marion Electrical Instrument Co.	284-300
Markem Machine Co.	283
Martin Company, Glenn L.	235
Measurements Corporation	292
Metal Textile Corporation	361
Metals & Controls Corp., General Plate Div.	96
Mica Insulator Co.	297
Micro Switch, A Div. of Minneapolis-Honeywell Regulator Co.	61
Microtime Laboratories	262
Midwestern Instruments	295
Miles Reproducer Co., Inc.	384
Millen Mfg. Co., Inc., James	266
Miniature Precision Bearings, Inc.	86
Minneapolis-Honeywell Regulator Co., Industrial Div.	66
Minneapolis-Honeywell, Brown Instruments Div.	250
Mitchell-Rand Insulation Company	356
Muirhead & Co., Ltd.	5

N.R.K. Mfg. & Engineering Co.	355
Narda Corporation, The	234
National Moldite Co.	203
New England Oven & Furnace Co.	380
New Hermes Engraving Machine Corp.	347
New Jersey Electronics Corp.	119
New London Instrument Co.	366, 368, 370, 374, 379
Nutt-Shel	71
Nothelfer Winding Labs.	118

Offner Electronics Inc.	32
O'Neil-Irwin Mfg. Co.	427
Orber Manufacturing Co.	384

Pacific Scientific Co.	321
Panoramic Radio Products, Inc.	369
Perkin-Elmer Corporation	329
Perkin Engineering Corp.	188
Permag Corp.	366
Phalo Plastics Corp.	327
Phelps-Dodge Copper Products Corp. Inca Mfg. Div.	82, 83
Philamon Laboratories, Inc.	245
Photo-crystals, Inc.	376
Polarad Electronic Corporation	266, 267
Polytechnic Research & Development Co., Inc.	28
Popper & Sons, Inc.	374
Potter & Brumfield Mfg. Co.	62
Precision Apparatus Co., Inc.	432
Precision Paper Tube Co.	222
Pyramid Electric Company	309

R.B.M. Division, Essex Wire Corp.	190
Radial Cutter Manufacturing Co.	428
Radio Condenser Co.	56
Radio Corporation of America	76, 77 4th Cover
Radio Engineering Laboratories, Inc.	59
Radio Engineering Products	349
Radio Materials Corp.	247
Radio Receptor Company, Inc.	239
Railway Express Agency, Air Express Div.	221
Raytheon Mfg. Company	19, 20, 45, 281
Reeves-Hoffman Corp.	354
Reeves Instrument Corp.	31
Remington Rand, Inc. Engineering Re- search Associates, Div.	300, 358
Resin Industries, Inc.	346
Revere Corporation of America	320
Richardson Company	80

Sauern Company	67
Sargeant & Wilbur Heat Treating Corp.	369
Sauereisen Cements Co.	384
Scientific Electronic Labs.	430
Secon Metals Corp.	328
Servo Corporation of America	316
Shalleross Mfg. Co.	286
Sierra Electronic Corp.	95
Sigma Instruments, Inc.	198
Signal Engineering & Mfg. Co.	365
Simpson Electric Company	52
Sorensen & Co., Inc.	4
South Chester Corp.	108
Southern Electronics Co.	326
Southwestern Industrial Electronics Co.	333
Sperry Gyroscope Co.	351
Sprague Electric Co.	11, 215, 242
Stackpole Carbon Co.	87
Standard Electric Time Co.	223
Standard Telephone & Cables Ltd.	306



“powder to part”

Quality Controlled Fluorocarbon Plastics

U.S.G. quality control extends through every operation in the fabrication and custom molding of parts from duPont TEFLON, Kellogg KEL-F and BAKELITE fluorothene.

This quality control insures uniform electrical, chemical and physical characteristics of the highest quality. It also assures uniform density and dimensional stability permitting superior accuracy and dependability in the finished part.

Get the advantages of these fluorocarbon plastics at their best. Whether your requirements are for sheets, rods, tubing, tape, bars, cylinders, beading, electrical spaghetti, or parts extruded, molded or machined to your specifications . . . see U.S.G.

Write for Bulletin No. 300.

UNITED STATES GASKET COMPANY
Camden 1, New Jersey

USG

FABRICATORS OF
FLUOROCARBONS & OTHER PLASTICS

Representatives in principal cities throughout the world





THE NEW
PRECISION MODEL **120**

GIVES YOU WHAT YOU WANTED
IN A
**HIGH SENSITIVITY
MULTI-RANGE TEST SET**

20,000 OHMS PER VOLT D.C.
5,000 OHMS PER VOLT A.C.

The '120' gives you . . .

- ✓ MORE RANGES
- ✓ AN EXTRA-LOW RESISTANCE RANGE
- ✓ AN EXTRA-LOW VOLTAGE RANGE
- ✓ AN EXTENDED LOW CURRENT RANGE
- ✓ A LARGER METER SCALE FACE
- ✓ SIMPLE, POSITIVE RANGE SELECTION
- ✓ POSITIVE CONTACT JACKS and PLUGS

Compare These Wide Spread Ranges
and Special Features:

- ★ 8 DC VOLTAGE RANGES: 20,000 ohms per volt.
- ★ 8 AC VOLTAGE RANGES: 5,000 ohms per volt.
0-1.2-3-12-60-300-600-1200-6000 volts.
- ★ 8 AC OUTPUT RANGES: same as AC volt ranges.
Built-in 600 volt blocking capacitor.
- ★ 7 DC CURRENT RANGES:
0-60-300 Microamperes. 0-1.2-12-120-600 Ma.
0-12 Amperes.
- ★ 5 RESISTANCE RANGES: self-contained.
0-200-2000-200,000 ohms. 0-2-20 megohms.
- ★ 8 DECIBEL RANGES: -20 DB to +77DB.
0 DB = 1 Milliwatt, 600 ohms.
- ★ EXTRA LARGE 5 1/4" RUGGED 'PACE' METER:
40 microamperes sensitivity, 2% accuracy.
- ★ 1% MULTIPLIERS and SHUNTS:
Wire-wound and deposited film types.
- ★ TWO JACKS SERVE ALL STANDARD RANGES:
Separately identified and isolated jacks
provide for extra high ranges.
- ★ "TRANSIT" SAFETY POSITION on range selector
protects meter during transport and storage.
- ★ CUSTOM-MOLDED PHENOLIC CASE and PANEL:
Compact, laboratory-styled instrument.

MODEL 120 . . . complete with internal ohmmeter
batteries, banana-plug test leads and detailed
operating manual. Overall case dimensions.
5 3/8" x 7 x 3 1/8" Net Price \$39.95

PRECISION Apparatus Co. Inc.

70-31 84th Street, Glendale 27, L. I., N. Y.

Export Division: 458 Broadway, New York 13, U.S.A. - Cables - Monhane
In Canada: Atlas Radio Corp., Ltd. 560 King Street W. Toronto 28

Want more information? Use post card on last page.

Sterling Engineering Company, Inc.	62	Waldes Kohinoor, Inc.	93
Stevens Arnold Inc.	339	Ward Leonard Electric Company	85
Stoddart Aircraft Radio Co., Inc.	230, 314	Waterman Products Co., Inc.	186
Stokes Machine Co., F. J.	50, 51	Waters Manufacturing Inc.	376
Stupakoff Ceramic & Manufacturing Co. Div. of the Carborundum Co.	324, 325	Watlow Electric Mfg. Co.	349
Sun Tube Corporation	210	Weckesser Co.	284
Superior Electric Company	57	Wenco Mfg. Co.	373
Superior Tube Co.	74	Westinghouse Electric Corp.	110
Switchcraft Inc.	370	Wheeler Insulated Wire Co., Inc.	244
Sylvania Electric Products, Inc.	9, 269	Wheeler Laboratories, Inc.	359
Syntronic Instruments, Inc.	365	White Dental Mfg. Co., S. S.	272
		Wincharger Corporation	283
		Wolfe Co., Inc. Franklin	289

Taylor Fibre Co.	44		
Technical Service Corp.	368	Xcelite, Incorporated	357
Technicraft Laboratories, Inc.	216		
Technology Instrument Corp.	302, 334		
Tektronix, Inc.	114		
Tele Coil Co., Inc.	370		
Tenney Engineering Inc.	241		
Textile Banking Co., Inc.	285		
Thomas & Skinner Steel Products Com- pany, Inc.	218		
Thompson Products Inc.	258		
Transitron Electronic Corp.	75		
Transradio Ltd.	341		
Tru-Ohm Products, Div. of Model En- gineering & Mfg. Co.	255		
Tung-Sol Electric Inc.	317	PROFESSIONAL SERVICES	385

Union Carbide and Carbon Corp., Bake- lite Co.	217
Union Carbide & Carbon Corp., Linde Air Products Div.	284
Union Switch & Signal, Div. of Westing- house Air Brake Co.	260
United States Gasket Co.	431
United Transformer Co.	2nd Cover
Universal Winding Company	64A, 64B, 303
University of California Press	363

SEARCHLIGHT SECTION

(Classified Advertising)

H. E. HILTY, Mgr.

SEARCHLIGHT ADVERTISING INDEX 424

Vacuum Metals Corp.	48
Valpey Crystal Corp.	360
Variflex Corporation	301
Varian Associates	287
Veeder-Root, Inc.	38
Vitramon Incorporated	378
Vulcan Electric Co.	363

This index is published as a convenience to the
readers. Every care is taken to make it accurate, but
ELECTRONICS assumes no responsibility for errors or
omissions.

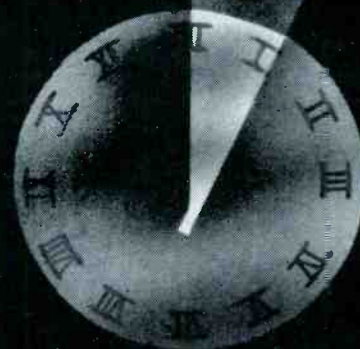
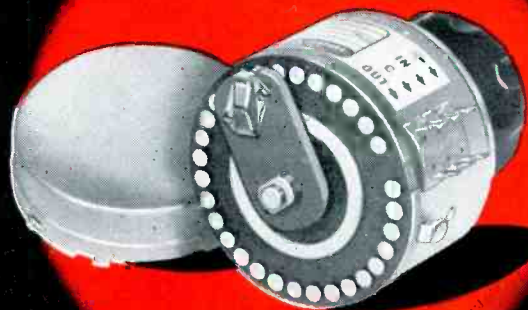

Time Means Nothing to a Daven Attenuator

Time and time again we hear that 10, 15, 20 . . . yes, even 25 years continuous use can be expected from Daven attenuators under normal conditions. A number of our customers expect 22-year life. This expectation is based on their experience with Daven attenuators still in operation which were purchased 25 years ago.

This kind of durability in electronic equipment isn't an accidental by-product at Daven. Skilled engineering at every step of design and production assures that Daven attenuators consistently outperform original equipment specifications. Check these exclusive Daven features that add up to leadership in the attenuator field:

"Knee-Action" Rotor

- Tamper proof
- Uniform contact pressure and low contact resistance over the life of every unit.
- Each rotor blade individually supported to give positive contact in operation under all types of conditions.

Low-Loss Molded Terminal Board

- For high resistance to leakage.

Rigidly Self-Supported Resistor Strips

- With air insulation.

Brass Case of 2-Piece Construction

- Greatly reduces clearance space required for removal of cover in rear of unit.

"Lock-Tite" Dust Cover

- Held by positive, bayonet-type lock which prevents cover from becoming detached under stress of vibration.

Enclosed Roller-Type Detent Mechanism

- For extra long life and positive indexing.
- Addition of detent does not increase depth of unit.

Write for catalog.



THE **DAVEN** co.

191 Central Avenue, Newark 4, New Jersey

World's Largest Manufacturer of Attenuators

IN MASS PRODUCTION

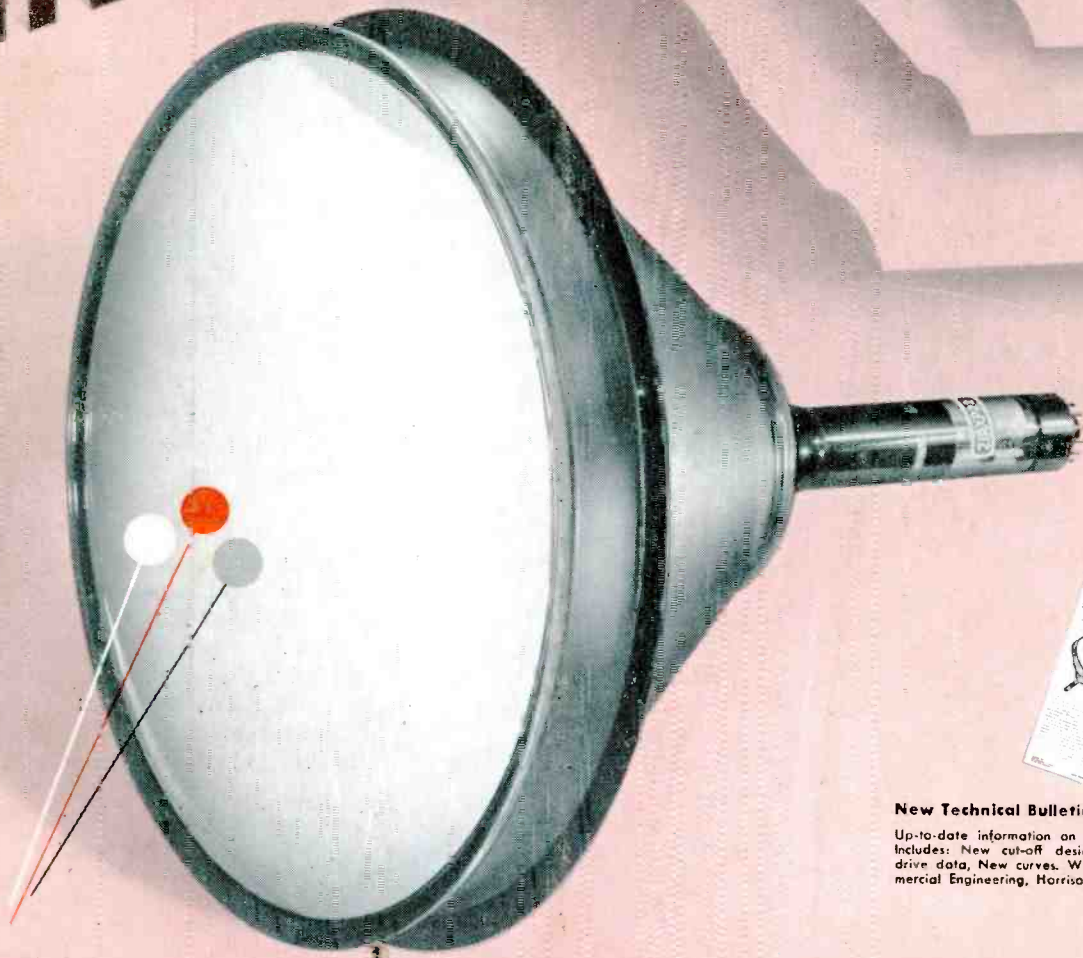

New Technical Bulletin

Up-to-date information on RCA-21AXP22. Includes: New cut-off design chart, New drive data, New curves. Write RCA, Commercial Engineering, Harrison, New Jersey.

RCA 21" COLOR PICTURE TUBES

To meet your production-line requirements on color-TV sets, RCA's extensive manufacturing facilities are now turning out 21-inch color picture tubes—in quantity. And, these facilities are being expanded to keep pace with your needs. Now you can plan "21-inch color" with confidence! Now, you can capitalize on the advantages of the RCA-21AXP22 in your color TV line. Consider just a few features of this remarkable tube:

- *Brilliant, faithful colors*—Through unique shadow mask.
- *Big, life-size pictures*—255 sq. in. area.
- *Bright, sharp pictures in color or black-and-white*—Precise registration—uniform color field.
- *Compact overall size for attractive cabinet styling*—70° deflection, plus short electron gun.
- *Proven performance*—Acclaimed by thousands of satisfied viewers—backed

by full 1 year warranty.

- *Light, strong metal-bulb construction*—Weight 28 lbs.—no external magnetic shielding required.
- *Economical*—All these features—and more—at moderate cost.

For complete technical data on the continuously produced RCA-21AXP22 color tube—and the other RCA tubes needed to round out your design and production program—call your RCA Field Representative.



RADIO CORPORATION of AMERICA
ELECTRON TUBES

HARRISON, N. J.