

APRIL • 1954

PRICE 75 CENTS

# electronics

A MCGRAW-HILL PUBLICATION



AGC 7

**Model Speeds Antenna Design  
For New Communications Ship**





# for **MILITARY COMPONENTS**

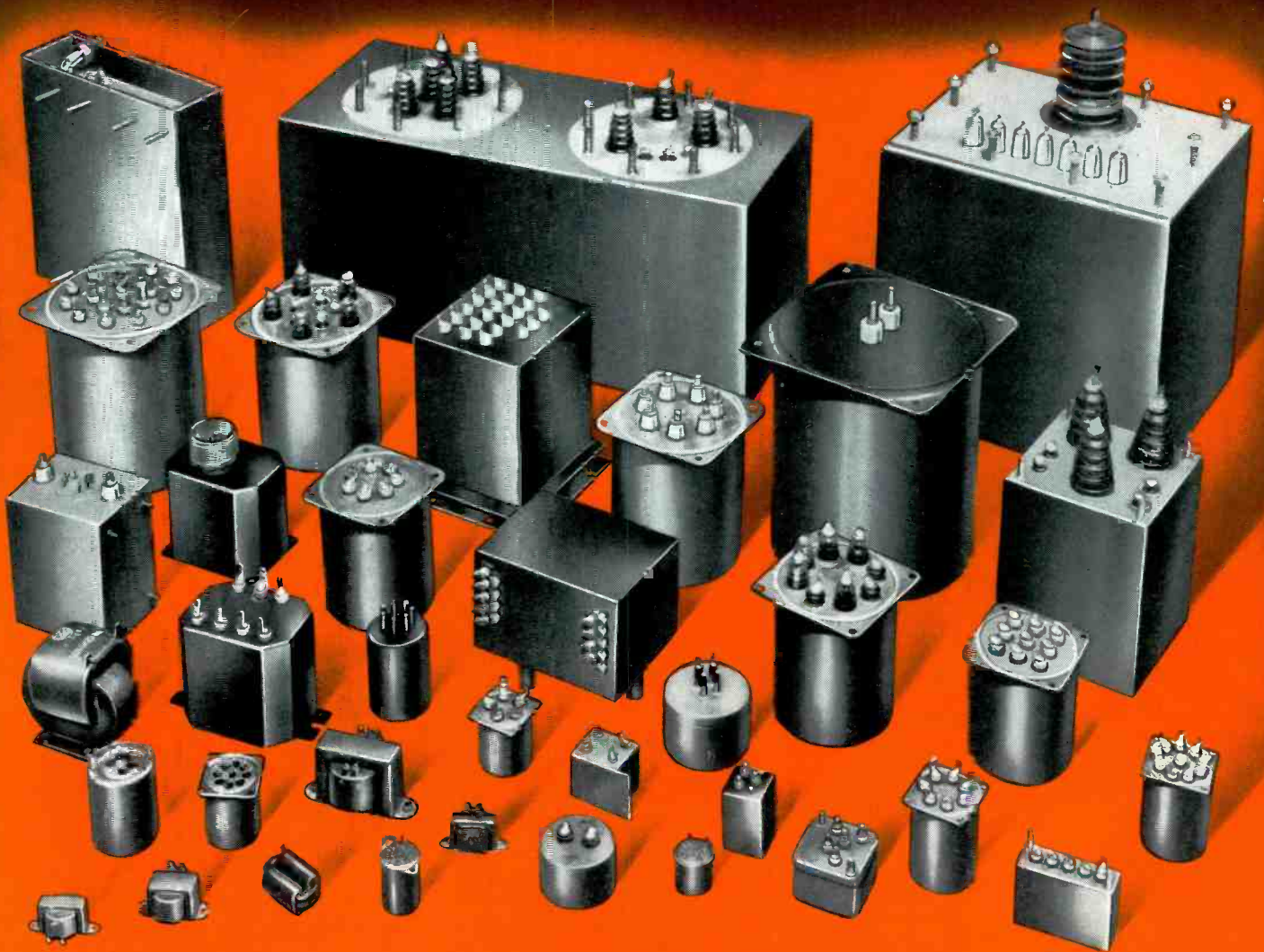

**Precision  
Production to  
Military  
Requirements**

The manufacture of transformers and associated devices for military requirements has been a specialty of U.T.C. for the past fifteen years. Thousands of military designs are in present production . . . a few examples are illustrated above.

In this photograph you will find transformers, reactors, filters, high Q coils, and magnetic amplifiers. Types illustrated include units to MIL-T-27, JAN-T-27, and ANE-19.

If you have a tough problem in an Hermetic or Fosterized unit, U.T.C. is your logical production source.

*United Transformer Co.*

150 VARICK STREET

NEW YORK 13, N. Y.

EXPORT DIVISION: 13 EAST 40th STREET, NEW YORK 16, N. Y.,

CABLES: "ARLAB"



# electronics

APRIL • 1954  
A MCGRAW-HILL  
PUBLICATION

**MODEL SPEEDS ANTENNA DESIGN**—All-brass 1/48-scale model of USS Mount McKinley is irradiated at scaled frequencies while rotating on model range at Navy Electronics Laboratory in San Diego, Cal. to find optimum positions for the many antennas (see p 162) COVER

Figures of the Month .....	4
Industry Report .....	5
Military Reliability of Electron Tubes .....	130
Capacitance Gage Checks Cable Sheath Thickness .....	134
Portable Sync Generator for TV Broadcasting .....	138
High-Frequency Transistor Amplifiers .....	142
Electronic Air-War Game Simulates Missile Strikes .....	146
Signal Overload Relay for Television Receivers .....	153
Ultrasonic Liquid Level Indicator Systems .....	156
Ship Models Predict Antenna Patterns .....	162
Sensitive Amplifier for Medical Research .....	164
Practical Two-Stage Transistor Amplifiers .....	169
Frequency-Code Modulation System .....	172
Gated Marker Generator .....	177
Simple Time-Delay Relay .....	178
Designing Surface-Wave Transmission Lines .....	180
Measuring Transistor Temperature Rise .....	185
Time-Shared Amplifier Stabilizes Computers .....	188
Transistor Equations Using h-Parameters (Reference Sheet) .....	191
Crosstalk .....	129
Electrons at Work .....	196
Production Techniques .....	242
New Products .....	292
Plants and People .....	338
New Books .....	398
Backtalk .....	404
Index to Advertisers .....	439

**W. W. MacDONALD**, Editor; **VIN ZELUFF**, Managing Editor; John Markus, A. A. McKenzie, Associate Editors; William P. O'Brien, John M. Carroll, William G. Arnold, David A. Findlay, Assistant Editors; Marilyn Wood, Gloria J. Filippone, Arlene Schilp, Editorial Assistants; Keith Henney, Consulting Editor; Gladys T. Montgomery, Washington Editor; Harry Phillips, Art Director; Eleanor Luke, Art Assistant

**H. W. MATEER**, Publisher; **WALLACE B. BLOOD**, Manager; R. S. Quint, Buyers' Guide Manager; Frank H. Ward, Business Manager; H. E. Hilty, Classified Manager; D. H. Miller, James Girdwood, New York; Wm. S. Hodgkinson, New England; Warren W. Shew, Philadelphia; Charles Wardner, James T. Hauptli, Chicago; J. L. Phillips, Cleveland; T. H. Carmody, R. C. Alcorn, San Francisco; Carl W. Dysinger, Los Angeles; Robert H. Sidur, Atlanta



April, 1954

ELECTRONICS

Vol. 27, No. 4



Member AEC and ABP

Published monthly with an additional issue in June by McGraw-Hill Publishing Company, Inc., James H. McGraw (1860-1948), Founder. Publication Office, 99-129 North Broadway, Albany 1, N. Y.

Executive, Editorial and Advertising Offices: McGraw-Hill Building, 330 W. 42 St., New York 36, N. Y. Donald C. McGraw, President; Willard Chevalier, Executive Vice-President; Joseph A. Gerardi, Vice-President and Treasurer; John J. Cooke, Secretary; Paul Montgomery, Senior Vice-President, Publication Division; Ralph B. Smith, Vice-President and Editorial Director; Nelson Bond, Vice-President and Director of Advertising; J. E. Blackburn, Jr., Vice-President and Director of Circulation.

Subscriptions: Address correspondence to Electronics—Subscription Service, 99-129 N. Broadway, Albany 1, N. Y., or 330 W. 42nd St., New York 36, N. Y. Allow one month for change of address. Subscriptions are solicited only from persons engaged in theory, research, design, production, maintenance and use of electronic and industrial control components, parts and end products. Position and company connection must be indicated on subscription orders.

Single copies 75¢ for United States and possessions, and Canada; \$1.50 for Latin America; \$2.00 for all other foreign countries. Buyers' Guide \$2.00. Subscription rates—United States and possessions, \$6.00 a year; \$9.00 for two years. Canada, \$10.00 a year; \$16.00 for two years. Other western hemisphere countries, \$15.00 a year; \$25.00 for two years. All other countries \$20.00 a year; \$30.00 for two years. Entered as second class matter August 29, 1936, at the Post Office at Albany, N. Y., under act of Mar. 3, 1879. Printed in U.S.A. Copyright 1954 by McGraw-Hill Publishing Co., Inc.—All Rights Reserved. BRANCH OFFICES: 520 North Michigan Avenue, Chicago 11, Ill.; 68 Post Street, San Francisco 4; McGraw-Hill House, London, E.C. 4; Washington, D. C. 4; Philadelphia 3; Cleveland 15; Detroit 26; St. Louis 8; Boston 14; 1321 Rhoades-Haverty Bldg., Atlanta 3, Ga.; 1111 Wilshire Blvd., Los Angeles 17; 738-9 Oliver Building, Pittsburgh 22. ELECTRONICS is indexed regularly in The Engineering Index.



**New**

**tubeless**

# ELECTRONIC VOLTAGE STANDARDS

## For calibration of meters and oscilloscopes—Model VRS-AC10

This new instrument can be used for direct checking and calibrating of vacuum tube voltmeters. It can also be used for indirect checking of power meters.

Range: 1 mv to 100 mv  
100 mv to 1 v  
1 v to 10 v

Accuracy:  $\pm 0.25\%$

Input: 1.5 VAC  $\pm 10\%$ , 1 $\phi$ , 60~

Output loading: 1 megohm or higher.  
However not damaged by short circuit.

We solicit inquiries for AC standards  
of other voltage and current ratings.

**AC**

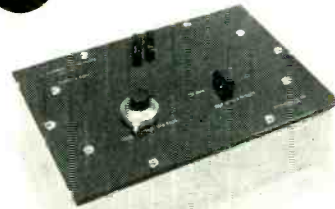

## DC voltage standard Model VRS15

The primary application of Sorensen's new tubeless DC standard is as a component in recording equipment, where it eliminates a power supply and a standard cell. It is also intended for use as a laboratory standard, illustrated below.

Output: 1 1/2 VDC at 6 ma. Not damaged by short circuit.

Output impedance: 12 ohms.

Accuracy:  $\pm 1$  mv against line

Ripple: 350 microvolts

Stability: a 24-hour stability check shows output drift well under 1 mv

Input range: 95-130 VAC, 1 $\phi$ , 60~

Other DC standards can be designed to your requirements up to 5 VDC and other currents. Special mechanical configurations of the DC standard will be designed for your particular applications

**DC**



Write for complete information.

Model VRS-AC10 and Model VRS15 are the latest additions to Sorensen's standard line of power regulating equipment. Send for your free copy of the new general catalog — write to Sorensen & Co., Inc., 375 Fairfield Ave., Stamford, Conn. In Europe: Sorensen A.G., Gartenstrasse 26, Zurich 2, Switzerland.

# SORENSEN



# THE NEW MUIRHEAD-WIGAN DECADE OSCILLATOR



TYPE D-650-A

**T**HIS precision laboratory oscillator, which covers a range of 1 to 111,100c/s with an overall frequency accuracy of  $\pm 0.2\%$  or  $\pm 0.5c/s$ , employs the decade tuning system, by means of which the frequency can be set quickly and accurately on four decade dials and a range switch. This system of tuning ensures the highest possible frequency accuracy and stability. It also enables a given frequency setting to be repeated exactly, and permits the addition or subtraction of a fixed number of cycles per second, thus giving an incremental accuracy of an extremely high order. No other type of oscillator possesses all these advantages.

## FEATURES

- Frequency range: 1-11,110c/s and 10-111,100c/s.
- Frequency accuracy:  $\pm 0.2\%$  or  $\pm 0.5c/s$ .
- Hourly frequency stability:  $\pm 0.02\%$  over most of range.
- Maximum output: 2W into 8000 ohms above 20c/s.  
50mW into 8000 ohms below 20c/s.
- Harmonic content: 1% at 1W output.
- Hum level: -80db relative to maximum output at 1000c/s.
- Power supply: 95-125V, 60c/s; 90W.
- Dimensions: 17 $\frac{1}{4}$  in. wide x 10 $\frac{1}{2}$  in. high x 13 in. deep.
- Weight: 83 lb.

MAIL THIS  
COUPON FOR  
DESCRIPTIVE  
BROCHURE



NAME \_\_\_\_\_  
POSITION \_\_\_\_\_  
COMPANY \_\_\_\_\_  
ADDRESS to which BROCHURE should be sent  
\_\_\_\_\_  
\_\_\_\_\_

100

**MUIRHEAD & CO. LIMITED • BECKENHAM • KENT • ENGLAND**



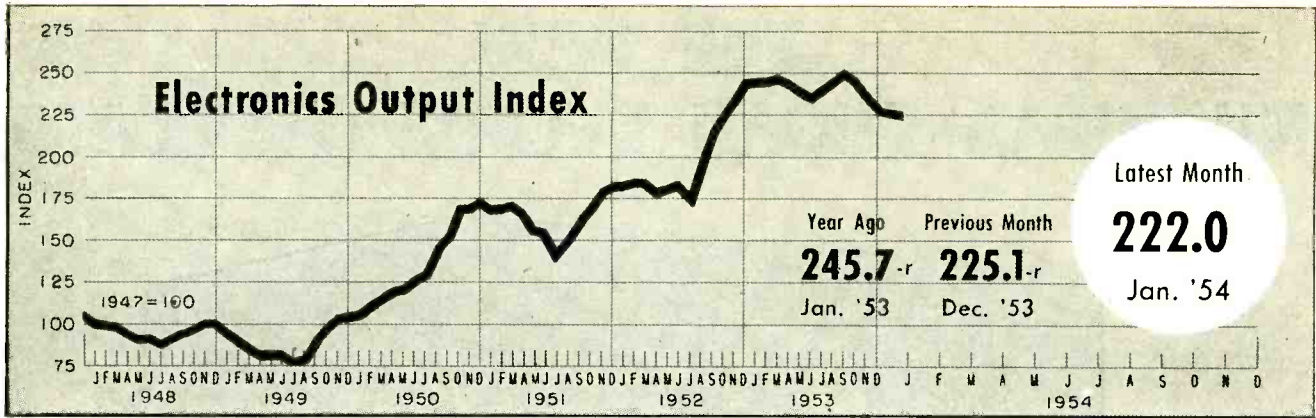

## FIGURES OF THE MONTH

	Year Ago	Previous Month	Latest Month
<b>RECEIVER PRODUCTION</b>			
(Source: RETMA)			
Television sets	719,234	449,787	420,571
Home sets	361,921	514,428	271,036
Clock Radios	189,592	117,672	159,932
Portable sets	93,962	103,931	46,571
Auto sets	447,667	365,084	394,442

	Year Ago	Previous Month	Latest Month
<b>RECEIVER SALES</b>			
(Source: RETMA)			
Television sets, units	640,073	774,856	731,917
Radio sets (except auto)	414,726	1,456,008	306,407

	Year Ago	Previous Month	Latest Month
<b>RECEIVING TUBE SALES</b>			
(Source: RETMA)			
Receiv. tubes, total units	37,343,081	23,404,026	22,133,347
Receiv. tubes, value	\$25,688,914	\$17,832,387	\$16,412,505
Pic. tubes to mfrs., units	988,316-r	644,287-r	557,681
Picture tubes, value	\$23,892,982-r	\$14,801,856-r	\$12,173,923

	Year Ago	Previous Month	Latest Month
<b>SEMICONDUCTOR SALES</b>			
(Source: RETMA)			
Germanium Diodes	1,568,334	733,029	689,409

	Quarterly Figures		
	Year Ago	Previous Quarter	Latest Quarter
<b>INDUSTRIAL TUBE SALES</b>			
(Source: NEIMA)			
Vacuum (non-receiving)	3rd '52	2nd '53	3rd '53
Gas or vapor	10,582,110	10,320,720-r	9,434,082
Phototubes	2,951,067	3,303,631-r	4,145,018
Magnetrons and velocity modulation tubes	566,234	706,055-r	510,686
Gaps and T/R boxes	8,491,301	10,523,247-r	9,822,600
	1,698,259	1,683,637-r	1,554,000

	Year Ago	Previous Month	Latest Month
<b>TV AUDIENCE</b>			
(Source: NBC Research Dept.)			
Sets in Use—total	21,234,100	26,973,000	27,666,000

	Year Ago	Previous Month	Latest Month
<b>BROADCAST STATIONS</b>			
Source: (FCC)			
TV Stations on Air	147	369	379
TV Stns CPs—not on air	221	197	198
TV Stns—Applications	815	134	99
AM Stations on Air	2,409	2,524	2,529
AM Stns CPs—not on air	131	120	128
AM Stns—Applications	252	165	154
FM Stations on Air	611	555	554
FM Stns CPs—not on air	20	19	19
FM Stns—Applications	8	4	3

	Year Ago	Previous Month	Latest Month
<b>COMMUNICATION AUTHORIZATIONS</b>			
(Source: FCC)			
Aeronautical	35,323	42,455	42,314
Marine	38,631	43,703	43,918
Police, fire, etc.	12,234	14,663	14,865
Industrial	15,761	19,797	20,053
Land Transportation	5,531	6,470	6,556
Amateur	117,106	115,518	116,369
Citizens Radio	1,892	5,439	5,492
Disaster	90	254	256
Experimental	507	506	525
Common carrier	1,037	1,430	1,479

	Year Ago	Previous Month	Latest Month
<b>EMPLOYMENT AND PAYROLLS</b>			
(Source: Bur. Labor Statistics)			
Prod. workers, comm. equip.	Nov. '52	Oct. '53	Nov. '53
Av. wkly. earnings, comm.	398.0	407.6	395.2
Av. wkly. earnings, radio	\$65.99	\$66.97	\$67.43
Av. wkly. hours, comm.	\$63.71	\$65.84	\$66.40
Av. wkly. hours, radio	41.5	40.1-r	39.9
	40.1	39.9-r	40.0

	Year Ago	Previous Month	Latest Month
<b>STOCK PRICE AVERAGES</b>			
(Source: Standard and Poor's)			
Radio—TV & Electronics	Feb. '53	Jan. '54	Feb. '54
Radio Broadcasters	304.5	273.4	281.7
	285.1	274.3	284.8

p—provisional; r—revised

## FIGURES OF THE YEAR

	1953 Total
Television set production	7,214,787
Radio set production	13,368,556
Television set sales	6,375,279
Radio set sales (except auto)	7,064,485
Receiving tube sales	437,091,555
Cathode-ray tube sales	7,582,835

## TOTALS FOR THE FIRST MONTH

	1953	1954	Percent Change
Television set production	719,234	420,571	-41.5
Radio set production	1,093,142	871,981	-20.2
Television set sales	640,073	731,917	+14.3
Radio set sales (except auto)	414,726	306,407	-26.1
Receiving tube sales	37,343,081	22,133,347	-40.3
Cathode-ray tube sales	988,316	557,681	-43.6



# INDUSTRY REPORT

electronics—APRIL • 1954

## New York Subways Go Electronic

FASTEST subway train operation in the U. S. will result from an all-electronic traffic control system to be installed on the Flushing line of New York's IRT. The \$9,028,995 job will be handled by Union Switch who have a similar system in Stockholm, Sweden.

► **What It Does**—Features of the traffic-control system include train identification that will identify an approaching train, operate switches automatically and indicate to passengers on the platform the classification of the train.

► **How It Works**—Each train will be equipped with an inert coil tuned to a specific frequency. Each frequency represents a train classification. At points along the right-of-way at which the identification is to be made there will be a bridge, tuned to each of the identifying frequencies. As the train goes by, the coil unbalances its corresponding bridge.

► **Speed**—When the new traffic control system is completed, the ten-mile Flushing Line will be operated from two control points instead of ten. Eventually, the whole line will be controlled from one point.

The new signal system will also allow the operation of 37 11-car trains an hour over the line against a maximum of 30 9-car trains at present. These two improvements should produce a 25½% increase in passenger-carrying capacity per train.

Stations along the line are being extended to accommodate 11-car trains. At present they only take trains of nine cars.

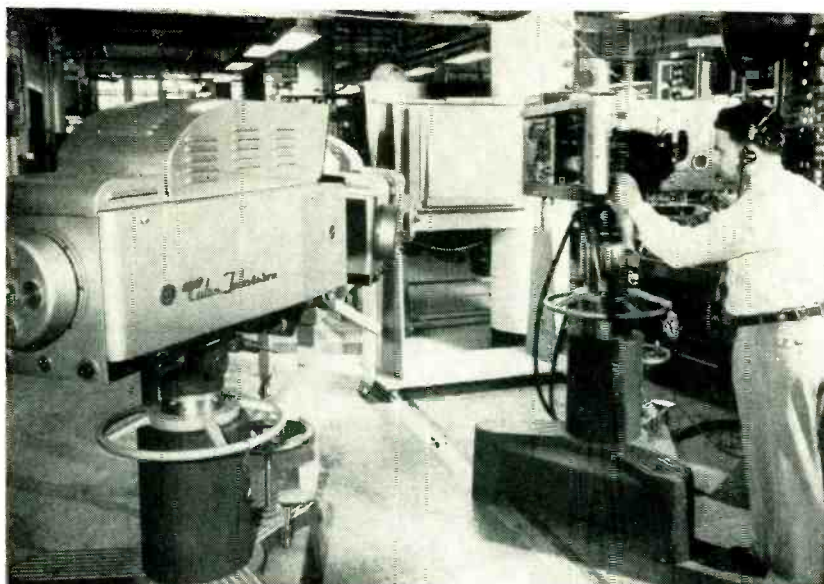

INITIAL shipments of commercial color cameras are made by RCA as . . .

## Manufacturers Boost Color Output

**RCA, GE and DuMont expand production plans to prepare tv broadcasters for color**

IN MARCH the pace of production activity for color tv station equipment increased when both RCA and GE announced deliveries of color camera equipment.

RCA has made delivery of several commercial color tv cameras and associated equipment to NBC and CBS. Production and shipment of the cameras will continue on a regular schedule against orders already received. These include orders from WKY, Oklahoma City; WBAP, Fort Worth; WBEN, Buffalo; WTMJ, Milwaukee; WCCO, Minneapolis; KTLA, Los Angeles; NBC and from CBS which recently increased its order to cover 12 com-

plete studio camera chains and associated equipment.

Each color camera chain includes the camera, an aperture compensator, rack-mounted control amplifier, shading generator, remote control panel, gamma corrector and master monitor and auxiliary switching unit.

► **Coders**—General Electric, which signed a patent license agreement for the right to manufacture and sell color apparatus developed by CBS, including the single-tube field-sequential color tv camera and the Chromacoder, also began deliveries in March. First camera went to CBS which has ordered four of the units.

The company also announced plans to modify existing black-and-white cameras for use with the

Chromacoder. Although none for individual stations have as yet been converted, it is estimated that the cost for converting one camera, including the coder, is about \$46,000. Because one coder unit can handle any number of field-sequential cameras, a second camera could be converted and added for about \$6,900 additional. Four cameras converted and coder come to about \$64,000.

Three-tube color cameras cost \$66,000 each.

► **Scanner**—DuMont, which shipped its first Colorvision slide scan-

ner in December to CBS, announced that it has delivered approximately 10 scanners to equipment manufacturers as a video source for test purposes since that time.

The firm has no immediate plans for production of color cameras but is concentrating on film equipment. Introduction of 16-mm color equipment is planned for the NARTB meeting this year. Production plans for 35-mm equipment are underway.

It has been estimated that by the end of 1954 at least 180 stations of all networks will be able to broadcast color tv.



CBS-type color tv camera built by GE uses field-sequential disk. Chromacoder converts signal to NTSC color.

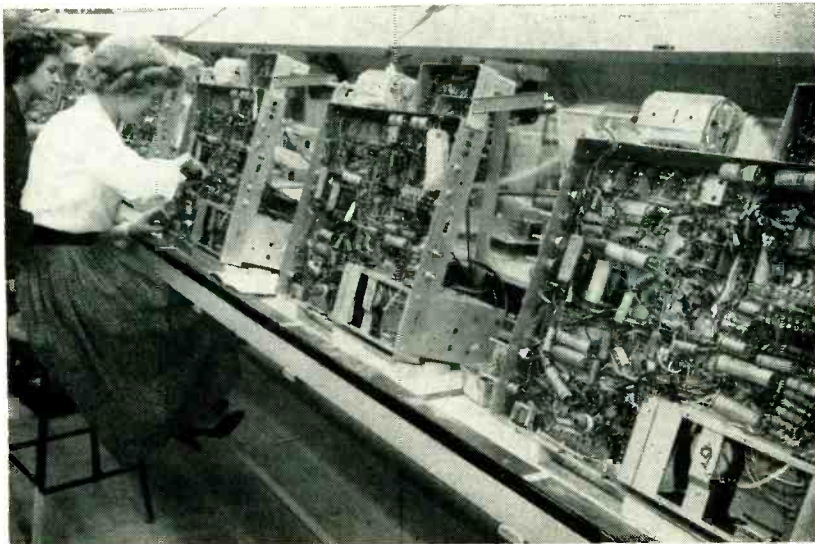

ASSEMBLY-LINE methods are used at Westinghouse as

## Production Begins on Color Sets

**Westinghouse and RCA are now producing color sets on regular production basis**

DURING March, two major tv receiver manufacturers, Westinghouse and RCA, announced commercial production of color tv receivers on an assembly line basis.

Westinghouse receivers are now being offered for immediate home delivery at 36 retail stores in New York City and 14 in northern New Jersey.

Suggested retail price of the set is \$1,295. The firm plans to market the sets in other major cities in the

near future.

► **Tubes**—RCA's first commercial models of color tv receivers went into production in March, three months ahead of schedule at its Bloomington, Indiana plant. A tentative list price of \$1,000 has been set for the 15-inch open-face console model. The RCA production model has 36 tubes including picture tube.

The company also announced that the production of RCA tricolor picture tubes had reached a going rate of 2,000 a month, within a period of two months following FCC's approval of NTSC color.

## Engineers Develop New Transistor Uses

**Include audio and computer fields; new production processes appear**

NEW USES for transistors include speech amplifiers built into hand microphones as well as terminal equipment and repeater amplifiers for rural carrier telephone systems. Circuits demonstrated recently indicate forthcoming application in electronic computers. Meanwhile development continues of transistors resistant to heat and moisture.

► **Hand Mike**—A junction transistor preamplifier built into a \$95 dynamic hand microphone has been announced. Use of the preamplifier achieves an overall output comparable to a carbon microphone but the unit is more directive and avoids hissing and frying sounds. The existing microphone bias powers the preamplifier without additional connection.

► **Carrier Telephone**—In Americus, Ga., AT&T has installed a rural carrier system that uses 300 transistors. The system covers 26½ miles and includes three terminal units and several repeater amplifiers. Use of transistors reduces the equipment size to 1/10

(Continued on page 8)



HIGHLY SENSITIVE...COMPACT IN SIZE!

# SYLVANIA PHOTODIODE

## 1N77A

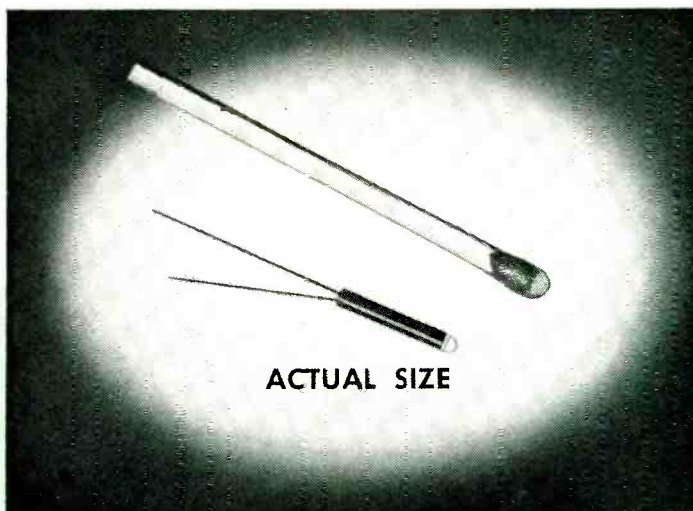

The Sylvania 1N77A is a highly sensitive compact junction photodiode.

Its useful sensitivity covers the visible spectrum and extends into the infrared region where it peaks at approximately 1500 Angstrom Units.

Consider these advantages:

- 1 Hermetically sealed in glass.
- 2 Extreme stability in operation.
- 3 High sensitivity (5.0 volt peak to peak across a 100 k-ohm load).
- 4 Low dark current ( $500 \mu\text{a}$  @  $-50$  volts).

The high sensitivity and compact packaging of the 1N77A should provide the answer to many light-sensing application problems. *Still more reasons why it pays to specify Sylvania.*

### DETAILED DRAWING

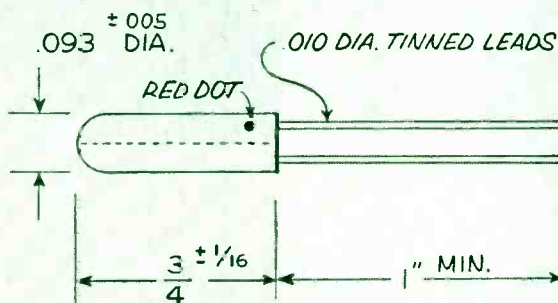

FOR FULL DETAILS about the complete line of Sylvania diodes write to Dept. 4E-1604 at Sylvania.

# SYLVANIA

Sylvania Electric Products Inc.,



1740 Broadway, New York 19, N. Y.

In Canada: Sylvania Electric (Canada) Ltd., University Tower Bldg.  
St. Catherine Street, Montreal, P. Q.

LIGHTING • RADIO • ELECTRONICS • TELEVISION



and requires only 1/20 the power of an electron tube system.

► **Computers**—An eight-stage decimal counter using junction transistors was demonstrated at a West Coast computer show and the introduction of a completely transistorized electronic computer may take place later this year.

► **Stabilized Germanium**—Change

of transistor characteristics caused by aging or effects of surface moisture can be avoided by using germanium stabilized by heat treatment in a bath of molten potassium cyanide. In announcing this development, Sylvania also called attention to a germanium-silicon alloy, which will permit effective transistor action up to about 350 F.

counted. If his count disagrees with that made by the phototubes, the toll recorder will lock. The operator may correct his error by depressing the proper axle key.

Axles are weighed separately as they pass over the weighing platform. Load cells and electronic storage units retain these weights and when the fare card is processed, the weight class is automatically punched into it.

► **Recheck**—At the exit interchange, equipment automatically reweighs the vehicle, comparing the weight class punched by the entrance recorder with the weight class determined by the exit classifier. It also reads the number of axles and the time.

The toll equipment will compute all revenue, compile traffic density data, total charges by account number and quickly audit collectors' daily work reports.



**DEMAND** is for more accurate fee collections as

## Electronic Management Rated Excellent

Management Institute cites firms in electronics field for management excellence in 1953

TWENTY companies in the industry are among the 348 companies in the U.S. and Canada that have been found eligible for the designation "excellently managed", by the American Institute of Management.

In all, the methods of 4,000 leading companies were evaluated by the Institute. Firms in the electronics field so designated are: AT&T, Burroughs, CBS, GE, IBM, McGraw Electric, Minneapolis Honeywell, Minnesota Mining, Motorola, NCR, Otis Elevator, Philco, RCA Sperry, Sprague, Square D, Sylvania, Thompson Products, Westinghouse and Zenith.

► **Ratings**—When auditing a management, the Institute uses a point system for rating 10 key factors. Each factor has an optimum and

(Continued on page 10)

## Electronics Moves In On Toll Roads

**Pennsylvania Turnpike orders new toll collection equipment; other roads may follow**

EXTENT to which electronic equipment can be utilized on turnpikes is emphasized by plans to equip all terminals and interchanges on the 360-mile Pennsylvania Turnpike with electronic toll equipment in the fall of next year. The Ohio Turnpike, now under completion, plans to install similar equipment. With about 2,000 miles of toll highways completed or authorized in the U. S. and at least that many more miles planned, the nation's toll roads represent a sizeable potential mar-

ket for specialized electronic equipment.

► **Phototubes**—Recently developed by IBM, the new toll collection and audit system to be used on the Penn Pike is a combination of phototubes, specially designed weighing platforms and toll recorders that make possible greater operating efficiency, increased revenue protection and more equitable vehicle classification.

► **How It Works**—When a vehicle pulls up to the toll booth the operator depresses a key on the toll recorder, shown above, corresponding to the number of axles he has



# DEPENDABILITY

is why Sprague  
Type DFP Twist-Loks<sup>☆</sup>  
are the preferred

## ELECTROLYTIC CAPACITORS

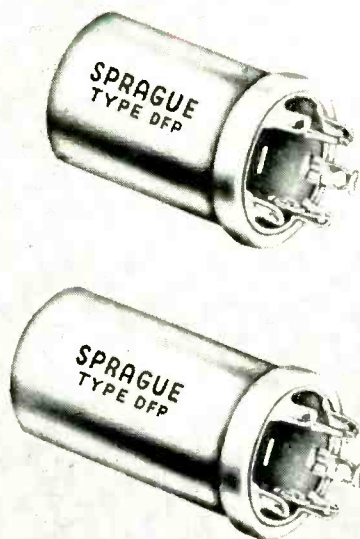

Leading television set makers rely on Sprague as their major source for electrolytic capacitors.

Stability under maximum operating conditions plus outstandingly long service life are the engineering reasons for this preference.

From the business standpoint, it makes good sense to deal with a supplier whose quality of product is uniformly excellent and who has the largest production facilities in the industry.

And now a new plant is being completed to permit Sprague to accept an even larger portion of your requirements.

**SPRAGUE ELECTRIC COMPANY**  
35 Marshall St., North Adams, Massachusetts

<sup>☆</sup>Trademark

Sprague, on request, will provide you with complete application engineering service for optimum results in the design of equipment using electrolytic capacitors.

# SPRAGUE

WORLD'S LARGEST CAPACITOR MANUFACTURER

minimum within which a company must come to be certified as excellently managed. The following table lists the ten factors with the minimum and maximum ratings:

Factors	Max	Min
Economic Function	400	300
Corp. Structure	500	375
Health of Earnings Growth	600	450
Fairness To Stockholders	700	525
Research and Development	700	525
Directorate Analysis	900	675
Fiscal Policies	1,100	975
Production Efficiency	1,300	975
Sales Vigor	1,400	1,050
Executive Evaluation	2,400	1,800

► **Executive Evaluation**—According to AIM this factor is most important. Some questions for evaluating this factor are: What executive personnel changes have occurred in recent years and why?

What program is followed in training promising executives? Have training programs been established on the top management level? How do executive salaries compare with the industry?

## Progress Payments Clarified By Defense

FIRMS whose main business involves government orders can breathe more easily; advance payments on Defense Department contracts have been reinstated.

Contractors may now receive progress payments to cover up to 90 percent of direct labor and material costs or up to 75 percent of total costs of work done under undelivered portions of government contracts. This statement of policy by the Defense Department clears up the state of confusion which led to a stoppage of all progress payments in January 1954.

The confusion began during the Korean war. At that time, progress payments were made overly liberal; some contractors openly discussed profits already made on undelivered items. Consequently, the Defense Department asked for an investigation of progress payment policies. This was interpreted by department officials as drastic curtailment and in January, 1954, complete stoppage of progress payments was ordered.

# Industry Wants Excise Tax Changes

## RETMA presses for excise tax relief for monochrome sets, full exemption for color tv

DRIVE to persuade the Senate Finance Committee to revise the excise tax reduction formula approved by the House of Representatives and substitute a proportionate cut in all excise taxes and exemption for color tv is being made by the Radio Electronics Television Manufacturers Association.

The House proposal as it now stands would place a ceiling of 10 percent on all excise taxes except those on liquor and tobacco. The present 10 percent excise tax on all tv sets would remain unchanged.

► **Take**—Excise taxes collected from the electronics industry in fiscal 1953 total \$159.3 million, the highest take from the industry on record. Collections for the first five months of fiscal 1954, which began last June, are above the 1953 amount.

The U. S. collects manufacturer's excise taxes on 20 categories of products. Radio and tv sets and parts excise totals rank sixth on the list, led only by gasoline and products of the automotive industry.

► **Reduction**—According to RETMA, the electronics industry agrees with the basic objective of the House bill to increase consumer purchasing power and stimulate production through excise tax reductions but believes it can be better achieved by broadening the base of products which will benefit from the tax cut. The House bill, the association says, will reduce the excise levy on many luxury products while a proportionate tax reduction would stimulate the production of many manufactured products.

By removing the 10-percent tax on color sets, Congress will follow the traditional policy of withholding taxes on new products and will bring about an immediate reduction in the price of color receivers,

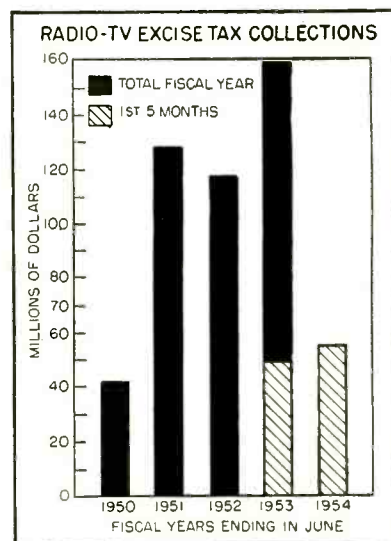

RETMA points out. It estimates that if a proportionate tax reduction is followed, the present 10-percent excise tax on tv sets would be cut to 8 percent.

## Packaging Electronics Is Big Business

**Bigger tubes and sets have affected packaging expense; color may increase it**

COST of the average picture tube carton is only about 60 cents. But multiply it by the number of picture tubes that were produced in 1953 and it can be seen that packaging in the electronics industry is big business indeed. Approximately \$4 million was spent for picture tube boxes alone last year. Add to this the cost of cartons for complete tv and radio sets, receiving and industrial tube packaging and that for military equipment and the total cost of packaging for the industry in 1953 was a top expense item.

► **Tubes**—Cost is one main reason why set makers were quick to ship black and white tv tubes already installed in receivers when it was

(Continued on page 12)



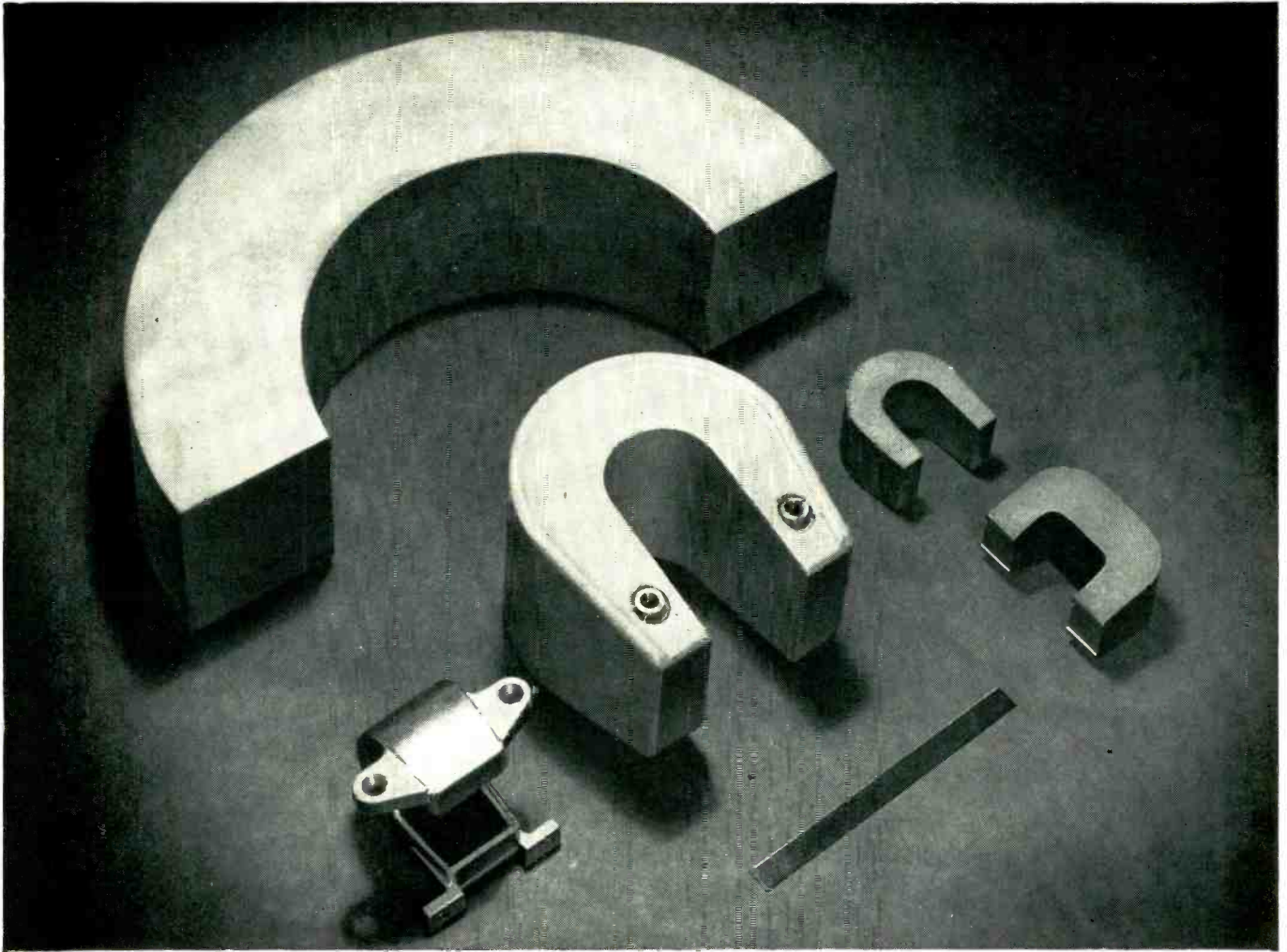

# PERMANENT MAGNETS and ASSEMBLIES for Magnetrons and Traveling Wave Tubes

The group of magnets illustrated above, weighing from a fraction of a pound up to 75 pounds, are indicative of the wide range of Arnold production in this field. We can supply these permanent magnets in any size or shape you may need, with die-cast or sand-cast aluminum jackets, Celastic covers, etc. Complete assemblies may be supplied with Permendur, steel or aluminum bases, inserts and keepers as specified . . . magnetized and stabilized as desired. • *Let Arnold handle your magnetron and traveling wave tube permanent magnet requirements.*

*Made to your  
Specifications*

**. . . ANY SIZE, SHAPE  
OR COATING REQUIRED**

*★ We'll welcome  
your inquiries*

W&D 4698

**THE ARNOLD ENGINEERING COMPANY**  
 SUBSIDIARY OF ALLEGHENY LUDLUM STEEL CORPORATION  
 General Office & Plant: Marengo, Illinois  
 DISTRICT SALES OFFICES . . . New York: 350 Fifth Ave.  
 Los Angeles: 3450 Wilshire Blvd. Boston: 200 Berkeley St.



found that it could be done safely. Then tube makers were able to use larger cartons for factory use in which six picture tubes could be shipped. Only tubes for replacement sales needed individual cartons.

But color tv may bring back the practice of shipping picture tubes and sets in separate cartons to the final customer. A few companies have indicated that they plan to ship color sets that way, at least initially. Westinghouse, however, is shipping color sets with tubes already installed.

► **Savings**—More companies are employing packaging experts to concentrate exclusively on the operation. One electronics firm set up a packaging department to coordinate its entire packaging program and made savings of some \$1 million a year.

Another company, Federal Mfg., found that its military packaging costs reached \$1 million in 1953. This year it decided to become a package manufacturer in an effort to convert the expense into a profitable business.

## Elevator Sales Go Up

LEADING manufacturers of elevators estimate that between 60 and 65 percent of all passenger elevators sales made in the past five years have been of the automatic type that uses electron tubes. Nearly 80 percent of all passenger elevator orders currently on the industry's books are reported to be of the automatic type and the percentage is seen increasing.

► **Tubes**—Total annual production of passenger elevators is roughly about 4,000 banks a year, according to one estimate. In some fully automatic elevators as many as 80 tubes are used per bank or shaft. In other types which are not traffic controlled, from 8 to 10 tubes may be utilized.

► **Market**—Tubes are moving into old elevators too. Companies which specialize in converting elevators to automatic operation do an increasing number of changeovers each year.

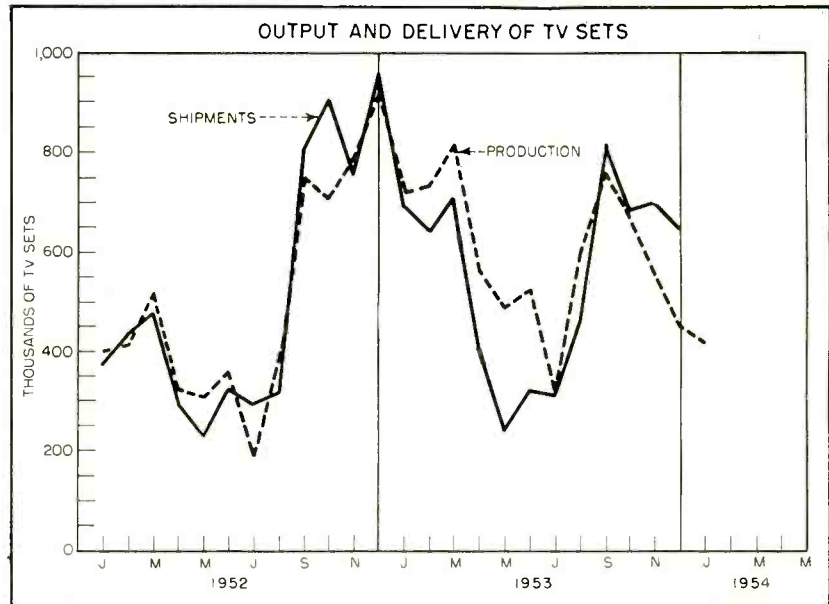

## TV Shipments Surpass Output

### Set production in relation to deliveries indicate status of the industry's pipelines

CHANGES in tv receiver distribution channels are indicated by the varying gap between set production and shipments to dealers. As is shown in the chart, monthly deliveries to dealers have dropped less since September, 1953 than have monthly production tallies.

In December, the widest gap in two years indicated that over 200,000 more sets were shipped to dealers by manufacturers and distributors than were produced during the month. Set manufacturers and distributors were evidently loaded with inventory even before the drop in retail sales occurred last year.

► **Concern**—The tv production cutbacks that were made during the final months of 1953 caused concern both in and outside the industry. But according to R. C. Sprague, chairman of the board of RETMA, the important fact that retail sales of sets were at virtually peak levels in 1953 has often been overlooked in the attention many people have given to output cutbacks which became necessary late in the fall to prevent further accumulation of inventories.

Sprague reminds that stocks of tv sets on hand at the beginning of last year were somewhat low in relation to normal demand and to the number of retail outlets; it was not until July or August that this condition was corrected. However, the drop in retail sales beginning in September was so sudden that there was overproduction for several months, with the result that November and December output had to be cut back fairly sharply, to bring total stocks down to the level of 1.9 million at the end of the year. Although this represents a substantial increase from 1.2 million a year earlier, it is not far out of line with a normal level of 1.6 to 1.8 million sets.

► **Where**—At the end of 1953, over 28.5 million tv sets had been shipped to dealers in the U. S., Hawaii and Alaska since 1946. Over 62 percent of the receiver shipments were concentrated in only eight states, all of which received over 1.25 million during the eight-year period. Leading this list was New York which received set shipments totaling 4.1 million units during the period.

The other states where tv set shipments to dealer totaled over a

(Continued on page 14)



# 6

## wonders of the age?

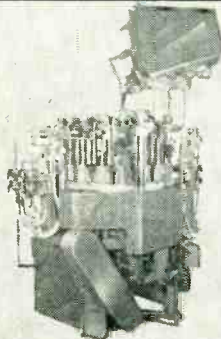

BULB MAKING MACHINE



GLASS TUBING CUTTING MACHINE  
VERTICAL TYPE

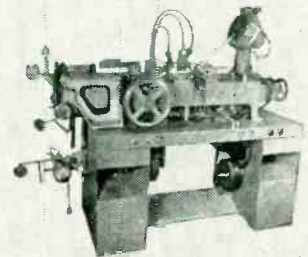

LEAD WIRE WELDING MACHINE

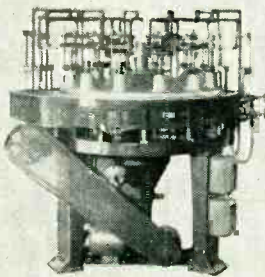

BUTTON STEM MACHINE

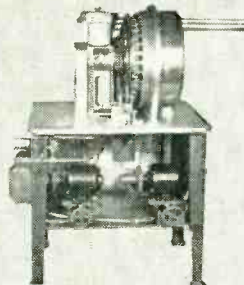

GLASS TUBING CUTTING MACHINE  
HORIZONTAL TYPE

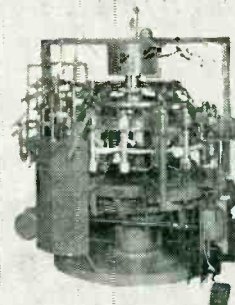

AUTOMATIC EXHAUST MACHINE

### **Built into the automatic machinery shown on this page is knowledge of every phase of electronic tube production...**

Kahle's "6 Wonders" are engineered to mass-manufacture Sub Miniature Tubes so that the burden of "knowing how" to make the product falls upon the machinery itself instead of the manufacturer. Forty-six years of intimate contact with the design and construction of custom machinery together with a long history of pioneering successes in electronics and allied industries, produce the "know-how" in such combinations of machines as the models depicted above. Kahle executives have vast experience in the actual manufacturing of the end products which such machinery produces. This cumulative knowledge is built into the machinery to solve bottlenecks and gives a smooth uninterrupted flow of the finished products.

**"Built-in know how" is what makes Kahle's name the password in the electronics and glass industries where production difficulties can be overcome with custom machinery.**

**Call on Kahle and learn how you can benefit from the company which enjoys the respect of the industry's leaders.**

# Kahle

ENGINEERING COMPANY  
1310 SEVENTH STREET • NORTH BERGEN, N. J.

©NTI

million units during the eight-year period were Pennsylvania, 2,647,072; California, 2,611,984; Ohio, 2,236,969; Illinois, 2,048,620; New Jersey, 1,462,698; Michigan, 1,386,

542 and Massachusetts, 1,257, 588.

A total of 28.4 million sets went to dealers in the U. S. but 45,308 sets were shipped to Hawaii while 2,330 sets went to Alaska in '53.

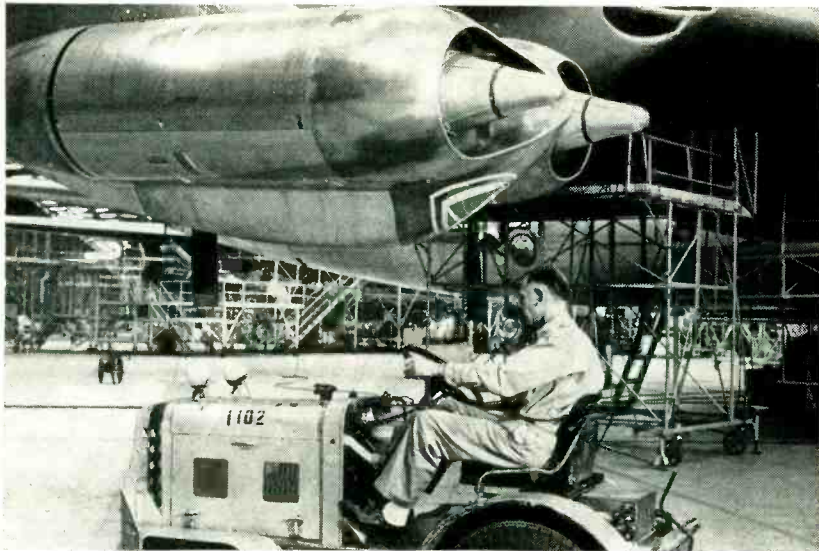

AIRCRAFT PLANTS use two-way radio for materials handling as . . .

fication may go as high as 150,000.

► **Per Acre**—Airframe manufacturers have found two-way radio useful in increasing the efficiency of materials-handling vehicles. They point out that the average airframe manufacturer uses more than 100 specialized vehicles for feeding assembly lines.

A Douglas aircraft plant which spreads over 110 acres, used 110 vehicles. North American, with a factory covering 230 acres, uses 195 vehicles. There are about 30 airframe manufacturers in business in the U.S., indicating the size of this market.

► **Future**—Total two-way radio sales in 1954 are estimated to approach \$40 million. The sales for Civil Defense, the leading market for such equipment in 1953, are expected to hold up this year.

That electronic manufacturers are aware of this growing business is underlined by the recent entry of DuMont into the field. The company has formed a mobile communications department to develop, manufacture and market mobile radio equipment. There are now more than 20 mobile and portable receiver and 35 mobile and portable transmitter manufacturers.

## Industrial Radio Surges Upward

### Special and low-powered industrial transmitters are gaining the lead

FACTORIES have become one of the most important markets in the industrial field for manufacturers of mobile radio equipment.

As indicated in the chart, the number of special and low-power

industrial transmitters authorized by the FCC for use mainly in plant areas has grown faster than all other services in the industrial classification. Manufacturing plants now rank second to utility companies as the industries number one market in this field.

There were 30,324 transmitters authorized in the special industrial field, as of March 1, 1953, comprised of 27,800 mobile station transmitters and 2,524 fixed transmitters. This represented an increase of 14,701 over the 15,615 transmitters authorized as of Jan. 1, 1952.

Authorizations for low-power industrial transmitters, all of which were mobile, increased during the period from 2,305 to 4,821. Both classifications nearly doubled their activity over the previous year's total. Extension of past rates of growth indicates that in 1954 special and low-power industrial authorizations may reach 40,000 and 6,000 respectively. Total transmitter authorizations in this classi-

### Specialized Computer Applications Increase

#### Modified input systems enhance computer utility; new design trends appear

ELECTRONIC computing equipment has been installed to calculate and record tolls on the Pennsylvania Turnpike. A computer has also been installed by the Census Bureau to read information recorded on census data sheets. Both are specialized computers rather than general-purpose machines.

An automatic tone transmitter that can feed data into a large computer by telephone lines is under study by the Air Force and a West Coast aircraft manufacturer. The transmitter may allow a computer to be operated from several points.

(Continued on page 16)

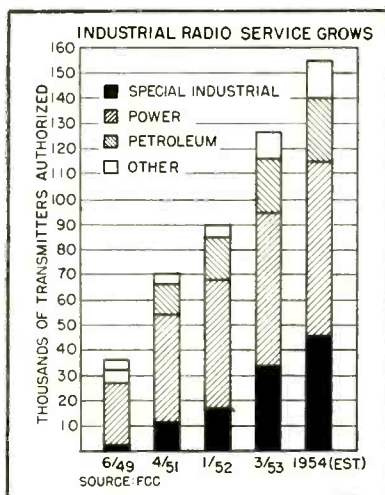



# SHOCK - VIBRATION - NOISE ISOLATION NOTES

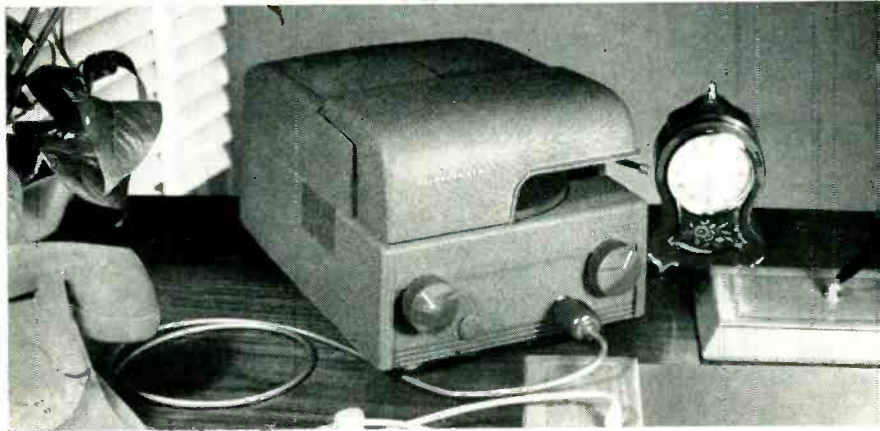

**Dictating Machine Floats on Barrymounts** — For noiseless operation, smooth, faultless playback, and the ultimate in protection against vibration and shock, Soundscribe Corp. chooses Barrymounts to support their new transcription unit. One more instance of how Barrymounts protect the performance of precision instruments. Ask for data on Type 372 Barrymounts.

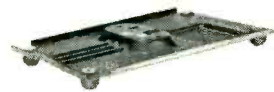

**Coast Guard Direction Finder Guarded by Barrymounts** — Where reliability of performance is really vital, sensitive electronic equipment *must* be protected from shock and vibration. Raytheon Manufacturing Company says: "We find that the high quality and effectiveness of these mountings help us assure the famed reliability and excellence of our own products." Ask for data on Type C-2000 Barrymounts.

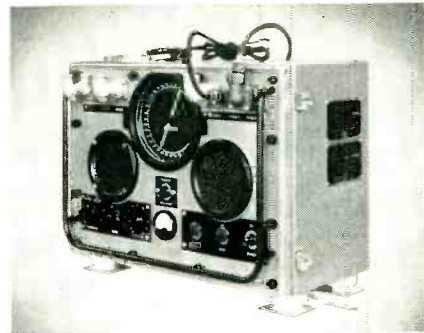

**All-Metl Barrymounts Protect Aircraft Radio Compass** — For safe, assured, brilliant operation, at extremely high altitudes and over a wide range of temperatures, Lear uses Barry ALL-METL vibration isolators to support the sensitive components of their "Executive" radio compass. They say: "We have chosen the Barry product because we feel it is a superior product from the standpoint of providing greater trouble-free life". Ask for data on Type M-44 Barrymounts.



**Industrial Machinery Mobilized by Barrymounts** — For example: a production line of eight punch presses was shut down, moved 200 feet across the plant, and was producing parts again in a total elapsed time of 23 minutes. No lagging, no shimming, and no walking of the machines in operation — because they were mounted on the new Leveling Barrymounts. This is *machine-tool mobility* — a new idea to make new profits for YOU. Ask for "LOOK — NO LAGGING!"

The wide range of Barry products and the experience of Barry engineers can help you solve shock, vibration, and noise problems in any area of military or industrial activity. Call our nearby sales representative or write directly to us.

THE **BARRY** CORP.

707 PLEASANT ST., WATERTOWN 72, MASSACHUSETTS

SALES REPRESENTATIVES IN

Atlanta Baltimore Chicago Cleveland Dallas Dayton Detroit Kansas City  
Los Angeles Minneapolis New York Philadelphia Phoenix Rochester  
St. Louis San Francisco Seattle Washington, D.C. Montreal Toronto

Other computer design trends include use of transistors, improved tape handling and design of low-cost machines.

Logistic Research Inc. is a new name in the computer business. The West Coast firm backed by Axel Wenner-Gren, Electrolux Corp. head, has sold one computer to the Navy.

► **Census**—Designed by the National Bureau of Standards, the Census Bureau's machine is called FOSDIC—Film Optical Sensing Device for Input to Computers. The machine uses a phototube and cathode-ray tube to sense positioned marks on census data sheets and convert the information to electrical impulses. Input to the machine is from microfilm copies of data sheets while output is on magnetic tape that can be fed directly to a computer.

► **Remote Input**—Transmission of accounting data over telephone wires at 1,000 characters a minute is accomplished automatically by an IBM unit that senses holes in punched cards and converts the information to tone impulses. A West Coast plane maker is using a tone transceiver to tie one of its labs to the computing center.

Key to computer potential business is Douglas Aircraft experience. Five years ago the company devoted only 500 sq ft to its computing center. Today, 12,000 sq ft are occupied.

► **New Firm**—The Logistic Research computer is called ALWAC. The computer can be sold for \$48,000 and is designed for the small plant—under 500 employees.

The company is also at work on a magnetic drum that eliminates friction between reading head and magnetic surface. It claims the so-called air-floating drum will store more than 2,000,000 decimal digits.

► **Design Trends**—Two computer circuit designs introduced by IBM at a West Coast computer show are a decimal counter using eight junction transistors and an array of ferrite memory cores hooked up to do the work of a rotating drum. Next step—a completely tubeless computer without moving parts.

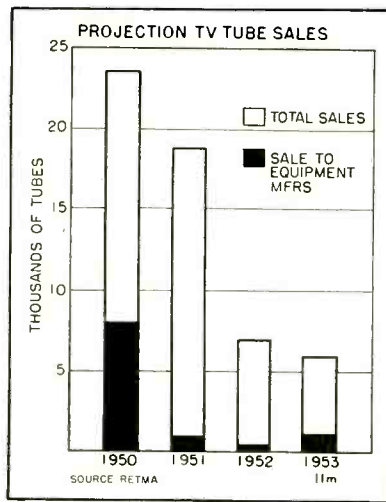

## Projection Television Is Down But Not Out

Home set production is virtually non-existent but there is some activity

DECLINE of projection tv is indicated in total factory sales of projection tv tubes, shown in the chart. Although renewal sales have held volume up somewhat, the sales drop has been sharp. Last year's volume for the first 11 months was only 25 percent as large as that in 1950.

Despite the black picture that these statistics indicate, there is a bright spot in projection tv trends. During the first 11 months of last year, nearly 1,000 projection tv tubes were sold to equipment manufacturers, almost double the total amount sold to this market during all of 1951 and 1952. Some of these tubes went into theater tv equipment but indications are that most of them are being used by tv set manufacturers for research and development purposes.

► **Color**—One major set manufacturer, in discussing the future of color tv, predicted that it would speed up the development of projection tv and indicated that the firm is continuing its activities in the projection field. Other manufacturers agree that there seems to be a place for projection in the color picture and say that they are continuing to experiment with it. However, some companies feel that projection is still passé.

## Financial Roundup

FINAL profit tallies for 1953 announced by companies in the electronics field show, on the whole, that 1953 was a banner year. Continued activity of some electronic manufacturers in security transactions indicates that further expansion is planned for this year.

The following firms made profit reports in the past month:

Company	Net Profit 12 months	
	1953	1952
AT&T	\$421,485,570	\$358,493,204
Emerson 3m—1954	449,231	899,516
12m—1953	2,988,432	2,262,556
General Electric	165,727,889	151,719,905
Magnavox 6 m	1,702,000	1,546,000
Minnesota Mining	17,977,771	16,089,995
Motorola	7,076,335	7,012,700
Philco	13,068,000	11,491,000
RCA	5,283,000	32,325,000
Stewart Warner	35,022,000	4,234,000
Stromberg-Carlson	4,081,000	1,240,746
Sylvania	1,667,308	6,960,625
Western Electric	9,536,181	47,081,705
Westinghouse	52,604,613	68,581,000

\*Proceeds from sale of WPTZ to Westinghouse

► **Securities**—Audio Devices filed with SEC covering 10,000 shares of common stock, (par 10 cents) to be offered at market (\$3.75) for the account of the selling stockholder.

Magnetics filed with SEC covering 250,000 shares of common stock to be offered at par (\$1 per share). Proceeds will be used to pay part of the cost of plant and equipment facilities.

Stromberg-Carlson registered with SEC covering 72,025 shares of convertible preferred stock (cumulative-\$50 par) to be offered to common stock holders at a rate of 1 preferred for 7 common. Proceeds will be used to repay \$1.1 million of notes payable to banks. The balance will go into general corporate funds.

Westinghouse registered two statements with SEC. One covered 483,190 shares of \$12.50 par common stock to be offered under the firm's restricted stock option plan to certain officers and other executives of the company. The other covered 200,000 shares of the \$12.50 stock to be offered under an employees stock plan to employees of Westinghouse and six specified divisions.

Plastic Wire & Cable offered its

(Continued on page 18)





# 0.1% ACCURACY from 30 c to 100 kc

## The Type 1610-A Capacitance Measuring Assembly

consists of five well-integrated G-R instruments for the accurate measurement of capacitance and dissipation factor. Two or three-terminal measurements are possible.

In addition to its usefulness in electrical development and testing, the Capacitance Measuring Assembly finds wide application in the dielectrics laboratory and chemical research organization. The close relationship between capacitance and dissipation factor and the physical and chemical composition of a substance make this precision apparatus very useful for investigations in countless basic research problems.

★ This assembly is widely used in conjunction with the G-R Sample Holder to study dielectric properties of plastics and other insulating materials such as steatite, teflon, polystyrene, mica and others.

★ Effects of interfacial polarization at low audio frequencies and dipole polarization in polymers may be investigated.

★ Characteristics and effects of surface water films may also be studied.

★ The Capacitance Measuring Assembly offers one of the best methods for measuring the Boella effect in high-valued resistors.

★ Characteristics of large inductors as well as resistors may be determined by substitution measurements.

The five G-R instruments included in the Capacitance Measuring Assembly are assembled in a compact cabinet-rack complete with all interconnection provisions.

**Type 1302-A Oscillator** . . . supplies up to 80-milliwatts from 10 c to 100 kc.

**Type 1231-BRA Amplifier and Null Detector** . . . 100  $\mu$ v input gives 10% meter deflection at mid-frequency range.

**Type 1231-P5 Adjustable Filter** . . . has eleven fixed frequencies . . . with external capacitors, any resonant frequency from 20 c to 130 kc can be obtained.

**Type 716-P4R Guard Circuit** . . . makes possible accurate impedance determinations between two points of a three-terminal network.

**Type 716-C Capacitance Bridge** . . . measures 0.1  $\mu$ mf to 1150  $\mu$ mf from 30 c to 300 kc and to 1  $\mu$ f at 1 kc . . . direct reading in dissipation factor from 0.00002 to 0.56 . . . basic direct reading accuracy is  $\pm 0.2\%$  for capacitance and  $\pm 0.0005$  for dissipation factor; in substitution measurements,  $\pm 0.1\%$  capacitance accuracy with correction chart supplied, and  $\pm 0.00005$  for dissipation factor.

**Type 1610-A Capacitance Measuring Assembly** . . . Complete and ready for two or three-terminal measurements . . . \$1930.00

**Type 1610-A2 Capacitance Measuring Assembly** . . . Without Guard Circuit, for two terminal measurements only . . . \$1635.00

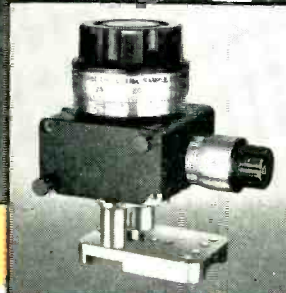
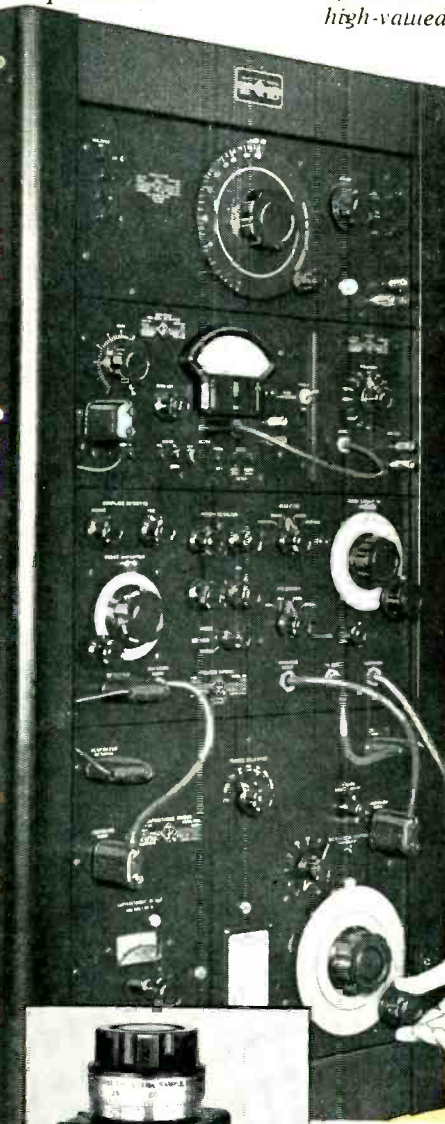

The unique Type 1690-A Dielectric Sample Holder is an accessory unit readily attached to the bridge unknown terminals. It permits precise determinations of dielectric constant and dissipation factor of practically any solid dielectric material.

The sample holder's 2-inch diameter electrodes are ground to optical flatness and are micrometer driven for highest accuracy. The instrument is rugged, completely shielded and useful to 100 Mc and higher. Additional Price \$435.00



Since 1915  
Manufacturers of  
Electronic Apparatus  
for Science and Industry

## General Radio Company

275 Massachusetts Ave., Cambridge 39, Massachusetts  
90 West Street NEW YORK 6    920 South Michigan Avenue CHICAGO 5    1000 North Seward Street LOS ANGELES 38

- Admittance Meters ☆ Amplifiers ☆ Coaxial Elements
- Distortion Meters ☆ Frequency Measuring Apparatus ☆
- Frequency Standards ☆ Impedance Bridges ☆ Light Meters
- Megohmmeters ☆ Modulation Meters ☆ Polariscopes
- Precision Capacitors ☆ Oscillators ☆ U-H-F Measuring
- Equipment ☆ Parts & Accessories ☆ Signal Generators
- Wave Analyzers ☆ Variacs ☆ TV & Broadcast Monitors
- Pulse Generators ☆ R-L-C Decades ☆ R-L-C Standards ☆ Unit Instruments ☆ Sound & Vibration
- Meters ☆ Stroboscopes ☆ Null Detectors ☆ Motor Controls ☆ Wave Filters ☆ V-T Voltmeters

stockholders the right to subscribe for 21,952 shares of common (par \$5) at \$10.50 per share on a 1 new for 5 held basis. Net proceeds will be used for working capital.

## Top Navigation Group Organizes For Action

Army, Navy, Air Force and Commerce to be represented on new board

AIR NAVIGATION Development Board (ANDB) will henceforth comprise persons at a high policy level from Army, Navy, Air Force and Department of Commerce. Chairman of ANDB may be selected from outside the government. The reorganized agency's charter makes it responsible for procurement, installation and operation of navigation and traffic control aids as well as research and development of new aids.

► **Greasing the Wheels**—Project funds for the Board's program will come from the participating departments, rather than solely from Commerce, as in the past. Responsibility and authority are now shared equally by the Departments of Defense and Commerce.

First major evaluation job will be on TACAN, a short-distance navigation system being pushed by the military. TACAN provides a pilot with the same type of continuous bearing and distance navigational information now available from the vhf omnirange and may later be useful in commercial flights.

► **Personnel**—Chairman of ANDB is Donald A. Quarles, assistant Secretary of Defense for research and development. Other members are Robert B. Murray, under-Secretary of Commerce for transportation; James N. Davis, special assistant for research and development for Secretary of the Army; James H. Smith, Jr., assistant Secretary of the Navy for air and Trevor Gardner, special assistant for research and development for the Secretary of the Air Force.

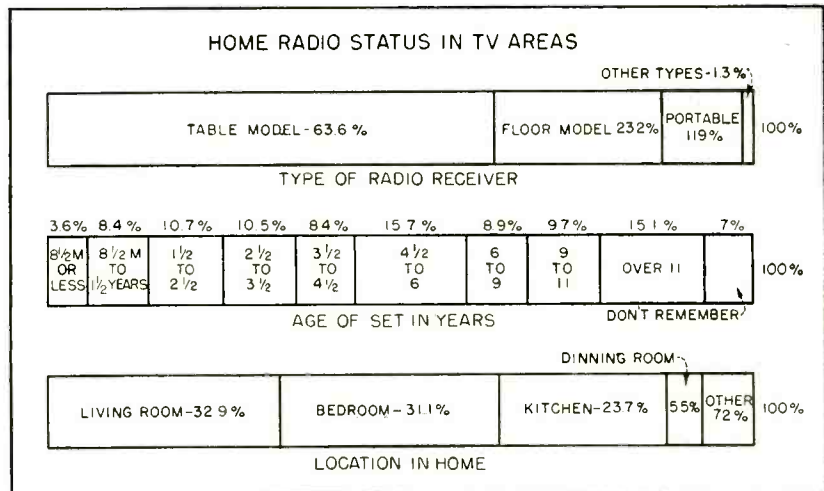

STATUS and characteristics of radio are shown as . . .

## Stations Rate Radio In TV Areas

Survey of the radio picture shows that sets are more than holding their own

SET MANUFACTURERS who might have misgivings about the future of radio in tv areas can find valuable and reassuring market information on the subject in a survey made by Politz Research for 11 broadcasters.

As shown in the chart, the type of receiver owned by people in tv areas is predominantly the table model. However, floor models are still popular. The living room is still the radio room in most homes and bedrooms rank second. Age breakdown of receivers in tv areas shows that over 55 percent are more than 4.5 years old.

► **Sales**—The survey also indicates the importance of radio replacement sales as against second set sales in tv areas: 47.3 percent of all home receivers purchased in tv areas were bought as additional sets; 35.5 percent were bought as replacements because the previous set was no longer used, and 17.2 percent were purchased as the first set.

Over 26 percent of the people who were without operating home receivers had none because the set needed repairs or batteries; 16.2

percent had none because they couldn't afford it; 15.3 percent said they watched tv instead and 12.8 percent reported that they had no use for it or didn't care for radio. A variety of reasons comprised the remaining percentage.

► **Expectations** — People were asked whether they expected to buy a radio receiver within the next few months. The survey, made early in 1953, showed that over 4 percent would, as an additional radio and 1.3 percent expected to, as a replacement. Total of 86.5 percent of all people surveyed did not expect to buy a set soon and 7.8 percent didn't know.

## Crackdown Ordered on Illegal Diathermy

SHORT-WAVE medical diathermy machines have long been disruptive to radio communications (ELECTRONICS, p 19, Feb. 1936). More recently, they have caused interference to aircraft, police and television broadcast services.

Methods for reducing or eliminating danger and annoyance to other users of the radio spectrum are known. They include crystal

(Continued on page 20)



# CHECK **RAYTHEON**



## for **PENCIL TUBES**

There's a **RAYTHEON Pencil Tube** for every service\*

Look at the chart. Radiosonde, low Mu, high Mu — whatever characteristics you're looking for in a Pencil Tube may be found in Raytheon's line.



And every one meets **RAYTHEON standards of Quality and Reliability**

Raytheon is the pioneer and leader in the development and manufacture of special purpose tubes. Raytheon production, testing and inspection techniques, worked out over sixteen years of making millions of tubes, offer the soundest possible reason for specifying Raytheon Pencil Tubes.

TYPE	APPLICATION	HEATER		FREQUENCY MC.	POWER OUTPUT	MAX. RATINGS	
		VOLTS	AMPS			PLATE VOLTAGE	PLATE CURRENT
CK5675	Local Oscillator Amplifier	E3	0.135	up to 3000	475MW at 1700 Mc	165 volts	24 mA dc
CK5794	Fixed Tuned Radiosonde Oscillator	E0	0.160	1680	500MW	120 volts	30 mA dc
CK5876	FF Amplifier Free Multiplier	E3	0.135	up to 1700	5 watts at 500 Mc	360 volts	25 mA dc
CK5893	Plate Pulsed Oscillator-Amplifier	E3	0.330	up to 3300	1200 watts peak	1750 volts peak	3 Amps peak



*Excellence in Electronics*

### **RAYTHEON MANUFACTURING COMPANY**

*Penning Tube Division — Home Office: 65 Chapel St., Newton 58, Mass.*

*For Application Information Call: Boston, Bigelow 4-7500 • Chicago, NATIONAL 2-2770 • New York, WHITEHALL 3-4980 • Los Angeles, REAMOND 7-4321*

**RAYTHEON MAKES ALL THESE:**

**RELIABLE SUBMINIATURE AND MINIATURE TUBES • SEMICONDUCTOR DIODES AND TRANSISTORS • NUCLEONIC TUBES • MICROWAVE TUBES • RECEIVING A4D PICTURE TUBES**

control to keep emanations within a definite assigned band and shielding.

► **Ignorance No Excuse**—Until July 1947, the radio law had inadequate teeth to bite the offender. Since then, Part 18 of the Federal Communications Commission's rules have declared illegal all medical diathermy equipment that is not type approved, certified or licensed. Penalties are prescribed for offenders.

But since doctors and athletic directors may not even know of the existence of such a regulatory body as FCC, the Commission has been understandingly lenient. Now

it proposes to blow the whistle. In a sobering report, FCC cites just one instance in which inspectors tracked down an illegal machine in Miami, Fla.

Directional bearings were taken at primary monitoring stations in Kingsville, Texas; Grand Island, Neb.; Allegan, Mich.; Laurel, Md.; and Powder Springs, Ga. Signals were also traced by the secondary monitoring station in Muskogee, Okla. The illegal radiation was picked up in Oregon, Washington and California.

From now on, the Commission warns, it will issue cease-and-desist orders, seek injunctions or institute criminal proceedings.

## Electronics Firms Study '54

**As final reports on 1953 business are made, manufacturers reassess prospects for this year**

CURRENT feeling of top management in the electronics industry about business prospects in 1954 is revealed in statements made by the presidents of seven leading companies as 1953 annual reports were announced.

► **Companies**—Emerson's president Benjamin Abrams pointed out that although its sales in 1954 are expected to exceed 1953's, the firm may not be so fortunate insofar as profits are concerned. During 1954, prices will have to be maintained at the lowest possible levels to maintain the interest of potential purchasers of black-and-white receivers. This, of necessity, he said, must have an effect on profits.

President Ralph J. Cordiner of GE expressed the belief that the year will bring a more favorable earnings climate than the last several years even though sales for his company are expected to decrease somewhat from the 1953 peak. Defense business is expected to make up a lower percentage of the total business volume in 1954.

Magnavox president Frank Freimann holds an optimistic view for

continuing good business during the final six months of the firm's fiscal year ending in June, 1954. He expressed the opinion that industry tv sales are likely to drop to a level somewhat lower than that achieved during the first six months.

Minnesota Mining top executives are hopeful that 1954 will be at least as good as the year just ended.

President Paul V. Galvin of Motorola forecast sales of 100,000 color tv sets in 1954 by the industry.

Sylvania officials expect competition will be increasingly intensive in the months ahead. However, they feel the company is better equipped and more effectively manned than at any previous time in its history.

Westinghouse president Gwilym Price expects a continued high rate of operation in 1954. He said the company's earnings will be effected by its ability to maintain profit margins in the face of increased competition and that with this in mind reduction in costs and expenses had been stressed for the past year and will continue to be. Even if the level of general business activity for 1954 is moderately lower than in 1953 as has been predicted, the firm is planning for and aiming toward larger billings and profits in the coming year.

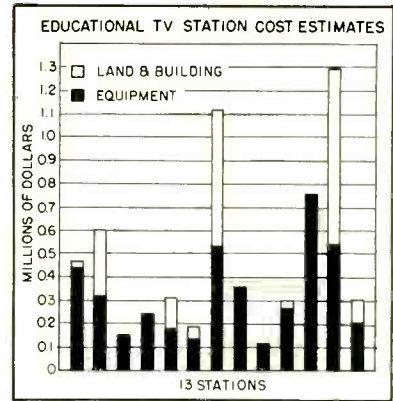

## Educators Examine Television Costs

WITH 30 educational tv stations expected on the air by the end of 1954, and prospects of more on the way, universities are scrutinizing the dollars and cents side of beginning operations.

The investments required, shown in the chart, are estimates made by 13 prospective operators. Costs vary widely because in many cases land and buildings are already on hand. Equipment costs, which include expenses such as labor, also vary because in some cases items such as towers are also on hand.

According to FCC Commissioner Doerfer, construction costs can range from \$100,000 to \$600,000. If a start is made from nothing, however, and a high-quality station is aimed for, the cost of construction and equipment can run at least \$500,000.

► **Operations**—Since educational stations will be nonprofit, operating cost is also important. Some estimates indicated that \$150,000 to \$200,000 a year will cover all of the reasonably chargeable costs. The University of Houston which has had a station in operation the longest, is now facing the problem of station operating expenses for its second year. Some observers foresee financial troubles ahead for educational tv because of the drain these costs will put on school budgets.

► **Industry Help**—Educators are receiving help from private industry in defraying costs. Emerson an-

(Continued on page 22)



# A New Level in Engineering is Achieved in the Functional Design of Toroidal Decades\*

This unique development permitting precision toroids to be combined in decade steps of inductance will appeal to all engineers who are familiar with the disadvantages of the ordinary type of inductance decade box.

All the decade units in the plug-in decade series are higher Q toroids such as are employed in the Burnell attenuation filters. They are guaranteed to a tolerance of 1% of the marked inductance and have extremely good stability of inductance vs. voltage and temperature.

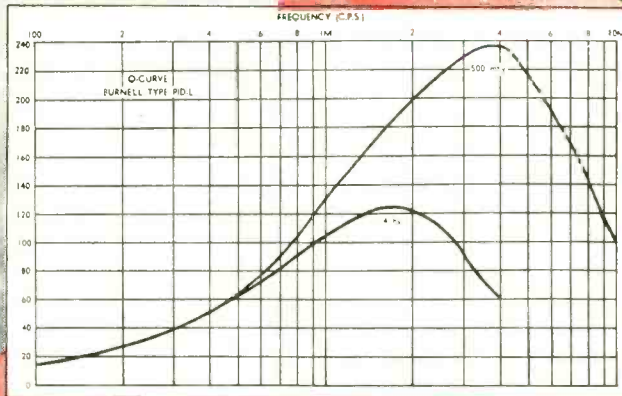
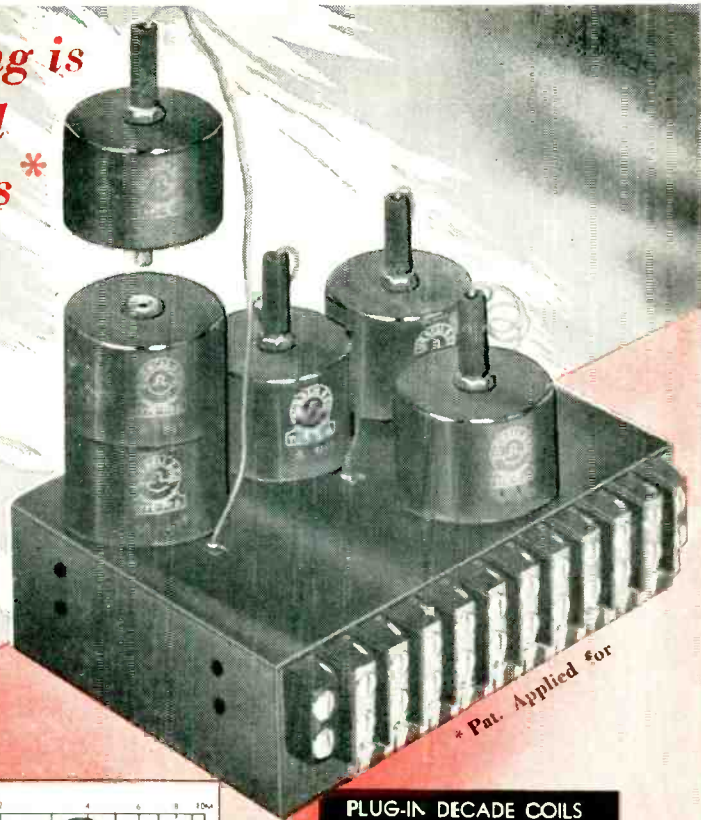

PLUG-IN DECADE COILS CAN ALSO BE DESIGNED WITH SPECIAL CHARACTERISTICS FOR SLIGHT EXTRA CHARGE. UNITS GENERALLY AVAILABLE FROM STOCK ARE AS FOLLOWS:

- P.I.D. 1 (MHYS)\*
- P.I.D. 2 "
- P.I.D. 3 "
- P.I.D. 4 "
- P.I.D. 8 "
- P.I.D. 10 (MHYS)\*
- P.I.D. 20 "
- P.I.D. 30 "
- P.I.D. 40 "
- P.I.D. 80 "
- P.I.C. 100 MHYS
- P.I.D. 200 "
- P.I.C. 300 "
- P.I.D. 400 "
- P.I.C. 800 "
- P.I.D. 1000 MHYS
- P.I.D. 2000 "
- P.I.C. 3000 "
- P.I.C. 4000 "
- P.I.C. 8000 "
- P.I.C. 10000 MHYS
- P.I.C. 20000 "
- P.I.D. 30000 "
- P.I.C. 40000 "
- P.I.D. 80000 "

\*Also available in P.I.D.-H Type for higher frequency range.

## OTHER RECENT *Burnell* ACHIEVEMENTS IN TOROIDS AND FILTER NETWORKS

### SIDE BAND FILTERS

Our most recent engineering development in communications filters has already stirred the interest of the leading receiver manufacturers in the country.

The new side band filters which eliminate, for most applications, the necessity for expensive crystal filters are expected to accelerate the advancement of single side band communications.

### MINIATURE TELEMETERING FILTERS

In recognizing the need for miniaturization of the presently bulky telemetering equipment, our engineering staff has succeeded in reducing the size of telemetering filters to as little as 25 to 50% of the original volume.

### SUB MINIATURE TOROIDS

Toroids for intermediate frequencies of 100KC to 1 megacycle. A wide variety of coils ranging in size from 3/8 inch provides high Q in the frequency range between audio and RF.

The tiny toroid about the size of a dime has been welcomed by designers of sub miniature electronic equipment for the transistor, guided missile and printed circuit field.

Literature for all the above available on request

Write for new and enlarged 16 page catalog 102A

Exclusive Manufacturers of Communications Network Components

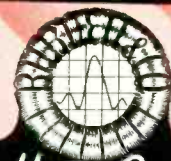

**Burnell & Company**  
YONKERS 2, NEW YORK  
CABLE ADDRESS "BURNELL"

nounced recently that \$90,000 of its \$100,000 educational tv grant is still available. KUHT-TV is the only station so far to receive a \$10,000 grant from the fund. KTHE-TV in Los Angeles is operating under a STA and will be eligible for a \$10,000 award from the firm upon issuance of a permanent license.

The University of North Carolina has received help from two firms in the form of \$50,000 in materials and labor on its tower, buildings and studio. Numerous private tv stations have donated use of their facilities for educational use.

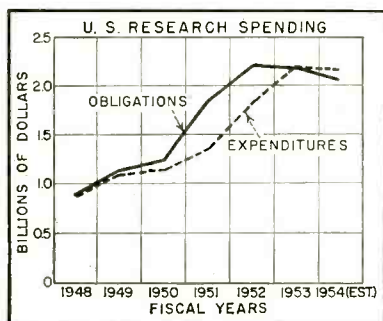

## U.S. Research Funds Seen Declining In '54

BUDGET estimates compiled by the National Science Foundation indicate, as is shown in the chart, that federal obligations and expenditures for scientific research and development will drop in fiscal year 1954 from those of previous years.

Research and development obligations for fiscal 1954 are estimated at \$2,074 million compared to \$2,187 million for 1953. Expenditures are estimated at \$2,187 million for 1954 compared to \$2,205 million in fiscal 1953.

With a decline in obligations for 1954 expected, a further decrease in expenditures in fiscal 1955 may result since the lag between obligations and expenditures has averaged about 9 months over the past several years. These estimates, which were revised, are still tentative since sev-

eral agencies plan further revisions in their programs.

► **Defense**—Department of Defense estimates constitute the largest portion of the totals for both obligations and expenditures.

## Tungsten Supplies Up; Prices Drop

**Government and domestic sources keep the electronics industry well supplied**

USERS of tungsten have had no trouble maintaining plentiful supplies of the metal for commercial products as well as government orders, despite the loss of China as a main source for the ore. Tungsten wire makers say that supply exceeds demand and new lower prices were announced by some suppliers.

Near-panic conditions prevail in the tungsten ore market. Good foreign tungsten ore is available as low as \$18 per short ton but even this pre-Korean price attracts no customers. Rumors that Russia had a surplus to sell added to the confusion. Now the U.S. no longer regulates internal or domestic use although exports are still controlled.

► **Use**—Total U.S. annual consumption of tungsten in 1949 was 5,210 short tons. Then, in 1950, after the Korean War had begun, it increased to 6,932. Consumption in current years has remained in that area.

The electronics industry is by no means the largest consumer of tungsten. One tungsten wire manufacturer estimates that the entire industry accounts for no more than 5 percent of the total used each year. Biggest users in the electronics field are transmitting and industrial tube manufacturers and relay makers. The metal is also used in equipment for aluminizing tv picture tubes. Less than one penny's worth of tungsten is used in the average tube, a price that includes all labor and processing costs from ore to finished metal.

► **Sources**—The present ample supplies of tungsten in the U.S.

Present figures indicate that in fiscal 1954 the department may obligate \$1,556 million, including a carry-over of \$142 million from previous years. Expenditures in 1954 by Defense are estimated at \$1,636 million.

are due largely to effective stockpiling encouragement of domestic ore production and the handling of Korean sources of supply. The U.S. controls over 60 percent of the tungsten mines in Korea. Korea became the number one source of the metal after the war began and China, which had been first, dropped to ninth place. Twenty other nations and home producers have contributed to the U.S. tungsten stockpile.

## Manufacturers Review Equipment Leasing

RECENT announcement by Emerson that it plans initially to lease color tv receivers to the public on a monthly fee basis has been responsible for some study of past and present equipment leasing arrangements.

► **Tubes**—Some time ago General Electric announced it would lease its high-power klystron tubes for uhf transmission to broadcasters. Since then over 30 leasing arrangements have been made. At a leasing fee of about \$2.50 per hour, stations can get three tubes, two for use and one spare. The fee also covers service on the tubes. The plan has worked well and it is now planned to sell the klystrons outright.

One of the early Univac computers, the installation at GE's Appliance Park, was leased by GE from Remington Rand for two years with an option to buy. With computer cost still high, leasing may continue for some time to come.

► **Sets**—Television sets have been rented before too. In 1948 during

(Continued on page 24)



# Improve Your Communications Service With Hammarlund Selective Calling

**ADD PRIVACY • SPEED • QUIETNESS • CONVENIENCE**

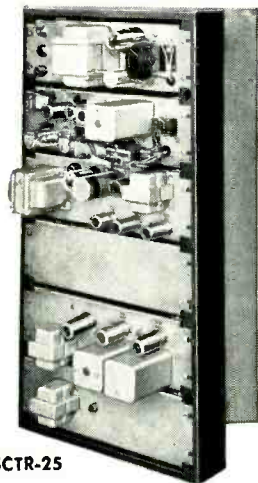

SCTR-25

**FOR FIXED STATIONS**

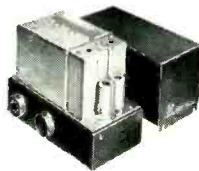

Decoder Unit  
SCM-30T



Coding Unit  
SCPB-30

**FOR INDIVIDUAL MOBILE UNITS**



Receiver Unit  
FRC-1

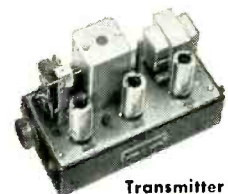

Transmitter Unit  
FTC-1

**FOR FLEET CONTROL**

Speeded operations, better manpower utilization, and elimination of confusion is achieved through the selective channeling of voice communications.

Hammarlund has available a wide range of tone-dialing and push-button operated systems for contacting fixed stations, individual mobile units, or fleets.

With the SCTR-25 fixed station equipment, for example, it is possible by means of coded audio frequency tone signals activated by a simple dialing operation, to selectively ring any single station on a system with as many as 126 stations. This is

particularly advantageous when there are a large number of individual telephones connected to the same speech transmission channel, such as with a long microwave radio relay network. The bell at each station operates only when that station is called.

Efficiency is increased for 2-way radio equipped individual or fleet mobile units when Hammarlund Selective Calling equipment is added, since confusion caused by today's overcrowded radio spectrum and skip-distance signals are eliminated. Each receiver is activated only when it is called.

For detailed information on Hammarlund Selective Calling systems, write to  
The Hammarlund Manufacturing Co., Inc., 460 West 34th St., New York 1, N. Y. Ask for Bulletin 57.



# HAMMARLUND

SINCE 1910

the political conventions, companies were formed for the sole purpose of renting sets.

## Conelrad Plan Extended to Aviation Services

METHODS for denying navigational aid by radio stations while at the same time providing broadcast service have already been tested (ELECTRONICS, p 5, Nov. 1953). Having successfully disposed of this phase in a hypothetical defense against enemy aircraft, the Federal Communications Commission now proposes rules for the aviation services.

► **Alerting**—Open to change until March 29, FCC's proposal would require all stations to maintain radio silence. Stations in communication with a CAA Air Route Traffic Control Center (ARTCC) can receive the alert by this channel. Other stations must provide a connection to a CAA circuit; keep a broadcast set (a-m, f-m or tv) continuously tuned in; monitor another station in contact with ARTCC or find some other method that will be approved by CAA.

Many stations in the aviation services will remain on the air, at least intermittently, for traffic control, Civil Defense or other approved activity.

## Industry Shorts

► **Regulation** for licensees of low-power industrial radio services (in-plant communications) is proposed by FCC which would prohibit further use for dispatching vehicles on public highways or streets.

► **Curtailed** of 15-inch color tube production at GE was made because of indications that the future trend is going to be toward the larger sizes of color tubes.

► **Colombia** has signed contract with Du Mont and Siemens & Halske for the installation of the first tv station in Bogota, scheduled to open in June.

► **Over** half of the nation's tv

owners (56 percent) have had their sets two or more years, according to RETMA.

► **Whirlwind** computer at MIT was used by five Du Pont scientists to operate, on paper, a chemical reactor in a company plant hundreds of miles away. Study resulted in a

25 percent increase in the reactor's production rate.

► **Sheraton Hotels** have entered the closed-circuit tv business and now offer business groups and associations a network of more than 28 hotels. An average cost per city using hotel closed circuits is \$1,200.

## MEETINGS

- APRIL 5-10: International Convention of Soundtrack Recording, Paris, France.
- APRIL 6-8: Radio Component Show, Great Hall, Grosvenor House, Park Lane, London, Eng.
- APRIL 15-16: RETMA Conference On Reliability of Electrical Connections, Illinois Institute of Technology, Chicago.
- APRIL 12-14: International Symposium on Information Networks, IRE, ONR, AAF, Signal Corps sponsorship, Engineering Societies Bldg., New York, N. Y.
- APRIL 12-14: Eighth Annual Frequency Control Symposium, Signal Corps, Berkeley-Cartaret Hotel, Asbury Park, N. J.
- APRIL 12-17: Symposium On Electronics And Television, National Museum Of Science And Technology, Milan, Italy.
- APRIL 19-20: Symposium on the Automatic Production of Electronic Equipment sponsored by Stanford Research Institute and U. S. Air Force, Fairmount Hotel, San Francisco.
- APRIL 21-23, 1954: AIEE Conference On Feedback Control, Claridge Hotel, Atlantic City, N. J.
- APRIL 24, 1954: Eighth Annual Spring Technical Conference, Cincinnati IRE, Cincinnati.
- APRIL 27-29: AIEE Electronic Components Conference, Washington, D. C.
- MAY 3-6: Spring Technical Meeting sponsored by URSI and IRE, National Bureau of Standards Bldg., Washington, D. C.
- MAY 3-14: The British Industries Fair, London and Birmingham, England.
- MAY 4-6: The 1954 Electronic Components Symposium, Department of Interior auditorium, Washington, D. C.
- MAY 5-7: 1954: Third International Aviation Trade Show, 71st Regiment Armory, New York, N. Y.
- MAY 5-7: IRE Seventh Region Conference & Electronic Exhibit, Multnomah Hotel, Portland, Oregon.
- MAY 7-8: New England Radio Engineering Meeting, IRE, Sheraton Plaza Hotel, Boston, Mass.
- MAY 10-12: The National Conference On Airborne Electronics, Dayton Biltmore Hotel, Dayton, Ohio.
- MAY 17-20: 1954 Electronic Parts show, Conrad Hilton Hotel, Chicago, Ill.
- MAY 24-26, 1954: IRE, IAS, ISA, AIEE Conference On Telemetering, Morrison Hotel, Chicago, Ill.
- MAY 25-27: Eighth NARTB Broadcast Engineering Conference, Palmer House, Chicago, Ill.
- JULY 16-18: High Vacuum Symposium, Committee On Vacuum Techniques, Berkeley Carteret Hotel, Asbury Park, N. J.
- JULY 6-9, 1954: International Conference on Electron Microscopy, Joint Commission on Electron Microscopy of International Council of Scientific Unions, London, England.
- JULY 8-12: British IRE 1954 Convention, Christ Church, Oxford, England.
- AUG. 24-SEPT. 4: National Radio Show of Great Britain, Earls Court, London, England.
- AUG. 25-27: 1954 Western Electronic Show & Convention, Los Angeles, Calif.
- SEPT. 1-16: Golden Jubilee Meeting of the International Electrotechnical Commission, University of Pennsylvania, Philadelphia, Pa.
- SEPT. 13-24: 1954: First International Instrument Congress And Exposition, Commercial Museum and Convention Hall, Philadelphia, Pa.
- SEPT. 16-18: Joint Electron Tube Engineering Council, General Conference, Chalfonte-Haddon Hall, Atlantic City, N. J.
- SEPT. 1954: International Scientific Radio Union, Amsterdam, Netherlands.
- SEPT. 30- OCT. 2, 1954: Second Annual International Sight and Sound Exposition, Palmer House Hotel, Chicago, Ill.
- OCT. 4-6: National Electronics Conference, Hotel Sherman, Chicago.
- OCT. 18-20: Radio Fall Meeting, Hotel Syracuse, Syracuse, N. Y.



# AIRPAX

## C747 MIDGET

### 400 CYCLE CHOPPER

**PROVEN PERFORMANCE**  
in large volume production  
is your best guarantee  
of quality!

*✓ note  
these facts...*

- AIRPAX has built nearly 1/4 million choppers
- AIRPAX maintains an engineering staff constantly striving to improve choppers
- AIRPAX has ample capacity for large volume production of choppers
- And AIRPAX choppers have proven performance life and reliability



MIDDLE RIVER BALTIMORE 20, MD.

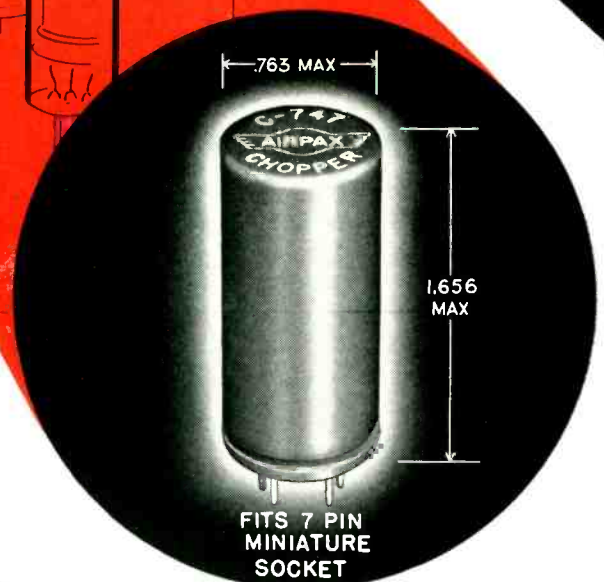

Weights less than 1 oz.

**SEVEN YEARS IN SERVICE**  
*This Electronic Calculating Machine*  
*Is A Giant of Precision*

♦ Mathematical robot with nearly 18,000 vacuum tubes does in hours what mechanical devices would require years to complete; built for war purposes, it has potentialities of interest to designers and engineers.



... and the large transformers  
 were all furnished by

**NOTHELFER**

NOTHELFER 3 Phase Plate  
 Rectifying Transformer  
 240/125 at 12½ KVA  
 125  
 All transformers designed  
 for 40° rise.

**T**HE Electronic Numeral Integrator and Computer shown above, designed and constructed in 1946 for the Ordnance Department, U. S. Army, at the Moore School of Electrical Engineering, University of Pennsylvania, is said to be the first all-electronic general purpose computer ever developed.

The design of the TRANSFORMERS among much other complex and expensive equipment, was limited by many unknown factors. However, this 3 Phase Plate Rectifying Transformer is representative of a typical installation by NOTHELFER, whose skill and experience has been instrumental in helping to solve many a difficult winding job.



**NOTHELFER WINDING LABORATORIES**  
 9 ALBERMARLE AVENUE • • • TRENTON 3, NEW JERSEY



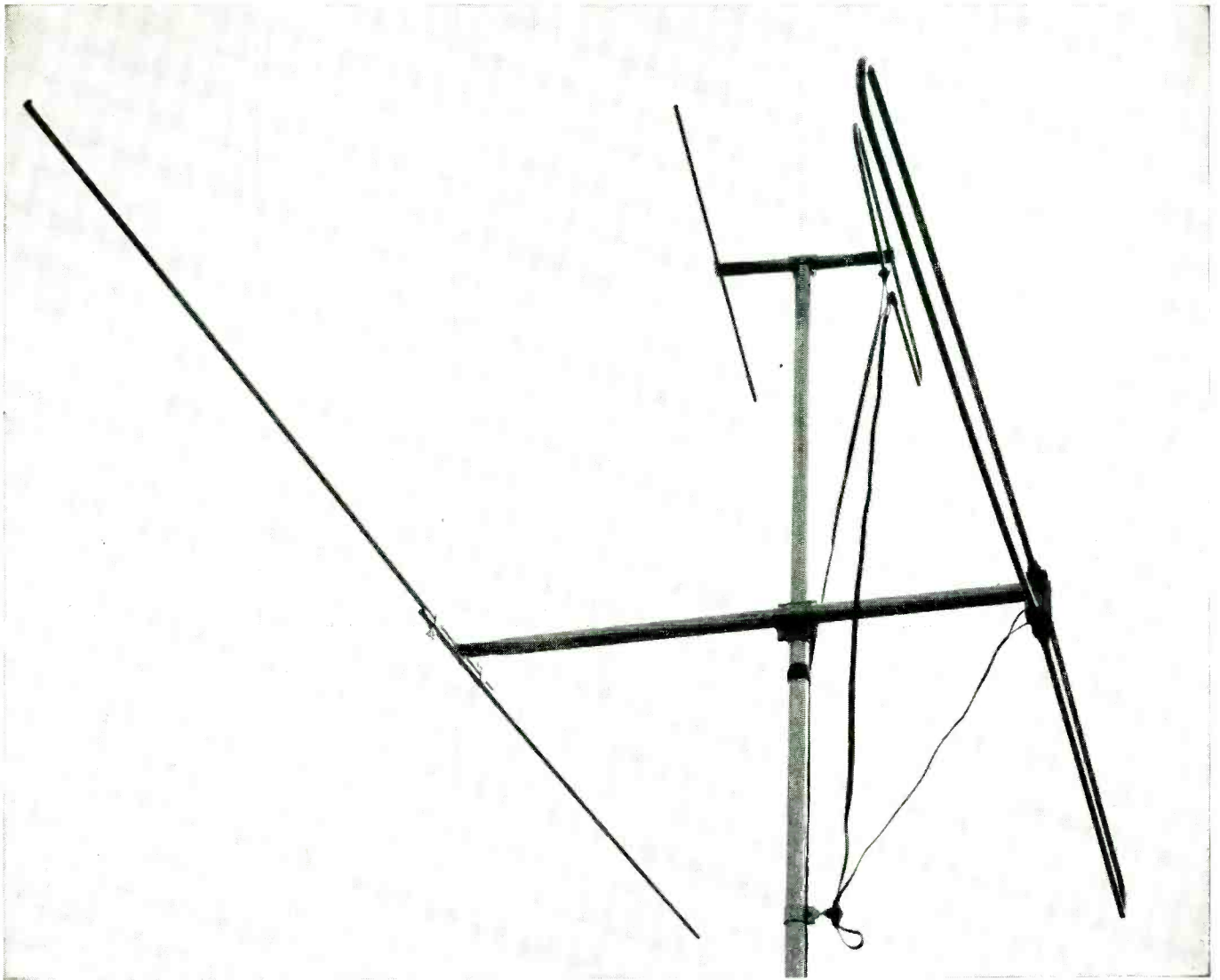

## COMING IN SHARP AND CLEAR

### ...OVER LEAD-IN COVERED WITH "BAKELITE" POLYETHYLENE

BAKELITE Polyethylene wire covering compounds provide constant impedance, low line loss and great resistance to weather. Where these outstanding materials are specified, you see *all* the picture the antenna picks up!

BAKELITE Polyethylene compounds have superior electrical and mechanical properties that permit smaller diameters in wire and cable—for easier handling, and for weight and space savings. They hold their toughness and pliability at -70 deg. C. . . . resist deformation in temperatures as high as 90 deg. C. BAKELITE Polyethylene is light, glossy-smooth—for easier pulling and stripping. It won't festoon. It resists oil, grease, alkalis, most strong acids, abrasion, moisture and mildew. A service life of several decades is indicated by tests with the black compound.

Learn how BAKELITE Polyethylene can help you in your wire and cable problems. Complete technical data on request to Dept. UB-79. Ask for Kabelitem No. 48.

FOR LINE WIRE, SIGNAL SYSTEMS AND SERVICE DROP—wet or dry—the power factor of BAKELITE Polyethylene (black compound) is only 0.004 at 25 deg. C.; dielectric constant is 2.5. Electrical properties of BAKELITE Polyethylene Resin stay constant through a frequency range of 60 cycles to 50 megacycles. Temperatures in the vicinity of 90 deg. C. have little effect on electrical properties. Volume resistivity is so high it can be measured only by very sensitive instruments. Voltage breakdown resistance is excellent, even after long-term water immersion.

# BAKELITE

TRADE-MARK

# Polyethylene

## WIRE COVERING

**BAKELITE COMPANY**, A Division of Union Carbide and Carbon Corporation **UCC** 30 East 42nd Street, New York 17, N. Y.

In Canada: Bakelite Company, Division of Union Carbide Canada Limited, Belleville, Ontario



Automatic testing and recording permits accurate evaluation of greater numbers of resistors

# ONLY IRC MAKES SO MANY JAN AND

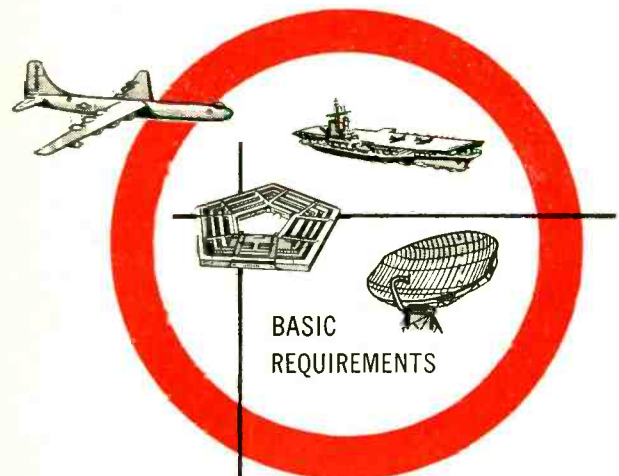

BASIC REQUIREMENTS

JAN and MIL Specifications are basic guideposts for electronic advancement, whether used as engineering reference points or as procurement standards. IRC's dual emphasis on mass production and frequent, accurate performance testing assures you of the highest performance standards at the lowest possible cost.

56 different IRC resistors is today's figure— all equivalent to JAN or MIL specifications. And all are standard units, available on excellent delivery cycle! If you manufacture end-equipment for the armed forces and must meet these specifications, or if you apply them as standards to your own requirements, depend on IRC for everything you need. For, manufacturing the widest line of resistors in the industry—127 different types in all—IRC is logically your best source of JAN and MIL type units.



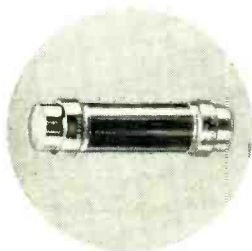

### JAN-R-29 specification

For all requirements of JAN-R-29 Specification, Amendment 4, IRC sealed precision Voltmeter Multipliers function efficiently even when exposed to the most severe humidity. Used with 1-milliamper DC instruments, they enable voltage measurements to be made up to 6000 volts. Send for Bulletin.

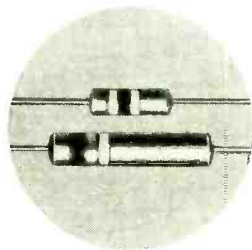

### JAN-R-184 specification

Unusually stable and inexpensive, IRC BW Wire Wounds meet JAN-R-184 Specification, Amendment 5, at 1/2 and 1 watt. Resistance element is uniformly and tightly wound on insulated core. Molded housing provides full insulation. Widely used in meters, analyzers, high stability attenuators, low-power ignition circuits, etc. Send for Bulletin.

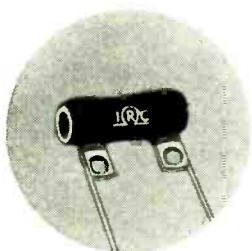

### MIL-R-26B specification

For high power dissipation, IRC Power Wire Wounds meet every commercial requirement of MIL-R-26B Specification, Characteristic G. Tubular, flat, fixed, adjustable, inductive, non-inductive, lead, lug and ferrule types provide resistors for virtually any circuit. From 5 to 225 watts. Send for Bulletin.

## MIL TYPE RESISTORS

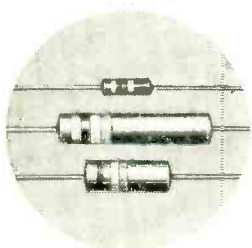

### MIL-R-11A specification

IRC Advanced BT Resistors meet and beat MIL-R-11A Specification, Amendment 2. Filament-type resistance element and other exclusive features afford extremely low operating temperature and superior power dissipation in a compact, light, fully insulated unit. Available at 1/4, 1/2 and 1 watt to MIL specification and 2 watts to commercial specification. Send for Bulletin.

# NEW

## product



# HERMETIC

## sealing terminal



Overcomes limitations of other types of hermetic sealing terminals.



Molded KEL-F\* body—chemically inert to organic solvents, acids, oils, fumes.



Rugged construction—tough and resilient; withstands constant vibration.

Type HS-1 Feed-Thru Terminals, provide assured hermetic sealing for electrical and electronic components. Exclusive IRC molding Technique bonds Kel-F\* to metal in a superior seal. Designed to the sealing requirements of MIL-T-27. Send coupon for full data

\*Trademark—M. W. KELLOGG CO.

Boron & Deposited Carbon Precisors • Power Resistors • Voltmeter Multipliers • Low Wattage Wire Wounds • Insulated Composition Resistors • Volume Controls •

Precision Wire Wounds • Ultra HF and HI-Voltage Resistors • Selenium Rectifiers • Insulated Chokes • Hermetic Sealing Terminals •



### INTERNATIONAL RESISTANCE CO.

403 N. Broad St., Philadelphia 8, Pa.

In Canada: International Resistance Co., Ltd., Toronto, Licensee

Send me data on  MF Voltmeter Multipliers,  BW Resistors,  Power Wire Wounds,  Advanced BT Resistors,  HS-1 Terminals.

Name \_\_\_\_\_

Title \_\_\_\_\_

Company \_\_\_\_\_

Address \_\_\_\_\_

City \_\_\_\_\_ Zone \_\_\_\_\_ State \_\_\_\_\_

*for* **BRASS**  
**Bridgeport** *Service*  
**CO.**

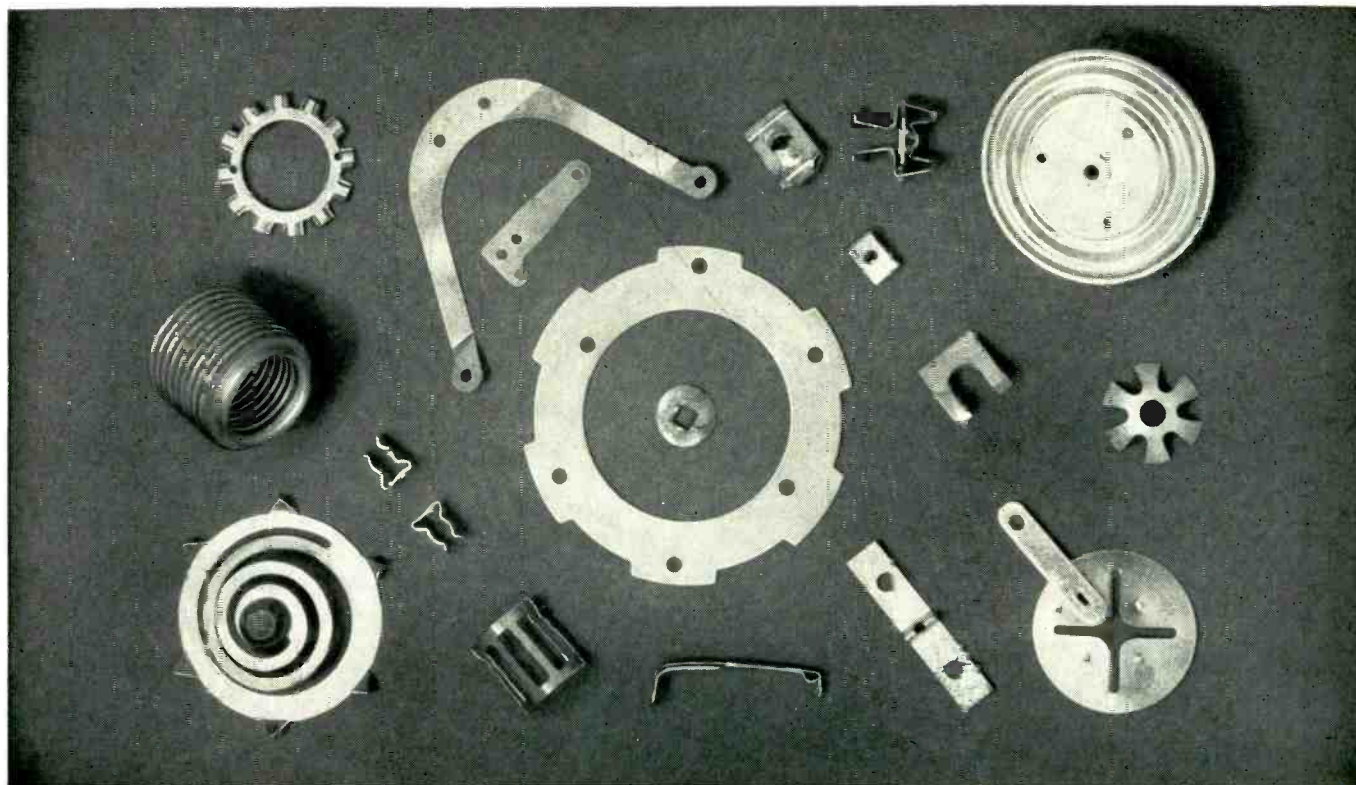

Reliability is built into many types of electrical and mechanical spring parts with Bridgeport Phosphor Bronze.

## ***Product improvement through . . .***

What do you look for in a spring material?

1. Resilience.
2. High fatigue resistance to withstand millions of flexing cycles.
3. High yield strength to withstand considerable deflection without taking a set.
4. Good corrosion resistance.
5. Sufficient ductility for stamping and forming.
6. Good electrical conductivity (if spring carries current).

## **BRIDGEPORT PHOSPHOR BRONZE**

These properties are engineered into Bridgeport's Phosphor Bronze through proper melting practice, special casting techniques and controlled mill processing. The superior quality of Bridgeport's Phosphor Bronze means superior performance — in electrical applications such as switches, relays, capacitors and controls... in mechanical applications such as bellows, diaphragms and lock washers.

Call on Bridgeport's Metallurgical Laboratory for help with your metal specification problems. Contact your nearest Bridgeport office for service.

Mills at Bridgeport, Conn., and Indianapolis, Ind.  
In Canada: Noranda Copper and Brass Limited, Montreal

## **BRIDGEPORT BRASS COMPANY**



30 GRAND STREET, BRIDGEPORT 2, CONNECTICUT





## "SPECIAL transformers?"

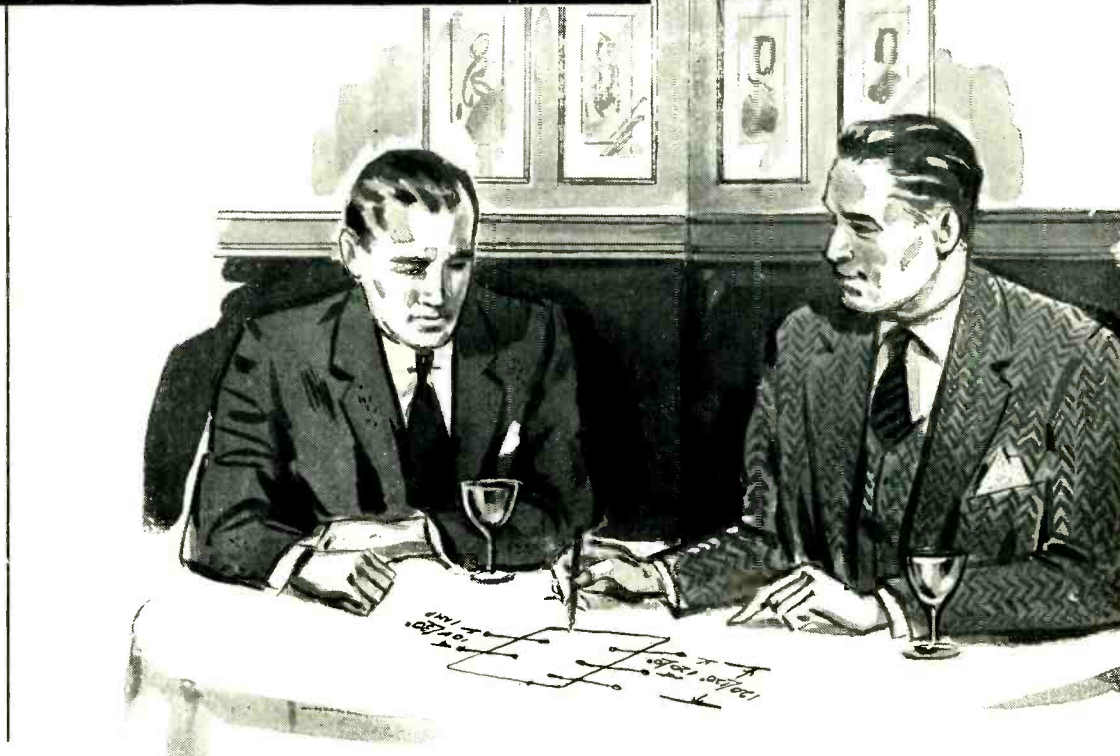

*... Oh, they're no problem with us.  
We let Electronic Transformer Company  
worry about 'em.'*

That's right. When we tackle those tricky special transformer jobs we relieve our customers of the complete headache. We're prepared to do *your* worrying, too, because custom-designing, custom-building transformers is our sole business. Government and industrial companies throughout the country have depended upon us since 1938.

Behind ETC transformer quality are a thoroughly trained engineering staff and the resources of our fully equipped laboratory and production department. We carry the ball from the circuitry stage right down the line to pilot and production runs.

What have *you* on the board or in your mind? Please telephone or write us without obligation.

### **ELECTRONIC TRANSFORMER COMPANY**

Transformers, Reactors and Filters Engineered to your Needs

209 WEST 25th STREET • NEW YORK 1, N. Y.

Telephone: WAtkins 4-0880

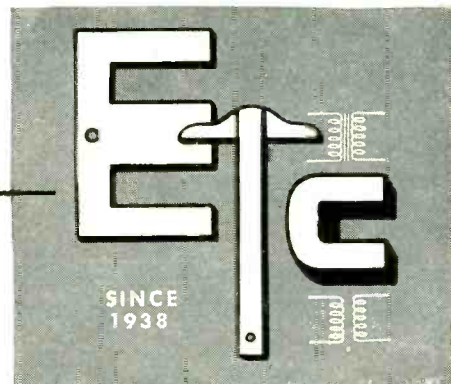



**PATENTED**

# Welded Terminals

Proved by Years of Service

**NOW AVAILABLE IN ALL**

**OHMITE<sup>®</sup>**

**WIRE-WOUND**

**RESISTORS**

**Provide a Perfect,  
Permanent Connection  
between Resistance  
Wire and Terminal**

#### WELDED RESISTANCE WIRE

All Ohmite resistors now have the resistance wire welded to the terminals instead of soldered or brazed. This provides a resistor with superior characteristics.

#### WELDED TERMINAL LUG

Another Ohmite resistor feature is the welded terminal band. The band is permanently held together around the resistor tube by means of welding, providing a strong, permanent fastening.

**SEE NEXT PAGE** 

Now in All Sizes . . .

# Welded Terminals

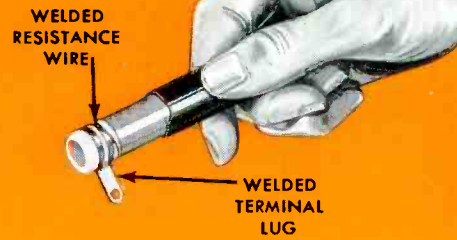

## ON **OHMITE**<sup>®</sup> RESISTORS



### PATENTED OHMITE PROCESS ASSURES PERFECT WELDS

Ohmite has perfected and patented a new welding technique, and has developed a method of testing every weld between the resistance wire and terminal. Thus, with every Ohmite resistor, you are assured of permanent terminal connections, unaffected by vibration or high temperatures.

### PERFECT ELECTRICAL CONNECTIONS

The fusion of the metal in the resistance wire and terminal lug provides a perfect and permanently stable electrical connection. This is extremely important in eliminating noise in audio circuits or instability in other highly sensitive circuits.

### HIGH-STRENGTH ALLOY TERMINALS

The terminals on Ohmite resistors are made of a special high-strength alloy, which has a coefficient of expansion that is properly related to that of the enamel, ceramic core, and wire. This keeps the terminal firmly anchored, and prevents cracking of the enamel.

The resistance wire is welded practically flush with the terminal, so there is no projection extending from the surface. Hence, the connection and terminal are as well covered and protected by the vitreous-enamel coating as the winding itself.

### PROVED IN TEN YEARS OF SERVICE

Ohmite developed welded terminals more than ten years ago. Since that time, this construction has been gradually extended to cover the entire Ohmite line. Millions of these welded resistors have proved their reliability in the toughest kind of service.

## *Plus* THESE OTHER OHMITE FEATURES

Ohmite resistors provide other important advantages, too—a superior vitreous-enamel covering, which holds the winding rigidly in place, preventing “hot spots,” and protecting the winding from moisture and fumes; strong ceramic core that is unaffected by cold, heat, fumes, or high humidity; and hot tinned terminal lugs for ease in soldering. For unflinching dependability, specify Ohmite resistors.

**OHMITE MANUFACTURING CO.**

3610 Howard Street, Skokie, Illinois (Suburb of Chicago)



WRITE on Company Letter-head for Catalog and Engineering Manual No. 40.

*Be Right with*

# OHMITE<sup>®</sup>

RHEOSTATS • RESISTORS • TAP SWITCHES



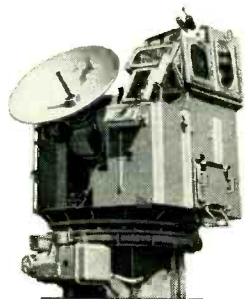
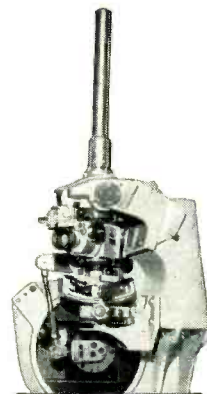
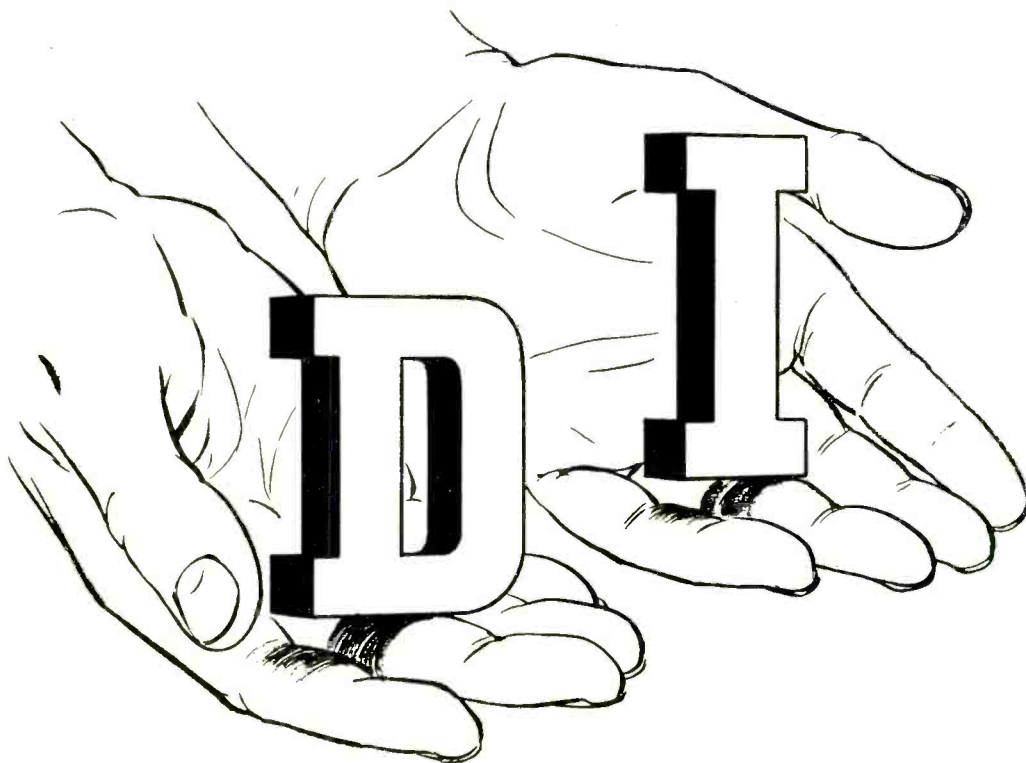

# Skilled hands

Skilled hands—1500 pairs of them are busy every day at Daystrom Instrument—performing research, development and manufacturing tasks on a wide variety of precision electrical and mechanical instruments. Daystrom specialists are prepared and ready to analyze your requirements and translate them from drawing board to finished products—all within our own modern plant of 350,000 square feet. All development and manufacturing are achieved through advanced techniques. We are proud of the fire control and radar equipment we produce for our Army and Navy. Daystrom products include computers, gyros, servo amplifiers, electronic chassis, sheet metal cabinets, test equipment, gear assemblies, servo controls, radio and precision potentiometers.

*Write today for our facilities report.*

- ★ RESEARCH
- ★ DEVELOPMENT
- ★ DESIGN
- ★ PRODUCTION



*DIVISION OF DAYSTROM, INCORPORATED*

**ARCHBALD, PENNA.**

*Affiliates:*

*American Type Founders, Inc., Elizabeth, N.J.; Daystrom Furniture Div., Olean, N.Y.; Daystrom Electric Corp., Poughkeepsie, N.Y.*

**PURCHASE ORDER**  
NUCLEONICS DIVISION  
**GENERAL ELECTRIC**  
ORDER NO. HWC-16908  
SHOW ORDER NUMBER ON ALL CORRESPONDENCE, INVOICES AND SHIPPING PAPERS.

**PURCHASE ORDER**  
VENDOR COPY  
REG NO. 913919  
FOR A O 12-1-51  
221A0  
ISSUER'S REFERENCE  
PURCHASE ORDER NO. 370

**PURCHASE ORDER**  
SPERRY GYROSCOPE COMPANY  
DIVISION OF THE SPERRY CORPORATION  
GREAT NECK, N. Y.

**PURCHASE ORDER**  
ALLEN B. DU MONT LABORATORIES, INC.  
35 MARKET ST., EAST PATERSON, N. J.

**PURCHASE ORDER**  
Westinghouse Electric Corporation  
2519 Wilkens Ave., Baltimore 3, Md.  
PURCHASE ORDER NO. 02J-86189  
DATE 11/8/51

**PURCHASE ORDER**  
FEDERAL TELEPHONE AND RADIO CORPORATION  
100 RINGBLAND ROAD - CLIFTON, NEW JERSEY  
DATE 11-17-51

**PURCHASE ORDER**  
FADA Radio AND ELECTRIC COMPANY, INC.  
525 MAIN ST., BELLEVILLE 9, N. J.  
1-PURCHASE ORDER  
P.O. 93  
DATE SEPTEMBER 16

**PURCHASE ORDER**  
RADIO CORPORATION OF AMERICA  
RCA VICTOR DIVISION  
MICHIGAN & LA SALLE STS., INDIANAPOLIS 1, IND.  
DATE 9-20-51  
ORDER 22242-0

**PURCHASE ORDER**  
STROMBERG-CARLSON COMPANY  
ROCHESTER 3, N. Y.

**PURCHASE ORDER**  
MOTOROLA INC.  
3102 NORTH WINDLASS DRIVE  
PHOENIX, ARIZONA  
Telephone 6-3631  
No. 509201 P -3  
509201 P-3  
Motor Television

**PURCHASE ORDER**  
PHILCO CORPORATION  
GOVERNMENT AND INDUSTRIAL DIVISION - PHILADELPHIA 14, PA.  
PURCHASE ORDER NO. 22006

**PURCHASE ORDER**  
the hallcrafters Co.  
MANUFACTURERS OF RADIO AND ELECTRONIC EQUIPMENT  
CABLE ADDRESS: HALLCRAFT, CHICAGO  
PHONE VAN NUYS 6-8000  
410 WEST FIFTH AVENUE  
Chicago 24, Ill.  
PURCHASE ORDER NO. 490

**Purchase Order**  
EXCELLENCE IN RAYTHEON ELECTRONICS  
RAYTHEON MANUFACTURING COMPANY  
WALTHAM 54, MASSACHUSETTS  
DIVISION: PRODUCTION  
SHIP VIA: PARCEL POST  
P.O. BOX, ALBANY  
DATE: 5061 373  
NO. 40-13  
THIS NUMBER ON PAPER, BAGGING

**PURCHASE ORDER**  
BELL TELEPHONE LABORATORIES  
INCORPORATED  
403 WEST STREET, NEW YORK 14, N. Y.  
CHELSEA 3-1000  
PURCHASE ORDER NO. A 198379 B  
SPECIAL INSTRUCTIONS  
RETURN TO US PROMPTLY WITH ACKNOWLEDGMENT WITH SHIPMENT

**PURCHASE ORDER**  
SYLVANIA ELECTRIC PRODUCTS INC.  
IPSWICH FIXTURE PLANT  
IP-1525  
PURCHASE ORDER NO. 18763  
SHOW THE NUMBER ON ALL CORRESPONDENCE

**PURCHASE ORDER**  
EMERSON RADIO and PHONOGRAPH CORPORATION  
111 EIGHTH AVENUE, NEW YORK 11, N. Y.  
ORDER NO. 4837  
DATE 8-7-51  
REQUISITION NO. 2120  
PROJECT OR

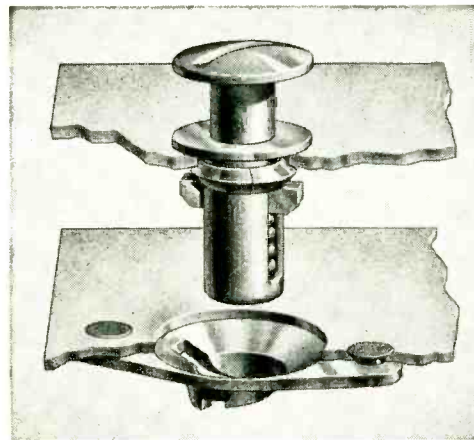

## For Electronics: Faster Assembly... Better Design

Why do leading electronic manufacturers order and re-order Simmonds' QUICK-LOCKS in quantity? For good dollar-wise reasons:

### IN ASSEMBLY—

- No special tools are needed for installation.
- Flexible mounting takes care of curved sheets and misalignment.
- Various material thicknesses can be handled.

### IN DESIGN—

- Initial loads taken by helical spring. Increased loads carried on solid supports.
- 90-deg. rotation locks and unlocks fastener.
- Stud is self-ejecting when unlocked.
- Stud is self-aligning. Makes mounting and de-mounting detachable panels simple.

QUICK-LOCK can help reduce your assembly costs and can add unusual advantages to your designs. Send for data and samples today.

**SIMMONS FASTENER CORPORATION**  
1750 No. Broadway, Albany 1, New York

# Simmons

QUICK-LOCK  
SPRING-LOCK  
ROTO-LOCK  
LINK-LOCK  
DUAL-LOCK

JUST OUT!  
NEW 36-PAGE CATALOG WITH APPLICATIONS.  
SEND FOR IT!

Fasteners that improve products  
and reduce assembly costs.



# A CEC SADIC system *gives you*

*digitized test data*

*with speed,  
accuracy  
and low cost*

In many research and development projects today, full scale structures or scale models are tested and re-tested hundreds of times with only slight changes in the test conditions. Where this occurs, as it does in aerodynamic wind tunnels or rocket and reaction motor static-test stands, a staggering amount of test data may be accumulated in analog form. Before this data can be evaluated by the test engineer it must be converted into digital—i.e., numerical—form. CEC's high speed, high accuracy SADIC digital data-

processing systems are unequalled for this purpose. Assembled from "building block" components to meet the precise requirements of the test project, they automatically convert analog voltages from thermocouples, pressure transducers, strain gages, etc., to digital form, with numerical readout on perforated tape,

punch cards, or tabulators. Where large quantities of such test data have to be processed, automatic digital data conversion with a Consolidated SADIC system pays for itself many times over by eliminating the costly, laborious, time-wasting necessity for extracting thousands of points from an accumulation of analog plots. For full details send for Bulletin CEC-3002-X2.

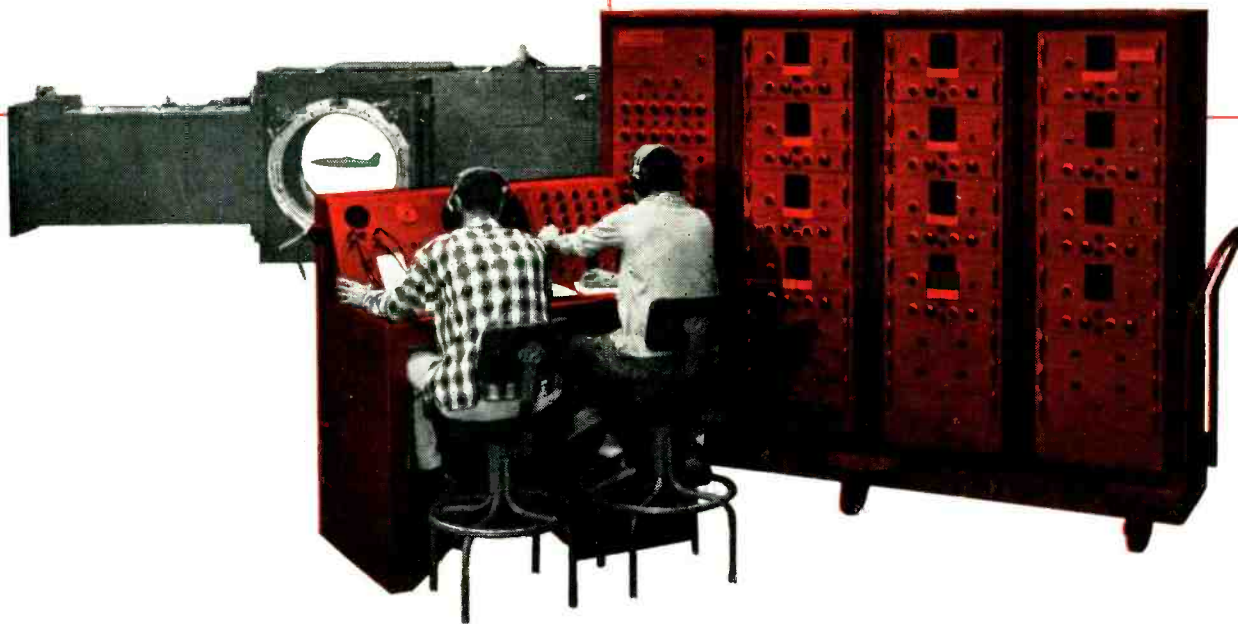

**Consolidated Engineering**  
CORPORATION

300 North Sierra Madre Villa, Pasadena 15, California

**ANALYTICAL INSTRUMENTS  
FOR SCIENCE AND INDUSTRY**

*Sales and Service through*

**CEC INSTRUMENTS, INC.**, a subsidiary  
*with offices in: Pasadena, Atlanta, Chicago, Dallas,  
Detroit, New York, Philadelphia, Washington, D.C.*

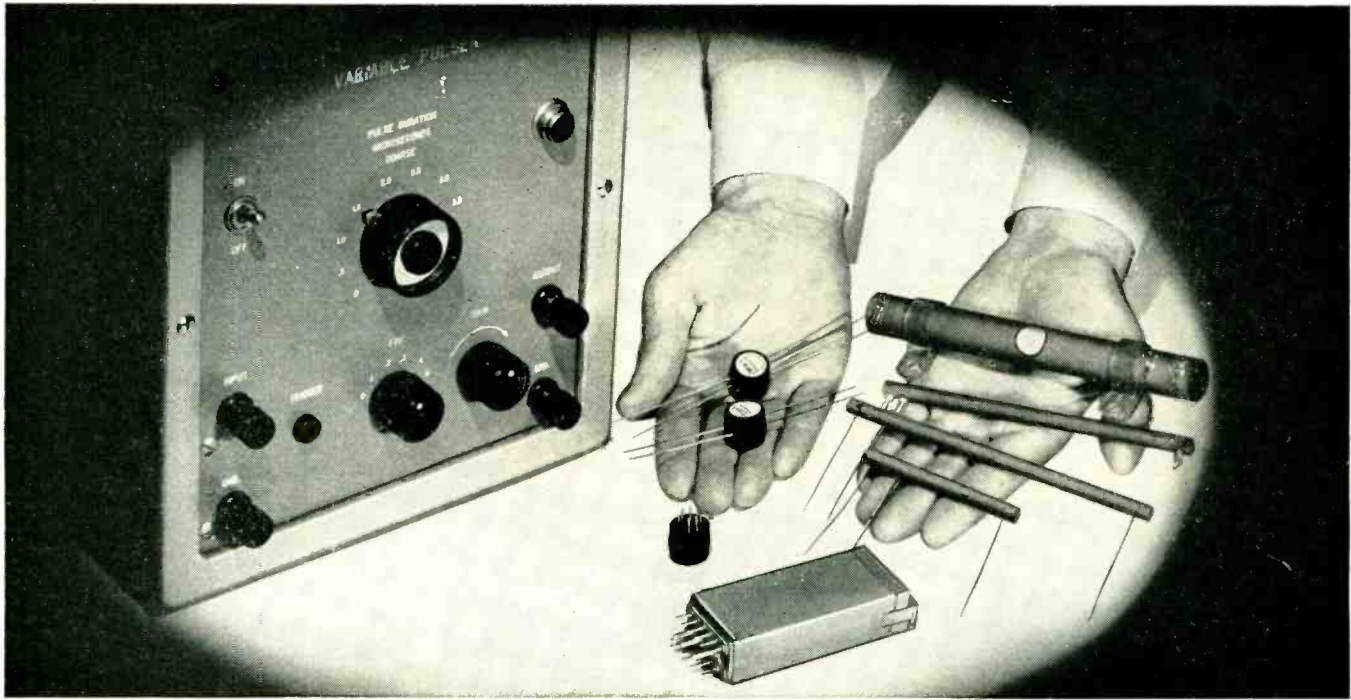

## New Instruments and Components to Aid in Design and Reduce Costs

by

# TECHNITROL

### Unique Variable Pulser is Valuable Laboratory Aid

The Technitrol Variable Pulser is a reliable, versatile instrument which converts the output of a laboratory oscillator into a series of pulses.

One use has been as a low pulse rate device to study the response of components and networks to isolated pulses. Another use has been as a variable pulse rate source to study P.R.F. sensitivity. Still another use has been as a constant high frequency source for a temporary clock pulse generator.

#### Characteristics

- Wide range of frequencies from 2 cps. to over 2.0 mcs.
- Pulse characteristics optimized with rise and fall times approximately 0.04  $\mu$ s. and 0.06  $\mu$ s. respectively.
- Duration of pulse variable from 0.2  $\mu$ s. to 5.0  $\mu$ s. in steps of 0.1  $\mu$ s.
- Accurate, stable pulse duration controlled by electric delay lines.
- Amplitude continuously variable without distortion from 0 to 45 volts.
- Trigger pulse precedes output pulse to synchronize oscilloscopes, etc.

### Tiny Encapsulated Pulse Transformers Wound to Your Requirements

Technitrol Pulse Transformers are wound on ferrite cores and cast in resin to form a  $\frac{3}{4}$ " sealed unit.

Type TE has 2-inch pigtail leads of No. 20 wire. Type TP has 7-pin plug-in for miniature tube sockets. Lends itself admirably to printed circuits where holes can be drilled in the circuit board, the transformer plugged into these and the pins soldered to the circuit leads on the side opposite the body of the transformer.

*When writing  
for information Specify application  
and requirements*

## TECHNITROL

ENGINEERING COMPANY

2751 North Fourth Street  
Philadelphia 33, Pennsylvania

### Very Compact Delay Lines Designed to Fit Your Need

A Technitrol Delay Line—with not more than  $\frac{3}{4}$ " diameter and  $6\frac{3}{4}$ " length, or in a package—will be designed for your particular circuit application. A variety of mountings offers you a wide choice.

- Delay: 0.01 to 1.6  $\mu$ s.
- Characteristic Impedance: 400 to 2500 ohms.
- Wide Frequency Response: 0.5  $\mu$ s. at 1200 ohms.  
3 db down at 5 mcs  
6 db down at 8 mcs  
10 db down at 10 mcs
- Continuing intensive research and development is expected to make available even greater band-widths.
- Linear Phase: to 9 mcs and beyond

The continuously wound Technitrol Delay Lines provide minimum pulse distortion and are extremely stable with temperature variations. A covering protects the winding from abrasion and mechanical damage.



ceramics and metal

are permanently  
and accurately combined

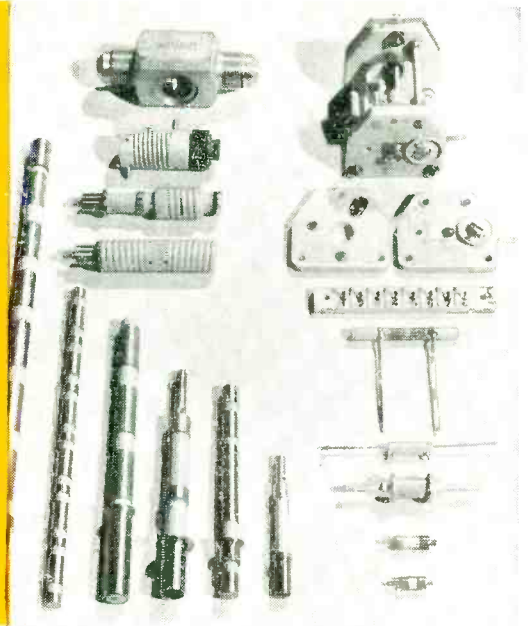

The metal bands on the rotor shafts shown at the left, above, are concentric with the shaft to within 0.001 in.

# Stupakoff assemblies

Your production procedure is simplified when you use high-precision Stupakoff ceramic-to-metal assemblies. Extensive experience in the field of electrical and electronic ceramics, thorough familiarity with methods of metallizing, and the use of modern precision manufacturing methods insure the high quality and uniformity of Stupakoff Assemblies.

Among the assemblies made by Stupakoff are: rotor shafts, strain and spreader insulators, stand-offs and trimmers. Ceramic bodies are specially formulated for the intended service; metals used include silver, copper, brass, stainless steel and monel. Stupakoff's broad experience in this field insures the selection of a method of assembly best suited to meet service conditions.

A few types of Stupakoff Ceramic-to-Metal Assemblies are illustrated in the photographs on this page.

**STUPAKOFF CERAMIC & MANUFACTURING COMPANY**  
LATROBE, PENNSYLVANIA



Some of the larger types of Stupakoff metallized ceramic parts.

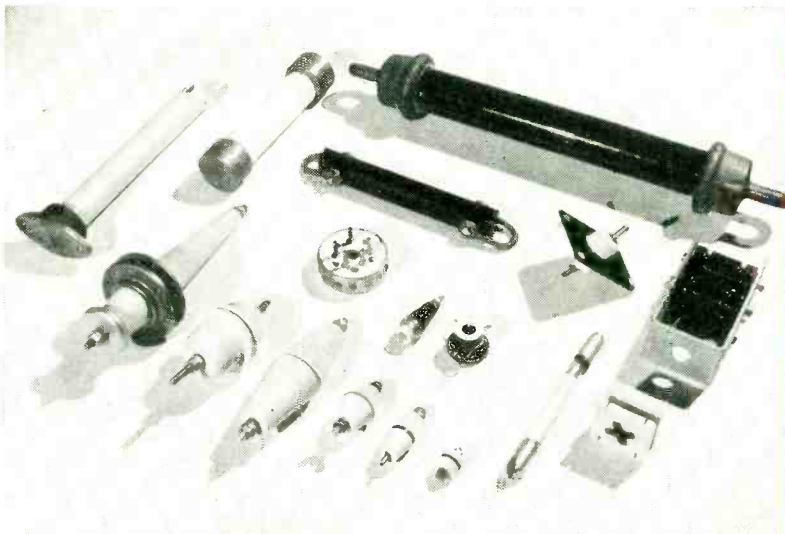

Small metallized ceramic parts are accurately made and dependably uniform.

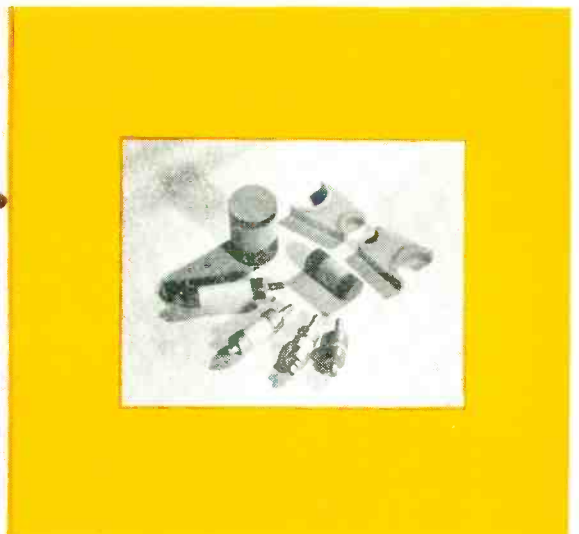

**WIDE  
RANGE**

# FAST-PULSE GENERATOR

**PG-200A  
Pulse Generator  
PGA-210  
Range Extenders**



## SPECIFICATIONS

### PULSE POWER

- Amplitude 100 volts open circuit
- Continuously variable over a range of -10 db
- 50 db attenuation in steps of approx. 10 db
- Driving impedance 50 ohms or less
- Max. average current (50 ohms load) 0.1 amp. for pos. pulses, 0.07 amp. for neg. pulses
- Max. recurrence rate at least 20,000 pps
- Max. duty cycle 50%, min. pulse interval (trailing edge to leading edge) approx. 40  $\mu$ s

### PULSE WAVEFORM

- Rise and decay times 0.03  $\mu$ s or less (10% to 90% amplitude)
- Crest and base line overshoots and ripple less than 5% of average pulse amplitude
- Duration calibrated 0.1 to 50  $\mu$ s, accuracy below 5000 pps within 5% or 0.1  $\mu$ s whichever is greater, accuracy above 5000 pps subject to additional 0.3  $\mu$ s error, min. pulse width less than 0.05  $\mu$ s (50% amplitude)

### PULSE POSITION

- Delay after external sync signal fixed at approx. 10  $\mu$ s or adjustable from approx. 20 to 70  $\mu$ s
- Advance or delay with respect to sync out trigger calibrated 0.1 to 50  $\mu$ s, accuracy below 5000 pps within 5% or 0.1  $\mu$ s whichever is greater, accuracy above 5000 pps subject to additional 0.3  $\mu$ s error

### RANGE EXTENDER

- 19 additional time increments of 50  $\mu$ s each
- Continuous calibrated coverage from 0.1 to 1000  $\mu$ s, accuracy within 5%
- Plugs into top of Pulse Generator directly above position or duration control

### SYNCHRONIZATION

- Externally by almost any 5 volt waveform from essentially 0 to 20,000 per sec.
- Internal single pulses, power line freq. or adjustable from 20 to 20,000 pps
- Recurrence rate meter, accuracy within 5%
- Sync out trigger 50 volts, 1  $\mu$ s duration

## *features*

- DURATION AND POSITION .05 TO 1000  $\mu$ s
- RISE AND DECAY TIMES CONSTANT .03  $\mu$ s
- SINGLE PULSES TO 20,000 PER SECOND
- 100 VOLTS, 50 OHMS DRIVING IMPEDANCE
- CALIBRATED WIDTH, POSITION AND RATE
- TRIGGER OR SINE WAVE SYNCHRONIZATION
- NEGLIGIBLE INTERACTION OF CONTROLS

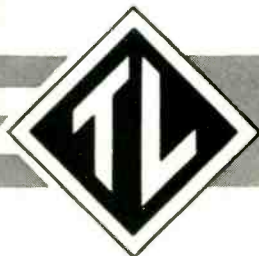

# TELETRONICS LABORATORY INC.

54 KINKEL STREET, WESTBURY, LONG ISLAND, NEW YORK



# Waldes Truarc Ring Saves \$2.84 Per Unit, Cuts Labor-Time and Materials in Hydraulic Packing Unit

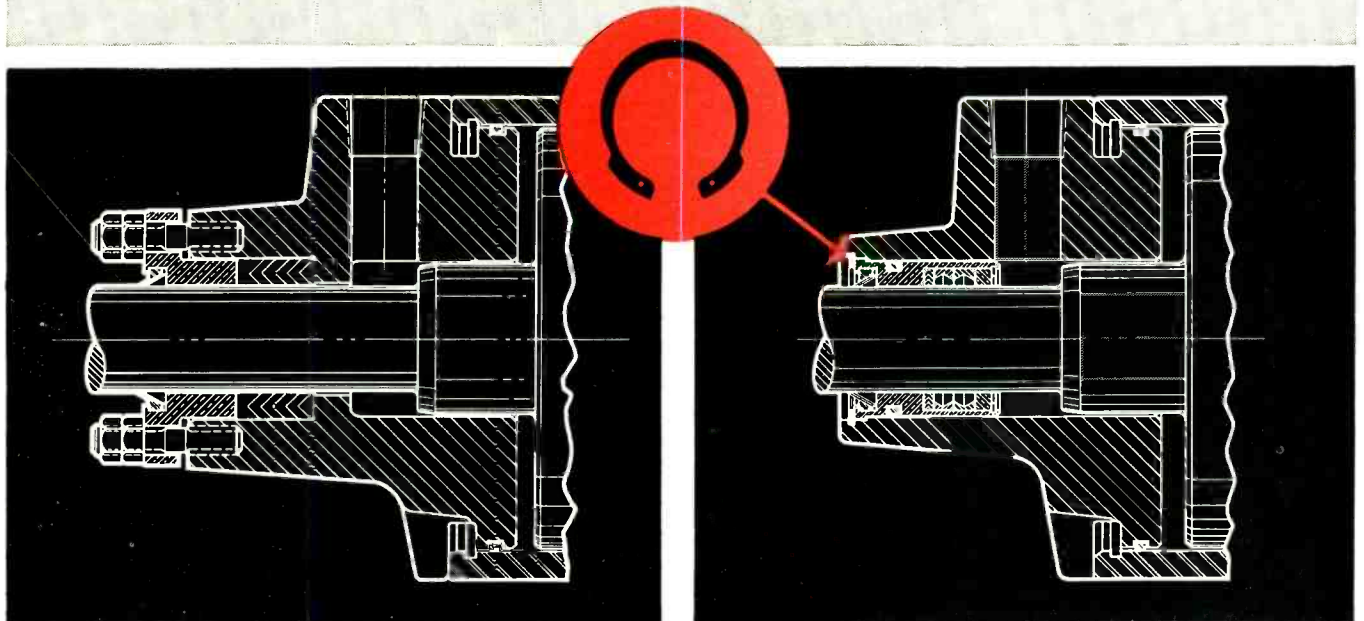

**OLD STYLE** stuffing box required skilled worker to install packing rings one at a time, then adjust packing glands by trial and error. Disassembly was equally difficult, time-consuming and costly.

**NEW** Monopak Cartridge is smaller, lighter, streamlined and installed with one Truarc Retaining Ring. Disassembly and reassembly with new cartridge takes unskilled worker just 1 minute.

Hydraulic Accessories Company of Van Dyke, Michigan, uses a single Waldes Truarc Inverted Ring (internal series 5008) to hold Monopak Cartridge in cylinder head.

New design eliminates costly machining and saves 2 1/8 lbs. of material. Re-design with Waldes Truarc Retaining Ring reduces stuffing box diameter from 3 1/2" to 2 7/8", and reduces length from 5 7/8" to 4 3/8". Allows savings in assembly, adjusting and testing.

### NEW DESIGN USING WALDES TRUARC RING PERMITTED THESE SAVINGS PER UNIT

#### MACHINE TIME SAVED:

Chucking, facing and boring . . . . .	\$ .72
Drilling and tapping 3 holes . . . . .	.18
Drilling and counterboring 3 holes . . . . .	.12
Assembling, adjusting, testing . . . . .	.90

#### MATERIAL SAVED:

1 1/2 lbs. cast iron . . . . .	.30
1/2 lb. bronze . . . . .	.23
3 studs . . . . .	.36
3 nuts . . . . .	.03

**TOTAL \$2.84**

Waldes Truarc Retaining Rings are precision-engineered . . . quick and easy to assemble and disassemble. Always circular to give a never-failing grip. They can be used over and over again. There's a Waldes Truarc Ring to answer every fastening problem.

Find out what Waldes Truarc Retaining Rings can do for you. Send your blueprints to Waldes Truarc engineers for individual attention, without obligation.

For precision internal grooving and undercutting . . . Waldes Truarc Grooving Tool.

See the Waldes Truarc exhibit at the A.S.T.E. Show, April 26-30. Booth No. 424, Precision Hall.

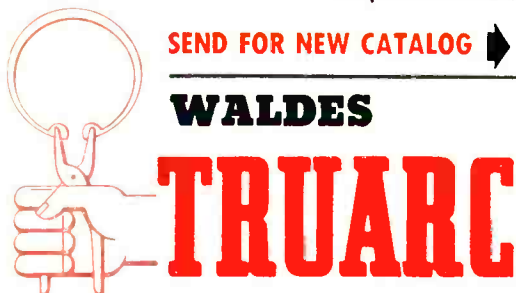

SEND FOR NEW CATALOG

**WALDES TRUARC**  
REG. U. S. PAT. OFF.  
**RETAINING RINGS**

WALDES KOHINOOR, INC., LONG ISLAND CITY 1, NEW YORK

WALDES TRUARC RETAINING RINGS AND PLIERS ARE PROTECTED BY ONE OR MORE OF THE FOLLOWING U. S. PATENTS: 2,382,847; 2,382,948; 2,416,852; 2,420,921; 2,428,341; 2,439,785; 2,441,846; 2,455,163; 2,463,380; 2,483,383; 2,487,602; 2,497,603; 2,491,306; 2,509,081 AND OTHER PATENTS PENDING



Waldes Kohinoor, Inc., 47-16 Austel Place, L. I. C. 1, N. Y.

Please send me the new Waldes Truarc Retaining Ring catalog.

(Please print)

E-046

Name.....

Title.....

Company.....

Business Address.....

City..... Zone..... State.....



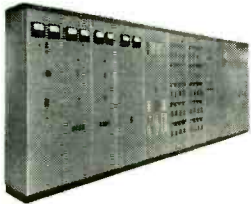

ARMSTRONG CORK CO.

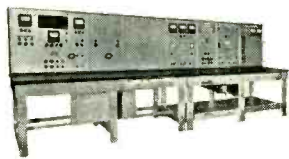

BELL AIRCRAFT CORP.

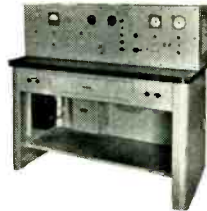

NASH KELVINATOR

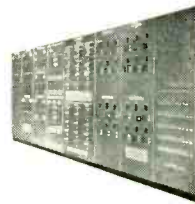

GENERAL ELECTRIC CO.

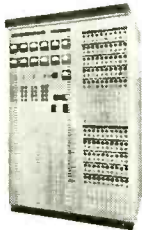

NAVAL RESEARCH LAB.

**STANDARD**  
*flexlab*  
**WHO'S WHO IN INDUSTRY,  
 RESEARCH, GOVERNMENT, EDUCATION?**  
 Just send for Flexlab Catalog No. 187  
 covering our Flexlab Laboratory  
 Equipment. It contains much valuable  
 information plus an impressive list of  
 Flexlab users... You will find yourself  
 in the best of company when you have  
 Standard design and build your next  
 panel installation... Consultation  
 without obligation.  
*"Custom Designed and Built"*



ABERDEEN PROVING GROUNDS

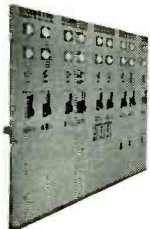

LOS ALAMOS  
PROVING GROUNDS

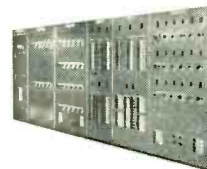

RADIO CORPORATION  
OF AMERICA

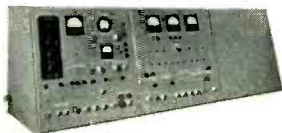

SIKORSKY AIRCRAFT



ATOMIC ENERGY COMMISSION

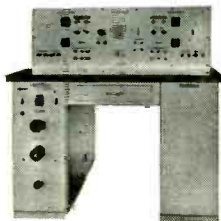

WESTINGHOUSE ELECTRIC CORP.

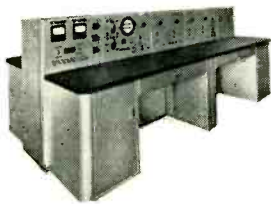

COMMONWEALTH EDISON CO.

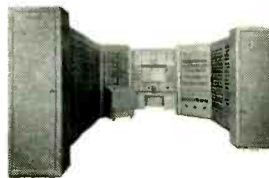

LACLEDE GAS CO.



NAVAL AIR  
DEVELOPMENT STATION

DISTRIBUTION SWITCHBOARDS • CONTROL BOARDS • TEST PANELS AND UNITS  
PRECISION TIMERS • CHRONO-TACHOMETERS • PIPELINE NETWORK ANALYZERS



**The STANDARD ELECTRIC TIME COMPANY**

97 Logan Street • Springfield 2, Massachusetts



Another **FIRST** from **-hp-**!

# Standard test instruments mounted exactly as you want them!



- all-metal cabinets
- relay rack
- end frames

◀ **-hp- 100D Frequency Standard in streamlined metal cabinet now offered with -hp- instruments**

Now you can buy **-hp-** instruments mounted any of three ways, and, later on, change to any other mounting you wish. This new versatility means greater utilization of your **-hp-** instruments, and can also increase the flexibility of your entire instrument setup.

**Cabinets.** **-hp-** instruments having the standard 10½" x 19" panel are now available in standardized **-hp-** AC 44 aluminum-and-steel cabinets. Equipped with sturdy carrying handles, these

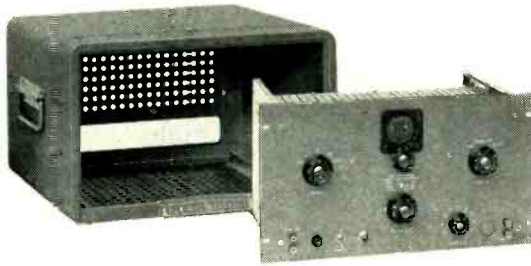

cabinets give your **-hp-** instruments greater protection, better ventilation, and a clean, rugged, modern appearance. Either the separate back cover or the cabinet itself can be removed quickly and easily. Cabinets are finished in wrinkle grey matching the **-hp-** grey baked enamel panel faces. **-hp-** AC44 cabinets are now available with the following instruments when factory shipment is made: **-hp-** 100C,D, 202A, 202B, 205A, AH, AG, 206A, 212A, 330B,C,D, 520A, 522A,B, 624B, 650A and 712B. Model AC44 Cabinet, with instrument, \$15.00; separately, \$25.00.

**End frames.** To increase flexibility and convenience of **-hp-** instruments for bench use, **-hp-** Model 17 End Frames are offered. These frames are of heavy gauge aluminum, equipped with sturdy

carrying handles and finished in **-hp-** grey baked enamel. They fit all late model **-hp-** instruments with panel size 10½" x 19", and may be attached in moments. **-hp-** 17 End Frames, \$7.50 set.



**Rack mounting.** Many **-hp-** instruments are basically rack mounting and can be installed directly into 19" relay racks. Many other **-hp-** instruments can be equipped for relay rack mounting at slight additional charge. A complete list of instruments available for rack mounting will be sent on request.



**Smaller -hp- instruments, too,** are now being delivered in new, streamlined cabinets. **-hp-** 512A Frequency Converter, illustrated, shows the rugged, lightweight metal cabinet now offered with such instruments as **-hp-** 200AB, 200CD, 410B and 715A.

**Write today for bulletin listing all -hp- instruments now available with new cabinets and other mounting options**

**HEWLETT-PACKARD COMPANY**

2999A Page Mill Road • Palo Alto, California, U.S.A.

Field representatives in all major cities

Data subject to change without notice. Prices f.o.b. factory.



**ATTEND THE I. R. E. REGION 7 CONFERENCE-TRADE SHOW**  
PORTLAND, OREGON • MAY 5, 6, 7

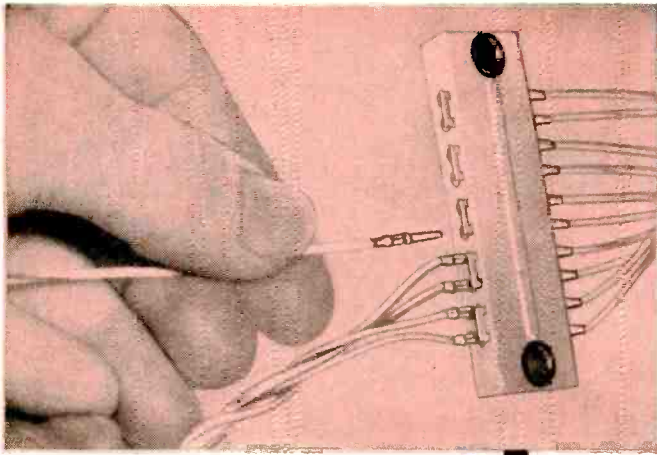

**BASIC 10 CONNECTOR TAPER-BLOK WITH DUAL CONTACTS**

Photo shows TAPER-BLOK with A-MP TAPER PINS in place. Strip measures only .610" x 2". Blocks, made of NYLON 100D1, can also be stacked to accommodate hundreds of circuits.

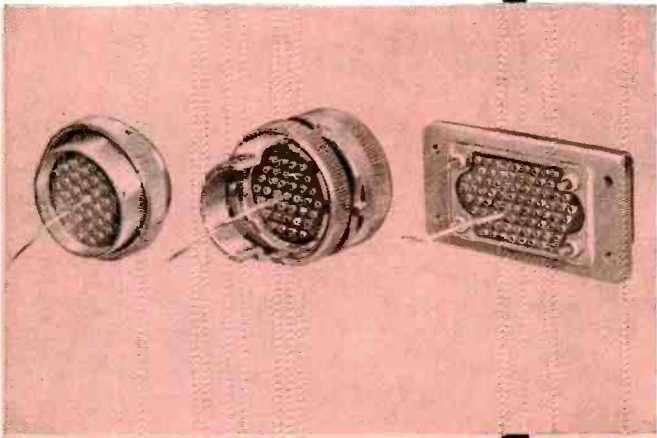

**TAPER PINS FOR MULTIPLE CONNECTORS, AND OTHER TYPES**

Amphenol, Cannon, Continental and Winchester Connectors now are available with tapered receptacles for A-MP self-locking TAPER PINS. Saves over 80% of your wire assembly time and provides uniformly higher quality connections at lower cost.

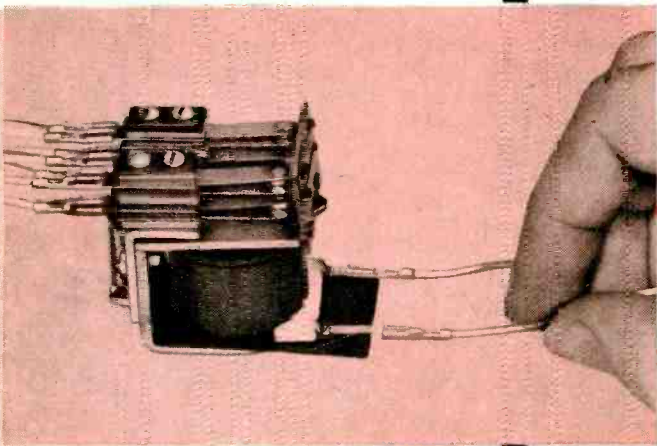

**TAPER TAB RECEPTACLE APPLICATIONS**

More and more flat tabs on relays, switches and other components are being tapered to receive A-MP TAPER TAB RECEPTACLES. Fast easy assembly reduces costs and provides higher quality connections.

**NEW AMP MINIATURE TAPER-BLOK**

**For AMP Taper Pins**

(Wire Ranges: #26 to #16)

**NEW TAPER-BLOK FOR A-MP'S TAPER PINS HELPS YOU SAVE SPACE AND WEIGHT, SPEEDS UP WIRING ASSEMBLY, SIMPLIFIES DESIGN, AND REDUCES COST!**

The TAPER-BLOK shown full size at the right has receptacles for 1000 connections, yet measures only 4" x 5" x 3/8"! Receptacles are designed to receive A-MP self-locking Taper Pins which can be easily pushed in place with A-MP's CERTI-LOK measured energy insertion tool.

Extremely high contact pressure assures dependable, uniform, low resistance connections for electric and electronic circuits.

Assembled TAPER-BLOKS are available in 10 and 20 connector sizes with single or dual receptacles. TAPER-BLOK strips can be assembled by stacking to provide the number of connections required for your design. Write for specific information and latest prints.

AMP Trade Mark Reg. U.S. Pat. Off.  
©AMP



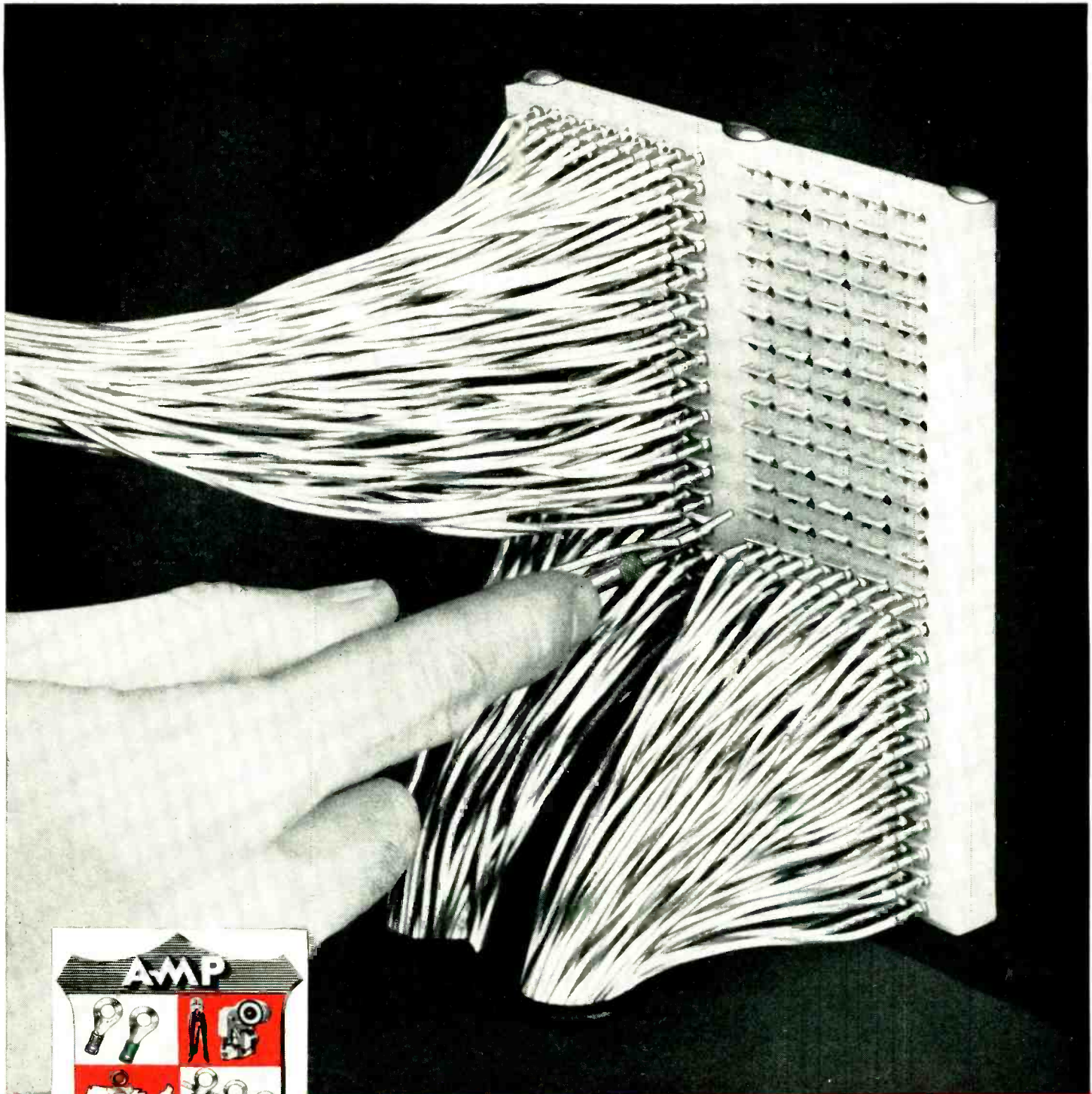

**AIRCRAFT-MARINE PRODUCTS, INC.**  
2100 PAXTON STREET, Harrisburg, Pennsylvania  
In Canada — AIRCRAFT-MARINE PRODUCTS, INC.  
1764 Avenue Road, Toronto 12, Ontario, Canada





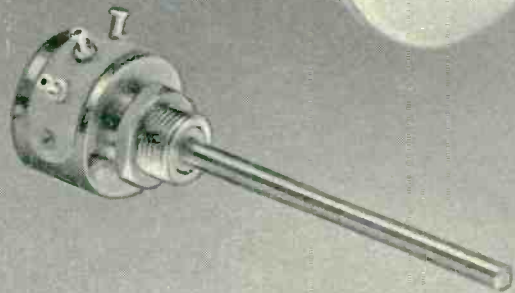
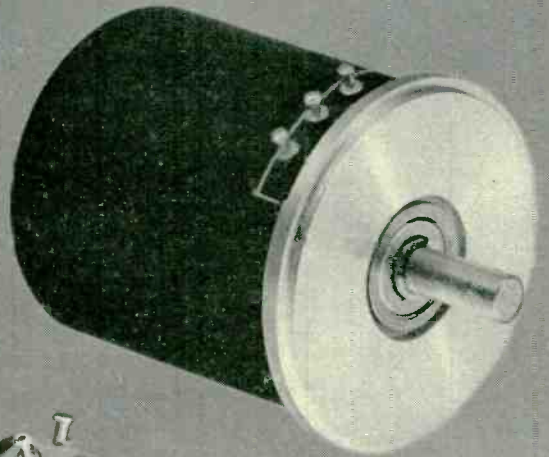
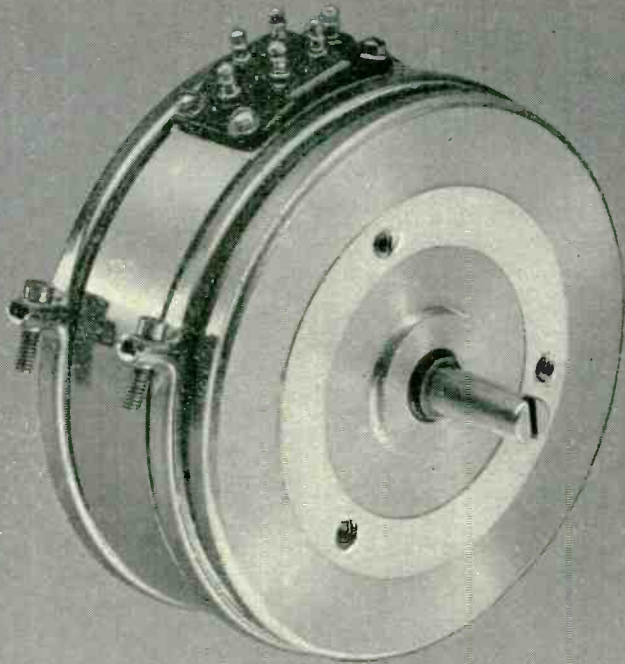

# 5 NEW

## 5 More reasons why FAIRCHILD can meet



**TYPE 753** — Sine-cosine potentiometer — Full sine-cosine function without mechanical cams and linkages — can be ganged up to 6 cups. 20,000 ohms per quadrant; linearity,  $\pm 0.5\%$  peak-to-peak; 3" diameter, 1 $\frac{1}{4}$ " long from front of servo flange to rear of cup. Also available as straight sine function.



**TYPE 745** — 10-turn helical potentiometer — Meets rigid government requirements for humidity, salt spray, altitude, temperature, vibration, shock, sand, dust and fungus resistance. High electrical accuracy (linearity  $\pm 0.025\%$ ); resistance range 100 to 300,000 ohms. 2" diameter, 2 $\frac{3}{8}$ " long from front of servo flange to end of case. Mechanical and electrical rotation, 3600° (+2° -0°).



**TYPE 771** — The FilmPot, metallic film potentiometer — Infinite resolution, high temperature operation (225°C). High wattage dissipation and exceedingly wide resistance range (100 to 200,000 ohms). Only  $\frac{3}{4}$ " in diameter and  $\frac{1}{2}$ " long. Resistance element is precious metal deposited on an inorganic base. Available with servo flange or threaded bushing mounting.



(Shown actual size)

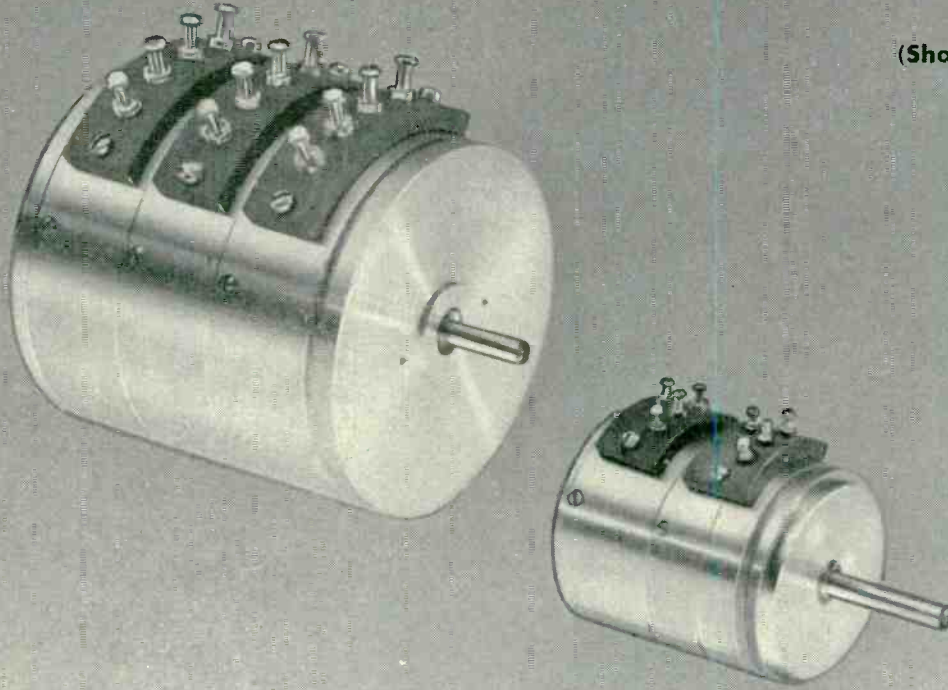

# POTENTIOMETERS

**all your precision potentiometer needs**



**TYPE 754**—2" linear potentiometer—Resistance range from 800 ohms to 100,000 ohms. High linearity ( $\pm 0.15\%$  standard). Internal clamp rings permit ganging up to 8 cups on single shaft without increasing over-all diameter. AIA standard 2" servo mount. Depth is 1" with .594" added for each cup section ganged. Cold-plated terminals are easier to solder and have better resistance to corrosion.



**TYPE 741**—1½" linear potentiometer—Internal clamp rings permit ganging up to 5 cups on a single shaft without increasing the over-all diameter. Resistance range 500 to 25,000 ohms; linearity  $\pm 0.5\%$  standard. Electrical angle 350°. Only 1½" in diameter and ½" long; starting torque is 0.25 oz.-in. The simplified slip ring construction and a one-piece paliney wiper give longer life and lower noise.

● Available immediately in sample quantities. Look to Fairchild for assistance in solving all your precision potentiometer problems. Fairchild has, or can make, a potentiometer to fit any requirement. For information write: Fairchild Camera & Instrument Corp., Potentiometer Division, 225 Park Avenue, Hicksville, L. I., N. Y., Dept. 140-45A1.

**FAIRCHILD**  
PRECISION POTENTIOMETERS

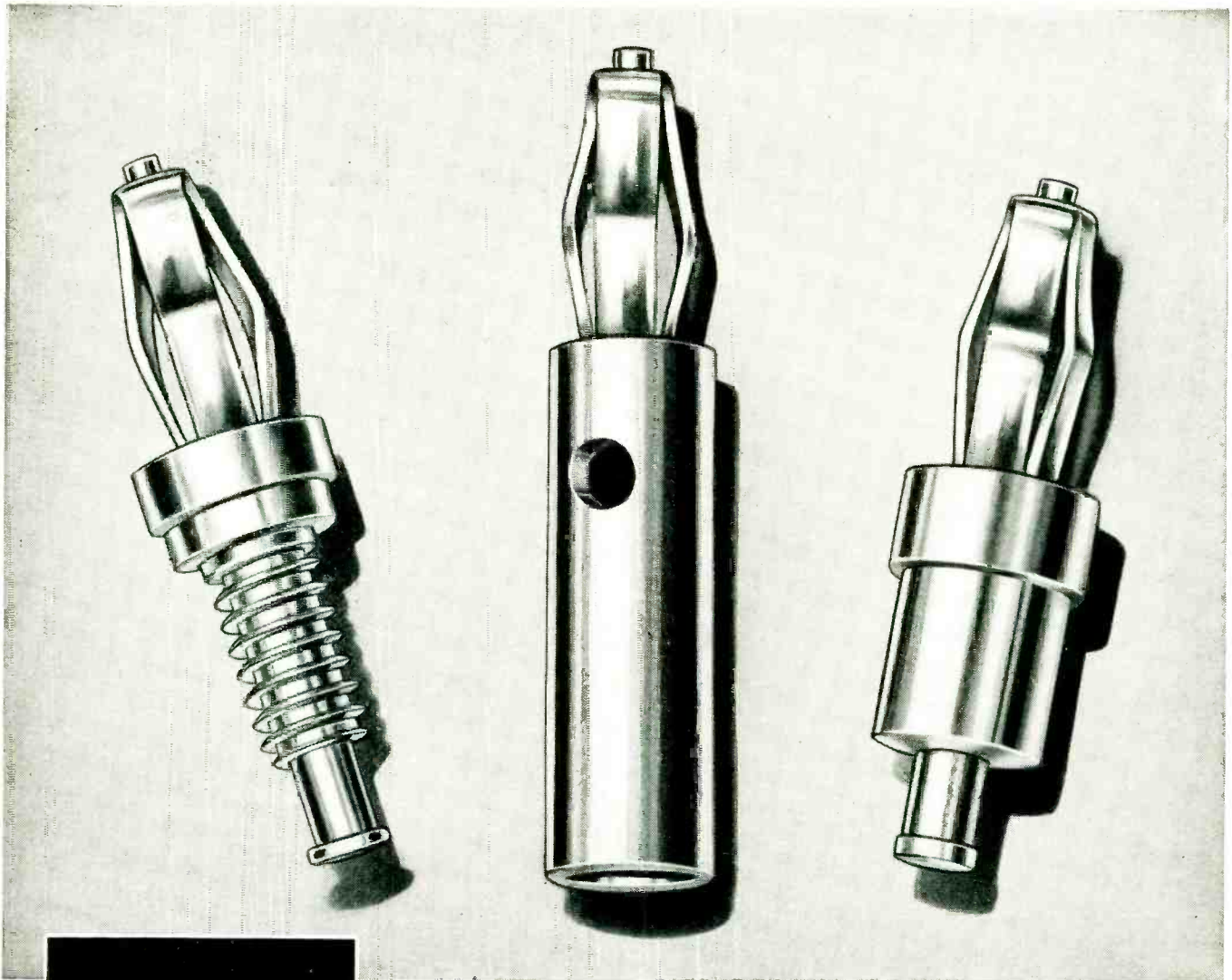

6 times enlargement

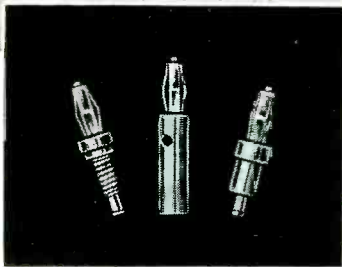

Actual size

# Ucinite Miniature Banana Pins

Heavy resistance to torque is a big feature of Ucinite miniature banana pins. The springs are mechanically riveted over and the large area around the tip of the pin is bonded by solder.

Pins are available in a variety of types, for assembly by staking . . . with nuts and washers . . . with soldered tails . . . with multiple plug-in features. Springs are designed to fit .093 sockets.

Built to withstand rough usage, Ucinite miniature banana pins are available in cadmium, silver or gold plate.

For further information, call your nearest United-Carr representative or write directly to us.

**The**  
**UCINITE CO.**  
*Newtonville 60, Mass.*  
Division of United-Carr Fastener Corp.

*Specialists in*  
**ELECTRICAL ASSEMBLIES,  
RADIO AND AUTOMOTIVE**



# Tailor-Made Fasteners in Volume Quantities

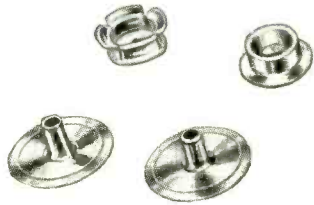

## MINIATURE BATTERY CONNECTORS

For use with small "B" batteries; afford quick and positive polarized electrical connections and worthwhile space savings on such small equipment as portable radios or hearing aids.

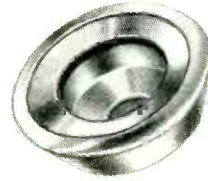

## FEMALE ANODE CONNECTORS

Made from cold rolled steel and plated to specification, this part provides the high voltage connection to a metal picture-tube strap, or allied connections.

## FISHTAIL RATCHET PLATE

Made in a wide range of sizes to hold on smooth metal, die-cast or plastic studs. For use on refrigerators, radio cabinets, washing machines and other products to hold medallions, nameplates, etc.



## VIBRATOR GROUNDING FASTENERS

Holds 1 1/2" dia. beaded or non-beaded vibrator in any position to radio chassis. Vibrator Can grounded to frame. Holding prongs designed to hold several types of Cans.



## RUBBER FOOT

Snap-in Rubber Foot for Record Changers and Phonograph Mountings eliminates threaded member, lock washer and nut thereby speeding assembly time and reducing costs.

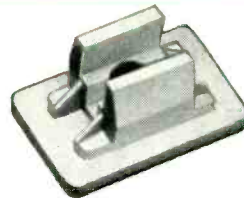

## NYLON SNAP-IN NUT

Designed for the attachment of shelf supports or channels to porcelain sheet metal liners. Used with sheet metal screws they provide high pull-out values and no chippage.

## INDICATOR-LIGHT PLUG BUTTONS

Snap-in type for electrical appliances. Removable. Jeweled or plain glass. Some plastic. Designed in a wide range of colors, shapes and sizes.



## SHELF SUPPORTS

Plastic Shelf Supports designed to snap into porcelain hole. Driven pin expands Trimount section securing fastener without porcelain chippage. Variety of shapes and sizes.

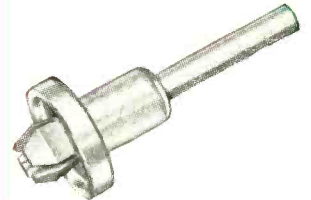

## PLUG BUTTONS

Made to snap into hole sizes 1/8" to 3". Can be embossed with ornamental or functional designs. Removable. Supplied with various finishes, in a variety of shapes and sizes.



## TUBING AND WIRING CLIPS

For use in electrical and hydraulic systems. Holds wires and tubing firmly, without chafing, under extreme vibration. Made in hundreds of sizes.

## TRIMOUNT STUDS

Designed to hold two or more thicknesses of material together. Easily installed by hand. Insure vibration proof attachment. Permanent or removable attachment. Wide variety of shapes and sizes.



**DOT**<sup>®</sup>

Parts illustrated are representative of the thousands of different specialized fasteners and allied devices designed and manufactured in volume by United-Carr and its subsidiaries for leading manufacturers of electronic equipment. United-Carr's wide and varied experience with special fastening problems in the automotive, aviation and appliance fields provides an unequalled background of technical knowledge which may well be applicable to your special needs.

**UNITED-CARR**

**FASTENER CORP.**

CAMBRIDGE 42, MASSACHUSETTS

# MICRO Precision Switches

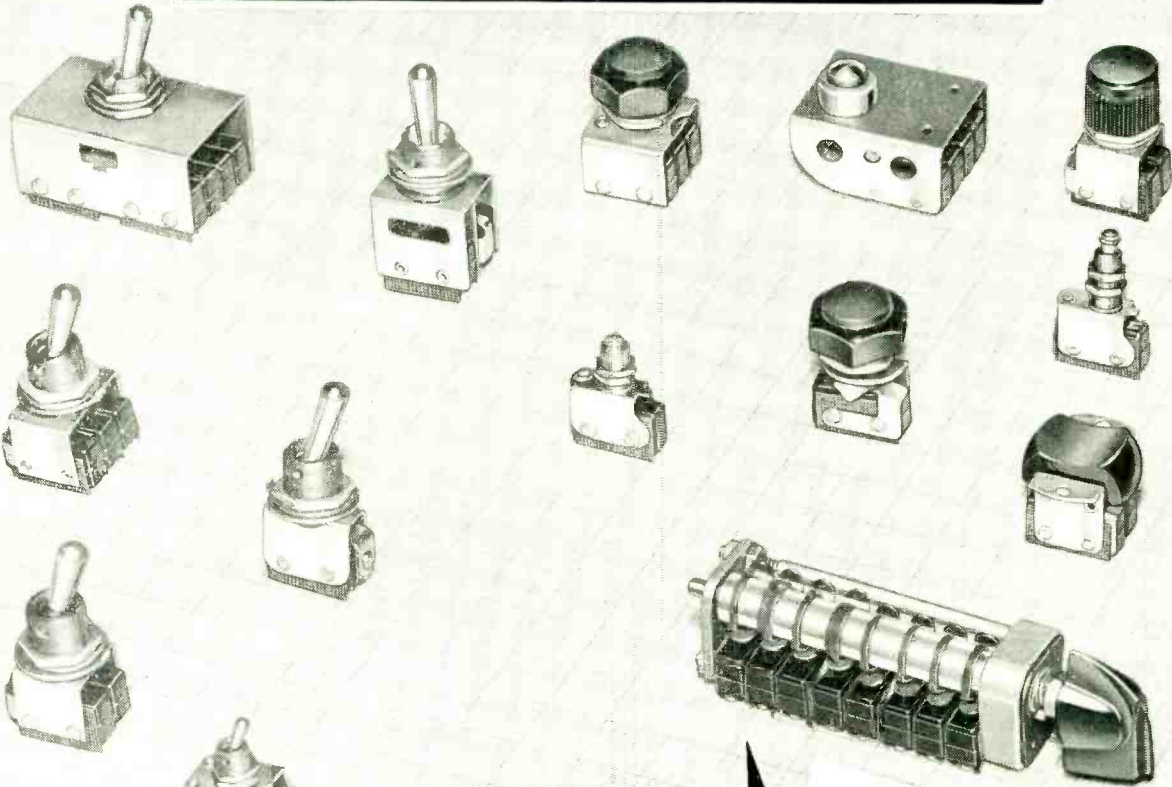

## A PRINCIPLE OF GOOD DESIGN

MICRO SWITCH provides a complete line of extremely reliable, small-size, high-capacity, snap-action precision switches. Available in a wide variety of sizes, shapes, weights, actuators and electrical characteristics. For all types of electrical controls.

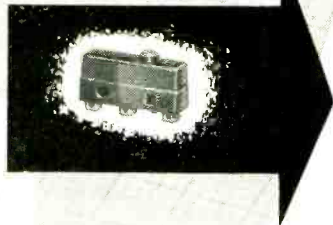

*Penny-size, Penny-weight, the MICRO subminiature will switch 5 amperes at 125-250 volts a-c*

- These actuators and assemblies offer electronic designers utmost freedom where small size and light weight are prime requisites.

Small enough to hide behind a penny and weighing but 1/15th of an ounce, the MICRO subminiature switch is capable of big switching jobs on both a-c and d-c current.

Shown here are but a few of the many switch assemblies available with this switch as the switching element. These include special switch actuators (lower left); toggle switch assemblies (upper left); push button assemblies (upper right) and an eight switch rotary selector switch assembly.

Contact your nearest MICRO SWITCH branch office today for complete information. Offices are located in 16 major cities.

# MICRO SWITCH

A DIVISION OF MINNEAPOLIS-HONEYWELL REGULATOR COMPANY  
 FREEPORT, ILLINOIS







Better Things for Better Living  
... through Chemistry

# ELECTRICAL ENGINEERING

PROPERTY AND APPLICATION DATA ON THESE  
VERSATILE PLASTIC MATERIALS: DU PONT NYLON,  
"ALATHON," "TEFLON," "LUCITE."

# NEWS

No. 1

1954

## Properties of Du Pont Nylon Provide Design Versatility

### POINTERS ON PROCESSING OF DU PONT POLYMERS

Injection molding  
process is rapid  
production method

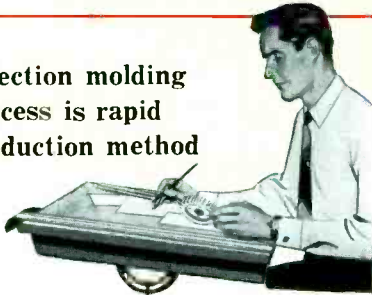

Injection molding is one process for producing large quantities of plastic parts. A typical injection-molding assembly, shown in the diagram, operates as follows:

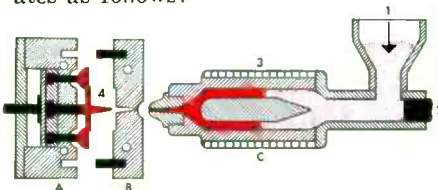

Parts marked *A* and *B* close and lock to form the  *mold* ; they move to contact part *C* which contains molten plastic. Measured quantities of the granulated plastic (1) are fed into the machine. The reciprocating ram (2) forces this material into the  *heating chamber*  (3), where the powder liquefies. Each forward motion of the ram (2) forces molten plastic into the closed mold (*A* plus *B*) where the plastic solidifies, and forms the  *molded part*  (4). Then the mold opens as shown in the diagram and the plastic part is ejected. In the meantime, the ram moves back, allowing more powder to feed into the machine, preparing it for another molding cycle.

The production rate depends on a number of variables, including the size of the part, and the number of identical cavities cut into the mold. If molded parts are small, dozens of them can be made at one shot, whereas large parts may be produced one at a time. Cycles (Continued reverse side, column 3)

Examples include coil forms, grommets, phone signal device, and wire jacketing



These coil forms show how Du Pont nylon can be molded into thin, intricate sections.

Du Pont nylon is well established for a wide variety of uses in the electrical field. Among the outstanding properties of nylon accounting for this acceptance are: good insulating characteristics; superior toughness and high temperature resistance (to 250°F.); strength in thin sections; and the ability to be formed into intricate pieces by injection molding.

Also of interest to electrical design engineers are nylon's abrasion resistance, good impact strength and resiliency. Many electrical parts have been redesigned for longer life by utilizing the unique combination of properties Du Pont nylon has to offer.

One proved application of molded nylon is for coil forms. Because nylon is tough and has strength in thin sections, compact and intricate designs are possible. Often, assembly steps are eliminated by incorporating various parts into the coil form itself. Mag-

netic cores and other metal inserts can be molded right into the nylon.

Another established use for Du Pont nylon is the strain-relief grommet. Toughness and resiliency of nylon allow the grommets to be snapped into position. The heat-resistance, strength and insulating properties of Du Pont nylon meet requirements of commercial electrical equipment. These grommets carry the U. L. Seal.

A telephone interrupter cam of Du Pont nylon is an interesting application. This cam regu-

OVER



Better Things for Better Living  
through Chemistry

# ELECTRICAL ENGINEERING

# NEWS

PROPERTY AND APPLICATION DATA ON THESE  
VERSATILE PLASTIC MATERIALS: DU PONT NYLON,  
"ALATHON," "TEFLON," "LUCITE."

No. 1

1954

*(Properties of Du Pont Nylon, Con't)*  
lates the timing of coded rings and busy-signals for phones. Rotating to actuate a leaf spring switch, the nylon cam helps provide the necessary signal. A single part replaces a complicated assembly; nylon gives better performance, and longer service life. Particularly valuable properties of nylon for this application are abrasion-resistance and resilience.

Du Pont nylon finds wide application as extruded coatings for wire and cables. Nylon is used as both primary insulation and as jacketing which covers other insulation. Nylon resists abrasion and attack by oil or gasoline. Nylon increases the service temperatures of some primary insulations and also retards volatilization of plasticizers from the primary insulations. Coatings in commercial use are from 3 to 15 mils thick. A thin coating is adequate because of the toughness of nylon. The coating is smooth, light in weight and flexible at low temperatures. Extrusion methods apply nylon at speeds as high as 1,000 feet per minute.

## INVESTIGATE Du Pont plastic engineering materials in your product development programs

One of the family of these versatile engineering materials is often a key factor in product improvement or new product design.

The wide range of properties available with "Alathon"\* polyethylene resin, "Lucite"\* acrylic resin, "Teflon"\* tetrafluoroethylene resin, and Du Pont nylon are helping solve industrial design problems.

### NEED MORE INFORMATION?

Clip the coupon for additional data on the properties and application of Du Pont plastic engineering materials.

E. I. DU PONT DE NEMOURS & CO. (INC.)  
Polychemicals Department  
Room 224 Du Pont Building, Wilmington 98, Delaware

Please send me more information on the Du Pont plastic engineering materials checked:

Du Pont nylon;  "Alathon";  "Teflon";  "Lucite". I am interested in the application of these materials for:

NAME \_\_\_\_\_ TITLE \_\_\_\_\_  
COMPANY \_\_\_\_\_  
STREET ADDRESS \_\_\_\_\_  
CITY \_\_\_\_\_ STATE \_\_\_\_\_  
TYPE OF BUSINESS \_\_\_\_\_

\*"Alathon", "Lucite", "Teflon" are registered trade-marks of E. I. du Pont de Nemours & Co. (Inc.)

## Dielectric properties of "Teflon" aid designers of miniature circuits

Miniature circuits can develop high temperatures, which combined with an increased electrical load, may result in the failure of tiny parts. The problems of insulating components of miniaturized circuits were investigated by Microdot Division, Felts Corporation, S. Pasadena, California, in conjunction with their development of a complete line of miniature coaxial connectors and assemblies.

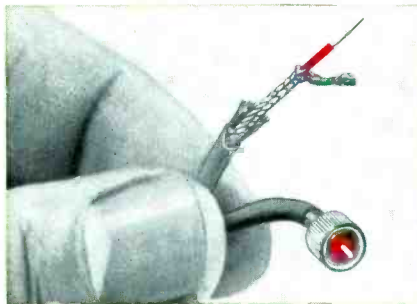

Coaxial connectors and cable are insulated with Du Pont "Teflon." These miniature-circuit parts are made by Microdot Division of Felts Corp.

The material which Microdot needed for the connectors and primary wire insulators had to have superior dielectric properties and heat-resistance. Durability and resistance to moisture were also essential.

Du Pont "Teflon" tetrafluoroethylene resin was chosen after extensive tests. "Teflon" is an excellent insulator. It has a dielectric constant of 2.0; the power factor is less than 0.05%, at frequencies as high as 30,000 megacycles. Exposure to arc leaves no carbonized path. The dielectric properties of "Teflon" remain constant at temperatures from -80°F to 500°F.

"Teflon" absorbs no water by ASTM Test D570-42.

Where resistance to high temperatures, good dielectric properties and durability are needed, Du Pont "Teflon" has proved its versatility.

## Du Pont nylon useful in components of aircraft wiring systems

The properties of Du Pont nylon make this versatile engineering material particularly adaptable for aircraft electrical systems. Nylon is used for cable clamps, strain-relief clamp blocks, grommets, wire guides and support blocks, terminal blocks and similar devices. Du Pont nylon is specified for these applications because it is tough, resists abrasion and extremes of temperature; it has the necessary dielectric characteristics, can be molded readily into intricate shapes, and is

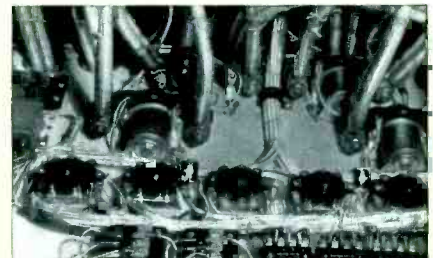

strong in thin sections. One type of airplane carries sixteen miles of cable jacketed with Du Pont nylon. Here, other properties of nylon are important—resistance to gasoline and high temperature, and lightness of weight.

Du Pont nylon is used continuously at temperatures (to a maximum of about 250°F.) Its heat-resistance permits component parts to be soldered without affecting the nylon.

Many manufacturing economies are obtained with nylon. Injection molding allows fast production of complicated shapes. Often a single part molded of nylon replaces an assembly of several parts. And because nylon can be molded around metal inserts, further design simplification is often possible.

### (Injection molding, continued)

of 1 or 2 moldings a minute are not uncommon.

Here are some of the advantages of injection molding:

1. High rate of production
2. Economical production in quantity
3. Little or no finishing cost
4. Parts molded to close tolerances.



*NOW, with our newly-completed plant facilities*

**2 to 3 WEEKS**

*DELIVERY ON*

**Heldor**

**\* BUSHINGS**

hermetic-seal, compression-type are shipped from stock, in most cases

**\* CANS and COVERS**

built to meet MIL-T-27 or Commercial Specifications

**\* ASSEMBLY SERVICE**

from assembly of bushings in cover to actual hermetic-sealing of your components

**3 to 4 WEEKS**

*DELIVERY ON* **\* PROTOTYPES**

and **SPECIAL SIZE CANS or COVERS** to your rigid specifications.

**\* SAME HIGH QUALITY---LOWER PRICES!**

Send us your specifications or prints for a money-saving "quote".

**HELDOR MANUFACTURING CORPORATION**



**HELDOR BUSHING & TERMINAL CO., INC.**  
238 Lewis Street • Paterson, N. J.



# OPTIMUM PERFORMANCE IN VITAL AUTOMATIC PILOT SYSTEM

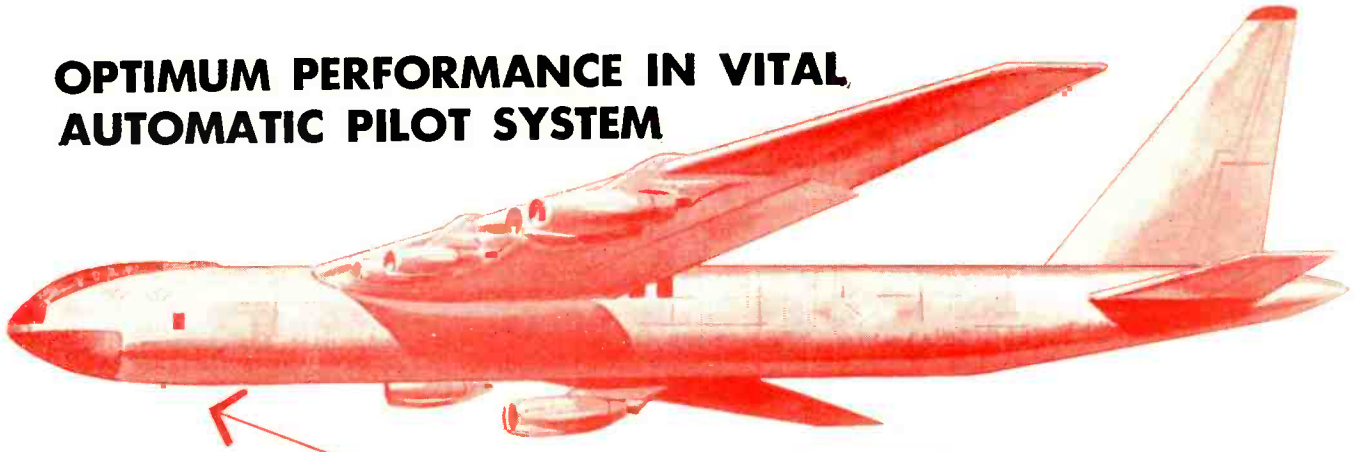

## ELECTRO TEC SLIP RING ASSEMBLIES

ONE PIECE UNIT  
REPLACES ASSEMBLY OF  
MULTIPLE COMPONENTS

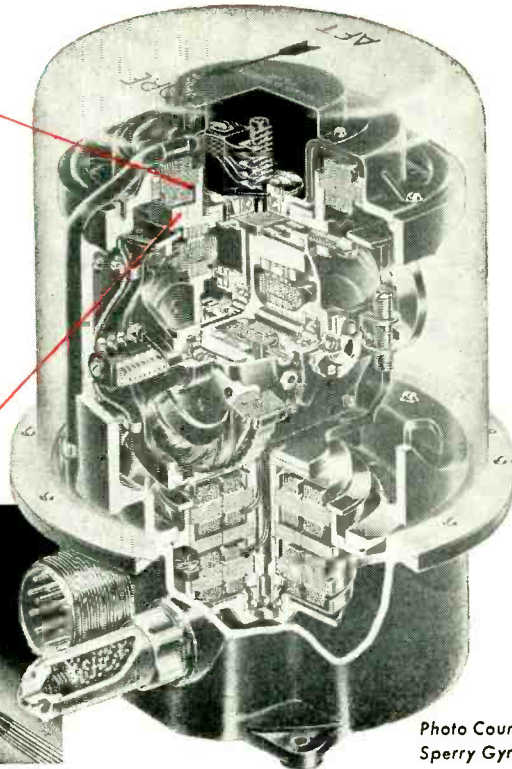

The instrument shown is a Sperry "Gyrosyn" compass which combines the advantages of gyroscopic stability and magnetic correction to provide an accurate directional reference.



Photo Courtesy  
Sperry Gyroscope Company

Offering Closer Tolerances,  
Absolute Uniformity and the  
Ultimate in Miniaturization:

- ONE PIECE, UNITIZED CONSTRUCTION
- ABSOLUTE MINIMUM FRICTION TORQUE
- DIAMETERS FROM .035" to 24.0"
- MINIMUM 1000 V.A.C. HI-POT INTER-CIRCUIT
- HARD SILVER RINGS PLATED TO PRECISELY MACHINED ONE-PIECE PLASTIC FORM
- SPECIAL SURFACE DEPOSITS PREVENT TARNISH, MINIMIZE FRICTION, BRUSH NOISE AND WEAR

### —featuring **SUPER DEPENDABILITY!**

The Sperry "Gyrosyn" compass is an outstanding example of precision and dependability. Electro Tec is proud to furnish slip ring assemblies which are consistent with the high accuracy and unfailing performance of this instrument. In this application, as in hundreds of others, Electro Tec meets specifications with a degree of accuracy unattainable with built-up or molding methods of manufacture. This extreme precision plus the many other advantages that result from Electro Tec manufacturing techniques have resulted in leadership throughout the industry. For complete cooperation in applying Electro Tec "know-how" to specific problems call or write the Sales Engineering Department.



## ELECTRO TEC CORPORATION

SOUTH HACKENSACK • NEW JERSEY

PRODUCTS OF PRECISION CRAFTSMANSHIP BY A NEW AND REVOLUTIONARY PROCESS \*

\* Patent Pending





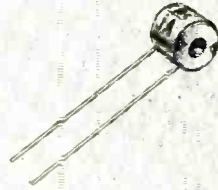

**RPC Type J resistors where subminiature requirements  
specify full size reliability and performance**

**Precision Wire Wound**

**Type JA** 1/4" diameter X 1/4" ong. Maximum resistance 125,000 ohms. 0.10 watt.

**Type JC** 1/4" diameter X 3/8" ong. Maximum resistance 250,000 ohms. 0.15 watt.

Tolerance 1% standard, tolerances to 0.05% available. All resistors furnished  
with low temperature coefficient alloys.

Special wire and impregnation available for greatly increased power rating.

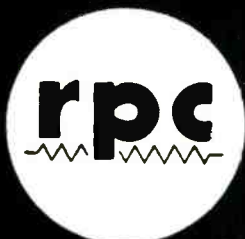

**RESISTANCE PRODUCTS CO.**

714 Race Street • Harrisburg, Pa.

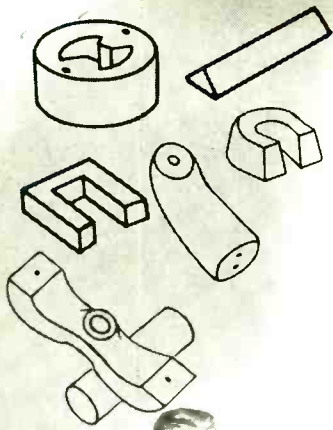

# Perpetual Energy



## Consumer Market

Perpetual energy is at work all around us. Shown here are only a few of the many examples of permanent magnets at work—all of which *add to the salability* of the product.

### Artificial Magnetic Eyes—

An artificial eye looks practically normal if it moves in unison with the natural one. To achieve this, a New York doctor developed an implant wherein is imbedded an Alnico permanent magnet.

After removal of a diseased or injured eye, recti muscles, originally attached to the natural eye, are attached to an implant, thereby imparting motility to this implant. Further operative procedure requires that the implant be covered with layers of tissue (tenons and conjunctiva) in order that the implant may be completely buried.

A custom-fitted plastic artificial eye is then made which also has a very thin Alnico magnet. As a result of the attraction between the magnet in the implant and the one in the artificial eye, and also due to the shape of the artificial eye, the eye can then move in unison with the natural one, as motility is imparted from the recti muscles to the implant and, in turn, to the artificial eye.

*Applications:* Among other consumer products that rely on permanent magnets are can openers with a magnetic lid-lifter, and the thermostat used in your home.

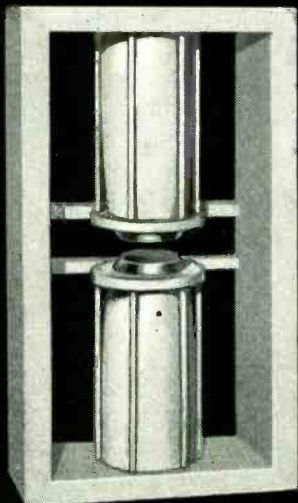
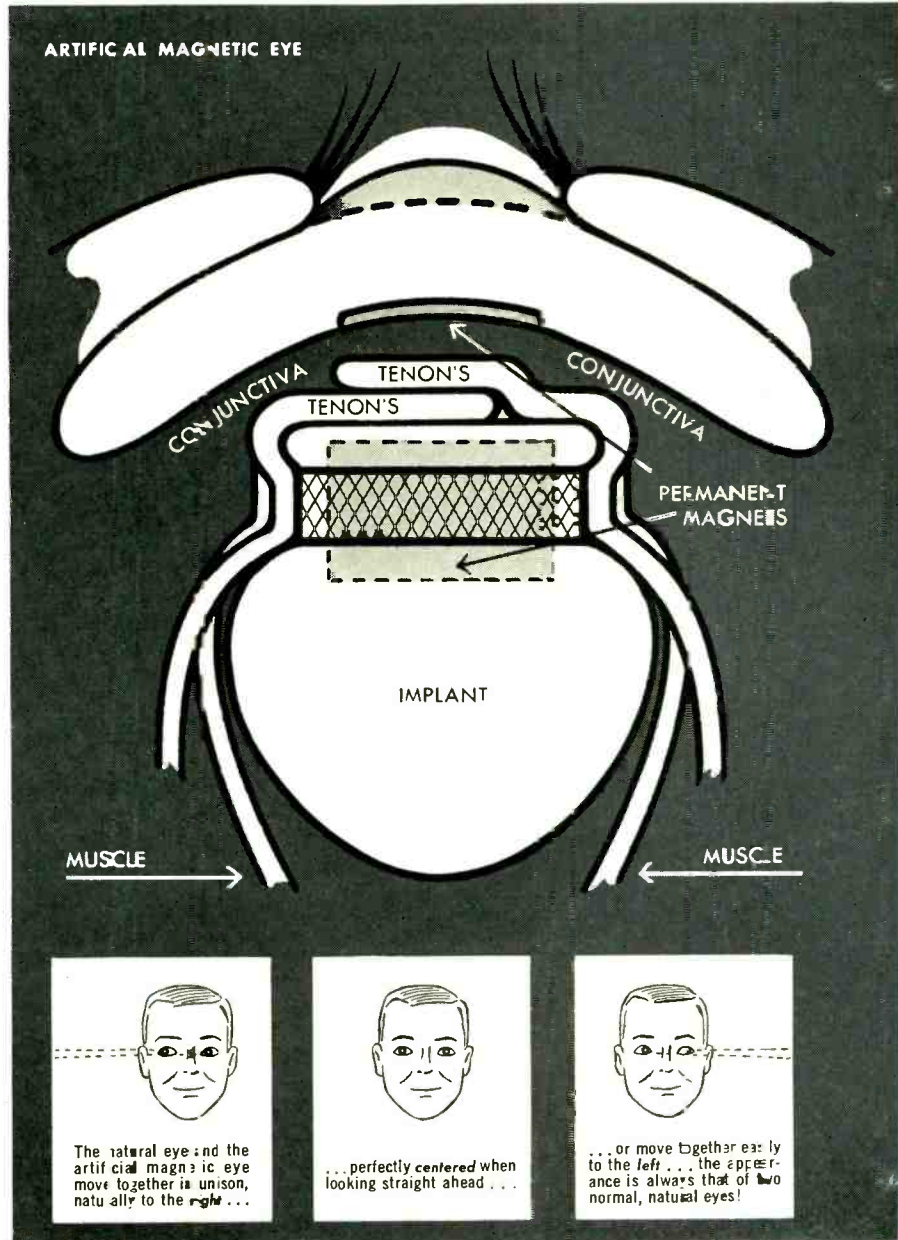

NUCLEAR RESONANCE RESEARCH ASSEMBLY

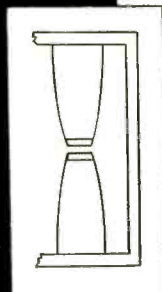

## Basic Research

*Research*—A highly specialized example of the use of permanent magnets in research is the nuclear resonance assembly shown on the left.

The Alnico V permanent magnets used in this assembly built for the University of Chicago by INDIANA produce a field of approximately 5,500 gauss. The assembly not only is *much less costly* than the electromagnetic mode s but it also does not require much of the expensive equipment required to maintain a stable field.

### Permanent Magnet



# Can Work For You!

**Perpetual Magnetic Energy... a Timeless Force...  
is hard at work in many fields and in many  
products...from Artificial Magnetic Eyes  
to Nuclear Resonance Research!**

You can't see it... smell it... or hear it. Nor can you taste it or feel it, but the "perpetual energy" of permanent magnets is at work for you in each one of these applications—and thousands more. Permanent magnets won't wear out. They can't be used up. They're a source of permanent energy instilled in your product "perpetually."

... *Unlimited are the future possibilities of permanent magnets in new product designs.* The field produced by the myriad of spinning electrons, the essence of permanent magnets, can work for you in these three ways: transformation of mechanical to electrical energy • transformation of electrical to mechanical energy • tractive effort. If you need a component to perform one of these three functions, INDIANA PERMANENT MAGNETS may be the solution to your design problem.

INDIANA provides you with the largest facilities in the world for the manufacture of permanent magnets and complete permanent magnet sub-assemblies. It will pay you to take advantage of INDIANA's wealth of experience, research leadership, and specialized engineering "know-how."

**The Indiana Steel Products Co.**  
VALPARAISO, INDIANA

SALES OFFICES FROM COAST TO COAST—BOSTON • CHICAGO  
CLEVELAND • NEW YORK • PHILADELPHIA • ROCHESTER • LOS ANGELES

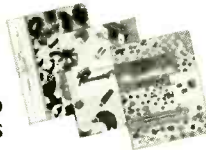

Write for  
DESIGN MANUAL  
No. 4-A-1  
CAST CATALOG  
No. 11-A-4  
SINTERED CATALOG  
No. 12-A-4

Electrical  
Industry

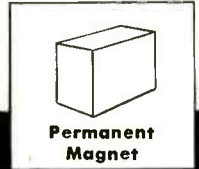

Permanent  
Magnet

GENERATOR

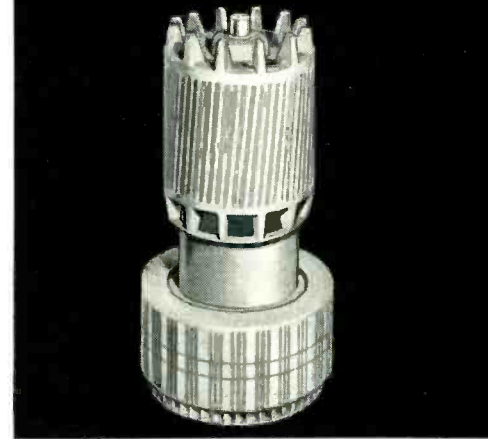

**Generators**—A well-known application in the electrical field is the permanent magnet generator. This 15 kva, 120/208-volt, 400-cycle model incorporates 28 Hyflux Alnico V, bar-shaped permanent magnets.

**Long service and minimum maintenance** are two things sought by users of generators. Permanent magnets help to provide these qualities. *Elimination of slip rings and commutators* means no sparking or radio interference. And there's no heat from the field coils nor is excitation power needed.

**Applications:** Magnetos, motors, gyroscopes.

## In 24 Hours—You can have INDIANA PERMANENT MAGNETS for your experimental work

**Loudspeakers**—Typical of the applications in this field is this 15-inch high fidelity speaker which uses a 10½ lb INDIANA Hyflux Alnico V magnet to achieve a frequency range from 30 to 16,500 cycles per second! INDIANA Hyflux Alnico V provides an energy product of 5¼ million BH Max or more, thereby assuring a magnetic field of high strength. Permanent magnets, in this case, are a *functional necessity* to this design—no substitute can do the job.

**Applications:** INDIANA magnets are consistently doing an outstanding job in many other typical products in this field such as focusing coils, ion traps, centering devices, radar, and guided missiles.

**Magnetic Separators**—There is almost an endless list of mechanical or holding applications. One of the more widespread, industrial applications is this permanent magnet separator, using three or more Hyflux Alnico V, U-shaped magnets each of which can exert a pull of 150 lb.

Here permanent magnets exert an effective pulling force through a distance of several inches... permitting your product to do the job better and safer, insure *uninterrupted production flow* by snatching "tramp" iron from materials to be processed... thereby preventing damage to machinery. And permanent magnets *require no electrical power, no wiring*... hence, they never spark, eliminating a definite fire hazard.

**Applications:** Among the many mechanical applications are: magnetic conveyors, magnetic sweepers, magnetic chucks and clutches.

**Watt Hour Meters**—One of the hundreds of different instruments requiring permanent magnets is this single-phase, 15-amp, 240-volt rating for 3-wire services watt hour meter. It uses an Alnico 1, horseshoe-shaped magnet weighing only 0.2 lb.

Here, the high quality of this permanent magnet material provides the uniformity and stability of field so necessary for *maintaining the initial accuracy* of this meter over a long period of years.

**Applications:** Mass spectrometers, vibration pick-ups, galvanometers, medical instruments, speedometers, fluxmeters.

Electronic  
Industry

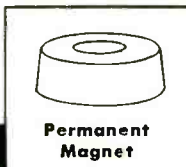

Permanent  
Magnet



LOUDSPEAKER

Mechanical  
Industry

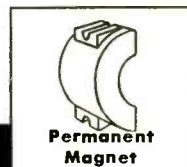

Permanent  
Magnet

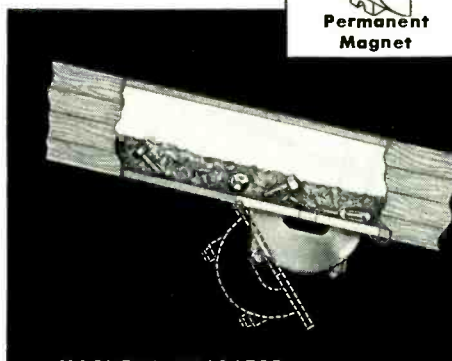

MAGNETIC SEPARATOR

Instrument  
Industry

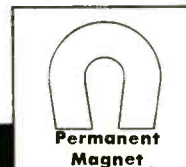

Permanent  
Magnet



WATT HOUR METER



# GENERAL PLATE ALCUPLATE®

(COPPER ON ALUMINUM)

*Cut Costs 15 to 30%*

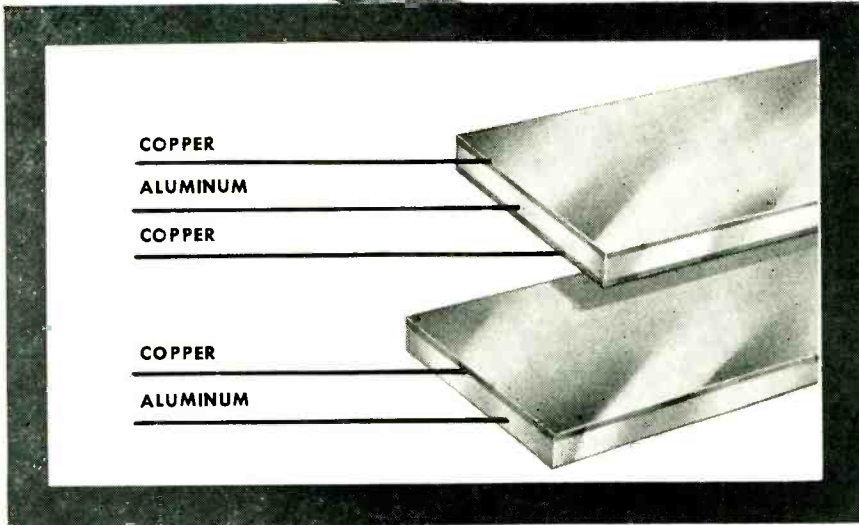

## ALCUPLATE Plus Features

- High Electrical Conductivity
- Excellent Heat Dissipation
- Soft-Soldering Surfaces
- Easy Fabrication
- Light Weight

## A Few of the Many Products Made from General Plate ALCUPLATE



**HEAT TRANSFER UNITS** — ALCUPLATE provides ideal fin sections at reduced cost over solid copper fins. The copper surface permits soft soldering of the fins to the tubes.



**ELECTRONIC CHASSIS** — Minimum weight combined with copper surface required for soft-soldering operations, electroplating, and low-resistance shield connections are advantages obtained by using ALCUPLATE.



**COMPONENT CASES** — ALCUPLATE is successfully drawn and formed into lightweight cases or cans and intricate parts.



**BUS BARS** — ALCUPLATE provides high conductivity, light weight, solderability... and is lower in cost than solid copper bus bars.



**ELECTRICAL TERMINALS** — Small terminals and large pressure-type connectors use single-clad ALCUPLATE... alleviates galvanic corrosion which otherwise results from aluminum and copper junctions.

Manufacturers of various products are reducing costs by 15 to 30% or more over an equal area of copper or brass with General Plate ALCUPLATE... Copper clad on one or both sides of aluminum.

Here's how ALCUPLATE saves — by permanently bonding a thin layer of copper to thicker less expensive aluminum. You get solid copper performance at a lower cost over solid copper. This combination has practically the same physical and electrical properties as copper plus the light weight of aluminum.

ALCUPLATE can be fabricated by stamping, drawing, spinning, and forming. Its malleability permits its use in the manufacture of many parts from work-hardened rather than annealed or dead soft materials.

ALCUPLATE is available in coils and flat cut lengths, copper clad on one or both sides of aluminum, 1/16" thick x 13" wide and under.

Technical Data Bulletin No. 702C gives full details. Write for a copy today.

**You can profit by using  
General Plate Composite Metals!**

**METALS & CONTROLS CORPORATION**  
**GENERAL PLATE DIVISION**  
34 FOREST STREET, ATTLEBORO, MASS.



first of its kind

# X-BAND SWEEP OSCILLATOR



wide band-- 8500 to 9600 mc  
dynamic testing of microwave components and systems -- utilizing unique crt display

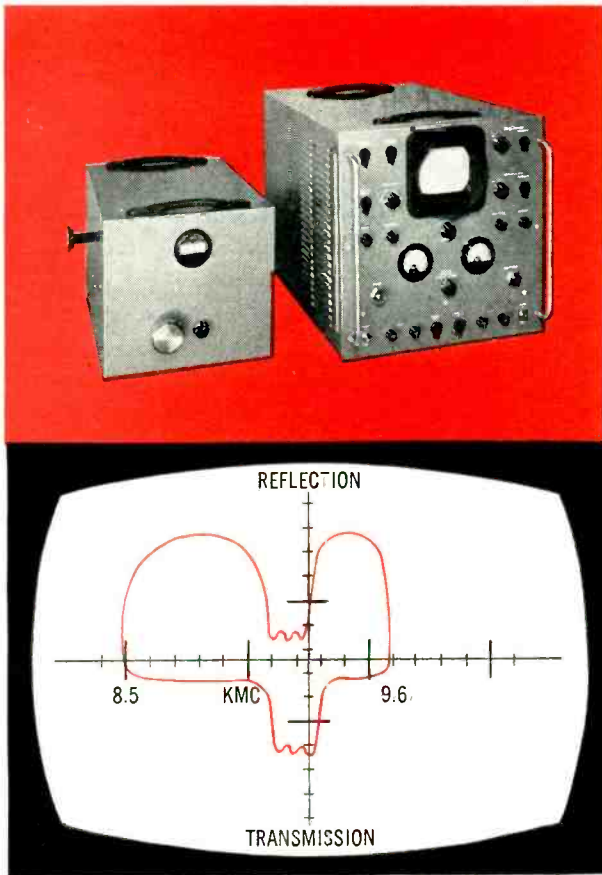

Now, for the first time, an instantaneous graphic display of the entire frequency range 8500 to 9600 MCS. This new Polarad X-Band Sweep Oscillator makes possible rapid, dynamic testing of microwave components such as TR tubes, antennas, crystal mounts, even complete microwave systems over a 1100 MC sweep at X-band. Eliminates laborious point-by-point testing methods. A unique display unit shows both reflection and transmission characteristics simultaneously, since two deflection amplifiers are utilized.

The X-Band Sweep Oscillator is an important instrument for laboratory and production line application. It gives one quick answer where formerly hours of checking were necessary. For further information, write to your nearest Polarad representative or the factory.

**A Typical Scope Display** (at left) Shows transmission and reflection characteristics of a double tuned cavity under test. This is an example of how the dynamic display reduces time required to test X-band components and systems. As a design tool in the laboratory, the effects of electronic or mechanical changes may be evaluated instantaneously. As a production tool, "go" and "no go" limits may be checked visually.

SPECIFICATIONS	
Frequency Range:	8.5 to 9.6 KMC
Output:	+ 12 dbm minimum into matched load
Output Variation:	± 1 db maximum
Sweeper Rate:	12 cycles per second
Operating Voltage:	115 V ± 10%
Input Power:	400 watts
Type of Output Connector:	UG-52A-U
Size of Control and Display Unit:	15 1/2" wide x 20 3/4" deep x 16 1/4" high
Size of Sweeper Oscillator:	12" wide x 16 1/4" deep x 12" high
Approx. Wt. of Control and Display Unit:	135 lbs.
Approx. Wt. of Sweeper Oscillator:	55 lbs.



**ELECTRONICS CORPORATION** 100 METROPOLITAN AVENUE, BROOKLYN 11, NEW YORK

REPRESENTATIVES: Albuquerque • Annapolis, Canada • Atlanta • Boston • Chicago • Cleveland • Fort Worth • Kansas City • Los Angeles • New York • Philadelphia • San Francisco • Seattle • St. Paul • Syracuse • Washington, D. C.

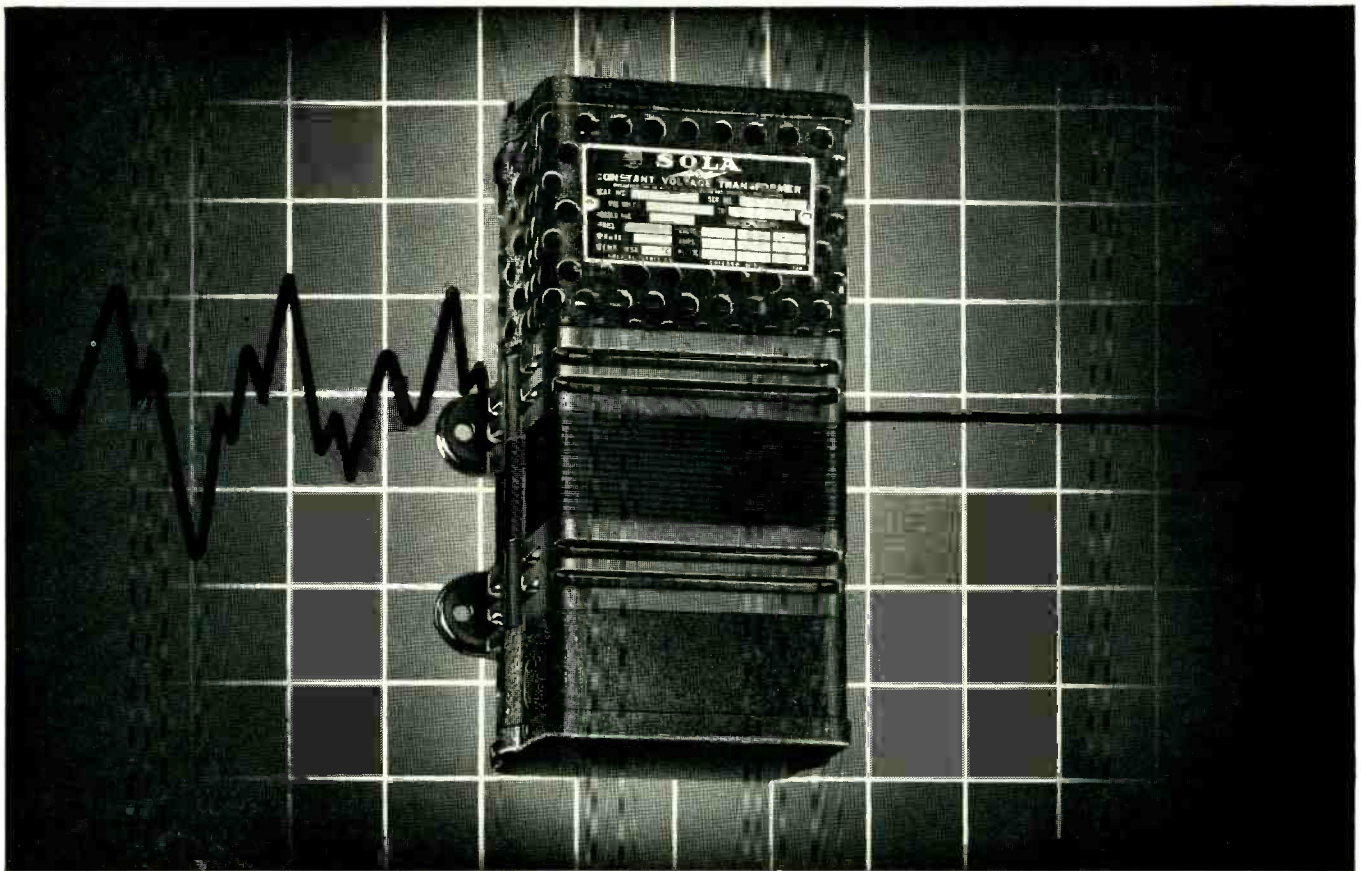

# Automatic, maintenance-free, instantaneous voltage stabilization

Static-magnetic constant voltage transformers are a practical and efficient solution for controlling input voltage to voltage-sensitive electrical and electronic equipment.

Sola Constant Voltage Transformers are widely used both as built-in components and as accessory units. They differ from regulators which depend solely upon saturation of core materials for their regulating action, or electronic types employing tubes. Sola Constant Voltage Transformers have the following characteristics:

1. Regulation within  $\pm 1\%$ , with primary voltage (transient or continuous) variations as great as 30%.
2. Response time less than  $1\frac{1}{2}$  cycles.
3. No moving or wearing mechanical parts, nor vacuum tubes; requires no manual adjustments.
4. Completely automatic, continuous regulation.

5. Self-protecting against short-circuits on output.
6. Current-limiting characteristics protects load equipment.
7. Can often be substituted in place of conventional non-regulating transformers.
8. Generally smaller than other types of regulators for similar duty.
9. Isolates the input and output circuits.

Forty-three Sola stock units are available in a wide variety of ratings, voltages and types. In addition, custom-designed units can be manufactured (in production quantities) to meet specific requirements.

The experience of the world's largest manufacturer of constant voltage transformers is available to you. We invite you to discuss your voltage stabilizing problems with a Sola Sales Engineer.

**SO LA** *Constant Voltage*  
**TRANSFORMERS**

WRITE FOR LITERATURE. Sola Constant Voltage Transformers are completely described in a 24 page manual. Write for a copy of 7D-CV-170 on your letterhead, please.

Transformers for: Constant Voltage • Fluorescent Lighting • Cold Cathode Lighting • Mercury Vapor Lighting • Luminous Tube Signs  
 SOLA ELECTRIC CO., 4633 W. 16th Street, Chicago 50, Illinois, Blshop 2-1414 • NEW YORK 35: 103 E. 125th St., Trafalgar 6-6464  
 PHILADELPHIA: Commercial Trust Bldg., Rittenhouse 4-4988 • BOSTON: 272 Centre St., Newton 58, Mass., Bigelow 4-3354  
 CLEVELAND 15: 1836 Euclid Ave., Prospect 1-6400 • KANSAS CITY 2, MO.: 406 W. 34th St., Jefferson 4382 • Repr. in Other Principal Cities





**Frequency 10 cps to 200 mc**  
**Interval 1  $\mu$ sec to 100 days**  
**Period 0 cps to 10 kc**

**measured instantly,  
 automatically, directly by  
 the revolutionary new...**



**-hp- 525A**  
**Frequency Converter**

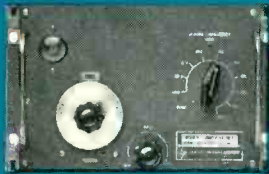

**-hp- 525B**  
**Frequency Converter**



**-hp- 526A**  
**Video Amplifier**



**-hp- 526B**  
**Time Interval Unit**

## **-hp- 524B ELECTRONIC COUNTER**

Why buy more instrumentation than you need? The new all-purpose *-hp-* 524B Electronic Counter with Plug-In Units gives you *precisely* the frequency, time interval or period measuring coverage you want now. Later, you can add other inexpensive plug-in units to double or triple the usefulness of the Counter.

Model 524B offers direct, instantaneous, automatic readings requiring no calculation, interpolation or complex instrument set-up. It has high sensitivity, high impedance, and its operation is so simple and dependable it can be used readily by non-technical personnel. Resolution is 0.1  $\mu$ sec, and accuracy is  $1/1,000,000 \pm 1$  count. Construction throughout is of highest quality components in a compact militarized design.

The new Counter with Plug-In Units gives you more range, more convenience, smaller size and lower cost than any commercial instrument combination ever offered. With this one compact equipment, you readily measure transmitter and crystal oscillator frequencies, time intervals, pulse lengths, repetition rates, frequency drift; make high accuracy ballistics time measurements or high resolution tachometry measurements, or use as a precision frequency standard giving convenience and flexibility not provided in the usual primary standard.

*Data subject to change without notice. Prices f.o.b. factory*

### **BASIC COUNTER**

The basic *-hp-* 524B Counter unit measures frequency from 10 cps to 10 mc with accuracy of  $\pm 1$  count  $\pm$  stability, reading direct in kc; or measures period from 0 cps to 10 kc with accuracy of  $\pm 0.3\%$  reading direct in seconds, milliseconds or microseconds. Eight-place registration, short term stability  $1/1,000,000$ , display time variable 0.1 to 10 seconds. \$1,890.00

### **COUNTER WITH PLUG-IN UNITS**

*-hp-* 525A Frequency Converter extends Counter's range to 100 mc, maintains accuracy, and increases Counter's video sensitivity to 0.1 volts through basic 10 cps to 10 mc range. \$225.00

*-hp-* 525B Frequency Converter like 525A but extends Counter's range to 200 mc at 0.25 volts sensitivity. \$225.00

*-hp-* 526A Video Amplifier increases Counter sensitivity between 10 cps and 10 mc to 10 millivolts for low level frequency measurement. \$125.00

*-hp-* 526B Time Interval Unit measures interval 1.0  $\mu$ sec to 100 days with accuracy of 0.1  $\mu$ sec  $\pm 0.001\%$ , reading direct in seconds, milliseconds or microseconds. Start, stop triggering in common or separate channels, through positive or negative going waves. \$150.00 (Plug-in units supplied in aluminum storage case).

*Request complete details today from your  
 -hp- Field Representative, or write direct*

**HEWLETT-PACKARD COMPANY**

4998A Page Mill Road • Palo Alto, California, U.S.A.



**ATTEND THE I. R. E. REGION 7 CONFERENCE-TRADE SHOW**  
**PORTLAND, OREGON • MAY 5, 6, 7**

# Ham on Rye or Rye on Hand?

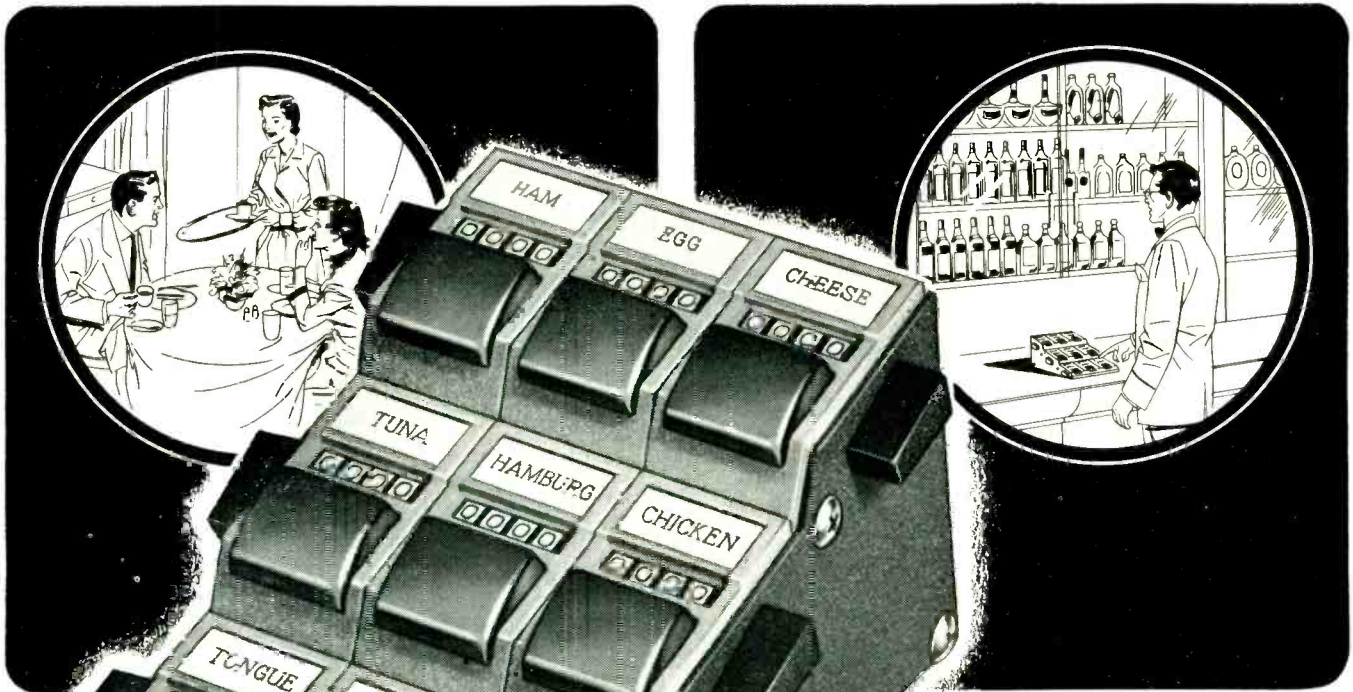

**Count BOTH**  
 (and 1,001 Other Items)  
 with this New Veeder-Root

## VARY-TALLY

### Multiple-Unit Reset Counter

Knowing how many apple versus lemon pies, for instance, are ordered on a given day . . . or how many cases of what are in the cellar . . . helps a restaurant *control*, make plans, make profits. The same goes for a manufacturer or wholesaler seeking tighter inventory control . . . or for any of the following:

- Traffic Engineers
- Schools and Colleges
- Nurserymen and Florists
- State Park and Forest Services
- Laboratories
- Milk Plants and Ice Cream Processors
- Researcher:
- Industrial Plants
- Textile Mills
- Inspection and Quality Control
- Jobbers, Wholesalers, Distributors
- Restaurants and Hotels
- Mail and Phone Order Departments
- Laundries and Linen Supply Houses
- Manufacturers of equipment for:
  - Order Control
  - Stock Control
  - Inventory Control
  - Traffic Control
  - Sales and Market Analysis
  - Laboratory Analysis
  - Payroll Preparation
- and What Do You Want to Count?

Arranged compactly on stands in tiers, the Vary-Tally can be supplied in any of 66 combinations, up to 6 banks high and 12 units wide, with a minimum of 2 units wide. Write for news sheet and prices.

*The Name that Counts*



## VEEDER-ROOT INC.

HARTFORD 2, CONNECTICUT

Chicago 6, Ill. • New York 19, N. Y. • Greenville, S. C. • Montreal 2, Canada • Dundee, Scotland • Offices and Agents in Principal Cities



Need a  
**SPECIAL**  
material?

LAVA • SILICON CARBIDE  
ALUMINA (vitrified or porous) • CORDIERITE  
STEATITE • ZIRCONIUM OXIDE • ZIRCON  
MAGNESIUM SILICATE • ALUMINUM SILICATE  
FORSTERITE • TITANIUM DIOXIDE

**VERSATILE**



Try **ALSiMAG**<sup>®</sup>

SEE OUR DISPLAY  
**BOOTH NO. 340**  
**BASIC MATERIALS**  
**EXPOSITION**

The Product  
Development Show  
CHICAGO  
MAY 17-20, 1954

Development of new, special purpose ceramic compositions is a regular part of our work. No matter what your requirements are, the chances are good that we have an ALSiMag composition that will do the job.

If you need a material with special characteristics or have a difficult design involving intricate shapes or close tolerances, give us your requirements. Let us show you what we can do.

53RD YEAR OF CERAMIC LEADERSHIP

**AMERICAN LAVA CORPORATION**

A Subsidiary of Minnesota Mining and Manufacturing Company

**CHATTANOOGA 5, TENNESSEE**

OFFICES: METROPOLITAN AREA: 671 Broad St., Newark, N. J., Mitchell 2-8159 • SYRACUSE, N. Y.: 204 Harding Place, Phone 9-0656 • CLEVELAND: 5012 Euclid Ave., Room 2007, Express 1-6685 • NEW ENGLAND: 1374 Mass. Ave., Cambridge, Mass., Kirkland 7-4498 • PHILADELPHIA: 1649 N. Broad St., Steveson 4-2823 • ST. LOUIS: 1123 Washington Ave., Garfield 4959 • CHICAGO: 228 N. LaSalle St., Central 6-1721 • SOUTHWEST: John A. Green Co., 6815 Oriole Dr., Dallas 9, Dixon 9918 • LOS ANGELES: 5603 N. Huntington Dr., Capital 1-9114



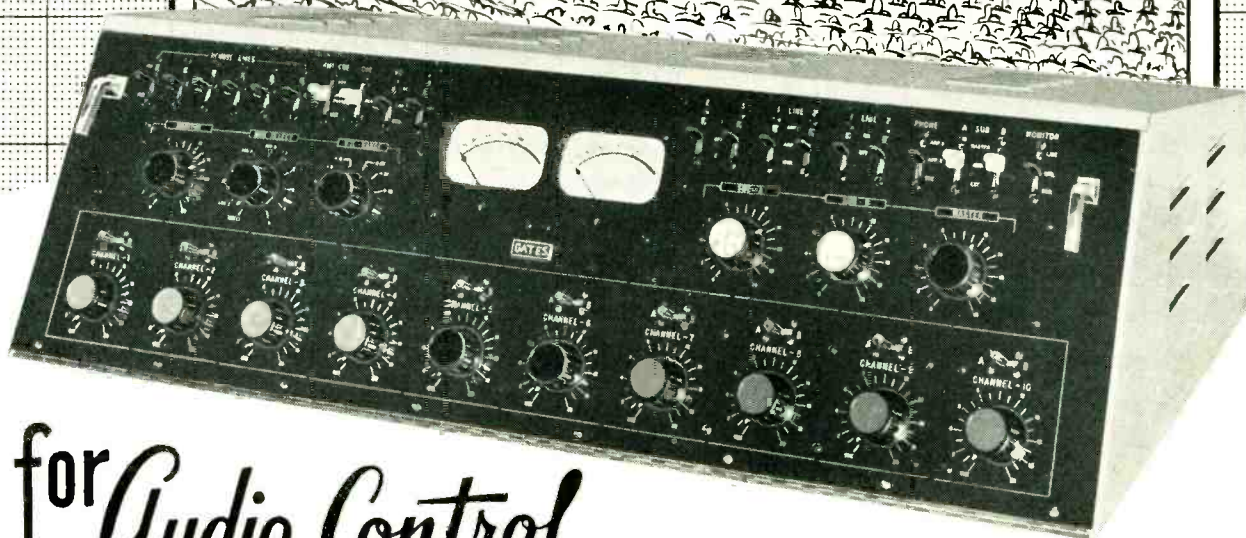

for *Audio Control*

**THERE'S JUST NOTHING FINER!**

The Gates CC-1 all plug-in audio console is *superlatively fine* — commercially beautiful to look at — warmly satisfying to operate — technically superb — functionally complete beyond expectation — and upholds the tradition of those that have long been associated with the very best.

There is indeed a lot of pleasure and contentment in the operation of a speech input console so quality filled—that behind the control panel are parts and workmanship that spell complete reliability and assurance that your audio quality and handling cannot be excelled—anywhere.

Your 240-page Gates master catalog, Pages 120-124, or speech input catalog DS-534, tells the CC-1 story. If your copy has been misplaced, only the asking will send another on its way to you.

*This Console is on display at all GATES stock-carrying branches in ATLANTA, HOUSTON and LOS ANGELES.*

**GATES**

**GATES RADIO COMPANY**

Manufacturing Engineers Since 1922

QUINCY, ILL., U. S. A.

Houston, 2700 Polk Avenue  
New York, 51 East 42nd Street

Washington, D. C., Warner Bldg.  
Los Angeles, 7501 Sunset Blvd.  
New York, International Div., 13 East 40th St.

Atlanta, 13th & Spring Sts.  
Montreal, Canadian Marconi Co.



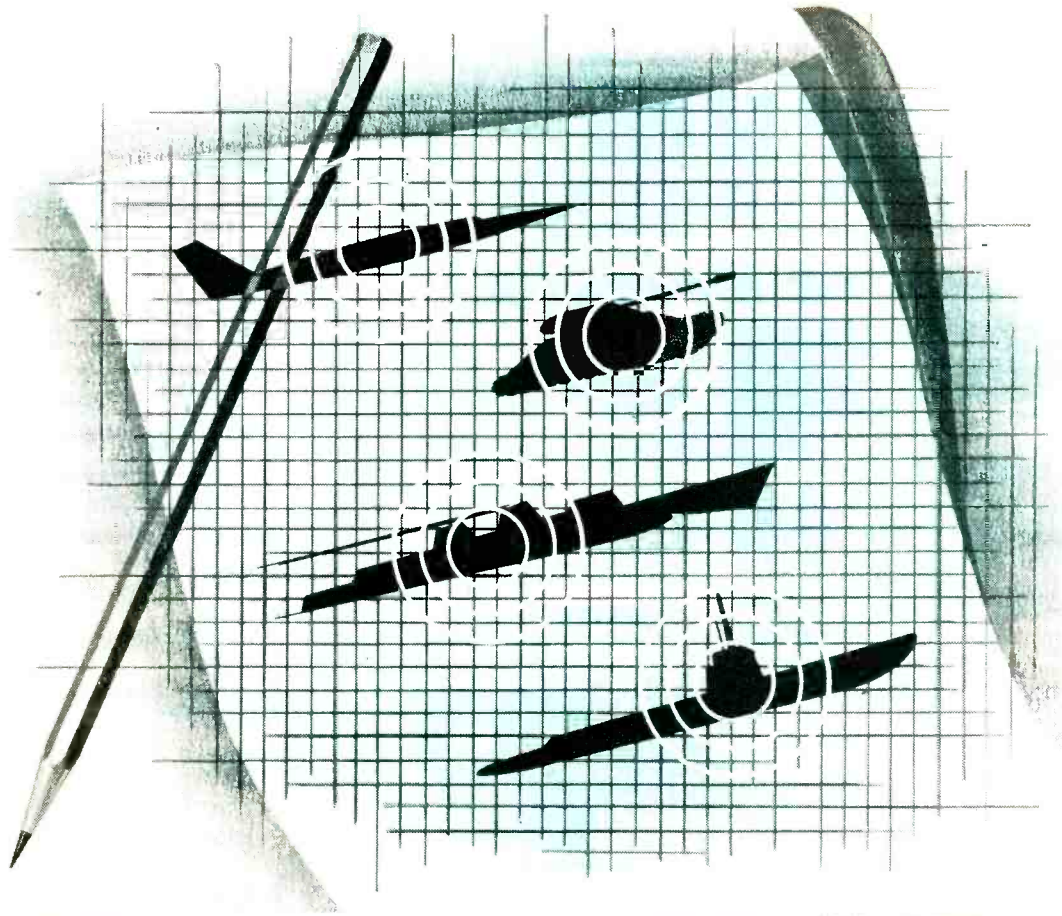

# EXPERIENCE...

When it comes to electronics . . . experience is our single greatest virtue.

The average experience of our electronic engineers is more than ten years in this specialized field.

Their contributions to this fast-developing industry are attested to by our producing acoustical-electronic firing error indicators . . . portable, high-powered, 1kw-plus long-range transmitters . . . and one-man, multi-channel

UHF transceivers. If you have a problem which may be solved by the use of electro-mechanical, hydraulic, pneumatic or electronic equipment, let's talk it over.

"WE DISTRIBUTE A WIDE RANGE OF AIRCRAFT EQUIPMENT FOR A NUMBER OF AMERICA'S LEADING MANUFACTURERS. A NEARBY BRANCH WILL BE HAPPY TO SERVE YOUR NEEDS. DO MORE BUSINESS . . . REALIZE MORE PROFIT WITH AIR ASSOCIATES' EQUIPMENT."

*J. E. Ashman*  
PRESIDENT



**IR**  
**ASSOCIATES, INC.**

TETERBORO, NEW JERSEY

DIVISIONS: ATLANTA • CHICAGO • DALLAS • GLENDALE • HACKENSACK • MIAMI • ORANGE • TETERBORO

ELECTRONICS — April, 1954

Want more information? Use post card on last page.

61

# AXIOM

Regd. Trade Mark

*High*

# FIDELITY OF SOUND

## MADE IN ENGLAND



12"

### AXIOM 150 Mk II

A 12-inch twin-cone full range high fidelity reproducer, with a power handling capacity of 15 watts.

**BRIEF SPECIFICATION:**

Frequency Coverage	- - - -	30/15,000 c/s
Fundamental Resonance	- - - -	35 c/s
Flux Density	- - - -	14,000 gauss
Nett Weight	- - - -	12lb. 13oz. (5.8 kg)

AUDIOPHILE  
NETT PRICE

**\$43.50**

### AXIOM 22 Mk II

A 12-inch twin-cone high-power P.M. loudspeaker combining generous bass handling capacity with full range high fidelity reproduction.

**BRIEF SPECIFICATION**

Frequency Coverage	30/15,000 c/s
Fundamental Resonance	35 c/s
Flux Density	17,500 gauss
Nett Weight	18 lb. 4 ozs. 8.3 kg.

AUDIOPHILE  
NETT PRICE

**\$65.00**

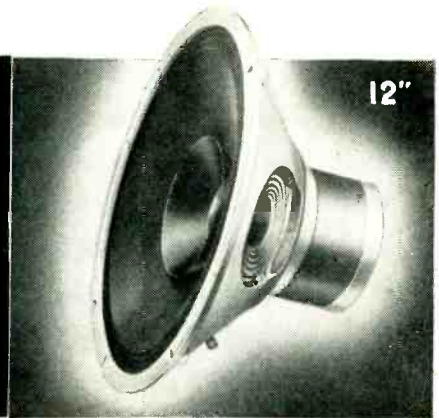

12"

### AXIOM 80

A medium power FREE SUSPENSION high fidelity P.M. reproducer for the professional enthusiast.

**BRIEF SPECIFICATION**

Frequency Coverage	- - - -	20/20,000 c/s
Fundamental Resonance	- - - -	20 c/s
Flux Density	- - - -	17,000 gauss nominal
Nett Weight	- - - -	9lb. 6oz. (4.2 kg)

AUDIOPHILE  
NETT PRICE

**\$52.30**



9 1/2"

FREE SUSPENSION

Exclusively distributed by:—

EAST:

Goody Audio Centre Inc.,  
235, West 49th St., New York 19, N.Y.

WEST:

Hollywood Electronics,  
7460, Melrose Avenue, Los Angeles 46, Cal.

NORTH & MID-WEST:

Newark Electric Company,  
223, West Madison St., Chicago 6, ILL.

SOUTH:

High Fidelity SSS,  
606, Peachtree St., N.E., Atlanta, Ga.

CANADIAN SALES OFFICE: A. C. Simmonds & Sons Ltd., 100, Merton St. Toronto 12.



# GOODMANS

GOODMANS INDUSTRIES LTD., AXIOM WORKS, WEMBLEY, MIDDLESEX, ENGLAND.



**THIS PRINCIPLE...**

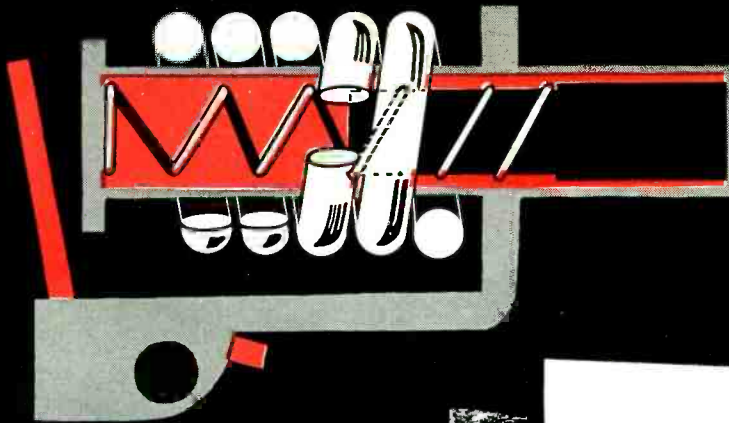

**provides custom  
fitted overload  
protection...**

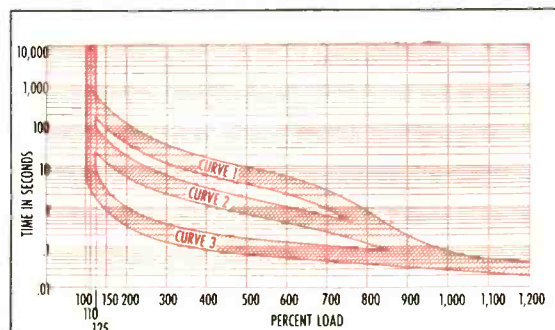

With the HEINEMANN hydraulic-magnetic principle, you can have overload protection in circuit breaker or relay form precisely designed for your product.

First, you are not limited to the nearest "standard" rating—you specify the exact rating based on the normal running current of your equipment.

Second, you have a selection of time delay response curves. Your choice is based on normal inrush characteristics as well as the size and duration of overloads that should be permitted—specifically in your product.

Furthermore, since Heinemann Circuit Breakers and Overload Relays do not employ thermal elements, their ratings never change . . . de-rating for ambient temperature is never necessary . . . nuisance power interruptions never occur. Yet, on dangerous overloads or short circuits, they provide the fastest circuit interruption available.

Send for descriptive literature.



**MORE INFORMATION?** *On circuit breakers (left), send for Bulletin SW; on overload relays (right) send for Bulletin 5101A.*

**HEINEMANN ELECTRIC COMPANY**

97 Plum Street • Trenton 2, N. J.



# NOW—the modern successor to the galvanometer

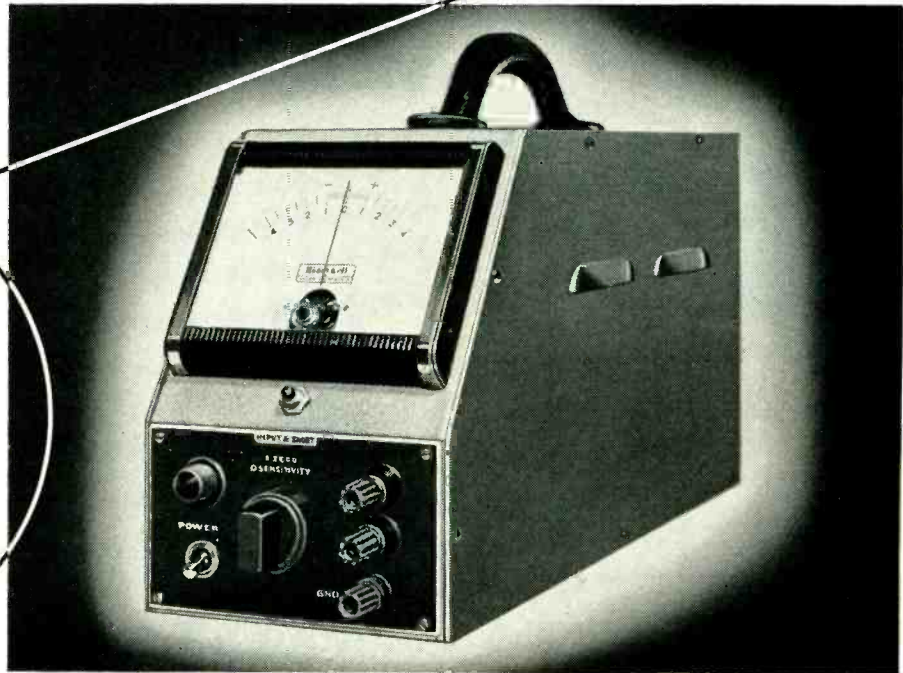
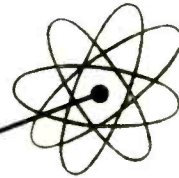

the new  
*Electronik*  
Null Indicator

## electrical characteristics

INPUT IMPEDANCE  
1500 ohms

CURRENT SENSITIVITY  
 $0.6 \times 10^{-9}$  amperes  
per millimeter

VOLTAGE SENSITIVITY  
1 microvolt  
per millimeter

OPERATING VOLTAGE  
115 volts, 60 cycles

If you use galvanometers, you'll be interested in the new *Electronik* Null Indicator. For here, at last, is the lab man's ideal d-c null balance detector . . . completely free from all the limitations of galvanometers.

**It's easy to use**—no "loss of spot" from excess signal; bridge balancing operation is simplified.

**It's self-protecting**—will take heavy over-loads without damage.

**It's vibration-proof**—undisturbed by nearby traffic or machinery.

**It goes anywhere**—needs no leveling or special mounting; plugs into 115-volt 60-cycle line; small case fits readily into experimental set-ups.

**It's stable**—holds steady zero after warm-up.

**It's fast**—indicates in less than one second; ideal for production testing.

**It's sensitive**—suitable for use with high precision measuring circuits.

The *Electronik* Null Indicator is priced within reach of any budget. It will be a valuable asset to your lab. Write today for complete information.

MINNEAPOLIS-HONEYWELL REGULATOR Co., *Industrial Division*, Wayne and Windrim Avenues, Philadelphia 44, Pa.

● REFERENCE DATA: Write for Instrumentation Data Sheet No. 10.0-12.



MINNEAPOLIS  
**Honeywell**  
BROWN INSTRUMENTS

*First in Controls*



# Rectifier Molded in Kel-F<sup>®</sup> Plastic, Smaller Than a One-inch Cube ... Boasts 100-G Shock Resistance

Unmatched compactness, high electrical efficiency under severe conditions, and exceptional durability are advantages gained by using "Kel-F" trifluorochloroethylene polymer to insulate this double-bridge instrument rectifier. The size of the rectifier belies its 3-ma output from each of two 130-volt rms full-wave bridges. Insulation of the many rectifier wafers and resistors in the unit is enhanced by the exceptionally high electrical resistance of "Kel-F". The high strength and stability of the molded fluorocarbon block also enable it to serve as a mount for parts, since the plastic is unaffected by high thermal and shock loads.

The parts of the rectifier are assembled in a block of injection-molded "Kel-F", which, in turn, is encased in plastic. The unit is made by International Resistance Company, Philadelphia, Pa., to specifications of the Raytheon Manufacturing Company, Waltham, Mass. Rectifier is employed in phase-comparator applications, has many other potential uses.

**For further information ask for Application Report E-122**

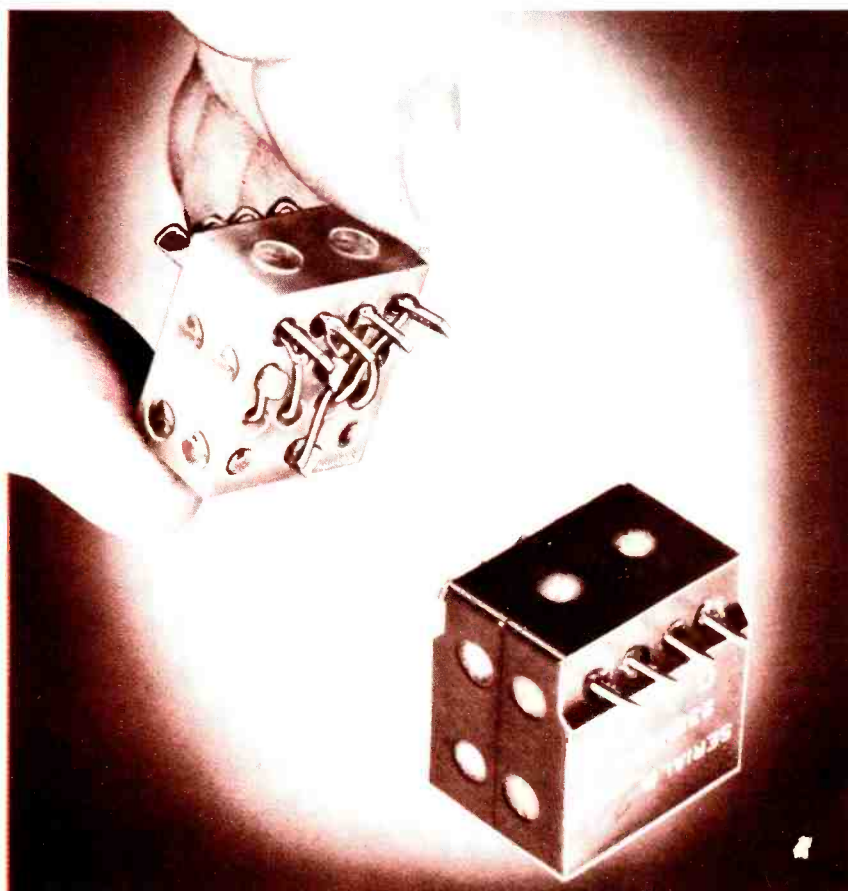

## Magnetic Stirring Bars Sealed in Kel-F<sup>®</sup> to Stop Corrosion and Breakage

A vacuum-tested casing of "Kel-F" permits these metal bars to be used indefinitely to "mix" highly corrosive acids, alkalis, solvents and peroxides—at from minus 200°C to plus 200°C—without corrosion or breakage. The fluorocarbon "skin" cannot crack or chip. Non-porous and non-absorbent, the covering is virtually self-cleaning, can even be sterilized.

Three sizes of stirring bars are now made by the Arthur H. Thomas Company of Philadelphia, Pa., by sealing cylindrical permanent magnets into extruded tubing. Extruded from unplasticized "Kel-F" Grade 300 by the Plax Corporation of Hartford, Conn.

**For further information ask for Application Report C-115**

(SEE REVERSE SIDE)



# Coil Connector of Kel-F® Boosts Actuator Motor Performance and Output, Simplifies Maintenance

Molding this coil connector for a miniature motor from "Kel-F" made possible the addition of a vital brake clutch, a sharp increase in output and the use of time-saving solderless terminals—without increasing the unit's size.

High insulation resistance of "Kel-F" under thermal cycling, allowed specification of a lighter connector for effective insulation over the temperature range of minus 65°F to 200°F without tracking or shorting. Exposed to high humidity, the plastic's zero water absorption prevents arcing or dissipation. Then non-wetting and smooth surface of the molded connector is fungus-inert.

The connector is injection molded from "Kel-F" unplasticized polymer by the United States Gasket Company of Camden, New Jersey. The Grand Rapids Division of Lear, Incorporated, manufacturers of precision aircraft instruments and electronic systems, uses this connector in a D.C. motor.

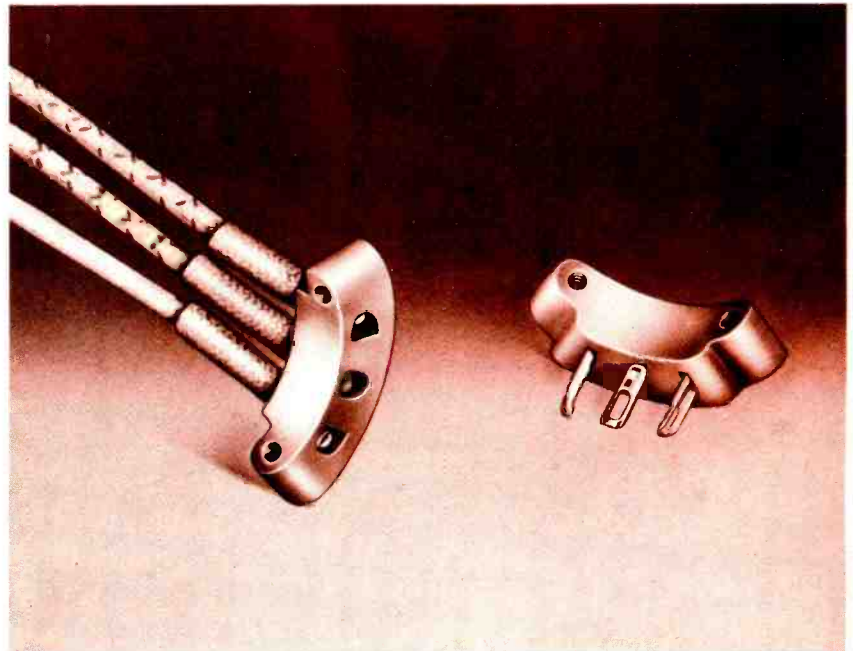

For further information ask for Application Report E-123

## Molders & Fabricators of the Month

Leading molders, extruders and fabricators specialize in the production of materials and parts made of "Kel-F" . . . each month this column will spotlight several of these companies with their principal services and products.

### Brilhart Plastics Corporation

Mineola, N. Y.

Injection, Compression & Transfer Molding  
Electrical & Electronic Components  
Gaskets, Diaphragms & "O" Rings

### Fluoro Plastics, Incorporated

Philadelphia, Pa.

Compression & Transfer Molding  
Gaskets & "O" Rings; Valve Seats; Containers  
Electrical & Electronic Components

### The Garrison Company

Kenilworth, N. J.

Extrusion & Production Machining  
Electrical & Electronic Components  
Wire Insulation

### Penn-Plastics Manufacturing Co.

Glenide, Pa.

Compression & Transfer Molding  
Electrical & Electronic Components

### Porous Plastic Filter Company

Glen Cove, N. Y.

Porous Filters

## Recent Significant Developments in "Kel-F"

**Electronic Tube Caps** boost performance of high-altitude communications equipment, removing interference from thermal cycling, high humidity.

**Asbestos, Glass Fiber**, other fillers being successfully incorporated in molded parts in high temperature, corrosive valve service, structural electrical members.

**Float Bodies** of "Kel-F" and powdered metal incorporated in flowmeter bodies machined of "Kel-F" for smaller, more accurate measuring devices for severe corrosives, liquid or gaseous.

**Welding**, by "hot gas" method being used in fabrication of corrosion-resistant feed hoppers.

Visit the Kel-F POLYMER EXHIBIT at the Basic Materials Show May 17-20 -- Chicago, Ill.

For complete information regarding any item mentioned in DESIGN AND PRODUCTION NEWS, ask for detailed APPLICATION REPORTS, write

### Technical Service

## CHEMICAL MANUFACTURING DIVISION

### THE M. W. KELLOGG COMPANY

P. O. Box 469, Jersey City 3, N. J.  
or offices in Boston, Chicago, Dayton,  
Los Angeles and New York



® Registered trademark for The M. W. Kellogg Company's trifluorochloroethylene polymer products.

KEL-F

TRIFLUORO  
CHLORO  
ETHYLENE  
POLYMERS

KEL-F

MOLDING  
POWDERS

KEL-F

FLUORO  
CHLORO  
CARBON  
PLASTIC

KEL-F

DISPERSION  
COATINGS

KEL-F

TRIFLUORO  
CHLORO  
ETHYLENE  
POLYMERS

KEL-F

OILS  
WAXES  
GREASES



*It is the designers and specifiers who USE the ELECTRONICS BUYERS' GUIDE.*

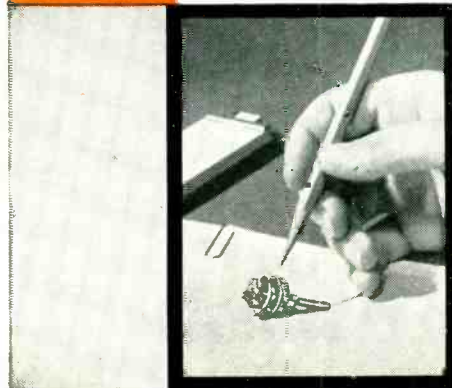
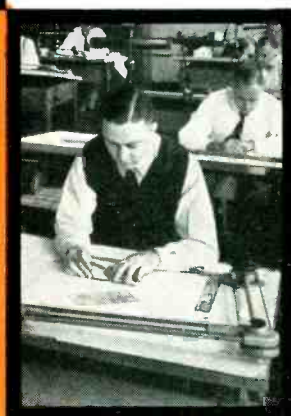
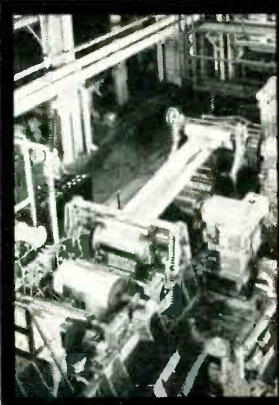
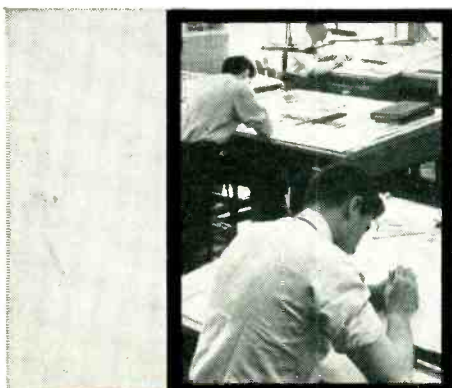

# USAGE

**OF THE "GUIDE" IS A PROVEN FACT!**

Questions that arise at the breadboard . . .  
 Questions of product specs,  
 Questions of manufacturers . . .  
 Designers requiring immediate  
 and accurate answers to their questions  
 simply resort to the most efficient  
 and expedient method  
 of getting those answers . . .

Of course, this is in the **ELECTRONICS BUYERS' GUIDE**  
 where questions are daily answered, all year 'round  
 in a manner complete and accurate.

The "Guide" is the accepted product reference book  
 of the entire industry.

You, too, can profit  
 by getting into the habit of looking it up in . . .

The results of a survey, **ELECTRONICS BUYERS' GUIDE QUESTIONNAIRE ON BUYING HABITS**, will be available in booklet form soon. Here are facts and figures that prove usage of the "Guide" as a purchasing source by the men who do the specifying and buying. In this booklet you will find what they bought . . . where they bought . . . how many times they bought. See printed evidence of the positive sales value of the "Guide." For your free copy, call your District Manager of **ELECTRONICS** or write to the Business Department of **ELECTRONICS BUYERS' GUIDE**.



**electronics BUYERS' GUIDE**



A McGraw-Hill Publication

330 West 42nd Street, New York 36, N. Y.



# Magnetic Materials are our Business

*...that's why it's smart business  
to buy from a specialist*

Through more than 50 years of specialization in the development and production of magnetic materials, Thomas & Skinner has gained the skills and know-how that *assures* you the *best* in engineering assistance—the *best* in quality production . . . at prices

that may be lower than you are now paying.

It will pay you to investigate the many advantages offered by Thomas & Skinner . . . *specialists in magnetic materials* . . . permanent magnets, electrical laminations, and wound cores.

**Specialists in magnetic materials, Permanent Magnets, Electrical Laminations and Wound Cores**



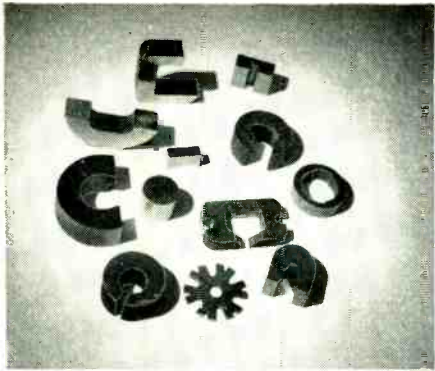

**PERMANENT MAGNETS** Whatever your needs — Alnico, cobalt, chromium—Thomas & Skinner can meet your specifications for either standard designs or special shapes. Typical of T&S advanced materials is Alnico 5Cb, offering an energy product of 5.70 million *nominal*. And typical of T&S advanced techniques is shell-molding, offering intricate shapes with tolerances as close as  $\pm .005$ " without grinding or finishing.

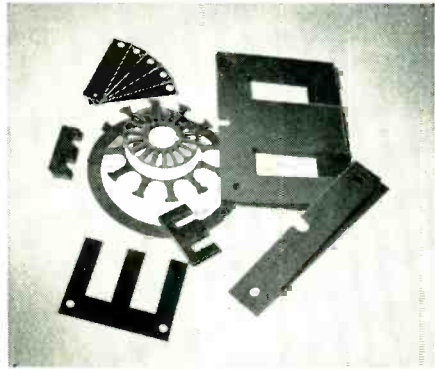

**ELECTRICAL LAMINATIONS** Geared to high volume production, T&S uses the most modern equipment available to produce high quality laminations in quantity at the lowest prices possible. Rigid quality control is maintained through each phase of production—stamping—atmosphere annealing— every vital step in producing top quality laminations. For every type application, T&S can provide all grades, all gauges to meet your demands for standard or special laminations. T&S's OrthoSil is also available for applications requiring directional electrical characteristics with extreme high permeability and low core loss.

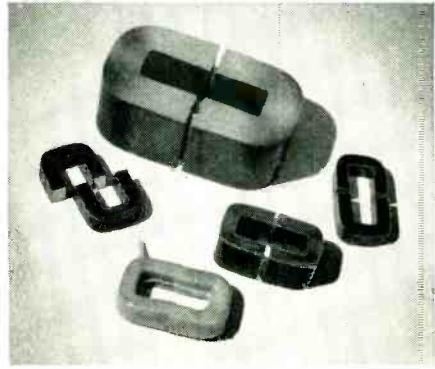

**WOUND CORES** You can save on both assembly costs and time—and reduce both size and finished weight—with "C" Type and Toroidal Wound Cores made from T&S OrthoSil. The directional magnetic characteristics and extremely rectangular hysteresis loop of oriented OrthoSil have proved advantageous on hundreds of applications, particularly in 400 cycle equipment at flux densities of 15,000 gauss and over.



**Did you know...** that you can now buy electrical laminations that are pre-tested with the certified reports sent to you with each shipment. Yes, Thomas & Skinner certifies that each order of laminations is tested and meets the most rigid specifications . . . you receive test figures for both core loss and exciting current *at* 10M gauss on each heat annealed. This means an additional savings to you since it eliminates the need for retesting on your part. Many of the leading transformer manufacturers specify T&S CERTIFIED LAMINATIONS. Perhaps you should too!

write today  
for free  
catalogs!

- Magnet Design—Bulletin 151 (for the design engineer)
- Standard Magnets—Catalog SM-1252 (complete data with dimensional drawings)
- Alnico 5Cb—Bulletin 1253 (details on today's newest Alnico)
- Laminations—Bulletin L-752 (applications, specifications, value graphs)
- Wound Cores—Bulletin WC-353 (specifications, value graphs)

Name and Title \_\_\_\_\_  
Company \_\_\_\_\_  
Address \_\_\_\_\_  
City \_\_\_\_\_



1122 EAST 23RD STREET  
INDIANAPOLIS, INDIANA

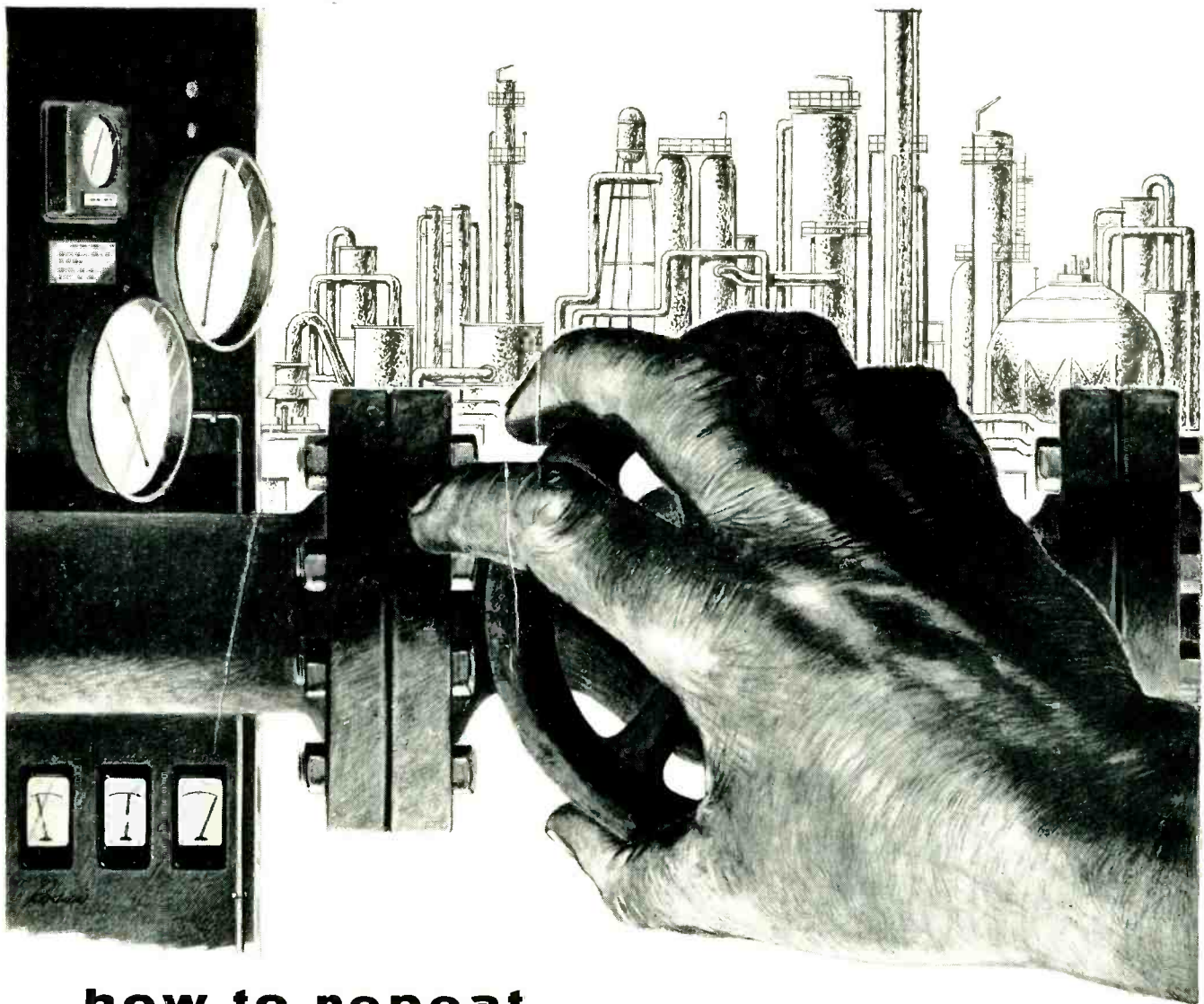

## how to repeat a master touch

*an electronic answer to process control*

"The master touch" by which a process achieves a perfect result may be a lucky combination of temperatures, pressures, agitation, timed feeding of ingredients and numerous other variables. But the desired results could be achieved every time — provided an exact process pattern could be fed to electronic controls.

**Ampex recordings provide a "perfect memory"** — Practically any chemical, metallurgical or manufacturing process can be "remembered" intact on magnetic tape by an Ampex Recorder. Any likely number of variables can be recorded concurrently and with high accuracy. They occupy parallel channels on a single width of magnetic tape; timing and synchronization are inherently perfect.

**The Ampex playback can actuate any reaction** — From this magnetic tape, the process is "played back" as a pattern of electrical signals. These can

operate valves, thermostats or pressure controls and can run motors, adjust speeds or control any other necessary mechanical or electrical responses. Thus a magnetic tape can repeat any process sequence that previously achieved a successful result, controlling it more closely than even a standby operator.

*Wherever you control a sequence of operations, magnetic tape may achieve important advantages. For further information, write today to Dept. E-1447*



**AMPEX CORPORATION**  
 934 Charter Street • Redwood City, California  
*Branch offices: New York, Chicago, Atlanta, San Francisco and College Park, Maryland (Washington, D.C. area).*  
*Distributors: Radio Shack, Boston; Bing Crosby Enterprises, Los Angeles; Southwestern Engineering & Equipment, Dallas and Houston; Canadian General Electric Company, Canada.*



# ERIE

*Complete line of*  
**DISC CERAMICONS**®

## HIGH VOLTAGE

HIGH VOLTAGE DISC CERAMICONS employ the same basic diameters that have been standardized in 500 volt Ceramic capacitors. Careful and detailed life testing has been accomplished over a long period of time to establish required dielectric thicknesses to assure conservative ratings in the high voltage line. Standard voltage ratings range from 1,000 through 6,000 Volts, D.C., Working.

## TEMPERATURE COMPENSATING

TEMPERATURE COMPENSATING DISC CERAMICONS, in four sizes, offer all standard combinations of temperature coefficient and capacitance value. They are tested for conformance to Erie specifications for Tubular Ceramicons and meet all requirements for RETMA REC-107A Class 1 ceramic capacitors. They are available in capacity ranges up to 1940 mmf.

## GENERAL PURPOSE

GENERAL PURPOSE DISC CERAMICONS have low series inductance which assures efficient high frequency operation. They are made in sizes from  $\frac{5}{16}$ " to  $\frac{3}{4}$ " diameter, and in capacitance values ranging from 4.5 mmf to .02 mfd.

ERIE DISC CERAMICONS are available in three classes, each having a wide range of capacitance values for the basic applications. These capacitors consist of flat ceramic dielectrics with fired silver electrodes. Lead wires are firmly soldered to the electrodes, and completed units are given a protective coating of wax impregnated phenolic. For complete description and specifications, write for catalogs and samples.

*ERIE components are stocked by leading electronic distributors everywhere.*

**ERIE RESISTOR CORPORATION . . . ELECTRONICS DIVISION**

TRADE **ERIE** MARK  
RESISTOR CORP.

**Main Offices and Factories: ERIE, PA.**

Sales Offices: Cliffside, N. J. • Philadelphia, Pa. • Chicago, Ill. • Detroit, Mich.  
Ashland, Ohio • Fort Wayne, Ind. • Los Angeles, Calif. • Toronto, Ontario

*Manufacturing Subsidiaries:*

**HOLLY SPRINGS, MISS. • LONDON, ENGLAND • TRENTON, ONTARIO**



## ADVANCED PERFORMANCE WITH THESE OUTSTANDING LINK FEATURES

1. **Virtually Friction-free** — Less than .01 inch ounces of frictional torque at the input to the gear box.
2. **Practically Backlash-proof** — Repeated tests find less than  $0.27^\circ$  on a gear box of 500:1 ratio.
3. **Low Inertia** — Aluminum gears, molecularly lubricated for a lifetime, help keep inertia down to less than  $4.5 \text{ gram cm}^2$  on a 500:1 gear box.
4. **Long Life** — Continuous performance tests of a 150:1 gear box for more than 1800 hours under 90 inch ounces of load at 3000 rpm assures dependable service.
5. **High Torque** — Rated at 120 inch ounces off the slow turning shaft.
6. **Overall Dimensions** —  $3\frac{1}{2}'' \times 3\frac{1}{2}'' \times 2\text{-}7/32''$ .

# Now!

## HI-PRECISION GEAR BOX

### RATIOS FROM 20:1 TO 3125:1

A new miracle in engineering — the LINK *Hi-Precision* Gear Box — is ready now for use in servo-mechanisms, computers and many other instruments that demand exceptional performance and design simplicity.

This light weight, lifetime lubricated gear box is now being produced in quantity — with custom craftsmanship.

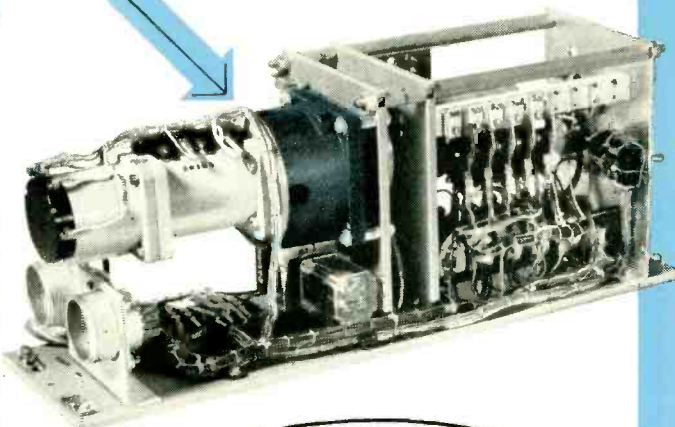

Dept. E-1, Link Aviation, Inc.  
Binghamton, N. Y.

Please send the following free information:

- Link Hi-Precision Gear Box Catalog  
 Attached is our servo-mechanism problem — how will your gear box solve it?

Name \_\_\_\_\_ Title \_\_\_\_\_  
 Firm \_\_\_\_\_  
 Street \_\_\_\_\_  
 City \_\_\_\_\_ Zone \_\_\_\_\_ State \_\_\_\_\_

Manufacturers of the world-famous Link Trainers, servo-mechanisms, servo-amplifiers, graphic recorders, fractional h.p. wide range variable speed drives, spur gear differentials, friction and over-drive clutches, index dials, phase angle meters, ratio voltmeters, precision potentiometers and other special electronic devices.



# engineers are critical people

( We know, because  
we're engineers, too )



Radio and TV stations, recording studios, commercial and industrial film studios, testing laboratories, program production organizations and a host of others have long needed a thoroughly professional, well designed, easily maintained tape recorder.

More than a year ago, Presto's top engineers were assigned to the development of such a recorder. Months later a test model was completed which not only met these specifications, but embodied a completely new principle of recorder design . . . unitized construction; the entire capstan drive is a separate, easily removed unit.

The instrument was designated "Model RC-11," and then a series of rigorous tests were begun. The RC-11 was run continuously for hours at a time under the most adverse conditions. These tests resulted in further improvements.

Finally, when we were satisfied that this was the finest tape recorder of its type that could be built, we tooled up and put it into production.

By reputation engineers are the most critical people on earth. (We know, because *we're* engineers, too.) And, some of the most qualified recording engineers who have seen and operated the RC-11 share one opinion . . . that here is the finest, easiest to operate, best performing tape recorder available today.

 **PRESTO** RECORDING CORPORATION  
PARAMUS, NEW JERSEY

Export Division: | 25 Warren Street, New York 7, N. Y.  
Canadian Division: | Walter P. Downs, Dominion Square Bldg., Montreal

## PRESTO RC-11 TAPE RECORDER

IN CONSOLE WITH 900-A3  
AMPLIFIER

- Self-contained Capstan Drive Unit—3 motor drive.
- Three magnetic heads in metal enclosure.
- Push button function switches.
- Reel capacity to 10½" diameter.
- Response: 50 to 15,000 cycles ± 2 db.
- Flutter: less than 1½% at 15"/sec.
- Signal to noise: 55 db. at 2% distortion.

WORLD'S LARGEST MANUFACTURER OF PRECISION RECORDING EQUIPMENT AND DISCS

[www.americanradiohistory.com](http://www.americanradiohistory.com)



# COMPLETE CIVILIAN LINE

Exceptionally good delivery cycle on civilian orders due to tremendous mass production facilities.

TYPE C45-70

NEW HIGH QUALITY MINIATURIZED "DIME-SIZE" CIVILIAN CONTROL—Performance Fully Equals Larger Types.

TYPE 70, 3/4" diameter variable composition resistor. Wattage rating: .3 watt for resistances through 10,000 ohms, .2 watt with 350 volts maximum across end terminals for resistances over 10,000 ohms. Also available in concentric shaft tandem construction C45-70 as shown above.

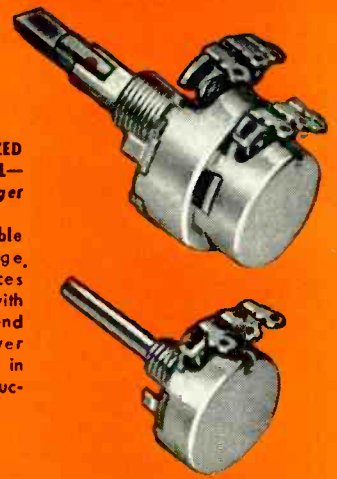

TYPE C2-45

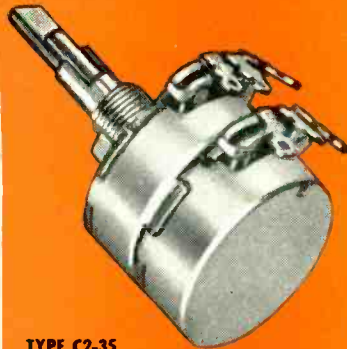

TYPE C2-35



TYPE C2-252



TYPE C2-25



TYPE GC-45, 15/16" diameter variable composition resistor. Wattage rating: 1/2 watt for resistances through 10,000 ohms, 1/3 watt for resistances over 10,000 ohms through 100,000 ohms, 1/4 watt with 500 volts maximum across end terminals for resistances over 100,000 ohms. Available with or without illustrated attached switch and in concentric shaft tandem construction C2-45 as shown above.

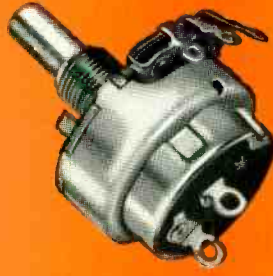

TYPE GC-35, 1 1/8" diameter variable composition resistor. Wattage rating: 3/4 watt for resistances through 10,000 ohms, 2/3 watt for resistances over 10,000 ohms through 25,000 ohms, 1/2 watt with 500 volts maximum across end terminals for resistances over 25,000 ohms. Available with or without illustrated attached switch and in concentric shaft tandem construction C2-35 as shown above.



TYPE GC-252, 2 watt, 1 17/64" diameter variable wirewound resistor. Available with or without illustrated attached switch and in concentric shaft tandem construction C2-252 as shown above.

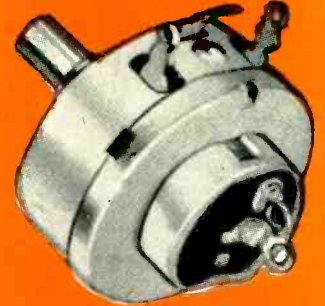

TYPE GC-25, 4 watt, 1 17/32" diameter variable wirewound resistor. Available with or without illustrated attached switch and in concentric shaft tandem construction C2-25 as shown above.

Typical concentric shaft tandem with panel and rear sections operating separately from concentric shafts (TYPE C45-70 ILLUSTRATED). Similar construction available for all military resistors.

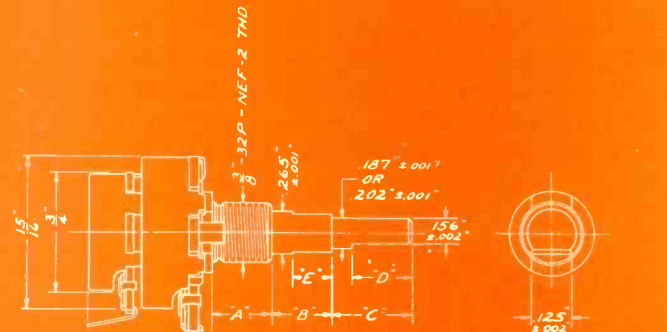

TYPE C45-70

## REPRESENTATIVES

Henry E. Sanders  
McClatchy Bldg.  
69th & Market St.  
Upper Darby, Penna.  
Phone: Flanders 2-4420

W. S. Harmon Company  
1638 So. La Cienega Blvd.  
Los Angeles 35, California  
Phone: Bradshaw 7-3321

John A. Green Company  
6815 Oriole Drive  
Dallas 9, Texas

## IN CANADA

C. C. Meredith & Co.  
Streetsville, Ontario

## SOUTH AMERICA

Jose Luis Pontet  
Buenos Aires, Argentina  
Montevideo, Uruguay  
Rio de Janeiro, Brazil  
Sao Paulo, Brazil

## OTHER EXPORT

Sylvan Ginsbury  
8 West 40th Street  
New York 18, N. Y.

ENLARGED SHAFT  
END VIEW

Specialists in





# COMPLETE MILITARY LINE

Immediate delivery from stock on 189 types including JAN-R-94 and JAN-R-19 types of variable resistors.

## NEW 38-PAGE ILLUSTRATED CATALOG—

Describes Electrical and Mechanical characteristics, Special Features and Constructions of a complete line of variable resistors for military and civilian use. Includes dimensional drawings of each resistor. Write today for your copy.

**TYPE 45, (JAN-R-94, Type RV2)**  
1/4 watt, 15/16" diameter variable composition resistor. Also available with other special military features not covered by JAN-R-94 including concentric shaft tandem construction. Attached switch can be supplied.



**TYPE 35, (JAN-R-94, Type RV3)**  
1/2 watt, 11/8" diameter variable composition resistor. Also available with other special military features not covered by JAN-R-94 including concentric shaft tandem construction. Attached switch can be supplied.



**TYPE 252, (JAN-R-19, Type RA20)**  
2 watt, 1 17/64" diameter variable wirewound resistor. Also available with other special military features not covered by JAN-R-19 including concentric shaft tandem construction. Attached switch can be supplied.

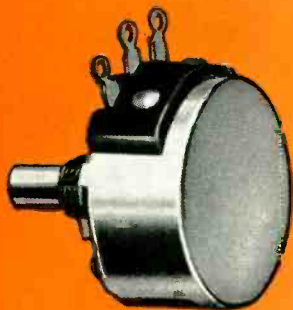

**TYPE 25, (JAN-R-19, Type RA30)**  
(May also be used as Type RA25)  
4 watt, 1 17/32" diameter variable wirewound resistor. Also available with other special military features not covered by JAN-R-19 including concentric shaft tandem construction. Attached switch can be supplied.



**TYPE 65, (Miniaturized)**  
1/2 watt 70°C, 3/4" diameter miniaturized variable composition resistor.

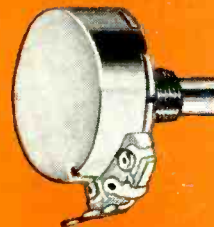

**TYPE 90**  
1 watt 70°C, 15/16" diameter variable composition resistor. Attached switch can be supplied. Also available in concentric shaft tandem construction.

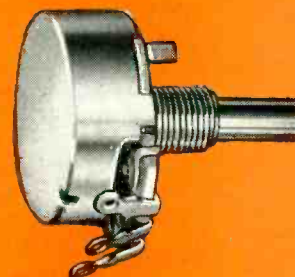

**TYPE 95, (JAN-R-94, Type RV4)**  
2 watt 70°C, 11/8" diameter variable composition resistor. Also available with other special military features not covered by JAN-R-94 including concentric shaft tandem construction. Attached switch can be supplied.

## UNPRECEDENTED PERFORMANCE CHARACTERISTICS

Specialty designed for military communications equipment subject to extreme temperature and humidity ranges. -55°C to +150°C...aridity to saturation.



**CHICAGO TELEPHONE SUPPLY Corporation**

ELKHART • INDIANA

*Precision Mass Production of Variable Resistors*

Burton Browne Advertising

From "The House of Resistors" \*\*  
come . . .

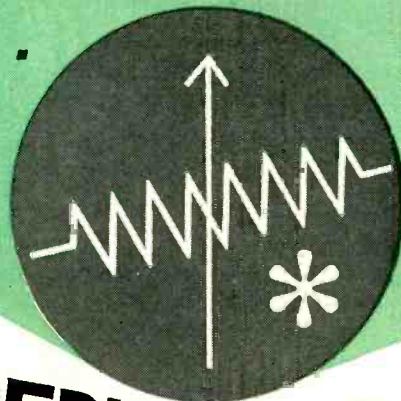

# COST-REDUCING CONTROLS

So you must get cost down in designing that assembly? That's just the time to enlist Clarostat's cost-saving talents and facilities. The same superlative engineering and production skill that accounts for the finest quality in controls and resistors, is also available for designing and fabricating cost-reducing components. Three typical examples are presented herewith. These are *standard* items, promptly available in any quantities, at marked savings. And for any extraordinary requirements, special controls and resistors can be developed, tooled-up and produced.

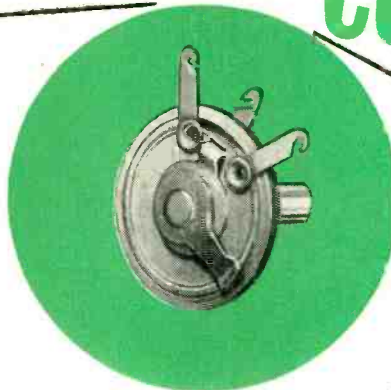

The original "Humdinger" Series MH. Compact, rugged, wire-wound control. Virtually millions in use. Fibre base holds resistance winding. Movable arm and shaft. 1-watt. 2 to 1000 ohms.

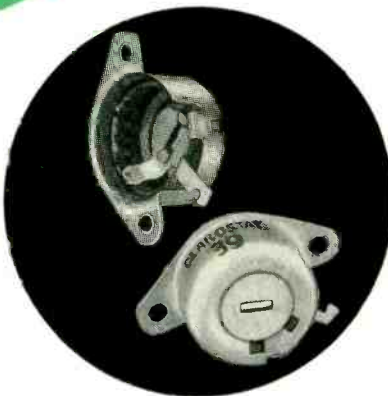

Latest "Humdinger" Series 39. Metal-case mounted with rivets or screws. Mounting surface serves as cover. Semi-fixed setting by screwdriver slipped into rotor slot — no shaft 2-watt 4 to 5000 ohms.

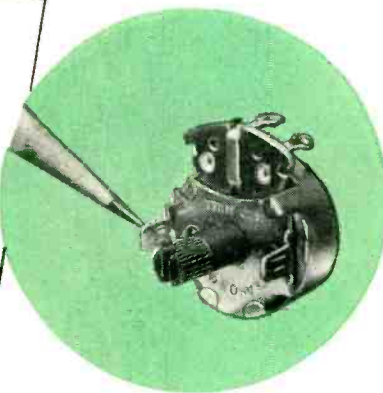

Twist-Tab Mounted Series 47. Eliminates usual bushing, lockwasher, nut. Composition-element control. Metal or plastic shaft. Plastic shaft has rear slotted protrusion, therefore adjustable from front or rear.

*It's easy*  
to do business with CLAROSTAT!  
Agents in all principal cities. ★ Wire Western Union — we have a direct wire. ★ Telephone Dover 975 — we have added trunk lines to render service. ★ Teletype — our TWX number is Dover 275-U.



## CONTROLS and RESISTORS

CLAROSTAT MFG. CO., INC., DOVER, NEW HAMPSHIRE  
In Canada: CANADIAN MARCONI CO., Ltd., Toronto, Ont.

\*\*Trade Mark



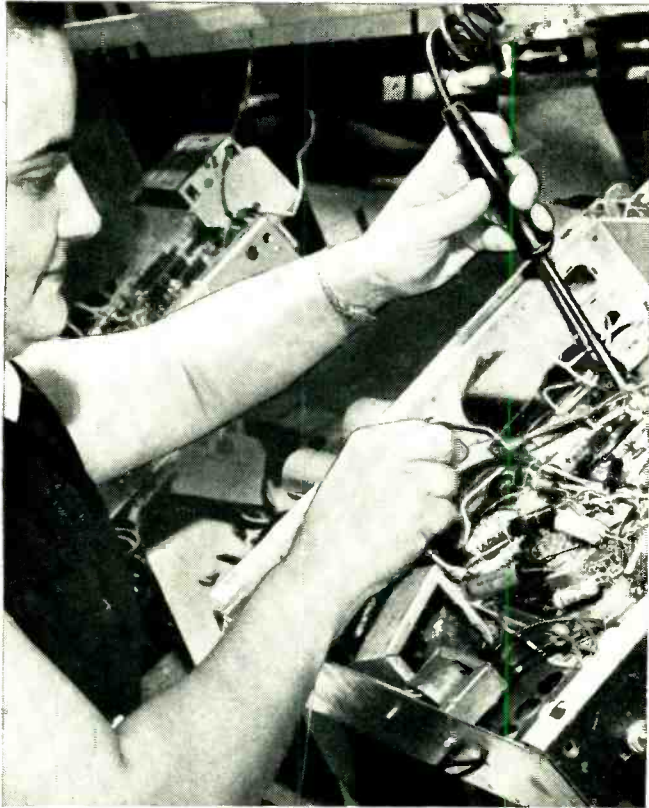

**LIGHT-AS-A-PENCIL G-E MIDGET** reduces operator fatigue, has longer-lasting Ironclad tip. The Midget solders like a pencil dots an "i."

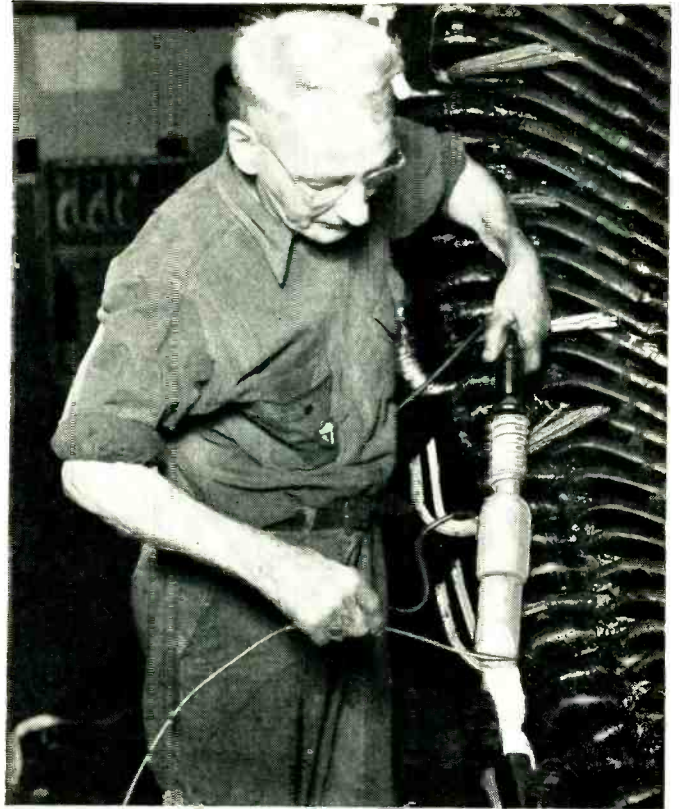

**EXTRA-HEAVY-DUTY G-E IRON** with long-life calorized copper tip is ideal for soldering heavy-gage cans and armature windings.

# You get lower costs, faster soldering with the complete line of long-life G-E irons

Select a soldering iron from General Electric's complete line for easier, faster, cost-cutting soldering. You can choose from 24 different irons with ratings from 25 to 1250 watts.

**Long-life G-E Ironclad Copper Tips** last up to *ten times as long* as ordinary tips. Ironclad tips combine the durability of iron and excellent heat-transfer of copper.

**For Soldering Small Connections**, you'll want to try the G-E Midget iron with easily interchangeable  $\frac{1}{4}$ -in.,  $\frac{1}{8}$ -in., and  $\frac{3}{16}$ -in. Ironclad tips. This  $1\frac{3}{4}$ -ounce, 25-watt iron reduces operator fatigue, makes pinpoint connections. And because the Calrod\* heater is *built right into the tip*, you get maximum heat transfer, amazing heat recovery for an iron of this size.

**For Medium-sized Jobs**, try G.E.'s sturdy Lightweight iron. This high-speed iron

for continuous soldering takes plenty of hard use. Because the iron has a thin shank and interchangeable  $\frac{1}{4}$ -in. or  $\frac{3}{16}$ -in. Ironclad tips, you can solder tight joints without damaging small connections.

**For the Bigger Soldering Jobs**, General Electric has larger irons ranging from the 75-watt,  $\frac{1}{2}$ -in. tip unit to the heavy-duty 1250-watt, two-inch-copper-tipped model. With a G-E Calrod heater *cast into the heating head*, you get unusually quick heating and high efficiency.

**Contact Your General Electric Sales Office or Distributor** to solve your soldering problems. Start cutting costs *and* increasing production with long-life, high-speed irons from the complete General Electric line. And for more information mail the coupon at right.

\*Reg. Trademark of the General Electric Co.

Sect. 720-126, General Electric Co.,  
Schenectady 5, N. Y.

Please send me Bulletin GEA-4519D,  
Industrial Soldering Irons.

Name \_\_\_\_\_

Company \_\_\_\_\_

Address \_\_\_\_\_

City \_\_\_\_\_ State \_\_\_\_\_

**GENERAL**  **ELECTRIC**

*Can you see this  
in your future?*

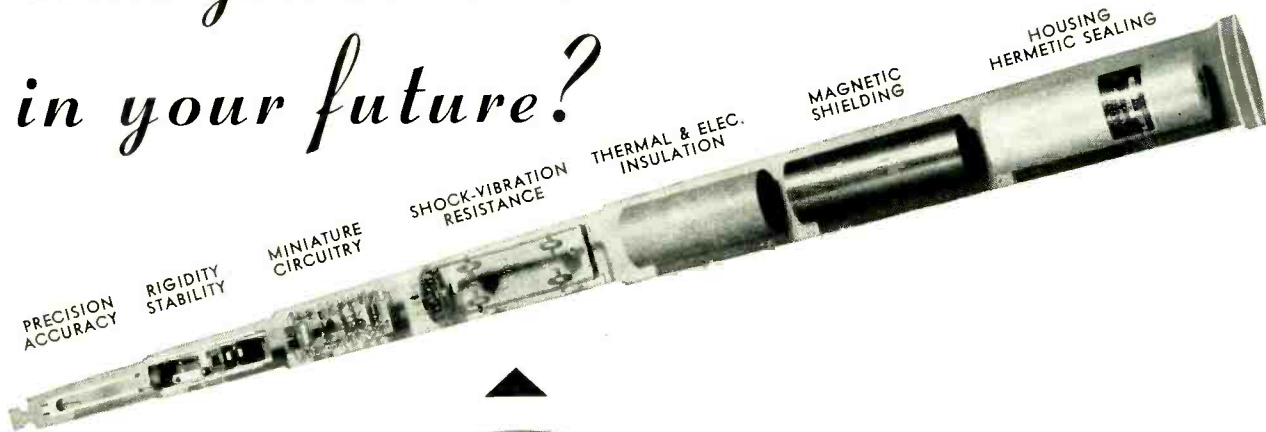

# FREQUENCY STANDARDS

IN QUANTITIES

PRECISION WITH RUGGEDNESS

**TYPE 2003.** Temperature-compensated tuning fork with most of the circuitry sealed inside. Requires a miniature double triode and 6 pigtail components in your circuit.

**TYPE 2007.** Temperature-compensated tuning fork with ALL circuitry, including sub-miniature double triode, sealed inside.

**FEATURES** — Plug in  
Interchangeable  
Shock-vibration resistant  
Hermetically sealed  
Light weight. (7 ounces)  
Small size (1½" x 4½")  
Meets JAN-MIL specifications

WRITE FOR DESCRIPTIVE LITERATURE, TYPE 2003-7  
OR SEND BRIEF OUTLINE OF REQUIREMENTS.

400.00  
CYCLES

Also available in—

240

500

1,000

2,000 cycles

ACCURACY: 1 PART IN 50,000



Manufacturers of a wide variety of timing equipment used in such fields as Aviation, Navigation, Ordnance, Ballistics, High-speed Photography, Viscosity Measurement, Fluid flow, Nuclear Physics, Telemetering, Chemical Reaction, Radiation Counting, Computers, Facsimile, Fire control, School and Industrial Research Laboratories. Accurate speed control.

## American Time Products, Inc.

580 Fifth Avenue

New York 36, N. Y.

OPERATING UNDER PATENTS OF WESTERN ELECTRIC COMPANY



# IT PAYS TO ASK THE STACKPOLE MAN!



## BEVERLY HILLS, CAL.



S. L. Spraggins  
373 South Robertson  
PHONE: Crestview  
5-1544

## PLAINVILLE, CONN.



Karl Dornish  
105 Farmington Ave.  
PHONE: Plainville 653

## ATLANTA, GEORGIA



Floyd Fausett & Son  
777 Pinehurst Ter., S.W.  
PHONE: Raymond 3104

## CHICAGO 13, ILLINOIS



Allen Woods  
3403 Broadway  
PHONE: Buckingham  
1-4200

## CHICAGO 39, ILLINOIS



C. R. Booth  
Room 317  
4000 W. North Ave.  
PHONE: Capital 7-2810

## DEARBORN, MICHIGAN



J. E. Vollmer  
24800 Winona Drive  
PHONE: Logan 1-6778

## MINNEAPOLIS 4, MINN.

H. M. Richardson  
9 East 22nd Street  
PHONE: GENEVA 4078



## GLENSIDE (Phila.), PA.

25 South Easton Rd. PHONE: Turner 1325  
J. R. Bengé Donald G. Brown



## KANSAS CITY 2, MO.

M. E. Bettis  
Room 11  
406 W. 34th Street  
PHONE: 0772-0773



## BUFFALO 3, NEW YORK

R. W. Mitscher  
487 Ellicott Sq. Bldg.  
PHONE: Washington  
2517



## NEW YORK 1, N. Y.

Joseph Sprung  
254 West 31st Street  
Room 1104  
PHONE: Longacre  
5-1820



## CINCINNATI, OHIO

W. C. Laing  
3253 Lambert Place  
PHONE: East 1435



## CLEVELAND, OHIO

C. A. Hammer  
Standards Bldg.  
PHONE: Cherry 1-7600



## DALLAS 9, TEXAS

Edward F. Aymond  
4310 Maple Avenue  
PHONE: Logan 5233



These Stackpole sales engineering representatives can help you in many ways—from making cost-saving suggestions to providing engineering samples and helping you procure dependable, economical components to match your production requirements and scheduling. Write, wire or call the engineer in your territory next time you need any of the materials listed below.

Electronic Components Division

**STACKPOLE CARBON COMPANY**

*St. Marys, Pa.*

**FIXED AND VARIABLE RESISTORS**

**SPECIAL RESISTORS**

**LINE, SLIDE OR ROTARY-ACTION SWITCHES**

**IRON CORES**

All types and shapes

**MOLDED COIL FORMS**

With or without iron core sections

**CERAMAG<sup>®</sup> ferromagnetic CORES**

**Low Value FIXED COMPOSITION CAPACITORS**

# STACKPOLE

## OAKVILLE, ONT., CANADA

W. T. Barron  
Box 126  
PHONE: OAKVILLE 2410



# Stabilize Amplifier Gain with

# GLOBAR<sup>®</sup> TYPE BNR VARISTORS

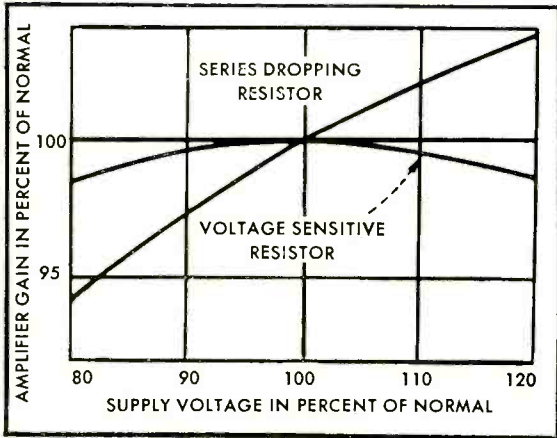
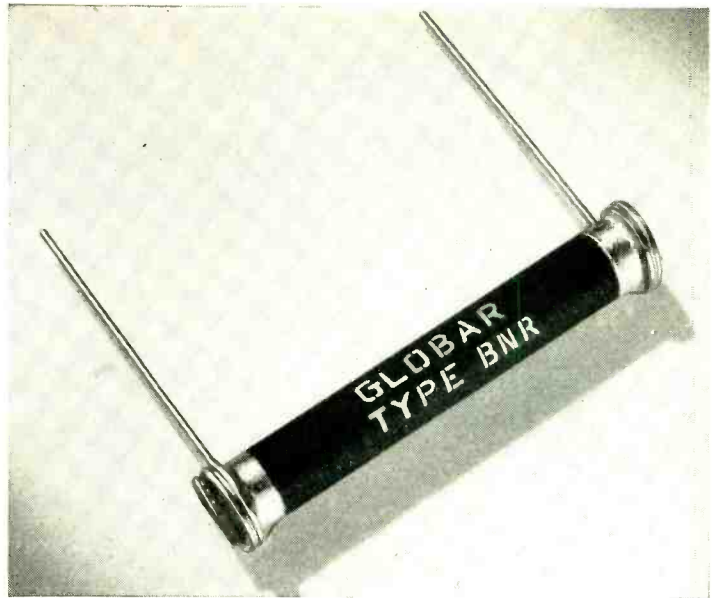

◀ Variation of gain with supply voltage for 12SK7 pentode in circuit using linear resistors and voltage sensitive (non-linear) resistors.

→ Circuit using voltage-sensitive resistors has voltage divider returned to ground through cathode resistor.

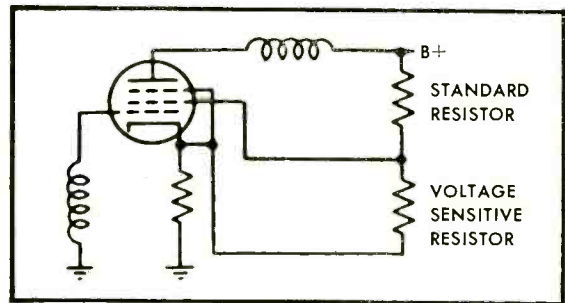

Varying supply voltages need *not* affect performance of pentode amplifiers. A GLOBAR<sup>®</sup> Type BNR Voltage Sensitive Resistor in the low potential section of the voltage divider—returned to ground through the cathode resistor, as shown in this circuit for a 12SK7—effectively limits gain fluctuations to within  $\pm 0.2\%$  when supply voltage varies from  $-10\%$  to  $+10\%$ . The same supply variation in a conventional circuit, with a regular series dropping resistor, results in fluctuations up to  $\pm 2.5\%$ ... more than 12 times as great.

GLOBAR BNR varistors give similar stabilization with nearly all r-f pentodes—and some beam pentodes. Our engineers will work with you on any voltage stabilization problem you have... without obligation. Write Dept. EL 87-43, The Carborundum Company, Niagara Falls, New York.

HOW YOU CAN USE GLOBAR TYPE BNR VARISTORS	
PRODUCT	APPLICATIONS
<b>Television Receivers, Cathode-ray Oscilloscopes</b>	Automatic picture-width control; surge limitation to protect tubes.
<b>Communications Equipment</b>	Automatic signal-strength control; surge limitation to protect tubes.
<b>Relays, Solenoids, Vibrating Contact Devices, etc.</b>	Reducing surge voltage peaks to limit arcing, insulation stresses.
<b>Small Motors</b>	Surge limitation to reduce arcing of contact points.
<b>Low voltage devices</b>	Spark reduction to lower interference on radio and television.
<b>Electronic circuits</b>	Voltage stabilization; surge limitation; generation of unusual wave shapes, harmonics; DC control of AC resistance; volume compression.

# GLOBAR<sup>®</sup>

## Ceramic Resistors

VOLTAGE SENSITIVE • CONVENTIONAL • TEMPERATURE SENSITIVE

by **CARBORUNDUM**

REGISTERED TRADE MARK

87-43



temperature & low voltage characteristics

# N.U. UNION DIODES

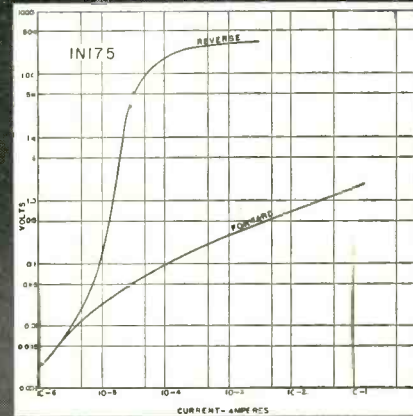
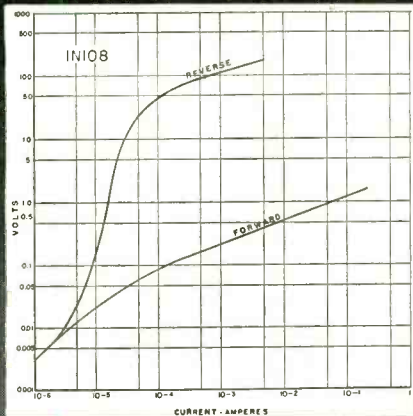
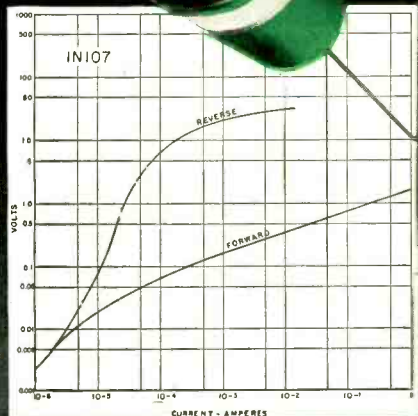

FORWARD & REVERSE CHARACTERISTICS OVER CURRENT & VOLTAGE RANGES

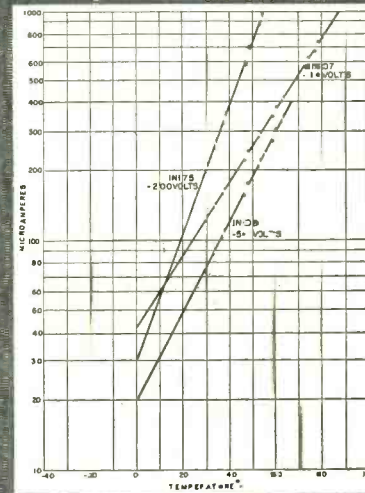
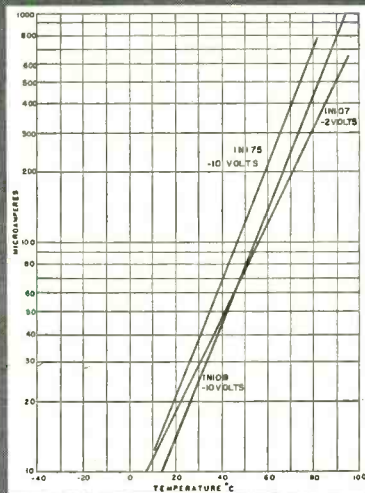
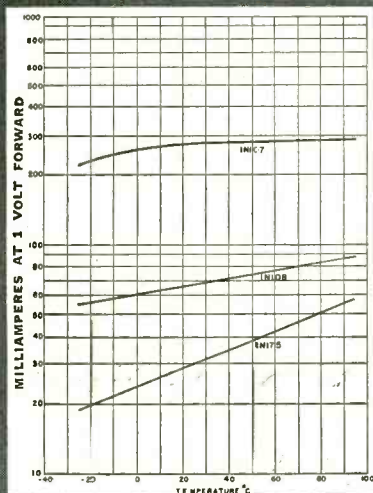

FORWARD & REVERSE CHARACTERISTICS UNDER TEMPERATURE CHANGES

ACTUAL SIZE



Your inquiries are invited on the many uses of Union Diodes exclusive with National Union. You will find that Union Diodes have characteristics particularly useful to the circuit designer interested in small signal and pulse applications. For example, the turn-on and turn-off time of the 1N107 is equal or superior to most point-contact diodes.

The accompanying charts show the Union Diode's behavior with temperature variations. Also plotted, over wide ranges of voltage and current, are their forward and reverse characteristics.

Important to you is the fact that Union Diodes are produced by the electronics engineers who helped pioneer the original research and development leading to such devices.



**NATIONAL UNION RADIO CORP.**  
HATBORO, PENNSYLVANIA



precision connectors by Continental



THESE CONNECTORS ARE ACTUAL SIZE

- Series SM-20.....Sub-Miniature Rectangular Connectors
  - Series 20.....Miniature Rectangular Connectors
  - Series H-20 .....Hermetical Seal Miniature Rectangular Connectors
  - Series C-20.....Miniature Hexagonal Connectors (Vibration Proof)
  - Series EZ-16.....Easy Release Power Connectors (Spring Loaded contacts)
  - Series 16.....Rectangular Power Connectors
  - Series 14.....Rectangular Power Connectors
  - Series PC.....Printed Circuit Connectors
  - Miniature Precision Stand-offs
- SPECIAL DESIGNS**—submit your connector problems to our engineering department.

# Continental Connectors

ELECTRONIC SALES DIVISION DeJUR-AMSCO CORPORATION

Write Dept. EC-4, DeJur-Amsco Corporation  
45-01 Northern Blvd., Long Island City 1, N. Y.



FIRST FOR

*Microscopic* PRECISION

OUR OBJECTIVE

**SPECIFY**

*Micro*

**BEARINGS**

TO MEET DESIGN NEEDS IN SMALL BEARINGS . . . . .

by providing design engineers in this country with precision bearings of improved performance through techniques capable of volume production at Microscopic tolerances and sizes.

**A MICRO FIRST** in improved performance. Precision RETAINER Bearings. In 1950, MICRO introduced retainers to the small bearing field. By separating the balls with retainers higher speeds and lower friction is possible. MICRO was also first to provide ground outer races.

**THE MICRO FAMILY OF RETAINERS ▼**



RIBBON  
RETAINER



CROWN  
RETAINER



MACHINED  
METAL  
RETAINERS



PHENOLIC PLASTIC



SPRING  
SEPARATOR

ENLARGED 3 X

**A MICRO FIRST**



THE NEW RIBBON R2 DOES NOT WIND-UP HANG-UP OR FALL OUT

For Easier Mounting, Simplified Design and Lower Machine Costs, Specify Micro Flange Type

**NEW HAMPSHIRE BALL BEARINGS, INC.**  
PETERBOROUGH, N. H.

**MICRO CIRCLE**

**TELEPHONE 424**



# Look to PHELPS REALISTIC APPROACH TO

**PRACTICAL KNOWLEDGE** of magnet wire application problems and trends.

**CONTINUING INVESTIGATION** of existing insulations to improve quality and performance.

**EXHAUSTIVE TESTING** and evaluation of new organic and inorganic insulation materials to determine fundamental properties and application possibilities.

**ENGINEERING ASSISTANCE** in selection and use of exactly right magnet wire for specific motor, transformer or coil.

*First for Lasting Quality—from Mine to Market*



# DODGE for a MAGNET WIRE RESEARCH!

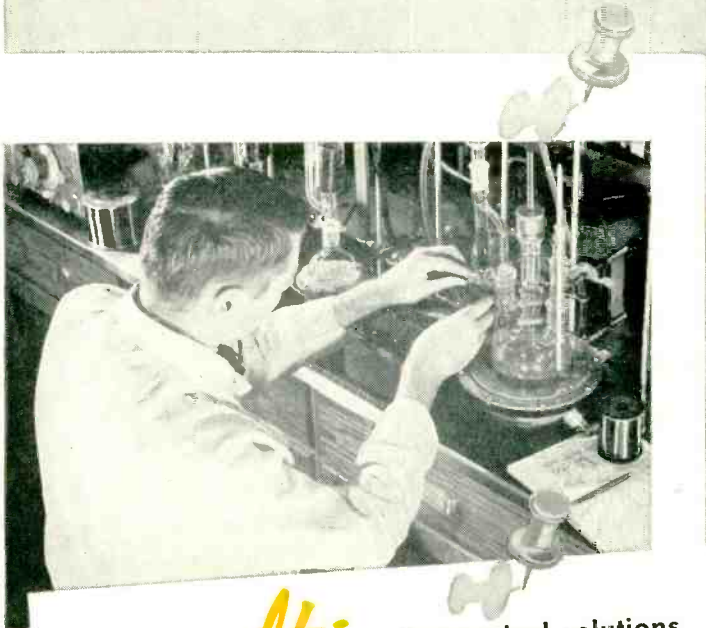

**Result:** Economical solutions to many varied and complex application problems!

The magnet wires pictured here illustrate the wide range of the Phelps Dodge line. Some of these wires—developed specifically by Phelps Dodge to answer special problems—suggest unlimited new applications for the future with overall savings to the user. Bondeze and Sodereze are examples of this kind of research.

Any time magnet wire is your problem, consult Phelps Dodge for the quickest, easiest answer!

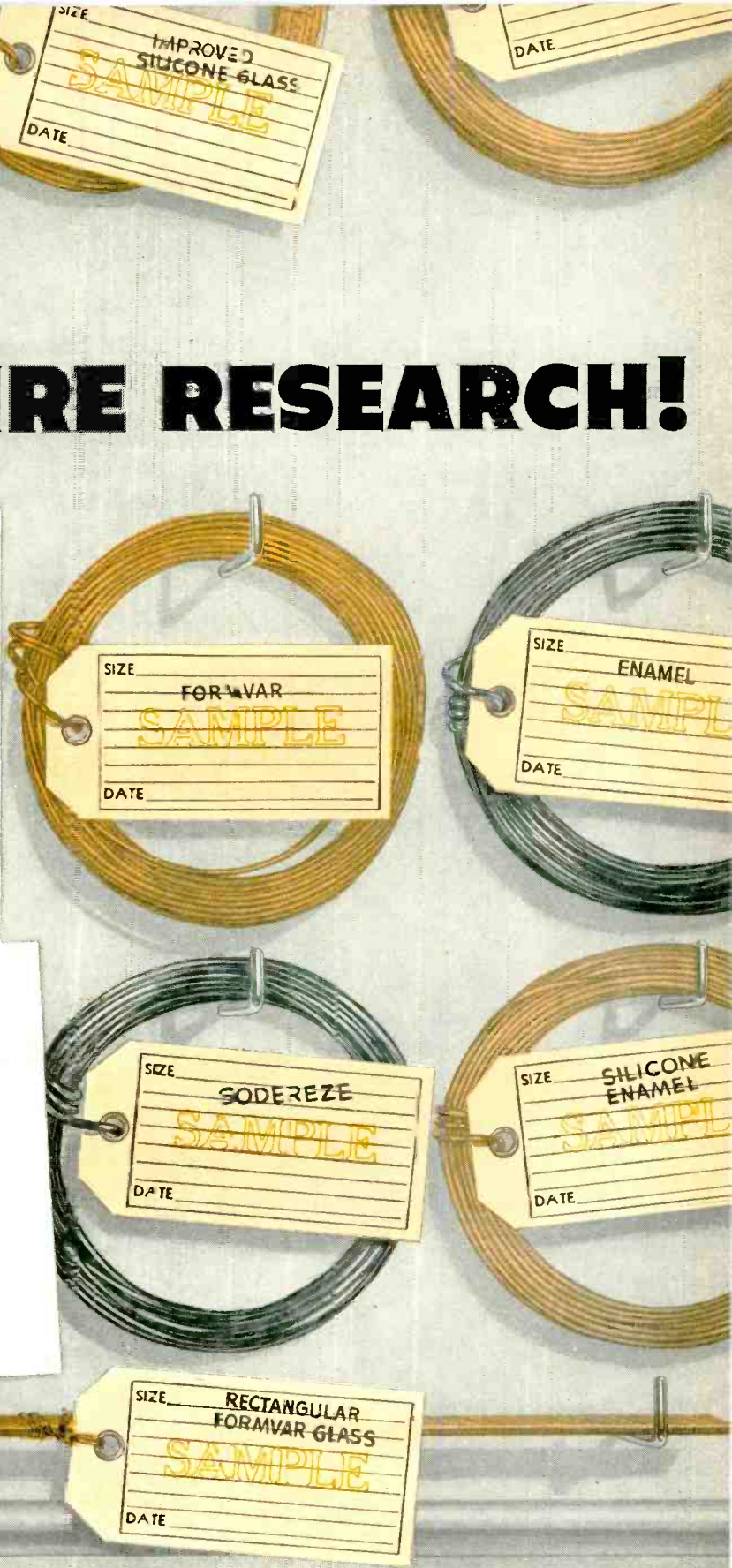

**PHELPS DODGE COPPER PRODUCTS  
CORPORATION**

**INCA MANUFACTURING DIVISION**  
FORT WAYNE, INDIANA

**A career in**

# advanced electronic development

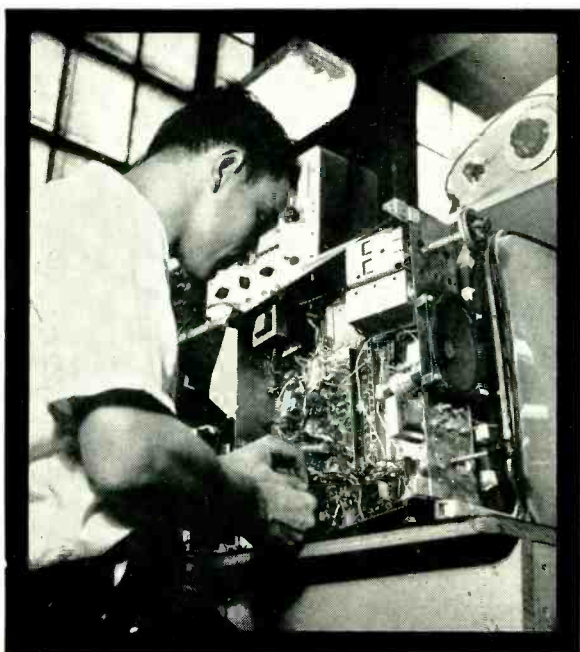

*Designers for Industry, Inc.* is helping many well-known electronics manufacturers meet the "challenge of change" by providing a pool of technical talent unsurpassed by any product development organization.

Our 180-man engineering organization not only generates product ideas. We are also equipped, by experience and facilities, to carry the project through its various stages of development to a final, tested, pre-production model.

*In the Electronics field*, the DFI organization has built a particularly strong background in miniaturization and modular construction techniques. Some of the many types of development projects we handle are listed below.

*Opportunities for unlimited advancement* are available at DFI for engineers who have proven records in electronics, electrical, electromechanical, hydraulic and mechanical engineering. Write for further information regarding opportunities in creative engineering work at DFI, as well as DFI employee benefits.

*DFI development  
work in electronics  
includes:*

COMMUNICATIONS  
VHF, UHF, and HF Receivers  
Television Receivers  
VHF and UHF Transmitters  
Microwave Systems  
Mobile and Specialized  
Military Equipment

MISSILE GUIDANCE  
Systems  
Servomechanisms

RADAR  
Circuitry  
Servo Systems  
Display Systems  
Mechanisms  
Beacons  
Systems  
Fire Control

CONTROLS  
Electromechanical  
Servomechanisms

COMPUTERS  
Test Equipment  
Systems Planning  
Circuitry  
Servomechanisms  
Intricate High-speed  
Mechanisms

COMPONENT PARTS  
Mechanisms  
Evaluation Programs  
Special Components

**DESIGNERS FOR INDUSTRY, Inc.**

2915 Detroit Avenue

• CLEVELAND 13, OHIO

Incorporated 1935





*Now...at no increase in price...*



# HERMETICALLY SEALED Germanium Diodes



## JAN TYPES

**COMPLETE METAL TO CERAMIC SEAL.** Gas-tight ceramic cases with metalized ends permit solder seal to nickel pins.

**MOISTURE PROOF.** These new diodes exceed the requirements of JAN humidity specifications.

**REQUIRED ELECTRICAL PROPERTIES.** More than two years of development were necessary to perfect this combination of hermetic seal and superior performance.

**MECHANICAL STABILITY.** Platinum-rhuthenium whisker is welded to the germanium pellet.

**LONG-LIFE.** The elimination of moisture effects adds years to the life of your equipment!



Production quantities of hermetically sealed types 1N69, 1N70, and 1N81 are now available. Hermetically sealed commercial types are expected to be ready in a few months. Be sure to include them in your design planning now! For complete information write: *General Electric Company, Section X444, Electronics Park, Syracuse, New York.*

- A. Ceramic Case
- B. Solder
- C. Germanium Pellet
- D. Weld
- E. Platinum-Rhuthenium Whisker
- F. Weld
- G. Solder
- H. Nickel Pin
- I. Weld
- J. Leaded Copper Clad Wire

### MAXIMUM RATINGS (At 25°C)

Hermetically Sealed DIODES	1N69	1N70	1N81*
Peak Inverse Voltage	75	125	50
Continuous Operating Inverse Voltage	60	100	40
Min. Forward Current (MA) at +1V	5.0	3.0	3.0
Max. Inv. Current (μc)			
At -50V	850	300	—
At -10V	50	25	10
AV Rectified Current (MA)	40	30	30
Peak Rectified Current (MA)	125	90	90
Surge Current (MA)	400	350	350

\*JAN approval applied for

### NEWS FROM OUR ADVANCED DEVELOPMENT LABORATORIES

● A four-terminal junction transistor has been developed having a region of negative output impedance. This switching device is unique in that two coincident trigger signals are required to turn it on. Thus two gating functions may be accomplished by a single transistor.

*You can put your confidence in—*

**GENERAL  ELECTRIC**

designer's

# INSTRUMENT guide

## FOR PRODUCTION MACHINES —

WESTON "per-cent load" ammeters and wattmeters make it easy for operators to secure optimum production from lathes, milling machines, automatics, grinders, etc. Prevent overloading — reduce tool breakage — assure uniform quality with fewer rejects. Other scale calibrations also available.

## FOR ELECTRONIC EQUIPMENT —

WESTON panel instruments are available in 1½", 2½", 3½", 4½" and 5½" sizes in all required ranges and types, including d-c, a-c, rectifier and thermocouple types. Approved ruggedized and sealed instruments available in all types in 2½" and 3½" sizes. Special panel bulletins give complete information.

## FOR RPM MEASUREMENTS —

WESTON electrical tachometer indicators are available with scales calibrated in RPM, or any function of RPM, such as feet per min. — pieces per hour, etc. Indicators can be mounted remotely; and if required, more than one indicator can be operated from one generator. Special compact, lightweight a-c and d-c generators permit wide flexibility in mounting and connection arrangements. Directly indicate speeds from 1 RPM to 40,000 RPM or higher.

## FOR TEMPERATURE MEASUREMENTS —

WESTON Bi-metal thermometers are rugged and dependable, and are readily adaptable for built-in needs. Available in angle and straight stem types, stem lengths from 2" to 72", scale lengths 3.40" to 9", ranges low as -100°F. and high as +1000°F. Corrosion resisting stainless steel stems — accuracy 1° of thermometer range.

Literature on any of the above instruments sent on request.  
WESTON Electrical Instrument Corporation, 614 Frelinghuysen Avenue, Newark 5, New Jersey.

6402

**WESTON**  
*Instruments*

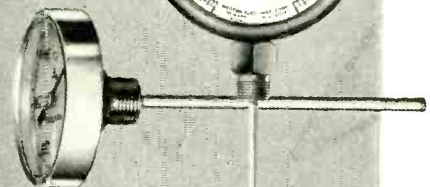
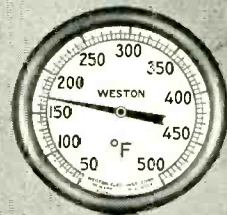
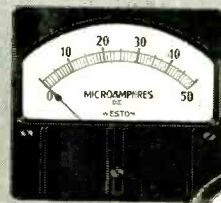
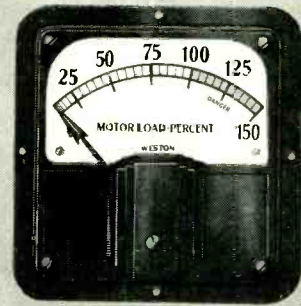





## Recommends Materials Best Adapted to your Vibration Control Requirements

Metal—Natural Rubber—Silicone—Neoprene—Buna S—Buna N—and others are selected by LORD Engineers to satisfy your specific en-

vironmental conditions and assure the most economical solution of your vibration control problem.

LORD research is constantly de-

veloping and evaluating new materials and processes to insure that the most complete line of vibration control mountings is at your disposal.

<b>LCS ANGELES 28, CALIFORNIA</b> 7048 Hollywood Blvd.	<b>DALLAS, TEXAS</b> 313 Fidelity Union Life Building	<b>PHILADELPHIA 7, PENNSYLVANIA</b> 725 Widener Building	<b>DAYTON 2, OHIO</b> 410 West First Street
<b>DETROIT 2, MICHIGAN</b> 311 Curtis Building	<b>NEW YORK 16, NEW YORK</b> 280 Madison Avenue	<b>CHICAGO 11, ILLINOIS</b> 520 N. Michigan Ave.	<b>CLEVELAND 15, OHIO</b> 811 Hanna Building

**LORD MANUFACTURING COMPANY • ERIE, PA.**

Over 27,000 basic designs and their variations are already available from which to choose.



*Headquarters for*  
**VIBRATION CONTROL**

# "DRIVER-HARRIS ALLOYS

have contributed greatly  
in making  
our performance possible"

says



CHICAGO TELEPHONE SUPPLY  
*Corporation*

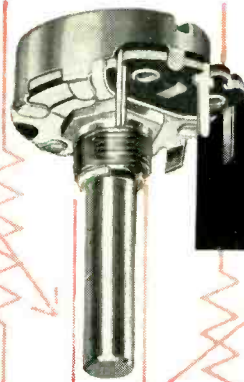

CTS 45 Series  $1\frac{1}{16}$ " dia.  
variable composition resistor  
with blade type printed  
circuit terminals.

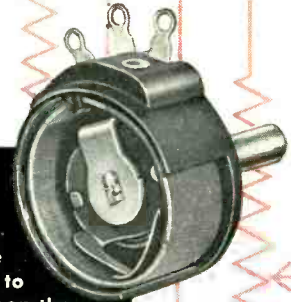

Cutaway view of CTS 252  
Series,  $1\frac{1}{4}$ " diameter  
2 watt wirewound variable  
resistor. The total resistance  
can be varied from 3 ohms to  
15,000 ohms, depending upon the  
size and type of resistance wire used.

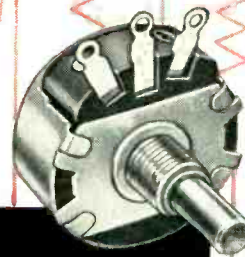

CTS 252 Series  
2 Watt  
Wirewound  
3-15,000 ohms

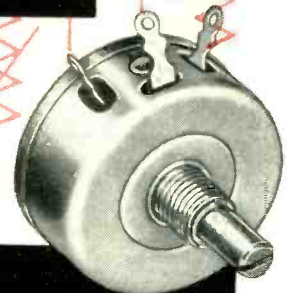

CTS 25 Series  
2 Watt  
Wirewound  
3-25,000 ohms

Chicago Telephone Supply Corporation has succeeded in accomplishing two things indeed difficult to combine, as summed up in their slogan "Specialists in Precision Mass Production of Variable Resistors." They manufacture the high quality variable resistors indispensable to radio, television, and military electronics. In fact, they are the world's largest producers of variable resistors.

To achieve this outstanding record, they concentrate their entire effort on variable resistors, they maintain close control over all manufacturing processes, and fabricate their own parts under close supervision from basic raw materials. Naturally, they make no secret of the importance to them of high quality materials.

States Chicago Telephone: "To make our raw material program effective, we have stressed the

importance of dependable, quality-minded sources of supply. Driver-Harris is a supplier with these qualities, and *Driver-Harris alloys have contributed greatly in making our performance possible.* For many years we have been using Driver-Harris Nichrome\*, Karma\*, Advance\*, and other D-H Alloy wires for our resistance windings, with excellent results. We can strongly endorse Driver-Harris' dependability and high quality products."

Nichrome, Advance, and Karma are at your service too, as are more than 80 other D-H alloys developed for application in the electrical and electronic fields. If a high degree of resistance and absolute uniformity of output are "musts" for your product, let us have your specifications. We'll be glad to make recommendations based on your specific requirements.

\*T.M. Reg. U.S. Pat. Off.

Sole producers of Nichrome, Advance, Karma



## Driver-Harris Company

HARRISON, NEW JERSEY

BRANCHES: Chicago, Detroit, Cleveland, Louisville, Los Angeles, San Francisco

In Canada: The B. GREENING WIRE COMPANY, Ltd., Hamilton, Ontario.

MAKERS OF THE MOST COMPLETE LINE OF ELECTRIC HEATING, RESISTANCE, AND ELECTRONIC ALLOYS IN THE WORLD



# VOLTAGE REGULATED POWER SUPPLY



## Model 2400

### MULTIPLE POWER SUPPLY

OUTPUT	VOLTS	CURRENT	REGULATION	RIPPLE
1	0-150 Bias	0-5 Ma.	*	5 Mv.
2	0-400	0-150 Ma.	0.5%	5 Mv.
3	0-400	0-150 Ma.	0.5%	5 Mv.
2 & 3 Parallel	0-400	0-300 Ma.	0.5%	5 Mv.
2 & 3 Series	0-800	0-150 Ma.	0.5%	5 Mv.
4	6.3 AC	10 Amp.	★	
5	6.3 AC	10 Amp.	★	

REGULATION: As shown in table for both line fluctuations from 105-125 volts and load variation from minimum to maximum current.

\*Regulation Bias Supplies: 10 millivolts for line 105-125 volts, 1/2% for load at 150 volts.

★All AC Voltages are unregulated.

# KEPCO

# LABORATORIES



131-38 SANFORD AVENUE • FLUSHING 55, N. Y.

INDEPENDENCE 1-7000

NEW POWER SUPPLY CATALOG AVAILABLE ON REQUEST. WRITE DEPARTMENT 789

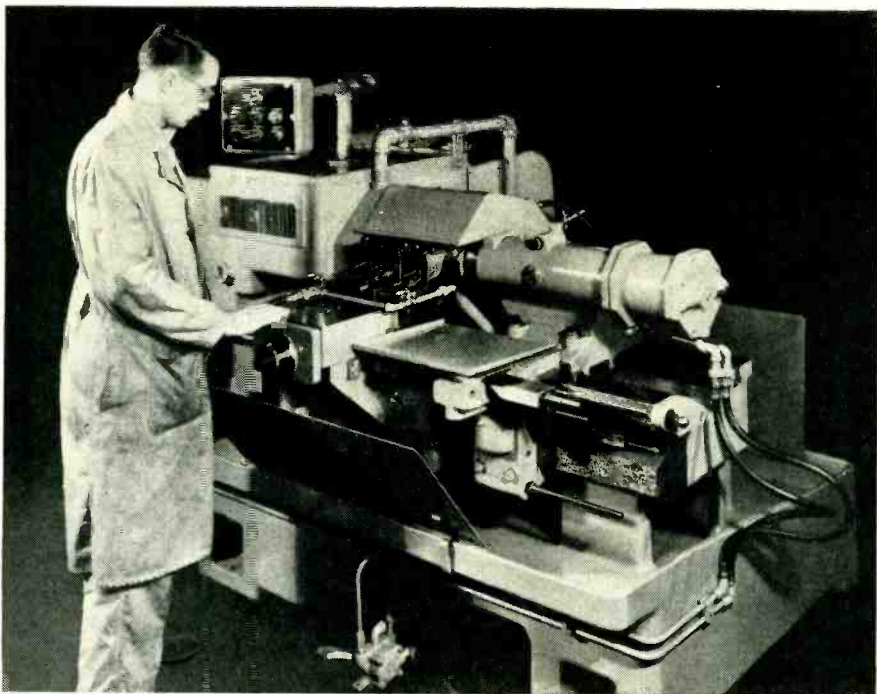

FASTER STARTING AND STOPPING HELPS THIS AUTOMATIC LATHE TO PRODUCE MORE

## General Electric Selenium Rectifiers Help Make This Lathe More Productive

Speeding up starting and stopping operations has increased the productivity of many of today's finest machine tools. In the Sunstrand automatic lathe pictured above, an electric brake and clutch combination starts and stops the machine spindle. Another electric brake provides a fast stop when the tool carriage is advanced to the work, or backed off to the unloading position.

**D-C POWER** to operate the electric brakes and clutch on this lathe is supplied by General Electric selenium rectifiers shown in the smaller photograph. Their high quality (see C.E.

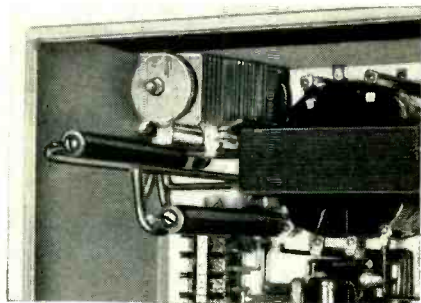

D-C POWER for the lathe's clutch and brakes comes from this selenium rectifier.

Hamann's article at right) makes G-E selenium rectifiers ideal for almost all machine tool applications.

**TOP PERFORMANCE** of G-E selenium rectifiers is the result of a unique "evaporation" process and careful inspection and testing. Besides providing stacks with exceptionally low forward voltage drop and low reverse leakage, this process assures greater uniformity of these characteristics among different stacks. These qualities last in service. On test in the laboratory, and on-the-job in almost every field of application, G-E selenium rectifiers are demonstrating their extremely slow aging.

**OTHER APPLICATIONS** for G-E selenium rectifiers include supplying power to operate d-c relays in various control circuits and as components in electronic equipment. A complete range of ratings is available in either open stacks or various types of sealed cases to meet special operating conditions. Contact your nearest G-E Apparatus Sales Office for complete information, or write Section 461-33, General Electric Company, Schenectady 5, New York.

## METALLIC RECTIFIER FACTS FOR ENGINEERS

Quality

by C. E. Hamann

One of the most overworked terms used in the selenium rectifier industry is "high quality." Every manufacturer claims "high quality" for his product. Every user wants "high quality" in the selenium components he buys because the quality of the end device can be no higher than that of the components assembled into it.

There are many yardsticks for measuring the quality of a selenium stack. Electrical characteristics, for example: low forward drop and low reverse leakage. Often one is sacrificed in favor of the other.

LOW FORWARD DROP

LOW LEAKAGE

UNIFORMITY

STABILITY

RELIABILITY

Which "yardstick" measures quality?

Real quality insures that both the forward and the reverse characteristics are good.

Uniformity of characteristics is another yardstick. If the characteristics vary from stack to stack the performance of the end equipment will be questionable.

Stability is another important standard in determining quality. The initial characteristics must be good, but they must stay good and not deteriorate with time and use.

Reliability is still another measure of quality. No matter how liberal the manufacturers replacement policy, frequent failures in the field are costly to the equipment manufacturer, and annoying to the equipment user.

All of these yardsticks must be considered carefully in determining quality. To really earn the title of "high quality" a selenium stack must measure up to a high standard of performance by every one of these yardsticks.

C. E. Hamann

General Electric Company

*You can put your confidence in—*

**GENERAL  ELECTRIC**





# Information Wanted...

## about your uses for

# C-D-F METAL CLADS

Did you know that C-D-F supplies a full range of metal clad laminates in both Dilecto and Teflon grades? With mounting interest in printed circuits it pays to consider the respective advantages of these new C-D-F materials . . . it also pays to line up all the Information Wanted facts and discuss your specific application with your C-D-F sales engineer (Offices in principal cities). He's a good man to know!

Grade of laminate  
 Sheet size  
 Overall thickness  
 Thickness tolerances  
 a. Standard NEMA  
 b. Closer to erances requiring sanding  
 Metal: Copper  Aluminum   
 Other  Thickness  
 Metal facing: One side  Both sides   
 Minimum bond strength  
 Punching requirements  
 Any other specifications

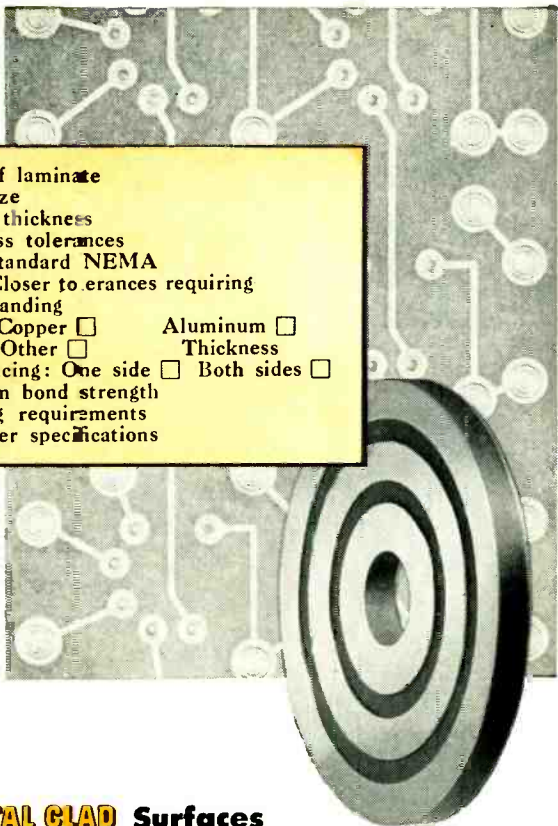

### Dilecto METAL CLADS

Printed circuits depend upon stable, uniform core material and Dilecto has years of proven insulation service (Dilecto is a laminated thermosetting plastic made only by C-D-F from paper, cotton, glass or asbestos fabric base, or a mat base). Normally phenolic or melamine impregnating resins are used for METAL CLAD sheet stock. There are many grades of Dilecto, but only the better electrical grades are supplied with metal foil surfaces. Outstanding is C-D-F grade XXXP-26, a hot punching grade with high insulation resistance, low and stable dielectric losses and excellent moisture resistance. Green color. New C-D-F Catalog GF-53 gives complete data on Dilecto grades. Write for your copy today.

### Teflon METAL CLADS

Glass fiber cloth is first coated with Teflon resin and laminated into C-D-F GB-112T sheet stock. This base withstands high heat (200°C. maximum operating temperature) with the dissipation factor and dielectric constant extremely low over a wide frequency range. No adhesive film is needed to bond metal to the Teflon laminate, thus the inherently good electrical properties of the core material are maintained. GB-112T has practically zero water absorption, so a METAL CLAD with this core offers consistent high insulation resistance with excellent stability of dielectric loss properties.

### METAL CLAD Surfaces

Copper foil (usually .00135" or .0027" thick) is bonded on one or both faces of the sheet grade of Dilecto selected. The foil used is a special grade of electrolytic deposition copper particularly adaptable for cementing onto laminated materials. An adhesive film is placed between the metal and the Dilecto, and cemented during the pressing and curing cycle. When closer tolerances are required C-D-F sands the Dilecto to the required thickness before bonding. Aluminum, silver, or other alloys of various metals may be supplied.

### Better Bond Strengths

One of the most important physical properties of a metal clad product is its peel strength, the pounds pull required to separate the foil surface from the core material. Working with years of laminating know-how, C-D-F has been successful in obtaining the following average test values for its METAL CLAD sheet stocks:

	Lbs. pull per 1" width
XXXP-26 plus .00135" copper	5 to 8
XXXP-26 plus .0027" copper	7 to 10
XXXP-26 plus .0015" aluminum	9 to 12
GB-112 Teflon plus .00135" copper	6 to 9

Sheet sizes: Dilecto grades — 38 x 38", 38 x 42"  
 Teflon grades — 16 x 36"

THE NAME TO REMEMBER FOR PRINTED CIRCUIT METAL CLAD STOCK

*Continental-Diamond Fibre Company*  
 NEWARK 16, DELAWARE



\*DU PONT TRADE MARK

Write for new C-D-F General Catalog GF-53, new C-D-F Teflon folder T-52, and talk METAL CLADS with your C-D-F sales engineer.

# Look what's happened to the "cat's whiskers"

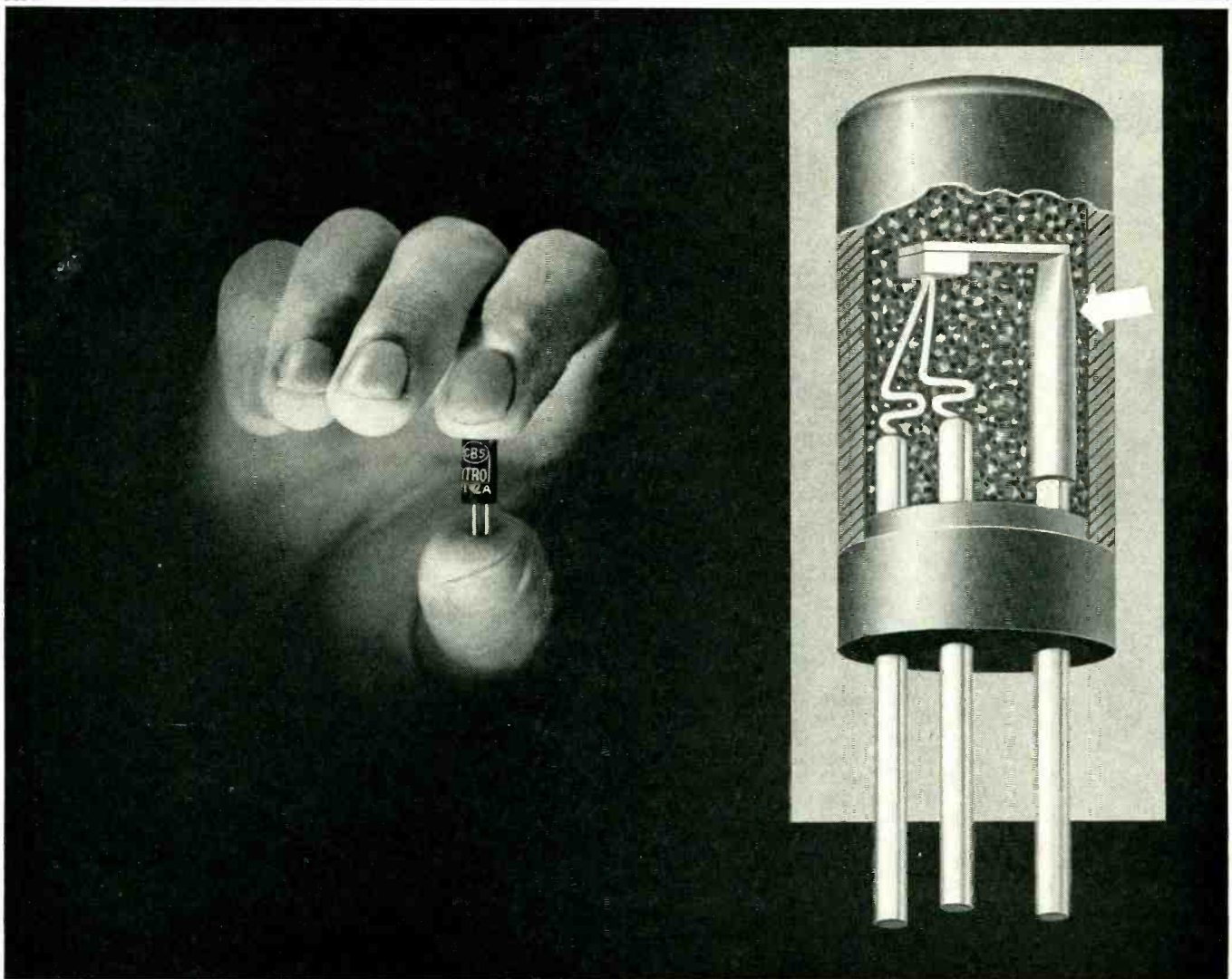

A miracle that can hide behind your thumb-nail is the hottest electronics news in years. Modernized descendant of the Twenties' crystal diode with its cat's whisker, the transistor threatens to send many vacuum tubes the way of old head sets.

No matter which ultimately gets the nod—tube or transistor—Superior will be in there pitching. Superior seamless and Lockseam\* nickel cathodes, anodes and grid cups are familiar to you in vacuum tubes. Now Superior tubing is going into transistors.

CBS-Hytron, a division of Columbia Broadcasting System,

Inc., uses Superior tubing for the L-shaped bracket that holds the germanium crystal in their PT-2A point-contact transistor. For this purpose they purchase tiny tubes—.032" I.D. x .003" wall. .193" long, drawn from seamless nickel. Added to the good welding, soldering and formability characteristics of the metal, Superior manufactures the brackets to the close tolerances CBS-Hytron must have.

Whether you are for the old or new order in electronics, if you need an idea or an analysis in small tubing, Superior is the first place to look. Superior Tube Company, Electronics Division, 2500 Germantown Ave., Norristown, Pa.

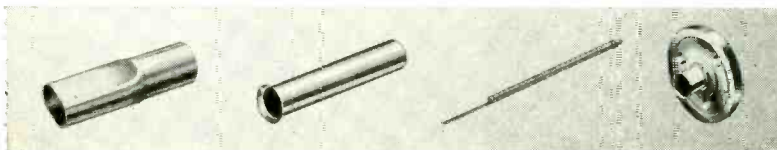

Seamless Nickel Anode. Flattened one end. .500" O.D. x .025" Wall x 1.625" long.

Seamless Nickel Cathode. Round, flanged one end. .070" / .072" I.D. x .0025" Wall. .295" long.

Lockseam\* Nickel Cathode. Round, tabbed, single bead. .045" O.D. x .0021" Wall. .27 mm long.

Disc Cathode .121" O.D. .312" long.



All analyses .010" to 3/8" O.D.  
Certain analyses in Light Walls up to 2 1/2" O.D.

Many types of nickel cathodes—made in Seamless and Lockseam\* from nickel strip, disc cathodes, and a wide variety of anodes, grid cups and other tubular fabricated parts are available from Superior. For information and Free Bulletin, address Superior Tube Company, Electronics Division, 2500 Germantown Avenue, Norristown, Pa.

\*Manufactured under U.S. Patents.



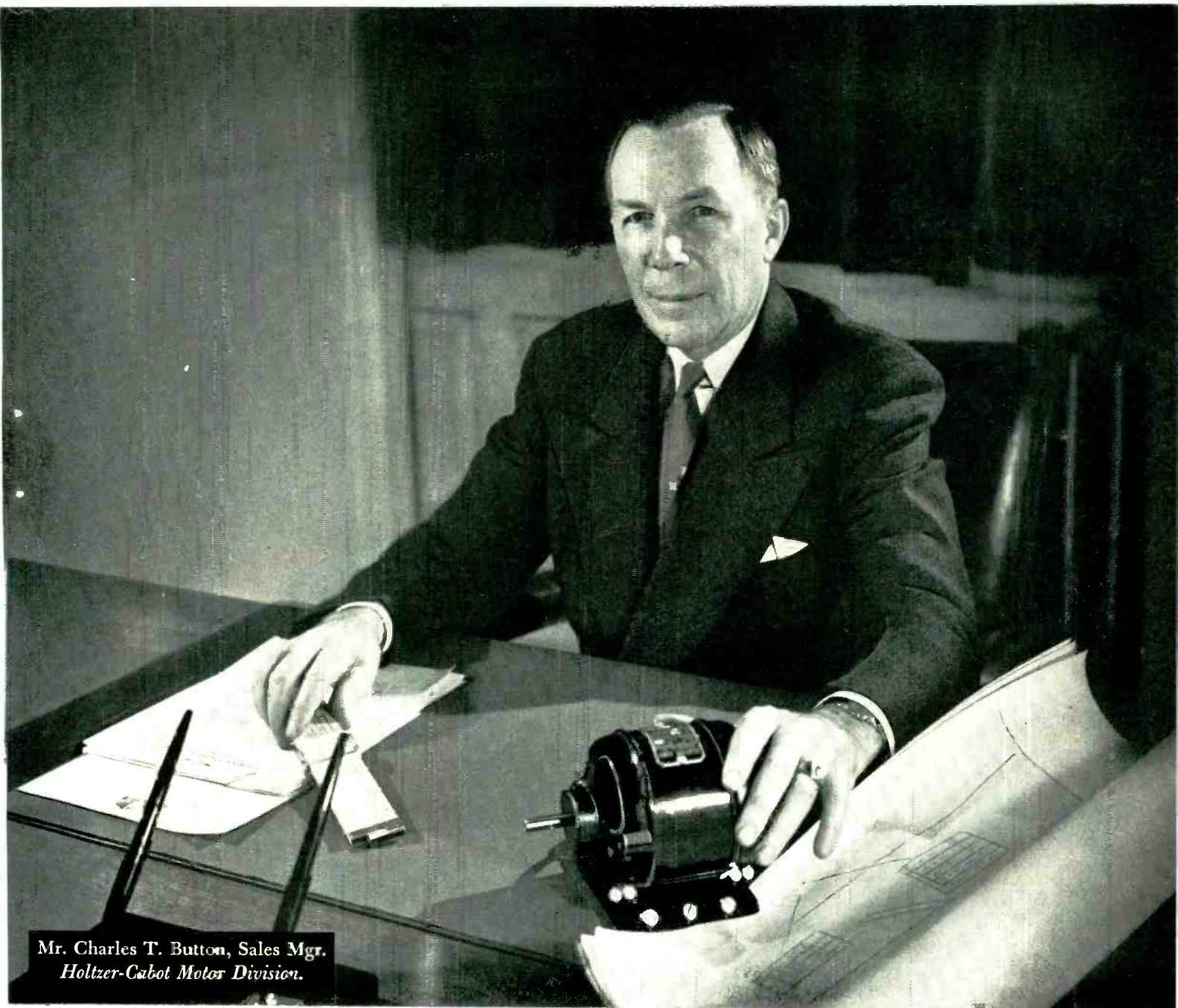

Mr. Charles T. Button, Sales Mgr.  
Holtzer-Cabot Motor Division.

## “Put our Motor Experience to Work for You!”

“Here at Holtzer-Cabot, we have a superb team of motor specialists who can – and do – solve practically any motor problem that is given them.

“I’ve been connected with the motor business for nearly 30 years, yet every now and then our design and development engineers will come up with a motor innovation, adaptation or solution that makes me blink!

“Our sales representatives, too, are something to be proud of. They’re men of long experience in motor application problems, they have a thorough knowledge of the business,

and give customers sound advice and help.

“If you have a problem in small-motor applications, take advantage of Holtzer-Cabot’s organizational skill and depth of experience. The same engineering ingenuity and manufacturing excellence that have made Holtzer-Cabot the standard of high quality in motors and related electrical apparatus for 78 years are yours to command.

“Write, wire or phone. There is, of course, no obligation on your part by doing so. Your problem will get expert – and prompt – attention.”

**NATIONAL PNEUMATIC CO., INC.** AND **HOLTZER-CABOT** DIVISIONS

125 Amory St., Boston 19, Mass.  
PHILADELPHIA • CHICAGO • NEW YORK • CLEVELAND  
Sales Service Representatives in Principal Cities throughout the Free World



Designers and manufacturers of mechanical,  
pneumatic, hydraulic, electric and electronic  
equipment and systems





**ELECTRICAL  
CORDS  
KEEP YOUR APPLIANCES  
IN SERVICE**

**MANUFACTURERS AND SERVICE MEN WHO SERVE BEST**

*Specify*

**Belden**

**WIREMAKER FOR INDUSTRY**



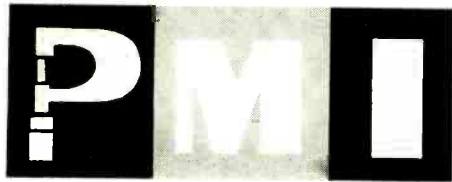
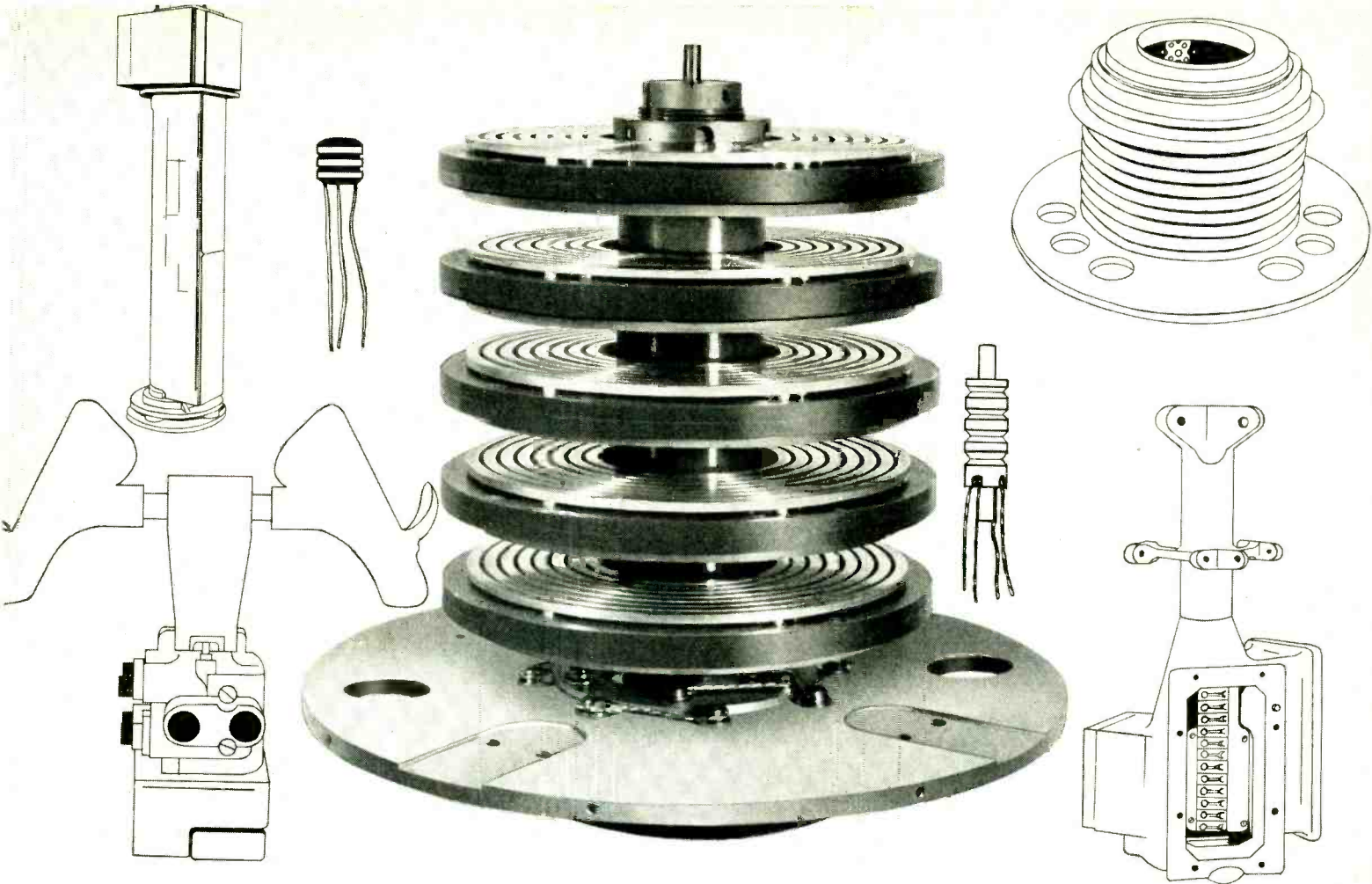

## for ELECTROMECHANICAL INSTRUMENT COMPONENTS

For more than 12 years, P M Industries has specialized in designing, developing, and producing electromechanical instrument components of widely divergent natures. The principal concern has been with slip ring assemblies (from 8-foot, 500-ring assemblies down to miniatures for synchros, gyros, and resolvers), but PMI also maintains a contract manufacturing service, producing such devices as operator control assemblies for anti-aircraft directors, electrical winches, guided missile components.

The years spent solving problems imposed by a diversity of customer specifications have abundantly endowed PMI with experienced engineers and skilled technicians, backed up by complete laboratory and factory facilities. The combination may well be of value to you in helping solve troublesome component problems. Your inquiries are invited and will receive prompt attention.

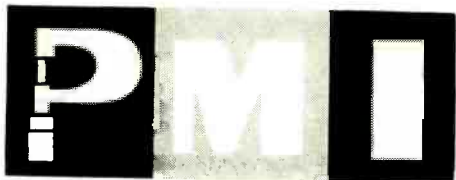

**PM Industries, Inc., Stamford, Conn.**  
 Design - Development - Production • Electro-mechanical Assemblies

# Selenium Rectifiers

**INTERNATIONAL  
RECTIFIER  
CORPORATION**

EL SEGUNDO  
CALIFORNIA

**Largest  
Range in the  
Industry**

- T  $\frac{1}{16}$ "
- U  $\frac{1}{8}$ "
- V  $\frac{1}{4}$ "
- Y  $\frac{3}{8}$ "
- Z  $\frac{1}{2}$ "
- X  $\frac{3}{4}$ "
- W 1"
- B2
- A5
- B5
- A10
- B10
- A15
- B-10-M

- A-1" x 1"
- B-1.2" x 1.2"
- C-1.5" x 1.5"
- L-2" x 2"
- D-3" x 3"
- E-4  $\frac{3}{8}$ " x 4  $\frac{3}{8}$ "
- N-5" x 5"
- J-4  $\frac{1}{4}$ " x 6"
- F-5" x 6"
- H-6  $\frac{1}{4}$ " x 7  $\frac{1}{4}$ "

Selenium Diodes  
Send for Bulletin 5D-1

Germanium Diodes  
Send for Bulletin GD-1

Hermetically Sealed  
Selenium Rectifiers

Metal Enclosed  
Selenium Rectifiers

Encapsulated  
Selenium Rectifiers

Pigtail Terminals

Ferrule Terminals

Stud Terminals

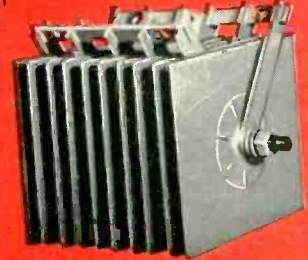

**POWER RECTIFIERS**  
Single Stack Ratings:  
125 ma to 2300 Amperes  
Single Plate Ratings:  
22 volts to 40 volts rms  
Send for Bulletin C-349

**CARTRIDGE TYPES**  
1.5 ma to 60 ma  
20 volts to 10,000 volts  
Send for Bulletin H-1

**PHOTOELECTRIC CELLS**  
Send for Bulletin PC-649

**INTERNATIONAL RECTIFIER CORPORATION**  
1521 E. GRAND AVE. EL SEGUNDO, CALIFORNIA. PHONE: OREGON 8-3778  
CHICAGO: 205 W. WACKER DRIVE. PHONE: FRANKLIN 2-3889  
NEW YORK: 501 MADISON AVENUE. PHONE: PLAZA 5-8665



**A 20-YEAR RECORD . . .**

# The Electric Power Companies' Case for Public Confidence

**An economic study of the record of the investor-owned electric power companies of the United States over the past twenty years underwrites their claim to public confidence today. A key factor of this record is set forth by the chart in the middle of this page. This shows that while the cost of living as a whole has almost doubled, the average price of electric energy for residential use in the United States has been cut in half.**

*performance of these companies during World War II, J. A. Krug, Director of the Office of War Utilities, said, "Power has never been too little or too late." The same can be said for the entire period of the past twenty years.*

*To be ready with enough power — on time — the electric power companies have expanded their production fourfold since 1933. This has required an investment of over \$17 billion in new*

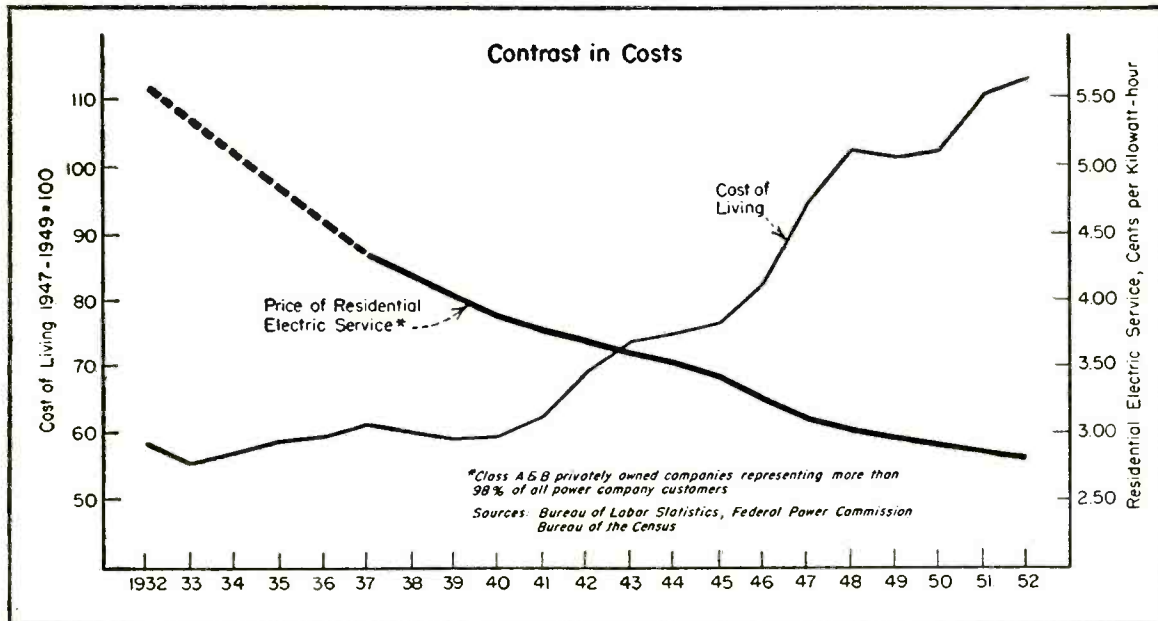

The average prices of industrial and commercial power also are much lower than they were twenty years ago.

Such a study confirms the record on other key accomplishments of the electric power companies during the past two decades.

*They have not failed, either in peace or war, to meet the nation's rapidly expanding electric power requirements. In paying tribute to the*

*facilities. To raise the funds for this investment they have enlisted the participation of about 3 million direct stockholders. Through life insurance companies, banks and similar institutions, about 90 million Americans — more than half of the nation's total population — have become investors in electric power companies. By thus relying on private investment for their expansion, the power companies have provided their*

plant and operating equipment without burden on the taxpayer.

In addition, the investor-owned companies have paid about \$12 billion in taxes to various governments — national, state and local — over the past twenty years. Unlike government-owned and -operated systems, they have received no public subsidies. When taxes and subsidies are taken into account, the rates for electricity charged by the investor-owned companies have been as low as, or lower than, those charged by government-owned and -operated systems.

Many Americans do not appreciate the job that the power companies have done over the past two decades. That is due, in part, to the public memory of financial abuses by some utility holding companies during the 1920's. This memory obscures a clear and unprejudiced view of the progress since those days. And some of the all-out advocates of reliance on government rather than on regulated private enterprise for the development of our power resources do their best to keep this memory of the past alive in the present.

### **An Impressive Case**

Some special cases of electric power development may involve problems for which the investor-owned companies are unable to provide full solutions. This may be true, for example, of some large multiple-purpose projects that combine electric power generation with related developments such as the improvement of navigation, flood control and the irrigation of arid lands. Some of the economic and administrative problems imposed by such projects are not well adapted to effective handling by private enterprise. Flood control and the improvement of navigation, for example, usually involve the provision of much costly service over and above the cost of producing power.

It is true, however, that in some cases development of the electric power side of multiple-purpose projects by private enterprise may well be more feasible than would appear from statements by some government power advocates. And the record indicates that even in those projects on which both the power generation and the other services are handled by public authority, it may well be desirable to have the investor-owned companies assume the transmission and distribution functions.

Our study of the record of the investor-owned and -operated companies over the past twenty

years has led us, of course, behind the statistics that bear on the wisdom of giving them a priority in the development of our power resources. It reveals that these enterprises are manned by people who, through lifetime experience, are peculiarly conversant with the needs of the communities they serve. They have given the consumer notably good service while conforming to standards set and enforced by public regulatory commissions. They have won the confidence of the investing public. By their nature and their experience they are competent to handle any power program that can be demonstrated to be economically sound.

### **The Paramount Public Interest**

By their economic performance during the last twenty years, the electric power companies have earned the confidence of the public. By relying on these companies to meet its electric power requirements the public will fully protect its economic interest in ample and efficient service at fair prices.

That is where our study comes out. Our findings do not touch the political consideration that private operation of electric utilities under public regulation is a safeguard against further concentration of both political and economic power in a federal government that already commands too great a concentration. But if these findings make an economic case for preferring power development by tax-paying business as against power development by governmental agencies, they clear the way for an appeal to the paramount public interest in safeguarding our personal and political freedoms against the further encroachment of government.

*This message is one of a series prepared by the McGraw-Hill Department of Economics to help increase public knowledge and understanding of important nationwide developments that are of particular concern to the business and professional community served by our industrial and technical publications.*

*Permission is freely extended to newspapers, groups or individuals to quote or reprint all or parts of the text.*

*Donald McGraw*  
PRESIDENT

**McGraw-Hill Publishing Company, Inc.**



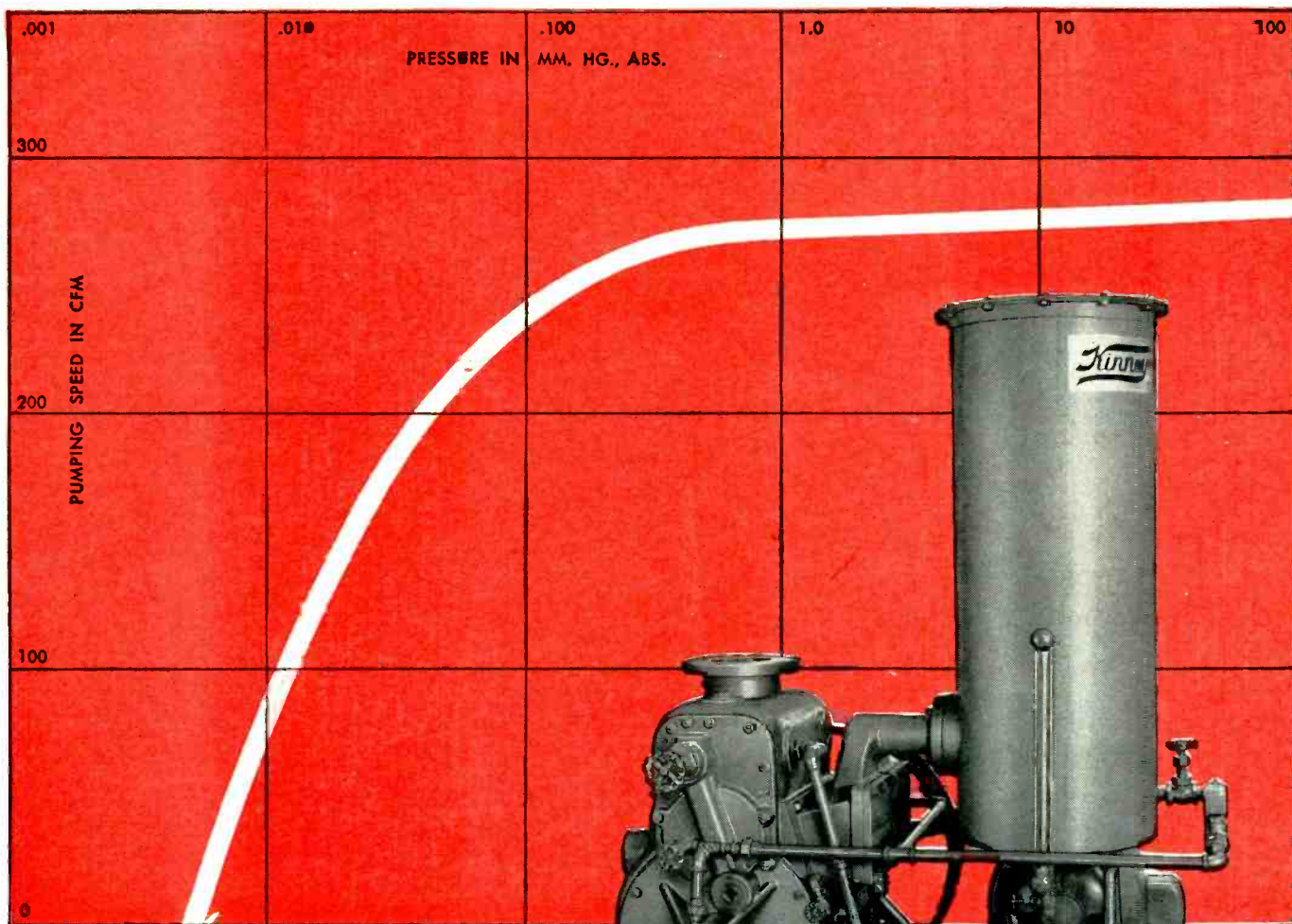

## A quality curve for vacuum

Here's the performance curve for the Kinney 311 cubic foot vacuum pump — Model DVD 14.9.18. Where high, fast vacuum is needed . . . in lamp works, power plants, cable impregnating operations, altitude chambers, coaters, and hundreds of other applications . . . this is the pump to pick. Model DVD 14.9.18 maintains high pumping speed in the low absolute pressure ranges . . . the reason why leading process companies depend on this vacuum pump for reliable, efficient operation.

Kinney district offices are staffed with competent vacuum engineers, ready to help you get the right vacuum pump for your needs. Send coupon for complete details.

Free air displacement of 311 CFM at 360 RPM — 15 HP motor.

Designed for easy accessibility of working parts.

Famous Kinney-perfected oil sealed pumping system.

Ask about special design for water-vapor removal.



### KINNEY MFG. DIVISION

THE NEW YORK AIR BRAKE COMPANY

3565 WASHINGTON STREET • BOSTON 30 • MASS.



Please send Bulletin V51B describing the complete line of Kinney Vacuum Pumps.

Our vacuum problem involves.....

Name.....

Company.....

Address.....

City..... State.....

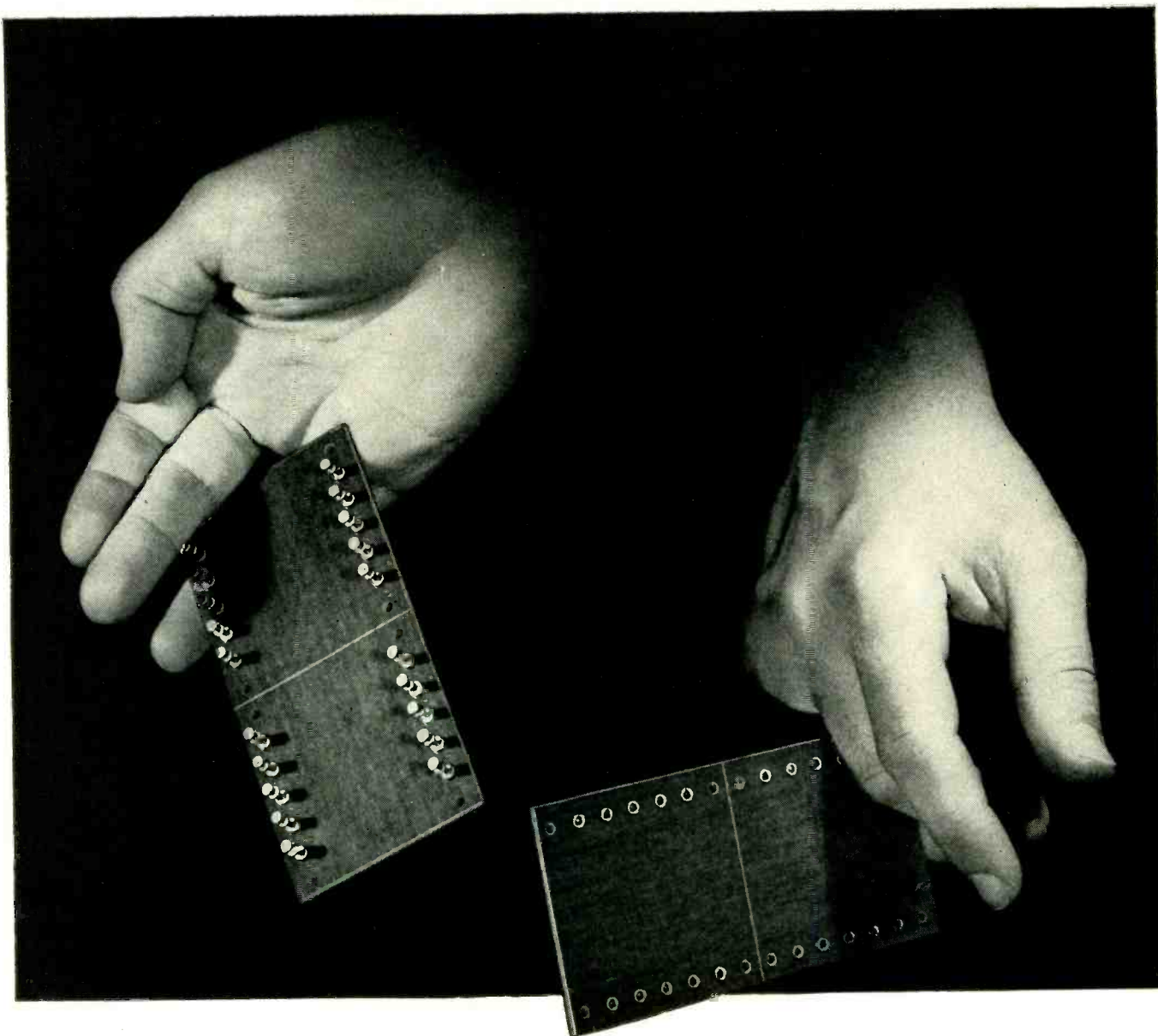

## No cracks, please

You'll find no radial cracks in C.T.C. terminal boards, or "cracked" rivet shanks on terminals. And there's a good reason for this.

Our swaging machines use tools that we designed ourselves in order to prevent just such damage. Terminals are fastened securely — *and carefully*. You benefit from a board that has no "weak spots" — that can give you the service you have a right to expect. And, of course, you also benefit from all the other quality control details that enable us to offer our customers *guaranteed* components — custom or standard. Coatings are smoothly applied — no wrinkles, no heavy deposits. C.T.C. terminals are made from certified stock that is free from defects. And the terminals themselves are guaranteed, even to the thickness of the coatings.

This C.T.C. quality control is given to all C.T.C. products including insulated terminals, coil forms, coils, swagers, terminals and capacitors. For all specifications and prices, write to

Cambridge Thermionic Corporation,  
437 Concord Avenue, Cambridge 38,  
Mass. West Coast manufacturers contact:  
E. V. Roberts, 5068 West Washington Blvd.,  
Los Angeles 16 and 988 Market St.,  
San Francisco, California.

*Terminal Board Data.* C.T.C. makes both standard boards and to your own specifications. Standard boards in cotton fabric phenolic, nylon phenolic or grade L-5 silicone impregnated ceramic. Custom made in cloth, paper phenolic, melamine, epoxy or silicone fibreglas laminates, imprinted as required and lacquered or varnished to specifications MIL-V-173 and JAN-T-152.

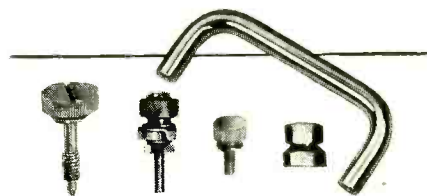

A wide variety of hardware is available at C.T.C. — all of it quality controlled and guaranteed for durability. This hardware includes terminal board brackets, standoff mounts, spacers, tube clamps, panel screws, thumb screws, dial locks, shaft locks, handles and handle ferrules.

# CTC

**CAMBRIDGE THERMIONIC CORPORATION**

*makers of guaranteed electronic components,  
custom or standard*





# NEW!

NEW!

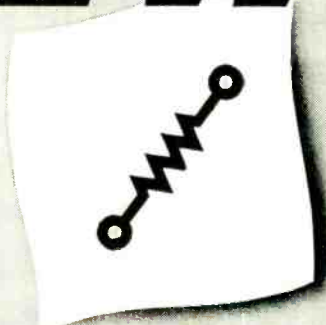

## for convenient point-to-point wiring...

### MINIATURIZED 5 AND 10 WATT WIRE-WOUND RESISTORS!

# Blue AXIAL LEAD Jackets®

PHOTOGRAPHS ACTUAL SIZE ▶



Here are two *truly miniaturized* self-mounting wire-wound power resistors to simplify your TV and industrial electronic production where space is a factor. They're ideal for point-to-point wiring, terminal board mounting, and processed wiring boards, where they fit in admirably in dip-soldered subassemblies.

Axial lead Blue Jackets are rugged vitreous enamel power resistors built to withstand the severest humidity performance requirements. As for *economy*, these newest members of the Sprague Blue Jacket family are low in cost... eliminate need for extra hardware... save time and labor in mounting!

You can get these outstanding new Blue Jacket Resistors without delay in any quantity you require. Sprague Engineering Bulletin 111 gives full data on these and all other commercial Blue Jacket Resistors. Send for your copy.

**SPRAGUE ELECTRIC COMPANY**  
35 Marshall Street, North Adams, Mass.

SPRAGUE TYPE NO.	WATTAGE RATING	DIMENSIONS L (inches) D		MAXIMUM RESISTANCE
27E	5	1 1/8	3/16	17,500 Ω
28E	10	1 3/8	3/16	35,000 Ω

Standard Resistance Tolerance: ±5%

# SPRAGUE

## PIONEERS IN ELECTRIC AND ELECTRONIC DEVELOPMENT

NORTH ADAMS, MASSACHUSETTS

EXPORT FOR THE AMERICAS: SPRAGUE ELECTRIC INTERNATIONAL LTD., NORTH ADAMS, MASS. CABLE: SPREXINT

# Introducing **FERRAMIC "Q"**

by **GENERAL CERAMICS**

**A NEW HIGH Q, LOW LOSS, HIGH FREQUENCY CORE MATERIAL WITH STABLE CHARACTERISTICS**



An ideal Core Material for Antenna Rods, Filter Inductances, Loading Coils, RF Coils and all other Applications Requiring High Performance up to 30 Megacycles.

Ferramic "Q" is an exclusive development of General Ceramics Corp. It was created to overcome the instabilities that characterized previous high performance ferrites. Exhaustive tests prove that Ferramic "Q" is completely stable in respect to age, shock, vibration, temperature. In addition this new material features higher Q and lower losses than former materials at all frequencies up to 30 Megacycles. Cost-wise, Ferramic "Q" offers extremely favorable comparison with competitive materials. For complete details, call, write or wire today.

OUTSTANDING ADVANTAGES OF FERRAMIC "Q" ARE SHOWN IN COMPARATIVE CHARACTERISTICS OF IDENTICAL COILS WITH CORES OF FERRAMICS J AND N, AND THE NEW FERRAMIC "Q" MATERIAL



CUP CORE F-261



RING CORE F-108



ANTENNA ROD F-214 - 8" LONG

	L	C	Q
Ferramic J	154	165	50
Ferramic N	120	210	65
Ferramic Q	73	350	175

Coil consists of 20 turns #28 AWG S.F. wire random wound. Cup cores mating surfaces ground (no air gap). Inductance measured in micro-henries, capacitance measured in micro-micro-farads on Boonton Model 260-A Q-Meter. Frequency 1000 Kcs.

	L	C	Q
Ferramic J	90	280	60
Ferramic N	60	425	100
Ferramic Q	35	725	400

Coil consists of 25 turns #20 AWG S.F. wire wound uniformly on toroid. Inductance measured in micro-henries, capacitance measured in micro-micro-farads on Boonton Model 260-A Q Meter. Frequency 1000 Kcs.

	L	C	Q
Ferramic J	340	75	120
Ferramic N	270	95	160
Ferramic Q	210	120	350

Coil consists of solenoid of 85 turns #26 AWG S.F. wire. Space wound along approx. 80% of rod length and centered on rod. Inductance measured in micro-henries, capacitance measured in micro-micro-farads on Boonton 260-A Q meter. Frequency 1000 Kcs.

## BASIC TOROIDAL MEASUREMENTS

Initial Permeability $\mu_0$ (1Mc)	125
Figure of Merit Q (1Mc)	400 approx.
Loss Factor $\frac{1}{\mu_0 Q}$ (1Mc)	.000020 approx.
$\mu_0 Q$ (5Mc)	.000031
(10Mc)	.000050
(20Mc)	.000097
$\mu_0$ vs Frequency Characteristics	Good to over 30 Mc
Q vs Frequency Characteristics	Good to over 30 Mc
Curie Temperature ( $^{\circ}$ C)	250
Temp. Coeff. of $\mu_0$ (1Mc) %/ $^{\circ}$ C (25 $^{\circ}$ C to 70 $^{\circ}$ C)	+0.08 approx.
Temp. Coeff. of Q (Same units as above)	-0.75
Saturation Flux Density $B_s$ (gauss) at $H_{dc} = 25$ oersteds	2900
Max. Permeability $\mu$ max	400
Coercive Force $H_c$ (oersteds)	1.90
Residual Magnetism Br	1050

## TYPICAL ANTENNA ROD MEASUREMENTS

FREQUENCY	Q	C = mmf.
0.6	334	344
0.8	350	189
1.0	350	120
1.2	338	83
1.4	318	60

## TEMPERATURE COEFFICIENTS

Antenna Rod No. F-214 (.330 x 8"). Standard Test Coil - Space wound solenoid 85 turns #26 AWG. Formex copper, occupying approx. 80% of length of rod and centered on rod. (Resonates at 1 Mc. with 120 mmf.)

$$TC = \frac{\% \Delta \mu_0}{\mu_0} (25^{\circ} \text{ to } 75^{\circ} \text{C})$$

Temp. Coeff. of Rod +1.0 to +2.0  
Temp. Coeff. of Coil only = 0



**General CERAMICS and STEATITE CORP.**  
TELEPHONE: VALLEY 6-5100  
General Offices and Plant: KEASBEY, NEW JERSEY.

MAKERS OF STEATITE, ALUMINA, ZIRCON, PORCELAIN, SOLDERSEAL TERMINALS, LIGHT DUTY REFRACTORIES, CHEMICAL STONWARE, IMPERVIOUS GRAPHITE, FERRAMIC MAGNETIC CORES





WAVEGUIDE BEND #557  
WAVEGUIDE BEND #536

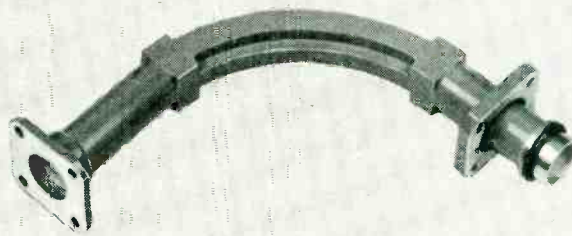

CIRCULAR WAVE GUIDE BEND #P600



LOW POWER TERMINATION #P540A  
WAVEGUIDE 90° TWIST #558



MAGIC "T" TUNER #P535

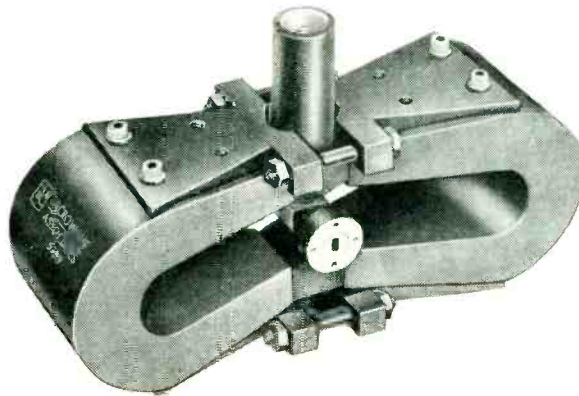

MAGNETRON #5789

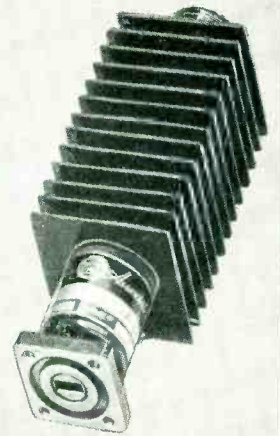

DUMMY LOAD #P537



FREQUENCY METER #P518

## PLANNING MILLIMETER WAVE OPERATIONS?

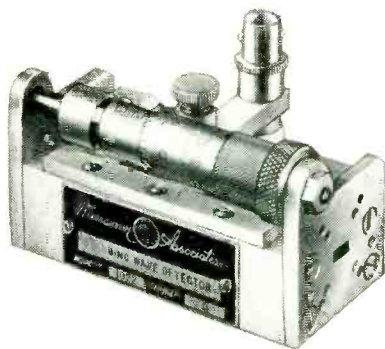

STANDING WAVE DETECTOR #1022

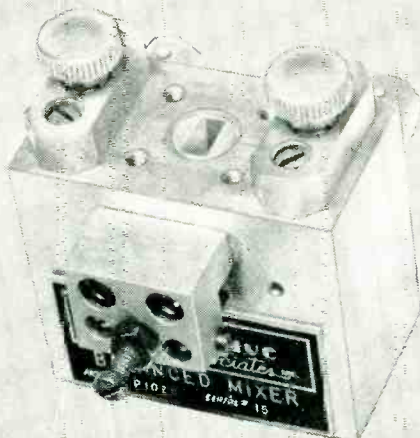

BALANCED MIXER #P1026

If you are working in the millimeter region — or are exploring it — you may be able to save considerable design and production time by acquainting yourself with our extensive experience, facilities and products in this field.

Available to you right now are over 40 items — components and test equipment — ready for you to incorporate in your designs and benches. Components for use in the 35 kmcs. band include slotted lines, frequency meters, loads and a spectrum analyzer adapter. If you are working with high resolution radar systems, we can furnish the long-life 40 KW 5789 magnetron, the 1N53 diode, complete duplexers, balanced mixers, echo boxes and many other components such as bends and transitions for operating circular wave guide in the low attenuation  $TE_{01}$  mode.

**SEND FOR DATA** Write for detailed specifications and catalog literature describing our millimeter components, magnetrons, TR and ATR tubes and silicon diodes.

If you have an interest in the millimeter waves, we would be pleased to give you the benefit of our experience to help you plan your operations in this region. **MICROWAVE ASSOCIATES, INC.**, 22 Cummington Street, Boston 15, Mass., Telephone COpley 7-4441.

 **MICROWAVE**  
Associates INCORPORATED

CONTINUOUS  
WAVE

F.M.

A.M.

SIMULTANEOUS  
F.M. and A.M.

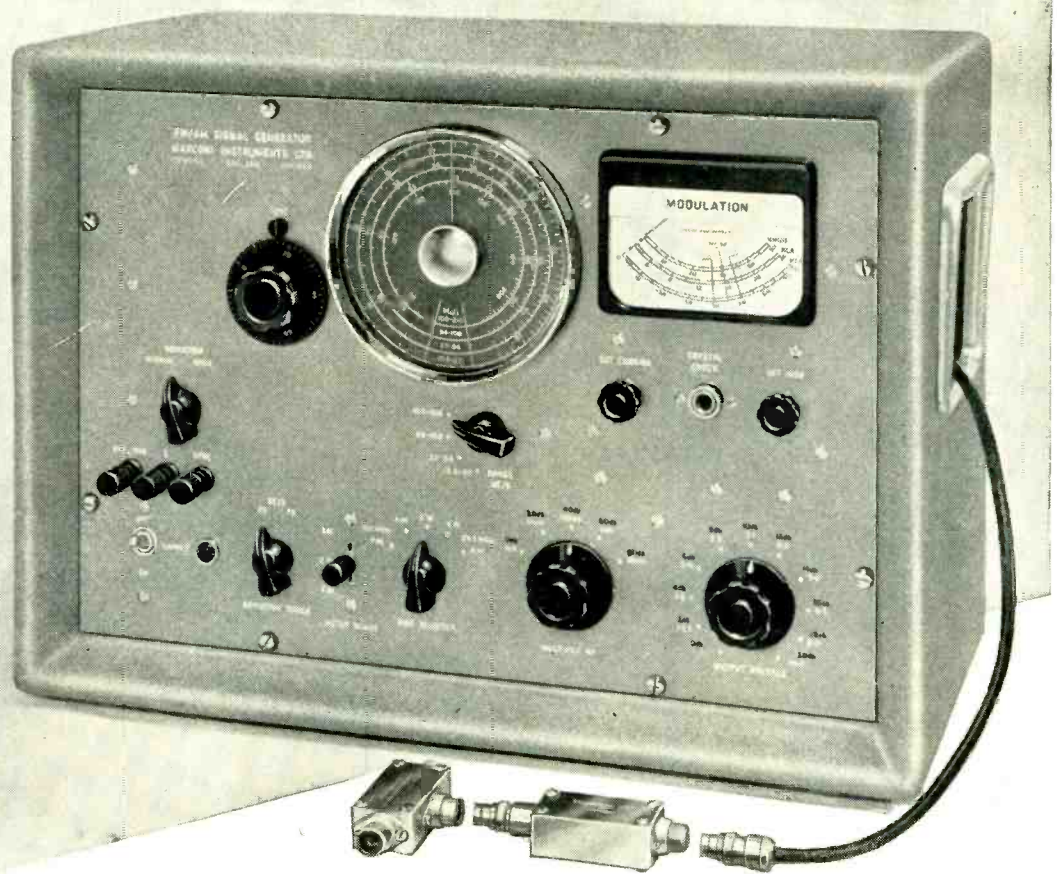

## F.M./A.M. SIGNAL GENERATOR TF 995A

The Marconi Signal Generator Type TF 995A is a compact, transportable, a.c. operated instrument covering from 13.5 to 216 megacycles in four crystal-standardized ranges. It has an open-circuit output level variable, in 1-db steps, from a minimum of 0.1 microvolts to a maximum of 100 millivolts at 52 ohms, and 200 millivolts at 75 ohms. The output may be c.w., frequency modulated, amplitude modulated, or simultaneously both frequency and amplitude modulated. The modulation, obtained either from an internal 1000-cps oscillator or from an external source, is variable to maximum frequency deviations ranging from 25 to 600 kc for f.m., and to depths up to 50% for a.m.

Full data and prices of any of the items listed below will be mailed immediately on request:

FM/AM SIGNAL GENERATOR TF 995A · UNIVERSAL BRIDGE TF 868

FM DEVIATION METER TF 934 · STANDARD SIGNAL GENERATOR TF 867

ALSO

VACUUM TUBE VOLTMETERS · FREQUENCY STANDARDS · OUTPUT METERS

WAVEMETERS · WAVE ANALYSERS · Q METERS · BEAT FREQUENCY OSCILLATORS

# MARCONI INSTRUMENTS

23-25 BEAVER STREET · NEW YORK 4

CANADA: CANADIAN MARCONI CO., MARCONI BUILDING, 2442 TRENTON AVENUE, MONTREAL

ENGLAND: Head Office: MARCONI INSTRUMENTS LIMITED, ST. ALBANS, HERTFORDSHIRE

Managing Agents in Export: MARCONI'S WIRELESS TELEGRAPH COMPANY LIMITED, MARCONI HOUSE, STRAND, LONDON, W.C.2

TF 995A



**NEW SINGLE LENS**

# GRAY TELOJECTOR

**STAR PERFORMER....**

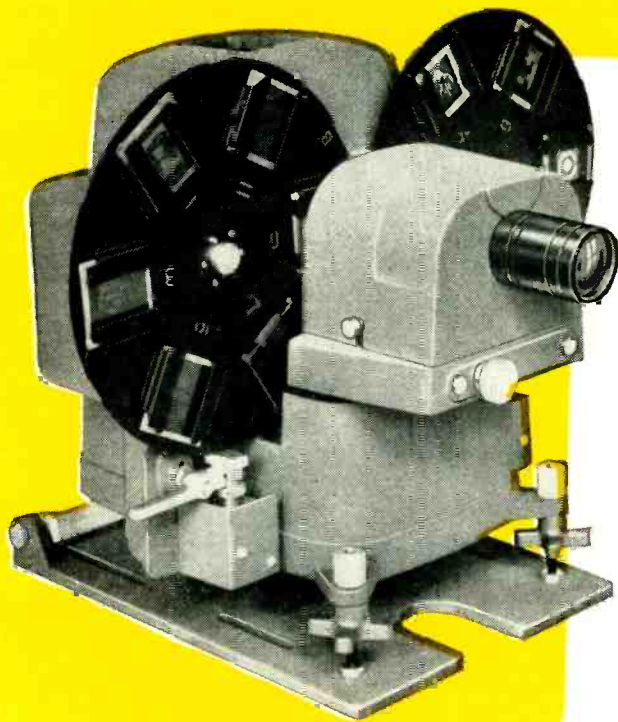

## Complete Projection System

The New Gray 3B Telojector (2" x 2" Transparency Slide Projector) utilizes a single lens—permits superposing of two images on an optical axis... eliminates any need for external registration adjustment. The improved unit provides positive focusing of images on the camera tube with an uninterrupted sequence of slides for television commercials, news flashes and photographs or station and sponsors' identification.

**for TV  
commercials**

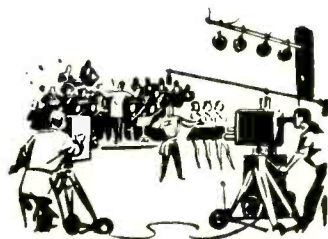

## Precision Projection

**BETTER Commercials at LOWER COST**

Yes... **now** you can use better 2" x 2" transparencies in uninterrupted sequence at lower cost. Important too, Gray Telojector is low in initial cost... ideal for budget-minded program directors. Telojector is compact, light weight, trouble-free. Two turrets take up to 12 slides at one loading. Additional loaded turrets are substituted in a matter of a few seconds... providing unlimited continual sequence. Controlled locally at the unit or remotely at the master video console. Also, can be used with the Gray 35B Manual Control Box to produce superposition, laps, fades and slide changes at any desired rate.

# GRAY RESEARCH

AND DEVELOPMENT CO., Inc., Hilliard St., Manchester, Conn.  
Division of the GRAY MANUFACTURING COMPANY  
Originators of the Gray Telephone Pay Station and the  
Gray Autograph and PhonAutograph.

## YOU ARE INVITED:

See the NEW, SINGLE lens Gray Telojector and complete line of TV—Broadcasting Equipment at Booth 297, I.R.E. Show, March 22nd—25th, Kingsbridge Armory, New York. If unable to visit I.R.E. Show write for illustrated, detailed information on the NEW, SINGLE LENS GRAY TELOJECTOR.

# Initiation CETRON

## FOR LONG LIFE, UNEQUALLED PERFORMANCE AND LOW COST

The superb quality of Continental Electric Co. special purpose electronic tubes for industry, the armed services, and for the replacement market is the result of nearly a quarter century of development and production.

Through research, CETRON Tubes are opening new fields of application and improving efficiency in traditional cir-

cuitry at the lowest cost per operating hour.

Data sheets for all or any family of types are immediately available for your selection of applicable tubes. We welcome comparative tests in your own equipment. You may discover surprising improvements in performance at substantial savings in cost.

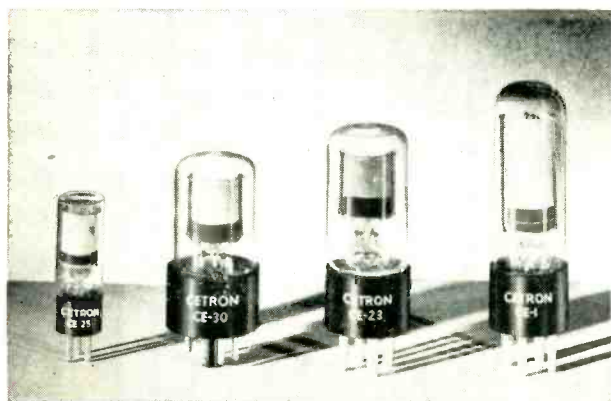

### CETRON PHOTOTUBES

Continental manufactures a type for practically every electronic application. Makes more different types of photocells and special purpose photocells than any other manufacturer in the world.

#### Chart of Types

CE-1-C	CE-B25V-C	CE-918
CE-1P23	CE-29-R	CE-919
CE-1P30	CE-30-C	CE-920
CE-1P32	CE-30V-C	CE-927
CE-1P37	CE-31V-C	CE-929
CE-1P39	CE-34-R	CE-930
CE-1P40	CE-B36-C	CE-934
CE-1V-C	CE-64-R	CE-5581
CE-B22-C	CE-73-R	CE-5583
CE-B25-C	CE-91-R	CE-5653

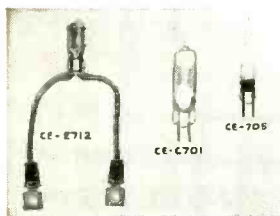

### LEAD SULFIDE

Continental Electric pioneered the early development of the Lead Sulfide Cell . . . a photoconductive rather than an emissive cell. Here are just a few of its applications;

1. Sound reproduction.
2. Infra-red photometry.
3. Burglar Alarms, door-openers, etc., especially using infra-red radiation.
4. Tubulating machines.
5. Phonograph pick-ups.
6. Controls and counters.
7. Low temperature pyrometry.



CE-228/JAN3B28

Filament Volts	2.5
Filament Amperes	5.0
DC Ampere Output	0.25
Peak Inverse Volts	10000



CE-235A  
Flexible Lead

Filament Volts	2.5
Filament Amperes	25.0
DC Ampere Output	15.0
Nom. DC Voltage	60
Peak Inverse Volts (E235 Stiff Lead)	230



CE-329C

Heater Volts	14.0
Heater Amperes	2.55
DC Ampere Output	3.0
Operating Inverse Volts	500
Surge Inverse Volts	3000

Send for our 1954 catalog; contains complete technical data covering our complete line.

CONTINENTAL ELECTRIC CO.  
GENEVA • ILLINOIS



# PHOTOTUBES • RECTIFIERS • THYRATRONS

(PARTIAL LIST)



**CE-393A/JAN393A**  
Mercury and Gas

Filament Volts ..... 2.5  
Filament Amperes ..... 7.0  
DC Ampere Output ..... 1.5  
Peak Inverse Volts ..... 1250  
Peak Forward Volts ..... 1250



**CE-872A**

Filament Volts ..... 5.0  
Filament Amperes ..... 7.1  
DC Ampere Output ..... 1.25  
Nom. DC Voltage ..... 2700  
Peak Inverse Volts ..... 10000



**C1A**

Filament Volts ..... 2.5  
Filament Amperes ..... 6.5  
DC Ampere Output ..... 0.64  
Peak Inverse Volts ..... 340  
Peak Forward Volts ..... 170



**CE-304**

Mercury Vapor

Filament Volts ..... 2.5  
Filament Amperes ..... 23.0  
DC Ampere Output ..... 12.5  
Peak Inverse Volts ..... 1000  
Peak Forward Volts ..... 1000



**CE-311/JAN3C23**

Filament Volts ..... 2.5  
Filament Amperes ..... 7.0  
DC Ampere Output ..... 1.5  
Peak Inverse Volts ..... 1250  
Peak Forward Volts ..... 1250



**CE-309/FG17**  
Mercury Vapor

Filament Volts ..... 2.5  
Filament Amperes ..... 5.0  
DC Ampere Output ..... 5.0  
Nom. DC Voltage ..... 1250  
Peak Inverse Volts ..... 5000



**CE-323B/JAN323B**

Filament Volts ..... 2.5  
Filament Amperes ..... 7.0  
DC Ampere Output ..... 1.5  
Peak Inverse Volts ..... 1250  
Peak Forward Volts ..... 1250



**C6J**

Filament Volts ..... 2.5  
Filament Amperes ..... 20.0  
DC Ampere Output ..... 6.4  
Peak Inverse Volts ..... 1250  
Peak Forward Volts ..... 750



**CE-210A**

Filament Volts ..... 2.5  
Filament Amperes ..... 6.5  
DC Ampere Output ..... 2.0  
Nom. DC Voltage ..... 230  
Peak Inverse Volts ..... 800



**CE-203**

Filament Volts ..... 2.5  
Filament Amperes ..... 20.0  
DC Ampere Output ..... 15.0  
Nom. DC Voltage ..... 150  
Peak Inverse Volts ..... 500



**CE-2W2**  
TV Color Circuits

Filament Volts ..... 2.5  
Filament Amperes ..... 5.0  
DC Ampere Output ..... 0.65  
Nom. DC Voltage ..... 750  
Peak Inverse Volts ..... 2500



**CE-206**

Filament Volts ..... 2.0  
Filament Amperes ..... 12.0  
DC Ampere Output ..... 6.0  
Nom. DC Voltage ..... 90  
Peak Inverse Volts ..... 300



**CE-220**

Filament Volts ..... 2.5  
Filament Amperes ..... 3.1  
DC Ampere Output ..... .020  
Peak Inverse Volts ..... 20000



**CE-205**

Filament Volts ..... 2.0  
Filament Amperes ..... 12.0  
DC Ampere Output ..... 5.0  
Nom. DC Voltage ..... 250  
Peak Inverse Volts ..... 900



**CE-221/4B25**

Filament Volts ..... 2.5  
Filament Amperes ..... 17.0  
DC Ampere Output ..... 6.4  
Nom. DC Voltage ..... 200  
Peak Inverse Volts ..... 725



**CR-5**

Filament Volts ..... 2.0  
Filament Amperes ..... 12.0  
DC Ampere Output ..... 5.0  
Nom. DC Voltage ..... 150  
Peak Inverse Volts ..... 900



**CE 249C/JAN249C**

Filament Volts ..... 2.5  
Filament Amperes ..... 7.5  
DC Ampere Output ..... 0.64  
Nom. DC Voltage ..... 2000  
Peak Inverse Volts ..... 7500



**CE-226/JAN4B26**

Filament Volts ..... 2.2  
Filament Amperes ..... 17.0  
DC Ampere Output ..... 6.0  
Nom. DC Voltage ..... 90  
Peak Inverse Volts ..... 375



**CE-202B**

Filament Volts ..... 2.5  
Filament Amperes ..... 20.0  
DC Ampere Output ..... 15.0  
Nom. DC Voltage ..... 250  
Peak Inverse Volts ..... 900



**CE-213A**

Filament Volts ..... 2.5  
Filament Amperes ..... 7.0  
DC Ampere Output ..... 2.5  
Nom. DC Voltage ..... 1500  
Peak Inverse Volts ..... 5000

IF YOU HAVE A TUBE PROBLEM . . . CONSULT CONTINENTAL

# Air Sea Rescue?



The "Princess Victoria" was lost just over a year ago and with her, 133 lives. This disaster occurred only 20 miles from land but search aircraft found the location too late because there was no ship-to-air communication. Further tragedies may well be avoided by ships being able to talk direct to each other and to aircraft. The RM.200 V.H.F. transmitter and receiver has been developed to meet this need.

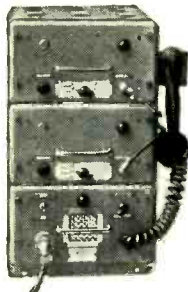

**TYPE RM.200** Multi-spot channel marine V.H.F. radio-telephone operating from A.C. Mains and/or Batteries. Amplitude Modulation.

**Range:** Ship-to-ship 25 miles; Ship-to-air over 100 miles.

Provides communication on the following INTERNATIONAL channels and 8 other channels.

121.5 Mc/s Aircraft Distress & Safety

156.3 Mc/s Marine Intership

156.6 Mc/s Marine Port Control

156.8 Mc/s Marine Safety & Calling

**Price £210** Delivery, 4 months



## REES MACE MARINE LTD.

..... ONE OF THE  GROUP OF COMPANIES



# PHILCO ANNOUNCES A REVOLUTIONARY NEW TRANSISTOR

## ***New Diffused Alloy Junction Type Has Amazing Advantages...***

Philco now presents to industry a new diffused alloy junction transistor with uniformity of characteristics never before attained in production.

Design engineers will welcome the predictable performance of circuits incorporating this superior transistor.

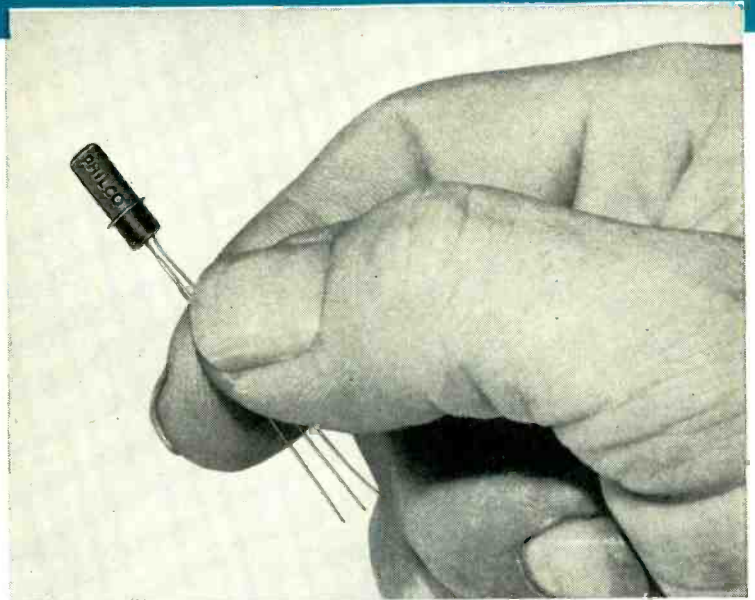

At last, here is a transistor that will operate with the same high degree of excellence in mass-produced units as in laboratory models—*eliminating the need for individual selection of transistors or associated components to meet equipment specifications!*

Now in production at Philco, this new transistor meets the high standards required for production applications. It is one of the smallest transistors

ever produced. Leads are fused in glass—the entire transistor is enclosed in a metal envelope—an instantaneous resistance weld hermetically seals the complete unit. Advanced processing techniques and new mechanical design features assure excellent characteristics and uniformity throughout the life of the transistor. Phone, write or wire Philco today for descriptive literature and specifications on this revolutionary transistor.

- Minimum size.
- Uniform characteristics.
- Hermetically sealed, resistance-welded metal case . . . leads sealed in glass.
- Designed to meet typical military environmental conditions.



**PHILCO CORPORATION**  
GOVERNMENT & INDUSTRIAL DIVISION • PHILADELPHIA 44, PA.



TWO VIEWS SHOWING MECHANISM  
ACTUAL SIZE

## POWERFUL MOVING COIL MECHANISM HAS GYRO-LIKE STABILITY

The Marion Type MEP-1 meter mechanism was designed to develop highest possible torque for a given volume of magnetic material. Its high torque, heavy eddy current damping and low relative inertia provide unusual performance characteristics simulating the stability of a gyro, in like environment. Already it is setting new and higher standards for reliability in moving coil indicating mechanism design for aircraft application, where the influence of vibration and rapid attitude changes on pointer indication are significant factors.

The gyro-like stability of the MEP-1 mechanism results from its unique mechanical design. An end-pivoted coil assembly, with a one piece bearing shaft and precise mechanical assembly operates in a self-shielded magnet structure which produces approximately 6000 Gauss in a single air gap. When the end-pivoted moving coil, of long turning radius, operates in a magnetic field of such strength, substantial gains in torque and eddy current damping are realized. This great torque, combined with relatively light weight, permits unit bearing loadings substantially lower (i. e. larger pivot and jewel radii) than heretofore normal.

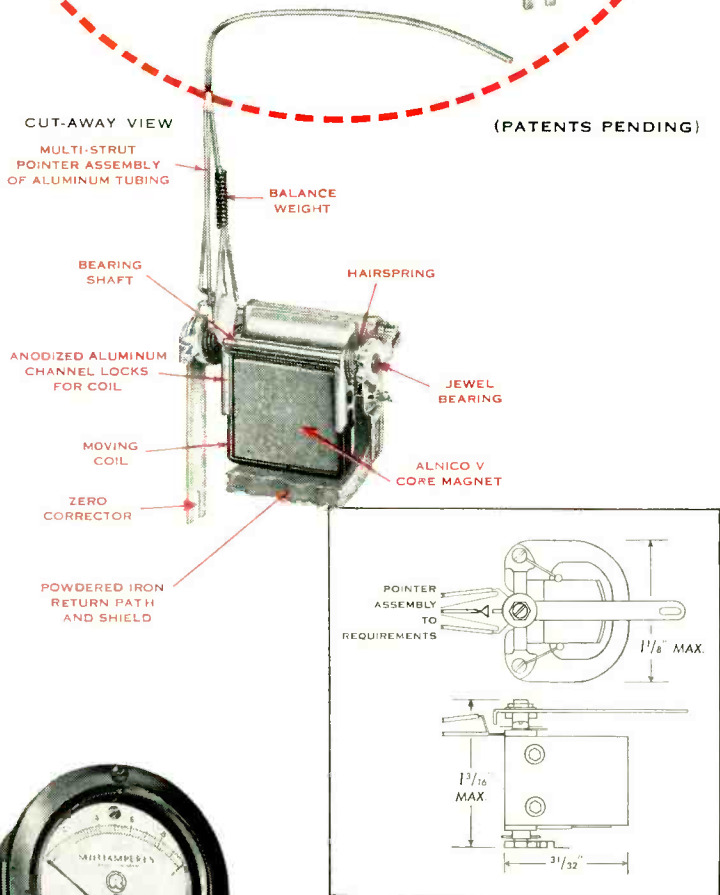

### MECHANISMS BY MARION

Although developed expressly for application in aircraft navigational instruments, many of the MEP-1 characteristics make it desirable for use as the sensitive element in control devices where it is required to initiate a control function. It is one of a number of Mechanisms by Marion that extend the field of moving coil mechanism application where previously size, weight or performance characteristics prevented their use.

Marion Electrical Instrument Company,  
401 Canal Street, Manchester, N. H.



Reg. U. S. Pat. Off.



MANUFACTURERS OF RUGGEDIZED AND "REGULAR" METERS AND RELATED PRODUCTS

Copyright 1954 Marion



# Eimac Klystron Report

# X544

## L BAND KLYSTRON

- 3 kw CW power output at 1400 mc
- Power gain of 1000 times

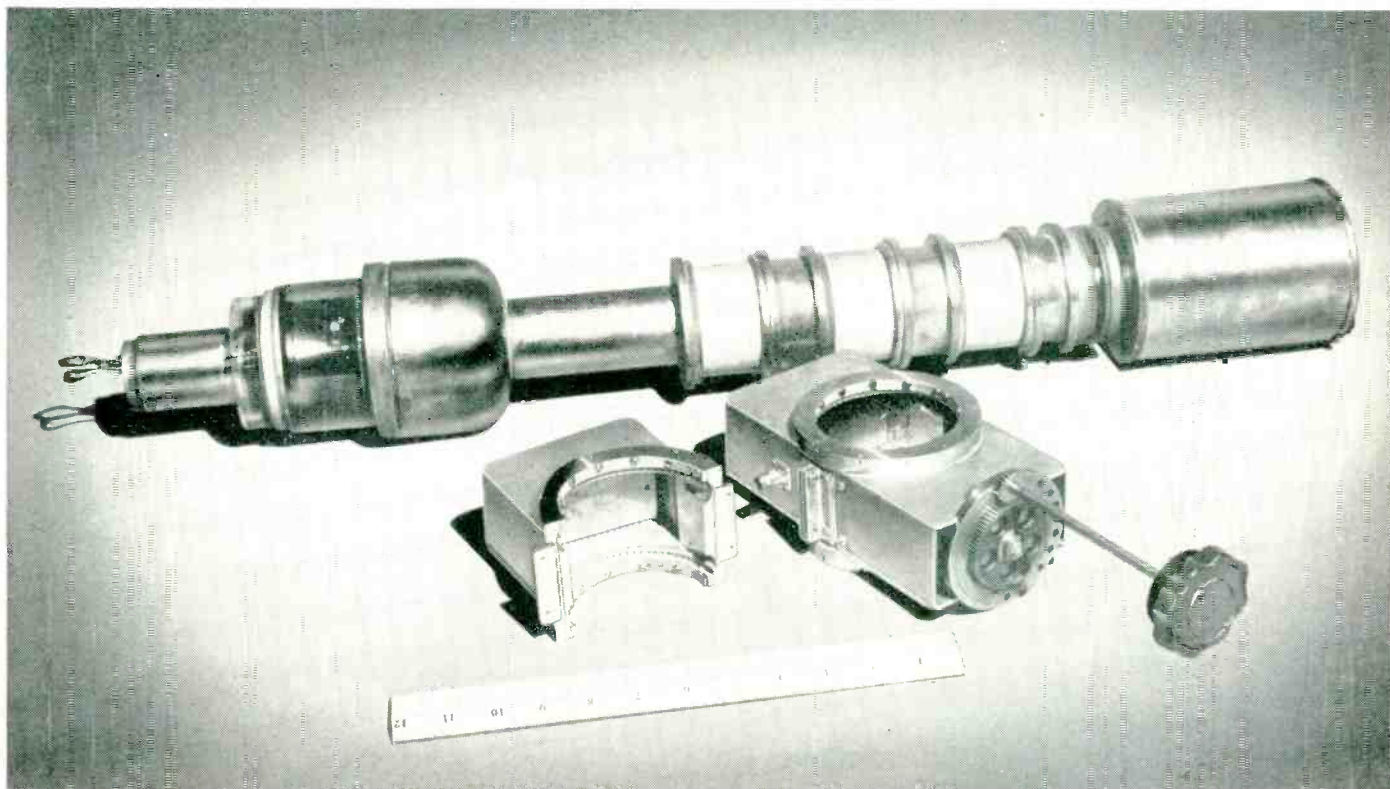

Eimac X544 and external tuning boxes.

**A** power gain of 1000 times at 1200-1400mc in CW operation has been registered by the new Eimac X544 three cavity, cascade type klystron. With only three watts driving power the X544 delivers 3kw power output. This high power and high power gain is possible over a 200mc range through the exclusive Eimac feature of completing tuning circuitry external to the vacuum system. Other features of the Eimac X544 are a long life cathode, ceramic tube cavities, practical design and light weight.

The X544 is another Eimac advancement in klystrons

for higher power at higher frequencies. Other Eimac klystrons include high power amplifiers for UHF-TV and sturdy reflex klystrons for use in conditions of severe shock, vibration and sustained acceleration at frequencies to 9600mc.

- For further information contact our Application Engineering Department

**EITEL-McCULLOUGH, INC.**  
SAN BRUNO • CALIFORNIA

*Eimac*

MARK OF EXCELLENCE IN  
ELECTRON-POWER TUBES



**There may be some doubt about  
flying saucers**

***But none about Victoreen  
Current Regulator Tubes***

More than 40 different Current Regulator Tube types are produced by Victoreen. Each tube type is designed to regulate the current at a definite value. A tube maintains its rated current within narrow limits after the threshold voltage is reached. From the great variety of tube types, with threshold voltages ranging from 1.5 to 35 volts and current ratings from 80 to 4200 ma, you may readily select just the tubes suited to your applications.

These top-quality Current Regulator Tubes will give many hours of low-cost, dependable regulation when used as recommended.

***Write for brochure listing Current Regulator Tubes  
with complete technical information about them.***



**The Victoreen Instrument Co.**

**COMPONENTS DIVISION: 3800 PERKINS AVE. • CLEVELAND 14, OHIO**



# IS YOUR RELAY REQUIREMENT DIFFERENT?

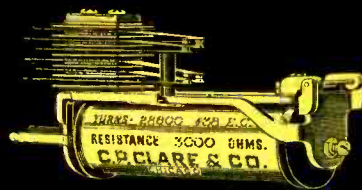

**FAST OPERATE—FAST RELEASE**—The Clare Type C relay will operate in from 0.005 to 0.04 second, depending on voltage applied, coil resistance, and contact assembly. Release time is from 0.006 to 0.020 second.



**SLOW OPERATE**—The Clare Type D Relay uses a low resistance copper slug to delay its operation. Operate time can be varied, from 0.01 to 0.1 second, by coil selection. Release time can be held low by heavy spring pressures and large residual settings.

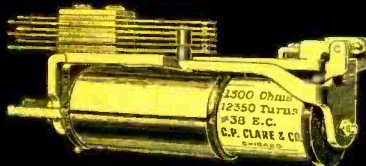

**SLOW RELEASE**—The Clare Type E Relay uses a copper slug on the heel end of the coil to hold circuits operated from 0.05 to 0.3 second after the coil circuit has been broken. Operate time is from 0.01 to 0.04 second.

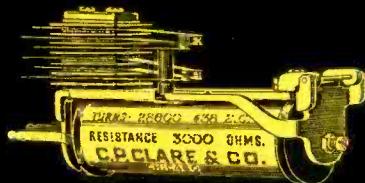

**SLOW ACTING**—The Clare Type H Relay uses dead-soft copper sleeve over coil core to delay buildup of magnetic flux so as to retard operation and release. Operate time may be from 0.01 to 0.05 second; and release time, from 0.03 to 0.3 second.



**SNAP ACTION**—The Clare Type CMS relay has enclosed snap-action switch contacts, rated at 10 amperes, 125 volts a-c

**FIRST**  
in the  
**INDUSTRIAL**  
**FIELD**

**These five  
CLARE RELAYS  
have successfully  
met thousands of  
difficult applications**

- CLARE RELAYS are built to render the utmost satisfaction to the user whose relay requirements are above the average—where extremely long life, and precise, reliable operation under severe conditions may be required.

Relays illustrated are all developments of the famous Clare Type C d-c Relay whose precision and dependability has been proved in thousands of military and industrial applications. They permit wide flexibility in design and construction to meet the most exacting requirements.

For full information on Clare relays, contact your nearest Clare sales engineer or write: C. P. Clare & Co., 4719 West Sunnyside Avenue, Chicago 30, Illinois. In Canada: Canadian Line Materials Ltd., Toronto 13. Cable Address: CLARELAY

- Write for Engineering Data Book

# CLARE RELAYS

# New Metal Lined CAPACITORS

by **Good-ALL**

Now you can get **ALL Good-All Capacitors**  
**ENCLOSED in METAL LINED TUBES**  
impregnated with "Marbelite" plastic

- Practically unaffected by humidity or climatic conditions.
- Eliminates troublesome field failures.
- Low capacitance change with temperature.
- Thermo setting, hard-as-marble, "Marbelite" plastic end-fill provides life-time sealing — eliminates costly pull-outs.
- Extremely durable.
- So Superior they are being used extensively by leading TV and Radio manufacturers of America.

## Use **GOOD-ALL METAL LINED CAPACITORS** for every Requirement

**Type 503ML** Enclosed "Marbelite" Capacitor is impregnated and sealed in hard-as-rock thermo-setting plastic. —50°C to +100°C operating temperature. Popular priced.

**Type 520ML** Enclosed capacitor is impregnated in highest quality capacitor oil. —50°C to +85°C operating temperature. Designed to meet exacting specifications of ALL TV and Radio circuits.

**Type 522ML** Enclosed capacitor is impregnated in Miracle "X." (Same high quality impregnant used in more expensive hermetically sealed capacitors.) Extremely high insulation resistance. Capacity change less than 5% over operating range of —55°C to +125°C.

Write for complete catalog covering all types of Good-All long-life capacitors. Our engineers are always ready to work with you on any capacitor problems. We invite sample orders for your evaluation.

\*Trade Mark Registered

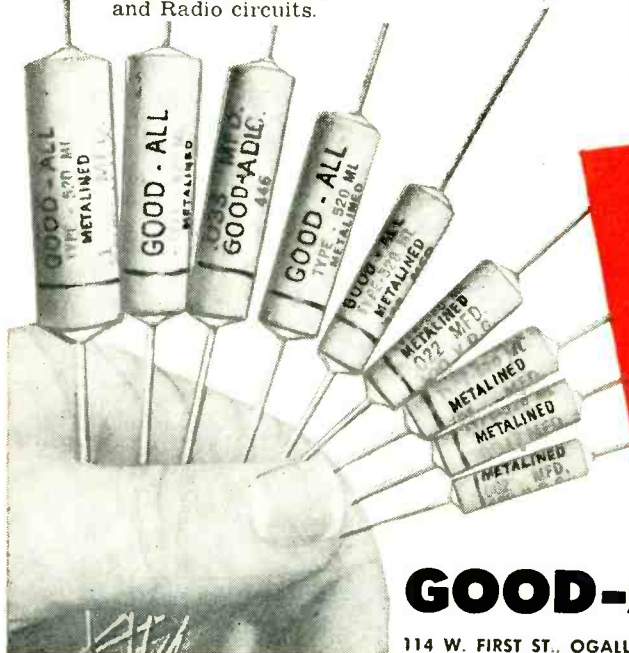

## **GOOD-ALL ELECTRIC MFG. CO.**

114 W. FIRST ST., OGALLALA, NEBRASKA • PHONE 112 OR 113—CABLE ADDRESS "GOODALLA"



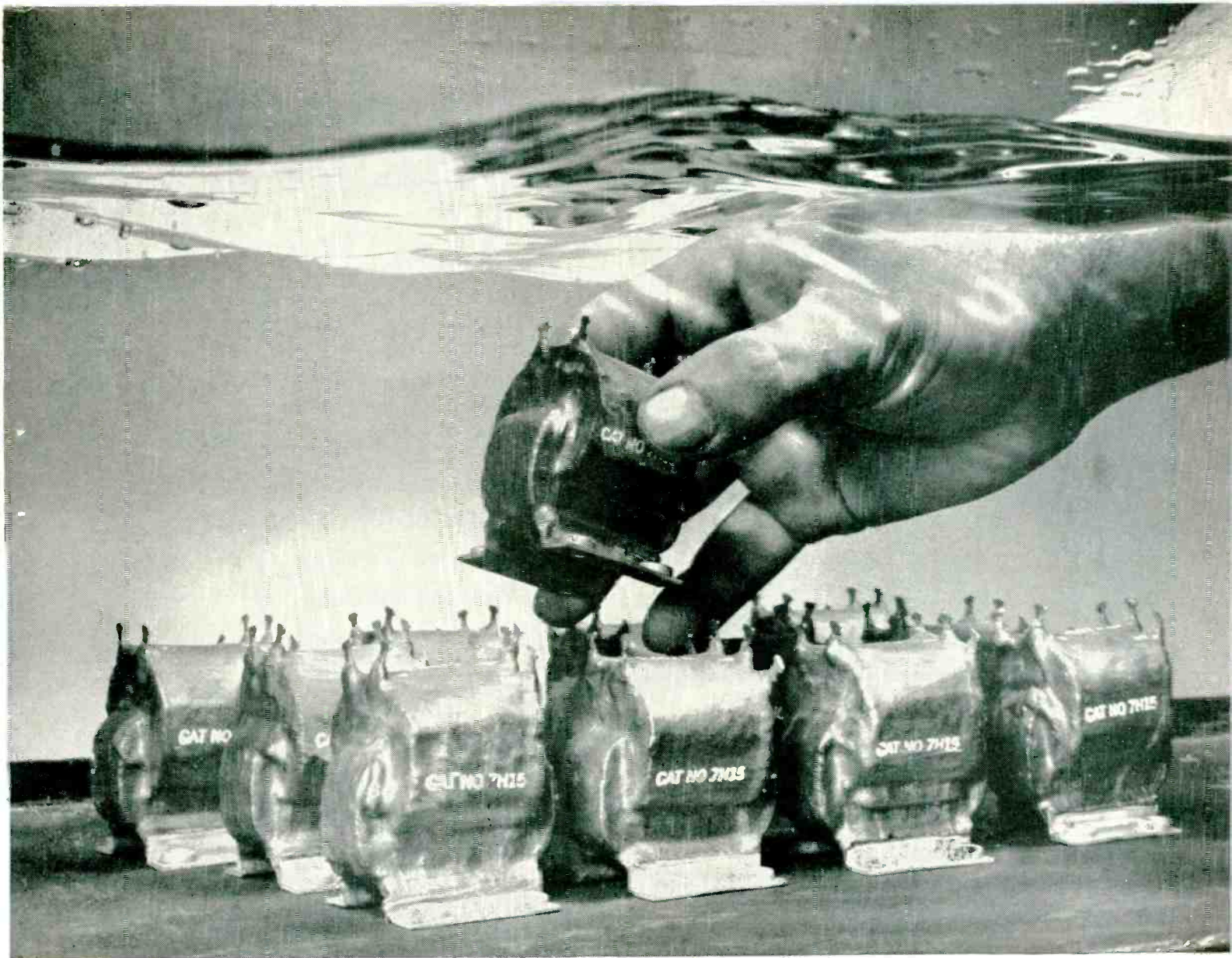

## Westinghouse Fosterite<sup>®</sup> Transformers must pass this 4-hour underwater test

If you're looking for a small, open-type transformer, fully protected against moisture, check the line of Westinghouse Fosterite impregnated transformers. This four-hour underwater test proves the point:

All Fosterite-treated transformers are completely submerged in hot water at 60° Centigrade for two hours, after which they are "thermal-shocked" in cold tap water, and soaked there for an additional two hours. An electrical test is then applied, in which each transformer must show an insulation resistance reading of at least 2000 megohms. Fosterite has to be good!

This is just one of many severe tests to which

Westinghouse specialty transformers are subjected. They assure you of quality that will meet your requirements exactly . . . quality that stands up under extreme conditions.

Fosterite impregnated and coated transformers can be made available to meet your most stringent specifications. In addition to moisture protection, Fosterite makes drastic weight reductions possible . . . as much as 30 to 50%, when compared to enclosed types.

Call your Westinghouse representative for further information, or write Westinghouse Electric Corporation, P. O. Box 868, Pittsburgh 30, Pa. J-70678

YOU CAN BE SURE... IF IT'S  
**Westinghouse**



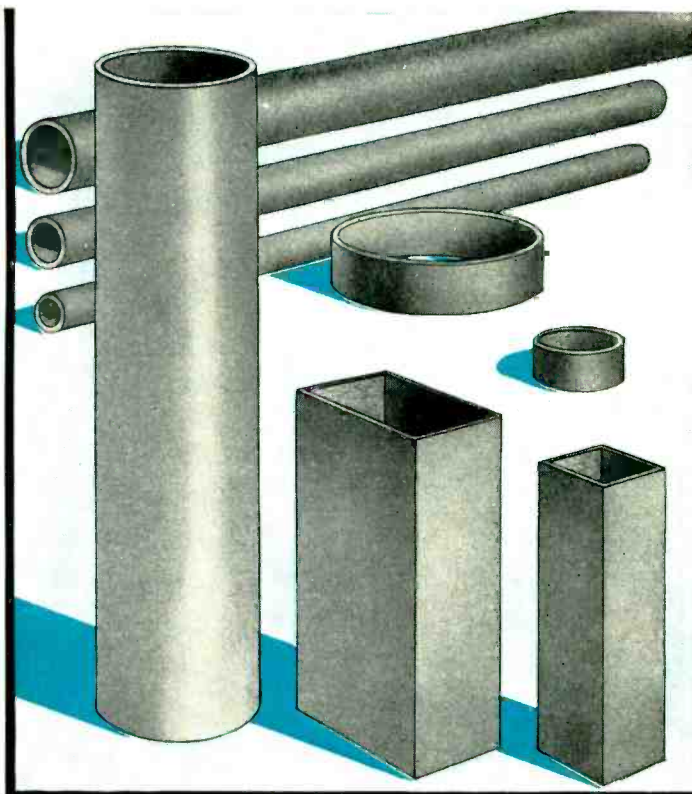

**PROVEN**  
IN HUNDREDS OF CRITICAL  
APPLICATIONS EVERY DAY

**QUALITY**  
TO MEET UNLIMITED  
NEW APPLICATIONS

**CLEVELITE\***  
LAMINATED PHENOLIC TUBING

Moisture Resistant  
Mechanically Strong  
High Dielectric Strength  
Dimensional Stability  
Low Loss Factor

## USE CLEVELITE

to make a good product better . . .  
and at lower costs!

## SERVICE

Our Design and Production Depart-  
ments are geared to customers' needs  
in every way. Deliveries are prompt!

WRITE to The Cleveland Container  
Company plant nearest you for a copy  
of our CLEVELITE brochure . . . of  
value to every Engineering Depart-  
ment.

\* Reg. U. S. Pat. Off.

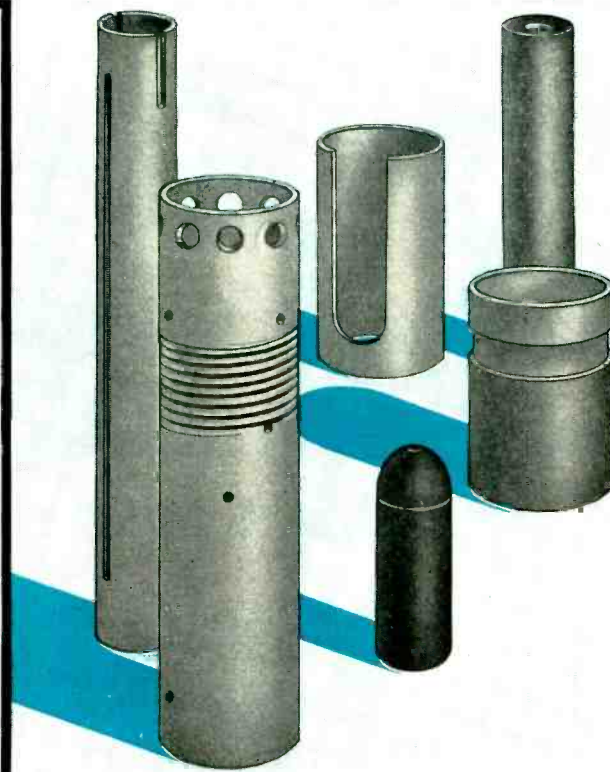

*Why Pay More?  
For Good Quality  
. . . call Cleveland!*

*The* **CLEVELAND CONTAINER Co.**  
6201 BARBERTON AVE. CLEVELAND 2, OHIO

PLANTS AND SALES OFFICES at Chicago, Detroit, Memphis, Plymouth, Wisc., Ogdensburg, N. Y., Jamesburg, N. J.

ABRASIVE DIVISION at Cleveland, Ohio

CANADIAN PLANT: The Cleveland Container, Canada, Ltd., Prescott, Ontario

### REPRESENTATIVES

NEW YORK AREA R. T. MURRAY, 604 CENTRAL AVE., EAST ORANGE, N. J.  
NEW ENGLAND R. S. PETTIGREW & CO., 62 LA SALLE RD., WEST HARTFORD, CONN.  
CHICAGO AREA PLASTIC TUBING SALES, 5215 N. RAVENSWOOD AVE., CHICAGO  
WEST COAST IRV. M. COCHRANE CO., 408 S. ALVARADO ST., LOS ANGELES





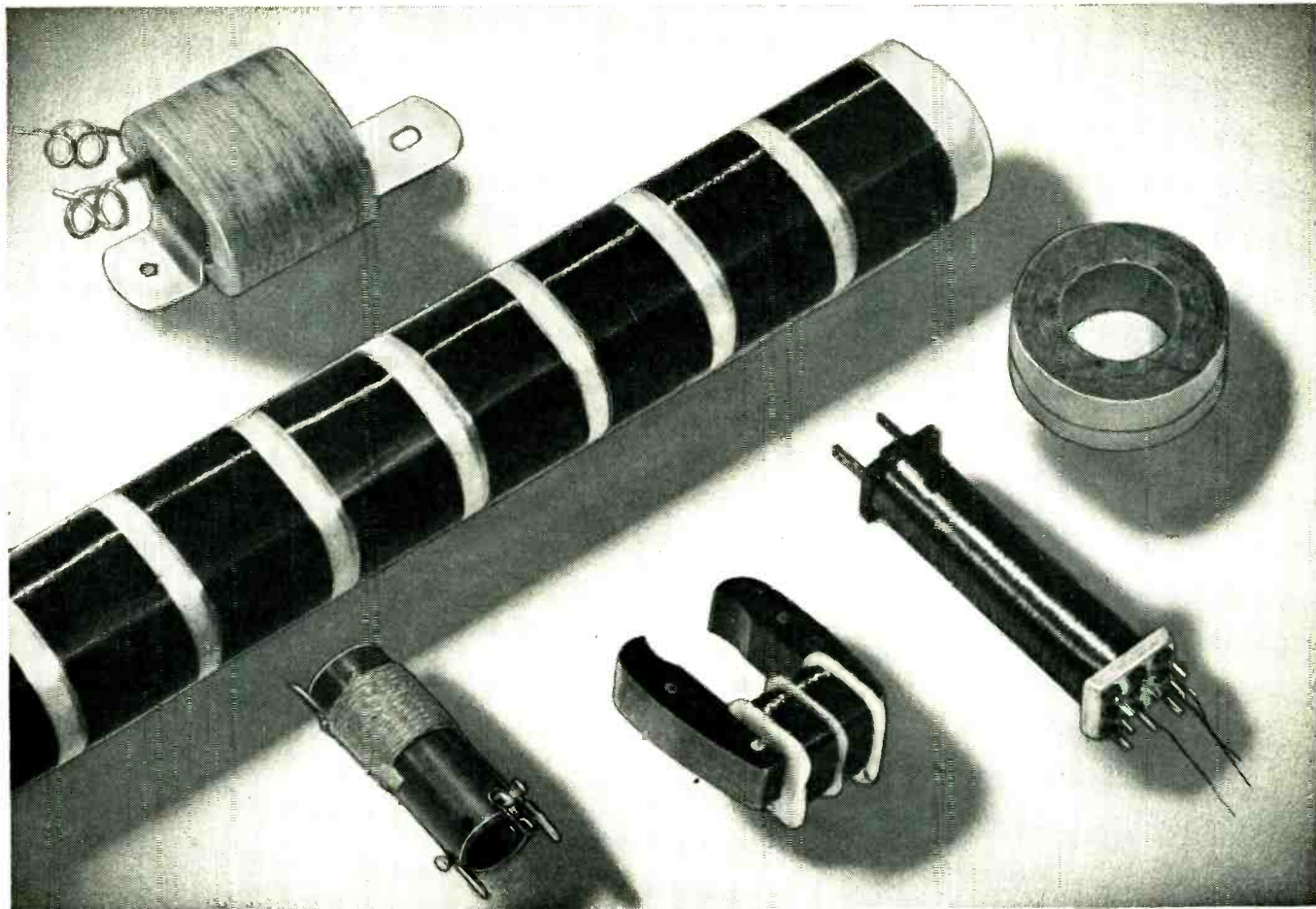

## These coils saved winding costs

Each of these coils represents a sizable saving on coil winding costs because it was wound on Universal Coil Winders.

There are Universal machines for a broad range of coil specifications and production requirements — long or short runs. Users report increased output, a higher degree of accuracy, and greater operator satisfaction.

The coupon will bring you information on the complete line — plus any specific data you wish regarding your particular

coil winding requirements.

Also: be sure to visit the Universal Demonstration Room nearest you — in Cranston, R. I. or Chicago, Ill. You'll see winders in operation and have a chance to talk over your coil winding problems with a Universal sales engineer.

To arrange for a visit to the Demonstration Room, write to UNIVERSAL WINDING COMPANY, P. O. Box 1605, Providence 1, R. I., or 9 South Clinton St., Chicago, Ill.

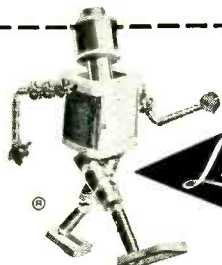

FOR WINDING COILS  
IN QUANTITY... ACCURATELY  
... AUTOMATICALLY... USE  
UNIVERSAL WINDING MACHINES

## UNIVERSAL WINDING COMPANY

P. O. BOX 1605, PROVIDENCE 1, RHODE ISLAND

Please send me

- Condensed Catalog of Universal Winders
- Information on Universal Winders for coil types that meet my particular needs. I enclose specifications and production requirements.

Name.....Title.....

Company.....

City.....Zone....State.....



**MOLONEY QUALITY IS NOW  
AVAILABLE IN THESE SPECIALTY  
TRANSFORMERS**

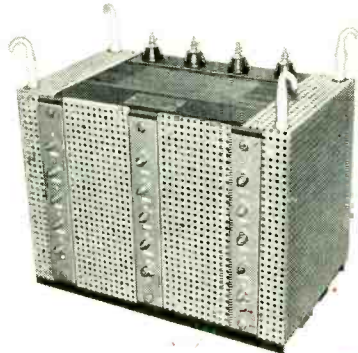
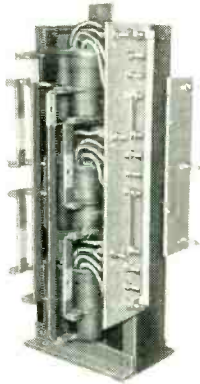
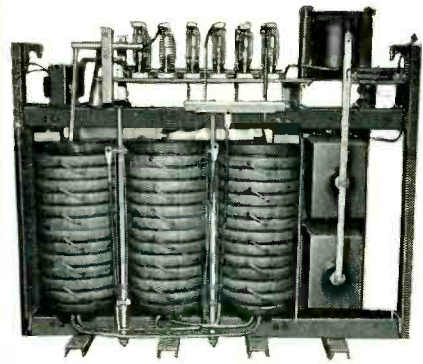
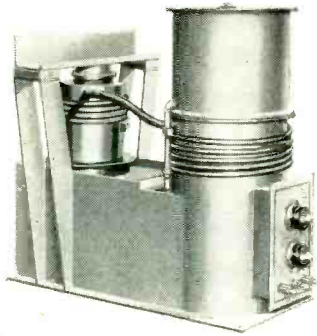

**POWER AND FILAMENT TRANSFORMERS • FILTER REACTORS • MODULATION TRANSFORMERS • PULSE TRANSFORMERS • CHARGING REACTORS . . .** NOW available to industry for applications which require the quality and superior performance characteristics of Moloney Transformers. Engineered to your specifications, tested to your specifications, *performance* to your specifications. Produced in any quantity . . . send your inquiry to us now for prompt attention.

**Physical Characteristics:** Per MIL-T-27 • Hermetically Sealed • Solder-sealed Bushings • Oil Filled Askarel Filled • Air Cooled; Class A, B and H.

Write for Bulletin SR-205 describing HiperCore Electronic Cores and Bulletin ST-3505 describing Specialty Transformers.

ME54-B



Moloney HiperCore Electronic Cores are available to manufacturers in any quantity in more than 1000 stock sizes or to your own special specifications.

# M O L O N E Y   E L E C T R I C   C O M P A N Y

*Manufacturers of Power Transformers • Distribution Transformers • Load Ratio Control Transformers • Step Voltage Regulators • Unit Substations • Electronic Transformers*

SALES OFFICES IN ALL PRINCIPAL CITIES • FACTORIES AT ST. LOUIS 20, MISSOURI AND TORONTO, ONTARIO, CANADA





# ENGINEERS

## for STABILITY and PROGRESS

NOW IS THE TIME TO INVESTIGATE

# Westinghouse

For industrial stability, progress and professional recognition, investigate Westinghouse! The Westinghouse Electronics Division . . . located in Baltimore, Maryland, is expanding its operations in the development of highly specialized commercial and military equipment. There are some excellent opportunities for engineers from the B.S. to the Ph.D. level. Investigate today!

- Job stability
- Extensive facilities
- Opportunities for advanced study
- Association with competent technical leaders

### SYSTEMS ENGINEERS

Systems Planning  
Systems Analysis  
Systems Evaluation

in

- Fire Control Systems
- Missile Guidance
- Radar
- Indicators

### ANTENNA ENGINEERS

Applied Research  
Development  
Design

in

- Fire Control Antennas
- Radar Antennas
- Microwave Plumbing Techniques

### ELECTRONIC CIRCUIT ENGINEERS

Applied Research  
Development  
Design

in

- Fire Control
- Communications
- Radar
- Missile Guidance

### COMPONENTS ENGINEERS

Evaluation  
Standardization  
Application

of

- Capacitors
- Resistors
- Switches
- Other Electronic Components

OR . . .

. . . if you have experience and education in communications, mobile radio, nuclear reactor instrumentation, technical writing, broadcast transmitters, high power audio amplifiers, high frequency heating application, servo mechanisms, magnetic amplifiers, etc., please apply.

*If employed at your highest skill in a defense industry do not apply.*

SEND TODAY

For your copy of "Gateway to an Engineering Future," including complete description of Electronics Division operations and the pleasant living conditions in Baltimore—home of the division.

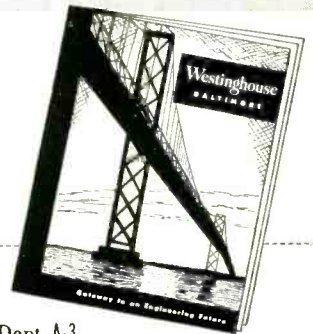

Mr. R. M. Swisher, Jr.  
Employment Supervisor, Dept. A-3  
Westinghouse Electric Corporation  
109 West Lombard Street  
Baltimore 1, Maryland

Please send me a copy of "Gateway to an Engineering Future."

Name \_\_\_\_\_

Address \_\_\_\_\_

City \_\_\_\_\_ State \_\_\_\_\_

Engineering Field \_\_\_\_\_

YOU CAN BE SURE...IF IT'S  
**Westinghouse**

ELECTRONICS DIVISION  
BALTIMORE, MARYLAND

OTHER TYPES OF RECTIFIERS TOOK  
THEIR TOLL AT THE TOLL GATES

... THEN



BRIDGED THE GAP!

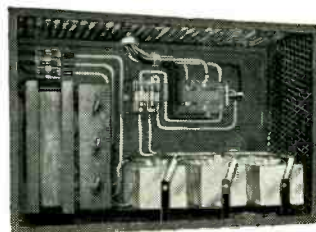
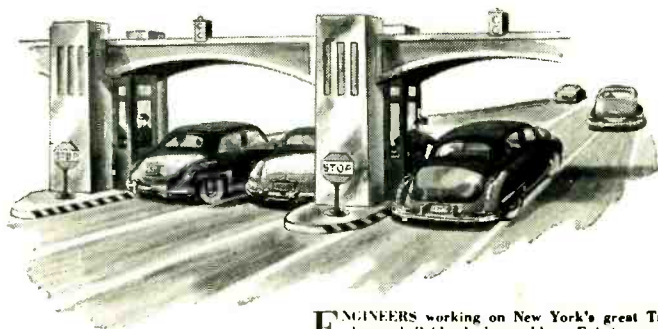

INSTALLATION AT TRIBOROUGH BRIDGE,  
60 VOLTS OUTPUT, 45 AMPS. CONTINUOUS  
DUTY, OPERATING 24 HOURS A DAY, 365  
DAYS A YEAR.

**E**NGINEERS working on New York's great Triborough Bridge had a problem: Existing rectifier installations controlling 22 toll lanes were not efficient. . . They were far too bulky for the current and voltages delivered. . . They generated too much heat.

*The solution?* Ralph M. Thompson of the Electronic Signal Company, Williston Park, L. I., to whom the contract was let chose and installed SELETRON Selenium Rectifiers built on aluminum . . . and the problem ceased to exist! For SELETRON Selenium Rectifiers actually require no more than 1/3th the space needed for the old equipment; they have low internal heat losses, and afford much better voltage regulation.

The Triborough Bridge installation is typical of hundreds of other applications where "job-rated" SELETRON Selenium Rectifiers have paid off in top performance. They are available in a variety of assemblies to cover a wide range of currents and voltages.

Perhaps you have a tough rectification problem that SELETRON engineers can solve. Will you write and tell us about it now? Our general catalog is yours for the asking, too. Just address Dept. ES-24.

SELETRON & GERMANIUM DIVISION  
**RADIO RECEPTOR COMPANY, INC.**

Since 1922 in Radio and Electronics

SALES DEPT. 251 West 19th Street, New York 11, N. Y.; FACTORY, 84 North 9th Street, Brooklyn



Speaking  
of long  
runs...

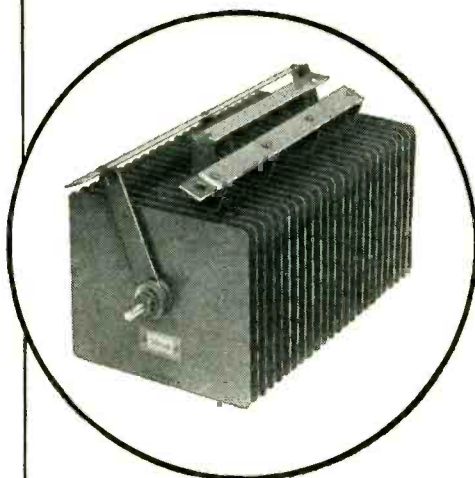

## How's this for continuous performance!



Back in 1948 an ad we ran told how SELETRON Selenium Rectifiers were operating successfully in a new installation on the toll lanes of New York's great Triborough Bridge.

Today after many years SELETRON's hit performance still continues. As a result, additional installations have been made at other tunnels and bridges under control of the Triborough Bridge Authority. These rugged rectifiers are giving positive proof of their long-lasting dependability on the bridge and in hundreds of other diversified applications.

If you have a spot in your plans for selenium rectifiers, you need SELETRON. Write us now without obligation, won't you, or study our catalog in Sweet's Product Design File. We also manufacture germanium diodes and transistors.

Seleton and Germanium Division  
**RADIO RECEPTOR COMPANY, INC.**

In Radio and Electronics Since 1922

SALES OFFICES: 251 WEST 19TH STREET, NEW YORK 11, N. Y., WATKINS 4-3633, FACTORIES IN BROOKLYN, N. Y.

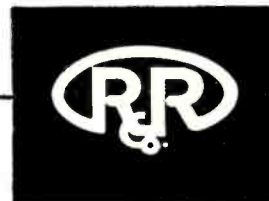



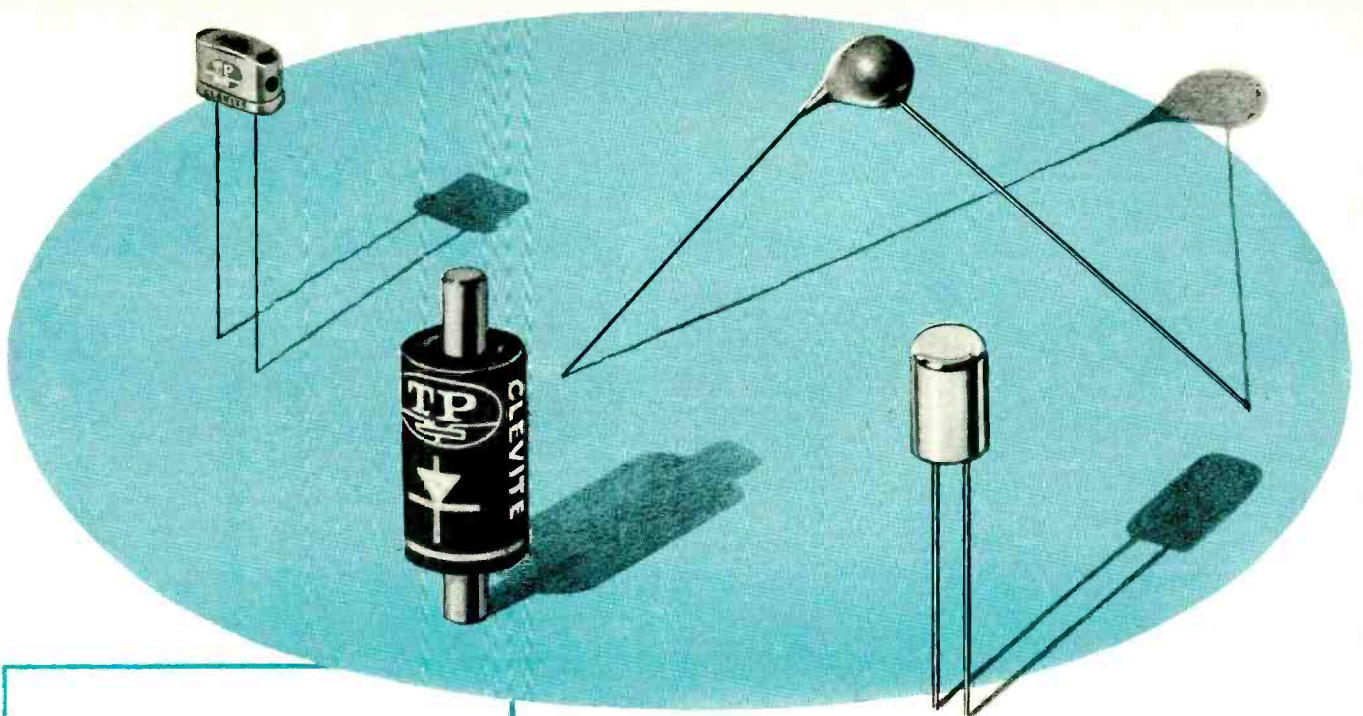

### Clevite Germanium Diodes

#### CARTRIDGE TYPE

1N34	1N65	1N98	1N147
1N34A	1N66	1N99	1N174
1N38	1N67	1N100	1N190
1N38A	1N67A	1N105	4A
1N48	1N68	1N107	4B
1N51	1N68A	1N108	4C
1N52	1N69	1N109	4D
1N54	1N70	1N110	4E
1N54A	1N72	1N111	4F
1N55	1N75	1N112	4G
1N55A	1N81	1N113	4H
1N55B	1N86	1N114	4I
1N56	1N87	1N115	4J
1N56A	1N88	1N116	4K
1N58	1N89	1N117	4L
1N58A	1N90	1N118	4M
1N60	1N95	1N124	4N
1N63	1N96	1N132	
1N64	1N97	1N133	

#### "DIOMITE" BEAD TYPE

D1N34	D1N65	D1N108	1C
D1N34A	D1N69	D1N109	1D
D1N48	D1N86	D1N116	1E
D1N51	D1N88	D1N117	1F
D1N54	D1N90	D1N118	1G
D1N54A	D1N95	D1N174	1H
D1N56	D1N96	1A	1J
D1N56A	D1N107	1B	

#### "MICROTEMP" DIODES

M1N38	M1N55B	M1N68A	M1N108
M1N38A	M1N58	M1N70	6A
M1N54A	M1N58A	M1N75	6B
M1N55	M1N63	M1N81	
M1N55A	M1N67	M1N107	

#### SPECIAL CASE TYPES

S1N39	1N188	1N189	5B
-------	-------	-------	----

For data sheets and complete information on CLEVITE transistors, diodes and transistor test sets, write Dept. E4.

## Only Clevite Germanium Diodes are available in 127 types!

### Cartridge—Bead—Can—Special Case Types—For All Applications

Nowhere else can you get this wide range of diode types — suitable for so many applications! Basically point contact or junction crystal rectifiers, CLEVITE Germanium Diodes offer numerous advantages over conventional vacuum tube diodes — including extremely long operating life and no filament or heater power requirements.

#### CLEVITE DIODES Offer All These Features!

- Universal Lead Mounting
- 30 different pigtail lead mounting positions on cartridge types permit design versatility and easy installation — *at no extra cost!*
- Positive Electrical Stability through precious metal electro-bonding
- Advanced Hermetic Sealing
- Provides moisture resistance and wide ambient temperature range operation at full ratings
- Uniformly Low Inter-Electrode Capacitance
- Micro-sized — Precision Tested — Rugged

#### LOW COST — HUNDREDS OF APPLICATIONS

As Rectifiers — Detectors — Discriminators — Limiters — Multipliers — Modulators — Switches — and many new, important uses that are being discovered daily!

# TRANSISTOR PRODUCTS, INC.

TELEPHONE: ALGONQUIN 4-0470  
CABLE ADDRESS: TRANSISTOR  
CODES: UNITED TELEGRAPH-HOUSE



SNOW AND UNION STREETS, BOSTON 35, MASSACHUSETTS  
AN OPERATING UNIT OF CLEVITE CORPORATION

TRANSISTORS • DIODES • SEMI-CONDUCTOR MEASURING EQUIPMENT

# Goat

## is a word **ADLAKE** engineers don't understand!

**Often**, a problem that "can't be solved" is merely one which hasn't yet been brought to the right people. When such problems come in to ADLAKE relay engineers...problems requiring special relays for unusual installations...they promptly drop the "can't". For, if there is no ADLAKE Relay to answer a specific need, one will be designed and manufactured to fill it.

**ADLAKE Mercury Relays** have proved their ability to stand up under the most adverse conditions of temperature and moisture. Their time delay characteristics are fixed and non-adjustable...normal line voltage fluctuations or ambient temperatures from  $-38^{\circ}$  to  $200^{\circ}$  F. have no material effect on these characteristics.

**Yes**, in chick incubators or diesel locomotives... wherever sensitivity and dependability are required...ADLAKE Relays can be counted on. Send for complete Relay catalog today...The Adams & Westlake Company, 1171 N. Michigan, Elkhart, Indiana. In Canada, write PowerLite Devices Ltd., of Toronto.

**EVERY ADLAKE RELAY IS TESTED  
—AND GUARANTEED  
—TO MEET SPECIFICATIONS!**



Type 1045 Quick-Acting Relay contact either normally open or normally closed.

**THE Adams & Westlake COMPANY**

Established 1857 • ELKHART, INDIANA • New York • Chicago  
Manufacturers of ADLAKE Hermetically Sealed Mercury Relays





# Announcing POWERSTAT Variable Transformers

## TYPE 136 AND 236

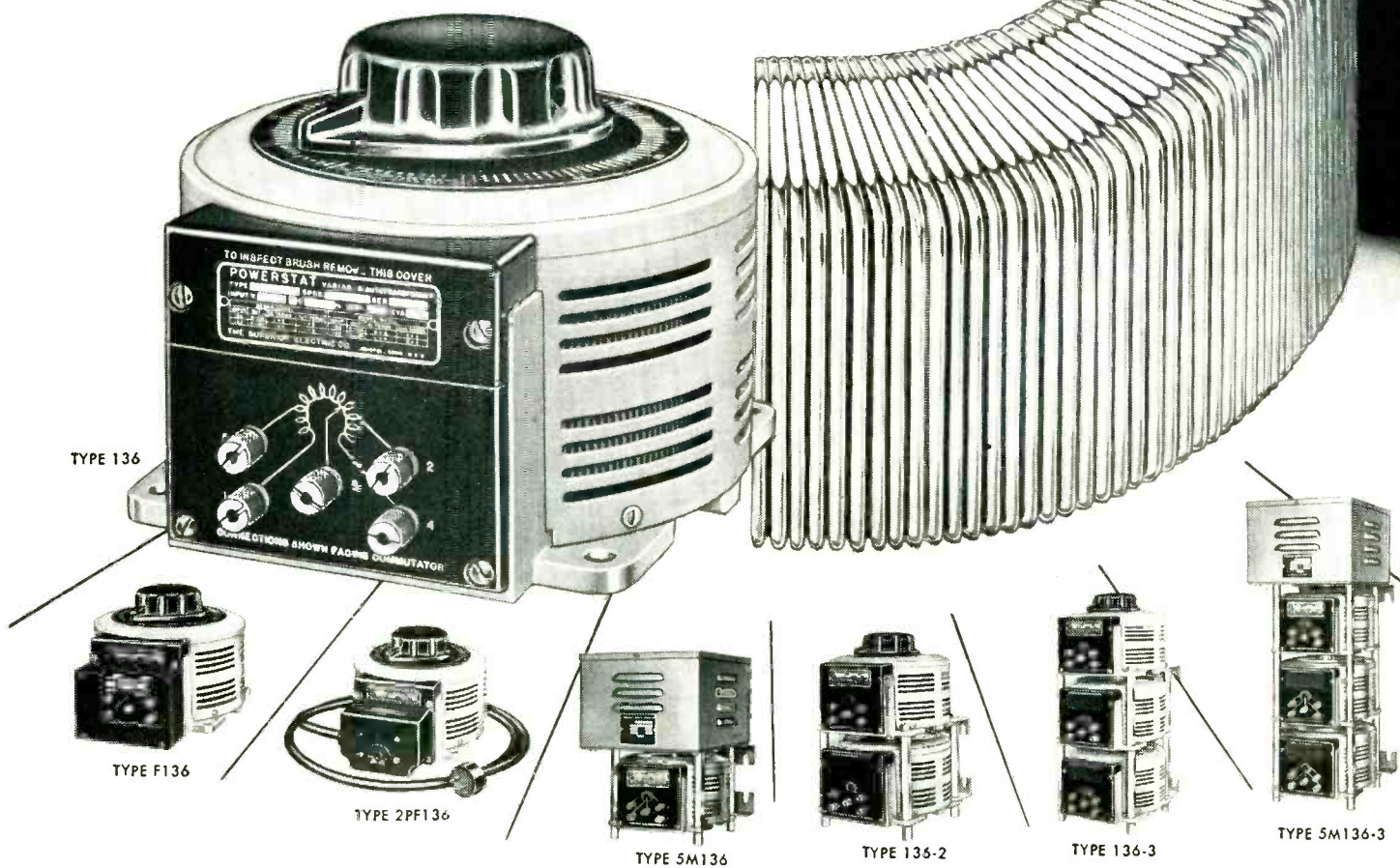

**Higher Ratings** — to meet the demand for POWERSTATS with 20 ampere capacity.

**Small Size** — “pancake” coil design provides compact assembly for panel or bench mounting.

**Easy, Versatile Installation** — 3 sets of mounting holes to suit all needs — simple to change from bench to panel mounting — binding post type terminals provide for any method of connection.

**Smoother Operation** — self-lubricating nylon bearing shaft support. Hand-fitted knob.

**Easy Service** — simply remove plate block for easy access to brush assembly.

**Rhodium Plate Commutator** — assures smoother performance and longer life — contact surface forever free of oxides — uniform contact drop maintained — corrosion reduced — allows greater overload characteristics.

Single and three phase assemblies are offered for manually-operated and motor-driven duty in 120, 240, 480 volt rating. Write for Bulletin P354.

**THE SUPERIOR ELECTRIC  
COMPANY**  
204 CLARKE AVENUE, BRISTOL, CONN.

Manufacturers of: Powerstat Variable Transformers • Stabiline Automatic Voltage Regulators • Voltbox A-C Power Supplies • Powerstat Light Dimming Equipment • Varicell D-C Power Supplies • Superior 3-Way Binding Posts

A FEW OF MANY EDO SONAR  
EQUIPMENTS FOR COMMERCIAL AND NAVAL USE

# EDO

*finest name in*

# SONAR

Ingenuity of design, proven performance and superior range with accuracy are the main reasons why EDO is now regarded and recognized as the outstanding leader in the development of echo-ranging equipment.

From deep depth sounders for navigation, survey, and ocean bottom exploration to a wide variety of under water detection systems, Edo equipment has made its mark and proven its superiority.

That's why when you see the Edo flying fish emblem on a sonar equipment you can confidently recognize it as a product of brilliant engineering and masterful workmanship—reliable beyond question.

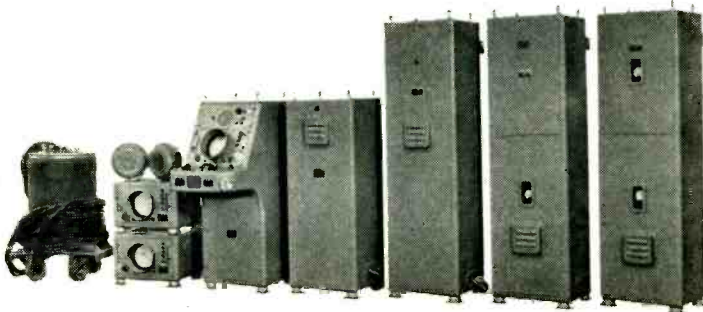

**EDO SCANNING SONAR** a typical example of a complex naval sonar system, developed and built for the U. S. Navy by Edo.

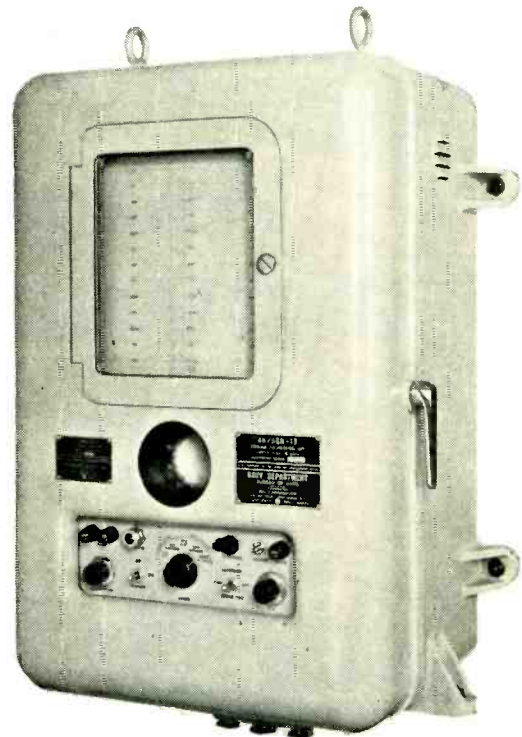

**0 TO 6000 FATHOM DEEP DEPTH SOUNDER** in wide use with U. S. Navy (AN/UQN-1b) now available commercially (Model 185). Gives clear indication of depth on cathode-ray tube in two scales: 0 – 100 feet; 0 – 100 fathoms. Records continuously in three scales: 0–600 feet; 0–600 fathoms; 0–6000 fathoms. The finest deep depth sounder available. For complete details send for Model 185 brochure.

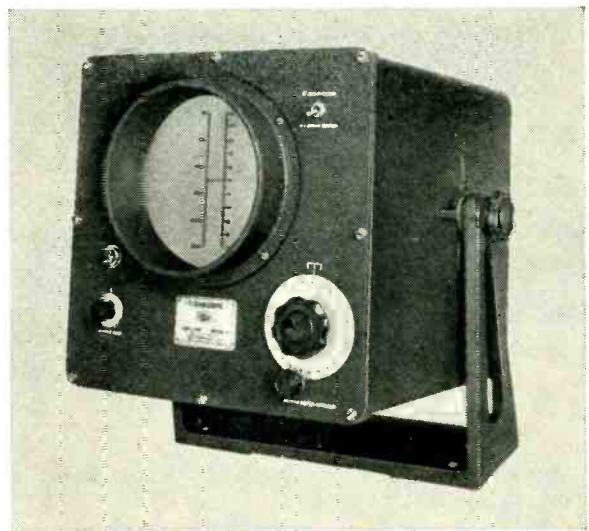

**EDO FISHSCOPE.** Most advanced fish finding device available today. Spots fish on cathode-ray tube in 0 – 250 fathom range, then magnifies any 10-fathom sector 25 times for clearer view. Commercial fishing boats equipped with the Fishscope report better than average hauls in far less time thanks to this Edo development. For full details send for Fishscope brochure.

**EDO CORPORATION • COLLEGE POINT, L. I., N. Y.**



Since 1925



STILL LEADING THE BIG

# Electronics Parade!

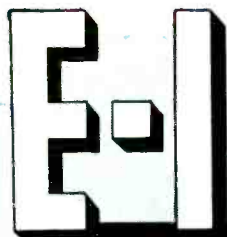

HERMETICALLY-SEALED

## miniature closures

—FOR TRANSISTORS AND OTHER COMPONENTS

NO. 1 SERIES NO. 3 SERIES

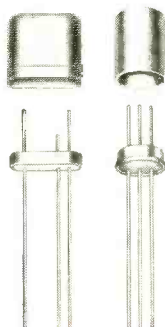

TRANSISTOR CLOSURES  
(SHOWN ACTUAL SIZE)

### WRITE FOR THESE CATALOGS

- BULLETIN 949-A On hermetically sealed terminals. Discusses cushioned glass construction, thermal shock resistance, preferred types and special terminals.
- BULLETIN 950-A On hermetically sealed multiple headers. Explains vacuum tight feature, cushioned glass construction, strain-free qualities.
- BULLETIN 951 With complete information on octal type plug-in and multiple headers. Solid metal blanks insure maximum mechanical strength and rigidity.
- BULLETIN 952 Complete information on E-I end seals for hermetic sealing condensers, resistors and other tubular electronic and electrical components.
- BULLETIN 953 Individual, color-coded hermetically sealed terminals. Available with glass inserts colored in standard, easily identified RMA color codes.

- BULLETIN 960 Compression type multiple headers. Super rugged, absolutely rigid and practically indestructible. Guaranteed vacuum-tight.

New EI Miniature Closures can be supplied in various standard types or economically produced to your exact specifications for all electrical and electronic applications. The EI closure types illustrated are typical examples of the many miniature designs now in production. Cases can be supplied in round, rectangular or square shapes with hermetically sealed terminations to your order.

FOR COMPLETE DATA AND PRICES ON SPECIFIC TYPES OF MINIATURE CLOSURES, CALL OR WRITE,

twice actual size

\*PATENT PENDING  
ALL RIGHTS RESERVED

DIVISION OF AMPEREX  
ELECTRONICS CORPORATION



# ELECTRICAL INDUSTRIES

44 SUMMER AVENUE, NEWARK 4, NEW JERSEY

EXPORT AGENTS: PHILIPS EXPORT CORP., 100 EAST 42nd STREET, NEW YORK 17, N. Y.

he's working for you



THIS FELLOW IS TRAINED IN YOUR BUSINESS. His main duty is to travel the country — and world — penetrating the plants, laboratories and management councils . . . reporting back to you every significant innovation in technology, selling tactics, management strategy. He functions as your all-seeing, all-hearing, all-reporting business communications system.

THE MAN WE MEAN IS A COMPOSITE of the editorial staff of this magazine. For, obviously, no one individual could ever accomplish such a vast business news job. It's the result of many qualified men of diversified and specialized talents.

AND, THERE'S ANOTHER SIDE TO THIS "COMPOSITE MAN," another complete news service which complements the editorial section of this magazine — the advertising pages. It's been said that in a business publication the editorial pages tell "how they do it"—"they" being all the industry's front line of innovators and improvers — and the advertising pages tell "with what." Each issue unfolds an industrial exposition before you—giving a ready panorama of up-to-date tools, materials, equipment.

SUCH A "MAN" IS ON YOUR PAYROLL. Be sure to "listen" regularly and carefully to the practical business information he gathers.



**McGRAW-HILL PUBLICATIONS**



# FREED

PRODUCTS OF EXTENSIVE RESEARCH

# A.C. BRIDGES & ACCESSORIES



No. 1110A - INCREMENTAL INDUCTANCE BRIDGE

This bridge has an impedance range of one millihenry to 1000 henries in five ranges and can be extended to 10,000 henries through the use of external resistance. The inductance values are read directly from a four dial decade and multiplier switch.

The inductance accuracy is within plus or minus 1% through the frequency range from 50 to 1000 cycles. For the largest multiplier at 1000 cycles, the accuracy of the bridge is decreased to 2%.

On the 1000 henries range, the D.C. is limited to 20 MA. On the 10 henries range the D.C. is limited to 200 MA. On all lower ranges, one ampere D.C. can be used.

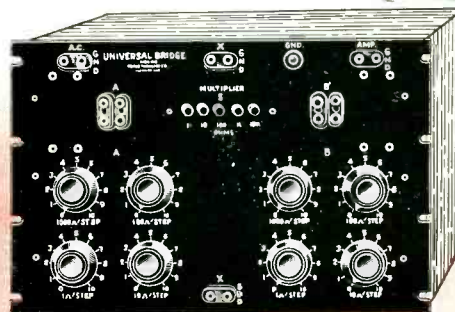

No. 1150 - UNIVERSAL BRIDGE

Offers a variety of five possible bridge circuits. A range of capacitance, inductance, impedance, and phase angle measurement can be made throughout the frequency spectrum from 20 cycles to 20,000 cycles. By using decade resistors in the variable arms the unknown can be measured to four significant figures. Operation is simple with terminals and controls arranged for convenience and ease of measurements.

Frequency range 20 cycles to 20,000 cycles. Inductor Range: 100 microhenries to 1000 henries. Capacitor Range: 1 micromicrofarad to 1 microfarad. Accuracy: 0.5% @ 1000 cycles. Condensers smaller than 0.001 mf should be measured by the substitution method.



No. 1180 - A.C. SUPPLY

A valuable laboratory instrument with continuous variable output from .1 volt to 100 volts at 60 cycles.

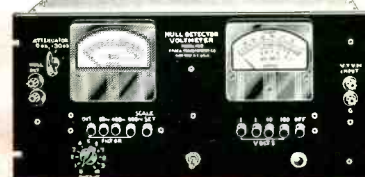

No. 1210A - NULL DETECTOR & VACUUM TUBE VOLTMETER

Provides simultaneous measurement of the voltage across the unknown and the balance of the bridge. Vacuum tube volt meter Sensitivity .1, 1, 10, 100 volts. Frequency range 20 - 20,000 cycles. Null Detector part of instrument same as Type 1140A.



No. 1170 - D.C. POWER SUPPLY

A stabilized Power supply primarily intended to be used as a D.C. supply for Incremental Inductance Bridge Type 1110A. Provides 4 continuously variable current ranges: 5 milliamperes, 25 milliamperes, 100 milliamperes, and 500 milliamperes. Maximum Output voltage 270 V.D.C. Noise level - 92 Db.



No. 1140-A NULL DETECTOR AMPLIFIER MODEL

A high gain null indicator for bridge measurements, providing visual null indications or aural indications when used in conjunction with headphones. The unit may also be used as a high gain amplifier for general laboratory work.

SEND FOR  
COMPLETE  
CATALOG OF  
TRANSFORMERS  
&  
INSTRUMENTS

# FREED TRANSFORMER CO., INC.

1722 WEIRFIELD ST. (RIDGWOOD) BROOKLYN 27, N.Y.

Consistently Dependable

# Cornell-Dubilier

mica capacitors

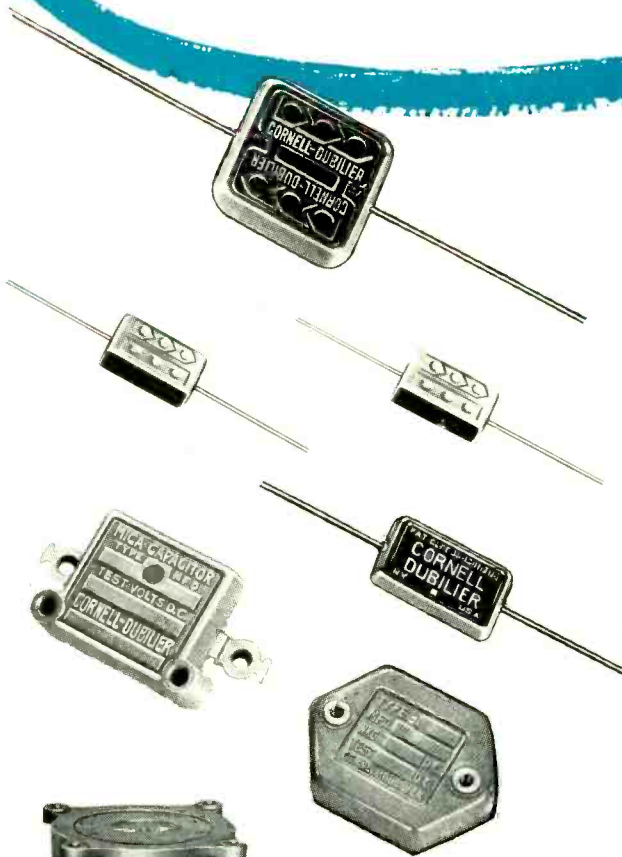

**They don't just meet ratings;  
they exceed them!**

Other capacitors may *look* like C-D micas. Other capacitors may have the same voltage ratings. But there, the resemblance ends. Because only C-D's have the built-in extras that are the result of over 40 years of capacitor leadership. From the tiny Silver Mikes\* to the largest heavy-duty power capacitors and Faradons\*, you can be sure that C-D capacitors will not just *meet* your specified rating, but will have an extra margin of safety that assures consistent dependability. Engineering samples gladly sent on request. For your special design and application problems, use our Technical Advisory Service.  
Cornell-Dubilier Electric Corp., Dept. K-44  
South Plainfield, New Jersey.

THERE ARE MORE C-D CAPACITORS IN USE TODAY THAN ANY OTHER MAKE

# CORNELL DUBILIER *Capacitors*

PLANTS IN SOUTH PLAINFIELD, N. J.; NEW BEDFORD, WORCESTER AND CAMBRIDGE, MASS.; PROVIDENCE AND HOPE VALLEY, R. I.; INDIANAPOLIS, IND.; FUGUAY SPRINGS AND SANFORD, N. C.; AND SUBSIDIARY, THE RADIART CORPORATION, CLEVELAND, OHIO



ANTENNAS



ROTORS



CAPACITORS



VIBRATORS



CONVERTERS

\*®





"Best Suited" for  
**HIGH TEMPERATURES**

## **VARGLAS SILICONE CLASS H TUBING and SLEEVING**

for applications requiring prolonged heat endurance at temperatures up to 260°C.

Varglas Silicone tubing and sleeving were developed by Varflex for applications involving continuous operating temperatures up to 260° C. Exceptional stability is combined with the following qualities . . .

**Flexibility** — sharp turns and 90° bends cause no cracking or peeling — no loss of dielectric strength.

**Dielectrically-Strong** — All grades conform to NEMA and MIL-I-3190 standards.

**Moisture-Resistant** — including resistance to salt water, mild alkalis and acids.

**Flame-Resistant** — Standard burning test is 45 seconds to burn 1 inch. Can

be made self-extinguishing on special order.

**Cold-Resistant** — Excellent resistance to chafing and abrasion, flexible to -35°C.\*

\*For temperatures down to -65°C, and for applications requiring extraordinary flexibility, we recommend our new Varglas Silicone Rubber sleeving and tubing. Inquiries invited.

### **Send for FREE SAMPLES**

Mail coupon today for free folder containing 25 different test samples of Varflex insulating sleeving, tubing, lead wire and tying cord.

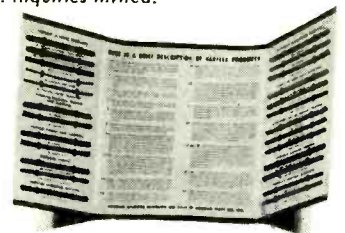

**Varflex**  
**CORPORATION**

Makers of  
Electrical Insulating  
Tubing and Sleeving

**VARFLEX SALES CO., INC.**  
(for Silicone Products only)  
308 N. Jay St., Rome, N. Y.

Please send me free folder containing samples of your electrical insulating tubing and sleeving.  
I am particularly interested in insulation for \_\_\_\_\_

Name \_\_\_\_\_  
Company \_\_\_\_\_  
Street \_\_\_\_\_  
City \_\_\_\_\_  
Zone \_\_\_\_\_ State \_\_\_\_\_

# Stop Troubles Before They Start... With Mallory Vibrators



The best time to do this is while your equipment is still in the design stage. Each element . . . the vibrator, transformer and buffer capacitor . . . must be carefully selected for balanced electrical characteristics if your power supply is to give top performance in service.

You can avoid vibrator power supply trouble by calling on the specialized knowledge and experience of Mallory engineers. Let them translate the power requirements of your equipment into a smooth operating, trouble-free design. You will save time and money and get the kind of performance you want.

Why call on Mallory? There are a lot of reasons . . . good ones. Our experience in this field is backed by an unmatched fund of engineering knowledge that started over 20 years ago when we produced the *first* commercial Vibrator. Our experience includes supplying more Vibrators for original equipment than all other makes combined.

That's not all. If you wish, we are equipped to design and manufacture complete power supply units . . . to your exact requirements . . . to meet your production schedules.

To save engineering time and reduce production costs, write us today. It is the best way to stop troubles before they start.

Expect more . . . Get more from **MALLORY**

Parts Distributors in all major cities stock Mallory standard components for your convenience.

**Serving Industry with These Products:**

- Electromechanical—Resistors • Switches • Television Tuners • Vibrators
- Electrochemical—Capacitors • Rectifiers • Mercury Batteries
- Metallurgical—Contacts • Special Metals and Ceramics • Welding Materials





# CROSS TALK

► **TWO SPRINGS . . .** This report is written in California, where spring came early, with San Francisco singularly free of fog and Los Angeles temperatures well up in the eighties. By the time it goes to press we will be back in New York, and thus will see two springs for the price of one.

Most noticeable thing about far-western industry in the past six months is a healthy tendency toward stabilization. Not so many new firms. Some consolidations. Subcontractors are suffering a little, principally because some prime contractors deem it desirable on many counts to do more of their own work. Business in general is good.

There is an air of urgency in the development of commercial electronic products by Coast manufacturers heretofore concerned chiefly with government business. Many have excellent pipelines into local aircraft, guided-missile and college research laboratories, so the result should be more of the highly specialized and only moderately competitive products for which the area is noted.

► **DIP-SOLDER WIRING . . .** Where mechanized wiring seems desirable, but production runs are short, extension of dip-soldering

techniques may solve the problem. We saw some wiring just the other day that consisted exclusively of solder flowed in thin streams onto an insulating base and it seemed to fill the bill experimentally.

► **CAGEY COLOR . . .** In our travels the impression is growing that tube makers in general are playing it safe on color-television picture tubes, producing just enough 15-inchers to keep a foot in the door while at the same time watching the other fellow for evidence of larger sizes.

No one wants to be caught without color tubes if the market suddenly blossoms. Nor does anyone wish to be committed in production if competition finds a practical way to provide sizes comparable with monochrome types.

Guessing is complicated by the fact that one suggested tube type does not appear to lend itself too well to the larger sizes and presents some problems in brightness. Another, that does not seem to be too difficult to produce in larger sizes and presents a bright picture, is still in process of refinement. Some engineers feel that there may be still a third type somewhere in the woodpile but, if there is, it is well-shrouded in industrial secrecy.

► **TAPE TRENDS . . .** The market for magnetic recording tape is expanding rapidly, with new applications showing up around every corner.

Movie producers have used a lot of it for some time, but the real news at the moment is the rate at which theater orders for stereophonic playback equipment are coming in. It is also becoming evident that tape recorders go nicely with home hi-fi equipment. Watch for new models aimed at this market by firms that have in the past concentrated upon professional users.

Doctors are digesting technical papers on tape, keeping up to date by listening instead of reading. (McGraw-Hill has done similar work in other fields.)

Tape is one of the keys to industrial automation. Several new firms have recently been set up to engineer automatic control into everything from "a peanut stand to a bank," and appear to be counting heavily upon it for programming.

Even in the geophysical field, where engineers are most reticent about divulging advanced techniques, there is evidence that the usefulness of conventional oscillographs is being extended through the use of magnetic tape.

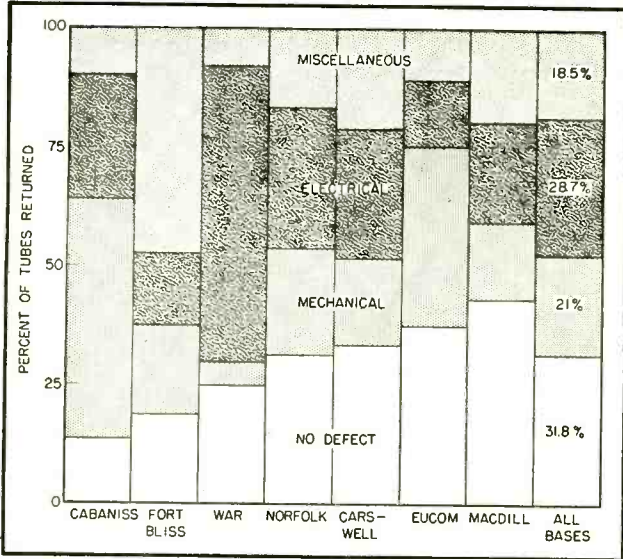

FIG. 1—Tubes returned fall into four defect classes: mechanical, electrical, miscellaneous including breakage and no defect

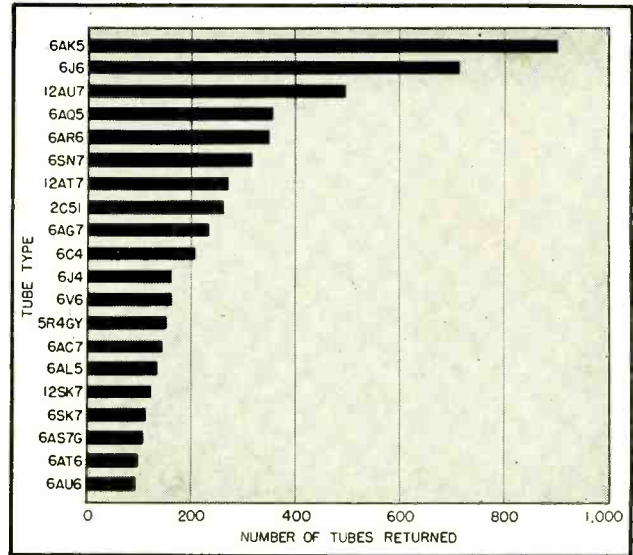

FIG. 2—Tube types 6AK5 and 6J6 lead the twenty tube types ranking highest in total number of returns for first quarter, 1953

# Military Reliability of

Study of over 150,000 electron tubes used in military equipment reveals types most likely to fail and discusses common kinds of failure. Tells what equipment designers and tube manufacturers can do to increase electron-tube reliability

By **E. R. JERVIS** and **J. SWAUGER**

*Aeronautical Radio, Inc.  
Washington, D. C.*

**S**EVERAL long-term programs have been launched by the armed services with a view to improving the reliability of more than 30 tube types. These types will be usable in more than  $\frac{2}{3}$  of all sockets in present-day military equipment. The improved types are being developed to reach a goal of 95-percent survival in 1,000 hours operation in contrast with 80-percent in 500 hours for presently available tubes.

A large-scale surveillance project is under way to determine the status of military electron tube reliability before and after use of improved tube types, to discover causes of unsatisfactory performance and to suggest measures for improving reliability. Field stations at eight military bases collect re-

jected tubes from military equipment. The tubes, with available failure data, are forwarded to Washington and subjected to both engineering and statistical analyses.

In two years, 88,500 tubes removed as defective by military technicians have been collected. Over 62,000 tubes have been installed in controlled tests. Tubes under test include over 14,000 of the 22 improved tube types as well as many thousands of their JAN prototypes.

Most of the information to be discussed concerns performance of JAN tube types since the improved versions have been used only in limited numbers during the last two years. This article covers from Sept. 1951 through March 1953 and

includes data from over 44,000 tubes collected from 44 general equipment types.

## Types of Defects

Tube returns have been classified in four general defect categories. Electrical defects include tubes rejected because of deterioration of performance caused by faulty processing during tube manufacture, end of normal tube life and environmental or operating conditions. Mechanical defects are physical defects in the structure caused by environmental conditions or weaknesses of tube construction. Miscellaneous defects include broken glass, noise, microphonism and defects caused by unusual environmental conditions or mishandling by main-



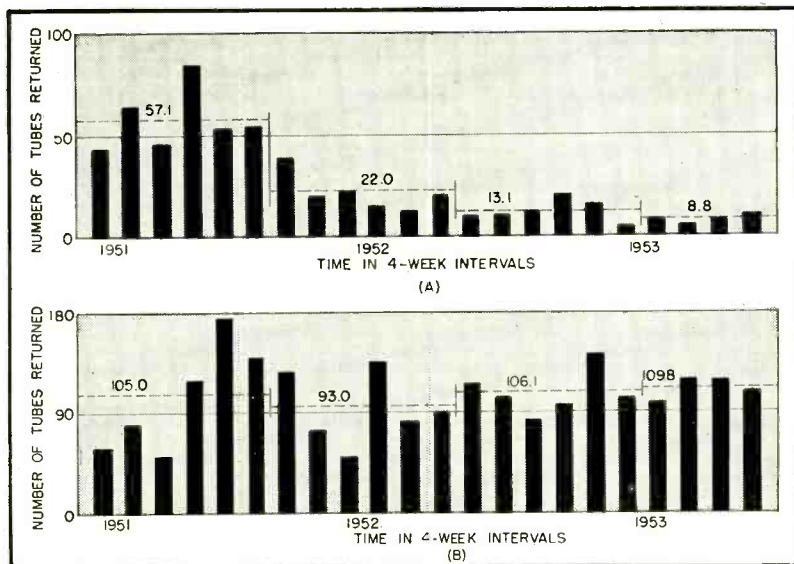

FIG. 3—Returns of 6AR6's from power supply of radar bombing system (A) and from complete system (B). Reduced failures are due to better ventilation

# Electron Tubes

tenance personnel. The no-defect category includes tubes removed by maintenance personnel yet found upon laboratory examination to contain no mechanical or electrical defects.

As shown in Fig. 1, one third of all the tubes rejected from military equipment are not defective at all. An additional one sixth of the tubes were probably damaged during installation or maintenance. The remaining 50 percent are truly defective. However,  $\frac{2}{3}$  of these failed only after progressive deterioration; they could have been located and removed before causing trouble. Therefore, only one out of every six tubes represents a failure such as would cause unpredictable equipment malfunction.

The equipment types installed at the different bases are similar. However, each base has a characteristic defect distribution pattern. These patterns reflect local operating procedure and maintenance practices.

Figure 2 is a ranking of the 20 tube types contributing the highest number of returns during the first quarter of 1953. While these tube

types constitute only about 10 percent of the types collected, they represent nearly half the total returns. Type 6AK5 alone contributed almost 10 percent.

Some tube types are numerous among those returned due to the large number in use. This group consists of old types such as the 6SN7, 6AC7, 6V6 and 6AG7 used in well-established equipment or newer tube types having wide application such as the 6AL5, 5R4GY and 6C4.

A second category includes tubes whose large return is due mainly to abnormal removals from some or all of the sockets in use. These include types 6AR6, 6AT6, 6J4,

12SK7, 6AQ5, 6AU6 and 2C51. With the exception of the 12SK7 these types are of relatively recent design and critical application.

Tubes in the third category—types 6AK5, 6J6, 12AT7, 6AS7 and 12AU7—show large returns due both to large socket populations and to abnormal removal from some of the sockets in use. The military services have already begun improvement projects on 17 of the 20 types listed in Fig. 2.

## Type 6AK5

The only outstanding weakness revealed in the 6AK5 is the heater. Table I gives a quantitative comparison of the reliability of the 6AK5 and its improved versions, types 5654 and 6096. Comparison is made of mean removals from 100 sockets during 100 hours of operation when the tubes are replaced with new ones upon failure. The fourth column gives number of failures if all no-defect removals are eliminated; in column five, eliminating both no-defect and electrical-defect removals indicates unpredictable failures causing equipment malfunction.

Information was also obtained from commercial airlines on a number of 5654's made by different manufacturers.

## Type 6J6

Tube type 6J6 is even more widely used than 6AK5 although the number of sockets under present surveillance is slightly less. Table II shows the defect distribution of all returns of this type and its improved versions during the first quarter of 1953. The no-defect category is larger for this type than for the overall average of all tubes from all bases. In returns of the improved type, electrical defects

### SIX WAYS TO INCREASE ELECTRON-TUBE RELIABILITY

- Limit power dissipation in soft-glass tubes to keep bulb temperature below 200 C.
- Limit cathode temperature to values minimizing interface formation and sublimation of nickel material.
- Limit heater temperature to 1,400 K to prevent heater-cathode trouble and heater burnout during cycling surges.
- Control metallic deposits on insulating surfaces by proper design of parts and insulators and proper shielding and coating of insulating parts.
- Control dimensions to obtain proper fit of parts and reduce vibration.
- Control fabrication and assembly to reduce operational failures due to faulty workmanship

lead mechanical by two to one. A breakdown of the electrical defects is also given.

A common electrical defect is heater-to-cathode leakage, probably due to the unusual physical layout of the tube. A large amount of power—as much as eight watts—is dissipated between the cathode and plates, and the grids have a tendency to expand, usually toward the cathode.

A comparison of results obtained in some controlled tests is given in Table III. The figures are of the same order of magnitude as those for type 6AK5 and the improvement of the premium versions over the prototype is also similar. However, the 6J6 appears to be overrated. To improve its reliability, it may be necessary either to decrease its maximum rating or to redesign radically its mechanical structure.

A double triode such as the 6J6 has almost twice as many chances of failure as a single tube but the returns do not show double the number of failures. This indicates that double triodes, performing the function of two tubes, have higher reliability than two single tubes.

#### Double Triodes

Other double triodes, such as the 6SN7, 12AU7, 12AT7, 2C51 and their improved counterparts also show higher reliability than comparable single tubes.

The 12AU7 compares favorably with the 6SN7 if the most recent design of the 12AU7 is considered, Type 12AT7, on the other hand, shows high-tem-

perature operation in its heater and cathode. This is indicated by the large percentage of returns for heater-cathode leakage and insulation failures. The 12AT7 has had wide acceptance among circuit designers because of its high transconductance and low heater requirements in spite of the extreme design features used to obtain such characteristics. These design features are responsible for the defects mentioned and should outweigh the performance characteristics if reliability is considered.

The 2C51 is similar to the 12AT7, but except for some insulation failures does not show the same weaknesses to as great an extent. The 2C51 has an improved version in the type 5670.

#### Types 6V6 and 6AQ5

Tube type 6AQ5 has been studied in comparison with type 6V6 of which it is the miniature counterpart. Table IV represents the defect distribution for these two types and their reliable counterparts.

The 6V6 exhibits a larger percentage of electrical defects than of other defects and is much higher in this category than the 6AQ5. The 6V6 shows a larger proportion of returns with interface resistance while the 6AQ5 evidences a greater tendency to fail because of emission degradation.

The temperature of the 6AQ5 has been estimated to be 100 C above that of the 6V6 at maximum rating. The higher operating temperature may explain the faster emission

deterioration of this type, resulting from evolution of gas and poisoning of the emitting surface by ion bombardment.

Failures may occur either due to loss of emission properties of the cathode, interface formation, evaporation of materials, vibration or a combination of any of these, and by catastrophic changes such as gas discharge within the bulb, glass strains, and shorts and opens.

#### Deterioration Failures

The rate of decay of cathode emission is related to the residual gas in the envelope at the beginning of tube life. As time passes, the cathode absorbs some of this gas and is gradually poisoned. This process may be accelerated if additional gas is developed as a result of electrical overloading or high ambient temperature.

Formation of interface resistance occurs most frequently in tubes that operate for long periods of time in circuits requiring low current densities. Composition of the nickel sleeve affects the speed of interface formation but exhaust schedules and operating temperatures are also important.

The evaporation of metal from hot elements in tubes produces gradual deterioration in the insulating properties of the tube structure and low-resistance paths between electrodes resulting in noise or irregular operation. Methods for minimizing this effect are coating smooth surfaces with rough insulating material to increase the length of the leakage

Table I—Removals of Tube Type 6AK5 and Improved Versions from 100 Sockets During 100 Hours

Source	Tube type	Mean removals	95-percent confidence interval	All failures	Catastrophic failures
Carswell AFB	6AK5	3.36	2.06-5.00	1.7	0.90
	6096	1.73	0.89-2.84	0.67	0.40
NOB Norfolk (air)	6AK5	4.87	3.24-5.45	3.08	2.05
	5654	1.90	1.69-3.14	0.71	0.47
	6AK5W	1.83	1.36-2.38	0.99	0.66
Commercial airlines					
	Tube mfr A, line E 5654	0.21	0.07-0.43	—	—
	Tube mfr A, line D 5654	0.33	0.12-0.60	—	—
	Tube mfr B, line E 5654	0.17	0.05-0.38	—	—
	Tube mfr B, line D 5654	0.29	0.10-0.60	—	—

Table II—Defect Distribution for Tube Type 6J6 and Improved Versions

Defect	6J6		6J6W, 6096, 6101	
	number	percent	number	percent
Mechanical	107	20	20	16
Electrical	86	16	41	32
No defect	213	40	55	43
Miscellaneous	130	24	12	9
Total	536	100	128	100
Electrical defects only (6J6 and improved versions)				
Degradation	135	55	—	—
Unbalance	37	15	—	—
Heater-cathode leakage	76	30	—	—
Total	248	100	—	—



path, proper shielding of electrodes, elimination of getter material, use of nonevaporating getters and inactive alloys and limitation to minimum operating temperatures in all elements.

If tubes are operating under conditions of constant vibration and frequent shocks, gradual deterioration can occur as a result of the enlargement of the supporting holes in the mica spacers. Eventually the electrical output produced by mechanical movement of the parts will overcome the useful output of the tube. Corrective measures include anchoring all elements firmly, using close tolerances on the mica spacers, processing the tubes at low temperature to prevent extreme expansion, using synthetic mica, Terratex or ceramics for spacers and redesigning the structure to obtain shorter electrodes and higher resonant frequencies for the elements.

Some causes of destructive gas discharge pressures are over heating of an electrode until it releases sufficient gas to reach arc discharge pressures, heavy heater-cathode leakages and slow air leaks.

If the glass envelope is not annealed properly or is subjected to unusual mechanical or thermal stresses it may crack. However, glass defects are infrequent where tubes are carefully handled.

The electrode most subject to shorts and opens is the heater. The operating temperature is one of the major reasons for failure. Low operating temperature for the heater is important to avoid burn-out and to reduce heater-cathode leakage.

Only about 12 percent of all tubes collected had definitely identifiable mechanical defects. Of these, more than half were attributable to the heater or heater-cathode circuit.

### Environmental Effects

High ambient temperatures, vibration and shock and abnormal supply voltage contribute to unreliability. Returns of tube type 6AS7G, and its reliable version, the 6080, from a voltage regulator used in a van-mounted fire control system illustrate this.

Operation in hot climates with the cabinet closed resulted in poor

**Table III—Removals of Tube Type 6J6 and Improved Versions from 100 Sockets During 100 Hours Operation**

	Tube type	Mean removals	95-percent confidence interval	All failures	Catastrophic failures
Carswell AFB.....	6J6	7.0	5.2-9.1	2.8	0.67
	6099, 6101	1.4	0.56-2.6	0.74	0.38
NOB Norfolk (air)....	6J6	4.46	3.4-5.6	3.22	2.12
NOB Norfolk (ships) ..	6J6	1.86	1.3-2.5	1.39	0.67
	6101	2.2	1.0-3.8	1.55	0.66

**Table IV—Defect Distribution for Tube Types 6AQ5, 6V6 and Improved Versions**

Defect	6AQ5		6005, 6095		6V6, 6V6GT, 6V6Y, 6V6TY	
	number	percent	number	percent	number	percent
No defect.....	152	49	4	17	45	41
Mechanical.....	28	9	6	26	3	3
Electrical.....	79	25	4	17	51	47
Miscellaneous.....	57	17	9	40	10	9
Total.....	316	100	23	100	109	100
Defective tubes only						
Mechanical.....	28	17	6	32	3	5
Electrical.....	79	49	4	21	51	80
Miscellaneous.....	57	34	9	47	10	15
Total.....	164	100	19	100	64	100

reliability in both type 6AS7G and its reliable version, type 6080. Operation in hot climates with the cabinet open gave satisfactory results if improved type 6080 was used while operation in air-conditioned vans gave normal life expectancy for both improved and JAN tube types.

In the power supply of a radar bombing system, the power supply chassis was originally mounted in the nonpressurized part of the plane where there was inadequate ventilation; 6AR6 returns per socket were four or five times greater than the average for all other sockets of the system. During flights above 30,000 feet, bulb temperature reached 315 C.

The power supply chassis was transferred to the pressurized zone of the plane and more effective blowers installed. A temperature check in the relocated chassis showed an average bulb temperature of 181 C. Figure 3A shows the returns of tube types 6AR6 and 6098 for four-week intervals over a period of almost two years. The gradual decrease in returns from an average of 57.1 to 8.8 for each

four-week period is readily noticeable. Figure 3B shows returns of all other tube types in the complete system during the same period, indicating that there was no comparable change in the aggregate returns.

### Misapplications

Severe misapplications are readily detected and corrected and do not constitute serious reliability problems. More troublesome are misapplications that produce only slight hardships. These include use of a tube type at its maximum rating when there is available another type that could be operated at a more conservative rating; use of a type not actually designed for a particular application when a more suitable type is available; and use of several tubes in parallel to avoid the use of a larger tube.

### BIBLIOGRAPHY

- "Investigation of Electron Tube Reliability in Military Applications", ARINC Gen Rpt No. 1, GPO, Washington, D. C.
- P. T. Weeks, Reliability in Miniature and Subminiature Tubes, *Proc IRE*, 39, No. 5, p 499, May 1951.
- G. H. Matson, S. Wagener, M. F. Holmes and M. R. Child, The Life of Oxide Cathodes in Modern Receiving Valves, *Proc IEE*, 99, Part III, p 69, March 1952.

# Capacitance Gage Checks

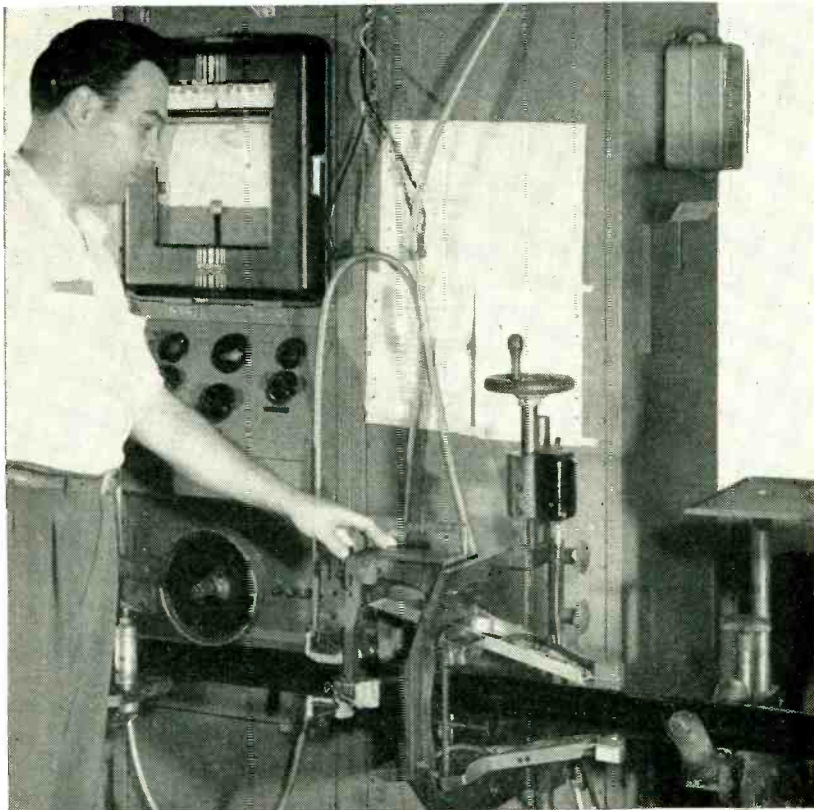

Measuring setup on cable production line. Toroid-shaped metal electrodes are in small blocks at right, held against sheath by metal arms mounted at angle to cable

By **B. M. WOJCIECHOWSKI**

*Test Set Development Engineer  
Western Electric Co.  
Kearny, N. J.*

**P**OLYETHYLENE extruded over a metal jacket replaces the conventional lead sheath in a new telephone cable now in use by the Bell System. The cable core is covered with a metal jacket that may either be one thin layer of aluminum or layers of aluminum and steel.

To achieve the desired mechanical properties, the metal jacket is corrugated circumferentially. Between the metal layer and the plastic sheathing, a bonding viscous thermoplastic compound is applied to fill the depressions of the corrugations on the metal surface. The sheathed cable leaves the extruder at an essentially uniform speed, in the range from 30 to 80 feet per minute, under the pulling force of a capstan. After leaving the extruder, the cable is cooled in a

trough of water and, before reaching the testing position, dried with compressed air.

## Measurement Difficulties

Some of the problems encountered in the manufacture of the new cable were related directly to the lack of reliable methods for measuring thickness of the plastic sheathing. Under manufacturing conditions where sheath thickness cannot be adequately controlled, excess material must be used to assure meeting minimum thickness requirements.

Before the new method was introduced, measurements were made by destructive testing of end samples. One or two circumferential strips were taken from each cable length and micrometer meas-

urements were made on each strip, at four to eight points. Unfortunately, the actual sheath thickness varies in a random way along the cable length, even between points only a few inches apart. A method based on a few point measurements, extrapolating long-cable properties which are describable in statistical terms only, thus left much to be desired.

## Choice of Method

For practical reasons as well as for anticipated lack of accuracy, measurements involving use of an x-ray machine were rejected. The success of an ultrasonic echo method would be doubtful, the main reason being the presence of corrugations and of an irregular layer of the filling compound under the polyethylene sheathing, obscuring delimitation of the reflecting boundary surface.

The capacitance method, at first, also had discouraging aspects. Only grounded capacitance measurements are involved, since the metal core cannot possibly be insulated from the corrugating and forming machinery. The required long-time capacitance-to-ground stability and accuracy of the measuring system were estimated to be of the order of 0.001  $\mu\text{f}$  and 0.003  $\mu\text{f}$ , respectively. Meeting requirements of this order, even under controlled laboratory conditions, presents some difficulties—and yet these requirements had to be met on a production line, on moving cable in the climatic and operational conditions prevailing in a large cable plant.

It was evident, therefore, that conventional grounded-capacitance



# Cable Sheath Thickness

Grounded direct-capacitance method utilizing shielded impedance bridge gives accuracy of 0.003 inch in measuring and recording thickness variations in polyethylene sheathing extruded over corrugated metal jacket of new telephone cable

measurements would not be practical. For instance, a shielded cable connecting the probes with the bridge circuit alone could produce wider random capacitance variations than the capacitance increments under measurement. A new method of grounded direct-capacitance measurement using an impedance bridge was therefore developed.

## Impedance Bridge Circuit

The bridge circuit shown in Fig. 1 has equal ratio arms magnetically coupled. An application of this type of circuit for capacitance measurements has been known for some time. Such a circuit is capable of performing in one balancing operation direct-capacitance measurements if the center point *B* of the transformer ratio-arms winding is grounded. For cable this is impossible because corner *D* of the bridge consists of the metal covering of the cable core, which is at ground potential. However, by connecting to corner *B* a shield that surrounds the *A-D* and *C-D* measuring arms, including cables and probes, three desirable results are achieved.

First, admittances from the measuring electrodes to the shield at *B* are not critical. These admittances appear across the transformer arms. As a result of a close magnetic coupling realizable between these arms, any loading effects across any one of them are symmetrically reflected at the *A* and *C* corners of the bridge, thus essentially not affecting its balance.

Second, stray admittances from the shield to ground appear across the opposite corners of the bridge

(detector diagonal). Therefore, they also have no essential effects on the circuit balance.

Third, as a result of the shield at *B*, stray admittances to ground from the measuring electrodes and from the connecting leads can be reduced to insignificant quantities.

## Performance of Bridge

The bridge arrangement measures capacitance quantities equivalent to direct capacitance, in a particular case where one of two measuring electrodes is grounded.

Realization of the grounded direct-capacitance measurements is made possible by having within the measuring arrangement a three-electrode system in which stray admittances from the third (ungrounded) electrode to either of the measuring electrodes do not affect the fundamental balance condition of the bridge network.

Residual effective capacitances between the measuring electrodes and ground are reduced to a desirable minimum (actually below  $1\mu\text{mf}$ , including calibrating capacitor and balancing networks). Also, any adverse capacitance effects of the cables connecting the bridge to the measuring probes are practically eliminated, even though these cables are several feet long.

The calibrated grounded direct-capacitance range of the bridge extends over  $0.32\mu\text{mf}$  in either direction off the balanced center position. Any unbalances within the  $\pm 0.25\mu\text{mf}$  range can be read in increments of  $0.005\mu\text{mf}$  per division on the dial of capacitor  $C_s$  or on the recorder scale.

Covering such a limited capacitance range directly with an adjustable capacitor presents practical difficulties, hence a capacitor network was used to reduce electrically the range of the  $2 \times 50\mu\text{mf}$  differential capacitor  $C_s$  to  $2 \times 0.32\mu\text{mf}$ . Use of such a network facilitates calibration and adjustability and greatly reduces the effects of mechanical instability of the variable capacitor. Similar networks serve for capacitance  $C_0$  and conductance residual-balance control  $G_0$ .

Stationary unbalances of the bridge network can be measured directly in a conventional manner

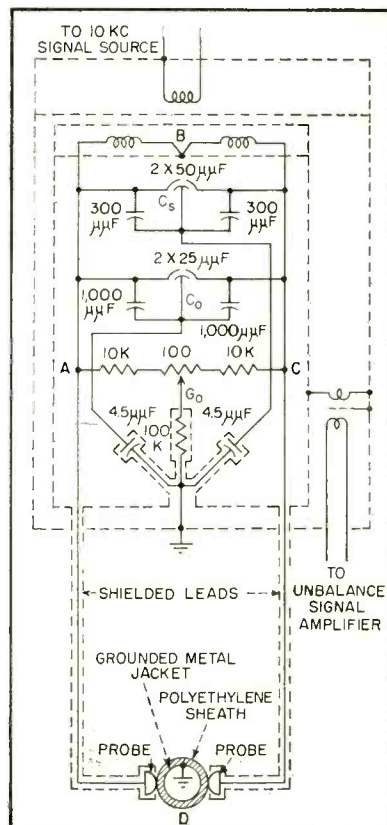

FIG. 1—Grounded direct-capacitance bridge circuit as used with two probes

by rebalancing the circuit with  $C_s$ . For unbalances rapidly varying in time, however, this null method could not be applied simply. Therefore, a proportional off-balance deflection method had to be used.

The circuit shown in Fig. 2 assures overall linearity between incremental capacitance unbalances and indicator deflections, so that variations in linearity no larger than 0.4 db over periods of several days and 0.2 db over several hours have been observed in the actual operating conditions.

Measurements with the bridge depend essentially on the calibrated capacitor  $C_s$ . To avoid necessity for frequent and quite elaborate calibration checking (within a few thousandths of a  $\mu\text{mf}$ ) of this capacitor in a laboratory, a set of supplementary high-stability auxiliary standards has been provided in the test-set assembly. The capacitance values (1.05  $\mu\text{mf}$ , 1.20  $\mu\text{mf}$  and 1.35  $\mu\text{mf}$ ) of these capacitors are so chosen that differences between any pair of them can be compared directly with the calibrated capacitor in the bridge circuit.

Reliability of this system is based on a reasonably high probability

that change in the calibrated value of any single capacitor will be revealed in the process of mutually comparing all four capacitors. The sensitivity of this method of ascertaining calibration accuracy at the operating position is actually higher than the sensitivity of the usually available laboratory equipment.

### Capacitance Unbalance Discriminator

For eccentricity measurements and control of the sheathing process it is essential to register the direction of incremental deviations from an arbitrary level. The phase-sensitive discriminator in Fig. 2 provides this indication. The unbalance signal from the bridge is fed through feedback amplifier  $V_1$ - $V_4$  and biased voltage limiter  $V_5$  to the center tap of transformer  $T_1$  in the discriminator circuit. The primary winding of this transformer is connected, through a continuously variable phase shifter, to the 10-kc signal source that also supplies the bridge circuit.

The d-c output from the balanced square-law discriminator stage is fed, through a time-delay network

of approximately 50 milliseconds, to power amplifier stage  $V_7$  and then through an attenuator to a zero-center recorder.

The voltage derived from the 10-kc power source across the secondary of  $T_1$  is the reference potential which, by adjustment of the phase-shifter, can be oriented so as to be in phase with the signal resulting from the reactive unbalance of the bridge circuit. Since the bridge output signal resulting from small conductance unbalances is essentially perpendicular to the ca-

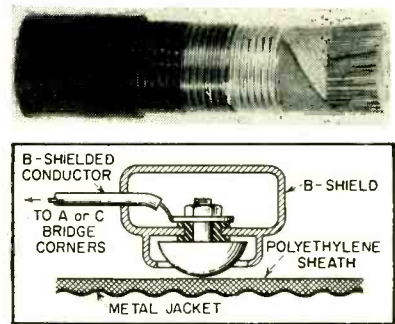

Cable construction and details of probe

pacitance unbalance signal, in this condition the circuit is not sensitive to limited unbalances of the real component.

At the operating sensitivity level, each of the 100 divisions of the recorder scale corresponds to 0.005  $\mu\text{mf}$ , or approximately to 0.001 inch of the incremental sheath thickness. The role of the attenuator is two-fold; it provides control of the over-all sensitivity of the measurements (in steps of 0.2 db) and it introduces a substantial (over 20 db) attenuation into the d-c output signal path. This loss is compensated by an added gain within the feedback-controlled a-c amplifier preceding the phase discriminator. The net result of this a-c for d-c gain-trading is a considerable improvement of the over-all circuit stability since the range of random drifts, such as are usually generated within the phase-discriminator and its direct-coupled output stage, are materially reduced.

### Measuring Probes

As has been mentioned above, two arms of the bridge circuit consist of a pair of admittances between the grounded metal core  $D$  of the cable and the probes sliding

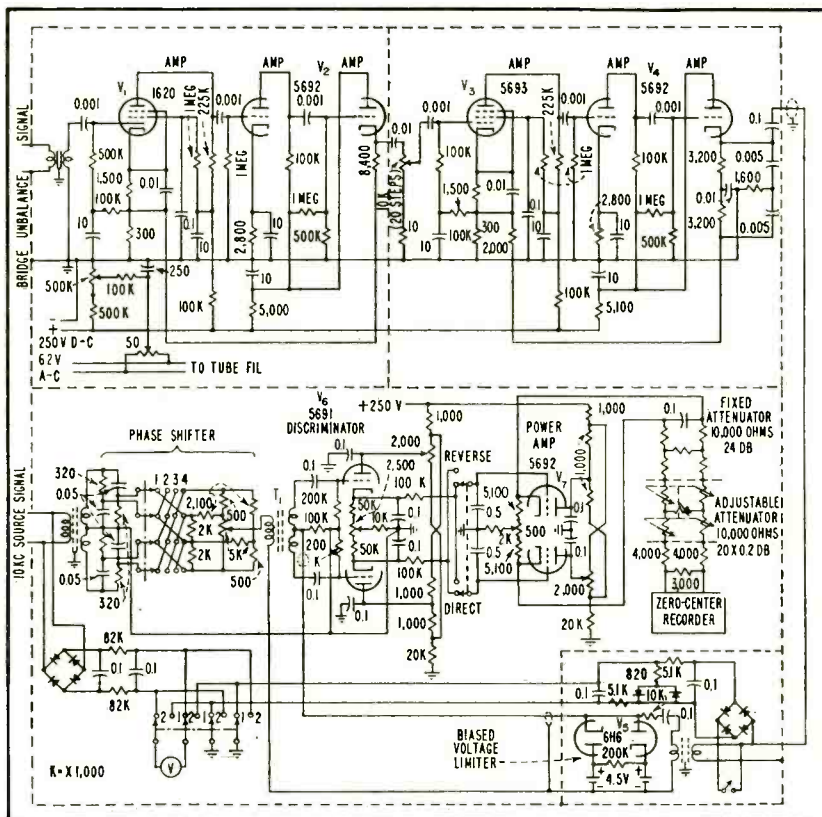

FIG. 2—Unbalance signal amplifier and capacitance unbalance discriminator



on the surface of the plastic cable sheathing. These probes are connected to the *A* and *C* corners of the bridge with two shielded flexible conductors (each about 10 feet long) and are maintained mechanically in the testing position by the probe assembly.

In the design of the probes and their assembly, various difficulties had to be overcome. The probes operate on cables subjected to some unavoidable swings and vibrations while moving with speeds up to 80 feet per minute. The capacitance from either of these probes to the metal cable core, in equivalent conditions, should match each other within approximately 0.001  $\mu\text{f}$ . This capacitance should not be appreciably affected by limited displacements of the probes with respect to the cable plane of symmetry, such as may occur in actual operating conditions.

Each of these probes is in the form of a cut-off segment of a toroid. This form of probe had various advantages, chief of which is that the capacitance from the probe to the cable core varies but little as a result of displacements and changes of position caused by the cable motion.

The probe electrodes, surrounded (except for the contacting face) by shielding, are mounted on mechanically balanced light aluminum arms. There may be one, two or four probes to an assembly, which can be turned over 360 deg around the cable axis. For eccentricity measurements two probes can be simultaneously used, having a spacing of 180 deg (for measurement of eccentricity across a diameter) or of 90 deg (for measurement of ellipsoidal eccentricity). Also, for eccentricity or direct thickness investigations and process settings one probe only may be used, with the other bridge measuring arm connected to an auxiliary standard.

### Performance Data

The average capacitance from the probe element to the grounded metal core varies from 1.1 to 1.3  $\mu\text{f}$  for cables measured. Incremental capacitance sensitivity for grounded direct-capacitance measurements, in normal operating conditions with the probes in contact

with a cable sample, is of the order of 0.001  $\mu\text{f}$ . Circuit stability and repeatability for periods over one hour duration is  $\pm 0.003 \mu\text{f}$ .

Overall linearity of the unbalance indications, as read on the recorder scale within the range of  $\pm 0.25 \mu\text{f}$  off center-balance position, is  $\pm (3 \text{ percent} + 0.003 \mu\text{f})$ .

Moving or twisting the connecting leads has no effect on balance stability. Swinging of the cable under measurement, even beyond the limits encountered in actual working conditions, produces barely noticeable effects on the balance indication.

### Production-Line Measurements

A typical example of a measurement performed on a cable section approximately 250-feet long is shown on Fig. 3. The upper curve represents a photograph of the recorder tracing. The lower curve was obtained by measuring actual thickness with a micrometer at 6-inch intervals, plotting them on the nonlinear vertical scale following the capacitance-versus-thickness function.

From comparison of these graphs a few observations can be made. The recorder indications are continuous average readings based on an area having a definite width and a length of a few corrugation spaces, while the micrometer readings are point measurements taken at discrete distances at the bottom of the corrugation valleys in the

polyethylene jacket. Despite this fact, the statistical character of both graphical results is closely similar. Assuming an average translation factor of 0.005  $\mu\text{f}$  per 0.001 inch and discarding tracing errors, the agreement for incremental measurements between both methods can be estimated to be of the order of 0.003 inch. This accuracy is ample for any practical purpose of incremental thickness control of cable sheathing.

The author wishes to thank R. I. Neel, W. T. Eppler and D. T. Robb of the Western Electric Co. for assistance given in various phases of this work. Especial credit for checking accuracy of the new method belongs to J. L. O'Toole of the Bell Telephone Laboratories group at Kearny, N. J.

### BIBLIOGRAPHY

- R. P. Ashbaugh, Alpeh Cable Sheath, *Bell Lab Record*, p 441, Nov. 1945.
- R. P. Ashbaugh, Stalpeh Cable Sheath, *Bell Lab Record*, p 353, Aug. 1951.
- F. W. Horn and R. B. Ramsey, Bell System Cable Sheath Problems & Designs, *Trans AIEE*, p 1,811, 1951.
- V. T. Wallder, Polyethylene for Wire and Cable, *Elec Eng*, p 59, Jan. 1952.
- H. G. Johnstone, U. S. Pat. 2,589,700, 1952.
- J. G. Ferguson, Classification of Bridge Methods of Measuring Impedances, *Bell System Tech Jnl*, p 452, Oct. 1933.
- C. H. Young, Measuring Inter-Electrode Capacitances, *Bell Lab Record*, p 433, Dec. 1946.
- L. Hartshorn, "Radio-Frequency Measurements by Bridge and Resonance Methods," John Wiley & Sons, New York, 1940, Chapter III.
- A. C. Seletzky, Cross Potential of a 4-Arm Network, *Elec Eng. (Trans)*, p 861, Dec. 1933.
- B. M. Wojciechowski, U. S. Pat. 2,554,164, 1951.
- B. M. Wojciechowski, Continuous Incremental Thickness Measurements of Non-Conductive Cable Sheath, *Bell System Tech Jnl*, p 353, March 1951.

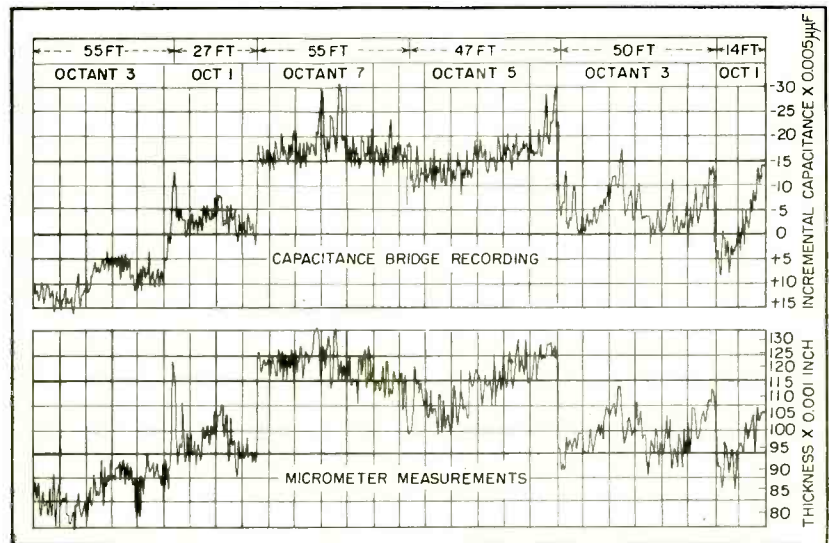
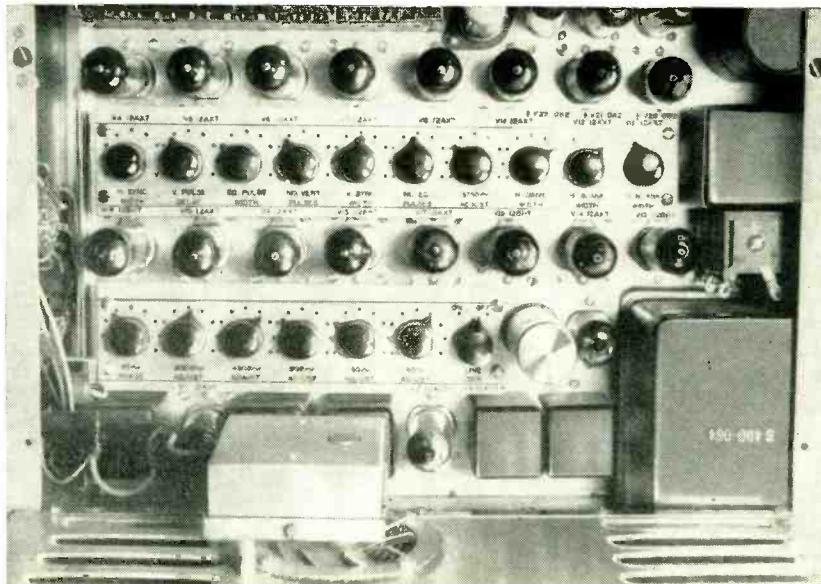

FIG. 3—Comparison of production-line recording with micrometer measurements of 248-ft length of Alpeh polyethylene-jacketed cable having 1.59-inch core thickness



Rear-panel view of sync generator, left, and tube and adjustment side of chassis, right

# Portable Sync Generator for TV Broadcasting

Miniaturized synchronizing pulse generator supplies standard RETMA signal at 4 volts negative peak to peak. Unit weighs only 20 lbs and is interchangeable with conventional television broadcast equipment. Built-in power supply is gas-tube regulated

**P**ORTABILITY AND SIMPLIFICATION of television broadcast studio equipment may be achieved by use of the synchronizing pulse generator to be described.

The generator furnishes standard RETMA synchronizing signals at 4 volts negative peak to peak across 75 ohms. It is housed in a briefcase-sized cabinet that also contains its regulated power supply. The photographs illustrate the tube and adjustment side of the chassis and the rear panel of the generator. Figure 1 is a functional block diagram and Fig. 2 is the complete schematic.

## Timer Section

The master oscillator and the 7-5-5-3 divider chain incorporate

five blocking oscillators each isolated by 1N51 germanium diodes. The timer generates the 31.5-kc and 60-cps trigger pulses to time the gates and multivibrators in the shaper section. All grid circuits in the timer section are connected through their respective time-constant controls to a +150-volt bus that serves as the afc line-lock path.

Tuned circuit  $C_1 - L_1$  in the master-oscillator grid circuit is a resonant stabilizer for maximum frequency stability. Shock excitation of this resonant circuit by the grid-current pulse produces added potential at the desired resonant frequency resulting in a high degree of grid stability.

Point *J* at the cathode of the

master oscillator terminates at the rear-panel waveform selector switch providing a signal at the rear-panel switch point for scope observation. Points *A*, *B*, *C* and *D* in the grid circuits of the 7-5-5-3 divider provide the same function.

## Line-Lock

The negative plate pulse and positive cathode pulses at  $V_{8d}$  are supplied to a balanced R-C network terminated in germanium diode clampers. The 6.3-volt 60-cycle reference from point *Y* in the power supply is injected at the junction, also designated *Y*.

When the 60-pps final divider output is in phase with the 60-cps line voltage, the equal-amplitude pulses occur at the instant the sine-



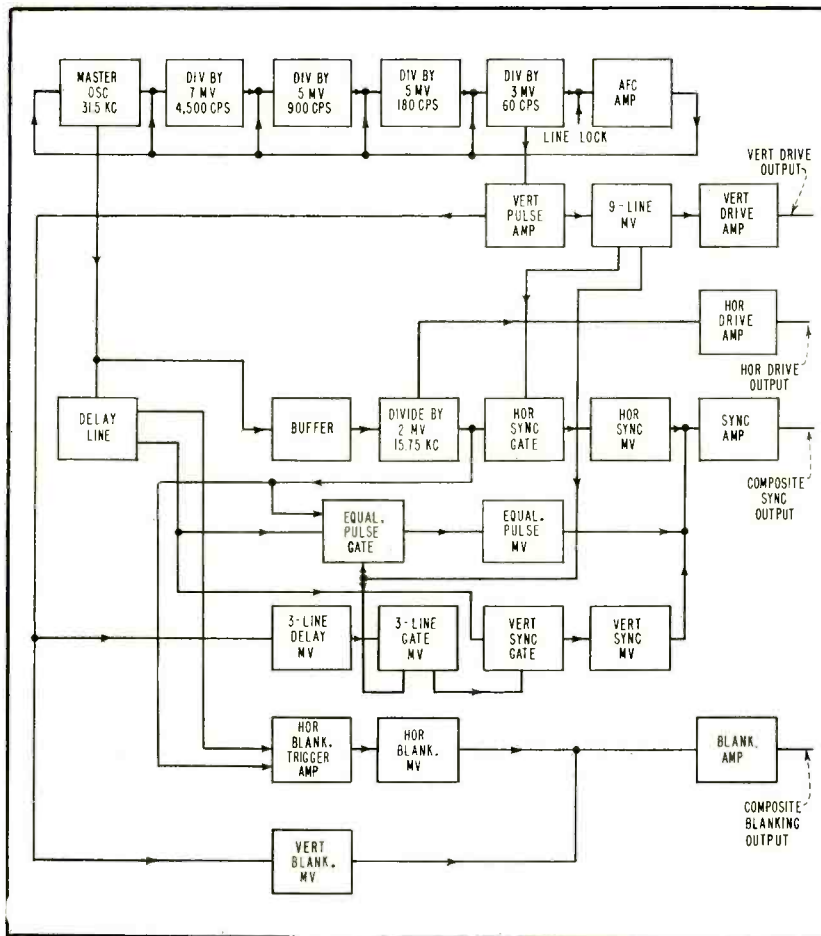

FIG. 1—Functional block diagram illustrates interconnection of stages

By HAROLD E. ENNES

Indianapolis, Indiana

wave reference is crossing its axis and the voltage appearing at the clamped grid of  $V_{3B}$  is zero.

If, however, the pulses occur early or late, the voltage rises or falls depending upon whether the positive or negative value of the a-c is clamped. Thus the pulses are caused to slide on the slopes of the sine-wave alternation until they coincide with the axis of the line voltage and the timer is locked with the line frequency.

Switch  $S_1$  is open for the line-lock position and  $V_{8B}$  serves as a d-c amplifier for the afc voltage fed to all grids of the timer section. Filter  $C_2 - R_1$  smooths out current variations. The circuit comprising  $R_2$ ,  $C_3$  and  $C_4$  provides a time-constant for afc action to prevent instability

from too-rapid action. With  $S_1$  closed, automatic frequency control action is removed.

Synthesis of the output pulses is best described with the aid of the waveform diagram, Fig. 3. Italicized letters in text refer to waveforms shown in Fig. 3. All multivibrators are of the driven type and must receive enabling voltage from associated gate tubes.

#### Camera Drive

Camera driving pulses are delivered only to the camera chains and slightly precede the composite sync signal to compensate for interconnecting cable delay. Positive 31.5-kc trigger pulses A from  $V_{1A}$  cathode are fed to the horizontal-drive buffer amplifier  $V_{8B}$  and appear as

amplified negative triggers at the grid of  $V_{10A}$ , the divide-by-two multivibrator. This section is driven to cutoff and drives  $V_{10B}$  into conduction.

This condition prevails in the absence of further triggering for an interval determined by the grid-potential adjustment and circuit time constant. Adjustment of  $R_3$  determines within limits the potential and time-constant of  $V_{10B}$  grid. With proper adjustment, alternate 31.5-kc pulses occur when  $V_{10A}$  is cut off and have no effect. Thus only 15.75-kc pulses B appear at the output. Different values of resistance and capacitance in the two grid sections result in asymmetrical pulses; the on time is less than the off time. Resistor  $R_4$  adjusts the width to system standards,  $\frac{1}{2}$  to 1 times blanking width. The 1N63 clamps the pulses on the grid of the horizontal drive amplifier  $V_{10}$  at 9 volts assuring flat-topped pulses in the plate circuit.

#### Vertical Drive

Positive 60-cycle pulses from  $V_{3A}$  cathode amplified by  $V_{11B}$  appear as negative triggers at the grid of the on section of the 9-line multivibrator,  $V_{17}$ . The NUMBER-OF-EQUALIZING-PULSES control  $R_5$  in the  $V_{17B}$  grid circuit determines the gating-pulse width for the vertical-equalizing and sync interval and automatically sets the width of the vertical-drive pulse. The positive pulses from the plate of  $V_{17B}$  applied to the grid of the vertical-drive amplifier  $V_{15}$  appear as standard negative-polarity pulses C at the plate.

#### Horizontal Sync

The horizontal-sync multivibrator  $V_4$  is gated by the horizontal-sync gate  $V_{5A}$ . The cathode of  $V_{5A}$  is tied to the cathode resistor of  $V_{17A}$ . In the period between fields when  $V_{17}$  is not triggered,  $V_{17A}$  is cut off and the cathode potential is negative.

The grid of  $V_{5A}$  receives delayed 31.5-kc trigger pulses from the delay line and 15.75-kc pulses from  $V_{10}$ . Since the grid of  $V_{5A}$  is biased to -108 volts by the regulated power supply, only the 31.5-kc D triggers occurring at horizontal-pulse time are of sufficient ampli-

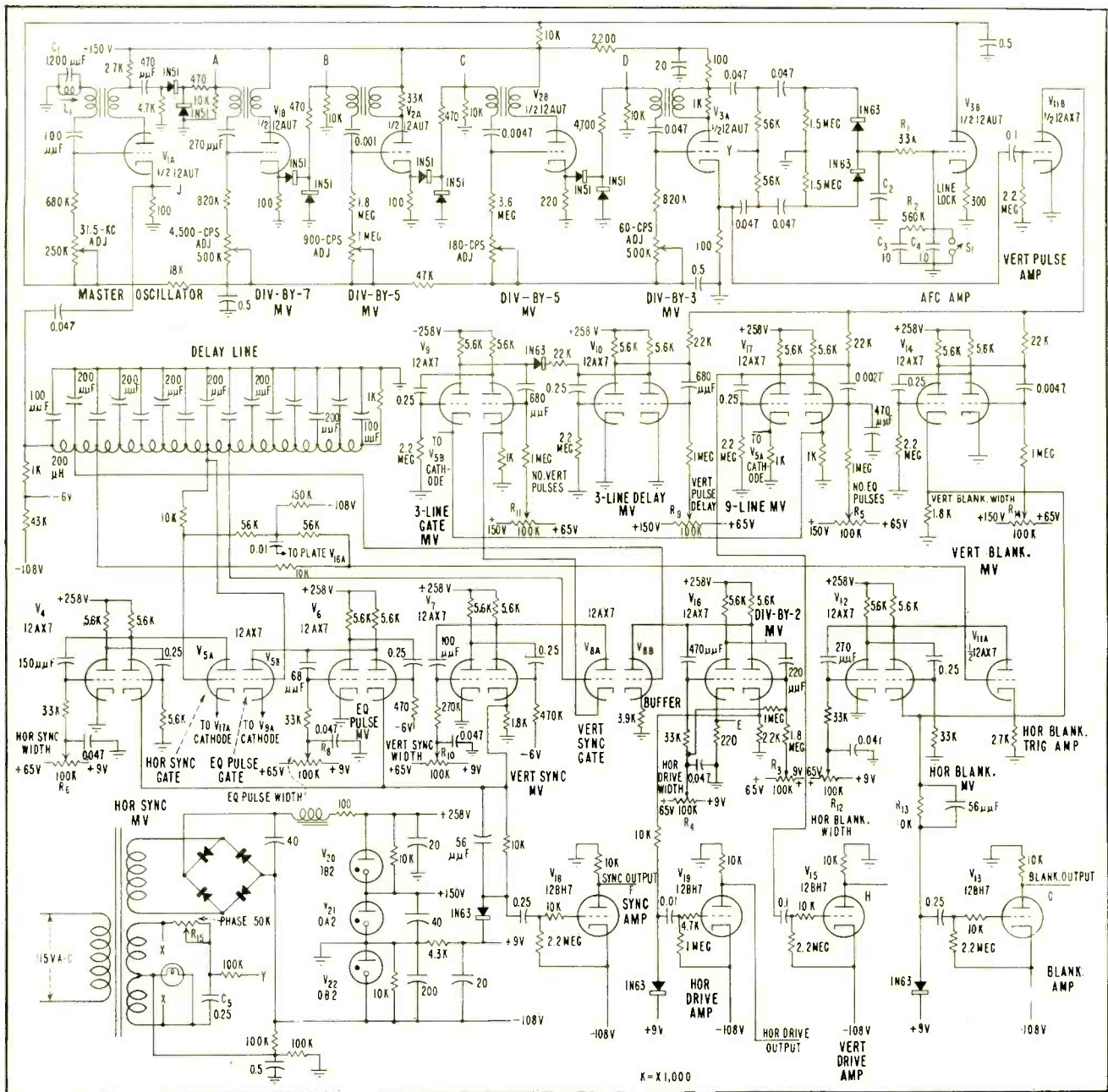

FIG. 2—Complete schematic shows how the 22 miniature tubes provide RETMA standard sync signal

tude to rise above cutoff level. The resultant negative 15.75-kc trigger pulses applied to the on section of the horizontal-sync multivibrator  $V_4$  drive that section off and opposite section on. The narrow triggers are widened by the horizontal-sync control  $R_8$  to standard horizontal-sync width. The cathode output pulses  $E$  feed through a common 10,000-ohm resistor to the sync amplifier stage  $V_{18}$ .

The horizontal sync multivibrator is gated off for the duration of the vertical interval. When the 9-line multivibrator  $V_{17}$  is triggered at the 60-cps field rate  $V_{17}$  is driven

on with its cathode going positive. With the horizontal-sync gate  $V_{5A}$  cathode also positive, the gate is closed at the start of the vertical interval. The gate remains closed for the 9-line duration of the vertical-sync interval.

### Vertical Sync

When the 9-line multivibrator  $V_{17}$  is triggered by a 60-cycle pulse, the cathode potential of  $V_{17B}$  falls in the negative direction. This point is common to both  $V_{5A}$  the 3-line gate multivibrator and the equalizing-pulse gate  $V_{5B}$ . Since the cathode of  $V_{5B}$  is now negative,

the gate is on,  $F$ . The delayed 31.5-kc trigger pulses on the grid of  $V_{5B}$  are transferred as negative triggers to the grid of equalizing-pulse multivibrator  $V_6$ . The on section of  $V_6$  is driven to cutoff and triggers the other section on. The narrow triggers are widened to standard equalizing-pulse width by the EQUALIZING-PULSE-WIDTH control  $R_6$ . Cathode output pulses  $G$  are fed to the same common 10,000-ohm load resistor as the horizontal sync, and hence to the grid of sync amplifier  $V_{18}$ .

At this point the first 3-line interval containing six equalizing pulses



is ended. Equalizing-pulse multivibrator  $V_6$  is gated off, and the vertical-sync multivibrator  $V_7$  gated on. This action involves four stages: the 3-line delay multivibrator  $V_{10}$ , the 3-line gate multivibrator  $V_9$ , the vertical-sync gate  $V_{8A}$  and also the vertical-sync multivibrator  $V_7$ .

The grid of the on section of 3-line delay multivibrator  $V_{10}$  receives a 60-pps negative trigger simultaneously with that applied to the 9-line multivibrator  $V_{17}$ . With  $V_{10B}$  driven to cutoff, the positive pulse on the plate holds the negative terminal of the 1N63 diode too far positive to allow conduction, hence prevents interaction between  $V_6$  and  $V_{10}$ . During this time the cathode of  $V_{9B}$  (3-line gate multivibrator), being common to the cathode of the vertical-sync gate  $V_{8A}$ , is of positive polarity and gates off the vertical-sync multivibrator  $V_7$ . This is the first 3-line interval of the total 9-line interval.

With proper adjustment of the VERTICAL-PULSE-DELAY control  $R_9$  in the  $V_{10}$  grid circuit,  $V_{10}$  returns to its nondriven state under control of its time-constant and grid potential. Tube  $V_{10B}$  returns to on, and the resultant negative plate pulse allows the 1N63 to conduct. The passed negative trigger drives multivibrator  $V_9$ . The  $V_{8A}$  cathode goes positive gating off  $V_{9B}$ , the equalizing-pulse gate, and the  $V_{9B}$  cathode goes negative gating on  $V_{8A}$ , the vertical sync gate.

Thus the equalizing pulses are shut off and vertical-sync pulses driven on. The 31.5-kc triggers on the grid of  $V_{8A}$  are passed as negative triggers to grid of the vertical-sync multivibrator  $V_7$ . The VERTICAL-SYNC-WIDTH control  $R_{10}$  widens the narrow triggers to standard vertical-sync width and the cathode output pulses  $H$  are combined in the common load and passed to the grid of sync amplifier  $V_{18}$ .

With proper adjustment of the NUMBER-OF-VERTICAL-PULSES control  $R_{11}$ , the 3-line gate multivibrator  $V_9$  returns to its non-driven state at the end of 3 lines. The cathodes reverse their polarities. The vertical-sync multivibrator  $V_7$  is gated off by  $V_{8A}$  gate and the equalizing-pulse multivibrator  $V_6$  is again gated on by gate  $V_{5B}$ .

The 31.5-kc pulses on the grid of  $V_{5B}$  are amplified as negative triggers to the grid of equalizing-pulse multivibrator  $V_6$  and the trailing six pulses are fed to sync amplifier  $V_{18}$ .

The 9-line multivibrator  $V_{17}$  is returned to its nondriven state gating off all vertical stages, and restoring horizontal-sync gate  $V_{6A}$  to on until the next 60-cycle vertical pulse.

The composite sync appears at the grid of sync amplifier  $V_{18}$  at positive polarity, is clamped at 9 volts by the 1N63 and the resultant clipped standard negative polarity composite sync  $I$  results at the output. Waveforms meet all RETMA specifications.

### Composite Blanking

The blanking pulses must slightly precede their respective sync pulses to establish front porch.

Horizontal blanking pulses are derived as follows: 31.5-kc triggers from the delay line together with 15.75-kc triggers from the divide-by-two multivibrator  $V_{18}$  are applied to grid of the horizontal-blanking trigger tube  $V_{11A}$ . Note that the 31.5-kc triggers are fed from a tap on the delay line allowing camera driving pulses to precede composite blanking but delaying composite sync from the start of blanking. Since  $V_{11A}$  grid is biased to -108 volts, only those 31.5-kc triggers occurring at the time of the 15.75-

kc pulses are of sufficient height to be passed as triggers for the horizontal-blanking multivibrator  $V_{12}$ . The cathode output pulses  $J$  adjusted in width by the HORIZONTAL-BLANKING-WIDTH control  $R_{12}$ , are fed to the common load resistor  $R_{13}$ , hence to the grid of blanking amplifier  $V_{13}$ .

For vertical blanking, 60-cps negative triggers from  $V_{11B}$  drive the vertical-blanking multivibrator  $V_{14}$ . The VERTICAL-BLANKING-WIDTH control  $R_{14}$  is adjusted for proper blanking width and the cathode output pulses are combined with horizontal-blanking pulses  $K$  in common load resistor  $R_{13}$  and passed to the grid of blanking amplifier  $V_{13}$ . The horizontal-blanking pulses occurring during the vertical interval stand atop the long vertical pulses and are clipped by the clamp action of the 1N63 diode in the  $V_{13}$  grid circuit.

Since the amplitude of the pulses is much higher than 9 volts at this point, a flat-topped composite blanking signal results.

The standard negative-polarity blanking pulses at the plate of  $V_{13}$  yield 4 volts peak to peak across 75 ohms at the output.

### Power Supply

The rectified voltage from the bridge-type selenium rectifier is gas-tube regulated providing -108, +9, +150 and +258 volts. The 60-cps lock-in circuit that provides a/c voltage to hold the master oscillator precisely 525 times the power-line frequency derives its line-frequency reference from the filament winding at point Y through the phasor control  $R_{15}$  and phase capacitor  $C_{15}$ .

This phasing adjustment properly times the system with shutter-type film projectors by phasing the sync pulses relative to the shutter synchronous motor so that shutter opening occurs well within the interval of the vertical blanking pulse. Resistor  $R_{15}$  is adjusted in practice for elimination of banding effects from any associated film chain.

The author congratulates G. Fathauer of Dage Electronics Corporation, upon the design of the camera chain and thanks Dage for permission to publish this article.

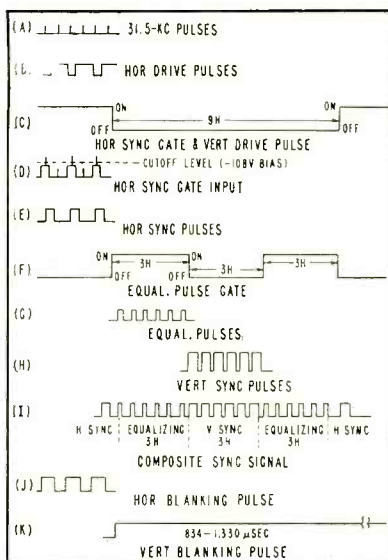
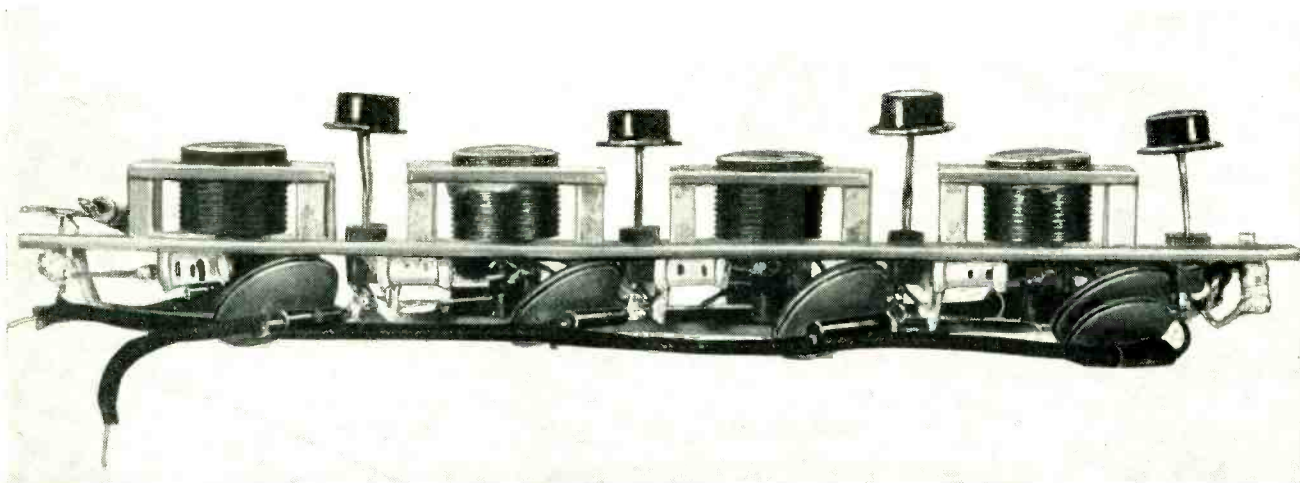

FIG. 3—Sync generator waveforms

# High-Frequency



Four-stage 455-kc intermediate-frequency amplifier uses rate-grown npn junction transistors in cascade

Design equations for getting optimum performance from video and radio-frequency amplifiers are presented. Sample design of four-transistor 455-kc i-f amplifier is described in detail; i-f gain is 18 db per stage with 14-kc bandwidth

**I**N THE APPLICATION of transistors to high-frequency circuits the low-frequency equivalent circuit must be modified since most of the parameters become complex. The finite input impedance of a transistor amplifier at high frequencies is an important factor along with the interaction between input and output.

The usual low-frequency equivalent-T circuit may be modified to apply at high frequency, as shown in Fig. 1, which shows the modified circuits for the grounded-base (A) and grounded-emitter (B) configurations. One important modification consists of the addition of the capacitor  $C_c$  across the collector resistance  $r_c$ . Additional important factors, not evident from these circuits, is that  $\alpha$  is complex, and both  $r_c$  and  $C_c$  vary with frequency. To a lesser degree  $r_e$  and  $r_b$  are also frequency dependent. However, it is customarily assumed that these two parameters are constant and resistive up to about the alpha cut-off frequency  $f_{\alpha}$ .

If operations at only one frequency were involved, it would obviously be adequate to take the proper values of the equivalent circuit parameters at that frequency and insert them in the usual mesh equations, using the proper vector additions, multiplications and so on. For wide-band use, such as video and pulse amplifiers, this method is inadequate, hence a great deal of analysis has gone into attempts to derive high-frequency equivalent circuits which adequately reproduce the transistor over a wide frequency range.

The variation of  $\alpha$  with frequency is a hyperbolic secant function of the parameters of the physical construction. This function can be approximated by the short-circuit current equation of a R-C distributed transmission line. Thus the ratio of output short-circuited current to input current is

$$\frac{i_o}{i_i} = \operatorname{sech} \sqrt{j \omega RC} \quad (1)$$

and  $\omega_{\alpha} RC = 2.43$ .

A further approximation can be made by a low-pass R-C network. In this approximation, the expression for the variation of  $\alpha$  with frequency becomes

$$\alpha = \frac{\alpha_o}{1 + j \omega RC} = \frac{\alpha_o}{1 + j \frac{\omega}{\omega_{\alpha}}} \quad (2)$$

since  $\omega_{\alpha} RC = 1$ .

The variation of the effective value of collector admittance  $y_{22}$  can also be calculated by the following approximate equations

$$y_{22} \cong \frac{1}{r_c} + j \omega C_c + \sqrt{\frac{j \omega C}{R}} \tanh \sqrt{j \omega RC} \quad (3)$$

$$y_{22} \cong \frac{1}{r_c} + j \omega C_c + \frac{\omega^2 C^2 R^2}{1 + (\omega CR)^2} + \frac{j \omega C}{1 + (\omega CR)^2} \quad (4)$$

Of particular interest in the utilization of the grounded-emitter configuration, is the variation of  $b$ , the current ratio, with frequency. Recalling that  $b = \alpha / (1 - \alpha)$ , it is



# Transistor Amplifiers

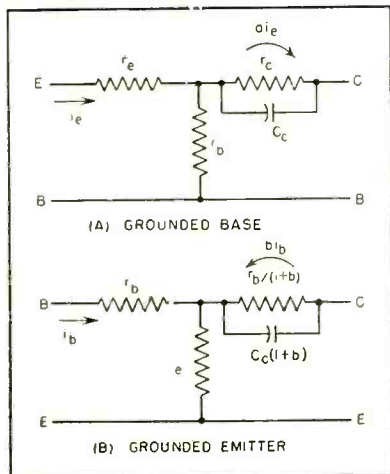

FIG. 1—Equivalent-T circuits

By **W. F. CHOW**

General Electric Company  
Electronics Laboratory  
Syracuse, New York

evident that the variation of  $a$  (which is approximately equal to  $\alpha$ ) will be reflected as an even greater variation in  $b$ , particularly due to the phase angle of  $a$ . The  $b$  cutoff frequency is approximately equal to  $(1 - a_0) f_{\alpha 0}$ .

## Single Stage Equations

Before going into the study of high-frequency amplifier design, it is necessary to study the equations for input and output impedances, and for power gain. Only equations for the grounded-base and the grounded-emitter configuration are studied, because the grounded-collector configuration has been found to be relatively less effective as a small-signal high-frequency amplifier.

Using the circuits of Fig. 1, the established equations for input and output impedances and power gain can be applied. In the following equations the collector impedance  $z_c$  includes both  $r_c$  and  $C_c$ .

The input impedance of the grounded-base amplifier is

$$z_i = r_e + r_b \left[ \frac{z_c(1-a) + z_L}{r_b + z_c + z_L} \right] \quad (5)$$

The output impedance is

$$z_o = z_c + r_b \left[ \frac{r_e + z_o - az_c}{r_e + z_o + r_b} \right] \quad (6)$$

where  $z_L$  and  $z_o$  are the load impedance and source impedance, respectively.

Due to the variation of  $z_c$  and  $a$  with frequency, the impedances  $z_i$  and  $z_o$  vary with frequency. For a constant  $z_L$ , the input impedance  $z_i$  of a junction transistor amplifier, as given by Eq. 5, will increase with frequency and appear as an inductive impedance. The effect of increasing the magnitude of  $z_L$  is to increase the magnitude of  $z_i$  and to decrease the phase angle.

For a point-contact transistor, the input impedance  $z_i$  will appear as an impedance having an imaginary term which increases with frequency, and a real term which can be either positive or negative depending upon the load resistance. When the load resistance is large enough the input impedance given by Eq. 5 will have a positive real term which will increase with frequency. When the load resistance is small the input impedance given by Eq. 5 will have a negative real term, but this negative resistance will decrease with frequency and eventually become positive as frequency increases.

The output impedance  $z_o$  for a given source resistance is in general capacitive because  $z_o$  is strongly capacitive. The magnitude of the output impedance decreases with increasing signal frequency.

The power gain of a grounded-base amplifier stage is given by

$$PG = \left| \frac{r_b + az_c}{r_b + z_c + z_L} \right|^2 \frac{[z_L]_R}{[z_i]_R} \quad (7)$$

where  $[z_i]_R$  and  $[z_L]_R$  represent the real components of  $z_i$  and  $z_L$  respectively. The variation of power gain with frequency is approximately proportional to the square of the variation of  $a$  with frequency. Due to the change of input and output impedances, the actual power gain at high frequency is less

than the approximate relation  $[a]^2$ .

The input impedance of a grounded-emitter amplifier is

$$z_i = r_b + r_e \left[ \frac{z_L + z_c}{r_e + z_L + (1-a)z_c} \right] \quad (8)$$

For a given load impedance, this input impedance decreases with increasing frequency and is capacitive. For a given frequency,  $z_i$  decreases as the ratio of  $z_L/z_o$  increases.

The output impedance of a grounded-emitter amplifier is

$$z_o = (1-a)z_c + r_e \left[ \frac{r_b + z_o + az_c}{z_o + r_b + r_e} \right] \quad (9)$$

In general, the output impedance decreases with frequency due to the decrease of  $z_c$  with frequency.

The equation for the power gain of a grounded-emitter amplifier is

$$PG = \left| \frac{az_c - r_e}{z_L + r_e + z_c(1-a)} \right|^2 \frac{[z_L]_R}{[z_i]_R} \quad (10)$$

where  $[z_L]_R$  and  $[z_i]_R$  represent the real components of  $z_L$  and  $z_i$ . This power gain also varies with frequency and is approximately proportional to the square of the variation of  $b$  with frequency.

## I-F and R-F Circuits

In the early application of point-contact transistors to high-frequency amplification, the grounded-base configuration was generally used. The principle of duality was applied and the single tuned vacuum-tube amplifier circuit was found to correspond to a transistor amplifier employing a series resonant circuit as the interstage network.

In using the series resonant cir-

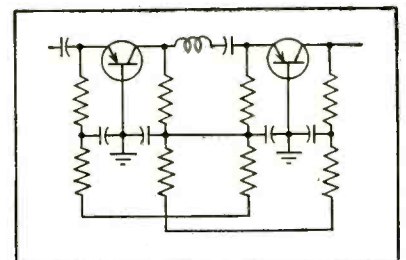

FIG. 2—Circuit showing series resonant coupling of transistors

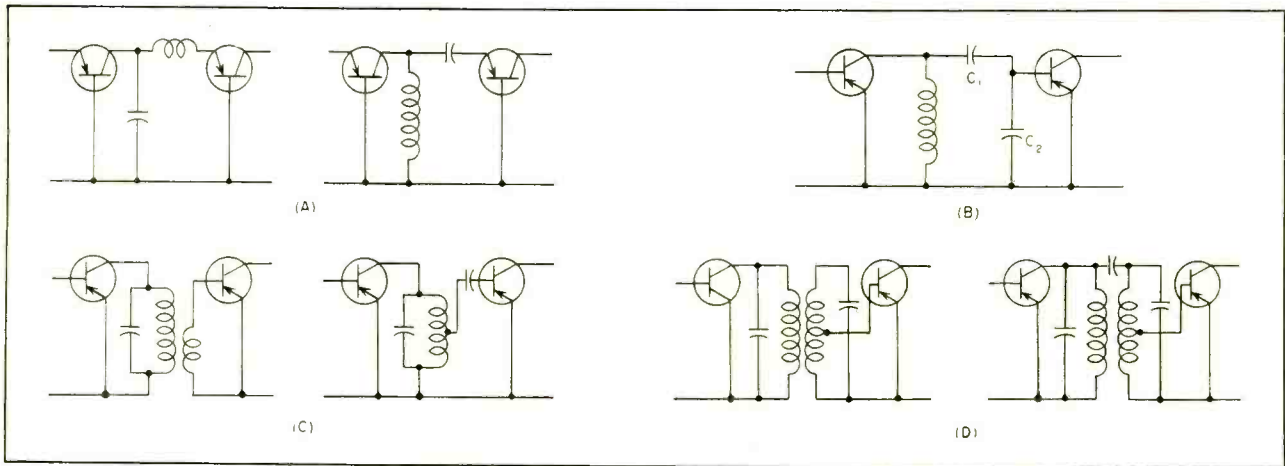

FIG. 3—Simplified circuits of available methods of coupling transistor stages

circuit as the interstage coupling network, the necessary condition is that the output short-circuit current amplification must be greater than unity. This implies that the point-contact transistor may be connected in either the grounded-base or the grounded-emitter connection, however, the junction transistor must be used in the grounded-emitter connection.

Figure 2 shows a series-resonant circuit used as the interstage coupling network between two point-contact transistor amplifiers. The input impedance  $z_i$  is in series with the tuned circuit and becomes the load of the preceding stage. For a given transistor and a given operating condition, the input impedance of this amplifier stage can be calculated from the impedance equation. Since the resonant circuit is in series with the input impedance, the effective  $Q$  of this amplifier stage will be modified by  $z_i$ . The power gain per stage will be approximately equal to  $A^2$ .

Besides the series-resonant circuit, the parallel-resonant circuit can be used as the interstage coupling network. However, when point-contact transistors are used with a parallel-tuned coupling network, the short-circuit instability problem arises. Unless the circuit is so designed that there are sufficient positive resistances in the circuit to compensate for the negative resistance component of the input impedance, the amplifier will oscillate. In practice, when point-contact transistors are used with parallel-resonant

coupling circuits as the interstage coupling network, the transistors are usually selected for short-circuit stability. With proper control of the operating point, one can usually obtain a stable amplifier using point-contact transistors. A stable point-contact transistor amplifier can also be obtained by inserting a resistance in series with the emitter (the grounded-base configuration is generally used), with about 3 to 6 db sacrifice of gain.

There are several practical arrangements for coupling two amplifier stages using a parallel-resonant circuit. They can be grouped into several classes as follows:

**Direct connection**—In this group the second amplifier is directly connected into the parallel-resonant circuit, either in series with the inductance or in series with the capacitance as shown in Fig. 3A.

**Capacitive-coupling**—In this group the second stage is connected to the junction of two capacitors as shown in Fig. 3B. These two capacitors are also the elements of the parallel-tuned resonant circuit and serve as an impedance transforming device.

**Inductive-coupling**—In this group the second stage is inductively coupled to the resonant circuit as shown in Fig. 3C. The secondary is not tuned and an impedance step-down is normally provided to match the input impedance of the following amplifier stage.

**Double-tuning**—The above three groups use single-tuned circuits for the interstage coupling circuits. Double-tuned circuits employing

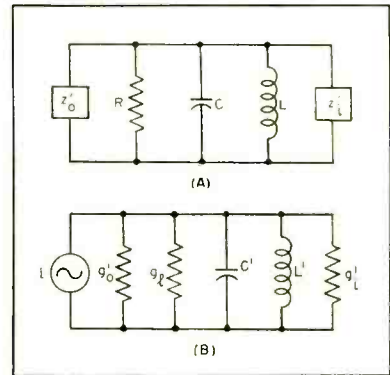

FIG. 4—High-frequency transistor equivalent circuits

either inductive coupling or capacitive coupling can also be employed, as shown in Fig. 3D. An impedance step-down is necessary where the input impedance is low.

In designing an interstage coupling network using parallel-resonant circuits, it is again necessary to consider the input and output impedances of each amplifier stage, since those impedances are in effect in parallel with the resonant circuit. Thus, the input impedance of the following amplifier stage will appear as the load of the preceding amplifier stage and the output impedance of the preceding amplifier stage will appear as the source impedance of the following stage. These impedance values will then be calculated by assuming that all the transistors used in this amplifier are practically identical.

In Fig. 4A a parallel-resonant  $RCL$  circuit is shown which is shunted by the effective output impedance  $z'_o$  and the effective input impedance  $z'_i$ . These two effective



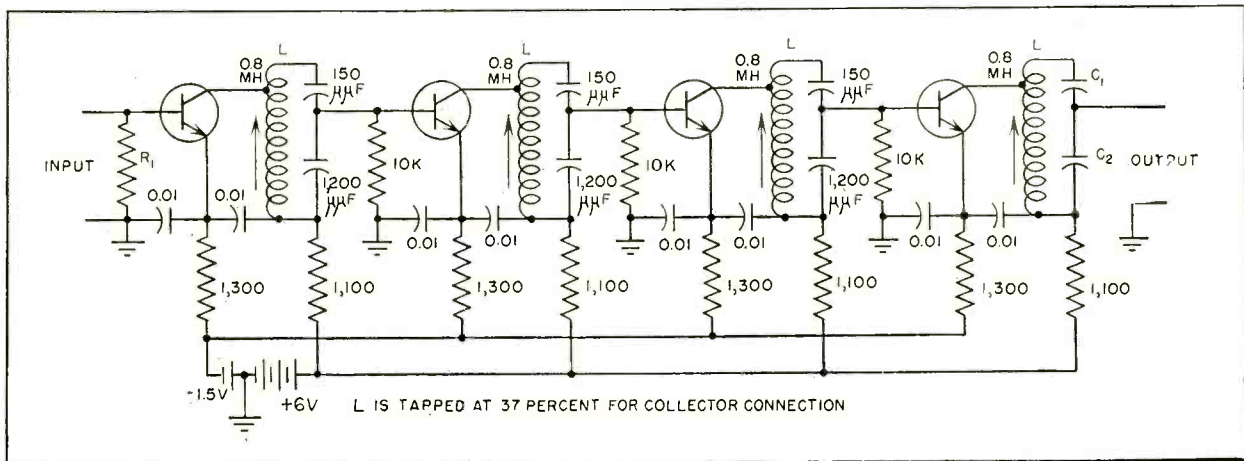

FIG. 5—Circuit diagram of 455-kc i-f amplifier having overall power gain of 58 db with 14-kc bandwidth. Battery current is 3.5 ma

impedances are the output impedance  $z_o$  and the input impedance  $z_i$  after the required impedance transformations. Let the reactive component of  $z_o'$  and  $z_i'$  be combined with the elements of the parallel-resonant circuit, as shown in Fig. 4B. The condition required for maximum power transfer from the preceding amplifier stage, through the interstage coupling network to the following amplifier stage, at resonant frequency is

$$g_i' = g_l + g_o' \quad (11)$$

where  $g_l$  corresponds to the loss in the interstage coupling network. If the ratio of available power (less the loss in the coupling network) to the available power is defined as the power loss factor  $F_p$ ,

$$F_p = \frac{g_o'}{g_o' + g_l} = \frac{1}{1 + \frac{g_l}{g_o'}} \quad (12)$$

The effective Q of such an amplifier stage will be determined by the total conductance and the inductance or the capacitance. Thus at resonant frequency  $\omega_o = 2\pi f_o$ ,

$$Q = \frac{\omega_o C'}{g_o' + g_l + g_i'} = \frac{\omega_o}{\Delta\omega} \quad (13)$$

where  $\Delta\omega$  is the bandwidth at the half-power points on the selectivity curve of this amplifier stage. Let the original unloaded Q of the parallel-tuned circuit be  $Q_o$ ,

$$Q_o = \frac{\omega_o C'}{g_l} = \frac{\omega_o}{\Delta\omega_o} \approx \frac{\omega_o C'}{g_l} \quad (14)$$

where  $\Delta\omega_o$  is the bandwidth. Combining Eq. 11, 13 and 14 to obtain the required impedance matching conditions and at the same time obtain the required bandwidth yields

$$\Delta\omega = 2 \left( \frac{g_o'}{C'} + \Delta\omega_o \right) \quad (15)$$

or solving for  $g_o'$

$$g_o' = \left( \frac{\Delta\omega}{2} - \Delta\omega_o \right) C' \quad (16)$$

and

$$g_i' = \frac{\Delta\omega}{2} C' \quad (17)$$

From Eq. 16 and 17 the required impedance transformation ratios can be found for a given resonant-circuit unloaded Q and the required effective Q of the amplifier stage. It is found that normally both the output impedance of the preceding amplifier stage and the input impedance of the following amplifier stage must be stepped up in order to satisfy narrow band requirements.

### Sample Design

An example of the design of an i-f amplifier will help to explain the principles discussed above. Assume that experimental npn rate-grown transistors are used, following average parameters;  $a$  equal to 0.9,  $r_e = 30$  ohms,  $r_b$  about 100 ohms,  $r_c = 1$  megohm and  $f_{\omega}$  about 1 mc as measured at  $I_c = 1$  ma and  $V_c = 5$  volts. Average available power gain in the grounded-emitter configuration at 455 kc is 18 db per stage. The average input impedance of each stage is

$$z_i = 1 / \left( \frac{1}{200} + j\omega 1,600 \times 10^{-12} \right) \text{ ohms} \quad (18)$$

and the average output impedance is

$$z_o = 1 / (10^{-4} + j\omega 25 \times 10^{-12}) \text{ ohms} \quad (19)$$

Using an inductance of about 0.8 mh and a  $Q_o$  of about 90, the capacitance  $C'$  required is about 150  $\mu\text{f}$ , if the desired overall effective Q of a four-stage amplifier is about 30. Therefore, the required effective Q of each stage is about 15. Using Eq. 16 and 17 the value of  $g_o'$  and  $g_i'$  and the required output and input impedance transformation ratios are  $g_o/g_o' = 7.3$  (20) and  $g_i/g_i' = 350$  (21) The circuit of such an amplifier is shown in Fig. 5. The power loss in the coupling circuit is given by Eq. 12 and is approximately 1.74 db per stage.

If the inductance is reduced to 300  $\mu\text{h}$  with the Q maintained at 90, the required  $C'$  is approximately 400  $\mu\text{f}$ . If the effective Q of the amplifier is maintained the same, the output and input impedance transformation ratio become  $g_o/g_o' = 2.74$  and  $g_i/g_i' = 132$ .

Using the circuit of Fig. 5 with 300- $\mu\text{h}$  inductance, a 60-percent tap is required on the inductance, and the 1,200- $\mu\text{f}$  capacitance should be increased to 2,990- $\mu\text{f}$ . The power loss in the coupling circuit is about the same as before. In the actual experimental setup, a loss of 2 to 3 db per stage usually occurs. This is due to the nonuniformity of the experimental transistors and the mismatch in the actual circuit.

This work has been supported by the U. S. A. F. Air Research and Development Command, U. S. A. F. Air Material Command, Army Signal Corps and Navy Bureau of Ships, under Contract AF 33 (600) -17793.



Playing of game illustrates principles of modern warfare in which protection of own bases and industrial factories is as important as striking enemy targets

# Electronic Air-War Game

**A** SIMPLE ELECTRONICS game using a dozen vacuum tubes can hardly be called a computer—but it can nevertheless illustrate some of the basic principles of modern military tactics.

The device is an analog of two industrial nations at war, the two sides being alike initially as in a chess game. That part of each side that simulates industry, with factories producing war munitions, provides two electrical potentials for use in furtherance of air operations against the enemy. One potential determines the rate at which a player can attack his opponent. The other potential simulates defensive capability and can be used by the player to protect one region or another of his industry.

Each player is provided with a target selector switch, a strike launching switch and a defense

**By L. I. DAVIS**

*Brigadier General  
United States Air Force  
ARDC, Baltimore, Md.*

potentiometer that controls the placement of interceptors.

Eight targets are provided on each side. Six of the targets represent factories producing war munitions such as aircraft engines, bomber assembly plants and oil refineries. These targets differ from each other either in location, in vulnerability, in speed of recovery after attack or in the logistic times between production of goods and use of the goods by the simulated offensive or defensive potential. The other two targets are a composite target representing bomber or missile launching bases and a composite target representing defensive bases, such as interceptor

aircraft or guided missile bases.

Although this game is a simplified analog of a complex problem, that of two large nations at war, it does meet the following minimum characteristics as a simulator:

(a) A simulation of the effect of launching and striking particular enemy targets, military as well as industrial.

(b) A simulation of the effect of protecting one's own bases and industrial factories against enemy strikes.

(c) A time scale of operations fast enough so that the duration of the war is not excessive, but not so fast that significant decisions, such as choice of targets, rate of attack and disposition of defense cannot be logically made during the course of the war.

(d) Indications to the players as



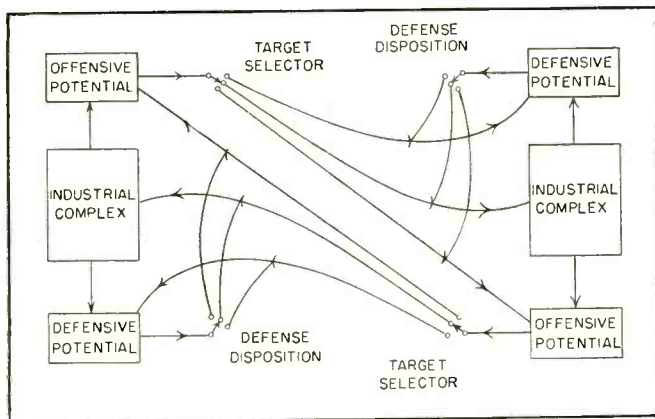

FIG. 1—Block diagram of game, illustrating strike and defense

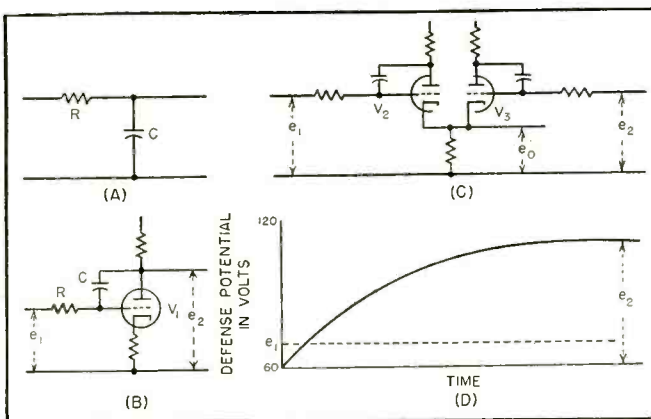

FIG. 2—Types of R-C charge and discharge circuits employed

Ten-tube circuit using multivibrators, R-C charge and discharge circuits and thyratrons simulates varying munitions-producing ability of an industrial complex during varying ratios of attack and defense chosen by players, who start with equal voltages. Meters and flashing neon lamps show progress of game and indicate winner

# Simulates Missile Strikes

to the progress of the war in terms of strength of or damage to one's own forces, which strikes are intercepted, and which targets the enemy has attacked.

(e) A definite indication of the end of the conflict and its winner.

(f) Reliable operation, with a minimum of adjustment and maintenance.

## General Design

The main elements of the game are shown in Fig. 1. The industrial complex produces two electrical potentials; one, which is called the offensive potential, determines the rate at which strikes can be launched at the enemy. These strikes can be directed at targets in the enemy industrial complex or against the enemy's force in being, such as his offensive bomber force, or his defensive interceptor force.

In the latter case the targets are the bases that enemy bombers and interceptors must use.

The second electrical potential produced by the industrial complex is the defensive potential. This can be used to defend against enemy strikes. Controls are provided to shift defenses from one part of the industrial complex to another, with consequent change in the probability of penetration.

In this particular game the industrial complex produces munitions at a rate that varies according to the stage of the war. The two sides start with undisturbed industries producing war munitions at equal rates. Damage to the complex as a result of enemy strikes results in decreased production rates.

At the start, with all targets at ground potential, the rate is at a maximum and of a value that can

sustain the size of the initial forces in being. As the war progresses, targets are attacked. Successive strikes charge the target capacitors to a level limited by the neon indicator bulbs. These attacks will cause the output potential to fall to zero at a rate determined by circuit time constants.

Several types of integrating or summing circuits are used to simulate the accumulation of goods as the result of production rates. The simple R-C circuit in Fig. 2A is adequate to represent the relation between production rate and goods on hand if the assumption is made that the goods on hand suffer depreciation or loss at a rate proportional to the amount on hand.

Longer characteristic times can be obtained by using a Miller integrating circuit as in Fig. 2B. Here the characteristic time is the

product of  $RC$  and the stage gain of the tube. Scale factors must be applied to the voltages to obtain the production rates in terms of units per month, as well as to the final voltages to obtain goods on hand or forces in being.

It is unnecessary for the purpose of this game to assign specific numbers to the rates and quantities. Suffice it to say that ground potential at the target capacitors represents an industrial production rate that will maintain at constant level the defensive and offensive forces in being. Damage to specific elements of industry will reduce the force in being an amount proportional to the reduction in production rate.

Figure 2C illustrates how a single twin-triode such as a 6SL7 can take two voltages, delay them by means of plate-to-grid capacitors and input resistors and combine them through the common cathode to give an output in the same sense and proportional to the higher of the input values. If the inputs are the inverse of production rates, then the output corresponds to a combination that is limited by the lower rate. The output of the industrial complex could then rise with time as in Fig. 2D as it recovers from attack.

### Circuit of Industrial Complex

Figure 3 gives the complete circuit diagram of the game. Eight targets are shown in the industrial complex, corresponding to the eight positions of the switch at the top of the diagram. Switch position 1 (Red side) provides a means of attacking the offensive potential or force in being. A strike consists of charging capacitor  $C_1$  through neon indicating bulb  $N_1$ . This charge, conducted through  $R_1$  to the grid side of the plate-to-grid capacitor of  $V_1$ , will produce a discrete and immediate effect on the plate voltage of  $V_1$ , which is the enemy's offensive potential. Attacks against target 8 will have the same effect on the plate voltage of  $V_8$ , which is the enemy defense potential.

Targets 2 and 7 represent factories producing munitions, such as aircraft engines. Strikes on target 2 charge  $C_2$ , which dis-

charges through  $R_2$  to  $C_3$ ; eventually through  $R_{10}$  the voltage is combined in  $V_2$  and  $V_8$  with a voltage representing another munition. The output, limited to a level determined by the higher input grid of the combination, is fed to the final integrator through  $R_{20}$  and represents the rate at which aircraft and necessary gasoline and supplies are furnished to the bomber bases.

Targets 3 and 6, for bombers and interceptors respectively, are analogous to aircraft assembly plants. Targets 4 and 5 add together and combine with the output of the aircraft assembly plants. The circuit constants chosen give these targets rather short recovery times and, since they contribute to both offensive and defensive potentials, they might simulate gasoline and oil industry.

Figure 4 shows the effect of bombing target 3. As target capacitor  $C_3$  is charged by the strikes, production rate  $Q_1$  (complement of capacitor charge) falls rapidly to zero. If the production rate is kept at zero by repeated attacks, output of combining and limiting tube  $Q_2$  will fall. The final output, the offensive potential, will fall as indicated by the curve for  $Q_3$ . Response is roughly second order, with time to the half-point about 180 seconds when bombed six times per minute. If a time scale is assumed such that 1 second represents 1 day, bombing target 3 will reduce the effectiveness of the enemy force in being by one-half in 6 months.

### Launching Strikes

The voltage that represents offensive potential is used to control the rate at which strikes are launched at the enemy. By assuming uniformly potent unit strikes, the effect of the size of the force in being is simulated by making the strike launching rate proportional to the offensive potential. This approximation greatly simplifies the circuit design, because the plate potential of  $V_1$  can be easily adjusted to 60 volts at the lower end of its excursion by cathode potentiometer  $P_1$  in Fig. 3. This plate voltage, applied to a neon bulb through network  $R_{12}$ - $C_{18}$ , produces a

sawtooth wave form with a steep negative front. At the upper end of the plate excursion, about 120 volts, the bulb will fire about once a second. At the lower end, it won't fire at all, representing a loss of offensive potential.

The waveform, differentiated by the coupling capacitor-resistor combination, is applied to the cathode of a small thyatron. When the grid of the thyatron is at the proper level, this pulse will cause the thyatron tube to ionize or fire, discharging  $C_{21}$  through neon bulb  $N_{11}$  and the variable resistance  $P_6$  to the target capacitor selected by switch  $S_{14}$ .

Capacitor  $C_{21}$  is charged to 210 volts from B plus through  $R_{11}$ . The neon bulb  $N_{11}$  serves to block the flow of current to and from the target capacitor except when the thyatron fires. Variable resistance  $P_6$  serves to limit the current discharge and is used as a fine control on target damage per unit strike.

The launching switch or key can be placed before or after the combination of  $C_{18}$  and  $N_{10}$ . Placed before the combination, the time required to charge the capacitor simulates a delay between launching a strike and arrival at the target. Placed after the combination (between  $C_{10}$  and the cathode of  $V_6$ ) the rate of flashing of  $N_{10}$  serves as a measure of the strength and readiness of the force in being. In most operations it will be desirable to launch at the maximum rate possible, in which case the key may be closed, leaving the hands free to manipulate fighter defenses and target selector switches.

### Interception of Strikes

The grid of thyatron  $V_9$  is driven by the plate of cathode-coupled multivibrator ( $V_7$  and  $V_8$  in Fig. 3) through voltage-dividing resistors  $R_{40}$  and  $R_{46}$ . The cathode of  $V_9$  can be adjusted to the proper level by  $P_5$ . A negative pulse from the multivibrator drives the grid negative and prevents the negative pulse on the cathode from firing the thyatron. The negative signal on the grid represents interception of the strike and is accordingly controlled by the strength and dis-



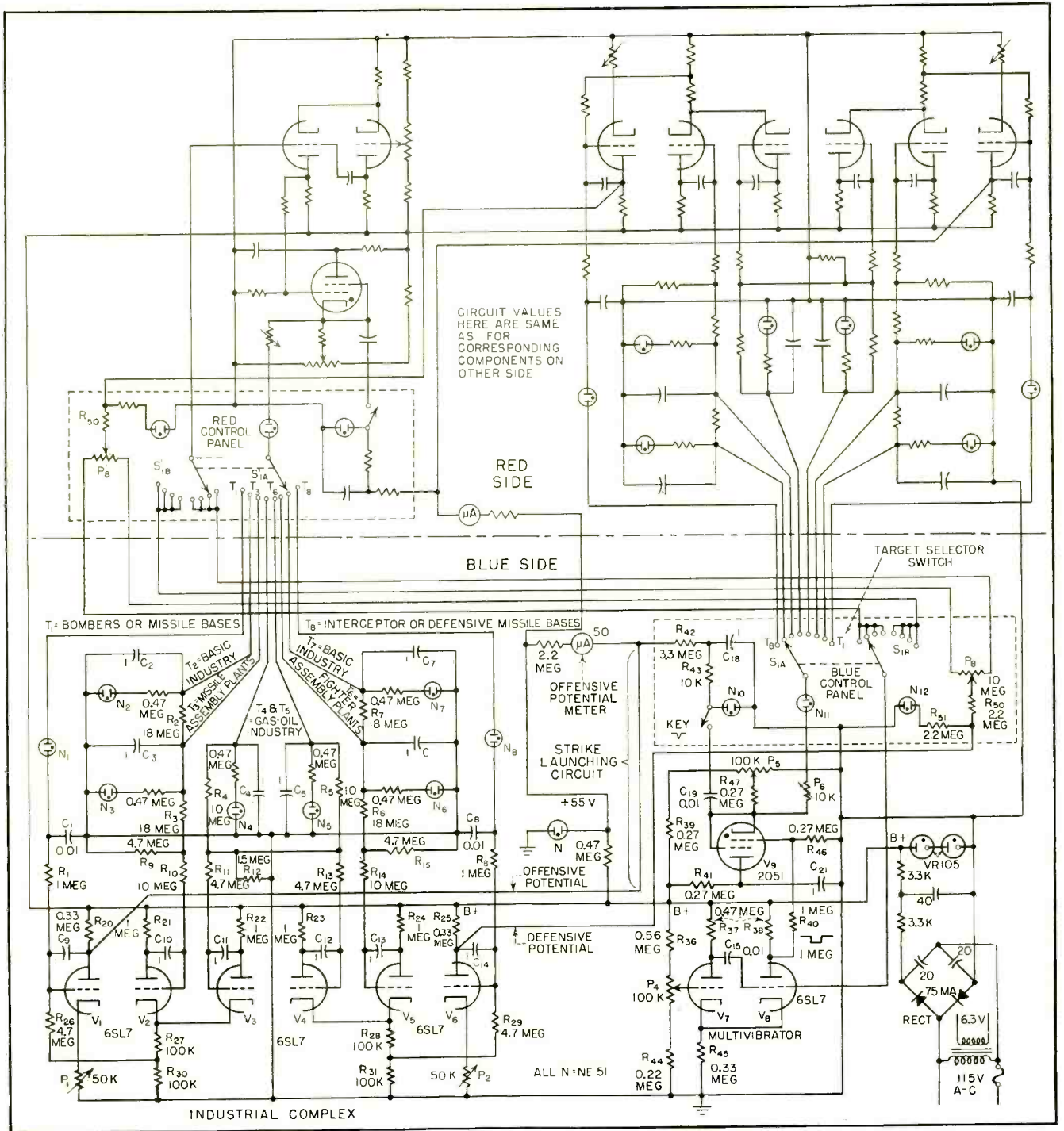

FIG. 3—Complete circuit of game. Since Red side uses identical components, order two of each identified part except those in power supply at lower right

position of enemy defenses.

The circuits that accomplish control of defenses are also shown in Fig. 3. Enemy defensive potential is applied to the moving arm of  $P'_s$  on the enemy control panel through  $R'_{20}$ . The ends of  $P'_s$  are connected to the second deck of gang switch  $S_{1B}$ , one side to the first four contacts and the other side to the other four.

The first deck of the gang switch

is the target selector switch of the friendly team. Accordingly, selection of targets 1, 2, 3 or 4 picks up the end of the potentiometer and places a resistance in the circuit that is determined by the setting of  $P'_s$ . The enemy defensive potential is thus connected to the multivibrator ( $V_7$  and  $V_8$ ) through  $R'_{20}$  and  $P'_s$ . This circuit resistance affects the percentage of time that  $V_8$  is conducting.

When  $V_8$  is conducting, the plate is at the lower level and the grid of the thyratron is too low to allow the tube to fire. This, then, is the intercept condition. On the other hand, when the enemy defensive potential is low (60 volts), the grid of  $V_8$  is below the cathode potential, and  $V_8$  is cut off. Under this condition the plate remains at a high level and the voltage impressed on the grid of the thyratron

tron is at such a level that a negative pulse on the cathode will cause it to fire.

The defensive potential furnished by the industrial complex varies between 60 and 120 volts. At 120 volts, with the circuit values indicated, the flip-flop will dwell about 50 percent of the time in the down or no-go position when the sole circuit resistance between defensive potential and multivibrator is  $R'_{50}$ . If the enemy guesses wrong and has placed his interceptors on the other side of the industrial complex (full potentiometer resistance in series with  $R'_{50}$ ), the plate will dwell only about 15 percent of the time in the no-go position.

### Element of Chance

For values of the defensive potential between 60 and 120 volts and for different settings of  $P'_8$ , the percentage of the time that the multivibrator will prevent the thyatron from firing is determined by the time required for the defensive potential to charge  $C_{15}$  through  $R'_{50}$  and  $P'_8$ . Here  $P_4$  places the cathode of  $V_7$  in the proper operating range and provides a fine control for adjusting the no-go dwell time. The multivibrator operates at about 20 cps as an average. This circuit provides a chance element that cannot be outguessed by manually closing the strike key.

### Displaying Progress

Inasmuch as this is a game intended for the entertainment of the players, means for displaying the progress of the contest are important. The neon bulbs at the target capacitors glow when the target is charged to the destroyed condition.

Neon bulb  $N_{10}$  flashes at a high rate when the offense is at a high level, and barely flashes when the striking force is low. Bulb  $N_{12}$  serves to indicate by its brightness the level of the defensive potential. Bulb  $N_{11}$  in the discharge circuit glows with an arc-type discharge each time that a launched strike penetrates the enemy defense. In addition, meters are provided to indicate to each side the level of its own offensive potential. These are 50-microampere  $4\frac{1}{2}$ -inch movements with red and green markings at the

low and high levels. Less sensitive meters may be used with appropriate circuit changes.

### Resetting Relays

Because of the long time constants, resetting of initial conditions would be lengthy but for the arrangement shown in Fig. 5. These relays were made up from four multicontact relays with 30-volt coils. Connecting the four in series across the 117-volt line gives positive action. The grounding contacts are used to ground target capacitors  $C_2$  through  $C_7$  and the grids of  $V_2$  through  $V_5$  of each side. The remaining pairs of contacts short integrating resistors  $R_{20}$  and  $R_{29}$  and their corresponding numbers on the other side. A tilt light is not necessary because the four relays with the 24 contacts close

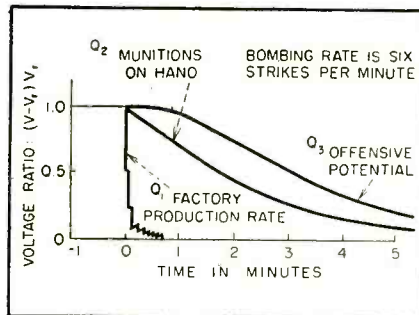

FIG. 4—Effect on offensive potential when attacked at bombing rate of six strikes per minute

circuit elements of the two sides. This is particularly important for plate load resistors  $R_{20}$  and  $R_{29}$ , for dividing networks  $R_{27}R_{30}$  and  $R_{28}R_{31}$  and for the attenuating networks between the target capacitors and the vacuum tubes.

It is not necessary or desirable that targets within a complex be alike, but attenuating ratios such as  $(R_8/R_9)$  should be within 2 or 3 percent of the corresponding ratio in the other system. Either 450-volt paper bathtub-type capacitors or 600-volt oil-filled types can be used for target and integrating capacitors.

Neon bulbs vary widely in flash point and regulating level. Connect a 500,000-ohm potentiometer from B plus to ground, with a voltmeter between one side and the moving terminal. Place each NE 51 bulb

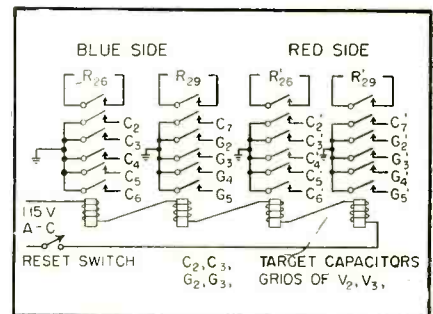

FIG. 5—Relay arrangement used to reset all capacitor potentials quickly for start of new game

with considerable racket.

The power supply is conventional. Selenium rectifiers supply about 280 volts to two VR 105 tubes that hold the B plus at 210 volts. The total drain is less than 10 ma, half of which is drawn by the VR tubes.

The panel arrangement used for the game is shown in Fig. 6 and in the photos. The two sides of the panel are identical except for facing meters and lettering in opposite directions.

### Assembly Precautions

Balance and adjustment of a device of this type can be made simple by a few precautions and by logical steps in setting the potentiometers. First, although 10-percent resistors are used throughout, pairs of equal value should be selected for the corresponding

in turn across the voltmeter and pair up those that will flash and stabilize within 1 or 2 volts of each other.

Variations between targets on the same side are allowable, but the average effect should balance out. The two neon bulbs that determine launching rates ( $N_{10}$  and its mirror image) are critical and should be the best pair of the lot tested. The launching rate is a function not only of the input potential, resistance and capacitance, but also of the difference between the flash and stabilizing voltage of the neon bulb.

Another component that should be checked against its counterpart is target capacitor  $C_1$ . This can be done beforehand with a capacitance meter, or later by counting the number of strikes necessary to



reduce the offensive potential from 120 to 60 volts. Another method is to use the neon tube and a resistor in a circuit similar to the strike launching circuit. Using the same resistance and bulb, different capacitors of the same nominal rating should cause the same discharge rate. If not, find a pair that do.

### Adjustment Procedure

If the foregoing precautions are observed in construction, the main calibration and adjustment will proceed quickly. A vacuum-tube voltmeter is required and a cathode-ray oscilloscope is desirable but not absolutely necessary. A convenient source of about 60 volts reference level is useful and can be quickly obtained with a 0.47-megohm resistor and a neon bulb connected to B plus. Connect this voltage source

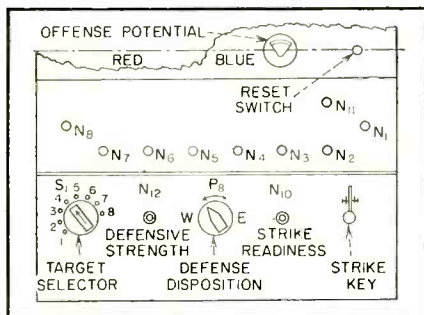

FIG. 6—Arrangement of controls, neon lamps and strike key on one half of front panel.

to the  $S'A$  switch terminal for target  $T_3$ , charging capacitor  $C_3$  to 60 volts. Short  $R_{10}$  and  $R_{20}$  with jumpers to eliminate the integration delays.

Adjust potentiometer  $P_1$  to yield 60 volts on the plate of  $V_1$ . Remove jumpers and note the change in plate voltage due to grid current through  $R_{20}$ . One or two volts change is permissible. Readjust  $P_1$  until the plate voltage is 60 volts. Repeat the procedure on target  $T_6$ , adjusting  $P_2$  to get 60 volts output from the plate of  $V_6$ . Make the same adjustments on the other industrial complex. Next, ground the targets by using the reset switch and note the upper levels of plate voltages of  $V_1$  and  $V_6$  on each side. They should be pretty well paired and close to 120 volts.

Next, adjust the multivibrators

that produce the square-wave blanking pulses to simulate interception of strikes. The cathode common to  $V_7$  and  $V_8$  should be very near 65 volts. Adjust  $P_4$  so the tube does not oscillate when the enemy defense potential is at 60 volts, but does start to oscillate when the potential rises to 65 volts. This can be quickly checked with an oscilloscope. Lacking that instrument, a neon bulb or a voltmeter will show the state of the plate of  $V_8$  and give a rough idea of the rate of oscillation.

Next, supply the multivibrator with 120 volts from the enemy defense potential. If the previous steps have been followed, this can be done by merely resetting the game. Turn  $P_5$  so that it adds no resistance to the circuit, the direction of turning depending upon the position of the target selector switch. Under these conditions, the square wave generated by the multivibrator should be about balanced; the plate of  $V_8$  should dwell in the high position as long as in the low position. Again a scope is desirable; but, after checking the two levels of the plate, a voltmeter can be used to determine the 50-percent-go/50-percent-no-go point. The ultimate test is to wait until all adjustments have been completed, then count the knockdowns per 100 strikes launched.

### Thyratron Circuit Adjustment

To adjust the thyratrons with potentiometer  $P_5$ , connect the voltmeter to the cathode, open the strike launching key, raise the cathode potential until the thyatron is well above the ionization point, then lower it until the tube fires under grid action alone. Note this voltage. Now raise the cathode about 5 volts above the noted level. Close the strike launching key with the target selector switch on some enemy target, preferably  $T_1$  since repeated bombing of that target will not affect the enemy defense potential. With fighter defenses (enemy) at 120 volts and the defense potentiometer providing maximum blanking width for the area of the target,  $N_{11}$  should flash only about half as often as  $N_{10}$ . Recheck the thyatron cathode by lowering its voltage until every strike pulse

fires the thyatron, then by raising it until none get through. The proper setting is midway between the two values, which should be about 10 volts apart. Repeat all of the foregoing adjustments on the other side of the game. Set the series resistance  $P_6$  in the strike circuit to 1,000 ohms.

### Final Balancing

The two systems can now be placed in opposition for final balancing. First, press the reset button two or three times to insure equal initial conditions. Check the launching rates at which  $N_{10}$  and its image flash. If the offensive potentials are equal and the components are matched, the rates should be close together. The difference in rate is best measured by timing the beats as the flashes synchronize, then fall out of synchronization. One beat in 30 seconds should be satisfactory.

Next, remove interception probability by connecting the potentiometer side of  $R_{30}$  to a source of 60 volts; do this on both sides. Now attack enemy target 1 at maximum launching rate. Note the number of strikes and the time required to reduce the enemy offensive potential from 120 volts to 60 volts. Repeat the process the other way, after resetting. If there is a marked disparity, check the matching of components. If they are close, adjust  $P_6$  or its image until the number of strikes required is within one of equality.

Now release the defenses, reset, set the defenses to protect target 1 on each side, and close the strike launching switches simultaneously. Try this two or three times; if one side wins all the time and in less than 3 minutes, recheck the multivibrator setting.

Potentiometer  $P_4$  can be used to control the width of the blanking pulses generated by the multivibrator. If an oscilloscope is not available, adjust  $P_4$  or its counterpart until the probability of penetration is the same for each side. This may require making 100 trials a side and keeping track of the interceptions. If the two sides are close, so that the contests last longer than three minutes but one side consistently wins, adjust series resistor  $P_6$  until

one side is as likely to win as the other.

This adjustment procedure may appear lengthy and the balance rather delicate, but it is essential because two systems are being placed in opposition and the difference between them integrated with respect to time. The two sides (when placed in opposition) produce a system that is as unstable as balancing a knife on its point. Any game of similar strategy on each side that lasts more than 6 minutes proves the game is well balanced.

### Play of Complete Game

Assuming that adjustment and calibration have been completed, find a prospective opponent and start learning the game together. First, try the following three contests, resetting after each.

(1) Red attacks  $T_1$  and Blue attacks  $T_3$ .

(2) Red attacks  $T_1$  90 percent of the time and  $T_3$  10 percent, while Blue attacks  $T_3$ .

(3) Red attacks  $T_1$  90 percent of

the time and  $T_3$  10 percent, while Blue attacks  $T_1$  50 percent and  $T_3$  50 percent.

These plans of attack should illustrate that in this game the primary target to attack is the enemy offensive potential and the primary object to defend is your own offensive potential. By stretching the imagination,  $T_1$  can be strategic bomber or missile bases;  $T_2$ , some element of basic industry, say aluminum or steel plant;  $T_3$ , bomber or missile assembly plants;  $T_4$  and  $T_5$ , some essential commodity common to both offense and defense, such as gasoline and oil;  $T_6$ , fighter assembly plants;  $T_7$ , more basic industry; and  $T_8$ , interceptor or defensive missile bases.

Since some of the games may be long drawn out, it is useful to establish a criterion of winning. When one side is below 10 percent of its offensive potential and the other is twice as great and increasing, the contest can be declared at an end, the winner being the one with the greater offensive potential.

Another criterion might be to declare as winner the side that can keep the opponent's strike and defense neon bulbs from flashing.

### Conclusion

The game as laid out in this design is meant to produce, with a minimum of parts, a device that will entertain players and illustrate a few basic principles in the employment of air power. The values chosen have little relation to the specifics of any engagement with a possible enemy of the United States. No attempt is made to simulate combat loss effects except to say that each side suffers losses in proportion to the amount of its force in being, the loss rate being the same on each side. Transportation, power and many other types of targets are not represented in the industrial complex. The important principles of war—offensive, concentration, mass and security—are illustrated and emphasized by the dynamics of an engagement speeded up many-fold.

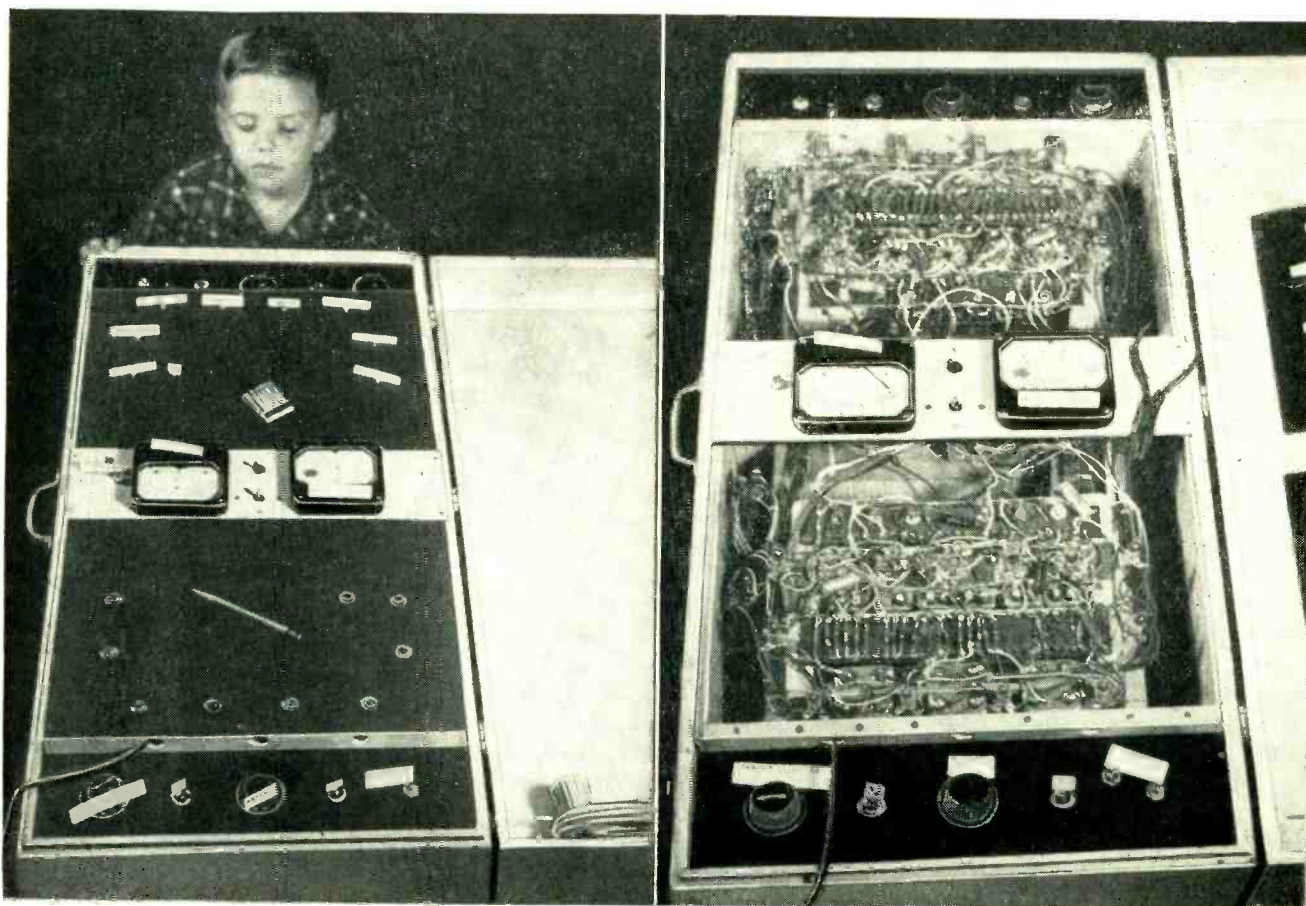

Panel of game. More labels can be added, identifying types of targets represented by flashing neon lamps and switch positions

Game with cover lifted. Meters, one facing each player, show amount of voltage remaining to fight with



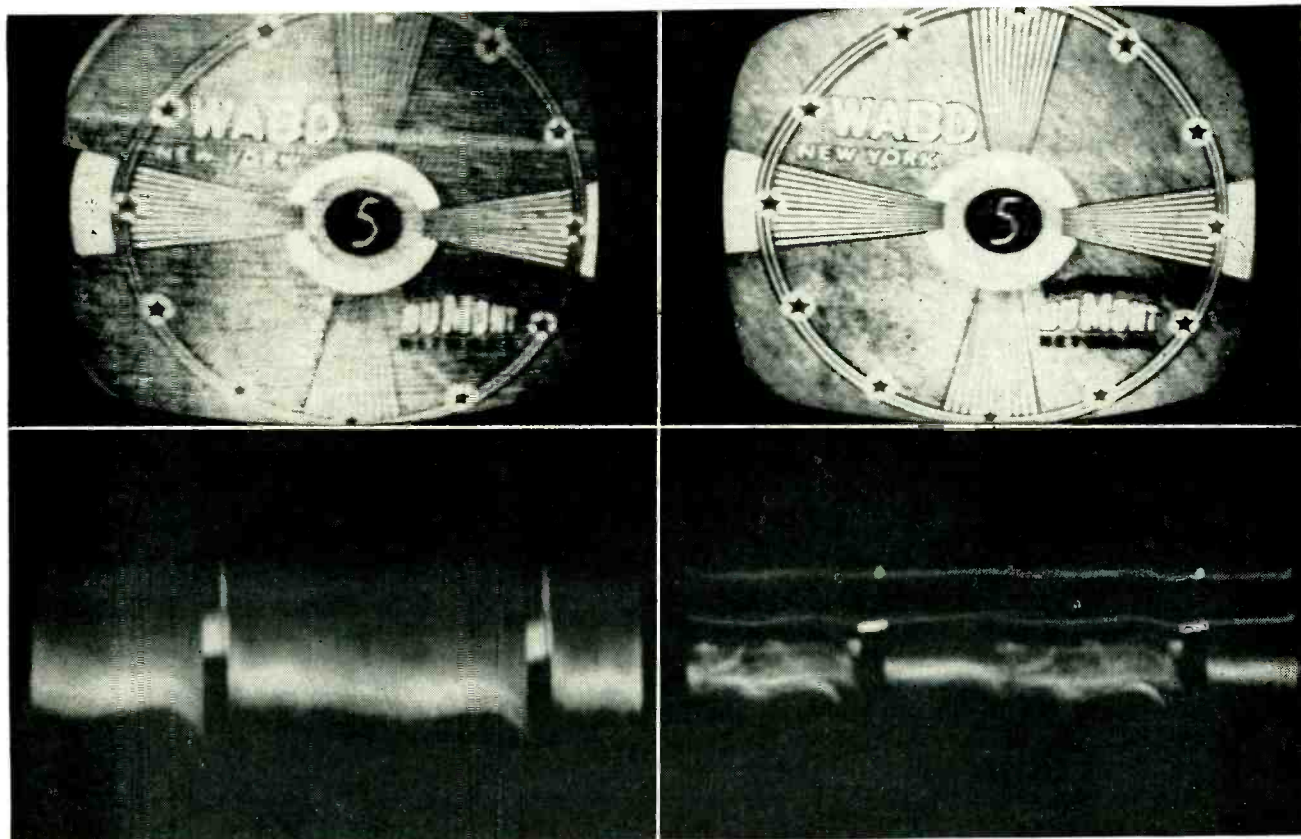

Received test pattern and video waveform, left, illustrates cross-modulation interference between channels caused by overdriving television receiver. Test pattern and waveform, right, show how the signal overload circuit corrects this condition

# Signal Overload Relay for Television Receivers

Automatic circuit prevents overdriving tv receivers in strong-signal areas. Relay in r-f and i-f plate circuits releases when increasing agc drops tube currents. Relay contacts open cathode circuit of cascode r-f amplifier, removing it from circuit to reduce gain

By **C. MASUCCI, J. R. PELTZ and W. B. WHALLEY**

*Sylvania Electric Products, Inc.  
Bayside, New York*

**D**ESIGNERS of home television receivers have tended to design increasingly high sensitivity into their sets. Many receiver manufacturers use a cascode r-f amplifier in their vhf tuners followed by a mixer and three or four intermediate-frequency stages.

The increased gain available from these receivers augments the signals from transmitters that are radiating increasingly higher power and gives rise, in some areas, to the serious problem of overloading the receiver circuits. For example, in the New York area signal levels in

the order of 1.0 volt have been measured.

Two possible problems associated with this increased radiated power and high receiver sensitivities are the prevention of receiver overload in areas where all signals are high and the prevention of receiver over-

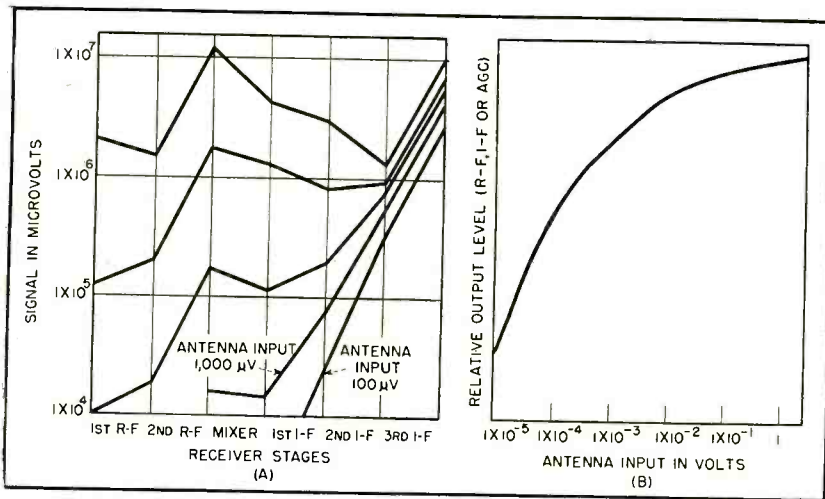

FIG. 1—Signal distribution for constant input (A), and typical stage performance (B)

load in areas where some signals are strong and some are weak.

This latter problem requires an automatic device that will reduce the receiver's sensitivity or gain for the strong channel and restore it on the weak channel. This unit, while not necessary, is also valuable for the first condition.

### Overload Characteristics

Overloading in a television receiver manifests itself in numerous ways. A few examples are:

(a) Cross-modulation interference between channels not necessarily adjacent. The received test pattern and corresponding video waveform shown at the left in the photograph illustrate this effect. The test pattern and waveform at the right show how the tv overload circuit to be described corrects this condition.

(b) Noisy pictures in high-signal areas. This is a result of operating the i-f tubes beyond cutoff.

(c) Loss of picture synchronization as a result of the compression of the sync information into the video.

(d) Complete reversal of picture.

Figure 1 is a graphical presentation of the signal voltages at various stages for fixed antenna input levels. As can be seen from the signal distribution throughout the receiver, there may be more than one point of overload as the input signal increases. Also, for each individual stage, the signal output increases up to a given level and then remains relatively constant for any

additional input signal. The point of flattening can be called the overload level for each stage. This figure also shows that agc cannot be used without considerable additional amplification to control overload.

### System Considerations

A desirable automatic overload system should supply the necessary attenuation for strong signals in such a manner as to prevent grid rectification in the first r-f stage and should be removed when the signal decreases to a predetermined level. It is essential, however, that insertion of attenuation be at a signal strength other than that at which it is removed so that a given signal will not cause the system to chatter. Above all, from the standpoint of economy and reliability, the system should require a minimum of components and wiring.

Possible methods of reducing the sensitivity of a receiver include inserting a resistor attenuator in the antenna lead-in, inserting a resistor attenuator in the r-f tuner and inserting attenuation in the r-f

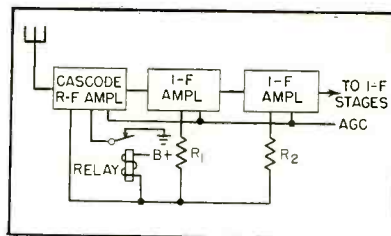

FIG. 2—Block diagram of receiver with overload circuit

amplifier by opening the cathode circuit.

The first method reduces the overall sensitivity of the receiver and precludes the satisfactory reception of weak signals.

The second method is good but expensive and requires individual field modifications.

Opening the r-f amplifier cathode circuit results in a marked decrease in gain and eliminates any possibility of grid rectification. This is the method that will be described in this article.

Some possible methods of controlling the point at which the gain reduction occurs in the receiver include use of a relay to open the r-f cathode by either the agc bus or a vacuum tube at the r-f grid and use of a modified t-r tube with a keep-alive voltage that can vary the reset.

### Automatic Attenuation

The use of the first control method is preferable from the standpoints of simplicity, reliability and economy. Figure 2 is a block diagram of the method.

The relay coil is in series with the combination of the cascode stage and one or more i-f stages to utilize the d-c amplification of the agc voltage. By placing the relay in the B+ side of the decoupling filters, its resistance and inductance have no detrimental effect on r-f and i-f operation. The spst contact of this relay is connected between ground and cathode of the cascode stage. Experiment has shown that, during warmup of the receiver the current drain of the i-f stages will close the relay and it will be held closed by the added cascode current.

As the signal strength increases, the agc voltage becomes more negative and the relay coil current decreases. As the overload point is approached, the decreasing relay current allows the contacts to open the r-f amplifier cathode, thus attenuating the signal and stopping the cascode amplifier current flow through the relay coil.

At this time the agc voltage decreases, thereby increasing the current through the i-f stages and relay coil. This increase, however, is not sufficient to close the relay again. If the signal decreases or the



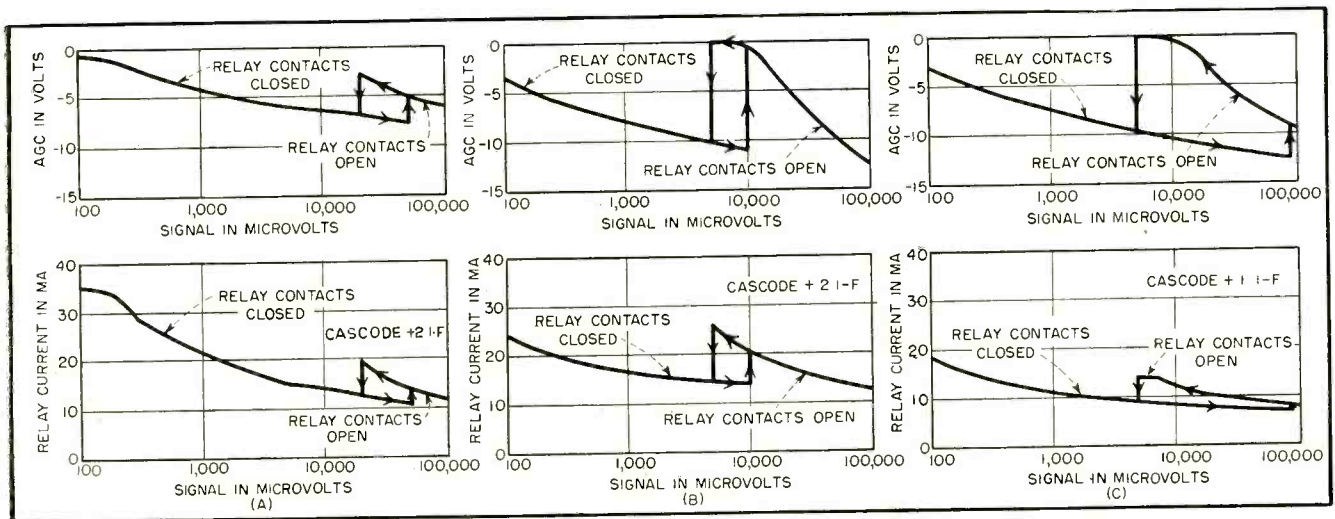

FIG. 3—Receiver overload control characteristics for medium range (A), wide range (B) and narrow range (C)

receiver is switched to a weaker signal, the further decrease in agc supplies sufficient current to actuate the relay, closing the cascode cathode circuit and allowing the receiver to operate with normal sensitivity. A quantitative analysis of this action is shown in Fig. 3A.

As the signal strength increases from 100  $\mu$ v to the preset overload point of 50,000  $\mu$ v, the relay coil current decreases from 33 ma to 11 ma and its contacts open, attenuating the signal a predetermined 29 db. This attenuation causes an agc voltage change from -7 v to -5 v that increases the relay coil current from 11 ma to 13.6 ma. This current, however, is insufficient to close the contacts

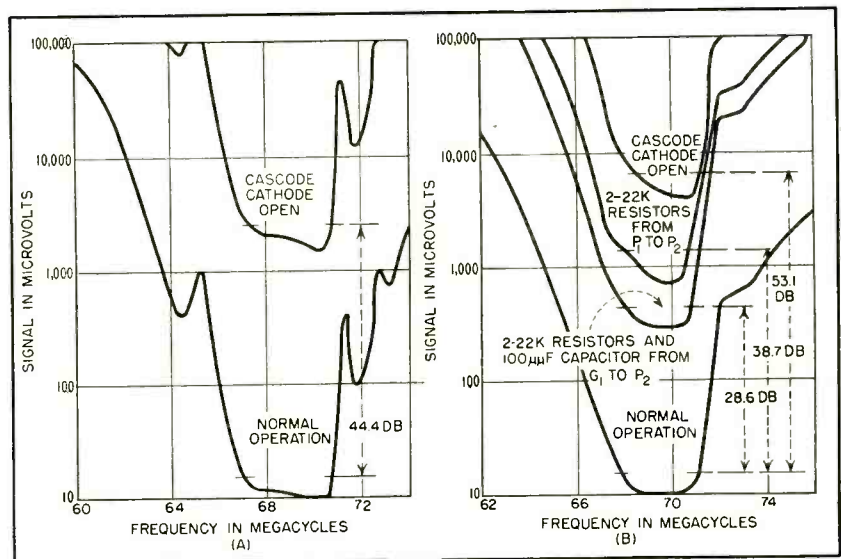

FIG. 5—Receiver response with and without overload elimination (A), and response with varying amounts of attenuation (B)

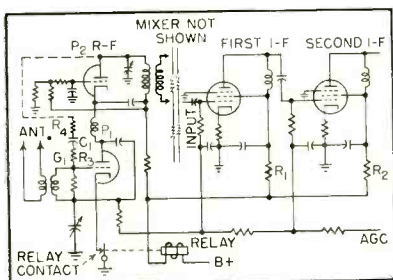

FIG. 4—Receiver overload control circuit

again and the relay remains open for this and any increased signal strength. When the signal decreases to less than 20,000  $\mu$ v, the relay closes and gives normal receiver gain.

The flexibility of the system is seen in Fig. 3B and 3C. In the

former, attenuation was inserted and in the latter, it was removed. Both adjustments can be made to predetermined signal levels by adjusting the relay.

### Circuit Considerations

As is shown in Fig. 4, the circuit requires the addition of one relay and two resistors,  $R_1$  and  $R_2$ . The control point can be adjusted by choosing a relay that opens at a given current. The point at which the relay closes may be determined by the pole-to-armature spacing.

The receiver's overall bandwidth is affected very little by opening the cathode, as shown in Fig. 5A. The attenuation can be varied up to ap-

proximately 50 db by bridging the cascode amplifier with a suitable resistance or R-C network. Typical networks with their resultant attenuations are shown in Fig. 5B. This network can remain in the circuit at all times.

The lead length from the cascode cathode to the relay contacts should be as short as possible and is easily accomplished by mounting the relay on the tuner.

The assistance of R. Zitta of the physics laboratories, in making the many measurements required is acknowledged, as is the assistance of the Du Mont Television Network for the use of the channel 5 test pattern.

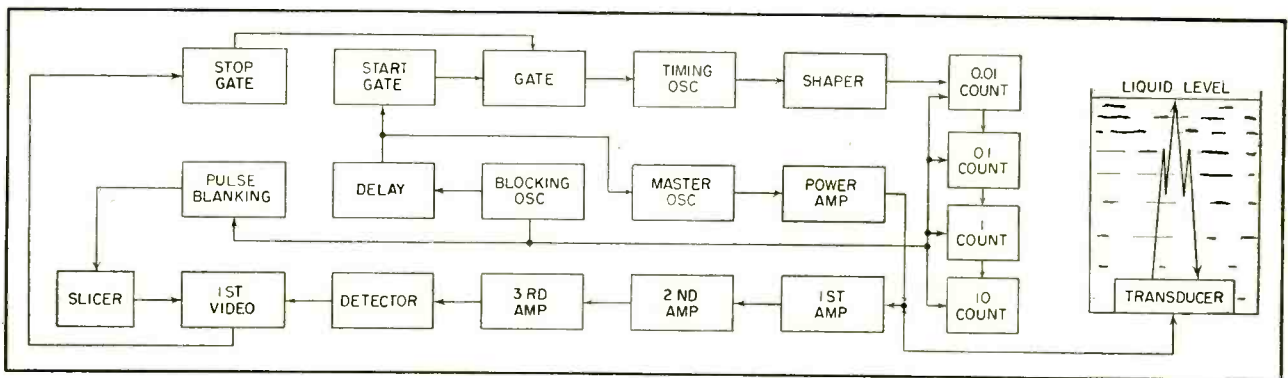

FIG. 1—Block diagram of manually calibrated ultrasonic gage, suitable for liquids having known, stable acoustical characteristics

# Ultrasonic Liquid Level

Height of surface or interface is indicated remotely to hundredths of a foot on decade counters, by using a 400-kc sonar type transducer at bottom of tank. One system compensates automatically for changes in velocity of sound. Chief use is for fully automatic process control and inventory in petroleum refineries and chemical plants

**A**CCURATE liquid level measurements are a most important adjunct to fully automatic process control and inventory. Although hundreds of different types of level gages have been available, many large industries have found it expedient to depend on simple dip sticks and calibrated chains to obtain reliable readings. One reason for this is the inability of moving-float systems to withstand continuous operation in the corrosive liquids found in industry. Another shortcoming has been the difficulty of accurately remoting level information obtained from sight gages.

The basic requirements for a useful gage, in approximate order of importance, are accuracy, reliability and low cost. Accuracy requirements of  $\pm \frac{1}{8}$  inch error in 50 feet are not uncommon in the petroleum industry where  $\frac{1}{8}$  inch change in the level of a large gasoline storage tank represents a difference in inventory of several thousand dollars.

This paper describes two sonar-type liquid level indicating systems which were designed to eliminate moving parts that sooner or later fail in rigorous industrial service.

By **ROBERT L. ROD**

*Director of Electronic Research  
Boque Electric Mfg. Co.  
Paterson, N. J.*

One of the equipments is automatically calibrated to compensate for changes in the velocity of sound with temperature and in different liquids. The other equipment incorporates manual calibration facilities and lends itself to special measurement problems involving liquids of known and stable acoustical characteristics.

Some pertinent features of both new instruments are the complete absence of floats, linkages, synchros, potentiometers and similar moving parts, as well as static capacitance probes that have usually been associated with the level-sensing elements of most existing gages. No direct-current flow is present in or around the tanks being gaged or in the coaxial cables that form the only connection between the indicators and the tanks themselves. Alternating-current energy is far below that required to strike gasoline fumes under any open or short-circuit conditions, and therefore

these systems are safe for use in explosive tank areas. Any number of tanks may be gaged economically by a common indicator which displays level readings directly in tens, units, tenths, and hundredths of a foot.

## System Theory

In the usual case, sound pulses are directed up through the liquid to the surface by a common transmitting-receiving transducer, where they are reflected back as echoes. Round-trip time intervals are measured, and the data are converted to decimal readings corresponding to the levels in feet. Energy is also reflected back from interfaces existing between immiscible liquids, including many having practically the same specific gravity; hence, the sonic level indicators may be used to determine the locations of these lines of demarcation.

Since digital information techniques are used, commercially available digital recorders and tape printers may be fed from the indicators over long distances. Inventory can be made automatic



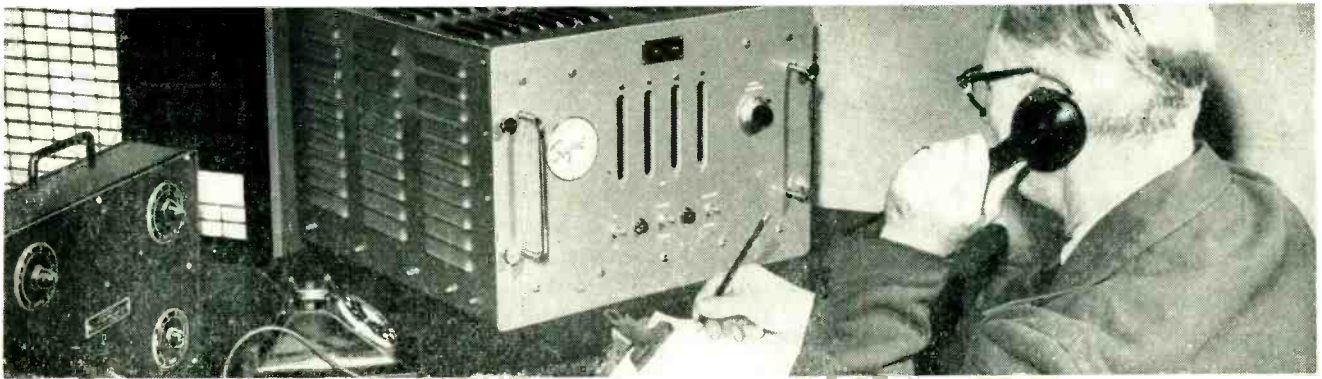

Automatic setup for gaging two groups of petroleum tanks from office of plant superintendent. Control box at left switches tank units

# Indicator Systems

from the data-taking stage to the printing of the actual level at some remote location such as the office of the plant superintendent.

From an electronic standpoint the fundamental operation of the two new systems closely resembles conventional sound-ranging techniques except that the operating frequency has been raised to 400 kc and the data presentation has been considerably improved and simplified. Echoes are returned from either air-liquid or liquid-liquid interfaces, the magnitudes being related to the specific acoustic impedances of the materials involved. The greater the difference in impedances, the stronger the returned echo. Interfaces between liquids and air reflect back practically all of the incident wave.

## Manual Calibration

The block diagram in Fig. 1 illustrates the operation of the manually calibrated sonic liquid level indicator. A free-running blocking oscillator, operating at a repetition frequency of about 0.5 cps, synchronizes the equipment and establishes the frequency of the level readings. Output pulses from the blocking oscillator are applied to time interval measuring circuits to reset the previous level reading back to zero prior to the start of another cycle of operation a short time later. This delay, used to insure the completion of the resetting process, is achieved with a mono-

stable multivibrator triggered by the astable blocking oscillator.

The trailing edge of the delay multivibrator output is used, after differentiation, to trigger the transmitter and start the time interval measuring circuits. These circuits are turned off again at the receipt of an echo pulse.

The actual transmitter consists of a pulsed master oscillator-power amplifier producing a 100-microsecond damped 400-kc sinusoid having a peak-to-peak amplitude of about 40 volts on the balanced twin-conductor coaxial cable to the transducer. Returning echoes pass over the same cable to a receiver consisting of a three-tube stagger-tuned band-pass amplifier followed by a detector and a video amplifier.

## Indicator

Liquid level readings are displayed in decimal form to the hundredths place on four chain-connected decade counters. The highest frequency counter, which reads hundredths of a foot, is fed a series of sharp input pulses derived from a pulsed sine-wave timing oscillator that is started and stopped by a bistable timing gate multivibrator operative only in the interval between transmission and reception of an echo. Translation of the time-interval measurement into level in feet is attained by manually adjusting the timing-oscillator frequency to a point where the period of each cycle corresponds to the time re-

quired for a sound pulse to travel 0.01-foot round trip through the particular liquid. Thus, each squared-up pulse fed to the first counter increases the level reading by a hundredth of a foot. The following three decades successively accumulate the carryover in the usual manner.

In water, sound travels 0.01-foot round trip in about 4 microseconds, the exact value depending upon the temperature and the degree of purity. This velocity corresponds to a correct timing-oscillator frequency of 250 kc. Other liquids require different frequency settings; the range required for commonly found liquids varies approximately 3 to 1, with water at about the center.

The counting interval is but a small part of the repetition period. The level readings, which are maintained for practically the entire time remaining before the start of another cycle of operation, thus appear continuous to the eye because of the persistence of vision. The counting itself is so rapid that it is all but invisible.

A pulse-blanking circuit is used to remove the amplified transmitting pulse appearing at the video amplifier. A slicer control is provided in the video stages to allow for selection of the desired echo above the general base-line noise.

Calibration may be accomplished by setting the level to a known height and manually adjusting the

front panel selector control until the indicated reading is in agreement. Readings taken thereafter will be accurate to  $\pm 0.01$  foot providing the liquid temperature and composition remain constant. If, for example, the temperature changes, a series of calibration data may be taken for future use.

### Automatic Calibration

Manual compensation is best suited to specialized applications that are not too frequently encountered in general industrial use. Automatic calibration is therefore a necessity in many cases. This is achieved with a closed servo loop system embodying a main pulsed transducer and an associated elapsed-time measuring circuit adapted to gage distance to a liquid surface (or liquid-liquid interface). In the same liquid is a similar calibrate system adapted to develop a series of spaced echo pulses from reflectors located at set intervals from a second transducer. The calibrate system automatically modifies the operation of the main cir-

cuit section so as to obtain true level readings despite changes in the velocity of sound for any reason, including variations in molecular structure and temperature differences.

The circuits employed are shown in block diagram form in Fig. 2. The two transducers used per tank are each mounted at the bottom of separate stillwells which are, in effect, acoustic waveguides. The calibrate stillwell is fitted with internal protuberances which reflect back echoes used for the calibration. The other stillwell serves no other function than to confine the sound pulses of the main transducer to a small part of the tank, and thus simplifies the placing of the tank elements with respect to nearby reflecting structural members. In filled tanks transducers may be at the top as in Fig. 3.

The transducers are pulsed in synchronism, and the echoes derived from the reflectors are compared in phase with similarly spaced pulses generated within the indicator itself by a series of fre-

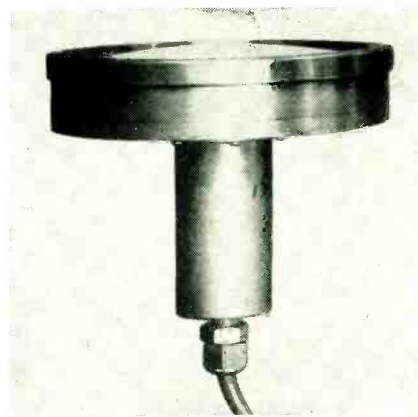

The adp transducer in corrosion resistant housing, with pressure-sensitive teflon window at top

quency dividers energized by the timing oscillator. The timing oscillator is started and stopped by a multivibrator gate operative only during the interval of time between transmission of a pulse by the main transducer and receipt of the corresponding echo.

Any difference in spacing between the two sets of pulses causes the timing oscillator to be shifted in frequency to reduce the spacing error to zero. Thus, this servo action automatically adjusts the timing oscillator to a frequency corresponding to the velocity of sound in any particular liquid.

Depending upon the size of the tank, reflectors are spaced either 4.00 or 8.00 feet apart starting from the first, or closest, reflector which is usually 2.00 feet away from the active face of the calibrate transducer. These spacings are ordinarily close enough to insure the adequate averaging of small differences in velocity which may be caused, for example, by heavier liquids settling to the bottom and by temperature gradients existing within the containers.

### Synchronizing Circuits

Operation is synchronized to a free-running blocking oscillator which operates at about 15 cps. Each blocking oscillator output pulse resets the decade counters to zero, starts a resetting delay circuit multivibrator and energizes a pulse-blanking multivibrator which is used for gating out the undesired transmitted pulses which feed through the two receivers. At the termination of the resetting delay

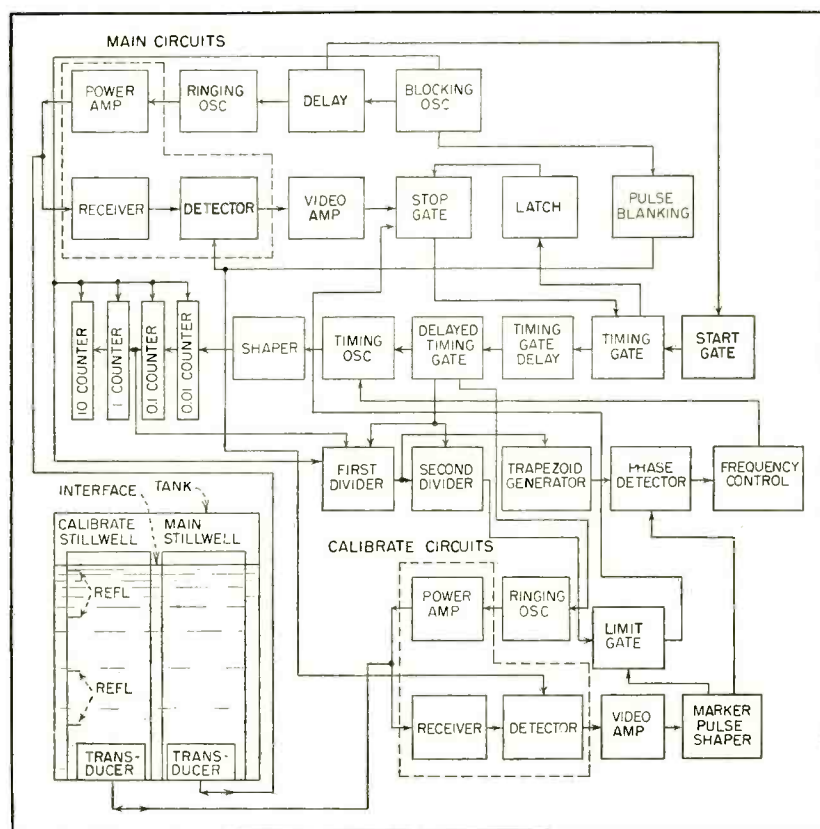
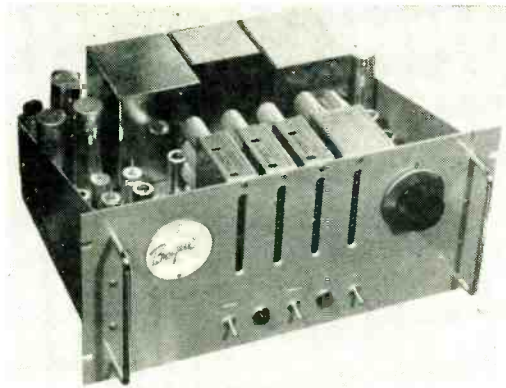
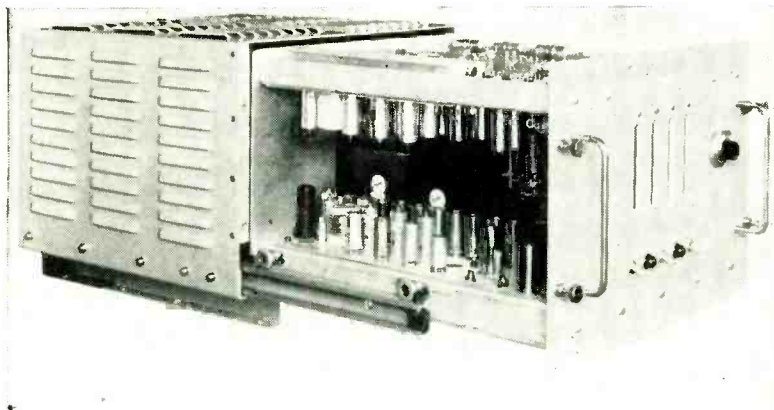

FIG. 2—Block diagram of automatically calibrated ultrasonic gage, using a separate transducer in a calibrate stillwell inside tank to measure distances between fixed metal reflectors. Associated calibrating circuits then correct for any variation in the velocity of sound in the tank





Manually calibrated system. Only other part is transducer in tank. Neon lamps of decade counter indicate height from 00.00 to 99.99 feet



Automatically calibrated system used with two transducers in tank. Calibrate circuits are in upper pan, and main circuitry is below. Chassis can be pulled out on roller slides as shown, for easy servicing of either pan

interval, the main transmitter, consisting of an exponentially damped ringing oscillator and a power amplifier, pulses the main system transducer for 100 microseconds. At the same instant the timing gate multivibrator is started and is turned off again the instant the returning echo arrives. The timing-gate output is delayed several hundred microseconds through a delay multivibrator and is reproduced in width at the delayed timing gate.

Actual on-off control of the timing oscillator is achieved by the delayed timing gate whose duration is exactly equal to the round-trip transit time. The shaped output of the timing oscillator is applied to the highest frequency decade counter. This in turn drives the three lower-frequency decades to produce a reading in tens, units, tenths and hundredths of a foot.

The leading edge of the delayed timing gate is also used to trigger the pulsed calibrate transmitter, which is identical to that used in the main system. One or more echo pulses will subsequently be received from the calibrate reflectors, the number depending upon the level of the liquid. The echo pulse from the surface or liquid-liquid interface will also be received.

At low liquid levels only the first reflector will be illuminated by the transmitting pulse, as the remaining reflectors are effectively blocked by the interface. Conversely, a long series of reflector echoes will be returned when the tank is almost full.

In order to remove the unwanted

interface echo that follows the reflector echoes, the calibrate receiver output is passed through a coincidence stage which is gated on by the undelayed timing gate, which ends before the calibrate interface echo returns. The delay multivibrator delays the timing gate sufficiently for removal of this interface echo.

#### **Error Voltage Circuits**

The reflector echoes are then applied to a one-shot multivibrator that produces an identical series of sharp pulses free from amplitude and width variations. Both the unwanted transmitted and interface echo pulses have been removed prior to this stage, so that only pulses representing the reflectors are passed to the following phase detector.

This comparison stage is also supplied with a series of trapezoidal pulses which are synchronized to a submultiple of the timing oscillator frequency by the dividing action of the two highest frequency decades and one additional scale-of-two divider. The division is such that when the sonic indicator is in normal operation the reflector pulses fall in the middle of the sloping leading edges of symmetrical trapezoids spaced apart by the same distance as the reflectors themselves.

An output error voltage is obtained from the phase detector which is proportional to the spacing time difference between the two sets of pulses. This difference is a function of both the velocity of sound, which changes the time spac-

ing between returning reflector echoes, and the timing oscillator frequency, which directly sets the trapezoid period.

For a particular liquid, the velocity may be considered as a constant and the timing oscillator frequency as the variable. In this case the error voltage derived from the phase detector is applied to a frequency-controlling element in the timing oscillator. This changes the frequency by the correct amount and in the appropriate direction as necessary to equalize the spacing between the two sets of pulses. When the pulses are exactly in time coincidence, the timing oscillator frequency will correspond to the velocity for the liquid being gaged, and the readings will be precisely correct.

#### **Timing Oscillator Circuits**

Frequency control of the timing oscillator is achieved with a saturable reactor whose control winding is energized by a d-c amplifier fed from the output of the phase detector. The signal winding of the reactor is a part of the resonant circuit of the timing oscillator.

Coincidence between the reflected pulses and the trapezoids does not necessarily represent a zero error voltage. The reactor is held at a center frequency, usually representing the median velocity of sound through water, by a fixed bias on the grid of the d-c amplifier. Error signals may vary the control current of the reactor about this bias value over the full operating range of the amplifier.

Because of the wide frequency-

shifting capability of the timing oscillator servo loop, means must be provided to prevent reflector echoes and trapezoids from becoming incorrectly matched when the timing oscillator frequency falls considerably away from its normal operating point, as would be the case when the equipment is turned on or when the common indicator is switched to another tank. The block diagram in Fig. 2 illustrates the location of a limit gate circuit that overcomes the possibilities of misalignment by first allowing only the nearest reflector at 2.00 feet to pass from the calibrate video amplifier to the phase detector circuits. The 2.00 foot reflector pulse is then compared with its corresponding trapezoid, and the resulting error voltage pulls the timing oscillator close to its correct frequency, a step that allows the following reflector pulses to pass through for comparison.

A simple coincidence amplifier is used as the limit gate, with reflector echoes applied to grid 1 and a suitable gating square wave applied to the suppressor grid. When the two inputs are misaligned by a sufficient amount the stop gate stage is prematurely energized by a pulse developed at the plate of the coincidence tube, and all further circuit functions involving the generation of trapezoids are terminated. The stop gate normally turns off the timing gate when the main interface echo is received. At coincidence, however, the limit gate output disappears, and normal circuit functions resume.

### Repetition Frequency

The time constants in the R-C integrating network of the phase detector have been made considerably longer than the repetition period in order to obtain adequately smoothed d-c error voltage. Practical limitations on the maximum time constant obtainable with reasonably chosen components have necessitated the raising of the repetition frequency of the entire equipment to about 15 cps, as compared to the 0.5-cps figure found adequate for the manually calibrated system. At this high repetition rate the counting interval, encompassing the time required for a pulse to travel

the maximum measurable height through the liquid, becomes comparable in duration to the following wait interval. Unless provisions are taken to eliminate the flicker, the counter readings would be unreadable, being rapidly in motion for practically half the time. A simple gating circuit has been added to disable the neon glow indicator lamps of all four decade counters during the counting. This circuit does not affect the dividing action of the decades and eliminates the flicker by illuminating the lamps only during the wait interval prior to another complete cycle of operation.

### Manual-Automatic Switch

The circuit of the timing oscillator and the following pulse-shaper amplifier is given in Fig. 4. In the manual position of the switch, the signal winding of the saturable reactor is disconnected from the cathode capacitors of the shock-excited timing oscillator, and an ordinary inductor shunted by a variable capacitor is substituted. The manual-calibrate switch also disconnects the B+ power from the calibrate receiver in the manual position.

In calibrate operation, the saturable reactor is reconnected in the circuit with its signal winding in the plate circuit of d-c amplifier tube  $V_{1A}$ . The 6,800-ohm resistor and  $V_{1B}$  across  $V_{1A}$  act as limiters controlling the maximum frequency excursions permitted the timing oscillator. The resistor sets the minimum current and hence the lowest frequency, while diode  $V_{1B}$  determines the highest frequency. Discriminator output voltage is fed directly to the grid of  $V_{1A}$  for frequency control.

The output of the pulse shaper, consisting of sharp negative-going pulses, is fed to the hundredths-place decimal counter which is a standard Berkeley unit.

### Transducers

Both Rochelle salt and ammonium dihydrogen phosphate (adp) transducers are used in conjunction with the sonic level indicators. The former material, being both temperature-sensitive and temperature-limited to operation in liquids below 40C, is best suited to gaging

water at room temperature. For more rigorous applications an adp transducer 7 inches in diameter is used.

To protect the internal crystal array, the face is fitted with an acoustically transparent teflon window that is impervious to practically all corrosive liquids. Upper temperature limit of the adp unit is 130C, while half-power beam-width is in the order of 5 degrees. The rear of the transducer incorporates a line matching transformer and optional provisions for resonating the capacitance of the crystal array when additional system sensitivity is required.

The basic manually calibrated equipment may be installed with only a single bottom-mounted transducer pointing upwards in a vertical fan-shaped cone approximately 10 deg wide, which must be free from reflecting supporting structures and similar objects. This is the simplest installation, although most applications require

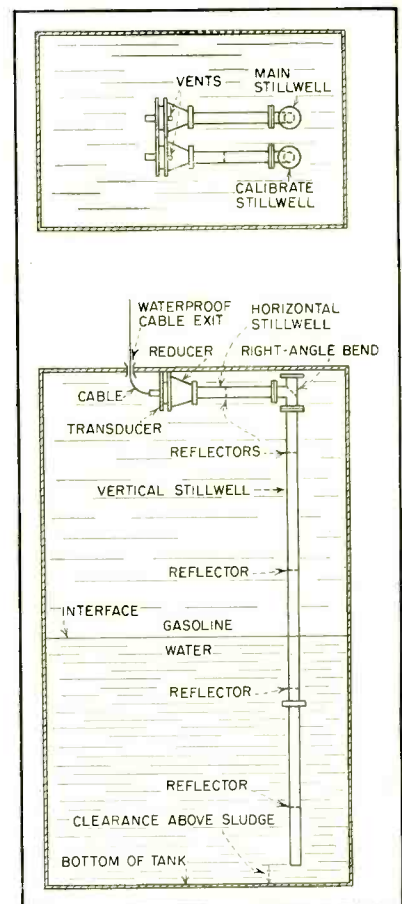

FIG. 3—Method of mounting transducers at top of continuously filled tank for monitoring gasoline-water interface



some additional means for confining the sound energy to an even more restricted part of the container. Stillwell pipe is frequently used to direct the sound energy up a narrow path to the interface and to prevent nearby objects, such as agitators, heating coils and braces from contributing echoes.

### Stillwells

In the automatic system the use of stillwells has been made standard, since this type of assembly is ideally suited to supporting the acoustical reflectors used in the calibrate section. Holes are provided for introducing the liquid into the pipe so that inside and outside levels are equal. Small holes used for this purpose will reduce turbulence frequently found in large mixing tanks and will thereby stabilize the reading of the sonic indicator.

The stillwell pipe, which is acoustically treated internally, may also be mounted on the outside wall of a tank providing sufficient tap-off pipes are provided for equalizing levels. This type of installation facilitates transducer cleaning which may be required periodically when the system is used to gage thick gummy liquids.

A typical tank installation of the automatic system is diagrammed in Fig. 3. This application involved the gaging of an interface level existing in a tank completely filled with varying proportions of two immiscible liquids, water and gasoline. Two internal stillwells were used, one for the main system and the other for calibration. The

transducers were mounted at the top of the tank, pointed horizontally at right-angle reflectors several feet away. This arrangement reduced the minimum range of the equipment, which is ordinarily 2.10 feet, to approximately one-half the diameter of the stillwell pipe flanges or about 0.50 foot. The reducing sections couple the larger transducer radiating area to the smaller-diameter stillwell pipe. This installation was designed to be immersed in the tank, and holes were provided to allow the liquids to seep into the stillwells. An electrical modification to the indicator was necessary to subtract the added horizontal distance.

### Application Data

Sonic liquid level indicators are also being used to gage more conventional petroleum storage tanks and similar large containers filled with corrosive and radioactive liquids. Both internal and external stillwell installations have been made, the choice depending upon particular local conditions.

One of the economic advantages of the sonic level indicators is the use of a common indicator in conjunction with a large number of transducer-equipped tanks. To facilitate tank-to-tank switching, a motor-driven remotely controlled rotary type switch was developed. This switch is specially designed to handle two-conductor balanced coaxial cable. Up to 24 positions may be selected from a remote control point by means of a seeking-type selector assembly energized from a conventional rotary control

switch on the control desk.

The indicators may be arranged to deliver digital level data to commercially available tape printers for automatic inventory purposes. These recorders may be up to several thousand feet away from indicators without necessitating special data transmission accessories. The level information may be remoted even greater distances, if necessary, over conventional wire-radio transmission networks. The new equipments can thus satisfy the need for versatile gages capable of accelerating the trend to completely automatic process control and inventory, particularly in large refineries and chemical plants.

Particular credit for their contributions to these developments is due John A. Herbst, vice-president of Bogue Electric, as well as Lawrence Saper, E. Kohler, William D. Becher, S. Zitovsky, W. Wojtulewicz, and many other members of the Bogue research department.

The author acknowledges the assistance of Clevite-Brush Development Co. and Thompson Products Co. Members of the instrument departments of the Esso Bayway, New Jersey refinery and the Sarnia, Ontario refinery of Imperial Oil, Ltd., graciously assisted in conducting field evaluation tests of sonic equipment. Part of the work undertaken to produce the sonic liquid level indicators was conducted under Bureau of Ships Contract No. NObs-54478.

### REFERENCE

- (1) Robert L. Rod, Gated Lamp Decade, *ELECTRONICS*, p 170, Oct. 1952.

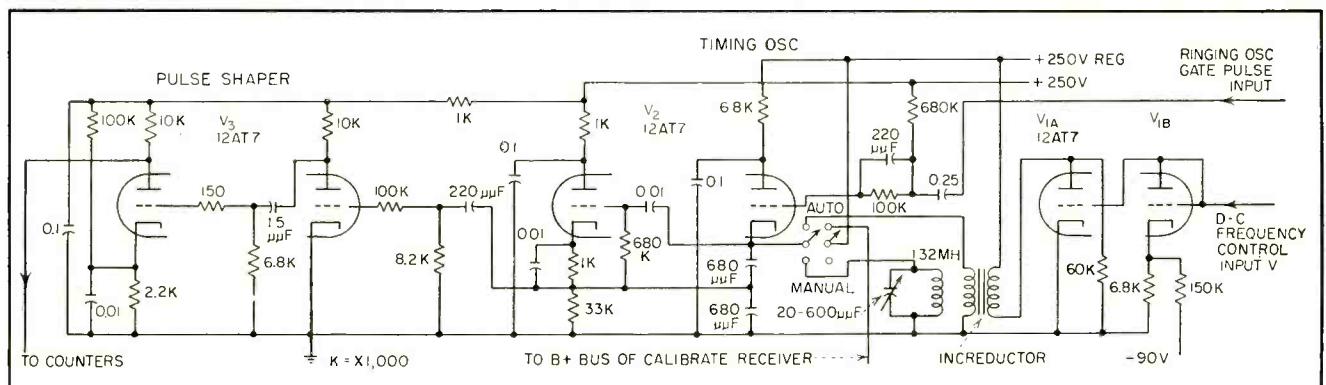

FIG. 4—Switching arrangement used in timing oscillator to provide optional manual calibration in automatic system



Scale model of *USS Mount McKinley* being tested at scale radio frequencies to determine directivity effects caused by ship's structure

# Ship Models Predict

Scale replica vessels constructed from brass sheet and rotated on a 22-foot metal turntable are illuminated at scale frequencies by distant antennas. Shipborne scaled antennas connected to receiver and polar recorder predict full-scale propagation patterns

ONE of the world's most unusual fleets sails on a specially constructed ocean of lead at the Navy Electronics Laboratory's Ship Model Range in San Diego, California.

Every vessel in the force is a scale replica of a real U. S. Navy warship already at sea or on drawing boards for tomorrow. The vessels and the model range are used in continuing studies of ships' antenna systems. Thousands of dollars and man-hours are saved annually by the techniques developed

during and since World War II.

First approach to the antenna system study was to test and measure antennas on operating ships, a procedure painfully expensive in terms of ship availability as well as money. Furthermore, new ships need accurate forecasting for communications design. The Bureau of Ships began in 1944 a complete shore-based ship model systems study. From 1945 to 1948 techniques and instrumentation were investigated on a series of preliminary facilities. Permanent plans

were ready by 1948. The present range and model laboratory has been in operation since 1950.

Valid results may be obtained from models, experience shows, if ship size and wavelength are scaled to the same value. It has been found that for frequencies greater than 2 mc the ship's structure usually has considerable effect on radiation patterns. Below 2 mc the structure is usually too small in terms of wavelength to affect patterns.

The primary factor influencing

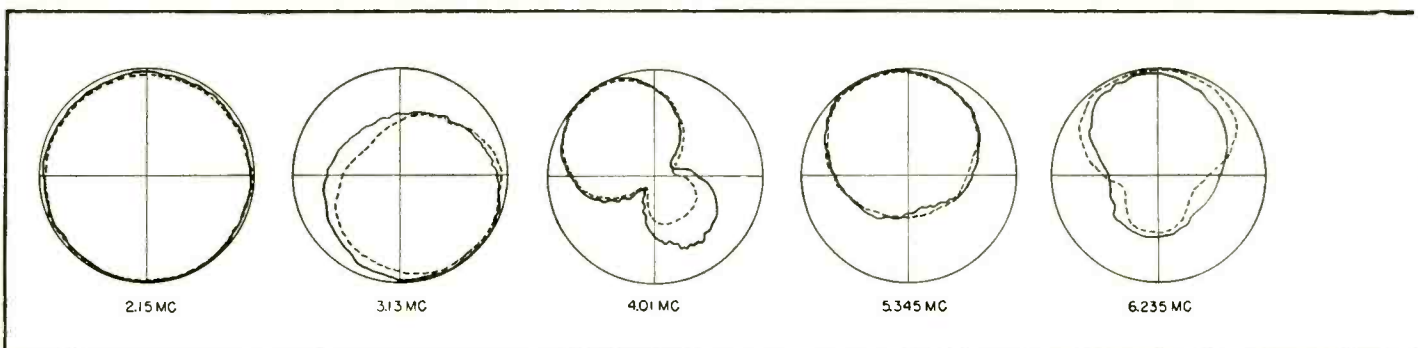

Comparison of antenna patterns of actual ship and scale model





Control room shows positioning dials and recorder

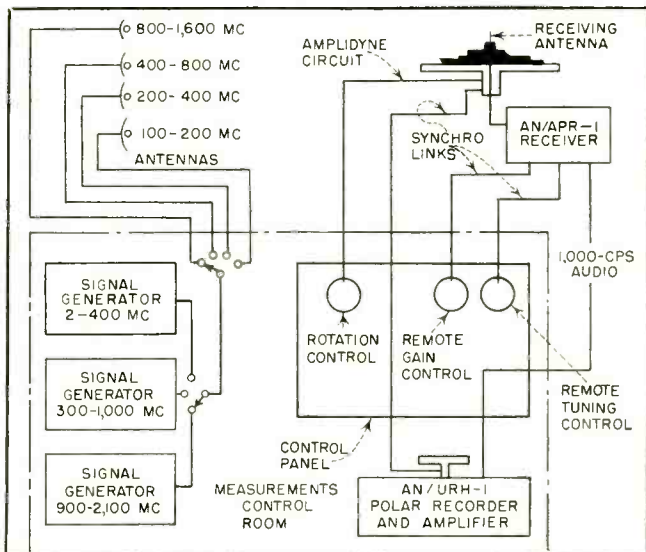

Model antenna is illuminated by proper frequency

# Antenna Patterns

directivity for vhf-uhf antennas, which are usually installed high on the mast, has been found to be nearby objects. A natural division of instrumentation has resulted, therefore, with one set of techniques for the 2-to-30 mc range and another for vhf-uhf. Complete ship models are made for the 2-to-30 mc studies. They are built usually to 1/48 scale (sometimes to 1/24) for ease in construction and to utilize available electronic equipment. Each model ship is made of sheet brass.

The ocean is simulated by a large, unobstructed, highly conducting ground plane. Center section of the plane is a flat metal turntable 22 feet in diameter. Surrounding it is a circular asphalt-concrete field, 160

feet in diameter, covered with a 0.008-inch coating of sprayed lead.

To record an antenna directivity pattern a continuous signal is sent to the model from a parabola at the edge of the field. The model antenna under test is connected to a receiver from which an audio output is obtained. The magnitude of the audio signal is used to control the deflection of a pen on a polar recorder, the turntable of which is rotated in synchronism with the

By **VAL SMITH**

*Head, Radio Antenna Systems*

and **C. M. HATCHER**

*Publications Editor*

*Navy Electronics Laboratory  
San Diego, California*

revolving model. Signal-strength amplitude is plotted as a function of bearing. This plot is a characteristic of the ship antenna and is applicable whether the antenna is used for transmitting or receiving.

Ground plane and turntable were designed to eliminate variances in directivity patterns caused by discontinuities within the field. Periphery of the field is sharply scalloped to reduce standing waves, which might be produced by reflections from the outer edge. The turntable was designed with an overhanging lip that turns within a mercury-filled trough in the ground plane. Discontinuities between the ship model and the turntable are eliminated by soldering the model to the turntable.

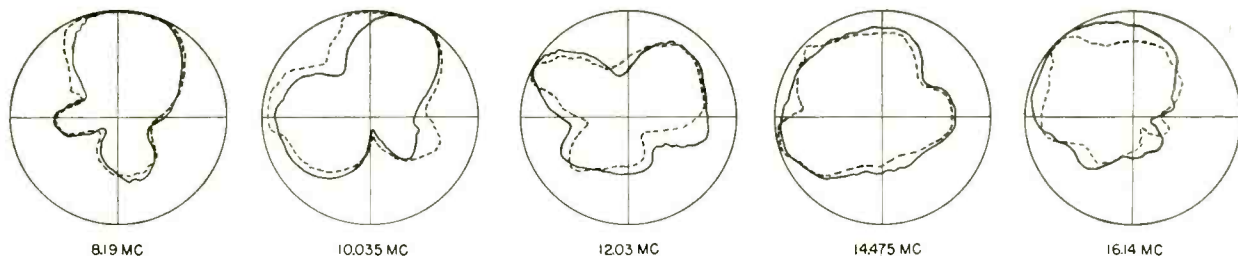

Dotted lines show 35-foot whip while solid lines are 1/24 scale

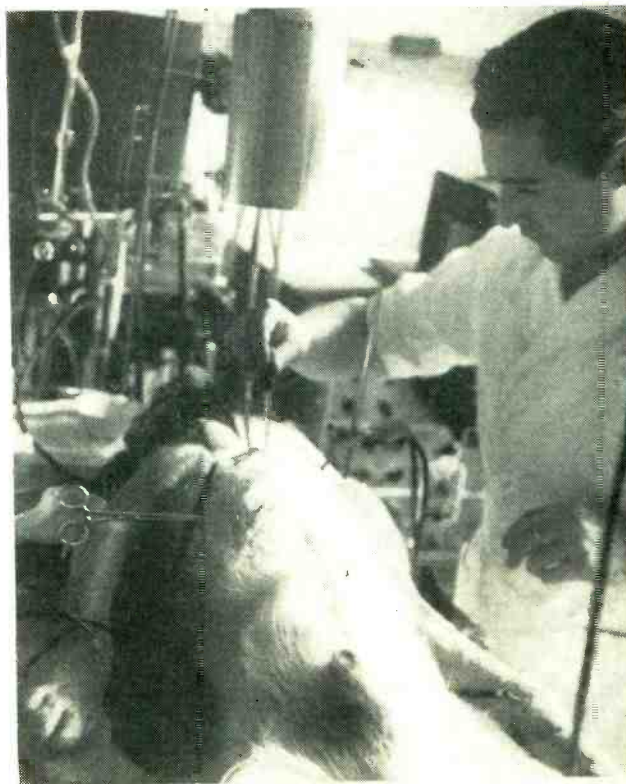
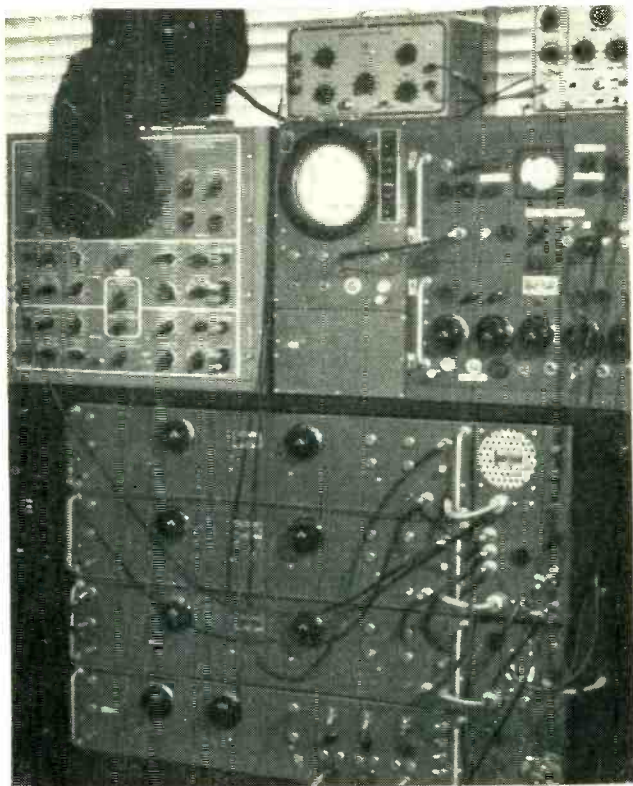

Electronic equipment (left) amplifies and records low-level nerve-current impulses picked up from animal on operating table (right)

# Sensitive Amplifier

Nerve impulses of 5 microvolts are amplified and recorded in studies aimed at providing a better understanding of nervous-system behavior. Equipment incorporates several unusual features. A dozen techniques for ultrasensitive amplifier design are described

**H**IGHLY SENSITIVE audio amplifiers with broad band-pass characteristics play an important role in studying the functional behavior of the nervous system. The equipment to be described is used to amplify and record nerve-current impulses. Its specifications are listed in Table I. The design is especially useful in handling low-level audio signals that cover a wide range of both frequency and output level. The installation shown in the photograph has been in operation for several years at the electrophysiology laboratory of the National Polytechnic Institute in Mexico City.

**By JOHN R. BECKWITH**

*Raytheon Manufacturing Co.  
Chicago, Ill.*

Figure 1 is a functional block diagram of the equipment. It consists of dual amplifier channels feeding a dual-beam oscilloscope equipped for motion photography. Monitoring is provided by both a speaker channel and a 5-in. cathode-ray oscilloscope. The equipment also includes a third amplifier channel for electrocardiograph or electroencephalograph signals and appropriate sweep circuits for the recording oscilloscope.

The first stage is the most im-

portant portion of the amplifier. Referring to Fig. 2, this stage comprises  $V_1$  and  $V_2$  for one of the dual channels and  $V_{11}$  and  $V_{12}$  for the other. The channels are identical in every respect and each has four stages of amplification.

Each stage is built in a chamber by itself, as can be seen in the photograph. All components are chosen for their low noise characteristics. The coupling capacitors are high-voltage mica and the resistors for the first stage are all noninductive wire wound. Resistors  $R_1$  and  $R_2$  control the first stage and largely determine the performance and noise characteristics of the



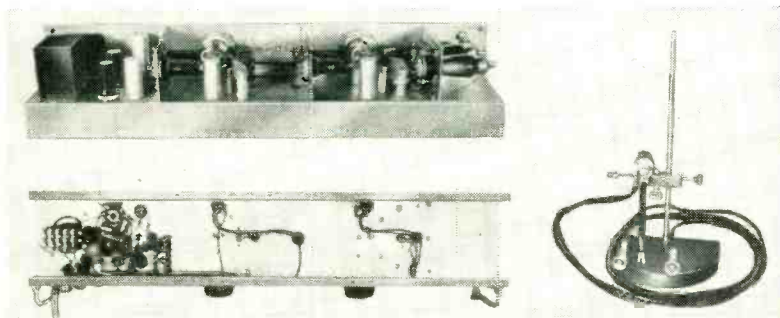

Bottom and rear views of amplifier (left) illustrate special shielded construction. Tantalum electrodes (right) connect directly to nerves of organism under study

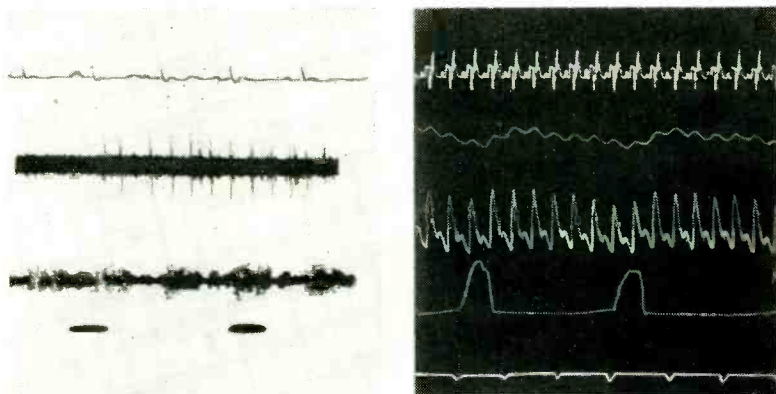

Oscilloscope traces (left) show electrocardiograph trace, nerve-current impulses and one-second time markers. Smoked-paper traces (right) record electrocardiograph signals, blood pressure, respiration and one-second markers

Table I—Requirements of an Amplifier for Studying Bioelectric Potentials

**Sensitivity:** 5 microvolts for full output (corresponding to a 3-in. displacement on a 5-in. cathode-ray tube having an accelerating potential of 5,000 v).

**Input Capability:** 5 microvolts to 100 millivolts.

**Bandwidth:** 10 cps to 25 kc.

**Hum:** Equivalent to a signal of 2 microvolts maximum.

**Interaction:** Not detectable from other amplifiers or devices connected simultaneously to the same nerve.

**Recording Response:** Zero inertia at 25 kc.

**Monitoring Outputs:** Aural and visual.

**Number of Channels:** Two for amplifiers and one for electrocardiograph or electroencephalograph.

**Distortion:** Less than one percent at 100 millivolts input and 50-percent output.

**Power Source:** All a-c operated, 50 or 60 cps.

**Display:** All signals must be available for either separate or simultaneous display

## for Medical Research

amplifier. Their value is found experimentally and varies with different amplifiers and even with different tubes. The optimum value is in the order of 10,000 ohms when the amplifiers are to be connected to the nerve through special platinum or tantalum electrodes.

The insulation used in supports and sockets is of high quality glazed ceramic to reduce noise and afford good insulation. Resistors  $R_3$  and  $R_4$  furnish bias for  $V_1$  and  $V_2$  and also form part of the feedback circuit. Resistor  $R_5$  is the common screen resistor. The screens are unbypassed to degenerate spurious signals appearing on only one of the push-pull grids.

The desired signal appears 180 deg out of phase at the screens, and bypass is not needed. For this same reason, the common connections at the cathodes of the following stages are left unbypassed.

Resistors  $R_6$  and  $R_7$  constitute the

plate load for the first stage and are brought to a wire-wound potentiometer used for balancing the plate voltages of the two tubes. This helps obtain identical performance and good cancellation of in-phase voltages through screen action.

Two 0.05- $\mu$ f capacitors provide coupling to the second stage. Resistor  $R_8$  is the hum and/or interference balance control. It is a 2-watt carbon composition potentiometer. A 470-ohm resistor provides bias for the second stage. Resistors  $R_{11}$  and  $R_{12}$  need not be wire wound since considerably more noise can be tolerated in this stage; they are 2-watt carbon composition units. A 50,000-ohm resistor balances plate voltages of  $V_3$  and  $V_4$ .

### Negative Feedback

A network of  $R_{11}$ ,  $R_{14}$ ,  $R_{13}$ ,  $R_{12}$ , and a 0.01- $\mu$ f capacitor provide variable feedback for one leg of the push-pull amplifier and for the other,  $R_{12}$ ,

$R_{16, 17}$  or  $18$  and their capacitor. This control is available on the front panel and assists in elimination of residual hum voltages with some loss of amplification.

Up to and including the third stage,  $V_5$  and  $V_6$ , the heater voltages are reduced one half by connecting the two tubes of each stage in series. A considerably lower temperature and activity level of the cathode is obtained, thereby materially reducing noise and hum in the tubes. The a-c field set up by the heater wires is so reduced that it can practically be disregarded provided that certain other precautions are observed.

Even though the 1620 tubes in the first stage are noted for low noise and hum and freedom from microphonism, they still must be selected for low noise and equal transconductance. All tubes must be selected in pairs.

The plate load for the third stage





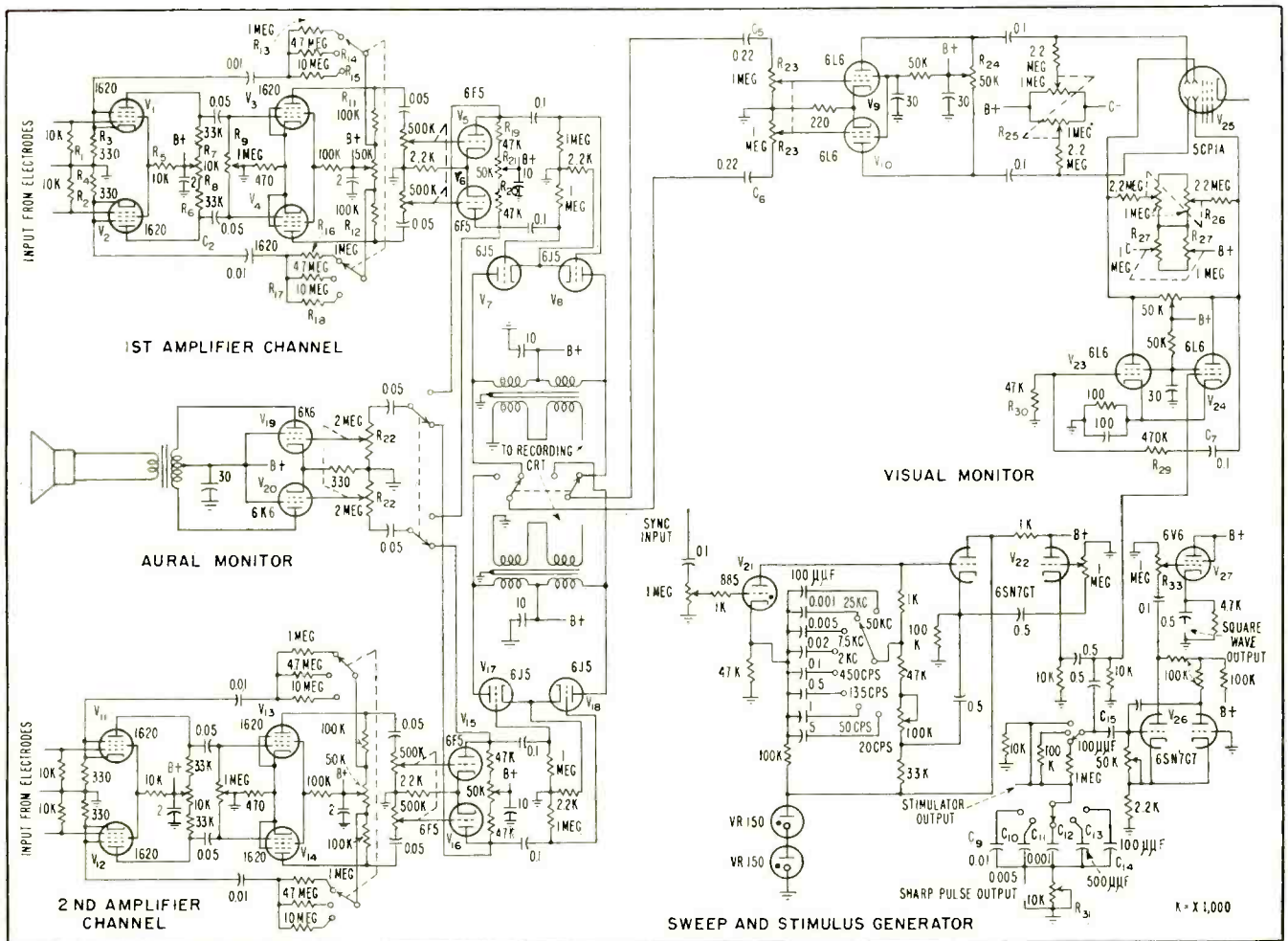

FIG. 2—Schematic diagram of dual amplifiers, aural monitor and visual monitor with stimulus and sweep generator

when excited projects a spot on the film. When the gain controls are opened and the camera started, records are obtained such as those shown. Visual monitoring is accomplished by a separate oscilloscope. Signals are obtained from the amplifiers at the plates of  $V_7$  and  $V_8$  for one channel and from  $V_{17}$  and  $V_{18}$  for the other. These signals are brought through selector switch, coupling capacitors  $C_5$  and  $C_6$  and gain control  $R_{23}$  to the control grids of two 6L6's in push-pull. Resistor  $R_{24}$  is the common plate load, semi-variable for adjusting plate currents. Display tube is a 5CP1A;  $R_{25}$  and  $R_{26}$  are the vertical and horizontal positioning controls. Potentiometer  $R_{27}$  provides astigmatism control.

The horizontal circuit for the oscilloscope is also in part the nerve stimulator used in the experiments. It consists of a thyatron  $V_{21}$  used as a sweep oscillator with means for synchronization. An eight-

position switch controls the frequency from 2 cps to 2 kc. The sweep circuit must be linearized particularly in the low-frequency ranges and  $V_{22}$  performs this function. The tube is a double triode and functions as a cathode follower for the sweep voltages. The sweep oscillator plate voltage is stabilized by two VR-150's. Tubes  $V_{23}$  and  $V_{24}$  are the sweep amplifiers. The exciting voltage is applied to the control grid of  $V_{23}$  and the voltage developed at the plate of this tube is reduced by voltage divider  $C_7$ ,  $R_{20}$  and  $R_{30}$  and applied to the control grid of  $V_{23}$  to obtain phase inversion.

### Nerve Stimulation

From the sweep cathode follower the signal is coupled to an attenuator from which voltage is obtained for stimulating nerves. This voltage is differentiated by capacitors  $C_8$  and  $C_{14}$  inclusive and variable resistor  $R_{31}$  so that sharp pulses may also be obtained. Capacitor  $C_{16}$  com-

prises a differentiating circuit together with the grid resistor. The pulse provided by this combination is applied to multivibrator  $V_{25}$ . This produces a square wave of varying duration at the exciting frequency. When the exciting pulse is of a repetition rate that exceeds the duration of the rectangular wave produced by the multivibrator, the oscillator will lock in at  $\frac{1}{2}$  or  $\frac{1}{3}$  the frequency or any integral multiple and become a counter that will stay in synchronism with the applied signal. Cathode follower  $V_{27}$  isolates the multivibrator from the output. Potentiometer  $R_{28}$  controls the size of the output wave.

Sometimes it is advantageous to brighten only a certain part of the response to a certain stimulus. This can be accomplished by lowering the total brightness of the picture until it is barely visible and then applying the square-wave output to the grid of the picture tube. This wave will be in synchronism with the

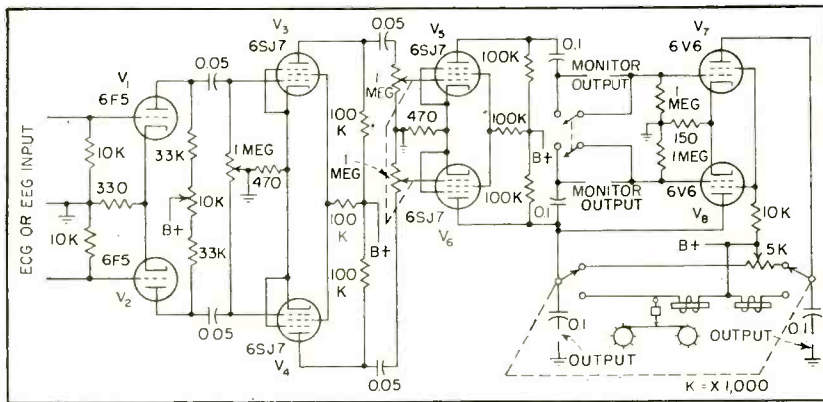

FIG. 3—Auxiliary amplifier is used to handle electrocardiograph or electroencephalograph signals

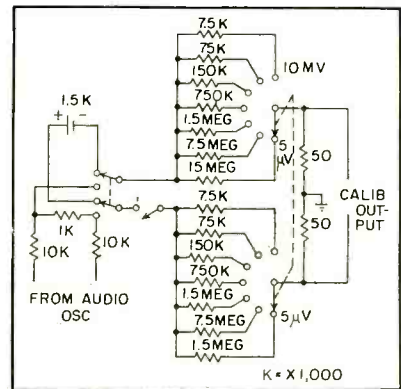

FIG. 4—Calibration circuit

stimulus and the sweep. Several parts in the trace can be illuminated when the multivibrator is run at a higher frequency than the stimulus.

The leads for the electrodes are flexible shielded cable terminating in coaxial connectors to be connected to the amplifier input. The electrodes consist of a short piece of lead shielding covering two insulated wires that terminate in tantalum or platinum hooks over which the nerve is placed. The separation between hooks is varied to meet different conditions. The lead conduit imparts ductibility to the end of the electrodes so they retain their shape once bent as required. This is an important feature, since nerves cannot be cut or strained during an experiment.

Connection should leave them completely undisturbed to prevent mechanical stimulus. The nerves and electrodes must operate under a continuous bath of serum to prevent the nerves drying out and causing a major disturbance to the organism under study.

An auxiliary amplifier of the same general characteristics as the main amplifiers but not of such high sensitivity and good frequency response, utilizing carefully picked commercial tubes, serves for recording an electrocardiogram on smoked paper. On the same paper is recorded respiration, arterial pressure, time signals and electromagnetic signals that point out when a certain stimulus or condition was changed or applied and restored. Thus a complete record of

the experiment is obtained. The schematic diagram of the auxiliary amplifier is shown in Fig. 3. The output of the third stage of amplification is broken by connectors so that the signal may be applied to either the visual or aural monitors or the output of the nerve-signal amplifier fed to the recording amplifier composed of  $V_7$  and  $V_8$ . Thus this signal may also appear on the smoked paper.

A calibrator shown in Fig. 4, is built as a separate unit so that any of the amplifiers may be calibrated and checked periodically at the following voltages:  $10\mu v$ ,  $50\mu v$ ,  $100\mu v$ ,  $500\mu v$ ,  $1\text{ mv}$  and  $10\text{ mv}$ . Operation of the calibrator is by a snap-action switch in series with the battery or a-c voltage from an audio oscillator. The output of the calibrator is available at low impedance and applied directly to the grids of the amplifier being calibrated.

The author thanks R. Alvarez-Buylla, chief investigator of the Dept. of Electrophysiology of the Instituto Politecnico Nacional in Mexico City, for his cooperation in numerous experiments and valuable suggestions.

## STUDYING NERVE-CURRENT CONDUCTION

The human nervous system is a vast and intricate communications network. The brain is the control center and the nerves the cables that carry the signals. Incoming signals describe the functional conditions of the various body organs (kinesthesia) as well as external conditions determined by the sense organs. The brain then dispatches through the nerves electrical commands that cause the body organs to react to these conditions.

Nerve-current conduction is an ionization phenomena. It transmits signals at about the speed of 10 meters a second. One theory about how this ionization takes place states that nerve fiber is composed of calcium ions on one side of an insulating membrane and potassium ions on the other. A heavier insulating membrane surrounds the nerve. An unbalanced potential between the metals makes the intervening membrane partially conductive and this unbalanced condition is transmitted along the nerve as a voltage pulse.

The study of nerve-current conduction involves recording both the signal going to the brain and the response returning from it. Since nerve potentials are in the order of microvolts, electronic amplification must be employed. The amplifier must have extremely high fidelity since nerve pulses occur at repetition rates of a few cycles while the pulses themselves contain frequency components of several kilocycles.

In addition this amplifier for neurophysiological research must be largely free from noise, hum and instability. Each amplification channel must be shielded from extraneous pickup either from adjacent amplifier channels or from the nerve stimulator used in the study

## BIBLIOGRAPHY

- R. Alvarez-Buylla, Estudio Comparativo de las Acciones del Dial, Nembutal, Penatol, Cloralosa y Uretano Sobre Electrocardiograma, Presion Arterial, Respiracion y Actividad de las Zonas Reflexogenicas Cardioaorticas y Senocarotideas. *Anal. Esc. Nat. Cienc. Bio.*, 6, p 131, 1950.
- R. Alvarez-Buylla, Estudio de la Actividad de los Quimiorreceptores del Seno Carotideo Sobre la Frecuencia Cardiaca. *Anal. Esc. Cienc. Bio.*, 6, p 175, 1950.
- R. Alvarez-Buylla, Estudio Oscilografico de la Actividad Electrica de los Quimiorreceptores del Seno Carotideo del Perro. *Acta Physiol. Bio. Latinoamer.*, 2, p 110, 1951.
- R. Alvarez-Buylla, Influencia de la Actividad de los Barorreceptores del Seno Carotideo Sobre la Frecuencia Cardiaca. *Arch. Inst. Card. Mex.*, 21, p 3, 1951.



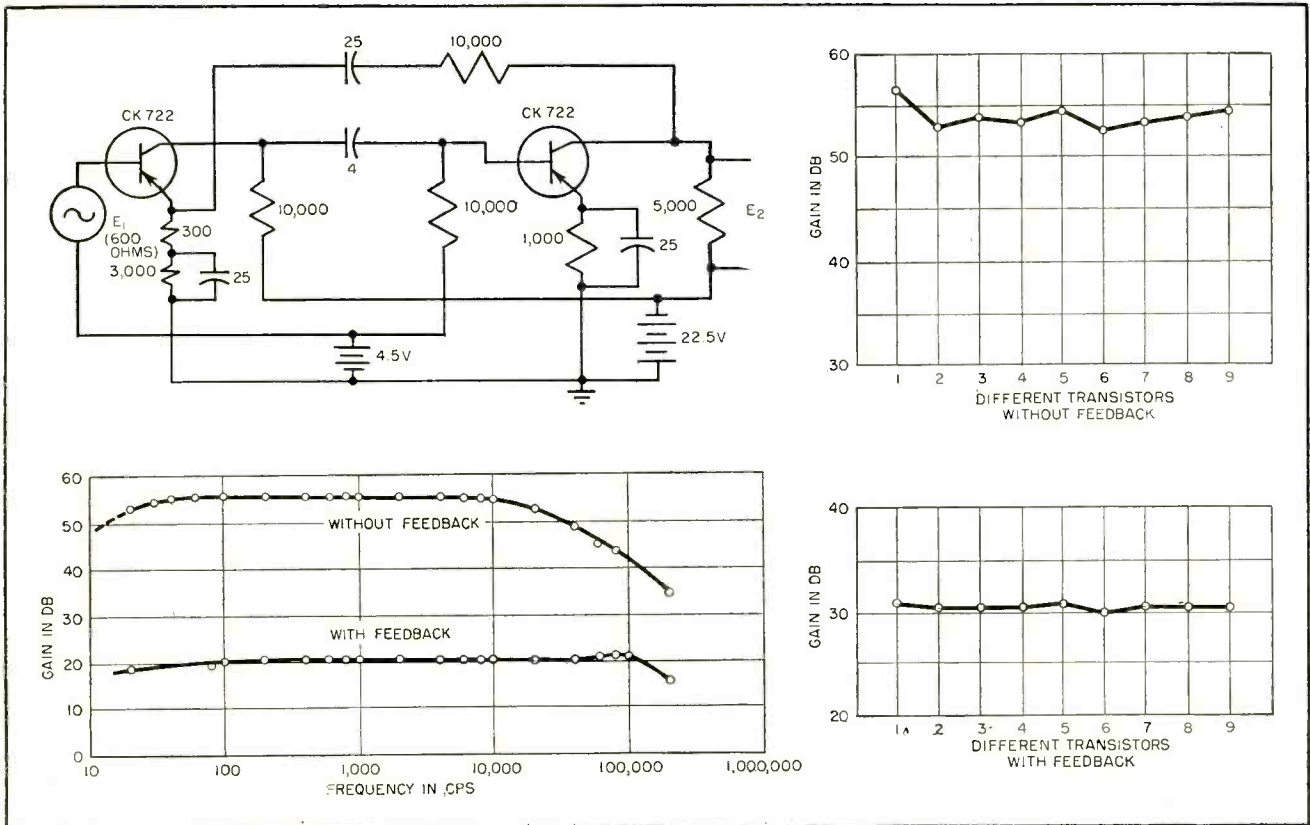

FIG. 1—Circuit and operating characteristics of grounded-emitter to grounded-emitter circuit

# Practical Two-Stage Transistor Amplifiers

Effects of feedback and choice of cascading arrangement are discussed. Curves show capabilities of various configurations in experimental circuits using commercially available junction transistors. Transistor interchangeability is also considered

**T**WO-STAGE resistance-coupled transistor amplifiers are finding increased application in the fields of communications and industrial electronics. Although requirements for various applications differ, it is generally desirable to choose a design that will provide maximum gain with impedance characteristics that permit use of simple coupling circuits.

Theoretical analyses show that of the nine configurations possible, using two transistor stages, four may be eliminated because of low

**By ROBERT L. RIDDLE**

*Electrical Engineering Department  
Pennsylvania State College  
State College, Pennsylvania*

gain when R-C coupling is used between stages. Two of the remaining configurations have limited usefulness because of low output impedance.

The remaining three configurations (grounded-emitter to grounded-emitter, grounded-base to grounded-emitter, and grounded-collector to grounded-emitter) have been tested experimentally with a

variety of commercially-available transistors, with and without negative feedback. The results of these tests are presented in the accompanying curves to provide designers with comparative data for choosing an optimum circuit for a given amplifying job.

## GE to GE

The grounded-emitter to grounded-emitter configuration has the greatest gain potential, as shown in Table I. This circuit is seen to have medium input and output im-

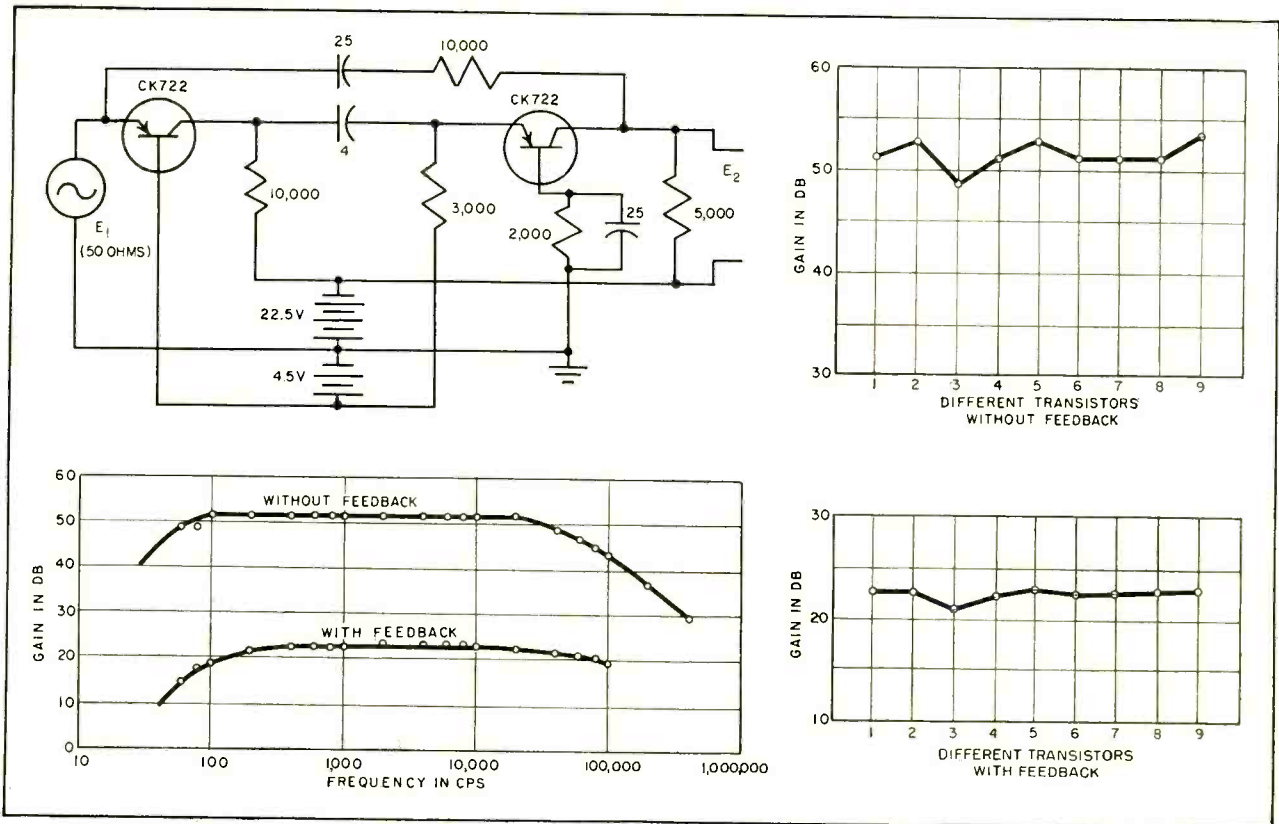

FIG. 2—Circuit and operating characteristics of grounded-base to grounded-emitter circuit

Table I—Theoretical Data for Two-Stage Transistor Amplifiers

Circuit	Gain	Relative Input Impedance	Relative Output Impedance	Gain in db
GE to GE	$\frac{R_L}{R_i} \left( \frac{\alpha}{1-\alpha} \right)^4$	med	med	67 db
GE to GC	$\frac{R_L}{R_i} \frac{\alpha^2}{(1-\alpha)^4}$	med	low	51 db
GE to GB	$\frac{R_L}{R_i} \frac{\alpha^4}{(1-\alpha)^2}$	med	high	35 db
GC to GC	$\frac{R_L}{R_i} \left( \frac{1}{1-\alpha} \right)^4$	high	low	25 db
GC to GE	$\frac{R_L}{R_i} \frac{\alpha^2}{(1-\alpha)^4}$	high	med	50 db
GC to GB	$\frac{R_L}{R_i} \left( \frac{\alpha}{1-\alpha} \right)^2$	high	high	30 db
GB to GB	$\frac{R_L}{R_i} \alpha^2$	low	high	25 db
GB to GE	$\frac{R_L}{R_i} \frac{\alpha^4}{(1-\alpha)^2}$	low	med	52 db
CB to GC	$\frac{R_L}{R_i} \left( \frac{\alpha}{1-\alpha} \right)^2$	low	low	52 db

pedances, relative to the other configurations, and should provide a gain of 67 db for high- $\alpha$  transistors.

The grounded-emitter stage gives a phase shift of 180 deg from input to output, resulting in the input and output being in phase in a two-stage cascade amplifier. This results in relatively complicated degenerative feedback connections.

The experimental circuit used to check the GE-to-GE combination is shown in Fig. 1, along with curves showing frequency response with and without feedback and curves showing effect of using different transistors. In this circuit, input impedance was matched and the output impedance mismatched to obtain high gain-bandwidth product.

Shunt to series degenerative feedback was used. This required an unbypassed resistor in the emitter lead of the first stage. This resistor resulted in local feedback in the first stage, reducing the overall effect of the feedback.

The power gain in db was obtained by using the expression

$$\text{gain in db} = 10 \log \frac{E_2^2/R_L}{E_i/R_i}$$



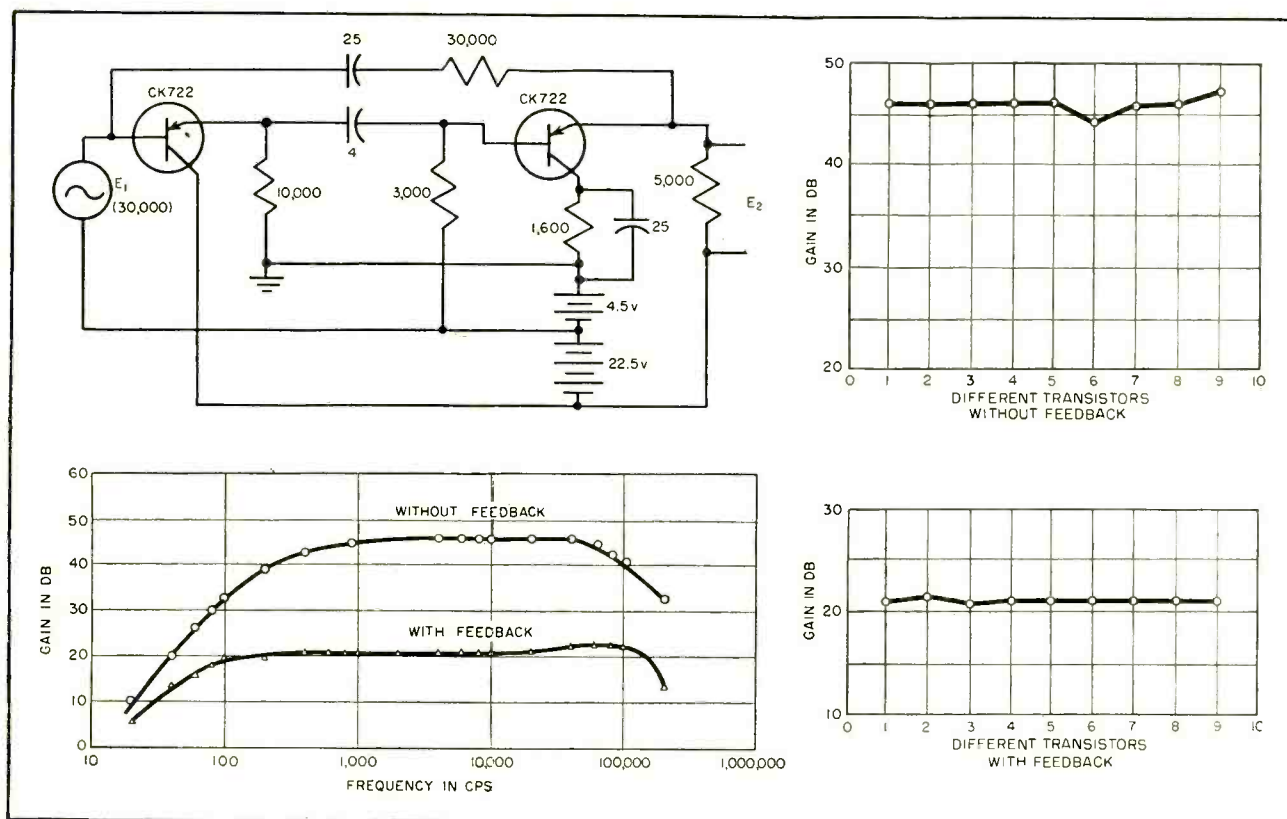

FIG. 3—Circuit and operating characteristics of grounded-collector to grounded-emitter circuit

where  $E_2$  is the output voltage,  $E_1$  the input voltage,  $R_L$  the load impedance and  $R_i$  the input impedance.

Feedback resulted in a flat frequency response curve over three decades from 100 to 100,000 cycles and reduced the variation with change in transistors from 3 db to 1 db.

### GB to GE

The circuit used for the grounded-base to grounded-emitter connection is shown in Fig. 2. In this circuit the input and output voltages are out of phase by 180 deg and therefore the feedback can be shunt-to-shunt feedback. This eliminates the local feedback in the first stage that was present in the GE-to-GE circuit. This should have resulted in greater stability for the gain with feedback when transistors were changed. This was not the case and can be attributed to the impedance levels present at the input and output. A change in the output impedance resulting from a change in transistors in the second stage results in a greater change in the feedback loop here over that of the GE-to-GE circuit.

The gain from this circuit is not as high as in the case of the GE-to-GE circuit and the frequency response is not as good.

### GC to GE

The final circuit tested was the grounded-collector to grounded-emitter combination. The circuit and curves for this configuration are shown in Fig. 3. In this circuit, as in the GB-to-GE circuit the input and output voltages are 180 deg out of phase and shunt-to-shunt degenerative feedback may be used. This circuit, like the others, was designed to give a large gain-bandwidth product. As a result the maximum gain was slightly lower than that predicted in Table I. The frequency response is similar to that of the GE-to-GE circuit and better than that of the GB-to-GE circuit.

Variation of gain with changes in transistors was very good for this circuit. Without feedback it was 2 db and with feedback it was 0.2 db. The better performance of this circuit is produced by high input impedance and 180-deg phase shift which permits feedback effective over the entire circuit.

The equations given in Table I are approximate gain equations for the nine possible two-stage cascade amplifiers. These equations neglect interstage losses. In these equations  $R_L$  is the load resistance of the last stage and  $R_i$  is the input resistance to the first stage.

The impedance levels indicated in Table I are relative. The input impedance to a grounded-base stage is low in comparison to a grounded-emitter stage, and the input impedance of a grounded-collector stage is high in comparison to a grounded-emitter stage.

Some of the equations shown in Table I are similar, such as those for the GE to GB and GB to GE but the differences in  $R_i$  and  $R_L$  result in the gains being different.

The GE-to-GE circuit gives the greatest overall gain without feedback but has less uniformity with change in transistors. The GC-to-GE circuit is most uniform in the latter respect, but it offers less overall gain without feedback.

The author wishes to thank R. G. Santilli and G. E. Romaine for their help in obtaining data presented in this article.

By  
**H. B. SCHULTHEIS, JR.**

*Pacific Division  
 Bendix Aircraft Corporation  
 Los Angeles, Calif.*

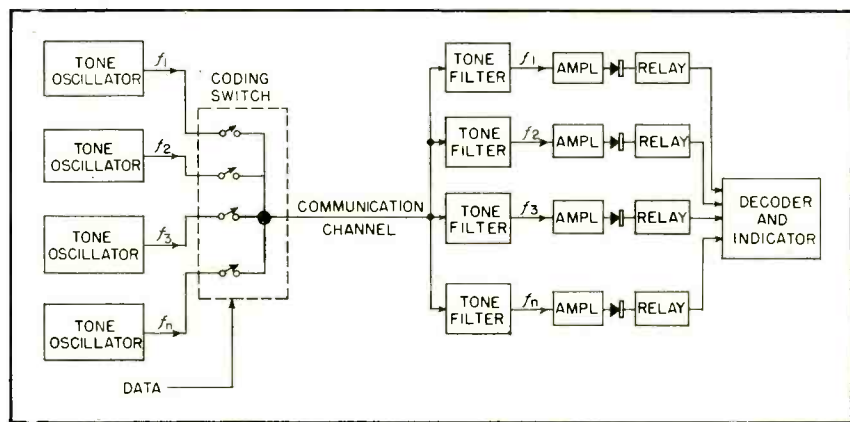

FIG. 1—Functional diagram of basic frequency-code telemetering system

# Frequency-Code

Analog data is conveyed numerically by simultaneous transmission of audio tone pulses whose on and off states correspond to binary digits. Synchronization of transmitter and receiver is unnecessary; channel interruptions produce no cumulative errors

**F**REQUENCY-CODE telemetering, using the equipment to be described, conveys analog information, such as shaft-rotation data, in digital form over either telephone lines or radio links with minimum vulnerability to noise and other common sources of error. The data are readily reconverted into easily interpretable form at the output.

## Operation

The basic principles of the system are illustrated in Fig. 1. Shaft settings are converted into digital signals by a special multisection coding switch that selects oscillator tones corresponding to digits of the binary number giving degrees of shaft rotation. Complete binary numbers, each represented by a tone group, are transmitted successively in direct response to changes in input data.

At the receiver, the composite tone is analyzed by a group of band-pass filters each followed by an amplifier, detector and sensitive re-

lay. The relays are connected in decoding circuits that convert the binary numbers into decimal data for display either on an indicator dial or lamp register.

## Seven-Digit System

A simplified schematic of a complete seven-digit frequency-code telemetering system is shown in Fig. 2. Seven tones, representing the seven digits of a binary number, are generated by a group of Wien-bridge oscillators each employing a 12AU7 dual triode. The oscillators are tuned to different frequencies within the range 500 to 1,700 cps. The output voltage from each oscillator is fed to a wiper on a seven-track printed-circuit coding switch, which is attached to a rotatable shaft. The shaft can be turned and set to any desired angular position by a control knob. The knob is fitted with a pointer that sweeps a 360-degree graduated scale. The rotatable coding switch and the oscillator assembly

are shown in Fig. 3. The electrical contact pattern on the coding switch conforms to the minimum-error code (or Gray code) given in Table I.

In the seven-digit system, a maximum of  $2^7$  or 128 binary numbers can be coded and transmitted, making it possible to divide the circular scale into 128 equal parts. Only 120 binary numbers are used, each representing a three-degree sector of the dial.

## Coding Process

Each track of the coding switch consists of alternate conducting and nonconducting segments, corresponding to the 1 and 0 values of each digit in the binary number to be coded. Two additional tracks, each consisting of an unbroken conductive ring, are connected electrically to all the conducting segments on the seven tracks. The wipers that contact the eighth and ninth tracks serve as the common output terminal of the coding switch. Thus, for any of the 120 three-degree set-



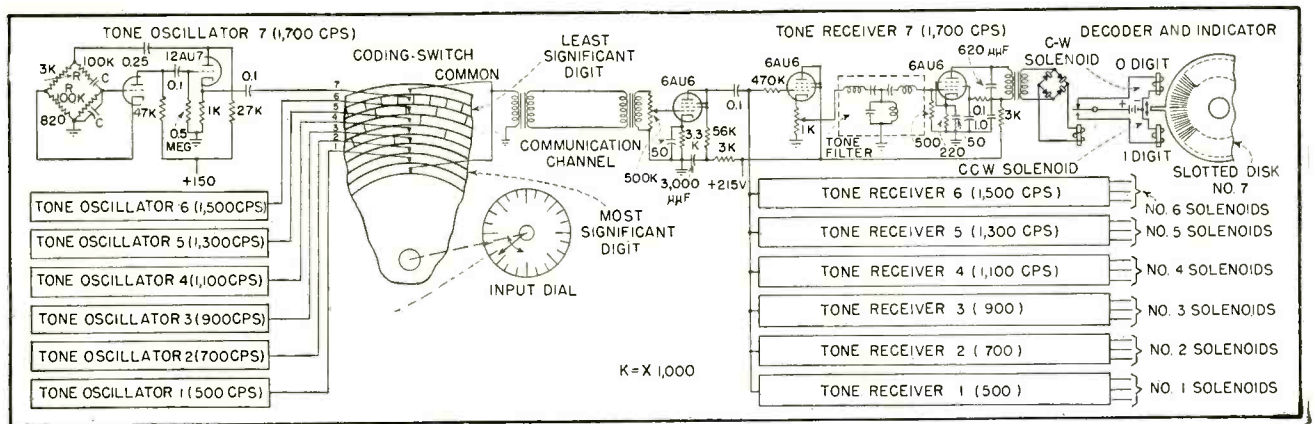

FIG. 2—Circuit of frequency-code telemetering system sending 2-unit binary code

# Telemetering System

tings of the coding switch shaft, a distinct combination of tones appears as a complex a-c voltage at the output terminals of the switch. This composite signal is applied through a transformer to a telephone line at a level of 0.27 volt rms per tone.

The oscillators are of plug-in construction and are assembled on a common chassis with an unregulated power supply. Space is provided for up to ten oscillators. Temperature compensation of the oscillator frequency-determining circuits holds frequency drift to less than  $\pm 4$  cps within the temperature

range  $-20$  to  $+80$  C. Supply-voltage variations of  $-10$  to  $+15$  percent produce less than  $\pm 1$ -cps frequency shift.

## Tone Receivers

The tone receiver assembly is shown in Fig. 4. Ten complete tone-receiving channels are provided, although only seven are used. The composite tone signal is passed through a single triode-connected 6AU6 preamplifier and then applied through isolation resistors to the input circuits of the individual tone channels.

Each channel consists of a 6AU6 triode-connected cathode follower, 600-ohm constant-K tone filter designed to pass only one of the tone signals, 6AU6 pentode amplifier, bridge rectifier and sensitive relay. Each filter has a 3-db bandwidth of 60 cps and adjacent-channel attenuation of 30 to 35 db.

Use of temperature-compensating capacitors in the filter tuned circuits prevents the 3-db points from drifting more than  $\pm 8$  cps within the temperature range  $-20$  to  $+80$  C. The sensitive relays have 1,000-ohm coils and are adjusted to

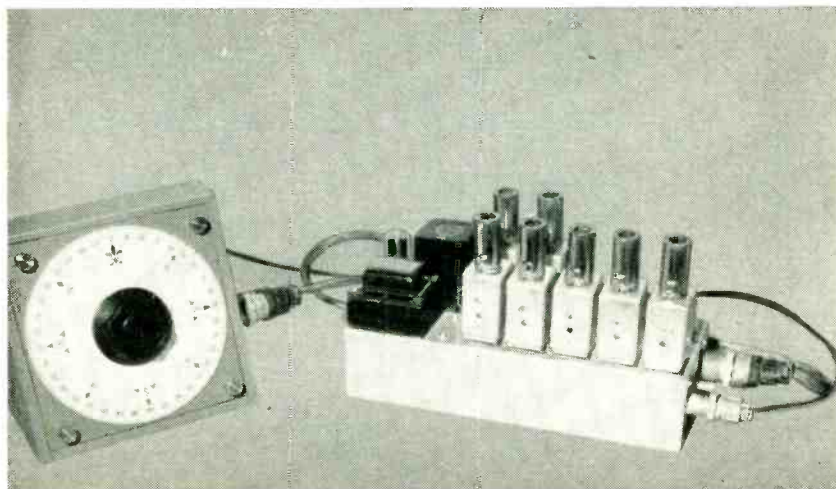

FIG. 3—Shaft-position coding switch and tone oscillator assembly. Open view of switch (right) shows binary-coding commutator rings

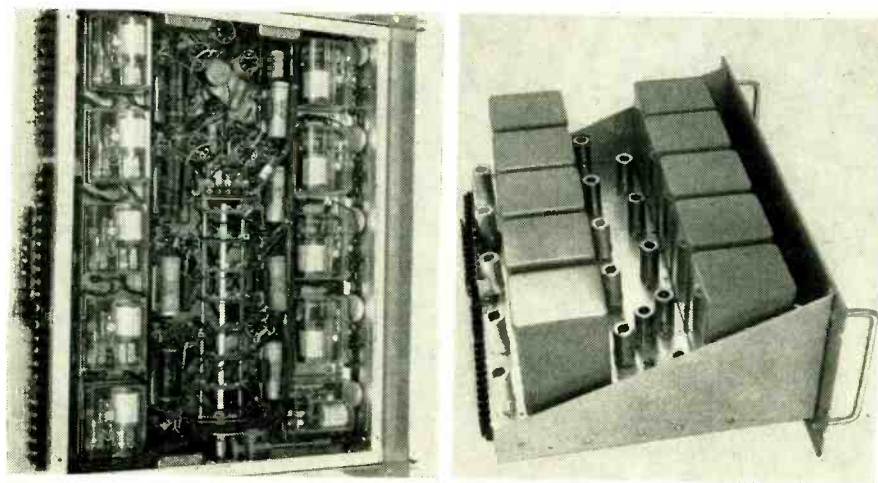

FIG. 4—Top and bottom views of tone-receiver chassis

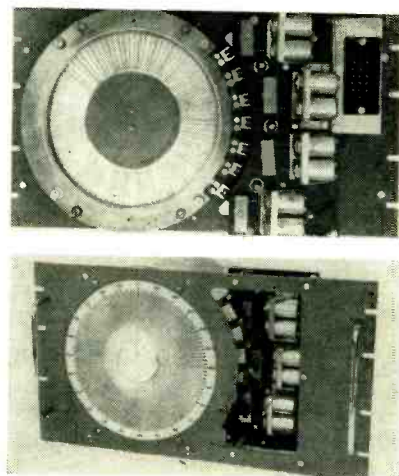

FIG. 5—Dial-type decoder and indicator

operate when the rectified tone current reaches 2.6 ma.

### Decoder and Indicator

The spdt contacts on each sensitive relay are connected to a pair of solenoids located in the decoder and indicator assembly shown in Fig. 5. The assembly contains seven pairs of solenoids, each corresponding to one digit of the incoming binary number.

The plungers in each pair of solenoids are connected mechanically to a projecting tab on one of seven circular code plates mounted on a common fixed center. Each code plate contains 120 radial slots spaced to conform with the 0 and 1 pattern of one digit of the minimum-error code. Each code plate is moved independently by its pair of solenoids between two stops that limit rotational motion to  $1\frac{1}{2}$  degrees.

When a tone is present at the input of any channel, the corresponding relay is energized causing voltage to be applied to the 1 solenoid in the decoder assembly. In the absence of a tone, the relay is applied to the opposite, or 0, solenoid of the pair.

### Dial Indication

A 1 signal causes the code plate to be held against its counterclockwise stop and a 0 signal causes it to be held against its clockwise stop. For any combination of code-plate settings, one continuous passage is opened through all the plates by mutual alignment of one group of radial slots. A 150-watt lamp

mounted in back of the assembly projects light through the open slit onto a graduated scale affixed to the front panel of the indicator.

The illuminated slot sweeps the scale in unison with the rotation of the transmitter coding-switch and the angular setting of the shaft is registered continuously by the light-slot indicator to an accuracy within  $\pm 1\frac{1}{2}$  degrees. The indicator responds accurately to shaft-rotation rates in excess of 10 rpm.

### Lamp Matrix

An alternate decoder and indicator, capable of direct conversion and display, is the numbered-lamp register. This unit is much simpler in construction than the slotted-plate decoder and is preferred where a circular display is not re-

quired. The circuit of a seven-digit 120-number lamp matrix is shown in Fig. 6. Relays  $RE_1$  through  $RE_7$ , actuated by the sensitive relays in the tone-receiver assembly are divided into two groups, each of which is arranged in a transfer-tree circuit.

### Relay Operation

Eight horizontal conductors,  $A$  through  $H$ , of a rectangular matrix are connected to the eight contacts of the third relay in the first group  $RE_3$  and sixteen vertical conductors, 1 through 16, are connected to the sixteen contacts of the fourth relay in the second group  $RE_4$ . The matrix has  $8 \times 16$  or 128 crossovers, corresponding to the 128 numbers in the seven-digit minimum error code. At each crossover point a

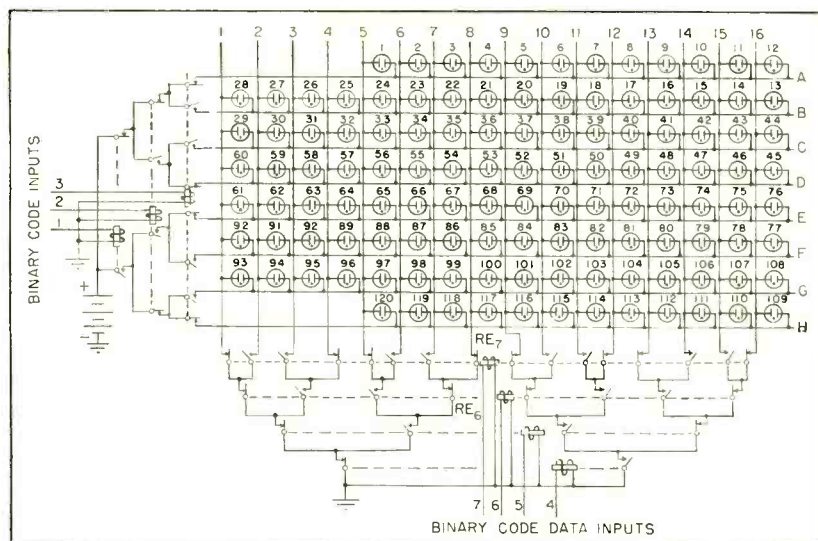

FIG. 6—Circuit of lamp matrix. Relay numbers correspond to binary inputs



neon indicator lamp is bridged between a horizontal conductor and a vertical conductor.

By numbering the lamps in a zig-zag manner and with the relay contacts wired as shown, the 120 numbered lamps match the sequence of the minimum-error binary code. For example when the binary number 0000110 is received, one terminal of the source voltage is connected through  $RE_1$ ,  $RE_2$ , and  $RE_3$  to horizontal conductor A, and the opposite voltage terminal is connected through  $RE_4$ ,  $RE_5$ ,  $RE_6$ , and  $RE_7$  to vertical conductor 5 causing lamp No. 1 to light.

### Multichannel Operation

Data sampling and distribution techniques permit multichannel operation with the frequency-code telemetering system. A block diagram illustrating the method of providing multichannel operation is shown in Fig. 7. A multipole commutator or stepping switch having one pole for each binary digit is inserted between the tone oscillators and the several angular-position coding switches.

The commutator applies the output voltage from the group of tone oscillators sequentially to the four individual data channel coding switches. The system illustrated is a four-channel, seven-digit system.

The seven oscillator output voltages are applied first to Coding Switch No. 1, then to Coding Switch 2 and so on repeating the cycle continuously. To allow the discrete

data samples to be identified and separated at the receiving station, a second group of tone oscillators is used to produce a designation code that is transmitted by another section of the commutator in synchronism with each quantity code. Since the designation code is also a binary code, the number of additional oscillators required for a multichannel system is  $2^n$  where  $n$  is the number of different input sources to be telemetered. Two oscillators generate designation codes

for the four data channels of Fig. 7.

The output signals from both groups of tone oscillators consist of a series of pulses, each pulse comprised of a combination of tones representing both the coding-switch position and the identification of the switch. This system may be classified as a pulse-frequency-code modulation or PFCM system. With the equipment described, the maximum sampling rate is about twelve binary numbers per second, making it possible to sample the output data of each of four coding switches at the rate of three readings per second from each switch.

### Number Storage

When binary numbers representing different measurements are transmitted sequentially over a common system, it is usually necessary to prevent interruptions or discontinuities in the displayed output information. In this system, interruptions in the output information due to the data-sampling and distributing processes are prevented by a number-storage circuit inserted between the output-data distributor and each of the indicators.

### Circuit Operation

Each indicator responds only to the binary data appearing in its respective number-storage circuit. In the absence of incoming data, each number-storage circuit holds the last binary number received, causing the indicator to remain locked at the desired position. Upon

Table I—Minimum-Error Binary Code\*

Decimal Number	Binary numbers	
	Natural binary code	Minimum error code
0	0000	0000
1	0001	0001
2	0010	0011
3	0011	0010
4	0100	0110
5	0101	0111
6	0110	0101
7	0111	0100
8	1000	1100
9	1001	1101
10	1010	1111
11	1011	1110
12	1100	1010
13	1101	1011
14	1110	1001
15	1111	1000

\* Binary numbers are so arranged that adjacent numbers differ by only digit to avoid large errors due to coding ambiguities

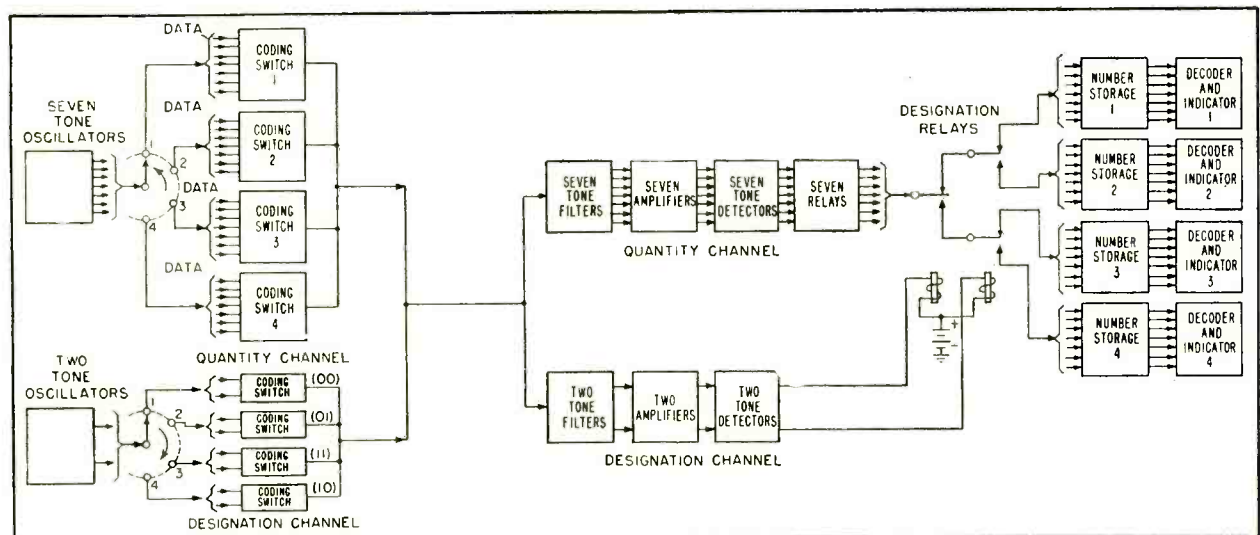

FIG. 7—Pulse-frequency-code modulation system showing four data channels

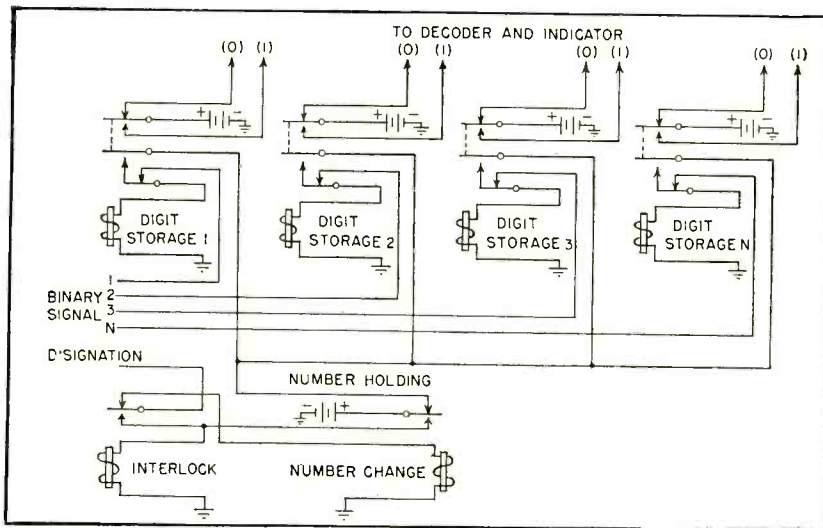

FIG. 8—Number-storage circuit for multichannel system

receipt of the predetermined function-designation code the last number held in the number-storage circuit is cancelled and the new incoming number assimilated and stored. The indicator then registers the new number.

### Operating Threshold

Each number storage circuit consists of a set of slow-operate relays, one for each binary digit in the quantity code plus a number-change relay and an interlock relay. The number-change relay is actuated momentarily when the designation code corresponding to its particular information channel is received. A typical number storage circuit is shown in Fig. 8.

Data-sampling is performed either automatically as with a continuous-running commutator, or upon demand.

With the latter method, a manually operated switch is added to each shaft-position coder to permit changing any one of the coding-switch settings and its corresponding remote indication without disturbing any of the other readings.

### Performance

The only source of fixed error in the frequency-code telemetering system occurs in the conversion of angular shaft settings into binary electrical signals. Neglecting an occasional random error when transmitting in the presence of noise, transmission, decoding and display produce no errors. Resolution of one part in 256 (about 0.4

percent or 1.4 degrees) is readily obtained in an eight-digit frequency-code system using a coding switch five inches in diameter.

In a switch assembly of this diameter, slight mechanical imperfections may introduce errors as large as  $\pm 0.2$  degree. Hence the overall accuracy of an eight-digit system is such that the output indication will match the input shaft setting within  $\pm 1$  degree. The ultimate or potential accuracy has not been determined. However, if no limitations are imposed on the permissible diameter of the coding switch, accuracies of  $\pm 0.4$  degree (nine digits) and  $\pm 0.2$  degree (ten digits) appear practicable.

The ability of the system to function accurately in the presence of noise depends to a large extent upon the operating threshold adjustment and the differential adjustment of the sensitive relays in the tone-receiver output circuits. There is sufficient gain to adjust the relays to an operating current threshold (2.6 ma) at least twice as great as the maximum noise current (1.3 ma) due to internal-system noise from all sources. Also there is sufficient gain to insure that the rectified tone signal applied to each relay is at least three times as great (7.8 ma) as the 2.6-ma threshold operating current, with nominal tone-receiver input voltage.

Average internal-system noise due to all causes is approximately 20 db below the operating threshold of the sensitive relays. The greatest amount of internal noise is con-

tributed by crosstalk, with noise due to intermodulation, oscillator harmonics, filter ringing and residual circuit noise contributing less in the order named.

Above the error threshold, amplitude variations as great as 30 db in the level of any tone or tone combination produce no change in output data. A signal-to-noise ratio of plus 1.5 db at the input to the tone receiver is adequate for error-free system operation.

Approximately 24 cps of the 60-cps bandwidth of each tone filter is reserved for cumulative frequency drift of the oscillator and filter. The remaining 36 cps is sufficient to accommodate transmission rates up to twelve binary numbers per second with no reduction in accuracy. This rate is equivalent to a shaft speed of three rpm in an eight-digit system, or six rpm in a seven-digit system. In operational use, transmission rates in excess of 20 binary numbers per second (10 rpm in a seven-digit system) have been attained with no discernible error or loss of data.

### Service Experience

Over a period of one year, using telephone lines and vhf radio channels, the frequency-code telemetering system has proved dependable and accurate, requiring no repairs or replacement of parts and only occasional minor adjustment.

The frequency-code telemetering system and data-handling components described in this paper were developed under contract with the U. S. Navy Bureau of Ships, Electronics Design and Development Division.

### BIBLIOGRAPHY

- Borden and Thynell: "Principles and Methods of Telemetering," p 56 and p 65, Reinhold Pub Corp.
- Moore, Jr., U. S. Patent 2,402,973, Jul. 2, 1946.
- Hayslett, U. S. Patent 2,502,786, Apr. 4, 1950.
- Schmitt et al, U. S. Patent 2,556,556, June 12, 1951.
- Landon, Theoretical Analysis of Various Systems of Multiplex Transmission, *RCA Review*, p 336, June 1948.
- Reeves, U. S. Patent 2,272,070, Feb. 3, 1942.
- Bayliss, A Ten-Channel Pulse-Code Telemetering System, *Electrical Engineering*, p 485, Nov. 1952.
- Follingstad, An Optical Position Encoder and Digit Register, *Proc IRE*, Nov. 1952.
- Goodall, Television by Pulse Code Modulation, *Bell System Tech Jour*, p 33, Jan. 1951.
- Keister et al, "The Design of Switching Circuits", p 50, Van Nostrand Co.
- Oliver et al, The Philosophy of PCM, *Proc IRE*, p 1,324, Nov. 1948.



# Gated Marker Generator

Marker train of 1-microsecond pips spaced 10 microseconds apart is initiated and stopped by negative-gate impulse. Spacing of continuous train of pulses is determined by two-way time of delay line connected across quaternary winding of blocking transformer

By G. D. JENSEN

*Electronics Engineer  
Navy Electronics Laboratory  
San Diego, Calif.*

**I**N RADAR and oscillography a need is frequently encountered for means of generating a train of evenly spaced electronic markers whose start and stop can be accurately controlled by an external signal, usually a range gate or a sweep gate. These marks can then be used to facilitate time or distance measurements, check sweep linearity or calibrate sweep speeds.

## Double Triode

In the circuit described this effect is accomplished in a simple dual-triode arrangement. Results are comparable in accuracy and quality to other methods using three dual triodes. The gating is effected using the principle of core saturation in the blocking-oscillator transformer. Interpulse spacing is determined by the two-way delay time of the lumped-constant delay line *D*.

The circuit operates as follows. In the absence of an initiating gate,  $V_1$  is at zero bias and the current flowing through the tube

passes also through  $L_2$ . This current establishes a saturation flux condition in the core of the blocking-oscillator transformer. The grid of the blocking oscillator tube  $V_2$  being returned to a negative bias insures that it is cut off.

When a negative gate is received at the grid of  $V_1$  current through it is rapidly cut off and collapse of the field in  $L_2$  induces a positive voltage at the grid of  $V_2$  by means of  $L_3$ . When current starts to flow in  $V_2$ , a regenerative process takes place that produces a sharp voltage pulse across  $R_K$  in the cathode of  $V_2$ . This is the output point of the circuit.

The pulse of current through  $V_2$  produces a similar pulse of voltage across the  $L_4$  winding of the blocking-oscillator transformer. The impedance of the  $L_4$  winding during the block is matched to the characteristic impedance of the delay line by resistor  $R_1$ . This positive pulse travels down the delay line and is reflected back in the same

polarity by the open-circuit termination of the delay line.

When the pulse arrives back at  $L_4$ , the grid of  $V_2$  has returned to a cutoff condition. Polarity of the windings is such that the positive pulse at  $L_4$  induces a positive pulse at the grid of  $V_2$  and the oscillator blocks again. Thus when  $V_1$  is cut off a continuous train of pulses is produced across  $R_K$  and their spacing is determined by the two-way delay time of the delay line.

## Saturated Core

When the negative gate ends and  $V_1$  conducts again, flux in the blocking-oscillator transformer core reaches a saturation condition. As the next reflected pulse arrives at  $L_4$  it can produce no further change in the flux in the transformer and hence does not trigger  $V_2$ . The circuit stays off until the next gate is received.

The delay line is built up of 14 sections with a delay of 0.358 microsecond per section. The pass band of 900 kc is just adequate for the application. Marker pulses appearing across  $R_K$  are spaced 10 microseconds apart. The marks are 30 volts in amplitude and one microsecond wide at the base. Delay between the leading edge of the initiating gate and the first mark is less than 0.5 microsecond. The damping resistor across  $L_2$  prevents ringing of the transformer-windings from interfering with operation of the circuit, which would otherwise occur.

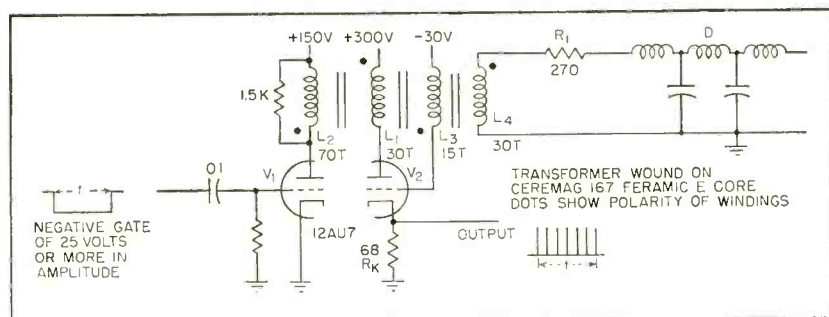

Circuit of the blocking-oscillator marker generator includes double triode, four-winding blocking transformer and open delay line

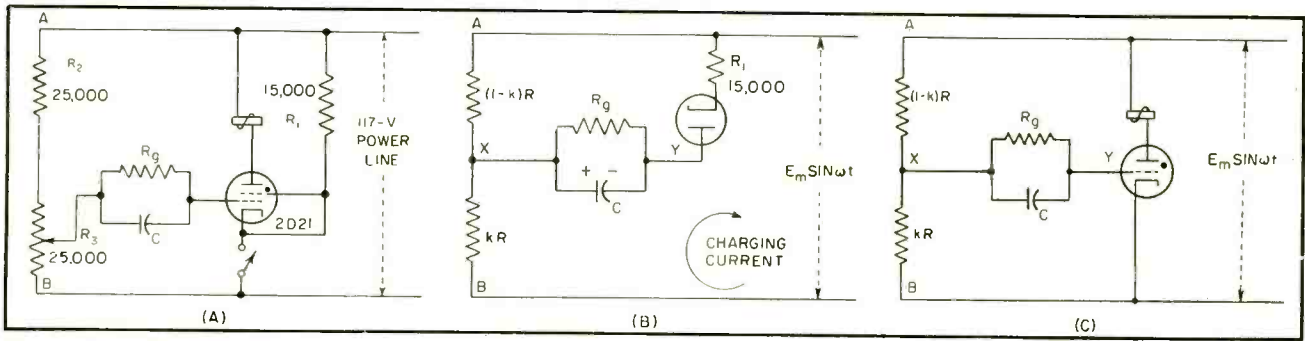

FIG. 1—Basic thyatron time-delay circuit (A), equivalent diode circuit when switch is open (B) and equivalent circuit when switch is closed (C). Timing interval is actuated by closing switch in thyatron cathode circuit.

# Simple Time-Delay Relay



Time-delay circuit was originally developed as part of firing circuits of the rocket launchers shown here firing a salvo from a naval vessel

By **EDGAR D. MORGAN**

*Electronics Engineer  
U. S. Naval Gun Factory  
Washington, D. C.*

**T**IMING circuits utilizing thyatrons are quite common and widely used. Many of them however, require elaborate circuitry and regulated d-c sources.

The circuit to be described operates from an a-c power line and requires no auxiliary d-c supply. Its accuracy compares favorably with more complicated types and it uses no precision components.

The circuit is designed to actuate a relay at a given time interval after the closing of a switch. The schematic is given in Fig. 1A.

While the switch is open, capaci-

tor  $C$  is charged by the grid current of the thyatron. Upon closing the switch, the capacitor discharges exponentially. Unlike more conventional applications, however, an a-c waveform is superimposed upon this decaying voltage. The combination of these two voltages determines the instant of firing of the thyatron, allowing more accurate selection of the time of firing as determined by the setting of potentiometer  $R_3$ .

## Grid Cycles

The switch position determines whether the grid circuit is being charged or discharged.

With the switch open, the cathode of the thyatron is connected

through  $R_1$  to one side of the a-c line. The plate of the tube is connected through the relay to the same side of the line. Consequently, there is no possibility of the tube firing.

The grid is connected through  $R_g$  and  $C$  to an alternating voltage somewhere between the potential difference between points A and B. When B is positive with respect to A, the grid is at some positive potential and the subsequent grid current charges capacitor  $C$ . This is analogous to diode action and the corresponding equivalent circuit is shown in Fig. 1B.

In this circuit, voltage divider  $R_2$ ,  $R_3$  of Fig. 1A has been drawn as two equivalent resistors. That portion between the center arm of  $R_3$  and point B has been indicated as  $kR$  and the total resistance between the center arm and point A as  $(1-k)R$ . As  $k$  varies between zero and one, every possible setting of  $R_3$  is covered.

Resistance  $R_1$  limits the peak charging current. If  $R_g$  is much larger than  $(1-k)R$ , the potential at point X with respect to point A is  $E_m(1-k)\sin\omega t$ . Neglecting the effect of  $R_1$ ,  $C$  will charge quickly to the peak value of this voltage on the positive half-cycles. If time constant  $R_g C$  is large compared with  $T$ , the period of the supply frequency,  $C$  will remain charged at a value of

$$E_{d-c} = (1-k)E_m \quad (1)$$



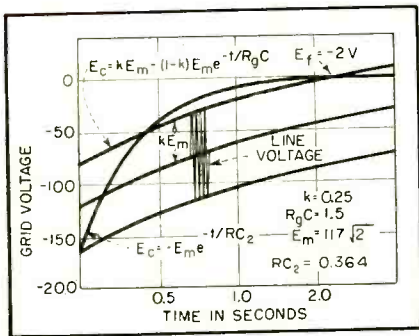

FIG. 2—Typical grid-discharge curve showing addition of waveforms

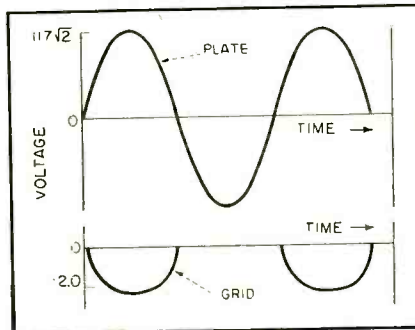

FIG. 3—Critical grid voltage curve for 2D21 with 117 volts rms applied

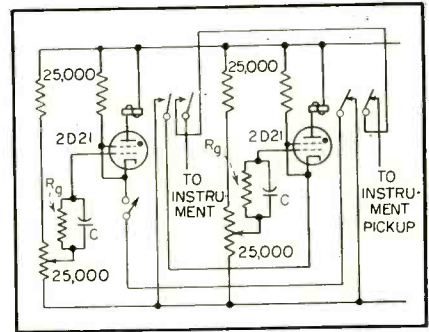

FIG. 4—Schematic diagram of sequence timer developed from basic circuit

Thyratron control circuit uses only a-c line power. Combination of grid waveforms permits more accurate time selection than can be obtained with conventional capacitor-discharge circuits. May be used for critical timing applications.

with polarity indicated in Fig. 1B.

When the switch in Fig. 1A is closed, the cathode of the thyratron is connected to point B and the plate and relay coil to point A. The circuit then assumes the form shown in Fig. 1C. The a-c potential at point X is now  $kE_m \sin \omega t$  with respect to point B. Capacitor C discharges exponentially through  $R_g$ . The sum of this exponentially decaying capacitor voltage and the a-c component forms the instantaneous grid voltage

$$E_e = kE_m \sin \omega t - (1 - k) E_m e^{-t/R_g C} \quad (2)$$

The thyratron fires when the positive peak value of this voltage reaches the critical firing potential,  $E_f$ , of the tube. Only the positive envelope of this voltage is of importance and

$$E_e = kE_m - (1 - k) E_m e^{-t/R_g C} \quad (3)$$

If  $E_e$  is set equal to  $E_f$ , the critical grid voltage, an expression indicating the time of firing after the closing of the switch is obtained. Thus

$$E_f = kE_m - (1 - k) E_m e^{-t/R_g C} \quad (4)$$

$$e^{-t/R_g C} = - \frac{E_f - kE_m}{(1 - k)E_m}$$

$$\text{or } t = R_g C \ln \frac{(1 - k) E_m}{kE_m - E_f} \quad (5)$$

The maximum value which  $k$  may assume is one making  $t = 0$ . Setting  $t = 0$  in Eq. 4 and solving for  $k$ , or  $k_{max}$ , as it may be called

$$E_f = k_{max} E_m - (1 - k_{max}) E_m$$

$$\text{or } k_{max} = \frac{E_f}{2E_m} + \frac{1}{2} \quad (6)$$

As  $E_f$  is normally close to zero, it may be assumed that  $E_f = 0$  and  $k_{max}$  may never exceed one-half. With  $k = \frac{1}{2}$ , the capacitor would charge initially to  $-E_m/2$  and the a-c component which is superimposed would have a peak value of  $E_m/2$ . The grid voltage would then equal zero upon closing the switch and the thyratron would fire on the first positive cycle of the applied voltage.

### General Considerations

A typical grid discharge curve is shown in Fig. 2. Values are given for 117 volts rms applied to a 2D21 thyratron connected as in Fig. 1A. Time constant  $R_g C$  has been chosen as 1.5 seconds and  $k$  as 0.25. A few cycles of line voltage are shown to indicate the envelope curves discussed previously. The critical grid voltage,  $E_f$ , is approximately -2 volts.

A simple d-c exponential curve has also been plotted on the same graph. This curve was chosen with an initial d-c charge equal to the peak applied a-c value, and with an R-C time constant adjusted to give the same time delay as the composite curve.

The accuracy of the timing interval is determined in part by the slope of the grid-discharge curve at the critical grid potential.

Figure 2 indicates that the en-

velope curve has a steeper slope at the time of firing than the simple d-c exponential curve. This insures more precise selection of the timing interval.

As  $k$  decreases, the d-c potential becomes greater and the a-c potential smaller. Thus, when  $k = 0$ , the circuit degenerates into a simple d-c grid control system.

In practice, the capacitor charges to somewhat less than the d-c voltage indicated making the actual time delay slightly less than that indicated by the equations.

Although the critical firing voltage,  $E_f$ , has been taken as a constant, it varies as the instantaneous plate potential varies. A graph of its value for a 2D21 is shown in Fig. 3. At the peak of the a-c cycle (when both grid and plate voltages are at their maximum positive values)  $E_f$  is constant at about -2.2 volts with 117 volts rms applied.

### Applications

Figure 4 is the schematic diagram of a sequence timer based on this circuit. It is designed to complete the input circuits of a group of instruments at a chosen time and to open these same inputs at a selected later time. The initiating switch is actuated automatically by associated devices.

The circuit described in this article was developed by Willard L. Hayes of the U. S. Naval Gun Factory.

# Designing Surface-Wave

Experimental data show optimum criteria for plastic-coated wire dimensions and launching horns. Surface-wave lines using polyethylene-coated wire have loss of 6 db per mile for a two-mile line at 250 mc. Recordings of propagation over 130-foot line at 2,000 mc indicate total loss of about 2 db

**T**HE SURFACE-WAVE transmission line (SWTL) is a relatively new type of transmission line that employs a single conductor as the wave-conducting means. Early theoretical investigations, originated by Sommerfeld in 1899, suggested the possibility of transmitting electromagnetic waves along a single conductor without radiation loss. However, the existence of such waves had not been verified experimentally.

On the contrary, experience showed that waves on a single conductor suffered large attenuation by radiation and this radiation from long-wire antennas has been extensively used. From that observation and also from later theoretical investigations it was generally concluded that nonradiating surface waves along a single conductor are nonexistent. The true situation, however, has been cleared up only in the past few years, as described below.

A nonradiating wave mode on a single conductor does exist but, under normal conditions, it is excited so weakly that it cannot be observed for it is overshadowed by the radiating or long-wire wave. The nonradiating wave mode is brought about by the resistivity of the wire. A plain, perfectly conducting wire would not guide a nonradiating wave at all. The finite conductivity causes a reduction in the phase velocity of field, compared to the free-space velocity and it is this reduction in phase velocity that establishes conditions rendering nonradiating wave propagation feasible.

An ordinary wire, however, is a poor guide for a nonradiating wave

By **GEORG GOUBAU**

*Coles Signal Laboratory  
Fort Monmouth, N. J.*

in that the wave is easily upset by small bends and even by the normal sag of the wire. If phase velocity is reduced more, for instance by covering the surface of the wire with a dielectric layer, the nonradiating wave becomes stable and can be excited more easily and with much higher efficiency. A wire covered with a dielectric layer of proper thickness is the wave conductor actually used in the swtl.

## Wave Development

The functioning of the swtl is best understood if it is compared with a coaxial line to which it is closely related.

Consider first a coaxial line filled with air as shown in Fig. 1A. Neglecting the effect of the finite conductivity, the guided wave is a transverse electric and magnetic wave that propagates with the velocity of light. If the space between inner and outer conductors is entirely filled with a dielectric material having a relative dielectric constant  $\epsilon_r/\epsilon_0$  (when  $\epsilon_0$  = dielectric constant of air) the character of the wave is unchanged, but the velocity is reduced by the factor  $\sqrt{\epsilon_r/\epsilon_0}$ .

Assume that only part of the space is filled with the dielectric, so that the conductor is covered with a dielectric sheath (Fig. 1B). The velocity then has a value between that in free space and that in completely filled line. The structure of the electric field is basically changed in that the elec-

tric field has a longitudinal component. Field lines are curved as shown in Fig. 1B and some of them no longer reach the outer conductor. The conduction current in the outer conductor that, for Fig. 1A, has the same magnitude as the current in the inner conductor, is now reduced by the displacement current, caused by the longitudinal component of the electric field.

If the radius of the outer conductor is increased while the inner conductor and the dielectric sheath are unchanged, more return current is formed by displacement current. If the outer conductor is large enough, conduction current is practically zero. Thus, the outer conductor becomes unnecessary. The inner conductor with the dielectric coat is adapted to transmit the wave alone and there is no radiation if the considered wave mode is excited.

The preceding explanation immediately suggests a method for exciting this wave mode. Starting from a coaxial-line section, the inner conductor of which has a dielectric coat, the diameter of the outer conductor is gradually increased until it is so large it has no considerable effect on the field and thus becomes superfluous. In this manner the coaxial wave is gradually transformed into the surface wave. The termination or launcher of the swtl comprises a coaxial-line section the inner conductor of which is connected to a dielectric-coated wire. The outer conductor of this cable is continued by a metal cone. A sketch of a complete swtl is shown in Fig. 2.

It is known that the attenuation of coaxial lines having the same



# Transmission Lines

inner conductor decreases with increasing diameter of the outer conductor because the transmitted power associated with a certain current increases with the cross-section of the field. Power dissipated in the inner conductor, being proportional to the square of the current, remains constant. Disregarding dissipation in the outer conductor and dielectric losses, the loss in coaxial lines having the same inner conductor decreases in inverse proportion to the impedance of the line. This results because impedance is the ratio between transmitted power and the square of the current.

Impedance of the swtl (if defined as power divided by current squared) usually lies between 200 and 400 ohms. Therefore, the loss in such a line is a fraction of that of an ordinary coaxial line having an inner conductor the size of the surface-wave conductor.

Compared with a two-wire line of the same impedance and the same size wires, the loss is about half, because dissipation occurs in only one wire rather than in two.

## Radiation Loss

Such comparison of the loss in the swtl to that of a coaxial or a two-wire line is not quite fair as there is radiation loss inherently connected with the formation of the surface wave. This loss, which is substantially independent of the length of the line, depends on the design of the launchers and their physical size. There is not yet a theory developed that will reveal their most favorable shape; it is a matter of experience to design them with high efficiency. An efficiency of 90 percent is easily obtained and requires no special precautions. If the taper of the cone were infinitely small the diameter of the opening alone would determine the efficiency.

Total loss of the swtl therefore consists of two parts, the termination or launching loss and the loss of the dielectric-coated wire. The latter is composed of the conduc-

tivity loss in the conductor and the dielectric loss in the dielectric layer. The dielectric loss is usually small compared to the conductivity loss.

Because of the launching loss, which is usually in the order of 1 db for both terminations together and substantially independent of the length of the line, the swtl cannot compete with ordinary transmission lines if they are so short that their loss is only 1 db or less. For longer lines the launching loss becomes of little importance and the superiority of the swtl becomes apparent.

Application of the swtl is also limited with regard to the frequency range. The practical lower-frequency limit, which appears to be around 50 mc, is determined by the extension of the field. The clearance around the conductor required for undisturbed transmission and

the size of the launchers both become inconveniently large. The practical upper-frequency limit has not yet been established.

## Climatic Effects

Being an open waveguide, the swtl is subjected to weather conditions, but to a much lesser degree than an open two-wire line. To study weather effects continuous recordings were made at two frequency ranges, one around 250 mc and the other around 2,000 mc. Measurements in the 250-mc range were made with a line two miles long, having a loss about 6 db per mile.

There was no noticeable increase during rain. Dry snow also seems to have little effect. Once, when the line was covered with a layer of about 1 inch of wet snow an increase of approximately 3 db per mile was measured. During the recording period of two years, little experience has been gained as to the effect of ice formation. Layers of ice formed were too thin to cause a detectable increase of loss. The recording equipment used was subjected to ambient temperature variations and not stable enough to detect with certainty signal variations of less than 1 db.

## Precipitation Effects

The recordings at 2,000 mc were made with an antenna feed line 130 feet long having a total loss of about 2 db. At this frequency the effect of rain was noticeable and occasionally an increase of the loss by one db was measured. Horizontally stretched lines are more affected because drops hanging on the line act at this frequency like little dipoles and cause radiation loss. The formation of ice is more serious; layers that had no influence on the two-mile line at 250 mc effected about 5-db increase in loss on the 130-foot line at 2 kmc.

The swtl, in contrast to twin-leads, is practically unaffected by formation of a film of water on a layer of soot because the electric

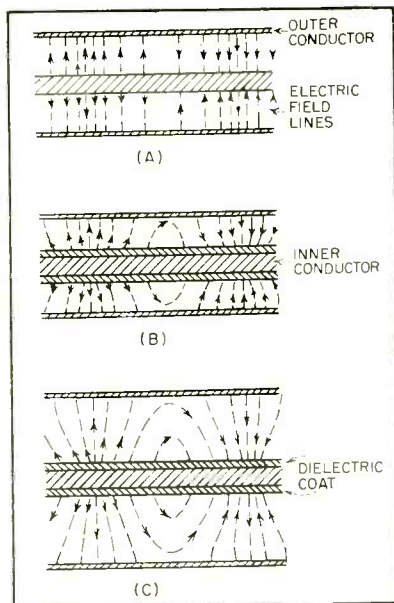

FIG. 1—Development of swtl from air coaxial (A), solid-dielectric and air (B) and increased outer sheath diameter (C)

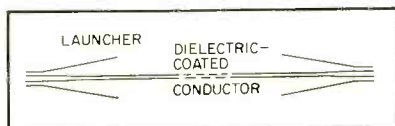

FIG. 2—Complete surface-wave transmission line

field is almost perpendicular to the surface. With twin lead such a layer forms a conductive bridge between the two conductors causing high attenuation.

A disadvantage of the swtl is its sensitivity to bends. If lines are properly designed, the loss caused by unavoidable bends at supporting points is negligibly small. Bends greater than 30 degrees should be avoided because they may cause a radiation loss of 0.5 db or more, depending on the reduction in phase velocity. Loss in a bend increases for small deflections approximately with the square of the deflection angle of the line. Conductors used for microwave lines should be prestressed to remove

kinks in the wire.

Supports of lines require as little material as possible. The experimental 2-mile line mentioned is suspended by nylon ropes fastened to telephone poles. Although this method of supporting the line is quite satisfactory and causes practically no distortion of the wave, more rigid methods are under study. If only a few supports are necessary, thin sticks of wood or other insulating materials may be used.

### Designing the Line

Graphs used for swtl design, given in Fig. 3, 4, 6 and 9, pertain to polyethylene-coated copper wires. They can also be used if the dielec-

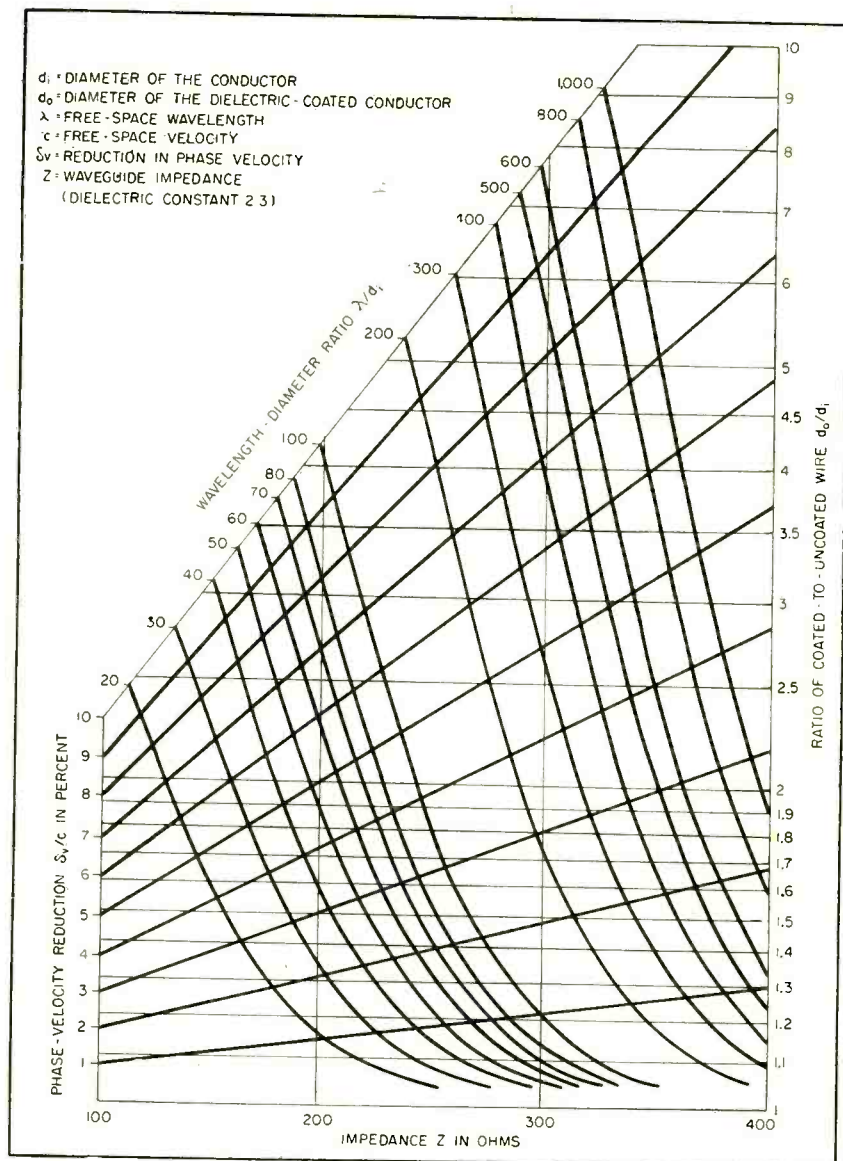

FIG. 3—Relationships among wire diameter, dielectric layer, phase-velocity reduction and impedance

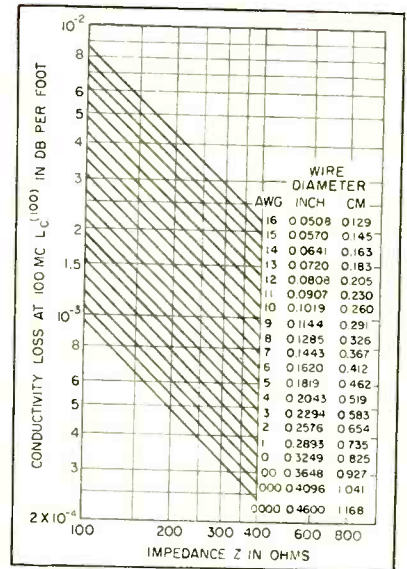

FIG. 4—Conductivity loss and impedance for various sizes of wire

tric coat consists of other materials. The corrections required in that case are indicated below.

Figure 3 shows the relation between the ratio  $d_0/d_1$  ( $d_0$  = diameter of the wire including the dielectric layer,  $d_1$  = diameter of the plain wire) and the impedance  $Z$  of the line, which is defined as the ratio between transmitted power and the current squared. One set of curves refers to various ratios  $\lambda/d_1$  ( $\lambda$  = free-space wavelength), the other set to various values of the reductions in phase velocity  $\delta_v$ , expressed in percentage of the velocity of light  $c$ .

### Desirable Characteristics

It is desirable to design the lines for high-impedance because loss decreases with increasing  $Z$  (see Fig. 4). On the other hand, the phase velocity should be reduced as much as is practical since the line is then less susceptible to bends. Furthermore, the extension of the field is smaller. Large  $Z$  and large  $\delta_v/c$  are contradicting conditions. A compromise is necessary to obtain optimum performance.

In the microwave range, where  $\lambda/d_1$  is small, a high impedance can be obtained only if the reduction in phase velocity is small. In this frequency range the line is used primarily for antenna feeds where it can be strung directly between the transmitter or receiver and the antenna. Bends are therefore



avoided and a small  $\delta_v/c$  is not objectionable.

It is still advisable to have a reduction in phase velocity of at least 1 percent otherwise layers of dust or water film would cause a large fractional increase of the effective thickness of the dielectric layer and have a considerable effect on line impedance and field extension.

In the uhf range, where  $\lambda/d_i$  is in the order of 100, the impedance can be made large even for a reduction in phase velocity of more than 5 percent; in that case the line is quite insensitive to bends and can be easily supported.

### Wire Size

Loss in the swtl is primarily determined by the size of the conductor. Therefore it is advisable to determine first the approximate wire diameter required for a specified loss of the line. This size is read off Fig. 4, which shows the conductivity loss per foot ( $L_c^{(100)}$ ) of various sizes of copper wire at the frequency  $f_o = 100$  mc, as a function of line impedance. The conductivity loss  $L_c$  per foot at any other frequency  $f$  is given by the expression  $L_c = L_c^{(100)}\sqrt{f/f_o}$ . (1)

An assumption must be made about the impedance of the line. Average value of  $Z$  is 250 ohms and this value may be used for a first approach. If the resulting reduction in phase velocity is too high or the extension of the field too great the assumed value can be modified.

An antenna feed line in the frequency range from 450 to 900 mc might have a maximum permissible loss of 0.01 db per foot. Allowing 20 percent for the dielectric loss, conductivity loss should not exceed 0.008 db per foot at the highest frequency of  $f = 900$  mc. From Eq. 1, the maximum value of  $L_c^{(100)}$  comes to  $2.7 \times 10^{-3}$  db per foot.

Assuming  $Z = 250$  ohms, the table on Fig. 4 shows that No. 14 AWG wire is adequate. According to the graph this wire has an  $L_c^{(100)}$  value of  $2.75 \times 10^{-3}$  db per foot for  $Z = 250$  ohms.

The ratio  $\lambda/d_i$  for the highest frequency ( $\lambda = 33.3$  cm,  $d_i = 0.16$  cm) is then 204. Using Fig. 3, for  $Z = 250$  ohms the ratio  $d_o/d_i = 4$  and the reduction in phase velocity

$\delta_v/c = 8.1$  percent. This reduction in phase velocity is high.

A ratio  $d_o/d_i$  of 3 and the same ratio  $\lambda/d_i$  would result in a  $\delta_v/c$  of about 6 percent, which is adequate if the line is essentially straight. Choosing for  $d_o/d_i$  the value of 3,  $Z$  and  $\delta_v/c$  for several frequencies within the considered band are determined. The result is plotted in Fig. 5.

The impedance varies between about 310 and 270 ohms and  $\delta_v/c$  from 5.2 to 6.1 percent. Conductivity loss  $L_c$  within the frequency range of the wire is now determined with Fig. 4 using several of the values of the  $Z$ -curve obtained before.

Loss  $L_c$  is plotted in Fig. 5. Dielectric loss in the insulating layer is obtained from the curves in Fig. 6 showing this loss as a function of the  $\delta_v/c$  for various values of  $Z$ .

It is interesting to note that the

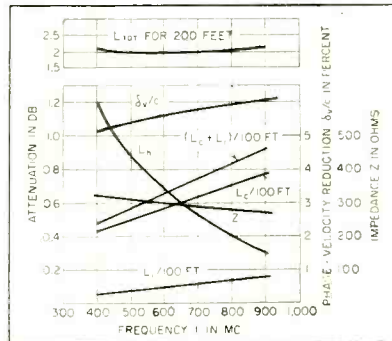

FIG. 5—Line characteristics for chosen parameters described in text

dielectric loss depends little on  $Z$  and almost entirely on the reduction in phase velocity. The curves in Fig. 6 pertain to a dielectric coat of brown polyethylene ( $\epsilon_i/\epsilon_o = 2.3$ , power factor  $5 \times 10^{-4}$ ) at a frequency of 100 mc. As indicated in the formula shown on the figure the loss  $L_d$  increases in proportion to the frequency. The dielectric loss of the line under consideration is plotted in Fig. 5 (curve  $L_d$ ).

Total theoretical loss of the dielectric-coated wire is  $L = L_c + L_d$ . At 900 mc this loss is about  $0.93 \times 10^{-3}$  db per foot. Experimental investigations have shown that the measured loss is usually several percent larger than the theoretical loss, probably owing to reduced surface conductivity of the copper. There-

fore wire size 14 will just meet the requirements in this example.

While loss in the wave conductor can be predetermined accurately, this is not so for loss in the launchers. Considering the receiving horn, presumably that part of the wave energy is lost for reception that propagates beyond the radius of the horn opening. The energy entering the mouth of the horn is not entirely converted into the coaxial-wave mode picked up at the end of the horn. Thus, loss consists of two parts; one part results from the limited size of the horn opening. The other part is a conversion loss that depends upon the shape of the horn. It is evident from the reciprocity theorem that the efficiency of a horn is the same for launching and receiving.

### Horn Loss

The loss of a horn can be expressed in terms of an impedance by dividing this loss by the square of the current of the surface wave. That part of the loss impedance due to the size of the horn opening ( $Z_\rho$ ) can be calculated. The graphs shown in Fig. 7 have been prepared for determining  $Z_\rho$  if the size of the horn and the reduction in phase velocity are given.

There is no theory as yet regarding conversion loss. However, if it is understood how this loss comes about, it can be kept small. To explain the causes of conversion loss, consider the launching process on a simple construction of a launcher shown in Fig. 8A. First, there is a discontinuity at  $X$  where the surface-wave conductor is attached to the center conductor of the coaxial-line section. If  $X$  is close to the mouth of the horn, the discontinuity causes a stronger excitation of the radiating or long-wire wave.

If  $X$  is close to  $Y$  where the horn

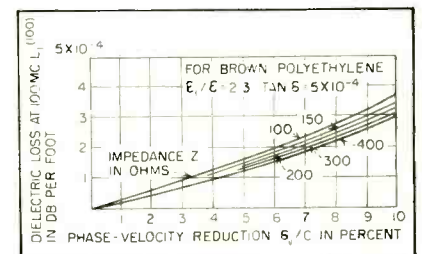

FIG. 6—Dielectric loss as a function of phase-velocity reduction

diameter is not much greater than the outer diameter of the coaxial section, the discontinuity may cause severe standing waves. Therefore, there is an optimum location for X, somewhere near the middle of the horn.

The coaxial wave, when expanded in the horn, tends to form spherical waves, as indicated in Fig. 8A, while the wave-front required at the mouth is plane, since the surface wave has plane phase surfaces. Also, the amplitude distribution of the expanded field at the mouth of the horn may not match that of the surface wave. This is particularly true if the horn diameter is too large and there is a possibility for the development of higher wave modes within the horn.

The best results were obtained with the launcher design shown in Fig. 8B. The coaxial section has large diameter and the inner conductor is tapered down until it approximately matches the diameter of the surface-wave conductor. The

horn consists of two sections with different tapers. The one that encloses the tapered inner conductor has a smaller taper than that enclosing the surface wave conductor. With such launchers a conversion loss of less than 0.1 db has been obtained.

The total launching loss of a surface-wave transmission line with properly designed launchers is not more than 1 db. Figure 5 contains a curve ( $L_h$ ) showing the launching loss of both terminations together, as it is determined with the graphs of Fig. 7. The curve is based on a horn diameter of 12 inches. The surface-wave conductor is that of the preceding example.

### Launching Loss

The conversion loss is not taken into account. Assuming a line length of 200 feet the total loss of the line over the frequency band from 450 to 900 mc is that shown in the upper curve of Fig. 5 ( $L_{TOT}$ ). Since the launching loss decreases

with increasing frequency while the conductor loss increases, the curve is almost flat over the entire frequency range.

Many different lines have been tested and their loss compared with the theoretically expected loss. It was found that the discrepancy was usually less than 20 percent, showing fairly good agreement.

If the dielectric coat on the wave conductor is not made of polyethylene but of another material, Fig. 9 may be used to determine the thickness of the coat that is equivalent to one of polyethylene. In this figure  $d_o/d_i$  is the ratio of the diameter of the polyethylene-coated wire and that of the bare wire,  $d_o'/d_i$  is the equivalent ratio in case of dielectric coat having a relative dielectric constant  $\epsilon_i'/\epsilon$  as indicated at the various curves. The dielectric loss obtained from Fig. 6 is changed by a factor  $2.6 \times 10^3 \tan \delta' / [(\epsilon_i'/\epsilon) - 1]$  where  $\tan \delta'$  is the power factor of the dielectric material used.

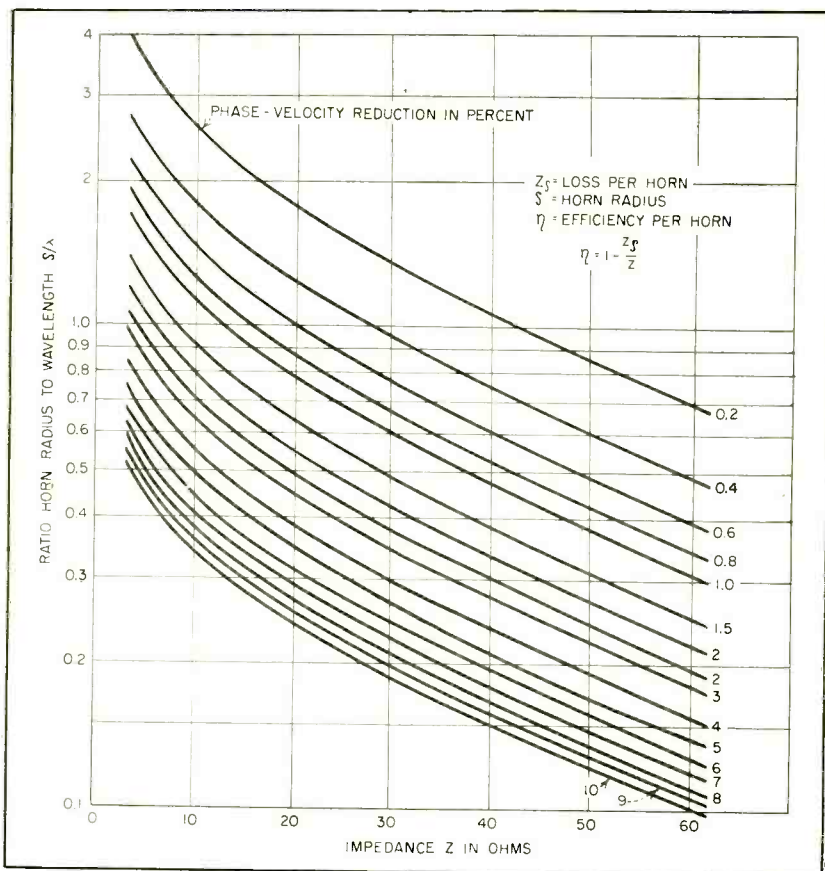

FIG. 7—Horn loss impedance related to dimensions. The curves show loss per horn when its size and reduction in phase velocity are known.

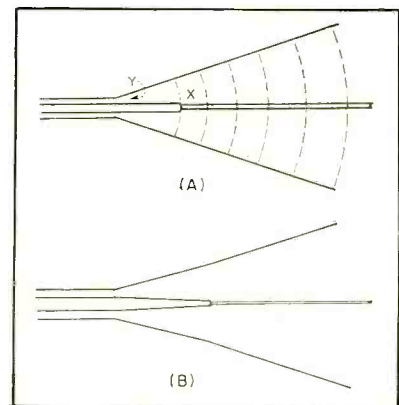

FIG. 8—Optimum launcher design employs tapered inner conductor

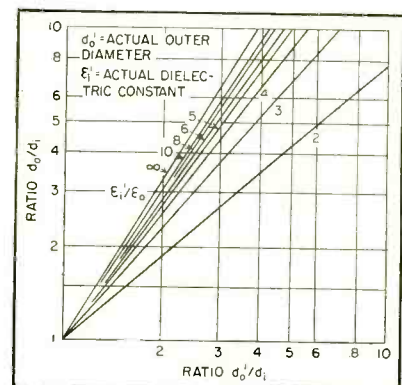

FIG. 9—Conversion loss for dielectric other than polyethylene



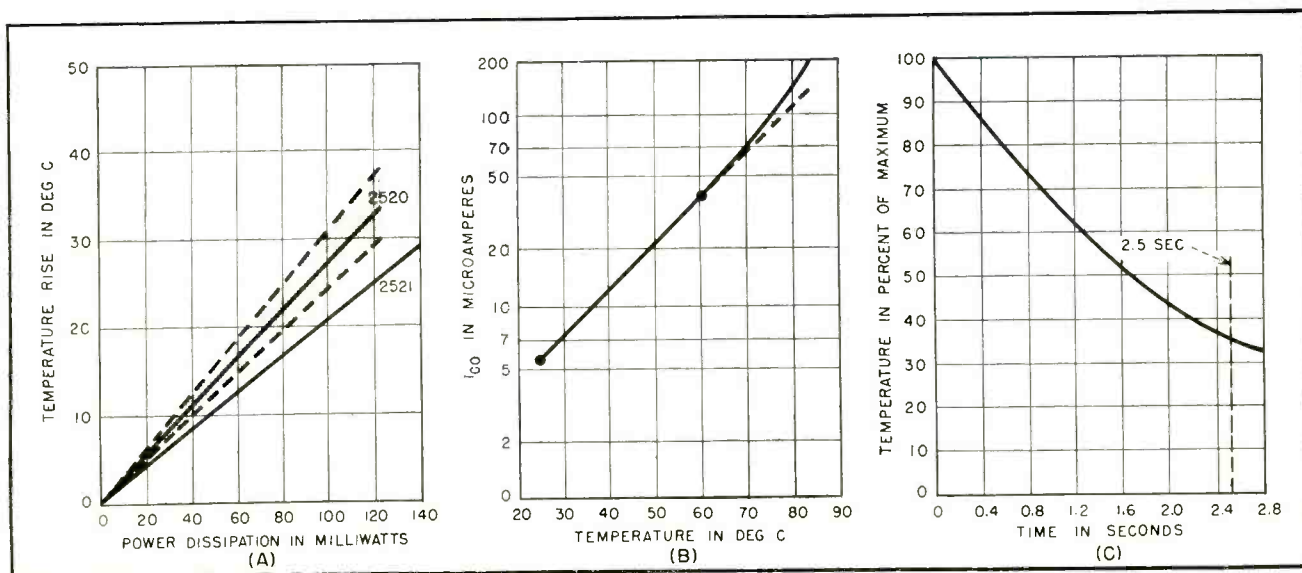

FIG. 1—Temperature rise with power dissipation (A) relates to corresponding change in reverse collector current (B). Thermal time constant (C) illustrates need for rapid measurement

# Measuring Transistor Temperature Rise

Rise in internal temperature at transistor junction may severely alter operating parameters. Test set described measures temperature rise with power dissipation indirectly by noting change in magnitude of reverse collector current with zero emitter current

**A**PLICATION of transistors is restricted by their maximum allowable internal temperature as is application of most electrical products. In the transistor, however, the immediate problem is excessive changes in operating parameters rather than destruction of insulation or permanent deterioration of performance characteristics. In fact, permanent deterioration due to temperature is not important below 110 C in diffused-junction transistors or 130 C in grown-junction types.

## Parameter Changes

Variation in transistor parameters due to temperature rise may

By **J. TELLERMAN**

*Arma Corporation  
Garden City, N. Y.*

either alter a-c performance or change the d-c bias so severely in some circuits that the transistor may run away and destroy itself. This article presents a simple method of determining the approximate temperature rise in a transistor and shows how such knowledge may lead to more complete circuit analysis and more efficient utilization of transistors.

Curves of transistor parameter variations as a function of temperature have been prepared<sup>1,2</sup> from which transistor circuit analyses at

different temperatures may be realized. These parameter versus temperature plots have been determined at the low dissipation of approximately 4.5 mw. To analyze transistor performance at higher dissipations, it is necessary to know the temperature rise at the junction, for it is the junction temperature that effects the magnitude of  $I_{co}$ , reverse collector current with zero emitter current;  $R_{co}$ , collector resistance; and  $A_1$  current gain.

Consider a case where the maximum ambient temperature is 40 C and optimum power output is required. It is known also that beyond 70 C the  $I_{co}$  becomes excessive. Therefore the maximum power that

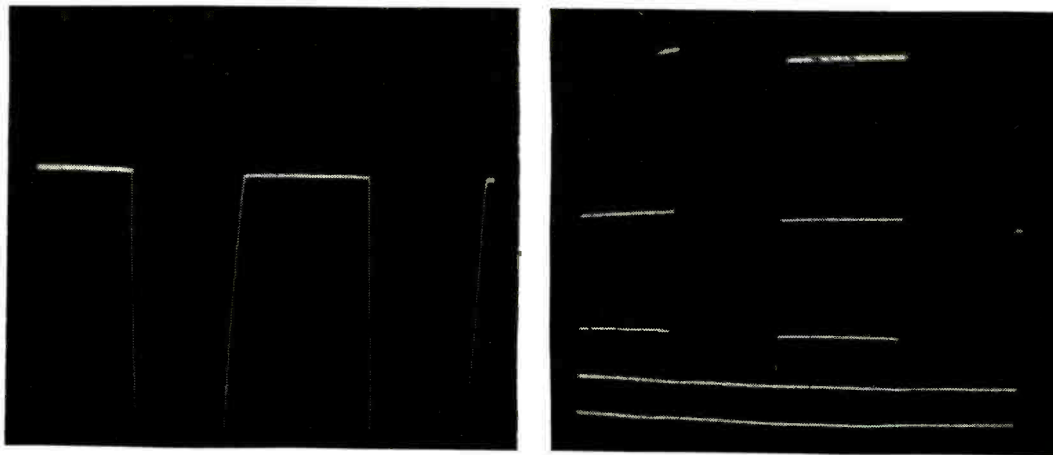

Base current waveform (left) describes half sine wave. Flat portion at top represents reverse collector current. Composite waveform (right) illustrates change of reverse collector current with power dissipation. From top to bottom the curves represent current at: 120 mw, 80 mw, 40 mw, 25 deg C level and zero level

can safely be dissipated will raise the transistor's internal temperature approximately 30 C. Figure 1A gives temperature rise as a function of dissipation for Germanium Products transistor samples in freely circulating air. This curve cannot be universally applied since different type transistors do not have the same thermal conductivities and different methods of mounting will provide variations in heat conduction. To utilize transistors efficiently a knowledge of the temperature rise per milliwatt dissipation for individual applications is desirable. This should be especially true in power transistor applications.

### Measuring Temperature

Inserting a thermocouple into a transistor junction and thereby opening the unit changes its thermal conductivity. Also the thermocouple itself acts as a conductor in removing the heat. Thus, an indirect method of finding the temperature rise is the more reasonable solution.

The transistor parameter most sensitive to temperature variation is  $I_{co}$ . This  $I_{co}$ , which is usually of the order of a few microamperes, contains a constant and an ohmic component. The constant term is due to thermally generated minority carriers that diffuse into the junction and is an exponential function of temperature. The

ohmic component may be the result of surface leakage across the space-charge region or possibly of local defects in the germanium.<sup>1</sup> Consequently  $I_{co}$  is directly affected by changes in the junction and in the immediate vicinity of the junction. By measuring  $I_{co}$  the magnitude of junction temperature is actually obtained.

### Measurement Technique

The experimental procedure of obtaining temperature rise versus dissipation requires measurements of  $I_{co}$  first as a function of known temperature, then as a function of dissipation and finally correlation of dissipation with temperature rise.

The first step simply means applying a voltage  $E$  between the collector and base with the emitter disconnected and measuring the collector current while the transistor is exposed to different temperatures in an oven. Up to about 60 C,  $I_{co}$  follows very closely an exponential function and two points on semilog paper, as shown in Fig. 1B, will approximately define the  $I_{co}$  versus temperature function. Above 60 C,  $I_{co}$  usually rises more sharply but it is commonly not necessary for  $I_{co}$  measurements to be taken above that temperature. The  $I_{co}$  slope on the semilog plot may not only differ for different make transistors but even for transistors of the same make. To avoid

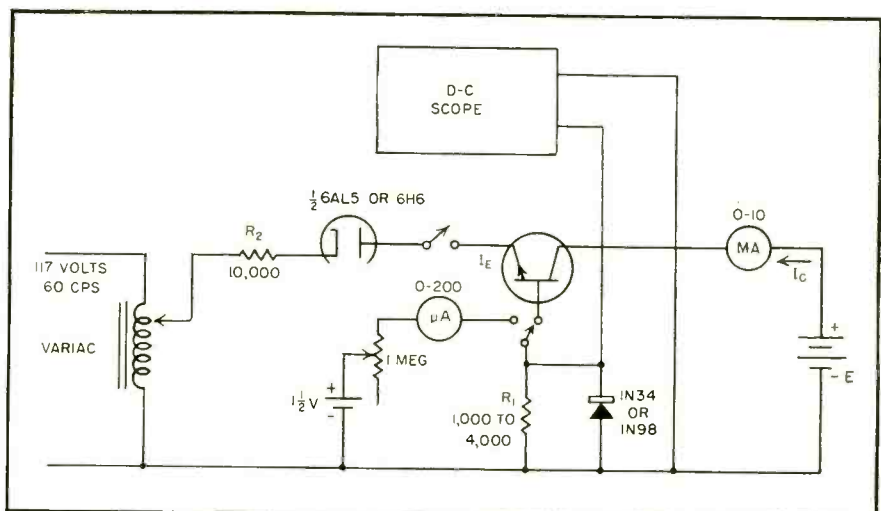

FIG. 2—Basic test set for measuring transistor temperature rise with power dissipation utilizes a d-c oscilloscope



excessive errors, it is advisable to obtain that slope for each transistor under measurement. Only those transistors should be selected to complete the temperature rise measurements for which  $I_{co}$  readings can be closely repeated at any one temperature. Aging or temperature cycling may sometimes be necessary to obtain stable  $I_{co}$  readings.

### Reverse Collector Current

The next step is to measure  $I_{co}$  as a function of power dissipated in the transistor. Since the thermal time constants of most commercial transistors are of the order of only two to three seconds and internal temperature drops off exponentially as shown in Fig. 1C, to avoid excessive errors  $I_{co}$  must be measured within roughly  $\frac{1}{3}$  second after switching off the power source. Since opening the emitter circuit and then measuring  $I_{co}$  on a microammeter results in excessive time lag and requires special transient-recording equipment, the circuit of Fig. 2 is shown as an example of a simple experimental technique having negligible time-lag errors.

A half-wave rectified current  $I_e$  flows in the emitter of the transistor. The magnitude of the current can be controlled with the continuously variable input transformer. This causes a rectified current of roughly  $AI_e$  to flow in the collector circuit. The power dissipated in

the collector junction is essentially  $E I_c$  where  $E$  is the voltage source, which must be of the same magnitude used to obtain the  $I_{co}$  versus temperature plot, and  $I_c$  is the d-c collector current read on the milliammeter. The diode in the base circuit minimizes the voltage drop across the base resistor insuring that the expression  $E I_c$  for power dissipated will be correct. Part of  $E I_c$  is dissipated in the base of the transistor but that portion is usually negligible.

During one half the time interval of the cycle the diode in the emitter circuit opens the emitter circuit so that  $I_{co}$  flows through the collector and the base. Consequently the base current ( $I_e - I_c$ ) is a half-wave rectified current and on the d-c scope the flat portions of the cycle represent a voltage  $I_{co} R_1$ . The rise of level of the flat portions give the increase of  $I_{co}$  due to heating of the junction. The rise of  $I_{co}$  can be converted into temperature readings from the curve of Fig. 1B and a plot of power dissipation versus temperature change made.

### VTVM-Chopper Circuit

An alternative method of obtaining  $I_{co}$  as a function of power dissipation is shown in Fig. 3. Here a chopper and either a d-c or a-c vacuum-tube voltmeter substitutes for the scope. This circuit measures  $I_{co}$  somewhat more indirectly. The voltage across  $R_1$  is a half-wave

rectified voltage and it is desired to obtain the rise of the flat portion of the wave which changes as a function of  $I_{co}$ . The chopping circuit excited by the same source as the emitter circuit has polarities as indicated and transfers about 85 percent of the flat part of the voltage, greatly attenuating the curved portion. Thus the chopping-circuit output should ideally be a square wave linearly changing with  $I_{co}$ .

This method is a little less accurate in its performance than the scope method because of the bridge drift in null voltage and the bridge's imperfect shorting action when clipping. A d-c vtvm that can read millivolt levels would be more desirable than an a-c vtvm in that the clipping bridge a-c null voltage, which is of the order of 10 to 15 millivolts, would not enter into any readings. The dissipation is essentially  $E I_c$ .

Experimental data compiled by the first method described with 10 Germanium Products type 2520's and 2521's is shown in Fig. 1A. The ends of the transistor leads were attached to a heavy terminal block and the units exposed to freely circulating air.

Various methods have been explored for reducing the temperature rise. A type 2520 with  $1\frac{1}{2}$  in. lead length was connected to a heavy terminal block. At 92 milliwatts dissipation in freely circulating air, a 26 C temperature rise above a 27 C ambient was observed. Upon applying a blower for several minutes the temperature rise reduced to 20 C.

Taping the transistor to a heavy piece of steel reduced the rise to 21 C. When the blower was in addition applied to the metal heat sink, the total temperature rise was only 19 C. Thus heat sinks or blowers permit an additional 25 to 30-percent power dissipation in the transistor with the same temperature rise as is shown when the transistor is just exposed to freely circulating air.

### REFERENCES

- (1) K. D. Smith, Properties of Junction Transistors, *Proc NEC*, 8, p 330, Oct. 1952.
- (2) John S. Saby, Fused Impurity PNP Junction Transistors, *Proc IRE*, 40, No. 11, p 1,359, Nov. 1952.

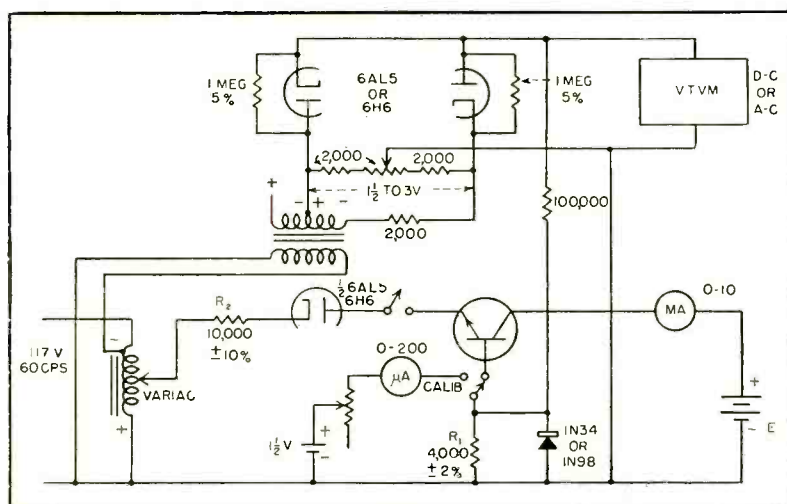
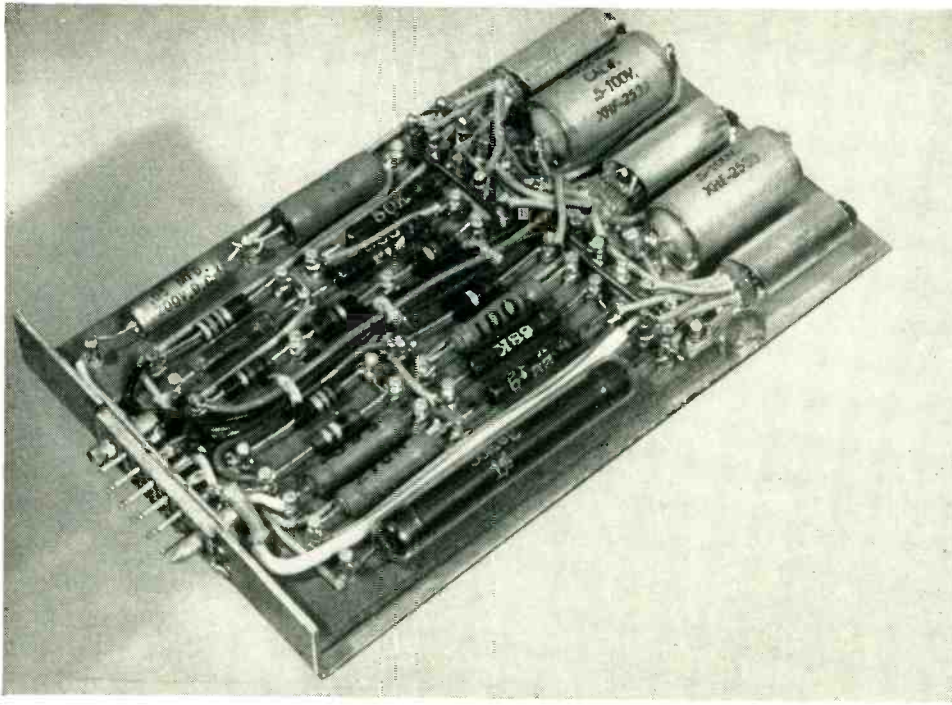

FIG. 3—Variation of test set has chopper and vacuum-tube voltmeter for direct-reading. Either an a-c or d-c vacuum-tube voltmeter may be used



Pulse amplifier uses three subminiature tubes. Shielded input lead and input grid lead are joined on insulated stand-off terminal at lower right of board to eliminate terminal board leakage

# Time-Shared Amplifier

To maintain zero output for zero input in d-c amplifiers used in analog computers special techniques or auxiliary devices are usually employed to reduce drift.

The operational amplifier<sup>1</sup>, circuit shown in Fig. 1, is a high-gain wide-band d-c amplifier having a zero d-c output level for zero input. The short-circuit transfer impedances  $z_i$  and  $z_f$  of the input and feedback networks are frequently complex in nature.

Impedances are selected to give a desired transfer function according to the equation

$$\frac{E_{\text{output}}}{E_{\text{input}}} \cong \frac{Z_f}{Z} \quad (1)$$

One of the most common methods of zero stabilization connects an inherently drift-free chopper-amplifier to the d-c amplifier input<sup>2</sup>. The rectified and filtered chopper-amplifier output zeros the amplifier. Zero offset or drift is reduced by a factor approximately equal to the d-c to d-c gain of the stabilizing amplifier.

Motor-driven rotary sampling switches have been developed for

commutating a single stabilizing amplifier among several operational amplifiers.<sup>3</sup> The input section of the switch samples each summing junction in sequence. The output section of the switch is synchronized with the input, connecting the output of the stabilizing pulse amplifier to the individual amplifiers through low-pass filters.

## R-C Amplifiers

If a simple resistance-coupled amplifier is employed as a pulse amplifier, interaction between the operational amplifiers may be caused by the time constants of the coupling capacitors in the pulse amplifier.

If one of the computer operational amplifiers is overloaded its summing junction frequently assumes a relatively large voltage. When the sampling switch contacts this junction, the pulse amplifier is overloaded and may be unable to recover in time to handle succeeding pulse samples from other summing junctions. A cumulative process results

in which all the operational amplifiers lose stabilization and saturate. It is then difficult to locate the amplifier at fault.

## D-C Pulse Amplifier

A direct-coupled pulse amplifier suitable for application as a non-overloading stabilization amplifier is shown in Fig. 2 and in the photograph. It employs three subminiature tubes.

Since there is no blocking capacitor at the amplifier input, grid cur-

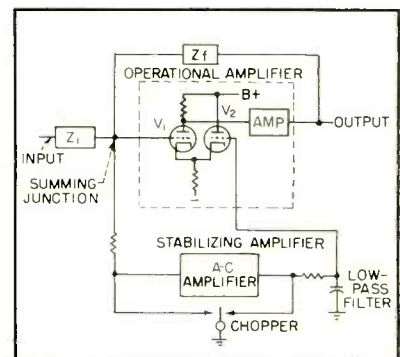

FIG. 1—Operational amplifier using chopper-driven a-c amplifier to provide stabilizing signal



By DEAN W. SLAUGHTER

Research Engineer  
Jet Propulsion Laboratory  
California Institute of Technology  
Pasadena, California

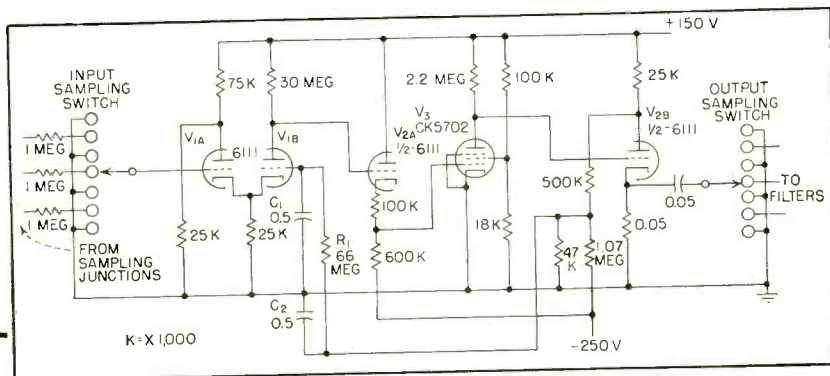

FIG. 2—Direct-coupled amplifier circuit has starved input stage to limit grid-current draw on operational amplifier summing junctions. Resistors are 1-percent deposited-carbon type. A 5-rpm, 60-contact Applied Science Corp. switch is used for input-output sampling

Quick recovery d-c amplifier furnishes zero-point stabilization to 30 operational amplifiers used in analog computer. Interaction between amplifiers can be held to less than 2 millivolts by circuit and filter design techniques

## Stabilizes Computers

rent is drawn by the input tube  $V_{1A}$ . This current flows through the resistor used to isolate the summing junctions from the switch contacts. The resulting voltage drop is equivalent to an error input signal of that amount. To reduce grid current to a negligible value, a starved input stage is employed.

### Starved Input

The input stage has a heater voltage of 5 volts instead of the usual 6 volts, a plate voltage of 35 volts and a plate current of 5 microamperes per section. The input stage employs a cathode-coupled circuit so that net phase reversal through the pulse amplifier is 180 deg, as required. The gain of this stage is 8 or 9.

A cathode follower  $V_{2A}$  couples the starved amplifier into the pentode amplifier stage  $V_3$  to avoid loading effects. The output stage  $V_{2B}$  is also a cathode follower.

The overall gain of the pulse amplifier is about 1,500. With this much gain in a direct-coupled am-

plifier, some way must be provided to prevent the last stage from being driven to cutoff by drift in the operating point of the first stage. Amplifier d-c gain is reduced to about 20 by d-c negative feedback to the grid of  $V_{1B}$ . Pulses that the amplifier is designed for are amplified at full gain because they are eliminated from the feedback path by the filter  $C_1, R_1, C_2$ .

The filter causes a small amount of pulse overshoot. Since the overshoot generated by a given pulse sample is still decaying when the next channel is sampled, overshoot can cause interaction between operational amplifiers unless it is held to a negligible value.

The amount of overshoot is directly proportional to d-c feedback through the filter and inversely proportional to the filter time-constant. If d-c gain is made less than 20 by feedback, overshoot will be excessive. If the filter is too large, the amplifier will be slow to recover from a temporary loss of supply voltages.

To assure adequate pulse rise-and-fall times, the amplifier should be laid out and wired to avoid excessive wiring capacitance. A d-c filament supply is essential for  $V_1$ . The supply voltages must be regulated to maintain about 45 volts at the output cathode. If different supply voltages are used, the d-c feedback circuit components must be altered.

### Output Low-Pass Filters

A 5-rpm switch is used for sampling. Each of the two poles of this switch has 60 shorting-type contacts. Every other contact is intended to be grounded, providing 30 amplifier channels.

A filter suitable for shorting-type operation is shown in Fig. 3. The following design considerations exist: At the beginning and end of each sample, the filter input is shorted to ground momentarily. It is essential that signal pulses appear at the amplifier output only when the output coupling capacitor  $C_1$  is connected to a filter, never

when  $C_1$  is grounded. For reliability, there should be a short period of time at the beginning and end of each pulse before  $C_1$  is ungrounded or grounded. However, during these times, filter capacitor  $C_2$  discharges back through the near-zero output impedance of the pulse amplifier. The effect is the same as that obtained by shorting the filter input to ground. In fact, the two phenomena may be lumped together so far as their effect upon the rectification efficiency is concerned.

A further design consideration involves internal leakage resistance between switch contacts. By the time the switch is ready for cleaning, resistance to ground at the filter input may be as low as 20 megohms. This resistance is denoted by  $R_1$  in Fig. 3.

### Values for Timing

As shown in the switch-contact timing diagram, Fig. 4, the timing parameters are:

$t_1$  = time for one switch revolution or cycle

$t_2$  = single pulse length

$t_3$  = total filter discharge time =  $(t_6 + t_7 + 2t_8)$ , in general less than  $t_2$

$E$  = rectification efficiency =  $\frac{\text{d-c voltage recovered}}{\text{pulse amplitude}}$

Rectification efficiency, considering the effect of the discharge time  $t_3$  is

$$E_1 \cong \frac{t_2}{t_2 + t_3} \quad (3)$$

Regarding the effect of leakage resistance  $R_1$ , capacitor  $C_2$  of Fig. 3 discharges through  $R_2$  and  $R_1$  for a very long time  $t_1$  and charges through  $R_2$  for a relatively short time  $t_2$ . Rectification efficiency, considering this parameter alone, is

$$E_2 \cong \frac{1}{\frac{R_2}{R_1} \frac{t_1}{t_2} + 1} \quad (4)$$

Net rectification efficiency is somewhat better than the product of  $E_1$  and  $E_2$ . Efficiencies on the order of 50 percent are usual. Since the pulse-amplifier gain is 1,500, a d-c to d-c gain of 750 is obtained from the stabilizing circuit.

To obtain sufficient filtering, a second low-pass filter section  $R_3C_3$  (Fig. 3) has been added. When a double-section filter is used  $R_2C_2$  must be much smaller than  $R_3C_3$  to

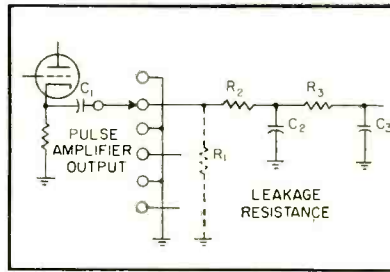

FIG. 3—Filter circuit used in output of stabilizing amplifier. Leakage resistance  $R_1$  across contacts can be as low as 20 megohms when switch is in need of cleaning

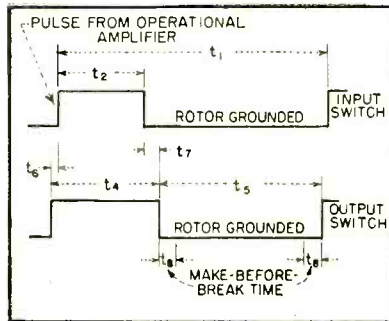

FIG. 4—Time relationships for stabilizing-amplifier input and output switch

prevent damped oscillations when subjected to transients. Time constants of 6 milliseconds and 30 seconds for  $R_2C_2$  and  $R_3C_3$ , respectively, have been found satisfactory.

When an operational amplifier is overloaded, the low-pass filter charges to some large voltage. When the overload is removed, several seconds are required for this filter to discharge and for the amplifier to regain its stabilized zero. This phenomena is typical of any type of stabilizing circuit using continuous balancing.

A recovery time of 20 to 30 seconds is typical.

Recovery time can be improved if clamping diodes are added at the individual filters to prevent the filter from charging under overload conditions.

An improvement factor of 5 is easily realizable.

### System Performance

With any of the stabilizing-amplifier inputs grounded through a 1-megohm resistor, the d-c voltage at the corresponding output filter due to rectified noise is less than 100 millivolts. This value is equivalent to about 100 to 200

microvolts of noise at the stabilizing-amplifier input.

The following data are given for a unity-gain inverting amplifier, that is, one having equal pure resistances for  $Z_i$  and  $Z_f$  of Fig. 1. A high-quality d-c operational amplifier with regulated power supplies was employed for the tests. With no signal input, noise output is about 1 millivolt peak-to-peak. The d-c drift is not more than a few tenths of a millivolt over periods of several days. Time required for the amplifier to regain a stabilized zero after a severe and prolonged overload is 20 to 30 seconds. A recovery time of 4 or 5 seconds can be obtained if filter clamping is used.

### Channel Interaction

To measure freedom from interaction under normal conditions, signals of a varying character were fed into a gain-of-ten summing amplifier ( $Z_i = 100,000$  ohms;  $Z_f = 1$  megohm) with amplitudes equal at least to its maximum signal-handling capability. Another gain-of-ten summing amplifier was stabilized on an adjacent channel. Signal voltage at the output of this amplifier due to interaction did not exceed 2 millivolts. When amplifier gain was reduced to unity, interaction was negligible.

Some interaction does exist under overload conditions. When the summing junction of the first amplifier reaches 30 volts, the output of the adjacent amplifier may become offset as much as 30 millivolts. This is due to an energy transfer at the input sampling switch. It is apparently a result of dielectric absorption, not resistive leakage. This phenomenon occurs even with high-quality insulating materials because of the enormous difference between signal levels at the adjacent contacts. Some improvement could perhaps be obtained by locating a grounded guard ring around each contact.

### REFERENCES

- (1) J. R. Ragazzini, R. H. Randall and F. A. Russell, Analysis of Problems in Dynamics by Electronic Circuits, *Proc IRE*, 35, p 444, May 1947.
- (2) E. A. Goldberg, Stabilization of Wide-Band Direct Current Amplifiers for Zero and Gain, *RCA Rev*, 11, p 296, June 1950.
- (3) W. E. Ingerson, Drift Compensation in D-C Amplifiers for Analog Computers, paper presented at IRE National Convention, New York, 1951.



# Transistor Equations Using h-Parameters

Equations based on four *h*-parameters of base-input common-emitter circuit permit rapid calculation of operating characteristics for other circuit configurations, using easily obtained measurements

**S**IMPLIFICATION of transistor circuit calculations and measurements result from specifying the four-terminal network with input current  $i_1$  and output voltage  $v_2$  as independent variables and output current  $i_2$  and input voltage  $v_1$  as dependent variables. The *h*-parameters are thus introduced, and circuit equations become

$$v_1 = h_{11}i_1 + h_{12}v_2 = \frac{1}{y_{11}}i_1 + \mu_{12}v_2$$

$$i_2 = h_{21}i_1 + h_{22}v_2 = \alpha_{21}i_1 + \frac{1}{Z_{22}}v_2$$

where  $h_{11}$ ,  $h_{12}$ ,  $h_{21}$  and  $h_{22}$  are the

By **C. C. CHENG**

RCA Victor Division  
Radio Corporation of America  
Camden, New Jersey

four *h*-parameters and  $y_{11} = 1/h_{11}$  is defined as the short-circuit input admittance,  $\mu_{12} = h_{12}$  the reverse open-circuit voltage gain,  $\alpha_{21} = h_{21}$  the forward short-circuit current gain, and  $Z_{22} = 1/h_{22}$  the open-circuit output impedance. These parameters are comparatively easy to measure and show directly the funda-

mental properties of the transistor, such as current gain. The fundamental parameters selected in this paper are the four *h*-parameters of the base-input common-emitter circuit. They are  $y_{11e} = 1/h_{11e}$ ,  $\mu_{bc} = h_{12e}$ ,  $\alpha_{cb} = h_{21e}$ , and  $Z_{22e} = 1/h_{22e}$ . All the circuit equations summarized in the following table for three basic circuit configurations are in terms of these four *h*-parameters so that application engineers can use them directly whenever the transistor *h*-parameters are specified.

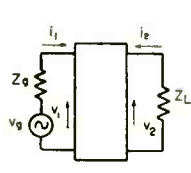
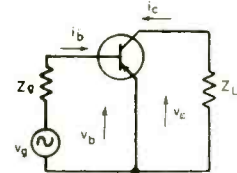
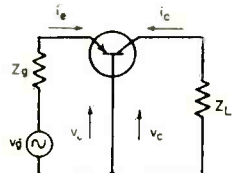
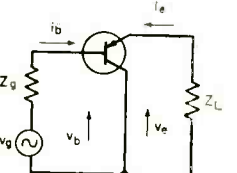
CIRCUIT CONFIGURATION	COMMON EMITTER	COMMON BASE	COMMON COLLECTOR
			
<p><i>h</i>-Parameter</p> $y_{11} = \frac{1}{h_{11}}$ $\mu_{12} = h_{12}$ $\alpha_{21} = h_{21}$ $Z_{22} = \frac{1}{h_{22}}$ $S = 1 - \mu_{12}\alpha_{21}y_{11}Z_{22}$	$y_{11e}$ $\mu_{bc}$ $\alpha_{cb}$ $Z_{22e}$ $S_e = 1 - \mu_{bc}\alpha_{cb}y_{11e}Z_{22e}$	$(1 + \alpha_{cb})y_{11e}$ $\mu_{ec} = \mu_{bc} \frac{S_e}{1 - S_e}, \text{ if }  \alpha_{cb}  > 1$ $\alpha_{ce} = \frac{-\alpha_{cb}}{1 + \alpha_{cb}} = -\alpha_i$ $\alpha \equiv -\alpha_{ce}$ $(1 + \alpha_{cb})Z_{22e}$ $S_b = 1 + (1 + \alpha_{cb})S_e$	$y_{11e}$ $\mu_{bc} = 1 - \mu_{bc} \approx 1 \quad  \mu_{bc}  < 1$ $\alpha_{cb} = -(1 + \alpha_{cb})$ $Z_{22e}$ $S_e = 1 + (1 - \mu_{bc})(1 + \alpha_{cb})y_{11e}Z_{22e}$ $\approx 1 + \alpha_{cb}y_{11e}Z_{22e} \quad \left  \frac{\alpha_{cb}}{\mu_{bc}} \right  > 1$

(continued on p 192)

# Transistor Equations Using *h*-Parameters

(Continued from p 191)

CIRCUIT CONFIGURATION	COMMON EMITTER	COMMON BASE	COMMON COLLECTOR
<b>Z-Parameters</b> $z_{11} = \frac{S}{y_{11}}$ $z_{12} = \frac{\mu_{12} z_{22}}{\alpha_{21} z_{22}}$ $z_{21} = -\alpha_{21} z_{22}$	$\frac{S_e}{y_{11e}}$ $\frac{\mu_{bc} z_{22e}}{-\alpha_{cb} z_{22e}}$	$\frac{S_b}{(1 + \alpha_{cb}) y_{11e}} = \frac{S_e}{y_{11e}}$ $\frac{S_e}{y_{11e}} - \mu_{bc} z_{22e}$ $\alpha_{cb} z_{22e}$	$\frac{S_c}{y_{11c}} = \frac{1}{y_{11e}} + \alpha_{cb} z_{22e}$ $\frac{(1 - \mu_{bc}) z_{22e}}{(1 + \alpha_{cb}) z_{22e}} = z_{22e}$ $\frac{1}{(1 + \alpha_{cb}) z_{22e}} = \alpha_{cb} z_{22e}$
<b>Y-Parameters</b> $y_{12} = -\mu_{12} y_{11}$ $y_{21} = \alpha_{21} y_{11}$ $y_{22} = \frac{S}{z_{22}}$	$-\mu_{bc} y_{11e}$ $\alpha_{cb} y_{11e}$ $\frac{S_e}{z_{22e}}$	$\frac{S_e}{z_{22e}}$ $-\alpha_{cb} y_{11e}$ $= \frac{1 + (1 + \alpha_{cb}) S_e}{(1 + \alpha_{cb}) z_{22e}} = \frac{S_e}{z_{22e}}$	$-(1 - \mu_{bc}) y_{11e} = -y_{11e}$ $-(1 + \alpha_{cb}) y_{11e}$ $\frac{S_e}{z_{22e}} = \frac{1}{z_{22e}} + \alpha_{cb} y_{11e}$

	COMMON EMITTER	COMMON BASE	COMMON COLLECTOR
<b>Other Parameters</b> $\alpha_{12} = \frac{1}{\alpha_{21}} \left(1 - \frac{1}{S}\right)$ $\mu_{21} = \frac{1}{\mu_{12}} \left(1 - \frac{1}{S}\right)$	$\frac{1}{\alpha_{cb}} \left(1 - \frac{1}{S_e}\right)$ $\frac{1}{\mu_{bc}} \left(1 - \frac{1}{S_e}\right)$	$\alpha_{ec} = \frac{-\alpha_{cb} S_e}{1 + (1 + \alpha_{cb}) S_e}$ $\mu_{cc} = -\frac{1}{\mu_{bc}} \left(1 - \frac{1}{S_e}\right)$	$\alpha_{be} = \frac{-1}{1 + \alpha + \frac{1}{y_{11e} z_{22e}}}$ $\mu_{eb} = \frac{1}{1 - \mu_{bc} + \frac{1}{(1 + \alpha_{cb}) y_{11e} z_{22e}}}$
<b>Input Impedance = <math>Z_{in}</math></b> $= \frac{1}{y_{11}} - \frac{\mu_{12} \alpha_{21}}{1 + \frac{Z_L}{z_{22}}} Z_L$	$Z_{in} = \frac{1}{y_{11e}} - \frac{\mu_{bc} \alpha_{cb}}{1 + \frac{Z_L}{z_{22e}}} Z_L$ $= \frac{1}{y_{11e}} - \mu_{bc} \alpha_{cb} Z_L; Z_L \ll z_{22e}$	$Z_{in} = \frac{1}{(1 + \alpha_{cb}) y_{11e}}; Z_L \ll z_{22e}$	$Z_{in} = \frac{1}{y_{11e}} + (1 + \alpha_{cb}) Z_L; Z_L \ll z_{22e}$
<b>Output Impedance = <math>Z_o</math></b> $= \frac{1}{z_{22} - \frac{\mu_{12} \alpha_{21}}{Z_o + \frac{1}{y_{11}}}}$ $= \frac{z_{22}}{S} \quad Z_o < \frac{1}{y_{11}}$	$Z_o = \frac{1}{z_{22e} - \frac{\mu_{bc} \alpha_{cb}}{Z_o - \frac{1}{y_{11e}}}}$ $= \frac{z_{22e}}{S_e} \quad Z_o < \frac{1}{y_{11e}}$	$Z_o = \frac{z_{22e}}{1 + \alpha_{cb} + S_e}$ $Z_o < \frac{1}{y_{11e}(1 + \alpha_{cb})}$	$Z_o = \frac{z_{22e}}{1 + \alpha_{cb} y_{11e} z_{22e}}$ $ \mu_{bc}  < 1,  \alpha_{cb}  > 1$
<b>Voltage Gain = <math>K_V</math></b> $= \frac{-y_{11} Z_L}{S - \frac{Z_L}{z_{22}}}$ $= -\frac{y_{11} Z_L}{S}, \text{ if } Z_L \ll z_{22}$	$K_V = \frac{-y_{11e} Z_L}{S_e - \frac{Z_L}{z_{22e}}}$ $= -\frac{y_{11e} Z_L}{S_e}$	$K_V = \frac{-y_{11e} Z_L}{S_e + \frac{1}{1 + \alpha_{cb}} - \frac{Z_L}{z_{22e}(1 + \alpha_{cb})^2}}$ $= \frac{-y_{11e} Z_L}{S_e + \frac{1}{1 + \alpha_{cb}}}$	$K_V = \frac{-y_{11e} Z_L}{1 + \alpha_{cb} y_{11e} z_{22e}}$

(Continued on p 194)



# Cinch

MICRO  
CONNECTORS

...THREE TO FIFTY  
CONTACTS

MINIATURIZED  
Micro Connectors (shown  
here completely within  
color area) save space,  
weigh less, and are more  
efficient.

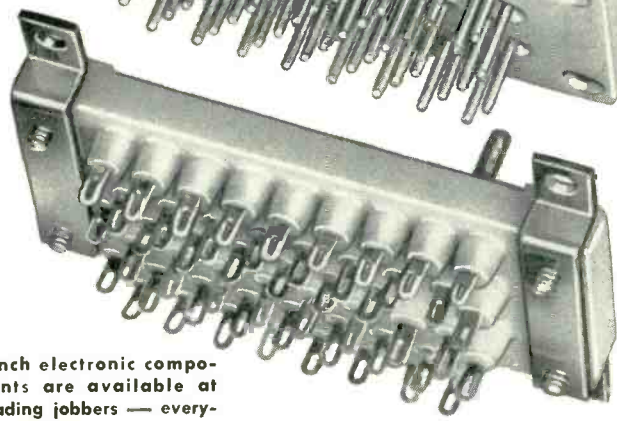
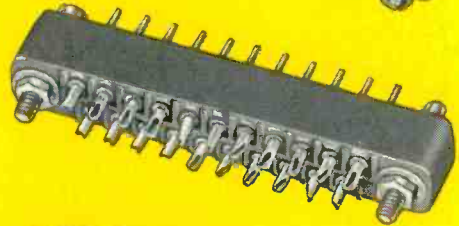
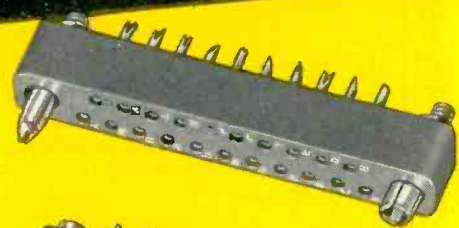
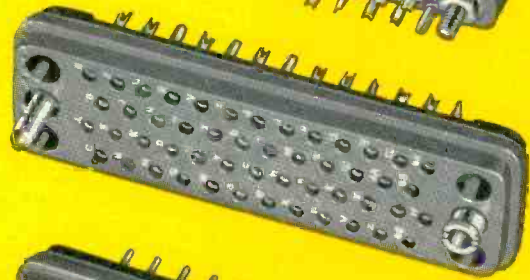
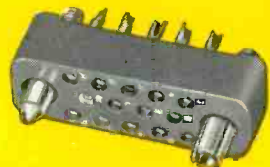
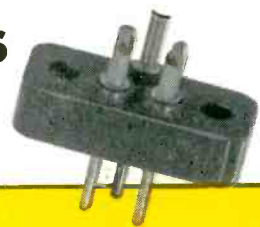

Cinch molded general purpose connectors are available with from three to fifty contacts in low loss material for chassis mounting or assembled with cap for cable applications, terminals gold or silver plated. Cinch experience indicated in the wide variety of designs and materials available, in service and consistent use, assures you the connector for your purpose.

**CONSULT CINCH**

**CINCH MANUFACTURING CORPORATION**

1026 South Homan Ave., Chicago 24, Illinois

Subsidiary of United-Carr Fastener Corporation, Cambridge, Mass.

Cinch electronic components are available at leading jobbers — everywhere.



**Cinch**  
ELECTRONIC  
COMPONENTS

# Transistor Equations Using *h*-Parameters

(Continued from p 192)

	COMMON EMITTER	COMMON BASE	COMMON COLLECTOR
Current Gain = $K_i$ $= \frac{\alpha_{21}}{1 + \frac{Z_L}{z_{22}}}$	$K_i = \frac{\alpha_{e b}}{1 + \frac{Z_L}{z_{22e}}}$	$K_i = \frac{-\alpha_{e b}}{1 + \alpha_{e b} + \frac{Z_L}{z_{22e}}}$	$K_i = \frac{-(1 + \alpha_{e b})}{1 + \frac{Z_L}{z_{22e}}}$
Power Gain = $K_p = 4R_g R_L$ $\left[ \frac{\alpha_{21}}{\left( Z_g + \frac{1}{y_{11}} \right) \left( 1 + \frac{Z_L}{z_{22}} \right) - \mu_{12} \alpha_{21} Z_L} \right]^2$	$K_p = 4R_g R_L$ $\left[ \frac{\alpha_{e b}}{\left( Z_g + \frac{1}{y_{11e}} \right) \left( 1 + \frac{Z_L}{z_{22e}} \right) - \mu_{bc} \alpha_{e b} Z_L} \right]^2$	$K_p = 4R_g R_L$ $\left[ \frac{\alpha_{e b}}{\left( Z_g + \frac{1}{(1 + \alpha_{e b}) y_{11e}} \right) \left( 1 + \alpha_{e b} + \frac{Z_L}{z_{22e}} \right) + \frac{S_e Z_L}{y_{11e} z_{22e}}} \right]^2$	$K_p = 4R_g R_L$ $\left[ \frac{1 + \alpha_{e b}}{\left( Z_g + \frac{1}{y_{11e}} \right) \left( 1 + \frac{Z_L}{z_{22e}} \right) + \alpha_{e b} Z_L} \right]^2$

Equations listed above are applicable to both high and low-frequency operation. For the low-frequency case only, substitute  $g_{11e}$ ,  $\alpha_{e b o}$ ,  $\mu_{bc o}$ ,  $r_{22e}$ , and  $S_{e o}$  for  $y_{11e}$ ,  $\alpha_{e b}$ ,  $\mu_{bc}$ ,  $z_{22e}$  and  $S_e$  respectively as shown in the equations that follow

Matched Input Resistance = $R_{im} = \frac{\sqrt{S_o}}{g_{11}}$	$R_{im} = \frac{\sqrt{S_{e o}}}{g_{11e}}$	$R_{im} = \frac{\sqrt{S_{e o}}}{g_{11e}} \frac{1}{\sqrt{1 + \alpha_{e b o}}}$	$S_{e o} = 1 + (1 + \alpha_{e b o}) (1 - \mu_{bc o}) g_{11e} r_{22e}$ $= \alpha_{e b o} g_{11e} r_{22e}$ $R_{im} = \frac{\sqrt{S_{e o}}}{g_{11e}}$
Matched Output Resistance = $R_{om} = \frac{r_{22}}{\sqrt{S_o}}$ Ratio $\frac{R_{om}}{R_{im}} = \frac{r_{22}}{r_{11}} = \frac{r_{22} g_{11}}{S_o}$	$R_{om} = \frac{r_{22e}}{\sqrt{S_{e o}}}$ $\frac{R_{om}}{R_{im}} = \frac{r_{22e} g_{11e}}{S_{e o}}$	$R_{om} = \frac{r_{22e}}{\sqrt{S_{e o}}} \sqrt{1 + \alpha_{e b o}}$ $\frac{R_{om}}{R_{im}} = \frac{r_{22e} g_{11e}}{S_{e o}} (1 + \alpha_{e b o})$	$R_{om} = \frac{r_{22e}}{\sqrt{S_{e o}}}$ $\frac{R_{om}}{R_{im}} = \frac{r_{22e} g_{11e}}{S_{e o}} = \frac{1}{\alpha_{e b o}}$
Matched Voltage Gain = $K_{Vm} = \frac{-\alpha_{21} g_{11} r_{22}}{S_o + \sqrt{S_o}}$	$K_{Vm} = \frac{-\alpha_{e b o} g_{11e} r_{22e}}{S_{e o} + \sqrt{S_{e o}}}$	$K_{Vm} = \frac{\alpha_{e b o} (1 + \alpha_{e b o}) g_{11e} r_{22e}}{1 + (1 + \alpha_{e b o}) S_{e o} + \sqrt{1 + (1 + \alpha_{e b o}) S_{e o}}}$ $= \frac{\alpha_{e b o} g_{11e} r_{22e}}{S_{e o} + \sqrt{1 + \alpha_{e b o} S_{e o}}}$	$K_{Vm} = \frac{(1 + \alpha_{e b o}) g_{11e} r_{22e}}{S_{e o} + \sqrt{S_{e o}}}$
Matched Current Gain = $K_{im} = \frac{\alpha_{21 o}}{1 + \frac{1}{\sqrt{S_o}}}$	$K_{im} = \frac{\alpha_{e b o}}{1 + \frac{1}{\sqrt{S_{e o}}}}$	$K_{im} = \frac{-\alpha_{e b o}}{(1 + \alpha_{e b o}) \left( 1 + \sqrt{\frac{1}{\alpha_{e b o} S_{e o}}} \right)}$	$K_{im} = \frac{-(1 + \alpha_{e b o})}{1 + \sqrt{S_{e o}}}$
Matched Power Gain = $K_{pm} = \frac{g_{11} r_{22} \alpha_{21 o}^2}{S_o \left( 1 + \frac{1}{\sqrt{S_o}} \right)^2}$	$K_{pm} = \frac{g_{11e} r_{22e} \alpha_{e b o}^2}{S_{e o} \left( 1 + \frac{1}{\sqrt{S_{e o}}} \right)^2}$	$K_{pm} = \frac{g_{11e} r_{22e} \alpha_{e b o}^2}{\alpha_{e b o} \left( 1 + \sqrt{\frac{1}{\alpha_{e b o} S_{e o}}} \right)^2}$	$K_{pm} = \frac{g_{11e} r_{22e} (1 + \alpha_{e b o})^2}{S_{e o} \left( 1 + \frac{1}{\sqrt{S_{e o}}} \right)^2}$



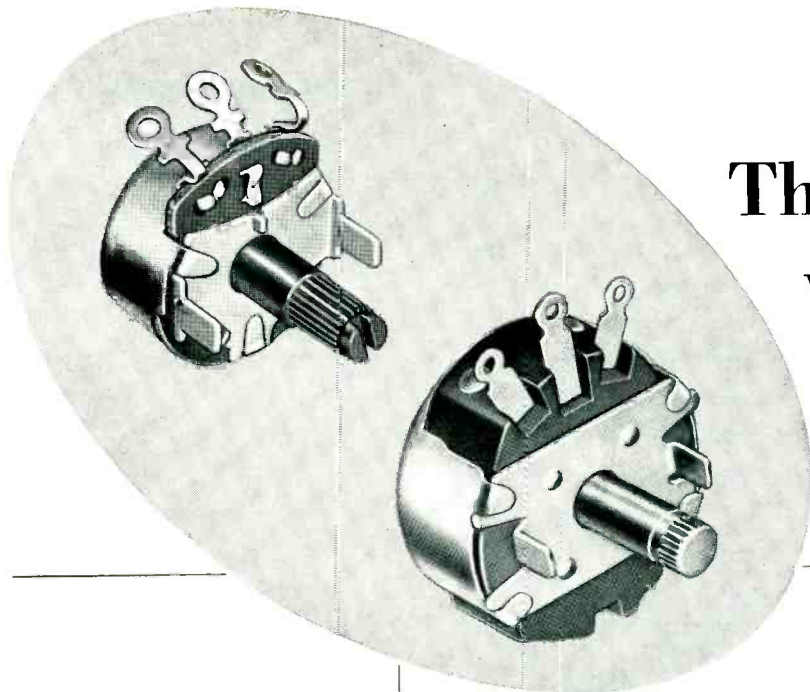

# These tab-mounted variable controls can trim your assembly costs

Looking for cost-cutting ideas? Mallory bushingless tab-mounted controls, either carbon or wire-wound, may be just what you need. They save you money in several ways:

*Easier mounting:* just twist the tabs, and the control is installed on the chassis. Extra built-in *stabilizing points* increase rigidity of mounting . . . prevent rocking.

*No hardware needed:* you save the cost of a lock washer and nut, besides obtaining a less expensive control.

Ideal for service adjustments in television receivers, these controls afford the high standards of Mallory performance at economical price. Both carbon and wire-wound types are available in choice of ratings, with or without attached switch. The carbon controls offer additional economies: an optional phenolic shaft at lower cost than steel, and a rotational stop that gives the effect of a fixed and variable resistor in a single unit.

For complete information, write today for the new Mallory Technical Bulletin.

*Expect more . . .  
Get more  
from MALLORY*

## Specifications:

Carbon Controls	Wire-Wound Controls
Resistance: 200 ohms to 10 megohms	3 to 15,000 ohms
Tolerance: +30% standard; ±20% available	+10% (closer tolerance on request)
Wattage: Linear: ½ watt Other tapers: ¼ watt	2 watts
Size: 15/16" dia., 17/32" deep	1 9/64" dia., 5/8" — .640" max.
Tapers: Linear, logarithmic, reverse logarithmic	Linear (standard); others on request
Shaft: Steel or phenolic	Steel
Mounting:	Two mounting lugs on 1/16" radius

Parts distributors in all major cities stock Mallory standard components for your convenience.

### Serving Industry with These Products:

**Electromechanical**—Resistors • Switches • Television Tuners • Vibrators  
**Electrochemical**—Capacitors • Rectifiers • Mercury Batteries  
**Metallurgical**—Contacts • Special Metals and Ceramics • Welding Materials



# ELECTRONS AT WORK

Edited by ALEXANDER A. MCKENZIE

Rawinsonde Probes Troposphere.....196	Matching Resistors at A-C.....200
Automatic Goniophotometer Measures Gloss .....196	Air-Sea Rescue System.....204
Monitor Measures Intensity of Radio-active Concrete .....198	Mixture Consistency Recorder.....210
Test Voltage Reference.....198	Transducers for Ultrasonic Drilling.....214
Television Aids Turbine Control.....200	Pulse Power Supply for Precipitators.....218
Atom Smasher to Fight Cancer.....200	Printed Electrostatic Generator.....222
	CRO Measurement of Beat Frequencies.....224
	Pertinent Patents .....226

## OTHER DEPARTMENTS

featured in this issue:

	Page
Production Techniques ..	242
New Products .....	292
Plants and People.....	338
New Books .....	398
Backtalk .....	404

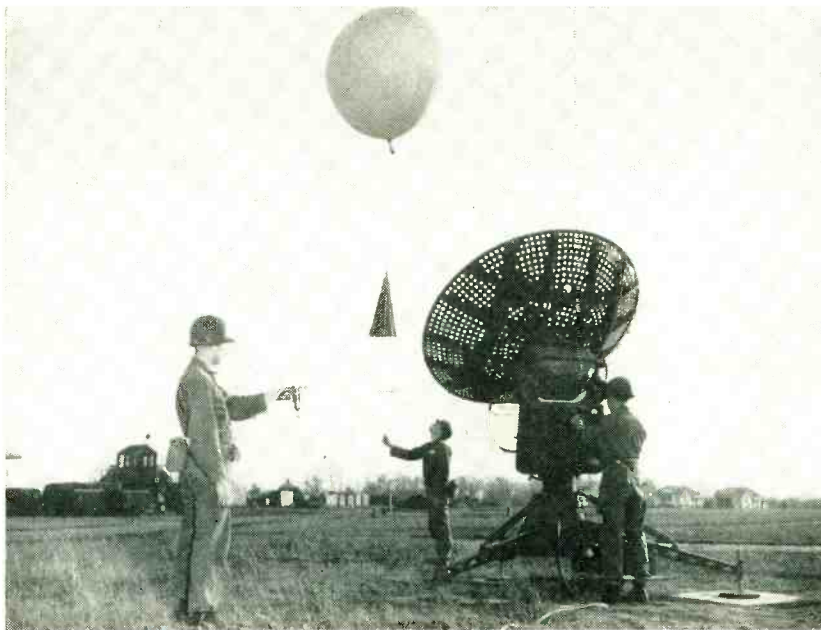

## Rawinsonde Probes Troposphere

Signal Corps personnel at Fort Monmouth, N. J. release sounding balloon equipped with parachute and radiometerograph. Radar antenna at right follows the free balloon to show wind velocity and direction while radio sounding equipment sends back signals to indicate altitude, temperature and relative humidity. Although most equipment released on east coast is lost over the Atlantic, the parachute protects individuals and ocean craft from injury

## Automatic Goniophotometer Measures Gloss

A TYPE OF GLOSS known as distinctness-of-image gloss (DIG) controls the sharpness of images seen in a reflecting surface. Measurement of this characteristic has been obtained with an instrument that scans rapidly over a small range of angles centered on the angle of specular reflection. By electronic means, the maximum slope of the

goniophotometric curve is measured by a meter deflection. Results with the instrument correlate well with judgements of trained observers.

The mechanical layout of the device is shown in Fig. 1. Light from lamp *S* passes through a slit and is reflected from test sample *X* to pass through simple lens *L* and then imaged on motor-driven

*D*. Transmitted light falls on phototube *P*. Output is amplified and differentiated before going to voltmeter equipment where rectified d-c is registered on a microammeter.

Figure 2A represents the function and its time derivative for a perfect reflector. Fig. 2B shows the typical curves for a glossy paint sample. Distortion of the curves caused by varying frequency response is not sufficient to affect results seriously.

Circuit of the experimental equipment, shown in Fig. 3, indicates that the photocurrent develops a voltage across the tapped resistor in the photocathode circuit, a portion of which is selected and amplified by the first type 6AU6 tube. Output is either attenuated by the  $R_1$ - $R_2$  network by closing the switch in the right direction or differentiated

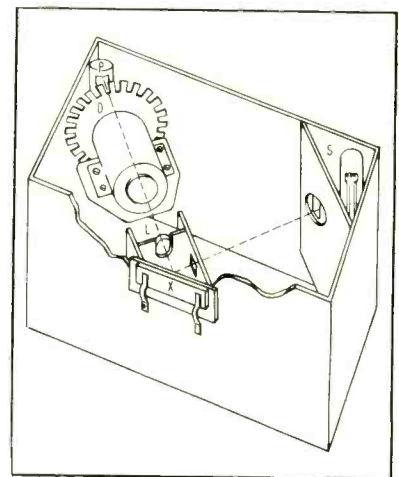

FIG. 1—Mechanical detail of the goniophotometer. Test sample is placed at *X*. Reflected light passing through rotating shutter *D* is received by phototube *P*



# NEW Q Meter Inductors for measurements up to 260 mc!

**INDUCTORS Type 590-A—  
accessories to Q Meter Type 190-A**

TYPE 590-A INDUCTORS					
Type	Inductance $\mu$ h	Capacitance $\mu$ mf	Approximate Resonant Freq. mc	Approximate Q	Approximate Distributed C $\mu$ mf
590-A1	0.05	8.0 — 95.0	70 — 230	320	1.5
590-A2	0.1	10 — 100	50 — 160	350	1.8
590-A3	0.25	8.0 — 80.0	30 — 100	310	2.3
590-A4	0.5	7.5 — 80.0	25 — 70	340	2.4
590-A5	1.0	7.5 — 65.0	20 — 50	300	2.9
590-A6	2.5	9.0 — 25.0	20 — 30	300	2.9

PRICE: \$10.00 each F.O.B. BOONTON, N. J.

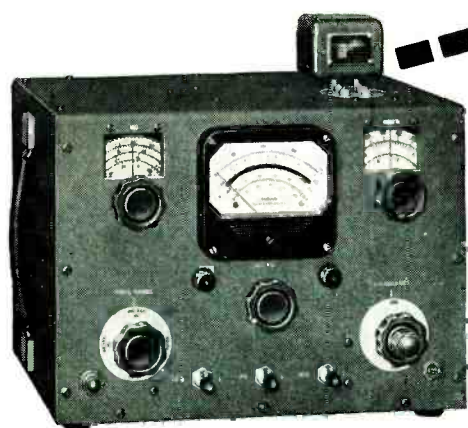
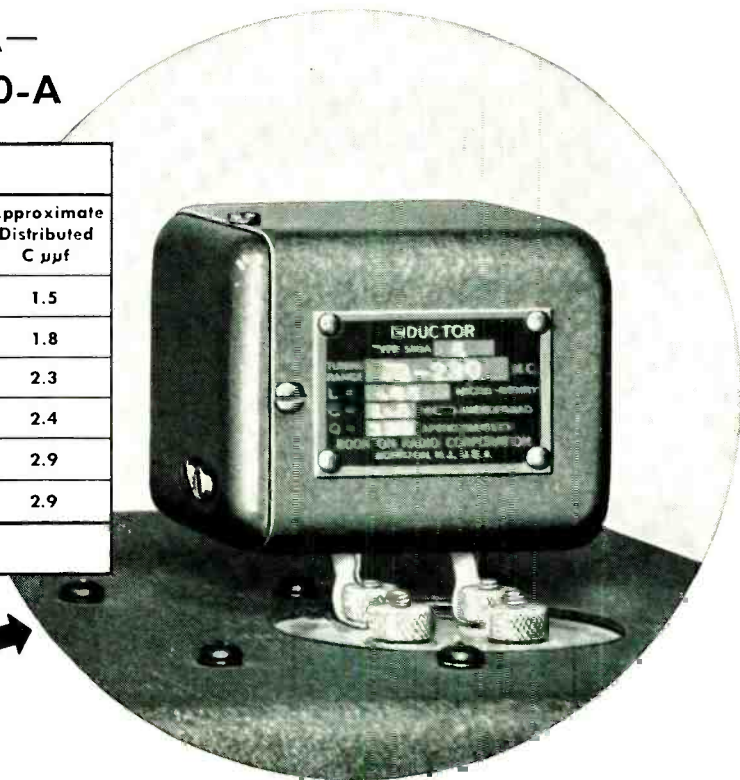

## Q METER Type 190-A

This new 190-A Q Meter measures an essential figure of merit of fundamental components to better overall accuracy than has been previously possible. The VTVM, which measures the Q voltage at resonance, has a higher impedance. Loading of the test component by the Q Meter and the minimum capacitance and inductance have been kept very low.

### SPECIFICATIONS—TYPE 190-A

**FREQUENCY RANGE:** 20 mc. to 260 mc.

**RANGE OF Q MEASUREMENT:**

Q indicating voltmeter	50 to 400
Low Q scale	10 to 100
Multiply Q scale	0.5 to 3.0
Differential Q scale	0 to 100
Total Q indicating range	5 to 1200

**PERFORMANCE CHARACTERISTICS OF INTERNAL RESONATING CAPACITANCE:** Range—7.5 mmfd. to 100 mmfd. (direct reading).

**POWER SUPPLY:** 90-130 volts — 60 cps (internally regulated).

Type 190-A Price: \$625.00 F.O.B. Factory

Inductors Type 590-A are designed specifically for use in the Q Circuit of the Q Meters Type 170-A and 190-A for measuring the radio-frequency characteristics of condensers, resistors, and insulating materials. They have general usefulness as reference coils and may also be used for periodic checks to indicate any considerable change in the performance of the Q Meters.

Each inductor Type 590-A consists of a high Q coil mounted in a shield and is provided with spade lugs for connection to the coil terminals of the Q Meters. The shield is connected to the lugs which connect to the Low Coil terminal in order to minimize any changes in characteristics caused by stray coupling to elements or to ground.

**BOONTON RADIO**

BOONTON · N · J · U · S · A ·

*Corporation*



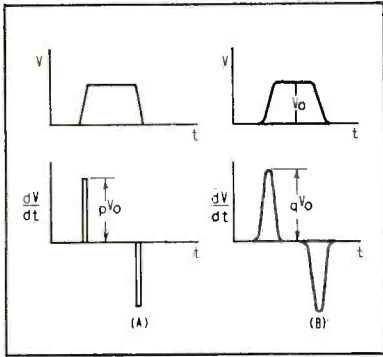

FIG. 2—Function and time derivative for perfect reflector (A) and for glossy paint sample (B)

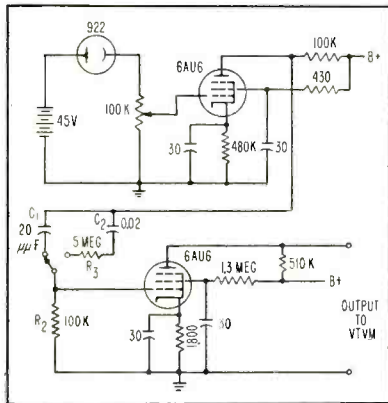

FIG. 3—Basic circuit of the gloss-measuring device, in the left position, the phototube signal is differentiated

by network  $C_1R_2$  by closing it to the left.

Output from either network is amplified by the second 6AU6 and the resultant voltage measured by the vacuum-tube voltmeter.

In making measurements, a suitable standard of gloss is inserted (such as a flat, polished piece of black glass or a front-coated aluminum mirror), the vtvm set to zero and the lamp voltage increased until the differentiated voltage reaches a certain amplitude. The standard is replaced by the sample, the lamp voltage readjusted and the value of DIG read on the meter.

A description of the instrument and its use, published in the *Canadian Journal of Technology*, has been abstracted here by permission of one of the authors, W. E. K. Middleton of the National Research Council, Ottawa, Canada.

### Test Voltage Reference

MORE VERSATILE than the usual standard cell, an adjustable voltage reference for which the circuit is shown in the diagram gives 0.1, 1.0 and 10 volts full scale with an

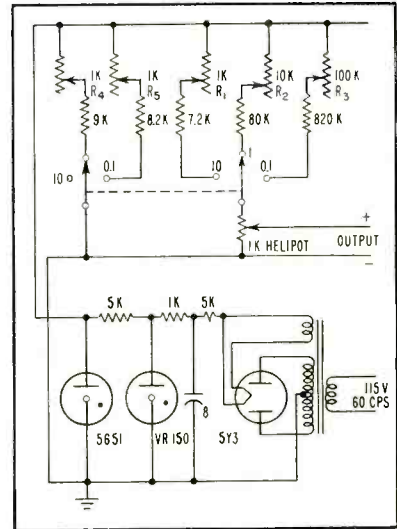

Circuit of the adjustable voltage reference employing two gas tubes

accuracy of 0.5 percent of full scale, the voltage being continuously variable.

Output from the rectifier is maintained constant at 150 volts by means of the type VR150. A second voltage regulator, type 5651 maintains a very stable voltage across its terminals of 87 volts.

Calibration resistors  $R_1$ ,  $R_2$  and  $R_3$  are used to set the scales accurately. Resistors  $R_4$  and  $R_5$  maintain

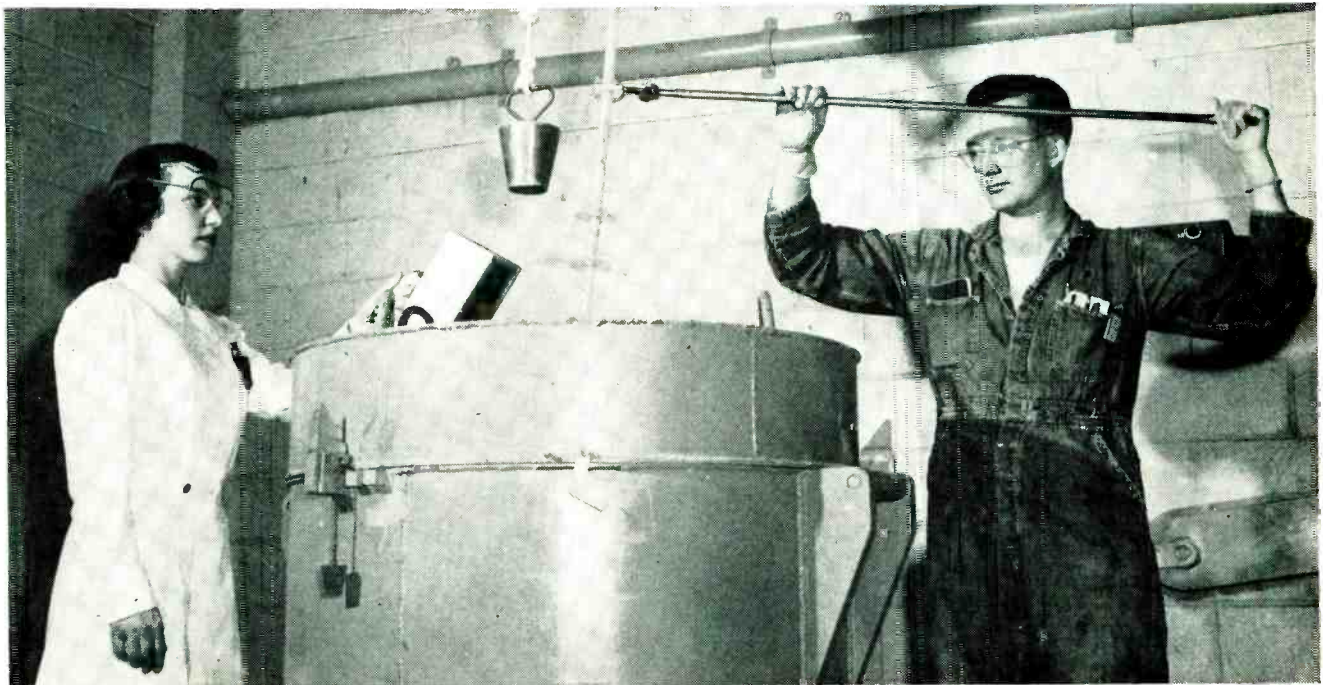

### Monitor Measures Intensity of Radioactive Concrete

Research technician at left checks activity near opening of hollow concrete cylinder as operator inserts tube of chemical solution that decomposes at a known rate for calibration purposes. Block

was constructed at Argonne National Laboratory of cement and radioactive fission products from nuclear reactor and will be used in Department of Food Technology, M.I.T.



## LIQUID-LEVEL GAUGE WEARS 7 LEAGUE BOOTS

Taking inventory was an oil-industry headache until the Shand & Jurs Company of Berkeley, California developed its Electronic Precision Remote-Reading Tank Gauge System...relying on HELIPOT\* precision potentiometers for translating critical measurements into voltages which are transmitted to an indicator located miles away.

**Tank-gauging** starts with a float riding on vertical guides. A perforated metal tape runs up from the float...over a sprocket-wheel...and down to a counterweight.

The sprocket-wheel, through a gear train, drives two HELIPOTS. The shaft of the first... a Model A, 10-turn unit...rotates 3600° as the float moves from the bottom of the tank to the top. The shaft of the other... a Model F, continuous-rotation unit... makes a full turn for each foot the float moves.

**The voltage outputs** of the two HELIPOTS are conducted to the remote station where either can be fed to the circuit of a Brown Instrument Co. self-balancing Wheatstone bridge.

The voltage of the Model A HELIPOT is read directly in feet... that of the Model F HELIPOT in 1/8" increments. Inventory of any number of tanks can be made quickly... by successively switching the outputs of their HELIPOTS into the circuit of the indicator.

**Operating** on a tank containing petroleum vapor, the HELIPOTS must be housed in an explosion-proof chamber. To overcome the problem of moisture condensation, the HELIPOTS operate completely immersed in oil...which enters the HELIPOTS themselves through holes in their housings. Condensation is drained periodically from the bottom of the chamber. Identical HELIPOTS, laboratory-tested while similarly immersed, showed negligible wear of coil or slider contact after 2 million revolutions.

**Application Data**... For complete details on this and other applications, write for Data File No. 402

\*T. M. REG. U. S. PAT. OFF. 314

HELIPOT makes a complete line of single-turn and multi-turn precision potentiometers, and turn-counting DUODIALS. Many models are regularly carried in stock for immediate shipment.

ELECTRONICS — April, 1954



 **Helipot** *first in precision potentiometers*

*Helipot Corporation/South Pasadena, California*  
*Engineering representatives in principal cities*  
*a division of BECKMAN INSTRUMENTS, INC.*



Want more information? Use post card on last page.

a constant drain from the power supply when switching to the 1 and 0.1-volt ranges.

Information on this circuit has been furnished by General Precision Laboratory, Inc.

## Television Aids Turbine Control

TELEVISION VIEWING screen (top center) in newly installed control room of giant Reuter power plant in West Berlin, Germany, enables operator to watch distant turbines and other machinery. →

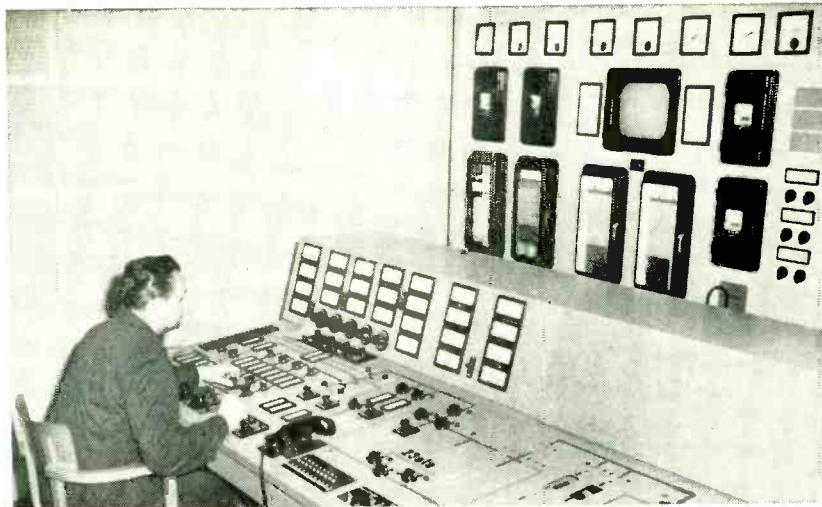

## Matching Resistors at A-C

By CONRAD JOSIAS

*Engineer  
Airborne Instruments Laboratory, Inc.  
Mineola, N. Y.*

TO CONTROL the quality of noninductive wirewound resistors in production and to select them for applications presents a problem in instrumentation. A matching technique has been developed that uses inexpensive equipment for tests that can be performed by unskilled operators.

A bridge system utilizes two very low-impedance legs in the

form of an accurately center-tapped computer reference transformer. The technique is reciprocal in nature so that by using relatively coarse components (one-percent carbon resistors), it is possible to bridge-select a transformer having an excellent phase characteristic and a center tap not more than 0.01 percent in error. The transformer introduces no amplitude error in the ratio match. However, it is necessary to take into account the inherent quadrature voltage that appears at the null point of the bridge resulting from imperfect phase qualities of the

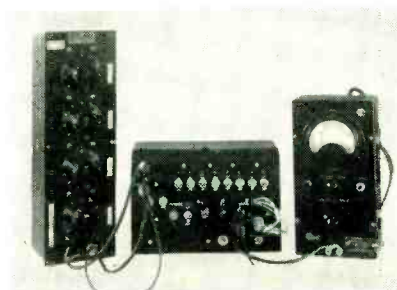

Test set and auxiliary equipment used in selecting matched pairs of resistors

transformer under test.

When the unknown pair of resistors  $R_1$  and  $R_2$ , to be matched are nominally equal, the equipment operates as a 1-to-1 bridge as shown in Fig. 1A. At the null as indicated by the meter

$$R_1/R_2 = 1 + \epsilon \quad (1)$$

where

$$\epsilon = [(R_{X1} + R_{X2}) - (R_{Y1} + R_{Y2})] / 2R_1$$

and subscripts X1 and Y1 indicate the values for null with the reversing switch in its first position, the X2 and Y2 indicate the values for null with the switch in its second position. The accuracy with which resistors were to be matched by this bridge was such that  $\epsilon \approx 0.0001$ .

The reversing switch eliminates the amplitude error from the transformer and permits the use of non-precision resistors for  $R_x$  and  $R_y$ . For  $\epsilon$  as low as 0.0001, carbon potentiometers and a multimeter can be used.

Should the meter measurement of the potentiometers be in error by 10 percent, an actual ratio of  $R_1/R_2 = 1.0001$  might be measured as

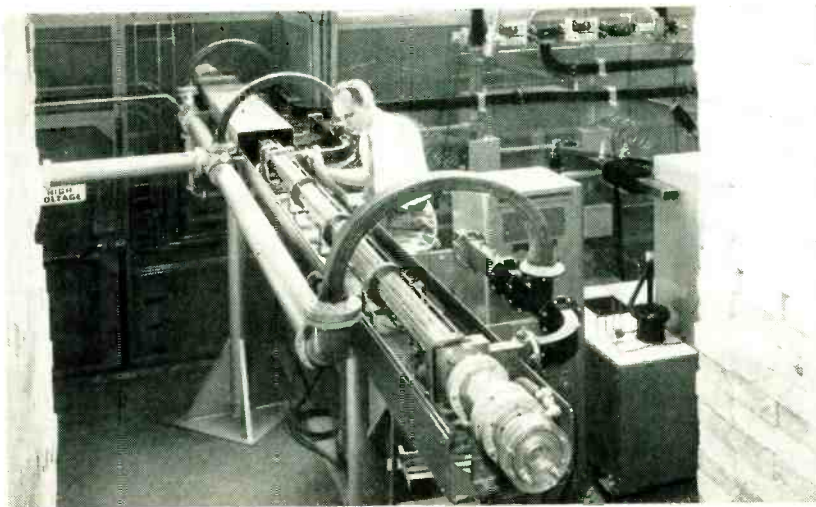

## Atom Smasher to Fight Cancer

Microwave linear accelerator built by High Voltage Engineering Corp. will be installed at Argonne Cancer Research Hospital. It is based upon designs from Stanford University and develops 50 million volts. Powered by two special klystrons, this linear accelerator launches bursts of electrons onto traveling radar waves. As electrons travel a 16-foot waveguide they reach a speed approximating that of light and weigh 100 times more than when they started. At the end of the guide, the high-voltage electrons pass through a thin aluminum window to be used for cancer research





# TIME-TRIED TETRODE

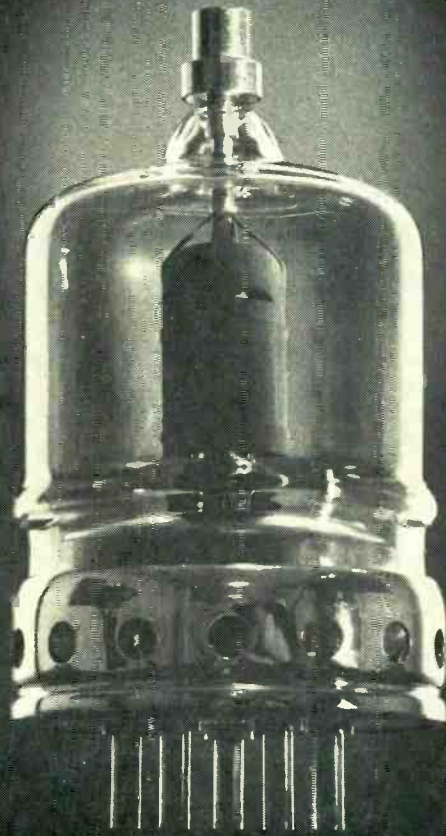

## LOS GATOS 4D21/4-125A

MODERN in every respect—  
with exclusive Sintercote black-  
body high-dissipation anode and  
emission-free grids—the Los  
Gatos 4D21/4-125A provides a  
new source of supply for a widely-  
applied tetrode type. Check  
Los Gatos for your requirements  
in other types with emphasis  
on long service life.

**LEWIS and KAUFMAN, Ltd.**

LOS GATOS 1

CALIFORNIA

Export Representatives: MINTHORNE INTERNATIONAL CO., INC.

15 Moore Street, New York 4, N. Y.

Cable: Address "Minthorne"





# NEW

## AMPHENOL Components stamped with the quality trademark—

**AMPHENOL**

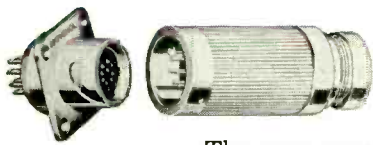

**miniature**

**165 Series**

The new AMPHENOL 165 series miniature AN-type connectors average about  $\frac{1}{3}$  the weight of standard ANs but retain the many features initiated by AMPHENOL in the larger connectors. The 165 series are the latest AMPHENOL contribution to the continuing program of miniaturization of components for instrumentation.



**Qwik**

**microphone connectors**

AMPHENOL QWIK Microphone Connectors are the newest, the most efficient and certainly the most attractive connectors ever offered for audio applications. They are available in 3 or 4 contacts and feature tough construction coupled with fine materials. Contacts are plated with gold over silver finished bronze.



**aljak** cable

ALJAK coaxial cable has been designed by AMPHENOL to permit a wider scope to cable applications in critical electronic equipment. Waterproof and semi-flexible, ALJAK is made with a tough aluminum jacket over extruded Teflon or polyethylene dielectric. The cable has very low attenuation as well as a smaller o.d. than equivalent RG type cables.

For further information about all of these AMPHENOL component write and request the special literature which has been prepared.

**AMERICAN PHENOLIC CORPORATION**

chicago 50, **AMPHENOL** illinois

1.0001  $\pm$  0.00001, which is a workable accuracy. With this 1-to-1 measurement, if components of the same construction are used, it is possible to match resistors up to about a megohm without difficulty in reactive mismatch.

For matching resistor pair  $R_1$  and  $R_2$ , where  $a > 1$ , the bridge shown in Fig. 1B is used. Assuming an ideal transformer, perfectly balanced in phase and amplitude

$$a = 1 + (1/b) + (R_2/R_1) \quad (2)$$

Leg  $bR_2$  is a bank of equal resistances. By paralleling various numbers of these resistors, the test set can be arranged to measure a wide variety of ratios. In one model of the test set, shown in the photograph, a row of toggle switches controls the number of standard resistors paralleled to form  $bR_2$ .

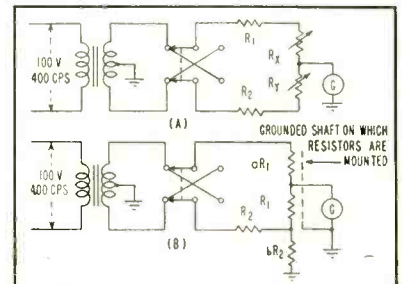

FIG. 1—Comparison bridge (A) for nominally equal resistors and general-purpose ratio-measuring bridge (B) for nonequal resistors

By using this mode of operation, the term  $1/b$  becomes an integer whereas in Eq. 2 the term  $1/b$  need not be an integer. For a workable bridge, a balancing resistor  $R_x$  must be inserted somewhere and new equations evolved. Utilizing the reversing switch and  $R_x$  in series with any of the four legs, the measured ratio  $a$ , in each case, as determined by the position of the null is given in Table I where  $R_x = (R_{x1} + R_{x2})/2$  and the subscripts have the meaning as before.

With resistor ratios from 2 to 7 (not necessarily integral) it is often possible to keep measurement inaccuracies below 0.01 percent. Ratios approaching 10 are often difficult to measure to better than 0.05 percent, however.

Proper reactive balances must be obtained to achieve accurate measurement of resistance ratios. Should the null contain excess quadrature



ARE YOU READY FOR

*Guaranteed*  
Core Performance?

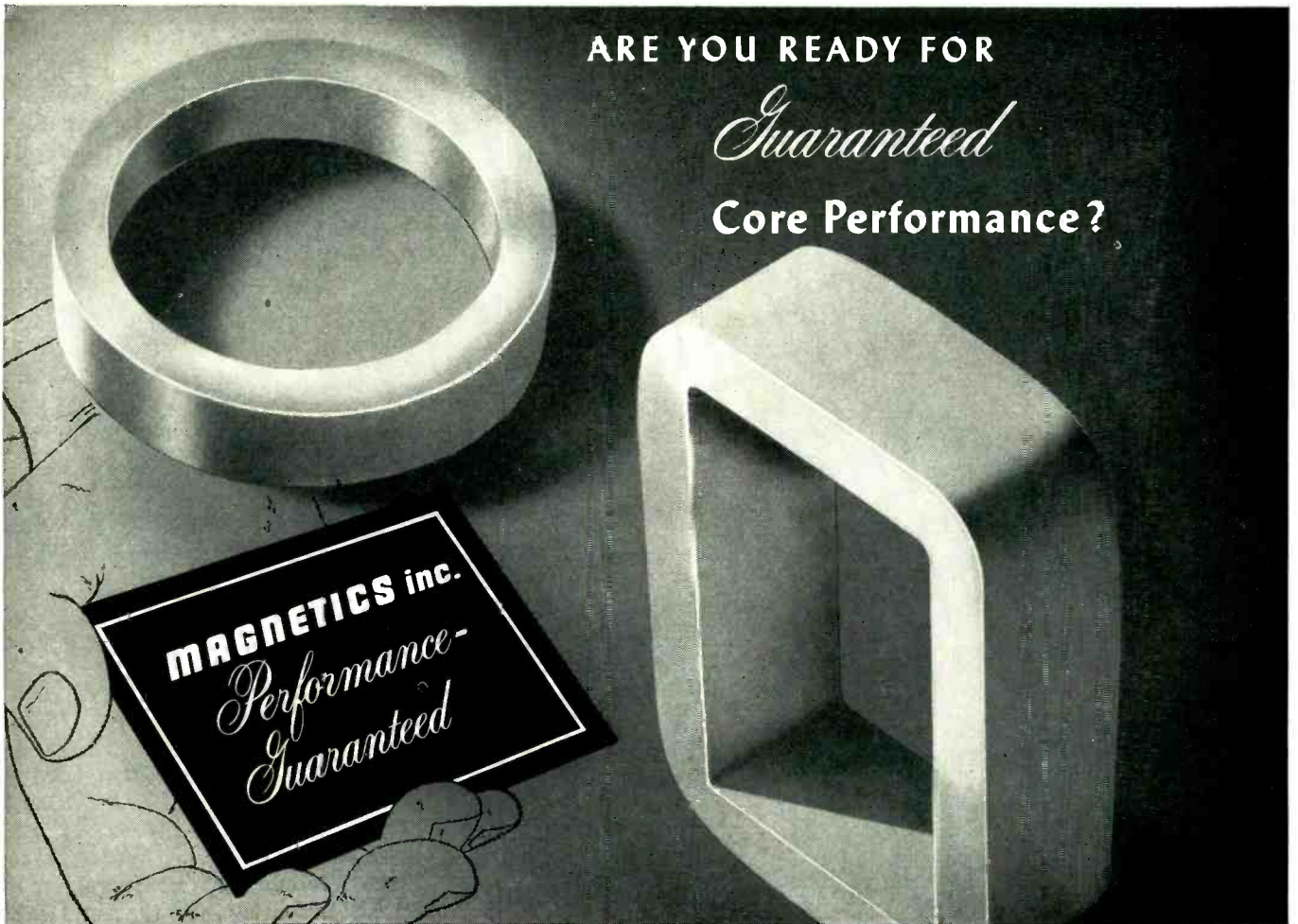

# TAPE WOUND CORES

Are you ready for a revolutionary concept in the electrical and electronic industry—the Magnetix, Inc. “Performance-Guarantee” on Tape Wound Cores. Guaranteed

to meet your specifications, and sold at standard prices; these Cores mean truly economical production of high permeability magnetic devices in your plant.

**TABLE A**  
BASIC PHYSICAL CONSTANTS OF  
COMMON MAGNETIC MATERIALS

Trade Name	% Ni	% Fe	Other	Grain Structure	Satur. Flux Density Gausses	Resistivity Microhm-Cm	Curie Point °C	Dens. Grams per cc
Hy Mu 80	79	17	4 Mo	“random”	8,700	57	420	8.72
48 Alloy	48	52	“random”	“random”	16,000	45	500	8.3
Orthonol	50	50	oriented	oriented	15,500	45	500	8.25
Magnesil	97	3	Si	oriented	20,000	48	700	7.65

**TABLE B**  
TRADE NAMES OF SIMILAR MATERIALS

Hy-Mu 80	48 Alloy	Orthonol	Magnesil
4-79 Permalloy	Carpenter 49	Orthonik	Armco Oriented T
Mo-Permalloy	Allegheny 4750	Permeron	Hypersil
Mu Metal*	Hypernik	Deltamax	Orthosil
		Hypernik V	Sillectron

Typical of the unusual scope of the material contained in Catalog TWC-100 are Tables A and B, reproduced from Page 4 of “Performance-Guaranteed Tape Wound Cores.”

## GET THE COMPLETE STORY

A wealth of new and unusual material on Tape Wound Cores is available to you in Catalog TWC-100, “Performance-Guaranteed Tape Wound Cores.” Tables A and B of the catalog, reproduced on this page, present a striking illustration of material not to be found compiled together elsewhere.

Data and descriptive details on high permeability materials . . . factory core matching . . . free engineering design services . . . pages of characteristic graphs and tables . . . are yours for the asking. Simply write on your company letterhead.

**MAGNETICS inc.**

DEPT. E-7, BUTLER, PENNSYLVANIA

# Heiland

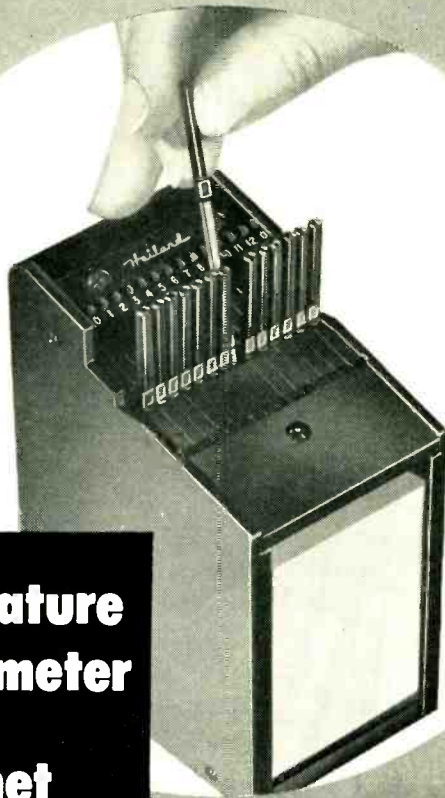

## Subminiature Galvanometer and Magnet Structure

### for Heiland Recording Oscillographs

Heiland presents a new line of subminiature galvanometers and a new concept in the design of magnet structures.

### Check these Quality Features

- ✓ Small-size, Compact
- ✓ High Sensitivity
- ✓ Extremely Stable
- ✓ Rugged Construction
- ✓ Low Drift
- ✓ Extended Frequency Range

Many additional features are incorporated to provide flexibility, reliability and ease of operation in all applications. Complete specifications will be released in the near future. Write or wire for complete details on Heiland Recording Oscillographs, Amplifiers and Bridge Balance Units.

**Heiland Research Corporation**  
130 EAST FIFTH AVENUE • DENVER 9, COLORADO

voltage, the balance setting of  $R_X$  will be far from accurate.

For some low-resistance resistors that are slightly inductive, paralleling high-impedance noninductive windings sometimes produces the desired capacitive effect. After the resistors are mounted on the bridge, capacitance can be trimmed to obtain a balance minimum of the proper magnitude, thereby completing the ratio test. A capacitor is added in parallel to the appropriate bobbin making the pair ready for installation.

**Table I—Equations of Matching Ratio for Series Combinations of  $R_X$**

$R_X$ in series with	$a$
$aR_1$	$1 + (1/b) + (R_2 - R_X)/R_1$
$R_1$	$(1 + 1/b)(1 + R_X/R_1) + R_2/R_1$
$R_2$	$1 + (1/b) + (R_X/bR_2) + (R_2 + R_X)/R_1$
$bR_2$	$1 + (R_2/R_1) + R_2/(bR_2 + R_X)$

The capacitive trimming has made possible the measurement of resistance at a-c. At the same time the trimming has compensated for distributed capacitance and resistor standards in the bridge. Final trimming is accomplished in the amplifier itself which has a different array of parasitic capacitance than the bridge. The trimming is finished when the phase of the null voltage is aligned with the phase of the input.

### Air-Sea Rescue System

A RADIO SEARCH system using a cathode-ray indicator to show the location of the person in distress also provides for two-way communication when the rescuing plane or ship draws near the position.

The equipment carried by wrecked personnel consists of a radio-beacon transmitter with antenna, speech modulator and receiving unit. The unit uses two tubes, one for beacon and one for voice transmitter-receiver.

To use the transmitter the wrecked person removes the protective cover from the rolled self-erecting, flexible metal-tape antenna. The length of the antenna is 62 percent of 243-mc wavelength,





We assure you of prompt delivery and courteous service of TRU-OHM WIRE WOUND RESISTORS . . . the finest available . . . from stock or to your specifications.

- Fixed vitreous enameled RESISTORS
- Adjustable vitreous enameled RESISTORS
- "Econohm" RESISTORS
- "Tru-Rib" RESISTORS
- Special size RESISTORS

Our engineering department is at your service to assist in the selection or design of a resistor to fit any and all applications.

Write for our latest catalog today on TRU-OHM RESISTORS and POWER RHEOSTATS.



Division of  
Model Engineering  
& Mfg., Inc.

General Sales Office: 2800 N. Milwaukee Avenue, Chicago 18, Ill.  
Factory: Huntington, Indiana

MANUFACTURERS: Power Rheostats, Fixed Resistors, Adjustable Resistors, "Econohm" Resistors, "Tru-rib" Resistors

which has been found to be optimum for land and sea operations.

When operating as a beacon the equipment transmits a coded 243-mc pulse generated in an optimized squegging oscillator controlled to provide groups of pulses at a low pulse-repetition frequency. Details of this pulsing are shown in Fig. 1. Each beacon has a different pulse spacing making it possible for the rescuer to tell them apart.

The peak power output of approximately 16 watts gives the beacon unit a maximum range of 66 miles to a rescue aircraft at 10,000 feet altitude, and 6 miles to a rescue ship with a 30 to 40-foot receiving antenna. These ranges are, of course, also determined by sensitivity of the rescue receiver. Battery capacity is adequate to maintain this signal for 20-hours continuous duty.

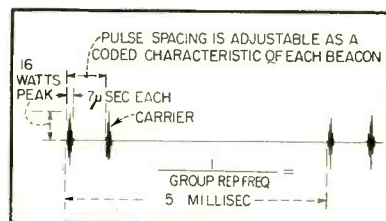

FIG. 1—Pulse group signal transmitted by SARAH rescue equipment. Spacing of pulses in group is variable from 15 to 300  $\mu$ sec

When the wrecked person is within visual or audible distance of the spotting or rescue aircraft or ship, he can operate a three-position switch to transmit voice. Modulation is by pulse-repetition-frequency variation of a 12,000-pps signal.

Battery capacity is adequate for 19 hours of beacon operation and 1 hour of voice transmit-receive operation.

With the selector switch in the receive position, amplitude modulated c-w from rescue craft can be received by means of a superregenerative receiver with a squegging rate of about 30 kilocycles. The carrier frequency is 243 megacycles.

The receiver presents a cathode-ray indication of the search area during the search phase shown in Fig. 2. Any beacons within the region covered by the receiving antenna appear as spikes on a ver-

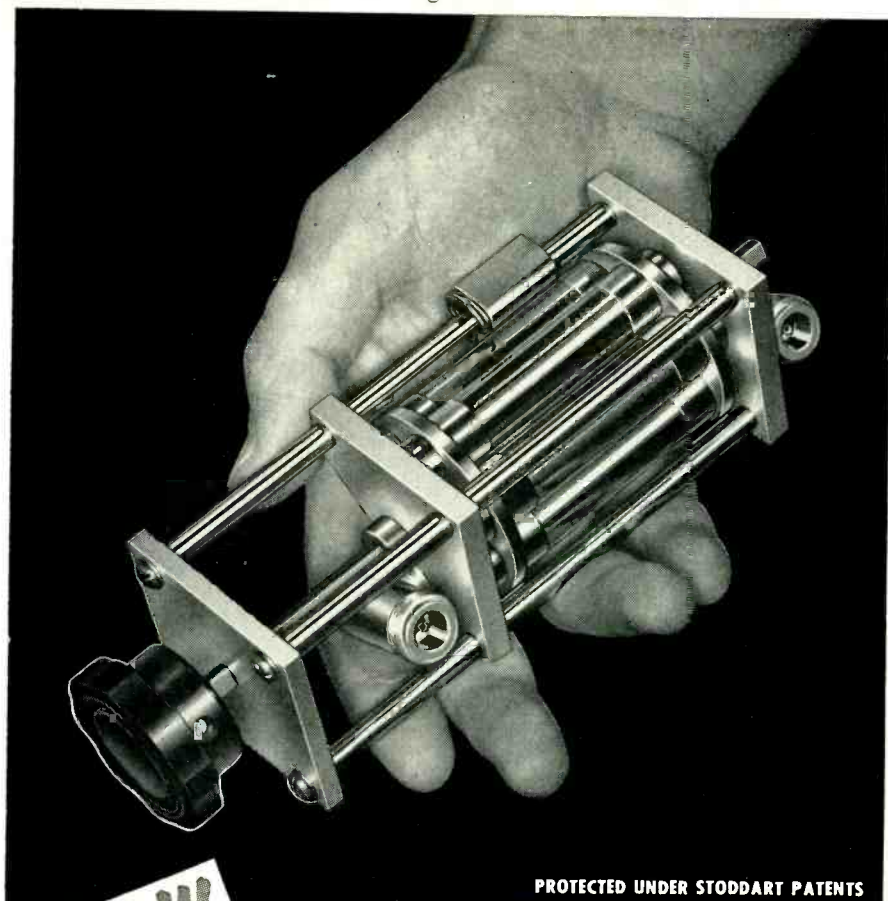

PROTECTED UNDER STODDART PATENTS

## Precision Attenuation to 3000 mc!

TURRET ATTENUATOR featuring "PULL-TURN-PUSH" action



SINGLE "IN-THE-LINE" ATTENUATOR PADS and 50 ohm COAXIAL TERMINATION

#### FREQUENCY RANGE:

dc to 3000 mc.

#### CHARACTERISTIC IMPEDANCE:

50 ohms

#### CONNECTORS:

Type "N" Coaxial female fittings each end

#### AVAILABLE ATTENUATION:

Any value from .1 db to 60 db

#### VSWR:

<1.2, dc to 3000 mc., for all values from 10 to 60 db

<1.5, dc to 3000 mc., for values from .1 to 9 db

#### ACCURACY:

$\pm 0.5$  db

#### POWER RATING:

One watt sine wave power dissipation

*Send for free bulletin entitled "Measurement of RF Attenuation"*

*Inquiries invited concerning pads or turrets with different connector styles*

### STODDART AIRCRAFT RADIO Co., Inc.

6644-A Santa Monica Blvd., Hollywood 38, California • Hollywood 4-9294



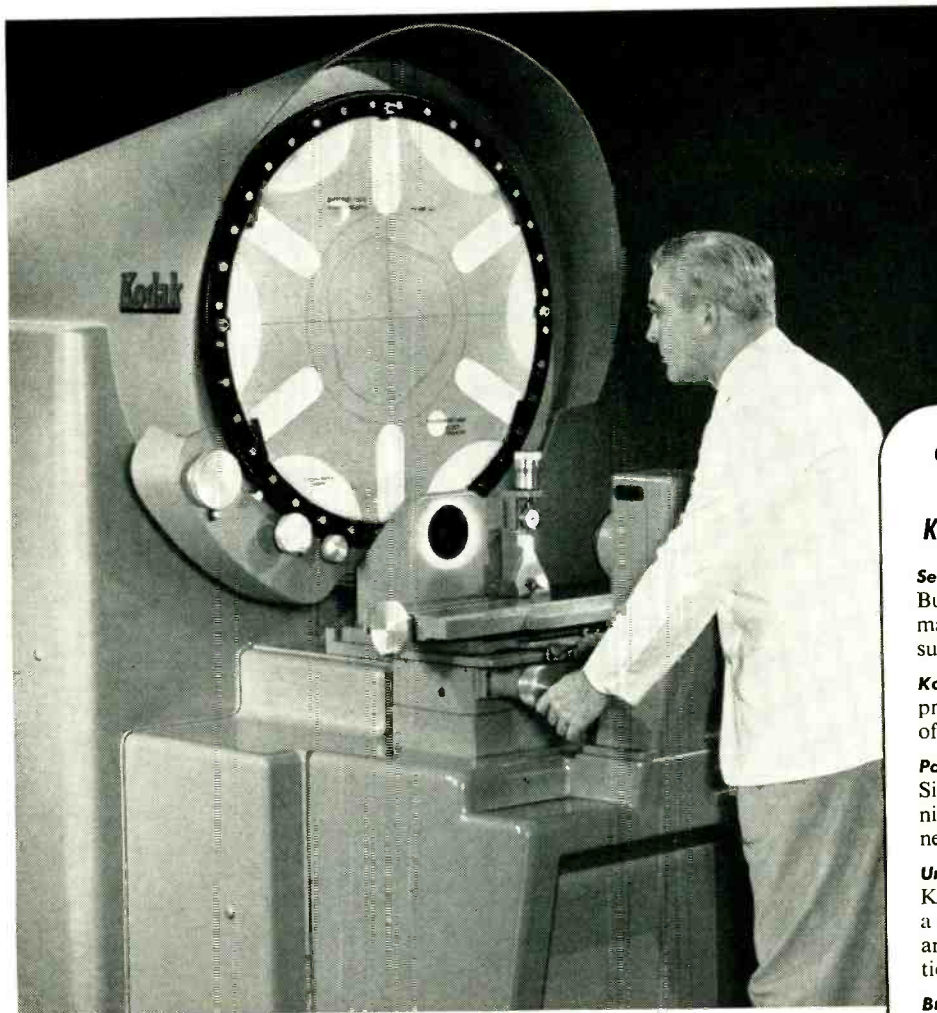

## Now... a 30-inch Contour Projector with Kodak's Advanced Optical Design

Ever since the first Kodak Contour Projector was built six years ago, engineers have asked for a 30-inch model with the same advanced optical refinements.

Now the new Kodak Contour Projector, Model 30, answers industry's need for a precision measuring instrument to handle large parts quickly, conveniently.

If yours is one of the hundreds of companies already using optical gaging methods, you'll want to learn how the new "Model 30" can boost efficiency in present operations. If you are not making use of optical gaging, you'll want to learn how the Model 30 makes its use far easier and more economical than ever before.

For complete details of the Kodak Contour Projector, Model 30, write to:

**EASTMAN KODAK COMPANY**

Special Products Sales Division

Rochester 4, N.Y.

**the KODAK CONTOUR PROJECTOR**

### Check these outstanding features of the Kodak Contour Projector, Model 30:

**Self-Contained Normal Surface Illuminator.** Built-in 1500-watt light source provides maximum surface illumination to inspect surface details, recesses, and blind holes.

**Kodak Magnification Selector.** Lens turret provides choice of magnifications at the flick of a switch.

**Par-Focalized Kodak Projection Ektar Lenses.** Six specially designed lenses provide magnifications from 10× to 100×. No refocusing necessary when you change magnification.

**Uniform Work Area At All Magnifications.** Kodak's unique relay lens system gives you a uniform 8-inch clearance between the part and optical system regardless of magnification selected.

**Bright Screen Image.** The 500-watt light source for shadow projection provides sharp, easy-to-read screen image across the full 30-inch diameter.

**Built-In Helix Table.** Worktable rotates 15° off center for compounding helix angles.

**Direct-Reading Rotary Screen.** Graduated to 2' of arc. Angular measurement is read directly from a dial without vernier. Dial may be zeroed, eliminating lost time in aligning protractor ring.

**64-Sq.-In. Measuring Area.** Eight-inch horizontal and eight-inch vertical table provides an area of 64 square inches for direct measurement. Worktable measures 26" x 8".

**Uni-Strut Assembly.** Provides maximum rigidity. Projection lenses and mirrors sturdily mounted on a single member.

**Compact Design.** Floor space required for the Kodak Contour Projector, Model 30, is approximately 1/5 less than that required for other 30-inch projectors.

See the Kodak Contour Projector,  
Model 30, at the Tool Show,  
Booths 307 and 311.

**Kodak**  
TRADE-MARK



**HERE'S ANOTHER FIRST...**

developed by **INDUSTRIAL**  
 in the research and design  
 of quality  
**CAPACITORS**

Addition of the 8 mfd. and dual 4 mfd. (600 vdc.) and dual 2 mfd. (1000 vdc.) makes Industrial's series of small case size inverted single-stud-mounting tubular oil-filled capacitors one of the most extensive in its class. Similar important units of the same type in the 600, 1000 and 1500 v. range keep this line fully abreast of new electronic demands.

Whatever your requirements may be, you'll find the answer in Industrial's complete line of oil, wax, electrolytic, Stabelex® and special capacitors.

We are not just engaged in the manufacture of electronic components—we are specialists in the research, design and development of quality capacitors. Our experienced engineering staff is ready to serve you. Send now for full information, including illustrated catalogs.

**INDUSTRIAL**

**CONDENSER CORPORATION**

3249 N. California Ave.,

Chicago 18, Ill.

tical reference trace of a c-r tube. By time sharing methods, a right and left antenna on the aircraft are arranged to display beacon spikes either to the right or left of the vertical reference trace. Directional information is thereby obtained. The right and left antenna patterns are inclined forward, and overlap ahead to provide a means for homing on the beacon.

When the first pulse from a beacon is received a linear vertical trace is initiated on the cathode-ray

CONDITION	TRANSMISSION FROM BEACON	RECEIVER SCOPE
OUT OF RANGE SCANNING	Two vertical spikes on a horizontal line.	Circle with a vertical line through the center.
SIGNAL PICKED UP BY SEARCH PLANE	Two vertical spikes on a horizontal line.	Circle with a vertical line through the center and a horizontal line at the top.
LATE HOMING PHASE	Two vertical spikes on a horizontal line.	Circle with a vertical line through the center and a horizontal line at the top.
SEARCH PLANE GOES THROUGH NULL AND GETS FIX	Two vertical spikes on a horizontal line.	Circle with a vertical line through the center.
BEACON ON VOICE OPERATION	A series of vertical spikes on a horizontal line.	Circle with a vertical line through the center and a series of vertical lines along it.
PICKUP FROM THREE BEACONS; 2 ON PORT, 1 ON STARBOARD	Three vertical spikes on a horizontal line, labeled A, B, and C.	Circle with a vertical line through the center and three horizontal lines at the top, labeled A, B, and C.
PICKUP FROM THREE BEACONS WITH PLANE HOMING ON BEACON C	Three vertical spikes on a horizontal line, labeled A, B, and C.	Circle with a vertical line through the center and three horizontal lines at the top, labeled A, B, and C.

FIG. 2—Beacon-unit transmission, and indications on receiver crt for various operating conditions

tube. The second pulse deflects the trace either to the right or left, depending on which antenna has received the signal. Since the beacon pulses are transmitted with a fixed, characteristic time spacing of group pulses, succeeding pulse groups rewrite the spike at the same place on the cathode-ray tube. The time-sharing frequency being about 30 cycles per second and the group-repetition frequency being about 200 groups per second, each spike is rewritten approximately 3 times in its half of the time-sharing cycle

As the aircraft flies over the beacon, the beacon signal will suddenly vanish, due to the vertical radiation pattern characteristic of the beacon antenna. By this method a fix is obtained. The width of the null will naturally vary with the altitude of the homing antenna.

When the beacon is switched for voice transmission, the cathode-ray presentation indicates a number of



# Ultra-Stable Microwave Oscillator



## MODEL 804

The LFE Model 804 Microwave Oscillator provides a source of highly stabilized microwave frequencies suitable for use as a local oscillator for microwave measurements, or in many other applications where a high degree of stability is required, such as Q measurements, SWR measurements and general narrow band design work. A dial accurately calibrated directly in frequency is an important feature. The main elements of the unit are a klystron oscillator, a stabilizing monitor loop which consists of a calibrated dual-mode reference cavity, a feedback amplifier and a self-contained power supply. Means are provided for modulating the oscillator.

## Specifications

### Frequency Coverage

8,500–10,000 Mc—X-Band

### Dial Calibration

Calibrated directly in frequency—  
1 Mc per division

### Frequency Stability

Short Term Deviation—less than one part in  $10^8$   
Long Term Drift—negligible after complete warm-up

### Modulation

Can be modulated 25% when stabilized,  
100% modulation possible when stabilization is removed

### Power Output

80–100 milliwatts  
Output flange—UG 40/U

### Power Consumption

160 watts

### Size

12-7/32" x 19" front panel, 19-1/4" deep,  
cabinet or rack mounting

### Weight

100 lbs.

For complete information,  
see your LFE engineering  
representative or write—



**LABORATORY for ELECTRONICS, INC.**

75-3 PITTS STREET • BOSTON 14, MASS.

PRECISION ELECTRONIC EQUIPMENT • OSCILLOSCOPES • MAGNETOMETERS • COMPUTERS • SOLID DELAY LINES

ELECTRONICS — April, 1954

Want more information? Use post card on last page.

209

equally spaced spikes produced by the 12,000-pps unmodulated carrier.

When the beacon goes on receive, the cathode-ray screen displays a number of small readily identifiable spikes indicating that the wrecked person is ready for voice reception.

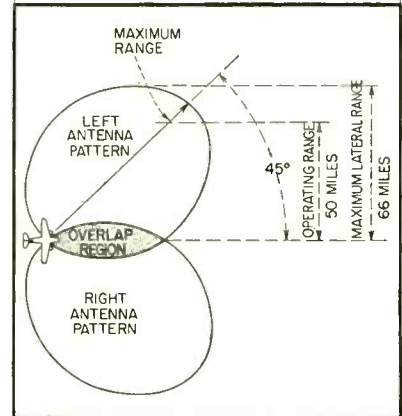

FIG. 3—Pattern of antennas on search plane. Overlap region in center is used for homing on beacon

The aircraft search and homing antenna is an elementary parasitic type having a driven dipole and one director. It has a directivity pattern as shown in Fig. 3. The overlapping of the right and left lobes from the two antennas makes homing possible since when the beacon is within a few degrees of dead ahead, spikes are shown on both sides of the crt vertical trace. When the spikes are exactly equal in length, the aircraft is headed directly for the beacon.

Aboard a rescue vessel a servo positioned Adcock homing array is employed.

### Mixture Consistency Recorder

THE POWER required to drive a mixer agitator is a function of the consistency of the mixture. By installing power-measuring equipment on a mixing or blending operation, it is possible to use the power measurement to regulate and record the consistency of the mixture.

The equipment consists of two components, a three-phase transformer-thermal converter assembly and an electronic potentiometer recorder.

The transformer and thermal converter assembly generate a d-c potential directly proportional to

## New!

"P" TYPE  
ENCAPSULATED  
RESISTORS

# Stable... Small... Light-weight...

Shallcross "P" Type Encapsulated Resistors are ideal for installation where stability, dependability, and minimum size and weight are a must. These radically new resistors offer the performance advantages of hermetically-sealed steatite resistors at less cost.

Because of the unique Shallcross method of encapsulating windings, "P" type resistors have greater maximum resistances, longer leakage paths, and higher wattage ratings.

Shallcross "P" type resistors are available in six MIL-R-93A lug-type styles and five axial lead styles with wattage ratings ranging from .500 to 3.5 watts. All styles meet and exceed JAN-R-93A, Characteristic A.

Complete information on sizes, ratings, and test results of Shallcross "P" type precision wirewound resistors is available in Engineering Bulletin L-30. Write for your copy today.

SHALLCROSS MANUFACTURING CO.  
522 Pusey Avenue, Collingdale, Pa.

# Shallcross

Our 25th Year 1929-1954



**Uniformity  
Ruggedness  
Reliability  
make the**



## **MACHLETT 2C39A**

**Preferred Choice of Equipment Manufacturers,  
Military and Commercial Users**

**New Standard for  
Electrical Uniformity**

The ML-2C39A sets the highest standard of electrical uniformity for UHF planar triodes.

Close tolerance parallelism between electrodes prevents uneven heating at high frequencies, minimizes arcing.

Uniquely processed grid, mechanically stable at high temperatures, assures frequency stability over broadest range of operating conditions.

Machined emitter surfaces with extremely uniform oxide deposit assure optimum cathode emission as well as freedom from uneven, grid distorting, heat.

**400% More Rugged**

Average strength of the ML-2C39A is over 400% greater than *any other* 2C39A, as measured in torque and pry tests.

**Unmatched Reliability**

Quality in design, materials, and production techniques build superior reliability into the ML-2C39A.

Final inspection includes r-f oscillation in both test oscillators, and prototypes of field equipments, to assure tubes of high power output and long, trouble-free life.

**Electrical Characteristics  
of ML-2C39A\***

Heater voltage, 6.3 volts	Grid-plate capacitance, 2.0 uuf
Amplification factor, 100	Maximum frequency, 2500 mc/sec
Transconductance, 22,000 umhos	Useful power output, 12-35 watts

*\*Manufactured to JAN specifications.*

Also made by Machlett to highest quality specifications: **ML-381** for pulsed applications (3500 V peak; 3 microsecond pulse; 1/2% duty cycle) and the **ML-322** clipper diode.

**For complete specifications and operating data, write to:  
MACHLETT LABORATORIES, INC. • SPRINGDALE, CONN.**



*Over 55 years of electron tube experience!*

# THE HOUSE THAT CALIDYNE BUILT

## THE CALIDYNE STORY

★ Six years ago it was only an idea. Then, a little company was formed to harness the destructive force of vibration and put it to constructive uses. The word "Calidyne" was coined. It combined "calibrate" and "dynamics" and implied the "measurement of a dynamic force" such as vibration. The beginning was humble and at first management itself constituted the only "employees." Progress was slow and the future doubtful.

★ By 1951 the company had become known and recognized. A demand developed for its products and expansion began in earnest. In 1953 Calidyne moved out of various obsolete buildings and consolidated operations in one modern, streamlined, sunlit structure of its own. Today the company consists of one hundred and twenty highly skilled people.

★ Calidyne's primary interest is to develop a complete line of vibration test and measurement equipment. Of this line Calidyne's custom-built Shakers are now the best known. They are produced in many sizes to meet individual requirements and are used for shake-testing (vibrating) various objects (assemblies, machines, vacuum tubes, etc.) to see what effect vibration will have on them in actual service. Many product manufacturers now find that they fill a very basic need. Perhaps you should investigate them too?



MAKERS OF SHAKER SYSTEMS FOR VIBRATION-TESTING YOUR PRODUCTS



# THE CALIDYNE COMPANY

120 CROSS STREET, WINCHESTER, MASSACHUSETTS

### SALES REPRESENTATIVES:

NEW YORK (Long Island)  
G. C. Engel, Rector 2-0091  
NEW JERSEY  
G. C. Engel, Ridgewood 6-7878  
PHILADELPHIA, PA.  
G. C. Engel, Chestnut Hill 8-0892  
CLEVELAND, OHIO  
M. P. Odell Co., Prospect 1-6171  
DAYTON, OHIO  
M. P. Odell Co., Oregon 4441

WASHINGTON, D. C.  
F. R. Jodon, Inc., Woodley 6-2615  
CHICAGO, ILLINOIS  
Hugh Marsland Co.  
Ambassador 2-1555  
DALLAS, TEXAS  
John A. Green Co., Dixon 9918  
WALTHAM, MASS.  
Robert A. Waters, Inc.  
Waltham 5-6900  
HOLLYWOOD, CALIFORNIA  
G. B. Miller Co., Hollywood 9-6305  
SEATTLE, WASH.  
G. B. Miller Co., Lander -3320

ALBUQUERQUE, NEW MEXICO  
G. B. Miller Co.  
Albuquerque 5-8606  
SAN FRANCISCO, CALIF.  
G. B. Miller, Lytell 3-3438  
MINNEAPOLIS, MINN.  
H. M. Richardson and Co.  
Geneva 4078  
ARNPRIOR, ONTARIO, CANADA  
Measurement Engineering Limited  
Arnprior 400  
NEW HAVEN, CONN.  
Robert A. Waters, Inc.  
Fullton 7-6760

the power consumed by the motor. This emf is applied to the electronic potentiometer, which continuously records it.

The transformer and thermal-converter consists of heaters, thermocouples and a network of transformers for both potential and current input as shown in Fig. 1. Although heat generated in a resistance is proportional to the square of the current flowing through it,

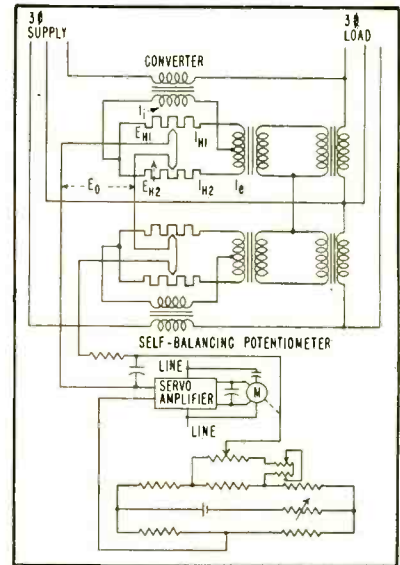

FIG. 1—Circuit of dough-consistency recorder. Thermocouples measure power consumed by three-phase motor driving agitator to indicate consistency

the output of this device is a linear function of the power being measured. This is accomplished by using a circuit that provides for cancellation of all squared terms leaving only a term proportional to the product of the in-phase voltage and current. In Fig. 1, the output to the potentiometer is equal to  $E_{H1} - E_{H2}$ .

Thermocouples with output linear with temperature will generate voltage that will be a constant  $K$  times temperature  $T$ .

$$E_{H1} = K_1 T_{H1} \quad (2A)$$

$$E_{H2} = K_1 T_{H2} \quad (2B)$$

Heat generated in a resistance is proportional to the square of the current flowing through it.

$$T_{H1} = K_2 I_{H1}^2 \quad (3A)$$

$$T_{H2} = K_2 I_{H2}^2 \quad (3B)$$

Combining the two sets of equations

$$E_{H1} = K_3 I_{H1}^2 \quad (4A)$$

$$E_{H2} = K_3 I_{H2}^2 \quad (4B)$$

The current flowing through the



# Why BUSS FUSES give "Trouble Free" Protection

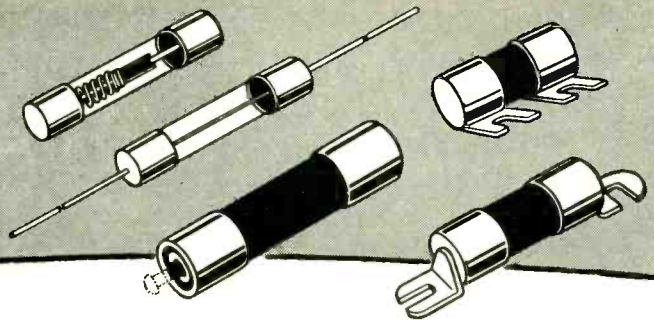

No matter when a BUSS fuse is called upon to operate, you can be sure of dependable and accurate electrical protection. For every BUSS fuse is tested in a sensitive electronic device that rejects any fuse not correctly calibrated, properly constructed and right in all physical dimensions.

This insistence on perfection is the reason manufacturers and service organizations can rely on BUSS as the one source for "trouble-free" fuses.

And by standardizing on BUSS fuses, you can simplify your buying, stock handling and records. The line is complete: standard type, dual-element (slow blowing), renewable and one-time types . . . in sizes from 1/500 ampere up — plus a complete line of fuse clips, blocks and holders.

Should you have a special problem in electrical protection — our fuse research laboratory and its staff of engineers are at your service to help you select the right fuse for the job — and if possible a fuse already available in wholesalers' stocks.

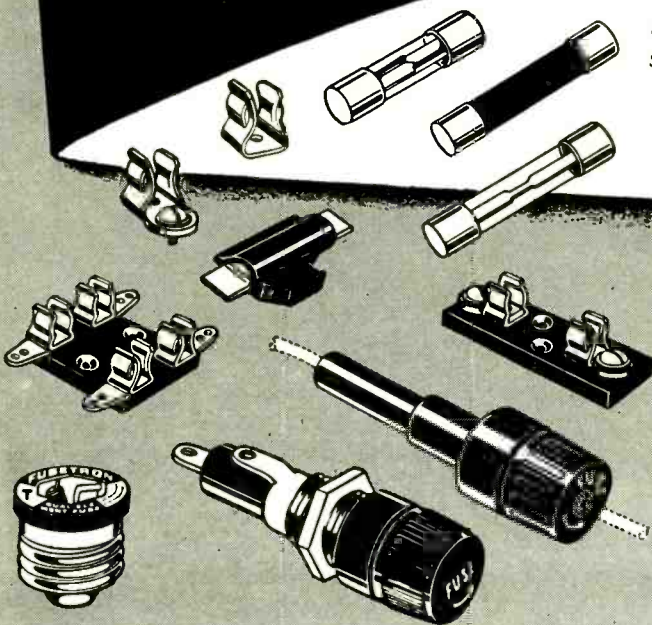

Makers of a complete line of fuses for home, farm, commercial, electronic and industrial use.

**FUSETRON**

TRUSTWORTHY NAMES IN  
ELECTRICAL PROTECTION

**BUSS**

BUSSMANN Mfg. Co. (Division of McGraw Electric Co.)  
University at Jefferson, St. Louis 7, Mo.

Please send me bulletin SFB containing facts on  
BUSS small dimension fuses and fuse holders.

Name \_\_\_\_\_

Title \_\_\_\_\_

Company \_\_\_\_\_

Address \_\_\_\_\_

City & Zone \_\_\_\_\_ State \_\_\_\_\_

ELRC-454

For more information mail this Coupon ►

# Winchester Electronics

MINIATURE and  
SUB-MINIATURE

## ELECTRICAL CONNECTORS

SERIES  
"QRE"

QUICK-  
DISCONNECTING  
SELF-ALIGNING

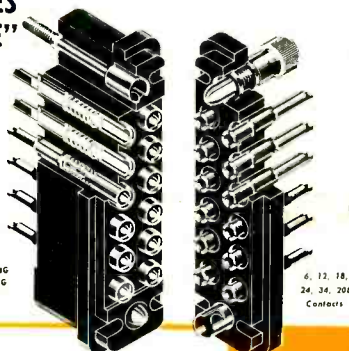

6, 12, 18,  
24, 34, 208  
Contacts

The Accepted Standard for  
QUALITY • COMPACTNESS • RUGGEDNESS  
LIGHT WEIGHT • DEPENDABILITY

These are the precision Connectors you saw featured at the I.R.E. SHOW. Connectors long established as the finest in the electrical connector art. These and many others...or completely new designs...are quickly available to you...for long and dependable trouble-free service.

SUB-MINIATURE SERIES  
"SMRE"



ACTUAL SIZE

7, 14,  
20, 26,  
29, 34  
Contacts

HEAVY DUTY TYPES "200" to "900"



Used in  
"AN" Shells

1/4 ACTUAL SIZE



SERIES "M"  
MINIATURE

4, 5, 7, 9  
Contacts

ACTUAL SIZE



SERIES "HM"  
HERMETIC PLUG  
(Round Hole)

Used with  
"M"  
Receptacles

ACTUAL SIZE



TYPES "RA" & "RB"  
WATERPROOF

4 or 9  
Contacts 1/2 ACTUAL SIZE



SERIES "MRE"  
MINIATURE

7, 8,  
9, 14,  
18, 20,  
21, 26,  
34, 41, 50,  
75 Contacts

1/2 ACTUAL SIZE



SERIES "HMRE"  
HERMETIC PLUG

Used with  
"MRE"  
Receptacles

ACTUAL SIZE



AIRCRAFT SERIES "A"

7, 10,  
15, 18  
Contacts

1/2 ACTUAL SIZE

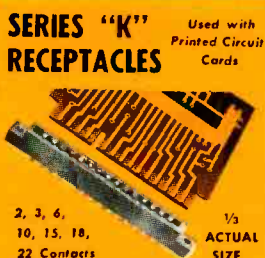

SERIES "K"  
RECEPTACLES

Used with  
Printed Circuit  
Cards

2, 3, 6,  
10, 15, 18,  
22 Contacts

1/2 ACTUAL SIZE



TYPES "CR" & "CM"

1/2 ACTUAL SIZE

MINIATURE  
PRESSURE-TIGHT

Many features are covered by our Patents: Nos. 161900, 162792, 2411861, 2466370, 2513080, 2526325, 2532538, 2633482 and 2659872.

Wire or write for catalog of other types or advise your special requirements.

heating elements is the algebraic sum of the current from the current and potential transformers.

$$I_{H1} = I_e + \frac{1}{2}I_i \quad (5A)$$

$$I_{H2} = I_e - \frac{1}{2}I_i \quad (5B)$$

Squaring Eq. 5

$$I_{H1}^2 = I_e^2 + I_e I_i + \frac{I_i^2}{4} \quad (6A)$$

$$I_{H2}^2 = I_e^2 + I_e I_i + \frac{I_i^2}{4} \quad (6B)$$

Combining Eq. 4 and 6

$$E_{H1} = K_2 \left( I_e^2 + I_e I_i + \frac{I_i^2}{4} \right) \quad (7A)$$

$$E_{H2} = K_3 \left( I_e^2 - I_e I_i + \frac{I_i^2}{4} \right) \quad (7B)$$

Combining Eq. 1, 7A and 7B

$$E_o = 2 K_3 I_e I_i \quad (8)$$

The recorder used is the Brown electronic strip-chart potentiometer. The input circuit differs slightly from that used in a millivoltage measuring instrument in order to eliminate the rapid power fluctuations caused by the mixing arms entering and leaving the mixture. The resultant record is a graph of consistency.

### Transducers for Ultrasonic Drilling

A PRACTICAL limit to the maximum cutting rates obtainable from a transducer used for ultrasonic drilling is set by the danger of fatiguing the material of the transducer under high alternating stresses set up in it. However, by careful design of transducer-to-drill bit couplings it is possible to produce more intense vibrations at the tip than those obtainable at the transducer face. This is achieved by using a step-up velocity transformer in the form of a tapered stub of metal. If properly designed, large oscillatory amplitudes, many times those at the transducer face, can be obtained at the free end. It is then feasible to operate the transducer at extremely low power levels and still obtain large motions at the drill.

To obtain maximum drilling rates, the tool must be made to move with as large an oscillatory amplitude as possible, the velocity at the tip being much less important than the displacement. This means that a low operating fre-

Winchester Electronics, Inc.

Products and Designs Are Available Only  
from Winchester Electronics, Inc.



WEST COAST BRANCH:

1729 Wilshire Boulevard, Santa Monica, California

GLENBROOK, CONN., U.S.A.



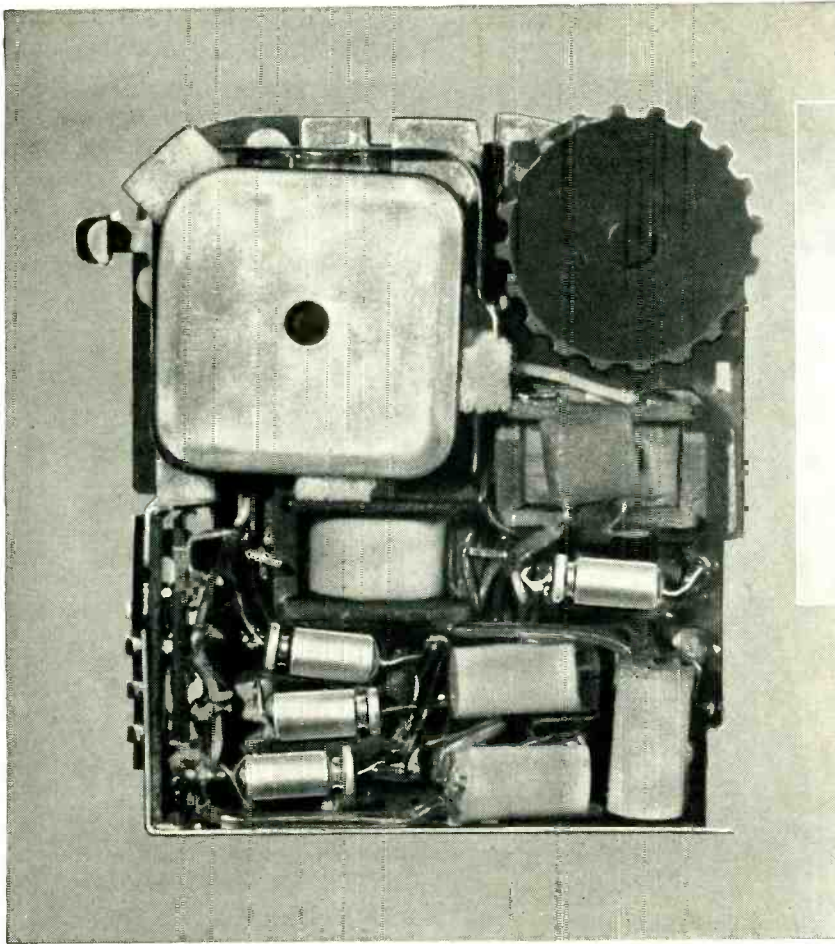

Four G-E Micro-miniature Tantalitic capacitors easily fit into small space provided in this new all-transistor hearing aid. Man above adjusts volume control.

Other applications now being investigated:

- WALKIE-TALKIES
- WRIST RADIOS
- PAGING SYSTEMS

## How Tantalitic Capacitors Are Used In Miniaturized Hearing Aids

Four G-E Micro-miniature Tantalitic capacitors are used in this new all-transistor hearing aid. These high-capacitance, small-size units are necessary due to the low-impedance characteristics of transistors, as compared with the vacuum tubes formerly used. Ceramic and paper dielectric capacitors cannot supply sufficient capacitance in the small size desired, according to hearing aid design engineers.

Pictures, circuit diagram, application information courtesy Sonotone Corp.

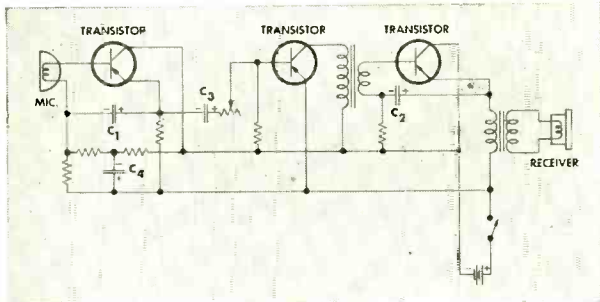

Simplified schematic diagram of Sonotone all-transistor hearing aid, showing location of G-E Micro-miniature Tantalitic capacitors.

Operating at a battery voltage of 2.5 volts, this hearing aid uses two units rated at 2 microfarads each for by-pass,  $C_1$  and  $C_2$  (see diagram). They give a low-impedance signal path from the source to the input of the transistor. Two 1-microfarad units,  $C_3$  and  $C_4$ , are used for coupling and filtering respectively, where their low leakage current of .18 microamperes/uf/volt at 25 deg. C is especially important.

G-E Micro-miniature Tantalitics can be obtained in ratings up to 20 volts, or, up to 8 uf in a  $\frac{5}{16}$ -in. long by  $\frac{1}{8}$ -in. dia. case size, higher capacitance in a  $\frac{1}{2}$ -in. long by  $\frac{1}{8}$ -in. dia. case size. Capacitance tolerance is  $-0\%$  to  $+100\%$ .

For more information about G-E Micro-miniature Tantalitic capacitors, contact your G-E Apparatus Sales Office or write for bulletin GEA-6065 to General Electric Company, Section 442-15, Schenectady 5, New York.

GENERAL  ELECTRIC

# Communication Engineers

with  
experience  
in  
the  
fields  
of

**Systems  
Engineering**

**Digital  
Techniques**

**Circuit  
Development**

**Electro-  
mechanical  
Development**

**Equipment  
Engineering**

## THE COMPANY

Hughes Research and Development Laboratories, located in Southern California, form one of the nation's leading electronics organizations. The personnel are presently engaged in the development and production of advanced electronics systems and devices.

## AREAS OF WORK

The communication group is concerned with the design and development of unique radio communication systems and with exploiting new radio communication techniques. People whose interests lie in the fields of propaga-

tion phenomena, antenna systems, network theory, magnetic recording, digital techniques, and intricate electromechanical devices are needed in this program.

## THE FUTURE

Engineers who enjoy a variety of problems requiring originality and ingenuity find the proper environment for personal advancement in these activity areas. Widespread future application of advanced communication techniques will enable the Hughes engineer to take full advantage of his experience as the Company expands commercially.

*Write today, giving details of qualifications and experience. Assurance is required that relocation of the applicant will not cause disruption of an urgent military project.*

*How to apply*

quency is an advantage since the lower the frequency the lower the input power required to produce the same amplitude. However, from the viewpoint of convenience in operation there is an advantage in keeping the frequency ultrasonic. The most efficient practical vibrator is a magnetostriction transducer resonant at around 20 kc.

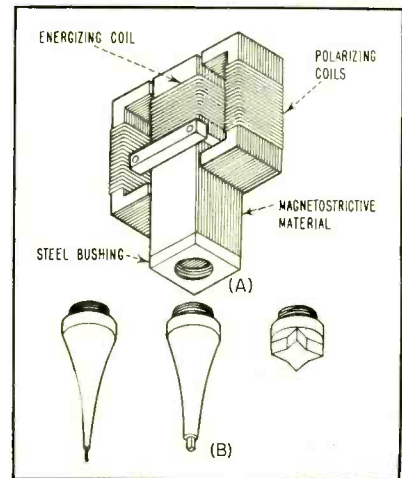

FIG. 1—Magnetostrictive transducer (A) and velocity step-up transformers (B) for obtaining high-amplitude oscillations from low-power oscillator

Figure 1 illustrates the essential features of an ultrasonic-drill transducer. The transducer consists of a stack of nickel laminations. A steel bushing tapped to serve as a tool holder is attached to the lower end of the stack. The transducer is clamped rigidly at its center and the upper half carries the energizing coil wound on a form, which, to avoid mechanical damping, does not make physical contact with the transducer.

A signal at the resonant frequency of the transducer is applied from a conventional oscillator and amplifier combination. Output from the amplifier is matched to the transducer load, which can be varied by adjusting the number of turns of wire on the energizing coil. In addition to the alternating drive field a d-c polarizing field is required. This signal should be large enough to give a flux density approaching saturation of the transducer material. This is most conveniently obtained by completing the magnetic circuit of the transducer by means of high-permeability laminations close to, but not

*Advancements in the fields of wave propagation, translation of information, communication theory, circuit techniques and equipment miniaturization have created a number of new openings for qualified engineers in the Hughes Advanced Electronics Laboratory.*

# Hughes

RESEARCH AND DEVELOPMENT LABORATORIES

Scientific  
and  
Engineering  
Staff

CULVER CITY,  
LOS ANGELES  
COUNTY,  
CALIFORNIA



# Hughes Diodes for Computer Applications

Types 1N191 and 1N192

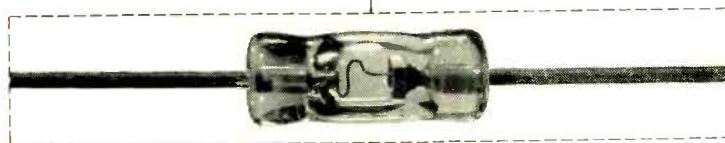

Actual dimensions  
of diode body:  
.265" X .130"

The reliability of Hughes Germanium Diodes in many types of computer applications has been recognized in the field for some time. Their performance—frequently under severe operating conditions—continues to add to this reputation.

Now, as part of the continuing program to meet the expanding requirements for computer components, Hughes announces the registration of Diode Types 1N191 and 1N192. Both are selected for their outstanding performance in computer service.

These computer type diodes, like all Hughes diodes, are designed to ensure extremely high moisture resistance... thermal stability... electrical stability... subminiature size... thorough dependability. These features mean long life with minimum maintenance.

### Recovery Time Characteristics at 25° Centigrade

**Type 1N191**  
50 K $\Omega$  @ 0.5  $\mu$ sec and 400 K $\Omega$  @ 3.5  $\mu$ sec maximum.  
**Type 1N192**  
50 K $\Omega$  @ 0.5  $\mu$ sec and 200 K $\Omega$  @ 3.5  $\mu$ sec maximum.

To measure pulse recovery for both types, diodes are pulsed at 30 mA in the forward direction and then a back voltage of -35 volts is applied.

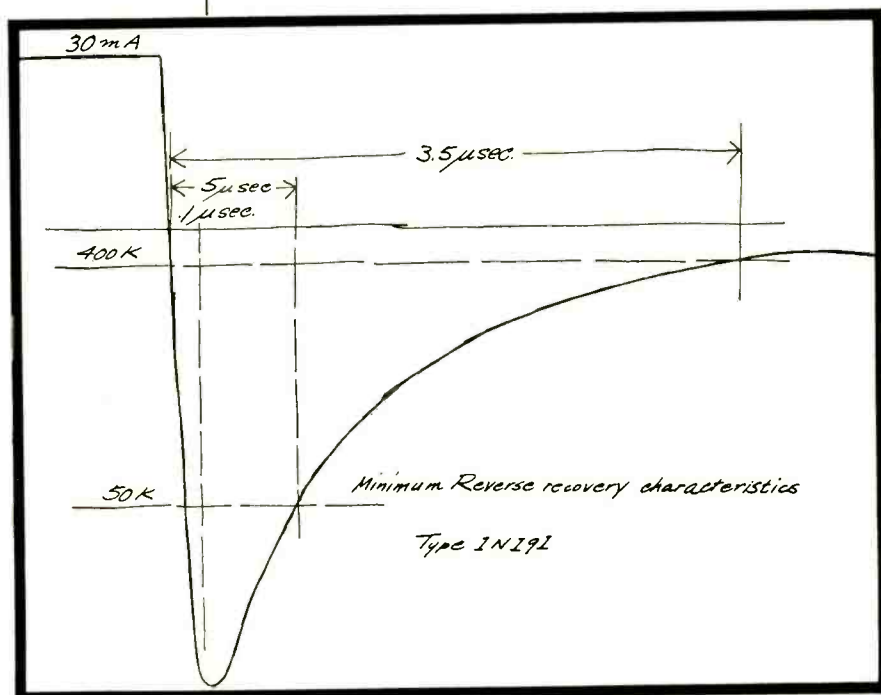

### Maximum Back Current at 55° Centigrade

**Type 1N191**  
0.25 mA @ -10V and .125 mA @ -50V.  
**Type 1N192**  
.05 mA @ -10V and .25 mA @ -50V.

If you need special computer type diodes, chances are that we can furnish them on a production basis—because we are constantly producing and providing many types to meet literally hundreds of electronics and communications applications. Among these are high forward conductance, low-voltage diodes, used for certain computer applications. Write for new descriptive brochure.

SEMICONDUCTOR  
SALES  
DEPARTMENT

**Hughes**

Aircraft Company  
Culver City  
California



NEW YORK CITY CHICAGO

when **ADVANCE**  
 supplies your relays...  
 you get **ACTION**

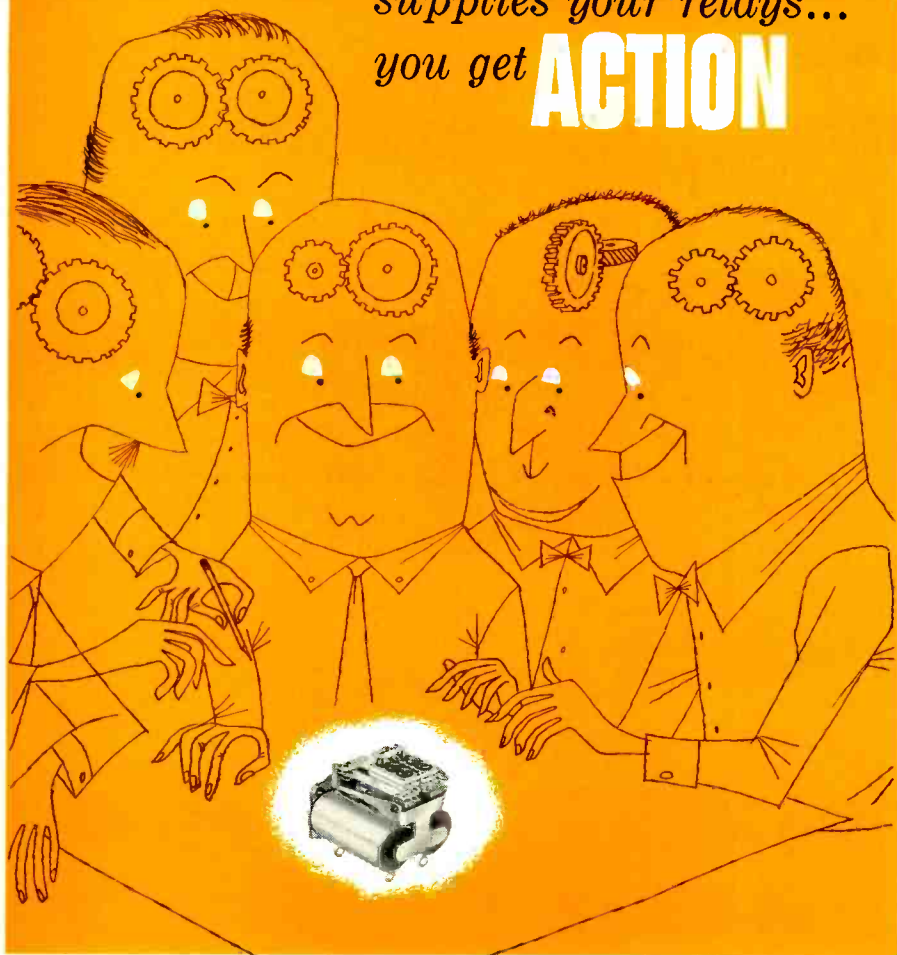

**Action on Standard Items.** Choose from a wide variety of in-stock relays, available for immediate shipment from Burbank or Chicago. Light-weight, small and precision-built, ADVANCE relays stand up under rugged service. They're specified by major manufacturers the country over.

**Action on "Specials."** When you need a specially designed relay, ADVANCE will work closely with your engineers to determine accurately what's needed...develop it in minimum time. You'll find us ready to cooperate with you on any relay problem.

**Action on Producing Relays.** There's manpower here to build your relays right...on time...and at the lowest prices consistent with top quality. It's our aim to help keep your production rolling...your products operating dependably. Whatever your relay problems—call ADVANCE for action.



## ADVANCE ELECTRIC AND RELAY COMPANY

2435 NORTH NAOMI STREET, BURBANK, CALIFORNIA

Sales Representatives in Principal Cities of U. S. and Canada

touching, the transducer.

Vibrations obtained at the transducer face are amplified by transmission down an exponentially tapered brass stub acting as a resonant velocity transformer. The drilling tip is screwed or soldered to the end of the stub. For efficient operation, the tip must be about the same size as the end dimensions of the stub. Consequently, to accommodate a large range of sizes it is convenient to provide a range of matching transformers having different transformation ratios and different end diameters as shown in Fig. 1B.

Cutting rate is roughly proportional to the square of the oscillatory tip amplitude and therefore proportional to the electrical power supplied, so that by driving the transducer harder proportionately greater drilling speeds may be obtained. This article has been abstracted from a paper entitled "A High-Frequency Reciprocating Drill" by E. A. Neppiras, in the *Journal of Scientific Instruments*, March 1953.

## Pulse Power Supply for Precipitators

IN ELECTRIC precipitators maximum particle collection is obtained when the electrical forces acting on the particles are made as large as possible. Collection efficiency depends on both the magnitude and the shape of the applied voltage wave. Maximum operating voltages are limited by sparking in the precipitator. Steady voltage has a relatively low sparking value and is unsuited for most precipitator applications. Both full-wave and half-wave unfiltered or pulsating rectified voltages have higher sparking values and are much more stable in operation but their characteristics are arbitrarily limited by the 60-cycle alternating voltage from which they are derived. The pulse method, on the other hand, is designed so that both the duration and frequency of the current pulses supplied are subject to precise adjustment and control.

The pulse equipment comprises a high-voltage high-power pulse



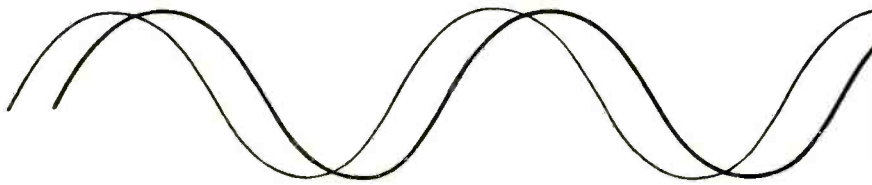
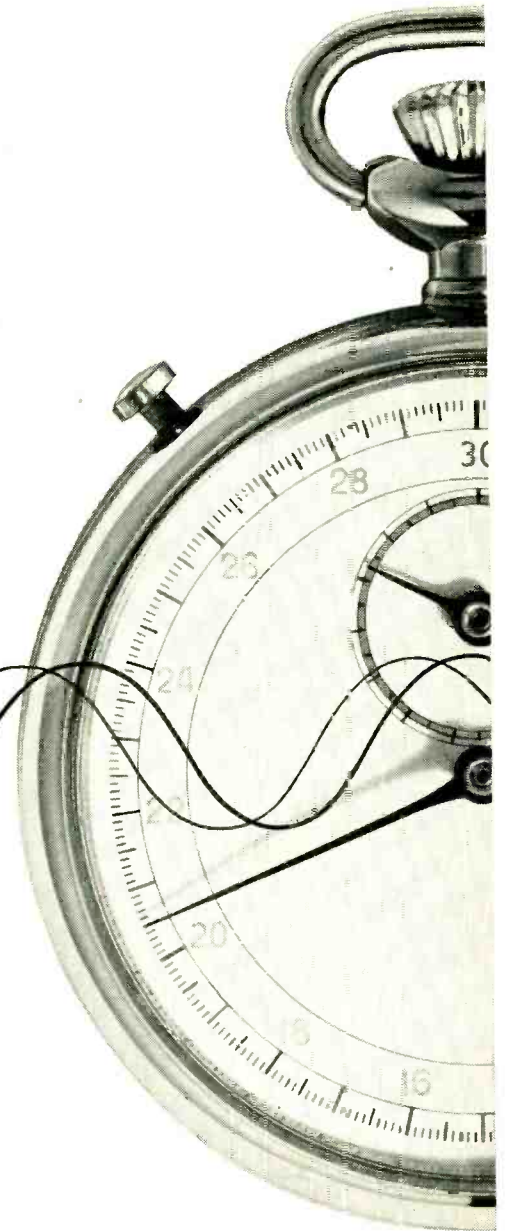

## WHAT TIME IS GREEN ?

In color television, the colors on the screen are determined in a special way. A reference signal is sent and then the color signals are matched against it. For example, when the second signal is out of step by 50-billionths of a second, the color is green; 130-billionths means blue.

For colors to be true, the timing must be exact. An error of unbelievably small size can throw the entire picture off color. A delay of only a few billionths of a second can make a yellow dress appear green or a pale complexion look red.

To ready the Bell System's television network for color transmission, scientists at Bell Telephone Laboratories developed equipment which measures wave delay to one-billionth of a second. If the waves are off, as they wing their way across the country, they are corrected by equalizers placed at key points on the circuit.

This important contribution to color television is another example of the pioneer work done by Bell Telephone Laboratories to give America the finest communications in the world.



To keep colors true in television, signals must be kept on one of the world's strictest timetables. Equalizers that correct off-schedule waves are put into place at main repeater stations of the transcontinental radio-relay system.

### BELL TELEPHONE LABORATORIES

IMPROVING TELEPHONE SERVICE FOR AMERICA PROVIDES CAREERS FOR  
CREATIVE MEN IN SCIENTIFIC AND TECHNICAL FIELDS.



# LONG BEACH

*in Southern California*

## OFFERS INDUSTRY

# PLENTY OF SKILLED LABOR

### Looking for a new plant site?

Then check on the large reservoir of skilled, semi-skilled and technical workers who own their homes in the Long Beach area.

Thousands of them came here during the war for defense jobs. They liked Long Beach so well they stayed to work in other growing industries. Many others are moving here daily.

Favorable climate, superior living and working conditions, year-round recreational advantages, and generally lower costs of living all contribute to a relatively contented, efficient and dependable labor supply.

Probably no other area offers such a concentration of desirable labor. And they'll be glad to work for you in Long Beach because, although they live here, many of them now work far from home.

### Other Advantages

There are at least 11 other reasons for locating your plant in Long Beach. Transportation, tax, utility and insurance savings; low-cost land values, construction and operation; and good housing facilities are a few of the profit-making factors.

Write today for complete information—yours for the asking. Naturally, all inquiries confidential.

CHAMBER OF COMMERCE • DEPARTMENT OF INDUSTRY

200 East Ocean Boulevard, Long Beach 2, California

generator, capable of supplying high-voltage pulses of the order of 100  $\mu$ sec duration at a frequency of several hundred pulses per second, which in turn may be commutated to as many as four or more precipitator sections. The method provides higher peak voltages and increased precipitator efficiency with inherent current-limiting action during precipitator spark-over.

The basic circuit is that of the line-type pulser in which energy is accumulated in a capacitor over relatively long periods and then discharged rapidly into the load, so that the output consists of a series of uniformly spaced high-power pulses.

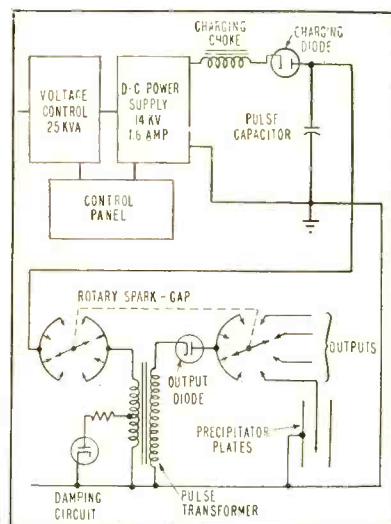

FIG. 1—Pulsed power supply for electrostatic precipitator. Rotary spark gap distributes pulses to a number of precipitator plates

A schematic diagram of the pulser set is shown in Fig. 1. The set is rated at 70-kv peak voltage, 300-milliampere average current, 15-kw average power, 480-cycle pulse frequency, and 150-micro-second pulse duration. Four commutated outputs are provided which permit operation of four separate high-tension precipitator sections from one set. The electrical operation of the pulser is characterized by an over-all efficiency of about 70 percent, and by a flexibility of power output, pulse frequency, and pulse duration. Pulse frequency is varied by means of a variable speed motor driving the rotary spark gap. Precipitator sparking is reflected in the pulse circuit by a momentary increase in the pulse discharge current, but with proper adjustment





helps put the  
**“LOCK”**

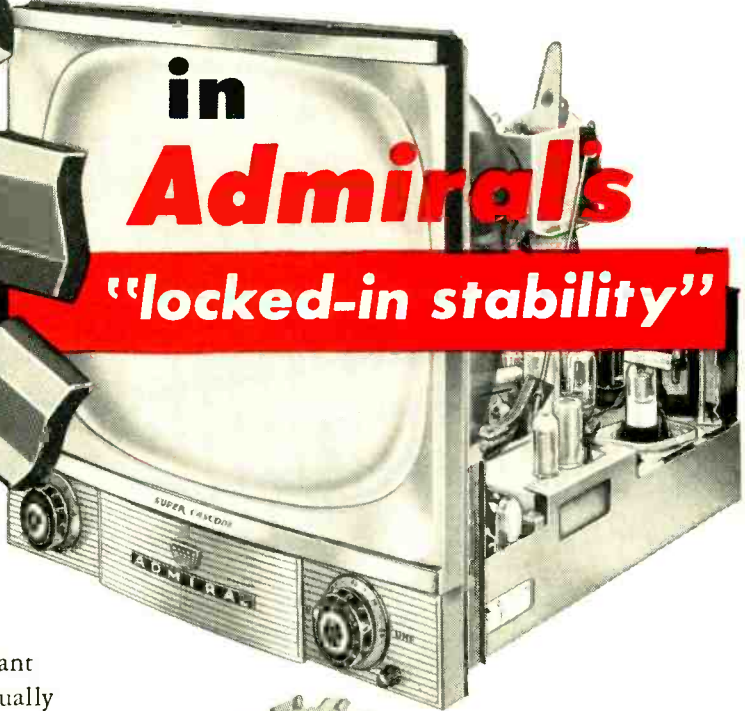

in  
**Admiral's**  
**“locked-in stability”**

Placed at strategic points in the chassis, Everlock lockwashers help keep Admiral TV sets at their brilliant best. Everlock's exclusive alternating chisel edges actually bite into both work and screw—provide fastenings that are *permanently secure*.

Remaining tight for the life of the product, Everlock lockwashers, locknuts and lock terminals help to safeguard many of America's foremost products.

If permanent, vibration-proof fastenings are part of *your* production picture, remember—with Everlock, you can *fasten* it and *forget* it. In sizes and materials to meet any specifications.



A full line of Everlock lockwashers and locknuts. Write for free catalog.

"EVERLOCK" IS THE REGISTERED TRADEMARK OF THOMPSON-BREMER & COMPANY

**THOMPSON-BREMER & COMPANY**

520 North Dearborn Street • Chicago 10, Illinois

SUBSIDIARY OF AMERICAN MACHINE & FOUNDRY CO., NEW YORK.

● Write for information or contact your nearby Everlock representative.

- |   |   |   |   |   |   |
|---|---|---|---|---|---|
| Kenneth D. DeLanoy<br>Dayton 3, Ohio          | J. M. Murphy<br>Manchester, Connecticut   | W. L. Barth, Jr.<br>Chicago 34, Illinois  | Thom Lundeen<br>Moline, Illinois        | Richard C. Dudek<br>Beverly Hills, California | J. J. McIntosh<br>Atlanta 6, Georgia        |
| Oscar P. Martin<br>Lakewood 7, Ohio           | Russell T. Brosius<br>Philadelphia 3, Pa. | C. W. McNeil<br>Houston, Texas            | Forrest Moschner<br>St. Louis, Missouri | P. L. Robertson<br>Milton, Ontario, Canada    | Donald G. Teeling<br>Indianapolis 44, Ind.  |
| J. Ramsey Reese, Inc.<br>New York 7, New York | Sam T. Keller<br>Detroit 1, Michigan      | Leonard F. Berg<br>St. Paul 14, Minnesota | A. J. Murphy<br>DeWitt, New York        | Sam T. Gleaves<br>Louisville 5, Kentucky      | Oregon Indus. Factors<br>Portland 1, Oregon |

# Performance bonded for keeps



## Centralab metallized ceramics combine electrical and physical properties of both materials

Centralab does remarkable things with ceramics. Forms can be molded, pressed, extruded, turned or machined. Metallizing ceramics by pressing, or plating opens many new electronic and industrial applications:

- Tens of thousands of condenser shafts complete with ball races, rotor bars, feed-thru bushings, hermetically sealed parts, complex machined units have been delivered since 1937.
- Designers can count on very close tolerances, finish, bearing surface and conductivity of metal parts combined with JAN-specified characteristics of ceramic materials, including:
  - High dielectric strength — 240 volts per mil.
  - Less loss at high frequency — loss factor at 1 MC — .007.
  - High mechanical strength — 18,000 psi, modulus of rupture.
  - Harder than quartz—7.5 Mohs' scale.
  - Impervious to moisture or acids (.005% $\epsilon$ ).

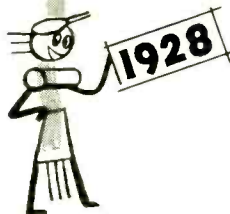

### Put Centralab's 26 years of ceramic experience to work for you

- Thousands of different ceramic formulas are "ready to go" to solve your particular problem.
- Large staff of ceramic and electronic engineers — available for consultation.
- All parts 100% tested in most modern, mechanized production facilities available anywhere.

Got a special ceramic problem that needs solving? Call on Centralab.

Standard items are available at your local (CRL) distributor—see Catalog 28 or JAN Bulletin 42-181.

# Centralab

A Division of Globe-Union Inc.  
914 E. Keefe Avenue • Milwaukee 1, Wisconsin  
In Canada: 804 Mt. Pleasant Road, Toronto, Ontario

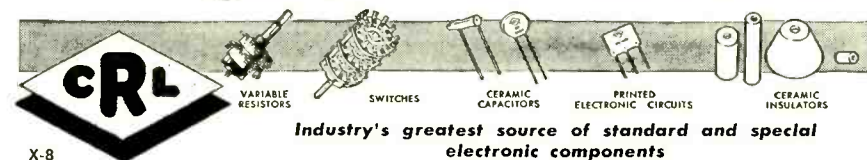

Industry's greatest source of standard and special electronic components

X-8

this produces little or no effect in the charging circuits.

This article has been abstracted from "Electrostatic Precipitator Pulse Power Supply" by H. J. White, *Electrical Engineering*, March 1953 p 236.

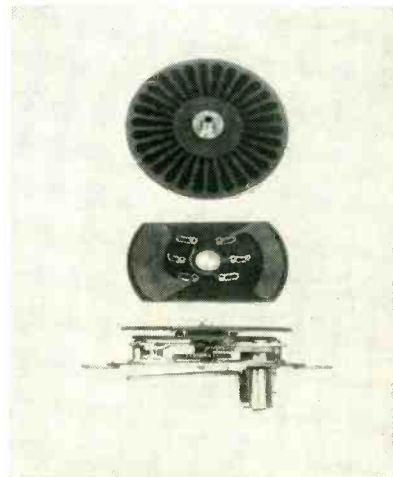

Rotor (top) stator (center) and reciprocating drive mechanism (bottom) for the miniature electrostatic generator used in nuclear radiation detector

## Printed Electrostatic Generator

ALPHA SURVEY METERS using the air proportional counter can be operated from a storage capacitor power supply. The probe requires 2,000 volts at a current of not more than  $10^{-12}$  ampere. Such a capacitor used in a Navy radiation survey instrument requires occasional recharging to make up leakage loss of about 100 volts.

To avoid use of special batteries or a power supply that would add complexity to existing electronic equipment, a miniature electrostatic source of high voltage has been developed by the National Bureau of Standards. Operation of the generator depends upon the ability of one charged body to induce a charge on another body close by.

The generator consists of a stator of two field plate conductors and a rotor with a number of pairs of conducting sectors. Printed circuit techniques are used to apply conducting areas to the flat insulating plates of the rotor and stator.

Several sets of brushes transfer electrical charge between the components of the system and the capacitor. The attached reciprocal



Rely on **C-A-C** for PRECISION • QUALITY • DELIVERY...



**SIZE**  
1-1/16 OD  
1/2 H  
6-32 MTG.



**SIZE**  
1-5/16 OD  
23/32 H  
6-32 MTG.

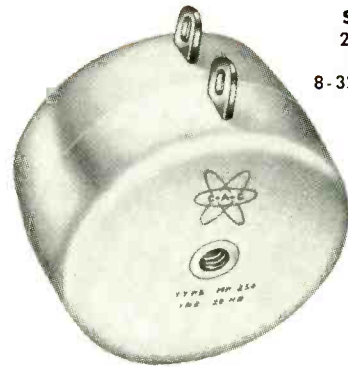

**SIZE**  
2 OD  
1 H  
8-32 MTG.

TYPES	Q max.	Freq.
MP206	140	14 KC
MP848	185	35 KC
MP603	170	60 KC
MP073	265	250 KC

TYPES	Q max.	Freq.
MP930	160	8 KC
MP395	225	25 KC

TYPE	Q max.	Freq.
MP254	210	6 KC

## MP TOROIDS

MP (Molded Plastic) units are the result of a long development program. CAC MP toroids have repeatedly passed all tests for MIL-T-27, Grade 1, Class A without exception. Most compact design—may be stacked—mounted by center bushing—absorbs mounting pressures—sturdy silver plated terminals—arrangements available up to 5 terminal connections—standard inductance values listed below shipped from stock—special inductances and configurations supplied promptly on request.

## STOCKED VALUE TABLE

MP206		MP848		MP930		MP395		MP254	
IND.	PART. No.	IND.	PART. No.	IND.	PART. No.	IND.	PART. No.	IND.	PART. No.
5.0 MH	MP-206-1-	2.0 MH	MP-848-1-	5.0 MH	MP-930-1-	5.0 MH	MP-395-1-	20 MH	MP 254-1-
6.0 MH	MP-206-2-	2.4 MH	MP-848-2-	6.0 MH	MP-930-2-	6.0 MH	MP-395-2-	24 MH	MP 254-2-
7.2 MH	MP-206-3-	3.0 MH	MP-848-3-	7.2 MH	MP-930-3-	7.2 MH	MP-395-3-	30 MH	MP 254-3-
8.6 MH	MP-206-4-	3.6 MH	MP-848-4-	8.6 MH	MP-930-4-	8.6 MH	MP-395-4-	36 MH	MP 254-4-
10 MH	MP-206-5-	4.3 MH	MP-848-5-	10 MH	MP-930-5-	10 MH	MP-395-5-	43 MH	MP 254-5-
12 MH	MP-206-6-	5.0 MH	MP-848-6-	12 MH	MP-930-6-	12 MH	MP-395-6-	50 MH	MP 254-6-
15 MH	MP-206-7-	6.0 MH	MP-848-7-	15 MH	MP-930-7-	15 MH	MP-395-7-	60 MH	MP 254-7-
17.5 MH	MP-206-8-	7.2 MH	MP-848-8-	17.5 MH	MP-930-8-	17.5 MH	MP-395-8-	72 MH	MP 254-8-
20 MH	MP-206-9-	8.6 MH	MP-848-9-	20 MH	MP-930-9-	20 MH	MP-395-9-	86 MH	MP 254-9-
24 MH	MP-206-10-	10 MH	MP-848-10-	24 MH	MP-930-10-	24 MH	MP-395-10-	100 MH	MP 254-10-
30 MH	MP-206-11-	12 MH	MP-848-11-	30 MH	MP-930-11-	30 MH	MP-395-11-	120 MH	MP 254-11-
36 MH	MP-206-12-	15 MH	MP-848-12-	36 MH	MP-930-12-	36 MH	MP-395-12-	150 MH	MP 254-12-
43 MH	MP-206-13-	17.5 MH	MP-848-13-	43 MH	MP-930-13-	43 MH	MP-395-13-	175 MH	MP 254-13-
50 MH	MP-206-14-	20 MH	MP-848-14-	50 MH	MP-930-14-	50 MH	MP-395-14-	200 MH	MP 254-14-
60 MH	MP-206-15-	24 MH	MP-848-15-	60 MH	MP-930-15-	60 MH	MP-395-15-	240 MH	MP 254-15-
72 MH	MP-206-16-	30 MH	MP-848-16-	72 MH	MP-930-16-	72 MH	MP-395-16-	300 MH	MP 254-16-
86 MH	MP-206-17-	36 MH	MP-848-17-	86 MH	MP-930-17-	86 MH	MP-395-17-	360 MH	MP 254-17-
100 MH	MP-206-18-	43 MH	MP-848-18-	100 MH	MP-930-18-	100 MH	MP-395-18-	430 MH	MP 254-18-
120 MH	MP-206-19-	50 MH	MP-848-19-	120 MH	MP-930-19-	120 MH	MP-395-19-	500 MH	MP 254-19-
150 MH	MP-206-20-	60 MH	MP-848-20-	150 MH	MP-930-20-	150 MH	MP-395-20-	600 MH	MP 254-20-
175 MH	MP-206-21-	72 MH	MP-848-21-	175 MH	MP-930-21-	175 MH	MP-395-21-	720 MH	MP 254-21-
200 MH	MP-206-22-	86 MH	MP-848-22-	200 MH	MP-930-22-	200 MH	MP-395-22-	860 MH	MP 254-22-
240 MH	MP-206-23-	100 MH	MP-848-23-	240 MH	MP-930-23-	240 MH	MP-395-23-	1.00 HY	MP 254-23-
300 MH	MP-206-24-	120 MH	MP-848-24-	300 MH	MP-930-24-	300 MH	MP-395-24-	1.20 HY	MP 254-24-
360 MH	MP-206-25-	150 MH	MP-848-25-	360 MH	MP-930-25-	360 MH	MP-395-25-	1.50 HY	MP 254-25-
430 MH	MP-206-26-	175 MH	MP-848-26-	430 MH	MP-930-26-	430 MH	MP-395-26-	1.75 HY	MP 254-26-
500 MH	MP-206-27-	200 MH	MP-848-27-	500 MH	MP-930-27-	500 MH	MP-395-27-	2.00 HY	MP 254-27-
600 MH	MP-206-28-	240 MH	MP-848-28-	600 MH	MP-930-28-			2.40 HY	MP 254-28-
720 MH	MP-206-29-	300 MH	MP-848-29-	720 MH	MP-930-29-			3.00 HY	MP 254-29-
860 MH	MP-206-30-	360 MH	MP-848-30-	860 MH	MP-930-30-			3.60 HY	MP 254-30-
1.00 HY	MP-206-31-	430 MH	MP-848-31-	1.00 HY	MP-930-31-			4.30 HY	MP 254-31-
1.20 HY	MP-206-32-	500 MH	MP-848-32-	1.20 HY	MP-930-32-			5.00 HY	MP 254-32-
1.50 HY	MP-206-33-			1.50 HY	MP-930-33-			6.00 HY	MP 254-33-
1.75 HY	MP-206-34-			1.75 HY	MP-930-34-			7.20 HY	MP 254-34-
2.00 HY	MP-206-35-			2.00 HY	MP-930-35-			8.60 HY	MP 254-35-
2.40 HY	MP-206-36-			2.40 HY	MP-930-36-			10.0 HY	MP 254-36-
3.00 HY	MP-206-37-			3.00 HY	MP-930-37-			12.0 HY	MP 254-37-
				3.60 HY	MP-930-38-			15.0 HY	MP 254-38-
				4.30 HY	MP-930-39-			17.5 HY	MP 254-39-
				5.00 HY	MP-930-40-			20.0 HY	MP 254-40-
				6.00 HY	MP-930-41-			24.0 HY	MP 254-41-
				7.20 HY	MP-930-42-			30.0 HY	MP 254-42-
				8.6 HY	MP-930-43-			36.0 HY	MP 254-43-
				10.0 HY	MP-930-44-				
				12.0 HY	MP-930-45-				
				15.0 HY	MP-930-46-				
				17.5 HY	MP-930-47-				

**IN ORDERING...**

Add suffix "A" to above numbers for clear bushing  
Add suffix "B" to above numbers for tapped bushings  
Replace "MP" prefix with "HS" for metal encased toroids (see back page for description).

COMMUNICATION ACCESSORIES COMPANY  
Hickman Mills, Missouri

# WHICH OF THESE CHARACTERISTICS ARE ESSENTIALS ON YOUR REMOTE CONTROL JOBS?

Accuracy . . . High Load Capacity . . . Adaptability . . . Freedom from Trouble . . . Long Life . . . Flexibility . . . these are some of the qualities of **ACCO TRU-LAY PUSH-PULL FLEXIBLE CONTROLS** that have made it possible to improve the operation of literally hundreds of mechanical products (list on request). Full description of this versatile **REMOTE CONTROL** is given in our **DATA FILE** available for your further study.

**ACCURACY** is inherent in the basic design, and in the standards of quality and precise dimension that control the manufacture of **TRU-LAY PUSH-PULL CONTROLS**. These are precision products, not gadgets.

**VERSATILITY** of this fine remote control can best be illustrated by citing some of the jobs it handles well . . . **HOT** jobs on jets and industrial furnaces . . . **COLD** jobs down to  $-70^{\circ}$  F. . . **WET** jobs (the conduit can be completely immersed) . . . **DIRTY** jobs . . . **ABRASIVE** jobs . . . **CORROSIVE** jobs . . . **HEAVY, TOUGH** jobs up to 1,000 lbs input . . . **LIGHT**

**DUTY** jobs . . . **REMOTE** jobs 150 feet or more from the control point . . . these units are frequently and successfully used in conjunction with electric, hydraulic and air controls . . . are thoroughly effective under almost any operating condition.

"**SOLID as a rod but FLEXIBLE as a wire rope**" aptly describes **TRU-LAY PUSH-PULL CONTROLS**. This *flexibility* provides positive, remote action whether anchorages are fixed or movable . . . it damps out noise and vibration—protects delicate instruments . . . it permits ease of handling and shipping even when assemblies are 100 or 150 feet long . . . it avoids the risk of damage always present with solid tubular controls that must be preformed to position . . . and flexibility greatly simplifies installation of controls by reducing the number of working parts and by making it possible to snake around obstructions. . .

to give you this simple and effective assembly

. . . rather than this complex (and expensive) series of linkages

**ADAPTABILITY** to all sorts of mechanical situations explains, in large measure, the wide-spread application of **TRU-LAY PUSH-PULLS**. Standard anchorages, fittings and heads have been designed that meet requirements on approximately 80% of the installations. Simple modifications of these standards, or minor changes in your own design, cover almost every special situation. Our engineers have the know-how on such matters.

**FREEDOM FROM TROUBLE** and **LONG LIFE** are assured even under exceptionally adverse operating conditions because of such things as . . . full protection of the flexible, inner, working member by the tough

Whether your interest is in a single application of this versatile **PUSH-PULL CONTROL**, or in its inclusion as a component of the product you manufacture, the six booklets and bulletins in this **DATA FILE** will answer your further questions, and will also provide you with the means of defining to us the application you may be interested in.

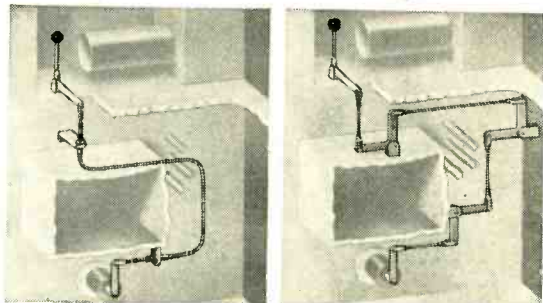

flexible conduit . . . lubrication of the inner, working member *for life* during assembly . . . seals that keep moisture, dust and other foreign matter out of the unit . . . cold swaging of fittings that makes them integral parts of the control unit. (Full construction details in our **DATA FILE**). We have never heard of a **TRU-LAY FLEXIBLE PUSH-PULL CONTROL** wearing out in normal service.



**ACCO**

WRITE for a copy, without obligation

**AUTOMOTIVE and AIRCRAFT DIVISION  
AMERICAN CHAIN & CABLE**



601-B Stephenson Bldg., Detroit 2

2216-B South Garfield Ave., Los Angeles 22 • Bridgeport 2, Conn.

ELECTRONS AT WORK

(continued)

driving system (illustrated) enables the rotor to be driven at speeds as high as 6,000 rpm.

Unique polarity of output voltage is established by means of a small external bias voltage to precharge the generator. This voltage is readily available from associated electronic equipment.

The unit illustrated, which is about three inches in its widest diameter, will charge a 0.02- $\mu$ f capacitor to two kilovolts in about 15 seconds using only hand power.

## CRO Measurement Of Beat Frequencies

By GEORGE PRELL  
Special Devices Division  
Askania Regulator Company  
Chicago, Ill.

THE METHOD described here is essentially a combination of common Lissajous and beat frequency techniques using an oscilloscope for detection and display. If a signal of fixed frequency  $f_s$  is applied to the horizontal plates and a signal of unknown frequency  $f_o$  is applied to the vertical plates a meaningless shaded rectangular pattern will result unless the frequencies have some rational relationship.

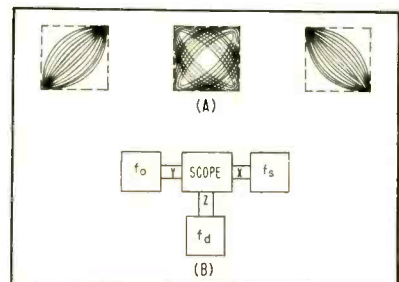

Oscilloscope patterns (A) obtained by applying a difference frequency to the Z axis as in (B)

If an interpolation signal of frequency  $f_d$  equal to the difference  $|f_s - f_o|$  is applied to the Z axis with sufficient amplitude to blank the picture during the negative half cycle, a stationary pattern will result whose shape depends on the phase relationship between  $f_d$  and  $|f_s - f_o|$ . By this method, the frequency  $f_o$  may be measured to an accuracy limited only by the accuracy of  $f_s$  and  $f_d$  and the patience of the observer in detecting movement of the pattern.

This method was used to measure the bandwidth of a tuned circuit at 4,000 cps, and resulted in a considerable increase in accuracy over the



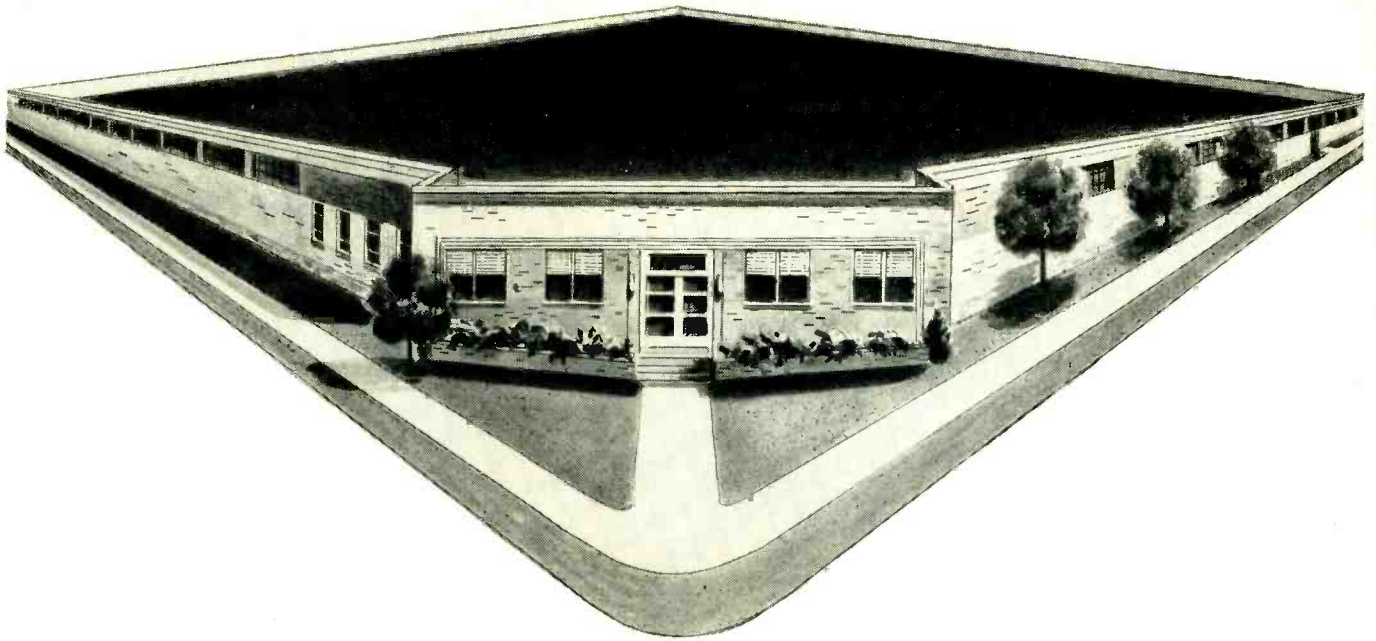

here's what's behind the  crystal that's so far ahead

**The Midland Factory** shown above is the world's largest plant devoted exclusively to producing crystals for frequency control. It is equipped with the finest and most complete production and testing machinery ever developed for this purpose. Here Midland pioneered development of crystals for color television, and is now ready for full-scale production.

**All this is important to you** for just one good reason: Every Midland crystal you use has been produced by such advanced techniques and under such rigid quality controls that you can be sure it will prove its completely reliable quality under every operating stress.



**Midland Critical Quality Control** extends through every step of crystal production, and includes precise angular control by X-ray. Uniform accuracy is maintained to the millionth part of an inch.

*Whatever your Crystal need, conventional or highly specialized,  
When it has to be exactly right, contact*



**Midland** MANUFACTURING COMPANY, INC.  
3155 Fiberglas Road, Kansas City, Kansas

WORLD'S LARGEST PRODUCER OF QUARTZ CRYSTALS

# Are your High-Cycle Alternator requirements special?

Lissajous method with a tunable oscillator.

## PERTINENT PATENTS

THE DIVERSITY of the electronic technique is demonstrated in the wide range of applications from which the patents, listed below, have been selected.

### Audio Amplifier

A recent British patent 688,273 for "Improvements in or Relating to Vacuum Tube Amplifiers" has been granted to W. H. Coulter of Chicago, Ill.

The improvements are in what have now become known as single-ended push-pull amplifiers.

The circuits of the invention for which the British patent was granted are shown in Fig. 1.

In the circuit of Fig. 1A two amplifier tubes are connected in series across a source of power. Coulter has proposed a terminology for these tubes that clearly sets forth which tube is involved in any discussions of such circuits.

The upper tube, having its plate connected to the B+ terminal is termed the free-anode tube and the lower tube having its cathode connected to the B- terminal as the free-cathode tube. The output load is connected between the junction of the series connected tubes and the B- terminal.

As is generally known, the principle of operation of the single-ended push-pull amplifier employs signals applied in push-pull to the grids of the series-connected amplifiers. The invention here discloses means of applying signals in push-pull to the two grids of the series-connected amplifiers while the output is single ended at the junction of the series tubes.

A single-ended signal is applied to the free-anode amplifier. A potentiometer  $R_1$  connected across the input circuit is employed to permit applying an attenuated signal to a triode phase-inverter stage so that it, in turn, drives the free-cathode amplifier with a signal 180 deg out of phase with that driving the free-anode amplifier. The phase-inverter cathode is returned to ground on B- through a potentiometer  $R_2$ . The resistance of  $R_2$  is



### Here Are Quick Facts:

**AMERICAN ELECTRIC REVOLVING FIELD ALTERNATORS**  
**CAPACITY RANGE**—15 KVA to 20 KVA (in stock). Up to 75 KVA on special order.  
**FAST RECOVERY**—Better than .2 seconds.  
**LOW VOLTAGE OVERSHOOT**—Less than 10%.  
**TOTAL HARMONIC CONTENT**—Under 5% on unbalanced 3-phase loads.

These characteristics apply to general uses. Where applications are specific, even better characteristics can be developed.

Where lowest possible maintenance, combined with excellent wave form characteristics are required, it's hard to match American Electric's Inductor-Type Alternators. But occasionally *special requirements* arise which may be better served by American Electric's Revolving Field Alternators.

### EXCITER REGULATING SYSTEM

Employs American Electric's trouble-free, direct-connected, high-cycle Inductor Alternator—which has no commutator, slip rings, brushes, springs, etc. Output is rectified and exciter-regulated by either electronic or magnetic amplifier means, then returned to the rotating field of the main alternator.



### MANY MODELS

American Electric Revolving Field Alternators are available in STATIONARY and PORTABLE TYPES, open and totally enclosed models, for all laboratory, production and testing applications.

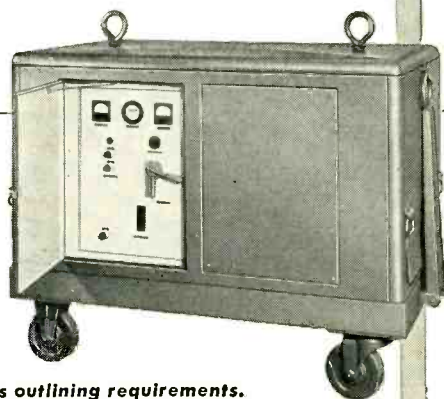

Write for details and quotations outlining requirements.

Also Manufacturers of  
 High Frequency  
 Inductor Alternators,  
 Miniature Electric Motors,  
 A.C. Industrial Motors,  
 Motor Driven Blowers & Fans



4811 Telegraph Road,  
 Los Angeles 22,  
 California

### FIELD ENGINEERING REPRESENTATIVES:

TRAVCO ENGINEERING COMPANY—Silver Spring (Md.) • Boston • Buffalo • New York City • Chicago • Dallas • Kansas City • Wright Field • Minneapolis • Seattle • Montreal • Toronto • JOE DAVIDSON & ASSOCIATES, Los Angeles.



Put your finger on

**EXTRA DEPENDABILITY**

by specifying...

CHESTER means dependability *plus* in wires and cables for every electronic and electrical application. The compounds used in all CHESTER Wire and Cable constructions are made in the CHESTER plant. Thus, complete control over selection of raw materials and manufacturing techniques, provides full control of quality... your assurance of uniformity in every foot of conductor bearing the CHESTER label!

**CHESTER**  
*plasticord-plasticote*  
**WIRES & CABLES**

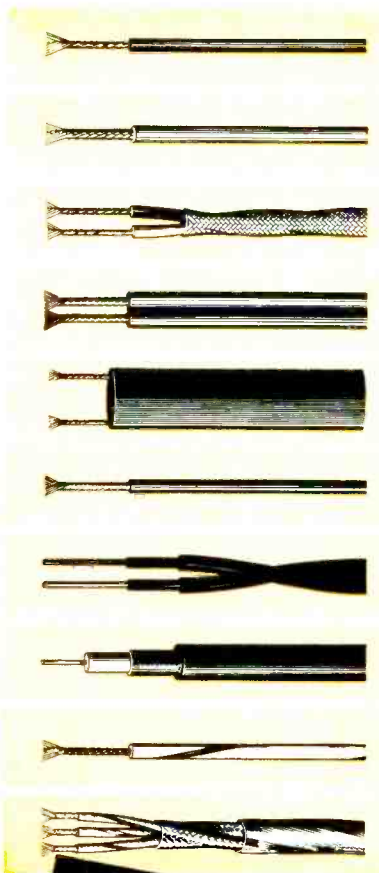

**JAN-C-76 WIRES\*** SRIR, SRHV,  
SRRF, WL

105°C, 90°C, 80°C, <sup>UL</sup> APPROVED; 120°C\*

**SHIELDED WIRES & CABLES**

**FLEXIBLE CORD**

**TV LEAD-IN WIRES**

**INSTRUMENT WIRES**

**COMMUNICATION WIRES** & CABLES TO SPECIFICATION

**COAXIAL CABLE**

**LACQUERED** AND NYLON COVERED **WIRES**

**SPECIAL WIRES** & CABLES TO SPECIFICATIONS

\*Solid colors or spiral marking

**CUSTOM CONSTRUCTIONS**  
to specification using Polyethylene, Polyvinyl chloride, Nylon, Braided and Lacquered Wires, Special Insulating Materials, Glass, Yarn, etc. Inquiries invited.

ASK *"Chesty"* FOR the New Chester Literature. Complete data on wires and cables for electrical and electronic wiring. Request yours, today!



REGISTERED  
U.S. PAT. OFF.

**CHESTER CABLE CORP.**

C H E S T E R • N E W Y O R K

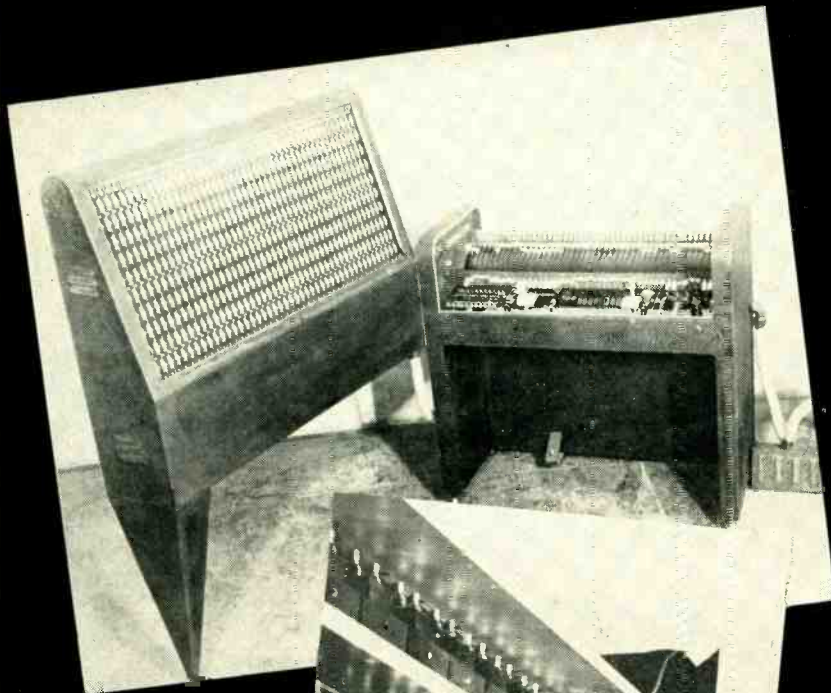

Photos  
Century Lighting Inc.



**ELECTRONS, INCORPORATED**

127 SUSSEX AVENUE  
NEWARK 3, N. J.

*Hundreds of our Inert Gas Thyratrons control  
Century Lighting Inc.'s electronic dimmers at  
C.B.S. TV City Hollywood*

very much greater than the load impedance so as to have no appreciable effect on the load. Adjustment of  $R_2$  is made to cancel the degenerative effect of the free-anode amplifier due to any signal voltage appearing across the load. When  $R_1$  and  $R_2$  are properly adjusted, signals on the grids of  $V_2$  and  $V_3$  are exactly equal and of opposite phase relation.

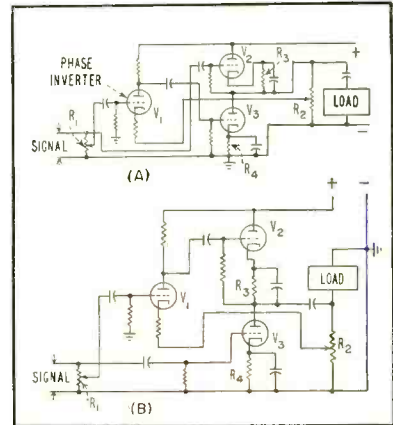

FIG. 1—Basic circuit of the series-tube amplifier (A) and alternative circuit (B) with  $R_2$  across load only

Figure 1B shows the circuit in which the signals fed to top and bottom tubes of the same amplifier are reversed. Resistor  $R_2$  in Fig. 1B is across the load only. In Fig. 1A,  $R_2$  is across both the load and output blocking capacitor. In Fig. 1A it can be seen that  $R_2$  is essentially in parallel with the free-cathode tube, whereas in the circuit of Fig. 1B it is essentially in parallel with the load. While independent cathode-bias resistors  $R_3$  and  $R_4$  are shown for each of the series connected amplifier tubes, bias may be obtained by other means.

The inventor points out that the circuits are useful in class-AB and class-B amplifiers because the capacitor in the load circuit supplies current during cutoff.

The major advantage of single-ended push-pull amplifiers such as that disclosed in this invention is their utility in directly driving load speakers of low impedance without need for an output transformer.

A U. S. patent 2,659,775 has been issued to Coulter for the same invention under the title "Amplifier Circuit Having Series-Connected Tubes." In Fig. 2 the basic additional circuit patented is shown and below, the circuit including an



# Do you have any of these problems?

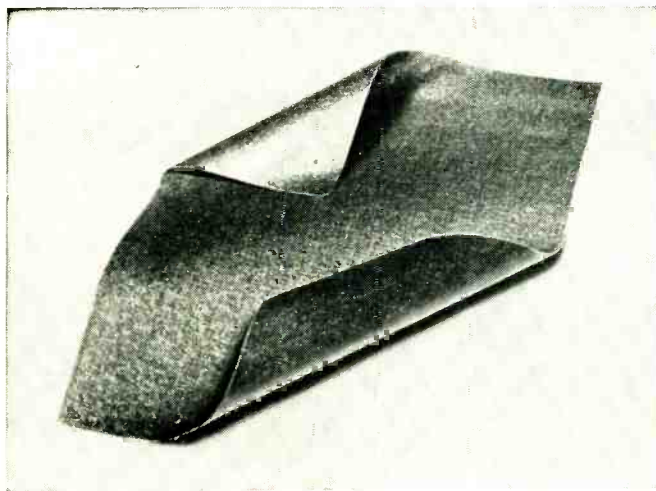

**1. Looking for a thin, flexible insulating material that will not break down under extremely high temperatures?** ISOMICA® Flexible Plate, Class B and Class H, built-up from continuous mica sheets, gives superior electrical and thermal insulation for coil wrappings and similar applications.

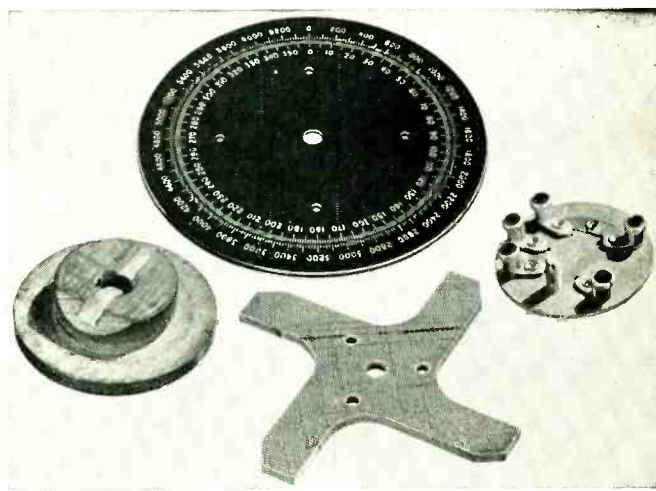

**2. Need a material with special mechanical, thermal and insulating properties?** LAMICOID®—a laminated plastic made with various fillers—gives you the properties you need for antenna parts, coil forms, tube sockets, switch gear and relay parts, panels, motor and transformer parts, and dozens of other uses.

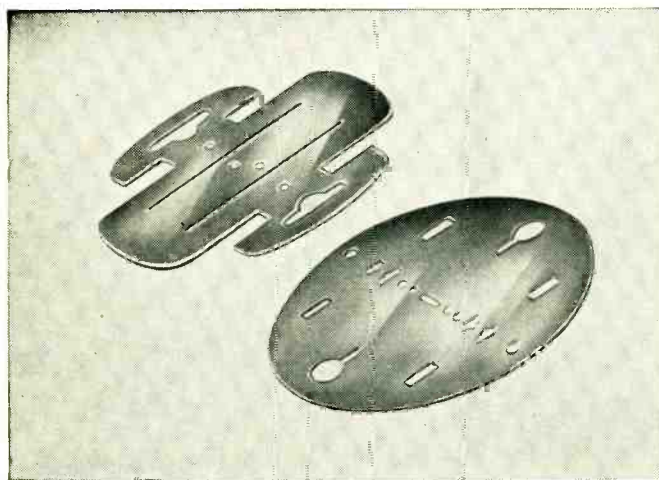

**3. Need accurately punched mica stampings for filament, grid and plate supports?** MICO produces mica stampings to extremely fine tolerances. Whenever you need precision-fabricated mica of the highest quality, call on MICO. We have 60 years of experience in this field.

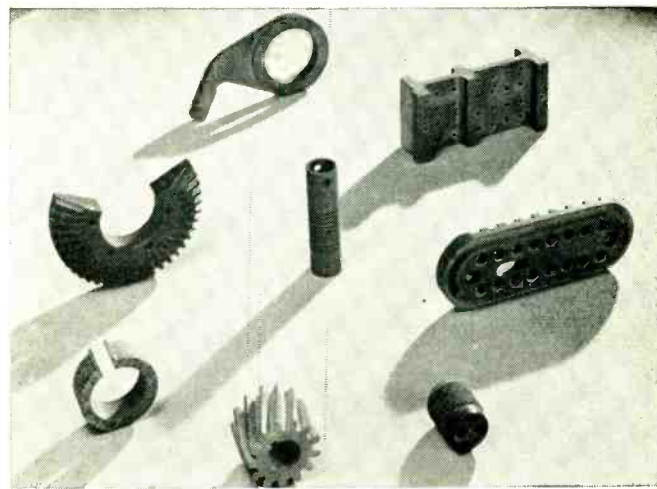

**4. Looking for precision-made fabricated parts?** Let us solve your problems with parts fabricated from LAMICOID®—a thermo-setting plastic—strong as metal, lighter than wood. We are fully equipped with the latest machinery and can provide you with the best possible service.

Whatever electrical insulation material you need—Class A to Class H—MICO makes it best. We manufacture it, cut it to size, or fabricate it to your specification. Send us your blueprints or problems today.



**MICA** *Insulator* **COMPANY**

Schenectady 1, New York

Offices in Principal Cities

In Canada—Micanite Canada Ltd., Granby, Quebec

LAMICOID® (Laminated Plastic) • MICANITE® (Built-up Mica) • EMPIRE® (Varnished Fabrics and Paper) • FABRICATED MICA • ISOMICA

The *Right Formula* For Solving Complex Problems...

**HUBBELL**  
*Interlock* **CONNECTORS**  
TRADE-MARK  
**+ New MAGNETIC DECISION ELEMENTS!**



*Inset shows closeup of computer blocks connected by wired Interlock Plugs.*

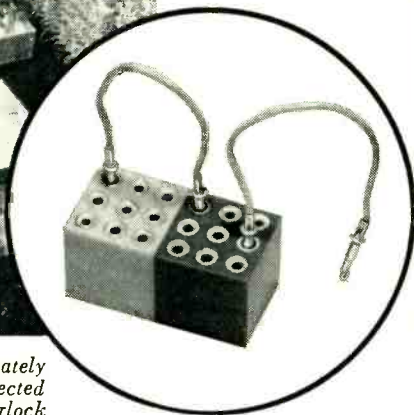

*Plugboard (above) contains approximately 1,000 Magnetic Decision Elements, connected in various configurations by Hubbell Interlock Type "B" Automatic Locking Plugs to form basic computing structures.*

Magnetic Decision Elements, designed by Minnesota Electronics Corp. and developed in collaboration with the U. S. Naval Ordnance Laboratory, White Oak, Silver Spring, Md., are basic computer blocks for building the entire arithmetic, program, control, and memory sections of any digital computer.

Hubbell Interlock connectors were selected to provide a low contact resistance for each block, necessary for accurate results in computations. Automatic locking... quick disconnect feature makes possible rapid cascading in any desired performance pattern. Plugs cannot disconnect accidentally from blocks, yet can be quickly disconnected when intended.

... Another example of Hubbell Interlocks's many applications in the field of electronics. Our development laboratory will cooperate with your engineers to adapt Interlock for your specific applications.

For Further Information, Write Dept. A:



**HARVEY HUBBELL, INC.**  
 Interlock Dept., Bridgeport 2, Conn.

**HUBBELL INTERLOCK DEVELOPMENTS**

Types A, B, C & S Plugs and Connectors • Flexible Terminal Strips  
 Test Prod Kits • Laminated Terminal Strips

input connection incorporating a split secondary transformer is shown.

These circuits are probably familiar to audio enthusiasts as the single-ended push-pull amplifier.

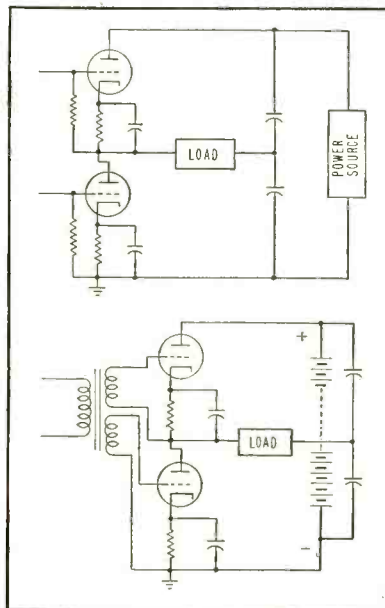

FIG. 2—Basic additional circuit of series-tube amplifier and split-secondary input transformer (below)

Basically, what is involved in the U. S. patented circuits in addition is the arrangement of a load circuit at the midpoints of both the series tube connection and the plate power voltage connection.

The signal applied to the upper tube between its grid and cathode is of opposite phase to that applied between grid and cathode of the lower tube. Hence, there is a push-pull input signal and single-ended output load.

*TV Synchronizing*

For those who have watched television programs wherein speakers are seen simultaneously on both coasts of this country engaged in conversation with the image of each of them occupying half the tv screen, it has seemed only short of miraculous that the sync generators are kept in step. It is even more remarkable when special effects such as lap dissolves and video wipes are effected between the local and remote stations.

A patent recently issued to R. C. Abelson of Chattanooga, Tennessee, for a "Synchronizing System" describes a means for synchronizing the local and remote sync genera-



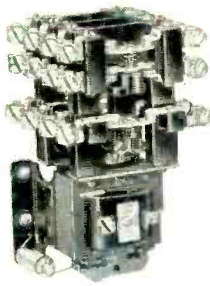

**Type BX-840 A-C Relays**

8 Normally open & 4 normally closed contacts.

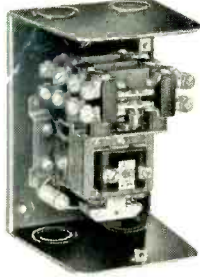

**Type BX-44 A-C Relays**

4 Normally open & 4 normally closed contacts.

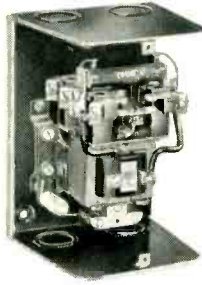

**Type BA Thermostat Relays**

For 3-wire gauge type thermostats with slow-moving contact elements.

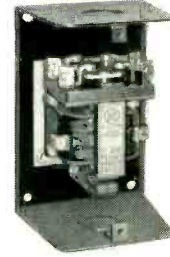

**Type CL Low Coil Current Relays**

For pilot controls, like oil burners or stokers, which can handle only small relay coil currents.

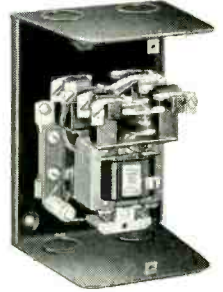

**Hum-free Permanent Magnetic Type Relay**

Requires no coil current to keep contact closed.

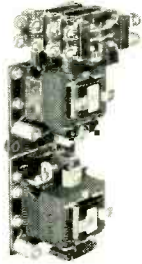

**Hum-free Latch Relays**  
For quiet applications.

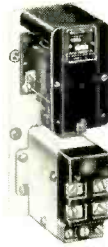

**Bul. 849 Pneumatic Timers**  
Adj. 1/8 sec to 3 minutes.

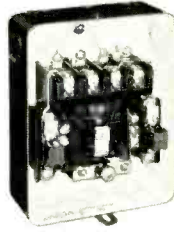

**Bulletin 709 Magnetic Starters**  
8 Sizes up to 300 hp, 220 v; 600 hp, 440-550 v.



**Bulletin 848 Dashpot Timers**  
Adjustable from 2 to 30 seconds.

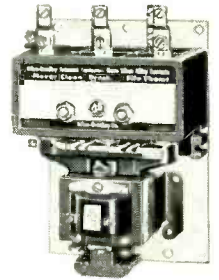

**Large A-C Contactors**  
For applications up to 900 amperes—600 volts.

# CONTACTORS • RELAYS • LIMIT SWITCHES • TIMERS

for Electronic Laboratories and Production Lines



**Bulletin 802 Precision Limit Switches**  
Wide Assortment of Types & Ratings.



**Bul. 802T Oiltight Limit Switches**  
Large variety of types.

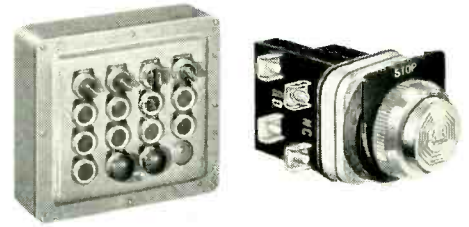

**Push Buttons—All Types and Sizes**  
Standard Duty—Heavy Duty—Oiltight.

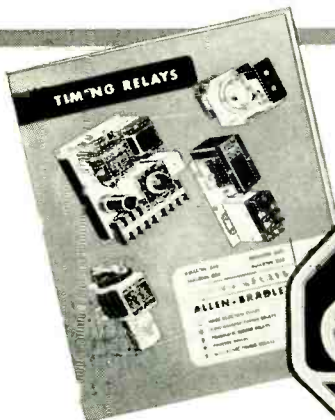

Send for **ILLUSTRATED BULLETINS**

They are handy reference guides for electronic and plant engineers who design testing and automatic produc-

tion equipment. Write for bulletins. Allen-Bradley Co., 110 W. Greenfield Ave., Milwaukee 4, Wis.



## ALLEN-BRADLEY

RADIO & TELEVISION COMPONENTS

QUALITY

# Eclipse-Pioneer



## CORROSION-RESISTANT AUTOSYN\* SYNCHROS (AY-200 SERIES)

### TYPICAL ELECTRICAL CHARACTERISTICS

	Type Number	Input Voltage Nominal Excitation	Input Current Milliampères	Input Power Watts	Input Impedance Ohms	Stator Output Voltages Line to Line	Rotor Resistance (DC) Ohms	Stator Resistance (DC) Ohms	Maximum Error Spread Minutes
Transmitters	AY201S-26	26V, 400~, 1 ph.	125	0.6	40+j230	11.8	12	6.8	15
Control Transformers	AY201S-25	From Trans. Autosyn	Dependent Upon Circuit Design				40	10.2	20
Differentials	AY231S-25	From Trans. Autosyn	Dependent Upon Circuit Design				14	10.2	30
Resolvers	AY221S-25	26V, 400~, 1 ph.	70	0.4	106+j440	11.8	60	11.4	24

## PYGMY AUTOSYN SYNCHROS (AY-500 SERIES)

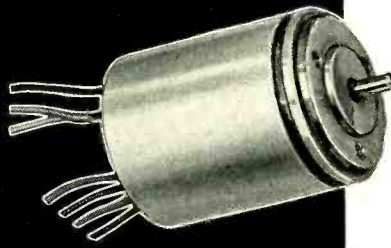

### TYPICAL ELECTRICAL CHARACTERISTICS

	Type Number	Input Voltage Nominal Excitation	Input Current Milliampères	Input Power Watts	Input Impedance Ohms	Stator Output Voltages Line to Line	Rotor Resistance (DC) Ohms	Stator Resistance (DC) Ohms	Maximum Error Spread Minutes
Transmitters	AY503-4	26V, 400~, 1 ph.	220	2.5	45+j100	11.8	23.0	11.0	24
Resolvers	AY503-2	26V, 400~, 1 ph.	220	2.5	45+j100	11.8	23.0	11.0	75
Control Transformers	AY503-3	From Trans. Autosyn	Dependent Upon Circuit Design				170.0	48.0	24
	AY503-5	From Trans. Autosyn	Dependent Upon Circuit Design				550.0	188.0	30
Differentials	AY533-3	From Trans. Autosyn	Dependent Upon Circuit Design				93.0	45.0	30
Resolvers	AY523-3	26V, 400~, 1 ph.	55	0.6	290+j490	11.8	210.0	42.0	30
	AY543-5	26V, 400~, 1 ph.	11	0.12	900+j2200	11.8	860.0	185.0	30

Available for all applications is the new, corrosion-resistant AY-200 Series of Eclipse-Pioneer Autosyn Synchros (1.431" dia. x 1.631" lg.). Where space and weight are prime considerations, Eclipse-Pioneer offers the AY-500 Pygmy Autosyn Synchro Series (0.937" dia. x 1.278" lg.) with corrosion-resistant models available in sample quantities. Whatever your synchro requirements may be, our long experience, modern facilities and advanced production techniques can work to your advantage. For full details, write Department C.

\*Registered trade-mark Bendix Aviation Corporation

**ECLIPSE-PIONEER, Division of  
TETERBORO, N. J.**

Export Sales: Bendix International Division, 205 E. 42nd St., New York 17, N. Y.



tors of tv broadcasting equipments. Patent 2,655,556 is assigned to Radio Corporation of America.

In Fig. 3 is shown a schematic and block diagram of the circuit involved where the present invention is applied to conventional tv sync generator systems. Here it can be seen that a master oscillator at 31,500 cycles is utilized through various count-down devices to provide the 15,750-cps horizontal and

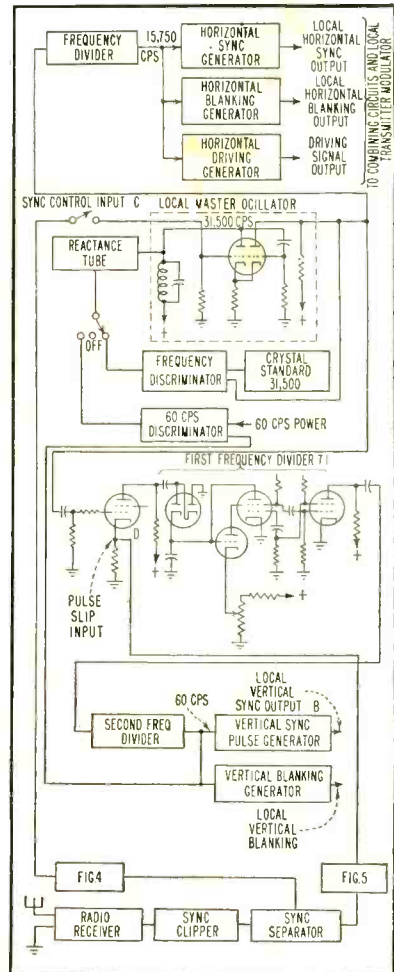

FIG. 3—Elements of the synchronizing generator remote control

60-cps vertical synchronizing signals. A frequency controlling means for the 31,500-cps oscillator is shown. The control may be from a crystal frequency standard or from the 60-cycle power line. Additionally there is an input of terminal C for the sync control signals provided in the practice of this invention.

In Fig. 4 and Fig. 5 are shown the sync gating circuits through which remote sync signals and local sync signals are mixed and gated to be fed to and control the 31,500-





Emile Montemurro, Midwest Manager of Fox Movietone News, tells how:

## He handles 300 reel problems a day!

"Old news is no news," says veteran newsreel cameraman Emile Montemurro.

"We've been getting the news to theaters and TV stations all over the U. S. — news that's hot and fresh — by using Air Express. We've relied on them for over 25 years.

"Air Express handles some 300 shipments a day for us. They go all over the country, coast to coast. With new TV

stations opening and using our newsreels, that figure will soon reach 600 a day!

"Other air services would cost us more than Air Express, we've found. Besides, you cannot duplicate the excellent personal attention Air Express gives every shipment."

It pays to express yourself clearly. Say Air Express! Division of Railway Express Agency.



# Air Express

GETS THERE FIRST via U.S. Scheduled Airlines



**MOTOR DATA**  
No. 125

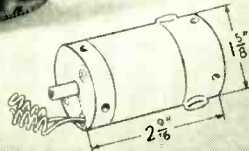
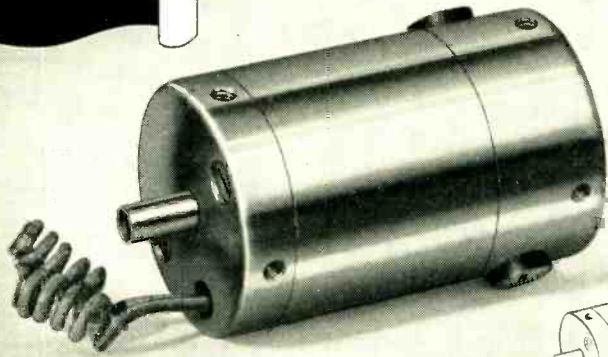

**EICOR**

**1600 FRAME MOTOR**

Torque 4.5 in. oz. at 5800 RPM

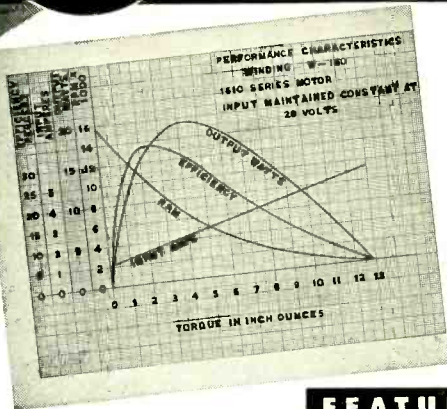

The power output of this precision motor is exceptionally high in proportion to its light weight and small size. Originally developed for numerous aircraft and portable applications, the characteristics of its performance can readily be modified for a variety of new uses.

**FEATURES**

**ELECTRICAL MECHANICAL**

- Series or shunt wound
- Unidirectional or reversible
- High starting torque
- Low starting current
- Low RF interference
- Armature and field windings Varnish impregnated and baked
- Completely enclosed
- Adaptable for any mounting
- Laminated field poles
- Stainless steel shaft
- Two precision ball bearings
- Mica insulated commutator
- Permanent end play adjustment

1600 FRAME MOTORS		Series	Shunt
Watts Output, Int.	(max.)	22	
Watts Output, Con.	(max.)		5
Torque at 8500 RPM	(in. oz.)	3	
Torque at 5800 RPM	(in. oz.)	4.5	1
Lock Torque	(in. oz.)	12	3
Volts Input	(min.)	5	5
Volts Input	(max.)	32	32
Shaft Diameter	(max.)	.250"	.250"
Temperature Rise		50°C.	40°C.
Weight		12 oz.	12 oz.

*Eicor, Inc.* 1501 W. Congress St., Chicago 7, Illinois

DYNAMOTORS · INVERTERS · ELECTRONIC CONTROLS · ALTERNATORS · MOTORS

cps generator and what is termed the slip-pulse input circuit of the first frequency divider for the 60

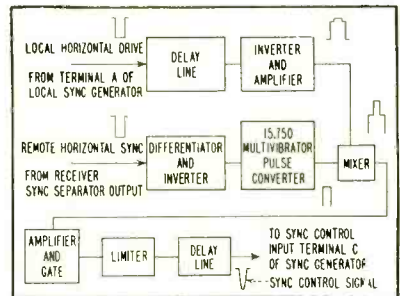

FIG. 4—Sync gating circuits (see Fig. 3)

cycle generator chain. The blocks of Fig. 4 and 5 represent fairly familiar circuitry for the tv engineer.

Figure 6 is a plot of a series of waveforms to illustrate the vertical signal control operation. Here it can be seen that at (A) the local

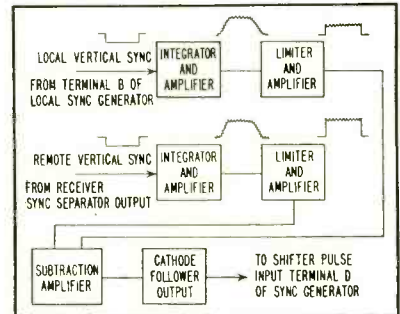

FIG. 5—Sync gating circuits (see Fig. 3)

and remote vertical signals are not coincident. The condition here shown is as the signals appear at the output of the subtraction amplifier of Fig. 5. The local pulse is the slip-pulse signal. It is applied at point D of Fig. 3. The amplitude of the local or slip pulse is made great enough to substantively interfere with the master-oscillator pulses being applied to the first frequency

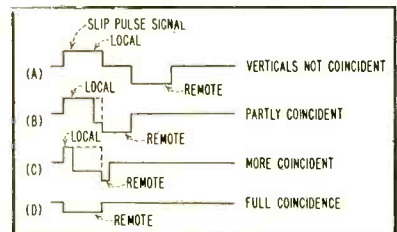

FIG. 6—Progression of sync coincidence

divider so as to require an appropriately greater number of pulses to reach the firing threshold of the first 7-to-1 frequency divider. Thus the dividing ratio will be altered to



# IN

# Complete Telemeter PACKAGE

BY

## BENDIX - PACIFIC

These compact, rugged FM/FM telemetering packages are available for many types of applications. Numerous models of plug-in subcarrier oscillators and associated components are available as standard equipment to provide for maximum versatility and efficiency.

**CUBICAL CONFIGURATION**

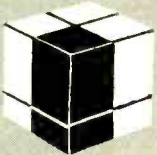

Vertical Components

**RECTANGULAR CONFIGURATION**



Horizontal Components

**CYLINDRICAL CONFIGURATION**



Wedge Shaped Components

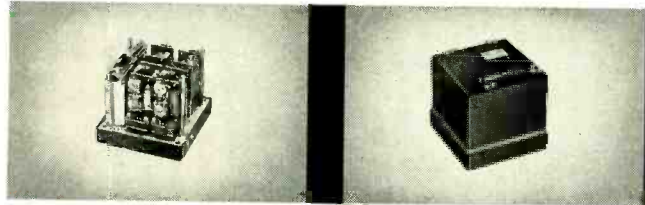

### Compact Four Band Telemeter, Models TATP-3 and TATP-4

These packages, each incorporating four plug-in subcarrier oscillators, when used with a power supply and RF transmitter, form a compact, rugged system for telemetering various functions. Each package contains its own voltage regulator and calibration relays. The packages may be combined to form an 8 or 12 band system. Each package measures approximately 4.5" in each dimension and weighs approximately 3 pounds including oscillators. Standord power supplies are available for operating up to 3 packages and a 2 watt RF transmitter. The model TATP-3 operates in any 4 of the RDB bands below 22 kc; the TATP-4 in any 4 of the bands from 22 kc up.

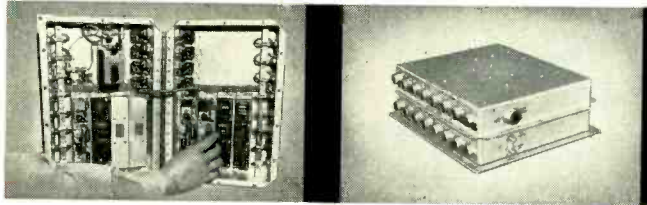

### Universal Eight Band Telemeter, Model TATP-2

Operates on any eight RDB bands from 1.7 to 70 kc permitting any combination of 8 resistance, voltage or inductance type measurements to be made by merely plugging in the proper subcarrier oscillators. The unit has provisions for mounting a model TXV-13 crystal controlled transmitter. Connectors are provided for a minimum of eight remotely located pickups. Standard power supplies are available for operation from 6, 12, 28 VDC or 115 VAC 400 cps power sources. Dimensions—14" x 12.4" x 4.75".

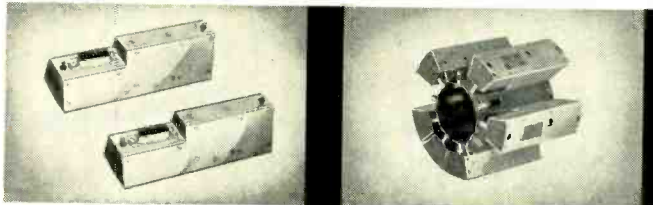

### Cylindrical Telemeter Configuration, Model TJW-1

These packages are built up of individual 30° wedge shaped components which plug into a cylindrical mounting assembly, Model TJW-1. As many as 10 subcarrier oscillators or other components can be installed into a 6.5" circular opening, 5.5" long. A center opening, approximately 1.5" in diameter, can be utilized for cables and pressure lines. A two-watt crystal controlled RF transmitter is also available for mounting in this configuration.

*Write for Complete Information*

**PACIFIC DIVISION • Bendix Aviation Corporation**

11600 Sherman Way, North Hollywood, California

East Coast Office:  
475 5th Ave., N.Y. 17

Export Division: Bendix International  
205 E. 42nd St., N.Y. 17

Canadian Distributors:  
Aviation Electric, Ltd., Montreal 9

RADAR



SONAR



HYDRAULICS



TELEMETERING



ELECTRO-MECHANICAL



ULTRA SONICS



# FOR THE MAXIMUM IN LEGIBILITY



specify

"U. S. R. C."

## EDGE-LIGHTED PANELS

meet all requirements  
of specifications

MIL-P-7788 and AN-P-89

Produced by the "Lackon" process, the photographic reproduction method which incorporates the better features of all other panel and dial processing methods. The "Lackon" process combines simplicity, flexibility, adaptability, reproducibility, accuracy and economy.

Regardless of whether your interest is in general appearance, uniformity of lighting, legibility, wear or weather resistance, long life or economy — it will be to your advantage to investigate the best.

May we furnish additional information and make available our engineering and lighting experience?

Write Dept. E-4.

UNITED STATES RADIUM CORPORATION  
335 Pearl St. New York 7, N. Y.



Want more information? Use post card on last page.

ELECTRONS AT WORK

(continued)

bring the local and remote vertical pulses into coincidence as seen at (B), (C) and (D) of Fig. 6.

The inventor points out that the control of horizontal synchronization is readily accomplished through various comparator and discriminator techniques.

### Velocity Measurement

A novel system for "Velocity Measuring by use of High Energy Electrons" has been awarded U. S. patent 2,637,208. The inventor is G. L. Mellen of Framingham Center, Mass. The patent is assigned to National Research Corp. of Middlesex County, Mass.

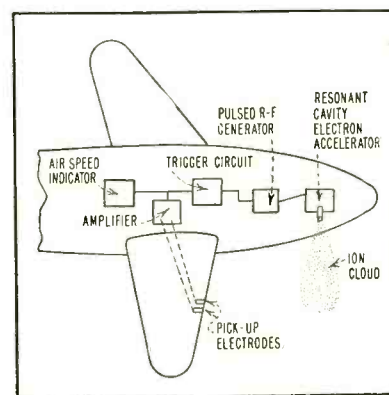

FIG. 7—Supersonic velocity device installed in aircraft

For the measurement of the velocity of objects moving at supersonic speeds specialized apparatus is required. In this invention an ionized gas is projected into the atmosphere from a forward portion of a vehicle or missile. The gas is detected by devices at a rearward portion of the vehicle. The method is clearly shown in Fig. 7 in block diagram form as installed in an aircraft.

The system may also be used to

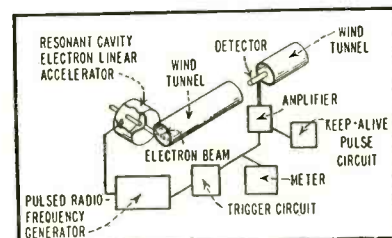

FIG. 8—Wind tunnel application of r-f velocity indicator

determine the equivalent velocity of a stream of air in a wind tunnel as shown in Fig. 8.

The method of operation of the system may be seen from the dia-



**CHATHAM** advance-designed yesterday

— in  
industry-wide  
use today!

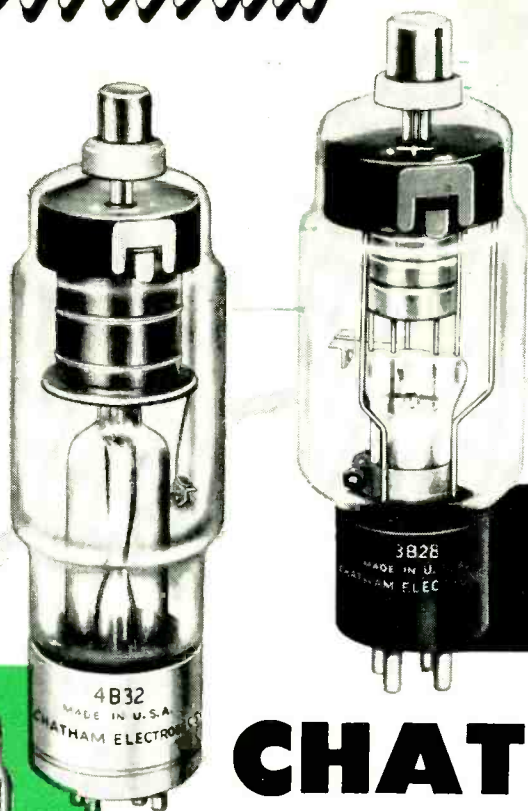

**AMPLIFIERS • REGULATORS • INERT GAS  
AND MERCURY RECTIFIERS • MERCURY,  
INERT GAS AND HYDROGEN THYRATONS**

**CHATHAM  
SPECIAL-PURPOSE  
TUBES**



◆ **3B28 RECTIFIER**

Rugged half-wave Xenon filled rectifier. Operates in any position. Ambient temperature range  $-75^{\circ}$  to  $+90^{\circ}$ C. Inverse peak anode voltage 10,000, average current .25 amps. Filament 2.5v., 5 amp.

◆ **4B32 RECTIFIER**

Ruggedly built, half-wave Xenon filled rectifier. Ambient temperature range  $-75^{\circ}$  to  $+90^{\circ}$ C. Inverse peak anode voltage 10,000, average anode current 1.25 amp. Filament 5v., 7.5 amp.

◆ **VC-1258 MINIATURE HYDROGEN THYRATRON**

for pulse generation. Handles 10 kw peak pulse power.

◆ **6336 TWIN TRIODE**

for voltage regulation. Features high plate dissipation, hard glass envelope.

◆ **6394 TWIN TRIODE**

Similar to 6336 except 26.5 volt heater instead of 6.3 volt heater.

◆ **5594 XENON THYRATRON**

Operates over wide ambient temperature range  $-55^{\circ}$ C to  $+90^{\circ}$ C.



5594



VC-1258



6394

STANDARD TYPES DIRECT FROM STOCK  
PLUS SPECIAL DESIGNS BUILT TO REQUIREMENTS

Chatham specializes in the development of general and special purpose tubes for both electronic and industrial applications. Many of the tubes originally developed by Chatham to fill a specialized need, now number among the most widely used tubes in the industry. For complete information on Chatham tubes — either stock items or types built to your requirements — call or write today.



**CHATHAM ELECTRONICS CORP.**

Executive and General Offices: LIVINGSTON, NEW JERSEY  
Plants and Laboratories: NEWARK and LIVINGSTON, NEW JERSEY

# Tenney

## SUB-ARCTIC INDUSTRIAL CABINETS

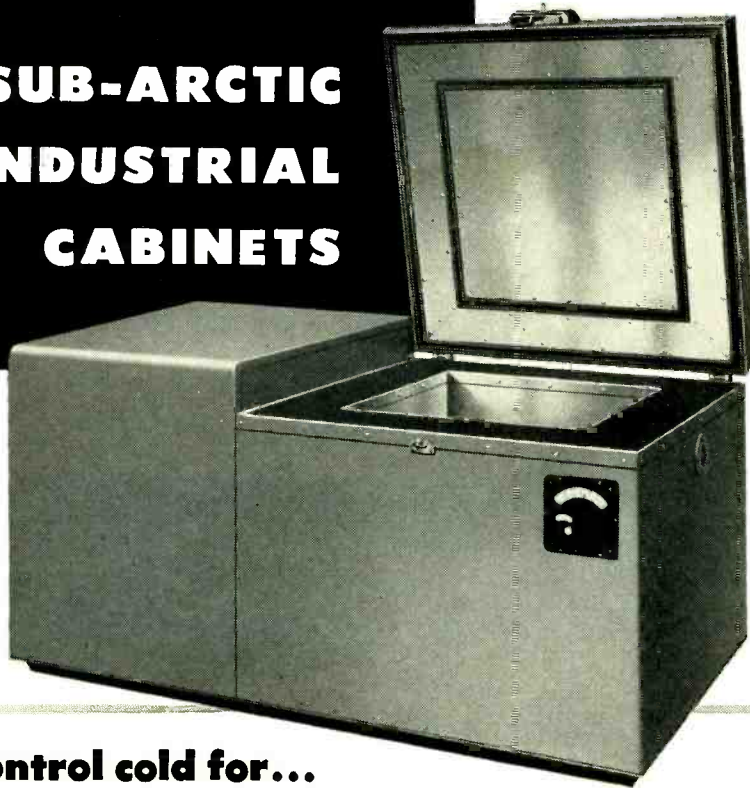

### control cold for...

#### METAL TREATING

Quick-Aging  
Stabilization  
Stress Equalization  
Shrink-Fitting  
Hardening  
Super-Hardening  
Tool Steel

#### RESEARCH & PRODUCTION TESTING

Products  
Metals  
Rubber  
Plastics  
Electronic Equipment  
Instruments  
Lubricants  
Cameras

to determine

Characteristics  
Tensile Strengths  
Magnetic Conduction  
Brittleness  
Contraction  
Viscosity  
Corrosion  
Longevity

#### PLUS STORAGE & PRESERVATION

of Chemicals, Biologicals, and Serums

Tenney Sub-Arctic Industrial Cabinets are adaptable to all these important applications—wherever low temperature refrigeration with constant control, rapid pull-down, reliability of operation, and minimum maintenance are essential to operations. There are 28 models available in standard and special units in 1, 4, 6, 9, and 12-cu. ft. capacities, either air- or water-cooled. And for low temperature points, there is a range of six ratings: -40, -80, -100, -120, -150, and -170° F.

For features, specifications, and optional equipment, write for Sub-Arctic Bulletin.

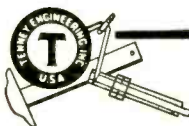

# Tenney

ENGINEERING, INC.

Dept. A, 1090 Springfield Rd., Union, N. J.

Plants: Union, N. J.; Newark, N. J.; Baltimore, Md.

Los Angeles Representative: George Thorson & Co.

Engineers and Manufacturers of Automatic Environmental Test Equipment

grams. Referring to Fig. 9, a cloud of ions is created in a chamber through which the gas to be ionized flows. The ionization time of the gas will be considerably less than the transit time of the ion cloud from the point at which the ions are projected into the medium to the point of detection.

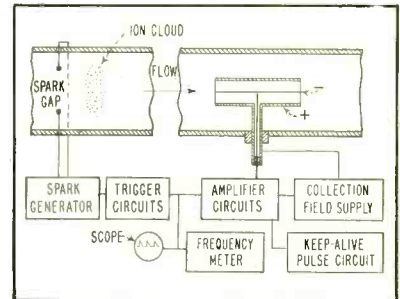

FIG. 9—Ion cloud is created by spark and detected by ionization chamber

The ions are created by an electric spark from a spark-gap discharge. The detection of the ions is accomplished with a form of ionization chamber. The ion current created in the ionization chamber is amplified. The amplified current is triggered in synchronism with the spark generator.

The inventor gives the following formula with which the velocity of a missile may be determined

$$V = 60/88 FD$$

when  $V$  = velocity in miles per hour

$D$  = distance in feet between the point of ion cloud ejection and the point of ion detection

$F$  = frequency in cycles per second of creation of the ion cloud. (Sparking trigger frequency)

The remainder of the circuit elements suggest the operation of the system to be similar to the frequency modulated vhf terrain clearance indicator wherein the Doppler effect is employed and the resulting frequency difference between arrival time of the detected signal and transmitted signal is converted to distance. In the present invention the resultant indication is velocity.

#### Coin Counter

Patent 2,652,136 has been issued to J. F. Morrison, assignor to Rowe Mfg. Co. of Whippany, N. J. for an "Electronic Coin Totalizer".

The invention describes a means





silicon

ACTUAL SIZE



Now . . . long-awaited *silicon junction diodes* are available; developed by Texas Instruments, a leading transistor manufacturer.

Operating temperatures up to 150°C are safe, offering a new degree of design freedom!



junction

New . . . extremely low back current characteristics, as low as 0.001 microamps at rated voltage. Glass-to-metal hermetic seals, of course. For more detailed information on these new silicon junction diodes — and on other new TI semiconductor products — write today.



diodes!



TEXAS INSTRUMENTS  
INCORPORATED

6000 LEMMON AVENUE DALLAS 9, TEXAS

# Bright spots for idea men!

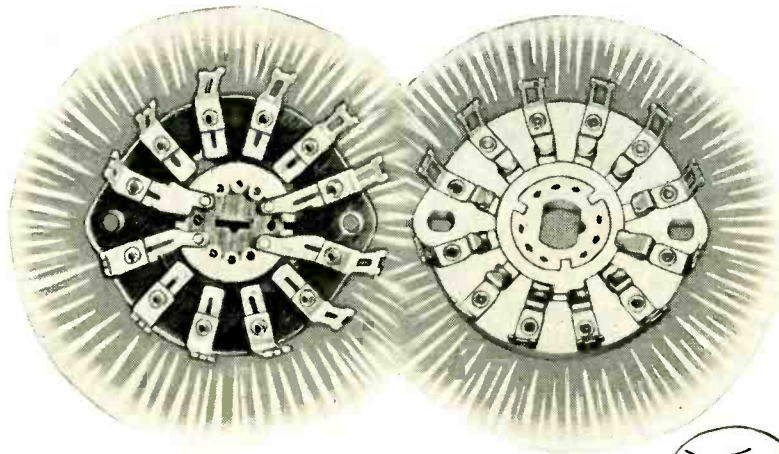

## You're never at a loss for the right type of switch when you design with Centralab

Better product performance? You bet! There are plenty of good reasons for the popularity of either Steatite or Phenolic insulation:

- Steatite insulation is Centralab's best — always supplied in JAN L-5 grade. Extremely low loss at high frequency (1MC — .007). Dow-Corning (200) treated to eliminate surface moisture. 100% quality-controlled by CRL from basic powders to finished section.
- Phenolic insulation—only high grades used. NEMA grade XXXP. MIL grade P3115B.
- Available in standard (1 7/8" dia.) or miniature size (1 1/2"). Sub-miniature (1 1/8").
- Standard or special switching combinations — 2 to 12 positions to 6 poles per section.
- Single or multiple sections. Also dual concentric miniature types.
- Indexing: 30° or 60° (standard or miniature); 90° (standard only).
- Shorting or non-shorting types.
- All hardware heavily cadmium-plated. Clips and contacts silver-plated spring brass. Solid silver alloy contacts available.



Centralab's staff of switch experts are the industry's most qualified "answermen"

- Centralab switches have been called the prototype of all selector switches in use today.
- Centralab has complete facilities for the design and volume production of custom switches.
- Widest variety of standard switches available from any manufacturer.

You name the switch . . . Centralab will deliver!

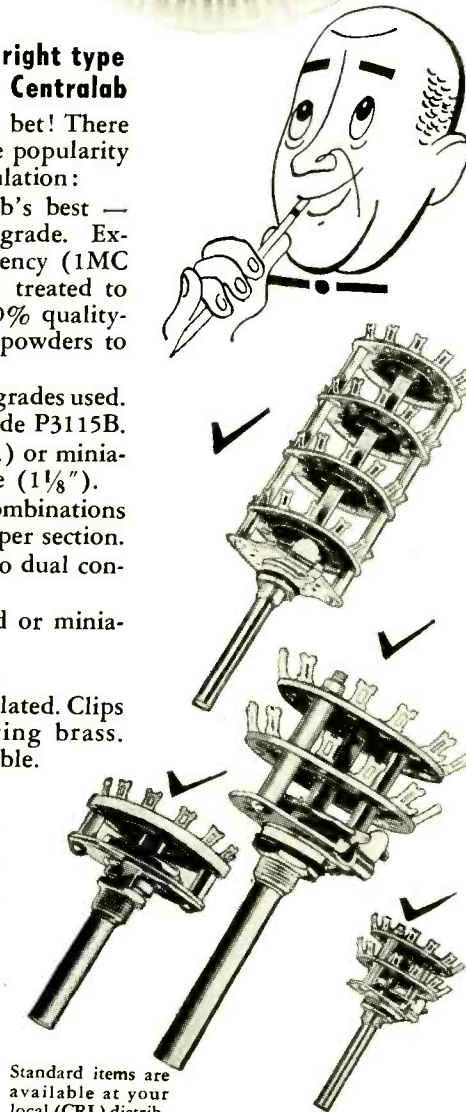

Standard items are available at your local (CRL) distributor — see Catalog 28.

# Centralab

A Division of Globe-Union Inc.  
914 E. Keefe Avenue • Milwaukee 1, Wisconsin  
In Canada: 804 Mt. Pleasant Road, Toronto, Ontario

VARIABLE RESISTORS

SWITCHES

CERAMIC CAPACITORS

PRINTED ELECTRONIC CIRCUITS

CERAMIC INSULATORS

**Industry's greatest source of standard and special electronic components**

of determining the required change to be dispensed by a vending machine and controlling the equipment to deliver the correct change along with the vending of the merchandise.

The circuit of this device is shown in Fig. 10. In the coin register, resistors  $R_2$  and  $R_3$  (2,000 ohms each) are arranged to be short-circuited by dimes. Resistors  $R_4$ ,  $R_5$ ,  $R_6$ ,  $R_7$ ,  $R_8$  (1,000 ohms each) are arranged to be short-circuited by nickels. Resistor  $R_9$  (5,000 ohms) is short circuited by a 25-cent piece.

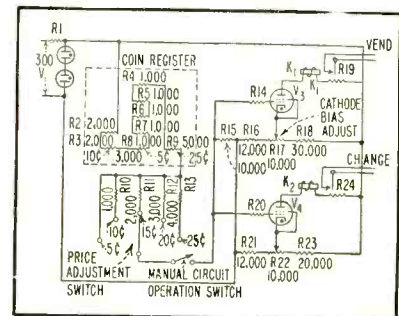

FIG. 10—Coin counter operates by shorting thyatron bias

The resistance values are such that any combination may add up to the resistance equivalent of  $R_9$ , thus reducing the total resistance in series by the cumulative values of the resistances short-circuited by the coins in the register up to a value corresponding to 25 cents.

Dropping coins into the register short circuits appropriate resistors to a parallel connection across  $R_{10}$  resulting in a bias change on thyatron  $V_3$  to trigger the thyatron and close relay  $K_1$ . This operates the vend mechanism when the correct amount, as required by the setting of the price adjustment switch, has been deposited in the coin register.

Thyatron  $V_4$  is set up in parallel with thyatron  $V_3$  to initiate a change-making cycle if the amount deposited in the coin register is greater than the price set by the price adjustment switch. Tube  $V_4$  will not operate if the correct amount is inserted but  $V_3$  will operate. If an insufficient amount is inserted neither  $V_3$  nor  $V_4$  operates. Settings of bias potentiometers  $R_{17}$  and  $R_{22}$  determine the operating conditions for each of the tubes  $V_3$  and  $V_4$ .

—N.L.C.



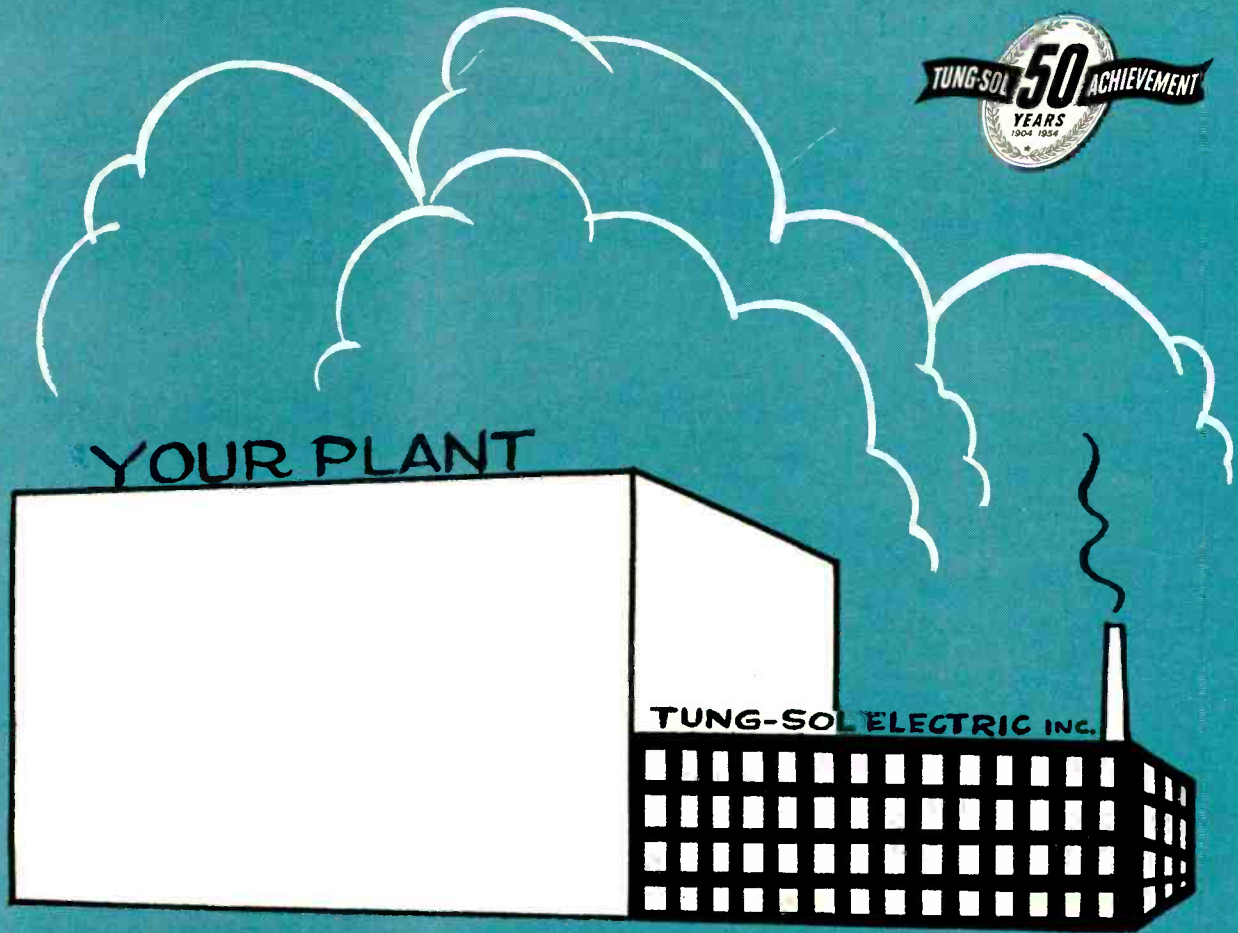

# Our plant becomes an extension of your plant

Our engineering and manufacturing facilities can make our plant a vital extension of your plant. We make nothing but electron tubes—no sets—no equipment. We are completely independent, so we are in a position to keep your plans in strict confidence—to work with you with as much loyalty and secrecy as if we were in your own organization.

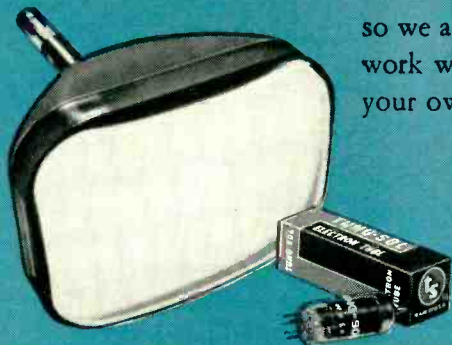

## TUNG-SOL ELECTRIC INC. Newark 4, N. J.

Sales Offices: Atlanta, Chicago, Columbus, Culver City (Los Angeles), Dallas, Denver, Detroit, Newark, Seattle.

**TUNG-SOL MAKES** All-Glass Sealed Beam Lamps, Miniature Lamps, Signal Flashers, Picture Tubes, Radio, TV and Special Purpose Electron Tubes and Semiconductor Products.

# Production Techniques

Edited by JOHN MARKUS

Elevated Instrument Railway Aids Calibration of Multimeters .....	242	Flocking Waveguide Stands .....	268
Automatic Cycling Machine For Socket and Plug Life Tests .....	242	Lifting Aids for Large Picture Tubes .....	270
Air-Driven Hand Drill Serves as Winder for Single-Layer Coils .....	244	Setscrew Fittings For Pipes Speed Plant Alterations .....	272
Quick-Leveling Mounts For Production Machines .....	246	Molding Tube Stems With Powdered Glass .....	273
Grid Stretcher .....	248	Switching Production Heads Gives Plant Savings .....	275
Self-Stacking Plastic Trays .....	250	Three-Size Turret Jig .....	277
Automatic Tip-Off Machine .....	252	Snap-In Mounts Serve as Resistor Terminals .....	278
Polishing Copper Laminates For Etched Circuits .....	254	Staples Serve as Conductors For Etched I-F Coils .....	279
Cotter Pins Serve as Insulator Terminals .....	256	Welding Techniques For Gold-Plated Grid Wire .....	280
Potting-Wax Centrifuge .....	260	Cement Adhesion Tester For Receiving Tubes .....	282
Moving TV Tube Dies With Fork Lift Truck .....	262	Screen-Bake Over for Picture Tubes .....	285
Tube Socket Holder .....	264	Inline System For Aluminizing Picture Tubes .....	286

## OTHER DEPARTMENTS

featured in this issue

	Page
Electrons At Work .....	196
New Products .....	292
Plants and People .....	338
New Books .....	398
Backtalk .....	404

## Elevated Instrument Railway Aids Calibration of Multimeters

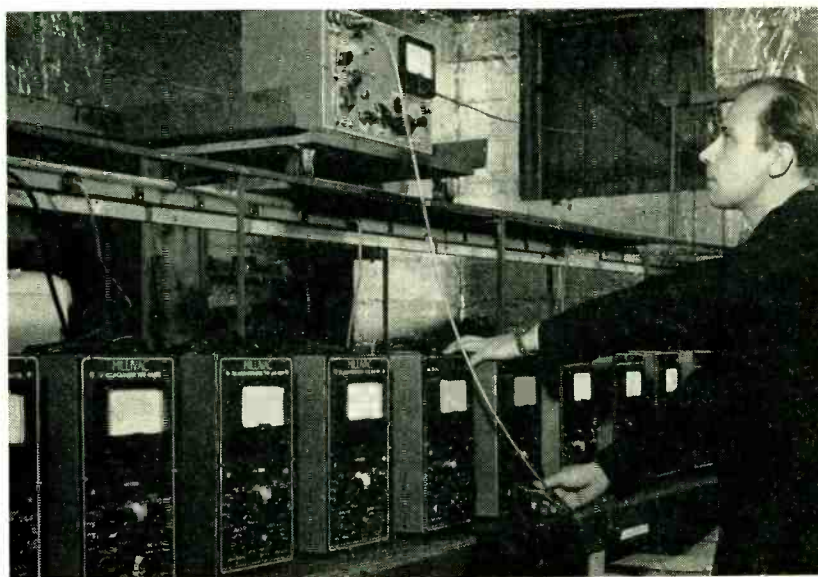

Method of using master standard on carriage running on overhead rails. Multimeters on bench are calibrated one after another

FINAL METER calibration for a batch of multimeters is expedited by placing the master calibration standard on a trolley cart which runs on overhead rails along the entire length of the production bench. The instruments to be calibrated are placed side by side on the bench and all set to the same range. The technician adjusts the calibration standard to the proper value, feeds the calibration signal into the first meter and adjusts it, then pushes the carriage to each other meter in turn and repeats the procedure.

The calibration standard and the meters are then switched to the next range and the carriage is pushed down the line again step by step for calibration. This technique is used in the Schenectady, N. Y. plant of Millivac Instrument Corp.

## Automatic Cycling Machine For Socket and Plug Life Tests

TO HELP evaluate characteristics of multi-pin plugs and sockets used in packaged equipment composed of plug-in units, an automatic cycling machine was devised by production service engineers of Lenkurt Electric Co., San Carlos, Calif. to cycle various plug and socket combinations through thousands of insertions and removals.

Design of telephone carrier equipment with all units made on a

plug-in basis is a departure from previous manufacturing methods where all carrier equipment was rack mounted and interconnected with fixed rack wiring and soldered terminal-block connections. Some means was necessary to assure the design and applications engineers that repeated insertion and removal of the plug-in units would not result in system failure through wear or damage to the multi-pin plugs

and sockets used in their equipment.

The plug and socket to be tested are mounted on special plates which can be adjusted to provide proper mating (or misadjusted if desired to determine the effects of misalignment). The plug mounting is fixed on the end of a compressed-air-operated piston and moves towards the socket on two guide rods. Length of the piston stroke is determined by two Micro Switches



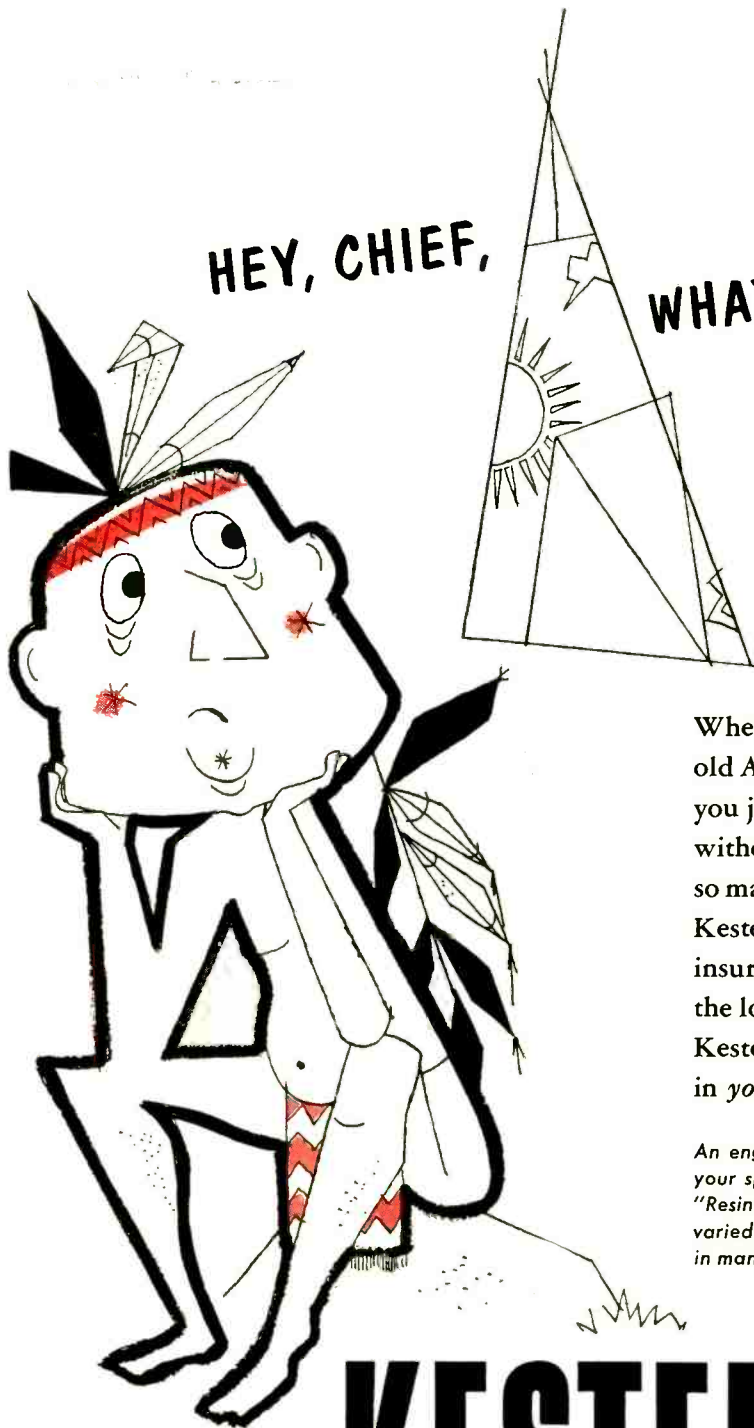

HEY, CHIEF,

WHAT'S A WIGWAM  
WITHOUT WAMPUM?

Whether it's shells or beads — or good old American dollars, for that matter — you just can't operate successfully without showing a profit. That's why so many progressive companies depend on Kester quality and performance to insure maximum results in production at the lowest possible cost. And we'll bet Kester Solder can mean more "wampum" in *your* "wigwam," too!

*An engineered adaptation can be made to your specific requirements with Kester "44" Resin, "Resin-Five" or Plastic Rosin-Core Solder . . . varied core sizes or flux-contents are available in many different diameters.*

# KESTER

S O L D E R   C O M P A N Y

4204 WRIGHTWOOD AVENUE, CHICAGO 39, ILLINOIS  
NEWARK 5, NEW JERSEY • BRANTFORD, CANADA



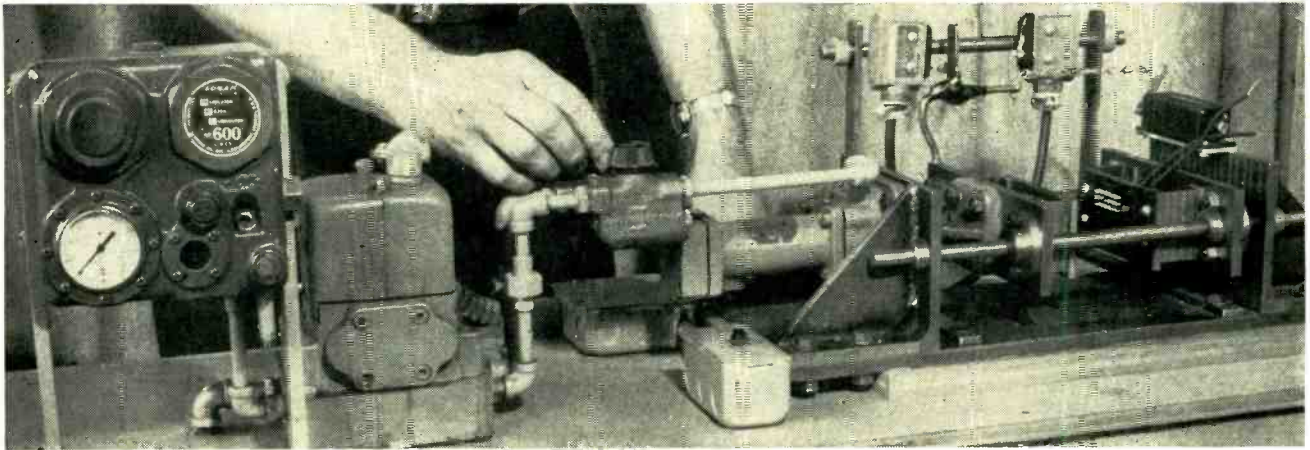

Life-testing multi-pin plug and socket, mounted at right end of cycling machine. Knobs being adjusted by engineer control time of stroke. Extension pipe on moving socket support trips snap-action switches, mounted on overhead rods, to actuate solenoid valves under man's right hand and give reversal of air cylinder operation

which control a valve directing compressed air to either side of the piston. Separate adjustable check valves control the piston speed in each direction so the cycling time can be varied from about 1/20 to 2 cycles per second.

When a plug and socket combination is being tested, a series circuit is connected through plug pins and socket sleeves so a continuous measurement of resistance can be made over any number of cycles. Gradual

wear then shows as a gradual change in resistance, while any mechanical damage will normally show as an abrupt resistance change. In addition, wear can be determined by accurate measurement of plug pin diameters before and after testing.

The automatic cycling machine has proved valuable to engineers in making acceptance tests of plugs and sockets. In addition, it is used to analyze rack wiring methods to

help prevent socket damage due to sleeve misalignment caused by improper tensions from the rack wiring.

The machine has also been used in testing wiring for tendency to fail after repeated bending either in a cable harness or at the point of attachment to a connection lug. For these tests the accurately determined length of the stroke is used to produce flexure through a controlled angle.

## Air-Driven Hand Drill Serves as Winder for Single-Layer Coils

AN ORDINARY air drill mounted horizontally on a simple bench stand provides smooth power for producing layer-wound coils having 30 to 40 turns each. The coil-holding arbor in the chuck of the drill is

easily changed for running another type of coil form. A counter just behind the drill indicates the number of turns wound, and is easily reset to zero after each operation by depressing a lever. The tech-

nique is used for winding i-f coils of television receivers in the plant of E. K. Cole Ltd., Southend-on-Sea, England.

The air-driven hand drill gun employed is made by Desoutter

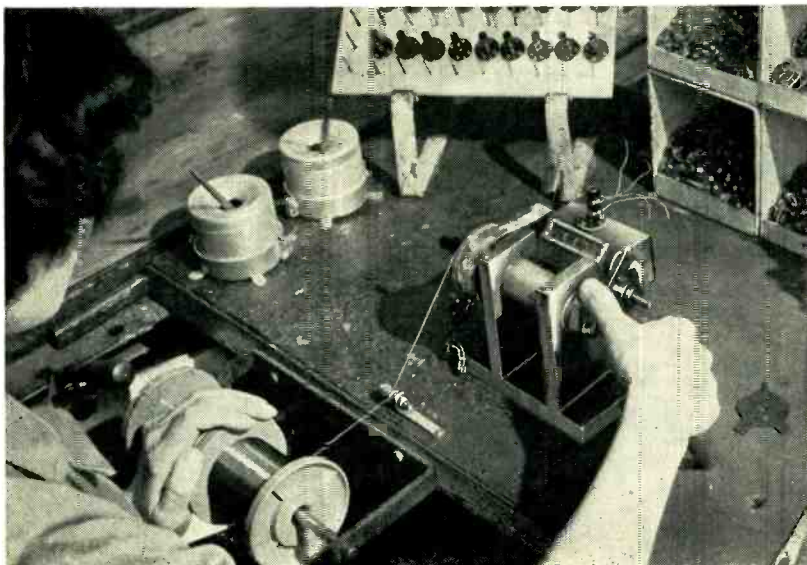

Air power winds i-f coils. Punched steel spiderweb gages on bench provide correct spacing between coils on form

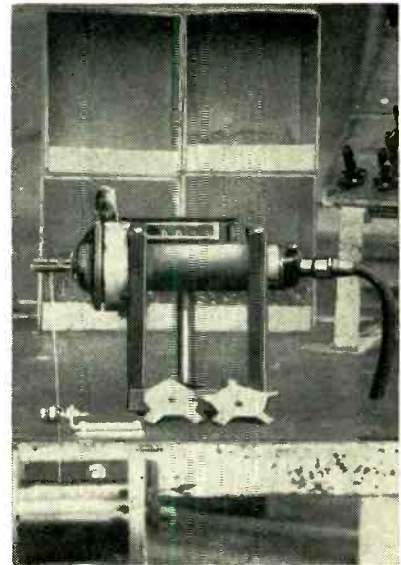





## Gems of Precision Engineering

### GLASS-TO-METAL VACUUM SEALS COMPETITIVELY PRICED

These glass-to-metal vacuum seals are quality products manufactured from glass and metals carefully selected for their closely matched expansion coefficients. Thermal shock tests are performed on every seal during the hot tin dipping operation which is conducted at the extreme temperature of 530° F. This plating procedure insures clean parts which will solder readily whether heating is accomplished by hot plate,

soldering iron, hot strip, or soft flame, AND WITHOUT DANGER OF BREAKAGE DUE TO THERMAL SHOCK.

Experience, selected materials, engineering skill, and controlled manufacturing combine to make Constantin vacuum seals leaders for their sturdiness, long life, and excellent electrical performance.

Seals are available in both High Compression and Kovar to hard glass types.



**MULTI-PIN CON PLUGS**  
A wide variety of standard sizes and configurations available. Leaders in the field specify CONSTANTIN CONNECTORS for their ruggedness and reliable performance.

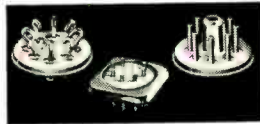

**MULTI-PIN HEADERS**  
Vacuum tight, glass-to-metal sealing makes CONSTANTIN HEADERS ideal for use in products demanding a stabilized atmosphere, and protection from temperature extremes and climatic conditions.



**TRANSISTOR MOUNTS**  
Constantin glass-to-metal vacuum sealed transistor mounts are available as a standard line in various sizes and configurations. Other types may be fabricated to your design specifications.



**TERMINALS**  
Available in all combinations of hooks, eyes, tubes and pierced flats. Precision built and especially noted for sturdiness and high electrical performance.



**CONDENSER END SEALS**  
Manufactured to assure a stabilized atmosphere under any conditions, these seals are excellent for capacitors, filters, delay lines, and precision resistors.



Also manufacturers of —  
CRYSTAL HOLDERS  
VACUUM COATING EQUIPMENT

## L. L. Constantin & Co.

**MANUFACTURING ENGINEERS**

Rt. 46 and Franklin Ave., Lodi, N. J.

# Considering Environmental Test Equipment?

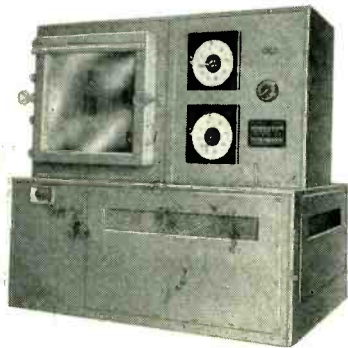

Be sure to look beyond the unit . . .

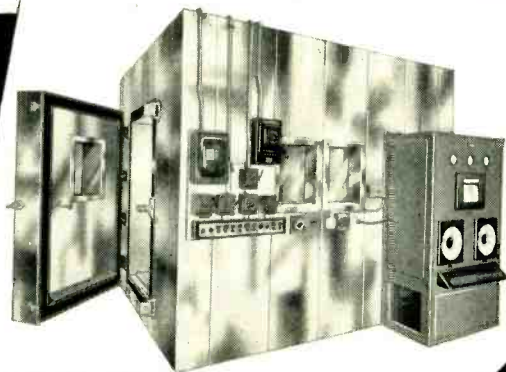
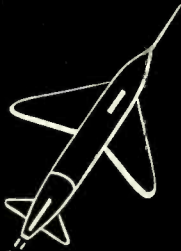

Bowser Technical Refrigeration pioneered the development and manufacture of environmental test equipment.

Bowser's complete engineering staff is available (at no obligation) to help in solving YOUR difficult test problems. Design engineers and production facilities are available to construct test equipment to meet your specialized requirements.

Typical of Bowser's standard test chambers are the Laboratory Unit and Walk-In Room shown above.

The Laboratory Unit has a temperature range from +200° F to -100° F, relative humidity range from 20% to 98%, altitude from sea level to 100,000 feet.

Standard Walk-In Rooms simultaneously produce altitude to 100,000 feet, temperature range from -100° F to +200° F, relative humidity from 20% to 98%.

Bowser also builds explosion chambers, sand and dust chambers, humidity simulation units, and environmental simulation chambers to meet any desired specifications.

Write for free descriptive bulletins or request a Bowser field engineer to consult on YOUR environmental test problem.

**BTR**  
RELIABILITY

**BOWSER TECHNICAL REFRIGERATION**

DIVISION BOWSER, INC. TERRYVILLE CONNECTICUT

PRODUCTION TECHNIQUES (continued)

Bros. Ltd. of The Hyde, London NW 9, England. A gear was added to the gun shaft to mesh with an identical gear on the turns counter, giving a 1 to 1 ratio. Starting and stopping is achieved with a push-button on the right-hand side, adjacent to the air supply hose.

A small bracket attached to the bench between the winding arbor and the wire reel holds a sewing-machine type of tensioning device. This is useful for providing winding tension needed for close-wound coils and for preventing the wire from flying when it is snipped off a finished coil.

## Quick-Leveling Mounts for Production Machines

PUNCH PRESSES, grinders and other machinery involved in the production of electronic equipment and components can be moved to new locations on any type of plant floor and set up ready for use in a few minutes by using Leveling Barrymounts in place of conventional floor anchor bolts. In one demonstration, an assembly line of eight heavy machines was moved and connected to power and air systems in only 24 minutes.

The new mounts also serve to absorb machine vibration, permitting use of punch presses in areas not having reinforced concrete floors. The mounts rest directly on the floor, and are leveled with a few turns of a wrench. Cost is about \$50 per set of four mounts capable of supporting six tons each. Once on a machine, the machine can be

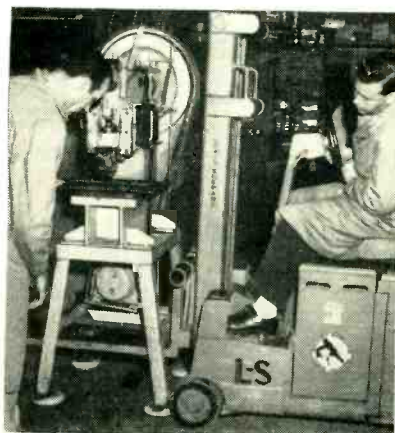

Method of using fork lift truck to move punch press equipped with leveling mounts



**TAYLOR Commercial Grade Vulcanized Fibre**  
 is tough, lightweight, abrasion resistant . . .  
 excellent for bending, punching, stamping and forming . . .  
 resistant to organic solvents, oil and gasoline . . .  
 has excellent electrical characteristics.

## Want to make something of it?

*Make it* into insulating plates, upset washers, arc barriers, terminal blocks, switch and appliance insulation, cases, face plates for golf clubs . . . or any other electrical or mechanical component that can benefit from the unique properties of this versatile material.

*Make it* in red, gray, black, or special colors.

*Make it* from sheets or rolls with these specifications:

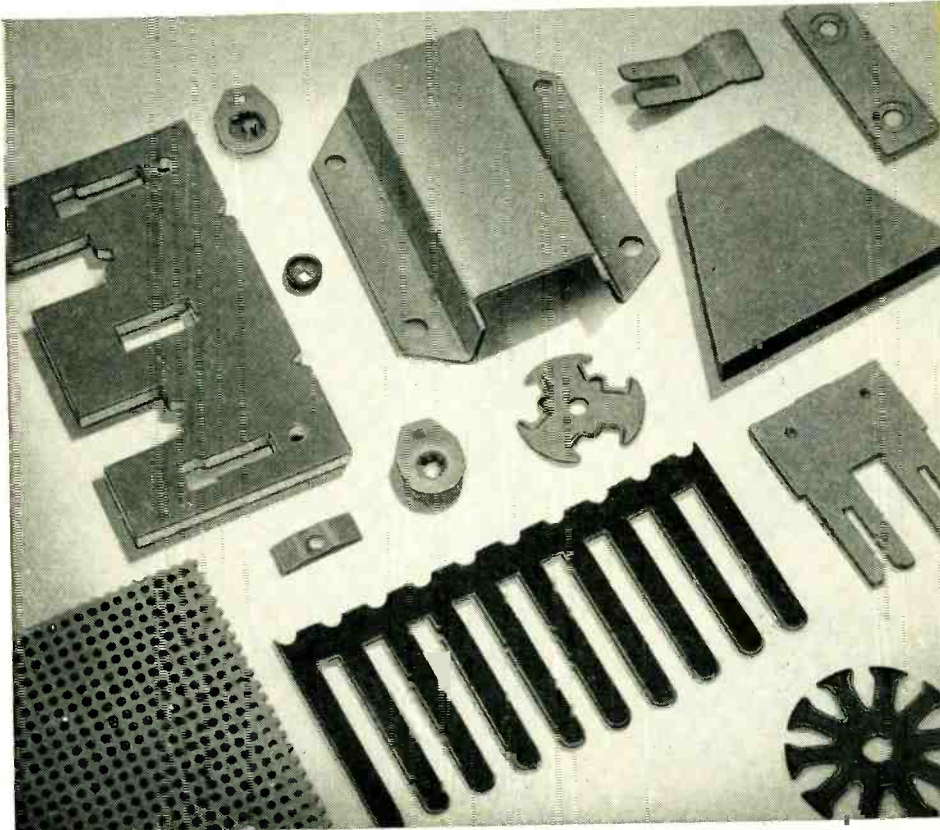

### SPECIFICATIONS

Thickness  
 Range: .005" to 1"  
 Finish: Pressed and  
 calendared  
 Punching: To 3/16" thick  
 Sheet Size: 56" x 90"  
 Roll Width: 56" for thicknesses of  
 .005" through .060".  
 Coils to 3/16" for thick-  
 nesses of .005" through  
 .090".

### PROPERTIES

#### Mechanical

Flexural Strength  
 (Lengthwise) 14000 psi min.  
 (Crosswise) 12000 psi min.

Tensile Strength  
 (Lengthwise) 7500 psi min.  
 (Crosswise) 5500 psi min.

Compressive Strength  
 (Flatwise) 20000 psi min.

Izod Impact Strength  
 (Lengthwise) 3.5 Ft.-Lbs./inch  
 (Crosswise) 2.9 Ft.-Lbs./inch

#### Electrical

Dielectric Strength  
 (1/32" thick) 250 min.

Short Time Test  
 (1/8" thick) 175 min.

Arc resistance,  
 seconds 100

*Make it* from turned rods. Diameters from 1/8" to 1" with ground or buffed finish.

*Make it* easy for yourself when you're buying vulcanized fibre. Call your Taylor engineer . . . he will be glad to work with you . . . help select the correct grades to fit your needs — Commercial, Bone, Super White, Abrasive and Built-up. Also ask him for samples of Taylor Laminated Plastics . . . Phenol, Silicone and Melamine Laminates . . . suited for a variety of your product requirements.

Taylor Fibre Company, Norristown, Pennsylvania — La Verne, Calif.

**TAYLOR**  
 Laminated Plastics  
 Vulcanized Fibre

# precision measurement demands **WAVELINE MICROWAVE...**

## instruments

Such as impedance measuring units incorporating the last word in precision ...

or impedance matching devices to facilitate laboratory measurements ...

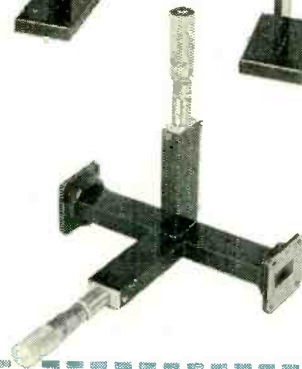
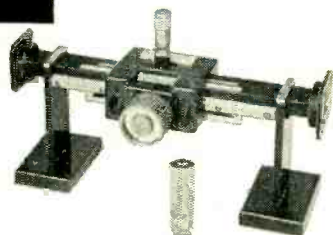

## and components

Whether they be custom built, special assemblies for experimental, and laboratory work ...

or components to be incorporated in radar or communication systems ...



## because ...

Years of experience supplying microwave instruments to meet the most exacting measurement needs of industry have established Waveline as the unchallenged precision leader in the field.

New expanded facilities insure even greater plant flexibility, faster deliveries on both catalog units and special assemblies.

Write or wire today for the address of the nearest Waveline field sales engineer who is always ready to give immediate and personal attention to your microwave problems.

Technical data on microwave instruments sent on request.

**WAVELINE** INC.

CALDWELL, NEW JERSEY

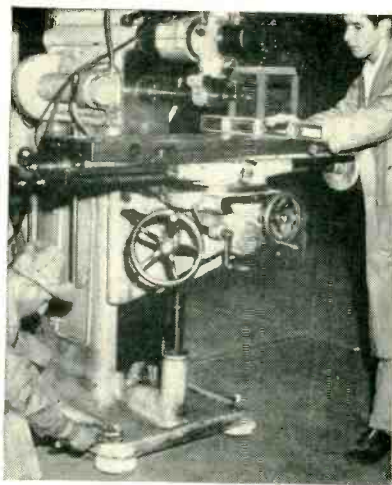

Method of leveling machine by adjusting bolt on mount

moved with a lift truck as often as desired for maintaining efficiency of production despite frequently changing product designs. A disabled machine can be quickly replaced, without a long halt in operation of the line. Repairs can then be made at leisure in a more permanent central tool room.

With all modes of vibration absorbed, walking of machines becomes impossible and there is hence no need for fastening machines to floors. In addition, the plant noise level is reduced, with corresponding increase in worker efficiency. The mounts are manufactured by Barry Corp., Watertown, Mass.

### Grid Stretcher

A HAND-OPERATED stretching mandrel has been developed by Amperex Electronic Corp. for precise shaping of wound grids for their type 5894 twin tetrode. The operator pushes a grid over the forward projecting split mandrel and rotates the hand crank half a turn. The



Method of loading grid on mandrel



# Now— Moldite Dependability in all 3!

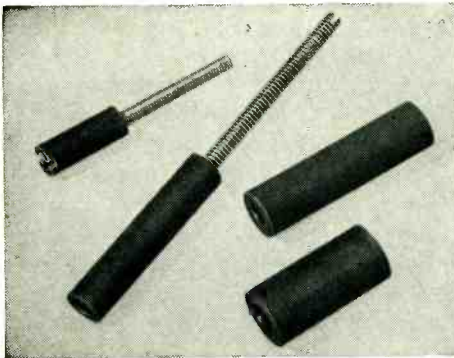

**FERRICORES**

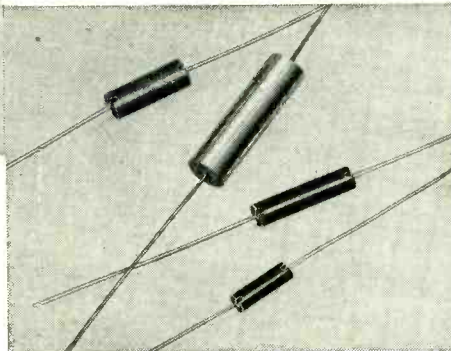

**MOLDED COIL FORMS**

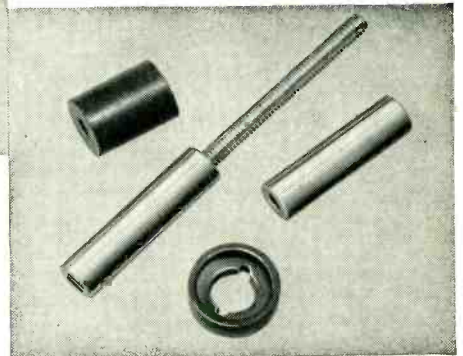

**MAGNETIC IRON CORES**

Moldite's famed precision production facilities are now devoted to 3 major types of electronic components —to give the industry a superlative core or coil form for every electronic application.

Through years of continued engineering and research Moldite has produced cores of guaranteed dependability, economy, quality and uniformity. Our customers' smooth running production lines tell the story best.

Specify a Moldite core specially designed and precision made for you, with absolute uniformity from first to last.



... Send for our new  
Catalog No. 110 —  
THE MOST COMPLETE  
LINE OF CORES  
IN THE INDUSTRY!

- FERRITE CORES
- MOLDED COIL FORMS  
(iron and phenolic)
- MAGNETIC IRON CORES
- FILTER CORES
- THREADED CORES
- SLEEVE CORES
- CUP CORES

Samples promptly submitted upon request for design, pre-production, and test purposes

**NATIONAL  
MOLDITE  
COMPANY**  
1410 CHESTNUT AVE., HILLSIDE 5, N. J.

Robert T. Murray  
614 Central Ave.  
East Orange, N. J.

Jerry Golten Co.  
2750 W. North Ave.  
Chicago 22, Ill.

Arnold Andrews  
521 Cumberland Ave.  
Syracuse, N. Y.

Perlmuth-Coleman & Assoc.  
1335 South Flower  
Los Angeles, Cal.

Jose Luis Ponte  
Cardoba 1472  
Buenos Aires

## USE POLYPENCO® Q-200.5 for UHF Installation Components

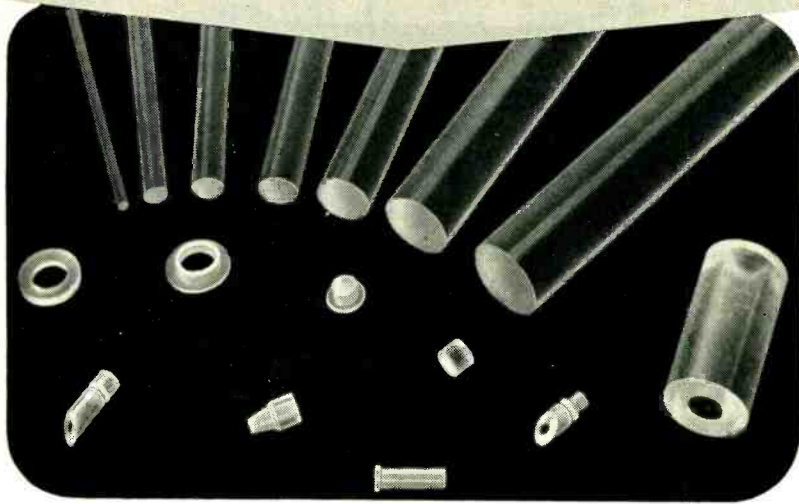

### STANDARD LENGTHS OF 6-8 FT. ASSURE LOW MACHINING COST

For low cost production machining of coaxial spacers, connector beads, stand-off insulators and many similar UHF components, POLYPENCO Q-200.5 is available now in centerless ground rod with diameters up to 1" and lengths of 6 to 8 feet.

### LOOK AT THESE DIELECTRIC PROPERTIES!

- Dielectric Constant: only 2.4 to 2.5
- Dissipation Factor: 0.0002 at 30 mc (remains practically constant over entire frequency range)
- Dielectric Strength: about 350 volts per mil

Get the full facts on POLYPENCO Q-200.5. Write for technical bulletin.

### CHECK THESE OTHER FEATURES

- Dimensionally stable up to 400° F
- Rigid and transparent
- Easily machinable on standard metalworking equipment
- Good mechanical strength
- Chemically resistant

**P**

**POLYPENCO Q-200.5**

nylon and teflon\*  
/ stock shapes, finished parts  
also available to your specifications

The POLYMER CORPORATION of Penna. • Reading, Penna.

\*Trademark for Du Pont tetrafluoroethylene resin



Turning crank to stretch grid

crank actuates an eccentric cam which pushes a tapered pin between the two halves of the mandrel to spread them apart the desired distance. The crank is then moved one-half turn backward to release the pressure so the shaped grid can be easily slid off. Springs bring the mandrel halves together when the pin is retracted.

### Self-Stacking Plastic Trays

COMPONENTS for magnetrons and other microwave tubes are protected from damage during handling or storage by using special molded plastic trays having individual recesses for each part. As an added advantage, the number of parts in either filled or unfilled trays can be counted at a glance. Removable inner trays of the plastic trays are interchangeable, so that the same standard pans can be used for many different types of parts. Wires running inside each pan at the top serve as supports when nesting the pans to prevent them from jamming into each other.

Smaller parts are stored in clear

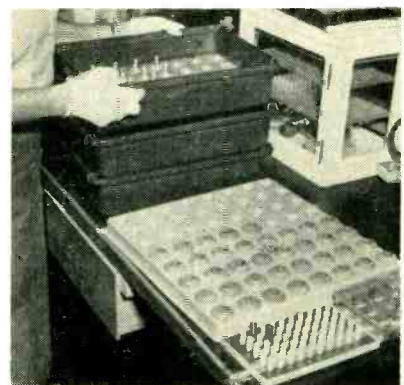

Tube parts in plastic handling trays





★ **BLILEY TYPE  
BH6A**



★ **BLILEY TYPE BCS-1A**

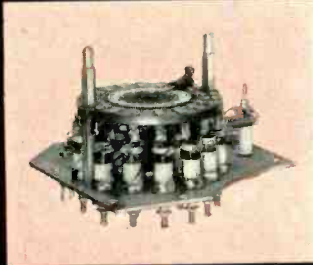

★ **CUSTOM-BUILT  
OSCILLATOR  
ASSEMBLY**



★ **BLILEY TYPE SDL-15**



★ **BLILEY TYPE  
TCO-1A**

# Bliley

**CRYSTALS - MILITARY AND COMMERCIAL**

**SOLID ULTRASONIC DELAY LINES**

**CRYSTAL OVENS**

**FREQUENCY STANDARDS**

**CUSTOM ASSEMBLIES**

**COLOR TV CRYSTALS**

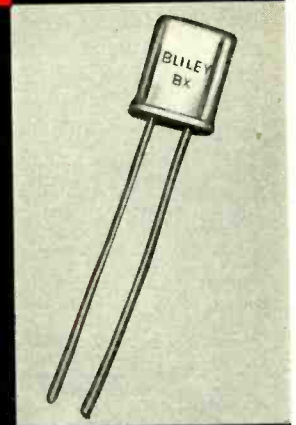

★ **BLILEY BANTAM BX**

Informative bulletins are available on all Bliley products. Write, specifying your requirement.



**BLILEY ELECTRIC COMPANY**  
UNION STATION BLDG., ERIE, PENNSYLVANIA

# RAYONIC CATHODE RAY TUBES

by

# Waterman

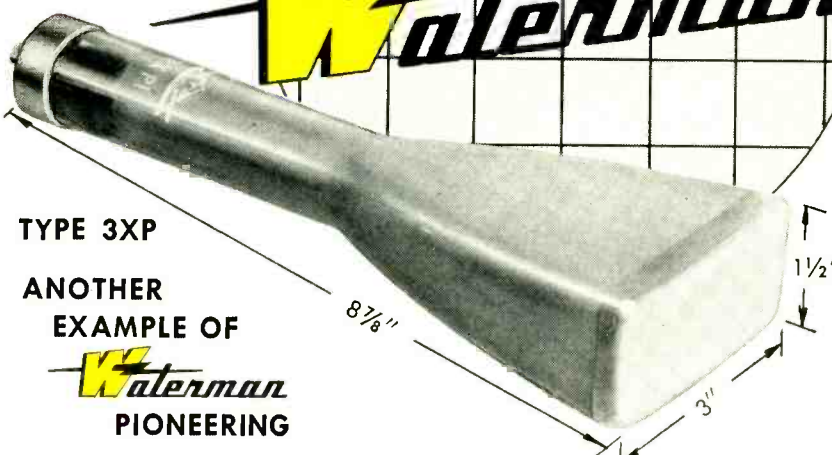

TYPE 3XP

ANOTHER EXAMPLE OF

**Waterman**  
PIONEERING

3XP RAYONIC CATHODE RAY TUBE provides a brilliant and sharply-defined trace and high deflection sensitivity at medium anode potentials. When comparing 3RP operating at 1000 volts second anode against 3XP operating at 2000 volts, the results are astonishing. For the same spot size, 3XP light output is improved by a factor greater than 4, vertical deflection sensitivity improved by a factor of 2, while the horizontal sensitivity remains unchanged. Because 3XP is enclosed in a short envelope and has half the inter-electrode capacities of the 3RP, the tube lends itself admirably to high frequency video work as well as for low repetitive operation.

**TECHNICAL DATA** The basic properties of the cathode ray tube that concern the designer or the user are: deflection sensitivity, unit line brightness, line width, static voltage requirements and physical size. A comparison between cathode ray tubes manufactured by Waterman Products Company is shown in the table below. These tubes are available in P1, P2, P7 and P11 phosphors. 3JP1, 3JP7, 3SP1 and 3XP1 are available as JAN tubes.

TUBE	PHYSICAL DATA			STATIC VOLTAGE			DEFLECTION*		LIGHT OUTPUT**
	Face	Length	Base	A3	A2	A2 Max.	Vert	Hor	
3JP1	3"	10"	Med Diheptal	3000	1500	2000	111	150	352
3MP1	3"	8"	Sm Duodecal		750	2500	99	104	33
3RP1	3"	9 1/8"	Sm Duodecal		1000	2750	61	86	44
3SP1	1.5x3"	9 1/8"	Sm Duodecal		1000	2750	61	86	44
3XP1	1.5x3"	8 7/8"	Loctal		2000	2750	33	80	218

\*Deflection in volts per inch.

\*\*Light output of an element of a raster line (one mm long and not exceeding .65mm in width) in microlumens.

All heaters 6.3 V AC, .6 AMP.

plastic boxes with hinged covers, available in hardware stores with various sizes of inner partitions. Tubular parts are stored on plastic pegs set into a plastic tray or sheet.

These material-handling techniques are used in the Hicksville, N. Y. plant of Amperex Electronic Corp. The large trays are molded economically from a new Boltaron plastic material that can be formed in simple wood molds.

## Automatic Tip-Off Machine

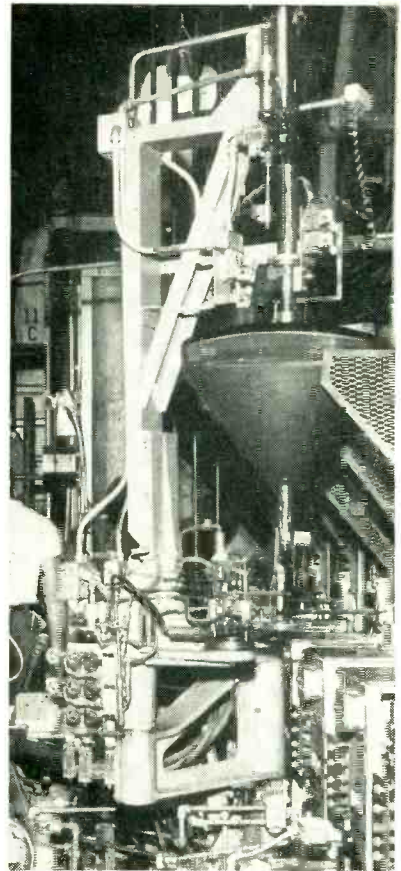

Tip-off machine has raised tube after completing seal. As next step, tube is swung forward so operator can remove it for transfer to overhead conveyor

THE DELICATE process of sealing off the glass tubulation of television picture tubes has been mechanized in General Electric's tube plant at Electronics Park, Syracuse, N. Y. After the exhaust machine has completed its index, the automatic tip-off unit swings into position with a live-vacuum suction cup directly above the bulb to be tipped. Pre-set fires adjust themselves to the proper position on the glass tubulation and, as it is heated to the soft-

## WATERMAN PRODUCTS CO., INC.

PHILADELPHIA 25, PA.

CABLE ADDRESS: POKETSCOPE

### WATERMAN PRODUCTS INCLUDE

3JP1, 3JP7, 3SP1, 3XP1 JAN RAYONIC®

Cathode Ray Tubes

3JP—3MP—3RP—3SP—3XP RAYONIC

CATHODE RAY TUBES

Available in P1, P2, P7, and

P11 Phosphors

POCKETSCOPES® PULSESCOPIES®

RAKSCOPES®

And Other Associated Equipment

MEMO...

Write for details today!



WATERMAN PRODUCTS



# BORG

The New Standard for Precision Multiturn Potentiometers  
... Eliminates The Necessity for Special Designs!

# New

## BORG MICROPOTS

Models Available for Test and Evaluation

SERIES 901-903  
TEN-TURN  
POTENTIOMETERS

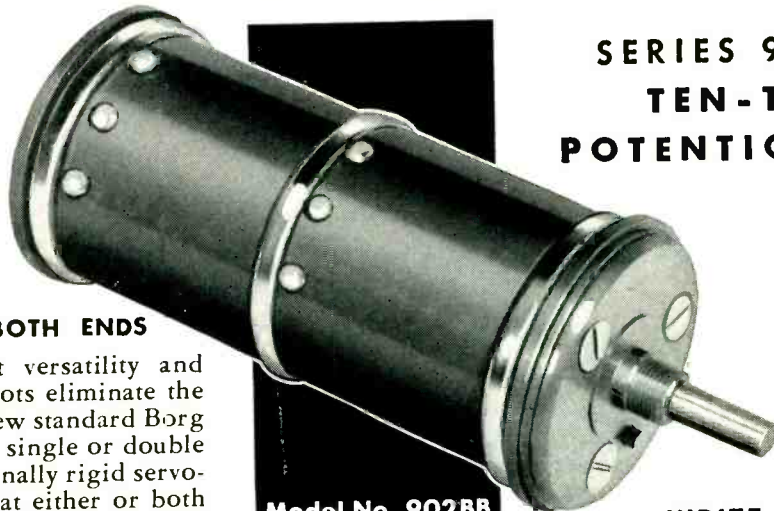

Model No. 902BB

### BUSHING MOUNT AT BOTH ENDS

Designed for the utmost versatility and adaptability, Borg Micropots eliminate the need for special design. New standard Borg Micropots are available in single or double shaft models with exceptionally rigid servo-mount or bushing-mount at either or both ends. The housing floats on sturdy mounting flange.

WRITE TODAY FOR  
COMPLETE INFORMATION

Borg 901 Series 10-turn and 931 Series 3-turn Micropots are built to the same superior advanced design-principles that have set the new standard for precision multiturn potentiometers.

SERIES 931-935  
THREE-TURN  
POTENTIOMETERS



Model No. 935S

### SERVO MOUNT AT BOTH ENDS

All potentiometers are available with double end support to assure efficient operation where subjected to excessive vibration. Precision ball bearings and precision rolled lead-screw provide higher accuracies and longer life. New scanning bar-contact reduces noise and lengthens life. Adjustable contact assembly provides higher accuracies at lower cost.



BORG EQUIPMENT DIVISION  
**THE GEORGE W. BORG CORPORATION**  
Janesville, Wisconsin

# Magnecord M80

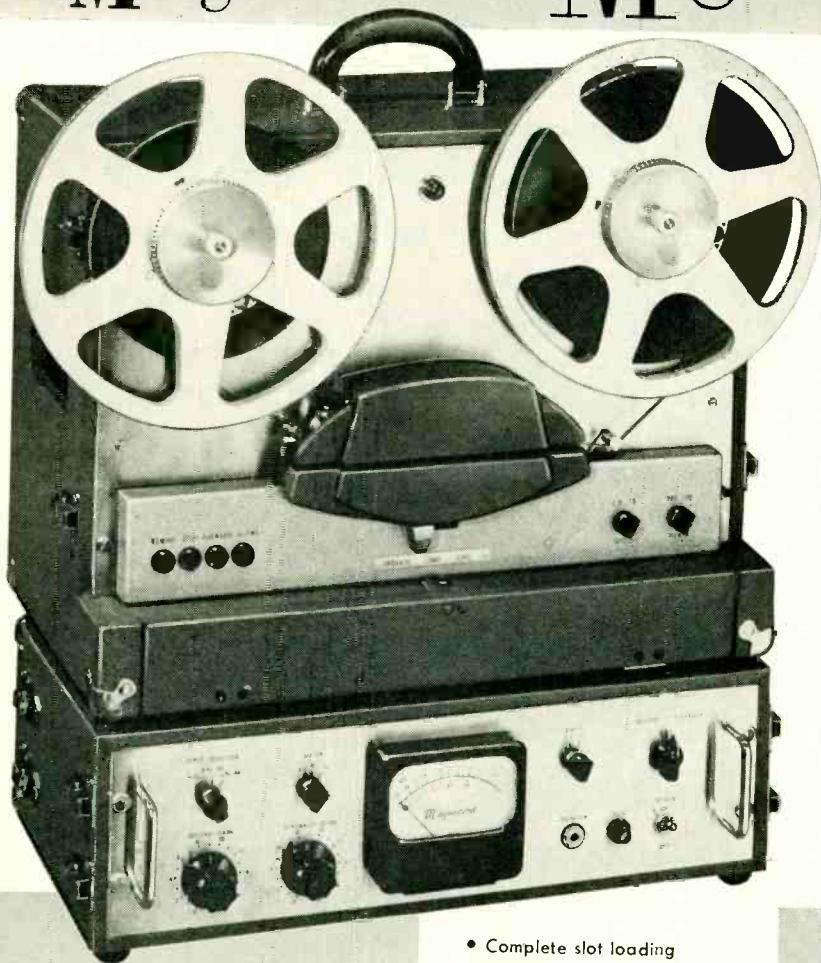

**the only  
professional  
tape recorder  
with every  
needed feature**

- Complete slot loading
- Interlocked pushbutton controls
- 15,000 cps response at 7½"
- Lowest flutter rate obtainable
- Full remote operation
- Automatic tape lifter
- Instantaneous stop and start
- Positive, direct-drive timing
- Interchangeable head assemblies
- Mounts in console, rack, or case

Feature for feature, the all-new Magnecord M80 is the finest professional tape recorder ever built for its price! The M80 is lighter, more compact, easier to operate and maintain than any comparable recorder, yet brilliantly superior in every performance specification! It is the outstanding choice for your precision recording requirements!

For full details, see the Magnecord distributor listed under "Recording Equipment" in the classified telephone directory. Or write:

**Magnecord, INC.**

DEPT. E-4

225 WEST OHIO STREET  
CHICAGO 10, ILLINOIS

PRODUCTION TECHNIQUES (continued)

ening point, the tube is raised, stretching the tubulation. Application of further heat cuts the tubulation and forms the final vacuum seal.

The tipping equipment then swings away from the exhaust machine, carrying the tube to position for removal by the operator. After manual removal of the tube, the machine is ready for the next cycle. Safety interlocks prevent improper sequential operation of the complex equipment.

## Polishing Copper Laminates for Etched Circuits

A ROTARY scrub brush in a modified drill press arrangement is used with extra fine pumice and water to prepare copper-clad plastic sheets



Polishing copper-clad plastic sheet with rotary scrub brush in drill press arrangement that is free to move horizontally as well as vertically

for conversion to etched components. The mounting arrangement permits moving the rotating brush horizontally in all directions so as to cover the entire surface of the sheet. Vertical pressure on the brush is applied conventionally with a drill press lever working against a spring. A belt drive is used for the motor, to achieve speed reduction along with flexibility of movement.

The polishing operation, which takes about 30 seconds per sheet, is used to remove oxides and adhering foreign material, clean the copper



Announcing another outstanding  
**DESIGN ACHIEVEMENT** by *Federal*

**S·C·S**  
 "SINGLE-CRYSTAL-STABILIZED"

GERMANIUM  
**DIODES**



Available in  
 these 14 types:

- |       |       |
|-------|-------|
| IN34  | IN55  |
| IN38  | IN53  |
| IN39  | IN58  |
| IN48A | IN63A |
| IN51A | IN63A |
| IN52A | IN65A |
| IN54  | IN75A |

**CHECK THESE FEATURES—**

- SINGLE-CRYSTAL GERMANIUM**—the finest for reliable performance
- MOISTURE-PROOF**—vacuum-sealed, all-ceramic construction to provide stable characteristics
- EVERY DIODE TESTED** for all characteristics, including oscilloscope tests for hysteresis and non-linearity
- COMPLETELY INSULATED CASE**
- POLARITY** clearly identified
- HEAT SINKS** protect during soldering
- SMALL SIZE** ( $-\frac{1}{4}$ " diameter,  $\frac{1}{2}$ " long)
- FLEXIBLE LEADS** for easy mounting
- NO FILAMENT**—no heater power drain or hum
- LOW SHUNT CAPACITY** (average 1 mmf.)
- SELF-HEALING** for temporary overloads
- NO CONTACT POTENTIAL**
- WITHSTANDS** adverse temperature and humidity cycling

**"SINGLE-CRYSTAL-STABILIZED"**

... precision-made and vacuum-sealed to provide a new high in performance for germanium diode applications!

Product designers! Now it's Federal's new *single-crystal-stabilized* diodes . . . bringing to you high-quality single-crystal germanium for the utmost in reliable performance, combined with a construction to provide stable operation over long hours of use.

Federal "S-C-S" Diodes are vacuum-sealed . . . solidly encased in a non-porous ceramic that firmly bonds both ends to case and leads, resulting in *moisture-proof* construction.

Federal "S-C-S" Diodes withstand repeated temperature and humidity cycling—without adverse effect on their electrical characteristics. Their small size, fully insulated case and flexible leads permit fast, easy mounting in all types of equipment.

Get all the facts about Federal "S-C-S" Diodes . . . a notable contribution to diode progress . . . insuring tens of thousands of hours of dependable performance!



*Federal Telephone and Radio Company*

SELENIUM-INTELIN DEPARTMENT

100 KINGSLAND ROAD, CLIFTON, N. J.

In Canada: Federal Electric Manufacturing Company, Ltd., Montreal, P. Q.  
 Export Distributors: International Standard Electric Corp., 67 Broad St., N. Y.

For details on Federal "S-C-S" Diodes, write to Dept R-113

# IRON FIREMAN Choppers

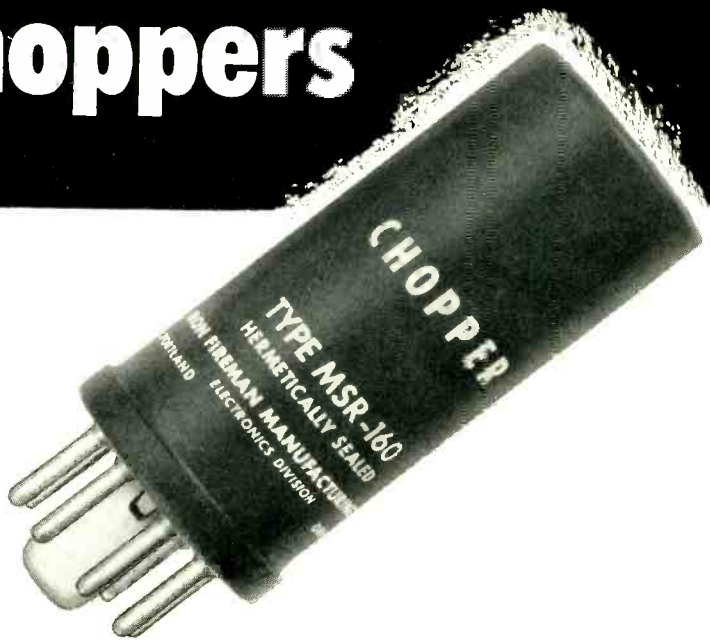

The new choppers developed by Iron Fireman's instrument specialists give outstanding performance in a wide range of electronic applications. They embody the integrity of design and quality of manufacture which have made Iron Fireman products trusted wherever they are used.

At right is illustrated a typical Iron Fireman Chopper operation as it would appear on an oscilloscope when a sine wave alternating current is impressed on the coil.

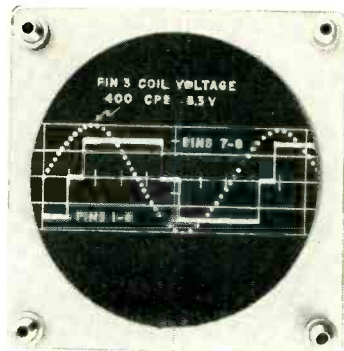

### Look at these Features:

- Exclusive new design
- Low noise pick up
- Minimum contact bounce
- High contact rating
- Long life
- Wide frequency response

For more information on choppers, as well as high speed relays and sensitive relays, write to:



**Iron Fireman Electronics**  
2800 S. E. 9th Ave., Portland 2, Ore. **DIVISION**

and leave a fine rough surface for coating with a photographic emulsion. High-quality fiber brushes costing approximately \$7 each are used to prevent undesired scratching. When the cleaning operation is carried out continuously, a brush lasts about a third of a day.

### Cotter Pins Serve as Insulator Terminals

SILVER-PLATED cotter pins inserted in insulating bushings are staked into chassis holes with a punch press for use as mounting terminals and connection points, by means of a technique developed in the television receiver plant of E. K. Cole Ltd., Southend-on-Sea, England. The pin terminals take considerably less chassis space than conventional Bakelite panel terminals with soldering lugs and riveted mounting brackets. The pin terminals also reduce overall labor and material costs, as all terminals on a chassis can be staked in one operation. The reduced size allows a better distribution of component parts, which in turn makes assembly and wiring operations easier.

The first step in production is machining the insulating bushing on a Brown & Sharp 00G automatic lathe. The insulating material used is a synthetic resin bonded fabric known as Carp Brand Tufnol, made by Ellison Insulators Ltd., Perry Bar, Birmingham 22B, England, but any other high-quality insulating material will serve the purpose.

After the bushing is automatically turned and formed, it is picked up by a transfer arm on the machine and moved into line with a small hole through which a cotter

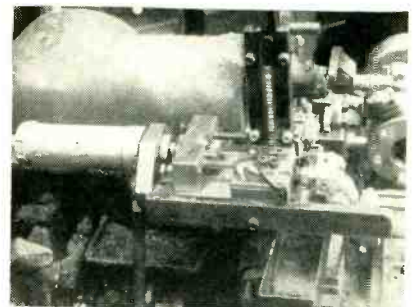

Automatic lathe for machining bushings and inserting cotter pins. Air cylinder at left drives in pins. Magazine feed for pins rises vertically at right



# How would you handle this electrical parts problem?

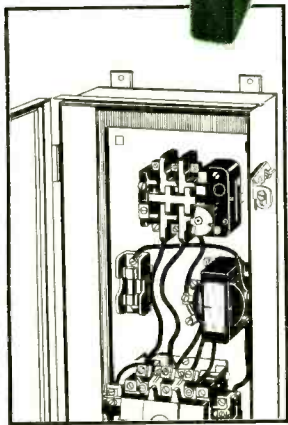
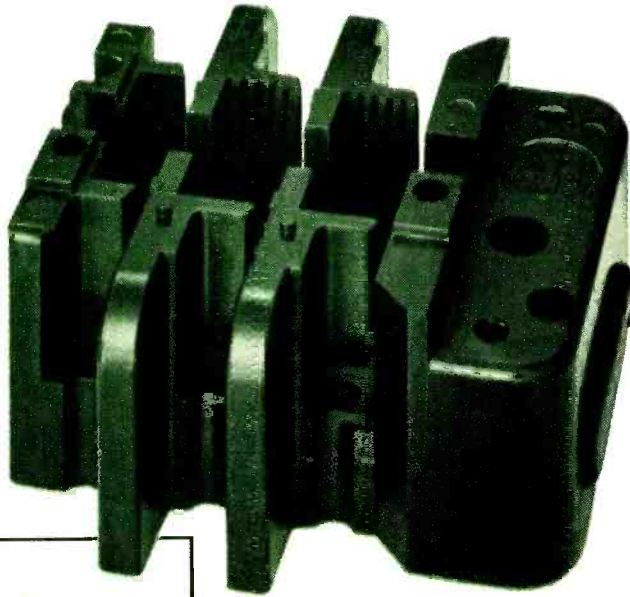

Combination starter, containing parts molded of Monsanto's Resinox 3700 thermosetting material, manufactured by Arrow-Hart & Hegeman Electrical Co.

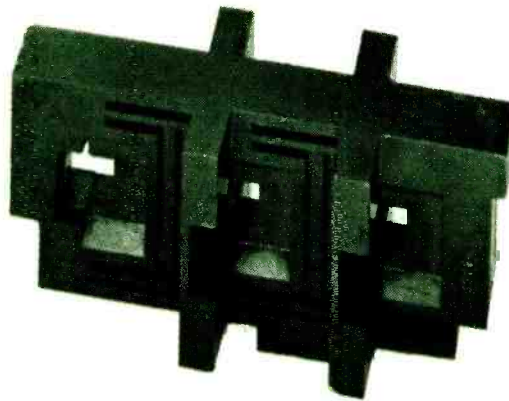

**Arrow-Hart  
solved it with  
new  
RESINOX 3700**

Arrow-Hart & Hegeman Electrical Company of Hartford, Conn. needed a strong, stable, electrical-grade material with high arc-resistance for important parts of their combination starter shown here. They specified Monsanto's new thermosetting molding powder, Resinox 3700. Result: Complete satisfaction!

Resinox 3700 is the ideal all-around material for magneto ignition, motor control and electronic circuits, and other electrical applications.

- 1** It combines high arc-resistance with outstanding dimensional stability. Eliminates undesirable after-shrinkage.
- 2** It has excellent moldability and relatively good impact resistance, plus good transfer molding properties.
- 3** It offers superior heat resistance.

Perhaps Resinox 3700 is exactly what *you* need to solve an electrical equipment problem. Write today for full information!

Resinox: Reg. U. S. Pat. Off.



SERVING INDUSTRY...  
WHICH SERVES MANKIND

MONSANTO CHEMICAL COMPANY, Plastics Division, Room 2502, Springfield 2, Mass. Please send me complete information on Monsanto's new Resinox 3700 arc-resistant material.

Name & Title \_\_\_\_\_

Company \_\_\_\_\_

Address \_\_\_\_\_

City, Zone, State \_\_\_\_\_

# New Booklet on Gamewell Precision Potentiometers

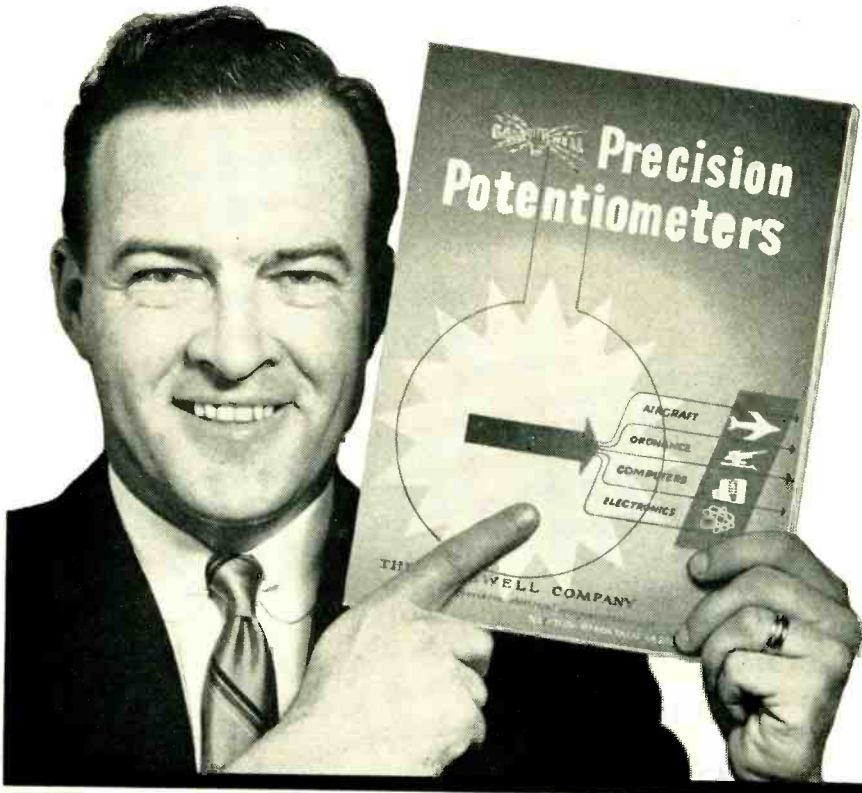

## CONTENTS

- Methods of Manufacture
- Windings Available
- Linear Potentiometers description condensed specifications
- Non-Linear Potentiometers description condensed specifications
- Special Applications
- Glossary of Terms Used
- Information Required with Orders

For your copy of this new Gamewell Precision Potentiometer booklet, just send us a note on your company letterhead. Your copy will be mailed immediately, at no obligation to you.

**THE GAMEWELL COMPANY** • Newfor Upper Falls 64, Massachusetts

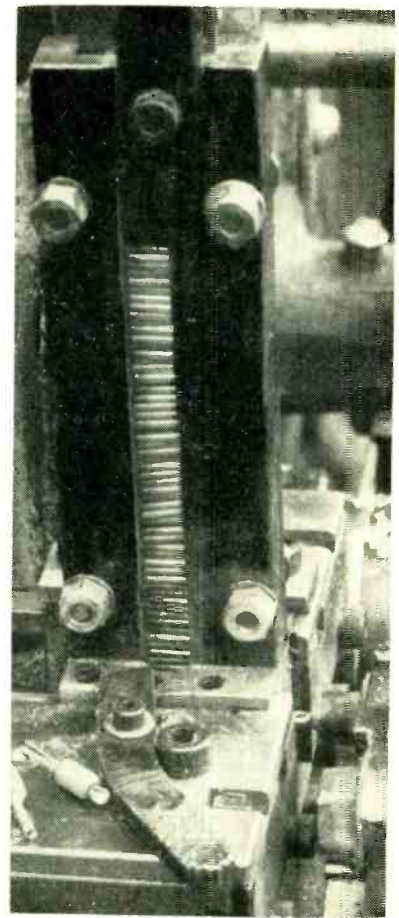
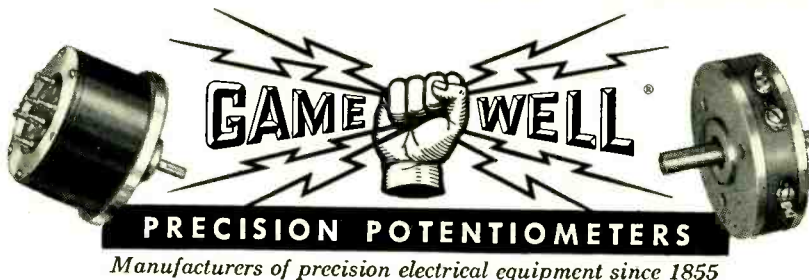

Details of magazine feed for pins

pin is automatically fed by an air-operated plunger. The transfer arm then moves past the ejector blade, releasing the pin and bushing assembly so it drops into the delivery chute.

The cotter pin is driven in with a tight friction fit so it cannot drop out later. The complete cycle time for making one terminal is 4.25 seconds. The air cylinder of the plunger that drives in the pin is operated by a roller valve which is tripped by a special cam on the main cam shaft of the lathe.

As the first step in staking the terminals to a chassis, the operator loads the pin and bushing assemblies into the bottom tool of the staking fixture, points upward. The chassis is next dropped over this fixture and the press is operated. The top tool consists of hollow punches with staking points that close up the chassis metal around the Tufnol bushings. No difficulty is encountered in placing the chassis over the terminals because the punched holes are appreciably larger than the bushings. The swag-



# Designed

to replace **TUBULAR CERAMIC** and **MICA** condensers at **Lower Cost!**

## RMC DISCAPS®

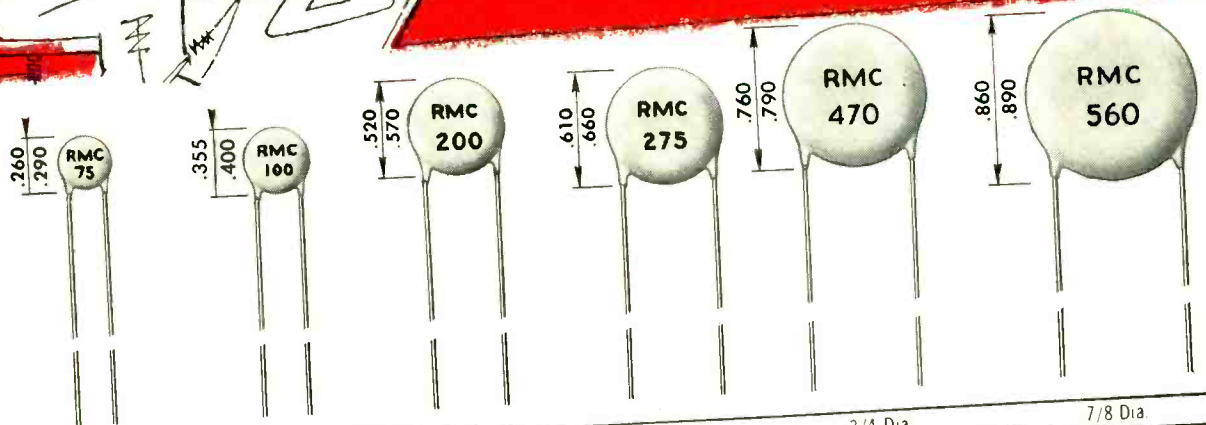

TC	1/4 Dia.	5/16 Dia.	1/2 Dia.	5/8 Dia.	3/4 Dia.	7/8 Dia.
P-100	1- 3 MMF	4- 9 MMF	10- 30 MMF	61- 75 MMF	76-100 MMF	101-150 MMF
NPO	2- 12	13- 27	28- 60	61- 75	76-100	101-150
N- 33	2- 15	16- 27	28- 60	61- 75	76-120	121-150
N- 75	2- 15	16- 27	28- 60	61- 75	76-140	141-150
N- 150	2- 15	16- 30	31- 60	76-100	101-150	151-190
N- 220	3- 15	16- 30	31- 75	76-100	101-150	151-190
N- 330	3- 15	16- 30	31- 75	80-120	121-200	201-240
N- 470	3- 20	21- 40	41- 80	151-200	201-280	281-350
N- 750	5- 25	26- 56	57-150	200-250	251-330	331-560
N-1400	15- 50	51-100	101-200	201-275	276-470	471-560
N-2200	47- 75	76-120	121-200			

The design of Type C temperature compensating DISCAPS has stood the test of more than four years of volume production.

Now universally specified as a money-saving replacement for tubular ceramic and mica capacitors, Type C DISCAPS are available in a wide range of capacities and temperature coefficients for many applications. They feature smaller size, lower self inductance, and greater dielectric strength. Rated at 1000 working volts, Type C DISCAPS assure trouble-free performance on VHF or UHF applications. Their lower initial cost and greater mechanical strength permit a substantial lowering of production costs.

If you have a design problem requiring a standard or special type of ceramic capacitor why not let RMC engineers solve it for you.

### SPECIFICATIONS:

POWER FACTOR: Over 10 MMF less than .1% at 1 megacycle  
Under 10 MMF less than .2% at 1 megacycle

WORKING VOLTAGE: 1000 V.D.C.

TEST VOLTAGE (FLASH): 2000 V.D.C.

CODING: Capacity, tolerance and TC stamped on disc

INSULATION: Durez phenolic-vacuum waxed

INITIAL LEAKAGE RESISTANCE: Guaranteed higher than 7500 megohms

AFTER HUMIDITY LEAKAGE RESISTANCE: Guaranteed higher than 1000 megohms

LEADS: No. 22 tinned copper (.026 dia.)

TOLERANCES: ±5% ±10% ±20%

These capacitors conform to the RTMA specification for Class 1 ceramic condensers.

The capacity of these capacitors will not change under voltage.

**SEND FOR SAMPLES**

DISCAP  
CERAMIC  
CAPACITORS



**RADIO MATERIALS CORPORATION**

GENERAL OFFICE: 3325 N. California Ave., Chicago 18, Ill.

FACTORIES AT CHICAGO, ILL. AND ATTICA, IND.

DISTRIBUTORS: Contact Jobbers Sales Co., 146 Broadway, Paterson 1, N. J.

# American Beauty

ELECTRIC  
SOLDERING  
IRONS  
for



**BETTER  
SOLDERED  
CONNECTIONS**



BANTAM—3118  
1/8" TIP  
30-WATT



BANTAM—3120  
3/16" TIP  
30-WATT



HEAVY-DUTY  
ELEMENT-IN-TIP  
—3438

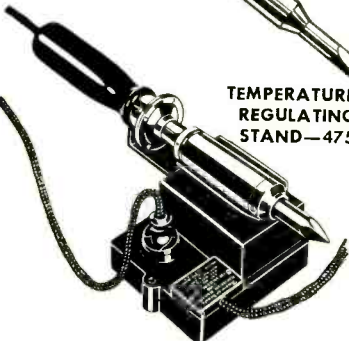

TEMPERATURE  
REGULATING  
STAND—475

**DEPENDABLE . . . DURABLE . . . EFFICIENT.** Since 1894 American Beauty Electric Soldering Irons have been the standard for performance for all soldering irons.

**NOW . . .** American Beauty gives you precision production soldering with the new BANTAM—a light, sturdy, quick-heating soldering iron with small-diameter tip.

### HEAVY-DUTY ELEMENT-IN-TIP—3438

A different, more efficient electric soldering iron than any on the market. An iron designed especially for heavy-duty or production-line use. It embodies a new type of heat application with the element permanently-embedded in the tip.

### TEMPERATURE REGULATING STAND 475

Set the thermostat at the desired temperature—your iron will be ready to use without waiting.

WRITE FOR DESCRIPTIVE LITERATURE

SINCE 1894—ALWAYS DEPENDABLE

**American Electrical Heater Company**



NO. 140-H

DETROIT 2, MICHIGAN



Inserting terminal pins in bottom tool of staking fixture



Removing chassis after all terminal pins have been locked in position with one staking operation

ing operation closes up this space to give a tight and rigid terminal mounting.

This method cuts the cost of terminals approximately in half as compared to the older technique of bolting terminals in position.

After assembly of the pins on the chassis, the legs are spread open as much as desired. The cotter pins used are long enough so that up to three wires can be soldered on each leg during the wiring of a television receiver. Additional connections can also be made to the head of the pin on the top of the chassis if desired. These pin heads also serve as convenient test terminals for troubleshooting during servicing of the receiver.

### Potting-Wax Centrifuge

METAL cans containing capacitors and resistors embedded in potting wax are spun at high speed in a centrifuge at the Hawthorne Works of Western Electric Co. This procedure was introduced to eliminate



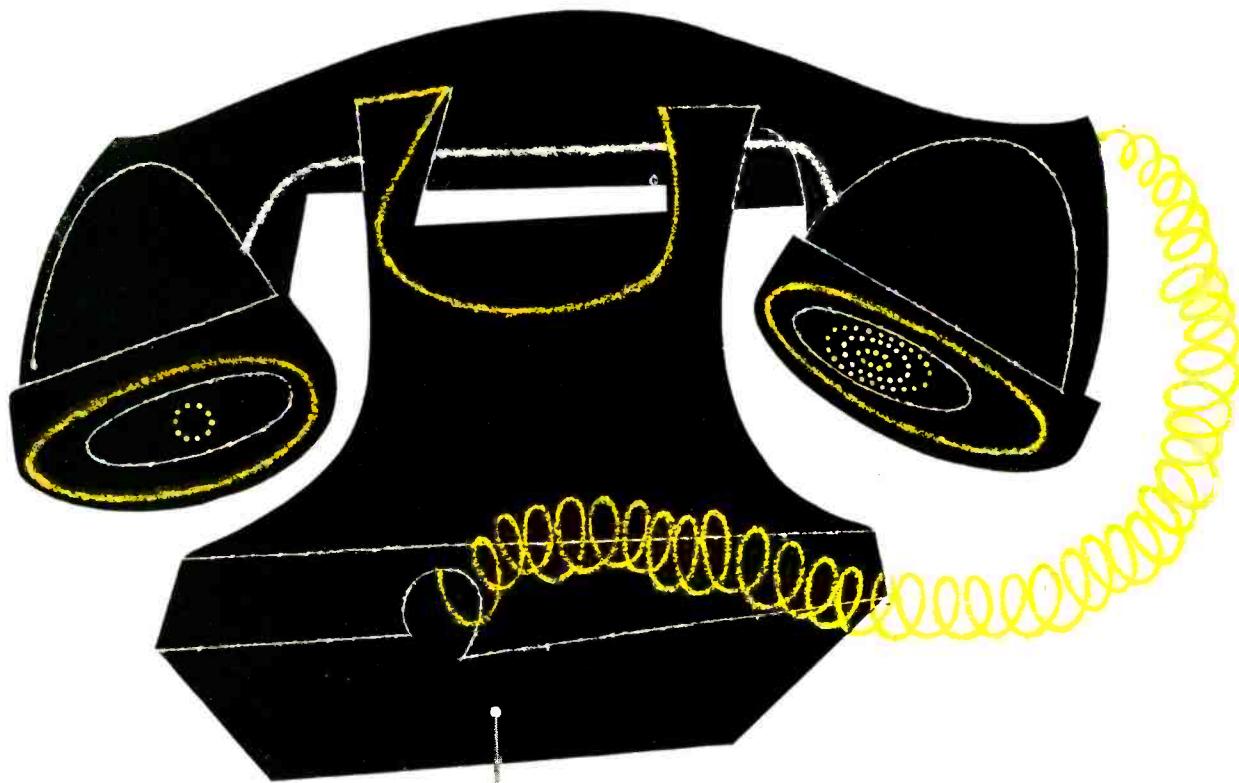

## CRUCIBLE PERMANENT MAGNETS

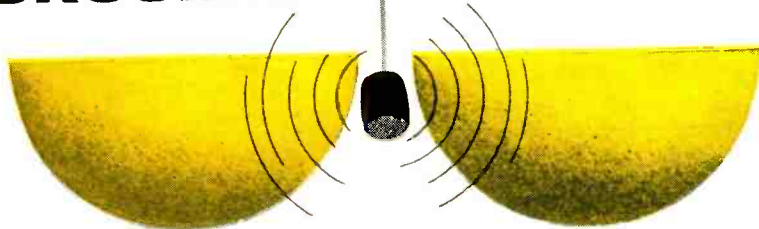

provide maximum energy . . . minimum weight

No matter what your permanent magnet application may be — galvanometer, speedometer, television or telephone — you'll find that Crucible alnico magnets have a *consistently higher* energy product. This means more energy from a smaller magnet.

Since alnico alloys were first developed, Crucible has been a leading producer of this superior type of permanent magnet. And Crucible alnico permanent magnets are made by the nation's foremost specialty steelmaker.

For alnico magnets that are unsurpassed in quality — *call Crucible.*



Join your  
Civil Defense Team  
**NOW!**



# CRUCIBLE

first name in special purpose steels

54 years of *Fine* steelmaking

## ALNICO PERMANENT MAGNETS

CRUCIBLE STEEL COMPANY OF AMERICA, GENERAL SALES OFFICES, OLIVER BUILDING, PITTSBURGH, PA.  
 REX HIGH SPEED • TOOL • RESISTAL STAINLESS • ALLOY • MAX-EL • SPECIAL PURPOSE STEELS

# STILL MORE WAYS TO SQUEEZE PENNIES OUT OF UPSET SPECIALS COSTS

Specially designed upset products are solving thousands of problems. Dozens of design pointers on them are yours for the asking. Send us your sketches, prints, finished products for suggestions.

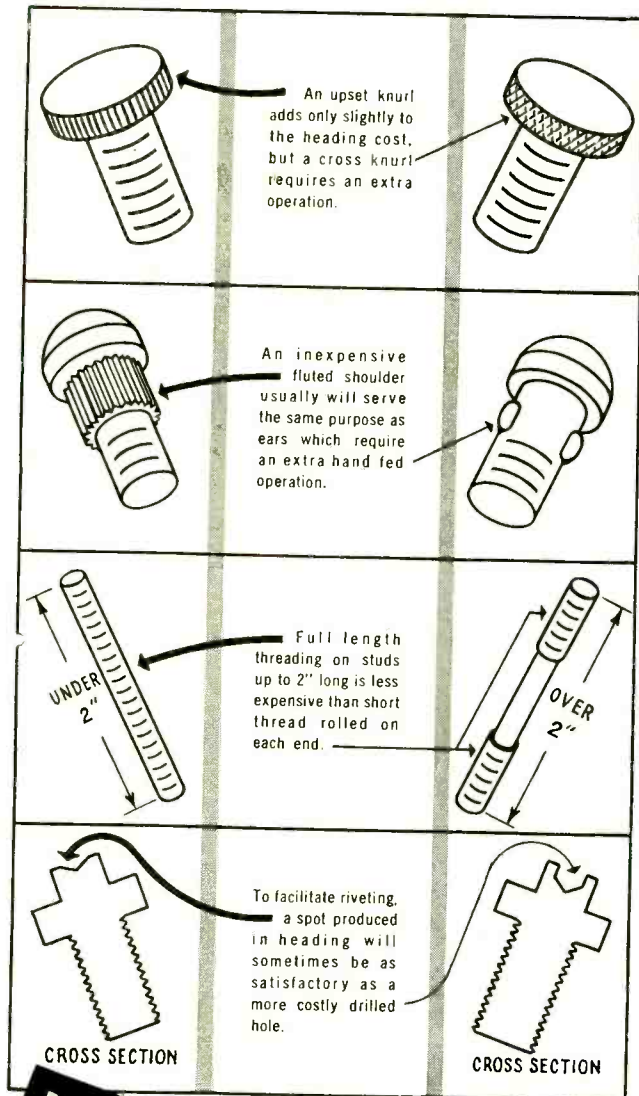

**REPRINTS**

of this and of previously published charts are available on request for use in drafting and purchasing departments.



**MACHINE SCREWS AND SPECIAL FASTENERS ARE OUR BUSINESS**



WRITE FOR OUR CATALOG

**THE PROGRESSIVE  
MANUFACTURING COMPANY**

50 NORWOOD ST., TORRINGTON, CONN.

Want more information? Use post card on last page.

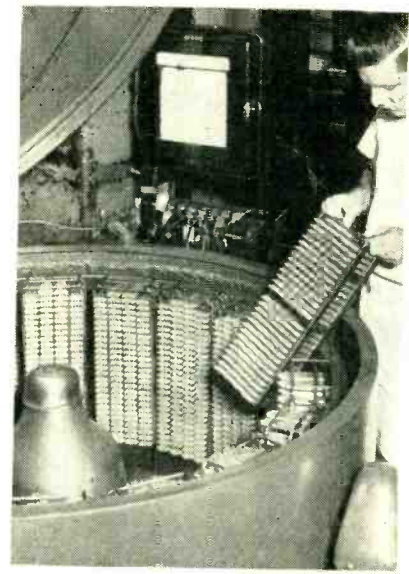

Loading racks of potted components into centrifuge. Cover at upper left is lowered before starting machine

the voids or cavities that formerly developed in the wax during shrinkage after cooling.

Spinning the cans in the centrifuge under a blast of hot air binds the wax together and eliminates cavities, thereby giving more dependable electrical networks. Savings in reprocessing costs and improved reliability of components combine to give an annual saving estimated to approach \$100,000.

## Moving TV Tube Dies With Fork Lift Truck

MALE and female dies for stamping stainless steel television tube shells, weighing 2,500 and 4,000 pounds respectively, are loaded into and removed from their press in the plant of the United Specialties Co. in Chicago with a Towmotor fork lift truck equipped with a special unloading device. This new material-handling technique is saving 65 percent of the time it formerly

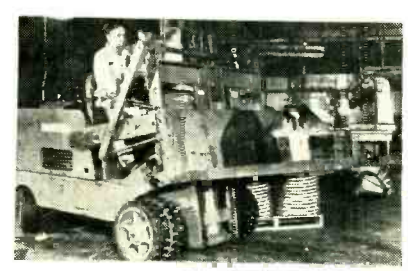

Using lift truck to move male half of picture tube shell die. Finished shells can be seen in background



the switch is ON to

**GUARDIAN**

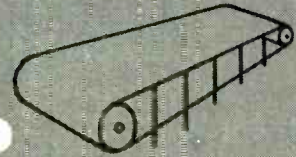
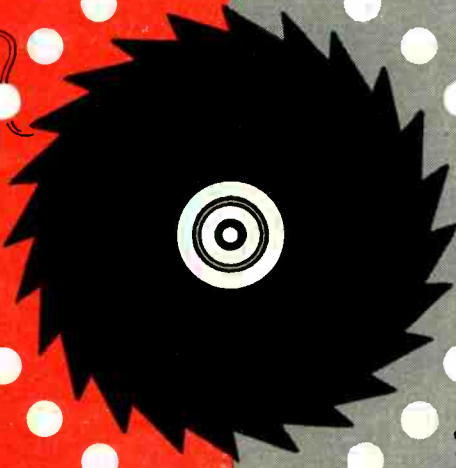

GUARDIAN

*High Precision*

**STEPPERS**

These *high precision* standard Guardian Steppers afford positive selection and control of multiple circuits in Business Machines, Counting Devices, Totalizers, Computers and a vast array of similar products at *low cost*. Applications include: automatic circuit selection; automatic sequence selection of circuits; automatic sequence cross-connection of circuits.

**SERIES M. E. R. GUARDIAN MIDGET ELECTRICAL RESET STEPPER**

Keeps the reset magnet open, allows the ratchet to reset freely on a pulse of 10 milli-seconds. Stepping magnet releases lock mechanism on first step to ready unit for recycle. Standard unit has one disk with one finger rotating counter-clockwise. Two fingers available. Up to 21 of total 24 points on disk are active. Rated at 10 steps per second. Voltage ranges: 6 v. to 115 v. A.C., 60 cycles, or 6 v. to 110 v. D.C. Auxiliary small combination contact switches can be mounted on ratchet or on either magnet. New 3-point mounting for easy installation.

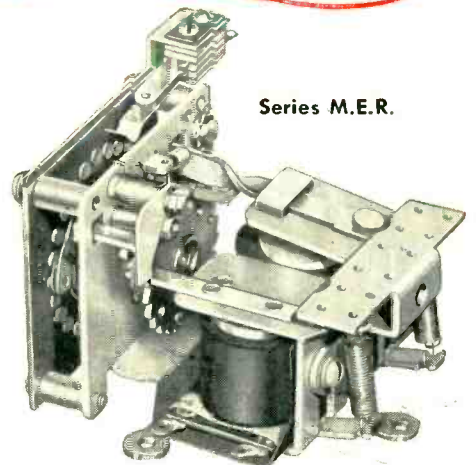

Series M.E.R.

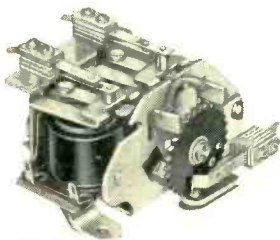

Series M.A.S.

**SERIES M. A. S. STEPPER**

A compact dependable Add and Subtract unit. Up to 27 active points on total of 30. Rated at 10 steps per second. S.P.D.T. contact switch can be mounted on any ratchet position or on either magnet. Available to operate on 6 v. up to 115 v. A.C., 60 cycles, or from 6 v. 110 v. D.C.

**SERIES M-120 STEPPER**

Up to 3 position contact combinations are available on the Guardian Series M-120 Stepper. 24 point ratchet employs case hardened steel construction to assure long life precision operation. Contact combinations in 3 standard ratings: 1.5, 10 and 12 amps. at 115v., 60 cycles, non-inductive. Voltage range: 6 v. to 115 v. A.C., 60 cycles; or 6 v. to 110 v. D.C. intermittent duty.

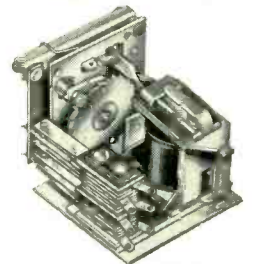

Series M-120

*Write* for catalogs featuring **Guardian Steppers, Relays, Solenoids, Switches, Solenoid Contactors and Hermetically Sealed Controls.**

**GUARDIAN**  **ELECTRIC**

1625-D W. WALNUT STREET

CHICAGO 12, ILLINOIS

A COMPLETE LINE OF RELAYS SERVING AMERICAN INDUSTRY

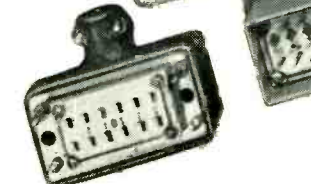
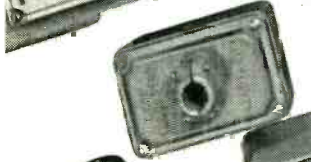
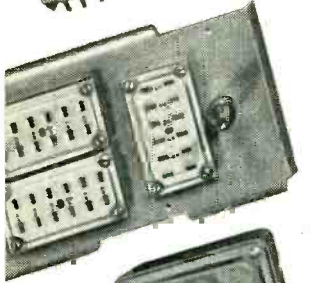
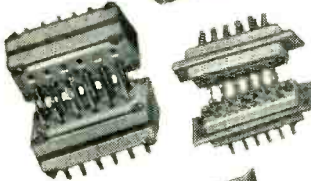
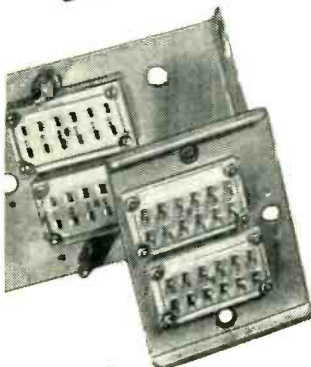
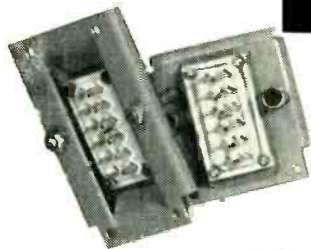
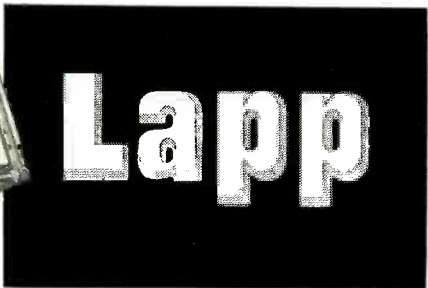
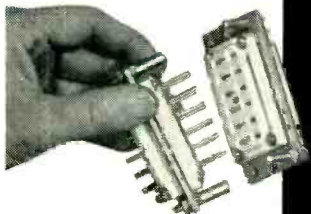

## MULTIPLE-CONTACT PLUG RECEPTACLE UNITS FOR SECTIONALIZING CIRCUITS

• For panel-rack or other sectionalized circuits, Lapp offers a variety of plug-and-receptacle units, some of which are shown here. Any number of contacts can be provided (in multiples of twelve). Male and female contacts are full-floating for easy alignment and positive contact. Contacts are silver-plated, terminals tinned for soldering. Polarizing guide pins are provided where desired. Insulation is steatite, the low-loss ceramic . . . non-carbonizing even under leakage flashover resulting from contamination, moisture or humidity. Write for complete electrical and mechanical specifications of available units or engineering recommendations for an efficient component for your product. Radio Specialties Division, Lapp Insulator Co., Inc., 112 Sumner St., Le Roy, N. Y.

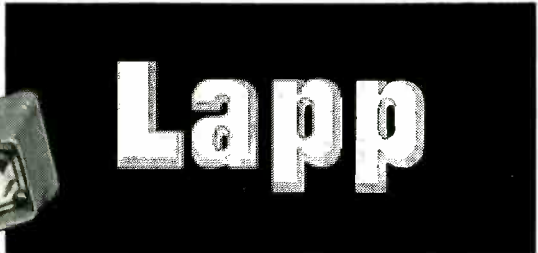

took two men to set up the dies. With the aid of the truck, the two die setup men can have the press ready for use in about 2 hours, as compared to 6 hours formerly required.

The same technique is used for removing the dies, by simply reversing the direction of the unloader and using two cables to pull the dies onto the forks. Removal now takes about  $\frac{3}{4}$  hour, as contrasted with 2 $\frac{1}{2}$  hours before. The LT-72 Towmotor truck and the unloader are made by Towmotor Corp., Cleveland, Ohio.



### Tube Socket Holder

STANDARD octal tube sockets with attached turrets are supported in a specially designed three-position holder during subassembly work at Ampex Electric Corp., Redwood City, Calif. The base of the holder is a piece of sheet metal bent at an angle of 45 degrees and nailed to a block of wood. The socket holder itself is bolted to the slanting face of the base, and has a detent mechanism that permits rotation and





# DESIGNER'S NEWS

—from the RCA Tube Division



### New Vidicon for TV Film Cameras

RCA-6326 is a small camera tube utilizing a photo-conductive layer as its light sensitive element and offering 600-line resolution. With it you can televise motion-picture film with an average high-light illumination of only 100-300 foot-candles on the tube face—and transparencies and opaques with a constant illumination of approximately 10 foot-candles on the tube face.

(length 6 1/4")  
(diameter 1")  
(RCA-6198 Vidicon is for Industrial TV)



(length 5 1/4")

### New Multiplier Phototube for Fast-Coincidence Scintillation Counters

Among the features offered by the RCA-6342 are its small spread in electron transit time and its relative freedom from after-pulses. It offers a "head on" design with flat face which allows excellent optical coupling between the cathode and the phosphor crystal. In addition, it has a focusing electrode to permit optimizing the magnitude, uniformity, or speed of the response in critical applications.



(length 15 1/4")  
(diameter 3")

### New Color-TV Image Orthicon

RCA-6474/1854 Image Orthicon is a television camera tube intended for use in color-TV cameras utilizing the method of simultaneous pickup of the studio or outdoor scene to be televised.

Features of this Image Orthicon include: exceptional sensitivity; a spectral response approaching that of the eye; and an ability to translate colors very accurately. Because it operates on a substantially linear signal-output characteristic, it can produce signals for pictures having natural tone values and accurate detail.

### New Beam Power Tube for UHF!

RCA-6448 is a beam power tube featuring a coaxial electrode structure. The tube is intended for operation as a grid-driven power amplifier to provide high gain at frequencies up to 1000 Mc. Sync-level power output is 15 Kw at 500 Mc in color or black-and-white TV operation—and 12 Kw at 900 Mc. RCA-6448 also features water-cooled electrodes, and a multi-strand thoriated-tungsten filament for economical operation, high emission capability, and long life.

(length 7-23/32" max)  
(diameter 1 1/4" max)

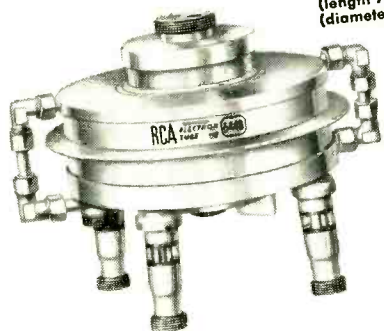

### RCA—"Headquarters" for

Tricolor Kinescopes, Receiving Tubes, Components, Power Tubes, Pickup Tubes, and Test Equipment for Color-TV—

Thyratrons  
Magnetrons  
TV Camera Tubes  
Rectifier Tubes  
Transistors

Voltage Regulator Tubes  
Cathode-Ray Tubes  
Vacuum-Gauge Tubes  
Transmitting Tubes  
Germanium Diodes

RCA Tube Division  
Commercial Engineering, Section D-19-R  
Harrison, N. J.

Please send me technical data on:

- Multiplier Phototube, RCA-6342
- Film-Camera Vidicon, RCA-6326
- Beam Power Tube, RCA-6448
- Image Orthicon, RCA-6474/1854

Name \_\_\_\_\_

Firm \_\_\_\_\_

City \_\_\_\_\_

Zone \_\_\_\_\_ State \_\_\_\_\_



**RADIO CORPORATION of AMERICA**

ELECTRON TUBES

HARRISON, N. J.

# Precision Attenuation —



Standard push-button Attenuators are the symbol for precision attenuation at very high frequencies. As the only accurate instruments of their kind they are in great demand for research work and regular service the world over.

Four models are now available, ready for building into your own equipment. Each is designed to handle inputs of up to 0.25 watt.

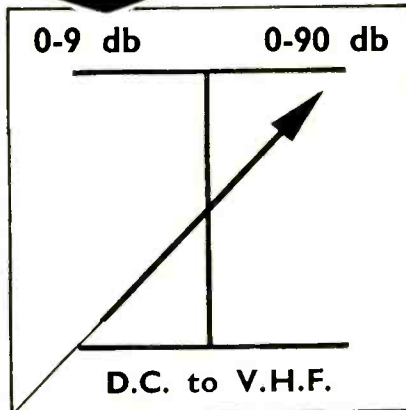

MODELS AVAILABLE	CHARACTERISTIC IMPEDANCE	
	75 ohms	50 ohms
0-9 db in 1 db steps	Type 74600A	Type 74600E
0-90 db in 10 db steps	Type 74600B	Type 74600F



## Standard push button ATTENUATORS

**D.C. Adjustment — Accuracy**

**High frequency performance**

**0-9 db models:** The insertion loss error will not exceed 0.05 db for any setting.

**0-90 db models:** The insertion loss error for the 90 db setting will not exceed 0.3 db. For other settings this limit falls linearly to a value of 0.06 db at the 10 db setting.

**0-9 db models:** At 50 Mc/s the insertion loss error for the 9 db setting will not exceed 0.15 db. For other settings this limit falls linearly to a value of 0.05 db for the 1 db setting.

**0-90 db models:** At 50 Mc/s the insertion loss error will not exceed 0.1 db per step.

N.B. All insertion errors are relative to zero db setting.

Calibration charts for frequencies up to 100 Mc/s for the 0-9 db models or 65 Mc/s for the 0-90 db models can be supplied, if required.

Bulletin on request to:—

**Standard Telephones and Cables Limited**

(An I.T. & T. Associate)

**TRANSMISSION DIVISION · LONDON · E.16 · ENGLAND**



Method of using socket holder



Finished turret in holder, showing how indentations in top plate provide clearance for grounding terminal lugs of socket. The entire holder is mounted on shaft going through slanting base, for rotation past detent spring in foreground

locking of the turret in any of three positions for maximum convenience during assembly work.

A socket assembly is inserted by pushing the socket down through the punched metal top plate after orienting the socket mounting lug with the cutouts in the plate. Pushing downward against the spring-loaded central column permits rotating the entire socket slightly, so that the threaded inserts of the flanges click into smaller indentations to lock the socket in position. Other indentations in the top plate provide clearance for the grounding



**HERMETIC SEALS**  
**FUSING of glass and metal**  
**ITEMS to your Specifications!**

*ITEM TO THE LEFT IS OUR NEW  
 COLOR T.V. CRYSTAL MOUNT.  
 SPECIAL ATTENTION IS GIVEN TO  
 DEVELOPING NEW ITEMS TO SUIT  
 SPECIFIC REQUIREMENTS.*

**WARREN PLASTICS CORPORATION**  
 WARREN, PENNSYLVANIA

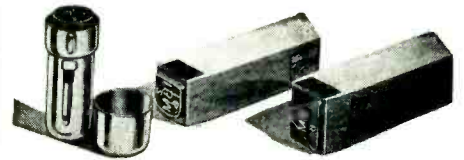

THE DURO-POCKET STAMP      THE PIN & PEG

# NEW! ENGRAVED

# Vinylite

## INSPECTION

# STAMPS

*Are better than rubber*  
**3 ways**

**ENGRAVED Vinylite IS ACID-PROOF**

Acid etching inks, used for permanent stamping on metal and all non-porous surfaces will eat away at rubber. Vinylite resists this action—gives longer life by far!

**ENGRAVED Vinylite STAMPING  
 GIVES RAZOR-SHARP  
 IMPRESSIONS EVERY TIME**

Opaque inks will clog shallow rubber stamp faces rapidly. Our deep-molded engraved VINYLITE stamp faces have more than three times the depth of ordinary rubber stamps. Markings always remain super sharp . . . an important advantage since this mark is a permanent record of your inspector's approval.

**ENGRAVED Vinylite HAS CUSHION-LIKE RESILIENCE**

Our VINYLITE molding process includes a timed curing that imparts to this versatile plastic all the elasticity of rubber. Resilient VINYLITE resists abrasive action, conforms to irregular surfaces . . . and lasts much longer!

**Engraved Vinylite stamp faces are adaptable to any marking device. They can be used to stamp on every surface, metal, wood, fabric, paper, plastic, etc.**

**KRENGEL MANUFACTURING CO., INC.**  
 Dept. IC, 227 Fulton St., New York 7, N.Y. Tel. CO 7-5714

Please check the following:

Free Vinylite Sample and Price List       Please have salesman call for appointment

NAME .....

COMPANY .....

STREET .....

CITY.....ZONE.....STATE.....

# Specification Coils

**—for every requirement—radio, FM,  
 TV and Government Applications!**

Including Universal, Bank Wound, Universal Progressive and Solenoid. All are precision-built to highest engineering standards and conform exactly to specifications. For uniform high quality, prompt delivery and economical unit costs, specify coils by Fugle-Miller. Radio, TV and JAN specifications are a specialty. Phone, wire or write for quotations.

ADDRESS INQUIRIES TO DEPT. E6

**FUGLE-MILLER  
 LABORATORIES**  
 MAIN STREET, METUCHEN, NEW JERSEY  
 Telephone: Metuchen 6-2245

# Modern PEC\* hero plugs profit leaks for etched chassis users

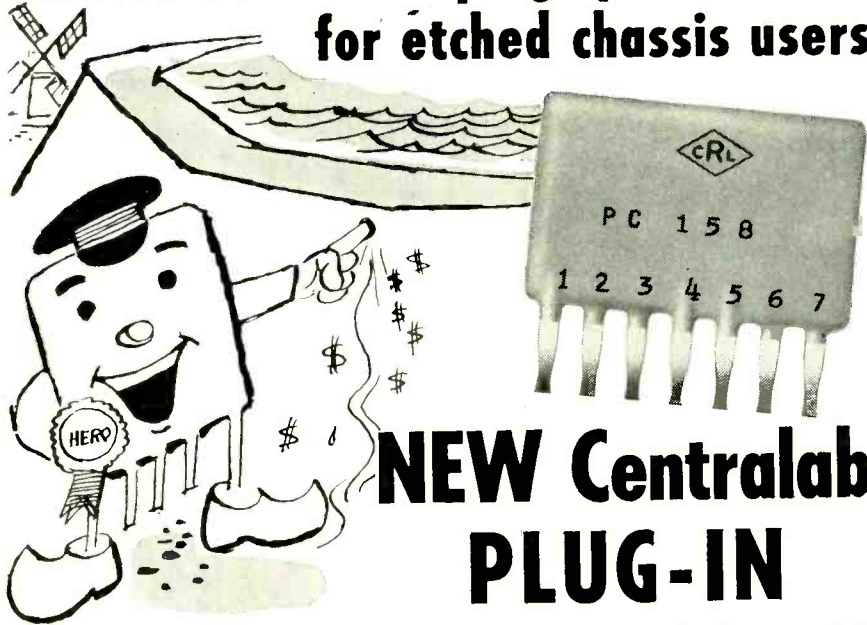

Printed Electronic Circuits now available with exclusive, fast-soldering tapered tab leads

Plug-in PEC's are 100% standardized... for your immediate production use

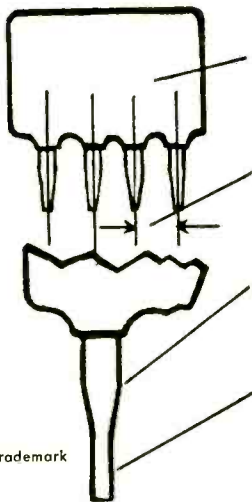

\*Trademark

- 30 STANDARD PEC PLATES — PC-156, illustrated, contains 3 resistors, 4 capacitors. Eliminates 8 parts, 9 extra soldered points. Simplifies circuit board pattern. Cuts down size and cost of circuit board.\*\*
- STANDARDIZED FOR FASTER LOCATING — uniform tabs spaced .172" ctr. to ctr., or multiples of .172" ctr. to ctr. Uniform leads are .344" long, and .045" — .049" wide at base.
- STANDARDIZED FOR AUTOMATIC CENTERING — twin taper tabs jam-fit in holes to hold plate away from chassis for above and below soldering. No accidental drop-outs.
- STANDARDIZED FOR POSITIVE SOLDERING — tab ends shaped flat to facilitate accurate soldering. Terminals fit 1/16" dia. (round) or 1/16" x 1/16" square holes. One shot of a solder-gun or dip soldering completes the job.

Who but Centralab would you expect to introduce "firsts" like Plug-in PEC's... Centralab is the industry's only thoroughly experienced PEC engineering and production source.



\*\*Need 100 or 1,000,000 Plug-in PEC's? Centralab has 'em! Write for Bulletin EP-40 for complete details.

Standard PEC's with wire leads are available at your local CRL distributor — see Catalog 28.

## Centralab

A Division of Globe-Union Inc.  
914 E. Keefe Avenue • Milwaukee 1, Wisconsin  
In Canada: 804 Mt. Pleasant Road, Toronto, Ontario

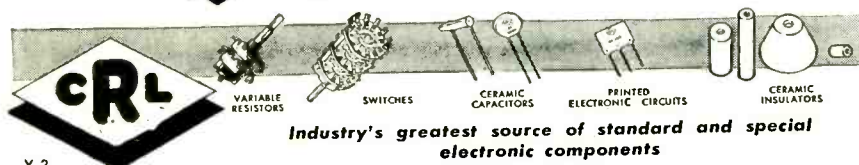

Industry's greatest source of standard and special electronic components

Y-3

terminal lugs on the socket. Removal of a finished unit is achieved by pushing the assembly down and rotating counterclockwise, just as for removing a bayonet-base lamp.

## Flocking Waveguide Stands

FLOCKING of bases for waveguide stands cut job time to one fifth of that previously needed for glueing on felt pads and turned out a neater job, in the Palo Alto, Calif. plant of Hewlett-Packard Co.

A silk screen setup was devised to apply the adhesive—not glue, but ordinary kitchen enamel the same deep green color as the flock. The enamel works well in the silk screen and gives a richer color to the felted base. While the paint could



Silk screen permits quick, even application of green kitchen enamel as flocking base on bottom of waveguide stand. Enamel works well in silk screen, gives rich color to the green flock

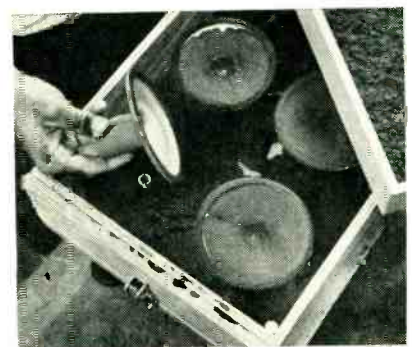

Four flocked stands come out after 15-20 sec agitation in standard flocking box. Note snap-on holding fixture



# COLLINS AUTOTUNES\* AND AUTOPOSITIONERS

*Precision re-positioning devices for application in electronic and industrial equipment requiring accurate multiple channel pre-set control*

THE Collins Autotune has long been the basis for both remotely and directly controlling automatic tuning of high quality, military and commercial communication equipment. It is also applicable to the design of many other industrial and electronic equipments. Variable pre-set positions are chosen by the operator — when once set, the Autotune automatically returns to the selected position with an accuracy unmatched by any other means.

*Collins*

**PACKAGED AUTOTUNE** — automatic repositioning device suitable for many applications in industrial control and radio equipment . . . positions one shaft or multiple shafts.

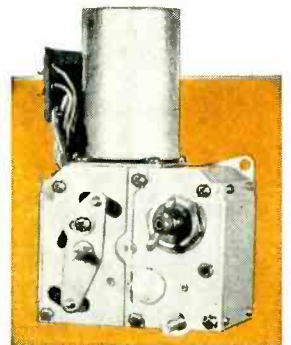

*Collins*

**AUTOTUNE SYSTEM COMPONENTS** — for variable pre-set positioning of multiple shafts incorporating several Autotunes driven by one motor.



Singleturn Autotune Head

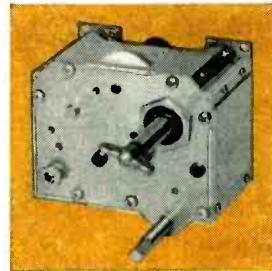

Multiturn Autotune Head

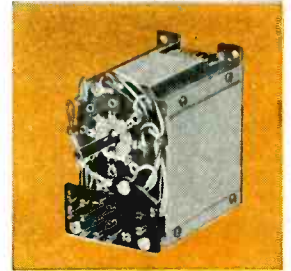

Autotune Control Unit

*Collins*

**AUTOPOSITIONER** — for use where up to 20 or more pre-determined fixed positions are needed. Both packaged and individual Auto-positioners are available.



*For complete information on Collins Autotunes and Auto-positioners, contact the nearest Collins office. You will receive prompt attention.*

\*Reg. U.S. Pat. Off.

**COLLINS RADIO COMPANY Cedar Rapids, Iowa**

11 W. 42nd Street, NEW YORK 36

1930 Hi-Line Drive, DALLAS 2

2700 W. Olive Avenue, BURBANK



# you can banish fear of component failure



## RELAYS

... BE ASSURED OF DEPENDABLE QUALITY!

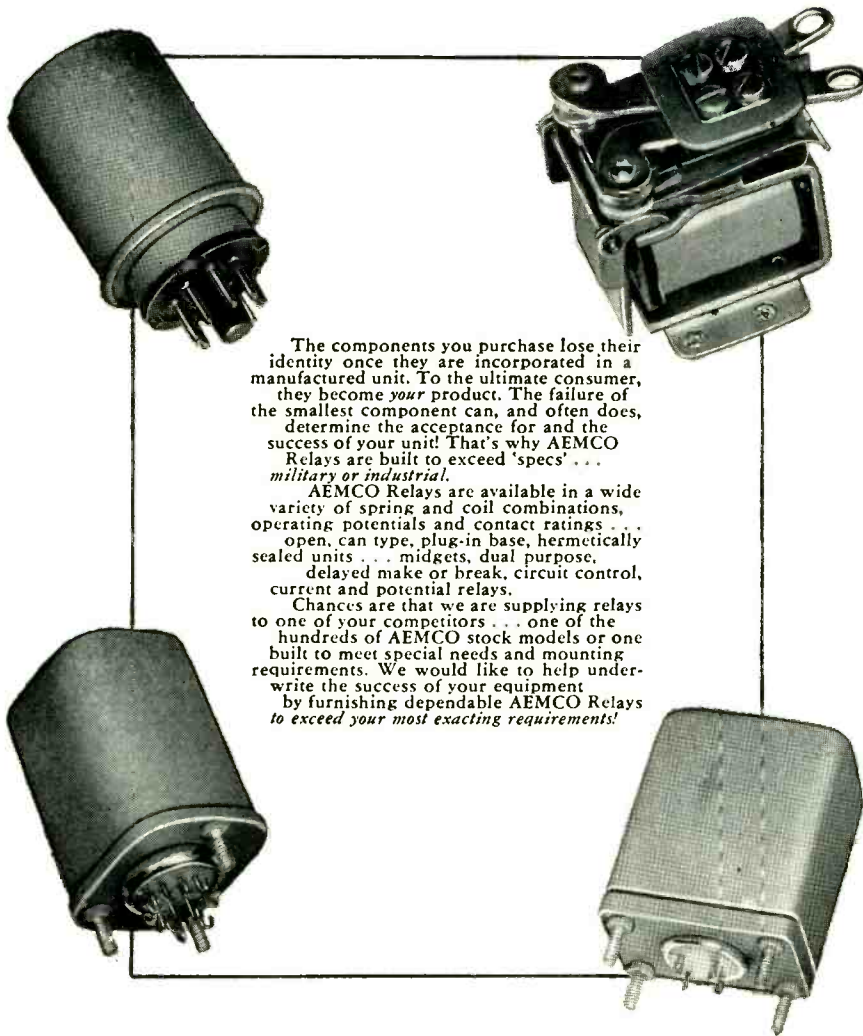

The components you purchase lose their identity once they are incorporated in a manufactured unit. To the ultimate consumer, they become *your* product. The failure of the smallest component can, and often does, determine the acceptance for and the success of your unit! That's why AEMCO Relays are built to exceed 'specs' ... *military or industrial.*

AEMCO Relays are available in a wide variety of spring and coil combinations, operating potentials and contact ratings ... open, can type, plug-in base, hermetically sealed units ... midgets, dual purpose, delayed make or break, circuit control, current and potential relays.

Chances are that we are supplying relays to one of your competitors ... one of the hundreds of AEMCO stock models or one built to meet special needs and mounting requirements. We would like to help underwrite the success of your equipment by furnishing dependable AEMCO Relays to exceed your most exacting requirements!

The Services of our Engineering Department are Available on Request. WRITE TODAY!



# Automatic Electric MFG. CO.

62 STATE STREET • MANKATO, MINN.

be applied by hand, the silk screen does a faster, evener job.

The stands are slipped on holding fixtures in the standard flocking box, four at a time, for an agitation period of 15 to 20 seconds using the longest fibred flock available ( $\frac{1}{16}$  inch).

### Lifting Aids for Large Picture Tubes

A COUNTERBALANCING lifting aid fitted with a live vacuum suction cup aids operators in handling 27-inch all-glass picture tubes weighing 45 pounds each, in the Syracuse, N. Y. plant of General Electric Co. The equipment relieves the operator of heavy work, allowing him to concentrate on guiding the bulb into and out of the processing equipment.

Counterbalancing is achieved in one setup by running the lifting cable up over pulleys to a power unit consisting essentially of a variable-speed electric motor driving a fluid transmission. This ar-



Lifting aid employing single vacuum-powered suction cup in conjunction with counterbalancing system employing motor-driven fluid transmission. Thumb of operator is on trigger button which is pushed to release vacuum after picture tube has been transferred to a rack or a conveyor cradle



rangement automatically applies the required lifting force to counterbalance the load being handled. The power unit is located on a platform suspended from the ceiling. Also on this platform is the vacuum pump for the suction cup. The lifting cable and control wiring feed out to a boom and then down to the desired operated point. The fluid transmission is the conventional automotive type, modified for belt drive from an electric motor on

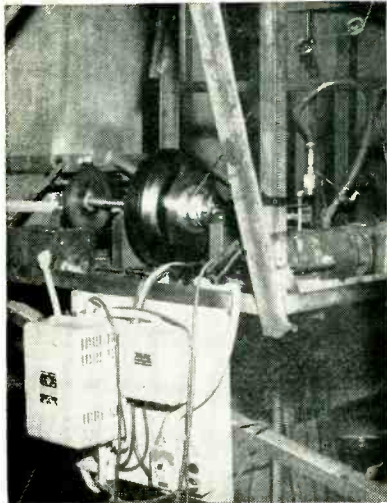

Under-ceiling platform supporting motor-driven counterbalancing units and vacuum pump. Lifting cable runs from drum on fluid transmission upward over pulleys to a boom (not shown) which swings over operator's working area

one side, with the cable drum on the other side.

A trigger button releases the vacuum to permit removal of the suction cup. An electric cable coming down along with the vacuum hose goes to a switch near the trigger button, used for starting and stopping the lifting button that automatically counterbalances the weight of the picture tube. This vacuum lifting aid was made by the Equipment Development Works, General Electric Co., Schenectady, N. Y.

In another setup for 27-inch tubes, lifting is done with a commercial air motor hoist made by Ingersoll-Rand, available from mill supply houses. Here two suction cups are used, to minimize the swinging of the picture tube as it is raised. A separate three-way control valve held in the operator's right hand is connected to the lift-

# MEPCO

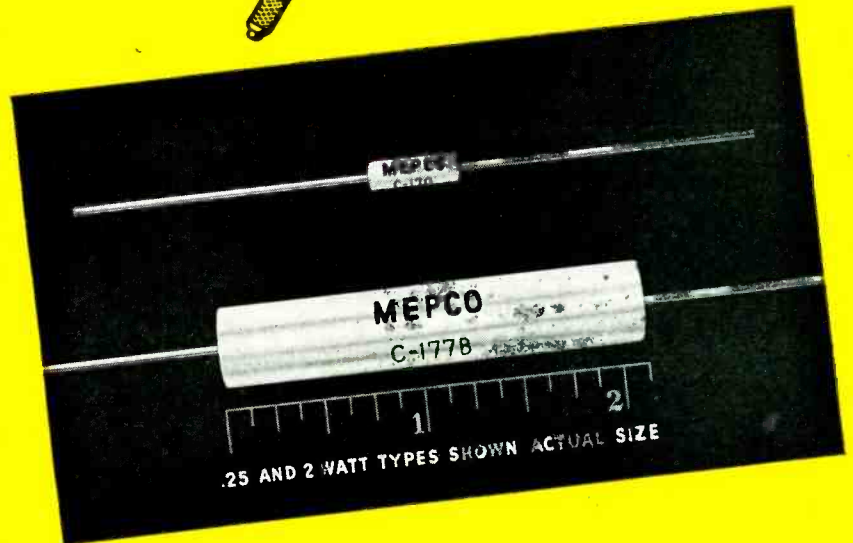

## Announcing a complete line of Deposited Carbon Resistors HERMETICALLY SEALED

.25 watt to 2 watt ratings

Mepco presents a complete line of Hermetically Sealed deposited carbon resistors with ratings from .25 watts to 2 watts.

These are not the usual varnish coated types. Instead, they are completely sealed in steatite housing, which assures positive moisture protection.

Also available are resin coated types manufactured to MIL-R-10509A, glass enclosed and helium filled high stability types, and high frequency rod and disc units.

Write for complete information. Fill-in and mail the coupon today.

**MEPCO, INC.**

Morristown,  
New Jersey

- Please send me information on Mepco deposited carbon resistors.
- Please send me information on Mepco wire wound resistors.

NAME \_\_\_\_\_ TITLE \_\_\_\_\_

COMPANY \_\_\_\_\_

STREET \_\_\_\_\_

CITY \_\_\_\_\_ STATE \_\_\_\_\_

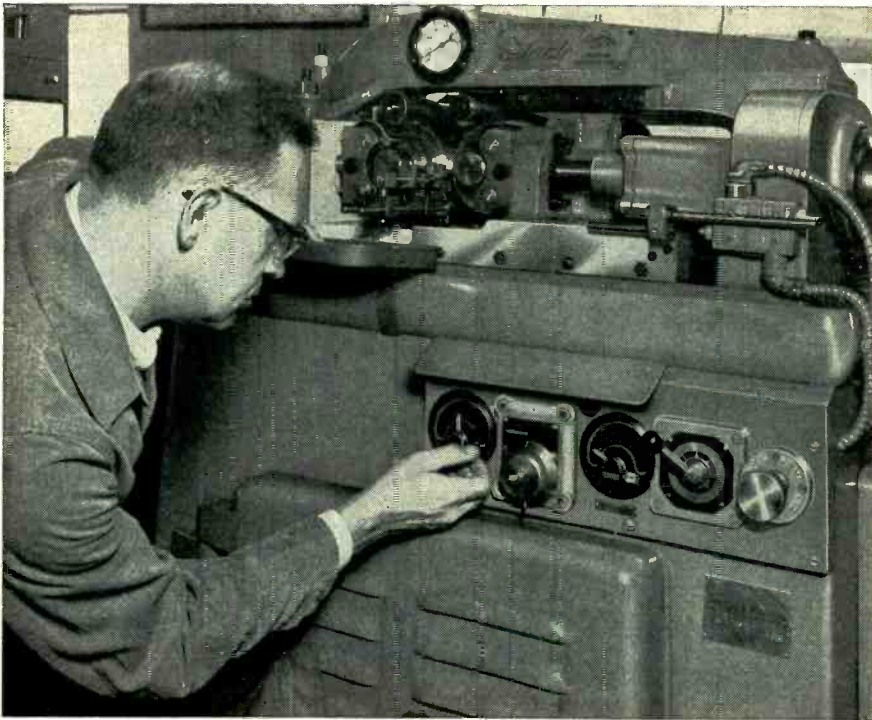

## THREAD PRECISION AND UNIFORMITY INSURED WITH CRAMER TIME CONTROL

The threading accuracy of this Steinle Roll Threading Machine is directly related to the highly dependable Cramer Timers which govern the roll slide movements. This carefully predetermined slide travel must be extremely accurate in order to insure thread precision and uniformity.

The Cramer TE Timer, at left, controls the time of dwell of the roll slide in its forward position, while the one at right dictates the exact loading interval. A simple adjustment of either timer permits slow-down or speed-up of the action. Cramer-controlled threading operations on the Steinle machine

have been speeded to 40 complete cycles per minute without sacrifice of thread accuracy. There has never been a report of timer failure.

The Steinle Machine is widely used by aircraft manufacturers and others who require extremely accurate threads. Cramer Timers are specified as original equipment for these machines due to their unusually high standards of accuracy and dependability.

If you have a time control problem, Cramer can help you. Write for complete information or technical advice.



*The overall accuracy of the Type TE (inclusive of setting) is within 2%, with repeat accuracy within 1/2 of 1%. The unit is Underwriters' Laboratories listed for use in industrial equipment.*

*A "look inside" will show you why you can always depend on Cramer for outstanding performance. Check the "inside" facts, today.*

SPECIALISTS IN TIME CONTROL

*the* R. W. CRAMER CO., INC.

BOX 3, CENTERBROOK, CONNECTICUT



Lifting aid using air motor hoist and two ordinary vacuum cups that do not require a vacuum line. The three hoses control the air-type hoist motor overhead. At right is the vacuum-type spinning chuck

ing unit with three lengths of rubber hose. One hose supplies air to the valve, one is for up and one is for down. Fingertip valves on the control bleed air into the cups to release the picture tube. When attaching the cups, the operator needs to apply only a slight pressure to make them grip the glass; no vacuum line is employed with the cups in this instance. Finger-actuated levers just above the cups operate tiny valves that bleed air into the cups to release the picture tube.

A single vacuum cup serves in conjunction with four rubber-covered positioning rods to hold the picture tube at a downward angle while it is being rotated by an electric motor through a gear reduction box when applying a conductive coating to the inside walls. The vacuum is applied to the suction cup through a rotating fitting. The operator releases the vacuum with a foot pedal while holding the tube with both ends, when transferring the tube from the spinning chuck to the wood fork on which it rests temporarily while he attaches the air motor hoist fitting.

## Setscrew Fittings for Pipes Speed Plant Alterations

COMMERCIALY-AVAILABLE Nu-Rail alloy fittings make it possible for regular plant maintenance crews at General Electric's picture-tube plant at Electronics Park, Syracuse, N. Y., to erect fencing, guard rails and similar units, using regular pipe for the horizontal and vertical members.

The fittings are made in many





Top fitting for post of pipe fence surrounding picture tube storage area

standard designs by Hollaender Mfg. Co., Cleveland, Ohio, to be used at corners, cross-overs, floor flanges, stair-railing mountings and other installations. Pipe lengths are held in position by set screws which permit rapid changing when necessary.

### Molding Tube Stems with Powdered Glass

HEAVY STEMS for Amperex type 6333 10-kw triodes are now produced with integral sealed-in copper terminals by means of a powdered glass technique developed in this firm's Hicksville, N. Y. plant.

The first step in the molding tech-

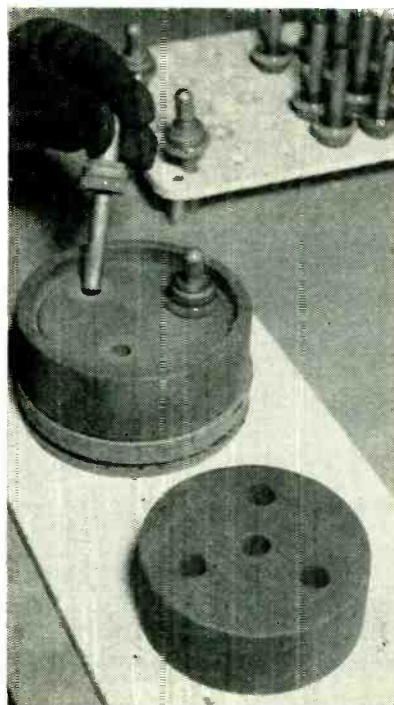

Loading terminals in mold

# Amerac's new... KLYSTRON CAVITY OSCILLATOR

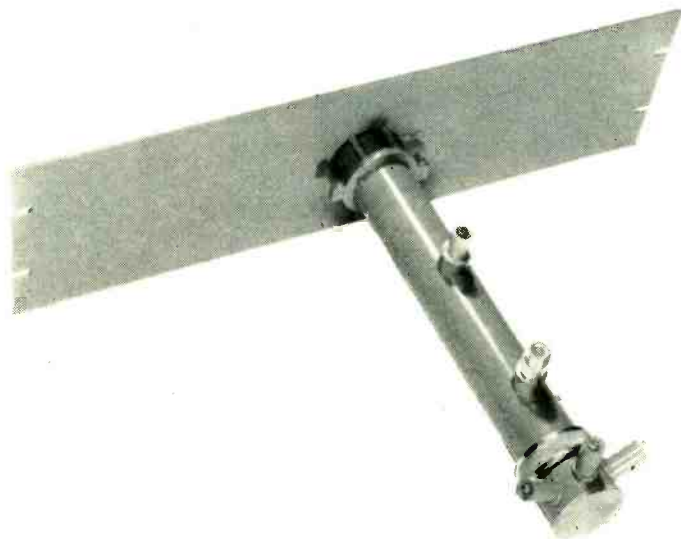

The type 198 Klystron Cavity Oscillator is a signal source designed to accommodate the Sylvania 6BL6 and 6BM6 Klystrons. Utilizing both tubes and two modes of operation, it is possible to generate a CW signal tunable over a frequency range from 1KMC to 4KMC. For the exact frequency range of each tube in either of its modes, as well as power output, consult the Sylvania specification sheets for 6BL6 and 6BM6 Klystrons. It is possible to gain full performance from these tubes in the type 198 Cavity Oscillator because the precision machined component parts of the best quality materials available have been held to exacting requirements of accuracy.

### FEATURES

- A tuning accuracy in the center frequencies of  $\pm 1$  MC, made possible by the precision machined tuning mechanism incorporating a Root counter for ease of calibration and observation.
- A quick release tube socket assembly, making tube changing a simple operation.
- A standard rack panel machined for secure attachment of the cavity, assembling neatly into your equipment.
- Silver plated conducting surfaces providing high radio frequency surface conductivity; Rhodium flash preventing corrosion.
- Female type N coaxial output connection.

Overall size, including panel, is 19" wide, 5 1/4" high, 12" deep. Finish is smooth gray or black lacquer on cavity, with nickel plate trim, and gray or black baked wrinkle enamel on panel.

Shipped with tubes, if desired, at extra cost.



Amerac Incorporated

116 TOPSFIELD ROAD  
WENHAM, MASSACHUSETTS

*pyroferric*

**iron cores**

**PYROFERRIC IRON CORES** are scientifically manufactured, under strictest quality controls to close electrical and mechanical tolerances.

**PYROFERRIC** services are available for the engineering of your core production requirements . . . your letterhead request will bring you M.P.A. Data Sheets and tables which give complete information including recommended sizes and tolerances, as well as a cross-referenced index of manufacturers' material designation.

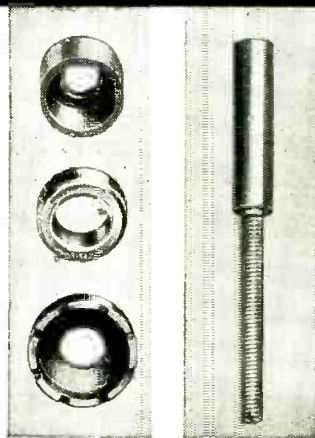

**PYROFERRIC**  
 PYROFERRIC BLDG. BRONX BOULEVARD  
 at 216th St., N.Y.C. 67

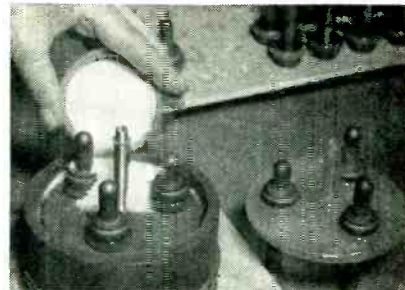

Pouring powdered glass in mold

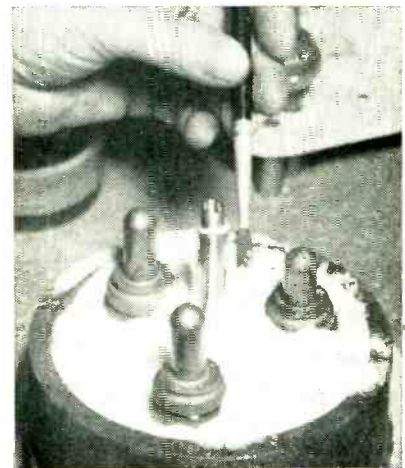

Leveling powdered glass

nique involves loading the heavy solid copper terminals in the combination graphite and ceramic mold for the stem. These terminals have previously been coated with glass in the region where they are to pass through the stem. The glass exhaust tubulation, with a spring inside to prevent it from collapsing, is then inserted in the center hole of the mold.

A measuring cup is now filled exactly level with powdered glass that has previously been prepared by grinding the required grade of

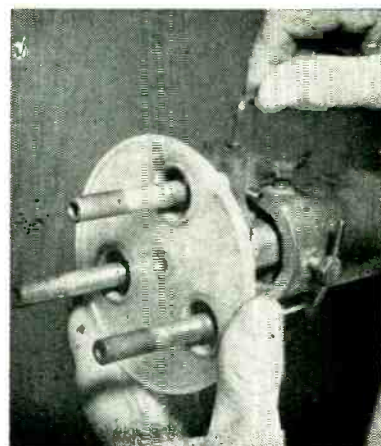

Locking finished stem on tailstock arbor of glass-blowing lathe



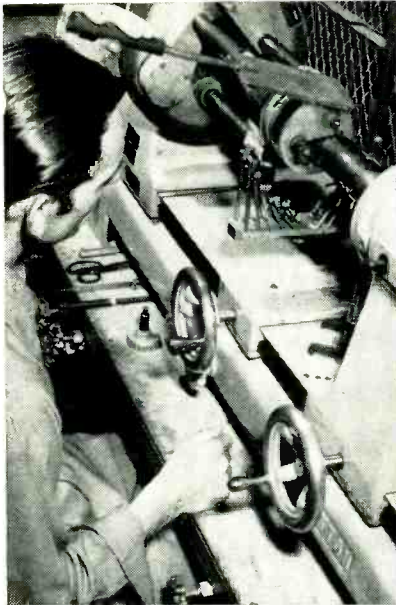

Sealing stem to envelope on lathe, with operator using paddle to true up the seal while glass is soft

glass. This powdered glass is carefully poured into the mold and distributed evenly around the terminals with the aid of an artist's brush. The mating top cover of the mold is now placed over the terminals and the mold is placed in an oven for heating sufficiently to fuse the glass.

The completed stem, after cooling, is locked in position on the tailstock of a Litton Industries model HSA standard glass-blowing lathe. The glass envelope is mounted on the headstock arbor and fused to the molded stem in a conventional manner with gas flames.

### Switching Production Heads Gives Plant Savings

By **BENNO BORDIGA**  
 Director of Manufacturing  
 Olympic Radio & Television, Inc.  
 Long Island City, N. Y.

THE PROBLEM of occasional inter-departmental friction on various levels of production in the Long Island City plant of Olympic Radio & Television, Inc. was largely solved by an experiment called "Operation Switch". This involved switching department heads for two days, to give each a deeper insight into the problems of the others.

At one of the regular monthly staff conferences, the idea was outlined. It was emphasized that this

## Dictaphone Telecord central dictation system uses **STERLING RELAYS**

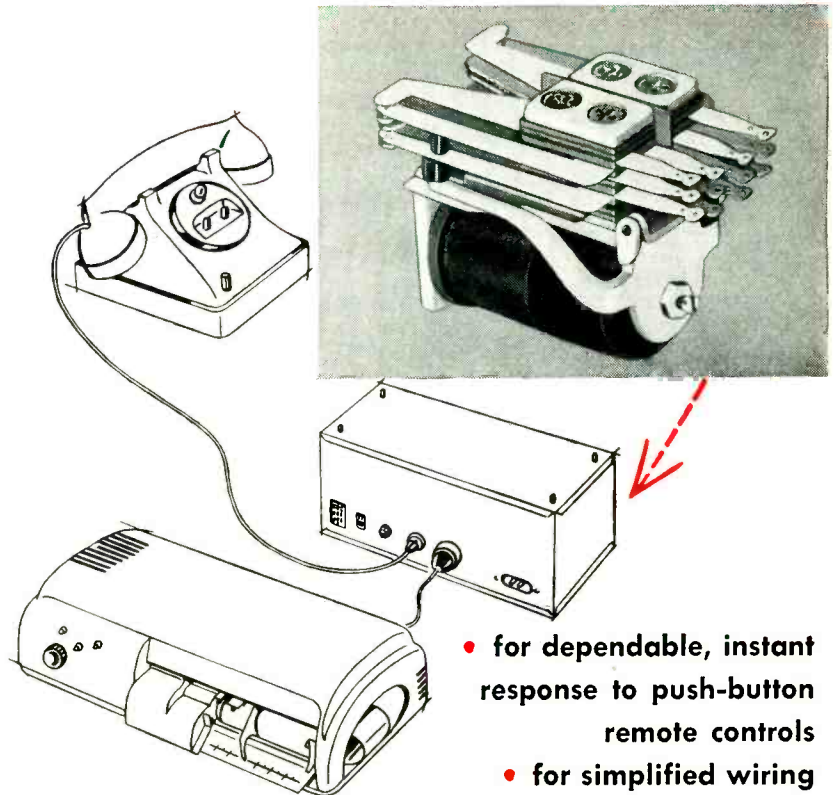

Complete remote control of the recording machine, assured privacy, and a substantial reduction in the required number of connecting circuits are made possible by Dictaphone's use of 12 relays in the Telecord control unit, plus one in each dictation instrument. To maintain high standards of quality and performance, Dictaphone uses standard Sterling Type GS Relays to fit exactly the needs of its circuits.

Whatever *your* product's requirements for relays, standard or special, it will pay you to submit your specs to Sterling!

### General Specifications Sterling Type GS Relays

**COIL**—Single or double wound up to 220 volts D. C. • **SPRING ASSEMBLY**—Up to 10 springs per pile-up, in any arrangement • **CONTACTS**—All types up to 3/16" diameter • **RESIDUAL**—Adjustable screw • **OPERATE TIME**—.005 to .050 sec. • **RELEASE TIME**—.010 to .100 sec. • **MOUNTING**—2 or 4 #8-32 or #6-32 tapped holes • **DIMENSIONS**—2½"x 1½"x 1-1/16" maximum • **WEIGHT**—6 to 10 oz.



**They're relays YOU can rely on!**

STERLING ENGINEERING COMPANY, Laconia, N. H.  
 Subsidiary of  
 AMERICAN MACHINE & FOUNDRY COMPANY  
 New York  
 AMF Products are better... by design

STERLING ENGINEERING CO.  
 54 Mill St., Laconia, N. H.

Please send your 28-page Sterling Relay catalog to

NAME \_\_\_\_\_

POSITION \_\_\_\_\_

FIRM \_\_\_\_\_

ADDRESS \_\_\_\_\_

# NEW Berkeley 1 MEGACYCLE-1 MICROSECOND

## Universal Counter & Timer

Four extended-range precision instruments at the size and price of one! Drives digital printer, IBM card punch converter, or digital-to-analog converter!



Berkeley's new Model 5510 Universal Counter and Timer provides the functions of counter, time interval meter, events-per-unit-time meter and frequency meter in one compact instrument. It will:

- ① — Count at speeds to 1,000,000 counts per second.
- ② — Count events occurring during a selectable, precise time interval.
- ③ — Measure time intervals in increments of 1 microsecond over a range of 3 microseconds to 1,000,000 seconds.
- ④ — Determine frequencies and frequency ratios, from 0 cps to 1 megacycle.
- ⑤ — Provide a secondary frequency standard (stability, 1 part in  $10^6$ ).
- ⑥ — Operate directly into (a) the new Berkeley Model 1452 single-unit printer, (b) Berkeley digital-to-analog converter, or (c) Berkeley data processor driving IBM card punches, electric typewriters, or teletype systems.

### CONDENSED SPECIFICATIONS

Input Sensitivity: 0.2 v. rms (Freq. meas.); 1.0 v. peak to peak (other functions)  
 Input Impedance: 10 megohms shunted by 35 mmf.  
 Time Bases: 1 mc, 10, and 1 kc; 100, 10 and 1 cps.  
 Gate Times: .00001, .0001, .001, .01, 0.1, 1.0 and 10 seconds  
 Crystal Stability: 1 part in  $10^6$  (temp. controlled)  
 Display Time: 0.2 to 5 seconds  
 Accuracy:  $\pm 1$  count,  $\pm$  crystal stability  
 Power Requirements: 117 v. ( $\pm 10\%$ ), 50-60 cycles, 400 watts  
 Dimensions: 20 $\frac{3}{4}$ " wide x 10 $\frac{1}{2}$ " high x 15" deep; panel, 8 $\frac{3}{4}$ " x 19"  
 Price: Model 5510, \$1,100.00 (f.o.b. factory).

Available for prompt delivery. Wire or write for technical bulletin, application data (see opposite page); please address dept. G4-1

M32

# Berkeley

division

BECKMAN INSTRUMENTS INC.  
 2200 WRIGHT AVE., RICHMOND, CALIF.

was not being done to belittle or show up inefficiencies in any department, but rather to get a fresh approach to dormant problems which might have existed for some time. Conferences would be held between each foreman and his stand-in after the experiment, in order to discuss on a close and friendly basis their various findings.

### Initial Planning

After successfully selling the idea to the department heads, top management was skeptical but cooperative. The day before the actual experiment, a conference was called and each department head was instructed to have a two-hour conference with his stand-in in order to acquaint him with the proper functioning of his new department.

On the day of the actual switch an air of excitement prevailed throughout the organization. Each new man tackled his assignment with enthusiasm. During the afternoon, another short conference was held and a general appraisal of the situation was obtained. The success of the experiment can be measured best by the fact that most of the men involved asked for an extension of the experiment in order to study the problem much more closely.

### Final Evaluation

Three days after the two-day experiment, a general conference was called to evaluate results. The most apparent result was a complete physical clean-up of the plant, since no department head wanted his section to appear in an unflattering light.

In addition, many problems which had just been pushed aside from week to week were aired. Many eyesores to which department heads had grown accustomed were rediscovered by their stand-ins. The maintenance staff was busily occupied for the next six-week period in an effort to catch up with the many maintenance problems which were thus discovered.

The total expense involved in this experiment, which by the end had received the enthusiastic approval of everyone, was a negligible cost



of conference time, which would amount to approximately 8 hours per man involved. Against this is an estimated saving of \$50,000 per year occurring from production-line suggestions made by those seeing departments in a new light on a king-for-a-day basis.

Since the experiment, a new spirit of understanding and co-operation has prevailed amongst department heads, who now view each other's problems with renewed respect. Numerous requests have been made to continue this experiment on a semi-annual basis.

### Three-Size Turret Jig

USE of a spring-steel leaf as one holding member on a rotating jig permits use with the three most common sizes of turrets attached to tube sockets. To insert a unit for subassembly work, the operator sets the socket end into a drilled recess in the rigid member of the

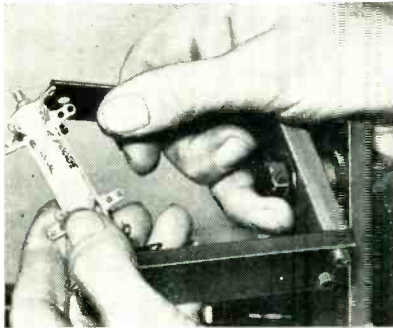

Inserting empty turret in jig

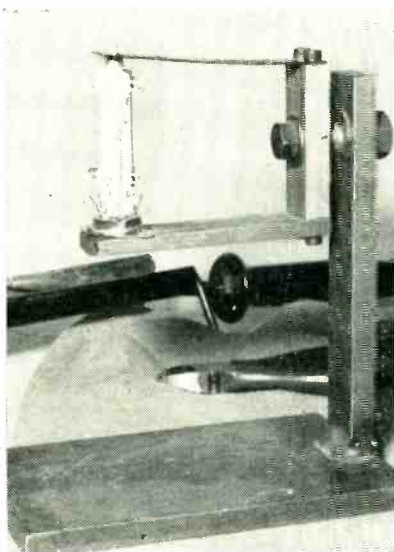

Turret in position on jig



**How  
BERKELEY EQUIPMENT  
helped solve a Problem**

*for Lenkurt Electric Co., San Carlos, Calif.*

**PROBLEM:** Increasing speed and accuracy in determining characteristics of filters and meshes at production-line test stands. Required: determination of frequency to an accuracy of  $\pm 1$  cycle.

**SOLUTION:** Use of a BERKELEY EPUT (Events-Per-Unit-Time) Meter to determine frequency, displaying results in direct-reading digital form, with an accuracy of  $\pm 1$  cycle.

**RESULTS:** Frequency checks are now made in 30 seconds, as against 5 to 10 minutes formerly required. Previous high possibility of error now virtually negligible. Substantial reduction in training required for test stand operators.

*May we help  
solve your  
problem?*

If it involves faster, more accurate, easier and simpler ways to measure frequency, flow, pressure, velocity, rpm., time intervals, viscosity—or high speed counting and counting plus pre-set control—chances are that BERKELEY can help you solve it. Complete data sheets covering many applications in these fields are yours for the asking—check the handy coupon below and mail it *now!*

M-22

**Berkeley**

*division*

BECKMAN INSTRUMENTS INC.  
2200 WRIGHT AVE., RICHMOND, CALIF.

Dept. G-4, 2200 Wright Ave., Richmond, Calif.

Please send me application data sheets checked

Name \_\_\_\_\_

Title \_\_\_\_\_

Address \_\_\_\_\_

City \_\_\_\_\_ State \_\_\_\_\_

**MEASUREMENT OF:**

- Flow
- Pressure
- Viscosity
- Frequency of \_\_\_\_\_
- Velocity
- RPM
- Operating Time

**COUNTING OR  
PREDETERMINED COUNTING OF:**

**CONTROL OF:**

- Cutting Stock to Length
- Packaging and Batching

# McCoy PRESENTS . . .

## TWO NEW ANSWERS TO "TOO OLD" PROBLEMS

### McCoy "McMITE" SUB-MINIATURE M-20 CRYSTAL

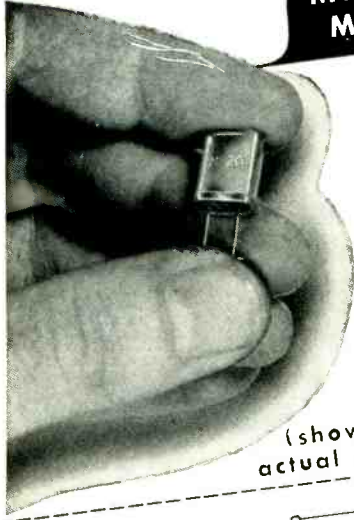

The McCoy M-20 "McMite" is a Subminiature hermetically sealed unit which delivers the same performance as a regular sized crystal, yet takes up just one-fifth the space formerly required.

The M-20 "McMite" Subminiature crystal meets Military characteristics and performance requirements for fundamental operation above 10 mc and overtone operation above 15 mc without any sacrifice of stability or dependability.

Now available for engineering and production quantities.

**FREQUENCY RANGE**  
10.0 mc to 110 mc

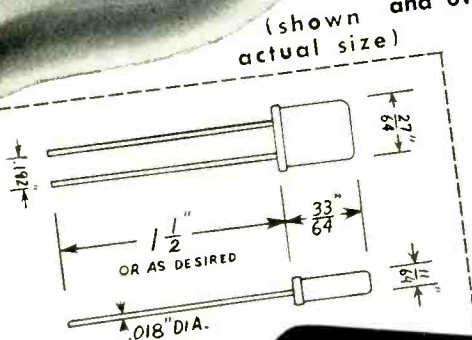

### McCoy MO-1 MO-1L (OCTAL) (LOCTAL) CRYSTAL OVENS

#### MO-1 (OCTAL)

Hermetic or gasket seal. Holds 1 or 2 McCoy M-1 (HC-6/U) crystal units. Temperature: 65°C to 85°C (adjustable). Stability: ±5°C from nominal. Ambient Ranges: -55°C to 5°C below nominal. Power: less than 6 watts. 6, 12 or 24 volt operation.

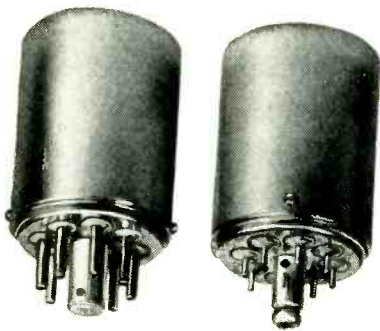

MO-1  
(OCTAL)

MO-1L  
(LOCTAL)

#### MO-1L (LOCTAL)

see description MO-1

One or the other of these McCoy Ovens is the answer to the problem of maintaining close temperature control in all transmitting and receiving equipment—mobile, railway, marine and aircraft.

Write, wire or call us for full information on these or any other of your crystal requirements.

**McCoy**  
ELECTRONICS COMPANY  
MT. HOLLY SPRINGS, PA.

holding jig, then bends up the spring leaf and brings it down over the projecting center bolt of the turret.

The metal upright of the jig is welded to a heavy metal plate serving as a weighted base. A small coil spring is placed on the pivot bolt between the upright and the rotating arm, to provide sufficient friction for holding the assembly in a desired position while permitting easy change of position. This simple jig is used in the Redwood City, Calif. plant of Ampex Electric Corp.

### Snap-In Mounts Serve as Resistor Terminals

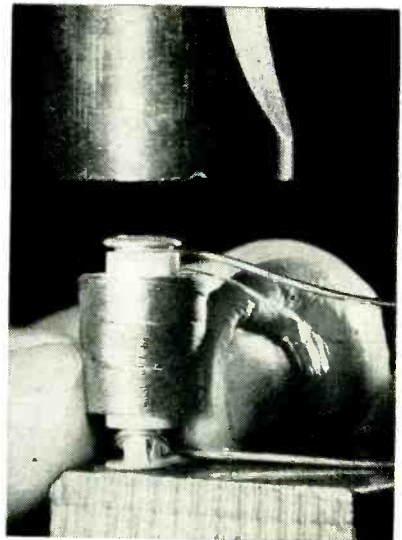

Pressing snap-in terminal into ceramic sleeve of finished coil on arbor press after first placing eyelet of formed lead over Tri-mount. Terminals are applied one at a time to insure accurate positioning

CHANGEOVER to a multiple winder for resistor coils necessitated use of leadless ceramic forms. This created the problem of adding terminals to the forms, as those previously used came fitted with leads.

The problem was solved in the plant of Hewlett-Packard Co., Palo Alto, Calif. by pressing United Carr Tri-mounts through eyelet leads into the ends of the ceramic form after winding, to serve as terminals. The terminals are pressed into the forms with the aid of an ordinary hand-operated arbor press. After winding ends are cleaned and wrapped around the



terminals and leads, the joints are made permanent by dip-soldering.

Although changeover from one-at-a-time winding to the four-coil multiple winder increased setup time and involved the extra terminal-mounting operation, the new machine cut over-all time per component in half.

### Staples Serve as Conductors for Etched I-F Coils

CONNECTIONS to inner ends of etched coils for 40-mc video i-f components are made at high speed and low production cost with a stapling machine to which has been added a sliding two-position anvil unit. The electric-motor-driven machine, made by New Jersey Wire Stitching Machine Co. of Camden, N. J., draws wire from an overhead reel and converts it into staples that are driven through previously punched

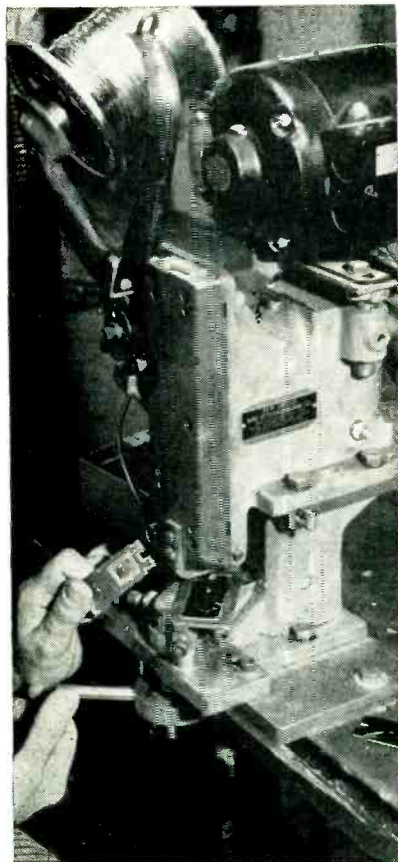

Applying conductors to back of etched i-f coil strip with stapling machine. One staple has already been applied, and operator has swung anvil around to correct position for other staple

*Voltage Surge Damage in Diesel-Electric Locomotives Stopped with VICKERS SELENIUM RECTIFIERS*

## PROBLEM

New diesel-electric locomotive designs required control circuits able to withstand highly repetitive "make-and-break" service, with *minimum maintenance*. Unless protected from high-voltage surges, characteristic of this type service, contactors would require too-frequent maintenance and replacement as a result of arc damage.

## SOLUTION

Vickers engineers designed selenium rectifier "safety valves" to fully protect the circuits. Dependable Vickers Rectifiers absorb the voltage surges, safeguarding vulnerable equipment. Vickers experience in producing quality rectifiers, and in engineering rectifiers to product problems, helps keep the diesels rolling.

In hundreds of applications, Vickers Selenium Rectifiers provide the economical, dependable solution to circuit protection and DC supply problems. When your plans for product development or improvement call for improved circuitry, consult experienced Vickers rectifier engineers. There's no obligation.

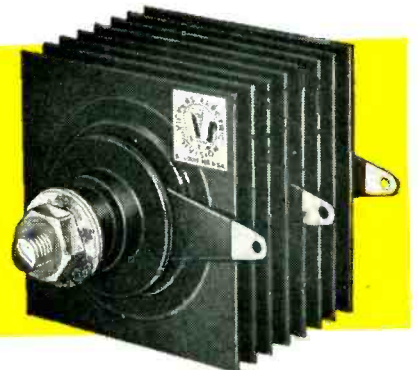

**VICKERS ELECTRIC DIVISION**

VICKERS Inc.

A UNIT OF THE SPERRY CORPORATION  
1801 LOCUST ST. • ST. LOUIS 3, MISSOURI

**IN STOCK NOW!**

at **CHICAGO**

hermetically sealed  
**400 CYCLE**  
**TRANSFORMERS**  
that meet MIL-T-27:  
**CLASS B\*** specifications



\*85° Ambient—40° Rise.

These rugged, compact transformers have been designed in close cooperation with organizations directly concerned with the development of standards for aircraft communication, guided missile and related equipment. They are engineered to meet future, as well as current requirements for 400 cycle power supplies.

**POWER TRANSFORMERS (All primaries 105/115/125 V., 380-1000 cycles)**

HIGH VOLTAGE A.C. Volts	SECONDARY D.C. Ma.	RECTIFIER Volts	FILAMENT Amps.	OTHER FILAMENTS Volts	FILAMENTS Amps.	CATALOG NUMBER
270-0-270	55	5.0	2	6.3 CT	2	4PHC-55
335-0-335	70	5.0	2	6.3 CT	3	4PHC-70
375-0-375	120	5.0	3	6.3 CT	4	4PHC-120
440-0-440	165	5.0	3	6.3	7.5	4PHC-165
				6.3	3	
				6.3	3	
450-0-450	200	5.0	2	6.3	0.6	4PHC-200A
				6.3	4	
				6.3	4	
550-370-75-0- 75-370-350	300	5.0	6	6.3 CT	0.6	4PHR-300
				6.3 CT	5	
				6.3 CT	1	

**FILTER REACTORS**

INDUCTANCE (henries)	MAXIMUM D.C. Ma.	D.C. RESISTANCE (ohms)	INSULATION VOLTS RMS	CATALOG NUMBER
2.0	55	160	2,500	4RH-255
2.0	70	240	2,500	4RH-270
2.0	120	105	2,500	4RH-2120
2.0	165	80	2,500	4RH-2165
2.0	200	77	2,500	4RH-2200
2.0	300	49	2,500	4RH-2300

**FILAMENT TRANSFORMERS (All primaries 105/115/125 V., 380-1000 cycles)**

SEC. VOLTS	SEC. AMPS.	INSULATION VOLTS RMS	CATALOG NUMBER
6.3 CT	3	2,500	4FH-63
6.3 CT	5.5	2,500	4FH-65
6.3 CT	10	2,500	4FH-610
6.3 CT	20	2,500	4FH-620

Write for Chicago Bulletin #32 listing more complete specifications on these units, specially designed for 400 cycle, high-temperature operation.



**CHICAGO**

*the World's Toughest Transformers*

**CHICAGO STANDARD TRANSFORMER CORP.**

3501 ADDISON STREET • CHICAGO 18, ILLINOIS

holes in the etched copper-clad plastic sheet.

A rotating two-position anvil, manipulated by a lever under the bench, permits precise application of staples in two different positions on strips having two coils. The staples serve to bring the inner lead of each coil out to the edge and connect it there to printed conductors going past the coils to the printed terminals of the unit. The stapling technique eliminates etching of conductors on both sides of the strip.

After stapling, each strip is held face up over a vertically mounted soldering iron, with the back of each staple resting in turn on the iron. Solder is applied to the clinched ends of the staples on the etched side, connecting staples to conductors securely.

**Welding Techniques for Gold-Plated Grid Wire**

THE OPERATION of winding grids for type 5894 twin tetrodes in the Hicksville, N. Y. plant of Ampere Electronic Corp. required development of special welding techniques for the 0.00024-inch gold-plated wire used.

The first step involves placing molybdenum grid rods in the grooved corners of the copper mandrel, which is designed to hold the rods in position automatically. The grid wire is now anchored at one end of the mandrel and the winding machine is started. A glass rod with a fine center hole is mounted

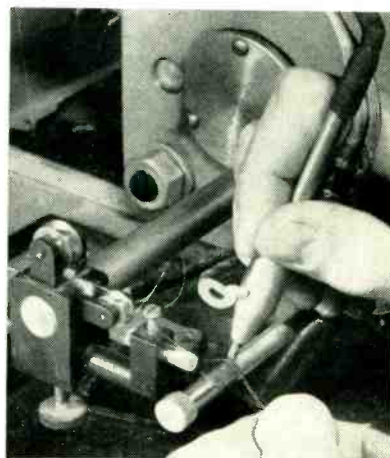

Welding nickel band around ends of grid on mandrel of winder



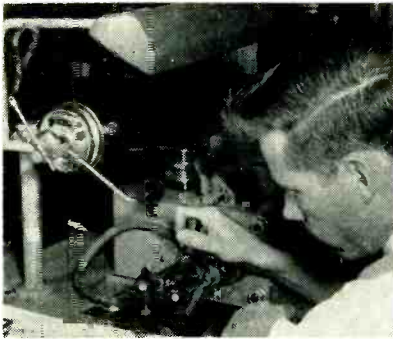

Using roller electrode to weld grid winding to moly rod

on the feedscrew-driven guide to give the required spacing between turns. Pulleys and an intricate automatic tensioning system maintain essentially uniform winding tension to minimize breakage of the delicate wire during winding.

After the winding has been completed and anchored, a nickel strap is welded around each end of the grid to the four rods, using a flow of nitrogen gas at the weld to stop oxidation of the nickel. The copper mandrel serves as the other electrode for welding. Spot welding is used here, with a pressure switch built into the hand-held welding electrode to start the electronic timer automatically each time the



Method of rocking roller electrode over grid for welding wires

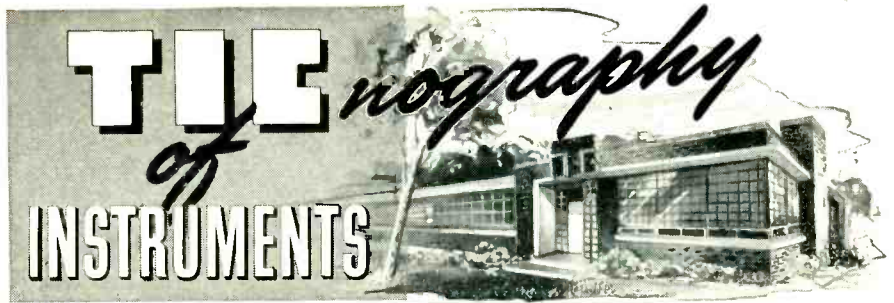

**TYPE 511-A POWER AMPLIFIER**

- PHASE SHIFT COMPENSATION
- NEGLIGIBLE DISTORTION
- HIGH VOLTAGE OUTPUT LEVEL

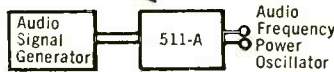

... a general purpose laboratory power amplifier featuring low distortion, low noise and excellent phase characteristics throughout the frequency range from 50 cps. to 50 kc. A choice of four outputs available to match various loads (5, 25, 200 or 1200 ohms). The 511A Power Amplifier is especially useful as a test driving source for tachometers, synchros, small motors, choppers, electro-mechanical devices and, with an audio frequency signal generator, as a power oscillator.

At rated frequencies and gain settings the overall phase shift is small. A special feature is the phase compensation circuit which permits the overall phase shift to be maintained at a constant value with varying gain. Harmonic distortion and intermodulation distortion are low. Output voltage up to 120 volts into a 1200 ohm load. Operates into loads varying from pure resistance to pure reactance.

The flexible system of phase shift control makes the 511-A Power Amplifier ideal for use in conjunction with phase measuring equipment as a power source in the investigation of phase characteristics of transmission lines, transformers, filters or equalizing networks, saturable reactors, magnetic amplifiers, and in acoustical measurements.

**SPECIFICATIONS:**

Output Characteristics and Gain (for 0.5% max. allowable harmonic distortion):

OUTPUT SELECTOR (Front Panel Control)	E <sub>out</sub> Max.	Voltage Gain	Optimum Load	P <sub>out</sub> Max.
Position 1	8 volts	1.4	5 ohms	12.8 W
Position 2	18 volts	2.8	25 ohms	13.0 W
Position 3	55 volts	8.0	200 ohms	15.1 W
Position 4	120 volts	21.0	1200 ohms	12.0 W

INPUT IMPEDANCE: 100 K ohms shunted by approximately 10 uuf.

FREQUENCY RESPONSE: At 10 watts or less output, essentially flat from 50 cps to 30 kc, down 0.5 db at 50 kc. At 10 to 16 watts, essentially flat from 50 cps to 30 kc, down 1.0 db at 50 kc.

HARMONIC DISTORTION: At 10 watts or less output, less than 0.5% total harmonic distortion (rms). At 10 to 16 watts output, less than 1.0% total harmonic distortion (rms).

PHASE SHIFT: 1.0° ± 1.5° from 50 cps to 10 kc.

Phase shift may be compensated at any single frequency to remain constant for all gain settings. Phase shift may also be made zero for a single frequency and a single gain setting.

INTERMODULATION DISTORTION (rms): Less than 0.5% from 50 cps to 15 kc for difference frequency of 150 cycles.

OUTPUT REGULATION: ±5% of rated output voltage from optimum load to open circuit on all ranges.

HUM AND NOISE: Less than 15 mv. with input shorted.

**TECHNOLOGY INSTRUMENT CORP.**

533 MAIN ST., ACTON, MASS., ACTon 3-7711



# Speeding Electronic Progress through CRYSTAL

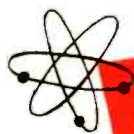

RESEARCH

The new JK-G9A extends the advantages of glass enclosed crystals to the medium-frequency range between 1200 kc and 5000 kc, providing a superior crystal for many applications in VHF and UHF equipment, frequency standards and monitors, and other precise requirements. The crystal operates in a vacuum, free of contamination and protected from its environment. The unit has excellent mechanical ruggedness. The crystal plate is custom designed for each application and is capable of performance far beyond previously available types. The unit may be designed for maximum stability over a wide temperature range, or temperature controlled in the JKO7E oven. Approximate height, above chassis, 2.375". Maximum dia. of octal base, 1.260". Consult us on specific applications.

**JK STABILIZED G9A CRYSTAL**

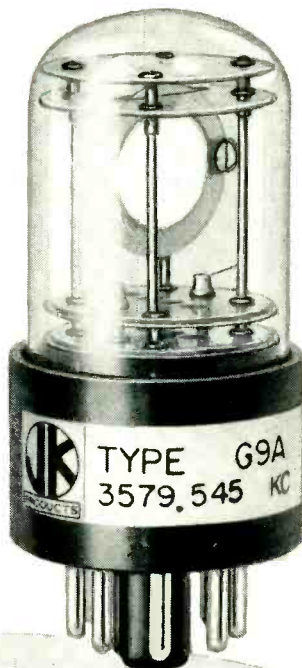

have you a **DESIGN PROBLEM?**

The James Knights Company leads in the design of crystals for the most critical applications. If you have a frequency control requirement of any nature consult us early in your design. An early consultation lets you make full use of the newest JK developments. Our broad experience and constant research can undoubtedly aid you in choosing the crystal unit best suited to your application.

**The James Knights Company  
Sandwich, Illinois**



*"Crystals for the Critical"*



electrode is pressed against the nickel strip. Either two or three cycles of current are used for welding.

Next, a continuous-duty roller welder segment is rocked over each of the four moly rods in turn to weld the gold-plated grid winding to the rods. Here also a stream of nitrogen is directed at the weld from a glass tube taped to the roller electrode. The flexible welding cable for the roller is encased in rubber tubing to prevent contact with the winding machine, since the mandrel is against the other electrode.

Both types of electrodes are frequently dipped into a pan of alcohol during use, to keep them cool and clean.

## Cement Adhesion Tester For Receiving Tubes

By W. P. KOECHEL  
Director of Quality Control  
Tung-Sol Electric Inc.  
Bloomfield, New Jersey

A LARGE percentage of radio receiving tubes utilize cement to fasten the glass to the base. The quality department must have complete assurance that any day's batch of cement is acceptable. For this reason, random samples of the tubes are subjected to an 18-hour im-



Setup for torque-testing tube bases to determine adhesive qualities of cement. Brass block on tester has hole arrangements for six different types of bases



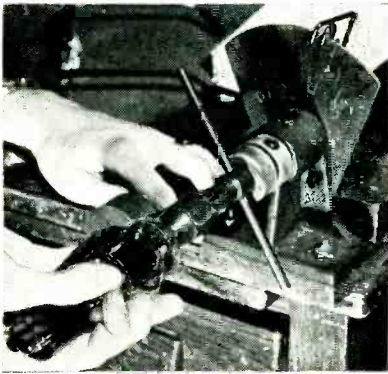

Setup for testing top-cap cement. Torque is applied by weight on rod just back of tube

mersion test in water at 50 C. After immersion in the water the tubes are subjected to a torque test to determine the adhesive qualities of the cement. The device used to torque-test tube bases consists of a pivoted socket on which is attached a fulcrum with a weight at the end. The tube base is inserted into the pivoted socket, and the operator (wearing a leather glove) then twists the glass envelope of the tube until the fulcrum is horizontal. At this point the



Top-cap torque-tester used on production line. Cap is rotated counterclockwise while inserting in hole, then rotated clockwise. This causes an off-center roller inside, spring-pushed in a clockwise direction, to wedge between the cap and the hub for gripping the cap

# TIE-TALKS

## FEATURE

TYPE  
RVHI

### HIGH TEMPERATURE TRIMMER POTENTIOMETER

... ideal for calibration, balancing, bias adjustment and similar functions in circuitry of Thermocouples, Pyrometers, Bolometers, or Strain Gauges making accurate measurements in high ambient temperature.

Typical operations where the high temperature characteristics of this potentiometer are most useful are in association with instrumentation of:

- JET ENGINES
- GAS TURBINES
- GUIDED MISSILES
- CRYSTAL AUTOCLAVES
- COMBUSTION PROCESSES AND STUDIES
- CRACKING PROCESSES
- METALLURGICAL PROCESSES
- SOLAR RADIATION MEASUREMENTS
- NUCLEAR REACTORS

The ambient temperature range is  $-55^{\circ}\text{C}$  to  $+145^{\circ}\text{C}$ . Stability is assured by pre-aging through temperature cycling. Rugged construction resists deterioration due to shock, vibration, humidity, salt spray, and corrosive atmosphere.

High resolution permits precise setting.

#### SPECIFICATIONS:

Standard Resistance Values: 100, 200, 500, 1,000, 2,000 and 5,000 ohms. Other values to 25,000 $\Omega$  available upon request.

Rated Temperature Coefficient of Resistance Wire: .00002 parts per  $^{\circ}\text{C}$ .

Dielectric Strength: Units tested for 1000 V. DC breakdown for 5 seconds.

Dissipation: 2 watts at temperatures up to  $80^{\circ}\text{C}$ , derated linearly from  $80^{\circ}\text{C}$  to zero at  $145^{\circ}\text{C}$ .

Ganging: Sections may be combined in ganged assemblies on a single shaft. One-piece stainless-steel clamp-ring permits precise phasing among ganged sections.

Mounting: Threaded bushing. Shaft locking device provided.

Write now for detailed specifications.

## TECHNOLOGY INSTRUMENT CORP.

533 MAIN ST., ACTON, MASS., ACTon 3-7711

# NEW lower priced FOCOMAG USES SINGLE FERRITE MAGNET

Another **HEPPNER** First

- Lower priced, compact. Cuts receiver costs. Uses only ONE ferrite magnet (an exclusive feature).
- Superior focusing - more uniform field. The sintered ferrite is extremely uniform throughout. Focuses all tubes up to 27".
- Completely shielded. No harmful external field.
- Extended focus range has very fine adjustment to exact focus.
- Built-in centering device.
- Flexible nylon adjusting shaft eliminates breakage.
- Picture positioning lever. You specify mounting arrangement.

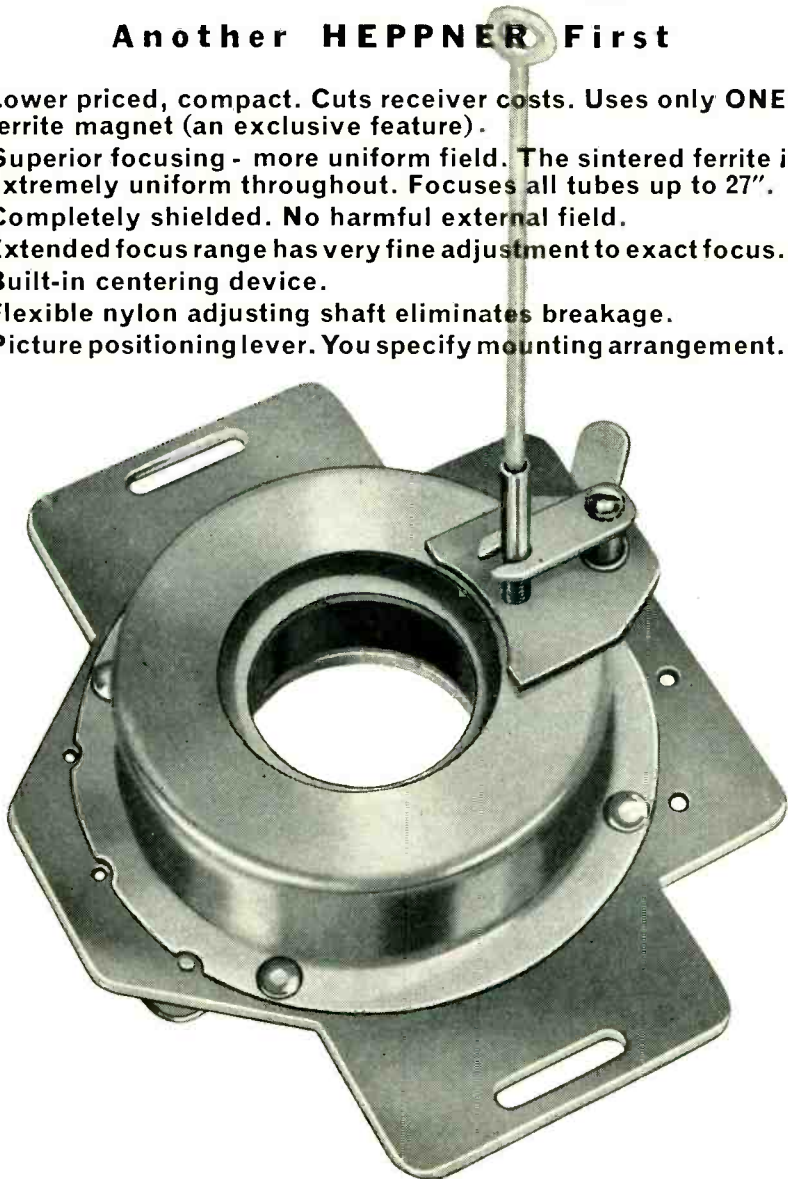

Lower your set costs with this NEW FOCOMAG. Write today for further information.

## HEPPNER

MANUFACTURING COMPANY

Round Lake, Illinois (50 Miles Northwest of Chicago)  
Phone: 6-2161

SPECIALISTS IN ELECTRO-MAGNETIC DEVICES

Representatives: **John J. Kopple**  
60 E. 42nd St., New York 17, N. Y.  
**James C. Muggleworth**  
506 Richey Ave., W. Collingswood, N. J.  
**Ralph Haffey**  
R. R. 1, U. S. 27, Coldwater Rd.,  
Ft. Wayne 8, Indiana  
**Irv. M. Cochrane Co.**  
408 So. Alvarado St., Los Angeles, Calif.

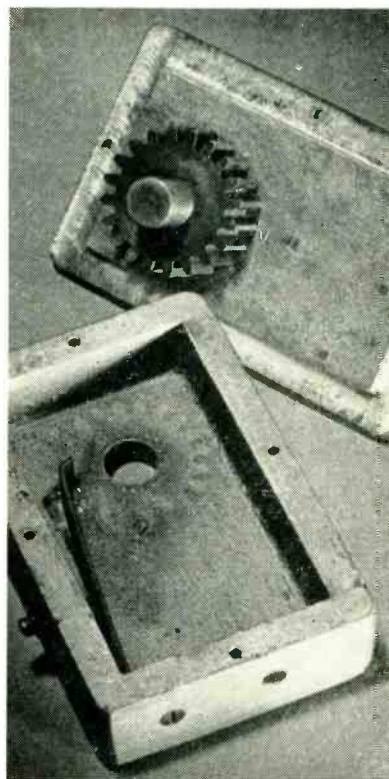

Inside of top-cap torque gage, showing how stiff flat spring bearing against gear provides friction equivalent to desired torque. Screw threaded through housing of gage bears against spring and can be adjusted to change torque

base is being subjected to a torque of 30 in.-lb. If the base should come loose at any intervening point, the fulcrum immediately drops back, but an idler indicator remains stationary, indicating on the scale at which point the base came loose.

A similar device is used to torque-test the top-cap cement of a tube. The scale here is calibrated up to 6 in.-lb.

As a quick test on the production line a different torque test device is used. The operator merely inserts the tube cap into the opening and gives the tube a few turns. In so doing, the top cap is subjected to exactly 2 in.-lb of torque.

Inside this device is a gear which is fastened to the same shaft that holds the chuck, along with an adjustable spring which engages with the gear and creates friction. Depending on the spring adjustment, a wide range of torque values may be obtained.

To calibrate this torque device, a small stud (the same diameter as the tube cap) has attached to it a fulcrum exactly 4 inches long. At



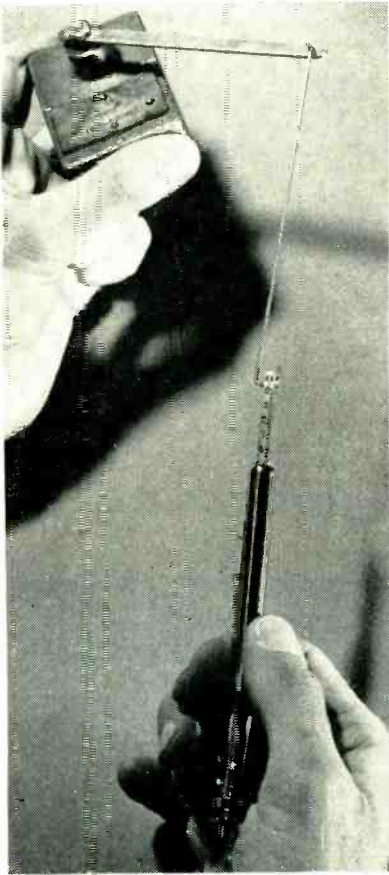

Method of using spring scale to calibrate top-cap torque gage. Flat lever arm has stud shaped like tube top cap, fitting into hole in gage

the 4-inch point there is a small hole which permits engagement of a calibrated spring tension tester. The scale of the spring tension tester is read during calibration at the particular moment when the fulcrum arm slips. Thus, to get 2 in.-lb of torque the spring on the side must be adjusted so that the fulcrum slips at the precise moment that the scale reads 8 ounces.

### Screen-Bake Oven for Picture Tubes

A WOVEN-WIRE conveyor belt moves television picture tubes through a 103-foot oven used in DuMont's Clifton, N. J. cathode-ray tube plant. Temperatures inside the oven can be as high as 600F for baking the screens inside the tubes.

At the loading end of the oven, tubes with freshly coated screens are placed on supports made from iron rods, to which are attached small blocks that serve as rests. The

# THERE'S MUCH THAT'S NEW IN THE FIELD OF MAGNET WIRE



OUR SPECIALIZED  
EXPERIENCE  
MAY BE HELPFUL

Today, with many new types of insulation available . . . new standards and specifications . . . new test and quality control procedures . . . Wheeler's 43 years of experience as magnet wire manufacturing specialists may be very helpful in deciding the best type of wire to use for your particular applications.

Wheeler, as a division of The Sperry Corporation, has developed an engineering staff exceptionally skilled in the magnet wire needs of precision electrical and electronic equipment manufacturers, with special emphasis on the smaller wire sizes and close control of electrical specifications. Production-wise, our exceptional facilities carry through from raw copper wire to the finished, insulated and tested product . . . under one roof and under one high standard of quality control every step of the way.

Your problems in Magnet Wire may safely be entrusted to our experts . . . whether standard or special . . . and including completed coils, transformers and other wire-wound components. We welcome your inquiries.

SEND FOR  
NEW MAGNET  
WIRE SHEETS

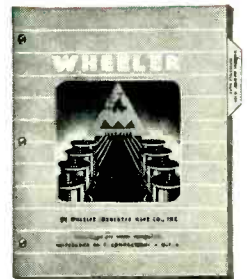

*We will be glad to send you this practical engineering data folder. Just give us an outline of your standard or special needs.*



MAGNET WIRE  
COILS  
COMMUNICATIONS  
EQUIPMENT  
TRANSFORMERS

MAKES THESE PRODUCTS A

*Specialty*

THE WHEELER INSULATED WIRE COMPANY, INC.

Division of The Sperry Corp. • 1101 EAST AURORA ST., WATERBURY 20, CONN.

13WH53

Designed for



Application

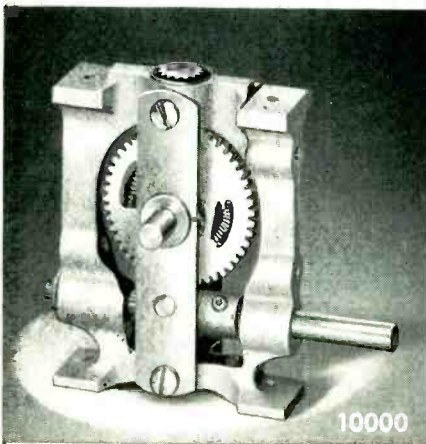

### The No. 10000 WORM DRIVE UNIT

One of our original Designed For Application products, tried and proven over the years. Rugged cast aluminum frame may be panel or base mounted. Spring loaded nickel plated cut brass gears work with polished stainless steel worm to provide low back lash. 1/4" diameter stainless steel drive and driven shafts. Available in two ratios, 16:1 and 48:1. Specify ratio in ordering.

## JAMES MILLEN MFG. CO., INC.

MAIN OFFICE AND FACTORY  
MALDEN  
MASSACHUSETTS



blocks are covered with an insulating and protective coating to minimize scratching of the tubes.

Strips of asbestos hang from the doors of the oven to form a curtain that serves to hold the oven temperature practically constant even though tubes are continually moving in and out.

Tubes are unloaded from the conveyor manually by an operator wearing asbestos gloves and are placed on an overhead conveyor for further cooling during transit to the next operation in the plant.

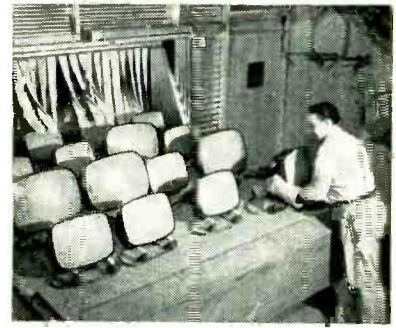

Unloading picture tubes after passage through Lehr screen-bake oven developed and built under the direction of Kenneth A. Hoagland

## Inline System for Aluminizing Picture Tubes

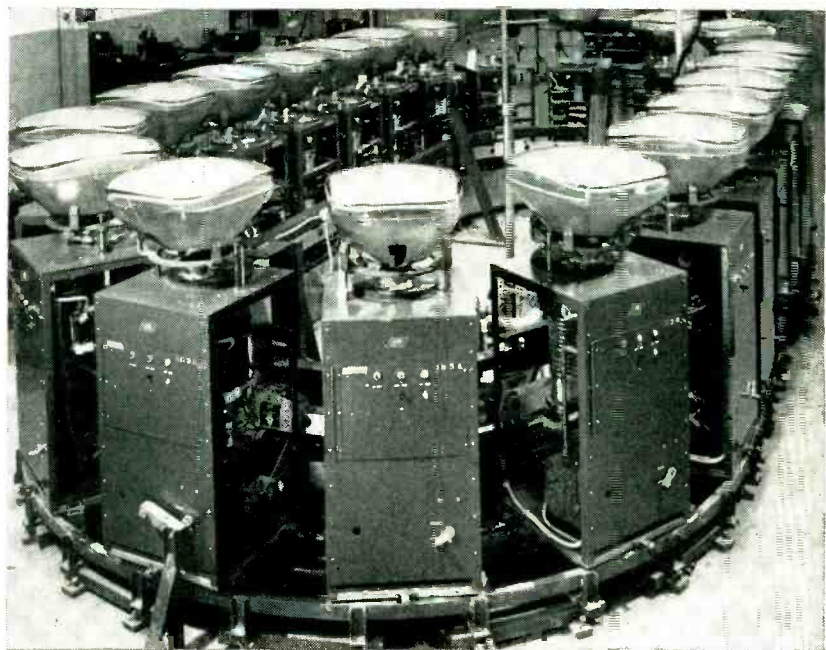

Complete 20-tube aluminizing system. In left foreground is the floor-mounted dog which trips the kick switch on each cart to change from rough pumping to the final fine pumping with the diffusing pump

AN ELECTRIC locomotive pulls 20 aluminizer carts around an oval track in the new inline system developed by Consolidated Vacuum Corp., Rochester, N. Y. for aluminizing tv tube screens. The carts will accommodate 21-inch, 24-inch or 27-inch tubes. Production rate for a 20-cart machine is approximately 100 27-inch tubes per hour, with still higher rates for smaller tubes.

The carts are coupled together in much the same way as the cars of a railroad train, except that the last car is coupled to the head of the locomotive to form an endless train. Heavy coil springs combined with

a few links of large roller-type chain provide shock-absorbent couplings that minimize jolts during startup.

Each cart is an aluminum casting mounted on rollers, supporting a complete vacuum pumping and aluminizing system. This means that a cart can be removed at any time for repair without interfering with production.

The locomotive cart has an electric motor that works through a reducing gear box to drive a pinion which engages the oval-shaped rack located at the bottom outer edge of the machine. Normal operating



# 4 mmf/ft



## AIR-SPACED ARTICULATED CO-AX CABLES

offer a unique combination of

- ✓ FRACTIONAL CAPACITANCE
- ✓ HIGH IMPEDANCE
- ✓ MINIMUM ATTENUATION
- ALONG WITH
- ✓ EXCEPTIONAL FLEXIBILITY
- ✓ LIGHT WEIGHT

### 38 STOCK TYPES

FOR ANY OF YOUR STANDARD OR SPECIAL APPLICATIONS

A few of the very low capacitance types are:

Type No.	Capacitance $\mu\mu$ F/ft.	Impedance ohms	O.D.
C.44	4.1	252	1.03"
C.4	4.6	229	1.03"
C.33	4.8	220	0.64"
C.3	5.4	197	0.64"
C.22	5.5	184	0.44"
C.2	6.3	171	0.44"
C.11	6.3	173	0.36"
C.1	7.3	150	0.36"

WE ARE SPECIALLY ORGANIZED TO HANDLE DIRECT ORDERS OR ENQUIRIES FROM OVERSEAS

SPOT DELIVERIES FOR U.S.

BILLED IN DOLLARS—SETTLEMENT BY YOUR CHECK CABLE OR AIRMAIL TODAY

**TRANSRADIO**  
CONTRACTORS TO  
H.M. GOVERNMENT LTD.

138a CROMWELL RD., LONDON, S.W.7  
ENGLAND

CABLES: TRANSRAD LONDON

ELECTRONICS — April, 1954

Pre-assembled partitions...made to exact specifications...for manufacturers of Radio, Electrical and Electronic components and allied products.

**P**artitions for  
**P**rotective  
**P**ackaging

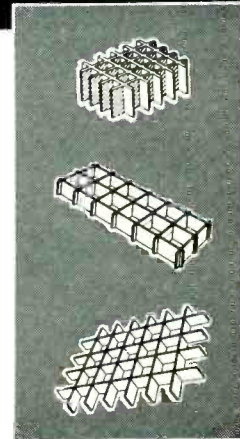

WRITE, PHONE or WIRE  
for QUOTATIONS on  
YOUR REQUIREMENTS

**peter partition corp.**  
Manufacturers of Cardboard Partitions

19-21 HEYWARD ST. BROOKLYN 11, N. Y.  
Telephone: TRIangle 5-4033

## NOW...SOLVE YOUR HIGH VOLTAGE PROBLEMS with BETTER EQUIPMENT

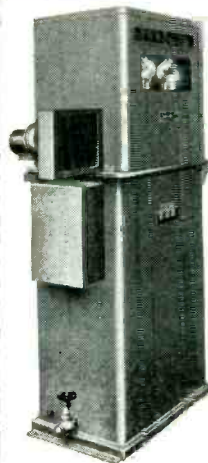

34 KW 17,000 V.D.C.



Our years of experience gives you MAGNATRON Heavy Duty High Voltage products... built for longer life and rugged performance

### ← NEW UNITIZED RECTIFIERS

For high voltage D.C. sources... lower initial cost... minimum upkeep... convenient — ready to connect to AC. line and D.C. load... compact — requires minimum floor space.

### AIR... OIL... ASKAREL

Plate Transformers. Filament Transformers. Filter Reactors. Modulation Transformers. Distribution Transformers. Pulse Transformers. Testing Transformers. Precipitation Transformers. General Purpose Transformers. Hi-Voltage Transformers.



Askarel Immersed Filter Reactor  
50,000 Volt Test

WRITE FOR DETAILED INFORMATION

MEETS STANDARDS OF AIEE-NEMA

A NAME SYNONYMOUS WITH EXPERIENCE

### MAGNATRON INCORPORATED

TRANSFORMERS AND ELECTRICAL EQUIPMENT  
WALTER GARLICK, JR., PRESIDENT  
246 SCHUYLER AVE., KEARNY, NEW JERSEY



Want more information? Use post card on last page.

# Announcing...

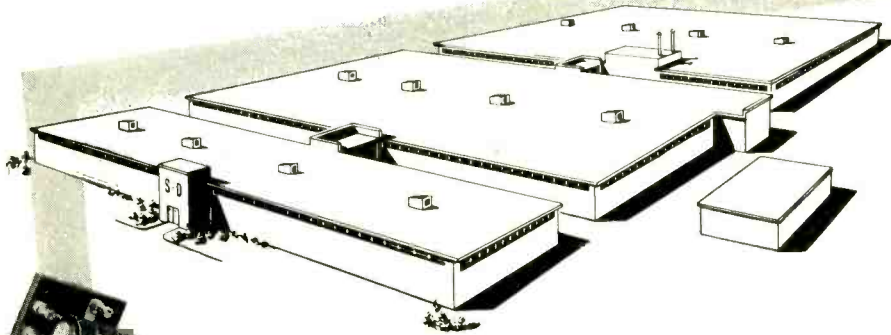

## A NEW PLANT

A modern building designed specifically for relay manufacture is another step in the continuing effort to improve Struthers-Dunn services and maintain maximum production of high quality products at favorable prices.

## A NEW LOCATION

The entire Struthers-Dunn factory and headquarter offices have been moved to a new location, approximately 15 miles Southeast of the Philadelphia-Camden Area.

## NEW ADDRESS

LAMB'S ROAD • PITMAN, N. J.

## NEW TELEPHONE

PITMAN 3-7500



# STRUTHERS-DUNN

5,348 RELAY TYPES

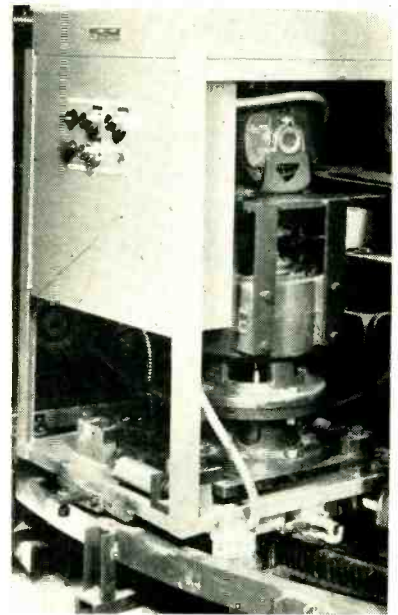

Locomotive cart, with drive motor on top of gear box. Pinion at bottom meshes with teeth of large oval rack to give positive motion without slippage

speed is approximately 4½ feet per minute, but this can be varied to provide the proper cycling time for any particular size of tube.

Electric power for the motors that drive the vacuum pumps on the carts is picked up by a trolley on each cart running in a Bulldog power duct. This duct is arranged in an oval just inside the path taken by the carts.

Power for the filaments that vaporize the aluminum is applied after pumpdown by means of a bus bar arrangement that is mounted on an oval steel frame directly over the power duct. Each cart has two contact brushes that slide over the bus bars as the cart moves through the vaporizing portion of the cycle.

The cycle starts with rough

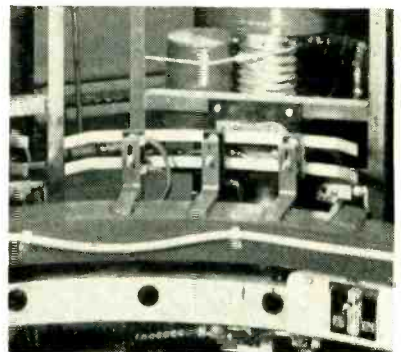

Method of mounting power bus bars on frame over power duct, for energizing the aluminum vaporizing filament on each cart in turn as they move past



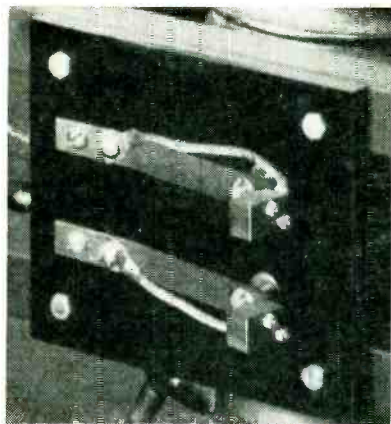

Brush mounting arrangement used on each cart for taking power from aluminum-vaporizing bus bars

pumping for 5 to 6 minutes on the mechanical pump alone. By the end of this period, the cart has moved to a point where a stationary dog on the machine actuates a lever that valves in the diffusion pump for about 5 minutes of fine pumping. Finally there is breaking of the vacuum, requiring about 1½ minutes. The remaining time in the cycle is used by the operator to unload each tube, replace the filament and load in a new tube on the cart. One man can handle the entire machine.

Each cart has one compound Kinney mechanical pump having a capacity of about 5 cfm, one Consolidated Vacuum booster type diffusion pump with a capacity of approximately 100 liters per second at 5 microns, a water pump and the necessary switches and valves. The vacuum pumps are secured directly to the body of a mechanically-operated bellows-sealed valve which closes off the diffusion pump during the rough pumping. This valve body also provides the recep-

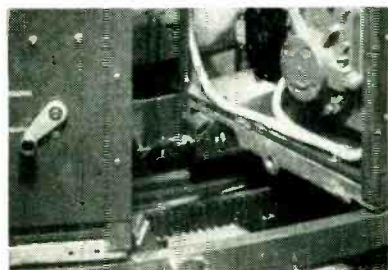

Details of coupling arrangement used between carts. At left is roughing-holding switch that is actuated by a stationary dog to turn on the diffusion pump at the correct time in the cycle

# a klystron is the HEART of airborne radar...

*At the blue-cold altitudes of jet fighters and guided missiles, corona problems cause plenty of trouble. Without the protection of a pressurized enclosure, ordinary klystrons fail. "Heart failure" has the same results, whether in human beings or in radar.*

**VARIAN OVERCOMES  
HIGH ALTITUDE PROBLEMS...**

Varian perfected the molded silicone seal for x-band radar klystrons which completely solves high altitude problems. With this seal, Varian klystrons withstand severe pressure and temperature differentials **without** short circuits, **without** frequency variation and **without** use of a separate pressure system.

Design leadership that solves tough application problems **first** is a Varian habit — the reason why radar equipment designers turn to Varian when klystron performance is a critical factor.

**PERFORMANCE PROVES  
DESIGN LEADERSHIP...**

**Only** Varian klystrons are wholly successful in unpressurized airborne radar systems. These seven outstanding features show why:

- Exclusive Silicone Seal
- Non-Microphonic Characteristics
- Low Voltage Operation
- Rapid Warm-Up
- Negligible Barometric-Frequency Coefficient
- Extremely Low Noise
- Rugged Construction

For high altitude applications, specify these production klystrons:

VA-6312/V-270
VA-6314/V-290
VA-6315/V-153
VA-6316/V-151

IN KLYSTRONS, THE MARK OF LEADERSHIP IS  
**VARIAN associates**  
PALO ALTO 1, CALIFORNIA  
*Representatives in all principal cities*

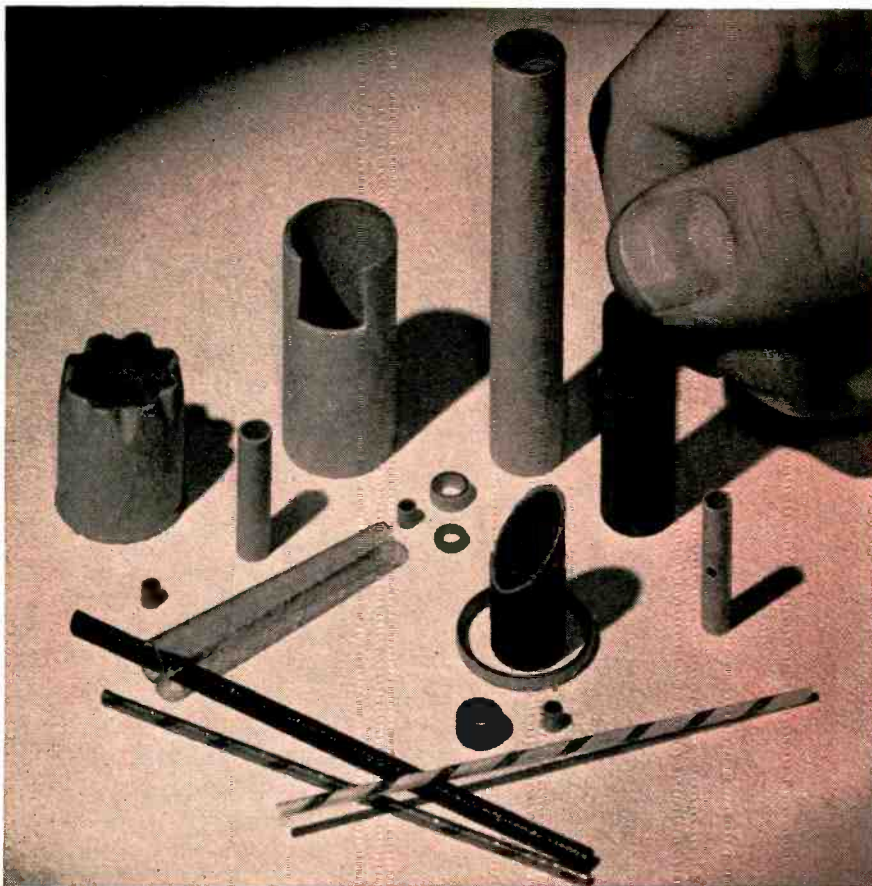

Stone's Electrical Insulating insulators, spacer bushings, or tubes are used as core or shaft liner and protector sleeves, in the insulating, rivet and screw manufacture of:

- FRAC. H. P. MOTORS • RELAYS • SOLENOID SWITCHES • TRANSFORMERS
- FLUORESCENT LAMP STARTERS • COMMUTATORS • ELECTRIC BLANKETS
- ELECTRIC CORD SETS • INDICATOR LIGHTS • VOLTAGE REGULATORS • ELECTRIC
- MEASURING EQUIPMENT • INCANDESCENT LAMPS • ELECTRIC TRAIN SETS

## You CAN Save Money and STILL Get Quality!

ANY OF the hundreds of America's leading manufacturers who are Stone's customers know this to be true.

They have found that Stone's 126-year-old heritage has paid off for them. This rich industrial background has enabled Stone to perfect more accurate methods of manufacture and to improve its mass-production techniques with the result that genuinely superior products are produced at low cost.

Stone specializes in small-diameter, spiral-wound insulating tubing from 3/64" to 1" ID. Larger sizes are available, of course. All Stone tubes are cus-

tom made, yet mass produced, and can be furnished in hi-dielectric kraft, fish paper, and plastic films in various wall thicknesses and lengths. They can also be formed, notched, punched, printed, dipped or impregnated with a variety of waxes and resins.

We suggest that you get in touch with our nearest representative or write directly to us. In either case, you will find an organization ready and able to serve you with unsurpassed service . . . the kind that has made us one of the world's largest small-diameter paper tube manufacturers.

**STONE PAPER TUBE COMPANY**  
 INCORPORATED  
 900-922 Franklin Street, N. E., Washington 17, D. C.

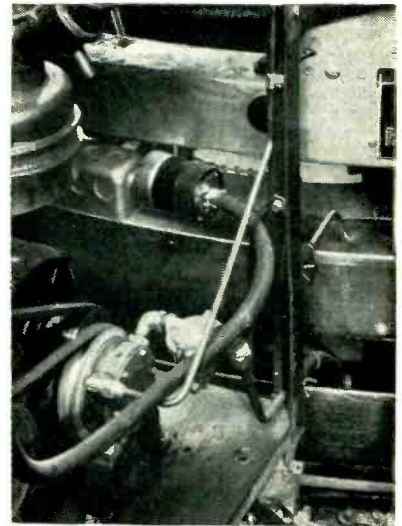

Cooling water from diffusion pump is drawn from gutter at bottom and is discharged into the upper gutter. Water pump is alongside electric motor at left. Above the gutters is the power duct from which the carts obtain line voltage a-c through chain-towed trolleys

tacle for the neck of the cathode-ray tube.

Cooling water for the diffusion pumps is supplied by a vane-type pump on each cart, driven by the vacuum pump motor through speed-reducing belts and pulleys. The pump draws water from one gutter that surrounds the machine and discharges it to another gutter directly below it. The gutters are located below the power duct, just inside the route of the cart.

Changing of filaments is made easy by mounting an alligator-type clip at the top of each filament post for holding the replaceable tungsten filament from which the aluminum is vaporized.

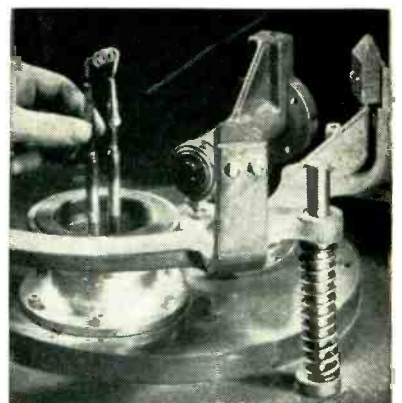

Method of installing replaceable filament from which the aluminum is vaporized. At right of filament is circular cam which operates valve over diffusion pump when it moves over a dog on the frame of the system



# STERLING

## A DEPENDABLE SOURCE FOR TRANSFORMERS MIL-T-27 & COMMERCIAL

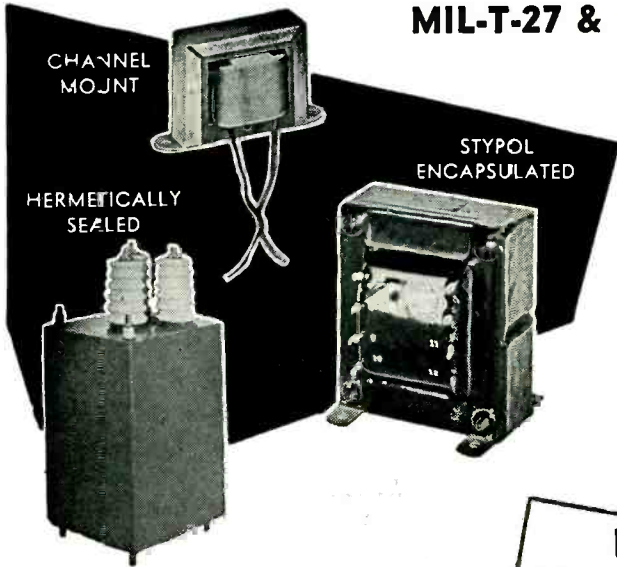

- Pulse
- Audio
- Power
- Filter Choke
- Filament
- RF Coils

Custom Built to  
your Specifications



**WE SOLICIT  
SAMPLES AND SHORT  
RUN PRODUCTION**

### New components, designs and techniques for the Electronics Engineer

- 1 Solving the problems of high voltage and corona suppression for Color TV

New Alden #220 FTSC 20-pin connector with high-voltage leads completely sealed in polyethylene.



Alden High Voltage Anode Cables to handle 20,000 to 30,000 volts. Of polyethylene with integrally molded tube cap of hi-temperature Nylon with extended sleeves; Hi-v. Disconnect completely sealed and with long leakage surface; phosphor bronze Anode Clip. Wide variety available.

- 2 Adapting electronic designs to Plug-in Unit Construction



With new Alden Back Connectors equipment becomes slide-in units with single accessible check point for all in-out leads.

- 3 Plug-in Packaging Components for starting plug-in design from scratch



Here are standard components of tremendous flexibility to assemble your circuitry into plug-in units, and end up with equipment all mounted as illustrated. Will accommodate tremendous variety of circuitry.

- 4 To mount your circuitry in compact vertical planes



Alden standard components, to mount your circuitry in compact vertical planes as illustrated here, consist of Prepunched Terminal Card, Miniature Staking Terminals, Card-mounting Sockets.

Tell us your area of interest and we'll send Spec. Sheets and details.



## IN-RES-CO TYPES CX & BX WIRE WOUND RESISTORS

**FEATHERWEIGHT!**  
—another IN-RES-CO solution  
for CIRCUIT DESIGNERS

SEALED IN MOLDED BAKELITE  
PLUS LIGHTWEIGHT

The dependable resistive elements that combine positive sealing with the important advantage of lightweight. Molded Bakelite core reduces weight by one-half compared to ceramics. Positive seal effectively protects the winding against harmful climatic conditions. Additional IN-RES-CO features include long life stability, hard soldered connections to terminals and extra-sturdy, vibration proof terminal leads. Both CX and BX Resistors include space-saving terminal supported axial terminals of tinned wire.



ASK FOR THE NEW  
RESISTOR HANDBOOK -  
Contains complete data on  
resistors for every purpose  
and their recommended  
applications. Please  
make request on com-  
pany letterhead

## INSTRUMENT RESISTORS CO.

COMMERCE AVENUE UNION NEW JERSEY



APPLICATION-DESIGNED RESISTORS FOR ELECTRONICS AND INSTRUMENTATION

# NEW PRODUCTS

Edited by WILLIAM P. O'BRIEN

Control, Testing and Measuring Equipment Described and Illustrated . . . Recent Tubes and Components Are Covered . . . Fifty-Seven Products and Fifty-One Bulletins Reviewed

## SIGNAL GENERATOR

provides decade selection

DECADE INSTRUMENT Co., Box 153, Caldwell, N. J., The Decalator 100-1 signal generator provides decade selection of 9,000 predetermined crystal-controlled frequencies, in 100-cps steps over the range from 100 kc to 1 mc. Its functional electrical and mechanical design permits instant selection of any desired frequency in its range. Frequency selection is accomplished by a series of easy-to-read window-type dials that display the unit's output frequency directly in kc. Two banks of crystals control the output of the device, having short-

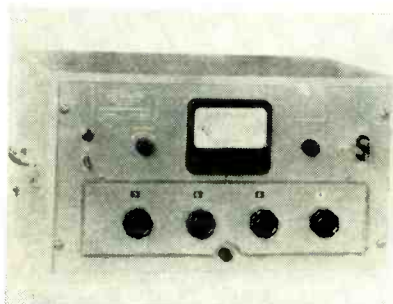

term stability of 5 cps and overall accuracy within 0.025 percent. Output voltage is 3 v maximum, into 600 ohms, with a total harmonic content of less than 3 percent at

## OTHER DEPARTMENTS

featured in this issue:

	Page
Electrons At Work . . . . .	196
Production Techniques . . . . .	242
Plants and People . . . . .	338
New Books . . . . .	398
Backtalk . . . . .	404

any frequency. Signal generator output measurement characteristics are obtained through the use of an output meter followed by a step-by-step attenuator calibrated in fractions of full-scale meter readings. An age circuit maintains the output level within 1 db. A heavy-duty electronically regulated power supply maintains overall stability under adverse power-line conditions.

## FILTER CAPACITORS

are molded ceramic units

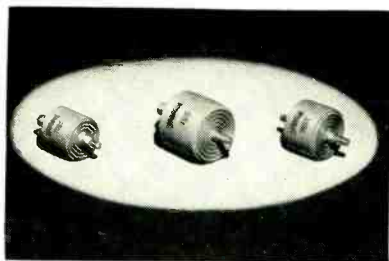

SPRAGUE ELECTRIC Co., 35 Marshall St., North Adams, Mass. The new molded ceramic h-v filter capacitors will find broad usage in the filter circuits of modern tv receivers and c-r instruments. These capacitors, molded in moisture-resistant, non-inflammable thermosetting plastic, are available with 15 different

terminal combinations to meet practically every mounting requirement. Standard rated capacitance is 500  $\mu$ f. Maximum operating temperature is 85 C. Type 702 C capacitors, rated at 25,000 v d-c, withstand a dielectric test potential of 35,000 v; type 701C, rated at 30,000 v d-c, a test potential of 40,000 v. Minimum insulation resistance under standard test procedures at 25 C is 10,000 megohms.

## TV COUPLER

utilizes a transformer with h-f core

TELE-MATIC INDUSTRIES, INC., 1 Joralemon St., Brooklyn, N. Y. Model AM-74 coupler operates two tv sets from one antenna on all vhf channels on either 72 or 300-ohm line. It is an inductive coupler incorporating an efficient transformer with a special high-frequency core. This maintains a constant impedance over the entire band and a minimum of loss as compared to a resistance network coupler. The

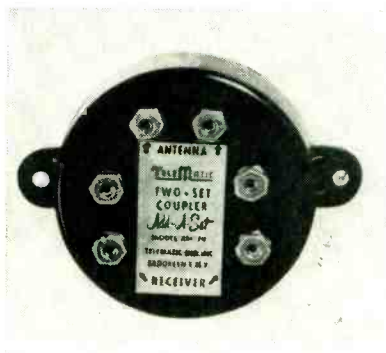

Add-A-Set coupler isolates the antenna and receivers by the use of individual windings of the transformer and, therefore, inter-receiver action is minimized.

## TV CAMERA SYSTEM features unitized design

KALBFELL LABORATORIES INC., 1090 Morena Blvd., San Diego 10, Calif. A new tv camera system featuring unitized design consists of camera,



# A new, efficient crystal diode holder

*Sturdy Sylvania Holder Contacts Provide High Retention for Diodes*

"Another improved part by Sylvania!"

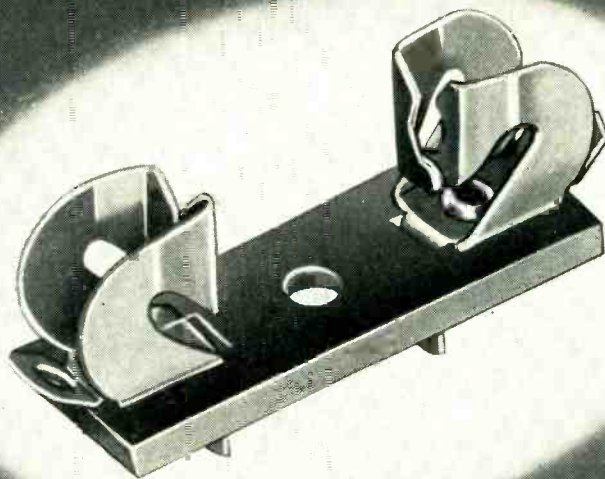

Here's a brand new, extremely efficient Crystal Diode Holder designed for you by Sylvania.

The contacts retain diodes with terminal leads ranging from .078 to .125 diameter, with ease of insertion and withdrawal. The center-line of retention is specially located at sufficient distance from the surface of the mounting plate to allow installation of large diam-

eter Crystal Diodes. Mounting plate is made of laminated phenolic and the contacts can be furnished in either phosphor bronze or brass with silver plating. Eyelets are made of nickel-plated brass.

For detailed specification sheets concerning this improved diode holder or any other Sylvania part write to Sylvania today!



# SYLVANIA



Sylvania Electric Products Inc., Dept. 4A-1602, 1740 Broadway, New York 19, N. Y.

In Canada: Sylvania Electric (Canada) Ltd., University Tower Bldg., St. Catherine St., Montreal, P. Q.

LIGHTING • RADIO • ELECTRONICS • TELEVISION

ELECTRONICS — April, 1954

Want more information? Use post card on last page.

293

camera control and synchronizer-monitor. The camera is constructed so that all operating adjustments can be performed remotely. It is ideally suited for installations in inaccessible locations. Its light weight and compact size make it useful for field and remote pickup operation in commercial broadcasting. Plug-in construction of camera control components provides ease of maintenance. Camera and camera control can be used separately to pro-

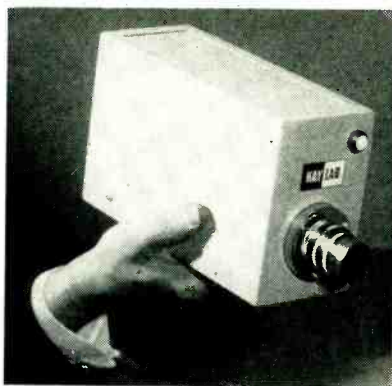

duce a noninterlaced picture. Broadcasters may supply horizontal and vertical driving pulses and standard blanking pulses to these two units through back-chassis connectors. Interlaced pictures are produced when the camera and camera control are used with the synchronizer-monitor. The monitor tube is large enough so that no additional receivers are required for practical operation. All controls are readily at hand for front-panel adjustment.

## RACK-MOUNTED FAN

cools electronic cabinets

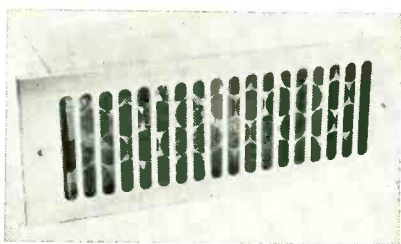

MCLEAN ENGINEERING LABORATORIES, P. O. Box 531, Princeton, N. J. A rack-mounted, self-contained unit is offered for cooling electronic cabinets. The assembly is a single unit with the filter located inside the case. Two fans, mounted side by side, provide maximum air with

minimum panel height. The cooling fits the standard 19-in. electronic rack and pressurizes the cabinet with filtered air, preventing dust from entering through cracks and joints of the cabinet. The fan assembly is rack mounted the same as any chassis and the filter is replaced from the front by merely removing the stainless steel grille.

## IMPEDANCE MATCHER

covers 400 to 900 mc

LINEAR EQUIPMENT LABORATORIES, Brightwater Place, Massapequa, L. I., N. Y. A new impedance matching device for the purpose of transforming the output impedance of an unbalanced source of voltage, such as a signal generator, noise generator or sweeper, to a balanced 300-ohm output is provided in the U-1, U-2 transformer-balun combination. Covering the 400 to 900-



mc portion of the spectrum, the units are specifically designed to facilitate measurements in the uhf-

tv band. Model U-1 transformer transforms a 50-ohm unbalanced source to 75 ohms unbalanced over the 300 to 900-mc range with an swr of less than 1.15. The U-2 balun transforms a 75-ohm unbalanced source to a 300-ohm balanced impedance over the 400 to 900-mc range with an swr of less than 1.2. Overall swr of the combination from 400 to 900 mc is less than 1.2. Terminations are available for calibrating the transformer or transformer-balun combination.

## MAGNETIC AMPLIFIER

is a low-level d-c device



POLYTECHNIC RESEARCH & DEVELOPMENT Co., INC., 55 Johnson St., Brooklyn, N. Y. Type 806 low-level magnetic amplifier features high sensitivity. It will operate from input signals as low as 200  $\mu$ w and will provide an output of 0.05 w of reversible polarity to a 50-ohm load. A power gain of approximately 300,000 can be obtained. The unit is completely self contained and requires no additional rectifiers or power supply. It oper-

ates from 115 v, 60 cycles, single phase. Two feedback windings are provided and may be connected externally.

## PULSED RECTIFIER for color tv receivers

RADIO CORP. OF AMERICA, Harrison, N. J. The 3A3 is a half-wave vacuum rectifier tube of the glass octal type designed for use as a rectifier of high-voltage pulses produced in the scanning systems of



# LAVOIE

**FOR THE NEWEST and BEST in ELECTRONIC EQUIPMENT**

## FREQUENCY METERS

Three frequency meters accurate to 0.001% cover ranges from 10 to 2000 MC. Model LA-5 covers the 10 to 100 MC range, LA-6, 100 to 500 MC and LA-61 500 to 2000 MC.

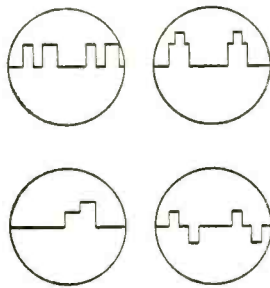
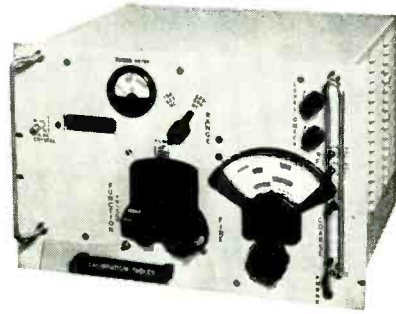

## PULSE GENERATOR—MODEL LA-592D

A double-pulse generator with wide range control, excellent pulse shape. Eliminates necessity for many instruments usually required in an electronics laboratory.

## OSCILLOSCOPE—MODEL LA-239C

The new and improved Lavoie oscilloscope offers wider frequency range, greater sensitivity and faster rise time. The Lavoie Camera Adapter may be added quickly and without modification.

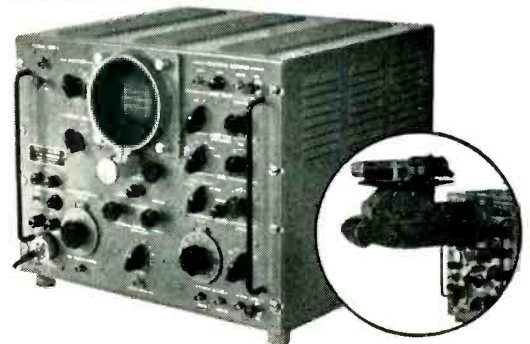

At The I.R.E. Show  
BE SURE TO SEE  
Low Cost Marine  
Radar by Lavoie

BOOTHS 400-401-500  
Production Road, Opposite Components  
and Electronics Aves.

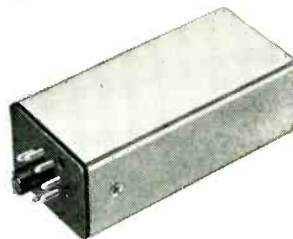

## PRECISION CRYSTAL OVEN 75° or 85° C

Maintains crystal temperature to within 0.025° C at normal room temperature—to within .15° C over outside range from -40° F to 150° F. Available for HC 6 or HC 13 crystal units.



*Lavoie Laboratories, Inc.*

MORGANVILLE, NEW JERSEY

here's antenna resolution

**"ON TARGET"**

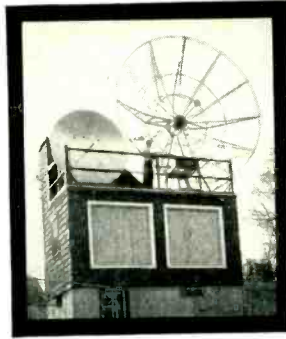

Highly Directive, high power (20-watt) transmitter with 18-ft. parabolic antenna, furnishes signal source.

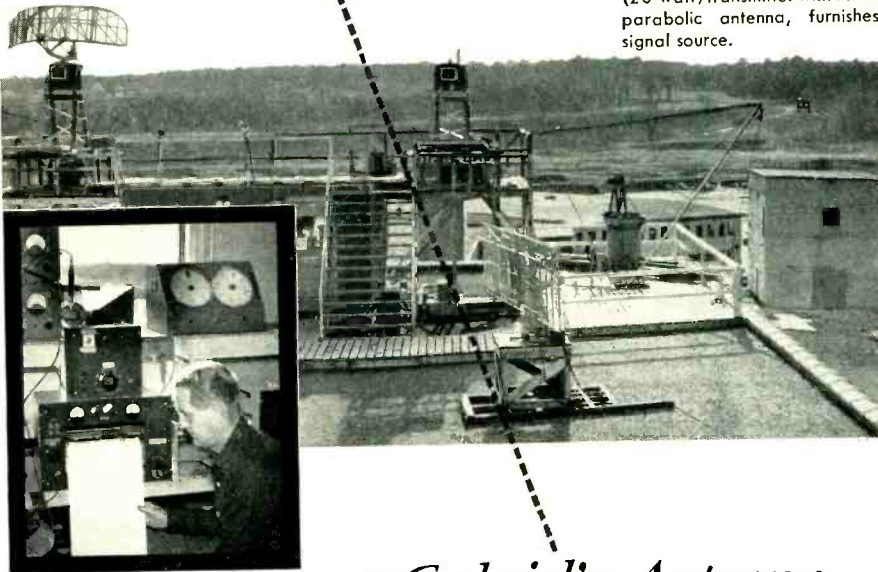

Power-driven, remotely controlled mounts permit 3 separate, simultaneous test set-ups. Recording systems, synchro driven for angle scaling, are linear  $\pm 0.25$  db over 40 db range.

## at Gabriel's Antenna Test Pattern Range

**FOR PRECISE RESOLUTION** of your antenna problem, typified by final check-out on this 2200-foot Test Pattern Range, Gabriel offers —

- Integrated Facilities for your requirements from basic idea through production.
- Research and development... pilot or full-scale production... to exact specifications of industry or defense.

**For example:** Large scale production of critical search-warning radar... and the major share of the nation's production of Microwave Antennas, designed and built by Gabriel... are "proved out" on this range.

IF your target is successful resolution of an antenna project...  
IF your problem lies in the frequency range 33 to 33,000 mc... **WRITE OR PHONE** — A Gabriel Antenna Specialist will talk over your needs, review specifications, make recommendations. Call him today. NORwood 7-3300

## Gabriel Electronics Division

Formerly Workshop Associates Division

The Gabriel Company • 200 Endicott Street, Norwood, Mass.



complete line of coaxial attenuators from 0.1 db to 60 db, with a frequency range from d-c to 3,000 mc. The attenuators may be obtained singly or in a turret selector containing any six values of attenuation, featuring a pull-turn-push selection sequence. Small overall size of turret selector is  $2\frac{1}{8}$  in.  $\times$   $2\frac{1}{8}$  in.  $\times$   $5\frac{1}{2}$  in. A 4-page pamphlet is available covering the complete line of coaxial attenuators from 0.1 db to 60 db, power ratings, specifications, illustrations and other features. The back cover of the pamphlet gives a block diagram of lab setup for measurements of attenuation using the company's equipment.



## AIRCRAFT SWITCHES are environment-proof

**MICRO SWITCH**, division of Minneapolis-Honeywell Regulator Co., Freeport, Ill., announces a new series of environment-proof switches designed for use in exposed locations in aircraft. They feature a hermetically sealed, split-contact switching unit enclosed in an aluminum housing. Their performance remains constant regardless of changes in atmospheric conditions. Six mounting holes in the housing are arranged to permit mounting the switch from either side. Drain holes allow drainage of any moisture that might collect within the housing. The bottom plate of the housing is easily removed for wiring or replacement of the basic switching unit. Typical dimensions are  $6\frac{3}{4}$  in.  $\times$   $3\frac{3}{4}$  in.  $\times$  1 in. Operat-



ing force is 9 lb and the total plunger travel is  $\frac{3}{8}$  in. Four different conduit connectors are available.

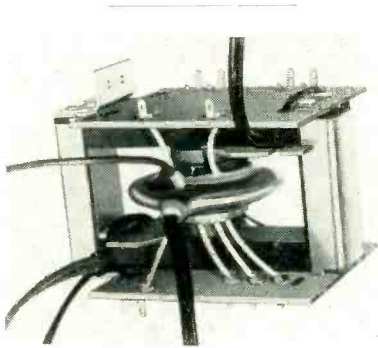

### TRANSFORMER for color synchronization

ELECTROMETRIC, INC., Woodstock, Ill. A new color tv horizontal output transformer designed for use with a single 6DC6 driver and to work into an 11.8-mh yoke is now available. Type CTV515 reproduces all pulses required for color synchronization, including keyed age, afc and peaking for horizontal driver circuit. High voltage is produced for focusing, beam acceleration and beam deflection. It delivers 20 kv regulated out of 3-tube voltage doubler with 750  $\mu$ a maximum load.

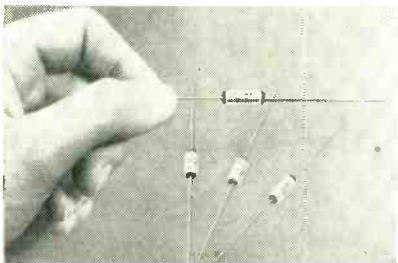

### TINY CAPACITORS in thirty-five varieties

CORNELL-DUBILIER ELECTRIC CORP., South Plainfield, N. J., has developed a line of compact subminiature Tantalum electrolytic capacitors. Size is kept to  $\frac{1}{8}$  in. long and  $\frac{1}{16}$  in. in diameter. The units are well suited for application in transistor circuits. They cover an operating temperature range from  $-55$  C to  $+85$  C and have considerably lower leakage current than other electrolytic types. The wound foil construction results in excellent frequency characteristics. Thirty-five

for the best in  
**TEFLON**\*

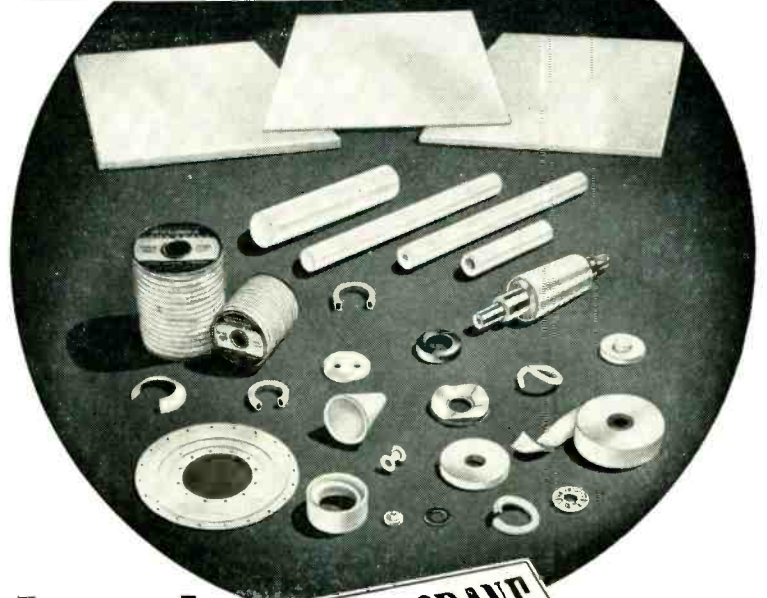

depend on

**JOHN CRANE**

- Uniformity
- Controlled Density
- Product Purity
- Accurate Dimension

Since Teflon first became available, "John Crane" has successfully engineered its application to solve innumerable and widely varying problems. Typical of this is the development of packings and other products for handling corrosive liquids and gases. Other important examples include production of electronic parts of high dielectric strength and low loss factor for vhf, uhf, and microwave insulation; also in the employment of its anti-stick characteristics in the handling of adhesive materials.

These and other application developments are closely tied with "John Crane's" fabricating technique, which has resulted in Teflon products of the finest uniformity, controlled density, product purity and accurate dimension.

Teflon is available in rods, tubing or sheets or in special molded and machined forms such as bellows, "C-V" Rings, braided packings, valve discs, electrical parts, washers, dough sheeting rolls, heat sealing jaws and countless other forms. Glass, carbon or graphite filled Teflon is also available.

Consult "John Crane" on your requirements. Send for 12-page illustrated catalog, *The Best in Teflon*, containing important data and suggested applications. Crane Packing Company, 1802 Cuyler Ave., Chicago 13, Ill.

\*DuPont  
trademark

**JOHN CRANE**

**CRANE PACKING COMPANY**



the COMPLETELY NEW



**HYCOR**  
**VARIABLE**  
**ATTENUATOR**

... a revolutionary design in attenuators!

- PROOF against SHOCK — MOISTURE — TEMPERATURE
  - Withstands ambient temperatures of  $-40^{\circ}\text{C}.$  to  $+100^{\circ}\text{C}.$ ; 95% humidity.
  - Resistive elements are accurate, noninductive, wire-wound and hermetically sealed in a special tough plastic compound.
  - Greater power dissipation.
  - Switch surface flat and smooth . . . easy to clean, BRUSHES CANNOT TRIP, exceptionally long life.
  - QUIET . . . extremely low switch noise level . . . ideal audio mixer controls.
  - "Lubricated for life" bearings.
  - Stock types available with "LADDER," "T," "H," "L" and potentiometer configurations up to 32 steps.
- Send for Bulletin A-2 for specifications and prices.

Representatives:

**BEEBE ASSOCIATES**  
1155 Waukegan Road, Glenview, Illinois  
**BURLINGAME ASSOCIATES**  
103 Lafayette Street, New York City  
**HARRISON J. BLIND**  
1616 Cord Street, Indianapolis 24, Indiana  
**G. M. HOWARD & ASSOCIATES**  
734 Bryant Street, San Francisco 7, California

**HYCOR SALES COMPANY**  
**of California**

11423 VANOWEN STREET  
NORTH HOLLYWOOD, CALIF.

NEW PRODUCTS

(continued)

varieties are available ranging in capacitance from 0.01  $\mu\text{f}$  to 8.0  $\mu\text{f}$ , and from 3 to 150 v d-c, in both polarized and nonpolarized types.

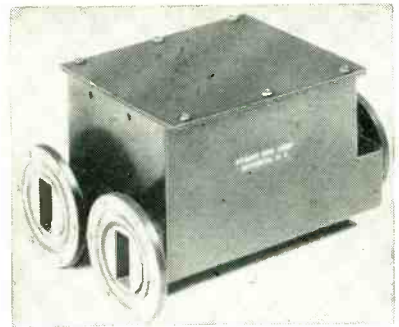

**WAVEGUIDE SWITCH**  
features simple design

BOGART MFG. Co., 315 Siegel St., Brooklyn 6, N. Y. Especially designed for switching of commercial microwave relay transmitters and receivers, model 4426 waveguide switch is an electrically operated spdt section of RG-50/U waveguide. A unique design employs insertion of an attenuator card into the disconnected member automatically, providing a termination for the switched member as well as increasing the isolation between arms to better than 60 db; vswr is less than 1.10 over a 17-percent bandwidth and the entire unit is operated by a momentary pulse of 115 v, 60 cycle power. Insertion loss through the connected member is less than 0.1 db. The simplicity of design makes the unit ideal for scaling to larger and smaller waveguide sizes.

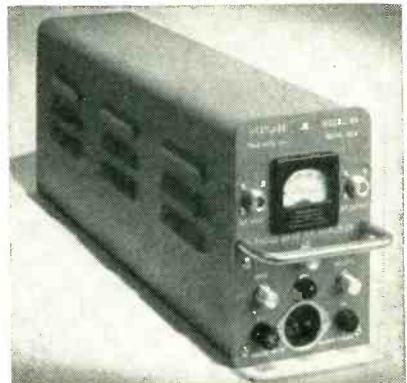

**R-F AMPLIFIER**  
of the broad-band type

WESTLABS INC., P. O. Box 1111,  
Palo Alto, Calif. Model 24 broad-

**GOLD INLAY KNOBS**  
IN ANY QUANTITY!

... and Never a Tool Charge

**NEW GEE-LAR**  
**GOLD INLAY KNOBS**

You can get beautiful gold inlay knobs, pointers, instrument controls . . . thousands of styles and varieties . . . in any quantity from GEE-LAR—The House of Knobs. They're available in both knurled and spring types, in either walnut or ivory backgrounds. For faster service and lower cost . . . plus the widest selection . . . get your Gold Inlay Knobs from GEE-LAR!

WRITE TODAY  
for Gee-Lar Catalog  
IT'S FREE!



THE HOUSE OF KNOBS

**GEE-LAR MANUFACTURING COMPANY**  
821 Elm Street • Rockford, Illinois





band amplifier utilizes a traveling-wave tube to provide high gain over the 2,000 to 4,000-mc frequency range. The small-signal gain averages 35 db, and the saturation output power, 30 mw. Maximum noise figure is 20 db or less. The unit is completely self-contained, including regulated power supplies and traveling-wave tube focusing structure. The amplifier is housed in a case of JAN aircraft equipment dimensions ( $4\frac{1}{2}$  in. wide  $\times$   $7\frac{1}{8}$  in. high  $\times$   $19\frac{1}{8}$  in. deep), and is directly usable as either a laboratory tool or a system component. Primary supply requirements are 108 to 122 v at 1 ampere, 50 to 800 cycles.

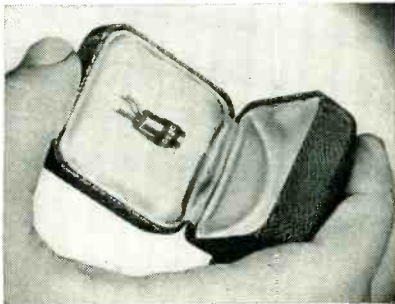

### TRANSISTORS are point-contact type

AMPEREX ELECTRONIC CORP., 230 Duffy Ave., Hicksville, L. I., N. Y., has available two new point-contact transistors. One is the type OC50 designed for amplifying purposes, and the other is the type OC51 designed primarily for switching operations. Both are useful in computers, and telephone and communications systems. They feature complete uniformity of characteristics and reliable performance by maintaining extremely tight manufacturing tolerances, both physically and electrically. A 30-page booklet describing the transistors and containing information on the theory and circuitry of the devices is available.

### TRIODE-PENTODE for use in color tv

RADIO CORP. OF AMERICA, Harrison, N. J. The 6AN8 is a general-purpose, multiunit tube of the 9-pin miniature type containing a medium-mu triode and a sharp cut-off pentode in one envelope. It is in-

# THEY'VE BOTH BEEN TO 3,000 JOINTS

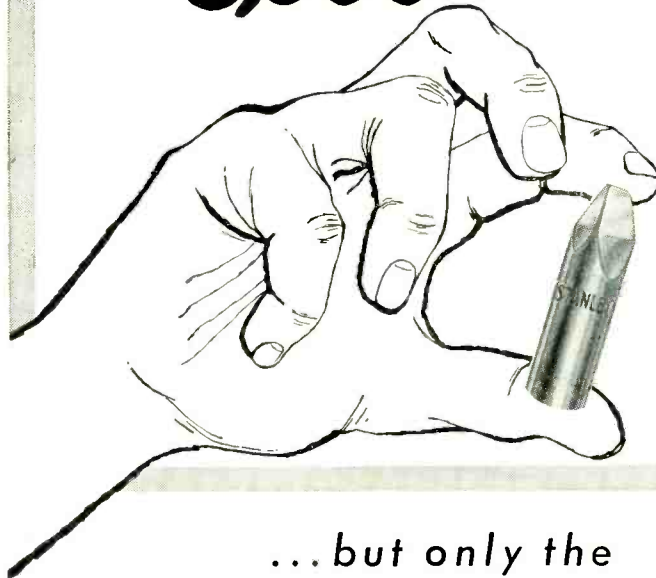

COPPER TIP

...but only the  
**STANLEY ARMOR CLAD**  
soldering tip is ready for more.

These two tips started useful life together on the same soldering tip is through. The Stanley Armor production line. 3,000 joints later all Clad, however, is ready for more.

This is only one reason why Stanley Armor Clad Soldering Tips belong on your irons. Here are some others:

1. Saves money on overall cost.
  2. Saves time on maintenance — no filing — 1/10 the tip changing.
  3. Better work from uniform tip length and unvarying heat.
  4. 41 sizes and shapes — screw or plug type — to fit all kinds of electric soldering irons.
- P.S. Stanley Electric Soldering Irons now available with replaceable heating element.



Call your Industrial Supply Distributor for Armor Clad Tips, or write Stanley Tools, 108 Elm Street, New Britain, Conn. Your name and address plus "Armor Clads" on a postcard will bring you a 36-page booklet — "Expert Soldering" by return mail. We'll include a folder showing the complete line of Stanley Armor Clad Soldering Tips and Electric Soldering Irons. Do it today.

THE TOOL BOX OF THE WORLD

# STANLEY

# Tools

A Division of The Stanley Works

HARDWARE • ELECTRIC TOOLS • STEEL STRAPPING • STEEL



Ruggedized  
and aged

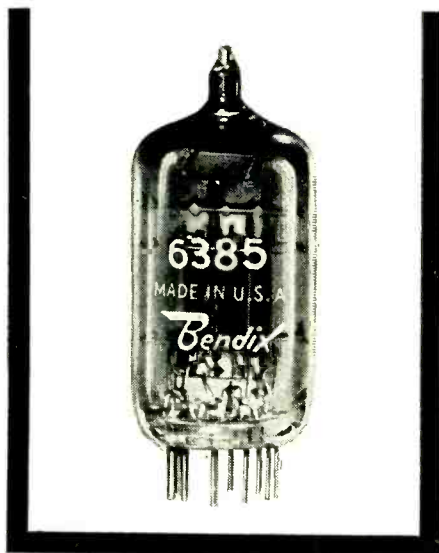

## "RELIABLE" DOUBLE TRIODE

Do you have an aircraft or industrial application that requires *utmost* dependability in increasing or controlling alternating voltages or powers . . . in changing electrical energy from one frequency to another . . . or in generating an alternating voltage?

If so, specify the Red Bank RETMA 6385 "Reliable" Double Triode. For it is specially ruggedized to perform at top efficiency longer, even under operating conditions of severe shock and vibration. And, as further assurance of its extra reliability, each RETMA 6385 is factory-aged with a 45-hour run-in under various overload, vibration and shock conditions, such as it might meet on the job.

Whether you need tubes as amplifiers, mixers, or oscillators, it will pay you to investigate the superior, longer-lasting performance qualities of the Bendix Red Bank RETMA 6385.

### RATINGS\*

Heater voltage—(AC or DC)**	6.3 volts
Heater current	0.50 amps.
Plate voltage—(max.)	360 volts
Max. peak plate current (per plate)	25 ma.
Max. plate dissipation (per plate)	1.5 watts
Max. peak grid voltage	+ 0 volts
	-100 volts
Max. heater-cathode voltage	300 volts
Max. grid resistance	1.0 megohm
Warm-up time	45 sec.
(Plate and heater voltage may be applied simultaneously.)	

\*To obtain greatest life expectancy from tube, avoid designs where the tube is subject to all maximum ratings simultaneously.

\*\*Voltage should not fluctuate more than  $\pm 5\%$ .

### PHYSICAL CHARACTERISTICS

Base	Miniature button 9-pin
Bulb	T-6 $\frac{1}{2}$
Max. over-all length	2 $\frac{3}{4}$ in.
Max. seated height	1 $\frac{1}{4}$ in.
Max. diameter	$\frac{7}{8}$ in.
Mounting position	Any
Max. bulb temp.	160°C

### AVERAGE

#### ELECTRICAL CHARACTERISTICS

Heater voltage, $E_h$	6.3 volts
Heater current, $I_h$	0.50 amps.
Plate voltage, $E_b$	150 volts
Grid voltage, $E_c$	-2.0 volts
Plate current, $I_b$	8.0 ma.
Mutual conductance, $g_m$	5000 $\mu$ mhos
Amplification factor, $\mu$	35
Cut-off voltage	-10 volts
Direct interelectrode capacitances (no shield)	
Plate-grid (per section)	1.7 $\mu$ f
Plate-cathode (per section)	1.1 $\mu$ f
Grid-cathode (per section)	2.4 $\mu$ f
Plate-plate	0.1 $\mu$ f



tended for diversified applications in color tv receivers. The triode unit with its relatively high zero-bias plate current is useful in low-frequency oscillator, sync-separator, sync-clipper and phase-splitter circuits. The pentode unit with its high transconductance may be used as an i-f amplifier, video amplifier, age amplifier and reactance tube. The basing arrangement and internal construction are designed so that coupling between the triode unit and the pentode unit is virtually eliminated.

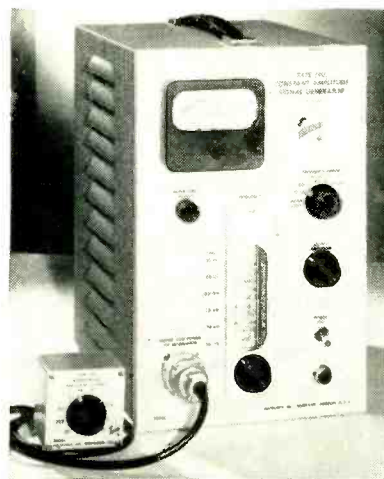

### SIGNAL GENERATOR is constant-amplitude type

TEKTRONIX, INC., P.O. Box 831, Portland 7, Oregon. Type 190 constant-amplitude signal generator generates sine waves in the frequency range of 350 kc to 50 mc. Output amplitude varies less than 2 percent from 350 kc to 30 mc; less than 4 percent from 30 mc to 50 mc. Frequency is continuously variable in 6 ranges, with frequency indication accurate within 2 percent. Output amplitude is continuously variable from 4 mv to 10 v peak-to-

**Bendix**  
Red Bank

Manufacturers of Special-Purpose Electron Tubes, Inverters, Dynamotors and Fractional HP D. C. Motors

DIVISION OF



EATONTOWN, N. J.

West Coast Sales and Service: 117 E. Providencia, Burbank, Calif.  
Export Sales: Bendix International Division, 205 E. 42nd St., New York 17, N. Y.  
Canadian Distributor: Aviation Electric Ltd., P.O. Box 5102, Montreal, P.Q.



peak in 10 ranges, with amplitude indication accurate within 10 percent. Output impedance is 52 ohms. The unit is convenient for checking the high-frequency response of video amplifiers.



**ANALOG COMPUTER is a self-contained unit**

MID-CENTURY INSTRUMATIC CORP., 611 Broadway, New York 12, N. Y. The MC-400 is a portable, highly accurate (0.1 percent) analog computer designed to meet the requirements of a laboratory test instrument or of a mathematical machine for the solution of differential equations. It consists of 12 chopper-stabilized amplifiers and 16 ten-turn potentiometers for handling linear operations, and 4 vacuum-tube diodes, 2 relay amplifiers, and 1 servo for simulating nonlinear performance. Dimensions are 52 in. x 24 in. x 27 in. The unit is completely self-contained. It has been applied to a wide variety of problems, the results of which are available on request.

**METER CASE with built-in stand**

TRIPLETT ELECTRICAL INSTRUMENT Co., Bluffton, Ohio, has available a Neolite case to house its three models of volt-ohm-milliammeters, numbers 630, 630-A and 630T. The

**Now a NEW**  
**"Pencil Point" SOLDERING TOOL**  
 FOR SMALL OR MINIATURE WORK

**IDEAL Thermo-Tip**

**INSTANT HEAT—  
 PINPOINT ACCURACY!  
 NOTHING TO HOLD  
 BUT AN ELECTRODE  
 "PENCIL"**

Tips Screw In to Fit the Job  
**DOUBLE METALLIC**  
**DOUBLE CARBON**

Other Tips Available

**Pencil-Thin  
 FOR EASIER, FASTER SOLDERING OF:**

- Electronic Circuits and Parts
- Aircraft Connectors
- Pin Type Plugs
- Wire-to-Wire
- Terminals
- Radio and TV Chassis
- Instruments
- Printed Circuits

Here is an all-new production tool expressly designed to make small and miniature soldering simpler and surer than ever before. It is so fast that some joints can now be soldered in less than 1 second! . . . so much lighter and easier to handle than soldering irons or guns that a woman can use it all day long without fatigue! Check this unique combination of features against your job requirements:

- GETS INTO SMALL, TIGHT SPOTS** because of smaller electrode pencil.
- NO HEAT DAMAGE**—instant resistance heating makes sound joints before resistors, condensers, printed circuits, terminal fibre, etc., can be damaged. Pinpoints the heat!
- NO "COLD FLOW JOINTS"**—resistance principle *requires* that metal be heated before the solder will flow. Tap switch adjust heat as needed.
- SAFE**—soldering pencil uses harmless (6v) voltage and high amperage from separate step-down transformer.
- LESS FIRE HAZARD**—electrodes are hot only when in use.
- LESS REPLACEMENT COST**—only low cost electrodes to buy.

**TIPS FOR EVERY SMALL JOB**  
 —2 sizes of double carbon, single carbon with ground clamp, double metallic. May also BE USED AS SOLDERING IRON  
 —two sizes of chisel tip irons.

**MAIL FOR FURTHER DATA**

**SOLD THROUGH LEADING DISTRIBUTORS**

**IDEAL INDUSTRIES, Inc.** **1055 Park Avenue, Sycamore, Illinois**

Please send catalog data on **NEW IDEAL THERMO-TIP.**

NAME.....

COMPANY.....

CITY.....ZONE...STATE.....

ADDRESS.....

# NEW DUAL PURPOSE R-F NOISE FILTER

Handles Equipment Susceptibility and  
R-F Noise Problems in a Single Package

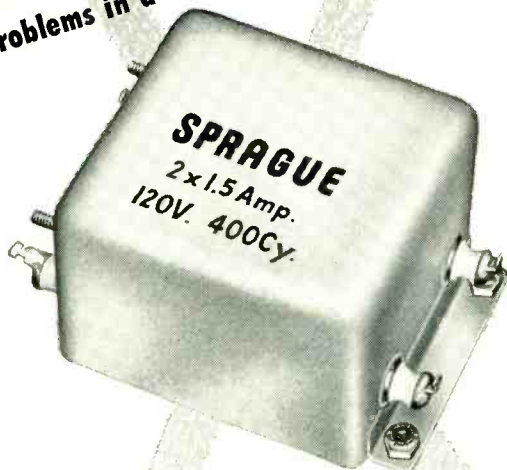

Is the equipment which you are designing susceptible to malfunctioning caused by r-f currents conducted through power lines? Will your equipment interfere with other equipments operated off the same power line?

A prominent electronics manufacturer facing these problems called on Sprague for help with r-f test equipment which was already in production. Specifications for a single filter to do both jobs were established by the manufacturer's engineers working closely with Sprague Field Engineers. The required insertion loss characteristics were set at more than 60 db from 14 to 40 kc and more than 80 db from 40 kc to 200 mc; line voltage drop was limited to one volt max. at 1.5 amperes at 400 cycles.

Sprague engineers designed this "impossible" dual circuit line filter in a case only  $3\frac{1}{8}'' \times 2\frac{7}{8}'' \times 2\frac{1}{8}''$ ! This filter not only outperforms units previously designed by others in efforts to solve the problem but also occupies only two-thirds the cubic space.

Once a custom-tailored design such as this has been completed and accepted by a Sprague customer, either production quantities or small runs are readily supplied with equal facility.

Let Sprague help you with your radio interference problems without obligation on your part. Write, wire, or phone the Sprague Electric Company, 11325 Washington Blvd., Culver City, California (TEexas 0-7491) or North Adams, Massachusetts (MOhawk 3-5311).

YOU CAN DEPEND ON

# SPRAGUE

The Sprague Electric Company  
is the World's Largest  
Capacitor Manufacturer.



case is constructed with a built-in stand that rests the unit at a convenient 45-deg angle when in use. It also has a back compartment that contains sufficient room to store an instruction book, leads, the stand and small tools. For carrying, the case has a firm handle.

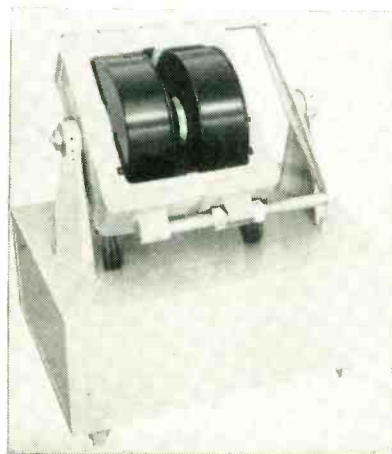

## LAB ELECTROMAGNET is multipurpose unit

VARIAN ASSOCIATES, Palo Alto, Calif. A remarkable range of field values and configurations is featured in the 6-in. model V-4007 multipurpose laboratory electromagnet. It features changeable pole caps for uniform or high field work, an adjustable gap that provides a gap range from  $\frac{1}{4}$  in. to 6 in. and a dolly mount that gives complete mobility without loss of rigidity in operating positions. The magnet yoke angle can be easily changed to provide a variety of positions for working access. Precise machining and accurate alignment assure a high degree of field uniformity. Also announced is a matching model V-2200 regulated magnet power supply that provides



highly stable d-c for operation of the V-4007 electromagnet.

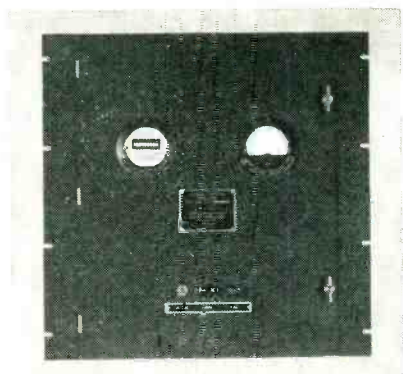

**POWER SUPPLY is frequency stabilized**

MARYLAND ELECTRONIC MFG. CORP., College Park, Md., has solved the problem of operating electrical devices requiring a very accurate source of 60-cycle power. The unit illustrated is the type M-2027 50-w frequency stabilized power supply. Electrical characteristics are: input frequency range, 50 to 70 cycles; power input, 655 v-a; output impedance, 1,000 ohms; output voltage, 115 or 230 v.

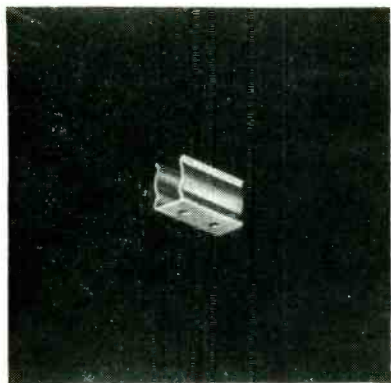

**COMPONENT HOLDER made of spring steel**

ATLAS E-E CORP., Bedford Airport, Bedford, Mass., has developed a new component holder for holding tubular capacitors, one and two-watt resistors, miniature and sub-miniature tubes. It is designed to provide superior rigid mounting for conditions of heavy shock and vibration where space is limited as in airborne electronic apparatus and guided missiles. Made of cadmium-plated spring steel, the component holder provides a 180-deg contact surface—against a normal

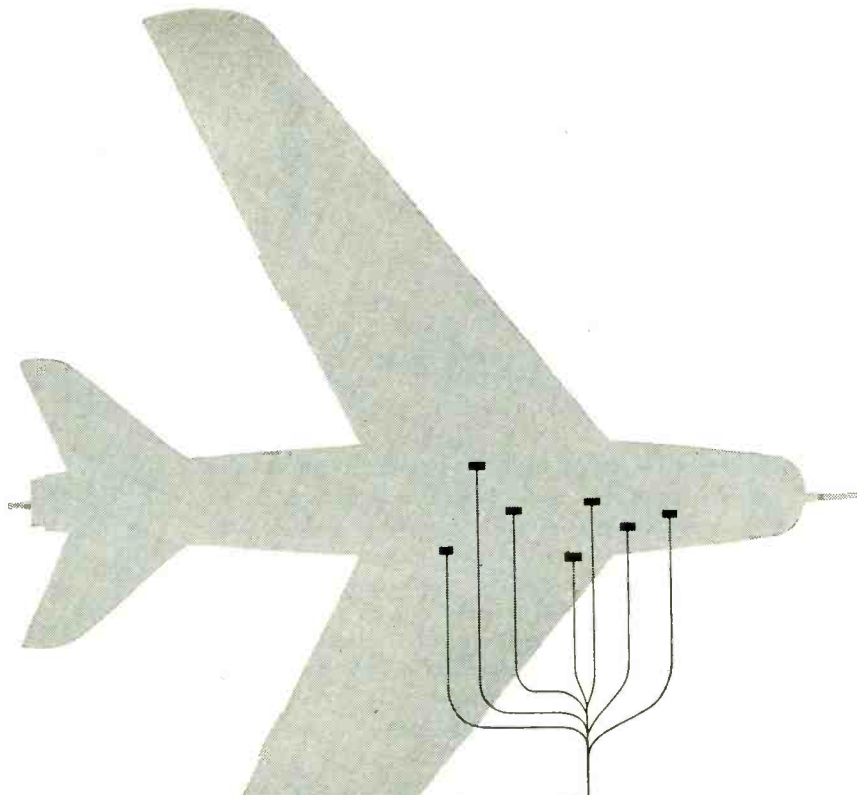

**SERVOS** make flight safe!

Miniaturized muscle men perform exacting control tasks on signal from electronic amplifiers!

Another example of Oster precision quality motors for avionics and for other closed-loop control systems.

Oster Avionic Products conform to military specifications for altitude, high and low temperature, life, shock, vibration, humidity, fungicidal treatment and salt spray.

You can depend on Oster quality in rotating components for automatic control.



Lightweight Oster Motor type 2W-2084 delivers 1/500 H.P. @ 6500 RPM on 24 to 29 volts DC. Suitable for push-pull, plate to plate operation. This motor will fill your needs in computer, fire control, and autopilot systems.

Insure dependability . . . specify Oster



Other OSTER Avionic Products include:

- Special motors: Servos, Synchros, Drive Motors, Blowers and Fans.
- Synchro generators, control transformers, transmitters, differentials, receivers and resolvers. Two-speed synchros and reference generators.
- Tachometer generators.
- Aircraft actuators, both linear and rotary.

- MECHANICAL ENGINEERS
- ELECTRONICS ENGINEERS
- ELECTRICAL ENGINEERS
- X-RAY ENGINEER
- PHYSICISTS
- AERODYNAMICISTS
- MATHEMATICIANS

**WORK** ON THE FRONT LINE OF THE NATION'S VITAL DEFENSE PROGRAM. Sandia Corporation is engaged in the development and production of atomic weapons—a challenging new field that offers opportunities in research and development to men with Bachelor's or advanced degrees, with or without applicable experience. Here you can work with able colleagues, eminent consultants and superior facilities on advanced projects of high importance — and also build a permanent career in a rapidly expanding field with a company that recognizes individual ability and initiative.

**LIVE** IN ALBUQUERQUE, THE HEART OF THE SUNNY SOUTHWEST. Located in the historic Rio Grande Valley at the foot of the Sandia Mountains, mile-high Albuquerque is famous for its climate—mild, dry and sunny the year around. A modern, cosmopolitan city of 150,000, Albuquerque offers unique advantages as a place in which to live. Albuquerque's schools, churches, theaters, parks, and modern shopping facilities afford advantages of metropolitan life—yet hunting, fishing, skiing and a multitude of scenic and historic attractions may all be found within a few hours' drive of the city. New residents have little difficulty in obtaining adequate housing.

**ENJOY** THESE OTHER IMPORTANT ADVANTAGES. These are permanent positions with Sandia Corporation, a subsidiary of the Western Electric Company, which operates Sandia Laboratory under contract with the Atomic Energy Commission. Working conditions are excellent, and salaries are commensurate with qualifications. Liberal employee benefits include paid vacations, sickness benefits, group life insurance, and a contributory retirement plan. This is not a Civil Service appointment.

*Make Application to:*

PROFESSIONAL EMPLOYMENT  
DIVISION C

**SANDIA**  
*Corporation*

SANDIA BASE • ALBUQUERQUE, NEW MEXICO



120 deg in most clips—the full length of the component. It comes in the following component diameter sizes: 0.175 in., 0.195 in., 0.235 in., 0.261 in., 0.312 in., 0.375 in., 0.390 in., 0.400 in., 0.562 in., 0.670 in., 0.750 in., 1.00 in. and 1.125 in. with lengths to 2 in.



### MOUNTING BRACKETS for E-Z release connectors

DEJUR-AMSCO CORP., 45-01 Northern Blvd., Long Island City 1, N. Y. Black anodized die cast aluminum precision mounting brackets are now available for Continental's series EZ16 easy release connectors. These brackets provide a simple, economical means for mounting the connectors while insuring the free floating action that is necessary to take advantage of the connector's self-aligning feature.

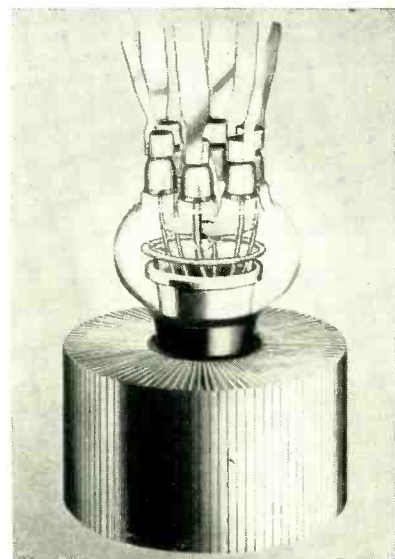

### POWER TRIODES with 3 and 6-kw output

FEDERAL TELEPHONE AND RADIO CO., 100 Kingsland Road, Clifton, N. J., has introduced two new 3 and 6-kw



output power triodes for use in new equipment designed for the electronic heating, broadcasting and communications fields. The F-6366 is a three-electrode industrial oscillator with 3-kw output and filament characteristics of 11 v, 29 amperes. The F-6367 is a three-electrode 6-kw tube designed for use as a modulator, amplifier and oscillator and having a filament voltage of 13 v and filament current of 36 amperes. Both tubes feature thoriated tungsten helical-type filaments and kovar grid and filament seals, contributing to ruggedness and more dependable operation. Maximum d-c plate voltage ratings of 5,500 v for the F-6366 and 6,200 v for the F-6367 apply up to 30 mc.

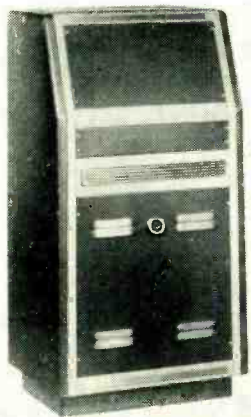

**EMCOR SYSTEM**  
of electronic enclosures

THE ELGIN METALFORMERS CORP., Elgin, Ill., has introduced a new standard line of flexible enclosures designed to meet custom requirements at up to one-fifth the cost of custom construction. The new line, known as the EMCOR system, is designed to meet specific requirements wherever medical, computing, research, integration, transmission, supervisory data, remote facsimile, radio and tv control equipment requires an enclosure, group of enclosures or complete control system. Construction is of heavy-gage steel. The system consists of a basic console assembly frame—21 in. wide × 48 in. high × 21 in. deep—with standard RETMA and WE mounting holes on entire front, top and back. Over 80 lineal inches of insert panel space is available over frame. Provision is made

*NOW...the new*

**CANNON**  
**AN-"E"**  
**PLUGS**

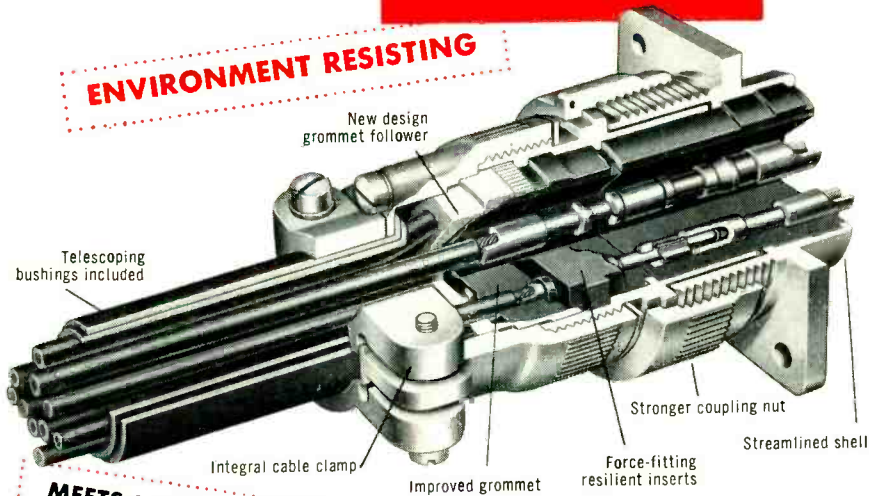

**ENVIRONMENT RESISTING**

**MEETS LATEST MILITARY SPECIFICATIONS**

**Streamlined Shell**  
Approximately 25% lighter than previous design.

**Stronger Coupling Nut**  
Improved strength features.

**New Grounding Lugs**  
Integral; convenient.

**Integral Cable Clamp**  
Space saving, fewer parts.

**New, lighter polychloroprene... or**  
Cannon's new exclusive premium Silcan 63, optional, featuring resilience, increased tensile strength, and long-lasting dimensional stability.

**Closed-entry socket contacts**, machined from solid high-conductivity copper alloys, silver-plated; hand tinned solder pots.

**Telescoping Bushings**  
Standard Equipment

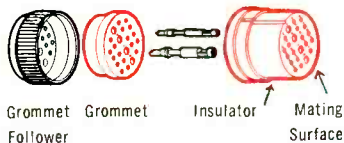

**No moisture condensation trap**

The Cannon AN-"E" Connector grommet provides positive seal against the rear of the resilient insulator. Mating surfaces of resilient insulators of connectors are sealed by compressing the insulators 3/32" during mating.

AN-"E" Connectors have **3 times the flashover** value of similar connectors, sealed.

An important feature for high altitude and other applications.



AN3108E Plug mated with AN3102E Receptacle

**Moisture proof!**  
**...Vibration resisting!**  
**...Resilient insulation!**

Just what you've been waiting for!

The new high-quality, streamlined, simpler, smaller, and lighter Cannon AN-"E" meets today's military specifications (MIL-C-5015A ASG) with improved connector performance. *Completely sealed from cable to cable.* A multi-service unit designed to meet your moisture condensation, flashover, corona, and vibration problems.

Write for "AN-E" Bulletin... **TODAY!**

Refer to Dept. 120

CANNON ELECTRIC COMPANY, 3209 Humboldt St., Los Angeles 31, California. Factories in Los Angeles; East Haven; Toronto, Canada; and London, England. Representatives and distributors in all principal cities.



**CANNON ELECTRIC**

**THE SYMBOL OF**  
**Quality**  
**IN TRANSFORMERS**



**dollars**  
**AND**  
**sense...**

Triad quality costs no more, and those who buy Triad transformers get what they pay for.

Superior design—finer materials—precise workmanship—distinctive appearance—continuous and unfailing service. All these contribute to the recognized value of Triad products.

Industry expects and gets—from Triad—the finest transformers made.

Triad Transformers are sold by select jobbers in principal cities. Write for Catalog TR-53G.



4055 Redwood Ave., Venice, California



**NEW PRODUCTS**

(continued)

for ease of wire installation via standard knockouts distributed over top shelf, base and side of unit. Provision is also made for a key, jack and auxiliary control panel.

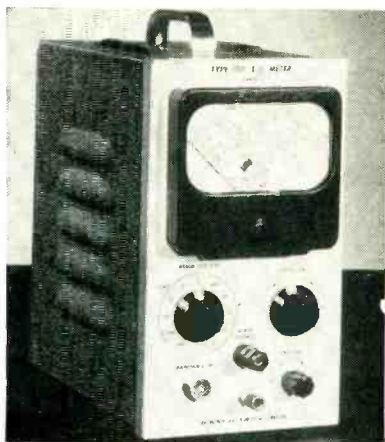

**METER**  
for small-value readings

TEKTRONIX, INC., P. O. Box 831, Portland 7, Oregon. Type 130 LC meter is a direct-reading unit for small values of inductance and capacitance in components and circuits. It has 5 ranges: 0 to 3, 0 to 10, 0 to 30, 0 to 100, and 0 to 300  $\mu$ h or  $\mu$ f, accurate within 5 percent of full scale. It features coarse and fine zero-adjust controls and an illuminated 4-in. meter. The type 130 is also convenient for component testing, sorting and color code checking on a production basis. Weight is 9 lb.

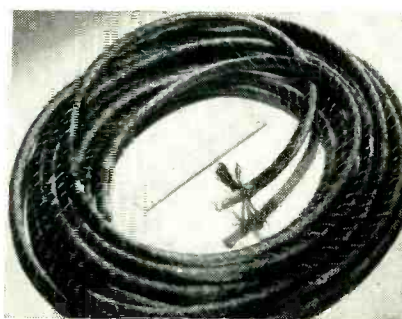

**H-V L-F LITZ CABLE**  
for 20 to 400-kc region

U. S. PLASTIC ROPE Co., 2581 Spring St., Redwood City 10, Calif. Specialized Litz cables for applications of high voltage in the 20 to 400-kc region are being wound on dielectric cores of rope-like construction,

**OPTICAL SYSTEMS**

**INDUSTRIAL PERISCOPES**

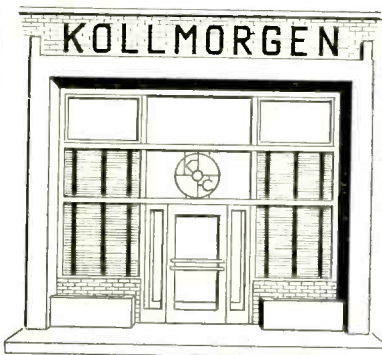

**DESIGN**  
**DEVELOPMENT**  
**MANUFACTURE**

For nearly half a century Kollmorgen has designed, developed and manufactured precision optics and optical systems for industry and the military.

We have the engineering "know-how", the design personnel and the manufacturing capacity to help you solve your optical problem.



Plant: 347 King Street • Northampton, Mass.

New York Office  
30 Church Street  
New York 7, N. Y.

Want more information? Use post card on last page.

April, 1954 — ELECTRONICS



formed from a variety of plastic films. Diameter limitations of the production equipment are  $\frac{1}{8}$  in. core diameter minimum, 2 in. maximum. Typical cables produced have included copper conductors of 33 and 38 gage laid on the core with a spiral of 3 turns per ft. A maximum of 125 multiconductor strands can be applied. Conductors of Nylon-enamel insulated wire can be made individually continuous to very rigid specification requirements.

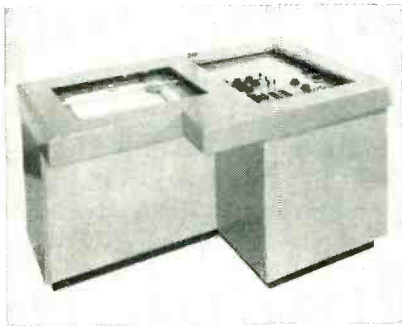

### ELECTROPLOTTER is $\pm 0.1$ percent accurate

BENSON-LEHNER CORP., 2340 E. Sawtelle Blvd., West Los Angeles 64, Calif., has available the new Electroplotter that plots on any type paper up to 11 in.  $\times$  17 in. from a variety of input data such as analog or digital computers, punched card machines or manual keyboard. In the latter case, a high speed 10-key keyboard with numerical verifier provides for plotting rates at about 35 points per minute. Pen traversing speed is 18 inches per second. Accuracy is  $\pm 0.1$  percent. The plotter has several special features among which are automatic symbol printing, independent zero and scale controls for each axis, selectable incremental advance when required and vacuum table for holding paper.

### A-C GENERATOR is wind turbine driven

HOLTZER-CABOT TELEPHONE EQUIPMENT DIVISION of National Pneumatic Co., Inc., 125 Amory St., Boston 19, Mass. A new wind turbine-driven generator serves as

# VHF

... Very High Frequencies



## • RADIO INTERFERENCE • and FIELD INTENSITY \* • measuring equipment

## • Stoddart NM-30A • 20mc to 400mc • Commercial Equivalent of AN/URM-47

PRINTED CIRCUITRY... Modern printed circuits offer many advantages over conventional wiring, lighter weight, more compact units and freedom from many of the troubles normally encountered in conventionally-wired electronic equipment. Vibration becomes even less of a problem with printed circuits, adding to the many portable features already available with Stoddart equipment.

ADVANCED DESIGN... Specialized engineering and modern production techniques have produced one of the most advanced instruments for the accurate measurement, analysis and interpretation of radiated and conducted radio-frequency signals and interference ever manufactured. Designed to laboratory standards, rugged, and with matchless performance, the versatile NM-30A is an outstanding example of modern instrumentation. Its frequency range includes FM and TV bands.

SMALLER SIZE... A wider frequency range and higher standard of performance is incorporated into an equipment whose size is one-third that of any similar equipment ever manufactured.

SENSITIVITY... Sensitivity ranges from one to ten microvolts-per-meter, depending upon frequency and antenna in use.

APPLICATIONS... Field intensity surveys, antenna radiation pattern studies, interference location and measurement for checking radiation from virtually any mechanical or electrical device capable of generating or radiating radio-frequency signals or interference.

Stoddart RI-FI\* Meters cover the frequency range 14kc to 1000mc

#### VLF

NM-10A, 14kc to 250kc  
Commercial Equivalent of  
AN/URM-6B. Very low frequen-  
cies.

#### HF

NM-20B, 150kc to 25mc  
Commercial Equivalent of  
AN/PRM-1A. Self-contained  
batteries. A.C. supply optional.  
Includes standard broadcast  
band, radio range, WWV, and  
communications frequencies.  
Has BFO.

#### UHF

NM-50A, 375mc to 1000mc  
Commercial Equivalent of  
AN/URM-17. Frequency range  
includes Citizens band and  
UHF color TV band.

**STODDART AIRCRAFT RADIO Co., Inc.**  
6644-A Santa Monica Blvd., Hollywood 38, California • Hollywood 4-9294

# Koiled Kords\* permit EASY SERVICING of In-a-Door or Sliding Units...

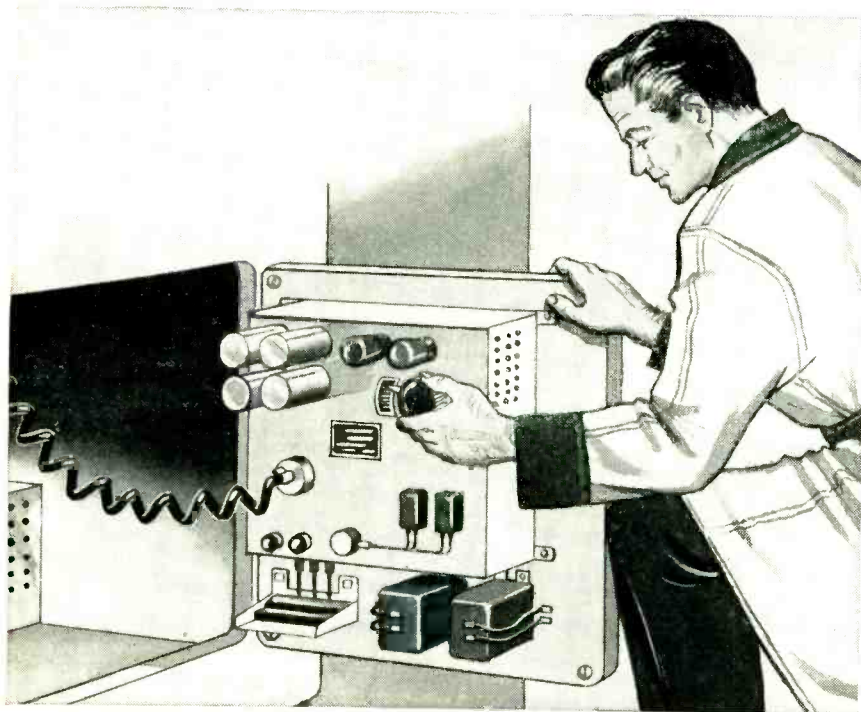

A six inch section of KOILED KORDS retractile cord will extend to more than two feet when pulled and when released will retract immediately to its original neat, compact, spring-like shape. KOILED KORDS solve the problem of carrying current to movable units without having a long trailing cord to foul in the mechanism. They make it possible to retain electrical contact between units when they are pulled out for servicing, facilitating trouble location and correction.

KOILED KORDS extend as needed without looping, dangling or tangling.

KOILED KORDS are compact, neat, attractive, built to withstand continued flexing.

KOILED KORDS are available on special order to your specifications in multi-conductor types up to 37 conductors. Stocked types include 2, 3, 4 and 5 conductor #23 AWG communications cords and 2, 3 and 4 conductor Underwriters' Laboratories approved SO, SJO and SV-neoprene jacketed power cords. KOILED KORDS can be supplied in 48 inch mandrel lengths or prepared into cord sets for attachment to equipment.

WRITE FOR KOILED KORDS APPLICATION BULLETIN SHOWING MANY USES.

# Koiled Kords

INCORPORATED

Box K, New Haven 14, Conn.

\*KOILED KORDS is the trademark of Koiled Kords, Inc.

NEW PRODUCTS

(continued)

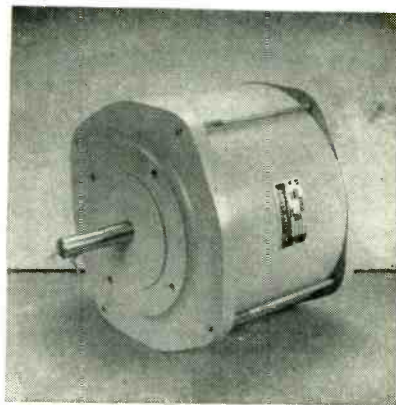

a source of power for use with transistors in unattended microwave relay stations. It meets power output requirements—based on operation of the generator in a wind velocity of 5 mph—of 1 w, 50 cycles, at 100 rpm. Equipped with heavy-duty sealed ball bearings, the generator is built in a 9 in. diameter frame to permit the mounting of a wind turbine on the generator and bell. Although of permanent-magnet construction, the advanced design eliminates cogging, and starting torque is held to within 4 oz-in.



## TWISTED TAB CONTROL features economy in cost

CLAROSTAT MFG. CO., INC., Dover, N. H., has announced the series 47 twisted tab control that eliminates the usual bushing, lockwasher and nut, thus effecting marked economy in the cost of the control. The unit is mounted by inserting the tabs through slots in panel or chassis, and twisting them to secure the control in place. The control is available with or without switch, in resistance values from 500 ohms to 5 megohms; 0.5-w rating; choice of tapers and taps; and all types of metal or plastic shafts, including,



if desired, a rear protruding slotted shaft.

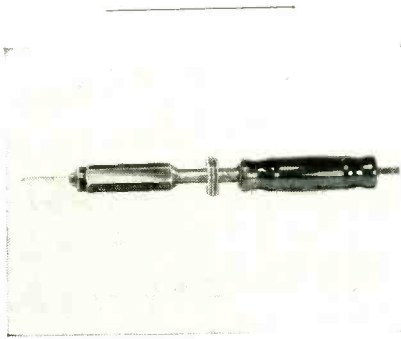

### SOLDERING IRON for fast production lines

HEXACON ELECTRONIC Co., 130 W. Clay Ave., Roselle Park, N. J., has added to its line an electric soldering iron for use on fast production lines where greater soldering speed is required from an iron with a small-tip diameter, and where lower tip replacement cost is a factor. The new iron is plug-tip type, rated at 100-w, but with  $\frac{1}{4}$ -in. tip instead of the conventional  $\frac{3}{8}$ -in. diameter tip. It reaches and maintains a temperature considerably beyond the 100-w  $\frac{3}{8}$ -in. tip iron and its large reservoir of heat speeds the soldering operation. Because less copper is used there is a saving of more than 50 percent in the tip replacement cost.

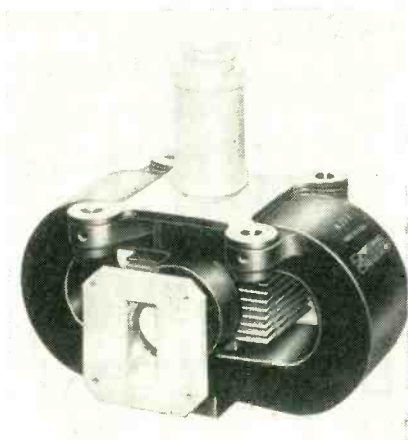

### MAGNETRON uses new techniques

MICROWAVE ASSOCIATES, INC., 22 Cummington St., Boston 15, Mass. The 4J52 magnetron used in airborne radar equipment has been redesigned to incorporate several

THE ONLY



COMPLETE LINE OF



GENERATING & TESTING EQUIPMENT



FOR

COLOR TV

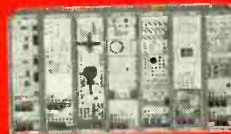

In color TV instrumentation, one name stands out — TELECHROME. No wonder, for only TELECHROME has had more than three years of experience producing Color TV generating, testing and broadcasting equipment for America's foremost TV manufacturers, broadcasters and laboratories.

Complete equipment for generating color bars; creating encoded and composite pictures from transparencies; color signal certification; transmission, reception, monitoring, and analysis of color pictures — literature on these and more than 100 additional instruments for color TV by TELECHROME are available on request.

DELIVERY 60 DAYS

The Nation's Leading Supplier of Color TV Equipment  
88 Merrick Road Amityville, N. Y.  
AMITYVILLE 4-4446

## STOP RF LEAKAGE ON THE DRAWING BOARD

... WHEN YOU DESIGN METEX ELECTRONIC WEATHERSTRIPPING INTO YOUR EQUIPMENT YOU GET ITS POSITIVE SHIELDING EFFECTIVENESS — AT MAXIMUM OVERALL ECONOMY

Plan now to take full advantage of *Metex Electronic Weatherstripping's* unusual effectiveness in shielding all types of electronic equipment. Because it is made of knitted wire mesh, *Metex Electronic Weatherstripping* is both conductive and resilient. It assures positive metal-to-metal contact between all mating surfaces. And being resilient it accommodates itself positively to surface inequalities.

In reality, *Metex Electronic Weatherstripping* can do more for you than just shield RF leakage. It can cut the cost of machining mating surfaces to close tolerances. It can eliminate the need for extra fasteners and many other costly means of making joints RF tight.

To get the best results and lowest production costs, design with *Metex Electronic Weatherstripping*, available in 3 basic forms:

- 1 Continuous lengths in various cross sectional shapes with or without fin for attachment.
- 2 Die-formed shielding gaskets, and
- 3 Sealing gaskets where the knitted wire gasket is combined with a sealing medium.



For detailed information on METEX ELECTRONIC PRODUCTS, write for FREE copy of "Metex Electronic Weatherstrips" or outline your SPECIFIC shielding problem — it will receive our immediate attention.

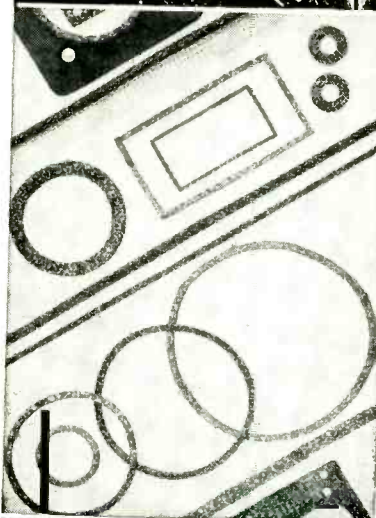

### METEX ELECTRONIC WEATHERSTRIPPING

For shielding on all types of electronic and electrical equipment

Each of these is made in various sizes and shapes which are readily adaptable to practically any equipment. The resiliency can be varied where necessary to meet specific requirements.

Applications in which *Metex Electronic Weatherstripping* has already proved its effectiveness include pulse modulator shields, waveguide choke-flange gaskets, local oscillators on TV sets, dielectric heaters, etc.

new improvements while retaining physical and electrical interchangeability. For improved stability and life under all conditions, particularly with long pulses, the oxide-coated cathode has been replaced by the new Philips dispenser-type cathode. This cathode is fabricated from tungsten impregnated with barium aluminate and is practically indestructible operating over a wider temperature range than the oxide type. A bifilar winding heater is used reducing tube noise. All of the glass in the tube being replaced by ceramic allows the tube to be baked out at considerably higher temperatures, insuring gas-free operation throughout life in addition to increasing its mechanical strength. The anode is of strap-vane type, known to be very reliable under steep pulse conditions. The waveguide output transformer of the tube has been designed for the center of anticipated load conditions.



### CRYSTAL is hermetically sealed

JAMES KNIGHTS Co., Sandwich, Ill., has introduced a new crystal in its G-9 series, available with flexure mode crystals from 4 to 80 kc. The new crystal provides rugged, precise frequency control at temperatures in the -40 to +70 C range. The crystals have a high ratio of capacities ( $C_0/C$ ) resulting in a high degree of isolation from associated circuitry. This unit provides a practical means of close frequency control in a range not cov-

## METAL TEXTILE CORPORATION

KNITTERS OF WIRE MESH FOR MORE THAN A QUARTER CENTURY

Roselle, New Jersey



Want more information? Use post card on last page.

April, 1954 — ELECTRONICS



ered by any other single type of crystal. The crystals are hermetically sealed in an evacuated glass holder for maximum protection and freedom from contamination to assure that their precise frequency accuracy will be maintained.

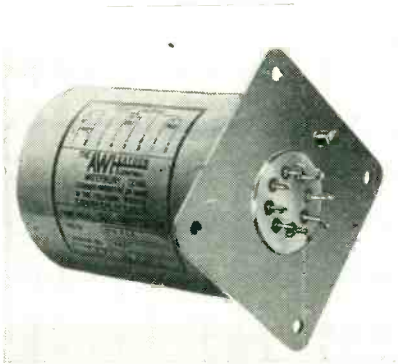

**TIME DELAY RELAY is hermetically sealed**

THE A. W. HAYDON Co., 232 N. Elm St., Waterbury, Conn., has in production a new line of hermetically sealed time-delay relays. Designed to take up less space than previously required, they can be supplied with 50, 60 or 400 cycle a-c or governed or standard d-c motors. Close accuracy and low power consumption are featured. The unit is enclosed in a lightweight aluminum hermetic housing, 2½ in. in diameter. Basic length for a single switch unit is 2⅞ in. Governed or filtered motors, special or extra switches increase this dimension slightly. Three-stud or flange mounting is available. Electrical connection can be made with a glass seal header or AN connector. Weight of the unit is about 1 lb.

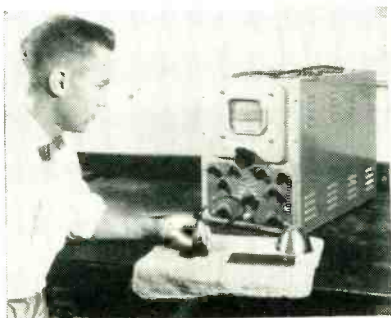

**ULTRASONIC UNIT measures metal thickness**

SPERRY PRODUCTS, INC., Danbury, Conn. A portable, ultrasonic in-

# Why Corning High-Temperature Film-Type Resistors

*are more rugged,  
more stable*

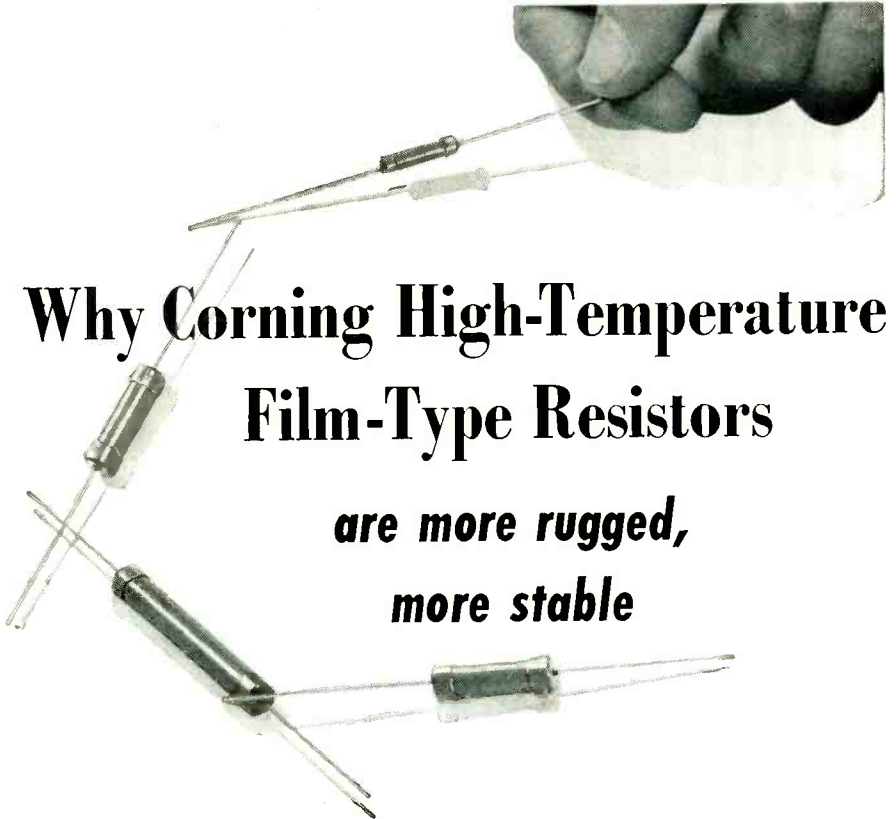

The answer lies in the way we make them. The base material is a special heat-resistant glass that not only has excellent temperature and electrical characteristics but is tough enough to withstand real abuse.

The film material, too, is entirely new for resistors. Fired in at red heat, it becomes an integral part of the glass form. And it's so stable it can be cycled from near absolute zero to red heat with little effect in its electrical properties.

Silver bands are fired in for terminations that have low resistance and low noise characteristics. And silver plated end caps are expansion fitted over the silver terminations to give a silver-to-silver contact that is both electrically and mechanically sound.

Then, a silicone varnish is baked onto the resistor which completely reduces the risk of entrapped moisture, gives better protection against external moisture and humidity and abrasion. The unit can be rubbed with a nail file without materially affecting its electrical characteristics.

It all adds up to this. If you want a high-temperature resistor that's electrically stable, mechanically rugged, then investigate Corning Type S Resistors. They can be operated at ambient temperatures up to 200°C. and at higher power levels to save space. The thin film construction and inherent stability provide excellent high-frequency characteristics. Normal resistance tolerance is 2%.

Get the details by sending the coupon below.

**NEW LOW PRICES**

We've recently made a radical reduction in prices for Corning High-Temperature Resistors. Now you can use them in applications where price was previously prohibitive.



**CORNING GLASS WORKS**

DEPT. EL-4, CORNING, N. Y.

Please send me information on:

- CORNING (High-Temperature) Type S Resistors,  CORNING (Accurate Grade) Type N Resistors,
- CORNING Load Resistors.

Name..... Title.....

Company.....

City..... Zone..... State.....

*Nature Made  
Their Properties...  
Fansteel Made  
Them Practical!*



**TUNGSTEN  
TANTALUM  
MOLYBDENUM**

The valuable properties of tungsten, tantalum and molybdenum usually make it self-evident whenever one of these metals is the best possible material for a given application. However, the most practical and economical method of fabricating parts is a never-ending problem.

Here, at Fansteel, we *make* refractory metals; from raw ore to finished ingot, bar, rod or sheet. In working with hundreds of other engineers on their fabrication problems, we have learned a lot about forming these metals—about stamping, bending, deep drawing, machining, forging, brazing or welding them.

If you use Tungsten, Molybdenum or Tantalum components, we can probably fabricate them for less money than you can—with less rejects, less scrap loss, and with a *fixed* price per unit. We'd like to discuss it with you.

We have some very interesting and informative booklets on Tungsten, Tantalum and Molybdenum. Write for your free copies today.

*Let FANSTEEL insure your cost control of  
refractory metal components*

**Fansteel Metallurgical Corporation**

**NORTH CHICAGO, ILLINOIS, U.S.A.**

42501C

NEW PRODUCTS

(continued)

strument for measuring the thickness of steel sheet where only one surface is available, for checking the continuity of bonds, and for testing raw stock for laminar defects, has been announced. Known as the Reflectogage and using high accelerating voltages and slow sweep speed, it gives visual indications of steel thickness from 0.014 to 0.400 on a flat-face, no-parallax CRT with directly adjacent calibration tape. The tape is made proportional to screen size so as to give maximum reading space and is cranked into position for any one of the six available testing ranges. Tolerance markers appear as a downward square step on the screen baseline and are adjustable in both width and position. Accuracy of readings is protected by a built-in voltage regulator.

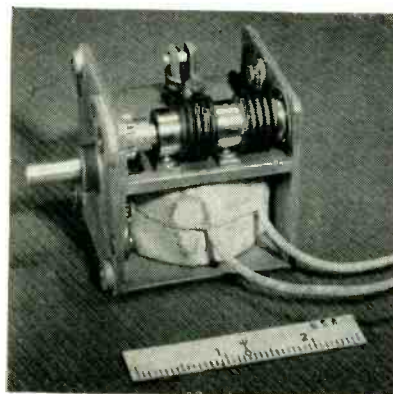

**ELECTRIC MOTOR  
has high starting torque**

THE VIKING TOOL & MACHINE CORP., Two Main St., Belleville 9, N. J., has developed a small electric motor that will be extremely useful wherever low speed, high starting torque is required, such as aircraft actuators, remote controlled rheostats and power switches, and indexing devices of all types. Present models operate on 115 v a-c, but the motor can be provided with different coils for other operating voltages. It will operate efficiently over a wide range of frequencies as well as pulsating d-c. The unit combines the feature of having its starting torque equal to its running torque, with instantaneous stopping when power is turned off. Units are now available delivering over 6 inch-pounds of torque at 30 rpm and operating satisfactorily over a



temperature range of  $-60$  to  $+500$  F.

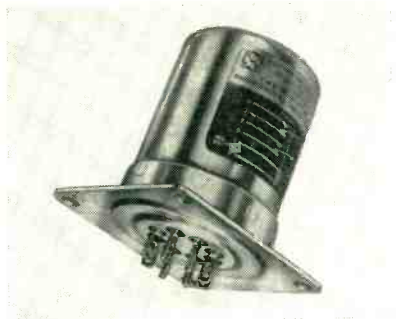

### TINY RELAY exceeds military specs

ELECTRO-MECHANICAL SPECIALTY Co., INC., 6819 Melrose Ave., Los Angeles 38, Calif., has introduced the miniature 10-ampere, dpdt relay. It is designed for quality, dependability and vibration immunity that exceeds military specifications. It is made for adaptability with coil resistance up to 80,000 ohms. The unit will operate over a sensitive range as low as 50 mw to 2 w. Mounting plate is drawn and formed of  $\frac{1}{8}$  in. steel. The relay measures 1.625 in. diameter, 2.187 in. height and 1.856 in. mounting dimension between 2 holes.

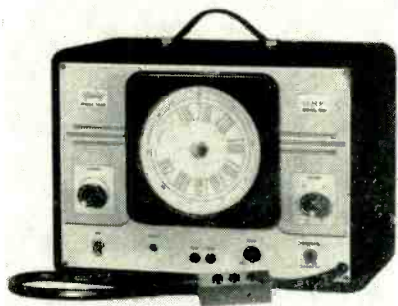

### MARKER GENERATOR and signal generator

THE TRIPLET ELECTRICAL INSTRUMENT Co., Bluffton, Ohio. Model 3436 is a new uhf marker generator and signal generator with the following features: uhf all fundamentals on channels 14 to 83 (470 to 900 mc); no harmonics for confusion; a large dial with uniform frequency graduations; and 13 in. of long easily readable scale. The r-f output average is 0.3 v. Output

# BALLANTINE

## STILL THE FINEST IN ELECTRONIC VOLTMETERS



Ballantine Model 300

### SENSITIVE ELECTRONIC VOLTMETER

Featuring a Logarithmic  
Voltage Scale and  
Uniform Decibel Scale

PRICE... \$210.

- Measures 1 millivolt to 100 volts over a frequency range from 10 to 150,000 cycles on a single logarithmic scale by means of a five decade range selector switch.
- Accuracy: 2% at any point on the scale over the ENTIRE RANGE.
- Input Impedance:  $\frac{1}{2}$  megohm shunted by 30 mmfcs.
- Generous use of negative feedback assures customary Ballantine stability.
- Output jack and output control permit voltmeter to be used as a flat high gain (70DB) amplifier.
- Available accessories permit range to be extended up to 10,000 volts and down to 20 microvolts.
- Available Precision Shunt Resistors convert voltmeter to microammeter covering range from 1 to 1000 microamperes.

For additional information on this Voltmeter and Ballantine Battery Operated Voltmeters, Wide-Band Voltmeters, Peak to Peak Voltmeters, Decade Amplifiers, Inverters, Multipliers and Precision Shunt Resistors, write for catalog.

## BALLANTINE LABORATORIES, INC.

100 FANNY ROAD, BOONTON, NEW JERSEY





**Made to SURVIVE!**



**Miniature POWER Resistors**

Carefully crafted for matchless performance, DaloHM miniature power resistors are made to survive the most severe environmental, shock, and vibration conditions.

DaloHM RH type resistors are completely welded from terminal to terminal. They are silicone sealed in a die-cast, black anodized radiator finned housing and mount on sub-panel for maximum heat dissipation.



25-Watt  
Type RH-25

50-Watt  
Type RH-50

Also Available RH-250—250 Watts  
RS Types—2, 5, and 10 Watt

- Temperature coefficient 0.00002/Deg. C
- Ranges from 0.1 Ohms to 55,000 Ohms, depending on type
- Tolerance 0.05%, 0.1%, 0.25%, 0.5%, 1%, 3%, 5%
- Manufactured in accordance to JAN-R-26A Specifications, Characteristic G

Write, Wire or Call  
1300 28th Ave. Phone 2139

**DALE PRODUCTS, INC.**

Columbus, Nebraska, U.S.A.

In Canada — Teletronics Corp., Ltd., Toronto and Montreal

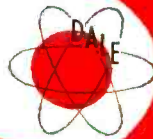

impedance is 150 and 300 ohms. It has a piston-type attenuator. The unit especially needed in fringe areas provides a reliable signal source to compare gain of uhf receivers and converters.

**POWER SWITCH has variety of applications**

CLAROSTAT MFG. Co., INC., Dover, N. H., is making available the series AE power switch to electronic equipment manufacturers to be used as an integral part, such as push-pull or rotary switches in record changers, and many other applications where a switch of this type is adaptable. The series AE switch is UL approved and rated 1 ampere at 250 v, 3 amperes at 125 v a-c or d-c. It is available in spst, spdt or dpst. It measures 1 1/8 in. in diameter.



**MICROPHONE STAND has safety air cushion**

ATLAS SOUND CORP., 1451 39th St., Brooklyn 18, N. Y. Prevention of accidental or sudden slippage of the microphone stand's telescoping section is assured with the MS-25 microphone stand that features a safety air-lock cushion. The telescoping section is always cushioned on air so that the escape of air permits only a slow quiet collapse of the stand if the clutch holding adjustment is insufficiently tightened or accidentally released. Thus the stand cannot suddenly crash down and cause a blast of sound to be fed to the amplifier. The MS-25 has a height adjustment of 37 in. to 66 in., and a base diameter of 17 in. The tube terminates in a 3/8 in.-27

**ILSCO**

UL QUALITY SP

**CONNECTORS**

LO 7 SIZES

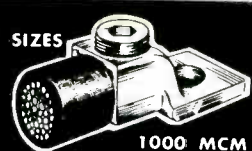

1000 MCM — 14

CAN NEUTRAL



60, 100 & 200 AMPS.

SLU 11 SIZES

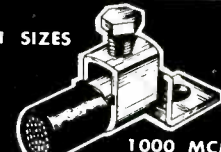

1000 MCM — 14

FUSE CLIPS



MANY SIZES AND TYPES

XT 6 SIZES

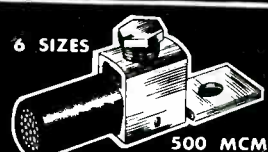

500 MCM — 14

TERMINAL BLOCKS

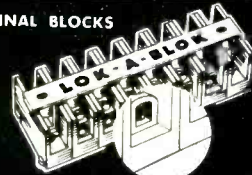

VT 6 SIZES

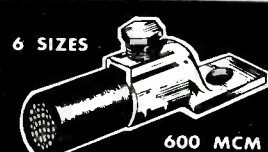

600 MCM — 14

WRITE FOR 80-PAGE CATALOG

ILSCO 5753 MARIEMONT AVE., CINCINNATI 27, OHIO

MU 3 SIZES



500 MCM — 6



carefully machined thread. Weight is 24 lb.



**CRT SHIELDS**  
are magnetic type

MULTI-METAL WIRE CLOTH CO., INC., 1350 Garrison Ave., New York 59, N. Y., is producing standard magnetic cathode-ray-tube shields for the 2-in., 3-in. and 5-in. tube sizes. Early delivery is assured on these low-cost Mu-metal and Nicoloi stock shields which formerly required three and four months for delivery. These shields can be furnished with light hoods, retainers and plexiglass windows. Write for literature and quotations.



**SIGNAL EQUALIZER**  
does not upset impedance

TELE-MATIC INDUSTRIES, INC., 1 Joralemon St., Brooklyn, N. Y., has introduced the automatic signal equalizer designed for locations where the signals from the l-f channels cause overloading and the h-f channels are not strong enough to tolerate any attenuation. Model AT-25 equalizer provides maximum attenuation on the l-f channel, and minimum attenuation on the h-f channel, without upsetting the impedance of the tv receiver. Once in-

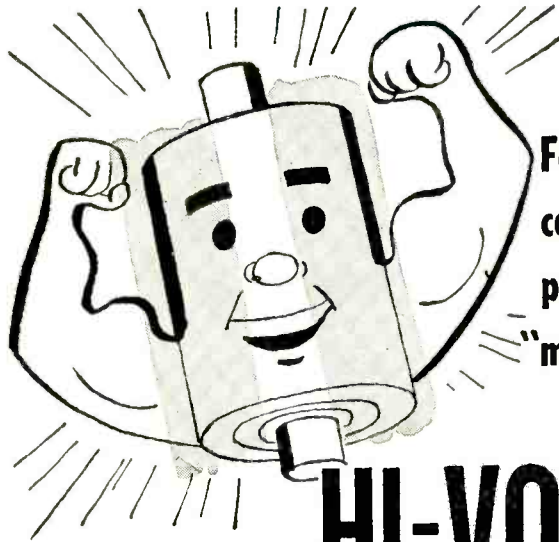

For outstanding capacitor performance put Centralab's "musclemen" to work

**HI-VO-KAPS.®**  
**withstand continuous overload up to twice rated voltage**

Centralab Hi-Vo Kaps are the industry standard for virtually ANY high voltage or TV application... plus a complete line for color TV.

- **Exclusive CRL Ceramic-X** assures high mechanical and dielectric strength. Electrodes permanently bonded to ceramic body.
- **Insulation resistance** — initial 10,000 megohms, minimum; after humidity 5000 megohms, minimum.
- **Low leakage** — Pattern reduces corona and lengthens leakage path.

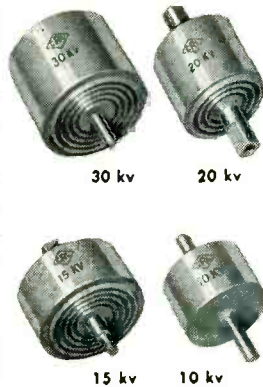

- **Variety of terminal connections** — rod, slotted, internal thread, external thread.
- **Capacitance:** 500 mmf + 50%-20%; 10kv, 20kv and 30kv d-c working. New 15kv Hi-Vo Kap now available.
- **Power Factor** — 1% maximum. After humidity 2% max.



Get Hi-Vo-Kap facts NOW from Centralab — Write for bulletin 42-10, NOW!

- All processes controlled from basic powders to finished product.
  - More than 150 engineering specialists available for consultation.
  - Modern production facilities in 7 convenient-to-you plants.
- The only complete line of standard and special ceramic capacitors.

Note: Standard items are available at your local (CRL) distributor — see Catalog 28.

**Centralab**

A Division of Globe-Union Inc.  
914 E. Keefe Avenue • Milwaukee 1, Wisconsin  
In Canada: 804 Mt. Pleasant Road, Toronto, Ontario

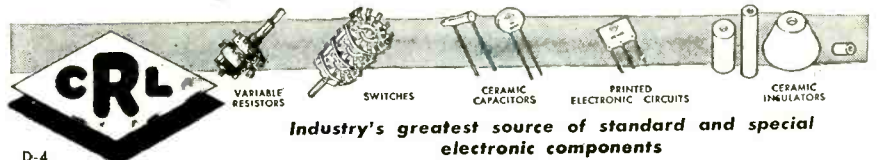

D-4

# Pick 'DIAMOND H' RELAYS



Shown Actual Size



...FOR HIGHER  
**VIBRATION**  
**RESISTANCE**

Vibration resistance range of "Diamond H" Series R Relays has been more than doubled, extending now from 0 to well over 1,000 cycles per second at 15 "G's."

Continuing engineering developments such as this are constantly broadening the adaptability of Series R Relays for a wide variety of applications . . . guided missiles, jet aircraft, fire control and detection, radar, communications, high speed camera, geophysical and computer apparatus . . . and similar applications requiring positive operation under critical conditions.

Hermetically sealed, miniature aircraft relays, Series R devices are basically 4PDT, but are also available in DPDT and 4PDT with two independent coils, either or both of which will operate the unit. Available with all standard mounting arrangements, including ceramic socket for interchangeability. Their design permits unusually compact grouping and provides a firm bond between relay and chassis. See us for special arrangements.

In their field still the smallest and lightest, (1.6 cu. in., 3.76 oz.) combining highest operating shock resistance (to 50 "G" and higher), widest temperature range (-65° to +200° C.) and greatest ability to break high currents and high voltages, Series R Relays consistently operate over 400,000 cycles without failure at 5 A. and go 3,500 or more under 30 A. at 30 V., D.C., resistive. They carry voltages up to 300 D.C. at 4/10 A. for more than 400,000 cycles. With low

contact loading, life expectancy is 10 million cycles or better.

Operating time is 10 ms. or less; drop out time 3 ms. or less. Coil resistances up to 35,000 ohms are standard; to 50,000 ohms available for special units. Sensitivity approaches 100 mw. at 30 "G" operational shock resistance. Inter-electrode capacitance is less than 5 mmf. contacts to case—less than 2½mmf. between contacts, even with plug-in type relay and socket.

Designed to meet all requirements of USAF Spec. MIL-R-5757B, they far surpass many. Bulletin R-150, giving basic performance data under varying conditions, is yours on request. Our engineers are prepared to work with you to develop variations to meet your specific requirements. Tell us your needs.

## THE HART MANUFACTURING COMPANY

202 Bartholomew Avenue • Hartford, Connecticut

stalled, the unit does not require switching or manipulation of the controls.

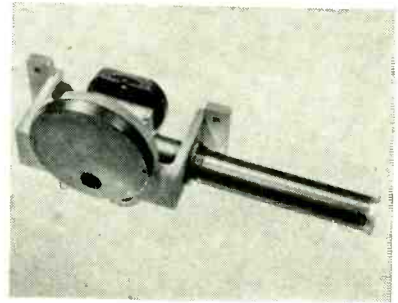

### PHOTOMETER for star measurement

L. C. EICHNER INSTRUMENTS, 19 Sebago St., Clifton, N. J., has produced a new type of photoelectric photometer which is mounted on astronomical telescopes for direct measurement of star magnitudes. The instrument measures the brightness and color of stars to an accuracy of one part in a thousand. Measurements are made by sensitive electrical equipment after starlight is converted to an electric current by a photoelectric cell. The photometer is mounted directly on the telescope's plate holder and employs the same adjustments as those used for photographic plates.

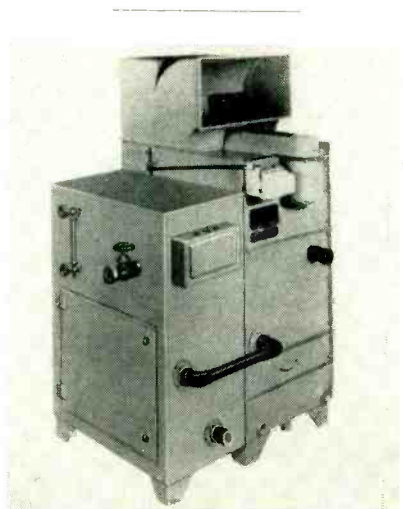

### HEAT EXTRACTOR is new package type

MAYER REFRIGERATING ENGINEERS, INC., Lincoln Park, N. J. A new package-type heat extractor, while primarily designed to provide recirculated cooling water for transmitter tubes, will find other indus-



trial uses for supplying cooling water to machine jackets, oils and coolants. This equipment employs the evaporation cooling principle and will supply cooling water as low as 86 F with a 75-deg wet bulb condition. The range of capacities is from 36,000 Btu per hr to 465,000 Btu per hr with entering water temperatures from 90 F to 160 F. Volume of cooling water is from 20 to 150 gpm. Full automatic temperature controls are included to deliver constant temperature cooling water, regardless of atmospheric temperatures or conditions. The whole unit is completely assembled, wired and piped in a compact form. Field installation consists only of running electric power to a prewired panel, external cooling and plumbing, piping and air-duct connections. Overall dimensions of the unit are 44 in. wide by 31 in. deep by 61 in. high.



### RECORD CHANGER handles three sizes

BIRMINGHAM SOUND REPRODUCERS LTD. of Old Hill, Staffs, England, has introduced the 1954 Monarch automatic record changer. It retains the regular features without any basic alterations. It includes the "Magidisk" selecting 7-in., 10-in., and 12-in. records intermixed in any order, as well as high-fidelity dual stylus cartridge ultra-rapid record change and other features. One of these is a simple centralized control. The sapphire styli in the turnover cartridge are easily replaceable and the cartridge is designed to cut record wear down to a negligible degree. With all working parts well protected against humidity and dirt, the unit is suitable for all climates. The Monarch auto-changer has a 4-pole motor that features smooth power and

ELECTRONICS — April, 1954

## IMPORTANT NEWS

### For the Electrical and Electronic Industries

## ... a New HARDENABLE SILVER ALLOY



#### Important Properties of SILVER-MAG-NICKEL

- ✓ Oxidation Hardenable
- ✓ High Electrical Conductivity — 70%
- ✓ High Thermal Conductivity
- ✓ Hardnesses to 70 — Rockwell 30 T
- ✓ Tensile Strengths to 70,000 psi.
- ✓ Corrosion Resistance Like Fine Silver
- ✓ Hardness Unaffected by Silver Brazing

SILVER-MAG-NICKEL is its name. As you receive it, it is soft and ductile, like fine silver. Fabricate your most intricate parts, then oxidation harden them and this new alloy will hold its temper permanently. This hardness is not disturbed even when subsequent elevated temperatures are encountered.

SILVER-MAG-NICKEL has excellent thermal and electrical conductivity. Its corrosion resistance is equal to that of fine silver. It is available in wire and strip in thicknesses down to .002".

Have you an application where SILVER-MAG-NICKEL can be used to advantage? See the list of properties to the left. Write giving full details of your potential application. Our engineers will be glad to discuss these properties with you.



## HANDY & HARMAN

General Offices: 82 Fulton St., New York 38, N. Y.  
DISTRIBUTORS IN PRINCIPAL CITIES

OFFICES and PLANTS  
BRIDGEPORT, CONN.  
PROVIDENCE, R. I.  
CHICAGO, ILL.  
CLEVELAND, OHIO  
DETROIT, MICH.  
LOS ANGELES, CALIF.  
TORONTO, CANADA  
MONTREAL, CANADA

Want more information? Use post card on last page.

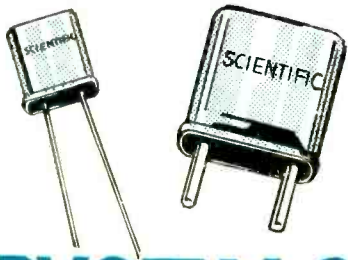

# CRYSTALS

FOR EVERY PURPOSE

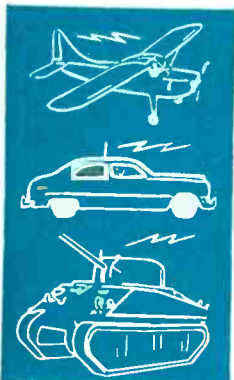

- AIRCRAFT
- MOBILE TWO-WAY
- LAW ENFORCEMENT
- TAXI
- RAILROAD
- BROADCAST
- AIR FORCE
- ARMY — SIGNAL CORPS

- NAVY
- HOBBY MODELS
- AMATEUR
- TELEVISION
- PIPELINE
- MARINE
- INDUSTRIAL



Consult our Research and Engineering Laboratory.

**IT IS AT YOUR SERVICE**

One of the Oldest Manufacturers of Crystals in the United States.

**ORDERS PROMPTLY FILLED**



**SCIENTIFIC RADIO PRODUCTS, INC.**

215 South 11th St.,  
Omaha, Nebr., U.S.A.

*Be Specific - Say Scientific*

NEW PRODUCTS

(continued)

still uses the turntable rubber mat. The unit is available for operation on 100 to 125 v and 200 to 250 v; frequency, 50 or 60 cycles as required.

## SERVOBOARD

on component parts basis

SERVO CORP. OF AMERICA, 20-20 Jericho Turnpike, New Hyde Park, N. Y. The Servoboard is a set of standard precision mechanical parts, including gears, shafts, bearings, hangers and mounting plates, which, when coupled to the necessary motors, tachometers, synchros, potentiometers and amplifiers, rapidly builds a flexible experimental mechanical assembly of a servo system, computer or regulator. It was developed as an aid to the design of servomechanisms by providing means for quickly synthesizing the electromechanical parts of the control system.



## SCALING UNIT

used for particle counting

BERKELEY SCIENTIFIC, division of Beckman Instruments, Inc., 2200 Wright Ave., Richmond, Calif. Model 2200 automatic scaling unit is a high speed instrument for automatic counting of electrical pulses obtained from nuclear particle detection equipment. It consists of an input pulse height discriminator, an electronic scaling channel with 1- $\mu$ sec paired pulse resolution, mechanical register, time clock and automatic control circuitry. High voltage is not supplied in this instrument. The scaling channel consists of 4 plug-in decimal counting units including one model 706A and three model 705A's. Count indication is entirely direct reading. Maximum counting speed is 100,000

## ACME STAR COMPOUND

FOR  
MIL-T-27, GRADE 1  
CLASS A  
TRANSFORMERS



A Raytheon transformer molded with Acme Star Compound

### NOTE THESE OUTSTANDING ADVANTAGES:

- Non-toxic
- Non-corrosive
- Eliminates Voids
- Thorough impregnation
- Simple one-phase molding process
- Tenacious adhesion to metal
- Assures complete moisture-proof seal

Acme Star Compound also passes Specification MIL-C-16923 (Ships), Compound, Embedding (Electronic Equipment), Type C.

Exterior cases are not required, as the compound alone provides protection.



**ACME WIRE CO.**  
NEW HAVEN, CONN.

MAGNET WIRE • COILS  
VARNISHED INSULATIONS  
INSULATING VARNISHES

Want more information? Use post card on last page.

Want more information? Use post card on last page.



per second. A four-digit mechanical register is used and provision is made for driving an external relay in parallel with the register.

## H-V INSULATION for internal wiring

INDUSTRIAL DIVISION OF MINNEAPOLIS-HONEYWELL REGULATOR CO., Wayne & Roberts Ave., Philadelphia 44, Pa., is manufacturing a moisture-proof h-v insulation for internal wiring of the company's electronic instruments. This thermoplastic material is impervious to moisture and thus is recommended for use where high humidity conditions prevail. Insulation comes in 10 base colors. Where tracers are required the insulation is white with two identically colored helical stripes to identify the base color and a third stripe to show the tracer color. Input circuit wiring will be solid white covered by color-coded rayon braid.

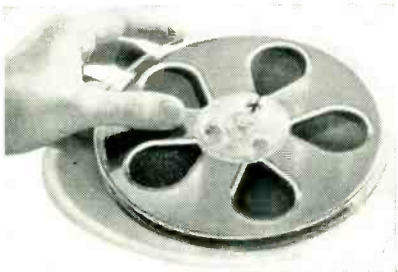

## PLASTIC REEL for magnetic tape

AUDIO DEVICES, INC., 444 Madison Ave., New York 22, N. Y., has announced a new and improved 7-in. plastic reel for magnetic sound recording tape. The reel has a 2½-in. hub that provides essentially the same accuracy of timing and freedom from tension stresses as the previous 2¾-in. hub, but its additional tape storage space eliminates the danger of the outer turns slipping off the reel. It holds the full 1,200 ft. of tape with ample capacity for adding long leaders at both ends and between selections on the reel. The reel flanges have larger solid web areas, providing more space for labeling and giving greater protection to the rolled tape. Raised edges around the rim

# Precision INSTRUMENT SWITCHES

## STOCK MODELS FOR **YOUR** JOB

There's nothing like stock models of Shallcross Instrument Switches for cutting equipment cost and design problems. For over 20 years Shallcross has made scores of basic switch types with countless variations for practically every electric-electronic application. Single or multi-deck types having up to 60 non-shorting positions are regularly produced. Contact resistance less than 0.001 ohm is a feature of many types. Several unique switches—usually "Special items" with other manufacturers—can quickly be supplied by Shallcross from stock. For a fast solution to any problem involving rotary switches, write to SHALLCROSS MANUFACTURING CO., 522 Lincoln Avenue, Collingdale, Pa.

**Just Out!**

New switch data. Send for Shallcross Engineering Bulletin L-31.

# Shallcross

**Servo Motors**  
meeting JAN environmental  
requirements need not be expensive!

# DIEHL

## "HI-AC-CEL" Low Inertia A. C. Servo Motors

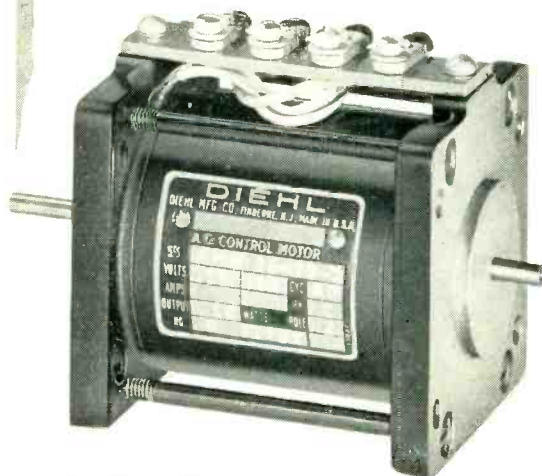

**Priced**  
**at only**  
**\$30.00**

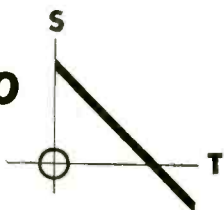

### SPECIFICATIONS:

Diehl Number:  
FPE 25-79-1  
10 Watts  
Maximum Output  
115 Volts  
Main Phase  
115 Volts  
Control Phase  
2 Poles  
2 Phase  
12.5 oz.-in.  
Locked Torque  
23.0 oz.-in. Torque  
at minus 3000  
R.P.M.  
.125 oz.-in.<sup>2</sup>  
Moment of Inertia  
1.6 lbs. in Weight  
38,600 Radians per  
Second<sup>2</sup> Theoretical  
Acceleration

This newly designed Diehl "HI-AC-CEL" Servo Motor affords high response and is suitable for a broad range of military and industrial servo-mechanism applications.

### FEATURES:

1. Cogging (Slot effect) is Negligible
2. No Single-Phasing
3. Speed-Torque curve extends into the negative speed range at approximately the same slope.

Diehl "HI-AC-CEL" Servo Motors are obtainable in ratings from 5 to 25 watts output with standard 115 volt control phase windings and also with high impedance control phase windings. All ratings can be furnished with either A.C. or D.C. integrally mounted tachometer generators.

Our wealth of experience in producing quality motors is at your service to help you select the unit best suited to your specific requirements. Copy of Technical Manual No. EL-0454 describing Diehl Servo Motors and related equipment is yours for the asking.



*Other Available Components:*

D.C. SERVO SETS • RESOLVERS  
MINIATURE PERMANENT MAGNET D.C. MOTORS  
**DIEHL MANUFACTURING COMPANY**

Electrical Division of THE SINGER MANUFACTURING CO.

Finderne Plant, SOMERVILLE, N. J.

Atlanta Baltimore Baston Chicago Detroit New York Philadelphia Worcester

and flange openings give increased strength and rigidity with minimum weight, and also serve to keep the large clear plastic flange surfaces from becoming scratched or marred in normal handling.

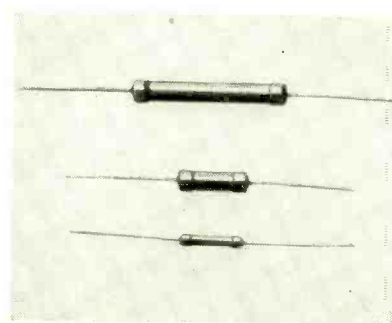

### STABLE RESISTORS in deposited carbon type

DALE PRODUCTS, INC., Columbus, Neb., has introduced its new commercial grade deposited carbon stable resistors in tolerances of 1, 2, 5 and 10 percent. Standard resistance ranges in the  $\frac{1}{2}$ -w size are from 1 ohm through 5 megohms; in the 1-w size, from 1 ohm through 10 megohms; in the 2-w size, 5 ohms through 100 megohms. A new tough silicone coating has been developed which seals the stable precision element and protects it from physical abrasion without the addition of protective sleeve.

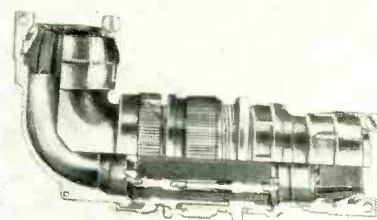

### CONNECTOR is environment resisting

SCINTILLA MAGNETO DIVISION, Bendix Aviation Corp., Sidney, N. Y. Type E environment-resisting electrical connector illustrated was developed to meet the high-altitude performance requirements of today's airplanes. It was designed to



protect sensitive electronic circuits from thermal shock, surface condensation and extreme vibration. Convenience of assembly is an important feature of this E connector. The space between insert and grommet provides an ample working area for all assembly and welding operations. The connector is completely serviceable since individual wires can be removed or repaired with the connector in place.

### COLOR TV COILS KIT contains 32 items

ELECTROMETRIC, INC., Woodstock, Ill., has announced a new color tv coils kit containing 32 items for use with shadow mask tubes. Included are a new distributed constant delay line, a new horizontal output transformer, horizontal dynamic-converging and dynamic-focusing transformer, horizontal dynamic-convergence phase control, width control, linearity control and a complete set of i-f, video and color information circuit coils.

### ADAPTER for tube testers

SUPEREX ELECTRONICS CORP., 23 Atherton St., Yonkers, N. Y., is marketing an adapter that can be used with any make tube tester and all picture tubes. Simplicity of operation is the keynote. One end plugs into the present tube tester (of any make or model), and the other end hooks into the picture tube, without removing the latter from the tv cabinet. Any tube, new or old, from 10 in. to 30 in., can thus be checked for electrostatic or magnetic shorts. Overall length is 49½ in.

### CONTROLLERS provide automatic testing

TINIUS OLSON TESTING MACHINE Co., 1022 Easton Rd., Willow Grove, Pa., has announced a line of automatic testing controls. The controllers are designed for production testing, proof testing, yield strength by the extension under load method, stress cycling (load),

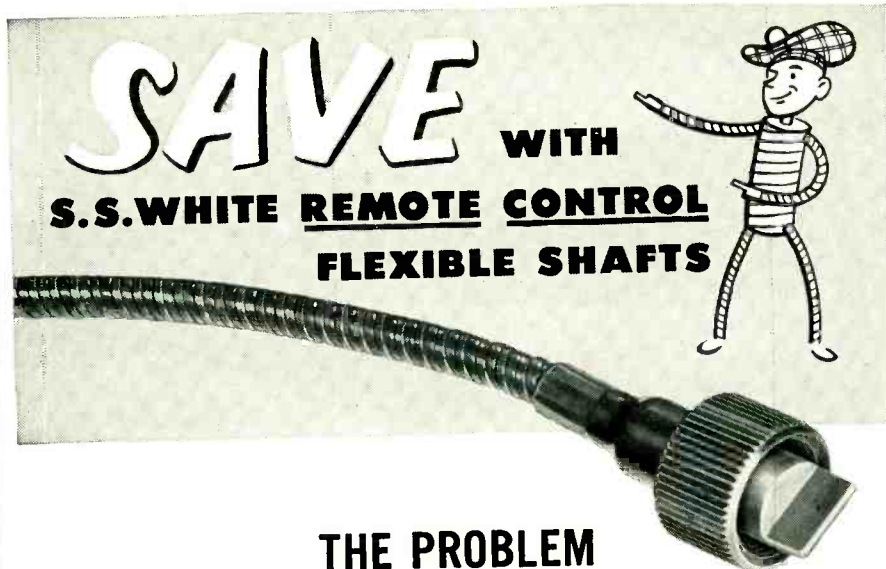

## THE PROBLEM

### PROVIDING SIMPLIFIED GEAR SHIFTING LEVER

A design engineer wanted to provide single-lever gear shifting for a duplex 10-speed truck transmission. He wanted to position a "flipper" on the shift that would control a selector valve supplying air and vacuum to the power cylinder of the shift. The control linkage between these components had to be simple in construction, economical from the standpoint of material, and had to permit easy movement of the shift lever. That's why the designer chose—

## THE LOW-COST SOLUTION

### AN S.S. WHITE REMOTE CONTROL FLEXIBLE SHAFT

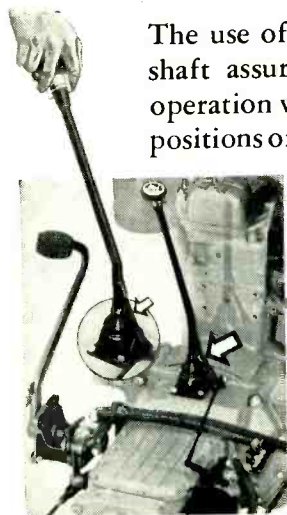

The use of one self-contained S.S. White flexible shaft assured smooth, positive, and dependable operation while readily conforming to the various positions of the shift. *The shaft was easily installed, needed no alignment, and required no adjustments after installation.* Even though your needs may be different, you'll realize great time and money-saving advantages by using S.S. White flexible shafts on your own remote control applications. Our engineers will be glad to cooperate with you in working out details.

### Write for the Flexible Shaft Handbook . . .

It contains 256-pages of data and facts on how to select and apply flexible shafts. We'll send it to you free, if requested on your business letterhead.



**THE S.S. White INDUSTRIAL DIVISION**  
**DENTAL MFG. CO.**



Dept. E, 10 East 40th St.  
NEW YORK 16, N. Y.

Western District Office • Times Building, Long Beach, California

strain (unit deformation) cycling and crosshead cycling.

### H-V PROBE LEAD extends d-c voltage ranges

RADIO CITY PRODUCTS CO., INC., 152 W. 25th St., New York City, N. Y., has brought out a new high-voltage multiplier probe lead for extending the d-c voltage ranges of model 655 peak-to-peak v-t voltmeter. It comes complete with multiplier resistor and terminations and is of the heavy-duty type with safety barrier. It multiplies the scale used by 100.

### Literature

**High-Gain Audio Input Tube.** Kingdom Products, Ltd., 23 Park Place, New York 7, N. Y., has published a single-sheet bulletin presenting the Emitron 2729, a voltage amplifying pentode that is expressly designed for the first stages of high gain audio amplifiers. Included are a typical circuit, operating data and characteristics chart. An illustration, dimensional diagram, ratings and operating conditions are also given for the KT66 power amplifier tube.

**Thyrite.** General Electric Co., Schenectady, N. Y. Bulletin GEA-4138C deals with Thyrite, a non-linear resistance material in which the current varies as a power of the applied voltage. The material described has found important applications in the electric-power, communications, and electronic industries. Included are photographs, tabular data, characteristics charts and circuits. A supplement to the bulletin contains a page of information to be filled in for special applications.

**Precision Stainless Steel Wire.** Fort Wayne Metals, Inc., 3211 MacArthur Drive, Fort Wayne, Ind. As an aid to present and potential wire users, the company has announced a new specification form that gives product design, engineering and purchasing departments a definitive means to

made a thorough...  
throughout the East Coast and  
found this sector the most suitable  
from every aspect for his company.

growing  
chain dep.  
sory store.  
centrally lo  
gasoline sta  
tery brands.

The first su  
to locate plan  
throughout  
the proport  
automobile  
markets an  
tion charg  
program, a  
existing plan  
spent \$20,000,  
said. It now ha  
tery plants w  
1930.  
The seco  
was to

representative  
furniture  
its then  
ory there.  
was selling  
week door-  
year had  
art and full

g nights he  
a baby table  
new features  
life easier for  
abies. By Oc-  
produced his  
then quit  
the help  
ng out

# LOST ONE MACHINE SHOP

...for the modification of  
servo system components...

**AND** it might well be yours! For if you

are now buying the components for servo systems from several manufacturers, you are probably wasting time, labor, machinery, and material, modifying the various units for better coordination. And you still end up with only the inferior performance that such a hodge-podge delivers.

Transicoil experience proves that you can save the time and trouble of secondary operations and end up with a better system by merely using assemblies made up of matched Transicoil components. The units comprising these assemblies are designed and constructed to work with each other for optimum efficiency, top performance, and actually cost less when assembled than the total purchase price of individual components acquired from several sources.

If you are now purchasing servo components from several manufacturers, a serious talk with Transicoil will pay you dividends in lower costs and a better system. But if you require only one component, you can be sure of optimum performance from the Transicoil units you specify.

# TRANSICOIL

**CORPORATION** 107 GRAND STREET  
NEW YORK 13, N. Y.

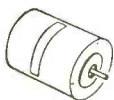

Miniature  
Control Motors



Motor and Gear  
Train Assemblies

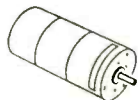

Motor, Generator, and  
Gear Train  
Combinations

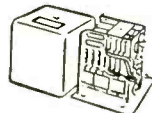

Servo  
Amplifiers

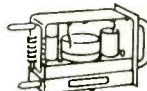

Plug-In  
Assemblies



specify wire requirements. The new form covers all known stainless steel wire subjects, and is designed both to suggest uses and to simplify buyer procurement problems. The rapidly lengthening list of uses which makes such a form extremely valuable includes electronic shielding, industrial brushes, minesweeper cable, non-magnetic stainless steel wire, spiral-four cabling, magnetic recording wire, suture wire, filters and spiral thread inserts. Standard or custom specifications can be listed on the new forms.

**Photoelectric Controls.** The Auto-tron Co., Box 722-H, Danville, Ill. A recent catalog describes general-purpose, fail-safe, high speed and ultrasensitive photoelectric controls with electronic timers and safety relays. The controls described have light sources with straight beams, wide selection of pin-point beams, and adjustable focus beams. They are also available with beam intensity adjustment, dual filament lamps and safety relays.

**Wattmeters.** Sensitive Research Instrument Corp., 9-11 Elm Ave., Mt. Vernon, N. Y. Volume 20, No. 4 of "Electrical Measurements" covers the selection and use of wattmeters. It deals with questions which a purchaser must ultimately answer, such as: What is the supply voltage?; do I need a low power factor wattmeter or can I use a standard 50-percent P-F model?; how much current does the load take?; and what ranges of voltage, current and power do I need? The 8-page illustrated booklet gives technical specifications.

**Mechanical Measurements With Electronic Counters.** Hewlett-Packard Co., 395 Page Mill Rd., Palo Alto, Calif. Proven techniques for making common mechanical measurements quickly and accurately with electronic counters are described in Vol. 5 No. 1-2 of the H-P Journal. The issue discusses techniques for measuring operating time of high speed clutches, rpm on very high speed shafts, stability of rotation, electrical relay operating times and

## ONLY KAY LAB MULTI-PURPOSE

### ABSOLUTE DC POWER SUPPLIES

PROVIDE

# .01%

STABILITY  
•  
REGULATION  
•  
CALIBRATION

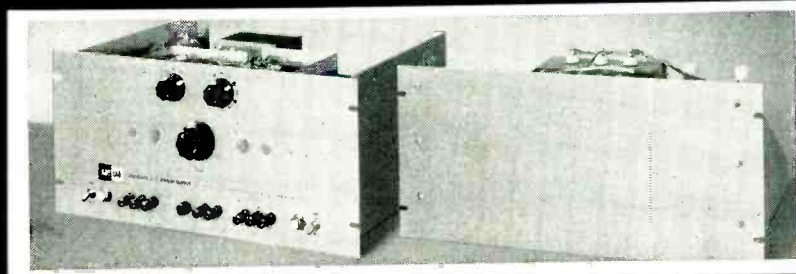

#### SPECIFICATIONS:

Long Time Stability; 100 parts per million  
Short Time Stability; 50 parts per million per hour  
Output Impedance; under 0.1 ohms  
Output Hum and Noise; under 0.5 millivolt  
Load Regulation Factor; .01%  
Line Regulation Factor; .01%  
Response Time; 1.0 milliseconds  
Bias Supply; 0 to 150 volts

These units are absolute sources of D. C. voltage independent of line voltage and output load variations. The output voltage is constantly compared against the internal standard cell and thus, absolute calibration and stability with reference to the cell is insured.

#### STANDARD POWER SUPPLIES

Model	Range	Current	Filament Voltage	Control Amps.	Overall Dimensions W H D	Output Voltage Cal.
30C-15	10-300V	150 ma.	VB	3	19x 8- $\frac{3}{4}$ x20- $\frac{1}{4}$	0.1%
30C-25		250 ma.	VB	5	19x 8- $\frac{3}{4}$ x20- $\frac{1}{4}$	0.1%
30C-50		500 ma.	VB	10	19x17- $\frac{1}{2}$ x13- $\frac{1}{4}$	0.1%
30C-100		1 amp.	VB	10	19x17- $\frac{1}{2}$ x20- $\frac{1}{4}$	0.1%
50C-25	10-500V	250 ma.	VB	5	19x 8- $\frac{3}{4}$ x20- $\frac{1}{4}$	0.1%
50C-50		500 ma.	VB	10	19x17- $\frac{1}{2}$ x13- $\frac{1}{4}$	0.1%
50C-100		1 amp.	VB	10	19x26- $\frac{1}{4}$ x20- $\frac{1}{4}$	0.1%

#### OUTPUT VOLTAGE CONTROL

VA . . . Output variable in one volt steps variable between steps by a potentiometer.  
VB . . . Output variable in ten volt steps adjustable between steps by a potentiometer.

Fixed voltage and constant current models available.  
Voltage and current calibrators available.

SEND NOW FOR FREE DETAILS AND NAME OF NEAREST REPRESENTATIVE.

PRECISE ELECTRONIC INSTRUMENTS

Kalbfell Laboratories Inc., 1090 Morena Blvd., San Diego 10, Calif.

# KAY LAB

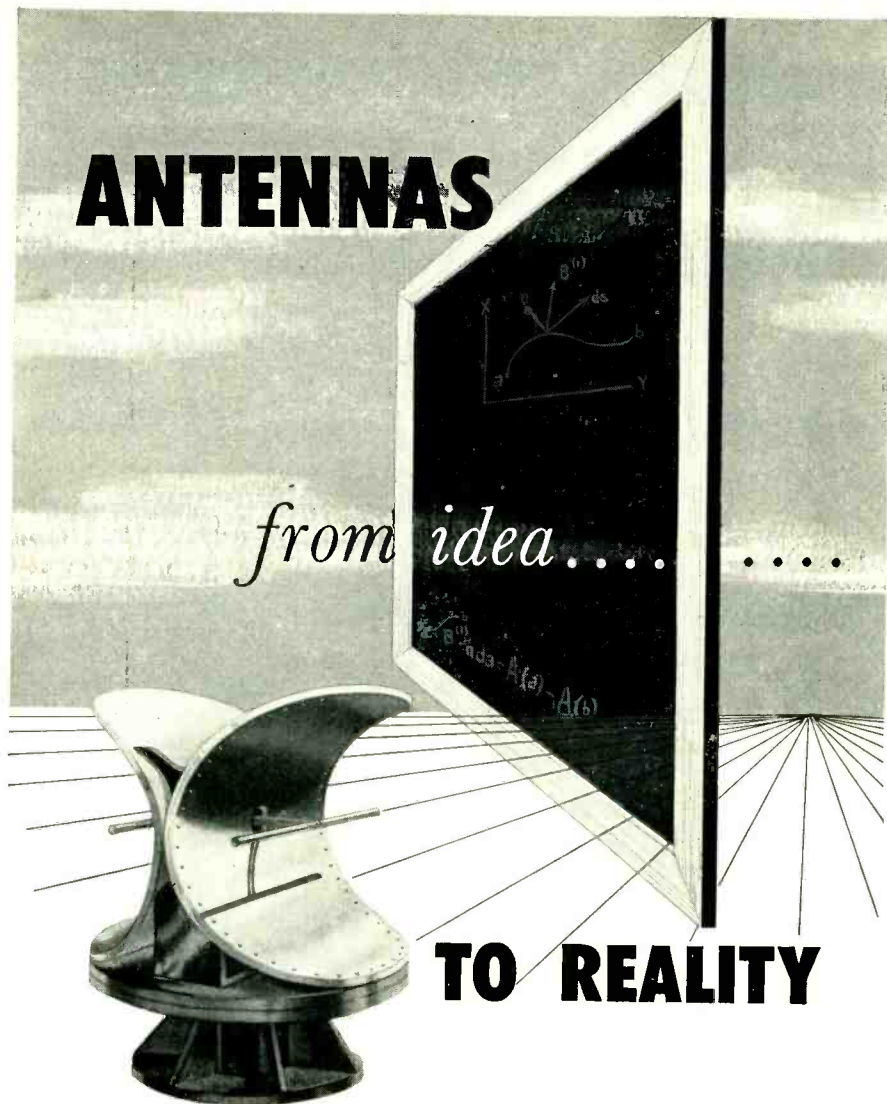

The keynote of superior systems planning is careful unit design. The Antenna, a vital link in many systems, requires a combination of creative genius and practical design talent.

Pickard & Burns, Inc. offers an antenna service unique in its completeness. Experienced engineers transform performance requirements into a design concept, then to physical reality which often involves not only laboratory models but pilot or full scale production.

From VLF through the millimeter region, the well-equipped laboratories of P & B are constantly serving the requirements of industry and the military for new and challenging antenna design.

Without obligation you are cordially invited to visit our facilities, and we would welcome an opportunity to discuss any antenna problem you may have.

For further information concerning our organization, its services and products, write for our brochure.



**PICKARD & BURNS**  
INCORPORATED

240 Highland Avenue, Needham 94, Mass.

phase delay in l-f devices such as servomechanisms. It also indicates how electronic counters may be applied to measurement of pulse interval or pulse duration, linear velocity, flow, distance expressed in time, viscosity and the timing of photographic and other high-speed mechanical equipment. Schematic and circuit diagrams illustrate appropriate mechanical and electronic setups for performing the measurements. Waveform drawings and oscillograms show how phenomena measured by a counter appear when studied visually.

**Electromagnetic Controls.** Automatic Switch Co., Orange, N. J., offers a pamphlet outlining their services and products for use on the power side of electronics systems. The pamphlet, titled "When Normal Power Fails," discusses items designed and constructed to RETMA standards and covers such controls as automatic transfer switches, engine-generator starting units, differential relays, time delay relays and complete control panels. Information is given on such related subjects as: current surge tests, adequate lighting, relay protection and auxiliary equipment for engine generator controls. Write for publication No. 528.

**Corner Console Enclosure.** James B. Lansing Sound, Inc., 2439 Fletcher Drive, Los Angeles 26, Calif., has issued booklet No. 34, a 4-page instructional folder on its rear-loaded folded horn corner console enclosure. Well illustrated with photographs and schematic drawings, it depicts eight separate and distinct constructional steps from raw material to the finished product: from the component assembly to the installation of the grille cloth.

**Wire and Cable Catalog.** Lenz Electric Mfg. Co., 1751 N. Western Ave., Chicago 47, Ill., has available a most elaborate catalog providing description and complete specifications on the company's entire line of hookup and lead wires and cables for the electronics field. All Lenz wire and cables



are fully illustrated, so that the catalog will prove very useful to electronic engineers and purchasing agents.

**TV Replacement Guide.** Thordarson-Meissner, Mt. Carmel, Ill. Flybacks, peaking coils, horizontal synes, focus coils, deflection yokes, width controls, vertical outputs and ringing coils are among the components listed in the recently published tv replacement guide. The 32-page booklet features schematics, diagrams, catalog material and replacement listings for approximately 6,000 tv models.

**Magnetic Recording Folder.** Logistics Research, Inc., 141 So. Pacific, Redondo Beach, Calif. A 4-page illustrated pamphlet on Airfloating, a new principle in magnetic recording of information, is now available. The pamphlet describes experimentation known as Project Halo, which is said to have eliminated the biggest barrier to widespread application of modern automatic computing equipment in business, manufacturing and science.

**Cyclo-Monitors.** Counter & Control Corp., 5213 W. Electric Ave., Milwaukee 14, Wisconsin. A new 34-page engineering data catalog describes the augmented line of Cyclo-Monitors—electric control devices that incorporate a spdt switch and a predetermining counter. The 3 basic models illustrated in the catalog pick up the count from a rotating machine member, a reciprocating member or an electric impulse from a sensitive switch or photoelectric cell. A number of new specialized types of Cyclo-Monitors are described for the first time. The catalog includes typical cycle diagrams, dimension drawings, photographs, performance ratings and other detailed information on these controls.

**Transistor Literature.** The Glenn L. Martin Co., Baltimore 3, Md., has published a 54-page booklet entitled "Guide to Transistor Literature." The transistor papers cited in this compilation number well over four hundred. A subject index is included. The entries



**Preformed Contact Finger Stock** is an ideal electrical weather stripping around doors of equipment cabinets as well as being excellent for use with VHF and UHF circuitry. Silver plated, it comes in three widths— $\frac{3}{16}$ ,  $\frac{3}{8}$  and  $1\frac{7}{16}$  inches.

**Variable vacuum capacitors** come in three models, are lightweight, compact, eliminate the effects of dust and atmospheric conditions and have low inductance. Also available are eight types of fixed vacuum capacitors.

**Air-system sockets**, designed for Eimac tube types 4-400A, 4-1000A, 4X150A, and 4X150D, simplify cooling and assure adequate air-flow to various seals. The 4-400A socket can also be used with the 4-125A and 4-250A

radial-beam power tetrodes if desired.

**HR heat dissipating connectors** provide efficient heat transfer from the tube element and glass seal to the air while making electrical connections to plate and grid terminals. Precision machined from dural rod, HR connectors come in ten sizes to fit most of Eimac's internal anode tubes.

**High Vacuum Rectifiers** come in eight models, are instant heating, have radiation-cooled pyrovac\* plates and can be operated in a variety of rectifying and voltage multiplying circuits. Also available are four types of mercury-vapor rectifiers.

\* An Eimac trade name.

• For further information write our Application Engineering department

**EITEL-McCULLOUGH, INC.**  
SAN BRUNO • CALIFORNIA  
Export Agents: Frazar & Hansen, 301 Clay St., San Francisco, California





# DC-AC CHOPPERS

*Triple Certified for Military Use*

**0-500 CPS**

Each production lot sampled and life tested to prove 1000 hours life while-cycled -55°C. to +85°C. No guesswork.

**1**

**2**

Every Chopper given not only 1 but 2 complete operating tests at -55°C. +25°C. +85°C. before shipment. Double proof of stamina. Nothing left to chance.

**3**

Gold contacts are used for superior results in the vital 0-1½ volt d-c range. No other material will match this fine performance.

Also available  
60 cycle types.

All military specifications met. Liberal safety factors to meet emergency conditions.

### EXAMPLES:

Frequency tolerance 0-500 cps.

Coil Voltage Tolerance:

+30% -20%

Noise level 200 microvolts.

Write today for complete information.

Catalog 280B 0-500 cps

Catalog 246D 60 cps

**STEVENS-ARNOLD**  
INCORPORATED

22 ELKINS STREET, SOUTH BOSTON 27, MASS.

highly versatile new 150 series system.

**Shock and Vibration Isolators.** The Barry Corp., 807 Pleasant St., Watertown 72, Mass. Product bulletin 538 presents detailed technical and application information on the series 670 and series 297. The units described are designed to reduce shock and noise caused by impact-type machines, and vibration and noise caused by heavy rotating and reciprocating machines. Isolators discussed are available in seven load ratings, covering the range from 500 to 4,400 lb per unit isolator. Included are data on dimensions and loads, installation procedures, variation of natural frequency with load, percent isolation of vibration for various frequencies and applied loads, and performance under shock.

**Short Slot Hybrid Junctions.** Microwave Development Laboratories, Inc., 220 Grove St., Waltham 54, Mass. Bulletin HJ-1 describes special features, gives electrical and physical characteristics of a line of short slot hybrid junctions that have found wide application in high-frequency radar and communications. Some applications are illustrated and described.

**Microwave Bolometers.** NARDA-Nassau Research & Development Associates, Inc., 66 Main St., Mineola, N. Y. A two-page color bulletin provides technical data on the N-821B bolometer, including resistance and sensitivity characteristics. Data are also included on the X-band frequency meter (Model 810) including a photograph of the unit.

**Measurement Techniques and Instrument Operation.** Sierra Electronic Corp., 1050 Brittan Ave., San Carlos 2, Calif. Five technical bulletins recently offered contain description, operation, application and measurement techniques for new instruments. Bulletin 101 covers directional couplers in the 10-kc to 3-mc range; bulletin 102—a line fault analyzer for locating telephone, telegraph and power line faults



$\frac{1}{2}$  to 200 miles distant; bulletin 103—model 121 wave analyzer for study of complex waveforms between 15 and 500 kc; bulletin 104—wideband directional couplers and crystal detector for power, vswr and match measurements from 30 to 1,500 mc; and bulletin 105—the model 141 wattmeter for r-f power measurement between 2 and 30 mc.

**Power Rectifiers.** McColpin-Christie Corp., 3410 W. 67th St., Los Angeles 43, Calif., has issued bulletins AC-54 and AC-54-1 on two lines of power rectifiers for aircraft use. The Stavolt rectifiers discussed are automatic voltage regulated types, and are engineered for applications requiring closely regulated d-c voltage. The Rectodyne manually controlled rectifiers covered are for applications requiring moderately stabilized d-c voltage, for 28½-v aircraft systems. Among features in both are the small, compact size and light weight. A new greatly simplified circuit is another important development.

**Stamping Manufacturers.** Pressed Metal Institute, 2860 E. 130th St., Cleveland 20, Ohio, has published a booklet containing an alphabetical listing of the facilities and services of all member companies. End products manufactured and sold by members of the institute are listed and numbered for reference to the page on which they can be found. The directory also contains suggested terms and conditions of sale for the pressed metal industry.

**Flexible Coaxial Cable.** Andrew Corp., 363 E. 75th St., Chicago 19, Ill. Bulletin 70-A illustrates and describes the type HX-O Heliac, a new  $\frac{3}{4}$  in. diameter r-f coaxial cable combining flexibility approaching that of solid dielectric cables with the high transmission efficiency of air dielectric cables. Complete technical characteristics are given.

**Microminiature Talytic Capacitors.** General Electric Co., Schenectady, N. Y. Bulletin GEA-6065 deals with microminiature Talytic-

# New, Improved Consolidated 7-300 recording galvanometers

*unequalled for performance and quality*

Products of a long range research program, CEC's new 7-300 series galvanometers incorporate better balancing techniques, new construction materials and a completely redesigned suspension system. The new 7-300 galvanometers are entirely new in design but fit all existing oscillographs, bringing increased control over linearity, sensitivity, damping, balance and stability. Smooth top-post rotation allows effortless, precise location of galvanometer light-spots on the record. Bodies are precision machined from solid stock for maximum strength, stability and ruggedness. Brass-tipped pole pieces, brazed in place under a hydrogen atmosphere, permit easy installation without forcible snapping into the magnetic block. Fourteen models give the new 7-300 series complete coverages of frequency ranges from 0 to 3000cps. For helpful information on the theory and use of galvanometers in general and for complete specifications on the superior 7-300 series, let us send you a copy of Bulletin CEC-1542-X2.

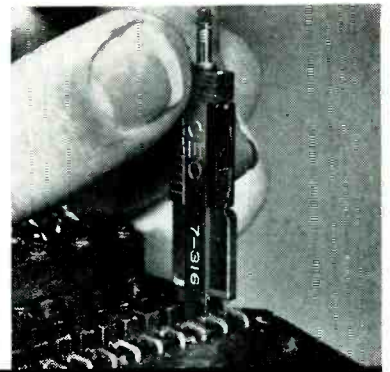

With bodies machined from solid stock and pole pieces brazed into place under hydrogen atmosphere, CEC's new 7-300 series galvanometers provide extreme ruggedness and dust-free closure.

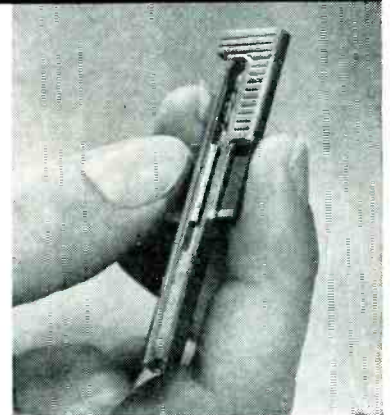

## Consolidated Engineering

CORPORATION

300 North Sierra Madre Villa, Pasadena 15, California

ANALYTICAL INSTRUMENTS  
FOR SCIENCE AND INDUSTRY

Sales and Service through **CEC INSTRUMENTS, INC.**, a subsidiary with offices in: Pasadena, Atlanta, Chicago, Dallas, Detroit, New York, Philadelphia, Washington, D. C.

92%

of  
UHF-TV WAVEGUIDE  
installations  
to date have been made  
by *Prodelin*  
using  
only aluminum

In Waveguide, PRODELIN is preminent... with all products field-proven... conserve power in UHF-TV. Call on PRODELIN to assist you in all phases of this important new development.

PRODELIN HAS SUPPLIED WAVEGUIDE TO ALL OF THESE STATIONS

- KACY — St. Louis, Mo.
- KETX — Tyler, Tex.
- KNUZ — Houston, Tex.
- KSTM — St. Louis, Mo.
- WEEU — Reading, Penna.
- WGLV — Easton, Penna.
- WHUM — Reading, Penna.
- WJHP — Jacksonville, Fla.
- WROW — Albany, N. Y.
- WTVU — Scranton, Penna.

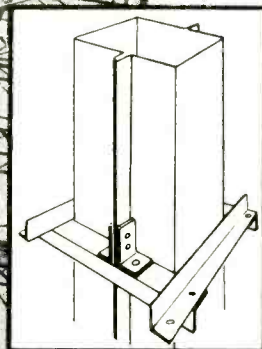

Write for complete, new catalog just off the press explaining in detail PRODELIN's leadership in Waveguide and associated system facilities.

**pdc** *Prodelin Inc* The World's Finest Transmission Lines  
305 Bergen Avenue  
Kearny, New Jersey  
Sales and Service Organization for PRODUCT DEVELOPMENT COMPANY, INC.  
Manufacturers of Antennas, Transmission Lines and Associated System Facilities

tic capacitors for low-voltage d-c applications. Included are an illustration and a diagram showing dimensions and tolerances. Ratings, specifications, application and prices are given.

**Electrostatic Voltmeter.** Sensitive Research Instrument Corp., 9 Elm Ave., Mount Vernon, N. Y. Volume 20, No. 9 of *Electrical Measurements* illustrates and describes the company's electrostatic voltmeter and its associated peak voltage adapter. Listed are full scale values, lowest readings, code words and prices.

**High-Vacuum Rectifier.** CBS-Hytron, Danvers, Mass., has prepared a series of design rating charts and curves defining the performance of its 5AW4 high-vacuum rectifier under a wide variety of operating conditions. The tube described is rated for continuous tv service. It has an A-frame construction for greater ruggedness, a heavy-duty 20-w filament for greater emission, and other engineering features that give it durability. It provides greater maximum average and peak currents, and it is also conservatively rated to provide large safety margins.

**Heavy-Duty Transformer Winders.** Geo. Stevens Mfg. Co., Inc., Pulaski Rd. at Peterson, Chicago 30, Ill., has released a catalog page describing its new model 147-AM heavy-duty transformer coil winder. Technical data are given on the types of coils wound, coil sizes and wire sizes handled, winding speed, motor equipment, set-up time, the instant reset automatic counter, the positive stopping magnetic brake, mounting and other features. The machine is also pictured.

**Precision Potentiometers.** Helipot Corp., 916 Meridian Ave., So. Pasadena, Calif. An eight-page illustrated technical paper, "Computing with Servo-Driven Potentiometers" examines linearity and loading effects in analog systems and shows how errors may be eliminated. Practical circuit techniques are discussed, including re-



striction of potentiometer range, preloading, and unloading with feedback amplifiers.

**High-Vacuum Rectifier.** Lewis and Kaufman, Ltd., 50 El Rancho Ave., Los Gatos, Calif. A new data sheet describes the Los Gatos brand 3B24W high-vacuum rectifier. The sheet illustrates the tube, provides outline dimensions and general characteristics. Average plate characteristics for this ruggedized half-wave rectifier are shown graphically for full-filament and half-filament operation.

**Connector Bulletin.** DeJUR-AMSCO Corp., 45-01 Northern Blvd., Long Island City 1, N. Y. The single-page technical sales bulletin No. 4 covers the series C-20 one-piece molded inserts hexagonal vibration-proof connectors. The connectors discussed insure constant reliability and performance under all conditions. Illustrations, description and specifications are given.

**Hermetic Seal Bushings and Terminals.** Helder Mfg. Corp., 238 Lewis St., Paterson, N. J. A complete line of MIL-T-27 and special transformer cases as well as compression-type bushing assemblies for hermetic sealing are illustrated and fully described in a new combined catalog. Complete with full engineering data, specifications and dimensional drawings, the illustrated bulletin covers the company's standard and nonstandard MIL-T-27 cases, hermetic seal bushing assemblies and assembly service.

**Curie Temperature Alloys.** International Nickel Co., Inc., 67 Wall St., New York 5, N. Y., has available bulletin A-167, featuring 6 pages, with 17 charts and illustrations. It contains data on the Curie temperature (the temperature at which a magnetic alloy becomes nonmagnetic) of many alloys and shows how this phenomenon is of importance. Four basic applications where the Curie temperature must be known are in devices that require: (1) strong magnetic properties over a wide temperature range; (2) a nonmag-

SERVOBIRD

"Let the Servoscope solve your 3D\* problems"

- \* Design —
- \* Development —
- \* Debugging

*of Servomechanisms—  
L-F Amplifiers—  
Electronic Systems*

With the Servoscope as a signal generator you can accurately and rapidly measure gain and phase shift of L-F amplifiers, servomechanisms, recorders and other circuits in the subsonic frequency ranges. Use it to develop designs and for production testing.

**Discovers Mistakes Before You Make Them**

Breadboard your intended servo system or other circuit designs—then, by either the frequency response or the transient response method, magnitude and phase curves can be obtained directly with only minutes of work.

**Only the  
SERVOSCOPE®  
offers all these advantages**

- Applicable to both AC carrier and DC servo systems.
- Generates Signals
  1. Sine-wave modulated carrier
  2. Low frequency sine wave
  3. Low frequency square wave.
- Built-in electronic sweep, phaseable with respect to generated signals.
- Dynamic frequency control range of 200 to 1.

For detailed information on how this versatile test instrument can save you man-hours, write Dept. E-4

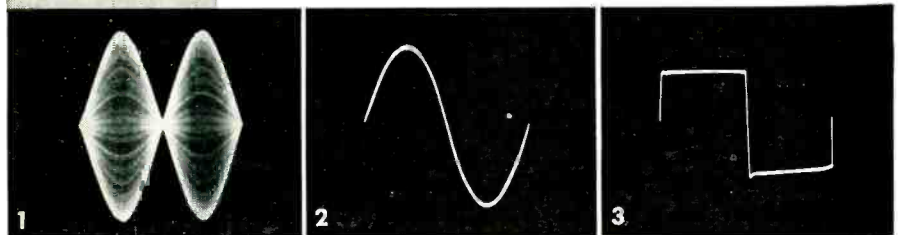

Output wave forms of Servoscope displayed against internal linear sweep generator, frequency 1/2 cps.

**SERVO CORPORATION OF AMERICA**  
New Hyde Park, New York

SC 114

# FEED-THRU SUPPRESSION CAPACITORS



Tobe feed-thru suppression capacitors provide simple, easily applied means of obtaining high attenuation of radio interference. Connected in series with any single line carrying radio interference, these three-terminal capacitors provide attenuation that increases with frequency, far beyond the point at which conventional "non-inductive" capacitors become self-resonant. The style

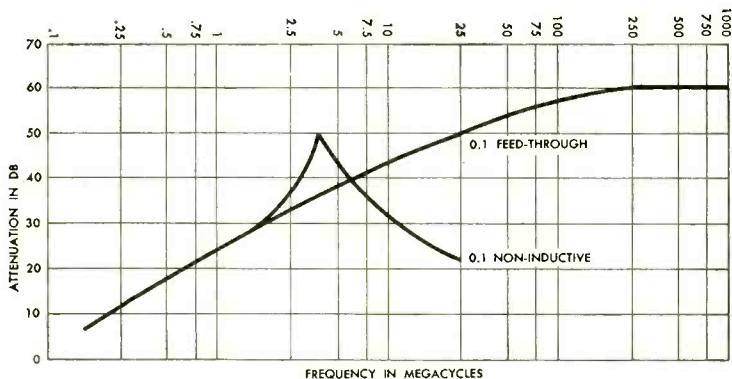

F1 unit shown is contained in a hermetically sealed, grounded, metal case with provision for single-hole mounting thru a bulkhead. Other mounting and terminal styles are available. These units will carry up to 250 amperes at voltages up to 4000 v.d.c. Detailed performance characteristics and data on specific applications will be furnished on request.



**TOBE DEUTSCHMANN**  
CORPORATION  
NORWOOD, MASSACHUSETTS

NEW PRODUCTS

(continued)

netic alloy having strength and other desirable properties as provided by nickel and iron; (3) special expansion alloys used for glass-to-metal seals, bimetal or in precision instruments; and (4) magnetic properties of the alloy to change with temperature, used for instrument compensation and the like. Some specific applications are given.

**Power Supplies.** Allied Engineering Div., Allied International Inc., Connecticut & Richards Aves., South Norwalk, Conn., offers its newest bulletin on power supplies for voltage regulation. The 8-page, 3-color catalog presents 5 standard models, including a miniature unit measuring 8 in. × 5 in. × 5½ in. overall. Clear illustrations and factual engineering specifications are given for each type of supply. The specifications provide information on input voltage requirements, voltage and current outputs, percent regulation, ripple, ambient temperature operating range, standard meters supplied and complete mechanical specifications. Included in the literature is a detachable specification sheet for those wishing price quotations on custom-built power supplies.

**Measuring Phase Shift.** Technology Instrument Corp., 531 Main St., Acton, Mass. Laboratory Report No. 8 featuring "A Method of Measuring Phase Shift through a Computing Magnetic Amplifier Using the Type 7000-A Primary Phase Standard" is available upon request. An additional feature deals with the measurement of small angles in the vicinity of zero degrees with the type 320-AB phase meter.

**Vibration Isolator.** The Barry Corp., 807 Pleasant St., Watertown 72, Mass. Product bulletin 537 presents detailed technical and application information on the series 262 and 633 Barrymounts for light industrial applications. Included are data on dimensions and load ratings, installation procedure, variation of natural frequency with load, and percent efficiency of isolation. Both series are designed to isolate vibration and noise caused by motors or



motor-driven equipment applying static loads of 30 to 260 lb to each unit isolator. Isolation of 60 percent to 85 percent of structure-borne vibration is obtained at 20 cps (1,200 rpm), and 95 percent or better at 1,800 rpm.

**Oscillograph Tubes.** National Union Radio Corp., Jacksonville Road and Summit Ave., Hatboro, Pa. A recent data sheet announces the new 8CP type 8½-in. oscillograph tubes. The six types described are electrostatic focus and electrostatic deflection tubes, differing only in the characteristics of the fluorescent screen. Other features are a zero first anode current electron gun and high voltage post accelerator electrode. The data sheet gives complete electrical and mechanical characteristics.

**Differential Pressure Potentiometer.** Bourns Laboratories, 6135 Magnolia Ave., Riverside, Calif. A 2-page data sheet No. 508 gives complete technical information on a new diaphragm bellows-type differential pressure potentiometer in standard ranges from 0-to-1 to 0-to-30 psi. Included are photographs, an outline drawing, a temperature-vs-deviation graph and complete detailed specifications covering such information as linearity, hysteresis, resolution and the effects of vibration and acceleration.

**Picture Tube Selector.** Allen B. DuMont Laboratories, Inc., 750 Bloomfield Ave., Clifton, N. J., has made available the picture tube selector, a pocket-size, slide-rule device that solves most picture tube replacement problems. It gives complete electrical values, basing, and important physical features for 36 major replacement picture tube types. Over 100 other tube type listings are indexed according to interchangeability with the basic types.

**Communications Receiver.** Hammarlund Mfg. Co., 460 W. 34th St., New York 1, N. Y., has announced a 2-color-, 4-page bulletin describing in detail the designs, specifications and operating procedure of its newest communications receiver, the HQ-140-X. The folder

# U. G. CONNECTORS

*Our Coaxial Cable Connectors Meet All Government Specifications*

**ALL ORDERS DELIVERED PROMPTLY**

*Manufacturers of Highest Quality Connectors*

**1** A1-11022—High voltage quick disconnect plug similar to, but does not mate with BNC. Weatherproof. Teflon insert. For use with RG-59, 62, and 71/U cable. Constant impedance of 50 ohms. Operating voltage—5 kilovolts. Operates satisfactorily to 10,000 megacycles.

**2** UG-154/U—A1-11070—Type LC Plug for use with RG-17/U cable. Fifty ohm impedance. Weatherproof. Five kilovolt rating. It may be used with RG-19/U cable at a rating of 10 kilovolts.

**3** UG-21D/U—A1-11072—Improved Type N Plug. Mates with standard type N and improved Type N Jacks. For use with RG-8, 9, 9A and 10/U cable. Weatherproof. Performance is good to 10,000 megacycles. Nominal impedance—50 ohms. May be used with 70 ohm cable if impedance matching is not important.

**4** MX-554/U—A1-11039—Type BNC Termination. Mates with BNC Receptacles and Jacks. Weatherproof. Furnished at any desired impedance. Operating frequencies same as standard BNC.

**5** A1-11047—High voltage quick disconnect right angle adapter. One male—one female end. Similar to, but does not mate with, BNC series. Weatherproof. Teflon inserts. Constant impedance of 50 ohms. Operating voltage—5 kilovolts. Operates satisfactorily to 10,000 megacycles.

**6** UG-355/U—And UG-356/U—A1-11006 Klystron Coupler. The UG-355/U couples two type N Jacks to a 726 C Klystron. The UG-356/U couples two type N Jacks to a 2K29 Klystron.

**7** UG-37A/U — A1-11032 — Ceramic insert, pressurized, high voltage receptacle. Weatherproof. Operating voltage—15 kilowatts. Flash over does not break down insulation. May be operated with high temperatures with no break down in pressure seal.

## ALLIED INDUSTRIES, Inc

2500 WOODLAND AVE.  
LOUISVILLE 10, KY.

# INTRODUCING...

# Dyna-Chek

**A DYNAMOMETER  
FOR MEASURING  
MOTORS OF  
2 HP AND UNDER.**

The DYNA-CHEK dynamometer was designed and developed in our own laboratories and proven by many years of service in production testing of our own motors. Depending upon associated equipment, DYNA-CHEK will accurately measure motors within 1/10th of 1%. DYNA-CHEK is available as the basic unit or in complete custom installations. For further details write for bulletin 154.

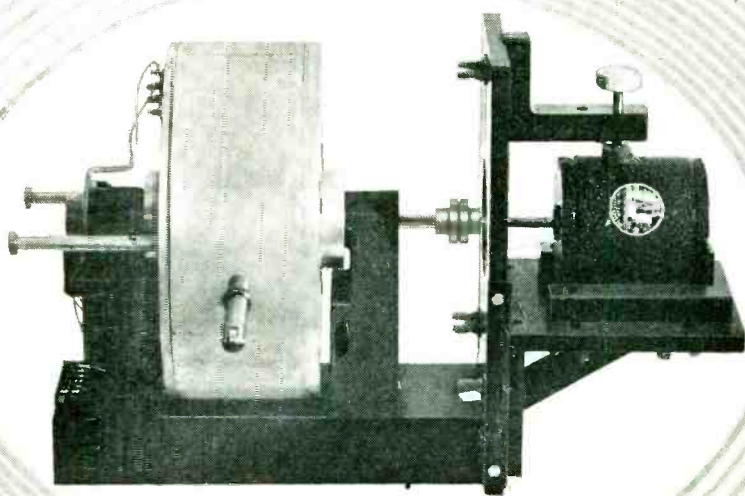

DYNA-CHEK is another quality Western Gear Works product. WESTERN GEAR WORKS has been a leader in the power transmission field since 1888.

Direct inquiries to:  
**Mr. B. A. Bannan, Vice-President**

**MISSION-  
WESTERN**

ENGINEERS, INC.  
132 W. Colorado Street  
Pasadena, California

pictures in detail, also, the layout, construction and physical design of the receiver, which is built for both amateur and professional use. The HQ-140-X covers the frequencies from 540 kc through 31 mc in six bands. Bandspread dial calibrations are for the 80, 40, 20, 15 and 10-meter bands.

**Leveling Mounts.** Barry Corp., 1100 Pleasant St., Watertown, Mass., has available a brochure dealing with its new leveling Barrymounts. The brochure outlines such advantages of the new LM-3 and LM-5 series as the installation and leveling of heavy machines without bolting or shims, increased plant mobility, reduced maintenance costs and lessening of the noise level.

**Relay Data File.** Price Electric Corp., Frederick, Md., has compiled a handy relay data file containing specifications and photographs of 42 relay types. The file serves as a convenient reference for both commercial and military relays and is no larger than an ordinary file folder. There are no loose sheets or attachments; all information being printed on the body of the folder itself. Information provided includes contact arrangements and rating, coil data, dimensions and weight. Requests for copies of the folder should be made on company letterhead.

**High Impedance Input Instrument.** Minneapolis-Honeywell Regulator Co., Wayne & Windrim Aves., Philadelphia 44, Pa. Data sheet 10.0-14 describes the Elektronik high impedance input instrument that can be used with source impedances varying from 0 to 50,000 ohms, without serious impairment of sensitivity, speed of response or damping. No d-c preamplifier is required. The instruments described are available for spans of 2 mv or greater, or 10 mv or greater.

**Liquid Level Indicator Systems.** Bogue Electric Mfg. Co., 52 Iowa Ave., Paterson, N. J., has available an 8-page booklet describing the operations of liquid level indicator systems using ultrasonic pulses. The bulletin, No. S-68, de-



scribes the systems, which use no moving parts but nevertheless accurately indicate liquid levels in petroleum, chemical and pharmaceutical processing and storage tanks within  $\pm 0.01$  ft. Included in the booklet is information on the application engineering and diagrams describing typical installations in different types of storage tank.

**Mercury Switches.** Micro Switch, a division of Minneapolis-Honeywell Regulator Co., Freeport, Ill., has published a 12-page, 2-color catalog No. 90 covering standard designs of mercury switches for use in a-c or d-c industrial and commercial switching applications that provide low force and tilt motion. It covers five families of switches, classified as protected, heavy duty, general use, small and sensitive mercury switches. In all, 29 catalog listings are included. The catalog gives complete information on each switch, including dimensions, description, electrical rating, differential angle, lead wires and the type of application that each switch is suited for. A complete section on technical data and application aids is included. Another section pictures and describes typical applications.

**Pulse Networks.** Corson Electric Mfg. Corp., 540 39th St., Union City, N. J. Pulse capacitor and pulse network design and production facilities are described in a 2-color bulletin. The single  $8\frac{1}{2} \times 11$ -in. sheet also illustrates typical company units, shows a typical installation (in a 10-megawatt test modulator), reproduces on oscillograph of a typical Corson waveform and discusses deliveries and ordering information.

**Amplifier System.** Heiland Research Corp., 130 E. Fifth Ave., Denver, Colo., has available the 5-page illustrated bulletin 107 with complete information and specifications on the model 119 amplifier system. It presents detailed descriptions of the various features, operation and applications of the 5,000-eps carrier-type amplifier system for static and dynamic recording.

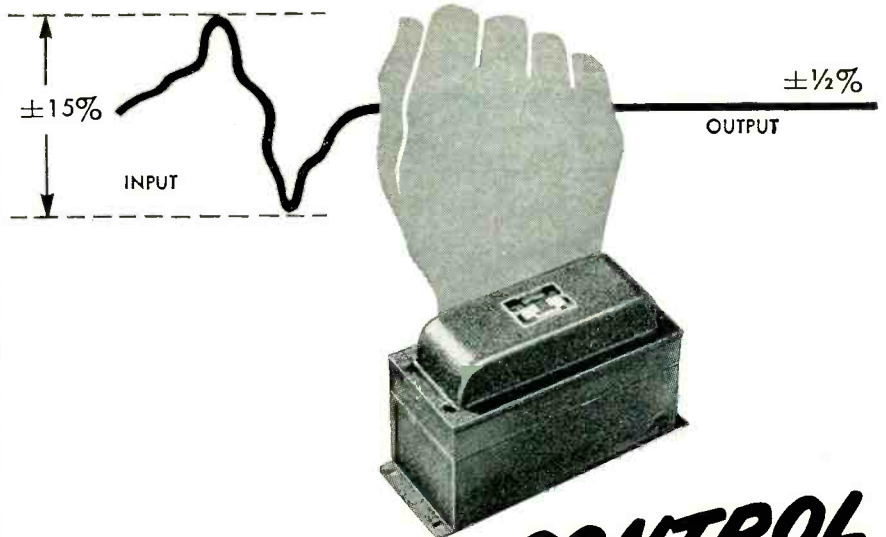

## SMOOTHER CONTROL OF WIDER VARIATIONS IN LINE VOLTAGE WITH **RAYTHEON** **VOLTAGE STABILIZERS**

Smooth output from a wider range of input voltages is just one example of how Raytheon Voltage Stabilizers excel other makes. All models are compact, light in weight and ruggedly built with no moving parts to wear out.

Standard catalog models rated from 15 to 2000 watts are carried in stock by 125 parts distributors from coast to coast... can be built into your equipment or used as an accessory. Custom engineered units from 5 to 10,000 watts are also available for military or commercial applications.

*Write for complete information and performance data.*

**RAYTHEON**  
*Excellence in Electronics*

**RAYTHEON**  
MANUFACTURING COMPANY  
EQUIPMENT SALES DIVISION  
DEPT. 6270A WALTHAM 54, MASSACHUSETTS  
DISTRICT OFFICES: BOSTON, NEW YORK, CLEVELAND, CHICAGO, NEW ORLEANS, LOS ANGELES (WILMINGTON), SAN FRANCISCO, SEATTLE  
INTERNATIONAL DIVISION: 19 RECTOR ST., NEW YORK CITY

RAYTHEON PRODUCTS INCLUDE: WELDPower\* welders; Voltage stabilizers (regulators); Transformers; Sonic oscillators for laboratory research; Standard control knobs; Electronic calculators and computers; Radio, television, sub-miniature and special purpose tubes and other electronic equipment. \*Reg. U. S. Pat. Off.

### TESTS PROVE 10 POINTS OF RAYTHEON SUPERIORITY

1. Deliver accurate AC voltage within  $\pm 1/2\%$
2. Stabilize output with more precision
3. Regulate better at full load
4. Hold up better under overload
5. Better no-load to full-load regulation
6. Accept wider input voltage range
7. Less voltage change as units heat up
8. Less change in output as frequencies fluctuate
9. Smaller, lighter, more compact, no moving parts
10. Cost less to operate

# PLANTS AND PEOPLE

Edited by WILLIAM G. ARNOLD

Industry associations name new officers . . . Manufacturers announce further plant expansions . . . Engineers and executives are promoted . . .



## Western Electronic Show Board Meets

THE 1954 WESCON board of directors held its first official meeting in Los Angeles. The Western Electronic Show and Convention, sponsored jointly by WCEMA (West Coast Electronic Manufacturers' Association) and the Los Angeles and San Francisco sections of IRE, will take place in Los Angeles August 25-27. Seated around the table are, left to right: R. A. Huggins of Huggins Labs;

W. E. Noller of Lynch Carrier; T. P. Walker of Triad Transformer, vice-chairman; Jeanne W. Jarrett, recording secretary; W. D. Hershberger of the University of California at Los Angeles, chairman; C. F. Wolcott of Gilfillan, vice-chairman; L. B. Ungar of Ungar Electric Tools, secretary-treasurer; Mal Mobley, Jr., business manager; N. E. Porter of Hewlett-Packard and J. H. Landells, Westinghouse.

## RETMA Conference Plans New Industry Actions

CULMINATING a three-day industry conference in New York City, RETMA took steps to facilitate the elimination of tv set radiation, to urge Congress to exempt color tv from excise tax and to support a research program in educational tv.

R. C. Sprague, RETMA board chairman, was authorized to appoint a committee to establish

procedures and facilities, after consultation with FCC, so that set makers can eliminate sources of tv interference.

President Glen C. McDaniel and the tax committee were authorized to renew their efforts to eliminate or reduce the wartime excise tax on tv sets and to make a special plea for temporary exemption of

## OTHER DEPARTMENTS

featured in this issue:

	Page
Electrons at Work . . . . .	196
Production Techniques . . . . .	242
New Products . . . . .	292
New Books . . . . .	398
Backtalk . . . . .	404

color tv sets in line with the customary waiver on new products and industries.

The radio-tv industry committee, under Max F. Balcom, tactily approved a proposal that tv manufacturers provide equipment for an educational research project at New Jersey State Teachers College at Montclair. The project, which has the support of the Ford Foundation, is designed to develop proper techniques for effective use of tv in school classrooms.

Reports on the outlook for military requirements for electronic equipment were made at the meeting. Present indications are that government spending for electronic military products in the fiscal year 1955-56 will be higher than expenditures in this field during the current fiscal year.

The problems retarding the growth of uhf broadcasting were discussed. It was the consensus of set division executive committee members that the growth of uhf is not being hampered by the shortage of either receiving or transmitting equipment.

The RETMA board adopted a resolution complimenting the FCC on its speedy handling of new tv station applications, including uhf, and its adoption of the NTSC color tv proposal. Earlier, the dissolution of NTSC was announced by its chairman W. R. G. Baker of GE. Referring to the work of the NTSC, Dr. Baker said: "For the second time engineers and scientists of the tv industry and allied fields have given freely and unselfishly of their time and efforts to create successfully a new service for the American public. The first NTSC created



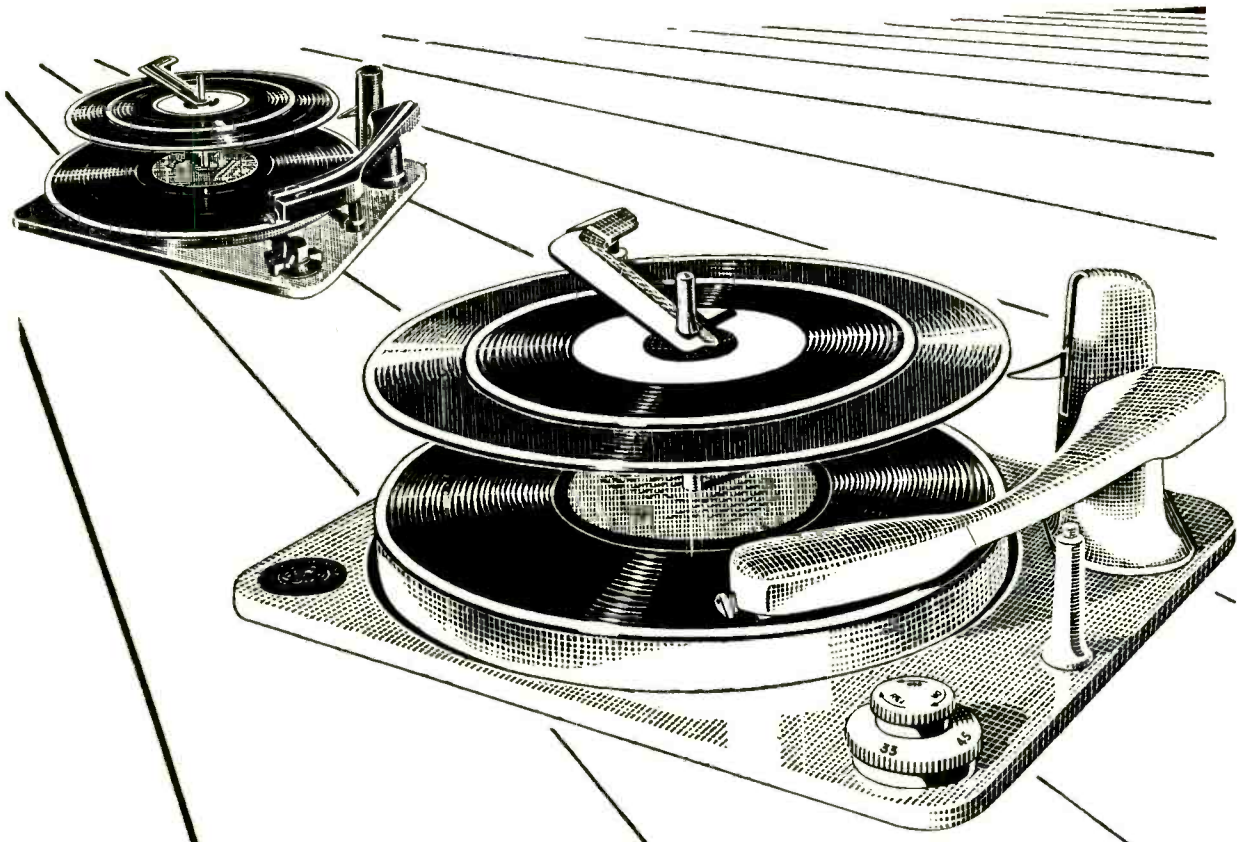

# *New Make-up for famous features*

Everyone knows the Monarch couldn't be better, but the universally acclaimed features have been given a new-look. It's fresher—smoother looking—superfinely finished. In fact it's a new conception that still stars—

- ★The 'Magidisk'—that exclusive feature of the Monarch that selects any record, any size, in any order.
  - ★The quickest changeover that gives uninterrupted pleasure.
  - ★The hidden music discovered by the BSR dual stylus cartridge.
  - ★The control—so simple—so handy.
- That is why it is agreed that the Monarch is the World's Finest and most wanted Auto-changer.



**WORLD'S FINEST AND MOST WANTED AUTOCHANGER**

**BIRMINGHAM SOUND REPRODUCERS LTD. OLD HILL, STAFFS. ENGLAND**

the standards for black-and-white tv. The present NTSC, after 3 years intensive work, has made possible the introduction of color tv."

In a letter to all of the members and alternates Dr. Baker said: "I would like to thank each member of the organization for the great effort they put behind this work. Especially do I appreciate your cooperation and understanding which to no small extent has made pos-

sible the outstanding results of the second NTSC."

In another action, RETMA filed a statement with the Senate Committee on Labor and Public Welfare supporting the President's recommendation for a secret strike ballot after a strike or work stoppage has started. According to the statement, RETMA supports a strike vote amendment to the Labor-Management Relations Act

because it would give recognition to the rights of individuals. The post strike vote is advocated in the statement because "in most instances no clear cut issue on which to vote could be presented to the employees prior to a strike". Also "employees could hardly be expected to hamstring their representatives and weaken their bargaining position by announcing through a vote that the possibility of a strike was cut."



J. Myers, western district manager and T. B. Moseley, southern district manager.

According to the company, sales of station and studio broadcast equipment have more than tripled from 1952 to 1953. Shipments to broadcasters in the past year were 167 percent greater than in 1952.

### New Committee Names Officers

A CONFERENCE COORDINATING COMMITTEE, which was established by six trade associations within the electronics industry to coordinate regional conferences run by sales representatives, has designated Russ Diethert, national president of The Representatives, as its chairman and S. L. Baraf of United Transformer as its co-chairman.

The six associations which participated in the committee are the National Electronic Distributors Association, West Coast Electronic Manufacturers Association, Radio Electronics Television Manufacturers Association, Eastern Group of the Sales Managers Club, Association of Electronic Parts and Equipment Manufacturers and The Representatives of Electronic Products Manufacturers.

### Hi Fi Institute Is Organized

THE HIGH FIDELITY INSTITUTE of the Electronic Industries, a non-profit association to promote the interests of the high-fidelity indus-

## Du Mont Aligns Communication Division

MANAGERS of the recently formed communication products division of DuMont Laboratories have been appointed. Executives of the mobile communications department, shown discussing sales and merchandising plans, are, left to right: Fred M. Link, director of operations for the department and formerly president of Link Radio; C. J. Harrison, department sales manager and previously marketing manager for the transmitter division; Herbert E. Taylor, Jr., manager of the communication products division and formerly manager of the transmitter division; and Robert E. Kessler, assistant division manager.

In the division's new tv transmitter department, James B.

Tharpe, formerly sales manager of the tv transmitter division, was named national sales manager. He joined the firm in 1947 as an engineering consultant to the transmitter sales department and in 1949 was appointed sales manager.

Named to aid Tharpe in the new setup is Kenneth F. Petersen, who was appointed marketing manager of the department. He joined WABD as maintenance engineer and later became supervisor of technical facilities for WPIX.

Others appointed to the new transmitter department are Charles E. Spicer, sales operations manager; Lewis C. Radford, eastern district manager; Herbert Bloomberg, central district manager; R.



# Advanced Flybacker Cuts Down Test Time

**RCP Model 123 Provides Fast, Reliable Check of Flyback Transformers and Yokes**

Designed for speedy testing of the horizontal output circuits in all TV receivers, the Flybacker is the latest design to come from the laboratories of the Radio City Prod-

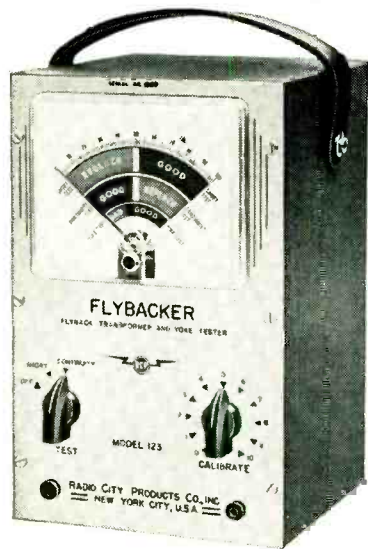

The RCP Flybacker is reasonably priced at only \$39.75

ucts Co., 152 W. 25th St. New York 1, N. Y.

Extremely sensitive, the Model 123 Flybacker immediately shows up a shorted turn in a flyback transformer or yoke.

All tests can be carried out with the components in place in the TV receiver. Flyback transformers and yokes in stock can be checked for opens, shorts, etc. Flybacker tests are also applicable to inductive windings on any transformer, choke speaker, solenoid, relays, etc., where the impedance is not relatively low. In fact, the instrument may be used as a proportional AC ohmmeter.

### Easy to Operate

Minimum of connections necessary. All you do is remove flyback plate caps—set switches—apply leads and then read meter. The slightest change in inductance due to a shorted turn or the effect of intermittents shows up on the meter immediately as "BAD".

Extra features provide added efficiency:—

- Three "GOOD BAD" Scales.
- One Scale For Yokes.
- Tests Low and High Impedance Yokes.
- Direct Reading Numbered Scale.

- Tests while components are in TV receiver.
- Tests high impedance sections of all transformers.

First introduced in December of last year, the instrument was an immediate success. Users everywhere have heaped praise upon its efficiency and advanced design.

## Signal, Marker, and Pattern Generator Combined in TV "DO-All"

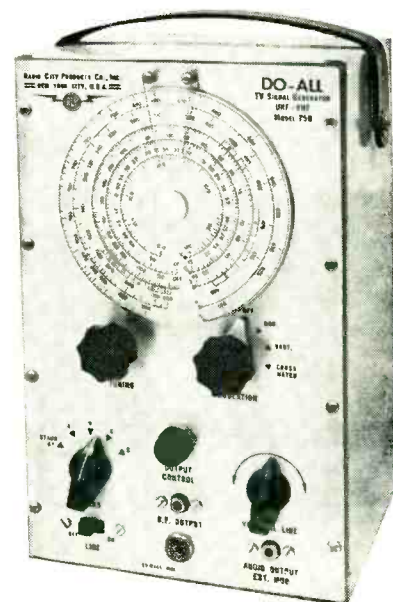

The RCP Model 750 is priced at only \$79.50

In the "DO-All" TV Signal Generator Model 750, the Radio City Products Co. has combined, in one instrument, the facilities of a signal generator, marker generator, and pattern generator for both UHF and VHF.

Versatile in concept, the RCP Model 750 can check, test and align front ends, IF's, sound and pix traps, linearity, syncs, sweeps, positioning, focus and deflection. Designed for portable or bench use, the Model 750 reflects the finest in construction and appearance. It is handsomely finished in an attractive brushed aluminum panel with a steel carrying case.

The superior design of the RCP Model 750 provides for the following advantages:

- Inductuner insures accuracy of within  $\frac{1}{2}$  of 1% over the entire range of 9Mc to 900 Mc.
- All VHF frequencies are on fundamentals.
- RF's and IF's are clearly calibrated on a large etched aluminum dial.
- Steady horizontal bars, vertical bars and crosshatch individually produced on all channels.

## Perfected Peak-to-Peak Measurement Achieved With VTVM "DO-ALL"

New circuit developments inherent in the RCP Model 655 provide for the efficient and accurate measurement of complex waveshapes. It

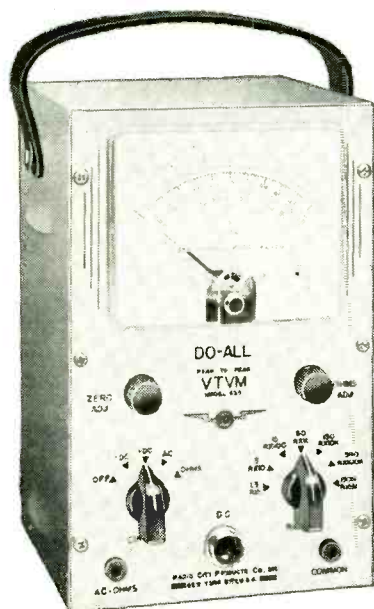

RCP Model 655 provides for the accurate measurement of complex waveshapes.

gives a true reading measurement of complex and sinusoidal voltages with necessary peak-to-peak or RMS value read directly for analysis of waveforms in video, sync and deflection circuits.

Versatility of measurement, built into each Model 655, serves a variety of industrial applications in the service of vibrator power supplies, AC generators and all equipment utilizing any type of waveform or DC.

The range and the coverage available with the RCP Model 655 provides a multitude of advantages. For example, peak-to-peak AC measurements of from .2V to 4200V on 7 ranges; AC RMS measurements of .1V to 1500V on 7 ranges; DC measurements of from .02V to 1500V on 7 ranges; RESISTANCE measurements of from .2 ohms to 1,000 megohms on 7 ranges.

Considering the many advantages available, the price—only \$59.50—beats any competitive product on the Market. Of high impedance design, the Model 655 makes use of an electronic balanced push-pull circuit and peak-to-peak rectification. The result is an absence of circuit loading, waveform error or frequency distortion.

For further information write Dept. E-4, Radio City Products Company 152 West 25th Street, New York 1, N. Y.

# now...TEFLON\* with Certified performance

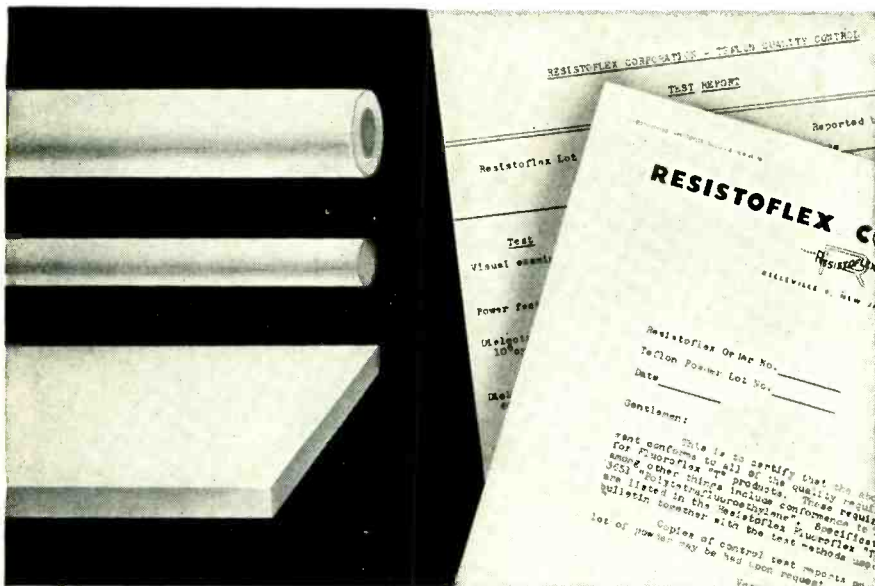

*Conformance to specifications assured  
in FLUOROFLEX®-T rod, sheet, tube*

Resistoflex will certify each shipment of "electrical grade" Fluoroflex-T products on six vital physical and electrical properties. Qualification tests are performed on all incoming Teflon powder to determine whether it will yield rods, tubes and sheets which are in conformance with specification AMS-3651 "Polytetrafluoroethylene." Processing under a quality control and inspection system approved by the USAF under MIL-Q-5923 specification maintains the identity of each lot of material through all stages of manufacture — from virgin powder to finished product.

An affidavit accompanies each shipment attesting to its conformance with AMS-3651. Certified test reports of the actual properties of any shipment will be furnished whenever they are requested.

Be sure of optimum performance in Teflon by specifying electrical grade Fluoroflex-T. Remember, too—Fluoroflex-T products are non-porous and stress-relieved. This means better dimensional stability, less costly machining and fewer rejects. For more details, write or phone...

\*DuPont trade mark for its tetrafluoroethylene resin.  
©Resistoflex trade mark for products from fluorocarbon resins.

## RESISTOFLEX

corporation

Belleville 9, N. J.

Want more information? Use post card on last page.

PLANTS AND PEOPLE

(continued)

try, was organized in Los Angeles. Its purpose is to work for uniformity of technical standards for the high-fidelity industry, new and increased markets, the establishment of equitable trade practices, effective promotional methods and generally to promote welfare of this industry.

Jerome J. Kahn of Chicago was named temporary commissioner of the group to launch the program outlined by it and to serve in a liaison capacity in the industry. Pending permanent organization of the group, he will serve without pay. Temporary headquarters of the institute will be in Chicago.

The six-man provisional board of governors includes: C. A. Hansen of Jensen, L. Carduner of British Industries, E. Berlant of Berlant Associates, G. Yarbrough of American Microphone, J. H. Cashman of Radio Craftsmen and W. O. Stanton of Pickering.



### TV Academy Presents Award To NTSC

L. HOFFMAN, president of Hoffman Radio, left, accepted the TV Academy's "Emmy" award to the National Television System Committee for the compatible color tv system. Ed Sullivan, master of ceremonies, lauded the tv industry for "contributing more than a million man-hours to bring color tv to the American people."

### The Representatives Membership Climbs

THE Representatives of Electronic Manufacturers recently added seven new members from Canada, one from Honolulu and 21 from



**for HIGH or LOW temp.**

**Specify Injection Molded  
SILICONE RUBBER**

Designers of original equipment now specify silicone rubber parts if they must undergo *extreme temperature changes* or if they require *constant dielectric properties*. Insulators, bushings, grommets and other small units are in continuous mass-production in our plants. *Prompt quotations on receipt of your sample or blueprint.*

**MINNESOTA SILICONE RUBBER CO.**  
5724 West 36th Street • MINNEAPOLIS 16, MINNESOTA

Affiliated with Minnesota Rubber & Gasket Co.  
OFFICES IN PRINCIPAL CITIES

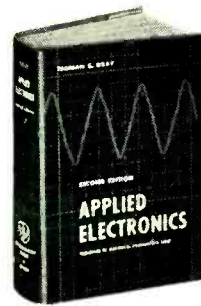

**Now  
ready . . .  
Applied  
ELECTRONICS**

2nd Edition

A Publication in *The Principles of Electrical Engineering Series*, M. I. T.

By **TRUMAN S. GRAY**  
The Massachusetts Institute of Technology

The 2nd edition of this classic work retains the purpose and much of the plan of the first edition. The major aims in its revision have been: to improve and clarify details; to bring the coverage up to date; and to include new developments such as *semiconductor rectifiers* and *transistors*.

It first explains the physical phenomena which form the fundamentals of electronics. Then it tells how the phenomena combine to govern the characteristics, ratings and limitations of electronic devices. Final chapters deal with various applications of electronics in different branches of electrical engineering.

*Applied Electronics* presents a clear picture of the subject, starting from elementary facts and principles. For those who have already gained a basic knowledge, its foundational treatment and practical illustrations and problems will provide a useful means for further study and reference.

1954    882 pages    illus.    \$9.00

**Introductory  
CIRCUIT THEORY**

By **ERNST A. GUILLEMIN**  
The Massachusetts Institute of Technology

Here are all the basic concepts and interpretations you need to keep up with the modern approach to advanced problems involving circuit theory. Complete with valuable graphic interpretations and computation aids.

1953    550 pages    illus.    \$8.50

**Mail for Your ON-APPROVAL**

Copies Now

**JOHN WILEY & SONS, Inc.**  
440 Fourth Ave., New York 16, N. Y.

Please send me the book(s) checked below for **FREE** examination. Within ten days I will either return the book(s) and owe you nothing or will remit the price(s) indicated, plus postage.

Applied Electronics, 2nd Edition, \$9.00  
 Introductory Circuit Theory, \$8.50

Name .....

Address .....

City ..... Zone.... State.....

**SAVE! POSTAGE!** Check here if you **ENCLOSE** payment, in which case we pay postage. Same return privilege. (E-44)

*Heathkit*  
**TEST EQUIPMENT**

BUILD YOUR OWN — INCREASE KNOWLEDGE — SAVE MONEY — BUY DIRECT FROM MANUFACTURER . . . Top quality instruments in kit form featuring latest design and circuit developments. Completely detailed step-by-step construction manual — clear pictorials — complete schematics. All sheet metal work punched, formed and finished. Low kit prices include tubes, chassis, cabinet and all necessary constructional components.

Kits for the school — service shop — industrial laboratory — hobbyist, etc.

Write for free catalog for further information.

**HEATH COMPANY**  
BENTON HARBOR 14,  
MICHIGAN

**GRID DIP METER KIT**  
\$19.50

**TUBE CHECKER KIT**  
\$29.50

**VACUUM TUBE VOLTMETER KIT**  
\$24.50

**CONDENSER CHECKER KIT**  
\$19.50

**NEW MULTIMETER KIT**  
\$26.50

**SIGNAL TRACER KIT**  
\$23.50

**NEW SCOPE KIT**  
\$59.50

**SIGNAL GEN. KIT**  
\$19.50

# IN A CLASS BY ITSELF

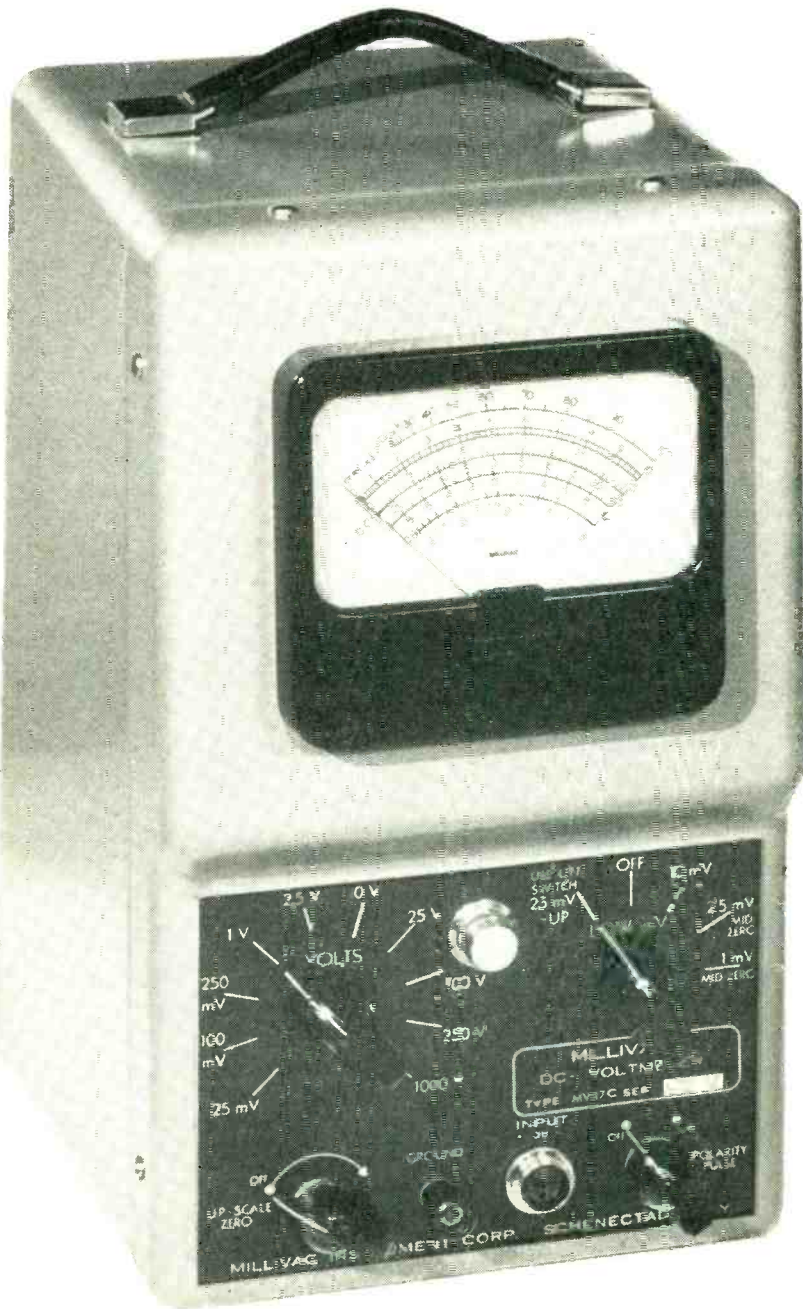

**MILLIVAC MV-17C**  
**100 MICROVOLTS to 1 KV-DC.**

TIME PROGRESSES—SO DO WE

**MILLIVAC INSTRUMENT CORPORATION**  
P.O. BOX 997, SCHENECTADY, NEW YORK

various regional chapters, bringing membership to 439 seniors, 200 associates and 1 honorary for a grand total of 640 members.

The New York chapter is the largest single unit of the organization. It recently topped the 100 mark in total membership.

Chicago has the second largest chapter with 96 members.

## Philco Appoints Two Chief Engineers

WILSON P. BOOTHROYD was appointed chief engineer of the advance development laboratory for Philco's tv and radio division. Harris O. Wood was named chief engineer of the tv division of the company.

Boothroyd has been in charge of Philco's engineering and development laboratory for the past four years. He is known for special research on microwave communication and television involving synchronizing circuits and color tv.

Wood has been in charge of the company's tv receiver design since 1951. During World War II he achieved an outstanding record at Philco in the design of radar and electronic equipment for the government, the company said. He was recently appointed chairman of the tv receiver committee of RETMA.

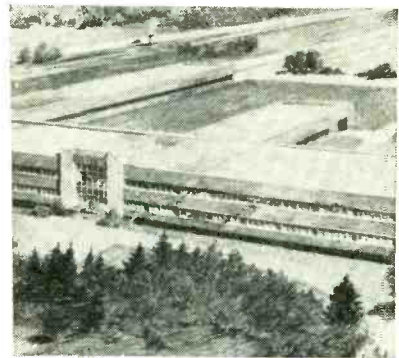

## Raytheon Plans Electronics Laboratory

TENTATIVE plans for the construction of a large electronics engineering and research laboratory in Wayland, Mass., 20 miles from Boston, were announced by C. F. Adams, Jr., president of Raytheon.

The plans are conditioned upon the completion of satisfactory arrangements with the officials of the town of Wayland and suitable fi-



# ALLIED

world's largest distributor of  
**ELECTRON TUBES FOR INDUSTRY**

**ALL BRANDS  
IN STOCK**  
AMPEREX  
G.E.  
EIMAC  
RCA  
RAYTHEON  
SYLVANIA  
TAYLOR  
TUNGSOL  
VICTOREEN  
WESTINGHOUSE  
and others



Everything in  
Electronics from  
One Dependable Source



## IMMEDIATE DELIVERY FROM STOCK

ALLIED stocks for *quick shipment* the world's largest distributor inventory of special-purpose electron tubes. We specialize in supplying the needs of industrial, broadcast, governmental and other users. To save time, effort and money—phone, wire or write to ALLIED for fast expert shipment.

Refer to your ALLIED Catalog for all electronic supplies. Write today for a FREE copy of the complete 268-page 1954 ALLIED Catalog.



**ALLIED RADIO**  
100 N. Western Ave.  
Dept. 11-D-4, Chicago 80, Ill.



## For your most **EXACTING REQUIREMENT** in **VINYL SLEEVING**



The more exacting your requirements in vinyl sleeving, the more reason to buy from Resin Industries. Precise compounding and meticulous workmanship assure strict adherence to specifications. Rigid quality control guarantees uniformity; and prompt, understanding service eliminates purchasing headaches. That's why Resinite is the largest supplier of vinyl sleeving to the aircraft industry. Send the coupon today for samples and prices.

# SHOCK PROOF

## VACUUM TUBE RETAINERS

These retainers are used to secure Vacuum Tubes and to resist side motion of Vacuum Tubes used in radio equipment which is subject to shock and vibrations. These retainers meet the requirement of all JAN specifications. The insulated portion is made of a melamine base Fibre Glass Phenol which provides 300 volts insulation to ground and withstands a temperature of 350 F. The insulated plate can readily be fastened or released by hand.

Available for envelope types T7, T8, MT8, T9, T12, ST12, T12ZDL, ST14, S14, ST16, T5½, T6½, MT-1C, ST19, T14, ST128CT-9.

*Manufacturers of  
Electronic Components*

# JAMES IPPOLITO & CO., INC.

401 CONCORD AVENUE, BRONX 54, N. Y.

# Resinite

**RESIN INDUSTRIES, INC.**

315 Olive St. • Box 1589 • Santa Barbara, Calif.

SPECIALISTS IN VINYL SLEEVING AND TUBING FOR THE  
AIRCRAFT, ELECTRONICS AND PHARMACEUTICAL FIELDS

Resin Industries, Inc.  
Box 1589, Santa Barbara, Calif.  
Please send samples and prices of  
sleeving as follows:

Name \_\_\_\_\_  
Firm \_\_\_\_\_  
Address \_\_\_\_\_  
City \_\_\_\_\_ Zone \_\_\_\_\_ State \_\_\_\_\_

# THIS BOOK DOESN'T

# tell all



**... but it's full  
of ideas  
you can use**

**S**UCCESSFUL developments in the electronics field depend mainly on three things: ideas . . . experience . . . facilities. *This book is full of all three.*

Just a short request on your letterhead . . . or the coupon below . . . will bring this valuable book in the mail to you at once.

## Thompson Products, Inc.

ELECTRONICS DIVISION • 2196 CLARKWOOD ROAD, CLEVELAND 3, OHIO

Thompson Products, Inc.  
Dept. E, Electronics Division  
2196 Clarkwood Road, Cleveland 3, Ohio

Please send me a copy of Electronic Advancement.

Name \_\_\_\_\_ Title \_\_\_\_\_

Company \_\_\_\_\_

Address \_\_\_\_\_

City \_\_\_\_\_ Zone \_\_\_\_\_ State \_\_\_\_\_



nancing. Company officials have been meeting representatives of the town to explore the possibility of re-zoning land for use as a site for the proposed laboratory. Options have been obtained on about 73 acres. It is expected that the plant will be occupied under lease.

Plans call for an initial building to be erected in two stages, to provide about 110,000 sq feet of floor space, with a possibility of additional sections in the future to total up to 300,000 sq ft of floor space. About 400 engineers and related personnel will occupy the first section, 400 in the second and eventually possibly 1,500, if and when the whole building is completed. Actual construction on the site, if approved, will begin shortly after the financial arrangements are completed and options are taken.

"This project," Adams said, "was initiated to provide increased space for our expanding engineering program which includes both commercial and governmental projects." He said that a gradual consolidation of the firm's research and engineering into a single location, instead of conducting them in many scattered areas, has been considered for some time.

In Chicago, Harold W. Beveridge has been named manager of Raytheon's equipment division operations. Beveridge has been with the firm for 9 years. He has had engineering experience with Laurentian Forest Protective Association, National Research Council of Canada, Naval Research Laboratory, and in other fields. He holds patents on mercury delay lines, beacon systems, high-speed digital computer memory systems and radar equipment.

Beveridge will be responsible for all development and production work carried out in Raytheon's equipment division plant in Chicago. This building formerly housed the special products department of the tv and radio division.

### Motorola Makes New Personnel Appointments

HENRY MAGNUSKI has been named associate director of research in Motorola's communications and electronics division and will be tech-





# PRECISION RF STEP ATTENUATOR\*

Model AT-120 0 to 1000 MC

Small, rugged ladder attenuator achieves attenuation accuracy and low vswr from dc to uhf. Suitable for all signal and sweep generators in this frequency range.

Care in design assures maximum flexibility in mounting, drive, and types of input and output connections.

Easily adaptable for inclusion in different types of test equipment and in laboratory and production test applications.

#### MAXIMUM STEPS

Ten (eleven contact positions)

#### ATTENUATION RANGE

Up to 120 db total

#### OUTPUT IMPEDANCE

50 or 75 ohms nominal

#### INPUT IMPEDANCE

100 or 150 ohms nominal  
50 or 75 ohms optional

#### INPUT AND OUTPUT VSWR

1.1 to 1000 mc at 50 ohms

Quick delivery on Standard Models. Prompt attention given to special requirements.

\*PAT. PENDING



TELEVISION  
CORPORATION

1001 FIRST AVENUE,  
ASBURY-PARK, N. J.

# ZOPHAR

## WAXES COMPOUNDS

Zophar Waxes, resins and compounds to impregnate, dip, seal, embed, or pot electronic and electrical equipment or components of all types; radio, television, etc. Cold flows from 100°F. to 285°F. Special waxes non-cracking at -76°F. Compounds meeting Government specifications plain or fungus resistant.

Let us help you with your engineering problems.

### ZOPHAR MILLS, INC.

112-130 26th Street,  
Brooklyn 32, N. Y.

# i.e.r.c.

heat-dissipating  
**sub-miniature  
TUBE CLAMPING SHIELDS**  
give lowest bulb temperatures and increased tube reliability!

Patents Applied For

I.E.R.C. tube clamping shields solve electron tube heat and vibration problems. Temperature reduction is made possible by conducting heat directly from bulb to the chassis or heat sink providing greater reliability.

**International**

WRITE TODAY! For complete information send inquiries to International Electronic Research Corporation, 175 West Magnolia Boulevard, Burbank, Calif.

electronic research corporation

**TOP PERFORMANCE COSTS LESS**  
with  
**JOHNSON**  
Type "C" and "D" Capacitors!

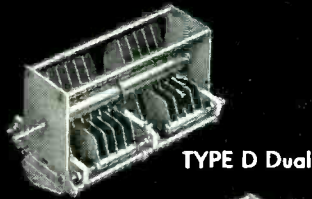

TYPE D Dual

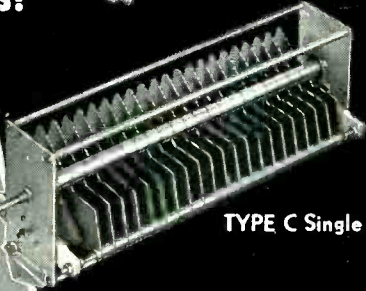

TYPE C Single

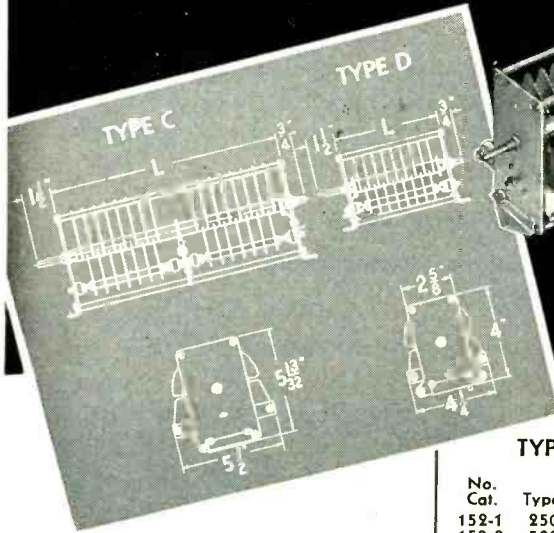

Tough, and of rugged construction, JOHNSON Type "C" and "D" capacitors are reliable, yet simply manufactured. Designed for use in medium power RF equipment, their functional engineering permits rapid, accurate assembly; resulting in lower construction costs and a lower sales price. The finest materials available today are used in the fabrication of JOHNSON Type "C" and "D" capacitors, and have been thoroughly tested and found ideally suited for their application.

**CONSTRUCTION**

Heavy aluminum end frames, .051" plates and 5/16" tie rods assure extreme rigidity. Rotor contacts are laminated phosphor bronze. Dual models have center rotor contact for electrical symmetry. Low-loss Steatite insulators are located outside the most intense RF fields and used solely to support stator assemblies. Shafts are 1/4" diameter, cadmium plated with 3/4" rear extensions.

Mounting brackets furnished for normal or inverted mounting. End frames drilled and tapped for panel mounting, special brackets or mounting of accessory components.

**SPECIAL TYPES**

Variations from standards such as special capacitances, ball bearings, dynamically balanced rotors, stainless steel shafts and right angle drive duals can be furnished in production quantities.

**TYPE C SINGLE SECTION**

No. Cat.	Type No.	Cap. per Sect.	Max.	Min.	Spacing	Number Plates	L
152-1	250C70	252	34	.175"	24	6 <sup>13</sup> / <sub>16</sub> "	
152-2	500C70	496	56	.175"	47	12 <sup>5</sup> / <sub>16</sub> "	
152-3	250C90	245	45	.250"	31	12 <sup>5</sup> / <sub>16</sub> "	
152-4	350C90	337	63	.250"	43	14 <sup>3</sup> / <sub>32</sub> "	
152-5	500C110	51	19	.350"	8	4 <sup>13</sup> / <sub>32</sub> "	
152-6	100C110	103	30	.350"	17	8 <sup>13</sup> / <sub>32</sub> "	
152-7	250C110	251	66	.350"	41	18 <sup>3</sup> / <sub>32</sub> "	
152-8	50C130	51	24	.500"	10	7 <sup>11</sup> / <sub>16</sub> "	
152-9	100C130	102	42	.500"	21	13 <sup>11</sup> / <sub>32</sub> "	

**TYPE C DUAL SECTION**

152-501	200CD45	204	21	.125"	15	8 <sup>19</sup> / <sub>32</sub> "	
152-502	300CD45	290	26	.125"	21	10 <sup>3</sup> / <sub>16</sub> "	
152-503	200CD70	198	27	.175"	19	12 <sup>3</sup> / <sub>16</sub> "	
152-504	300CD70	305	37	.175"	29	16 <sup>3</sup> / <sub>16</sub> "	
152-505	150CD90	147	30	.250"	19	14 <sup>23</sup> / <sub>32</sub> "	
152-507	50CD110	50	18	.350"	8	10 <sup>5</sup> / <sub>16</sub> "	
152-509	100CD110	103	32	.350"	17	16 <sup>23</sup> / <sub>32</sub> "	
152-510	50CD130	51	24	.500"	10	14 <sup>23</sup> / <sub>32</sub> "	

**TYPE D SINGLE SECTION**

153-2	100D35	99	14	.080"	8	2 <sup>29</sup> / <sub>32</sub> "	
153-4	250D35	252	24	.080"	20	4 <sup>29</sup> / <sub>32</sub> "	
153-6	500D35	496	36	.080"	39	6 <sup>29</sup> / <sub>32</sub> "	
153-7	100D45	104	19	.125"	12	4 <sup>29</sup> / <sub>32</sub> "	
153-8	150D45	146	23	.125"	17	4 <sup>29</sup> / <sub>32</sub> "	
153-9	50D70	51	17	.175"	7	2 <sup>29</sup> / <sub>32</sub> "	
153-10	70D70	72	18	.175"	11	4 <sup>29</sup> / <sub>32</sub> "	
153-11	100D70	98	23	.175"	15	4 <sup>29</sup> / <sub>32</sub> "	
153-12	150D70	151	31	.175"	23	6 <sup>15</sup> / <sub>16</sub> "	
153-13	250D70	244	45	.175"	37	10 <sup>7</sup> / <sub>16</sub> "	
153-14	350D70	351	62	.175"	53	13 <sup>11</sup> / <sub>32</sub> "	
153-15	50D90	53	20	.250"	10	4 <sup>29</sup> / <sub>32</sub> "	
153-16	70D90	73	25	.250"	14	5 <sup>15</sup> / <sub>16</sub> "	
153-17	100D90	99	30	.250"	19	7 <sup>15</sup> / <sub>16</sub> "	
153-18	150D90	149	43	.250"	29	10 <sup>5</sup> / <sub>16</sub> "	

**TYPE D DUAL SECTION**

153-501	100DD35	95	13	.080"	8	4 <sup>25</sup> / <sub>32</sub> "	
153-502	150DD35	147	15	.080"	12	5 <sup>15</sup> / <sub>16</sub> "	
153-503	200DD35	202	19	.080"	16	7 <sup>15</sup> / <sub>16</sub> "	
153-504	300DD35	291	24	.080"	23	9 <sup>15</sup> / <sub>32</sub> "	
153-505	500DD35	496	38	.080"	39	13 <sup>11</sup> / <sub>32</sub> "	
153-506	150DD45	155	24	.125"	18	9 <sup>15</sup> / <sub>32</sub> "	
153-507	200DD45	198	27	.125"	23	12 <sup>3</sup> / <sub>16</sub> "	
153-508	50DD70	52	15	.175"	8	5 <sup>15</sup> / <sub>16</sub> "	
153-509	70DD70	72	17	.175"	11	7 <sup>15</sup> / <sub>16</sub> "	
153-510	100DD70	97	22	.175"	15	9 <sup>15</sup> / <sub>32</sub> "	
153-511	150DD70	151	31	.175"	23	13 <sup>11</sup> / <sub>32</sub> "	
153-513	50DD90	52	19	.250"	10	9 <sup>15</sup> / <sub>32</sub> "	
153-514	100DD90	97	30	.250"	19	14 <sup>27</sup> / <sub>32</sub> "	



Henry Magnuski

nical consultant on all products manufactured by the division.

Magnuski is credited with developing the firm's "Walkie-Talkie," AN/CPN-6 radar beacon and the first 1,000-mile private microwave system in the U.S. He developed the basic circuits of the company's Sensicon receiver for two-way radio communication systems as well as a vhf cavity resonator.

Before his promotion, Magnuski had been chief engineer of the microwave research department and later chief engineer of the communications and electronics division's research department. He was educated in Poland and was chief engineer in charge of military communications equipment for the Polish State Radio & Telephone plant before coming to this country in 1939. He joined Motorola in 1940.

Also in the communications and electronics division, Lloyd P. Morris has been appointed chief engi-



Lloyd P. Morris



**E. F. JOHNSON COMPANY**

CAPACITORS, INDUCTORS, SOCKETS, INSULATORS, PLUGS, JACKS, DIALS, AND PILOT LIGHTS

280 SECOND AVENUE SOUTHWEST • WASECA, MINNESOTA



World's  
Smallest Coax...  
**MICRODOT®**  
Connectors & Cable



New pre-production  
Kit for Design-in  
and experiment

See that your products are design competitive...feature Microdot advantages. Order Microdot Kit #553 today...and save valuable experiment time by having the precise parts you need for multi-stage tests. Satisfaction is assured. Simply clip this advertisement to your letterhead with P.O. or check for \$60. Mail to address below.



**MICRODOT**  
DIVISION OF FELTS CORP.  
1826 Fremont St., So. Pasadena, Calif.



Both Connector and Cable in  
this box are actual size!

**PHOTO  
EQUIPMENT...**

**G** geared to  
**INDUSTRIAL  
& SCIENTIFIC Uses**

**FREE 55th Annual Catalog**

96 Pages crammed with THOUSANDS of Newest Photo Tools, Cameras (Press, Studio, Candid, Special Purpose, etc.), Lenses, Projectors, Lighting Equipment, Developing Equip., Enlargers, etc., for Amateur — Professional in daily Scientific or Industrial work.



**CAMERAS**—of all types! Special purpose, Photomicrography, Laboratory, NEW POLAROID LAND BACK, etc.

**LENSES**—World's largest stock from 3/8" to 72". — All speeds, and types, special Mounts, Lenskoting, etc.

**LABORATORY EQUIPMENT** — Stainless Steel Equipment, Dryers, etc. Write TODAY to . . .

**Burke & James, Inc.**

FINE PHOTOGRAPHIC EQUIPMENT SINCE 1897  
321 S. Wabash Ave., Chicago 4, Illinois, U.S.A.

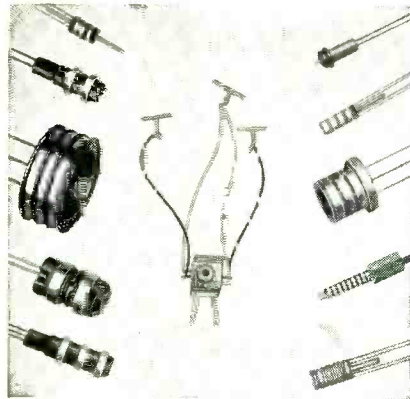

Miniature and Sub-Miniature  
**SLIP RING ASSEMBLIES**  
**BRUSH BLOCK ASSEMBLIES**  
**COMMUTATORS**  
and other  
Electro-Mechanical Components  
**PRECISION MADE**  
**TO YOUR OWN SPECIFICATIONS**

Precision molded products with exacting tolerances in precious and non-precious solid metals of all alloys. All types of Thermo-Plastic and Thermo-Setting materials.

Slip Ring Assemblies fabricated or one-piece precision molded to your specifications in Nylon, Kel-F, Mineral filled Mellamine, Phenolic, and other materials. Rings and leads spot welded or brazed together for positive electrical circuit.

Our Swiss methods and techniques are geared to meet exacting requirements. We invite your inquiries.

**COLLECTRON CORPORATION**

Murray Hill 2-8473 • 216 East 45th Street • New York 17, N. Y.

for maximum economy...  
**5KW VACUUM TUBE  
BOMBARDER  
OR INDUCTION  
HEATING UNIT**

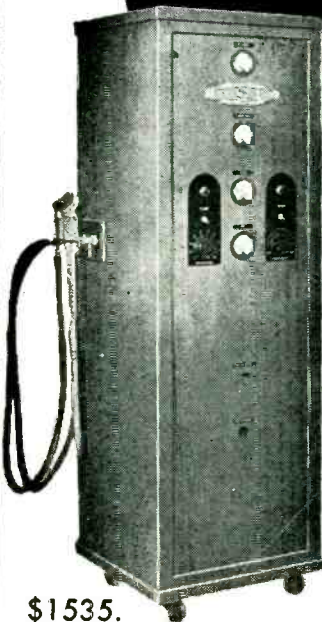

\$1535.

Simple...Easy to Operate...Economical  
Standardization of Unit Makes This New Low  
Price Possible.

Maximum economies can be obtained only by use of correct frequency and power combinations when applying the techniques of induction heating to manufacturing processes.

It is significant that only Scientific Electric in the present market, can offer you a selection of frequencies depending on power required, in wide power range. 2-3½-5-6-7½-10-12½-15-18-25-40-60 KW (all units above 60 KW are considered custom built). This means that electronic heating equipment produced by Scientific Electric is tailored to your needs...fitted perfectly to the task entrusted to it, enabling you to keep your initial investment in equipment to a minimum while affording you all the proven advantages of electronic heating.

Write now for complete information or send samples of work to be processed. Specify time cycle for your particular job. We will quote on proper size unit for your requirements.

DESIGNERS AND MANUFACTURERS OF HIGH FREQUENCY AND HIGH VOLTAGE EQUIPMENT SINCE 1921

*Scientific Electric*

105-119 MONROE ST.  GARFIELD, N. J.

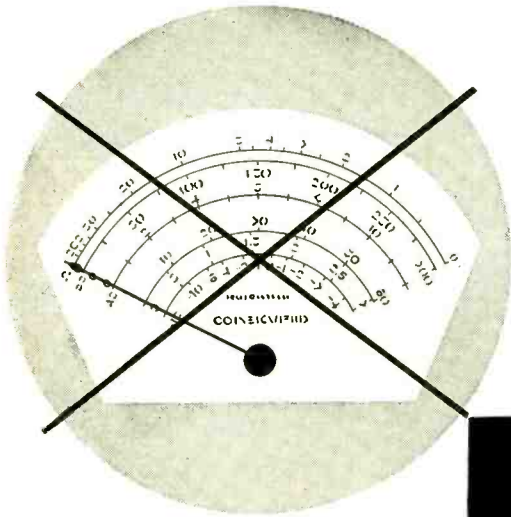

The Digitester \$1185.00

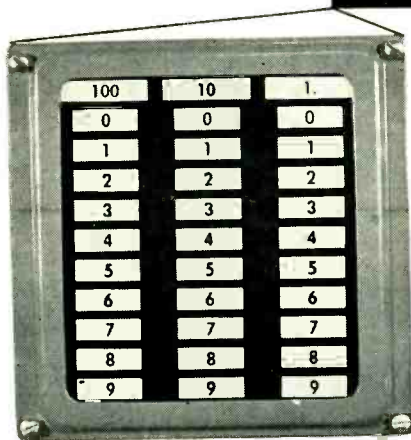

*Telecomputing's new digital instrument*

## measures resistance, voltage and current with push-button speed

The versatile Digitester serves as a combination digital volt-ohm-milliamperemeter, gives you 0.1% accuracy and .8 second speed. In addition, readout is in decimal numbers instead of analog form.

Wide measuring ranges are an important advantage of the Digitester. You can measure up to 10 megohms, 1000 volts, or 1 ampere. Maximum accuracies (lowest scales) are  $\pm .01$  ohms;  $\pm .00001$  volts;  $\pm .01$  microamperes.

Operation does not involve any manual adjusting or balancing. You simply press a panel button to get decimal readout.

A digital ohm meter called the Digi-ohm is also available at \$985.00. It measures resistance with the same speed, accuracy and wide range as the Digitester.

Specifications on the Digitester and Digi-ohm will be sent you upon request. Please address inquiries to Preston W. Simms, Dept. E-4.

### TELECOMPUTING CORPORATION

BURBANK, CALIFORNIA • Washington, D. C.

neer of a new service, the national radio systems consulting service. His primary duties will be advising on engineering design of complex, co-ordinated vhf point-to-point and 2-way radio systems for customers. He joined the firm in 1940 and has served as chief systems engineer since 1947.

Leonard G. Walker was promoted to power utility product engineer and acting product manager



Leonard G. Walker

in the communications and electronics division. As product manager, he has engineering, marketing and production responsibility extending from engineering concept of equipment to successful installation of the system. Walker's group handles power line carrier, audio frequency carrier, supervisory control, power line coupling networks and related devices. Prior to his new assignment, he was chief

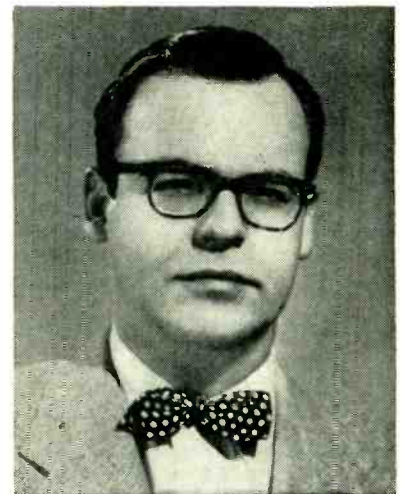

Harold A. Jones



# TAKE IT FROM WEMPY THE KING OF NUTS

Special nuts, custom made to your exact specifications is my business. Whether you require steel, brass, stainless steel or aluminum, regardless of capacity (We even make 5/32" hexagon miniature nuts) you always get *uniformity, dependability* and the *quickest service* when you deal with us.

And remember this: You'll probably pay no more for our *special fasteners* than you are now paying for ready-made standard nuts.

Write  
Dept. A  
for  
Illustrative  
Catalog

**WESTFIELD METAL PRODUCTS CO., INC.**  
WESTFIELD, MASS.

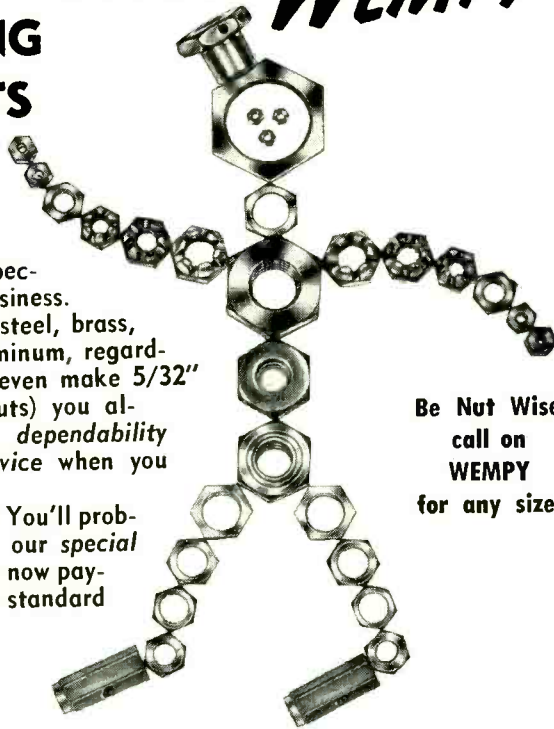

Be Nut Wise  
call on  
**WEMPY**  
for any size.

# THERMISTORS

provide  
**TIME DELAY**

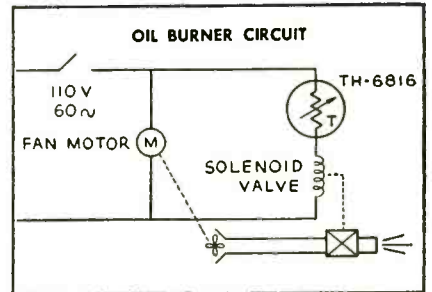

**Carboloy® Thermistors** in the electrical control of an oil burner, delay opening of solenoid valve until combustion chamber is ready to receive properly aerated oil. A mechanical timer was eliminated, and the cost of the unit reduced.

The resistance of Thermistors—unlike metals—changes negatively with temperature increases. Their inherent thermal inertia makes them ideal for signalling and warning devices and controls. Thermistors are available in two grades and in rod, disc or washer form, in a wide variety of sizes.

The **Carboloy Engineering Appraisal Service** will work with you on specific applications involving Thermistors. Send coupon, today, for literature.

## Current—Time Curve

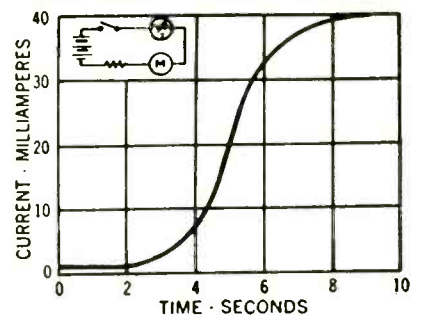

"Carboloy" is the trademark for the products of the Carboloy Department of General Electric Company

## CARBOLLOY

DEPARTMENT OF GENERAL ELECTRIC COMPANY

11139 E. 8 Mile Street, Detroit 32, Michigan  
Send me free technical information on Carboloy Thermistors.

Name \_\_\_\_\_  
Company \_\_\_\_\_ Position \_\_\_\_\_  
Address \_\_\_\_\_  
City \_\_\_\_\_ Zone \_\_\_\_\_ State \_\_\_\_\_

# ELECTRAN

- ★ Transformers
- ★ Saturable Reactors
- ★ Electronic Devices

# Transformers



Dependable  
Components

Dependable delivery  
schedules

Designers and Custom Builders—small and medium quantities—from milliwatts to 50 KVA, single or polyphase.

May We Bid On Your Requirements?

# ELECTRAN MFG. CO.

1901 CLYBOURN AVENUE • CHICAGO 14, ILLINOIS

# Engineers Who "Go with Gilfillan" Stay with Gilfillan



## Microwave Transmitter and Receiver Engineers Urgently Needed Now!

There are many reasons why outstanding engineers build careers at Gilfillan.

With 7 plants located in Southern California, Gilfillan is big enough for every phase of engineering, production and final test—yet not so large an engineer gets lost. You have the satisfaction of following your work through.

Work is interesting. Ideas begin here. We have long range commitments; including designing equipment for all 3 military services, dealing with advanced or

unsolved techniques; and working with problems in coming civilian fields.

You will be given assistance, yet initiative is encouraged. You will have unusual freedom and recognition. You will be paid according to ability, not seniority.

Send for our Gilfillan brochure today. It can be the first step in discovering the all-around, satisfying, *permanent* career you want. Address your request to R. E. Bell, Dept. E4, Gilfillan Bros., 1815 Venice Blvd., Los Angeles 6, Calif.

In GCA, Radar and Electronics

Research, Design and Production...

The FIRST Name is

# Gilfillan



Los Angeles

PLANTS AND PEOPLE

(continued)

systems engineer for power utility products. Before joining the firm in 1951, he was electrical engineer for the Idaho Power Co. in Boise.

Harold A. Jones was named executive assistant to the national sales manager of Motorola Communications & Electronics, Inc., a wholly owned subsidiary of the parent company. He will assist the national sales manager in sales and promotion management of all communications products distributed through the subsidiary. Direct factory distribution is made through ten regional sales offices.

Jones has been with Motorola since 1946, and since 1949 has headed its technical information center, a post he will continue to hold.

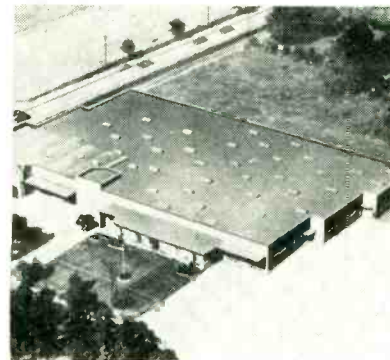

### Ketay Readies New Manufacturing Plant

INSTALLATION of equipment is underway at Ketay Manufacturing's new 43,000 sq ft plant in Commack, Long Island, N. Y.

Production equipment includes stamping facilities for 3 million pounds of lamination materials per year. Special facilities for corrosion-proofing materials will be provided. The plant will produce electronic and electromechanical devices, airborne electronic devices and flight instruments.

### CBS Names Christensen And Mintz

THE APPOINTMENT of John W. Christensen as vice-president and chief engineer of CBS Laboratories was announced by Peter C. Goldmark, recently named president of the Labs. Seymour Mintz was



Ability to solve . . . Capacity to produce  
**SEND YOUR Printed Circuit PROBLEMS**  
**TO WILMAR!**

Wilmar has both ability and capacity to develop and manufacture printed circuits to solve your electronic design problems. Modern facilities are available to you for special, small-scale problems or the mass-production of dependable units. Your inquiry on Wilmar's ability to serve you or on a specific design problem will receive prompt attention!

**Advantages of Wilmar Printed Circuits!**

- Save space, assembly time; cut errors
- Minimum of wiring labor costs
- Components easily accessible
- Cut inspection time
- Uniform wiring; faster soldering
- Improved reliability



Write, Wire or Phone  
**TODAY!**

Get the facts right now about  
**Wilmar Printed Circuits.**

2715 E. 14th ST. • KANSAS CITY 27, MO.



he's working  
for you

THIS FELLOW IS TRAINED IN YOUR BUSINESS. His main duty is to travel the country — and world — penetrating the plants, laboratories and management councils . . . reporting back to you every significant innovation in technology, selling tactics, management strategy. He functions as your all-seeing, all-hearing, all-reporting business communications system.

THE MAN WE MEAN IS A COMPOSITE of the editorial staff of this magazine. For, obviously, no one individual could ever accomplish such a vast business news job. It's the result of many qualified men of diversified and specialized talents.

AND, THERE'S ANOTHER SIDE TO THIS "COMPOSITE MAN," another complete news service which complements the editorial section of this magazine — the advertising pages. It's been said that in a business publication the editorial pages tell "how they do it" — "they" being all the industry's front line of innovators and improvers — and the advertising pages tell "with what." Each issue unfolds an industrial exposition before you — giving a ready panorama of up-to-date tools, materials, equipment.

SUCH A "MAN" IS ON YOUR PAYROLL. Be sure to "listen" regularly and carefully to the practical business information he gathers.



**McGRAW-HILL PUBLICATIONS**

in maintaining low-drift frequency stability...  
**it's the ANGLE that counts!**

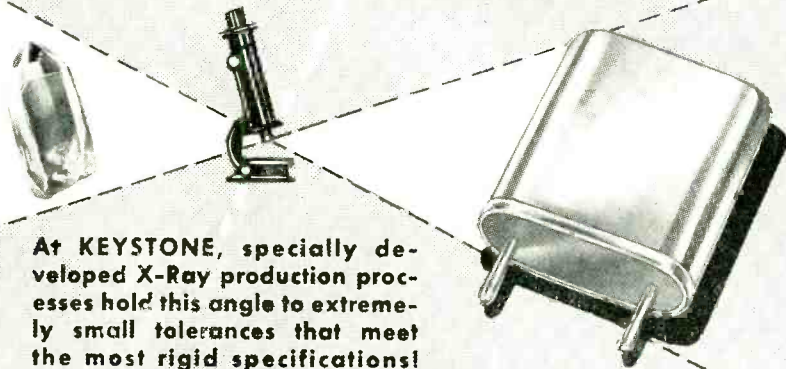

At **KEYSTONE**, specially developed X-Ray production processes hold this angle to extremely small tolerances that meet the most rigid specifications!

**KEYSTONE QUARTZ CRYSTALS**

Now serving, the world over, in military and commercial frequency control applications . . . have established a solid reputation for reliability.

From rough quartz to finished plug-in unit, Keystone high-precision production techniques and numerous hand operations—make possible exact quality control not obtainable by ordinary methods. Choose Keystone "Performance-Tested" Crystals wherever top reliability is a must!

Consult with us on your specialized design problems, at either your plant or ours. Crystal brochure on request to Dept. E-4

**NEW!**  
**COLOR TV**  
**CRYSTALS**  
 Now Available!  
 Write for Information.

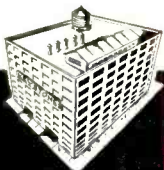

**KEYSTONE ELECTRONICS COMPANY**  
 114 Manhattan Street Stamford, Connecticut



ACN

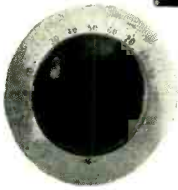

AM



N

**POPULAR NATIONAL DIALS**

For years, National dials have been the popular choice of amateurs, experimenters and commercial users because of their smooth, velvety action, easily-read scales, and quality construction. Many dials, like the N and ACN dials shown, can be specially calibrated or supplied with blank scales for commercial application. Write for drawings and prices.

**NEW TYPE FWT BANANA PLUGS**

Moulded of mica-filled bakelite in accordance with JAN specifications, this new type is styled for easy gripping. Leads can be brought direct from the prongs or through the holes at the base of the plug. Top of plugs are designed to receive additional plugs. Prongs and screws are nickel-plated brass. Write for drawings and specifications.

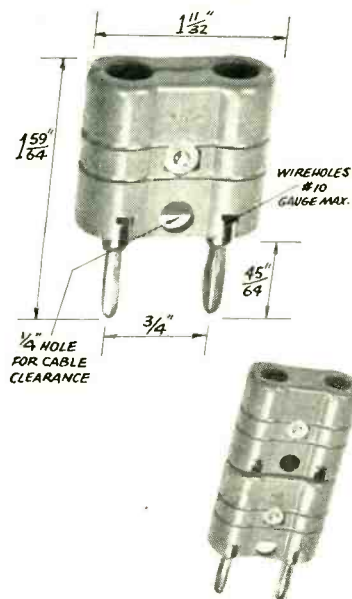

**Write for drawings**



John W. Christensen

named president of CBS-Columbia. Christensen joined the firm in 1946 and participated in the development of color tv projects, including the field sequential system and the CBS Chromacoder.

During the war, he was associated with Radio Research Laboratories of Harvard University in the development of vhf and uhf antennas, receivers and direction-finding systems for aircraft and guided missiles. For his contributions in these fields he received citations from the War Department and the Navy. In 1941 and 1942 he was a member of the engineering staff of KSL in Salt Lake City. Mintz was formerly vice-president and advertising director of Admiral. He was associated with the company for ten years. Previously he was with Montgomery Ward.

CBS-Columbia also announced that Carmine Masucci has been appointed to the engineering staff as a senior project engineer assigned to the advanced development department. He was formerly a member of the engineering department



Seymour Mintz



Now — HIGH LINEARITY  
**POTENTIOMETERS**

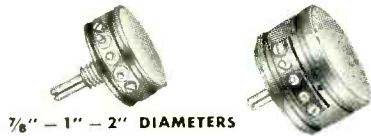

7/8" - 1" - 2" DIAMETERS

**Precision Wire Wound  
For Better Performance**

1. Low Temp. Coeff. Windings
2. Precious Alloy Contacts
3. Aluminum Alloy Bodies
4. Rugged Terminals
5. Max. Rotational Life
6. Environment Proof

Minimum diameters — dual, triple or quadruple assemblies with independent phasing and optional mounting provisions.

Write today for further information

**CUSTOM PRODUCTS SECTION**



**VECTRON, inc.**

Electronic and Electro-Mechanical Equipment  
404 MAIN STREET, WALTHAM 54, MASS.

Sub-miniature  
Radio Interference  
**FILTERS**



- ✓ Highest efficiency
- ✓ Small, lightweight to save space
- ✓ For high temperature and altitude operation
- ✓ High attenuation

Filters custom designed to meet your requirements!

Phone, write, wire us TODAY!



2082 Lincoln Ave., Altadena, Calif.  
Phone SYcamore 8-1185 • Offices in Washington, D. C. and Detroit, Mich.

**Precision  
PAPER TUBES**

2000 SIZES  
in any shape  
ID or OD

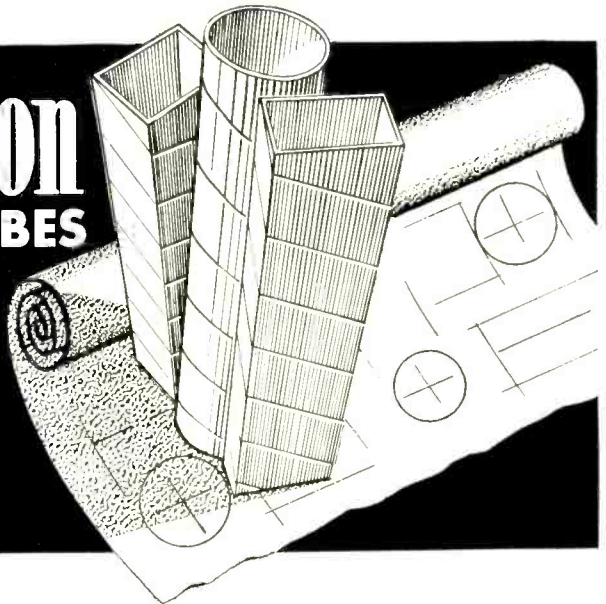

Whatever your specific needs, depend on PRECISION PAPER TUBES to meet all requirements. Spirally wound under pressure, PRECISION PAPER TUBES are subjected to rigid tolerance control to insure strict adherence to specifications and provide maximum winding space. PRECISION PAPER TUBES possess 15 to 20% greater strength, yet are light in weight.

Made from the finest dielectric kraft or fish paper, phenol impregnated, acetate or combinations, PRECISION PAPER TUBES afford high insulation, heat dissipation and moisture resistance. Available in any size, shape, I.D., O.D.—any quantity.

Write for Arbor List of over 2000 sizes . . . Send specifications for free sample.

**PRECISION PAPER TUBE CO.**

2041 W. CHARLESTON ST.

CHICAGO 47, ILL.

Plant No. 2: 79 Chapel St., Hartford Conn. Also Mfrs. of PRECISION Coil Bobbins

**THE NEW ELECTRONIC CHOPPER**  
by **AVION**

all electrical!  
no moving parts!

- LIFE—3000 HOURS MINIMUM
- CASE SIZE—7/8 x 7/8 x 2
- WEIGHS ONLY 1.6 OUNCES
- HIGH INPUT IMPEDANCE



The completely new design of this Avion Chopper provides for 100% electronic operation . . . achieved by modulation of D.C. voltages by alternate illumination at line frequency . . . of the photoconductive element in a voltage divider.

Compact, light, and durable, this unit is ideal for conversion of D.C. and A.C. in the fields of servomechanisms, computing devices; D.C. null measurement circuits, and other electronic control systems.

Send for complete data on this new Avion product

**OTHER AVION PRODUCTS**

Altitude & Air Speed Control Units • Electronic Invertors • Frequency Converters  
Magnetic Memory Systems • Miniature Plug-In Amplifier Units • Power Supplies  
Voltage Regulators • Replaceable Subminiature Amplifier Assemblies • Signal Generators



**AVION**  
INSTRUMENT CORP.

Division of American Car and Foundry Company

299 Highway No. 17 • Paramus, New Jersey

# Kearfott developed Servo Motors ... in production

- A Navy BuOrd Size 9 to Size 18
- B From 25/32" to 1 57/64" long
- C Plain Shafts .1200" and .1721" Diam. Pinion Shafts—13 Teeth 120 Pitch .1247" O.D. 15 Teeth 96 Pitch .1771" O.D.
- D Plain Shafts from 5/16" to 1/2" long Pinion Shafts from 5/32" to 7/16" long

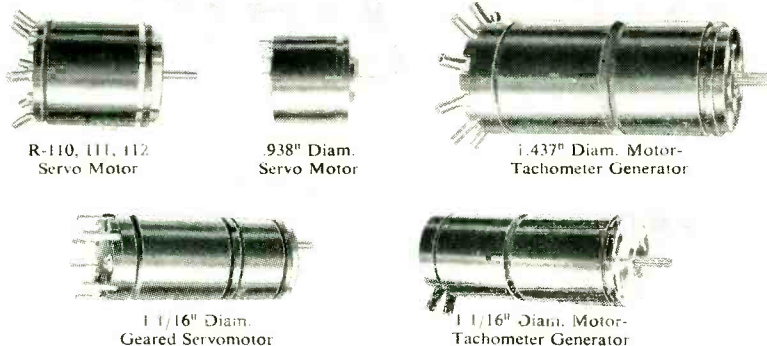
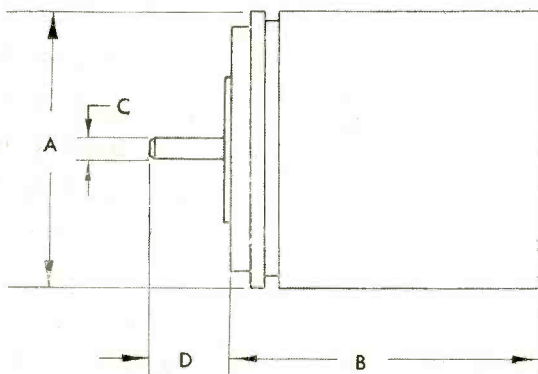

Shown Approx. 1/2 size

Characterized by very low rotor inertia, low time constants and high stall torque, Kearfott Servo Motors are available for your most exacting requirements. Unitized housing and stator construction makes possible optimum performance under extreme environmental conditions.

For either 26 or 115 volt, 60 or 400 cycle excitation, stall torque values range from .30 to 3.5 oz.-in. Geared Servo Motors in the same diameters can be provided with reduction ratios ranging from 10:1 to 300:1. Various Motor-Generator combinations provide 1/2 to 3.1 volts per 1000 R.P.M. with linearity, over a speed range of 0-5400 R.P.M., of 1% for damping or .1% for computing purposes.

Send for Bulletin describing Servo Motors of interest to you.

**KEARFOTT COMPONENTS INCLUDE:**

Gyros, Servo Motors, Synchros, Miniaturized Vacuum Tube and Magnetic Amplifiers, Tachometer Generators, Hermetic Rotary Seals, Aircraft Navigational Systems, and other high accuracy mechanical, electrical and electronic components.



**KEARFOTT COMPANY, INC., LITTLE FALLS, N. J.**

Midwest Office: 188 W. Randolph St., Chicago 1, Ill., West Coast Office: 253 N. Vinedo Ave., Pasadena, Calif.

*A General Precision Equipment Corporation Subsidiary*

of Sylvania, and holds a number of electronic patents.

The firm also announced that it inaugurated the first of a series of 35-hour color tv training seminars for selected distributor personnel. They will cover basic color principles, the Colortron tube, signal transmission, basic circuitry, components and installation-maintenance procedures.



**Gertsch Named President of WCEMA**

E. P. GERTSCH, owner and president of Gertsch Products of Los Angeles, was selected president of the West Coast Electronic Manufacturers' Association for 1954.

Gertsch was one of the founders of WCEMA and has been an active leader in the association since its birth 11 years ago. He has served on the board of directors as vice-chairman of the Los Angeles Council in 1952 and as chairman of the first WCEMA scholarship committee. He was recently elected chairman of the 1954 executive committee for the Los Angeles Council.

Prior to organizing his own company, Gertsch held management positions with Hoffman Radio, Air Associates and RCA.

**Cornell Builds New Engineering Center**

CONSTRUCTION has begun on Cornell University's new \$1.6 million electrical engineering center. It will house the school of electrical engineering and will provide advanced facilities for instruction and research in communications, illumination, servo-mechanisms, elec-



MANUFACTURERS OF

# Electronics

## EQUIPMENT

requiring *immediate factory space*, in units of any size, and *skilled experienced workers* for branch operations are urged to investigate the specialized facilities in

# LAWRENCE

MASSACHUSETTS  
(Research Center of America)

write to:  
**GREATER LAWRENCE  
CITIZENS COMMITTEE FOR  
INDUSTRIAL DEVELOPMENT**  
Lawrence, Massachusetts

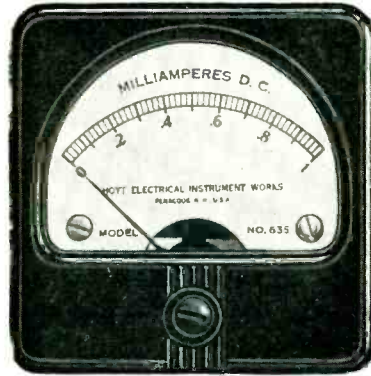

ACCURATE  
EASY-TO-READ  
RUGGED  
DEPENDABLE

Sole  
Selling  
Agent

**BURTON-ROGERS COMPANY**  
42 CARLETON STREET  
CAMBRIDGE 42, MASS., U.S.A.

for YOU . . .  
THE BENEFITS OF  
50 YEARS'  
EXPERIENCE

## 1904 HOYT 1954 ELECTRICAL INDICATING INSTRUMENTS

For your particular requirements, HOYT Panel and Portable Meters provide superior service at reasonable cost: Voltmeters - Ammeters - Microammeters . . . Moving-Coil, Repulsion or Rectifier Types . . . Suppressed Zero and Differential Meters . . . all carefully designed and accurately made. Write today for literature and prices on the HOYT Meters you need.



Mark your own symbols, numbers, lettering, on your small parts, tools, identification and name plates . . . easily, simply, quickly . . . tracing from a master with the GREEN ENGRAVER.

Widely used in electronic and plastic fields, in machine tool shops and wherever permanent marking is needed. The GREEN ENGRAVER engraves equally well on metals, plastic, wood, hard rubber and glass.

✓ Fact-filled folder on request . . . showing how economies in costs, labor and time are achieved with the GREEN ENGRAVER.

✓ Routs ✓ Models ✓ Profiles ✓ Engraves  
Etching attachment and other special equipment for industrial uses are available.

*Green Instrument Co.*  
INCORPORATED

363 PUTNAM AVE., CAMBRIDGE, MASS.

## Versatile FREQUENCY AND FM DEVIATION Meters

For development . . . production . . . and communication testing!



**LAMPKIN 105-B  
MICROMETER FREQUENCY METER**

Heterodyne-type, uses one crystal to measure all frequencies from 0.1 to 175 mc. Accuracy better than 0.005%. Readings in absolute frequency, or percentage of error from desired frequency. Useful as precision, low-level, CW signal generator, 20 mc. up. Price \$220.00

MEET FCC SPECS—for mobile-radio maintenance. SMALL SIZE—less than 13" wide, less than 14 lbs., apiece.

For technical data, mail coupon today!



**LAMPKIN 205  
FM MODULATION METER**

Direct indication of peak deviation on voice modulation, 0-25 kc. positive or negative. Tunable 25-200 mc. in one band. Doubles as relative field-strength meter. Built-in speaker. Jack for oscilloscope. Price \$240.

LAMPKIN LABORATORIES, INC.  
INSTRUMENTS DIVISION  
BRADENTON, FLORIDA

Without obligation, please send me data on Lampkin meters.

Name \_\_\_\_\_

Street \_\_\_\_\_

City \_\_\_\_\_ State \_\_\_\_\_

**LAMPKIN LABORATORIES, INC.**  
Bradenton, Florida

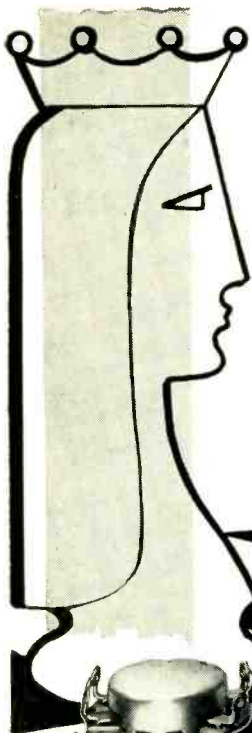

# Make your next move...

to industry's greatest variable resistor value...

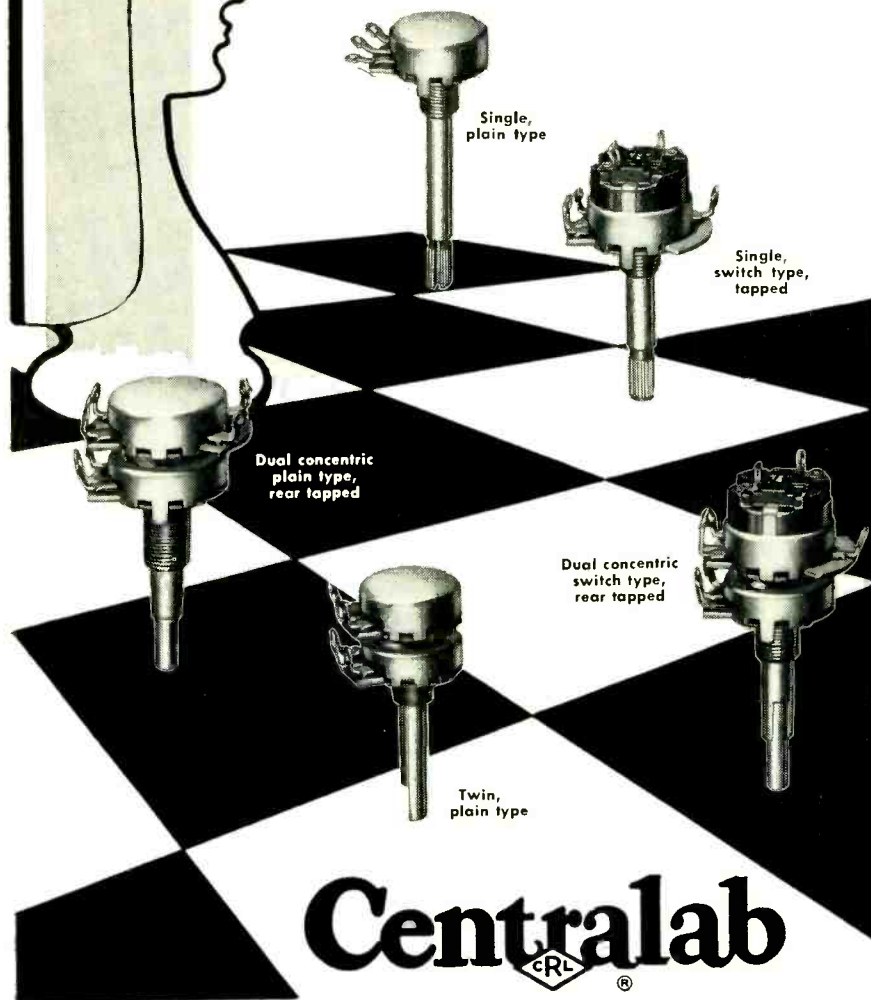

## Centralab

### Model 2 Radiohm®

**SPECIFY** Centralab Model 2 Radiohms — it's a move in the *right direction* to new production simplicity... new, finer performance. Model 2's are only 1<sup>3</sup>/<sub>16</sub>" in diameter, and rated at 1/2 watt. You get lower noise level, longer life, more value for your money.

Imagine the larger variety of uses in TV, radio, sound and test applications. Available in two switch ratings — 5 amps @ 125 volts a-c and 8 amps @ 125 volts a-c. There are six different switching combinations for real flexibility and greater circuit simplification.

For complete technical data, write for Bulletin 42-164.

trical machinery and other phases of electronics and power.

The building will be named for Ellis L. Phillips of Plandome, Long Island, N. Y., a Cornell engineering graduate of the class of 1895, former president of the Long Island Lighting Co. and founder of the Phillips Foundation of New York which granted the funds.

The center features a large sound-proof, echo-free chamber for work in acoustics and audio research, along with specialized labs for work in electronics, vacuum tubes, transistors, tv and radar. A computing section will house the McIlroy pipeline network analyzer developed at Cornell and a Westinghouse network analyzer for studying power systems. The roof will be used for research with antennas and other equipment.

Completion of Phillips Hall, which is expected in one year, will enable the school to consolidate activities now being carried on in five buildings. The high-voltage, ionosphere and radio astronomy laboratories will continue at their present sites.



### Air Associates Elects Sereno Vice-President

CHARLES A. SERENO has been elected vice-president and general sales manager of Air Associates, electronic and mechanical products divisions.

The new officer held executive engineering posts for five of his seven years with the company. During this time, he directed the reestablishment of the electronic equipment division at Orange,

## Centralab

A Division of Globe-Union Inc.  
914 E. Keefe Avenue • Milwaukee 1, Wisconsin  
In Canada: 804 Mt. Pleasant Road, Toronto, Ontario







# TRANSFORMERS

" Fill Your Need to a "

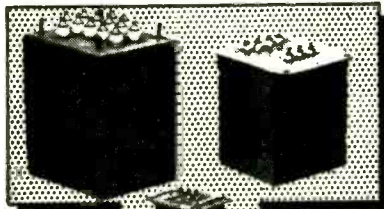

For INDUSTRIAL and ELECTRONIC EQUIPMENT

Let us quote on your Specifications, no obligation

SAMPLE SHORT and LONG RUNS

Delivery as Promised!

DESIGNED TO COMMERCIAL AND MILITARY SPECIFICATIONS (MIL-T-27 and AN-E-19)

## EPCO Products Inc.

2500 Atlantic Ave.  
Brooklyn 7, New York

for the ELECTRONIC INDUSTRIES

# Quality

## Ribbons STRIPS

**MOLYBDENUM  
TUNGSTEN  
TANTALUM  
FORMED PIECES**

*Your Special Metals Rolled to Thin Sizes & Close Tolerances*

YOUR INQUIRIES WILL RECEIVE PROMPT ATTENTION

### H. CROSS CO.

15 BEEKMAN ST., N. Y. 38, N. Y.  
Worth 2-2044 and Cortlandt 7-0470

## IF IT'S NEW . . . IF IT'S NEWS . . . IT'S FROM **ELCO**

Now at last, it is possible for you to assemble your own connectors when you want them, the way you want them, with Elco's Varicon Connector Kit. Yes, from America's quality manufacturer of sockets, shields and connectors comes this sensational Kit containing all parts needed for almost



any type of miniature connector, with any number of circuits. Variations in arrangement of contacts at time of assembly makes possible the use of more than one connector, with the same number of contacts, but with different polarity. As for Varicons, they're the famous miniature connectors with identical male and female components; high current and voltage rating; low resistance, low capacitance. Your finished connectors will be precision connectors of high quality, appearance, practicability and versatility. Kits are available in general purpose phenolic black or in colors; low-loss mica; or alkyd. Sold exclusively through jobbers. Moderate price. Order your Varicon Connector Kit at once.

For Name of Nearest Jobber, Write or Phone ELCO Corporation  
190 W. Glenwood Ave., Phila. 40, Pa.; GARfield 6-6620

# ARCTIC COLD or TROPIC HEAT

In every corner of the globe . . . Standard Piezo Crystals are functioning with complete fidelity . . . just as faithfully as they did in their final, comprehensive inspection in our plant. Standard Piezo Crystals are truly masterpieces of precision . . . the rugged, accurate and dependable end-product of an exacting and vigorous system of manufacture, inspection and quality control. Quality is standard with Standard Piezo.

*Synonymous with Quality*

## Standard Piezo Co.

CARLISLE PENNSYLVANIA.  
Phone 1495

Let our engineers help you with your Crystal needs. Send specifications or an outline of your requirements.

# GOT A JOB FOR THE WORLD'S MOST SENSITIVE GYRO?

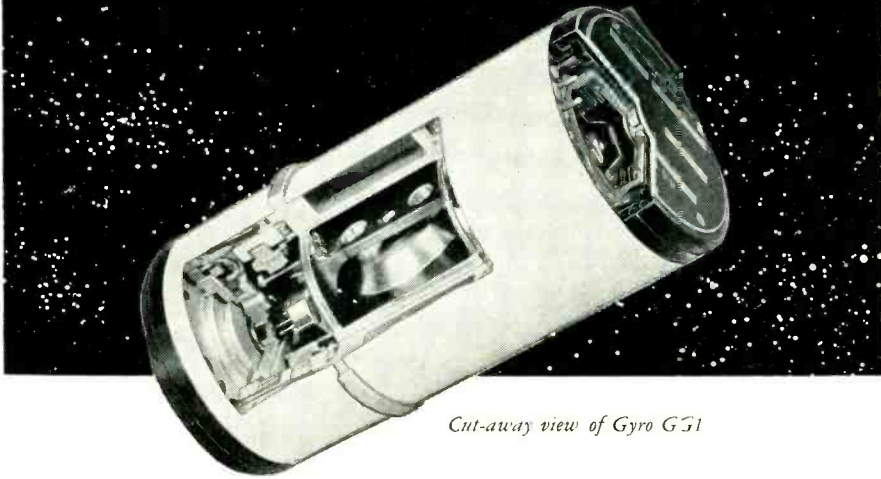

*Cut-away view of Gyro GG1*

**T**HAT cylinder you see above should soon be causing a lot of excitement, now that we're permitted to take the security wraps off.

Its name is the Honeywell Integrating Gyro, called HIG for short. To date we've made over 10,000 of these amazing gyros.

Their moving parts rotate in a fluid on a gimbal that is jewel-mounted. Because of this nearly frictionless mounting, the HIG can measure things as minute as a speed 1/100th that of the hour hand on a watch.

And it's so rugged it can do such precision jobs even after being used as a hammer to drive a nail.

Up to now, major uses of the HIG have been in missile guidance systems and in radar stabilization and fine control systems. You may have a very different application of the HIG in mind. If so, we'd like to hear from you. The address is Honeywell Aero Division, Dept. 658 (E), Minneapolis 13, Minn. We'll be glad to send full details—on the HIG, and on our full gyro line as well.

Besides the HIG, Honeywell, a leader in gyro production, manufactures Vertical Gyros, Cageable Vertical Gyros and damped and undamped Rate Gyros—all available on a mass production basis to industry.

## Specifications of Honeywell Integrating Gyro GG1

**Pickoff Resolution:** Better than 0.00001 radians of arc.

**Pickoff Sensitivity:** 34 mv/milliradian with 100 ma. excitation at 400 cps.

**Angular Momentum:** 100,000 gm cm<sup>2</sup>/sec.

**Rotor Speed:** 12,000 rpm.

**Gimbal Travel:**  $\pm 6.0^\circ$

**Transfer Ratio**  $\frac{\text{Output Angle}}{\text{Input Angle}} = 1$

**Characteristic Time Constant:** 0.0028 seconds.

**Spin Motor Power Requirement:** 10 volts, 400 cps, three phase, 0.65 amperes per phase.

**Weight:** less than 3 lbs.

**Dimensions:** length 6"; diameter 2.75".

# MINNEAPOLIS Honeywell

*Aeronautical Controls*



N. J., and worked on the development and design of products.

He also directed engineering at Air Associates' aircraft products division in Teterboro, N. J. as chief engineer. He headed the development of a-c and d-c motors, electro-mechanical actuators and hydraulic components for systems.

Sereno was appointed chief engineer over all production divisions in March, 1953.

## Seventeen More Companies Join RETMA

ADMISSION of 17 electronics firms to membership in RETMA brought the association's membership to an all-time high of 373. The new members are:

Acro Products, Philadelphia; The Bank of New York, New York; C-B-C Electronics, Philadelphia; Cubic Corp., San Diego; Davis Electronics, Burbank; Hydro-Aire (subsidiary of Crane Co.), Burbank; Kay-Townes Antenna, Rome, Ga.; Kline Iron and Metal, Columbia, S. C.; Litton Industries, Los Angeles; Phen-O-Tron, New Rochelle, N. Y.; Plamondon Magnetics, Chicago; Precision Electronics, Franklin Park, Ill.; Safran & Arnold Electronics, Toledo, Ohio; Telechrome, Amityville, N. Y.; Thomas Associates, Los Angeles; Tristao Manufacturing, Kansas City, Mo. and Unitek Corp., Pasadena, Calif.

## Ford Names Buchhold And Slawson

THEODOR BUCHHOLD, formerly chief of the guidance and control branch of the guided missile development division of Redstone Arsenal, has joined Ford Instrument as staff consultant to the vice-president for engineering. He will specialize on research and development projects.

Dr. Buchhold developed magnetic amplifier circuits used in electronic instrumentation and designed electric locomotives and automatic controls and regulators.

During World War II he was professor of electrical engineering at the University of Darmstadt and consulting engineer to Brown, Boveri and Co. of Mannheim, Ger-



# New... RELAYS

- SUB-MINIATURE
- ANTI-VIBRATION
- SUPER-RUGGED

## WIDE SELECTION OF RELAY TYPES...

Sensitive from .010 watts. Hi temperature and temperature compensated. Fast operate or time delay. Frequency tuned (vibrating reed type).

Designed to meet or exceed  
MIL R 5757B

Vibration: Withstands to as high as 20 Gs to 1000 cycles per second. Temperature range: -65° to 200°C. Life: Into the millions of operations. Open or hermetically sealed. Optional plug-in or solder terminals. Variety of mounting arrangements. High contact current.

SEND FOR CATALOG AND ENGINEERING DATA

# NEOMATIC INC.

9010 BELLANCA • LOS ANGELES 45, CALIF. • OREGON 83814

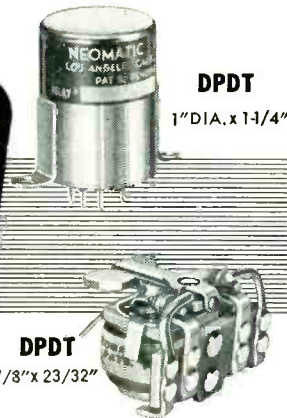

# 60-DAY FREE TRIAL

of America's most popular  
bench assembly stool



A tired worker costs **MUCH**  
more than a good chair

- 4-way adjustable backrest
- Scroll shaped posture seat
- Tamper-proof tubular all-welded construction
- Adjustable height ranges from 17" to 25" or 24" to 32"

Now test Royal's famous No. 515 stool in your own plant without cost or obligation. See why the country's top firms choose it for superior versatility and durability. Write for free trial stool today!

metal furniture since '97



**Royal Metal Manufacturing Co.**  
175 North Michigan Avenue, Dept. 2104, Chicago 1

Factories: Los Angeles • Michigan City, Indiana  
Warren, Pa. • Walden, N. Y. • Galt, Ontario  
Showrooms: Chicago • Los Angeles • San Francisco  
New York City • Authorized Dealers Everywhere

**MAIL TODAY**

Royal Metal Mfg. Co., 175 N. Michigan Ave.,  
Dept. 2104, Chicago 1, Ill.

- We want to test your No. 515 stool for 60 days without obligation. Send short \_\_\_\_\_ tall \_\_\_\_\_ model.
- Please send your new catalog of industrial seating.

Name \_\_\_\_\_

Firm Name \_\_\_\_\_

Address \_\_\_\_\_

City \_\_\_\_\_ Zone \_\_\_\_\_ State \_\_\_\_\_

## Facts you should know about HEYCO STRAIN RELIEFS!

the Nylon Bushings that Anchor cord to housing

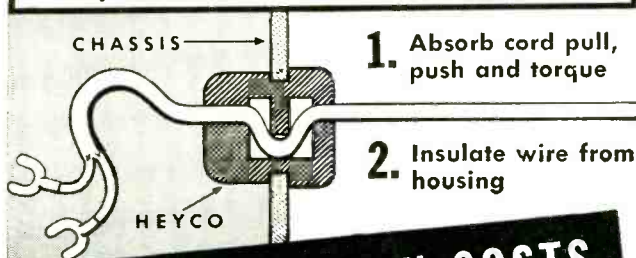

1. Absorb cord pull, push and torque

2. Insulate wire from housing

**CUT PRODUCTION COSTS  
IMPROVE PRODUCT QUALITY**

**APPROVED**  

SAMPLES? Send wire size and chassis information—  
Try HEYCOS at no cost to you—today!

MADE IN ALL SIZES FOR CLOCK WIRE TO 5-10/3 CABLE

**HEYMAN MANUFACTURING COMPANY**  
KENILWORTH 2, NEW JERSEY



HEYCO ELIMINATES STRAIN ON TERMINALS!



THE HEYMAN ORGANIZATION WITH 25 YEARS STAMPING EXPERIENCE HAS MODERN PRESS CAPACITY FOR OVER 2,000,000 FINISHED STAMPINGS PER DAY. ASK FOR BULLETIN 33





# TUBE SOCKET "Firsts"

Among recent additions to the METHODE line are a number of innovations and improvements whose worth has been quickly recognized by electronic designers and producers.

The following are a few of the new accessories which have already found high production applications.

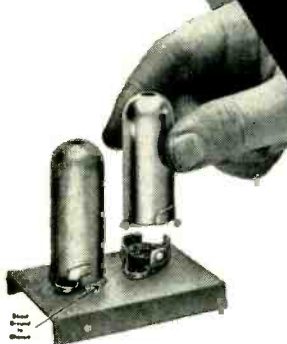

## "Twist-on" Tube Shield Bases

"Twist-On" type of tube shield and base, which can be mounted separately or in combination with molded sockets, as illustrated. Projecting lugs on shields provide direct ground to chassis under screw pressure and a reliable shock and vibration proof mount.



## Laminated Miniature Tube Sockets

With softer alloy tube pins resulting from material conservation measures, the wiping action of METHODE laminated miniature socket contacts provides uniform withdrawal of tubes without breakage, stress or damage to pins . . .

Industry may look to METHODE for further electro-mechanical developments to assist in meeting the problems of increased complexity of new radio, television and communications equipment. Consultation is invited on wiring device applications which involve large production requirements or will meet an industry-wide need.

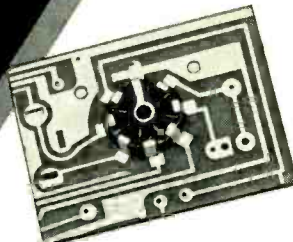

## Tube Socket for Printed Circuits

Miniature, octal and noval units with simple, time-proven design features providing reinforced mechanical spring contact with printed conductors, easily supplemented by solder dip operations. Insulators are heat resistant black phenolic and hardware is cadmium plated copper base alloy. Available with or without tube shield terminals, ground straps, and jumper bars.



Theodor Buchhold

many. During this period he contributed to the development of the V2 guided missile.

In 1946 Dr. Buchhold left Germany to join the missile group in Fort Bliss, Texas which included top rocket and missile experts from the Peenemuende laboratories. In 1950 the group moved to Redstone Arsenal, Huntsville, Alabama.

Kenneth Slawson has been appointed assistant to the president of Ford Instrument and is concerned with general administrative problems. He started with the firm in 1928. In 1946 he was appointed manager of E. G. Staude Manufacturing, another Sperry division. As a result of the recent sale of Staude to the Bryant Chucking Grinder Corp. he returned to Ford



Kenneth Slawson



## METHODE Manufacturing Corp.

2021 West Churchill Street • Chicago 47, Illinois

### District Sales Offices:

#### Indiana, Ohio, Michigan

V. C. Macnabb Indianapolis  
R. L. Colfax Fort Wayne

#### California, Arizona

W. S. Harmon Los Angeles

#### New York State

M. P. Andrews Fayetteville (Syracuse)

#### Pennsylvania, Southern New Jersey

D. T. Cooper Glenside (Philadelphia)

#### New York City, Northern New Jersey

G. A. Boeck Mountain Lakes, N. J.

#### Texas, Oklahoma

E. F. Aymond Co. Dallas Tulsa

#### New England

Garber Sales Co. Boston New Haven

#### Washington, Maryland, Virginia

J. W. Whitfield Washington, D. C.

#### Canada

Kelly-Heenan Co. Toronto

#### Overseas Export

Sylvan Ginsbury  
8 West 40th Street, New York, N. Y.



# NEW ELECTRO PROXIMITY PICK-UP SYSTEM



**Proximity Actuated Transducer produces constant electrical output independent of speed or motion**

**No mechanical contact with exciting metal**

It consists of Model 4910 Proximity Pick-Up transducer, cable and Model 4901 control unit. Produces DC voltage of constant amplitude when any metallic mass is near the pick-up. Output voltage remains constant while exciting metal is close to pick-up and drops to zero when removed. Rise and delay time of voltage is extremely fast producing a definite snap action.

Write now for engineering information and specifications!



**ELECTRO PRODUCTS  
LABORATORIES**

4501-J N. Ravenswood Ave., Chicago 40  
Canada: Atlas Radio Ltd., Toronto, Ont.

**Actuates electronic or electro-mechanical devices for:**

- Counting parts.
- Indicating position.
- Indicating distance traveled.
- Detecting presence of metal.
- Indicating rate of travel.
- Sequence timing devices.
- Operating from 0 to over 12,000 times a minute.

**FREE BULLETIN**

# how **HOT** can **ENGINEERED CERAMICS** .... get?

At temperatures that would melt elements like Titanium (1800° C.) or Platinum (1773° C.) FRENCHTOWN ALMANOX, 95% Alumina Ceramic, will not begin to soften—not until the temperature hits 1927° C.

Even the softening temperature of 1649° C. for FRENCHTOWN #7873, 79% Alumina, far exceeds the melting points of Chromium, Iron, Cobalt, Nickel and other metals.

**LINEAR THERMAL EXPANSION  
OF ALMANOX (95% ALUMINA)**

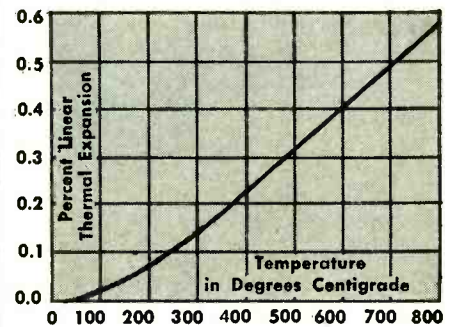

Not only the remarkable heat resistance of Alumina Ceramics but low thermal expansion (like that of Almanox shown above) presents wide design possibilities whether for mechanical, electrical or electronic applications.

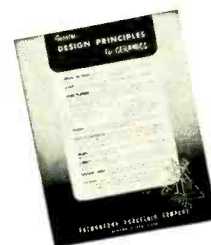

For complete information, send for this bulletin on Design Principles and chart of electrical and mechanical properties of FRENCHTOWN ENGINEERED CERAMICS.

## SWITCHCRAFT<sup>®</sup> INTRODUCES ANOTHER "MINI-MIX" MINIATURE 2-INPUT AUDIO MIXER

**FOR USE WITH RECORDERS AND  
AMPLIFIERS USING JONES  
TYPE CONNECTORS.**

Made to fit recessed connections such as used by Webcor tape recorders.



Part No.  
325  
"Mini-Mix"

**THESE FEATURES HAVE MADE "MINI-MIX" THE POPULAR MIXER**

- Ideal for use with Tape, Wire or Disc Recorders; Amplifiers, Musical instruments, etc.
- Weighs only 3 ounces—small size.
- Connects directly to equipment.
- Attractive brown finished case—nickel plated accessories.
- Minimum lead lengths inside shielded housing minimizes "stray pick-ups".
- Gain control knobs located directly "in line" with inputs eliminate confusion in selection.



Part No.  
310  
"Mini-Mix"  
Phone Jack inputs with Phone Plug output fitting standard jacks.



Part No.  
320  
"Mini-Mix"  
Microphone connector input and output mating with standard mic connectors.

VISIT US AT THE  
1954 ELECTRONICS PARTS SHOW  
MAY 17-20  
CONRAD HILTON HOTEL, CHICAGO

**SWITCHCRAFT  
INC.**

1332 N. Halsted St., Chicago 22, Ill.  
Canadian Representative ATLAS RADIO CORP. LTD.  
560 King St. W. Toronto 2R Canada.  
Phone: Waverly 4761

**AVAILABLE AT ALL LEADING RADIO PARTS JOBBERS •**

**Frenchtown**  
**PORCELAIN COMPANY**  
86 Muirhead Ave. . . Trenton 9, N.J.

# PHALO

*hooks up with progress . . .*

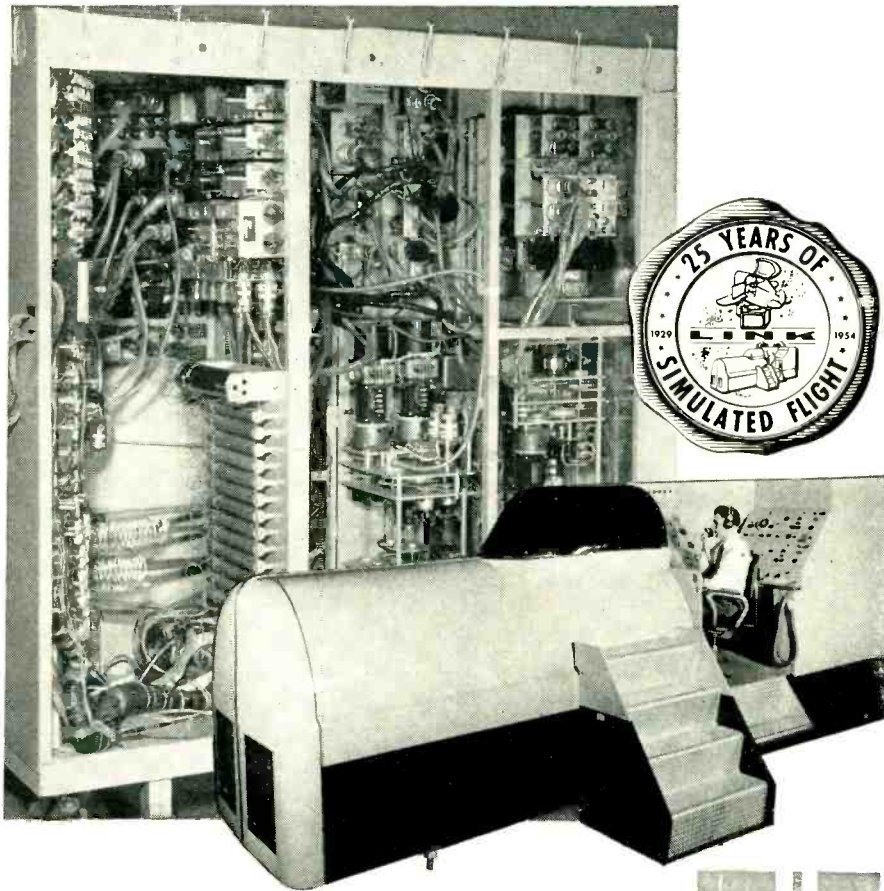

John E. Nelson

*in Simulated Flight with*

## LINK

The highly complex electronic systems of the LINK B-47B jet flight simulator shown here with the basic C-11B jet trainer are classic examples of LINK'S progressive approach to modern flight training. PHALON hook up wires have an important role in these electronic systems and in other key wiring operations which have made the famous LINK TRAINERS synonymous with the latest and the finest in simulated flight.

*When the requirement is dependability in insulated wires, cables or cord sets, look to PHALO*

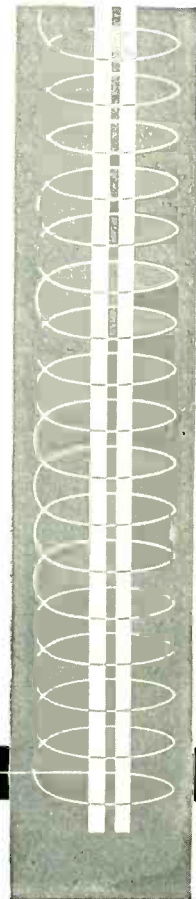

gion which includes 21 states and part of Pennsylvania.

For the past year, he has been product manager for industrial and transmitting tubes in Schenectady. In that capacity he directed the planning and coordination of all the company's industrial and transmitting tube development. He joined GE in 1942 on the company's test engineering program, following nine years with the U. S. Department of Agriculture. In August, 1942, he joined the engineering section and later served as section leader responsible for the design and development of thyratrons and control ignitrons. In 1946 he was named sales manager for industrial and transmitting tubes. In 1951 he was named acting product manager for industrial and transmitting tubes and in 1952 was appointed product manager.

The tube department also formed a replacement tube southeastern sales region and appointed C. Bryon Farmer as regional sales manager.

Creation of a new field sales organization for GE germanium products was also announced. Six men were named as sales and applications engineers for the items to manufacturers of electronic equipment. They are: L. L. Emmel, C. J. Goodman, J. B. Jolly, H. F. Hodsdon, V. J. Huntoon and A. C. Oeinek.

### Hallicrafters Builds New TV Set Plant

A \$1.5 MILLION factory is being built in Chicago for Hallicrafters. The new plant will be used for ex-

## PHALO PLASTICS CORPORATION

CORNER OF COMMERCIAL ST. • WORCESTER • MASS.

Insulated Wire and Cables — Cord Set Assemblies



# Specify MEYERCORD DECAL Transfers



— for long  
day-after-day  
production runs—

— for difficult  
highly-specialized  
applications



**Meyercord Laboratory and Production Experience**  
— PLUS Unexcelled Service — to Serve You Better!

Sometimes we are too prone to tell our friends about the spectacular achievements of Meyercord in solving those "impossible" decal transfer applications... like the new E-51 aircraft decals that resist up to 900 degree temperatures of jet engines, as well as the ravages of strong solvents and aircraft fuels. Specialized decal applications are a mighty important part of our business... but we're still first and foremost in the business of supplying standard Meyercord nameplate and identification decals. Whether you make typewriters, appliances, electrical conduit...

any product that is turned out on long-time production runs, be sure to investigate the advantages of Meyercord decal *uniformity, fine quality and unbeatable service* on your production line.

**Send for This Manual of MEYERCORD DECAL NAMEPLATES**

Shows hundreds of uses for durable, washable decal nameplates... as trademarks, instruction charts or diagrams—in any size, colors, or design. The Meyercord Nameplate Manual is FREE... but request it on your business letterhead, please.

**THE MEYERCORD CO.**  
*World's Largest Decalcomania Manufacturers*

DEPT. S-303, 5323 WEST LAKE STREET  
CHICAGO 44, ILLINOIS

This **FREE BOOK** will show you

dozens of ways to  
save with electric  
heating units

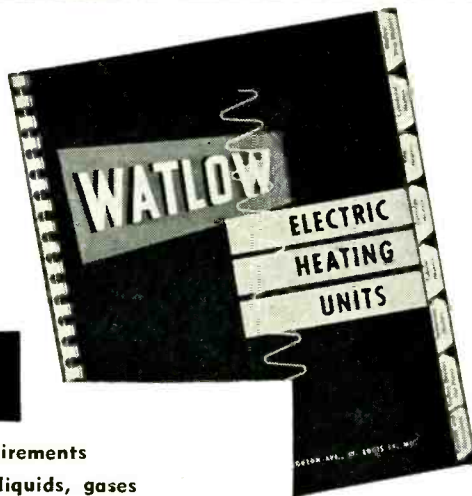

**Contains Such Valuable Information as:**

- How to determine wattage requirements
- Specific heat tables for solids, liquids, gases
- Heat loss tables
- Energy charts for heating air & water

PLUS how to select and apply Watlow's complete line of Strip, Cylindrical, Ring, Cartridge, Tubular and Immersion Heaters to meet your particular needs.

**SEND for  
Your Copy  
Today!**

**WATLOW**

SINCE 1922—DESIGNERS AND MANUFACTURERS OF ELECTRIC HEATING UNITS

**ELECTRIC MFG. CO.**  
1390 FERGUSON AVE.  
SAINT LOUIS 14, MO.

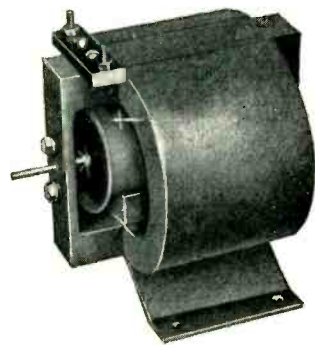

This Motor  
Runs on Only  
**75 MILLIONTHS**  
of a watt

**What's this to you?**  
Just this—

Perhaps RAM can also help YOU when you need a component to do a job electrically, electro-mechanically or electronically.

This small, versatile, highly flexible factory specializes in special-purpose devices designed, developed and manufactured to your order—either short runs or production quantities.

**When you need this kind of help—CONTACT**

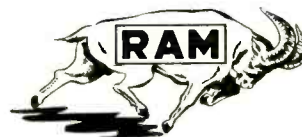

Servicing the Air Force, Navy and civilian industry, in some cases the seemingly impossible has been accomplished to save our customers thousands of dollars.

**Send for new Brochure K54—illustrating devices that have solved problems for others.**

**RAM METER, INC.**

Founded 1936

1102 Hilton Road  
Ferndale  
DETROIT 20, MICHIGAN  
Telephone Lincoln 4-7220

THE *S. White*

**"AIRBRASIVE" UNIT  
WORKS WHERE OTHER  
METHODS FAIL**

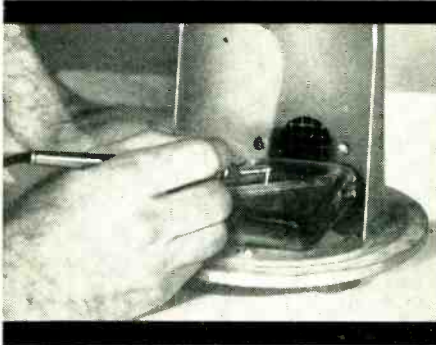
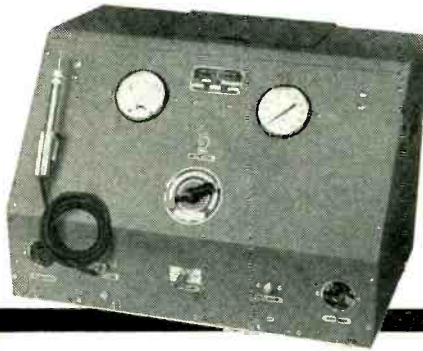

**...for cutting  
hard, brittle  
materials**

**for controlled  
removal of  
deposited  
surface coatings...**

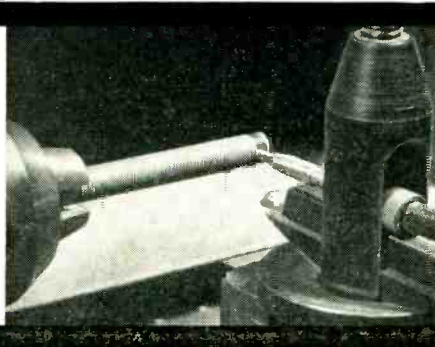

**...for shaping  
fragile  
crystals**

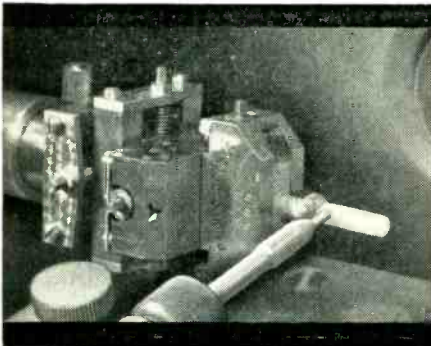

The "Airbrasive" method has proved successful on many jobs considered to be "impossible" to do by conventional means.

The process — which produces a cutting effect by the impingement of an ultra high-speed stream of finely graded abrasive particles... can be used for a variety of precision operations on hard, brittle

materials including cutting, drilling, scribing, film removal and light delicate deburring.

We'll be glad to demonstrate the Unit to you at either our New York or California Office. Or, if you prefer, we'll conduct tests on your samples and advise you as to the suitability of the "Airbrasive" process to your needs.

BULLETIN 5307 has full details on how the "Airbrasive" Unit operates as well as full details on its application and use. Send for a copy.



THE *S. White* INDUSTRIAL DIVISION  
DENTAL MFG. CO.



Dept. EB 10 East 40th St.  
NEW YORK 16, N. Y.

Western District Office • Times Building, Long Beach, California

to his present position.

Robert Armstrong has joined the quality control division as assistant to its director, C. E. Ellis. He was formerly with Electrol as utility manager. Previously he was associated with Arma, Pioneer Instruments and the Aluminum Company of America.

### Daven Promotes Head Engineers

J. P. SMITH, JR., formerly chief engineer of the Daven Co., has been promoted to director of engineering.



J. P. Smith, Jr.



Walter Voelker

Walter Voelker, formerly of Day & Zimmermann, Leeds & Northrup and Bell Labs, has been appointed chief engineer of the company.

### GE Names Managers For Tubes and Germanium

JOHN E. NELSON was appointed central regional manager for GE equipment tube sales. He will direct all equipment tube sales and commercial engineering activities in the re-



# FOR PUBLIC ADDRESS, RADIO, and kindred fields, **JONES** 400 SERIES PLUGS & SOCKETS

of proven quality!



P-406-CCT



S-406-AB

Socket contacts phosphor bronze cadmium plated. Plug contacts hard brass cadmium plated. Insulation molded bakelite. Plugs and sockets polarized. 2, 4, 6, 8, 10, 12 contacts. Steel caps with baked black crackle enamel. Catalog No. 18 gives full information on complete line of Jones Electrical Connecting Devices — Plugs, Sockets and Terminalstrips. Write

**Howard B. Jones Division**  
CINCH MANUFACTURING CORPORATION  
CHICAGO 24, ILLINOIS  
SUBSIDIARY OF UNITED-CARR FASTENER CORP.

Branch Stores: Wilmington, Del., Atlantic City & Camden, N. J., Salisbury, Md.

**SAVE TIME and COST**  
BUY 58 BRANDS FROM  
ALMO'S SINGLE SOURCE  
LEADING ELECTRONICS  
DISTRIBUTOR IN THE EAST



### FREE INFORMATION

ALMO RADIO COMPANY  
412 North 6th St. Philadelphia 23, Pa.  
Write to ALMO RADIO CO. for These Free Industrial Catalogs.

Triplet  GE  Simpson  Stancor  
 Amphenol  Almo Industrial News

Your Name .....  
Company Name .....  
Address .....  
City ..... Zone ..... State .....

*versatile*

Multi-channel --  
telegraph A1 or  
telephone A3.



**RUGGED**

Components conservatively rated. Completely tropicalized.

Model 446 transmitter operates on 4 crystal-controlled frequencies (plus 2 closely spaced frequencies) in the band 2.5-24.0 Mcs (1.6-2.5 Mcs available). Operates on one frequency at a time; channeling time 2 seconds. Carrier power 350 watts, A1 or A3. Stability .003%. Operates in ambient -35° to 45°C. Nominal 220 volt, 50/60 cycle supply. Conservatively rated, sturdily constructed. Complete technical data on request.

Here's the ideal general-purpose high-frequency transmitter! Model 446... 4-channel, 6-frequency, medium power, high stability. Suitable for point-to-point or ground-to-air communication. Can be remotely located from operating position. Co-axial fitting to accept frequency shift signals.

**STABLE**

High stability (.003%) under normal operating conditions.

AER-O-COM

3090 DOUGLAS ROAD MIAMI 33, FLA.

Reg. U. S. Pat. Off.

A-100

# THE "SNAPPER" THERMAL TIME DELAY RELAY

POSITIVE  
"SNAP ACTION"

Why . . . leading Electronic Manufacturers acknowledge the new ELLY "SNAPPER" as a major advancement in this field, and have already accepted this relay as a standard component of their latest equipment . . . the test results indicate that the "SNAPPER" is superior to units now on the market.

One of America's leading electronic equipment manufacturers, after complete exhaustive tests, reports:  
"IT'S SNAP ACTION CONTACT MOTION GIVES EXCELLENT OPERATION UNDER CONDITIONS OF VIBRATION, A POINT WHERE COMPETITIVE RELAYS FALL DOWN."

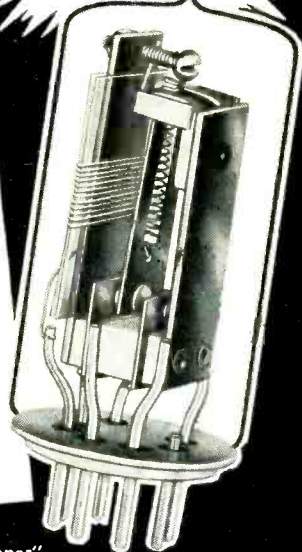

Send for our  
"Bulletin Number Snapper"

**ELLY ELECTRONICS CORP.**  
P. O. BOX 395 . . . FAIR LAWN, NEW JERSEY

# DUMONT MILCAPS

**GLASS-TO-METAL HERMETICALLY  
SEALED SUBMINIATURE CAPACITORS**

MEETS THE OPERATING  
REQUIREMENTS OF MILITARY  
SPECIFICATIONS MIL-C-25A



MILCAPS are subminiature paper capacitors hermetically sealed in tinned brass tubular cases. Perfect enclosure of the impregnated paper sections is achieved by the use of glass-to-metal solder seal terminals. MILCAPS are recommended for all applications where size is a primary consideration . . . and are available in any one of the following impregnants: Stabilized Halowax (85° c); Mineral Oil (85° c; or Duroil (125° C).



Send for Your  
Free Copy Today

**DUMONT-AIRPLANE & MARINE INSTRUMENTS, Inc.**  
OFFICE  
15 William Street  
New York 5, N. Y.  
FACTORY  
Clearfield  
Pennsylvania

panded tv manufacturing, warehousing and as a central shipping point for all of the firm's products. It will have 200,000 sq ft of floor space and will provide employment for an additional 1,000 people when completed in mid-July.

All administrative offices and the production of communications equipment, high-fidelity instruments and standard and short-wave home radios will continue in the main company plant in Chicago.

The new plant brings total space used by the company for manufacturing and storage to 422,000 sq ft. The new plant is expected to streamline and consolidate the firm's operations and at the same time allow for greater production.

## Ryder Named Dean At Michigan State

JOHN D. RYDER, head of the electrical engineering department at the University of Illinois, has been named dean of the school of engineering at Michigan State College, effective July 1, 1954. He succeeds Dean Lorin G. Miller who retired July 1, 1953.

Dr. Ryder worked with GE in the development of electronic equipment. Later, he became supervisor of the electronic section of the Bailey Meter research laboratory in Cleveland. Two dozen patents reflect his work there.

In 1941, Dr. Ryder became assistant professor at Iowa State College and in 1944, as full professor, he was placed in charge of electronics courses. In 1947, he became assistant director of the Iowa Engineering Experiment Station. He became professor and head of the electrical engineering department at the University of Illinois in Sept., 1949.

## Federal Telephone and Radio Plans Expansion

FEDERAL Telephone and Radio plans to expand its operations generally, to have a more diversified line of products and, although it has heavy military commitments, to make a larger proportion of its production available to commercial customers.

To make space for the expansion, the manufacture of monochrome tv



**HAND STYLE**

# AGF "Super" Blowpipes

are supplied in three styles and a variety of sizes for use with all types of gases.

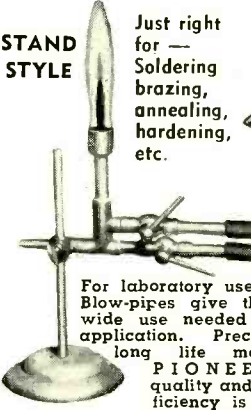

**STAND STYLE**

Just right for —  
Soldering, brazing, annealing, hardening, etc.



**HAND STYLE**

For laboratory use AGF "Super" Blow-pipes give the freedom of wide use needed to suit every application. Precisely made of long life materials, AGF PIONEER quality and efficiency is always assured.

AGF  
AMERICAN GAS FURNACE CO.  
130 Spring St., Elizabeth 4, N. J.

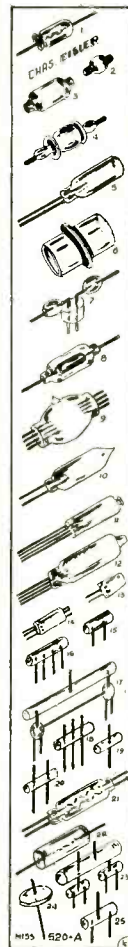

*You Name It EISLER Makes it...*

**ELECTRONIC GLASS WORKING EQUIPMENT for  
RADIO, TELEVISION TUBES, INCANDESCENT LAMPS, GLASS  
LATHES for TELEVISION TUBES**

We make Transformers, Spot and Wire Butt Welders, Wire Cutting Machines and 500 other items, Indispensable in your production. Eisler Engineers are constantly developing New Equipment. If you prefer your own designs, let us build them for you. Write to Charles Eisler who has served The Industry over 34 years.

Machines for small Radio Tubes of all kinds.  
**SEND YOUR GLASS PROBLEMS TO EISLER**  
24 POSITION BARREL CAM INDEXING TYPE  
TURNTABLE FOR GLASS BUTTONS  
MADE BY EISLER

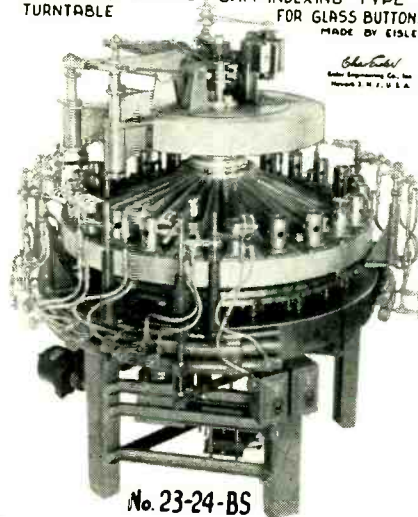

World Famous  
for Over 33 Years  
*Charles Eisler* M.E.

DR. CHAS. EISLER M.E. PRES.  
**EISLER ENGINEERING CO., INC.**

751 So. 13th St., NEWARK 3, N. J.

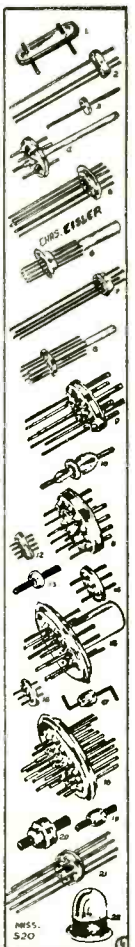

put  
**BACK ISSUES**  
to work

Whatever you do with this magazine after you've clipped pertinent articles or advertisements, please don't destroy it.

**HERE'S WHY:**

Churches, Boy Scouts, civic and veterans' organizations will welcome all the waste-paper you have. They can get a good price for it. Increase their funds.

And, you can make a direct contribution to American mobilization by saving paper of all types—whether in magazine form or not. Since the Korean War began, there's been a great increase in the demand for products manufactured from wastepaper.

Save it for your favorite organization. Chances are they have scheduled pick-ups.

**10 mc DECADE Scaler**

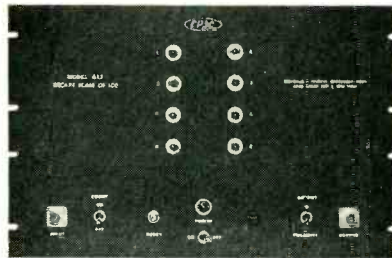

**0.1 Microsecond Resolution  
SPECIFICATIONS Model 412**

**INPUT CIRCUIT:**  
POLARITY: Positive pulses only.  
AMPLITUDE: Minimum amplitude of 5 Volts required at low counting rates, increasing to 10 volts minimum at the maximum counting rate.  
REQUIRED RATE OF RISE: Minimum of 10 volts per  $\mu\text{sec}$ .  
INPUT IMPEDANCE: Greater than 5000 ohms.  
RESOLVING TIME: 0.1  $\mu\text{sec}$ .  
MAXIMUM ACCEPTABLE UNIFORM RATE: 10mc or 10<sup>7</sup> counts/second, no lower limit on counting rate.  
SCALING FACTOR: Decade Scale of 100 Neon light interpolation.  
**OUTPUT:**  
POLARITY: Positive or Negative pulse selected by front panel switch.  
PULSE CHARACTERISTICS: Triangular pulse of approximately 1  $\mu\text{sec}$  rise time, 4  $\mu\text{sec}$  width and 50-60 volt amplitude.  
POWER REQUIREMENTS: 105-125 volts, 50-60 cycles, approximately 175 watts.  
SIZE: 10-1/2" x 19" x 13" deep

Complete literature on request Dept. LD-4

**EPSC ELECTRICAL & PHYSICAL  
INSTRUMENT CORP.**  
42-19 27th Street, L.I.C. 1, N. Y.

**"INDUSTRIAL"**

for

**Electronic Components**

Precision engineered electronic components and connecting devices for all your needs.

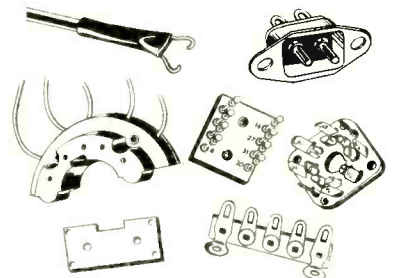

- LAMINATED TUBE SOCKETS
- DUO-DECAL SOCKETS
- ANODE CONNECTORS
- INTERLOCK PLUGS
- TERMINAL STRIPS
- WIRED ASSEMBLIES
- METAL and BAKELITE STAMPINGS
- TERMINAL BOARD ASSEMBLIES
- TUNER STRIPS, SOCKETS and BRACKETS for UHF

Our extensive design and production facilities are available for developing your special requirements and applications. Representatives in principal cities throughout U.S.A. Call or write for samples and information. OREGON 7-1881



**INDUSTRIAL HARDWARE Mfg. Co., Inc.**  
109 PRINCE STREET • NEW YORK 12, N. Y.

**For improved performance in high vacuum systems**

**"WESGO" ALUMINA INSULATORS**

- ultra high purity  
- made to any design requirements

For details on properties, write for illustrated brochure.

**WESTERN GOLD & PLATINUM WORKS**  
589 BRYANT STREET, SAN FRANCISCO 7, CALIFORNIA

Thousands of an inch  
10 20 30 40 50 60 70 80 90 100

DIA METER OF INSULATOR, .083"

picture tubes has been discontinued. The area formerly devoted to this operation will be used mainly for greater production of power vacuum tubes for broadcast and industrial markets. The manufacture of magnetrons will be stepped up substantially.

The company plans expansion of its line of germanium diodes, selenium rectifiers and magnetic amplifiers. Other features of the company's expansion program include cable products, a line of low-band vehicular mobile radio, new pulse time modulation microwave equipment and new railroad electronic equipment.

Federal's distributor organization is now being extended and strengthened and a program of local warehousing has started.

**Weston Names Lamb and Gilbert**

THE Weston Electrical Instrument Corp. has appointed Frank X. Lamb vice-president and Roswell W. Gilbert as assistant to the president.

Lamb will retain his former title of chief engineer and will take on additional responsibilities in super-

**NEW VERSATILITY & ECONOMY**

**TINY NYLON MOLDED PARTS**

**A GRIES SPECIALTY**

Endless new design possibilities with GRC's Nylon small parts. Greater job adaptability, precision, economy. GRC's unique facilities produce finest Nylon parts in one high-speed operation; delivered automatically trimmed, ready for use. Single cavity molds provide more precise tolerances.

**LOW MOLD COSTS!**

GET ALL THESE NYLON ADVANTAGES:

- unusual toughness • good bearing qualities
- wide temperature range • abrasion resistance
- high strength • light weight • moldable in complex shapes and thin sections.

Tiny parts also available in other thermoplastics, specializing in AUTOMATIC INSERT MOLDING.

Write today for Bulletin and Demonstration Samples.

**GRIES REPRODUCER CORP.**

151 Beechwood Ave., New Rochelle, N. Y.  
Phone: New Rochelle 3-8600

MAXIMUM SIZE .025 oz. - 1/4" long  
NO MINIMUM

All parts actual size



Frank X. Lamb

vision of mechanical and electrical engineering activities. He joined the firm in 1921 and served as a design, project and liason engineer. He was resident engineer for the company, assigned to the Nippon Electric Co. in Japan, from 1937 to 1939.

Gilbert, in addition to his new post, will continue to serve as director of research. He joined Wes-





Roswell W. Gilbert

ton in 1934 as a research engineer and since has specialized in the development of ultra sensitive devices including combination electromagnetic and electronic types. The holder of 24 patents, he has served as both division chief and laboratory director.

### RETMA Plans Connection Conference

PRELIMINARY plans for a conference on reliability of electrical connections to be held April 15-16 at the Illinois Institute of Technology in Chicago were announced by RETMA's engineering department.

The conference, which will be divided into four sessions and a demonstration period, will be devoted to a study of methods of connecting to the terminations of wires and cables to produce equipment free from difficulties caused by loose and broken connections.

Aimed at project engineers and production superintendent as well as the inspection personnel of electronic equipment manufacturers, the conference will be participated in by representatives of the Aircraft Industries Association and aircraft manufacturers engaged in producing electronic apparatus.

### Volkert Completes Plant Expansion

JOHN VOLKERT METAL STAMPINGS has added 12,000 sq ft of floor

**10 $\mu$ V/CM - r. m. s. 1cps to 500Kc, 700 $\mu$ V-d.c.**

**A NEW MILESTONE IN OSCILLOGRAPH HISTORY**

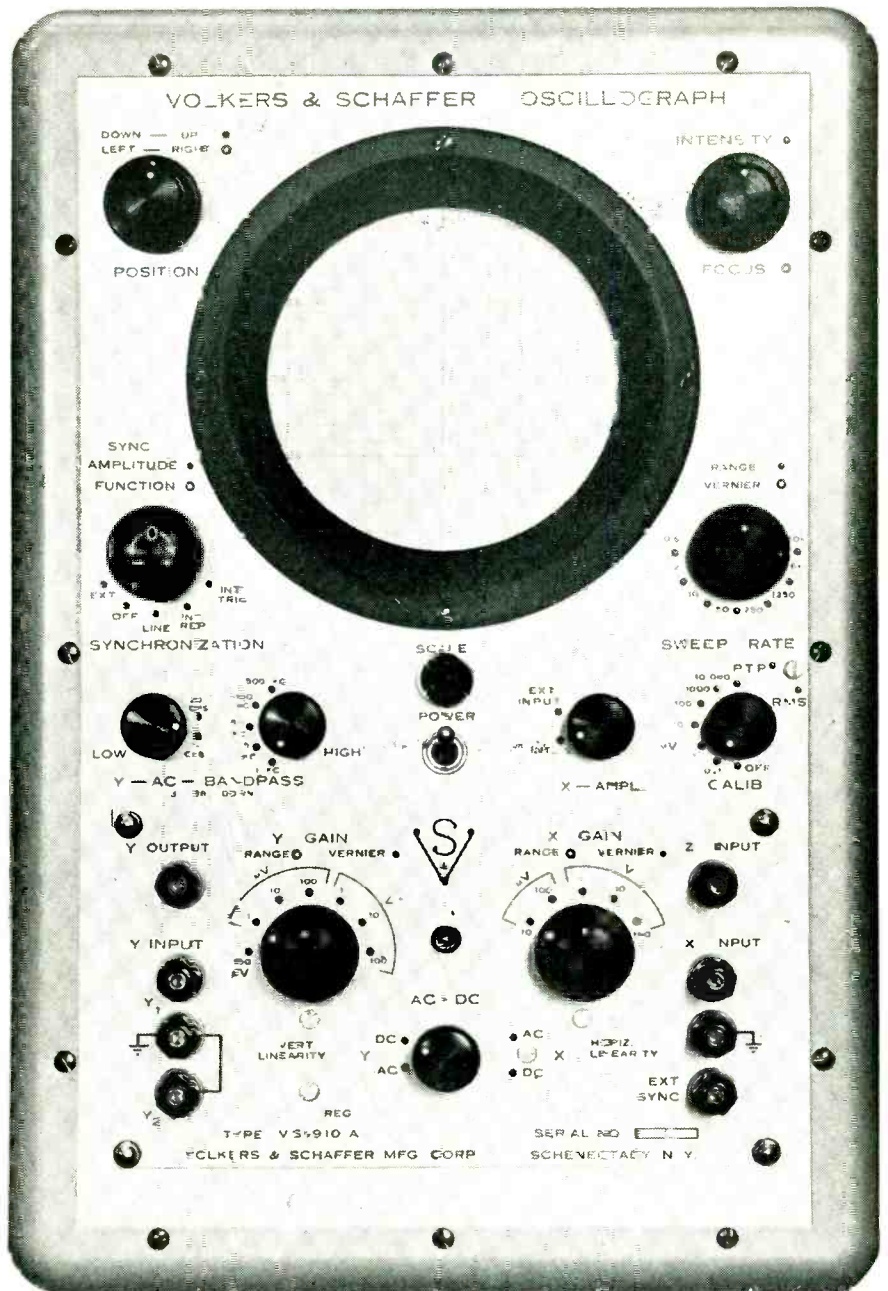

The astonishing performance of this new oscilloscope is based on the successful combination of 4 distinctive design-features: Heavy overall feedback (including d.c.),

DC-heated *electronically* regulated filaments, "the starved" amplifier circuit, originated by Dr. W. K. Volkert, and gas-diode coupling in a new circuit.

WRITE FOR FULL INFORMATION

**VOLKERS & SCHAFFER**

BOX 996

SCHENECTADY, N. Y.

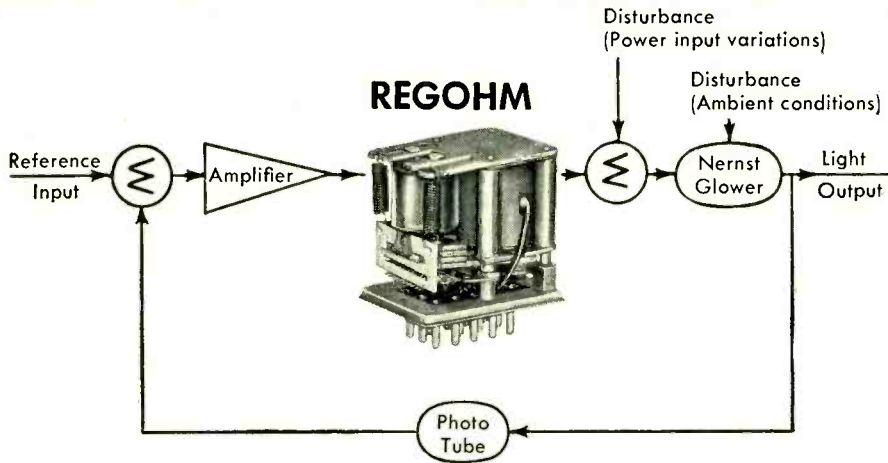

## Regohm keeps radiation energy constant for new infrared spectrometers

Since infrared analysis must be able to record changes as slight as 1 part in a million of a chemical substance, the energy source must be kept constant. The above block diagram shows how Regohm does this for a Perkin-Elmer Infrared Spectrometer.

In most applications, Regohm directly senses what it controls. Here, however, Regohm serves as a power amplifier. A photo tube acts as the sensing device. Its output is electronically amplified, using a balanced DC amplifier to raise the power level of signal and eliminate the effects of drift.

The photo tube is constantly sensitive to changes from the Nernst glower by delivering current output proportional to changes in radiation. Output from the Reference Balanced Amplifier changes above and below fixed voltage.

Reacting to milliwatt output changes in the amplifier, Regohm produces large changes in power input to the Nernst glower. Hence, the Regohm circuit adjusts for all variations in source intensity, counteracting disturbance from power input changes and ambient temperature conditions. Regohm's dashpot stabilizes the control system.

Electric Regulator takes pride in the fact that high performance alone was the reason for P-E's choice of Regohm for equipment that is the "Cadillac" in its field.

### 7 Reasons why Regohm can simplify your control problem

1. **Regohm is small in size**—It is compact, lightweight, position-free.
2. **Regohm is a high-gain power amplifier**—Milliwatt variations in signal energy control energy changes millions of times greater.
3. **Regohm's isolated signal and control circuits**

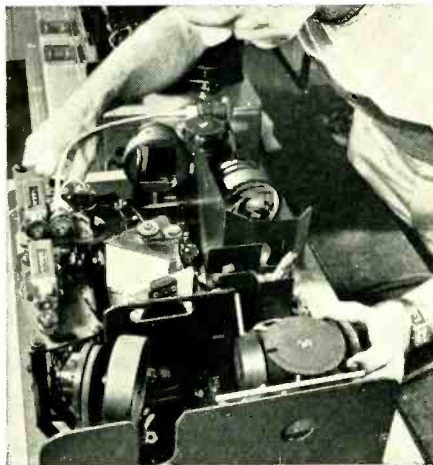

Assembling a Perkin-Elmer Infrared Spectrometer

eliminate impedance matching problems—Signal coils may have ratings from 0.01 to 350 amperes. Control resistance range unlimited.

4. **Regohm will correct system instability**—A reliable, sturdy dashpot aids system damping.

5. **Regohm's effect can be calculated in advance**—Its response is independent of rest of servo system.

6. **Regohm assures continuous control**—In "closed loop" systems a high-speed averaging effect occurs.

7. **Regohm has long life**—Plug-in feature simplifies replacement when necessary.

*Regohm can be applied to your control system or regulation problem. Our engineering and research facilities are always at your service. Write for Bulletin 505.00, analyzing Regohm's characteristics and applications. Address Dept. E., Electric Regulator Corporation, Norwalk, Conn.*

# REGOHM



CONTROL COMPONENT IN: Servo systems • battery chargers • airborne controls • portable and stationary generators • marine radar • inverters • locomotive braking systems • mobile telephones • guided missiles • signal and alarm systems • telephone central station equipment • magnetic clutches • railroad communication systems • magnetic amplifiers.



Newly enlarged Volkert plant

space to its plant in Queens Village, L. I., N. Y., bringing total plant area to more than 30,000 sq ft.

A new building has been constructed to house executive offices, a conference room, an apprentice training section, the production welding department and a new finishing room. The warehousing and shipping departments have been modernized and enlarged. A specially-built room has been set up with vaporized degreasing and Honite finishing equipment. Storage capacity at the plant has been tripled with the installation of storage racks having a capacity of 750,000 pounds.

## Sylvania and Stanford Plan Project

AN "Honors Cooperative Program In Electronics", designed to aid outstanding college seniors who are interested in doing graduate work in electrical engineering combined with full-time electronics employment, has been planned by Sylvania and Stanford University.

Each student selected will receive a full year of graduate work and an M.S. degree from Stanford in two calendar years. Students will be employed in research and development work in Sylvania's Mountain View, Calif. laboratories, which are a short distance from Stanford at Palo Alto. All participants will be allowed the time necessary to attend regular classes at Stanford.

Men selected will be on a reduced working schedule of 35 hours per week at Sylvania labs but will receive full salary based on the standard 40-hour work week. In addition,



# ENGINEERS

## ELECTRONIC:

Minimum of five years experience in circuit design with primary emphasis on pulse circuitry and high frequency RF technique.

## MECHANICAL:

Minimum of five years experience in packaging electronic equipment as well as in mechanical design of small electro-mechanical devices.

This company, engaged in the field of telemetering, developing, and producing transmitters, receivers, data treating equipment and special electronic and electro-mechanical devices, offers permanent positions with liberal benefits including paid vacations, sick leave, bonus, insurance plan, etc.



Please Send Complete Resumes to:

# ASCOP



WE PROVIDE ▲ THE LEVER • YOU MOVE THE WORLD

**APPLIED SCIENCE CORP. OF PRINCETON**

P. O. Box 44, Princeton, N. J. • Plainsboro 3-4141

## It's "TREATMENT" that makes **DANO** your Best Bet for Coils

ways at your service. Yes, Dano coils and Dano customers are always treated in the manner that makes your production pay dividends.

- Form Wound
- Paper Section
- Acetate Bobbin
- Molded Coils
- Bakelite Bobbin
- Cotton Interweave
- Coils for High Temperature Application

Send us samples or specifications with quantity requirements for our recommendations. No obligation!

Also, Transformers Made To Order



## THE DANO ELECTRIC CO.

MAIN ST., WINSTED, CONN.

**Cunningham**  
ESTABLISHED 1938



## crossbar

A truly superior switch for MASTER CONTROL AND MONITOR SWITCHING OF AUDIO & VIDEO CIRCUITS Also COMPUTERS • TELEMETERING TELEPHONY • DELAY LINES ETC.

Extreme flexibility  
Fast quiet switching  
Crosstalk down 60 Db at 10 MC  
Any group of setups may be held intact while setting up others  
Provision for spot or remote control  
Strapwiring eliminated  
Excellent HF characteristics  
Palladium contacts  
Reduced cost  
Compact design, small size  
Low operating power—2.5 watts  
Simple "package" installation

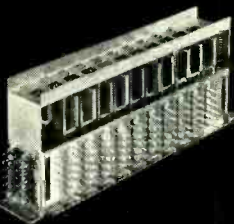

- Individual magnets at each cross-over.
- Maximum, six conductors per circuit.
- Life-tested to 100 million operations.

**JAMES CUNNINGHAM, SON & CO., INC.**

Dept. T-1, Rochester, New York

Tel: BAKER 7240



## CHECK LIST

### COMPONENTS FOR THE ELECTRONIC INDUSTRY

#### ✓ CONNECTORS (AN Types)

- RECEPTACLES
  - PLUGS
  - CAPS
  - CABLE CLAMPS
- Pressurized — Waterproof  
High Voltage — Capacitor



#### ✓ CONNECTORS (RF Types)



- UHF
- BNC
- BN
- PULSE and TRIAX PULSE TYPES

#### ✓ RACK & PANEL Types

- Special DT
- DTGS
- DTKS
- DT HIGH VOLTAGE
- DT MINIATURE

New 1954 Layout  
Bulletin Available

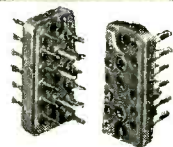

#### ✓ CABLE ASSEMBLIES



- STANDARD MOLDED
- SPECIAL
- RIGHT ANGLE
- COAXIAL

#### ✓ MISC. COMPONENTS

- VIDEO JACKS—PLUGS
- SHORTING PLUGS
- SPECIAL JACKS—FEED THRU
- SWITCH BOOT
- SEALING-GASKETING DEVICES
- POLARIZED CONNECTORS
- UHF MOBILE ANTENNA
- ROTARY SHAFT SEALS
- CABLE CLAMPS



Write for  
Catalog!

Skilled in Electronic Component Parts  
**RESEARCH • DESIGN  
ENGINEERING  
MANUFACTURING**

**H. H. BUGGIE, Inc.**

726 STANTON STREET  
TOLEDO 4, OHIO

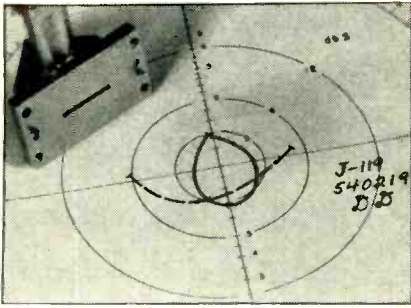

## MICROWAVE DEVELOPMENTS

Wheeler Laboratories is an engineering organization offering consulting and engineering services in the fields of radio and radar.

In designing microwave components, impedance plots on circle charts of reflection coefficient are our constant guide in understanding and making best use of waveguide circuits such as the resonant iris shown above.

At present, Wheeler Laboratories includes a staff of twenty engineers under the personal direction of Harold A. Wheeler, a group of designers, and a model shop. Regular additions to the staff are continuing in order to keep pace with our expanding program of work.

Inquiries are welcomed regarding specialized problems in microwave design; a brief summary of our work is available on request.

### Wheeler Laboratories, Inc.

122 Cutter Mill Road, Great Neck, N. Y.  
HUunter 2-7876

# STAINLESS fasteners in STOCK

All types and sizes of screws (slotted, Phillips, socket, hex head), bolts, nuts, washers, rivets, keys and pins

- Over 9000 items in stock means immediate delivery from one source
- New Garden City plant now operating at top speed and quality
- Unsurpassed facilities for quantity fabrication of specials
- A staff of seasoned engineers always available for consultation
- Pioneers in the manufacture of stainless steel fasteners

WRITE NOW FOR FREE COPY OF  
96 PAGE FASTENER MANUAL P10

MANUFACTURERS SINCE 1929  
**ALLMETAL**  
**SCREW PRODUCTS COMPANY, INC.**  
GARDEN CITY NEW YORK

tion, as part of the firm's educational assistance policy, each student will be reimbursed for 50 percent of his tuition fee upon the satisfactory completion of each quarter's work.

In the parts division of the company, Albert Lederman was appointed engineering specialist and section head in a new mechanized circuits department for application of stamped and printed circuits.

Lederman was previously a technical representative for the firm in Washington, D. C. He has served as secretary of the Panel on Electron Tubes of the Research and Development Board for the Department of Defense and served with the Conference Committee on Electron Tubes for Computers in Atlantic City in 1950.



### Feldmann Elected President Of National Union Radio

C. RUSSELL FELDMANN was elected president of National Union Radio. He is also chairman of the board, a position he has held since 1946. He succeeds Kenneth C. Meinken, who resigned.

"National Union's company policies and current program of expansion into new fields of electronics will continue unchanged," Feldmann said.

### Huntoon Named Physics Director For NBS

ROBERT D. HUNTOON was appointed associate director for physics of the National Bureau of Standards. The Bureau's organization now provides for four associate directors.

Dr. Huntoon, formerly director of NBS Corona, Calif. Labora-



tories, has also been designated acting chief of the NBS electronics division and of the bureau's central radio propagation lab.

As director of the Corona labs, which are now being operated by the Defense Department, he was responsible for a research and development program that included guided missiles, electronic ordnance devices, digital computers and infrared measurements. He joined the NBS staff in 1941 and was one of the principal NBS scientists concerned with the design and development of the proximity fuze. He was appointed chief of the NBS electronics section in 1945 and directed fundamental research on electronic circuits, control devices and other electronic ordnance components. In 1947 he became assistant chief of the atomic and radiation physics division and chief in 1948. During this period he also served as coordinator of atomic energy commission projects at NBS. During 1940 and 1941 he was a research physicist in the tube division of Sylvania.

Ralph A. Lemm has been appointed technical director of the Naval Ordnance Laboratory, Corona, California succeeding Dr. Huntoon.

Other recent promotions at NOL-Corona include the designation of four division chiefs: H. K. Skramsted, missile systems division; F. S. Atchison, physical science division; H. A. Thomas, fuze division and G. R. Sams, missile evaluation division.

The new Naval Ordnance Laboratory was formed last fall by transfer of the Corona Laboratories of the National Bureau of Standards to the Navy Bureau of Ordnance.

### RCA Victor Division Appoints Conrad & Chiei

ANTHONY L. CONRAD has been appointed manager of the RCA missile test project in the government service division of the RCA Service Co.

Frederick Chiei has been appointed manager of the technical operations section in the division, the post formerly held by Conrad.

Conrad joined the company as a

# ENGRAVE

PANELS OF ANY DIMENSIONS IN  
YOUR OWN SHOP

with the **Engravo** *graph*  
Portable Model I-S



**TRACER  
GUIDED FOR  
UNSKILLED  
LABOR**

Send for Booklets  
I-S 29—portable model  
H-29—heavy duty model

**NEW HERMES, Inc.** 13-19 University Place, N.Y. 3  
CANADA: 359 St. James St., Montreal

AVAILABLE for IMMEDIATE DELIVERY...

## FTL-30A SLOTTED LINE

THE UTMOST IN  
**PRECISION**  
... for VHF-UHF  
**IMPEDANCE  
MEASUREMENTS**

in the range of 60 to 1000  
megacycles per second  
Accuracy  $\pm 2\%$

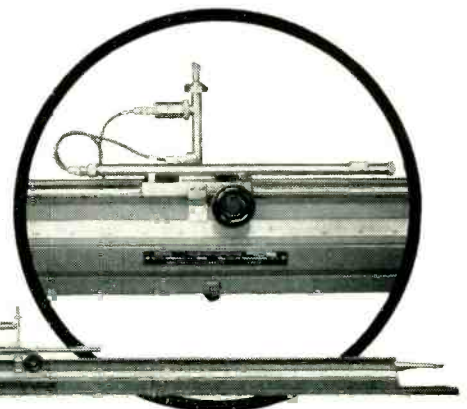

The FTL-30A also covers—with slightly reduced accuracy—the 1000 to 2000 megacycle range. It is a coaxial line 250 centimeters long... having a surge impedance of 51.0 ohms  $\pm 0.5$  ohms.

Special design features include: extremely rigid construction... high sensitivity and selectivity due to efficient probe tuning... end connectors adapted to use of Type N connectors... full utility down to 60 megacycles.

For complete details, write for Brochure FTL-30A



## Federal Telecommunication Laboratories

A Division of International Telephone and Telegraph Corporation  
500 WASHINGTON AVENUE NUTLEY, NEW JERSEY

# INCREMENTAL INDUCTANCE

*quickly - simply - accurately*



The new Type 1002-A Incremental Inductance Bridge combines outstanding features of compactness, ease of operation, accuracy, and wide range of measurement. A visual balance indicator allows measurements to be made in a few seconds, even in noisy locations. Maximum sensitivity at the balance point greatly increases the accuracy of balance. Only a single balance control is used, with cathode ray tube indication.

Inductance can be measured from one to 200 henries. Direct current through the reactor under test is accurately controllable from one to 500 ma, depending on the resistance of the coil windings. The effect of a change of dc on the inductance value is immediately measurable, by simple re-balancing. The inductance is measured at a constant frequency of 120 cps.

For design and test work on iron-core inductors, filter chokes, transformers, and plate reactors, this compact and self-contained instrument is unsurpassed.



Write today for technical details and price information.

**WATERS MANUFACTURING, inc.**

*Waltham 54, Massachusetts*

APPLICATION ENGINEERING OFFICES IN PRINCIPAL CITIES

## MINIATURE *Wire-Wound* POTENTIOMETERS

*that don't NEED incoming check*

**Problem:** To find a potentiometer that —

- Dissipates 3 watts continuously at 80° C, through 50,000 ohms total resistance.
- Occupies no more space than absolutely necessary.
- Weighs as little as possible.
- Maintains accurate resistance settings, over a wide range of temperatures.
- Will not require YOU to do production-control checking for the manufacturer.



**Solution:** Waters Series RT-7/8 and RTS-7/8 —

- Precision wire-wound construction.
- Three watts continuous, to 80 degrees C.
- Resistances from 10 ohms to 50,000 ohms.
- Diameter 7/8", depth 3/8".
- Weight about 1/2 ounce per section — multiple ganging easily provided.
- Temperature coefficient of resistance 0.00002 parts per degree C.
- Individually checked through a production quality control system that guarantees you full performance from EVERY unit in your order.

**WATERS MANUFACTURING, inc.**

*Waltham 54, Massachusetts*

APPLICATION ENGINEERING OFFICES IN PRINCIPAL CITIES

Write today for technical details and price information.



tv service technician in 1946. He was promoted to manager of a factory service branch where he served until 1947. From 1947 to 1949, he was engaged in personnel work and systems engineering at RCA Service Co. headquarters. Then he served as manager, tube quality control group, and later manager, technical operations section. In 1953, he received the RCA Victor Award of Merit, the firm's highest award for salaried employees, for his work in the guided missile field.

Chiei also joined the company as a tv serviceman, serving in that capacity from 1947 until 1950, when he was made a field engineer in the government service division of the company. From 1951 until his present appointment, he served as manager, engineering group, in the field operations section of the division.

The engineering products division of RCA held a fourth color tv technical training program. A total of 101 broadcast engineers attended including 22 engineers from NBC, 15 from CBS, 13 from AT&T and 50 from independent broadcasting stations. It raised to more than 300 the total number of broadcasters given training in theory and operations of new color tv broadcast equipment.

The company also held its 19th black-and-white tv technical training program. A total of 56 broadcast engineers and consultants, including 9 foreign tv engineers, attended the clinic.

### Admiral Corp. Makes New Moves

HARRY HANSON has been named chief designer for Canadian Admiral Corp. He has been directly connected with production design for the past 8 years.

Since 1945, Hanson has been supervisor of cabinet engineering at RCA in Ontario, Canada. Previously he was at the head office in Montreal. Starting with 12 years drafting experience, he gained general production experience from 1939 to 1945.

In the U. S., Admiral announced



**XCELITE Hand Tools**  
PREFERRED BY THE EXPERTS

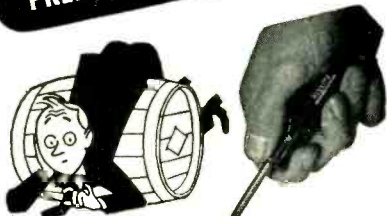

4728 @  
**FOCALIZER ADJUSTMENT**  
Got You Over a Barrel?  
**This XCELITE Tool**  
Makes It Easy!

- Beryllium-copper blade does not affect image as does steel
- No frequent regrinding, as with plastic or fibre blades
- 10" shank to reach into chassis easily
- Broad blade to grip screw snugly!
- Big hand-fitting quality XCELITE handle!

**XCELITE, Incorporated**  
(Formerly Park Metalware Co., Inc.) Dept. C  
Orchard Park, N. Y.

*For Originality*  
**LOOK TO XCELITE**

**QUARTZ CRYSTALS**

FT-243—.093" Pin Dia.—.486" Pin SPC.  
For HAM and GENERAL USE • Guaranteed

Low Frequency—FT-241A for 55B Lattice Filter etc.—.093" Pins. .486" SPC. marked in Channel Nos. 0 to 79, 54th Harmonic and 270 to 389, 72nd Harmonic. Listed below by Fundamental Frequencies. Fractions omitted.

370	393	414	436	458	520	400	461	5910	2030	2290	3232
372	394	415	437	459	522	440	462	6370	2045	2300	3237
374	395	416	438	460	523	441	463	6450	2052	2305	3250
375	396	418	441	463	525	442	464	6470	2065	2320	3322
376	397	419	443	465	526	444	465	6497	2082	2360	3510
377	398	420	444	466	527	445	466	6522	2105	2390	3520
379	401	422	448	470	529	446	468	6547	2125	2415	3550
380	402	423	449	471	530	447	469	6610	2131	2435	3570
381	403	424	451	473	531	448	470	7350	2145	2442	3580
383	404	425	452	474	533	450	472	7380	2155	2532	3945
384	405	426	453	475	534	451	473	7390	2220	2545	3955
385	406	427	454	476	536	452	474	7480	2258	3035	3995
386	407	429	455	477	537	453	475	7580	2260	3155	3995
387	408	430	456	478	538	454	476	7810	2280	3202	
388	409	431	457	479	539	455	477	7930	2282	3215	
390	411	433	459	516		457	479				
391	412	434	460	518		458	480				
392	413	435	461	519		459					

49¢ each. 10 for \$4.00 | 99¢ each. 10 for \$8.00

1015	6100	6625	7340	8340	4035	5675	6350	7475	7775
2125	6125	6640	7350	8350	4080	5700	6375	7500	7800
3500	6140	6650	7375	8380	4165	5706	6375	7506	7825
3640	6150	7000	7400	8400	4190	5725	6400	7525	7840
3680	6175	7025	7425	8425	4280	5743	6406	7540	7850
3735	6200	7050	7440	8450	4300	5750	6425	7550	7873
3760	6440	7073	8000	8475	4330	5773	6673	7573	7875
3800	6450	7075	8025	8500	4397	5780	6675	7575	7900
3840	6473	7100	8050	8525	4490	5806	6700	7600	7906
3885	6475	7125	8073	8550	4495	5840	6706	7606	7925
3940	6500	7150	8075	8575	4535	5852	6725	7610	7940
3955	6506	7175	8100	8600	4735	5873	6750	7625	7950
3995	6550	7200	8125	8625	4840	5875	6775	7640	7973
6000	6573	7250	8150	8650	4930	5880	6800	7641	7975
6025	6575	7300	8173	8700	4950	5906	6806	7650	8206
6050	6600	7306	8175	8733	4980	5925	6825	7673	8225
6075	6606	7325	8200		5030	5940	6850	7675	8250

99¢ each. 10 for \$8.00

**BC746 TUNING UNITS**  
—Foundation coils and condenser for 80 meter VFO or exciter—Less xtals. — 98¢

49¢ each. 10 for \$4.00

See article by W3PPQ in March '54 CQ  
Add 20¢ postage for each 10 crystals or less

**SUN**  
PARTS DISTRIBUTORS, LTD.

520 Tenth St., N.W. - Wash., D. C. Dept. E

**OK** UNDER MIL-E-5272 TESTS for  
extreme temperatures  
humidity - salt spray - vibration  
*Aerohm* wire-wound trimmer potentiometers

**Micro-miniature Series AP 1/2**

- Two watts continuous at 80° C.
- Resistances from 10 to 20,000 ohms.
- Diameter 1/2 inch, depth 1/2 inch.
- Temperature coefficient 0.00002/degree C.
- Weight 1/4 ounce.
- Sealed well enough to permit potting.

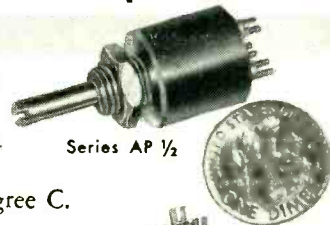

**Series AP 1 1/8**

- Four watts continuous at 80° C.
- Resistances from 10 to 100,000 ohms.
- Diameter 1 1/8 inch, depth 1/2 inch.
- Weight less than 3/4 ounce.
- Temperature coefficient 0.00002/degree C.

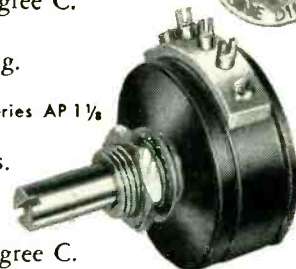

All Aerohm potentiometers are individually checked through a quality-control system that guarantees you full performance from every unit in your order.

Write for full details and prices.

**Aerohm CORPORATION**  
282 MOODY STREET, WALTHAM, MASSACHUSETTS

**ici** Carry-Through  
Printed Circuits

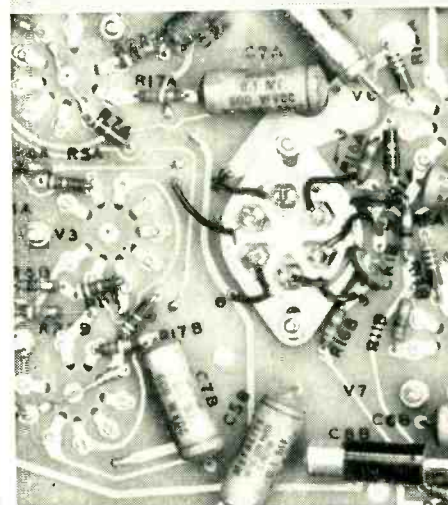

- speed production
- eliminate hardware with I. C. I.

I. C. I. carries the pattern of the printed circuit through the holes to the other side to maintain efficient continuity.

NO hardware... with resulting excellent economies plus speeded-up production and more useable space. In a one square foot area of a printed circuit board .125" thick, 150 holes .020" in diameter can be successfully plated through.

I. C. I.'s unparalleled experience and engineering staff are at your disposal. Write, detailing your requirements for specific help and a copy of our thorough, new technical brochure which explains our research, design and conversion services.

I. C. I. also handles complete sub-assemblies as shown.

**ici** Insulated Circuits  
INCORPORATED

115 ROOSEVELT AVENUE  
BELLEVILLE, NEW JERSEY

Career-chance of a lifetime

for

# Electro-Mechanical

and

# Electronic

# Engineers

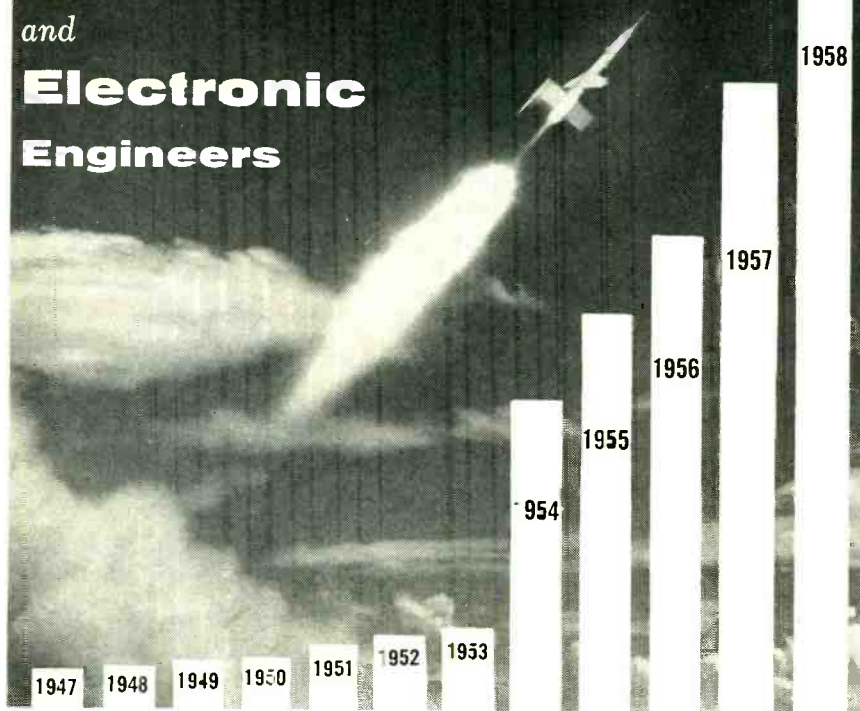

## Your career can go up

with Lockheed's expanding Missile Systems Division

- Outstanding career opportunity comes rarely in a man's life. But such an opportunity exists now for Electro-Mechanical and Electronic Engineers in Lockheed's Missile Systems Division.
- Recently formed from other Lockheed engineering organizations, the Missile Systems Division is in a stage of dynamic expansion. For Electro-Mechanical and Electronic Engineers of ability, experience and initiative this is an unparalleled opportunity for advancement and achievement. A number of present openings are on a high executive level.

### The openings are for

#### ELECTRO-MECHANICAL ENGINEERS

with circuit or servomechanisms experience (aircraft or missile experience preferred)

#### ELECTRONIC ENGINEERS

experienced in any or all of the following fields: Micro-Wave Techniques, Electronic Components, Circuit Design, Flight Instrumentation

- In addition to outstanding career opportunities, the Lockheed Missile Systems Division offers you excellent salaries commensurate with your experience, generous travel and moving allowances, and a better life for you and your family in Southern California.

Coupon is for your convenience

.....

Mr. L. R. Osgood • Dept. E-M-4  
**LOCKHEED MISSILE SYSTEMS DIVISION**  
 7701 Woodley Avenue • Van Nuys, California

Dear Sir: Please send me information on the Missile Systems Division.

.....

\_\_\_\_\_ my name

\_\_\_\_\_ my field of engineering

\_\_\_\_\_ my street address

\_\_\_\_\_ my city and state

plans for the construction of a million dollar consolidated warehouse on a 10-acre tract of land in Leyden Township, Ill. The new 152,000 sq ft structure will eliminate the use of seven warehouse locations in the area. It is scheduled for completion in June, 1954.

Television and radio receivers produced in Admiral plants in Chicago, Harvard, McHenry and Bloomington, Ill., as well as raw materials, will be stored in the new building, thereby simplifying and expediting shipments of mixed carloads to distributors.

The company also announced that it held a color tv training school for company field engineers and distributor service engineers. Each prospective student was given a color perception test before starting the course. Any service personnel found to be color-blind will confine their future service activities to black-and-white tv, it was said.

## Burndy Engineering Names Engineers

At Burndy Engineering, I. F. Matthyse, formerly chief design engineer, has been appointed assistant chief engineer and W. F. Bonwitt, who was previously chief of planning engineering, has been appointed chief administrative engineer.

Matthyse has been in the engineering department of Burndy for 25 years, during which he has been engaged in the design of electrical connectors and cable limiters. A total of 14 patents have been granted to him and 12 patent ap-



I. F. Matthyse



# SPEED UP

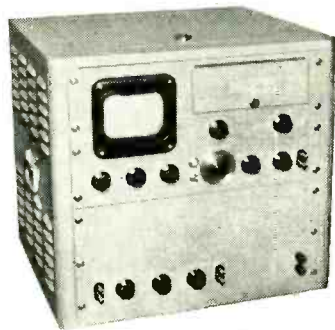

## AUDIO WAVE FORM ANALYSIS

### PANORAMIC SONIC ANALYZER LP-1

Many engineers find that Panoramic's LP-1 expedites their entire measurements program. LP-1 analyzes sound vibrations and electrical waveforms quickly, conveniently, accurately. Designed to eliminate the tedious problems commonly associated with audio wave form analysis, the Panoramic technique provides valuable visual information in seconds!

- visualizes frequency and amplitude of waveform components between 40 and 20,000 cps; magnifies small portions of spectrum for detailed analysis; displays easily photographed; scans spectrum in 1-second; analyzes changing and static phenomena.

It will pay you to investigate the many unique advantages of LP-1.

- **SPECIAL APPLICATIONS**
- Investigations of closely spaced sound and vibration frequencies. Harmonic analysis of waveforms having low frequency fundamentals. Spectrum analysis requiring constant band width.
- Panoramic's LP-1 offers scores of unique advantages; it will pay you to check their application to your problems; write today for complete specifications.



WRITE TODAY  
for Complete Specifications

10 South Second Ave., Mount Vernon, N. Y.  
Phone: MOUNT Vernon 4-3970

Want more information? Use post card on last page.  
ELECTRONICS — April, 1954



W. F. Bonwitt

plications are still pending.

Bonwitt joined Burndy in 1938 and has been occupied largely in heading the firm's testing, research and quality control programs.

### GPL Subsidiary Acquires Computer Company

LIBRASCOPE of Glendale, Calif., a subsidiary of General Precision Equipment Corp., acquired the Minnesota Electronics Corp. of St. Paul, manufacturers of digital computers and components. The Minnesota firm recently developed "subminiature magnetic decision elements" that consist of electronic units such as diodes, resistors, and related components pre-packaged in small plastic cubes. When used in proper combination they are said to provide flexibility and simplicity in computer design and construction. For special applications such as airborne computers they replace units of approximately ten times their size, the company said.

Librascope plans use of the elements in its computers. It is understood that Minnesota Electronics will continue to operate with present management and personnel.

### Avien Forms New Electronic Firm

CONTROL LABORATORIES has been formed by Avien, manufacturers of aircraft fuel management systems and other aeronautical products.

President of the new company, which will be associated with Avien, is Stanley J. Smith, recently director of engineering and development at Simmonds Aeroaccessories.

R. J. Levine, formerly director of

Career-chance of a lifetime for

## Research Engineers



1954

### Your career can go up

with Lockheed's expanding Missile Systems Division

- Recently formed from other Lockheed engineering organizations to prepare for the era of automatic flight, the Missile Systems Division offers a few Research Engineers the career opportunity of a lifetime.
- For Research engineers of ability, experience and initiative, this is an unparalleled opportunity for advancement and achievement.
- The positions now open call for experience in airborne weapons systems problems such as: weapons design, system evaluation, guidance methods, sub-system requirements and operational problems.
- In addition to outstanding career opportunities, the Lockheed Missile Systems Division offers you excellent salaries commensurate with your experience, generous travel and moving allowances, and a better life for you and your family in Southern California.
- Coupon below is for your convenience.

.....  
Mr. L. R. Osgood Dept. E-MRE-4  
LOCKHEED MISSILE SYSTEMS DIVISION  
7701 Woodley Avenue, Van Nuys, California  
Dear Sir: Please send me information on the  
Missile Systems Division.

my name \_\_\_\_\_  
my field of engineering \_\_\_\_\_  
my street address \_\_\_\_\_  
my city and state \_\_\_\_\_

Want more information? Use post card on last page.

**NEW** SA25  
Microwave  
**SPECTRUM  
ANALYZER**

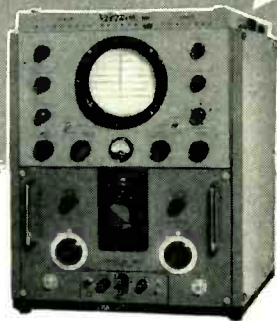

## 12 NEW FEATURES

- 1) "Low Noise" 20 KC IF Amplifier
- 2) Amplified Wavemeter Indication
- 3) Double Range Sweep — 2 to 20 CPS
- 4) Extended Frequency Response
- 5) DC Filament Supply for Klystron
- 6) Longer Persistence CR Tube
- 7) Visual Viewing Filter
- 8) Flat Face Cathode Ray Tube
- 9) Special Illuminated Scale
- 10) Improved Display Linearity
- 11) Improved High Speed Retrace
- 12) Improved Sweep Intensification

PLUS ALL THE  
OUTSTANDING FEATURES OF  
VECTRON'S MODEL SA20  
INCLUDING:

Large Clear 5" Oscilloscope Pattern  
Standard Bezel to accept Camera or Hood  
Minimized Controls for Maximum Operating  
Convenience

Double Conversion for Maximum I. F. Stability  
Regulated Klystron Oscillator Power Supply  
Easy Access for Adjustment or Maintenance

plus Your Choice of

12 INTERCHANGEABLE R. F. HEADS  
for S, L, C, X and K BAND



For full details  
and specifications  
Write today for  
Bulletin SA25

**VECTRON, inc.**

Electronic and Electro-Mechanical Equipment  
404 MAIN STREET, WALTHAM 54, MASS.

VECTRON FOR DESIGN AND MANUFACTURE OF:  
Precision Electronic Components    Microwave Test Equipment  
Electronic Networks and Filters    Radar Units and Systems  
Complete Electronic Systems        Special Test Instruments  
Variable Frequency Power Supplies    Electronic Control Units

Want more information? Use post card on last page.

380



Stanley J. Smith



Robert J. Levine

engineering at Avien, has been appointed vice-president of the new corporation and elected to the board of directors.

"The new company," L. A. Weiss, president of Avien, stated, "is planned to be a development facility specializing in the electronic control and servomechanical fields for aeronautical and other industries."

Smith is an inventor in the aircraft instrument field and particularly in the field of fuel quantity gages, in which he is credited with a large number of key patents.

Other officers of Control Laboratories, to be located in Valhalla, N. Y., will be L. A. Weiss, vice-president and H. H. Myers, secretary-treasurer.

### Volkers & Schaffer Opens New Division

THE Volkers & Schaffer Manufacturing Corp. has been established by Volkers & Schaffer, Inc. to manufacture and promote the "Starved Direct Coupled Amplifier," a highly sensitive oscilloscope which incorporates the starved am-

have you  
thought about  
*Florida*  
for plant  
location?

Florida offers decided advantages to manufacturers in certain fields of electronics such as . . .

Tubes  
Resistors  
Coils  
Expensive Transformers  
Light weight electro-  
mechanical components  
Specialized instruments  
and equipment

Key personnel, engineers and good production workers are available, employee morale is high and the labor climate is excellent. More than 1,965 new residents move to Florida every week.

Florida's sunny year-round good weather assures reduced construction, plant maintenance and heating costs.

Florida is strategically situated for serving Southern and Latin-American markets.

In Florida you pay no state income taxes, no state ad valorem tax, no state inheritance tax.

Florida already has well established electronics research and development facilities—with room for more.

#### A MANUFACTURER SPEAKS

Quoting the president of a Florida electronics company:

"We are firmly convinced that our firm could not have made the strides it has made in the last three years in any other state in the Union."

For further information write:  
Industrial Development Division,  
State of Florida, 3306C Caldwell  
Building, Tallahassee, Florida.

**you'll always  
do better in**

*Florida*

Want more information? Use post card on last page.

April, 1954 — ELECTRONICS



Patent Applied For

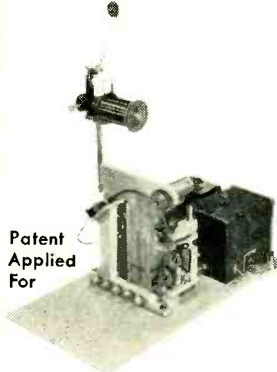

# NEW wide-range HARDER TOROIDAL COIL WINDER

NEW MODEL "M" COMBINES THE SPEED AND FLEXIBILITY OF THE HARDER MODEL "L" WITH FAR GREATER RANGE OF WIRE RANGES

This new, improved Model "M" winds toroidal coils 1/4" inside dia. and smaller, to 3" outside dia. and larger, in wire sizes #20 solid or stranded, to #44, with winding speeds 1000 tpm on small wire and reduction to 250 tpm on larger wires. Single layer close spaced windings readily accomplished with larger wires. Multifilar windings of same or different size wires made without pre-twisting or cementing and without tangling.

write for free information today!

**DONALD C. HARDER CO.**  
3338 INDIA STREET, SAN DIEGO 1, CALIF.

## UNLIMITED OPPORTUNITIES for ... Electrical Engineers and Physicists to do Digital Computer Engineering

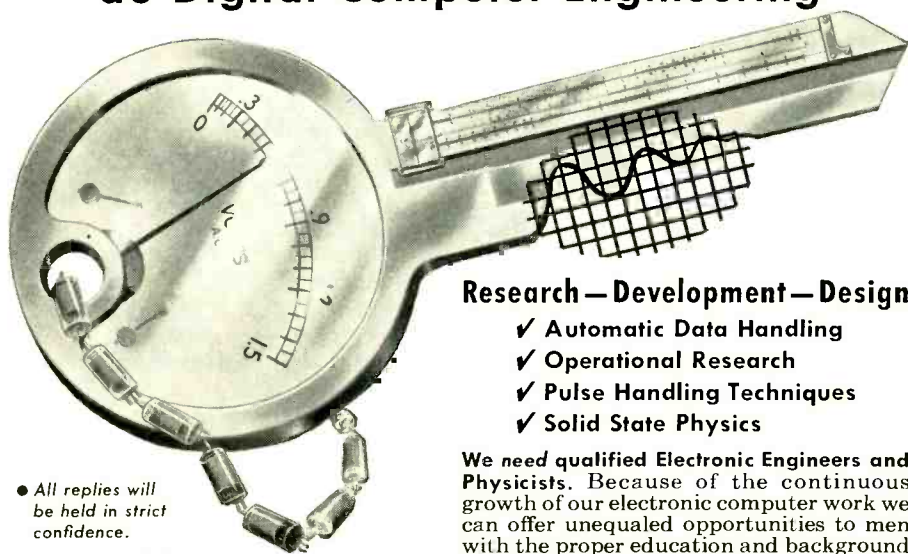

- All replies will be held in strict confidence.
- Interviews will be arranged at our expense.

### Research — Development — Design

- ✓ Automatic Data Handling
- ✓ Operational Research
- ✓ Pulse Handling Techniques
- ✓ Solid State Physics

We need qualified Electronic Engineers and Physicists. Because of the continuous growth of our electronic computer work we can offer unequalled opportunities to men with the proper education and background in the Electronics field . . . permanent positions, financial security, professional development.

HERE IS THE KEY TO YOUR FUTURE...

ENGINEERING RESEARCH ASSOCIATES

DIVISION OF **Remington Rand**

1902 West Minnehaha Avenue, Dept. E-00, St. Paul W4, Minnesota

## Roanwell Standard Navy Hand-Held MICROPHONE



Style #044

USED IN  
SMALL AIRCRAFT



AND  
MOTORCYCLES



### OUT-OF-STOCK DELIVERY

Beginning May, 1954

Designed to rigid Navy specifications, this dependable, lightweight microphone features long-life, high output, and all-position response. Incorporates use of long-life detent switch. Cord is reinforced by a rubber protector for maximum flexure life. Available also with coil cord — on made-to-order basis.

### HANGER STYLE 035

Designed for use with Style #044



Roanwell hand-held microphone. Made of hardened steel, finished in cadmium plate. Resilient heat-treated



spring grip holds microphone securely, prevents vibration.

WRITE FOR COMPLETE DATA

**ROANWELL CORPORATION**

27 SIXTH AVE., BROOKLYN 17, N. Y.

for **PROVEN RESULTS** specify

**McGRAW-HILL**

**Mailing Lists**

**You can save time, avoid needless expense, increase your results  
by having McGraw-Hill Lists do your mail advertising job!**

Three quarters of a century of practical experience is made available to you when you turn your direct mail jobs over to McGraw-Hill. And these seventy-five years of leadership in the development and perfection of lists assure you the maximum results at the lowest cost per order or inquiry.

Those who are acquainted with mailing lists know that year-after-year acceptance of lists does not come by chance or luck. Accepted lists, like McGraw-Hill's, hold their places by merit alone. Nor does success one day guarantee success the next. Vigilant eyes must constantly add new names, delete, change, check, recheck, etc. Inferior lists are dropped as soon as shortcomings are noticed . . . "good lists" yield to better lists.

For seventy-five years expert list users have preferred McGraw-Hill by long odds. No matter how few names you use—whether your business is large or small—the best lists, McGraw-Hill Lists, are the most economical in the long run.

The world-wide reputation McGraw-Hill has earned as builders of the finest mailing lists was born of constant research in our office and in the field—constantly adding new names . . . developing new markets, new avenues of revenue for direct mail list users.

*Proven Results*



**McGRAW-HILL**  
DIRECT MAIL LIST SERVICE

**McGraw-Hill Publishing Co., Inc.**

*DIRECT MAIL DIVISION*

**330 W. 42nd Street, New York 36, N. Y.**

McGraw-Hill Mailing Lists are built—and constantly maintained—to provide, as accurately as humanly possible, complete rosters of the industries we serve.

Investigate their tremendous possibilities in relation to your own product or service. Your specifications are our guide in recommending the particular McGraw-Hill lists that best cover your market. When planning your industrial advertising and sales promotional activities, ask for more facts or, better still, write today. No obligation, of course.

Direct Mail Division, McGraw-Hill Publishing Co.  
330 West 42nd Street, New York 36, N. Y.

Please send me, at no cost, mailing list information that will cover my markets.

Name ..... Title.....  
Company .....  
Address .....  
City and State.....  
Product or Service.....



# DUAL-TRACE APPLICATIONS

The Tektronix Type 535 Oscilloscope and Type 53C Dual-Trace Plug-In Preamplifier make a combination superior to a dual-beam oscilloscope in most applications. Because both waveforms appear on the same time base, accurate time comparisons are assured. Flexibility provided by independent positioning, sensitivity, and polarity inversion controls makes almost any sort of waveform comparison easy. The one exception is the observation or recording of two simultaneous transients of less than a millisecond duration. For this a dual-beam instrument is more practical.

Two typical dual-trace applications with the Type 535 and Type 53C are the comparisons of amplifier grid and plate voltage waveforms, and network input and output waveforms.

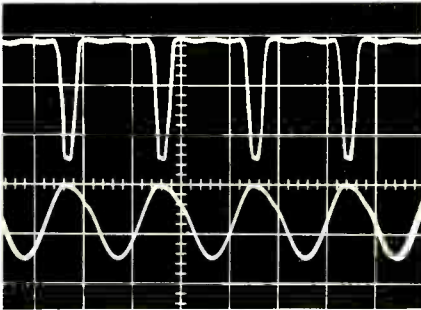
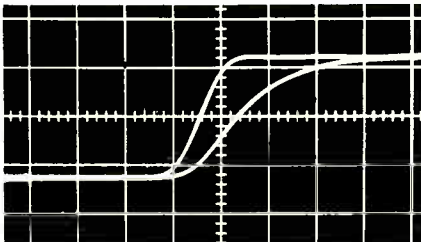

Plate and grid voltage waveforms of a class C amplifier working into a resistive load. Traces may be brought together for closer comparison.



Output of an RC network superimposed on the input pulse. Both waveforms appear on the same 0.04  $\mu\text{sec}/\text{cm}$  sweep, accurately measuring the risetime deterioration caused by passage through the network.

## MAIN OSCILLOSCOPE FEATURES

**600,000,000 to 1 Sweep Range**—0.02  $\mu\text{sec}/\text{cm}$  to 12 sec/cm, continuously variable. Calibrated—0.02  $\mu\text{sec}/\text{cm}$  to 5 sec/cm, accurate within 3%.

**10 KV Accelerating Potential**—Brighter display at low repetition rates.

**Flexible Sweep Delay**—1  $\mu\text{sec}$  to 0.1 sec, jitter-free, incremental accuracy within 0.2% of full scale. Type 535 Oscilloscope—\$1300 plus price of desired plug-in units.

## DUAL-TRACE PLUG-IN PREAMPLIFIER

### Type 53C Specifications

#### Two Identical Amplifier Channels

Frequency Response—DC to 8.5 mc.

Risetime—0.04  $\mu\text{sec}$ .

Sensitivity—0.05 v/cm to 20 v/cm calibrated, continuously variable to 50 v/cm.

#### Electronic Switching

**Triggered**—actuates alternate sweeps.

**Free-running rate**—100 kc, approximately.

Type 53C Dual-Trace Unit—\$275.

## OTHER PLUG-IN PREAMPLIFIERS

Type 53A Wide-Band DC Unit—\$85.

Type 53B Wide-Band High-Gain Unit—\$125.

Type 53D High-Gain Differential Unit—\$145.

Prices f.o.b. Portland (Beaverton), Oregon.

Please write for complete specifications.

 **Tektronix, Inc.**  
P. O. Box 831A, Portland 7, Ore.  
Cable: TEKTRONIX

Want more information? Use post card on last page.

ELECTRONICS — April, 1954

PLANTS AND PEOPLE

(continued)

plifier circuit invented by W. K. Volkers, vice-president of the company. President of the new manufacturing division is Roy B. Hoag.

## Radio Receptor Names Mendel

RALPH MENDEL was appointed vice-president in charge of the engineering products division of Radio Receptor. He joined the company in 1948 and for the past few years has been manager of the division. Prior to 1945 he was with RCA International.

## Sprague Appoints New Plant Manager

ROBERT L. PARRIS was named manager of the new plant of Sprague Electric, now under construction at West Jefferson, N. C.

The new plant, which will manufacture capacitors, will open late this spring. It is the sixth branch plant to be established by the concern.

Parrish, who has been associated with the main plants of the company for some time, was formerly senior chemical engineer with Abbott Laboratories.

## Printed Circuit Firm Begins Operations

THE OPENING of Insulated Circuits, a new printed circuit manufacturing company, took place in Belleville, N. J.

Officers of the firm are: R. A. Curran, president; Louis Eisenstein, vice-president and treasurer; Max Eisenstein, secretary and G. H. Ogens, sales manager.

The 7,500 sq ft plant has facilities

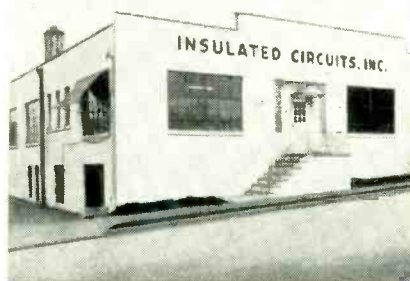

Insulated Circuits plant

# MAGNETIC STORAGE DRUMS

Available:

- 4 additional types from 24,000 bits capacity
  - fixed heads for fast access
  - lower and higher speeds
- Special applications will be reviewed upon request

Write for bulletin 182-3

Illustrated: Type 2

- 600,000 bit capacity
- 8 inch diameter
- 38 inches long
- 500 tracks
- Single moving head
- 575—1750 RPM

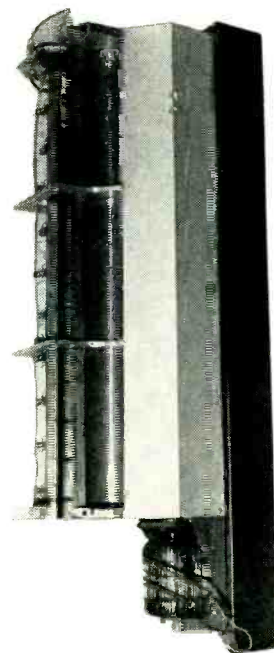

**W. S. MACDONALD Co., Inc.**

33 University Road, Cambridge, Mass.

Want more information? Use post card on last page.

**JELLIFF****ALLOY 800 RESISTANCE WIRE***for miniaturized precision-instrument components**the ideal resistance wire for*

fixed and variable resistors of high ohmage — resistance boxes and bridges — voltmeter and wattmeter multipliers — and other miniature wire-wound units.

Where space is at a premium and performance is a "must" — these outstanding qualities of Jelliff Alloy 800 will assure that your products conform to the tightest specs.

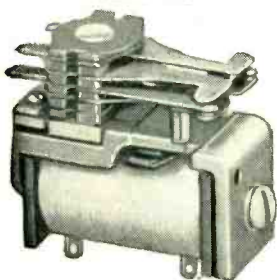
High resistivity, 800 ohms/cm — Low Temperature Coefficient,  $\pm 20$  ppm per  $^{\circ}\text{C}$  — Non-Magnetic — Highly Stable Electrically and Mechanically — Diameters from 0.0009" to 0.0056" — Bare, enameled or oxidized, or insulated with silk, Nylon or cotton — Solders and Winds easily.For Complete Data Address  
Department 17**THE C. O. JELLIFF****MANUFACTURING CORP. SOUTHPORT, CONN.****MIDGET TELEPHONE TYPE RELAYS**  
*in hermetically sealed containers*Surface mounting, open type, Series 80 Relay — size:  $1\frac{1}{32}$ " l. x  $\frac{5}{8}$ " w. x  $1\frac{25}{64}$ " h.

Compact, multiple contact with vibration and shock-proof characteristics. Designed to meet various operating requirements typical of Armed Services applications.

Unique pile-up arrangement reduces width below the conventional relay, thereby reducing over-all space volume.

Coils are varnish-impregnated to resist high humidity conditions. All ferrous parts are treated to pass salt-spray tests.

*Engineering Representatives in Principal Cities*WRITE FOR  
BULLETIN  
MTR-6

*Wheelock* RELAYS  
**SIGNAL**  
ENGINEERING & MFG. CO.  
154 WEST 14<sup>TH</sup> ST. NEW YORK 11, N.Y.

ties for production and assembly of printed circuits without sub-contracting. Plant personnel and facilities are being increased to implement construction and to accommodate additional sub-assembly contracts.

**Ward Products Names  
Engineering Director**

THE WARD PRODUCTS CORP., division of Gabriel, announced the appointment of William H. Rickards to the newly created position of director of engineering. He will expand antenna engineering facilities for the firm. His most recent affiliations were with the Radiart Corp. and Cleveland Electronics. His work in recent years has been in the design and development of tv and automotive antennas.

**Indiana Steel Names  
Two Executives**

JAMES R. IRELAND, formerly staff assistant to the vice-president in charge of research and engineering for Indiana Steel Products, has been appointed assistant director of research. He will have direct responsibility for all research, including that to be done under a new contract with the Air Force for basic and applied research on magnetics.

Before coming to Indiana Steel, Ireland served seven years as chief engineer for Thomas &amp; Skinner Steel Products Co.

James G. Richmond was named



# MICO

Precision Apparatus

## PORTABLE PANTOGRAPH ENGRAVER

with  
SUPERIOR  
FEATURES



TOROID COIL WINDERS  
UHF COAXIAL WAVEMETERS

Send for Illustrated Catalogs

MICO INSTRUMENT CO.

76-E Trowbridge St. Cambridge 38, Mass.

## Miniature Tap Switches



Series 12  
For Military  
Series 5000  
For Commercial

### Both Models

- 1 to 6 Decks
- Up to 10 Positions Per Deck
- Minimum Space Required
- Rated 1 amp., 115 v., A.C., Non-Inductive



523 Hilgrave Avenue  
La Grange, Illinois  
Phone:  
Fleetwood 4-1040

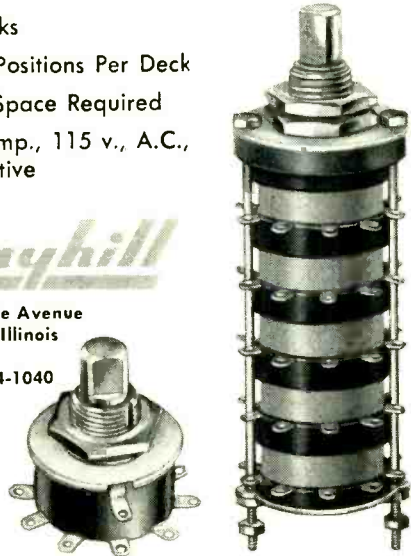

Over 85% of the torque wrenches used in industry are

# STURTEVANT

## TORQUE WRENCHES

Read by Sight, Sound or Feel.

- Permanently Accurate
- Practically Indestructible
- Faster—Easier to use
- Automatic Release
- All Capacities

in inch ounces . . . inch pounds . . . foot pounds  
(All Sizes from 0-6000 ft. lbs.)

STURTEVANT TORQUE MANUAL

Every manufacturer, design and production man should have this valuable data. Sent upon request.

PA STURTEVANT CO  
ADDISON [QUALITY] ILLINOIS

# DC-7

NEVER BEFORE such Magnificence . . . such Power such Performance!

and NEVER BEFORE has the A. W. HAYDON COMPANY been so proud of its contribution . . .

In the never-ending conquest of the vast barriers of space and time, Douglas goes ever forward meeting every challenge that men and machines must face. The newest — and brightest — star in the aviation firmament, the Douglas DC-7, is truly a miracle of the mastery of men over machines . . . and in this great work sixteen A. W. Haydon timing devices play an important part. We at A. W. Haydon take pride in our contribution toward bringing a mass of metal and machinery into integrated performance which meets Douglas' high standards. Integrated performance is born of a multitude of small component parts, working in perfect mechanical and electrical coordination. The A. W. Haydon precision timing instruments are a vital part of this vast network.

DOUGLAS DC-7, the ultimate in comfortable and safe air travel. Swift, luxurious, dependable — the new DOUGLAS DC-7 justly deserves the accolades it is receiving.

A. W. Haydon Time Delay Relay is a very important component of the automatic prop feathering system.  
A. W. Haydon Time Delay Relay times duration of prop deicing equipment.  
A. W. Haydon Repeat Cycle Timer is a vital part of the cabin pressurization equipment.  
A. W. Haydon D.C. Timing Motors are used in the cabin pressurization systems.

when timing poses a problem — consult

(Catalog sent on request)

The A.W. HAYDON COMPANY  
235 NORTH ELM STREET  
WATERBURY 20, CONNECTICUT  
Design and Manufacture of Electro-Mechanical Timing Devices

**NEW! Subminiature Metallized Paper CAPACITORS**  
Funginert Plastic Encased

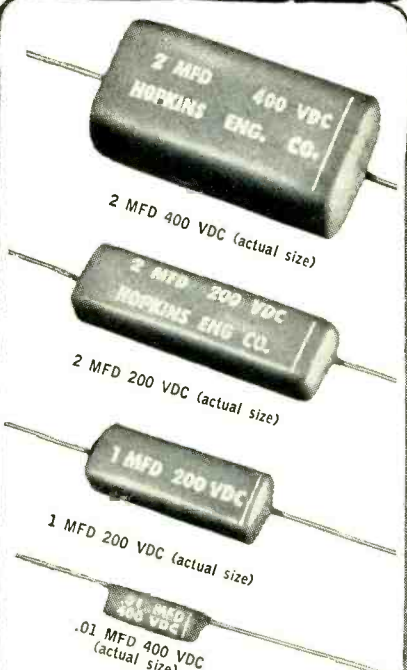

- ✓ Resin impregnated and rectangular shaped for maximum space conservation
- ✓ Completely encased in a non-nutrient plastic for maximum fungus and humidity protection
- ✓ Operating temperature range -55°C to +100°C
- ✓ Temperature coefficient +.07%/°C
- ✓ Excellent capacity retrace

Also available in HERMETICALLY SEALED drawn metal containers (shown approx. 1/2 actual size)

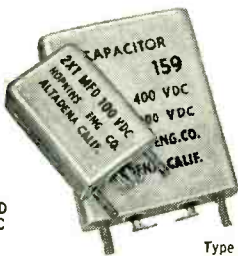

2X1 MFD 100 VDC

Type 159,  
1 MFD 400 VDC;  
2 MFD 400 VDC

A multiplicity of sizes is available in either plastic encased or hermetically sealed capacitors. Special designed units also made to your exact specifications.

Write or wire us, today!



FACTORY: 2082 Lincoln Ave. Altadena, Calif. SYcamore 8-1185  
Offices in WASHINGTON, D. C. and DETROIT

assistant manager of the manufacturing division and will be responsible to the vice-president in charge of manufacturing for all functions of the division. Before joining the company as a staff assistant in 1953, he was employed by International Harvester as materials controller.

**Breitwieser Elected Lear Vice-President**

CHARLES J. Breitwieser, who recently joined Lear as director of engineering, was elected a vice-president of the company. He is also manager of the general development and engineering division.

Previously he was with P. R. Mallory & Co. as director of engineering in charge of its central engineering laboratories. Prior to joining Mallory, he was with Convair for over 9 years as chief of electronics and research laboratories, responsible for the electronics and guidance section, guided missile flight test section, engineering test laboratories and the missile and airplane instrumentation section.



**Micamold Radio Elects Executive Vice-President**

J. GERALD MAYER, attorney and senior partner in the law firm of Mayer, Rigby and Seeley, has been elected executive vice-president of Micamold Radio of New York City.

Mayer, an engineer and attorney, was associated for a number of years as an engineer with Western Electric. He was the World War II chief of the contract termination

**Fits your Product --- Builds Sales**

**BRADLEY HAS A RIGID PLASTIC BOX FOR YOU . . .**



**Series 300**  
8 1/4" x 4 1/4" x 1 1/4"  
(assorted compartments)

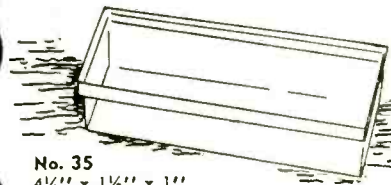

**No. 35**  
4 1/4" x 1 1/2" x 1"

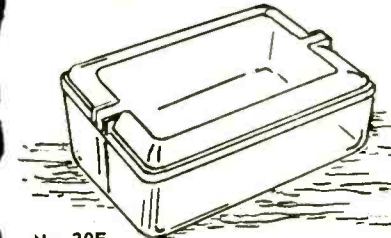

**No. 30F**  
5 1/4" x 4" x 1 1/4"

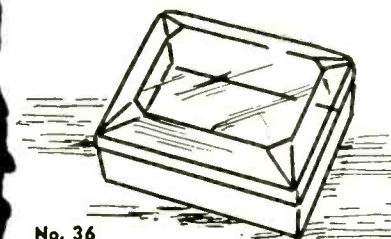

**No. 36**  
2 1/4" x 1-7/8" x 1 1/4"

Many aggressive merchandisers of industrial components are using our polystyrene boxes to improve their packaging . . . create sales appeal.

Write for illustrated catalog, giving dimensions, etc. . . or visit our new factory and showrooms when in Chicago.

Available from Stock molds . . . "World's largest assortment of plastic boxes."



**BRADLEY INDUSTRIES**

1656 N. Damen Ave. Chicago 47, Ill.



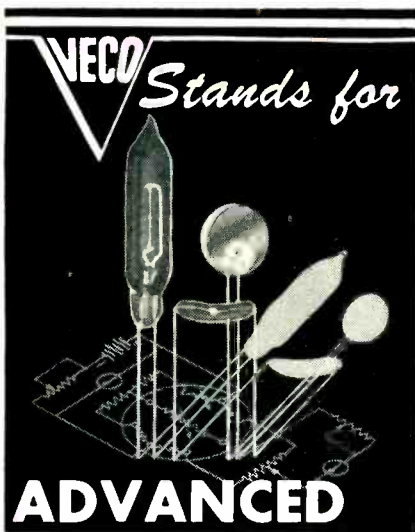

**ADVANCED DESIGN . .**

A recent development in sensing elements provides the basis for a new and better approach to problems in measurement and control. VECO THERMISTORS have an extremely high negative temperature coefficient of electrical resistance. Their small size and extreme sensitivity to thermal changes offer engineers a circuit element to utilize in new applications, and for the improvement of older methods.

BEADS • WASHERS • DISCS • RODS

**SOME PRACTICAL USES:**

Time delay • Gas analysis • Volume limiting • Surge protection • Vacuum manometry • Flow measurement • Temperature control • Temperature measurement • Radar power measurement • Temperature compensation • Oscillator stabilization • and many new applications being developed.

SEND FOR —  
**VECO THERMISTOR DATA BOOK**

**VECO GAS ANALYSIS CELLS**

employ Veco glass-coated Thermistors as sensing and reference elements (no open wires, therefore no corrosion).

\$5 cash or money order will bring you the VECO Experimentors' THERMISTOR-VARISTOR Package, No. 168. 7 items and application circuitry—value over \$15!

**Victory**

ENGINEERING CORPORATION  
MANUFACTURERS OF:

- 4 Electronic & Thermal Control Instruments
- Temperature Sensing Devices
- Combustion Analyzers

Springfield Road, Union, N. J. Tel. UNIONVILLE 2-7150  
Want more information? Use post card on last page.  
ELECTRONICS — April, 1954

organization in the office of the Chief of Signal Officer and since that time has been counsel to various electronic industry groups.

A. P. Hirsch, president of Micamold, said that the step was taken in line with a policy of expansion both with respect to facilities and products.



**Armour Research Names Disney**

VIRGIL H. DISNEY was promoted to manager of the electrical engineering research department at Armour Research Foundation of Illinois Institute of Technology.

Disney joined the foundation staff in 1949, serving first as supervisor of the electronics section. He was promoted to assistant manager of the electrical engineering department in 1951.

Before coming to Armour, Disney was a project engineer with Sperry Gyroscope. He was with Curtiss-Wright from 1946 to 1947, serving as assistant section head of research. From 1943 to 1946 he was a project engineer for C. G. Conn. In 1942-43 he taught in the engineering and science management war training program at Illinois Tech, and from 1937-1942 he was an electrical engineer for American Can.

**Beltone Makes Research Grant**

A GRANT of \$1,000 to the audiology department of Northwestern University for electronic research equipment was announced by Sam Posen, chairman of the Beltone In-

**DESIGNED Especially for TRANSISTOR CIRCUITS**

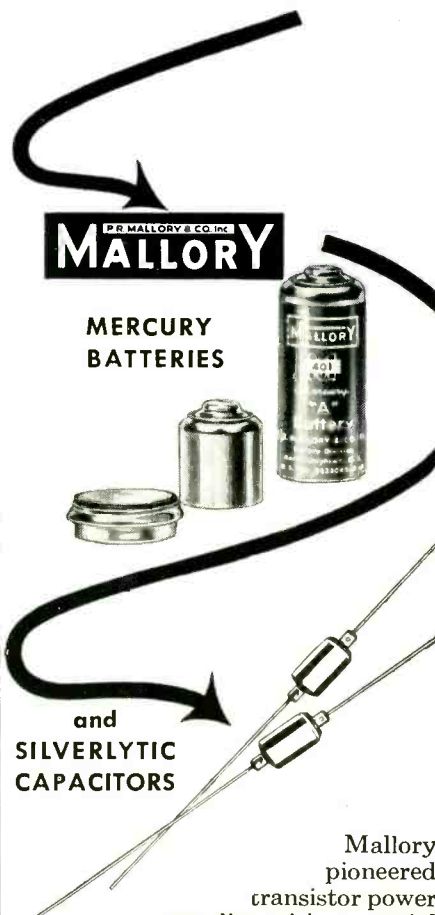

and SILVERLYTIC CAPACITORS

Mallory pioneered transistor power supplies with a special line of Mercury Batteries that deliver the constant-current, constant-voltage necessary for the best performance of transistor circuits. In addition, Mallory Batteries offer unusually long shelf life and high ratio of energy to size and weight.

Tiny, specially-developed Mallory Silverlytic Capacitors also meet every requirement of low voltage transistor applications.

For complete data, write or call P. R. MALLORY & CO. INC., Indianapolis 6, Indiana.

Available NOW

IN PRODUCTION QUANTITIES



Want more information? Use post card on last page.

stitute for Hearing Research in Chicago.

The equipment will be used in current studies aimed at improving techniques of clinical testing of hearing loss.

### Designers For Industry Names Engineers

RECENT promotions and additions were made to the staff of Designers For Industry. Franklin L. Eger joined the firm on the technical survey staff as senior field investigator and Dante J. Domizi as senior project designer in electronics engineering.

Recent promotions include P. N. Bredesen to assistant project manager, electronics; and H. G. Gilbert, E. Holasek, E. F. Mazur and G. J. Prusha to project designers, electronics.

### Ampex Names Read Assembly Head

STANLEY N. READ has been named superintendent of assembly operations by Ampex Corp. Before joining the firm he was engaged in the installation of manufacturing plants and management controls. He brings to his new position more than 16 years of administrative experience in the engineering and production of communication equipment for Magnavox, Centralab, Kellogg Switchboard and other firms.

### Aerovox Division Names Whitton

RAYMOND WHITTON has joined the Burbank, Calif. factory of Cinema Engineering, a division of Aerovox. He will head the tool and die design department.

Whitton has been in the field a score of years, most recently as tool maker and shop foreman for West Coast Engineering and previously with the U. S. Navy ordnance plant as a tool maker and tool designer. An enlarged tool-design department has been installed in Cinema's new Burbank facility.

John A. Oliver has joined the division as a staff engineer. He had been with Hughes Aircraft for the past three years in research analytic activities and previously,

# PRECISION SYNCHROS SERVO MOTORS RATE GENERATORS



Infra Electronic Corporation is playing an important part in the precision manufacture and assembly of electronic and electromechanical system components for the Military.

We invite your inquiry when commercially available units will not meet your system demands.

Custom design, development, and manufacture of Test Sets, Kits and Consoles for pre-flight check out and ground maintenance of airborne systems.

## INFRA

### Electronic Corp.

— Roseland, New Jersey —

Manufacturers of Precision Synchros

Want more information? Use post card on last page.

let **WILLIAMS**  
help you apply

**ferric oxides**

to the manufacture  
of your

# FERRITES

You'll be well repaid by getting the facts on a special group of Pure Ferric Oxides, developed by Williams especially for use in the manufacture of ferrites.

Williams Ferric Oxides analyze better than 99%  $Fe_2O_3$ . They contain a minimum of impurities. They are available in a broad range of particle sizes and shapes. Among them, we're certain you'll find one that's "just right" for your requirements. The proper application of Ferric Oxides to the manufacture of Ferrites is our specialty.

Tell us your requirements . . . we'll gladly send samples for test. Chances are good that our Ferric Oxide "Know How" can save you considerable time and money. Address Dept. 25, C. K. Williams & Co., Easton, Pa.

## WILLIAMS

COLORS & PIGMENTS

C. K. WILLIAMS & CO.  
Easton, Pa. • East St. Louis, Ill.  
Emeryville, Cal.

P.S. We also produce IRN Magnetic Iron powders for the Electronic Core Industry, the Magnetic Tape Recording Industry and others. Write for complete technical information.

Want more information? Use post card on last page.



# VULCAN

## ELECTRIC HEATING UNITS



### Strip Heaters

for Flat Surfaces . . .  
Shallow Pans . . . Hot Plates . . .  
Ovens . . . Platens . . . Dies . . .  
Plastic Extruders . . . Tanks  
Melting Pots . . . Package  
Sealers etc.

One-piece rust-resisting sheath

Heater coil of nickel chromium wire, insulated from inner sheath wall with a refractory selected for best thermal conduction and stability at elevated temperatures

Terminal screws stainless steel.

Two sheaths (1) for temperatures up to 750° F max and (2) up to 1200° F, max.

Catalog tells complete story

# VULCAN

## ELECTRIC COMPANY

DANVERS 10, MASS

# FOR MARKING...



**PLASTIC • METAL  
GLASS • PAPER  
RUBBER • CERAMIC  
CARDBOARD**

*in such products as Resistors, capacitors, valves, tubes, labels, sleeves, spark plugs, cartons, etc., etc.*

**THESE PRODUCTS AND MANY OTHERS OF ALMOST ANY MATERIAL AND SHAPE CAN BE IMPRINTED**

ON THE

# REJAFIX MARKING MACHINE

**Why not send us samples of your products? They will be test-printed and returned to you for your examination!**

- REJAFIX HAND-OPERATED MODELS FOR SMALL RUNS. FULLY AUTOMATIC MODELS FOR MASS PRODUCTION.

EST. 1922

# POPPER & SONS INC.

300 FOURTH AVENUE  
NEW YORK 10, N.Y.

**FOR YOUR Evaluation**

## AGMA INTERPRETATION OF YOUR GEAR DATA GRAPHICALLY PRESENTED

To avoid possible inaccurate interpretation of the quality gear you require we enclose, with our quotation, a chart detailing the tolerances to which we will manufacture your gear.

We base our price on the class of gear depicted on the chart. Our interpretation is based on AGMA Standards for fine-pitch gears.

6718

# Dexter MACHINE PRODUCTS, INC.

CHELSEA, MICHIGAN, Box 328  
Phones: Detroit WE 3-1694—Chelsea 2-1791

# PRECISION TRANSFORMERS

...built to fill your exact requirements... and to all government specifications. No job too big or too small.

Development and design facilities available.

We specialize in **MAGNETIC AMPLIFIER development**

YOU can improve the performance, life and reliability of your circuits . . . eliminate costly equipment maintenance and replacement part costs by using ATLAS Magnetic Amplifiers for:

1. Low level amplification
2. Regulated DC power supplies
3. Motor drive controls
4. Thermocouple and photocell to relay applications

We welcome inquiries. Send sketches of your circuit and list desired performance characteristics . . . we'll do the rest.

### CONSTRUCTION TYPES:

- Hermetically sealed
- Fosterite
- Scotch Cast
- Open types

# ATLAS

## ATLAS ENGINEERING CO., Inc.

3 EDGEWOOD ST., ROXBURY, MASS.



## USE US FOR FAST FOOT WORK

Modern research makes things change fast. Your very size of production concentration may hamper the "dexterity of your foot work."

We, being smaller, with all around experience, may be able to aid you in quick movements to keep up with progress.

*Use us for mobility.*

## CONRAD & MOSER

Workers in Aluminum,  
Brass, Steel & Plastics

DESIGNING  
ENGINEERING • MANUFACTURING  
MECHANISMS • MACHINES  
PARTS • TOOLS • DIES • MOLDS  
STAMPINGS • CASTINGS  
MACHINING • SHEET METAL  
ENCLOSURES & CHASSIS  
1/8 to 1/2 NAVY SPEC ALUMINUM  
SPOT WELDING AND HELIARC  
WELDING.

2 Borden Ave.  
Long Island City 1, N.Y.



Want more information? Use post card on last page.

390

PLANTS AND PEOPLE

(continued)

for ten years, was at Oak Ridge, Tenn. in various projects and capacities.

### Varian Elects Three Directors

JAMES B. DU PRAU, Theodore Moreno and Emmet G. Cameron were elected to the board of directors of Varian Associates.

Du Prau is vice-president and assistant to the president of Columbia-Geneva Steel Division of U. S. Steel and a member of their board of directors.

Dr. Moreno is manager of tube design and improvement at Varian. He has been with the company since 1951.

Cameron is works manager in charge of the firm's San Carlos, Calif. plant.

Directors reelected were: R. H. Varian, president; H. M. Stearns, executive vice-president and general manager; S. F. Varian, vice-president for engineering; R. M. Leonard, secretary; E. L. Ginzton, F. P. Farquhar, David Packard, D. G. McAllister, G. D. Merner and C. V. Heimbucher.

The company reported that its high-power amplifier klystron, designed and built for GE, is now in use in over 24 uhf tv stations. The Varian nuclear induction magnetometer, developed for Byron Jackson Co., was recently announced and is a portable device for the location of subterranean or under-sea mineral bodies by detection of variations in the magnetic field of the earth.

### New Research Lab Is Established

TECHNIQUES, a new electronics research and development laboratory, has been established in Goleta, Calif.

The firm occupies approximately 1,200 sq ft of space in Building 120 at the Santa Barbara, Calif., Airport. The company presently has a military subcontract with Goodyear Aircraft on radar design and a direct commercial contract with Goodyear on computer design.

For the present, the company consists of two engineers, Carl A. Wiley and Ben. R. Gardner, presi-

**DEFINITELY—**  
IN  
EXACT PROPORTION!

## GIANNINI SYNCHRONOUS MOTORS

CUSTOM-DESIGNED

When it's imperative that speed correspond *exactly* with supply frequency, Giannini-designed motors are unmatched. More than that, these rugged instruments perform under extreme environmental conditions—and are being precision manufactured to meet *exact* physical dimensions, frequency response, impedance characteristics and mechanical dynamics.

GIANNINI

### HYSTERESIS MOTORS

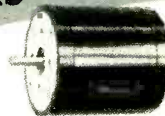

*Custom-designed to start and synchronize high inertia loads quietly and smoothly . . . remaining independent of line and load fluctuations . . . and operate at various synchronous speeds by switching.*

GIANNINI

### SALIENT POLE MOTORS

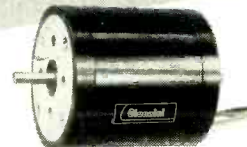

*Custom-designed to synchronize in particular shaft angular positions at minimum noise level. Especially well suited for framing, registering or similar applications.*

May we cooperate in the design and development of your projects involving synchronous motors and other rotary electro-magnetic devices?

**Giannini**

Special problem? Further information? Please write:

**G. M. GIANNINI & CO., INC.**  
ElectroMechanical Division  
East Orange, New Jersey

Want more information? Use post card on last page.

April, 1954 — ELECTRONICS



dent, both of whom have had extensive experience in the field.

**Reliance Plans Plant Addition**

THE Reliance Electric and Engineering Co. plans a new 90,000 sq ft plant addition to its Ashtabula, Ohio division. The addition will increase plant and office area to a total of 220,000 sq ft. The company's new line of a-c motors will be built at the plant.

**Robertshaw-Fulton Makes Plant Moves**

CONSTRUCTION began on a new 237,000 sq ft plant in Long Beach, Calif. to house the Grayson Controls Division of the Robertshaw-Fulton Controls Co. The new \$2.5



Proposed Robertshaw-Fulton plant

million plant will employ about 2,400 people with an annual payroll in excess of \$7 million.

Construction of a \$500,000 addition to another California plant of



Thomas H. Jeffers

# — the Counter —

**YOU'VE BEEN WAITING FOR!**

BY SODECO GENÈVE

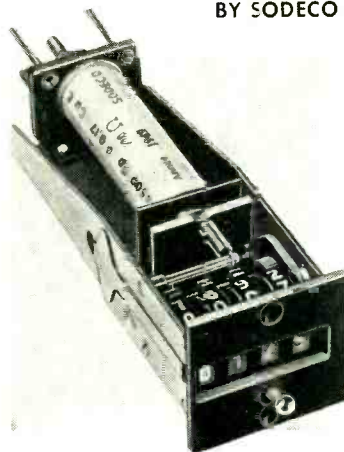

- Instantaneous reset . . . to zero at a touch of the button
- Compact . . . flush-mounting plate measures only 1-5/16" x 1-3/16" — counter is only 4-3/8" deep
- Fast . . . standard models count up to 10 impulses/sec. (Special models available with speeds up to 25 impulses/sec.)
- Half-numbers . . . show when coil is energized
- 3, 4, or 5 digit models

**RUGGED  
ECONOMICAL  
ACCURATE**



Write for Bulletin 21

## LANDIS & GYR, Inc.

45 West 45th Street • New York 36, N. Y.

### STANDARD SIGNAL GENERATOR

**MODEL  
65-B  
RANGE  
75 KC  
to  
30 MC**

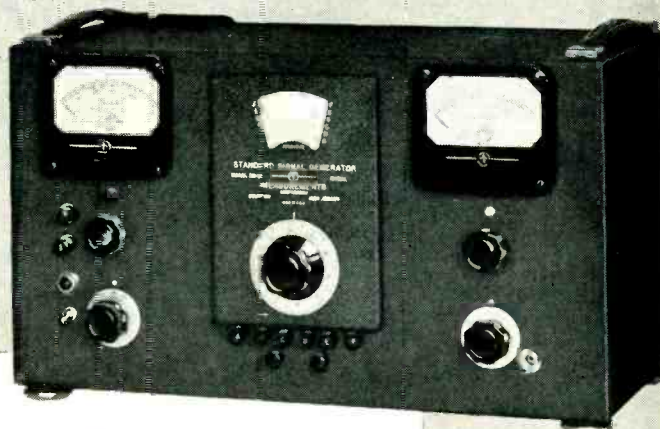

**Individually Calibrated Scale**

- OUTPUT:** Continuously variable, .1 microvolt to 2.2 volts.
- OUTPUT IMPEDANCE:** 5 ohms to .2 volt, rising to 15 ohms at 2.2 volts.
- MODULATION:** From zero to 100%. 400 cycles, 1000 cycles and provision for external modulation. Built-in, low distortion modulating amplifier.
- POWER SUPPLY:** 117 volts, 50-50 cycles, AC.
- DIMENSIONS:** 11" high, 20" long, 10 1/4" deep, overall.
- WEIGHT:** Approximately 50 lbs.

Catalog on request

- MANUFACTURERS OF**
- Standard Signal Generators
- Pulse Generators
- FM Signal Generators
- Square Wave Generators
- Vacuum Tube Voltmeters
- UHF Radio Noise & Field Strength Meters
- Capacity Bridges
- Megohm Meters
- Phase Sequence Indicators
- Television and FM Test Equipment

**MEASUREMENTS CORPORATION**  
BOOMTOWN NEW JERSEY

# FIRST CHOICE FOR PRECISION MADE TRANSFORMERS

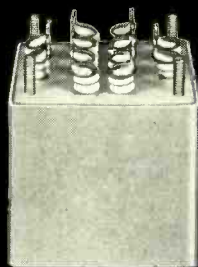

**Acme**  **Electric**  
TRANSFORMERS

● Precision is two-fold in Acme Electric transformers. Exact mechanical dimensions facilitate installation in limited space. Unvarying electrical characteristics provide for dependable performance.

**ACME ELECTRIC CORPORATION**  
314 WATER ST. • CUBA, N. Y.

West Coast Engineering Laboratories:  
1375 W. Jefferson Blvd., Los Angeles, California  
In Canada: Acme Electric Corp. Ltd.  
50 Northline Road, Toronto, Ontario

the company began recently.

The firm also announced that Thomas H. Jeffers was named to the new position of assistant general manager of the Anaheim division and an assistant vice-president of the firm. T. T. Arden continues as general manager of the Anaheim division.

Jeffers was formerly chief engineer at Anaheim, which is one of eight of the company's divisions.



## Lackman Joins Chester Cable

JOHN LACKMAN was appointed executive technical director of Chester Cable Corp. He has been employed in the technical department of E. I. DuPont de Nemours and also worked with major wire companies.

Chester Cable recently completed its fourth major plant expansion in the past five years.

## University Of Michigan Sets Control Courses

THE COLLEGE OF ENGINEERING of the University of Michigan has planned two intensive courses in automatic control. The first is scheduled for June 14-19, the second for June 21-23, 1954. The courses are intended for engineers who wish to obtain a basic understanding of the field but cannot spare more than a few days for the purpose. The aim of the courses is to make it easier to learn by a coherent presentation of the fundamentals of modern automatic con-

# SPECIALIZED PLATING <sup>by</sup> NARL

NARL's CONTINUOUS PROCESS ELECTROPLATING EQUIPMENT and CONTROLS ASSURE ACCURATE WIRE and STRIP PLATING of PRECIOUS and BASE METALS and ALLOYS.

Continuous **WIRE PLATING** to:

- Maintain low contact resistance at high temperatures
- Improve adhesion of insulation
- Reduce secondary emission
- Protect against corrosion
- Lubricate dies

**SMALL PARTS PLATED** with: platinum, gold, silver, solder, etc., such as ● Electrical connectors, and contacts ● "Tinkertoy" components.

Continuous **STRIP PLATING** to: ● Increase life of blanking and stamping dies ● Lower finishing cost.

**CONSULT NARL now** for information and suggestions on how **PLATING** can **IMPROVE** the **QUALITY** of **YOUR WORK**, and **STEP UP YOUR PRODUCTION.**

Research • Development  
Production

**NORTH AMERICAN  
RESEARCH LABORATORIES, INC.**

PHONE: CHESTNUT 5-7373

725 LEXINGTON AVENUE, KENILWORTH, N. J.

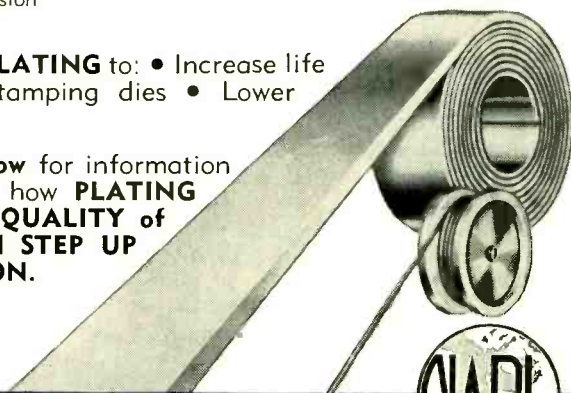



**PRECISION • STABILITY •  
LOW NOISE LEVEL  
S.S. WHITE TYPE 65X  
MOLDED RESISTORS**

**Rating**—1 Watt.  
**Temperature Coefficient**—From approx. + 0.1% /°F for 5000 ohm resistors to approx. - 0.2% /°F for 10 megohm resistors.  
**Voltage Coefficient**—Less than 0.02% /Volt.  
**Upper Temperature Limit**—170°F for continuous operation.  
**Standard Range**—1000 ohms to 9 megohms. For general commercial service.  
**Noise Level**—A low noise level is inherent in all 65X resistors. Where noiseless operation is essential, we are equipped to test and guarantee standard range resistors with "less noise than corresponds to a resistance change of 1 part in 1,000,000, for the complete audio frequency range."

Send for Bulletin 4906. It gives full details on S.S. White Molded Resistors. Write for a copy.



**EXTREME  
HIGH VALUE  
RANGE**

Up to 10,000,000  
megohms for specialized  
scientific and industrial  
service.

**THE S.S. White INDUSTRIAL DIVISION**  
**DENTAL MFG. CO.**



Dept. R, 10 East 40th St.  
NEW YORK 16, N. Y.

Western District Office • Times Building, Long Beach, California

**chassis  
trak**

**at  
your  
service**

**ultra thin  
—only 7/32"**

actual thickness

chassis  
tilts back  
for servicing  
ease

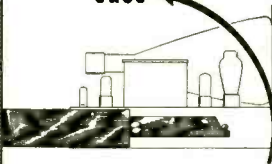

AT YOUR  
ELECTRONIC  
PARTS JOBBER

- Supports 175 lbs.
- Extends to 22 7/8"
- Fits all standard chassis and racks
- Chassis instantly removable
- Permanently lubricated
- All hardware included
- Meets JAN salt-spray requirements

**CHASSIS-TRAK CORP.**  
6250 E. Iona Road  
Indianapolis, Ind.

**GENERAL MAGNETICS INC.**

has openings for

**ELECTRICAL ENGINEERS**

With at least three years experience in design and development of **MAGNETIC SERVO AMPLIFIERS & VOLTAGE REGULATORS.**

A chance to grow with a young and progressive company. Salary and advancement commensurate with ability. State education, experience and salary requirements.

Address all inquiries to:

**GENERAL MAGNETICS INC.**

135 Bloomfield Ave.

Bloomfield, N. J.



**NEW**

*Allenpoint  
Set Screws*

WITH  
**SCIENTIFICALLY-DESIGNED  
SMALLER CUP POINTS**

Tested comparatively by United States Testing Company\* with standard cup point screws and screws with angled and serrated points, the new Allenpoint demonstrated (1) greater locking power at all measured installation vs removal torque pressures, (2) uniformly high shaft holding power in torque resistance tests, (3) unmatched performance under vibration, and (4) more complete shaft contact pattern. Sold *only* by leading Industrial Distributors. Write for more facts about the results of these important tests of set screw performance.

\*Report No. E 5576,  
March 17, 1953.



**ALLEN**

MANUFACTURING COMPANY  
Hartford 2, Connecticut, U.S.A.



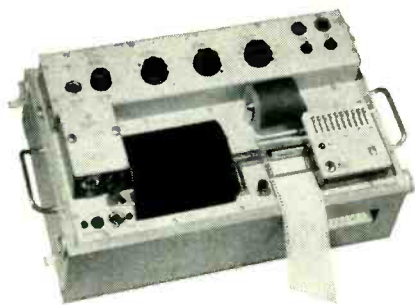

## FOR HIGH SPEED RECORDING OF VOLTAGE LEVELS

Use the Bruel & Kjaer Level Recorder

**BRUEL & KJAER MODEL BL-2304**

With this precision instrument you can make high speed recordings of signal level variations. The level of A.C. voltage from 20 to 200,000 cycles per second is accurately recorded. It simplifies recording frequency response curves for microphones, loudspeakers, filters, amplifiers, hearing aids, and other audio equipment. It is useful in recording reverberation decay curves, noise levels, and electrical voltage levels.

With this recorder you have a choice of nine recording speeds and ten chart speeds. Recording accuracy is within 1%. Calibration is made quickly with an internal standard signal.

For complete specifications on this and other Bruel & Kjaer instruments, write Brush Electronics Company, Dept. K-4, 3405 Perkins Avenue, Cleveland 14, Ohio.

### ACOUSTIC AND TEST INSTRUMENTS

*Bruel & Kjaer instruments, world famous for their precision and workmanship, are distributed exclusively in the United States and Canada by Brush Electronics Company.*

- BL-1012 Beat Frequency Oscillator
- BL-1502 Deviation Test Bridge
- BL-1604 Integration Network for Vibration Pickup BL-4304
- BL-4304 Vibration Pickup
- BL-2002 Heterodyne Voltmeter
- BL-2105 Frequency Analyzer
- BL-2109 Audio Frequency Spectrometer
- BL-2304 Level Recorder
- BL-2423 Megohmmeter and D. C. Voltmeter
- BL-3423 Megohmmeter High Tension Accessory
- BL-4002 Standing Wave Apparatus
- BL-4111 Condenser Microphone
- BL-4120 Microphone Calibration Apparatus and Accessory
- BL-4708 Automatic Frequency Response Tracer

## BRUSH ELECTRONICS COMPANY

formerly  
The Brush Development Company.  
Brush Electronics Company  
is an operating unit of  
Clevite Corporation.



Want more information? Use post card on last page.

394

PLANTS AND PEOPLE

(continued)

trol and to provide a comprehensive set of notes to serve as a framework for further study. The role of analog computing methods will be emphasized.

### Micromax Company Changes Its Name

THE Micromax Company of Brooklyn has changed its name to Computer Instruments Co. in order to describe the nature of its line of products. The company is manufacturing electronic computer and servomechanism components. Its manufacturing plant will remain in Brooklyn and facilities will be expanded. All Micromax personnel will be retained, according to the firm.

### Union Electric Acquires TV Products Company

UNION ELECTRIC & MANUFACTURING of Jersey City, N. J. acquired all the resources of TV Products Co. of Paterson, N. J., manufacturers of television yokes and transformers.

The merger of the two companies was in line with Union Electric's policy of expansion of volume and curtailment of overhead so as to better meet a competitive market.

### Scintilla Magneto Changes Its Name

THE Scintilla Magneto division of Bendix Aviation has dropped "Magneto" from its name and is now known as "Scintilla Division". "Magneto" was deleted from the Scintilla name as it is no longer descriptive of the size and scope of the division's operations.

### New Magnetic Recording Company Organized

MAGNE-TRONICS, a New York corporation, has been formed to operate in the audio visual fields and promote magnetic tape sound recording and reproduction. The company will distribute musical tapes with playing times of from two to eight hours.

P. L. Deutsch heads the new company as president and J. F. Hards, formerly vice-president of

FIRST IN A SERIES

**ADC**



hocus pocus is all right, BUT...



KNOW-HOW GETS RESULTS!

Magic tricks may be a little out of our line . . . but tricky transformers are right up our alley! Take the time our chief engineer, (we call him Merlin) fooled the alchemists of a well known equipment manufacturer. They thought it impossible to develop prototypes of 14 different transformers in just a few short weeks. (Others tried and failed to meet their rigid equipment specs plus MIL-T-27.) Without sleight-of-hand, ADC designed and delivered 14 sets of samples which received full qualification approval—and production quantities were delivered right on schedule.

Magic? Not really, though our success almost cost us a good secretary. Seems our customer, convinced that Merlin was a wizard, sent him a book on parlor tricks. After reading it, Merlin wanted to see if sawing a woman in half was as easy for him as designing and building transformers, filters, reactors and chokes to your specification.

We have a catalog, and who hasn't? But ours is unique—designed to help you select and specify iron core components for your particular circuits. Write for it today!

**ADC**

**AUDIO DEVELOPMENT COMPANY**  
2833 13th Avenue So., Minneapolis, Minn.

Want more information? Use post card on last page.

April, 1954 — ELECTRONICS



Audio Video Tape Libraries, is vice-president. Hards is also president of the Magnetic Recording Industry Association.



**Weid Named Melpar Vice-President**

ARTHUR C. WEID has been appointed vice-president of Melpar, subsidiary and central research lab of Westinghouse Air Brake. He has been chief engineer for Melpar since 1951 and executive assistant to the executive vice-president and general manager since 1952. After joining Melpar in 1947, he became project engineer in charge of the engineering development of microwave systems and other electronic and sonar devices.

He worked at Columbia University's Airborne Instrument Laboratory. During the post-war period, when the lab became an independent commercial organization, Weid was director of military engineering projects.

**Waveline Appoints Chief Engineer**

JOHN M. DEL VENTO has been named chief engineer of Waveline of Caldwell, N. J. He is enlarging the staff of the engineering department and plans to accelerate the firm's research and development programs.

Prior to joining the company he served in various capacities in the field of microwave research and development with organizations such as Federal Telecommunication

*Built* TO ESTABLISHED STANDARDS FOR MAXIMUM SHIELDING EFFICIENCY

Lindgren True Double Shielded SCREEN ROOMS Patent Pending

*Lindgren* SCREEN ROOMS

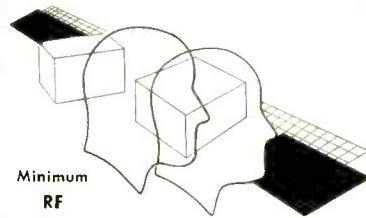

Minimum RF Interference



Easy to Assemble

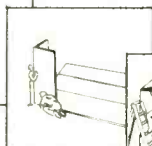

Structurally Sturdy

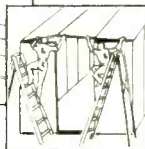

Standardized Units

Sales Engineering Representatives Throughout the United States

A screen room is no place for makeshift construction. Where RF interference must be eliminated to a known degree, SCREEN ROOMS must be built to scientific standards, not "by guess and by golly." That is why LINDGREN double-shielded enclosures are increasing in use by so many of America's leading industries, where testing and operation must be done under controlled conditions that will not tolerate leakage or uncertainty.

HIGHEST ATTENUATION GUARANTEED

BRONZE SCREEN 126-128 DB;  
COPPER SCREEN 142-146 DB;

LINDGREN screen rooms are economically manufactured at the factory. They consist of pre-fabricated units, easily assembled where you want them... conveniently portable to any location. More than 30 standard sizes available.

Used by leading manufacturers of electrical and electronic equipment... and more than meets government specifications.

WRITE for Descriptive Circular, Attenuation Charts, Construction Diagrams, Specifications and Prices.

ERIK A. *Lindgren* & ASSOCIATES

Established 1939

4515-17 N. RAVENSWOOD AVE. CHICAGO 40, ILL. Phone SUNnyside 4-0710

**DEKADIAL** for accurate resistance, capacitance, inductance. Readings to four significant figures.

**RANGE SELECTOR:** seven positions

**CIRCUIT SELECTOR:** six positions

Universal **BINDING POSTS** connect to all bridge arms

**DETECTOR SWITCH**

**GENERATOR SWITCH**

**DISSIPATION FACTOR and "Q" DIAL**

**7.5  $\mu$ a - 0 - 7.5  $\mu$ a GALVANOMETER**

**IMPEDANCE BRIDGE**

*Wide Range*

Resistance: 1 milliohm to 11 megohms  
Capacitance: 1 mmf to 1100 mfs.  
Impedance: 1 mh to 1100 henrys

*Exceptional Accuracy*

Resistance:  $\pm 0.1\%$   
Capacitance:  $\pm 0.25\%$   
Inductance:  $\pm 1.0\%$

SHOWN  
MODEL 250-C1  
\$340

9" x 11" x 11" over-all. Convenient operation from battery, or from AC power lines with E.S.I. accessory amplifier.

*Write to factory for literature and analysis of your needs.*

**ELECTRO-MEASUREMENTS, INC.**

Formerly BROWN ELECTRO-MEASUREMENT CORP.

**4312 S. E. STARK STREET**  
**PORTLAND 15, OREGON**

Are You Throwing Away  
\$ \$ EVERY YEAR?

\$ \$ because of  
PRODUCTION STOPPAGE  
COSTLY REJECTS

These Facts Will Save  
YOU Plenty...

NO VOIDS\*  
LESS WASTE  
with

**ALPHA**

**CEN-TRI-CORE**

**ROsin-FILLED**

**SOLDER**

**MORE JOINTS PER POUND  
WITH CEN-TRI-CORE**

### Exclusive Features

- \* guarantees against rosin voids or skips
- eliminates cold joints and rejects
- available in eight core sizes
- solders to plated or oxidized parts
- simultaneous "wetting flow" and take
- surpasses federal specifications for non corrosiveness and purity
- thin walls insure rapid heat transfer and faster fluxing action

for further  
information  
write . . .



**ALPHA METALS, INC.**

59 Water St., Jersey City 4, N. J.

Specialists IN SOLDER For Over 50 Years  
Want more information? Use post card on last page.



John M. Del Vento

Labs and National Union Radio. He specialized in uhf and micro-wave at the University of Illinois and Brooklyn Polytechnic. During World War II he served with the Air Force in navigation and radar instruction.

### New York Central Names Electronics Engineer

THREE appointments in the communications department of the New York Central were announced. Richard P. Corporon joins the Central as electronics engineer succeeding A. Auerbach, who has resigned. Roy A. Calendine, chief telephone and telegraph inspector at Detroit, became general plant supervisor at New York and William B. Anderson, commercial traffic supervisor at Detroit, was named communications traffic supervisor at New York.

Prior to his present appointment, Corporon was associated with Western Electric and was communication engineer of the Indiana and Michigan Electric Co. He was an engineer in the transmitter design section of RCA and was design and test engineer in guided missiles for Bendix Aviation. In his latest position he was manager of development engineering for Penn Controls of Goshen, Indiana.

### Dean Electronics Moves To Bronx

DEAN ELECTRONICS Co. has moved from Brooklyn to the Bronx, N. Y. The new quarters will permit the firm to produce radio and high-fidelity units in addition to their line of phonographs.

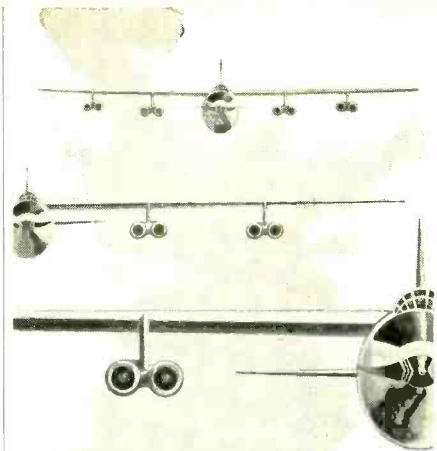

"UNIVERSAL SERIES"

**GYROS**

New "Universal Series" Gyro is available in Free, Directional and Vertical types, and in composite Gyro sets for sensitivity in three planes.



Features fast, remote caging that positively locks the gimbals in their normal erected position; remote uncaging; torque-motor erection; and unrestricted 360° rotation of both gimbals. AC or DC rotors, and synchro or potentiometer outputs are optional. Reduced drift rate, greater life expectancy, and improved resistance to environmental shock, acceleration and vibration are incorporated in a 4" dia. x 5" unit. Write for complete engineering information.



GYRO SETS  
AIRBORNE INSTRUMENT  
DIVISION

**G. M. GIANNINI & CO., INC.**  
PASADENA 1, CALIF. • EAST ORANGE, N. J.

**Giannini**

Want more information? Use post card on last page.

April, 1954 — ELECTRONICS



# selective insulation



If your design includes a coil, let us help you select proper insulating materials . . . with high dielectric values, adequate moisture resistance, rugged and serviceable physical properties. Make the coil a strong point in your product, instead of a danger spot. Coto-Coil Company, 65 Pavilion Avenue, Providence 5, R. I. New York office: 10 E. 43rd Street, New York 17.

**Coto** PRECISION WOUND **Coils**

**YOU CAN'T  
SHAKE 'EM LOOSE!  
BUT YOU CAN COOL 'EM OFF...**



With BIRTCHER

## KOOL KLAMPS

BIRTCHER KOOL KLAMPS will help keep your subminiature tubes COOL... and hold them firm and secure, regardless of how they are shaken, or vibrated.

KOOL KLAMPS are made of a specially developed heat treatable alloy 99 1/2% pure silver of high thermal conductivity.

KOOL KLAMPS under certain conditions are able to reduce bulb temperatures as much as 40° C. KOOL KLAMPS have proved of particular value in miniaturized electronic equipment.

Where heat conditions are less critical, beryllium copper KOOL KLAMPS are available.

**The BIRTCHER CORPORATION**  
4371 Valley Blvd.  
Los Angeles 32, California  
Dept. E-4-4

Please send Bulletin which describes and illustrates Kool Klamps in detail.

Company .....  
Attention of .....  
City ..... State .....



## LAB DOLLY MODEL A

- ... with 8 power outlets (1500 watts, 110 VAC) and a 10 foot heavy duty extension cord.
- Ball Bearing Swivel Rubber Tired Casters.
- Constructed of Aluminum. Features 2 Shelves for Equipment and a pan for test leads, notebooks, etc.
- Recommended by Laboratories wherever used.

Price **4950**

FOB Louisville, Ky.

- 31 1/2" high, 18 3/4" wide, 27" long.

## TECHNICAL SERVICE CORP.

1404 W. Market St. Louisville 3, Kentucky

Cosmic

**ELECTROLYTIC  
and  
PAPER TUBULAR  
CONDENSERS**

FOR  
**A.C. D.C. SETS  
PHONOGRAPHS**  
etc.

CONDENSER SPECIALISTS SINCE 1923

**COSMIC RADIO CORPORATION**  
853 Whittier St., Bronx, N. Y.  
Phone LUdlow 9-3360

**Dictate reports accurately—promptly!**  
**make your car, boat or plane a "rolling office"**

with **ATR**  
**INVERTERS**

for changing your storage battery current to  
**A.C. Household ELECTRICITY**  
*Anywhere*  
*... in your own car!*



**mounted out of sight under dash or in trunk compartment!**

**EASY TO INSTALL**  
**EASY TO OPERATE**

**ATR INVERTERS**

especially designed for operating standard 110 volt A. C. . . .

- TAPE RECORDERS
- WIRE RECORDERS
- EXECUTIVES
- SALESMEN
- PUBLIC OFFICIALS
- POLICEMEN
- FIREMEN
- DICTATING MACHINES
- ELECTRIC RAZORS
- OUTDOOR MEN
- REPORTERS
- FIELD INSPECTORS
- DOCTORS
- LAWYERS, ETC.

*See your jobber or write factory*  
 ✓ NEW MODELS    ✓ NEW DESIGNS    ✓ NEW LITERATURE  
 "A" Battery Eliminators,    DC-AC Inverters,    Auto Radio Vibrators

**ATR** **AMERICAN TELEVISION & RADIO CO.**  
*Quality Products Since 1931*  
 SAINT PAUL 1, MINNESOTA, U. S. A.

Want more information? Use post card on last page.

**NEW BOOKS**

**High Fidelity Techniques**

By JOHN H. NEWITT. *Rinehart Books, Inc., New York, 512 pages, \$7.50.*

MR. NEWITT, it seems to this reviewer, has written a book full of excellent material which, however, does not take into account the real needs of his intended audience. Any writer on high fidelity has of course a serious problem in aiming his material effectively at some sizeable segment of the potential readership, spread as that readership is over such a wide spectrum of technical competence, from rank layman to practicing engineer. Mr. Newitt says in his introduction that he is writing for:

- (1) the practicing engineer who doesn't know audio but wants to improve his home system;
- (2) prospective constructors of home sound systems who need guidance on choice of equipment;
- (3) the radio serviceman who wants to do custom sound work;
- (4) recording studios and public address operators concerned with installing high-quality equipment;
- (5) professional audio technicians, engineers, and home receiver designers "who desire a concise working reference to the noteworthy developments in the art."

In this reviewer's opinion readers in the five categories listed by Mr. Newitt, and particularly the last, will not find the book detailed enough in the engineering sense, nor indeed, sufficiently up to date, to serve as a guide to the most advanced practice in audio. This is all the more a pity because the author clearly has an unusually broad understanding of the subject and highly valuable practical experience.

The faults of the book can be generalized, with some unfair simplification, as (1) a lack of enough quantitative data to raise the various discussions above the level of description; much of this—"less of that" which is of no help to the contractor; and (2) a failure to take his audience seriously enough. The first is partly a result of the second, of course. Apparently Mr. Newitt

**MAGNETIC-AMPLIFIER CIRCUITS**

*Just Published!*



This practical treatment of fundamental principles, characteristics, and applications logically develops the various kinds of basic and more complex magnetic amplifier circuit arrangements without extended mathematical considerations. Descriptive and graphical methods are used to give qualitative and quantitative interpretation of essential facts. Material is systematically classified according to circuit functions so you can compare and select solutions best suited to your special problem. By William A. Geyger, U. S. Naval Ord. Lab. 277 pp., 135 illus., \$6.00

**PROBABILITY AND INFORMATION THEORY WITH APPLICATIONS TO RADAR**

*Just Published!*

Shows in easy stages how the theory of probability applies to electronics, communication, and particularly radar. Using basic mathematics, it discusses the theory of probability distribution, mathematical description of waveforms, Shannon's information theory, applications of inverse probability to problems of signal and noise, etc. By P. M. Woodward, Telecomm. Research Establishment, Malvern, England. 128 pp., \$4.50

**TELEVISION BROADCASTING**

Practical manual for radio engineers, operations personnel, and others interested in the technical aspects of television broadcasting. Covers in detail the equipment, facilities, and techniques involved in the running of a television studio—topics such as lighting, staging, television recording, and color television equipment. Gives a valuable insight into the whole field without the use of complex mathematics. By Howard A. Chinn, Columbia Broadcasting System. 688 pp., 346 illus., \$10.00

**ELECTRONICS FOR COMMUNICATION ENGINEERS**

Saves research time and effort on electronic problems in communications. Its 252 articles from *Electronics* contain a wealth of design equations, charts, nomographs, tables, etc. Covers amplifiers—antennas—audio—cathode-ray tubes—components—electronic music—filters—measurements—microwaves—oscillators—power supplies—propagation—pulses—receivers—transmission lines—transmitters. Edited by John Markus and Vin Zeluff, Assoc. Editors, *Electronics*, 624 pp., hundreds of illus., \$10.00

**SEE THESE BOOKS 10 DAYS FREE**

McGraw-Hill Book Co., 330 W. 42 St., NYC (36)

Send me book(s) checked below for 10 days' examination on approval. In 10 days I will remit for book(s) I keep, plus few cents delivery, and return unwanted book(s) postpaid. (We pay for delivery if you remit with this coupon—same return privilege.)

Geyger—MAG. AMP. CIRCUITS—\$6.00

Woodward—PROB. & INFORM. THEORY WITH APPLICATIONS TO RADAR—\$4.50

Chinn—TELEVISION BROADCASTING—\$10.00

Markus & Zeluff—ELEC. FOR COMM. ENGRS.—\$10.00

(Print)  
 Name .....

Address .....

City ..... Zone ..... State .....

Company .....

Position ..... L-4

This offer applies to U. S. only

Want more information? Use post card on last page.



has missed the extent to which the classes of readers he is addressing have been exposed, in this year 1954, to the basics of audio.

There is a lot on the plus side. Mr. Newitt is very good on speakers, baffles and horns. He has notably wise things to say about constructing amplifiers at home, about price-versus-quality choices, about the ancient triode and tetrode battle, about listener tests and on many other points.

For this reviewer the best section of the book is Chapter 12, on the general planning of custom sound installations. Anybody in this business, or going into it, ought to read this chapter, which is full of good sense obviously based on experience.

With some deletions, the book could serve as an excellent "Basic Audio", intended for readers less demanding technically than those he has tried to reach. The coverage of the book is complete, as far as general topics is concerned, including the psychological factors in listening to reproduced sound, the basics of hearing and acoustics, the various components of the reproducing chain, a whole chapter on distortion, special high fidelity circuits, tuners, record players, magnetic recording and the above-praised chapter on custom installation work.—R. S. LANIER.

**Television Broadcasting**

BY HOWARD CHINN. *McGraw-Hill Book Company, Inc., first edition, 700 pages, 1953, \$10.00.*

THIS book by one of the industry's experts is a contribution which seems likely to be an enduring reference. Any engineer engaged in either technical television operation or the engineering design of television broadcasting facilities will find it a valuable tool, both for study and for reference. The subject is not approached from the theoretical or mathematical viewpoint. The book is simply and clearly written, but at the same time it presupposes a good working knowledge of the fundamentals of communication engineering. It is not for the beginner; and the person who is seeking merely conversational knowledge in this field



**TERMALINE  
DIRECT READING  
R. F. WATTMETERS**

(DUAL RANGE)

MODEL 611—0-15 and 0-60 Watts

MODEL 612—0-20 and 0-80 Watts

IMPEDANCE—51½ Ohms

Models 611 and 612 are popular instruments in research and design laboratories, vacuum tube plants, transmitter manufacturing plants, and in fixed and mobile communication services.

They are ruggedly built for portable use, and are as simple to use as a D.C. voltmeter. The power absorbing load resistor is non-radiating, thus preventing transmission of unwanted signals which interfere with message traffic in communication services.

Frequency range: 30 to 500 MC (30 to 1,000 MC by special calibration)

Impedance: 51.5 OHMS—VSWR less than 1.1

Accuracy: Within 5% of full scale

Input connector: Female "N" which mates with UG-21 or UG-21B. Adapter UG-146/U is supplied to mate with VHF plug, PL259.

Special Scale Model "61s" are available as low as ½ watt full scale, and other models as high as 5 KW full scale.

Catalog Furnished on Request



**BIRD  
ELECTRONIC CORP.**  
1800 EAST 38<sup>TH</sup> ST., CLEVELAND 14, OHIO  
TERMALINE Coaxial Line Instruments

**NEELY  
ENTERPRISES**  
Hollywood • San Francisco  
Albuquerque  
**EARL LIPSCOMB  
ASSOCIATES**  
Dallas • Houston

**ELECTROPLATED**

*Wires*

Corrosion Resistance

Better Solderability

Suppression of Grid Emission

Improvement of Electrical Characteristics



SINCE  1901

**GOLD, SILVER, RHODIUM, PLATINUM.**  
and other metals, applied to many different types of wire to meet your specifications. Uniform plating, scientifically controlled.  
Write for Latest List of Products

**SIGMUND COHN MFG. CO. INC.** 121 So. Columbus Avenue, Mt. Vernon, N. Y.

# SPEED UP

## factory and service tests!

### UHF TV SWEEP GENERATOR MODEL 130



Features continuous frequency coverage in one band; at least one volt output into 75 ohms; wide sweep; blanked signal on return sweep provides a reference baseline.

#### SPECIFICATIONS

- Freq. Range: 450-900 mc.
- Sweep Width: 0-40 mc min.
- Sweep: 60 cycle, sine wave.
- Output: (1.) 0.1-1.0 volts
- (2.) 0.01-0.1 volts approx.

### FM SIGNAL GENERATOR MODEL 100C

Designed to give precision performance over a single tuning range (27-230 mc). Negligible leakage; low spurious outputs; no auxiliary frequency changer unit required.

Write for specifications and catalog on complete line of measuring equipment. See our demonstration at the New York I. R. E. show - Booth 166.

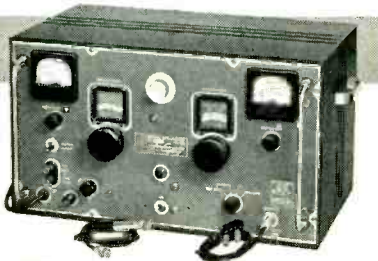

# NEW LONDON INSTRUMENT Company

P. O. BOX 189E  
NEW LONDON, CONN.



## RESINITE

### GIVES YOU THE HIGHEST INSULATION RESISTANCE OF ANY RESINATED PRODUCT

Performance data—compiled from laboratory tests, actual field operations and reports from manufacturers—prove the outstanding operating characteristics of Resinite. In volume resistivity... low moisture absorption... excellent thermal properties... low power factor... and resistance to voltage breakdown... Resinite outperforms all other resinated products.

Resinite Coil Forms are available with inside or outside threads—slotted, punched or embossed. Special three-row threaded design permits axial pressure in excess of 25 lbs. Torque controllable to + or - 1 inch oz.

Write today for full details and technical information

## RESINITE CORPORATION

DIVISION OF PRECISION PAPER TUBE

2035E West Charleston Street, Chicago 47, Illinois  
79 Chapel St., Hartford, Conn.

- RESINITE 8104  
very high dielectric properties under extreme humidity.
- RESINITE "AC"  
very high dielectric properties—completely immune to electrolytic corrosion.
- RESINITE 104  
for stapling, severe forming and fabricating.

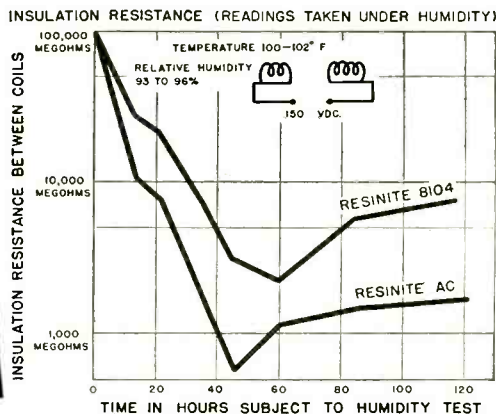

Tests conducted on .253 I.D. x .283 O.D. tubes used on coil forms for television receivers.

will probably be better served by other less comprehensive texts. This book is for the professional, and the professional will appreciate the thorough, authoritative, matter-of-fact style. The illustrations are well done, the type is easy to read, and the entire book is remarkably free from errors.

In the preface the author explains the organization of chapters with regard to the order in which the various topics are taken up. The stereotyped convention of starting in a studio, with camera and microphone considered first, and continuing with subsequent chapters on various portions of the system as traversed by the signal in conventional order, has been modified without losing continuity. The first chapter deals with the fundamentals of a television system, and as the successive chapters are studied in turn, the progression is one which provides a good unity to the entire book. On the other hand, any one chapter is complete if read separately.

The book contains a wealth of practical information based upon the actual operating and engineering experience of a large television network, much of which has not been published heretofore. The sections on lighting, communication facilities, switching systems and facilities and practices related to the audio portion of television broadcasting are especially noteworthy. The information on surveying and operating remote pickups should be invaluable to television broadcasters just entering this field. A great deal of practical, detailed information on the design and installation of television broadcast facilities is included. Anyone who has wrestled with video cross-talk in a multiple studio plant will appreciate the section dealing with the problem of ground connections in unbalanced video transmission systems.

The thoroughness with which the entire subject has been treated constitutes something of a challenge to the reviewer to find any omission worthy of note. It might be pointed out, however, that no treatment is included on the long-light-application-cycle type of intermittent pro-



# NEW HORIZONS

Today's horizons in electronic engineering are limited only by the vision of the individual himself. To those qualified men who desire to stand on the constantly changing frontiers of electronic development, we offer a chance to pioneer and grow with a soundly-established, yet young and progressive company.

## • Electronics Field Engineers

Local & Field Assignments Available

At least 5 years' experience in any one of these fields: Servo Mechanisms; Special Weapons; Microwaves; Antennas; Circuit Design; Flight Simulators; Radio Propagation; Electronic Computers and Communications.

Qualified to instruct in the operation and supervise installation, maintenance and repair of Radar, Sonar, Flight Simulators and allied electronic equipment in the field.

Salary and advancement commensurate with ability; liberal vacation, sick leave, 9 paid holidays, group life, sickness and accident insurance plans, and a worthwhile pension system.

## STAVID ENGINEERING, INC.

Personnel Office, 312 Park Avenue  
Plainfield, N. J.—Plainfield 6-4806



1 MFD. 2 1/2" x 2" x 1"



0.5 MFD. 1 3/4" x 1 1/4" x 1 1/8"



0.25 MFD. 1 3/4" x 1 1/4" x 7/8"



0.1 MFD. 1 3/4" x 1 1/4" x 7/8"



0.05 MFD. 1 3/4" x 7/8" x 1 1/16"

# ULTRA-HIGH PRECISION POLYSTYRENE CAPACITORS

as low as 0.1% tolerance in most values

CAPACITANCE AVAILABLE—0.05 to 10.0 MFD.

VOLTAGE AVAILABLE—100 to 400 VDC

INSULATION RESISTANCE—10<sup>6</sup> MEG./MFD.

TEMP. COEFF.—100 P.P.M. per °C (—20° to 140°F)

DIELECTRIC ABSORB.—.015%

DISSIPATION—.0002

Special Values to Close Tolerances—Our Specialty

## SOUTHERN ELECTRONICS CO.

239 W. Orange Grove Avenue, Burbank, Calif.

✓ Check **YOUR SPECIFICATION** with **VECTRON'S New VFS200 Variable Frequency Power Supply**

✓ Does your specification call for a wide range of input power frequency?

✓ Does it require Servo Amplifier operation at plus or minus 20% of normal frequency?

✓ Does your Motor Generator power source have harmonics which cause inaccuracies?

✓ Does need of special power frequencies delay your production or testing?

25—2000 Cycles — to 200 V.A.

Write today for further information

**VECTRON, inc.**

Electronic and Electro-Mechanical Equipment

404 MAIN STREET, WALTHAM 54, MASS.

## EITEL McCULLOUGH, INC.

COMMON STOCK  
BOUGHT - SOLD  
QUOTED

Prospectus on Request

## Schwabacher & Co.

Established 1919  
INVESTMENT SECURITIES

Members

NEW YORK STOCK EXCHANGE  
SAN FRANCISCO STOCK EXCHANGE  
and OTHER LEADING EXCHANGES

600 MARKET STREET  
SAN FRANCISCO 4, CALIF.

SINCE 1920 QUALITY WENCO PRODUCTS **SPADE BOLTS**

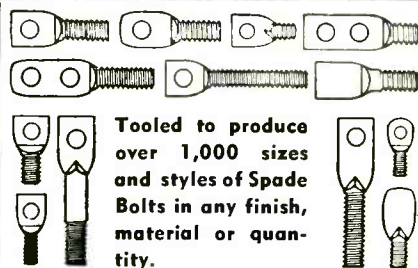

Tooled to produce over 1,000 sizes and styles of Spade Bolts in any finish, material or quantity.

Specialists in Designing and Manufacturing All Purpose Fasteners, Terminals and Mounting Lugs.

OTHER PRODUCTS:

**Simplex**

Wire Strippers and Cutters

TOOLS AND DIES

METAL STAMPINGS

WIRE SPECIALTIES

REPLACEMENT TIPS

for Electric Soldering Irons

Send samples or specifications for quotations. Descriptive bulletin on request.

**WENCO MANUFACTURING CO.**  
1133 W. Hubbard St., Chicago 22, Ill., U.S.A.

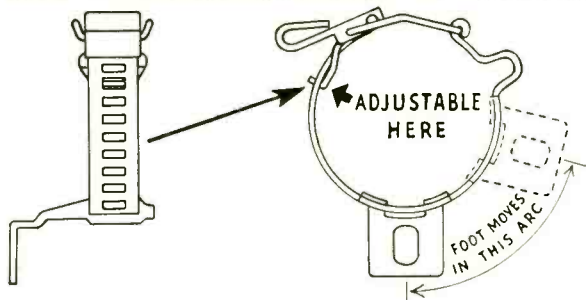

## Augat Adjustable Tube Clamps are 3 ways more dependable!

1. Made of 18% nickel silver for greater fatigue value, tensile strength and durability.
2. Available in an endless variety for standard and special type tubes.
3. Rigidly tested; meets all requirements of government specifications.

STYLE #	DIAMETER—INCHES
1001	2.185 — 2.250
1002	1.250 — 1.377
1003	1.593 — 1.703
1004	1.862 — 2.000
1005	1.125 — 1.250
1010	1.062 — 1.375
1022	1.150 — 1.375

Write today for Catalog and Samples

### AUGAT BROS. INC.

31 PERRY AVENUE • ATTLEBORO, MASS.

jector for television film transmission, and the use of background projection or process shots has not been included—the latter perhaps because it is considered to be in a special effects category.

There is a final chapter on color television broadcasting equipment, and considering the fluid state of the color television art at the time the book was written, perhaps it might better have been omitted. In any event, a treatment of color television broadcasting as thorough as that given to monochrome would certainly call for a separate volume. These shortcomings are minor indeed, however, in the light of the over-all excellence of this significant contribution by Mr. Chinn to the literature of our profession.—  
ROBERT E. SHELBY, *National Broadcasting Co.*

### Data and Circuits of Television Receiver Valves

BY J. JAGER. *Philips Technical Library. Elsevier Press, New York and Houston, 1953, 228 pages. \$4.50.*

THE MAJOR part of this book is a catalog of receiving tubes and picture tubes suitable for television receivers. The tubes described are of Dutch manufacture and carry the Philips designations. While many of the tube types are very similar to American types there is no way of establishing such correspondence in the book, the only alternative being a point-by-point comparison of the socket connections, dimensions and electrical characteristics with those of tubes described in other catalogs. On this account the book is not likely to be of interest or use to American engineers, although it should be very useful to the large and growing corps of television engineers in Europe who operate within the Philips orbit.

The latter part of the book consists of about 70 pages of elementary circuit description, such as intercarrier sound and stabilized synchronization. Here also the circuit designs are tied to specific tube types carrying the Philips designations. Also described are typical tuner units, scanning yokes, output transformers and focusers carrying Philips catalog numbers. This book forms a part of the Philips Techni-

## INTRODUCING THE "RUNT"

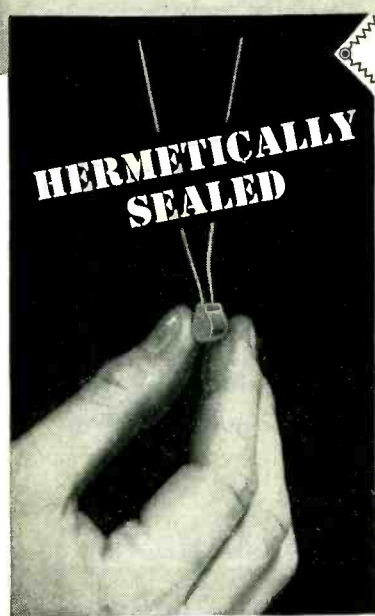

Sub-Miniature

### NM-2 Precision Wire Wound Resistors

A remarkable new sub-miniature addition to the famous "N-Cap" line of precision wire wound resistors. Measures a mere 1/4" x 1/4". Power rating .1 watt. Values up to 60K ± 1%.

Hermetically sealed to withstand rugged environmental conditions.

"N-Caps" also available in all standard MIL-R 93A sizes.

Illustrated Catalog on "N-Caps" and other precision, wire wound products contains valuable engineering data. Write for it today.



**EASTERN PRECISION RESISTOR CO.**  
Richmond Hill 18, New York



**HERE'S WHAT  
We  
MEAN BY -**



*Miniature*  
**BEARINGS!**  
**Roller Bearings**

as small as  
**0.4724" OD**  
an **RMB first**

- For heavy radial loads
- Separable raceways for easier assemblies
- Shielded against contamination
- Sizes from 0.4724" OD to 1.0236" OD
- Available now

**Bring your Miniature  
Bearing Problems to RMB**

A complete line of over 250 miniature and instrument bearings including pivot, radial and roller types are available for prompt delivery. Experimental quantities from stock.

Write for catalog 13,  
or see our catalog in Sweet's Files.

**RMB LANDIS & GYR,**  
**INCORPORATED**

45 West 45th St. • New York 36, New York  
Want more information? Use post card on last page.

ELECTRONICS — April, 1954

NEW BOOKS

(continued)

cal Library, and is put up in the impeccable style of that series. Its content, however, is closer to the commercial catalogs and application notes issued by American tube companies.—DONALD G. FINK, *Philco Corp., Philadelphia, Pa.*

**THUMBNAIL REVIEWS**

**Data for X-ray Analysis, Volume 1, Charts for Solution of Bragg's Equation; Volume 2, Tables for Computing the Lattice Constant of Cubic Crystals,** by W. Parrish, B. W. Irwin, and M. G. Ekstein, Philips, Eindhoven. Distributed in U. S. by North American Philips Co. Inc, Mt. Vernon, N. Y. Charts and graphs aimed at simplifying X-ray crystallographic analysis.

**Research Operations in Industry.** Edited by David B. Hertz and Albert H. Rubenstein. Columbia University, 1953, 453 pages, \$8.50. Papers delivered at the third annual Conference on Industrial Research, June 1952, plus selected papers from the first and second conferences.

**Television Tube Location Guide.** Howard W. Sams & Co., Inc., Indianapolis, Ind., 1953, Vol. 4, \$2.00. Gives 173 diagrams showing locations of tubes and fuses in late model television receivers, along with tube failure check chart for each receiver.

**Receiving Tube Substitution Guidebook, Supplement No. 2.** By H. A. Middleton. John F. Rider Inc., 480 Canal St., New York 13. N. Y. 48 pages, 8½ x 11, 1954, \$.99. Contains 134 tv picture tube and 190 receiving tube substitutions.

**Leaders in American Science.** Edited by Robert C. Cook. Box 150, 110 Seventh Ave., Nashville, Tenn., 852 pages, 6 x 9, 1954, \$12.00. Contains biographies of over 13,500 men of science. 1,600 photos, plus a 36-page list of distinguished scientists by field. Nicely produced and useful.

**Transistor Research Bulletin, Vol. 1,** December 1953. National Scientific Laboratories, 2010 Mass. Ave., N. W., Washington 6, D. C. To be published every alternate month on a subscription basis. No price given. Initial issue contains articles on new semiconductors, dynamic operation transistor test set, small-area junction diodes, German transistor and diode developments and a three-page bibliography of pertinent material.

**Industrial Electronics.** By R. Kretzmann. Philips; Eindhoven; distributed by Elsevier Press Inc., 155 East 82 St., New York 28, N. Y., 250 pages, 1953, \$5.50. General principles of electronics as applied to modern industry.

**TV Troubleshooting.** By Robert G. Middleton. John F. Rider, Inc., 480 Canal St., New York 13, N. Y., 156 pages, 8½ x 11, 1954 \$ .99. Contains pages 8½ x 11, 1954, \$3.30. Vol. 2, containing material not found in Vol. 1.

*12-Dynode*  
**MULTIPLIER  
PHOTOTUBES**

by **DU MONT**

type K1213



type K1209

Twelve-dynode multiplier phototubes—a line exemplified by the 3-inch Type K1213 and the 5-inch Type K1209 shown here — are now offered by Du Mont for those applications where extremely high gain is required — or where optimum signal-to-noise ratio, at conventional gain is a major consideration.

Among the features contributing to the excellent operating characteristics of the 12-stage multiplier phototubes are the specially designed dynodes which assure maximum electron collection, and a new basing in which all leads are widely separated, reducing leakage current, and hence noise.

Naturally, these new tubes provide the same excellent cathode-sensitivity, stability, and low dark current that characterize Du Mont's widely accepted 10-stage multiplier phototubes.

For additional information write to:

Technical Sales Department

**Allen B. Du Mont Laboratories, Inc.**  
760 Bloomfield Ave., Clifton, N. J.

Want more information? Use post card on last page.

## BACKTALK

### Acknowledgment

DEAR SIRs:  
THE SERIES of articles, "Transistors: Theory and Application," that appeared in consecutive issues of ELECTRONICS, from March 1953 to January 1954, was made possible by wholehearted cooperation of a number of our fellow workers.

We wish to acknowledge most gratefully the assistance of the many personnel of the Evans Signal Laboratory, as well as of the Signal Corps Engineering Laboratories in general, during the many phases of the preparation of this series. Particular acknowledgment is due to Mrs. H. L. Owens and Miss D. Coblenz for the typing; to members of the Solid State Devices Section, Thermionics Branch, for consultation; and to Dr. H. Zahl and Lt. Col. W. M. Van Harlingen of SCEL HQ for guidance and encouragement. Thanks are especially due to the clearance personnel, both at SCEL and Washington, D.C., for their expeditious handling of security details.

ABRAHAM COBLENZ  
HARRY L. OWENS  
Signal Corps Engineering Laboratories  
Fort Monmouth, New Jersey

### Engineer Imports

DEAR SIRs:  
I AM A professional engineer (B. E., Sydney University) who wishes to establish permanent residence in the United States of America.

About twelve months ago I made application to be admitted to the U.S. under the immigration quota. I am informed that it will still take a considerable time for my turn to come. Meanwhile employers in the U.S. are desperately in need of engineers. I understand from a report in ELECTRONICS (December 1952, p6) that these matters could be materially speeded up if an intending employer petitions on my behalf the Department of Immigration and Naturalization. I am most anxious to contact an employer who would be prepared to act for me in this manner. . . . Such action would help reduce the shortage of professional engineers.

D. A. ASHFORD  
New South Wales, Australia

# CONTACTS

FOR THE FIELD OF ELECTRONICS

**Auricon  
Hollywood**

16mm SOUND-ON-FILM EQUIPMENT FOR TELEVISION NEWSREELS, TV FILM INSERTS AND KINESCOPE RECORDINGS...SOLD WITH A 30-DAY MONEY-BACK GUARANTEE. YOU MUST BE SATISFIED!

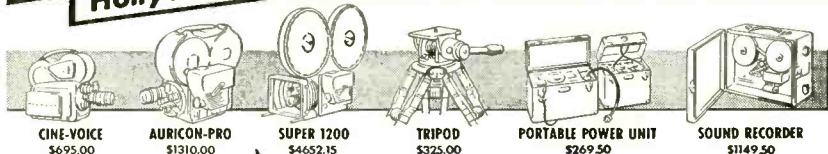

CINE-VOICE  
\$695.00

AURICON-PRO  
\$1310.00

SUPER 1200  
\$4652.15

TRIPOD  
\$325.00

PORTABLE POWER UNIT  
\$269.50

SOUND RECORDER  
\$1149.50

WRITE FOR FREE  
ILLUSTRATED  
INFORMATION

**BERNDT-BACH, Inc.**  
7373 Beverly Blvd., Los Angeles 36, Calif.

MANUFACTURERS OF SOUND-ON-FILM RECORDING EQUIPMENT SINCE 1931

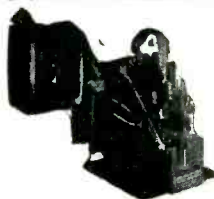

EISLER MANUFACTURES COMPLETE EQUIPMENT

WELDERS FOR SPOT & WIRE BUTT  
RADIO, TV TUBE EQUIPMENT & REPAIR UNITS  
INCANDESCENT, FLUORESCENT MFG. EQUIPMENT  
NEON SIGN MAKERS EQUIPMENT, GLASS LATHES  
ELECTRONIC EQUIPMENT, VACUUM PUMPS, Etc.  
Wet Glass SLICING & CUTTING MACHINES for Lab Use  
TRANSFORMERS, SPECIAL & STANDARD TYPES

EISLER ENGINEERING CO., INC.

751 So. 13th St. Newark 3, N. J.



Have you problems in  
**Metal to Glass Seals?**

NAME IT . . . WE'LL MAKE IT!  
TERMINALS  
HEADERS  
END SEALS . . . SPECIAL ITEMS

QUALITY PRODUCTS CO.  
387 Charles St., Providence, R. I.

*Precision*  
**BLACK ANODIZING**

Specializing in black anodizing, both sulphuric and chromic, on all alloys and castings.

All other colors as well.

GOVERNMENT CERTIFIED  
Contact us for special service.

HENRY and MILLER INDUSTRIES, INC.  
675 Garfield Ave., Jersey City, N. J.  
HEnderson 4-4200

**Shorted Turn Indicator**

Sensitive, rugged, non-shocking  
for unmounted coils; \$150. f.o.b.  
HUNTINGTON BEACH, CALIF.

**KARTRON**



**FLUXES**

SODERING  
BRAZING & WELDING

L. B. ALLEN CO. INC. Chicago 31, Ill.

6731 BRYN MAWR AVE.

**TEST EQUIPMENT REPAIRED**

Contractors to U. S. Government

Repairs and calibration by skilled craftsmen on all makes of Meters, Testers, V.T.V.M.'s, Scopes, etc. Prompt service. All work guaranteed. For immediate estimate send instrument by P. P. Ins. to  
**DOUGLAS INSTRUMENT LABORATORY**  
Electrical Instrument Repairers  
176 NORFOLK AVENUE ROXBURY 19, MASS.

use this  
**CONTACTS  
SECTION**

to

- PROMOTE NEW USES
- PROMOTE NEW USERS
- GET NEW SALES OUTLETS
- REACH ALL BUYING INFLUENCES
- EFFECTIVELY \*\* ECONOMICALLY



# PROFESSIONAL SERVICES

## ALPHA ENGINEERING LABS

TROUBLE-SHOOTING SPECIALISTS  
Waveguide tube twisting, bending and forming.  
Broaching. Tooling design, improvements and  
methods.

ANDRÉ TEMPE  
P. O. Box 107 Phone Budd Lake, N. J.  
Hackettstown 340

## ANNIS ELECTRIC RESEARCH LABORATORY, INC.

CONSULTING — RESEARCH — DEVELOPMENT  
AND DESIGN OF RADIO AND ELECTRONIC  
EQUIPMENT  
Antennas, Wave Propagation, Information Storage,  
Computers, Impedance Matching and Variable  
Speed A-C Motors.  
P. O. Box 581 1401½ S. Neil St.  
Champaign, Ill. Tel. 6-1708

## W. J. BROWN

Registered Prof. Engr. Connecticut, Ohio, England  
ELECTRONIC CONTROL SYSTEMS  
Consulting — Research — Development  
INTERNATIONAL CLIENTELE  
71 Gurley Road Stamford 4-4876  
Stamford, Conn.

## CODETYPER LABORATORIES

PRINTED CIRCUITS, EMBEDMENT CELLS  
AND MINIATURIZATION ENGINEERS

Redesign your standard product using cost and  
labor saving Printed Circuits. We perform all  
engineering and supply you with Master Plates for  
your production. Reasonable, fast service.  
550 Fifth Avenue, New York 18. JUN 4487

## CROSBY LABORATORIES, INC.

Murray G. Crosby & Staff  
Radio - Electronic

Research Development & Manufacturing  
Communications, FM & TV  
Robbins Lane, Hicksville, N. Y.  
Hicksville 3-3191

## EDGERTON, GERMESHAUSEN & GRIER, INC.

Consulting Engineers

Research Development and Manufacture  
of Electronic and Stroboscopic Equipment  
Specialists in High-Speed Photography  
160 Brookline Avenue Boston 15, Mass.

## Eldico of New York, Inc.

Pioneers of Television Interference Elimination from  
Transmitters, Induction Heaters, Diathermy and  
etc.

Donald J. S. Merten & Engineering Staff  
44-31 Douglaston Pkwy Douglaston, N. Y.  
Bayside 9-8686

## ELECTRONIC RESEARCH ASSOCIATES, INC.

"TRANSISTORIZE" YOUR PRODUCT!

Complete Service in consulting, research, devel-  
opment, and production on transistor circuitry,  
products and instrumentation.  
715 Main Street North Caldwell, N. J.  
Caldwell 6-6729

## ERCO RADIO LABORATORIES, INC.

Radio Communications Equipment

Engineering - Design - Development - Production  
Pioneers in Frequency Shift Telegraph  
Garden City • Long Island • New York

When  
time  
is  
short . . .

put the solution of your problems up  
to a specialized Consultant whose pro-  
fessional card appears on this page. His  
broad experience may save you months  
of costly experimentation.

## ELECTRONICS

330 West 42nd St., New York 18, N. Y.

## HANSON-GORRILL-BRIAN INC.

Products & Mfg. Development

ELECTRICAL - ELECTRONIC  
HYDRAULIC - MECHANICAL

One Continental Hill Glen Cove, N. Y.  
Glen Cove 4-7300

## HIGHLAND ENGINEERING CO.

William R. Spittal & Staff

DESIGN, DEVELOPMENT AND MANUFACTURE  
OF TRANSFORMERS, CHOKES, ETC.  
FOR THE  
ELECTRONIC, INDUSTRIAL & ALLIED FIELDS  
Main & Urban, Westbury, L. I., N. Y.  
WE-7-2983

## HOGAN LABORATORIES, INC.

John V. L. Hogan, Pres.  
Applied Research, Development, Engineering

Est. 1929. Electronics, Optics, Mechanisms, Fac-  
simile Communication, The Circle Digital Computer,  
Electro-sensitive recording media, Instrumentation.  
155 Perry Street, New York 14. CHelsea 2-7855

## INTERFERENCE MEASUREMENT LABORATORY

Interference Study per Government Specifications  
Shielded Space for Interference Investigation  
Field Surveys for F.C.C. Certification of Induction  
and Dielectric Heating Equipment  
1844 Utica Avenue Brooklyn 34, New York  
Navarre 8-1248

## THE KULJIAN CORPORATION

Consultants • Engineers • Constructors

Electronic Control  
Specialists

Utility • Industrial • Chemical

1200 N. Broad St., Phila 21, Pa.

## Measurements Corporation

Research & Manufacturing Engineers

Harry W. Houck Martial A. Honnell  
John M. van Beuren  
Specialists in the Design and  
Development of Electronic Test Instruments  
Boonton, New Jersey

## NEW ROCHELLE TOOL CORP.

FOR CERTIFICATION OF INDUCTION  
AND DIELECTRIC HEATING EQUIPMENT  
IN ACCORDANCE WITH F.C.C. RULINGS

Mobile Test Unit Available Entire U. S.  
320 Main St. New Rochelle, New York  
Phone NE 2-5555

## NIAGARA ELECTRON LABORATORIES

CONSULTATION - DESIGN - CONSTRUCTION  
MFG. THE THERMOCAP RELAY

Specializing in solution of problems of electronic  
and electro-physical instrumentation for the re-  
search of analytical laboratory. Industrial plant  
problems also invited.

Andover, New York Cable Address: NIATRONLAB

## MAURICE I. PARISIER & CO.

Communications Expert

International Engineering Consulting  
RADIO BROADCASTING & COMMUNICATIONS  
Planning & Installation Supervision

Communication Equipment for Armed Forces  
1475 Broadway New York 36, N.Y. LONGacre 4-5434  
Offices: Paris-Buenos Aires — Sao Paulo-Bombay

## PICKARD AND BURNS, INC.

Consulting Electronics Engineer

Analysis and Evaluation  
of Radio Systems

Research, Development and Production  
of Special Electronic Equipment

240 Highland Ave. Needham 94, Mass.

## ALBERT PREISMAN

Consulting Engineer

Television, Pulse Techniques, Video  
Amplifiers, Phasing Networks,  
Industrial Appliances

Affiliated with  
MANAGEMENT-TRAINING ASSOCIATES  
3308-14th St., N. W. Washington 10, D. C.

## JOSEPH RACKER COMPANY

Radar Consultants & Editors

Technical Manuals

Research and Development

140 Nassau Street New York 38, N. Y.  
Worth 4-1463

## ROTRON RESEARCH CORPORATION

Research and Development

Fluid Dynamics and Heat Transfer.  
Exclusively Electronic Applications

Cooling Problems, Heat Exchangers, Fans,  
Turbines and Pump Designs  
Woodstock, N. Y. Phone 2408

## THE TECHNICAL MATERIAL CORPORATION

Communications Consultants

Systems Engineering

General Offices and Laboratory

700 Fenimore Rd., Mamaroneck, N. Y.

## WHEELER LABORATORIES, INC.

Radio and Electronics

Consulting—Research—Development  
R-F Circuits—Lines—Antennas

Microwave Components—Test Equipment  
Harold A. Wheeler and Engineering Staff  
Great Neck, N. Y. HUNter 2-7876

## YARDNEY LABORATORIES, INC.

Research - Design - Development

Electro-Chemical Generators of Energy

105 Chambers Street Worth 2-5500  
New York 7, N. Y.

**UNDISPLAYED RATE**

\$1.80 a line, minimum 3 lines. To figure advance payment count 5 average words as a line. POSITION WANTED undisplayed advertising rate is one-half of above rate, payable in advance. BOX NUMBERS count 1 line additional.

**INFORMATION**

DISCOUNT 10% if full payment is made in advance for four consecutive insertions of undisplayed ads (not including proposals). EQUIPMENT WANTED OR FOR SALE Advertisements acceptable only in Displayed Style.

**DISPLAYED—RATE PER INCH**

The advertising rate is \$16.10 per inch for all advertising appearing on other than a contract basis. Contract rates quoted on request. AN ADVERTISING INCH is measured 7/8 inch vertically on one column, 3 columns—30 inches—to a page. ELECT.

Send NEW ADVERTISEMENTS to N. Y. Office, 330 W. 42 St., N. Y. 36, for the May issue closing April 2nd. The publisher cannot accept advertising in the Searchlight Section, which lists the names of the manufacturers of resistors, capacitors, rheostats, and potentiometers or other names designed to describe such products.

## PROGRESSIVE ENGINEERS LOOK WEST

Qualified Electronic and Electro-Mechanical engineers find happy association with a Western electronics pioneer and leader.

- **DESIGN** Commercial and military projects. Radar, DME, Communications, Noise, Test Equipment including color T.V.—Many others with real interest & challenge.
- **DEVELOPMENT**
- **PRODUCTION**

Relocation expenses—excellent working conditions—Central location. Scheduled reviews & advances. Fine insurance plan. Move should not disturb urgent military projects. Send complete resume with income history & requirements to engineering employment mgr.

## Hoffman LABORATORIES, Inc.

3761 SO. HILL ST. LOS ANGELES 7, CALIF.  
(A Subsidiary of Hoffman Radio Corp.)

### MICROWAVE SERVO ENGINEERS

Must have BSEE plus experience in design and fabrication of airborne systems. Excellent opportunity for qualified men. Ideal living conditions on the sunny San Francisco peninsula.

**DALMO-VICTOR CO.**

1414 El Camino Real San Carlos, Calif.  
LYtelf 3-3131

## WANTED DIVISION HEAD DEVELOPMENT and PRODUCTION

Well established precision watch parts manufacturer entering field of industrial electronic instruments and controls. Seeking fully experienced engineer with successful record in both engineering and management. Ability to design and create original products. Must have knowledge of market and sales potentials. FIRST-HAND KNOWLEDGE AND ACTUAL EXPERIENCE IN PROPOSED PRODUCTS MOST ESSENTIAL. Location Metropolitan New Jersey. P-1900, Electronics. 330 W. 42 St., New York 36, N. Y.

### EXECUTIVE PHYSICIST

Many years experience in research and development of a large variety of electronic tubes. Familiar with semiconductor devices. Available as consultant or for permanent position. PW-2006, Electronics. 330 W. 42 St., New York 36, N. Y.

### ENGINEERING AND SALES REPRESENTATIVES AVAILABLE

Established and expanding organization desires to represent additional manufacturers in the Maryland, Virginia and District of Columbia area. ANSELL ENGINEERING COMPANY 8641 Colesville Road Silver Spring, Md.

### ESTABLISHED MANUFACTURERS REPRESENTATIVE

Rome, N. Y. including Griffiss AFB has opening for one or two additional clients in electrical-electronic field. Engineering and legal backgrounds. WRIGHT ASSOCIATES 127 W. Liberty St. Rome, New York

### Manufacturers' Representatives wanted

By rapidly expanding component manufacturer (Electronic Hardware, Turret terminals and Terminal Boards) Write stating present line and territory.

RW-1998, Electronics  
330 W. 42 St., New York 36, N. Y.

REPLIES (Box No.): Address to office nearest you  
NEW YORK: 330 W. 42nd St. (36)  
CHICAGO: 520 N. Michigan Ave. (11)  
SAN FRANCISCO: 68 Post St. (4)

### POSITIONS VACANT

OPENINGS IN Guided Missile and Rocket Development Program. Need qualified personnel in the fields of engineering, mathematics, physics, chemistry, ballistics. Opportunity for self expression and extension of present scientific knowledge. Write or send application on Standard Form 57, which can be obtained at your Post Office, to Commanding General, Redstone Arsenal, Huntsville, Alabama: Attn: Luther Adams, Civilian Personnel Division.

SWITCH ENGINEER wanted with considerable experience in design and manufacture of high quality rotary switches. Address reply to Box P-1841, Electronics.

ELECTRONICS OR insulation engineer with successful sales experience to sell Mycalex glass-bonded mica. Excellent opportunity for creative selling. Mycalex Corporation of America, Clifton, New Jersey.

LARGE INDUSTRIAL instrument manufacturer has openings for Service Engineers in New York and Philadelphia. Opportunity for advancement to Sales Engineering after two or three years service. Intensive four months' factory course will be offered. P-2080, Electronics.

### SELLING OPPORTUNITY OFFERED

INDUSTRIAL REPRESENTATIVES wanted for Manufacturer of Molded Radio, Television, Instrument knobs, and Plastics. Most territories open. Please send resume of lines carried and areas covered to box RW-1968, Electronics.

### POSITIONS WANTED

PHYSICIST EXPERIENCED in developing electronic and mechanical instruments. Currently managing small development company. Desires position of engineering or engineering and management responsibility. 12 years experience. PW-1791, Electronics.

AUSTRALIAN PROFESSIONAL communication engineer desires to immigrate. Aged 31, experienced in system development and circuit design of carrier telephone equipment, also wartime radar. Potential employers please contact PW-1858, Electronics.

BORON CARBON Resistance Films: Chemical Engineer with experience desires position in process development or improvement of same or similar products. PW-1963, Electronics.

BUYER, ELECTRONICS and instruments. 2 yrs. exp. AEC contractor, 4 yrs. U S Navy electronics, master's degree, write Box PW-1980, Electronics.

ENGINEER, AUTOMATON Factory Systems. Machinery. Components, parts feeders, transmitters, controls. PW-2090, Electronics.

### BUSINESS OPPORTUNITY

Executive will invest \$25,000 to \$75,000 with services in Profitable Business, preferably hard goods, distribution or wholesale: have office space in N.Y.C. BO-1927, Electronics.

### PLANTS AND PROPERTIES

Industrial Building Gastonia, N. C., 52,500 sq. ft. mill construction, wired, sprinklered, steam heat, rail siding. For lease. Write Gastonia Industrial Diversification Commission, Box 823-E, Gastonia, N. C.

## FRANCE Electronics

An old established sales-engineering importing company, wishes to represent 1 or 2 additional non-competitive factories in France. Can furnish finest U. S. references. Our Principal is now here to negotiate. Only large, well established manufacturers please write to

Box 396; 1474 B'Way., N. Y. 36

### MANUFACTURERS

Aggressive sales organization in Middle Atlantic States can provide representation for additional electronic or electrical equipment or parts.

**MACLEN CORPORATION**  
Manufacturers Representative

3226 Ninth Street, N.E. Washington 17, D. C.



For Engineers . . .

# Clear Horizons ahead

. . . at Goodyear Aircraft Corporation

**BUILD YOUR CAREER** and help build tomorrow's world with the pioneer and leader in lighter-than-air craft. There's a clear, bright future at Goodyear Aircraft for engineers with talent, aptitude and ambition.

**FORCEFUL, CREATIVE THINKING** is the key to Goodyear's progressive research and development programs in missiles, electrical and electronic systems, servomechanisms, new special devices and fiber resin laminates. Design and development engineering opportunities are many and varied . . . are now available to capable and imaginative men and women in the field of airships, aircraft and aircraft components.

**POSITIONS ARE OPEN** in several fields with salaries based on education, ability and experience.

Physicists	Civil engineers
Mechanical engineers	Welding engineers
Aeronautical engineers	Electrical engineers

Openings also exist for personnel with ability and experience in technical editing and writing, art, and motion pictures.

**AKRON, HOME OF GOODYEAR AIRCRAFT**, is located in the lake region of northeastern Ohio. Cosmopolitan living, year-round sports and recreation, cultural and educational advantages make this thriving city an ideal spot for a pleasant home.

**THE TIME TO PLAN A CAREER IS - NOW!** Write, giving your qualifications, or requesting an application form.

C. G. Jones, Salary Personnel Department

**GOODYEAR AIRCRAFT CORPORATION**

**AKRON 15, OHIO**

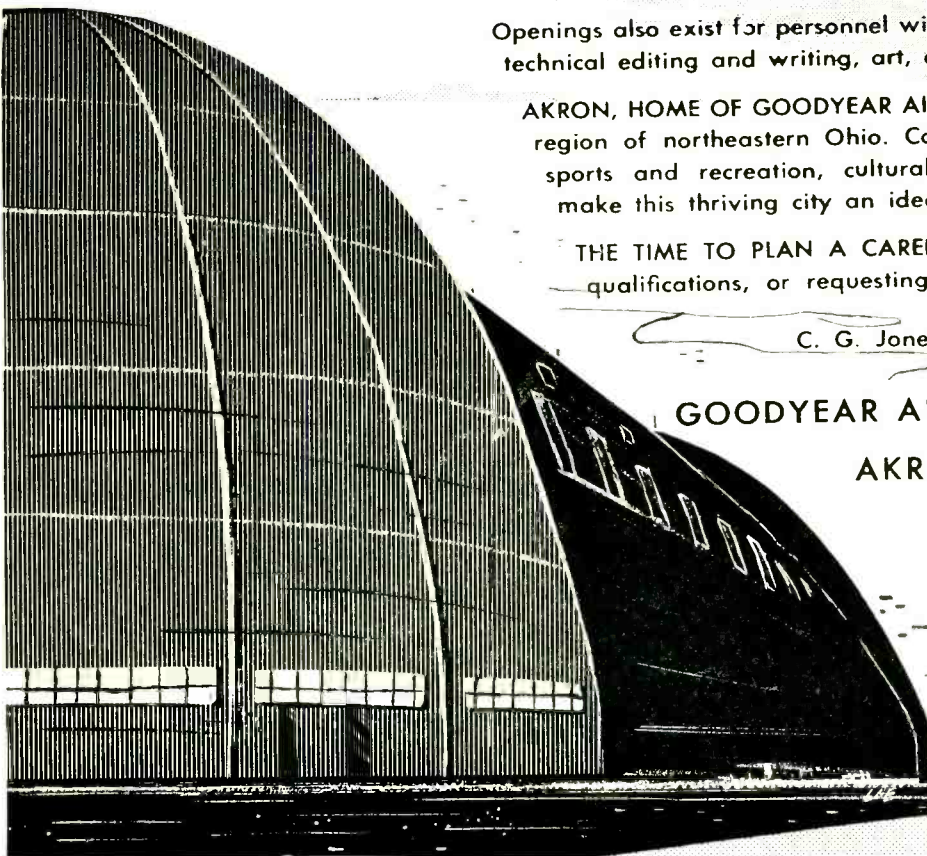

Here are 5 reasons why you will want to come with us if you are a . . .

*mechanical engineer*

*mechanical designer*

*electrical engineer*

*Physicist*

*Metallurgist*

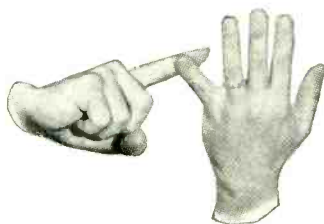

1. You can get in "on the ground floor" in the field of electronic computers and associated equipment for use in business machines. This means excellent opportunity for advancement.
2. You can plan your future with a long-established, highly successful Company.
3. You will receive a good salary, plus substantial "fringe" benefits.
4. You and your family will enjoy Dayton . . . a clean, progressive city with outstanding school facilities.
5. You will find NCR a friendly place to work, with employee morale at a high level.

Act at once. Write today to Employment Manager, Department A, describing your education and experience.

THE NATIONAL CASH REGISTER COMPANY, Dayton 9, Ohio

# engineers

DESIGNERS — DRAFTSMEN  
Electrical — Mechanical

1946 1947 1948 1949 1950 1951 1952 1953

## Do YOU belong in this picture of progress?

EXCEPTIONAL project diversification — military and commercial — enables MELPAR to offer you individual recognition, rapid advancement and ground-floor opportunity with a progressive company.

Experience desired in one or more of these or allied fields: Data Handling Equipment (magnetic cores, magnetic recording equipment, analogue to digital conversion, shaft digitizers) • Flight Simulation (servomechanisms, pulse circuitry, electronic cabling) • High Frequency Antennas • Audio and Video Circuit Design • Small Mechanisms Design • Mechanical Packaging of Electronic Components • Heat Transfer and Thermodynamics • Design of reciprocating compressors, hot gas generators and diesel engines

# melpar

INCORPORATED

440 Swann Ave., Alexandria, Va.  
10 Potter Street, Cambridge, Mass.

A SUBSIDIARY OF THE WESTINGHOUSE AIR BRAKE COMPANY

## HIGHLY QUALIFIED ENGINEERS DESIRED BY Digital Computer Laboratory at Massachusetts Institute of Technology

to design and develop high-speed electronic digital equipment involving vacuum-tube and magnetic-core circuitry.

Openings are also available for outstanding candidates to work on use of high-speed digital computers to control large physical systems. This involves study of control requirements of the whole system, reduction of them to a simple pattern of control instructions, and translation of the pattern into computer code. Position requires appreciation for physical systems, ingenuity, and imagination. Training in computer principles provided as necessary.

Persons from other fields wishing experience in digital computers for industrial and military uses are encouraged to apply. Positions carry opportunity for advancement. Salary appropriate to candidate's experience and training.

Address:

**DIGITAL COMPUTER LABORATORY, MIT**  
211 Massachusetts Avenue  
Cambridge 39, Massachusetts



**ENGINEERS:**

**DOES YOUR  
PRESENT JOB  
GIVE YOU**

**ALL THESE**

**RCA**

**CAREER**

**ADVANTAGES?**

**POSITIONS NOW OPEN FOR  
SENIOR DEVELOPMENT  
AND DESIGN ENGINEERS:**

- ✓ ELECTRONIC . . .
- ✓ COMMUNICATIONS . . .
- ✓ MECHANICAL . . .
- ✓ COMPUTER . . .
- ✓ ELECTRON TUBE . . .

**PERSONAL INTERVIEWS ARRANGED  
IN YOUR CITY.** A copy of our booklet  
"Challenge and Opportunity," describing the role of the  
engineer in RCA, will be mailed upon request. Please  
send a complete resume of your education and  
experience to:

**MR. JOHN R. WELD**  
Employment Manager, Dept. 300D  
Radio Corporation of America  
30 Rockefeller Plaza  
New York 20, N. Y.

- CHECK SHEET**
- | Yes                      | No                       |   |
|--------------------------|--------------------------|---|
| <input type="checkbox"/> | <input type="checkbox"/> | PROFESSIONAL RECOGNITION AND PRESTIGE?  |
| <input type="checkbox"/> | <input type="checkbox"/> | ADVANCEMENT IN STATUS?  |
| <input type="checkbox"/> | <input type="checkbox"/> | SECURITY AND STABILITY?   |
| <input type="checkbox"/> | <input type="checkbox"/> | CHALLENGE AND OPPORTUNITY?  |
| <input type="checkbox"/> | <input type="checkbox"/> | HIGH SALARY SCALE AND OPPORTUNITIES<br>FOR PROMOTION?                             |
| <input type="checkbox"/> | <input type="checkbox"/> | EXCELLENT SUBURBAN HOUSING AT<br>REASONABLE COST?                                 |
| <input type="checkbox"/> | <input type="checkbox"/> | FACILITIES FOR PROFESSIONAL<br>ADVANCEMENT?                                       |
| <input type="checkbox"/> | <input type="checkbox"/> | UNEXCELLED TECHNICAL AND LABORATORY<br>FACILITIES?                                |
| <input type="checkbox"/> | <input type="checkbox"/> | ASSOCIATION WITH TOP SCIENTISTS?  |
| <input type="checkbox"/> | <input type="checkbox"/> | TUITION REFUND PLAN FOR ADVANCED STUDY?   |
| <input type="checkbox"/> | <input type="checkbox"/> | MILITARY OR COMMERCIAL OPPORTUNITY?   |
| <input type="checkbox"/> | <input type="checkbox"/> | MODERATE COST OF LIVING?  |
| <input type="checkbox"/> | <input type="checkbox"/> | MODERN RETIREMENT PLAN?   |
| <input type="checkbox"/> | <input type="checkbox"/> | COMPANY-PAID LIFE INSURANCE?  |
| <input type="checkbox"/> | <input type="checkbox"/> | COMPANY-PAID LIBERAL HOSPITAL, SURGICAL<br>AND DISABILITY PLAN (FAMILY BENEFITS)? |
| <input type="checkbox"/> | <input type="checkbox"/> | LIBERAL VACATION PLAN?  |
| <input type="checkbox"/> | <input type="checkbox"/> | LIBERAL HOLIDAY SCHEDULE?   |
| <input type="checkbox"/> | <input type="checkbox"/> | PROFESSIONAL STATUS AND UTILIZATION OF<br>YOUR EDUCATION AND EXPERIENCE?          |



**RADIO CORPORATION of AMERICA**

# M. I. T.

## LINCOLN LABORATORY

Staff research positions available for exceptional electrical engineers with advanced training or experience in pulse circuitry and microwave applications.

*Please reply to:*

Personnel Department, P. O. Box 390,  
Cambridge 39, Mass.

### CAREER OPPORTUNITIES *for* ENGINEERS

Desiring the challenge of interesting and diversified projects—  
Wishing to work with congenial associates and modern equipment and facilities—  
Seeking permanence of affiliation with a leading company and steady advancement—  
Will find these in a career here at **GENERAL MOTORS**.

Positions now are open in **ADVANCED DEVELOPMENT** and **PRODUCT DESIGN**.

**COMMERCIAL AUTOMOBILE RADIO**

**MILITARY RADIO, RADAR AND ELECTRONIC EQUIPMENT**

**ELECTRONIC COMPONENTS**

**INTRICATE MECHANISMS** such as tuners, telemetering,  
mechanical linkages, controls, etc.

**ACOUSTICS**—loud speakers, etc.

Inquiries invited from recent and prospective graduates as well as experienced men with bachelors or advanced degrees in physics, electrical or mechanical engineering. Salary increases based on merit and initiative. Vacations with pay, complete insurance and retirement programs. Relocation expenses paid for those hired.

*All inquiries held in confidence and answered*—**WRITE or APPLY to**  
**DELCO RADIO DIV. GENERAL MOTORS CORP. Kokomo, Indiana**

### DESIGN ENGINEERS

The Pacific Division, Bendix Aviation Corporation has openings for design engineers in development of radar, sonar and telemetering offering excellent opportunities for growth with the corporation and the opportunity to live in Southern California. Positions are open at several levels.

Please Address Inquiries to

**W. C. WALKER**

**ENGINEERING EMPLOYMENT MANAGER**  
11600 Sherman Way North Hollywood, California

### ENGINEERS

**SYSTEMS  
RADAR  
SERVO  
COMPUTER**

**BACKGROUND:** Responsible positions open for top level development and project engineers with practical and research experience in:

**Advanced Electronic Circuits  
and Systems  
Microwave Radar  
Microwave Receivers  
and Transmitters**



Requirements emphasize advanced analytical and/or management experience on highly complex electronic and electro-mechanical systems.

Kindly send resume and salary requirements to

**The W. L. MAXSON CORP.**  
460 W. 34th ST., NEW YORK 1, N.Y.

### ELECTRONIC ENGINEERS

for design & development work  
WITH A YOUNG PROGRESSIVE COMPANY

- ✓ digital techniques
- ✓ computers
- ✓ radar

SEND RESUMÉ OF EXPERIENCE AND EDUCATION, WITH SALARY REQUIREMENTS, TO

Electrom. Engineering Company of California  
180 SOUTH ALVARADO STREET,  
LOS ANGELES, 37, CALIFORNIA  
DUNKIRK 2-7353





## An Opportunity

is offered for intelligent, imaginative engineers and scientists to join the staff of a progressive and self-sustaining, university-affiliated research and development laboratory. We are desirous of expanding our permanent staff in such fields as electronic instrumentation, missile guidance, microwave applications, design of special-purpose electronic computers, and in various other applied research fields of electronics and physics.

Salary structure and benefit programs are on a par with industry. In addition, there are many tangible advantages, such as our self-sponsored internal research policy, of interest to men with ingenuity and initiative.

**CORNELL AERONAUTICAL  
LABORATORY, INC.**



BUFFALO 21, NEW YORK

*Bendix Aviation Corporation*

### ● YORK Division . . .

This NEW division of our nationally-famous corporation has openings for . . . .

## ENGINEERS PHYSICISTS

Top-flight men in advanced fields of electronic research, development and product engineering are needed for challenging work under ideal conditions in our new, modern plant.

You benefit at Bendix York from our location in the heart of a beautiful suburban area, from high wages, paid vacations and holidays . . . and excellent opportunities for advancement.

Openings at all levels.

Write, Wire or Phone  
Department Y-1



**AVIATION CORPORATION ●  
YORK DIVISION**

Phone: York 5521

York, Penna.

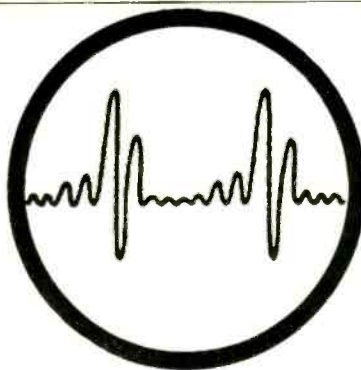

## SPECIAL OPPORTUNITIES FOR SENIOR ENGINEERS

Convair in beautiful, sunshiny San Diego invites you to join an "engineers" engineering department. Interesting, challenging, essential long-range projects in commercial aircraft, military aircraft, missiles, engineering research and electronics development. Positions open in these specialized fields:

Electrical Design	Servo-mechanisms
Mechanical Design	Aerodynamics
Structural Design	Thermodynamics
Structure	Operation Analysis
Weights	System Analysis

Generous travel allowances to those accepted  
For free brochure, write Mr. H. T. Brooks,  
Engineering Dept. 900

## CONVAIR IN BEAUTIFUL SAN DIEGO

3302 PACIFIC HIWAY  
SAN DIEGO 12, CALIFORNIA

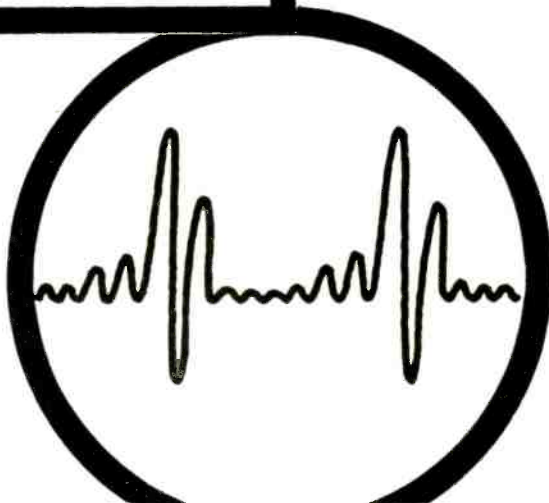

## ENGINEERS, EE

- Responsible position involving design and development of H.F. pulse magnetic recording components and systems.
- Also engineers for R.F., I.F. and microwave projects.

*Small enough to grow . . .*

*Large enough to be stable . . .*

These are just two of the advantages of working for Kollsman. In this friendly organization you'll work with intriguing problems concerning the design and development of America's finest aircraft instruments. You'll find the most modern facilities, available, and a conveniently located plant in a quiet residential area only 20 minutes by subway from the heart of New York. Not to be overlooked are the generous benefits including paid life, hospitalization, surgical, accident and health insurance.

Please submit resumes to: Employment Manager

### KOLLSMAN Instrument Corp.

80-08 45th Ave., Elmhurst, L. I., New York  
Phone: NEwtown 9-2900

## ELECTRONICS ENGINEER

### TV YOKE DESIGN

RCA's Tube Division has a career opportunity for an electronics engineer with BSEE degree and 4 or more years design experience on kinescope deflection components. Familiarity with yoke manufacturing techniques desirable. Liberal company-paid benefits program.

Please forward resume of experience and salary progression to:

Mr. Robert A. Wallace

Engineering Personnel

### RADIO CORPORATION OF AMERICA

Camden, New Jersey

## DEVELOPMENT ENGINEERS

**FOR:** Design Engineering, Practical Research, Investigations of Theories, Functional Analysis

An interesting challenge for senior design engineers to work directly with top project supervisors helping through the prototype stage new developments in:

- Automatic Control Instruments
- Electronic Navigational Aids
- Magnetic Amplifiers
- Airborne Armament Systems
- Guided Missile Controls
- Computing Equipment

For these jobs we are interested in men with two or more years experience in electro-mechanical work related to the above fields or in men with superior scholastic records in physics; electrical, electronic or mechanical engineering.

### YOU'LL LIKE WORKING AT FORD INSTRUMENT

- Not too large, not too small
- Stable but progressive company
- N. Y. C. location with all its additional varied opportunities
- Above-average fringe benefits
- Pension Plan
- Nine Paid Holidays
- Two Weeks vacation with pay
- Tuition assistance for further related studies

Our policy of permanency of positions and continuity of service does not allow us to employ engineers unless there is a *clear and definite need for them projected years into the future*. And we promote from within.

If you can qualify, we urge you to contact by mail, or if in N. Y. C. phone:

Mr. P. F. McCaffrey, Stillwell 4-9000, Extension 416

### FORD INSTRUMENT COMPANY

Division of the Sperry Corporation

31-10 Thomson Ave., Long Island City, N. Y. (20 minutes from the heart of New York City)

## Wanted: Manufacturer's Representatives for Electronic Instruments

A young, progressive instrument manufacturer on the West Coast seeks an aggressive sales organization capable of handling its line of electronic digital data recording systems and process control instruments. Protected territories are open throughout the United States and Canada. Write, stating present lines and territory now covered to Box

RW-2065, Electronics  
330 W. 42 St., New York 18, N. Y.

EMPLOYMENT . . . EQUIPMENT  
BUSINESS . . .

**OPPORTUNITIES**  
*Whatever your need—  
think "SEARCHLIGHT" FIRST*



## Transformer Engineers

# COLLINS RADIO COMPANY

has openings in Dallas, Texas, for qualified electronic engineers experienced in design and development of radio transformers and components.

Applicants must have B.S. in Electrical Engineering, Electronics, or Physics, and at least two years experience in magnetics or electro-magnetics including high permeability steel applications.

Employee benefits include air conditioned plant, free insurance, liberal vacations, and company-paid retirement benefit plan.

Qualified applicants write giving educational and experience resume to:

JOHN D. MITCHELL

Dir. of Industrial Engineering

## COLLINS RADIO COMPANY

Texas Division

1930 Hi-Line Drive Dallas 2, Texas



## IMAGINATION

Got more than your share? Like to have the freedom to use it, with commensurate recognition? Then, you've come to the right ad!

That is, if you're an electronic or mechanical engineer with practical experience in the electronic industry.

We need engineers with imagination. We're growing and going . . . you're just in time to go with us. You'll enjoy the job plus the advantage of pleasant living conditions in a large, modern city . . . without the disadvantage of big city pressure.

The man to contact is Arthur E. Harrison, Vice-President of Engineering. The time is now! You'll never regret it!

**wilcox**

Aviation Communications and Navigation  
Fourteenth & Chestnut,  
Kansas City 27, Mo.

# Why?

ELECTRONICS ENG.

PHYSICISTS

MECHANICAL ENG.

## Here Is Why Bendix Radio Is The Place For YOU To Work

### Challenging work in The development of:

Radar (Airborne and Ground)  
Auto Radio and Test Equip.  
Airborne & Mobile Comm. Equip.  
Missile Guidance Systems  
Computer Applications  
Research & Development  
(Incl. Transistors and Printed Circuitry)



Excellent salaries.  
Semi-annual work reviews with advancement on merit.  
Modern, air-conditioned plant located in beautiful suburban area with ample housing, good schools, attractive shopping centers, major league sports.  
Numerous employee benefits.

Call, wire or write Mr. L.H. Noggle, Dept. J

## Bendix Radio

DIVISION OF BENDIX AVIATION CORPORATION  
BALTIMORE-4, MD. Phone VALley 3-2200

# DIGITAL COMPUTER ENGINEERS

The Bendix Research Laboratories need competent engineers for the development of special-purpose digital computers. This program involves all phases of planning and construction, including both logical and circuit design. Applicants should have experience with electronic circuitry and an interest in the general subject of digital data-handling systems. Experience in the digital computer field is desirable.

Good opportunities for professional growth are offered by this laboratory, whose staff of scientists is active in fields such as radar, computers, servo-mechanisms, and nucleonics. Advanced study at local universities is encouraged and supplemented by special company-sponsored courses.

Please send brief resume to:

Personnel Director

## BENDIX AVIATION CORPORATION RESEARCH LABORATORIES

4855 Fourth Avenue

Detroit 1, Michigan

## WANTED!

Quartz crystal manufacturing plant needs electronic engineer with varied experience in circuit design and application. Physics background helpful. Salary commensurate with experience. Write giving details of education and experience.

### PAN-ELECTRONICS CORPORATION

901 West Peachtree St., Atlanta, Georgia

## WANTED

## ALWAYS BUYING

SMALL AND LARGE LOTS OF

**Screws-Nuts-Bolts-Washers  
Rivets-Lugs-Eyelets, Etc.**

and any & all types of Radio  
TV, ELECTRONIC HARDWARE, PARTS etc.

### LOUIS E. GANCHER CO.

468-472 WEST B'WAY - NEW YORK 12, N. Y.

"IN RADIO SINCE 1921"

# WHITE-RODGERS ELECTRIC CO.

ARMAMENT  
ENGINEERING  
DIVISION

NEEDS

ENGINEERS

for

RESEARCH,  
DESIGN,  
DEVELOPMENT

of

MISSILE GUIDANCE SYSTEMS  
AUTOMATIC FLIGHT FORMATION  
SYSTEMS and ASSOCIATED COMPONENTS

To formulate dynamics and computer equations,  
and to design and develop experimentally  
electro-mechanical computers and instrument  
servo-mechanisms

SEND RESUME TO EMPLOYMENT MANAGER  
1201 CASS AVE. ST. LOUIS 6, MO.

### URGENT

Will Buy BC348R Receiver @ \$75.00  
BC348H—K and L Receivers \$70.00  
Ship via EXPRESS C.O.D., subject to inspection to

H. FINNEGAN

49 Washington Ave., Little Ferry, N. J.

## WANTED - BC-221

Heterodyne Frequency Meters



Any quantity, any model—we will purchase for cash, provided only that each unit is complete with original Calibration Book, tubes, crystal and cabinet.

Large numbers needed.  
Write, wire or telephone

Weston Laboratories, Inc.

HARVARD MASSACHUSETTS

### WILL BUY

All ART13/type T47A \$200.00; ART13 type T47 \$150.00; BC348 unmodified \$65.00; BC348 modified \$50.00; APN9 \$200.00; ARC3 complete \$350.00; R77 Receiver \$200.00; ARC1 Radio \$200.00; BC312 \$60.00; BC342 \$60.00; ship via Express C.O.D., subject to inspection to

H. FINNEGAN

49 Washington Ave. Little Ferry, N. J.

IF there is anything you want

that other readers can supply—

OR . . . something you don't want—

that other readers can use—

Advertise it in the SEARCHLIGHT SECTION



*"An Unexcelled Opportunity  
For Professional Growth . . . ."*

# ELECTRONIC ENGINEERS & PHYSICISTS

IN RESEARCH AND DEVELOPMENT

GUIDED MISSILES • RADAR • SOLID STATE PHYSICS •  
VACUUM TUBES • ELECTRONIC NAVIGATION •  
TELEVISION • MICROWAVES • ANTENNAS •  
RADIO • COMPUTERS • TRANSISTORS •

DIRECT INQUIRIES TO:  
THE EMPLOYMENT DEPT.

## CAPEHART-FARNSWORTH

CORPORATION  
FORT WAYNE, INDIANA



### QUARTZ CRYSTALS!

Available NOW!  
In frequencies from 100 to 10,000 Kc.  
MOUNTED IN FOLLOWING  
TYPES HOLDERS

Bendix MX-9E	CR-5 B/U	FT-249
Billey AR4-W	CR-5U	FT-500
Billey AR7-W	CR-6 B/U	G.E. 103
Billey FT-164	CR-6U	G.E. G-43
Billey FT-171-B	CR-8U	J.K. Type F
Billey MC-7	DC-8	Motorola FMT
Billey MC-72	DC-9	Piezo AA9G
Billey MO-2	DC-10	Piezo CR-4 B/U
Billey SR-5	DC-11-A	Premier FT-164
BSD-380-G	DC-15	Premier PL-217
Collins 1-C	DC-26	RCA AVA 10J
Collins 1-D	Franklin DC-35	RCA MI-8412A
Collins 1-G-1	FT-171	RCA MI-8412B
Collins TCS	FT-241-A	RCMA R-1
CR-1A	FT-243	

COMPLETE SETS OF CRYSTALS  
AVAILABLE FOR FOLLOWING SETS.

ARC-1	BC-684	SCR-522
ARC-3	BC-745	SCR-536
ARC-5	BC-1000	SCR-608
ART-13	LM	SCR-609
BC-452	SCR-211	SCR-610
BC-604	SCR-274N	SCR-619
BC-610	SCR-300	TRC-1
BC-620	SCR-508	TRC-2
BC-659	SCR-509	
BC-669	SCR-510	

INQUIRIES INVITED. WRITE TODAY!  
SHIP BAND FREQUENCIES AVAILABLE  
IN VARIOUS TYPE HOLDERS, AT  
GREATLY REDUCED PRICES!  
LARGE QUANTITIES!

DISCOUNTS FOR QUANTITY PURCHASES!  
WE INVITE INQUIRIES FROM FOREIGN BUY-  
ERS, AIRLINES, MILITARY AND EXPORT  
PURCHASERS, MANUFACTURERS, JOBBERS,  
WHOLESALE AND VOLUME DEALERS.  
Send For Complete Crystal Catalogue!

TEST EQUIPMENT  
Clean Merchandise At Bargain Prices!

Measurements Corp. 78-B Test Set with original  
Calibration Chart. BC-1066A Radio Receiver. High  
Frequency Field Intensity Meter

Calibrator 620-A	TS 35/AP
EE-65G	TS-102 A/AP
I-96A Sig. Gen.	TS-428 (XM-2) PCM
IE-19A	TS-481/U
LM Freq. Meter	W.E. 17B
TS 7/ASQ	W.E. 19C (SPC)
TS 14/AP	

ELECTRONIC COMPONENTS  
APG Low Altitude Altimeter. Complete with all  
components. New. In Original box.  
BC-800. With BC-1145 Control Box. New.  
BC-5 Components. 0-75/URT Oscillator.  
APQ-13 Junction Box. SCR-274-N Components.  
BC-1333 Marker Beacon. TSP-3 Indicator.  
MN-26L Radio Compass Receiver.

WRITE FOR PRICES ON ALL ABOVE ITEMS.  
STATE QUANTITIES DESIRED.

**U. S. CRYSTALS, INC.**  
805 S. UNION AVE.  
LOS ANGELES 17, CALIF.

## TUBES: Industrial Receiving Transmitting

SPECIALISTS IN  
JAN & RUGGEDIZED  
TYPES

Standard Brands Only				Fully Guaranteed					
0A2	.85	3C21	5.00	304TH	7.75	832A	7.50	5702	2.95
0A3	1.05	3C23	6.75	304TL	7.75	837	.95	5702WA	4.50
0B2	.85	3C24/24G	.95	313C	4.00	838	3.25	5703	1.20
0C3	.90	3C45	11.50	316A	.80	865	.95	5703WA	3.50
0C3W	3.65	3DP1	2.80	TR317	14.75	866A	1.75	5718	5.00
0D3	.90	3E29	11.50	323B	8.25	872A	3.50	5719	5.50
0D3W	3.65	3FP7	1.75	338A	28.50	884	1.85	5720	23.00
1B24	9.00	3G P1	2.70	359A	4.50	885	1.65	5725	1.50
1B24A	27.50	3HP14	6.60	388A	1.50	921	1.85	5726	3.25
1B26	2.20	4B22	7.50	394A	3.00	922	1.60	5744	2.00
1B27	11.50	4B25	8.00	GL414	120.00	954	.35	5749	2.15
1B42	8.00	4B32	11.00	GL434A	14.00	955	.45	5750	2.50
1B47	12.00	4C35	19.25	GL446A	1.10	956	.45	5751	2.95
1B63A	45.00	4J32	220.00	GL464A	9.50	959	1.75	5763	1.50
1P21	49.50	4J36	140.00	471A	2.20	966	1.50	5783	6.00
1P23	2.50	ELC5B	3.50	532	3.50	1612	2.00	5787	4.25
1P28	9.00	5BP1	3.35	KU627	17.00	1614	1.95	5814	1.85
1P40	1.55	5BP4	3.35	700A	19.95	1616	.85	5825	12.75
1P41	2.80	5C22	45.00	700B	19.95	1619	.35	5829	2.75
1P42	5.00	5D21	12.00	700C	19.95	1620	6.20	5837	110.00
1Y2	6.50	5FP7	1.50	700D	19.95	1625	.30	5840	6.00
1Z2	3.20	5J29	11.50	701A	6.50	1632	.95	5844	2.00
2B22	2.25	5LP5	17.00	702A	1.75	1633	.90	5881	2.50
2C33	4.50	5R4G Y	1.20	603A	4.50	1636	2.50	5901	6.50
2C40	10.00	5R4W G Y	4.93	702A	1.85	1641	2.00	5902	11.00
2C43	14.95	6AC7W	3.25	705A	1.90	2050	1.85	5910	
2C44	.98	WE6AK5	1.25	706B	18.50	2050W	5.95	5915	1.20
2C51	4.85	6AK5W	1.65	5545	35.00	5545	35.00	5932	8.50
2C53	13.50	6AL5W	3.00	5550	39.50	5550	39.50	5937	24.00
2D21	1.20	6AQ5W	3.50	5551	60.00	5551	60.00	5948	795.00
2D21W	2.50	6A6	1.50	5557	8.50	5557	8.50	5949	185.00
2J21	6.50	6AS6	1.50	5588	14.00	5588	14.00	5956	60.00
2J22	5.00	6AS6W	3.25	5559	21.50	5559	21.50	5957	60.00
2J26	13.00	6AS7G	3.50	5560	28.00	5560	28.00	5958	60.00
2J31	20.00	6CJ	7.25	5594	9.00	5594	9.00	5959	60.00
2J37	12.00	6F4	3.50	5632	12.15	5632	12.15	5964	1.45
2J40A	32.00	6F6WGT	4.85	5634	4.50	5634	4.50	5995	6.00
2J50	20.00	6J4	5.75	5636	7.50	5636	7.50	6005	3.50
2J51	250.00	6J6W	1.50	5638	3.00	5638	3.00	6072	5.50
2J54	62.95	6K4A	5.50	5639	12.00	5639	12.00	6095	write
2J54B	95.00	6L6WGA	8.45	5640	12.50	5640	12.50	6096	write
2J61	30.00	7AK7	7.00	5641	8.00	5641	8.00	6097	write
2J62	25.00	7C30	85.00	5642	1.20	5642	1.20	6098	write
2K22	20.00	9C24	250.00	5643	8.00	5643	8.00	6099	write
2K23	11.50	9LP7	3.50	5644	12.00	5644	12.00	6101	write
2K25	27.50	15R	.50	5645	7.50	5645	7.50	6111	9.00
2K28	25.00	FC17	6.50	5646	7.50	5646	7.50	6112	9.40
2K29	24.00	FG27A	15.00	5647	5.50	5647	5.50	6120	13.35
2K30	32.00	25Z6WGT	4.85	5651	2.25	5651	2.25	6135	2.75
2K33	175.00	28D7	1.40	5651WA	5.85	5651WA	5.85	6146	4.85
2K33A	180.00	FG32	14.00	5654	1.65	5654	1.65	6163	3.25
2K34	140.00	FG33	23.00	5656	9.25	5656	9.25	6187	2.50
3B24	4.00	3T	3.50	5670	3.25	5670	3.25	6187	2.50
3B24W	11.00	FG105	18.50	5676	1.15	5676	1.15	6201	5.00
3B25	3.50	FG172	29.95	5686	3.00	5686	3.00	6394	12.50
3B26	2.75	215A	7.50	5687	2.75	5687	2.75	8001	5.50
3B28	4.95	249C	6.00	800	1.50	800	1.50	8011	.75
3B29	10.25	250TH	16.50	805	3.20	805	3.20	8013A	3.95
3BP1	3.70	250L	16.50	829B	12.50	829B	12.50	8020	2.00
3CP1	2.00	274B	2.25	830B	2.75	830B	2.75	8025	5.25

Complete  
Line of  
Receiving  
TUBES.  
Write for  
Quotes.

# MILGRAY

## ELECTRONICS, INC.

120 Liberty St.  
New York 6, N. Y.  
REctor 2-1297-8

# Reliance Specials

## COAXIAL CONNECTORS

A full line of JAN approved connectors in stock



18-1AC	50.42	PL-274	\$1.10	UG-88/U	50.90
83-1AP	.30	PL-275	2.10	UG-89/U	1.10
83-1BC	.35	SO-239	.40	UG-102/U	.80
83-1F	1.10	UG-13/U	1.70	UG-103/U	.68
83-1H	.22	UG-201/U	1.05	UG-104/U	1.40
83-1J	.73	UG-21/U	.85	UG-106/U	.15
83-1R	.40	UG-21B/U	1.00	UG-107/U	2.75
83-1RTX	.65	UG-21C/U	1.05	UG-146/U	2.00
83-1SP	.45	UG-21D/U	1.45	UG-167/U	3.75
83-1SPN	1.50	UG-22/U	1.30	UG-169/U	.12
83-1T	1.30	UG-22A/U	1.60	UG-176/U	.12
83-2AP	1.95	UG-22B/U	1.20	UG-185/U	.95
83-2J	2.10	UG-23/U	1.20	UG-196/U	1.05
83-2H	1.65	UG-23B/U	1.50	UG-203/U	.65
83-2AP	1.40	UG-23C/U	1.10	UG-224/U	1.15
83-22P	2.10	UG-24/U	1.30	UG-255/U	1.95
83-22I	1.40	UG-27/U	1.25	UG-260/U	.85
83-22H	.68	UG-27A/U	2.25	UG-261/U	1.10
83-22SP	.80	UG-27B/U	2.95	UG-262/U	1.10
83-22T	1.95	UG-28A/U	2.95	UG-273/U	1.45
83-16A	.12	UG-29B/U	1.75	UG-274/U	2.30
83-185	.12	UG-30/U	2.70	UG-290/U	1.95
CW-123A/U	.45	UG-31/U	1.85	UG-291/U	.95
M-35H	1.30	UG-58/U	.70	UG-306/U	2.65
M-35J	.30	UG-58A/U	.90	UG-414/U	1.95
M-35VA	.65	UG-59A/U	1.90	UG-499/U	1.25
PL-25H	.75	UG-88/U	1.75	UG-625/U	1.35
PL-25V	.45	UG-85/U	1.65		
PL-25VA	.50	UG-87/U	1.40		

## NEW COAXIAL CABLES Jan approved

	Price per 1000 ft.		Price per 1000 ft.
RG5/U*	\$140.00	RG22/U*	\$150.00
RG7/U	180.00	RG22A/U	285.00
RG7/U*	85.00	RG24/U	675.00
RG8/U*	100.00	RG26/U	475.00
RG9/U*	250.00	RG-29/U*	50.00
RG9A/U	330.00	RG34/U*	300.00
RG10/U	240.00	RG35/U*	900.00
RG11/U*	100.00	RG41/U*	295.00
RG11A/U*	150.00	RG54A/U*	97.00
RG12/U	240.00	RG55/U*	110.00
RG13/U*	216.00	RG57/U*	325.00
RG17/U	650.00	RG58/U*	60.00
RG18/U	900.00	RG58A/U*	70.00
RG19/U	1250.00	RG59/U*	60.00
RG20/U	1450.00	RG62/U*	75.00
RG21/U*	220.00	RG77/U*	100.00

Add 25% for orders less than 500 feet.  
\*No minimum order—other 250 minimum.



## UNIVERSAL JOINTS ALUMINUM

3/4" hole, 1/2" O.D. 1-1/8" long with two 6/32 tapped set-screw holes EACH 85¢  
3/16" hole, 3/8" O.D. 1-1/4" long with two 6/32 tapped set-screw holes EACH 80¢

## FIXED COMPOSITION RESISTORS

Type EB 1/2W 10%	5¢ ea.	\$4.00 per C
BB 1/2W 5%	10¢ ea.	8.00 per C
Type GH 1W 10%	8¢ ea.	6.00 per C
GH 1W 5%	16¢ ea.	12.00 per C
Type HB 2W 10%	11¢ ea.	9.00 per C
HB-2W 5%	22¢ ea.	18.00 per C

AVAILABLE IN ALL STANDARD RMA VALUES

## POSTAGE STAMP MICAS

Available in All Standard RMA Values

PLAIN		SILVER	
5 mmf to 910 mmf	5¢	5 mmf to 910 mmf	10¢
.001 to .0013 mfd	8¢	.001 to .002 mfd	20¢
.0015 to .005 mfd	15¢	.0022 to .0091 mfd	50¢
.0062 to .0091 mfd	20¢	.01 mfd.	95¢
.01 mfd.	28¢		

## AIRCRAFT GENERATORS

OUTPUT—115 VAC 10.4 AMPS 800-1400 CY 1 PH. PLUS 30 VDC 60 AMPS. \$29.50  
OUTPUT 30 VDC 15 AMPS 2500-4500 RPM 8" L x 5" DIA SPLINE SHAFT 3/4 x 1-1/2" WT 16 lbs. \$45.50  
OUTPUT 28 VDC 140 AMPS 2500-4500 RPM. \$38.50

## STORAGE BATTERIES

BB-54 Willard 2 volt 20 amp. hrs. built in charge indicator 4 x 3 x 5 1/2 high—BRAND NEW \$1.95 ea. 100 lots \$1.75 ea. 1000 lots \$1.50 ea.  
BB-212/U 2 volt 40 amp. hrs. 6 1/2 x 2 3/8 x 4 1/2 high BRAND NEW \$2.35 ea.  
NT-6 6 VOLT 3.5 AMP Hrs. 3 x 1-3/4 x 2 1/2 \$1.95 ea.  
ALL BATTERIES SHIPPED DRY

## PULSE TRANSFORMERS

UTAH 9262 3 windings-peak 200 VDC Current 10 MA. Turns Ratio 1-1-1 Impedance Variable 0-5000 ohms \$42.50 ea.  
MANY OTHER PULSE TRANSFORMERS IN STOCK DATA UPON REQUEST

## W.E. D-150734

### PHASE SHIFT CAPACITOR

.75 to 2.75 mmfd 4 stators—single rotor—continuously variable phase shift 0-360 deg. \$22.50 ea.

TERMS—Cash with Order or 25% Deposit—Balance C.O.D. Net 10 Days to Rated Accounts. All Prices are Net F.O.B. Our Warehouse.

## PRECISION RESISTORS

at Bargain Prices—Wire Wound Spool Type

1/4 watt 1% tolerance WW3 or equal Only 35¢ ea.	.250 5	14.98	125.	723.1	7000	32.7K
	.334 7.4	16.37	130	750	7500	32.80K
	.502 9.1	25	147.5	855	8000	33.3K
	.557 10.48	30	180	1000	8500	35K
	.627 10.84	46	210	2193	8800	35.89K
	.760 11.1	52	220.4	2200	10K	36K
	1.11 11.25	55.1	235	2250	12K-2%	37K
	1.53 12.32	72	260	2500	14.82K	40K
	2.13 13	79.81	298.3	3427	15.75K	47K
	2.04 13.02	87	301.8	4000	16.7K	50K
	2.5 13.15	90	366.6	4451	17K	51K
	3.13 13.3	97.8	400	5000	20K	59.15K
	3.5 13.52	105.8	414.3	5900	25K	79.01K
	4.13 13.89	123.8	705	6500	30K	125K

1 watt 1% tolerance WW4 or Equal 45¢ ea.

1 watt 1% tolerance WW4 or Equal 60¢ ea.

1 watt 1% tolerance WW5 \$1.50

100K 128K 150K 240K 320K 500K 600K

120K 130K 350K 65¢ ea.

81K-2% 522K-1% 645K-1% 700K-1% 1 meg-5%

SOUND POWERED HANDSET

Brand New TS-10 Type—includes 5 ft. cord. USES NO BATTERIES

Headset with 2 Phones and Chest Mike. Includes 20 ft. Rubber Cord. BRAND NEW. EACH \$14.88

Same as above except used exc. condition. Each \$9.95

SOUND POWERED HEAT & CHEST SET

Navy Type M Head and Chest Set. For Work Requiring Free Use of Hands. Heavy Duty—Consists of Headset with 2 Phones and Chest Mike.

Includes 20 ft. Rubber Cord. BRAND NEW. EACH \$14.88

Same as above except used exc. condition. Each \$9.95

## OIL FILLED CONDENSERS

MFD	V.D.C.	Price	MFD	V.D.C.	Price
5.2	50	\$0.85	5	2,000	\$1.65
6	400	.85	8	2,000	7.95
3 x 3	400	1.00	12	2,000	8.95
1	600	.55	0.25	3,000	2.52
0.5-0.5	600	.40	0.5	3,000	2.40
2	600	.60	2	3,000	4.50
4	600	1.65	2	4,000	7.95
8	600	1.85	0.01	5,000	.95
10	600	3.25	1	5,000	4.88
4 x 3	600	2.50	0.03-0.03	6,000	1.50
4	1,000	1.59	1	6,000	9.95
1	1,000	.68	0.02-0.02	7,000	1.55
2	1,000	.95	0	7,000	1.75
3	1,000	1.70	0.1-0.1	7,000	5.95
1	1,500	1.45	0.1	7,500	2.25
0.02	2,000	.65	0.075-0.075	8,000	6.50
0.1-0.1	2,000	1.30	0.15-0.15	8,000	6.95
0.1-0.5	2,000	.95	0.25	20,000	19.95

## OIL FILLED AC CONDENSERS

MFD	V.A.C.	Price	MFD	V.A.C.	Price
7.5	220	\$1.95	15	440	\$5.25
20	220	3.95	1	660	2.95
1	236	.49	2	660	3.50
4	236	1.60	3	660	3.60
1	236	1.95	4	660	3.75
3	330	1.45	5	660	3.85
4	330	2.25	6	660	4.25
20	330	6.75	8	660	4.50
25	330	7.50	0.2	750	.69
4.4	375	2.15			

## High Current Filament Transformer

Ameritan type W Pri. 105-125 V. 60 cy. 1 Phase—Sec. 5V. 190 amps.—97 KVA 35 KV. RMS Insul. Test 7x10x12; Ft. 80 lbs. Ideal For Use As Arc Welder. SPECIAL \$29.50 ea.  
Kenyon S-14940 S.C. #2Z8943-1073 Pri. 105-125 V. 60 Cy. Sec. 5V. 115 Amps. \$19.60 ea.

## RAYTHEON PLATE TRANSFORMER

TYPE UB355A  
PRI. 110V/220V/440V/60 cy.  
SEC #1 300V @ 4 AMPS, SEC. #2 300V @ 4 AMPS.  
1780 RMS TEST, 9% x 9 1/2% x 8 1/2" HIGH. \$19.95

## Choke 10 hy 400 MA 90 OHMS HERMETICALLY SEALED

5 1/4 x 4 1/2 x 4 H. \$4.88

## MERKLE-KORFF GEAR REDUCTION UNITS

Type SG15-3B Flexo-Action. High torque. Precision gears. #RM-10 ratio 103-1 input shaft 3/16 output 3/16 \$3.95 ea.  
#RM-11 ratio 296-1 input shaft 3/16 output 1/4 \$3.95 ea.

10 MA DC METER 3" rd DeJur #310.	\$3.95
1 MA DC METER 3" rd DeJur #310.	\$5.75
1 MA DC METER Fan type 4" scale.	\$3.95
5 AMP AC METER 4" rd JBR #432.	\$4.11
500 MA DC METER 2 1/2" rd G.E.	\$2.95
30 VDC METER 2 1/2" rd G.E.	\$3.95
500 MICROAMP DC METER 2 1/2" rd SUN.	\$4.30
AT-4/ARN-1 ALTIMETER ANTENNA NEW.	\$9.75
RT-7/APN-1 ALTIMETER EXC. USED.	\$25.00
WE D 17584 MERCURY RELAY.	\$8.75
AT-48UP 3 CM HORN ANTENNA.	\$9.95
INVERTER 6VDC to 110VAC 60 CY 75W.	\$22.95
IN34 CRYSTAL.	.66¢
1 RPM TIMING MOTOR HAYDON 115 VAC.	\$1.95
8 RPM TIMING MOTOR INGRAM 115 VAC.	\$1.79
.05 MFD 600 VDC bathtub cond. side term.	.30¢
.06 MFD 1000 VDC bathtub cond. side term.	.35¢
.1 MFD 600 VDC bathtub cond. bottom term.	.39¢
3 x .1 MFD 600 VDC bathtub cond. side term.	.39¢
3 x .1 MFD 600 VDC bathtub cond. side term.	.49¢
.25 MFD 400 VDC bathtub cond. side term.	.35¢
.5 MFD 600 VDC bathtub cond. side term.	.49¢
.1 MFD 600 VDC bathtub cond. side term.	.59¢
2 MFD 600 VDC bathtub cond. side term.	\$1.25

## RG 8/U COAX CABLE New Gov't Surplus 100 Ft—\$5.95

BC-221 FREQ. METER uncalibrated.	\$80.00
VERNIER DRUM for BC-221 0-50 180°.	95¢
VERNIER DIAL for BC-221 0-100 360°.	\$1.50
BLANK CALIBRATION BOOK for BC-221.	\$4.95
SET MAIN TUNING COND. specify model.	\$19.95
BC-221 CASE used good condition.	\$1.75
PRECISION POT. 12 ohm 3 watt G.R. #301.	\$1.75
PRECISION POT 12 ohm 4 watt DeJur #292.	\$1.75
PRECISION POT 20 ohm 4 watt DeJur #292.	\$1.75
PRECISION POT 50 ohm 4 watt DeJur #292.	\$1.75
PRECISION POT 500 ohm 4 watt Centralab #48-501.	\$1.75
PRECISION POT 2000 ohm 6 watt DeJur #260.	\$2.50
PRECISION POT 6000 ohm 6 watt DeJur #260.	\$2.50
PRECISION POT 5000 ohm 8 watt Muter #314A.	\$2.50
PRECISION POT 6000 ohm 8 watt Muter #314A.	\$2.50
PRECISION POT 5000 ohm 12 watt DeJur #271-T.	\$3.50
SET SCREWS Allen 4-40 x 1/2".	\$1.75/C
SET SCREWS Allen 4-40 x 3/16".	\$1.75/C
SET SCREWS slotted 8-32 x 3/16".	\$1.35/C
SET SCREWS square head 8-32 x 5/16".	\$1.35/C
LINESMAN'S PLIERS 8" with side cutters.	\$1.69
DUCK BILL PLIERS 5 1/2".	\$1.59
CK-5517/1013 cold cathode tube.	\$2.25
32 MFD 2500 VDC photoflash cond.	\$15.80
30 MFD 2500 VDC photoflash cond.	\$14.75
2X2 TUBES RCA.	2 for \$1.00
6SN7 Tubes Sov. or KenRad.	3 for \$2.20
5 BPI Cathode ray tube.	\$5.50
200 1/2W RESISTORS Ass't. all insulated.	\$2.50
5 lbs. HARDWARE Ass't. nuts, bolts etc.	\$2.00
GEAR ASS'T. 100 gears, bushings etc.	\$6.50
RHEOSTAT 25 W 145 ohm 7/16" shaft.	85¢
RHEOSTAT 25 W 370 ohm 7/16" shaft.	85¢
RHEOSTAT 25W 400 ohm 7/16" shaft.	85¢
RHEOSTAT 50W 8 ohm S.D. shaft.	\$1.09



**FREQUENCY METER 375 to 725 MCS**



Model TS-127/U is a compact, self-contained, battery powered, precision ( $\pm 1$  Mc) frequency meter which provides quick, accurate readings. Requires a standard 1.5V "A" and 45V "C" battery. Has 0-5 Min. time switch. Contains sturdily constructed HI-"Q" resonator with average "Q" of 3000 working directly into detector tube. Uses 957, 186 and 354 Tubes, complete new with inst. book, probe and spare kit of tubes. Less \$47.50

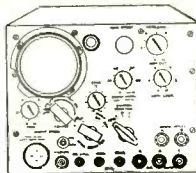

**PANADAPTER and SCOPE AN/APA-10**

A combined Panomatic Adapter and Oscilloscope. Has 3 coax input connectors for feeding in from receivers having I.F. of 455kc., 5.2 mc or 30mc. Designed also to be used as regular oscilloscope for testing other equipment. Has both vertical and horizontal push-pull amplifier inputs, etc. Complete with 21 tubes including 3" CR scope tube. For operation on 115V. 400 Cy. Price...\$99.50 For operation on 115V. 60 Cy. Price...\$145.00 80 page inst. manual of AN/APA-10 available separately for those who wish to study circuits etc. before purchasing...\$2.75

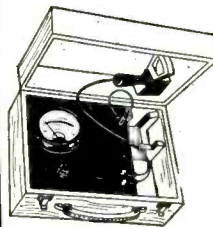

**FLUXMETER**

Used to calibrate field strength of magnets from 500 to 4000 gauss and indicate polarity. Probe has gap of 1/4". Beautifully built in hardwood case with hinged cover. Instructions for operation on under side of cover. Size 12 1/2 x 9 x 6 in. Ideal for lab and school use. New. An exceptional value \$24.50 at.

**MOTOR GENERATORS**

2 KVA O'Keefe and Merritt, 115DC to 120AC, 50 cy., 1 Ph., Export Crater, New. \$149.50  
**MOTOR GENERATOR, TYPE CGU-2** Unit of U. S. Navy TCK-7 Transmitter Motor; 2 H.P. 230V. D.C., 10 amps. Generator: 1800V. D.C., 0.4 A, 500V. D.C., 0.35A, 115V. D.C., 1.5A, 12 V. D.C., 2A, 3480 I.P.M. Self excited. Brand new including spare armature. \$69.50  
**ALLIS-CHALMERS 230DC to 115AC** 60 cy., 1 Ph., 1.25 KVA. \$225.00

**INVERTERS**

Onan M-G-215H. Navy type PU/13. Input 115/230, 60 cy., 1 Ph. Output: 115, 480 cy., 1 Ph., 1.2Kw and 267 W at 4 amps. New. \$295.00  
 Onan M-G-0-75. Navy type PU/11 Input: 115/230, 60 cy., 1 Ph. Output: 115, 480 cy., 1 Ph., 5.3 amps. and 26 VDC @ 3.8 Amps. New. \$225.00  
**Leland Elec. Co. PE206A**. Input: 28DC at 38 Amps. Output: 80V, 800 cy., 1 Ph., 45V. New. \$22.50  
**G.E. J8169172**. Input: 28DC. Output: 115, 400 cy., 1 Ph., 1.5KVA. New. \$32.50  
**G.E. 5AS131551A**. Model 2183. Input: 28DC. Output: 115, 400 cy., 1 Ph., 1.5 KVA. Regulated. New. \$89.50  
**Eloor. 74DC to 110AC**, 60 cy., 1 Ph. at 2.4 Amps. New. \$39.50

**DYNAMOTORS**

Navy type CAJO-211444. Input: 105 to 130VDC. Output: either 26VDC at 20 amps. or 13VDC at 40 amps. Radio filtered and complete with line switch. New. \$89.50  
**TYPE PE94CM**. For SCR-522. Brand new in overcast cases. Has wide band input and output filters. \$19.50

**AMPLIDYNES**

5AM211J7. Input 27 VDC @ 15 A. Output 60 VDC @ 2.5 4600 RPM. New. \$22.50  
 5AM31N9A. Input 27 VDC @ 44 A. Output 60 VDC @ 8.8 A., 7500 RPM. New. \$23.50  
 5AM31N18A. Input 27 VDC @ 44 A. Output 60 VDC @ 8.8 A., 8300 RPM. New. \$12.50

**SMALL D.C. MOTORS**

G.E. 5BA50LJ2A. Armature 27VDC at 8.3 Amps. Field 60VDC at 2.3A RPM 4000. H.P. 0.5. New. \$27.50  
**Oster W-5**. 27.5DC. 1/20HP, 3600RPM Shunt Wound. New. \$9.50  
**Dumont Type ELBG**. 24VDC. 46-1 gear ratio. For type B-4 Intervalometer. New. \$6.75

**400 CY. BLOWERS**

Westinghouse Type FL 115V, 400 cy., 6.700 RPM. Airflow 17CFM. New. \$3.95

**SYNCHROS**

Ford Inst. Co. Synchro Differential Generator. Mod. 3 Type 581DC. 90/90V. 400 cy., Ord. Dr. 173020. New. \$12.50  
 Armor. Synchro Differential Generator. Type 6DG. New. \$29.50  
 Hobart Mfg. Co. Synchro Differential Generator Type XIX 115V, 60 cy. New. \$4.95. 5F, 5C, 5CT also in stock.

**D.C. SELSYN MOTOR**

Step by step type for use with potentiometer in D.C. Selsyn Control Systems. Bendix—Type CAL 14810 (AK1 Mod 0). 70 Volts DC input. \$8.95

**300-1200 MC. XMITTER**

AN/APT-5 Brand New in original cases. \$139.50

**AN-APR-1 RECEIVERS**

Less tuning units. Excellent condition. \$195.00

**METER SPECIALS**

G.E. Type DO-50. 3" Sq. Scale reads 0-3 D.C. Basic Mov. 10 MA. P.S.V.=3. New. Price \$2.45  
 G.E. Type DO-50. 3" Sq. Scale reads 0-3/0-9 V. D.C. Basic Mov. 10 MA. F.S.V.=3. New. Price \$2.45  
 G.E. Type DO-50. 3" Sq. Scale reads 0-80 Amps. D.C. and F.S.V.=.050. New. Price \$2.45  
 G.E. Type DO-50. 3" Sq. Scale reads 0-100 Amps. D.C. and F.S.V.=.050. New. Price \$2.45

**SCR-522 EQUIPMENT**

Complete BC-624C receivers and BC-625AM Transmitters including mounting racks, plugs, connectors, dynamotor. Brand new equipment with instruction manuals.

**RADAR SETS**

**MODEL SQ**. Portable radar set, 10CM. Operates on 90-130 volt, 60 cy., 1 Ph. "A", "B" and "PPI" presentation. Complete with tech manual and full set of operating spare parts.  
**MODEL SG-1**. Consists of complete equipment including Radar Transmitter-Receiver CRP-43AAK-3, Range and Train Indicator CRP-55ADC-3, Control Amplifier CRP-50AAT-1, Motor Dynamometer Amplifier (Amplidyne) CG-21AA and Antenna Assembly CRP-66ABJ-1.  
**MODEL ASG-1** Radar unit consisting of transmitter and converter assembly CRP-43ABC, Antenna assembly CRP-ACZ. Mounting Base CRP-10ARL, etc.  
 Spare Parts available for Model SQ and SG-1 Radar.

**RADAR ANTENNAS**

**Type SO-1** (10CM) assembly with reflector, waveguide nozzle, drive motor, etc.  
**Type SO-3** (3 CM.) Surface Search type with reflector, drive motor, etc., but less plumbing. New in original cases.  
**Type SO-13**, (10CM.) Complete assembly with 24" dish, dipole, drive motor, gearing, etc.

**MISC. RADAR EQUIPMENT**

Modulator Units for SO-1 (CUZ-50AGD) Pulse Trigger units for SD-5 Transmitter-Receiver units SO-13 Spare Parts for SQ Marker-Oscillator crystals in holders 88.35KC Bearing Control Units CRP-23AFK Synchro Amplifiers—Bendix 90° Waveguide Bends 10CM Bronze Signal Monitors CRP-60AAN Repeater Amplifiers CBM-50AFO Oscillator Tube Cavities for SO-1, 13 etc., RF303 10CM Horns, 1 1/2 x 7" waveguide, stand-off contact, flange input, circularly polarized horn output Duplex Tees #223065-17 Auxiliary Rectifier CABM-20237 (SO 2 Radar) SO-1 Antenna R.F. Nozzle Assemblies (RF502) SO-1 Antenna Reflector Assemblies (RF503) SO-1 Antenna Reflector Assemblies (RF503) SO-1 Antenna Waveguide Resonance Chamber Assemblies (RF515) SO-1 R.F. Coupling Waveguide to Transmitter (Z304) SO-1 R.F. System and duplexing cavity (RF301 with V309)

**Radar Repeater Adapters NAVY TYPE CBM-50AFO**

A repeater unit for video signals and trigger pulses designed to work in conjunction with standard Navy radar equipments wherein provision is made for operation of remote P.P.I. sets. This adapter provides on video and trigger pulse lines for operating one or more remote P.P.I. control installations. 115 Volts, 60 cycles A.C. Dimensions are 3 1/2 x 2 1/2 x 1 1/2 in. New \$97.50

**G. E. BATTERY CHARGER**

**Charges 54 Cell Battery at from 1 to 10 ampere rate** Input 115V., 60 cy. 1 Phase. The model 6RC89F16 Copper Oxide battery charger consists of a transformer, a secondary reactor, a copper oxide rectifier, a fan, a ventilating fan, control circuits and auxiliary equipment necessary for proper operations. Transformer tapped for various supply voltage. Eight secondary taps for adjusting charging rate. Built into metal cabinet. Metered. Complete with spare fan and fuses. New in original packing cases. Shipping weight approx. 305 lbs. Price...\$149.50

**REPAIR PARTS FOR BC-348**

(Models H, K, L, R) Also BC 324 Models F, K. Coils for ant., r.f., det., osc., I.F., c.w. osc. xtal filters, 4 gang cond., front panels, dial assemblies, vol. controls, etc. Write for complete list and free diagram.

**9 CONDUCTOR CABLE**

Army spec. CG-215 Weatherproof 9 Cond. 20 AWG stranded tinned copper, plastic ins., color coded, double vinyl jackets with tinned copper braid between. Dia. 9/16" made by G.E. Available 1000, 1500, 2000 ft. reels. Price \$1.15 per Sample 100 ft. Coil. \$15.00

**G. E. SERVO AMPLIFIERS**

Used in B20 planes for Central Station Fire Control Systems B2, B3 and B4. Used to drive Amplidyne 5AM31N9A and Control Motor 5BA50LJ2A listed in 1st column. New less tubes. \$29.50

**PARABOLOIDS**

17 1/2" diameter, spun magnesium dishes, 4 inches deep. Reinforced perimter. Two sets of mounting brackets on rear. Opening at apex for waveguide dipole assembly 1 1/2 x 1 1/2". Per Pair \$12.50

**TUBE SPECIALS**

1N21B	\$1.95	3BP1	\$3.25
1B24	6.95	3CP1	1.25
2J62	23.50	6BD7	2.95
2A31	4.50	8J1	9.50
3B22	1.95	8C6	4.95

**SAWTOOTH POT**

Continuous winding 2 rotating and two take off brushes varies voltage to linear sawtooth wave. W.E. No. KS 15128. New. \$3.95

**HIGH VOLT OIL CAPS**

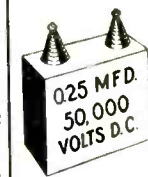

MFD.	Volts	Price
.001 50 KV	\$22.50	
.025 50 KV	34.50	
2 x .025 50 KV	34.50	
.135 7.5 KV	6.95	
.2 50 KV	67.50	
.25 15 KV	15.50	
.2 20 KV	19.50	
.25 50 KV	67.50	
1. 15 KV	49.95	
2. 5 KV	13.75	
2. 6 KV	14.50	

**SPECIAL! 1.0 MFD. 7500 VDC Oil filled capacitor. Cat. No. 26F681. \$9.75 Only.**

**MICA CAPACITORS**

High voltage Transmitting types, thousands in stock. Wide selection of sizes, types & ratings. All new and made by top manufacturers. Write for complete listings.

**SWEEP GEN CAPACITOR COAXIAL TYPE**

High speed ball bearings. Split stator silver plated coaxial type 5/10 minif. Brand new...SPECIAL \$1.95

**SYNCHRO CAPACITORS**

6-.6-6 mfd Mark 12, Mod. 2, type 1C \$1.75  
 10-10-10 mfd Mark 1, Mod. 2, type 3C \$6.65

**HIGH POT TRANSFORMER**

Westinghouse. Pri: 115, 60 cy. Sec: 15-000V C.T., @ .060A. C.T. ungrounded. Excellent for high-potting tests. Size OA 12 1/2 x 8 1/2 x 9 1/2. Weight 67 lbs. Fully enclosed steel case. Price...\$29.50

**PULSE TRANSFORMERS**

KS-9563 Supplies 3500V peak from 807 tube \$3.95  
**High Reactance Trans. G. E. Type Y-3502A**—60 cy. Voltage 120-135, Ind. H.V. winding 135 in. Output Peak 22.8KV. Cat. #318066G1. \$39.50

**60 CYCLE TRANSFORMERS**

G. E. Step-Down. 6KVA. Pri: 230/460, Sec: 115/125, 60 cy. Size: 20" x 11" x 9 1/2". Weight 225 lbs. Navy grey finish, integral junction box and mounting brackets \$125.00  
**Plate Trans. Raytheon U-5815**. Pri: 440/220, 60 cy. 3 phase. Sec: each phase 1310V @ 0.67A test 0000V. \$110.00  
**Plate Trans. Pri: 115V., 60 cy., 1 Ph., 2.5A, 1470V. C.T. @ 1.2A, tested at 5500V. IMSL Raytheon. Size 12 1/2 x 10 x 10 in. Shipping wt: 150 lbs. New. Price...\$27.50**

**400 CYCLE TRANSFORMERS**

Auto. KVA. 945S—520P Volts 460/345/230/115 New. G.E. Cat. #80G184. Weight 22 lbs. \$4.50  
 Fil. In: 0/75/80/85/105/115/125. Out: 5V3A/5V3A/5V3A/5V6A/6.3V0.5A No. 7249010. \$1.95  
**Plate. KS9560 800 cy. Pri: 115V. Sec: 1350-0-1350 at .057A Eleestat shld. \$2.95**  
**Plate & Fil. KS9555. Pri: 115V. Sec: 930-0-930 and three 6.3V windings. \$3.95**  
**Fil. KS9553. Pri: 115V. Sec: 8.2V1.25A /6.35V1.5A Eleestat Shld. Wt. 0.5 lbs. \$2.95**  
**Plate & Fil. Pri: 0/80/115V. Sec: 1=1200 V DC @ 1.5MA. Sec: 2=2-400V DC @ 130MA. Fil Secs: 6.4V4.3A, 6.35V. 8A (Ins. 1500V) 5V2A/5V2A. \$4.95**  
**Plate. Thordarson T46889 500 cy. Pri: 105/120. Sec: 2800-0-2800. 7KV Imp. 1.5KVA. \$29.50**  
**Misc. types: G.E. #68G665X, #68G665X, #68G667, #68G668X, #80G200, #80G199 each \$2.00**

**RECTORS**

KS9589 Retard. 411Y @ 100MA. \$1.00  
 #2C2270/R2 For Kever Unit BC409. \$3.75  
**Multi-Choke 3 by @ 275A 70 ohms, 17 by @ .125A 200 ohms, 17 by @ .125A 200 ohms 7 1/2 x 6 1/2 x 3 1/2. \$6.95**

**30-100,000 CYCLE MODULATION TRANSF.**

For RCA, Type 250-K Broadcast Transmitter (M1-7242) P to P Primary Imp. 15,000 ohms. Secondary Load 5,930 ohms. Size 1 1/4 x 3/8 x 1 1/8". Wt. 143 lbs. New \$49.50

**ALTITUDE INDICATOR**

Type ID-14A/APN-1. Brand New in original cartons. Special...\$2.95

**FREQUENCY STANDARD**

Complete self contained, dual 100/1000 kc crystal, multi-brator and harmonic amplifier. Calibrates with WWV and provides 1000, 100, and 10 kc check points from 100 to 45,000 kc. 115V, 60 cycles. New with instructions. \$2395



**TERMS: Rated Concerns Net 30, FOB Bronxville, New York. All Merchandise Guaranteed. Prices Subject to Change.**



**HERSHEL RADIO CO.**

# LOWEST PRICES ON ALL ELECTRONIC NEEDS

### MODULATION and DRIVER TRANSFORMERS



Both Units Only  
Modulation trans. 815 class AB2-56 Watt Driver, 6SN7 to Modulator, **\$4.95**

### SQUIRREL CAGE BLOWERS

R.E.L. V.D.C. 12 or 24-40 Watt Max. **\$4.95**



TYPE FL 115V—100 Cycle 6700 R.P.M. Westinghouse Electric. **\$3.95**

### BK 22K RELAY



Only **\$3.95**

Used with SCR-269F. Change Over. Contains 28 Volt Step Relay, 5 Deck, 6 Position Switch. 12V D.P.S.T.

Model S-1

## BOMBSIGHT

Made By SPERRY MFG.

**\$4950**

LIMITED SUPPLY!

Contains over 100 Precision Bearings, Ground Optic Lenses, Gears, Motors.

BRAND NEW!

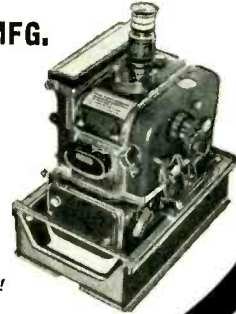

IGNITION COILS  
PRI. 150v. Condenser. Discharge SEC. 15,000 Volt. **\$1.29**

### I.F. TRANSFORMERS YOUR CHOICE!

**95¢**

30 MC Silver Slugged  
T-104-35-110 MC  
10 MC 1st. I.F. FM  
10 MC 2nd. I.F. FM  
T109 5 MC DISC.  
50KC & 150KC I.F. Coils  
60 MC I.F. Trans Fixed

### BUTTERFLY CONDENSERS



Type A Freq. Range 76 to 300 MC. Can be used with 955 Tube.

YOUR CHOICE **\$4.95**

Type B Freq. Range 300 to 1000 MC. Can be used with 368 AS Tube.

### DIRECTIONAL GYRO

For A-5 Automatic Pilot

Only **\$24.50**

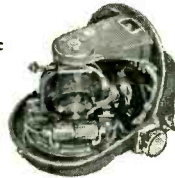

M-1 Directional Gyro. Made by Sperry Mfg. Brand New!

### ARTIFICIAL HORIZON GYRO

MADE BY G-E

**\$24.50**

Sealed in Original Factory Metal Container.

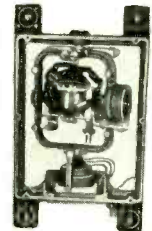

### VACUUM SWITCH

Magnetic Type **\$1.95**

15000 V Contacts 30 Amp Operates with DC Coil Spdt DONUT ANTENNA **\$9.95**

CTZ 66-AFJ 144 MC TO 156 MC

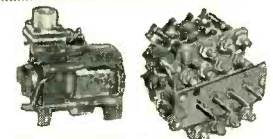

GUN CAMERA MOTOR **\$2.75**  
7500 RPM Will Run Series or Shunt 28 V.D.C. Coils 2 MC to Size 2 1/2" x 1 1/2" x 2"

Permeability TUNER **\$4.95**  
From BC-72R Contains: RF-1st Det. and OSC. Coils 2 MC to 5 MC If. Freq 456 KC

### PHONOGRAPH CRYSTAL Ceramic Type



Made by Sonotone Mfg. 1.4 Volt output. Sapphire Needle. 50 to 14,000 cycle Freq. Response Hi Fi. Special

Only **\$2.35**

### OIL CONDENSERS

MFD.	VDC.	Price
1	5000	\$4.95
1	3000	3.95
5	2500	1.95
1	6000	6.95
2	6000	9.95

### FIL TRANSFORMER



110 volt 60 cy. 4 volt at 16 AMPS. 2.5 v. at 1.75 amps. **\$1.95**

POTTER and BRUMFIELD OVERLOAD RELAYS



1—5000 Ohms Coil Current 10ma. 2—110V. 60 Cy. AC Coil S.P.D.T. **\$1.95**

### RCA OUTPUT TRANSFORMER



ONLY **\$1.95**

P.P. 6L6's 25 Watt  
PRI 5000 Ohms Output. Sec. = 1 500 Ohms Sec. = 2 600 Ohms sidetone 15 to 15,000 cy. Fla: Hi Fi special.

### FIL TRANSFORMER



**\$4.95**  
5 Volt 10 Amps RMS Test 35 Kv 60 Cy 115 V.A.C. Uses 872A Tube

### GO-9 XMITTER

FREQ 3-18 MC & 300 to 600 KC  
Only **\$125**

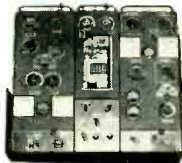

Band Switching 100 Watt Output Brand New. Operates 110 Volt-800 Cycle. Less Tubes.

### WILLARD BATTERY



**\$2.65**  
2 Volt Wet 20 AH

### FULL WAVE METER RECTIFIER



For use with 0-1 MA Meter **95¢**

C. R. T. TUBES	Microphone MC
3AP1	253A 49¢
3BP1	Transformer C410 with PL54 Plug.
5BP1	Low to High Impedance 69¢
9LP7	

### TRANSMITTING & RECEIVING TUBES

814	\$2.69	931A	\$3.95
VT127A	\$3.95	3C24	.89
15E	\$1.50	872A	\$2.69
304TL	\$6.50	8020	\$1.19

### MAIL COUPON TODAY

Gentlemen;  
Please send me your FREE Bulletin listing many other ELECTRONIC SPECIALS.  
Name .....  
Address .....  
City ..... State .....

# HERSHEL RADIO CO.

5245 GRAND RIVER  
Detroit 8, Michigan  
Phone TYler 8-9400

TERMS: Cash with order or 25% DOWN—BALANCE C.O.D. NET 10 DAYS RATED ACCOUNTS ALL PRICES NET F.O.B. DETROIT Merchandise Subject to Prior Sale



COMPLETE LINE OF RECEIVING TUBES

GUARANTEED BRAND NEW

TUBE SPECIALS!!

STANDARD BRANDS ONLY

WRITE FOR OUR NEW BULLETIN

Table listing various vacuum tubes with columns for Type No., Price, and descriptions. Includes sections for 'X' BAND ACCESSORIES, SYNCHROS, PULSE TRANSFORMERS, and CRYSTAL DIODES.

2 φ LOW INERTIA SERVO MOTORS
Diabi FPE-25-11—75V 60 cy., 1.1 Amp 4 Watts. \$34.50
KOLLSMAN—45 Volt 60 cycle 4 watts 1500 RPM—new \$22.50

Table listing OIL FILLED CONDENSERS with columns for MFD, VDC, Price, and VDC. Includes a section for OILMITES.

UTAH
G.E.—K2464; K2468; K2469; K2744B; 68G627; 68G828; 68G928G1; 80G13; 80G152
WESTINGHOUSE—132AW2; 139DW2F; 166AW2F; 176AW2F; 187AW2F.

REVERSIBLE GEAR HEAD MOTORS
G.E. 5BA10AJ65—27.5 VDC .66A 2.35 RPM 8 oz-ft Torque \$27.50
G.E. 5BA10FJ18—24 VDC .51A 9.5 RPM 10 oz-in Torque \$22.50

TACHOMETER GENERATOR
Elinco type PM-1M, DC Tachometer Generator—New \$27.50
MERCURY RELAY
SPDT 5 Amp mercury wetted, glass sealed contacts; Oper. coil-36 VDC, 4500 ohms, pulls in at 8 MA.

COAXIAL CONNECTORS

Table listing COAXIAL CONNECTORS with columns for Type, Price, and other specifications.

Full line of JAN Approved coaxial connectors in stock UHF-N-BN-BCN-pulse—Prices on request.

COAXIAL CABLE

Table listing COAXIAL CABLE with columns for Type, Price Per M Ft., and other specifications.

ELECTRONIC RESEARCH LABORATORIES
715-19 ARCH ST. PHILA. 6, PA.
Telephones - MARKET 7-6771 - 2-3



# COMMUNICATIONS EQUIPMENT CO.

## MICROWAVE COMPONENTS



### "S Band," RG48/U Waveguide

**POWER SPLITTER** for use with type 726 or any 10 CM Shepherd Klystron. Energy is fed from Klystron antenna through dual pick-up system to 2 type "N" connectors. \$22.50 EACH

**DIRECTIONAL COUPLER.** Broadband type "N" Coupling, 20 db. with std flanges, Navy #CABV47AAN-2 (as shown) \$37.50

- LHTR. LIGHTHOUSE ASSEMBLY.** Parts of RT39 APG 5 & APG 15, Receiver and Trans. Cavities w/assoc. Tr. Cavity and Type N CPLC. To Receiver. Uses 2C40, 2C43, 1B27. Tunable APX 2400-2700 MCS. Silver Plated. \$32.50
- BEACON LIGHTHOUSE cavity p/o UPN-2 Beacon** 10 cm. Mfg. Bernard Rice, each. \$32.50
- MAGNETRON TO WAVEGUIDE Coupler with 721-A Duplexer Cavity, gold plated.** \$45.00
- 721A TR BOX** complete with tube and tuning plungers. \$12.50
- MENALLY KLYSTRON CAVITIES** for 707B or 2K28 \$4.00
- WAVEGUIDE TO 7/8" RIGID COAX "DOORKNOR"** ADAPTER CHOKE FLANGE SILVER PLATED BROAD BAND \$32.50
- AS14A AP-10 CM Pick up Dipole with "N" Connectors** \$4.50
- 0AJ ECHO BOX, 10 CM TUNABLE.** \$22.50
- HORN MODEL-TO-TYPE "N" Male Adapters, W. E. #D167284.** \$2.75
- I.F. AMP. STRIP, 30 MC, 30 d.b. gain, 4 MC Bandwidth, uses GAC's with video detector, A.P.C. less tubes** \$24.00
- POLYDRO ANTENNA, A831/APN-7 in Lucite Ball.** Type "N" Feed. \$22.50
- ANTENNA, AT49A/APR: Broadband Conical, 300-3300 MC Type "N" Feed.** \$12.50
- "E" PLANE BENDS, 90 deg. less flanges.** \$7.50

### X Band— RG 52/U WAVEGUIDE

- HORN FEED, Mounted at end of 1' run.** Designed to be used with dish reflector. \$15.00
- VSWR Measuring Section.** Consisting of 6" straight section, with 2 pick-up, Type "N" Output Jacks. Mounted 1/2 Wave apart. \$8.50
- 1" x 1/2" WAVEGUIDE** in 5' lengths, UG 39 flanges to UG40 cover. \$17.50
- Rotating-joints** supplied either with or without flush mounting. With UG40 flanges. each. \$12.50
- Bulkhead Feed-thru Assembly.** \$15.00
- Pressure Gauge Section** 15 lb. gauge and press nipple. \$10.00
- Pressure Gauge, 15 lbs.** \$2.50
- Directional Coupler, UG-40/U Take off 20db.** \$12.50
- TR-ATR Duplexer section** for above. \$8.50
- Waveguide Section 12" long** choke to cover 45 deg twist & 2 1/4" radius, 90 deg bend. \$4.50
- Waveguide Section 3 ft. long** silver plated with choke flange. \$4.50
- Rotary Joint** choke to choke with deck mounting. \$17.50
- 90 degree elbows, "E" plane 2 1/4" radius.** \$12.50
- Microwave Receiver, 3 CM. Sensitivity: 10-13u Watts.** Complete with L.O. and AFC Mixer and Waveguide Input Circuits, 6 I.F. Stages give approximately 120 DB gain at a bandwidth of 1.7 MC. Video Bandwidth: 2 MC. Uses latest type AFC circuit. Complete with all tubes, including 723A/B Local Oscillator. \$175.00
- ADAPTER, waveguide to type "N", UG 81/U, p/o TS 12, TS-13, etc.** \$14.50
- ADAPTER, UG-163/U round cover to special bfl. Flange for TS-45, etc.** \$2.50 ea.

### 1 1/4" x 5/8" WAVEGUIDE

- VSWR SECTION, 6"L, with 2-type "N" pickups** mounted 1/2 wave apart. \$7.50
- GG 98B/APQ 13 1/2" Flex Section, 1 1/4" x 5/8" O.D.** \$10.00
- X Band Wave GD 1 1/4" x 5/8" O.D.** 1/16" wall minimum. per ft. \$7.50
- Sluc Tuner Attenuator W.E. guide, gold plated.** \$6.50
- Bi-Directional Coupler, Type "N" Takeoff 25 db.** coupling. \$27.95
- Bi-Directional Coupler, UG-82. Takeoff 25 db.** coupling. \$24.95
- Waveguide-to-Type "N" Adapter, Broadband.** \$22.50

### 1/2" X 1/4" W.G.—1.25 CM.

- APS-34 Rotating joint.** \$49.50
- Right Angle Bend E or H Plane, specify combination of couplings desired.** \$12.00
- 45° Bend E or H Plane, choke to cover.** \$12.00
- Mitered Elbow, cover to cover.** \$1.00
- TR-ATR-Section, Choke to cover.** \$4.00
- Flexible Section 1" Choke to choke.** \$5.00
- "S" Curve Choke to cover.** \$4.50
- Adapter, round to square cover.** \$5.00
- Feedback to Parabola Horn with pressurized window.** \$27.50
- 90° Twist** \$10.00

### JAN WAVEGUIDE FLANGES

- UG 39/U ..... \$1.10      UG 51/U ..... \$1.65  
 UG 40/U ..... \$1.25      UG 52/U ..... \$3.40  
 UG 40A/U ..... \$1.65      UG 52A/U ..... \$3.40

### —IN STOCK—

AIA	APS-4	APT-4	SJ-1
APA-9	APS-6	MKIV	TJ
APA-10	ASD	MKX	TBK
APN-3	ASH	RC145	TBL
APN-7	BG	RC148	SCR520*
APN-9*	DAS†	SO-1	SCR521
APS-2	DBS†	SO-8	SCR518
APS-3	APT-2	SG-1	

\* COMPONENTS. † LORAN EQUIPMENT

### —TEST SETS—

TS-10	TS-12	TS-159
TS-36	TS-36	TS-968
TS-47	TS-34	TS-270

## MAGNETRONS

Type	Freq. Range (MC)	Peak Power Out (KW)	Duty Ratio	Price
2J21A	3345-9405	50		58.75
2J22	3267-3333	265		7.50
2J27	2965-2992	275	.002	19.95
2J31	2820-2860	285	.002	24.50
2J32	2780-2820	285	.002	28.50
2J38*	3249-3263	5		16.50
2J39*	3267-3333	8.7		24.50
2J48	9310-9320	50	.001	24.50
2J49	9000-9160	50	.001	59.50
2J56*	9215-9275	50	.001	132.50
2J61†	3000-3100	35	.002	34.50
2J62†	2914-3010	35	.002	34.50
3J31	24-27KMC	50	.001	85.00
4J34	2740-2780	900		125.00
5J23	1044-1056	475		49.00
700B	690-700	40	.002	29.50
700D	710-720	40	.002	39.75
706EY	3038-3069	200	.001	32.50
706CY	2976-3007	200	.001	32.50
725-A	9345-9405	50	.001	24.50
730-A	9345-9405	50	.001	24.50
4J38	3550-3600	750	.001	169.45

\* Packaged with magnet. † Tunable over indicated range.

### KLYSTRONS

723A	\$12.50	2K25/723A/B	\$27.50
723A/B	19.50	417-A (Sperry)	17.50

## 70 WATT MAGNETRONS

These tubes provide a simple, rugged, inexpensive source of C.W. energy. An inexpensive power supply is all that's required.

### CHARACTERISTICS:

Heater: 6.3 v. 3.8 A.	Power out: 70 W CW
Anode V: 1250 V.	Anode current: 125 ma.
Pk. Input: 200 Watts	Av. input: 100 W

Each tube is packaged with an integral magnet, and is tunable over the range shown below:

TYPE RANGE (MC.)	TYPE RANGE (MC.)
QK 60 ..... 2840-3093	QK 61 ..... 2975-3170
QK 62 ..... 3135-3330	

Price \$85 ea.

## 400 CYCLE TRANSFORMERS

(All Primaries 115V, 400 Cycles)

Stock	Ratings	Price
352-7102	6.3V/2.5A	1.45
M-7472426	1450V/1.0MA, 2.5V/.75A, 6.4V/3.9A, 5V/.5V/3A, P/O 1D-39/APG-13	4.95
352-7039	640VCT @ 380MA, 6.3V/.9A, 6.3V6A 5V/6A	5.49
702724	9800/8600 @ 32MA	8.95
KS9584	5000V/290MA, 5V/10A	22.50
KS9607	734VCT/177A, 1710VCT/177A	6.79
352-7273	700VCT/350MA, 6.3V0.9A, 6.3V2.5A 6.3V/.08A, 5V/CA	6.95
352-7070	2x2.5V/2.5A (2KV TEST) 6.3V/2.25A, 1200/100/750V. @ .005A	7.45
352-7196	1140/1.25MA, 2.5V/1.75A, 2.5V/1.75A —5KV Test	3.95
352-7176	320VCT/50MA, 6.4V/3A, 6.3VCT/20A, 2x6.3VCT/6A	4.75
RA6400-1	2.5/1.75A, 6.3V/2A —5KV Test	2.39
901692	13V 9A	2.49
901699-501	2.77V @ 4.25A	3.45
901698-501	900V75MA, 100V/.04A	4.29
Ux8855C	900VCT/.067A, 5V/3A	3.79
RA6405-1	800VCT/65MA, 5VCT/3A	3.69
T-48852	700VCT/806MA5V/3A, 6V/1.75A	4.25
352-7098	2500V/6MA, 300, VCT, 135MA	5.95
KS 9336	1100V/50MA TAPPED 625V 2.5V/5A	3.95
M-7474319	6.3V/2.7A, 6.3V/2.6A 6.3VCT/21A	4.25
KS9884	27V/4.3A, 6.3/2.9A, 1.25V/.02A	2.95
52C080	650VCT/50MA, 6.3VCT/2A, 5VCT/2A	3.85
32332	400VCT/35MA, 6.4V/2.5A, 6.4V/1.5A	3.85
68G631	1150-0-1150V	2.75
80G198	6VCT/.0006A KVA	1.75
302433A	6.3V/9.1A, 6.3VCT/6.5A, 2.5V/3.5A, 2.5/3.5A	4.85
KS 9445	592VCT/118MA, 6.3V/8.1A, 5V/2A	5.29
KS 9685	6.4/7.5A, 6.4V/3.8A, 6.4/2.5A	4.79
70G30G1	600VCT/367MA	2.65
M-7474318	2100V/.027A	4.95
352-7069	2-2.5V Wdgs. at 2.5A, Each Lo-Cap., 22Kv Test	5.95
352-7096	2.5V1.79A, 5V/3A, 6.5V/6A, 6.5V/1.2A, D/O BC800	4.95

## THERMISTORS

- D-164699 **Bead Type DCR: 1525-2550 Ohms @ 75 Deg. F. Coefficient: 2% Per Deg. Fahr. Max. Current 25 MA A.C./D.C.** \$2.50
- D-167332 **Bead Type, DCR is 1525-2550 Ohms. Rated 25 MA at .825-1.175 VDC.** 1.35
- D-167613 **Disk Type DCR: 355 Ohms @ 75 Deg. F. P. M. 2.5% 1 Watt** 1.35
- D-166228 **Disk Type 7120 Ohms @ 60° F. 2220 Ohms @ 80° F. 2590 Ohms @ 100° F. 1640 Ohms @ 120° F.** 1.35

## 10 CM R.F. HEAD

Complete R.F. Head and Modulator delivers 50 KW Peak R.F. at 3000 MC. Pulsar delivers 12KV pulse at 12 Amp. to magnetron of .5. 1. or 2 microsec. duration at duty cycle of 001. Unit requires 115V, 400-2400 Cycles, 1 Phase @ 3.5A. Also 24-28 VDC @ 2A. External sync. Pulse of 120V Reg'd. Brand New. Complete with schematic and all tubes...\$375.00

## PULSE NETWORKS

- 15A—1,400-50: 15 KV, "A" CKT, 1 microsec. 400 PPS. 50 ohms imp. \$37.50
- G.E. #3E (3-84-810) (8-2-24-405) 501P/T: 3KV "E" CKT Dual Unit: Unit 1, 3 sections, 0.84 Microsec. 810 PPS, 50 ohms imp.; Unit 2, 8 Sections, 2.24 microsec. 405 PPS 50 ohms imp. \$6.50
- 7-5E3-1-200-67P. 7.5 KV, "E" Circuit, 1 microsec. 200 PPS 67 ohms impedance 3 sections. \$7.50
- 7-5E4-16-60-67P. 7.5 KV, "E" Circuit, 4 sections 16 microsec. 60 PPS, 67 ohms impedance. \$15.00
- 7-5E3-3-200-67P. 7.5 KV, "E" Circuit, 3 microsec. 200 PPS, ohms imp. 3 sections. \$12.50
- KS8865 **CHARGING CHOKE:** 115-150 H @ .02A. 32-40H @ .08A. 30,700V Corona Test, 21KV Test \$37.50
- G.E. 25E5-1-350-50 P/T. "E" CKT, 1 Microsec. Pulse @ 350 PPS, 50 OHMS Impedance. \$69.50
- KS9623 **CHARGING CHOKE:** 16H @ 75 MA, 380 Ohms DCR, 900V Vac Test. \$14.95
- G.E. 6E3-5-2000 50 P/T. 6 KV, "E" Circuit 0.5 usec/2000 PPS 50 ohms/2 sections. \$7.50
- SPRAGUE H-615 "E" Circuit 10KV, 0.85 microsec. pulse at 750 PPS 50 ohms. \$27.50
- SPRAGUE H-616 "E" Circuit, 10KV 2.2 microsec. pulse at 3.755 PPS—50 ohms. \$27.50

## PULSE EQUIPMENT

MIT. MOD. 3 HARD TUBE PULSER: Output Pulse Power 144 KW (12 KV at 12 Amp). Duty Ratio: .001 max. Pulse duration: 5, 1.0, 2.0 microsec. Input voltage: 115 v. 400 to 2400 cps. Uses: 1-711B, 4-89-B, 3-728, 1-713. New. Less Cover—\$136

TPS-3 **PULSE MODULATOR.** Pk. power 50 amp. 24 KW (1200 KV pk): pulse rate 200 PPS, 1.5 microsec. pulse line impedance 50 ohms. Circuit series charging version of DC Resonance type. Uses two 705-A's as rectifiers, 115 v. 400 cycle input. New with all tubes. \$49.50

## PULSE TRANSFORMERS

RAYTHEON WX 4298E: Primary 4KV, 1.0 USEC. SEC: 16KV-16 AMP. DUTY RATIO: .001 400 CYCLE FIL. TRANS. "BUILT-IN" \$42.50

W E C O: KS 9948: Primary 700 ohms; Sec: 50 ohms. Plate Voltage: 18 KV. Part of APQ-13. \$12.50



GE #K-2449A  
 Primary: 9.33 KV, 50 ohms Imp.  
 Secondary: 25 KV, 450 ohms  
 Pulse length: 1.0/5 usec @ 635/120 PPS, Pk Power Out: 1.740 KW  
 Bifilar: 1.5 amps (as shown). \$62.50

GE #K-2748-A, 0.5 usec @ 2000 PPS, Pk. Pwr. out is 32 KW impedance 40-100 ohm output. Pri. volts 2.3 KV Pk. Sec. volts 11.5 KV Pk. Bifilar ratio: 1:3 Amp. Fitted with magnetron well.

K-2745, Primary: 3.1/2.8 KV, 50 ohms Z. Secondary: 14/12.6 KV 1025 ohms Z. Pulse Length: 0.25/1.0 usec @ 600/800 PPS. Pk. Power 200/150 KW. Bifilar: 1.3 Amp. Has "built-in" magnetron well.

K-2461-A, Primary: 3.1/2.6 KV—50 ohms (line). Secondary 14/11.5 KV—1000 ohms Z. Pulse Length: 1 usec @ 600 PPS, Pk. Power Out: 200/150 KW. Bifilar: 1.3 Amp. Fitted with magnetron well. \$39.75

UTAH X-151T-1: Dual Transformer, 2 Wdgs. per section 1:1 Ratio per sec 13 MH inductance 30 ohms DCR \$7.50

UTAH X-150T-1: Two sections, 3 Wdgs. per section. 1:1:1 Ratio, 3 MH, 6 ohms DCR per Wdg. \$7.50

68G711: Ratio: 4:1 Pri: 200V. Sec. 53V, 1.0 usec Pulse @ 2000 PPS, 0.016 KVA. \$4.50

TR1049 Ratio: 2:1 Pri. 220 MH, 50 Ohms sec. 0.75 H. DCR 100 Ohms. \$6.75

K-904695-501: Ratio 1:1. Pri. Imp. 40 Ohms. Sec. Imp. 40 Ohms. Passes pulse 0.6 usec with 0.05 usec rise. \$8.95

Ray UX 7896—Pulse Output Pri. 5v sec 41v. \$7.50

Ray UX 6442—Pulse Inversion 40v + 40v. \$7.50

PHILCO 72560, 352-725, 352-728

RAYTHEON: UX8693, UX9866. \$5. ea.

W.E.: D-166310, D-166638, KS9800, KS9948. \$3.75

UTAH #2622, with Cracked Beads, but will operate at full rated capacity. \$5.00

UX 8693 (SCS #229627-54): 3 Wdgs. 32 turns #18 wire. DCR is: 362/372/4 ohms. Total voltage 2500 vdc. \$5.00

## MODEL MCG BATTLE AMPLIFIER

Entire unit consists of 2, 250 watt amplifiers mounted in a 7 ft. rack, together with tube check device, alarm signal generator, and distribution panel. Both amplifiers feature variable volume compression. Output stage consists of P-P parallel 809's. Used, but in excellent condition, complete with all tubes; operates

MAIL ORDERS PROMPTLY FILLED. ALL PRICES F.O.B. NEW YORK CITY. 25% DEPOSIT WITH ORDER. BALANCE C.O.D. RATED CONCERNS SEND P. O.

131 Liberty St., New York 7, N. Y. Dept E-4 Chas. Royen Phone: DIgby 9-4124



**POWER TRANSFORMERS**

CT-479	7000V/018A (2 X Ind. V. Test) 2.5V	17,800 V. Test	\$37.50
CT-138	520-0-520V/500 MA, 6.3V/3A, 6.3V/17A, 2 X 5V/3A		14.75
Comb. Transformers 115V/50-60 cps Input			
CT-013	450-0-450V @ 200 MA, 10V/1.5A, 2.5V 5A 5V/3A		6.95
CT-341	1050 10MA, 625V @ 5MA, 26V @ 4.5A 2x2.5V/3A, 6.3V @ 3A		9.95
CT-071	110V .200A 33/200, 5V/10, 2.5/10		4.95
CT-403	350VCT .026 A 5V/3A		2.75
CT-331	585VCT .086 A 5V/3A, 6.3V/6A		4.25
CT-456	390VCT 80 MA 6.3V/1.3A, 5V/3A		3.45
CT-442	525VCT 75 MA 5V/2A, 1 CT/2A, 50V/200 MA		3.85
CT-43A	600-0-600V .08A, 2.5VCT/6A, 6.3VCT/1A		6.49
CT-7-501	650CT 200MA, 6.3V/8A, 6.3V/5A		6.49
CT-444	230-0-230V .085A, 5V/3A, 6V/2.5A		3.49
Filament Transformers 115V50-60 cps Input			
Item	Rating	Each	
FT-140	5VCT @ 10A 25KV Test	\$22.50	
FT-157	4V/16A, 2.5V/2.75A	2.95	
FT-101	6V/25A	7.79	
FT-324	6.25V/21A, 2x7.75V/6.5A	14.95	
FT-824	2x26V/2.5A, 16V/1A, 7.2V/7A, 6.4V/10A 6.4V/2A	8.95	
FT-463	6.3VCT/1A, 5VCT/3A, 5VCT/3A	5.49	
FT-55-2	7.2V/21.5A, 6.5V/6.85A, 5V/6A, 5V/3A	8.95	
FT-38A	6.3/2.5A, 2x2.5V/7A	2.79	
FT 650	2.5V/10A-3KV TEST LO-CAP	7.50	
Plate Transformers, 115V 60CY Input			
PT 175	550-0-550VAC (400VDC) @ 150MA \$6.30		
PT 157	660-0-660 VAC (500VDC) or 550-0-550 VAC (400VDC) at 250 MADC	8.70	
PT 158	1080-0-1080V (1000VDC) at 125MA Plus 500-0-500 VAC (400VDC) at 150MADC Simult. Ratings.	10.80	
PT 159	900-0-900 VAC (750VDC) or 800-0-800 VAC (600VDC) at 225 MADC	10.35	
PT 167	1400-0-1400 VAC (300MADC) or 1175-0-1175 VAC (1000VDC) at 300MADC	25.50	
PT 168	2100-0-2100 VAC (1750VDC) or 1800-0-1800 VAC (1500VDC) at 300 MADC	33.00	
PT 062	2900-0-2900 VAC (2500VDC) or 2385-0-2385 VAC (2000VDC) at 300MA	48.00	

**GE M-7470689 Input: 115 V, 60 Cycle, Single Phase 1 WDG 3700V Tapped at 710V 1 WDG 1700V Primary Rated .0377KVA Lo-Cap Donut Construction \$24.75**



**FILTER CHOKES**

Stack	Description	Price
CH-187	Swing, 4-16H, 150MA, 210 ohms, 3KV Test	\$3.90
CH-189	Swing, 4-16H, 250MA, 125 ohms, 3KV Test	6.60
CH-190	Swing, 3-14H, 300MA, 80 ohms, 3KV Test	6.90
CH-CEC117	9-60H/.05-400MA, 10KV Test	14.95
CH-366	20H/.3A	6.95
CH-322	.35H/350MA-10 Ohms DCR	2.75
CH-141	Dual 7H 75 MA, 11H/60 MA 5KV DC Test	4.69
CH-119	8.5H/125 MA	2.79
CH-69-1	Dual 120H/17 MA	2.35
CH-8-35	2/5H 380 MA 25 Ohms	1.79
CH-776	1.28H 130 MA/75 ohms	2.25
CH-344	1.5H/145MA 120V Test	1.75
CH-43A	10H V 15MA 850 ohms DCR	6.95
CH-366	20H/300MA	1.95
CH-999	15HY 15MA 400 ohms DCR	1.95
CH-445	0.5 HV/200 MA, 32.2 OHMS, 3000 V.T.	1.39
CH-170	2x0.5H/380 MA, 25 OHMS	2.79
CH-533	13.5H, 1.0 AMP DC, 13.5KV INS	29.95

**DYNAMOTORS**

TYPE	INPUT VOLTS	AMPS	OUTPUT VOLTS	AMPS	Price
DM 416	14	6.2	330	170	\$6.75
DM 33A	28	7	540	250	3.95
BD AR 93	28	3.25	375	150	7.50
23350	27	1.75	285	075	3.95
B-19 Pack	12	9.4	275	110	8.95
DA-3A*	28	10	500	050	
			300	260	6.95
			150	010	
			14.5	5	
PE 73 CM	28	19	1000	350	22.50
BD 69J	14	2.8	220	08	12.95
D-402†	13.5	12.2	300	200	
			8	8VAC	12.50
SP 175	18	3.2	450	06	4.49
DM 25†	12	2.3	250	0	6.95

† Less Filter  
 † Used, Excellent  
 PE 94-C, Brand New

**INVERTERS**

PE-218H: Input: 25/28 vdc, 92 amp, Output: 115V, 350/500 cy 1500 Volt-amperes. NEW \$37.50  
 PE-286: Input: 28 vdc, 36 amps, Output: 80 v 800 cy, 500 volt-amps. Dim: 13" x 5 1/2" x 10 1/2"  
 New \$22.50  
 NAVY COR-211095: Input 22-30 VDC/75-60A. OUTPUT: 115V/400 CV. 1 KVA @ 8.7A. RPM: 4800 with coupling provision for motor. Brand New Original packing. \$150.00

Send M.O. or Check. Shipping Chgs. C.O.D.

**COMMUNICATIONS EQUIPMENT CO.**  
 131 Liberty St. Dept. E-4 New York City 7, N.Y.

**RELAYS**



**MINIATURE RELAYS**

COOK 482, 24VDC; DPDT; 500 ohm	±R918	1.50
G.E. CR2791G110F2 24VDC; DPDT; 300 ohm; ±R919		1.50
CLARE A20545; 8VDC; 1B; 45 ohm; ±R920		1.25
AUTOMATIC 754A; 12VDC; DPDT 6 Amp; 200 ohm; ±R921		1.50
AUTOMATIC 754; 6VDC; DPDT 6 Amp; 50 ohm; ±R922		1.50
POTTER BRUMFIELD KR11D; 6VDC; DPDT; 75 ohm; ±R923		1.95
ALLIED SK; 8.5 ma; 4500 ohm; DPDT; ±R1015		2.50
ALLIED FID; 8 ma; 1A; 3000 ohm; ±R916		1.50
RBM 23024; 6 ma; 4PST n.o. (4A's); 6500 ohm; ±R802		2.95
LEACH P3; 3 ma; SPDT; 1280 ohm; ±R941		1.25
SIGMA 41F; 12VDC; SPDT; 340 ohm; ±R925		1.95
SIGMA 1F8000S; 1 ma; SPDT; 8000 ohm; ±R1287		5.95
SIGMA 41F87; 2 ma; SPDT; 10000 ohm; ±R914		2.25
SIGMA 1F8000S; 2.5 ma; SPDT; 8000 ohm; ±R1002		2.75
D163221 AMER. TOTALIZER, 24 VDC, DPDT 300 ohms, Anti-Capacity Arms. ±R134		1.75
CLARE 24VDC; 4PDT; 300 ohms; ±R524		2.90
ADVANCE K1604; 12 1/2 ma; DPDT; 6500 ohm; ±R532		2.00
ADVANCE K1504; 220VAC; DPDT; ±R531		2.00
ADVANCE K1604; 3VDC; 14.5 ohm; DPDT; ±R795		2.00
POTTER BRUMFIELD KR11A; 24VAC; DPDT; ±R812		1.95
PRICE 1050; 7 ma; 2800 ohm; DPDT; ±R1016		2.25
PRICE 1050; 5 ma; 6500 ohm; DPDT; ±R1017		2.50
MINIATURE SK; 24VDC; DPDT; 425 ohm; ±R795		1.50
MINIATURE SK; 24VDC; 3 PDT; 425 ohm; ±R796		2.50
MINIATURE SK 24VDC; 4PDT; 425 ohms; ±R525		2.95
23012-0 RBM, 24VDC, SPDT, 250 ohms. ±R172		1.25
7251 ARC, 24VDC, SPDT, 300 ohm ±R406		1.25
7252 ARC, 24 VDC, DPST, n.o. (2A's) 300 ohm, Anti-Capacity Arms, Ceramic Insulation, ±R354		1.25
A21577 CLARE, 24VDC, DPST n.o. (2As) 250 ohms, ±R352		1.25
P3 LEACH (Pair on Bakelite Strip) Each relay; VDC, SPDT, 1 ohm ±R353 pr 2.50		
ZH77628-1 AUTOMATIC, 12VDC, Make One, Break Two (1B, 1C) 640 ohms Dual Telephone Type Contacts ±R244... 1.50		
73A23 ALLIED, 24VDC, Make 3, Break 1, (2As, 1C) 300 ohms. ±R403... ea. 1.50		
TB 302 PRICE, 24VDC, Make 3, Break 1, (2 As, 1C) 200 ohms, ±R404... ea. 1.50		
RIO COOK, 12-24VDC, 3PST n.o. (3As), One contact 10A, 250 ohm, ±R427... 1.75		



**ARC 3 & ARC 5 RELAYS**



55251 (K403, K405) Telechron; 24VDC; SPST; n.o. (1A); 300 ohm; ±R174		1.25
55340 (K203) Price; 24VDC; SPST n.o., (1A); 300 ohm; ±R170		1.25
55342 (K206, K213) Telechron; 24VDC; (2A's); (1C); 300 ohm; Anti-Capacity Arms; Low Loss Bakelite Insulation; ±R171		1.50
55476 (K101) Clare; 12-24VDC; Co-Axial Antenna Relay; SPDT (1C); 275 ohms; ±R421		8.95
55526 (K109, K116) Cook; 24VDC; (1A, 1C); 300 ohm; Ceramic Insulation; ±R107		1.75
55528 (K107) G. E.; 12VDC; 6PST n.o., (6A's); 150 ohm; ±R426		2.00
55531 (K106) Cook; 12-24VDC; (2A's, 2C's); 150 ohm; ±R405		1.95
55585 (K103) G. E.; 12-24VDC; Sealed Plug-In Relay; SPDT (1C); 2500 ohm; ±R419		4.25
55836 (K406) G. E.; 24VDC; SPDT; 250 ohm; ±R402		1.50
55837 (K401, K402) RBM; Same as ±R108G; ±R108R		1.50
55837 (K401, K402) Allied; Same as ±R108G; ±R108		1.75
23012-0 RBM; 24VDC; SPDT; 250 ohms; ±R172		1.50
6395 ARC; 12-24VDC; SPST n.o. (1A), 10 Amp Contacts; 200 ohm; ±R213		2.00
7251 ARC; 24VDC; SPDT; (1C); 300 ohm; ±R406		1.50
7252 ARC; 24VDC; DPST n.o. (2A); 300 ohm; ±R354		1.50
7735 ARC; 24VDC; Antenna Relay; SPDT (1C); 200 ohm; ±R799		3.50

**FEDERAL & WESTERN ELECTRIC TYPE E SENSITIVE RELAYS**



Number	Coil Rating	Contact Arrangement	Stock No.	Price	10 for
UE2CG	400	2A, 1B, 1D	R 756	1.75	15.00
UE2EB	250	1A, 1C	R 757	1.25	11.25
UR2JL	1500	3A, 1C, 1D	R 758	2.25	20.00
UR2YD	650	2A, 1B, 1C	R 759	1.75	15.00
UR2YC	800/400	1C, 2A, 1B	R 760	1.75	15.00
UH1AL	100/400	2D, 1A, 1B	R 761	2.25	20.00
UR243	2000	3A	R 762	1.75	15.00
UR2TR	200	1C	R 763	1.25	11.25
UIPS	100	1C	R 764	1.25	11.25
UR2TL	800	3C, 1A	R 765	2.25	20.00
UE2KN	1200	2A, 1B	R 766	1.75	15.00
UR2HM	150/150	2A	R 767	1.25	11.25
UR2S	1.8	2A	R 768	1.25	11.25
UR2SH	1500	1C, 2D, 2A, 1B	R 769	3.00	25.00
UE2HR	100	1A	R 770	1.25	11.25
UR2XK	1500	1C, 1D, 3A, 1B	R 771	3.00	25.00
UR2GC	1500	3B, 1C, 2A	R 772	3.00	25.00
UR2DG	1500	2C, 3A, 1B	R 773	3.00	25.00
UT2AZ	700	1C	R 774	1.75	15.00
UT2B4	700	2A	R 775	1.75	15.00
UR2HX	1500	2C, 2A, 1D	R 776	3.00	25.00
UE2B	700	2B	R 777	1.75	15.00
UR2YE	1500	4A, 1B, 1C, 1D	R 778	3.00	25.00
UE2KX	1000	2A, 1B, 1C	R 779	2.25	20.00
7040MT	100	1C	R 780	1.25	11.25
UR4LK	1000/1000	3A, 2C, 1D	R 781	3.00	25.00
UR2KX	400	1C, 3A	R 782	2.25	20.00
UR1JP	1000	2C, 2D, 1A	R 783	2.75	22.50
UR2RE	1000	6A	R 784	1.25	11.25
UR4E	200	1C, 1A	R 785	3.00	25.00
D166042	1000	1C	R 787	1.50	12.50
UH4AK	500/500	2A	R 788	1.50	12.50
UR2XH	1500	2C, 2D, 2A	R 789	2.75	22.50
UE2A	800	1C, 2A	R 790	1.50	12.50
UR2A	1800	2A	R 791	1.50	12.50
UR2TG	1500	2B, 2D, 1A	R 792	2.75	22.50
UR2XC	100	2A	R 793	1.50	12.50
7040HA	500	2A	R 794	1.50	12.50

A—Normally Open; B—Normally Closed; C—Double Throw; D—Make Before Break.

TERMS:—All prices F.O.B. Our Plant. Rated Firms Net 10 Days; All Others Remittance with Order.  
 Merchandise returnable within 10 days for full credit.

324 CANAL ST., N.Y.C., 13, N.Y. Walker 5-9642  
**Universal general corp.**

Orders Under \$10 Remittance With Order. Plus Approximate shipping charges (coverage will be returned).



**WANTED**

ARC-1, 3, ART-13, BC-342, 348, AP510, 15, TS-13, 35, 146, 147, 148, 174, 175, 263 ETC. All SCR, BC, AN, TS. ALL TUBES.

**RADALAB**

87-17 124th STREET  
Richmond Hill 18, New York  
Phone Virginia 9-8181-2-3

Prices FOB NYC. Rated firms open account. Prices subject to change without notice

CABLE: Radalab, NY  
TELETYPE: NY-4-4361

**MOBILE RADIO  
SCR-508**

10 Channel FM Receiver and Transmitter. Frequency Range 20-27.9mc. Receiver is manually tuned, transmitter is crystal controlled. Consists of 2 BC-603 Receivers, BC-604 Transmitter, FT-237 mount, Box 80 xtals BC-606 Control, A-62 Phantom Ant., Headsets, mike, and antenna. Input 12v DC. SCR-608 also avail. . . . .POR

**SCR-291A**

1.5-30mc automatic direction finder. This equipment used to take bearings on transmitters within its freq. range. Complete equipments available comprising the following: BC-1147A Rec., PN 31, Power Panel, BC-1159, automatic bearing goniometer, RC-223 antennae system consisting of 5 masts with legs, MC-412, MC-413 phase inverters calibrating transmitter, cables, 115v 60 cyc gasoline generator. Complete equipment overhauled and guaranteed. . . . .POR

**VE REMOTE PPI INDICATOR**

This is a remote PPI indicator "7 in." screen for use with any Radar for remote viewing. Contains all indicating circuits and is driven by the main Radar. Input 115v 60 cyc. POR

**AN/APN-3 SHORAN EQUIPMENT**

This equipment is used for navigation, surveying, and automatic blind bombing. Operates in conjunction with AN/CPN-2 ground-beacons. Operating frequency of this equipment is 290mc. The accuracy is plus or minus 10 feet up to its range of 300 miles. We can supply bombing computers, if desired we can supply APN-3 spares. AN-CPN-2 ground-beacons also available. . . . .POR

**SCR-536 HANDI TALKIE**

Freq. range 3.7-5.5mc crystal controlled battery operated handtalkie. The range of this equipment is approximately 2 miles. We can supply these sets to your specified freq. within its range. Completely reconditioned and guaranteed. Large quantity available. . . . .POR

**AN-GSQ/1A SPEECH SCRAMBLER**

This is a very compact unit designed to be attached to either a radio or telephone circuit to scramble speech or code. This equipment utilizes coded cards in each terminal equipment. Unless the properly numbered card is inserted on the receiving end the speech can not be unscrambled. This provides an excellent privacy system. Complete equipment available consisting of: scrambler, code card set, cables, etc. This equipment can be used with any field or airborne communications equipment. . . . .POR

**AN/TP-1**

10cm mobile light weight radar set used to direct anti-aircraft searchlight and to search for aircraft. Technical characteristics as follows: range 35 miles, presentation 7" PPI, 5" A scope plus 2 tracking scopes. This set gives direct indication of target height directly in feet. Complete anti jamming facilities included. These sets can be very easily modified to increase the range. These sets are built on a very very small 4 wheel trailer. Complete installations available with or without spare parts. . . . .POR

**SCR-522**

Airborne Transceiver, Freq. 100-156 Mc. This unit is crystal controlled 4 channel. Power output approx. 10 watts. Consists of: BC-624 Receiver, BC-625 Transmitter, FT-244 mount, BC-602 control box, PE-94 dynamotor, antenna, plugs . . . . .\$137.50

**AN/TPQ-2 K-BAND GROUND RADAR**

Very late model set. Used to plot trajectory of artillery and mortar shells and to enable counter battery fire with extreme accuracy. This Radar is so accurate and sensitive it will pick up movements of personnel on the battlefield. It can also be used to measure height of cloud cover for weather forecasting. Mfg: WESTERN ELECTRIC. Write

**AN/APR-4**

38-4000 mc precision receiver consists of receiver and five tuning units to cover the full range. Each tuning unit is calibrated directly in mc. Input 115v 60 cyc. . . . .POR

**RF-3A/AP X-BAND FREQUENCY  
SWEPT MANUALLY TUNED  
ECHO BOX**

Frequency range 8500-9600mc. This equipment consists of an echo box with a motor mounted on one end which provides a frequency swept response from the echo box enabling it to be easily observed on the Radar indicator. Input 28v DC 5 amps. Can be supplied in 110v 60 cyc AC. . . . .POR

**AN/ART-13 AUTO-TUNE AIRCRAFT  
TRANSMITTER**

This equipment covers the frequency range of 2-18mc. and is automatically tuned 10 channel. Power output is 75 watts CW. 60 watts phone. This equipment consists of T-47 or T47A transmitter, dynamotor power supply, control box, racks, antennae loading unit, etc. . . . .POR

**AN/PPN-1 REBECCA GROUND  
BEACON**

This equipment operates on 215 mc and is used in conjunction with AN/APN-2 or SCR-729. Provides a signal enabling the aircraft carrying the APN-2 to home on it. This equipment is completely portable and operates from a 12 volt battery. Complete installations avail. . . . .POR

AN/APN-2 and SCR-729 equip. avail.  
BC-348R CAA and Military approved model. . . . .POR  
AN/APT-5 300-1200 mc transmitter 30 watts output. . . . .\$169.50  
AN/APR-5 1000-3100 mc receiver  
BC-639 100-156 mc. . . . .POR  
AN/APS-10 3cm airborne Radar. . . . .POR

**BC 610 TUNING UNITS**

TU 49 New . . . . .9.75  
TU 53 New . . . . .9.75

**SPECIAL PURPOSE TUBES**

1B24 . . . . . 6.75	3DP1 . . . . . 2.50	RX-21 . . . . . 7.50	328A . . . . . 4.00	709A . . . . . 1.75	832A . . . . . 7.50
1B27 . . . . . 11.00	3E29 . . . . . 9.00	RK-23 . . . . . 2.00	329A . . . . . 7.50	715A . . . . . 3.00	833A . . . . . 28.50
1B32 . . . . . 1.25	3EP1 . . . . . 4.00	RK-62 . . . . . 2.00	348A . . . . . 7.50	715B . . . . . 4.00	836 . . . . . 2.50
1B42 . . . . . 7.25	3GP1 . . . . . 2.50	RK-72 . . . . . 1.00	349A . . . . . 7.50	715C . . . . . 16.50	837 . . . . . 1.00
2AP1 . . . . . 5.50	4B27 . . . . . 7.50	RK-73 . . . . . 1.00	350A . . . . . 4.00	719A . . . . . 15.00	838 . . . . . 2.75
2C33 . . . . . 2.25	4C27 . . . . . 10.00	F-128A . . . . . 75.00	352A . . . . . 15.00	721A . . . . . 1.75	846 . . . . . 125.00
2C39A . . . . . 13.50	4E27 . . . . . 13.75	HK-154 . . . . . 5.00	354A . . . . . 15.00	723A/B . . . . . 12.00	849 . . . . . 20.00
2C40 . . . . . 5.75	4J34 . . . . . 75.00	VT-158 . . . . . 30.00	355A . . . . . 15.00	724A . . . . . 1.50	860 . . . . . 2.00
2C44 . . . . . 1.00	4J35 . . . . . 125.00	FG-190 . . . . . 9.50	F-375A . . . . . 12.50	724B . . . . . 1.75	861 . . . . . 13.50
2D21 . . . . . 1.00	5BP1 . . . . . 3.00	HF-200 . . . . . 13.50	393A . . . . . 6.50	725A . . . . . 4.00	866A . . . . . 1.00
2E22 . . . . . 1.75	5BP4 . . . . . 3.00	C-202 . . . . . 12.50	394A . . . . . 2.00	726A . . . . . 7.50	869B . . . . . 55.00
2J21A . . . . . 6.50	5CP1 . . . . . 3.75	204A . . . . . 25.00	417A . . . . . 7.50	726B . . . . . 35.00	872A . . . . . 2.00
2J26 . . . . . 10.00	5D21 . . . . . 11.00	205B . . . . . 1.00	GL-434A . . . . . 12.00	726C . . . . . 35.00	878 . . . . . 1.25
2J27 . . . . . 9.25	5FP7 . . . . . 1.00	F-207 . . . . . 100.00	446A . . . . . 1.00	728CY-GY . . . . . 13.50	884 . . . . . 1.00
2J31 . . . . . 19.00	5FP14 . . . . . 7.00	217A . . . . . 3.50	446B . . . . . 3.00	802 . . . . . 3.00	885 . . . . . 1.50
2J32 . . . . . 20.00	5JP1 . . . . . 13.00	WL-218 . . . . . 25.00	450TL . . . . . 37.50	803 . . . . . 3.00	892R . . . . . 250.00
2J33 . . . . . 20.00	5JP4 . . . . . 13.00	250R . . . . . 5.00	WL-460 . . . . . 12.00	805 . . . . . 3.00	902-P1 . . . . . 7.50
2J34 . . . . . 18.00	5JP11 . . . . . 35.00	251A . . . . . 100.00	464A . . . . . 7.00	807 . . . . . 1.25	913 . . . . . 10.00
2J36 . . . . . 75.00	5J30 . . . . . 23.50	253A . . . . . 6.00	WL-468 . . . . . 20.00	808 . . . . . 1.50	918 . . . . . 2.00
2J38 . . . . . 8.25	5J32 . . . . . 60.00	267B . . . . . 7.00	527 . . . . . 15.00	809 . . . . . 2.50	923 . . . . . 1.00
2J56 . . . . . 75.00	5R4GY . . . . . 1.00	271A . . . . . 5.75	WL-530 . . . . . 10.00	810 . . . . . 9.75	931A . . . . . 3.75
2J61 . . . . . 28.50	C6A . . . . . 7.50	274B . . . . . 2.00	WL-531 . . . . . 4.75	811 . . . . . 2.50	959 . . . . . 1.50
2K25 . . . . . 19.75	C6L . . . . . 5.50	276A . . . . . 7.50	559 . . . . . 1.00	812 . . . . . 2.50	CK-1006 . . . . . 1.50
3AP1 . . . . . 5.00	6BL6 . . . . . 50.00	282A . . . . . 7.50	631-P1 . . . . . 4.75	813 . . . . . 10.00	1614 . . . . . 1.50
3BP1 . . . . . 3.00	6BM6 . . . . . 60.00	283A . . . . . 3.75	700A-D . . . . . 8.50	814 . . . . . 2.75	1624 . . . . . 1.00
3B22 . . . . . 2.25	6C21 . . . . . 15.00	286A . . . . . 6.50	701A . . . . . 4.00	815 . . . . . 2.75	2050 . . . . . 1.25
3B24 . . . . . 3.75	6G4 . . . . . 4.75	304TH . . . . . 6.75	702A . . . . . 1.50	822 . . . . . 17.50	ZB-3200 . . . . . 125.00
3B24W . . . . . 7.50	6J4 . . . . . 4.75	304TL . . . . . 5.00	702B . . . . . 2.50	826 . . . . . 1.00	8002R . . . . . 85.00
3B25 . . . . . 3.50	7BP7 . . . . . 3.00	307A . . . . . 2.00	705A . . . . . 1.00	828 . . . . . 9.00	8012 . . . . . 1.75
3B26 . . . . . 2.75	9GP7 . . . . . 7.50	310A . . . . . 3.00	706AY-GY . . . . . 25.00	829A . . . . . 6.00	8013 . . . . . 2.00
3B28 . . . . . 4.00	9LP7 . . . . . 3.00	311A . . . . . 5.25	707A . . . . . 5.00	829B . . . . . 9.00	8020 . . . . . 1.00
3C23 . . . . . 6.75	12DP7 . . . . . 12.50	313C . . . . . 3.00	707B . . . . . 8.75	830B . . . . . 2.00	8025 . . . . . 3.00
3C24/24G . . . . . 1.00	12GP7 . . . . . 13.50	323B . . . . . 9.75	708A . . . . . 2.50	832 . . . . . 6.50	PD8365 . . . . . 50.00

**western engineers**

ELK GROVE, CALIFORNIA  
GEORGE WHITING, OWNER

• Prices do not include transportation  
• Usual terms apply

• Unconditional guarantee extended  
• Subject to prior disposition





**TELEVISION CAMERA**

Mfr. R.C.A. Type CRV-ATK or ATJ For training and experimental work in the instruction of TV techniques. Television studios can adapt it for movie pick-up chain, titles, slides and test patterns. SCANNING: vertical 40-60 FPS, horizontal 13,500-15,800 C.P.S. VIDEO AMPLIFIER: Use 1846 conoscope . . . six stage amplifier and clipper. CAMERA DIMENSIONS: 12 1/2" x 10 1/2" x 20". WEIGHT: 49 lbs. Used, good condition. . . \$295.00

adapt it for movie pick-up chain, titles, slides and test patterns. SCANNING: vertical 40-60 FPS, horizontal 13,500-15,800 C.P.S. VIDEO AMPLIFIER: Use 1846 conoscope . . . six stage amplifier and clipper. CAMERA DIMENSIONS: 12 1/2" x 10 1/2" x 20". WEIGHT: 49 lbs. Used, good condition. . . \$295.00

**SINE-COSINE GENERATORS (Resolvers)**

Diehl Type FJE-43-9 (Single Phase Rotor). Two stator windings 90° apart, provides two output sequel to the sine and cosine of the angular rotor displacement. Input voltage 115 volts, 400 cycle. . . \$30.00 ea. Diehl Type FPE-43-1 same as FJE-43-9 except it supplies maximum stator voltage of 220 volts with 115 volts applied to rotor. . . \$25.00 ea.

**VOLTAGE GENERATORS (RATE)**

ALNICO MIDGET D.C. VOLTAGE GENERATOR Type B-35-D . . . \$17.50  
ALNICO MIDGET D.C. VOLTAGE GENERATOR Type B-44-D . . . \$17.50  
A.C. GENERATOR: 67 V., 20 Cyc., 2-Phase, .015 Amps. Type PM-1, 1200 R.P.M. . . \$15.00

**400 CYCLE 3-PHASE GENERATOR**

120 Volts, 11.7 amps and 28 VDC @ 14.3 amps. Mfg. by HOMELITE . . . equipped with dual V-belt pulley . . . \$275.00

**SYNCHRONOUS SELSYNS**

110 volt, 60 cycle, brass cased, approx. 4" dia. x 8" long. Mfg. by Diehl and Bendix. Quantities Available. REPEATERS . . . \$20.00 ea. TRANSMITTERS . . . \$20.00 ea.

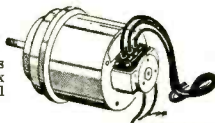

**AUTOSYN MOTOR TYPE 1**

115 VAC; 60 cycle; 1-phase; DIR. #4279 Foot mounted; Mfg. Bendix Aviation Corp. . . \$15.00 ea.

**SYNCHROS**

General Electric MOD. 2J15M1; 115-57.5 Volts 400 Cycle . . . \$22.50 ea.  
AUTOSYN MTR. KOLLSMAN Type #403; 32 VAC; 60 cycle; single phase . . . \$22.50  
AUTOSYN MTR. BENDIX Type #851; 32 VAC; 60 cycle; single phase . . . \$22.50  
MICROSYN UNIT, Type 1C-006-A . . . \$35.00  
IF Special Repeater (115V-400 Cy.) . . . \$15.00 ea.  
21F 3 Generator (115-400 cyc) . . . \$10.00 ea.  
5CT Control Transformer: 90-50 Volt; 60 Cy. . . \$45.00  
5F Motor (115/90 Volt-60 cyc.) . . . \$45.00  
5SDG Differential Generator (90-94 volts - 400 cyc.) . . . \$30.00 ea.  
TRANSMITTER, BENDIX C-78248; 115 Volt, 60 Cycle . . . \$25.00 ea.  
Differential-C-78249; 115 V., 60 Cy . . . \$5.00  
5N MOTOR (115 Volts/60 Cycle) . . . \$22.50  
REPEATER, BENDIX C-78410; 115 Volt, 60 Cycle . . . \$37.50 ea.  
REPEATER, AC synchronous 115 V., 60 cycle, C-78863 . . . \$15.00 ea.  
REPEATER, DIEHL MFG. No. FJE 22-2; 115 Volt; 400 Cy. Secondary 90 V. . . \$27.50  
5G GENERATOR (115/90) 60 cycles . . . \$45.00  
7G Synchro Generator (115/90 volt; 60 cycle) . . . \$75.00  
6G Synchro Generator (115/90 volt; 60 cycle) . . . \$60.00  
6DG Synchro Differential Generator (90/90 volt; 60 cycle) . . . \$50.00  
215F1 Selsyn Control Transformer: 105-55 Volts; 60 Cycle . . . \$22.50  
21D5HAI Selsyn Generator: 115-105 Volts; 60 cycle . . . \$50.00  
21J1F1 GENERATOR: 115-57.5 Volt; 400 cycle. . . \$12.50 ea.  
21J1H1 DIFFERENTIAL GENERATOR: 57.5-57.5 Volt; 400 cycle . . . \$12.50 ea.  
21J1G1 CONTROL TRANSFORMER: 57.5-57.5 Volt; 400 cycle . . . \$7.50 ea.  
21J5H1 SELSYN GENERATOR: Mfg. G. E., 115-105 Volts, 60 Cycle . . . \$27.50

**PANORAMIC ADAPTER Model AN/APA-10**

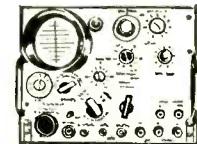

Provides four types of presentation: (a) Panoramic (b) Aural (c) Oscillographic (d) Oscilloscopic. Designed for use with AN/ARR-7, AN/ARR-5, AN/APR-4, SCR-587 or other equipment with I.F. or 455 kc., 5.2 mc or 30 mc. Includes 21 tubes with 3" scope tube. PRICE . . . \$99.50

**INVERTERS**

**10563 LELAND ELECTRIC**

Output: 115 VAC; 400 cycle; 3-phase, 115 VA; 75 PF. INPUT: 28.5 VDC; 12 amp. . . \$59.50

**PIONEER 12117**

OUTPUT: 26 volts; 400 cycles; 6 volt amperes, 1-Phase. INPUT: 24 VDC; 1 amp. . . \$25.00 ea.

**ALTERNATOR, CARTER**

Mfg. Carter Motor Co.; OUTPUT: 7 VAC; 9.7 amp.; 650 cycles, and 295 VDC, 200 amps. INPUT: 26.5 VDC; 10.5 amps; 6500 rpm. . . \$49.50 ea.

**PE 218 LELAND ELECTRIC**

Output: 115 VAC; Single Phase; PF 90; 380/500 cycle; 1500 VA. INPUT: 25-28 VDC; 92 amps; 8000 RPM; Exc. Volts, 27.5 BRAND NEW . . . \$39.95 ea.

**PE 109 LELAND ELECTRIC**

Output: 115 VAC, 400 cyc; single phase; 1.53 amp; 8069 RPM. Input: 13.5 VDC; 29 amp. . . \$65.00

**MG 153 HOLTZER-CABOT**

Input: 24 V. DC, 52 amps; Output: 115 volts — 400 cycles, 3-phase, 750 VA. and 26 Volt — 400 cycle, 250 VA. Voltage and frequency regulated. . . \$95.00 ea.

**PIONEER 12130-3-B**

Output: 125.5 VAC; 1.5 amps, 400 cycle single phase, 141 VA. Input: 20-30 VDC, 18-12 amps. Voltage and frequency regulated . . . \$75.00

**12116-2-A PIONEER**

Output: 115 VAC; 400 cyc; single phase; 45 amp. Input: 24 VDC 5 amp. . . \$65.00

**10285 LELAND ELECTRIC**

Output: 115 Volts AC, 750 V.A., 3 phase, 400 cycle, .90 PF, and 26 volts, 50 amps, single phase, 400 cycle, .40 PF. Input: 27.5 VDC, 60 amps, cont. duty, 6000 RPM. Voltage and Frequency regulated. . . \$95.00

**10486 LELAND ELECTRIC**

Output: 115 VAC; 400 Cycle; 3-phase; 175 VA; .80 PF. Input: 27.5 DC; 12.5 amp; Cont. Duty. . . \$90.00 ea.

**PIONEER 10042-1-A**

DC INPUT 14 Volts; OUTPUT: 115 Volts; 400 Cycle 1-Phase; 50 Watt. . . \$75.00

**94-32270-A LELAND ELECTRIC**

Output: 115 Volts; 190 VA; Single Phase; 400 Cycle; .90 PF, and 26 Volts; 60 VA; 400 Cycle, .40 PF. Input: 27.5 Volts DC 18 amps cont. duty, voltage and freq. regulated . . . \$95.00

**PIONEER 12147-1-B**

OUTPUT: 115 VAC 400 cycle; Single phase. INPUT: 24-50 VDC; 8 amps. . . \$79.50

**MG 149F HOLTZER CABOT**

OUTPUT: 26 VAC @ 250 VA; 115V @ 500VA; Single Phase; 400 cycle. INPUT: 24 VDC @ 36 amps. . . \$69.50

**EICOR CLASS "A" NO. 1-3012/08-7**

OUTPUT: 125 VAC; 400 cycle; single phase; 100 VA. INPUT: 24-30 VDC; 11 amps; Duty Int. Voltage and Frequency Regulator . . . \$99.50

**HAZELTINE PULSE GENERATOR MODEL 1017**

Electrical Characteristics: Pulse Freq: Initiating and sliding pulse-external. Pulse Width: Initiating and sliding pulses, 10 microseconds. Pulse Amplitude: Initiating and sliding pulses, plus 150 volts. Sliding Pulse Delay: variable over full trace length. Sweep Duration: 50, 200, and 1000 microseconds. TUBES: 16-6SJ7; 3-6AG7; 3-6L6; 2-6J5 gt; 2-6SN7 gt; 1-5U4 G; 1-6SK7; 1-6Y6G; 1-9J1; 1-9002. Power Input: 110-125 volts, 60 cyc, single phase, batteries non-a. Dimensions: 13 1/2" x 20 1/2" x 23". Weight: 85 lbs. PRICE . . . \$149.50

**1 MFD, 25,000VDC CAPACITORS Mfg. by Cornell-Dubilier TYPE 25100 . . . \$59.50 ea.**



**ALNICO FIELD MOTORS**

(Approx. size overall . . . 3 1/2" x 1 1/2" diameter)  
DELCO #5069600: 27.5 volts DC; 250 RPM. . . \$15.00  
DELCO #5069230: 27.5 VDC; 145 rpm. . . \$15.00  
PM Motors Delco Type #5069371: 27.5 volts; DC Alnico Field; 10,000 R.P.M.; dimensions 1" x 1" x 2 1/2" long; shaft extension 1/2" diameter 0.125". . . \$15.00

**PIONEER GYRO FLUX GATE AMPLIFIER**  
Type 12076-1-A, complete with tubes. . . \$22.50

**AC CONTROL MOTOR**

A. C. SYNCHRONOUS MOTOR Type RBC 2505; Volts 115; Cycles 60; RPM 2. Mfg. HOLTZER CABOT ELECT. Approx. size: 2 1/2" x 2 1/2" x 3 1/2". . . \$15.00 ea.

**400 CYCLE MOTORS**

EASTERN AIR DEVICES #133 Synchronous Motor 115 Volt; 400 cycle. . . \$17.50  
115 Volt; 2 Phase; 400 cycles \$25.00 ea.  
PIONEER: TYPE CW-2 Phase; 400 cycles. . . \$17.50 ea.  
EASTERN AIR DEVICES TYPE J49A; 115 V, 0.1A; 7000 rpm. Single phase 400 cycle. . . \$17.50 ea.  
AIRESEARCH: 115V; 400 CPS; Single phase 6500 RPM; 1.4 amp; Torque 4.6 in. oz; HP. .03. . . \$10.00 ea.

EASTERN AIR DEVICES TYPE JM6B: 200 VAC; 1 amp; 3 phase; 400 cycles, 600 RPM. . . \$12.50 ea.  
EASTERN AIR DEVICES, TYPE J31B: 115 V, 400 1200 Cycle, Single Phase. . . \$79.50 ea.  
AIRESEARCH: AC Induction, 200 V; 3 Phase, 400 Cycle, 2 H.P.; 11,000 RPM; 8 amps. . . \$25.00 ea.  
AIRESEARCH: AC Induction, 200 V; 3 Phase, 400 Cycle, 12 H.P. 6500 RPM; 1.5 amps. . . \$25.00 ea.  
Electric Motor: PNT-1490-AT, Serial No. 207, 208 V., 400 Cycles, 3 Phase Kearfoot Co., Inc. . . \$17.50 ea.

**SERVO MOTOR 10047-2-A; 2 Phase; 400 Cycle, with 40-1 Reduction Gear \$17.50**

**SMALL DC MOTORS**

GENERAL ELECTRIC #5BA10AJ18 . . . 27 VDC; RPM 110; 1 oz. FT. . . \$12.50  
DELCO #5069625 . . . 27 VDC; 120 RPM; Governor controlled . . . \$22.50  
EMERSON 175: 12 Volt DC; 1/8th HP; 10 amp; 3800 RPM; Approx. size: 2 1/2" x 5". . . \$9.95 ea.  
DELCO #5072000: 27.5 VDC, 11.75 rpm. . . \$15.00  
DELCO #5068750: 27 VDC; 160 RPM; built-in reduction gears . . . \$12.50 ea.  
J. OSTER: series reversible motor 1/50th H.P., 10-000 RPM; 2 1/2" VDC; 2 amps; SPERRY #806059; approx. size 1 1/2" x 3 1/2" . . . \$7.00 ea.  
General Electric Type 5AB10AJ37; 27 volts, DC; 5 amp; 8 oz. inches torque; 250 RPM, shunt wound; 4 leads; reversible . . . \$12.50  
General Electric, Mod. 5BA10FJ33; 12 oz. inches torque 12 DC, 56 RPM, 1.02 amp. . . \$15.00 ea.  
General Electric Type 5BA10AJ52C; 27 volts DC; 5 amp; 8 oz. inches torque; 145 RPM; shunt wound; 4 leads; reversible . . . \$12.50  
GENERAL ELECTRIC DC MOTOR Mod. 5BA10AJ-64, 160 r.p.m.; 65 amp; 12-oz.-in. torque 27V DC. . . \$12.50  
2 1/4 H.P. MOTOR—Mfg. LEEBEE-NEVILLE Co; Type 1454-MO; 24VDC; 4000 RPM; 100 amp. . . \$35.00

**115 VOLT GENERATORS**

Brand new Eclipse generators: 115 VAC; 9.4 amp; 1000 watts; single phase; 800 cycles, 2400-4200 rpm. DC output is 30 volts at 25 amp. Unit has spline drive shaft and is self-excited. . . \$29.95

**MICROPOSITIONER**

Barber Colman AYLZ 2133-1 Polarized D.C. Relay; Double Coil Differential sensitive, Alnico P.M. Polarized field, 24V contact; 5 amps; 28 V. Used for remote positioning, synchronizing, control, etc. \$12.50 ea.

**BLOWER**

Eastern Air Devices, Type J31B; 115 volt; 400-1200 Cycle; single phase; variable frequency; continuous duty; L & R. #2 blower; approx. 22 cu. ft. /min. . . \$15.00



**BLOWER: Mfg. John Oster: Type C2A-1R; 27 VDC; .63 amps; 1/100 H.P.; 7000 RPM; Series Wound . . . \$9.95 ea.**

**BLOWER ASSEMBLY**

115 Volt, 400 Cycle, Westinghouse Type FL, 17CFM, complete with capacitor. New. . . \$12.50 ea.

**TEST EQUIPMENT TS-45/APM**

For measuring relative output power and transmitted freq. of radars and adjusting receivers. Components of the set are a thermistor-type power meter, coaxial line-type freq. meter, a 723A oscillator, attenuator, and a choke coupling. Set is designed for continuous wave operation, with jack provided for external pulsing.

Electrical Characteristics: Freq. Range . . . Airborne X Band. Accuracy: Freq. Meter plus or minus 5 mc.; Power Meter plus or minus 1.5 db. (relative only). Signal input: rf power; minus 10 to plus 37 dbm. Attenuator: Calibrated, adjustable 0-30 db loss. Power: 110-130 volts, 60-2400 cycles, 55 watts. TUBES: 1-723, 1-6V6, 2-6ZY5G, 1-6SL7GT, 1-VR150-30. Batteries: None. Mechanical Characteristics: 10" x 9 1/2" x 8". Weight: 18 lbs. PRICE . . . \$295.00

**Immediate Delivery ALL EQUIPMENT FULLY GUARANTEED All prices net FOB Pasadena, Calif.**

**C and H Sales Company**  
BOX 356-X EAST PASADENA STATION • PASADENA 8, CALIFORNIA







## RADIO-RESEARCH INSTRUMENT CO.

### 10 CM. "S" Band

**F-28/APN-19 BEACON FILTER CAVITY.** 2700-2900mc. Max. 1.5-db loss at ctr. freq. over band, 3db at 15 mc band ends. Meets full JAN spec. Gov't source insp. available. Fully calibrated to above spec. \$32.50. Uncalibrated, guaranteed \$28.50.

**COAXIAL MIXER.** Xtal. detector assy designed for beacon revrs. Trombone tuned input. "N" fittings. 2 types available—feed thru or take off to xtal. \$17.50.

**LIGHTHOUSE CAVITY.** For 2C40 tube. Tuneable 2700-2900mc w/suitable adj. of grid caps. Can be freq. modulated. \$25.00

**STANDARD REFERENCE CAVITY.** 2650-3050mc. Invar tuning center conductor of  $\frac{1}{4}$  wave-length. 50 ohm coax "N" input output conn. Inc./sec. stability. Loaded Q betwn 650 and 3000 w/xmsn loss .5 to 5 db adjustable. Unloaded Q approx 6000. Concentric xmsn type resonator. Tuning mech. lock. \$28.50

**CRYSTAL MOUNT.**  $\frac{3}{8}$ " std. coax. "N" fittings. Holds any IN21 type xtal. Incl. impedance match tuner. \$17.50

**FEEDBACK DIPOLE.**  $\frac{7}{8}$ " coax. for parabola. 11 $\frac{3}{4}$ " o.a. \$14.50

**MIXER BLOCK** w/p.u. loop. "N" fitting. \$8.50

**ECHO BOX.** TS-207/UP. 2700-2900mc. micro adj. \$64.50

### 10 CM. WAVEMETER

2700-3000mc. Hi-Q coaxial transmission type, N fittings, micrometer head, 3mc. absolute accuracy, w/calib. curve. Factory new \$86.50

### Pulse Components

KS-9643 Miniature, perm. core. Z ratio 1:1. \$5.00

145WP AND 132AWP low volt pulse xmsn \$5.50 each

D168983 Network 125 ohm, herm sid. \$3.50

LV PULSE 50-4000kc. 120-2350 ohms, herm core \$6.50

**PULSE CONN.** UG180 type rubber insert, male chassis mt. w/12" cable D166389 \$2.00

UG36 type male cable mt. \$5.00

UG38 type female w/mtg flk. air to oil \$5.50

High Voltage Pulse Transformers. G.E. Types 95G2023, K2748A, K2759

### Antenna Drives

**COMPLETE.** 12rpm clockwise, rotation, 115V 60 cy GE motor, incl sine potentiometer & bearing indicator. \$137.50

**GEAR-MOTOR ASSY.** Gear speed 95.5, gear ratio 9 to 1, motor speed 860 shunt wd. 6 amp, volts, 250A-125F cont duty. \$84.50 each

**MOTOR DRIVE ASSY.** 115-VDC motor 1/20 hp, 1725 rpm. Gear box 172 rpm, 11 in. lbs. torque. cpld to 9 in. step down gear. \$35.00

**SCR 584** J-K sect. High speed Rotary Joint. \$35.00

### Accessories

**PARABOLIC REFLECTOR** 4ft. dia. RCA hi gain dish \$84.50

**VARIA. COND.** 4 gang. 7 to 144 mmf/sect. Ball bearings. \$2.25

**PATCHING CABLE.** Male type "N" ea. end 3ft. \$2.50

**COMPLETE STOCK 400 CY. TRANSFOR.**

**Frequency Shift Comparator**  
AN/URA-8A Frequency Shift Converter Comparator. Compares and selects best of two converter outputs for maximum operation. New with Tubes. Recent production. Includes Mounting Rack. \$135.00 ea.

### 3 CM. "X" Band

**CRYSTAL MOUNT.** Holds any IN23 type xtal. 1" x  $\frac{1}{2}$ " guide std coax output, UG40 flg input. \$15.00

**DIRECTIONAL COUPLER.** Uni dir, 20db, type "N" output, UG39 flg. to UG40chk. JAN type CG-176/AP. \$25.00

**WAVEGUIDE.** Std RC-52/U sharp internal corners. Any lgth up to 12 ft. \$1.25 per ft.

**FLEXIBLE SECTION.** Apx 6". UG39 flgs. \$10.00

**TR-ATR SECTION.** Duplexer assy w/UG-39 to UG40 run, iris cplg, epig to 1B24 type TR tube, ATR cavity 724 type compl. w/tuning slugs. SO-3 Radar component. \$8.50

**ROTARY JOINT.** UG40 choke to choke, w/mounting, plate for easy installation, 360 deg. rotary coupling for lab or high speed scanner. \$12.00

All material guaranteed surplus.

A complete variety of microwave plumbing is available in most bands incl. test accessories and radar system components. **WRITE US YOUR REQUIREMENTS.** We pride ourselves in our ability to serve the microwave industry. A prompt reply is given to all inquiries. Immediate Delivery.

Telephone: Udson 6-4691

550 FIFTH AVE., NEW YORK, N. Y.

## TEST EQUIPMENT

**Spectrum Analyzer.** Model TSN-4SE-8500-9600 MC. calibrated linear below cut-off attenuator, calibrated frequency meter, tuned mixer, 4 IF stages, 3 video stages, overall gain 125 db., regulated power supply.

**Spectrum Analyzer.** same as above but modified for 100 to 1000 MC frequency range

**X Band VSWR Test Set.** TS-12, complete with linear amplifier, direct reading VSWR meter, slotted waveguide with gear driven traveling probe, matched termination and various adaptors, with carrying case.

**R. F. Power Meter**—1 to 600 MC 0-15 and 0-60 Watt scales. May be used as dummy load for 0 to 1000 MC.—100 W maximum. VSWR less than 1.1 from 0 to 600 MC. less than 1.3 from 600 to 1000 MC.

**X Band Pick up Horn.** AT48/UP with coax fitting.

**TS-45/APM-3 Signal Generator** 8700-9500 MC. 110V. 60-800 cps.

**TS-35A/AP X Band Signal Generator.** pulsed, calibrated power meter, frequency meter, calibrated attenuator. 110V 60-800 cps.

**30 MC I.F. Strip.** Video and Audio Amplifier and 115 volt 60-2600 cps Power Supply. Bandwidth 10 MC. new, part of SPR-2 receiver.

**High Pass Filter F-29/SPR-2.** Cuts off at 1000 MC. and below; used for receivers above 1000 MC.

**TS-125 Calibrated S Band Power Meter** with attenuator

**TS-110 S Band Echo Box** 2400 to 2700 MC. Portable.

**S Band Signal Generator Cavity** with cut-off attenuator. 2300 to 2950 MC. 2C10 Tube, with modulator chassis.

**VD-20K Voltage Divider** for measuring high video pulses. 20 KV max. ratio's 1:10 and 1:100, transmission flat within 2db, 150 cps to 5 MC

**Waveguide Below Cut-off Attenuator** L101-A. IHFF connectors at each end. calibration 30-100 db.

**TAA-16 Tuned Linear Audio Amplifier.** 300 to 8000 cps, output meter reads direct in VSWR or Power DB. Regulated power supply, 110V 60 cps.

**FPM 3 X Band Power and Frequency Meter.** frequency meter 8500 to 9600 MC., accuracy  $\pm 4$  MC absolute,  $\pm 0.5$  MC on frequency difference up to 60 MC. Calibrated attenuator 0-20 db, power measuring range 1 to 1000 MW, pulsed or CW without external attenuator, video detector, self-contained battery powered, portable, with coaxial and waveguide adaptors.

**T85/APT 5, 300 to 1600 MC.** 40 watt noise modulated transmitter.

**110-330 MC Oscillator Butterfly.**

**80-300 MC Mixer Butterfly** with socket for 955 (used as diode)

**400-800 MC. Oscillator Butterfly** with 703 tube mounted on it.

**Field Intensity Meter.** RCA 308A, 120 to 18000KC.

**S Band Signal Generator**—2K28 Klystron, self-pulsed or ext. triggered.

**Mark 5, "S" Band Signal Generator**—2.4 to 3.4 KMC 2C40 Oscillator, Motor tuned.

**X Band Receiver.** tuneable, waveguide input 9200-9600 MC.

**QX Checker.** Boonton, Type 110-A.

**Synchroscope**—Sylvania Model 5.

**Synchroscope**—Model P4.

**D.C. Amplifier**—TS 580/U-GR Model 715 AM.

**Hetrodyne Frequency Meter**—GR616C, 100 to 5200 KC.

**Noise Distortion Analyzer**—H.P. Model 325B.

**Sweep Speed Calibrator.** 200 KC. 1 MC. 5 MC.

**Tuning Units** P/O APR-4 TN16 30-80 MC, TN17 80-300 MC., TN18 300-1000 MC., TN19 1000-2200 MC., TN54 2200-4000 MC.

**AN/APR 1 Receiver.** used with above tuning units. 110 V 60 cycle.

**Measurements 75 Standard Signal Generator.** Calibrated output, 124 to 510 MC.

**Rotary Joints.**  $\frac{7}{8}$ " Coaxial, S Band.

**Antenna.** Coaxial, pressurized, S Band. Can be used with parabolic reflector.

**Microvoltage**—Ferris Model 10B + 10C.

**Frequency Standard**—James Knight Co. 1.5 and 10 MC check points.

**F. M. Test Set**—X Band, with wavemeter and wattmeter, 110V 60 cycle AC.

**Recording Ammeter**—Esterline Angus 0-5MA.

**TS-36-8.5 to 9.6 KMC Power Meter** .1—1000 MW.

**TS-33-8.7 to 9.5 KMC Frequency Meter** and Video Detector.

**K Band**—slotted line, gear driven traveling probe.

**K Band**—Attenuator 27 to 34 KMC.

**K Band**—Low Power Dummy Loads. 1 Watt.

**TS-13/AP Consists of Signal Generator "Xa" Band.** Wavemeter + wattmeter.

**TS-155 Test Set for S Band radar**—uses 2C40 oscillator, self-contained, power monitor, self-pulsed 115V 60-800 cycles.

**Impedance Bridge**—Type TBX-1BR 8.5 to 9.6 KMC—CRT Indicator.

**S Band directional couplers**  $3\frac{1}{2}$ " waveguide.

**S Band Coaxial to Waveguide** door knob transition 1  $\frac{1}{2}$ " coaxial to 3  $\frac{1}{2}$ " waveguide.

**S Band Low power waveguide terminations.**

**CN 29 S Band Coaxial Attenuator.** Type N Connectors. 20 db.

**Model P 142 Signal Generator** 1200-4000 mc—with wavemeter and wattmeter.

**High Power U.H.F. Attenuator** 100-Watts 20 db, 30 db or 40 db, 515 OHMS impedance, type N connectors, dissipates 100 watts of power, uses tapped load resistor as above, frequency range 1-700 Megacycles.

**P M 12 Peak reading power meter** 50 KW maximum, 2-700 Mc. can be used for dummy load up to 100 Watts average power.

**TPS-52-PB S Band Attenuator.** variable,  $\frac{7}{8}$ " coaxial with type N adaptors.

## HIGH POWER DUMMY LOADS

**X Band, 1 $\frac{1}{4}$ " x  $\frac{5}{8}$ " guide, choke or plain flange, dissipates 350 watts average power continuously in still air, VSWR less than 1.15 between 7 and 10 KMC, weight  $5\frac{1}{4}$  pounds.**

**X Band,  $\frac{1}{2}$ " x 1" guide, choke flange, dissipates 250 watts average power continuously in still air, VSWR less than 1.15 between 8.2 x 12.4 KMC, weight  $3\frac{1}{4}$  pounds.**

**X Band,  $1\frac{1}{4}$ " x  $\frac{5}{8}$ " guide, plain flange, dissipates 200 watts average power continuously in still air, VSWR less than 1.15 between 7-10 KMC, weight  $3\frac{1}{4}$  pounds.**

**X Band, 1 $\frac{1}{4}$ " x  $\frac{5}{8}$ " guide, plain flange, dissipates 250 watts average power continuously in still air, weight 2 pounds 4 ounces.**

**S Band,  $1\frac{1}{2}$ " x 3" guide dissipates 1,500 watts average power in still air, VSWR less than 1.15 between 2.5 to 3.7 KMC, choke flange, weight 13 pounds.**

**TS 231 X Band Dummy Load** 7-10 KMC Max VSWR 1.1, dissipates 200 Watt average power in still air.

**TS 108 X Band Dummy Load** 9300 MC, Max VSWR 1.15.

**X Band, High power attenuator** 8-12 KMC, 250 watts dissipation Fixed attenuation from 6-50 db.

**L Band Coaxial Dummy Loads, 500 Watts Dissipation**  $1\frac{1}{2}$ " coaxial.

**Coaxial Dummy Load**—DC to 300 MC 1000 Watts in still air, type N Input connector, VSWR less than 1.2.

**TS 235 Coaxial High Power Dummy Load** "L" Band— $1\frac{1}{2}$ " coaxial.

**High Power Dummy Load**—3 inch coaxial.

**TS 338 S Band, dummy load**—2.5 D 3.7 KMC, Maximum VSWR 1.1 dissipates up to 700 watts in still air.

## NIBUR SALES CORPORATION

P. O. Box 811

Red Bank, New Jersey

Telephone: Red Bank 6-5810

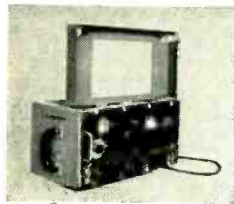
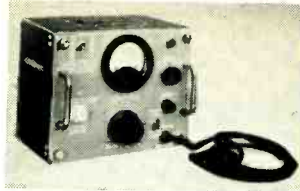
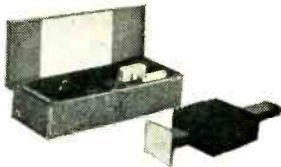

# ATTENTION EXPORT HOUSES

Perhaps you did not realize that Weston Laboratories, Incorporated provides a complete package when it comes to fulfilling your foreign requirements. We provide, in addition to equipment of your choice, complete instructions, a normal complement of accessories and complete export packaging at no additional charge. Little wonder that we have been contacted by so many of you in the past six months. If you require Military type test equipment, let us know your needs for immediate answer.

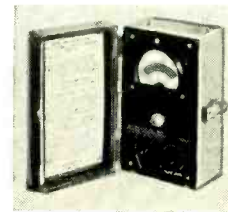

AN-APA-10	BC-595-TU	1-117	1-212	OAW	TS-32A/TRC-1	TS-89/AP*	TS-148/UP*	TS-218/UP	TS-338
AN-APR-1	BC-1060A	1-122	1-222/A	P4	TS-33/AP	TS-90*	TS-153	TS-220/TSM	TS-359A/U
AN-APR-4	BC-1066A	1-126	1-223/A	P4E	TS-34/AP	TS-92/AP	TS-155	TS-226A	TS-363/U
AN-TSM-4	BC-1201A	1-130A	1-225	SG-8/U	TS-35/AP	TS-96/TPS-1	TS-159-TPK	TS-230B	TS-375
AN-UPM-13	BC1203	1-134B	1-245	TAA-16WL	TS-36/AP	TS-98/AP	TS-164/AR	TS-232/TPN-2	TS-377/U
AS-23	BC1236/A	1-135	1E-21A	TS-1ARR	TS-39/TSM	TS-100/AP	TS-170/ARN-5	TS-239B	TS-418
AT-67	BC-1255/A	1-137A	1E-36	TS-3AP/AP	TS-45/APM-3	TS-101/AP	TS-173/UR	TS-250/APN	TS-419
AT-68	BC-1277	1-139A	1F-12/C	TS-8A/U	TS-46/AP	TS-102/AP*	TS-174/U	TS-251	TS-421/U
AT-39	BC-1287A	1-140A	1S-185	TS-10A/APN-1	TS-47/APR	TS-108/AP*	TS-175/U*	TS-257/AWR	TS-433/U
AT-48	1-46B	1-145	1S-189	TS-11/AP*	TS-51/APG-4	TS-110/AP	TS-182/UP	TS-263	TS-465/U
BE-67	1-49	1-147	LAD	TS-12/AP*	TS-55/AP	TS-111/CP	TS-184/AP	TS-268*	TS-480/U
BC-221*	1-56	1-153A	LAE-2	TS-13/AP*	TS-56/AP	TS-117/GP*	TS-189/U	TS-270A	TS-505
BC-376	1-61B	1-157A	LAF	TS-14/AP	TS-59	TS-118/AP	TS-192/CPM-4	TS-281/TRC-7	TS-589/U
BC-438	1-83A	1-167	LM*	TS-15/AP	TS-60/U	TS-125/AP*	TS-194/CPM-4	TS-285/GP	TS-615/U
BC-439	1-86A	1-168	LU-2	TS-16/APN	TS-61/AP	TS-127/U	TS-195/CPM-4	TS-297*	TS-616/U
BC-638	1-95A	1-177	LZ	TS-18	TS-62/AP	TS-131/AP	TS-197/CPM-4	TS-301/U	TS-617/U
BC-639	1-96A	1-178	ME-6/U	TS-19	TS-63/AP	TS-138	TS-198/CPM-4	TS-303/AG	TS-620/U
BC-906D	1-97A	1-186	OA	TS-23/AP	TS-65A/FM2-1	TS-142APG	TS-203/AP	TS-311/FSM-1	TSX-45E
BC-918B	1-98A	1-196A	OAA-2	TS-24/APM-3	TS-66/FM2-1	TS-143/CPM	TS-204/AP	TS-317/FSM-1	TSS-4SE
BC-923A	1-106A	1-198A	OAK	TS-24/APR-2	TS-76-APM-3	TS-144/TRC-6	TS-205AP	TS-324/U	TVN-85E
BC-936A	1-114	1-203A		TS-26/TSN-1*	TS-78/U	TS-146	TS-207	TS-328	TUN-8HU
BC-949/A	1-115	1-208		TS-27/TSM	TS-87 AP	TS-147/AP*	TS-210/MPM	TS-328	TTX-10RH

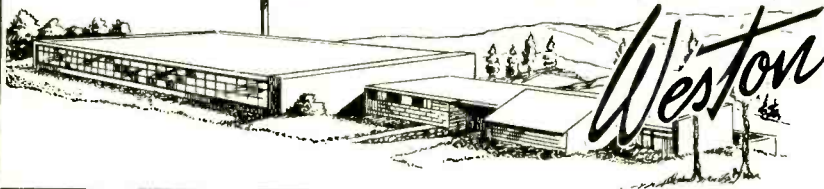

**LABORATORIES, INC.**  
 HARVARD, MASS.  
 Tel: HARVARD 250—AYER 300—TWX HARV 193  
 Cable: WESLAB

LOOK! FABULOUS LOW PRICES — EVEN FOR RADIO SHACK

Industrial, Receiving, Special-Purpose

FREE!

New 1954 electronic parts mail-order catalog! Better than ever!

OC3/VR-105 .79	71A .45
OD3/VR-150 .69	QK-72 .50.00
1A3 .78	RG-72/CRP72 .85
1A5GT .62	FG-90 2.50
1B22 1.11	100TH 7.50
1B24 7.95	VR-105 .79
1B27 9.95	112A .39
1B32/532A 1.75	211/VT4C .79
1N21 .69	227A 3.50
1N22 .95	274B 1.95
1N27 .95	EL-302.5 1.00
1P23 1.95	304TH 9.95
1R4 .39	GL-316A 1.69
1T4 .49	350A 2.95
2A3 .75	371A 1.95
2AP1 7.50	388A 1.95
2B22 1.50	394A 2.50
2C33 2.75	WL-417A 12.50
2C40 9.95	GL-434A 12.50
2E22 1.50	GL-446A 1.50
2J21 4.95	464A 3.95
2J21A 5.95	CK-501X .59
2J22 6.50	532A 1.95
2J27 8.95	GL-605 35.00
2J34 19.95	WL-653B 45.00
2J50 49.50	7P-653 35.00
2J55 65.00	705A 1.50
2X2 .39	706AB 12.50
2X2A 1.10	706AY 16.50
3A4 .59	707A 6.50
3B7/1291 .62	721A 1.50
3C23 8.50	723AB 14.95
3C24 1.95	
3DP1 2.50	
3D6/1299 .39	
3EP1 3.50	
3FP7 1.69	
3GP1 2.50	
3JP12 4.50	
4B22/EL5B 3.50	
4B25/EL6CF 3.50	
EL C5B 3.50	
EL C6A 3.50	
4J36 95.00	
4J37 95.00	
5BP1 4.69	
5D21 11.50	
5FP7 1.65	
5JP2 12.50	

**T  
U  
B  
E**

**PRICES  
DROP  
DROP**

**RADIO SHACK**  
 CORPORATION  
 167 Washington St., Boston 8, Mass.

6AG7 .79	724A 1.25
6AJ5 .95	724B 1.50
6AJ6 .49	725A 5.50
6B6G .55	726A 9.95
6C6 .55	801 .75
6C8G .55	803 3.10
6H6 .49	805 2.50
6K7 .45	807 1.35
6SC7 .75	810 9.95
6SH7GT .59	811 2.10
6SH7 .59	813 8.95
7C4/1203A 39	814 2.25
7E5/1201 .69	815 3.00
7E6 .45	816 1.10
10Y .79	826 .90
12A6 .69	830B 1.95
12C8 .59	832 2.50
12J5GT .40	838 7.95
12SF7 .40	838 2.50
12SJ7GT .40	866A 1.00
14H7 .49	872A 1.95
14J7 .49	884 1.00
15R .55	902P1 4.50
CK-22 .69	954 .29
CK-25 2.10	954 .29
23D4 .45	957 .29
FG-27A 4.90	1616 .75
30SP .39	1619 .49
45SP .35	1624 1.00
53A 1.00	1625 .35
QK-59 50.00	1629 .55
QK-60 50.00	1655/6SC7 .75
QK-61 50.00	1846 50.00
	2051 .79
	8005 4.25
	9001 .95
	9002 .85
	9003 .99
	9004 .39
	9006 .34

APRIL SPECIAL 304TH \$9.95

**LARGE QUANTITIES**  
**24 Volts D.C. RELAYS**  
 Rating 1 Amp. to 250 Amp.

- Leach # 5058-CDW-G17
- Leach # A957-7220-A
- Leach # 1027-BF
- Leach # 1227-B2A
- Leach # 1254-2L
- Leach # 1257
- Leach # 2024-188
- Leach # 7108-D24
- Leach # 7202-D24
- Leach # 7210-24
- Guardian # B9-32139
- Guardian # G38557
- Guardian # 34464
- Guardian # 35901
- Guardian # B8-34056
- Guardian # B2A
- Hart # B4-694-R10
- Hart # B8-694-R15A
- Auto-Lite # B8-WSL-4002
- Auto-Lite # B8-WSL-1001
- Auto-Lite # B1-WSG-1005
- Cutler Hammer # B4-6041H17C
- Cook Electric # 114
- Advance # 1713
- Chapin # RE-800-1-10
- Square D # B2A
- RMB # B2A
- Cook Electric # 114
- M & H # 405437BH

Inquiries invited! Write and tell us of your requirements. Descriptive literature and prices available upon request.

**MARITIME SWITCHBOARD**  
 Instrument & Accessories  
 336 CANAL STREET, NEW YORK 13, N. Y.  
 WOrth 4-8216 (7)



SAVE ON TUBES BRAND NEW TUBES GUARANTEED TUBES

OA2 . . . . . \$ .95	2J31 . . . . . 20.00	3J1P1 . . . . . 12.50	5J1P1 . . . . . 22.50	217C . . . . . 4.95	706AY . . . . . 27.50	809 . . . . . 2.95	2051 . . . . . 1.00
OA3/VR75 . . . . . 1.10	2J32 . . . . . 20.00	3K30 . . . . . 199.50	5J1P2 . . . . . 19.95	221A . . . . . 1.95	706BY . . . . . 27.50	811 . . . . . 2.90	2051 . . . . . 5.50
OA5 . . . . . 3.50	2J33 . . . . . 25.00	4B24 . . . . . 6.95	5J1P4 . . . . . 22.50	250R . . . . . 8.95	706CY . . . . . 27.50	811A . . . . . 3.50	5611 . . . . . 115.00
OB2 . . . . . 1.10	2J34 . . . . . 25.00	4C27/ CV92 . . . . . 10.00	5J1P5 . . . . . 27.50	250TH . . . . . 16.50	706DY . . . . . 27.50	812 . . . . . 2.95	5633 . . . . . 8.95
OB3/VR90 . . . . . 1.00	2J36 . . . . . 89.00	4C35 . . . . . 17.50	5J23 . . . . . 29.50	250TL . . . . . 15.00	706FY . . . . . 27.50	813 . . . . . 9.95	5634 . . . . . 8.95
OC3/VR105 . . . . . .90	2J42 . . . . . 125.00	4E27 . . . . . 14.50	5J26 . . . . . 99.50	FG258A . . . . . 149.50	706GY . . . . . 29.50	828 . . . . . 9.95	5637 . . . . . 4.00
OD3/VR150 . . . . . .85	2J49 . . . . . 85.00	4J22 . . . . . 99.50	5J29 . . . . . 10.00	2748 . . . . . 2.75	707B . . . . . 13.55	829 . . . . . 7.00	5639 . . . . . 8.95
1B22 . . . . . 1.75	2J51 . . . . . write	4J23 . . . . . 99.50	5J30 . . . . . 29.50	300B . . . . . 5.95	708A . . . . . 3.95	829B . . . . . 9.95	5643 . . . . . write
1B23 . . . . . 5.75	2J56 . . . . . 89.50					832A . . . . . 8.50	5646 . . . . . 8.95
1B24 . . . . . 7.00	2J61 . . . . . 29.50					836 . . . . . 3.45	5651 . . . . . 2.50
1B26 . . . . . 2.30	2J62 . . . . . 25.00					837 . . . . . 1.45	5654 . . . . . 1.75
1B27 . . . . . 11.00	2K22 . . . . . 17.50					838 . . . . . 3.98	5656 . . . . . 14.95
1B32/532A . . . . . 2.98	2K23 . . . . . 19.95					849 . . . . . 24.50	5657 . . . . . 200.00
1B35 . . . . . 7.50	2K25 . . . . . 20.00					851 . . . . . 49.50	5670 . . . . . 3.50
1B42 . . . . . 8.25	2K26 . . . . . 55.00					852 . . . . . 17.50	5672 . . . . . 1.29
1B63A . . . . . 42.50	2K28 . . . . . 25.00					860 . . . . . 3.50	5676 . . . . . 1.29
1D21/SN4 . . . . . 4.50	2K33A . . . . . 95.00					861 . . . . . 15.00	CK5678 . . . . . 1.00
1N21B . . . . . 2.50	2K34 . . . . . 139.50					865 . . . . . 4.00	865 . . . . . .98
1N22 . . . . . 1.25	2K41 . . . . . 125.00					866A . . . . . 1.30	5693 . . . . . 4.25
1N23B . . . . . 3.25	2K45 . . . . . 110.00					869B . . . . . 55.00	5694 . . . . . 2.60
1N34A . . . . . .79	2K48 . . . . . 99.50					872A . . . . . 2.75	5702 . . . . . 2.95
1N38 . . . . . 1.50	2X2A . . . . . 1.40					874 . . . . . 1.10	5704 . . . . . 2.50
1N44 . . . . . 1.10							5718 . . . . . 6.00
1N47 . . . . . 4.50							5719 . . . . . 8.95
1N55 . . . . . 2.75							5750 . . . . . 3.10
1N63/K63 . . . . . 2.39							5787 . . . . . 6.00
1N69 . . . . . .59							CK5787 . . . . . 2.25
1P28 . . . . . 7.75							5814 . . . . . 4.50
1P29 . . . . . 2.00							5844 . . . . . 2.95
1P36 . . . . . 2.75							5876 . . . . . 14.95
1P39 . . . . . 1.20							5902 . . . . . 8.95
1Z2 . . . . . 2.75							5905 . . . . . 12.50
VS-9 . . . . . 7.50							5907 . . . . . 9.00
2AP1 . . . . . 7.50							5907 . . . . . 9.00
2AS15 . . . . . 4.25							5916 . . . . . 9.00
2B22 . . . . . 2.25							5916 . . . . . 4.95
2C21/1642 . . . . . .69							5932 . . . . . 4.50
2C36 . . . . . 29.50							5972 . . . . . 2.75
2C39 . . . . . 12.50							6005 . . . . . 2.95
2C39A . . . . . 17.50							6026 . . . . . 8.95
2C40 . . . . . 7.25							6110 . . . . . 9.50
2C42 . . . . . 12.50							6121 . . . . . 9.95
2C43 . . . . . 14.95							6201 . . . . . 4.50
2C44 . . . . . .89							6805 . . . . . 4.95
2C46 . . . . . 17.50							8012 . . . . . 1.95
2C51 . . . . . 3.85							8013 . . . . . 4.95
2C52 . . . . . 3.75							8020 . . . . . 1.25
2D21 . . . . . 1.15							8025 . . . . . 4.75
2D21 W . . . . . 2.49							8025A . . . . . 5.95
2E24 . . . . . 3.30							9001 . . . . . 1.15
2E26 . . . . . 3.25							9002 . . . . . .98
2E31 . . . . . 1.40							9003 . . . . . 1.50
2E35 . . . . . 1.40							9004 . . . . . .69
2J26 . . . . . 12.50							9005 . . . . . 1.50
2J27 . . . . . 12.50							

YOUR SURPLUS WANTED  
We Pay Highest Prices!

**SPECIAL!**  
Vacuum Capacitors  
50 mmfd. 15,000 v. \$7.50  
12 mmfd. 32,000 v. \$10.00  
50 mmfd. 32,000 v. \$12.50  
100 mmfd. 20,000 v. \$14.00

**5" DUAL GUN TUBE SPECIAL!**  
Long persistency face. Valued at \$200.00. This tube has been rejected for military use.  
Fully guaranteed. Only **\$17.95**

All Prices F.O.B. Los Angeles, subject to change without notice. Minimum order \$5.00. Orders for \$5.00 should be prepaid in full.

**Jsh** SALES CO.  
ELECTRONICS  
Dept. EC  
7552 Melrose Ave.  
Los Angeles 46, California

Thousands of other types in stock. Send us your requirements. RECEIVING TUBES? We carry a complete line in stock. Standard brands only!

**B7 COCKPIT LAMP**  
**PULL OUT LIGHT**  
For Aircraft, Boats, Cars and Workshops. Gives White or Red Light. Unit pulls out 6 feet from self-rewind reel. Any Voltage. Mounts Anywhere. Small Bakelite case 3 x 3/4 x 4/4.  
**\$2.25**  
EA

**CAPACITOR SPECIALS**  
Cat. #22F-391 1 MFD. 600 V DC. . . . .75 ea.  
Bathubs ST CP-53 Case  
Cat. #23F-154 1 MFD. 500 V DC. . . . .45 ea.  
Channels Oil Filled  
Cat. #TJU-10010 1 MFD. 1,000 V DC  
Ceramic-Screw Term . . . . .60 ea.

**2J1G1 SELSYNS BRAND NEW**  
**2J1F3 400 CYCLE**  
RELAYS — SWITCHES — SWITCHETTES — BLOWERS — ALL TYPES — IN STOCK  
**NEW YORK ELECTRONICS**  
218 Fulton St., N. Y. 7, N. Y. Rector 2-4137

**K-RK-ARC-UG-PL-AN**  
**CONNECTORS**  
*In Stock for Immediate Delivery*  
**Connector Corporation**  
OF AMERICA  
137 Hamilton St., New Haven 11, Conn. Phone: Spruce 7-2513  
New York Phone: Lexington 2-6254

**WE BUY AND SELL GOVERNMENT SURPLUS**  
electronic components, units, wire, etc.  
Your Inquiries Invited  
**LAPIROW BROS.**  
1649 Hoffer St. Kirby 1285 Cincinnati 23, Ohio

**GLASS TUBING**  
PYREX - NONEX - URANIUM  
BULB & CYLINDERS  
WRITE FOR FREE MONTHLY LIST  
**HOUE SUPPLY COMPANY**  
PHONE KEYPORT 7-1286  
M. R. #1 Box 86X Keyport, N. J.

**NEVER BEFORE AT THIS PRICE**

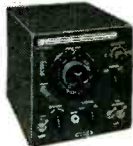

Frequency 125 - 20,000 kc  
Input 12 or 24V DC .6 or .3 Amp and 120-475V 5-20 MA

**LM FREQUENCY METER**

HETRODYNE MODULATED Complete With Calibration Book While They Last **\$49.50 ONLY**

**TG-10 KEYS**



Automatic Code Training Keyer, originally used for class instruction. Includes a push-pull 6L6 amplifier, variable speed synchronous drive motor and rewind. Tube complement 3-6SJ7, 1-6SN7, 1-5Y3. Dimensions: 25"x19"x11" Limited Quantity **\$24.50**



**FREQUENCY STANDARD**

Input: 110v 60cy - AC Intervals: 10kc & 200kc Tube Complement: 1-5U4, 2-6SJ7, 2-6N7, 2-6L6. An accurate crystal controlled, multi-vibrator test set for checking frequencies up to 30mc **BRAND NEW \$29.50**

*Precision Test Equipment*

FROM THE *World's Largest Stock* IMMEDIATE DELIVERY

**SIGNAL GENERATORS**

TS 13-AP	I-72	I-196
TS 35-AP	I-96	I-208
TS 45-AP	I-122	LAF
TS 120-UP	I-130	804C

Measurements No. 78 Ferris No. 18B

**RANGE CALIBRATORS**

TS 5-AP	TS 19-AP	TS 102-AP
---------	----------	-----------

**FREQUENCY METERS**

BC 221	LM	TS 174
--------	----	--------

**POWER METERS**

TS 33	TS 36	TS 125	I 203
-------	-------	--------	-------

**ECHO BOXES**

TS 61	TS 62	TS 110	TS 207
-------	-------	--------	--------

**DELAY LINES**

TS 10 A-B-C	TS 89 AP
-------------	----------

**OSCILLATORS**

TS 170	BC 376	BC 638
--------	--------	--------

Hewlett Packard 200 B D

**OSCILLOSCOPES**

TS 34	Dumont 208-224-241	TS 100
-------	--------------------	--------

**SPECTRUM ANALYZERS**

TS 148	Marconi TF 890.1
--------	------------------

**MISCELLANEOUS**

TS 12-AP	TS 89-AP	IE 21
TS 16-APN	TS 118-AP	IE 36
TS 32-TRC.1	TS 184A-AP	I 56
TS 51-APG	TS 251	I 95
TS 56-AP	TS 268-U	I 100
TS 78-U	IE 19	I 139A AN-UPM.1

**ASSOCIATED INDUSTRIES**  
CABLE ADDRESS *Ami* LOS ANGELES  
**6855 TUJUNGA AVENUE**  
**NORTH HOLLYWOOD, CALIF.**

**REDUCED PRICES**

**TYPE AYLZ 3055S MICROPOSITIONER**

Barber-Colman. Polarized d-c relay. Double coil differential current sensitive. 50 volts max. per coil. Alnico (P.M.) Field. Use for remote control, positioning etc.

**SA-437 \$6.75**

**PIONEER PRECISION AUTOSYN**



Pioneer Type AY-101D Transmitter of Control Transformer for controlled servo circuits. 26 volts 400 cycles single

phase. Weighs 5 oz.

**SA-24 \$14.50**

We also have in stock Type AY201-3B, AY231-3B, AY-131D and AY223.

**DIEHL PM MOTOR**



Type FD6-21 27.5 volts d-c single shaft with speed of 10,000 rpm WE No. KS-15098L01. Ideal for

models, blowers, etc.

**SA-433 \$6.75**

**P.M. MOTOR AND RATE GENERATOR**

Precision motor generator with ball bearings. 115 volts d-c on the motor. We have various models with the following generator outputs: .6 volts/M, 3 volts/M, 9 volts/M, 4.5 volts/M. Please specify which generator output you desire. Motor speeds approximately 7500 rpm.

**SA-427 \$24.50**

**1500 VA INVERTER**

GE — 5AS131-NJ3 (PE-118) Input 26 VDC at 100 amps. Output 115 v. 400 cy. 1 φ at 1500 VA. PF 0.8 W.E. Spec. Ks-5601L1.



**SA-286 \$14.50**

*Servo-Tek*

**PRODUCTS CO.**

INCORPORATED

1086 Goffle Rd. Hawthorne, N. J.

Hawthorne 7-3100

**REVERSIBLE GEARED-MOTOR**  
Delco-PM-Permanent Magnet Alnico Field Motor



#5071895 1/4" SHAFT or 11/16 GEAR... \$17.50  
#5069600... \$18.50

Clamps to hold motor: \$1.50 ea.

**GRAIN OF CORN LAMPS**

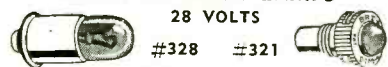

28 VOLTS #328 #321 10 for \$3.00 100 for \$25.00

#318 3V AMBER OR CLEAR 10 for \$1.80 100 for \$15.00

LM32 10 for \$4.50 Bausch & Lomb 10 for \$6.50 EXTENSION SOCKET ON CORD & TRANSFORMER FOR LM 32 \$3.50

#326 10 for \$3.00 2 1/2 Volts

REDMOND Powerful 5" Blower or Ventilator 115 volts AC 60 cycles 18 watts. For Kitchen — Laboratory. Heat or Cold or Chemicals... \$8.95

Ford Spark Coil by Delco-Remy 1/2" \$2.75

SMALL BLOWER OR AGITATOR FOR COOLING T.V. ETC. \$4.50

A Miracle Switch that will not leave you in the Dark. Delayed Action Light Switch... \$1.95

3" Round Elapsed Time Meter... \$13.75

**MARKTIME 5 HOUR SWITCH**

A 10 amp. timing device. Pointer moves back to zero after time elapses. Ideal for shutting off radios and TV sets when you go to bed. Limited supply at this special PRICE... \$4.90

Also available in 15 min., 30 min., 1 hr. at \$5.90

**10 Seconds to 24 Minutes Timer**

A hand wound electric TIMING SWITCH. Pointer moves back to ZERO and shuts off RADIO-TV—Electric Mixer—Photographic Devices—Time Delay etc. Furnished with Calibration Chart and Pointer Knob. Biggest bargain we ever had... \$1.25

**Genuine TELECHRON Motors**

2 RPM	\$2.90
3 RPM	3.90
4 RPM	2.90
3.6 RPM	3.15
1 RPM	3.95
60 RPM	4.30
3 R.P. Hr.	2.85
1 R.P. 2 Hr.	2.80
1 R.P. 12 Hr.	3.25

Laboratory Special 1 of Each Above \$25.00

**HAYDON SYNCHRONOUS TIMING MOTOR**

110v. 60 cycle 30 RPM	\$2.60
110v. 60 cycle 1 RPM	\$2.85
230V 1 RPM	1.00
60C 12 RPM	1.00

ALL PRICES F.O.B. N. Y.

EST. 1923 **BLAN** EST. 1923

64F Dey St.

New York 7, N. Y.

**X-RAY**

All types for industrial and experimental applications. Tubes, cables and components.

**MEDICAL SALVAGE CO., INC.**  
217 E. 23rd St. New York 10, N. Y.  
Murray Hill 4-1267





**OIL CONDENSERS**

MFD	V.D.C.	Price	MFD	V.D.C.	Price
1	1000	50.32	4	800	.75
1	6000	7.50	5-5	400	.70
2	600	.45	7	600	1.05
2	1000	.55	10	600	1.10
3-3	600	.85	25	600	.72
4	1000	.80	25	6000	.75
4-4	1000	1.10			

**BATHTUB CONDENSERS**

MFD	V.D.C.	Price	MFD	V.D.C.	Price
.05	600	50.19	1-1-1	600	.24
.05-.05	600	.22	1	400	.25
1-1	600	.20	1	600	.28

**HEADSETS**

Model	Impedance	Price	Model	Impedance	Price
HS-23	high	52.95	HS-33	low	2.45
HS-33	low	2.45	HS-30	low imp	1.49
HS-30	low imp	1.49	H-16	U high imp	4.95
H-16	U high imp	4.95	CD-307A	cords with PL55 plug	
CD-307A	cords with PL55 plug		and JK26 jack	8" long	1.19

**BC-221 FREQUENCY METERS**

Reconditioned. PERFECT! Complete with tubes and crystal! **\$129.50**



**SELSYN 2J1G1**

Operates from 5 1/2 V 100 cycles. Suggested wiring for 110 V 60 cycle included. New, tested. Price Each **\$4.50**

**DYNAMOTORS**

Type	Input	Output	Excellnt Used Brand	Price
DM-32A	28V 1.1A	250V .05A	4	\$4.90 \$7.50
DM-33A	28V 5 A	575V .16A	1	2.25 3.95
	28V 7 A	510V .25A		
DM-34D	12V 2.8A	220V .080A		14.50
DM-40	14V 3.1A	172V .138A		7.95
DM-28	28V	224V .07A		3.95 6.95
DM-21	14V	235V .09A		6.85 16.50
PE-73	28V 20A	1000V .350A		9.50 12.50
PE-86	28V 1.25A	250V .060A		2.95 5.50
PE-94A	28V 10A	300V .200A		7.50 11.50
		150V .101A		
PE-94C	28V 10A	300V .200A		10.00 12.75
		150V .101A		
PE-98	14V 2.1A	300V .200A		22.50 37.50
		150V .101A		
PE-101	13V 12.6A	400V 1.35A		3.75 4.85
	26V 6.3A 9V AC	1.12A		
PE-103	6V 12V	500V .160A		27.50 44.50
		500V .160A		
PE-104	6V 1A	84V .09A		12.50 14.50
(Vibrator)	12V 5A	51V .03A		
DM-414 (with filter)	14V 2.8A	220V .080A		12.50
PS-225 (with filter)	28V 3.2A	375V .150A		10.50
ICOR Dynamotor				
D-401	27V 6.05A	300V .200A		9.95
		18V AC 2.2A		

**INVERTERS**

PE-206 Inverter-Leland				
In: 28V DC-38A				
Out: 500V 800 cyc. 80VA 1 Ph.			9.75	12.50
PE-218 Inverter-Leland-Wincharger-GE.				
In: 28V DC-92A				
Out: 115V 380/500 Cyc. 1500VA 1 Ph.			16.50	24.50

**INTERPHONE AMPLIFIER**

Easily converted to an ideal Inter-Communications set for office, home or factory. Original. Complete with tubes. New **\$4.75**

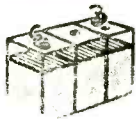

**WILLARD 6-VOLT MIDGET STORAGE BATTERY**

3-amp hr. BRAND NEW. 3 3/4" x 1 13/16" x 2 23/32" Uses standard electrolyte. **\$2.65**

**WILLARD 2-Volt Storage Battery**

20 AMP. HR. BRAND NEW **\$2.69**

1-QUART ELECTROLYTE For Above. Enough For TWO CELLS. BOTTLE **\$1.45**

7-Prong 2-Volt VIBRATOR. For Portable And FARM SETS (GE LB530). **\$1.49**

Please include 25% Deposit with order-Balance C.O.D. MINIMUM ORDER \$3.00. All Shipments F.O.B. Our Warehouse N.Y.C.

**CONTINENTAL RADIO COMPANY**

Phone COrtland 7-4605  
51 Vesey St. • New York 7, N. Y.

**CONDENSERS**

**10 mfd.—600 v .....\$98**

Three term, bot. mtg. channel type. Dims. 3 3/4" x 2 1/2" x 2". Two 5 mfd. sections rated 400 V at 72 deg "C". 1800 V test. Meets commercial specs. for 600 V operation up to 40 degs "C". Ideal for filter or power factor application. Repeat sales prove this rugged high quality condenser to be of outstanding value. Carton of 24, weight 42 lbs. Large qua. available **\$ .89**

**4 mfd.—600 v Type TLA \$1.45**  
Brand New-Orig. Cartons—4 1/2 x 1 1/2.

**1 mfd.—6 kv .....\$7.95**

**1 mfd.—25 kv .....\$59.50**

**16 mfd.—600 v .....\$1.75**

Dual 8 mfd oil filled cond. hermetically sealed and packed. Tobe type PT-SC-11 measuring 3 3/4" x 2 3/8" x 2 3/8". Stud mtg. centers 2". Plugs into standard four prong socket.

Mfd.	Volts	Price	Mfd.	Volts	Price
.0016	15KV	55.75	2	600V	.59-.79
.0028	18KV	5.95	2	1000V	.85
.005	005-		2	1500V	1.29
.01	10KV	4.75	2	1000V TLA	1.29
.012	25KV	22.50	2	1500V	1.50
.02	18KV	5.25	2	2500V	2.80
.02	20KV	17.90	2	4000V	3.95
.025	025-		2	4000V	5.80
.03	50KV	55.00	2	4000V	7.95
.03	7500V	4.50	2	5000V	12.50
.03	18KV	15.95	2	7500V	32.95
.035	18KV	12.35	2	7500V	39.50
.05	5KV	2.49	2-2	32.5KV	P. U. H.
.05	7500V	2.95	3	600V	.59
.08	12.5KV	15.35	3	4000V	11.95
	1500V	.59	3	150V	1.35
	3000V	.49	3-3	400V	1.05
	2500V	1.39	3-3-3	2500V	1.25
	3000V	1.39	4	600V TLA	1.45
	5000V	1.35	4	1000V TLA	1.40
	7500V	1.75	4	1500V	2.25
	1500V	3.50	4	1500V	2.25
	10KV	9.50	4	2000V	4.35
	10KV	12.95	4	2500V	7.95
	12KV	14.95	4	3000V	7.95
	12KV	14.95	4	4000V	13.95
	25KV	29.50	4	5000V	22.50
	2000V	.98	4	7500V	52.50
	1500V	3.50	4-4-4	600V	2.40
	1500V	3.95		330V AC	1.75
	15KV	10.95	5	1000V	1.99
	4000V	17.95	5	1500V	2.98
	2000V	2.25	5	330V AC	1.75
	2500V	1.29	6	600V	1.85
	1000V	1.75	6	1000V	2.25
	4000V	3.25	6	1500V	3.65
	3000V	1.45	6	2000V	3.95
	15KV	15.95	7	145V	1.45
	20KV	19.95	7	800V	1.99
	30KV	29.50	8	200V	1.35
	20KV	19.95	8	600V	3.25
	10KV	1.29	8	600V Rg	1.79
	1500V	1.85	8	600V AC	3.50
	2000V	2.20	8	1000V	3.25
	3000V	2.39	8-8	600V	4.25
	1000V	3.15	8-8-8	600V	7.25
	5000V	4.15	10	600V	1.75
	2000V	.90	10	600V AC	2.25
	600V	.69	10	1000V	2.75
	1000V	.69	10	1500V	2.75
	25KV	55.50	10	600V AC	6.25
	400V	.45	12	1000V	99.50
	1000V	.59	12	1500V	6.75
	1500V	.69	12	600V	6.95
	2000V	1.35	15	330V AC	4.95
	2500V	1.95	15	440V AC	4.95
	3000V	2.50	15	600V	3.95
	3000V	3.35	15	1000V	5.35
	5000V	6.85	15	1500V	6.35
	6000V	8.25	15	300V	69.50
	10KV	12.60	16	1500V	5.85
	10KV	27.95	20	600V	5.85
	15KV	45.50	20	330V AC	7.50
	18KV	49.50	28	1000V	5.25
	20KV	59.50	30	330V AC	5.25
	25KV	70.00	80	4000V	49.50

**25 KW 3 phase 60 cy. diesel gen.**  
Control panel, bats., etc.  
Specially priced & guaranteed.

**SEE MARCH ISSUE FOR**

Mica conds., trans. rcvng. Channel, bathtub & tubular oil conds.

**ALSO**

Micro sws., relays, rheostats & "J" potentiometers

**WANTED**

Condensers of all types in any quantity, also other standard components. Top prices.

Write:—ART HANKINS, Owner

**MONMOUTH RADIO LABS.**

BOX 159 OAKHURST, N. J.



**RADIO - RADAR - INSTRUMENTS**  
**AIRCRAFT - PHOTO EQUIPMENT**

**We will Beat All Competition**

Airlines and Governments—Please note, all equipment meets CAA or government specifications.

**RT-18 (ARC-1) Transceiver 495.00**

**ARC-3 (Complete installation) 975.00**

**AM-26/AIC Amp. 19.50**

**R-5/ARN-7 R.D.F. 245.00**

**BC-639 Receiver 245.00**

**BC-640 Transmitter 895.00**

**We will Beat All Competition**

**BC-611 Handy Talkie 110.00**

**BC-348 Receiver 110.00**

**BC-221 Freq. Mtr. 99.50**

**ID-60/APA-10 Ind. 145.00**

**CRT-3 Dual Channel 75.00**

**BC-733D Receiver 34.50**

**APN-9 Loran 850.00**

**TS-251 Loran Test 650.00**

**We will Beat All Competition**

**TS-45/APM-3 X Band Signal Generator 375.00**

**IE-36 Test Set 49.50**

**TS-35/UP Test Set 495.00**

**M-299 Mike Adaptor 3.95**

**AN-104B Antenna 6.75**

**AS-27A Antenna 27.50**

**MG-153 Inverter 115.00**

**MG-149F Inverter 52.50**

We cut MC-124 and MC-215 Flexible Shafts to any desired length—CAA or government specifications.

Check our prices for Selsyns, instruments, coax and cannon plugs—radar test equipment—aerial and photographic equipments—radio mounts, antennas.

Send for FREE catalogues on

- Communication Equipment
- Inverters - Dynamotors
- Radio-Radar Test Equip.
- Aerial Photographic Equip.

**EQUIPMENT WANTED**

**Semler Industries, Inc.**

6853 Lankershim Blvd, North Hollywood, Calif.







**RECEIVING**

Type No.	Type No.	Price
OZ4	6X4	.36
1A7	497B4	.44
1AX2	617L7	.59
1B3	12A7G	.39
1L4	4512A7	.64
1NL5	5912AU6	.39
1R5	4812A7	.69
1S4	5812AX4GT	.59
1T4	4812AX7	.59
1U4	4812B7	.65
1U5	4812BZ7	.63
1XA2	6312C8	.34
3A5	4812K8	.58
3Q4	4812K8GT	.85
3V4	5112S7GT	.64
5Y3GT	3612S7GT	.69
5Z3	4412S7GT	.64
6AC7	8512SH7	.75
6AF4	8912SK7GT	.62
6AG5	4612SL7GT	.49
6AK5	7312S07GT	.56
6AT6	3714A5	.59
6AU6	4012BQ6GT	.75
6AV6	5512S6GT	.39
6AX4	8512S6GT	.38
6B8	8532L7GT	.98
6B8G	5312S7GT	.98
6BA6	4013W4	.37
6BE6	37135Y4	.45
6BZ7	39135Z3	.43
6C5	49135Z3GT	.48
6C6	45135Z3GT	.48
6CD6	1.10 45Z3	.42
6D6	6950B5	.44
6F8G	9950C5	.44
6J6	49106LGT	.62
6N7	98106LGT	.62
6SM7GT	50106LGT	.62
6SL7GT	49106LGT	.62
6U7G	45106LGT	1.00
6U8	59176	.43

**WE SPECIALIZE EXCLUSIVELY IN TUBES AT LOWEST WHOLESALE PRICES**

The only thing we handle is—TUBES—of every kind and description—serving the industry for years. Thus, we can give you a more comprehensive selection of types and the advantage of more competitive prices. All our tubes are fully guaranteed. From amongst the 3000 different types we have in stock, for immediate delivery, we list here only a few of the common types. These are but a sampling of our immense variety—therefore we urge you to order any other unlisted types. Minimum order \$10. Please include 25% deposit with order. **ADDITIONAL DISCOUNTS:** On orders for \$25 or more, deduct 3%. Prices subject to change without notice. All prices F.O.B. our Warehouse, New York City. All tubes individually boxed.

**RECEIVING TRANSMITTING SPECIAL PURPOSE**

Type No.	Type No.	Price
2E22	1.19 2K22	22.50
2E30	2.30 2K23	10.95
2E31	1.25 2K25	28.19
2E43	1.29 2K28	27.40
2J21A	15.50 2K29	22.50
2J22	11.50 2K33	215.00
2J26	26.95 2K39	130.00
2J27	29.50 2K41	125.00
2J31	24.00 2K45	145.00
2J32	28.50 2K50	340.00
2J33	26.00 2K54	198.00
2J34	23.50 2K55	197.00
2J36	98.00 2K56	175.00
2J37	12.50 2Y3G	1.99
2J38	17.50 2X2	.39
2J39	9.50 2X2A	1.15
2J40	34.00 3B22	2.40
2J42	24.00 3B24	4.60
2J48	10.50 2J49	7.11
2J50	90.00 3B25	3.49
2J51	225.00 3B26	3.65
2J55	7.85 3B28	5.95
2J56	145.00 3C22	79.00
2J61	44.00 3C23	7.28
2J62	44.00 3C24	1.75

**FREE:** Send for our latest listing. Please inform us of your excess tube inventories, so we may forward our best offer to you.

**ELECTRON TUBE WHOLESALE, INC.**  
RECEIVING • TRANSMITTING • SPECIAL PURPOSE  
140 DUANE STREET • NEW YORK 13, N. Y. • Phone: BArlay 7-7616

**TRANSMITTER TA-2J-24**

High powered crystal controlled, long-range transmitter. Frequency range: 300-600 Kc and 2.9-15 Mc. Eight separate channels are provided. New. Send for complete literature. P.U.R

**OSCILLOSCOPE SPECIALS!**

DUMONT	#224	3 in.	\$149.50
DUMONT	#208	5 in.	225.00
DUMONT	#168	5 in.	87.50
R.C.A.	#158	5 in.	87.50
BROWNING	#PE	5 in.	195.00

**Measurements Corp. SIGNAL GENERATOR MODEL 78-B**

FREQUENCY RANGE: 15 to 25 and 190 to 230 mc. in two bands. OUTPUT VOLTAGE: 1 to 100,000 microvolts. MODULATION: AM, fixed at 30%. POWER SUPPLY: 117 V., 50-60 cycle. Like new condition. \$49.50

**Radar** Ask for complete listing of our Radar Equipment

**LM CRYSTAL CALIBRATED FREQUENCY METER**

Frequency range: 125 Kc. to 20 mc. With audio modulation and calibrated hand book. Complete with tubes and crystal, including 2 neon regulator tubes. Like new condition. \$49.50

**Test Equipment**

**RECEIVERS—TRANSMITTERS**

**New Catalogue No. 113**

Lists Inventory of Aircraft, Industrial and Military Electronics Equipment. Now off the Press. Send for Your Copy Today!

ARROW SALES INC.

Shipping Address: P. O. BOX 3878-E, N. HOLLYWOOD, CALIF.  
Office-Warehouse: 7460 VARNA AVENUE, N. HOLLYWOOD, CALIF.  
POplar 5-1810 • Stanley 7-6005 • Cable Address: ARROWSALES

SPECIAL SALE!

ALL brand new in original cartons

7,000 . . . 5BP1's  
100 . . . 5AP1's  
100 . . . 720 DY's  
300 . . . 808's

AN/APR4 new and used receivers . . .

Tuning Units TN-16-17-18

Write for prices on all above . . .  
NEW CATALOG AVAILABLE . . .  
WRITE TODAY!

R W ELECTRONICS

Dept. EL, 2430 S. Michigan Ave.  
Chicago 16, Ill.  
PHONE: CALumet 5-1281-2-3

**TRANSMITTERS—RECEIVERS, ETC.**

Wileox CW-3D; Hallcrafters R44/ARR5; SX-25; S-27; BC-499A-B; BC-500B; BC-904; Collins 323RA; BC-614 Speech Amplifier; R85/TPL-1 (Incl. 2K41 Klystron)

**POWER SUPPLIES**

RA-105A, PE-117, PE-94B-C, RA-58

**RECORDER REPRODUCER—AN/UNQ-1B**

**TEST EQUIPMENT**

TS 559/FT. TS 59/APN-1, TS 10/APN

**CHESTS OF SPARES**

TDE, TCP, TAJ, TBM, RAK, SA, PPI

**BATTLE ANNOUNCING EQUIP. & SPARES**

MP-22 Mast Base; TCP (RMCA 8012) m/g 115 v; Inverters, 115 DC-AC, 60 C., 150 W; PN 31A Control Panels

TRANS-WORLD ELECTRONICS CO.

41 Union Square, New York 3, N. Y.  
WAtkins 9-1079

All Sales FOB Our Warehouse N. Y. C.

4 PDT RELAY



26.5 VDC midget  
425 ohm \$2.95

Above frame also in:—  
280 ohm @ \$2.75. 12 vdc 70 ohm @ \$1.95. DPDT: 12 vdc, 120 ohm @ \$1.95. DPDT 0 vdc, 18 ohm \$1.95. SPST N.O. double break 10 A cont. 2.2 vdc 15 ohm \$1.95

RELAY 3 PDT 24 vdc 250 ohm Clare Type K \$ 2.75  
CONNECTOR 15 pin Amphenoil #26-151 . . . 69  
250 WATT output xformer WE #KS9496 . . . 9.95  
S BAND CONVERTER Navy CG-16ABW . . . 39.50  
ISOLATION XFORMER 35 watts 115v. & 6.3 2.45  
SYNCHRO MOTOR I FS 115/90 v 400 cycles 14.95  
MOTOR 100-1800 eye. 115v EAD J31C . . . 9.95  
SILVER TRMR ERLE TS2a 1.5-7, 4-30, 7-45 . . . 32  
LINK MOBILE XMTRS =25 FM 30-40 MC. 49.50  
TRANSISTOR or 5 pin submini socket . . . 1.13  
PL-141, SO-121, PL-68, AN-3106-10s-2s, 83-1H.  
Variable Frequency electronic generator 1400 watt output 300-3500 cy. 220/60/in. CML #1400.

CONDENSERS in stock: bathtubs from .02 400v to 2 mfd—600v, upright oils (CP65 pyranols, YAB, etc) from 3x.1-600v to 1 mfd 600v. Large oils from 1-7500v to 1 mfd-2.000v. Also mica, silver mica, variables, trimmers. Write for Bulletin.

EMPIRE ELECTRONICS COMPANY

409 Avenue L, Brooklyn 30, N. Y. Cloverdale 2-4000

**INSTRUMENTS AND METERS**

RADAR TEST UNIT, Echo Box, 150-240 MC, 115 Volt AC, Liebel-Flarshelm Co.  
TEST SET for 1MC Block Mica Elect. Qual., Boonton Radio # 130, AWS C 75.3 Cap. ABCDIB.

TEST UNIT, I-176. \$42.50  
INDICATOR ID-101/MRN-3, st. # 3E2877. \$39.50  
101 . . . \$39.50  
TEST SET TS-32A/TIC-1 . . . \$17.50  
SERVO POT., S-147500, st. #6583808, W.El. \$39.50  
FREQUENCY METER, 58 62, 100-130V, JBT 21/PC, 2 1/2" case. . . \$13.50  
FREQ. METER, 55-65, 100-150V, Fram. \$14.50  
case. . . \$14.50  
ELAPSED TIME METER, 110 volt 60 cycle, registers to 9,999.9 and repeats, Cramer RT-211, 3 1/2" rd case . . . \$13.50  
ELAPSED TIME METER, 200-240 Volts 60 cycle, to 9,999.9 hrs. and repeats, Cramer RT-311 3" square case . . . \$13.50  
DC MICROANMMETER, 0-50, Electrotech #350  
AWS type MR34W050DCUA, 3 1/2" case. . . \$ 8.50  
DCMA, 0-500, SC type IS-122, st #3F222, G.E. 2 1/2" bl. se. . . \$ 6.50  
RF Amp, 0-3, for Navy XMTR, Weston 507, 2 1/2" case, black scale. . . \$7.50  
RF AMP, 0-8, SC type 18-89, GE DW-44, 2 1/2" case, bl. se. . . \$6.50  
DCMA 0-200, for TCS XMTR, Weston 508, \$ 8.50  
RF Amp, 0-3, for Navy XMTR, Weston 507, 2 1/2" case, black scale. . . \$ 7.50

Items Brand New and Guaranteed Net FOB warehouse. Send for additional listings, details.

AVIONIC ASSOCIATES

124 Birchwood Road Paramus, N. J.  
Ridgewood 6-6336



**SPECIAL**  
**2K33A...\$185.00 ea.**  
 Brand New in Original Cartons

**EMELTONE ELECTRONICS CO.**

71 W. Broadway - N. Y. 7, N. Y. Phone Rector 2-1696

**SPECIAL**  
**QK-250 \$110.00**  
**QK-249**  
**QK-182** each

**Crystal Diodes**

Standard Brands Only

CRYSTAL DIODES	OC3-VR150	2J48
1N21A 1.75	1B21A 2.50	2J48 45.00
1N21B 2.00	1B22 2.50	5J26 125.00
1N22 10.00	1B23 7.00	350A 350.00
1N22C 1.70	1B24 12.00	5J27 80.00
1N23 1.95	1B25 3.50	5J28 250.00
1N23A 2.25	1B27 3.00	6A15 80.00
1N23B 2.85	1B29 2.75	6A16 28.00
1N25 5.25	1B32 3.25	6A17 100.00
1N26 8.00	1B33 9.00	6A18 35.00
1N27 8.00	1B34 9.00	6A19 185.00
1N28 4.25	1B35A 60.00	6A20 140.00
1N31 6.00	1C1B 6.00	6A21 150.00
1N34 7.11	1P21 28.00	6A22 125.00
1N34A 1.71	1P28 10.00	6A23 60.00
1N35 2.20	1Z2 2.00	3A5 .95
1N38 1.30	2C26A .60	3B22 3.50
1N39 3.00	2C34 .50	3B24 5.50
1N40 11.50	2C30 20.00	3B24W 8.50
1N41 12.00	2C39A 21.00	3B25 4.50
1N41 1.75	2C40C40 30.00	3B26 5.50
1N44 1.50	2C43 17.50	3B27 4.50
1N48 .62	2C44 1.50	3B28 4.50
1N51 2.00	2C46 30.00	3C24 1.50
1N52 1.37	2C50 9.00	3C31 6.00
1N54 .90	2C51 5.00	3C33 3.00
1N58 1.20	2C52 33.00	3C37 10.00
1N60 .61	2D21 1.25	3C45 18.00
	2E22 2.50	3E29 12.00
2AP1 8.00	2E23 3.24	3K100A 40.00
3AP1 10.00	2E26 2.40	4-125A 25.50
3AP1A 12.00	2E27 3.50	4-150A 30.00
3BP1 6.00	2E36 4.50	4-250A 38.00
3CP1-51 2.00	2I21A 10.50	4-500A 100.00
3DP1-52 6.00	2I22 10.00	4-1000A 140.00
5CP1 5.50	2I24 25.00	4-2000A 250.00
5BP1 4.50	2I27 20.00	4B25 8.50
5CP1 6.00	2I31 39.00	4B26 10.00
5FP1 2.50	2I32 48.25	4B28 6.00
5GP1 5.20	2I33 25.00	4C27 38.00
5LP1 20.00	2I34 25.20	4C35 26.00
7BP1 7.00	2I36 110.00	4C37 16.50
	2I37 15.00	4D32 21.05
	2I38 24.00	4J42 195.05
OA2 1.00	2I39 15.50	327A 4.50
OB2 1.80	2I40 38.00	327B 2.50
OB3-VR90 .80	2J42 150.00	329A 47.00
		329B 14.50
		332A 45.00

**SPECIAL PURPOSE TUBES**

45.00	5J26	125.00	350A	8.00	730A	35.00	956	.55	5718	5.80
63.00	5J27	80.00	350B	8.00	731A	4.50	957	.40	5719	11.00
250.00	5J28	1.50	355A	21.00	801	2.10	958	.95	5720	18.75
80.00	6A15	1.65	357A	19.00	802	4.00	958A	1.00	5722	6.25
20.00	6AK5W	2.00	371A	4.00	816	4.00	1616	1.50	5725	3.90
70.00	6AK5	1.00	371B	.85	804	16.00	1619	4.00	5726	2.00
28.00	6AN6	3.25	388A	3.00	805	3.00	1620	6.00	5734	16.00
100.00	6AR6	2.75	393A	9.95	807	1.65	1622	2.25	5751	1.50
35.00	6AS6	2.25	394A	4.00	807W	11.50	1624	1.50	5763	3.25
30.00	6AS7G	4.00	417A	12.00	808	2.25	1625	.30	5792	2.50
185.00	6C3	7.00	434A	13.95	809	3.50	1626	.25	5814	9.00
140.00	6C21	22.00	446A	2.50	810	11.50	1630	.85	5840	14.00
150.00	6C24	55.00	450TH	50.00	811	2.95	1631	1.40	5879	1.65
125.00	6N4	2.50	450T1	50.00	811A	3.75	1632	1.00	5881	3.00
60.00	10Y	.80	471A	3.00	812	3.50	1633	2.25	5888	8.00
.95	12AE	.65	502	73.00	813	11.50	1641	1.30	5901	8.00
3.50	12AV7	1.70	517	15.00	814	3.75	1655	1.25	5904	8.00
2.00	15E	2.00	530	16.00	815	4.50	1665	1.25	5925	13.50
8.50	15R	1.25	532A	3.50	816	1.25	2050	7.20	6095	.85
5.50	FG-17	8.00	575A	21.50	826	1.50	2051	.80	6096	.60
6.60	RX21	8.00	600	7.00	828	12.00	828	12.75	6527	5.50
4.50	F627A	7.50	602	6.00	829B	12.75	829B	4.00	6527	2.50
3.50	35T	6.00	604	7.75	830B	4.00	5527	9.50	6545	1.00
32.00	RK65	11.00	700A	24.00	832A	9.50	5545	35.00	6100	2.25
11.00	75TH	13.00	701A	24.00	833A	41.00	5559	18.00	6101	1.00
30.00	100TH	26.00	700C	26.00	834	27.00	7193	44.00	7193	.65
18.00	FG-172	25.00	701A	15.00	836	3.75	5563	44.00	8008	2.00
12.00	211 Sp	1.25	701B	3.50	837	3.95	5582	2.65	8013A	3.00
40.00	GL-218	30.00	705A	1.50	838	9.00	860	15.00	8019	2.25
25.50	249B	9.00	707B	16.00	843	1.25	5585	11.00	8020	3.90
30.00	249C	7.00	708A	5.50	845	55.00	5633	12.75	9001	1.20
38.00	309R	73.00	734A	16.00	851	19.00	5635	3.25	9002	1.30
100.00	250R	12.00	715A	6.00	852	26.00	5638	10.50	9003	1.30
140.00	250TH	22.00	715B	9.00	860	1.45	5651	12.85	9004	2.30
75.00	250TL	29.00	715C	29.00	861	1.45	5654	2.50	9095	.40
8.50	252A	28.00	717A	1.20	864	90.00	5654	1.40	9096	4.00
10.00	253A	28.00	719A	28.00	866A	3.50	5672	17.00	9097	4.00
28.00	258B	72.00	721A	8.00	869B	3.50	5678	1.30	9098	1.50
8.00	304TH	8.00	721B	9.50	872A	1.58	5678	9.20	9099	1.20
8.00	304TL	8.00	723A/B	20.00	876	1.75	5679	4.50	9099	4.50
16.50	317A	3.25	724A	3.75	878	1.75	5679	4.50	9099	4.50
21.05	316A	2.50	724B	2.25	884	1.58	5679	1.50	9099	4.50
195.05	327A	4.00	725A	10.00	885	1.75	5679	4.50	9099	4.50
300.00	328A	8.00	726A	14.00	888A	6.00	5682	4.50	9099	4.50
47.00	329A	8.50	726B	49.00	955	.67	5682	4.50	9099	4.50
14.50	332A	45.00	726C	69.00	955	.67	5682	4.50	9099	4.50

**Receiving Tubes**

**Klystrons, Magnetrons**

35.00	956	.55	5718	5.80
4.50	957	.40	5719	11.00
2.10	958	.95	5720	18.75
4.00	958A	1.00	5722	6.25
4.00	1616	1.50	5725	3.90
16.00	1619	4.00	5726	2.00
3.00	1620	6.00	5734	16.00
1.65	1622	2.25	5751	1.50
11.50	1624	1.50	5763	3.25
2.25	1625	.30	5792	2.50
3.50	1626	.25	5814	9.00
2.50	810	.85	5840	14.00
50.00	811	2.95	1631	1.40
3.00	812	3.50	1633	1.00
73.00	813	11.50	1641	2.25
15.00	814	3.75	1655	1.25
16.00	815	4.50	1665	1.30
3.50	816	1.25	2050	7.20
21.50	826	1.50	2051	.80
7.00	828	12.00	828	12.75
6.00	829B	12.75	829B	4.00
7.75	830B	4.00	5527	9.50
24.00	832A	9.50	5545	35.00
24.00	833A	41.00	5559	18.00
26.00	834	27.00	7193	44.00
15.00	836	3.75	5563	44.00
3.50	837	3.95	5582	2.65
16.00	843	1.25	5585	15.00
5.50	845	55.00	5633	11.00
16.00	851	19.00	5635	3.25
6.00	852	26.00	5638	10.50
9.00	860	1.45	5651	12.85
29.00	861	1.45	5654	2.50
1.20	864	90.00	5654	1.40
28.00	866A	3.50	5672	17.00
8.00	869B	3.50	5678	1.30
9.50	872A	1.58	5678	9.20
20.00	876	1.75	5679	4.50
3.75	878	1.75	5679	4.50
2.25	884	1.58	5679	4.50
10.00	885	1.75	5679	4.50
14.00	888A	6.00	5682	4.50
49.00	955	.67	5682	4.50
69.00	955	.67	5682	4.50
			5703	1.90
			5704	2.75

PRICES SUBJECT TO CHANGE ALL ITEMS SUBJECT TO PRIOR SALE WRITE, WIRE OR PHONE CASH PAY FOR YOUR SURPLUS TUBES—SEND LIST AND PRICES

**TELEPHONE RELAYS**



Large Stock of  
 CLARE, TYPES C D & E  
 COOKE, AUTOMATIC—ELECTRIC  
 ALL TYPES OF COILS and PILE-UPS  
 Send Us Your Specs. for Our Quote

**CLARE TYPE C STANDARD SIZE SENSITIVE TELEPHONE RELAYS**

Coil	Contacts Will Close at	Price
1) 6500 ohms 1C	4 MA	\$2.50 ea.
2) 6500 ohms 1B-1C	3.5 MA	2.75 ea.
3) 6500 ohms 2A	4 MA	3.00 ea.
4) 6500 ohms 2A-1B	4 MA	3.00 ea.
5) 6500 ohms 5A	5 MA	3.25 ea.
6) 6500 ohms 5A-2D	5 MA	3.50 ea.

**CLARE TYPE G HALF SIZE SENSITIVE TELEPHONE RELAYS**

Coil	Contacts Will Close at	Price
1) 6500 ohms 2A	5 MA	\$2.50 ea.
2) 5800 ohms 3A	4 MA	2.50 ea.
3) 5800 ohms 2B-1C	5 MA	2.50 ea.
4) 4850 ohms 1C	4 MA	2.50 ea.
5) 3600 ohms 1C	6 MA	2.00 ea.
6) 4850 ohms 1A	5 MA	2.00 ea.
7) 3300 ohms (None)	ACTUATOR	1.50 ea.

All above Relays may be used for continuous duty operation on 110V. D.C.

**OTHER TYPE C TEL. RELAYS**

1) 1300 ohms 2A-1B
--------------------

## WHY SEARCH? AARON HAS IT!

Call Gene Morasco, Sr.  
WA. 1-9188

**AARON ELECTRONIC SALES**  
6025 Mt. Elliott  
Detroit 11, Michigan

### CARRIER EQUIPMENT

Western Electric CF-1A 4-channel carrier telephone terminals.  
EE-101-A 2-channel 1000/20 cycle carrier ringers.  
CFD-B 4-channel carrier pilot regulated telephone terminals complete with four channels 1000/20 cycle ringing.  
CFD-B 4-channel pilot regulated telephone repeaters.  
C-42-A V. F. telegraph in from 2- to 12-channel terminals.  
FMC 1 or 2 channels carrier telephone terminals, automatic regulation, duplex signaling each channel. Carrier frequencies above 35 KC. Ideal for adding channels above type "C".  
Complete engineering and installation services offered.

**RAILWAY COMMUNICATIONS, INC.**  
Raytown, Missouri  
Telephone: FLEming 2121

### WHOLESALE ONLY

**ELECTRONIC COMPONENTS  
AIRCRAFT EQUIPMENT  
HYDRAULICS**

**RADIO & ELECTRONIC SURPLUS**  
13933-9 BRUSH STREET  
Detroit 3, Mich. TO 9, 3403

### LOOK HERE!

WILCOX CW-3 Receiver with coils. Brand new in original cartons. . . . . \$45.00  
TBW-RBM equipment—complete systems—Signal Generator—GR-S04B 8-330 mc . . . \$175.00  
MARINE Transmitter Receiver 65 watt Northern Radio with power supply. . . \$195.00  
FIL. TRANSFORMER—tapped at 8-9-10-11-12 volts 5 amps. . . . . \$4.95  
5000 MFD-50V. Electrolytic cond. . . \$2.95  
BARRY MOUNTS 896-6G. . . . . each \$3.30  
DYNAMOTOR ZA/USA .0515 output 500 v. 50 ma. input 12/24v. 4/2 amp. in original sealed packing. . . . . \$4.25  
CABLE 250 ft. reels. 4 cond. #17. . \$12.00  
25% with COD orders fob Hempstead  
**ALGERADIO ELECTRONICS CO.**  
147 Front St. Hempstead, N. Y.

Transmitters: BC-610-E, ART-13, TCS-12  
Receivers: BC-312, BC-342, BC-348, TCS.  
Frequency Meters: BC-221, LM.  
New equipment and components by Hammarlund, Harvey Wells, E. F. Johnson, & National.  
**ALLTRONICS**  
Box 19, Boston 1, Mass.  
Richmond 2-0048, 2-0916

### HYDRO-ELECTRIC SERVO ACTUATORS

From A-5 Autopilot, with 1/4 HP 27.5 VDC 11 A. Delco motor, 2-1500 ohm valve act. coils, over 60 ft.-lbs torque max. on large dia. cable drum.  
USE FOR: Machine Tool Actuator; Steering Engine for Remote Controlled Boats, Autos, Cars, Planes  
NEW SURPLUS. . . \$22.50 EACH WITH DATA  
CAPT. JOE, 1804 Market St., PHILA. 3, PA.

## Quick ANSWERS

to your

business problems...

MISCELLANEOUS business problems are daily being solved quickly and easily by the use of the Searchlight Section of McGraw-Hill publications.

The Searchlight Section is classified advertising; you can use it at small cost, to announce all kinds of business wants of interest to other men in the fields served by these publications. It is the regular meeting place of the man with business needs and the men who can fill those needs.

When you want additional employees, want to buy or sell used or surplus new equipment, want additional products to manufacture, seek additional capital, or have other business wants—advertise them in the Searchlight Section for quick, profitable results!

Classified Advertising Division

**McGRAW-HILL PUBLISHING CO., INC.**  
330 West 42nd Street, New York 36, N. Y.

## SEARCHLIGHT (Classified Advertising)

SECTIONS  
are found in these  
McGRAW-HILL  
Publications

- American Machinist
- Aviation Week
- Business Week
- Bus Transportation
- Chemical Engineering
- Chemical Week
- Coal Age
- Construction Methods & Equipment
- Electrical Construction & Maintenance
- Electrical Merchandising
- Electrical Wholesaling
- Electrical World
- Electronics
- Engineering & Mining Journal
- E. M. J. Metal Mineral Markets
- Engineering News-Record
- Factory Management & Maintenance
- Fleet Owner
- Food Engineering
- National Petroleum News
- Nucleonics
- Petroleum Processing
- Power
- Product Engineering
- Textile World
- Welding Engineer



# NEW YORK'S RADIO TUBE EXCHANGE

TYPE	PRICE	TYPE	PRICE	TYPE	PRICE	TYPE	PRICE	TYPE	PRICE	TYPE	PRICE	TYPE	PRICE
OA2	\$1.00	2J31	34.00	3C24	1.50	5BP1	3.95	203A	7.50	464A	7.50	802	3.95
OA3	1.10	2J32	29.00	3C31	2.95	5BP2A	12.00	211	.95	471A	1.25	803	5.95
OB2	.99	2J33	12.00	3DP1	7.50	5BP4	3.95	217C	12.00	527	18.00	805	4.95
OB3	1.10	2J34	36.00	3DP1A	10.00	5CP1	7.50	242C	10.00	WL530	23.00	807	1.50
OC3	.96	2J36	90.00	3DP1A-52	10.00	5CP7	6.95	244A	9.50	WL531	22.50	808	1.95
OD3	.89	2J38	35.95	3EP1	5.00	5CP7A	14.00	249C	4.25	WL532	1.75	809	2.95
ClB	2.95	2J39	8.95	3E29	15.50	5D21	18.00	250TH	19.95	WL533	15.00	810	10.50
1B21	1.50	2J40	29.00	3FP7	5.00	5FP7	1.95	250TL	12.00	HK654	35.00	811A	3.75
1B22	1.50	2J42	135.00	3HP7	5.00	5J1	27.50	274B	2.75	700A/D	10.00	812A	3.95
1B23	6.95	2J49	60.00	4A21	2.75	5JP2	19.50	304TH	10.00	701A	4.50	813	13.75
1B24	12.00	2J50	55.00	3GP1	5.00	5JP4	27.50			703A	3.95	814	3.75

**TERRIFIC SLASHES in PRICE**  
up to 70% from PREVIOUS LOW PRICES

1B26	1.75	2J55	150.00	4B26	5.49	C6A	11.00	307A	3.50	704A	1.95	815	6.25
1B27	12.50	2J56	110.00	4C27	22.50	C6J	7.50	310A	4.50	705A	1.75	816	1.45
1B32	2.95	2J61	35.00	4C28	35.00	7BP7	5.00	310B	4.95	706AY/FY	25.00	829	11.00
1B38	35.00	2J62	35.00	4E27	16.00	7DP4	9.00	311A	6.50	707A	9.75	829A	12.00
1B50	23.00	2K22	15.00	4J25	150.00	12AP4	50.00	312A	3.50	707B	15.00	829B	15.00
1B51	7.50	2K23	15.00	4J26	150.00	12DP7	24.00	323A	15.00	714AY	18.00	830B	2.00
1B56	35.00	2K25	27.50	4J27	150.00	LM15	225.00	327A	3.75	715A	4.50	832A	9.95
1B60	35.00	2K26	64.00	4J28	150.00	15E	1.75	328A	6.75	715B	9.00	833A	45.00
1N21	1.25	2K28	35.00	4K29	150.00	15R	.75	350A	10.00	715C	22.50	834	7.50
1N21A	1.75	2K29	35.00	5J30	150.00	NE16	.59	350B	5.95	717A	1.50	836	3.95
1N21B	2.75	2K33A	95.00	4J31	150.00	20-A	.75	352A	3.00	718AY/EY	30.00	837	2.75
1N21C	19.50	2K39	140.00	4J32	150.00	KY21A	8.25	HK354C	15.00	719A	22.50	838	5.95
1N22	1.00	2K41	135.00	4J33	150.00	RX21	8.00	357A	15.00	720AY/GY	150.00	849	35.00
1N23	1.95	2K45	80.00	4J34	100.00	HK24G	1.50	368AS	4.95	721A	3.50	860	3.50
1N23A	2.75	2K50	275.00	4J35	150.00	25T	2.95	371B	1.50	722A	3.50	861	25.00
1N23C	7.50	2K54	125.00	4J36	150.00	45 Special	.35	385A	4.50	723A/B	18.00	862A	1.50
1N25	4.50	2K55	125.00	4J37	150.00	RK39	2.75	388A	1.80	724A	1.95	869B	67.50
1N26	6.75	2K56	72.00	4J38	150.00	HF59	1.75	393A	7.50	724B	2.25	869BX	50.00
1N27	3.50	3AP1A	10.00	4J39	150.00	VT52	.35	394A	3.95	725A	9.00	872A	3.50
1N34A	.79	3BP1	7.20	4J40	150.00	HK54	4.50	MX408U	.50	726A	9.00	878	1.50
1N43	2.25	3B24	4.50	4J41	150.00	RK72	1.00	417A	15.00	726B	45.00	879	.50
2B4	1.25	3B25	5.50	4J42	190.00	RK73	1.00	434A	15.00	726C	45.00	880	250.00
2B22	1.75	3I26	5.00	4J51	190.00	FG95	19.95	446A	1.95	728AY/GY	15.00	884	1.50
2C34	.15	3I28	8.00	4J52	225.00	100TH	7.95	446B	3.95	730A	22.50	885	1.50
2C40	9.00	3I28	8.00	4J53	225.00	FG105	20.00	450TL	45.00	750TL	120.00	914A	75.00
2C42	12.00	3C22	99.00	CSB	250.00	122A	1.75	450TH	52.50	801A	.90	931A	5.00

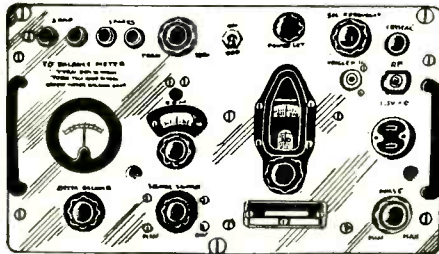

**NEW TS-147 C/UP TEST SET**  
Hard-to-get  
**X-Band SIGNAL GENERATOR**  
Now Available

Test Set TS 147 C/UP is a portable Microwave Signal Generator designed for testing and adjusting beacon equipment and radar systems which operate within the frequency range of 8500 MC to 9600 MC.



**NEW**  
**MICROWAVE TEST EQUIPMENT**  
**TS148/UP**  
**SPECTRUM ANALYZER**

Field type X Band Spectrum Analyzer, Band 8430-9580 Megacycles.

Will Check Frequency and Operation of various X Band equipment such as Radar Magnetrons, Klystrons, TR Boxes. It will also measure pulse width, c-w spectrum width and Q or resonant cavities. Will also check frequency of signal generators in the X band. Can also be used as frequency modulated Signal Generator etc. Available new complete with all accessories, in carrying case.

## Other test equipment, used checked out, surplus

- TSK1/SE K Band Spectrum Analyzer
- TS3A/AP Frequency and power meter S Band
- RF4A/AP Phantom Target S Band
- TS12/AP VSWR Test Set for X Band
- TS13/AP X Band Signal Generator
- TS14/AP Signal Generator
- TS33/AP X Band Power and Frequency Meter
- TS34/AP Western Electric Synchroscope
- T35/AP X Band Signal Generator
- TS36/AP X Band Power Meter
- 1-96A Signal Generator
- TS45 X Band Signal Generator

- TS47/APR 40-400 MC Signal Generator
- TS59/AP Frequency Meter 400-1000MC
- TS100 Scope
- TS102A/AP Range Calibrator
- TS108 Power Load
- TS110/AP S Band Echo Box
- TS'25/AP S Band Power Meter
- TS'26/AP Synchroscope
- TS147 X Band Signal Generator
- TS270 S Band Echo Box
- TS174/AP Signal Generator
- TS175/AP Signal Generator

- TS226 Power Meter
- TS239A-TS239C Synchroscope
- TF890/1 X Band Spectrum Analyzer
- 834 General Radio Frequency Meter

### SURPLUS EQUIPMENT

- APA10 Oscilloscope and panoramic receiver
- APA38 Panoramic Receiver
- APS 3 and APS 4 Radar
- APR4 Receiver and Tuning Units
- APR5A Microwave Receiver
- APT2-APT5 Radar Jamming Transmitter

MINIMUM ORDER  
25 Dollars

**YOU CAN REACH US ON TWX NY1-3235**

Cables:  
TELSERUP

**SPECIAL**  
Wide Band S Band Signal Generator  
2700/3400MC using 2K41 or PD 8365  
Klystron, Internal Cavity Attenuator,  
Precision individually calibrated Fre-  
quency measuring Cavity. CW or Pulse  
Modulated, externally or internally.

Large quantities of quartz crystals mounted  
and unmounted.  
Crystal Holders: FT243, FT171B others.  
Quartz Crystal Comparators.  
North American Philips Fluoroscopes Type 80.  
Large quantity of Polystyrene beaded coaxial  
Cable.



**LIBERTY ELECTRONICS, INC.**  
135 LIBERTY STREET  
NEW YORK 6, N. Y.  
Phone WOrth 4-8262

**RECORDER, SIGNAL GENERATOR—AMPLIFIER, & Voltage REGULATOR**

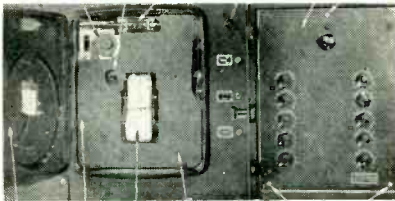

**RECORDER, SIGNAL GENERATOR—AMPLIFIER, AND VOLTAGE REGULATOR UNIT of BC-968 TRAINER**—Used for assimilated Radar identification when used with BC-412 Scope. Signal Generator generates various AC wave forms. Recorder was used to record difference in scope and generator wave forms as guided by operator. 110 Volt 60 cycle operation— with Manual. Shipping Weight: 270 lbs. Complete Unit. NEW! **\$59.50**

**OR AVAILABLE AS SEPARATE ITEMS:**  
**SIGNAL GENERATOR—AMPLIFIER:** Can be adjusted for various wave forms. 110 Volt 60 cycle operation. Voltage regulated supply 300 Volt 100 MA. 6.3, 5 A.; 5 Volt 3 A. Power Supply. 15 Tubes: 1/7A6, 3/7A8, 3/7KT, 3/7N7, 1/5Y3GT, and 4/VR1 150. **\$19.95**  
 With Tubes and Manual. **\$19.95**  
**RECORDER—Complete with 115 V. 60 cycle 1/125 HP Gear Head Motor, Yeeder Counter, Pen, etc. and with Manual. \$19.95**  
**CONSTANT VOLTAGE REGULATOR—115 V. 60 cycle, 80 VA, Sola #30726. \$14.95**

**SOUND POWERED HEAD AND CHEST SET**

**NAVY TYPE**—No Batteries required. Ideal for TV Antenna installations, and many other uses. 29 Ft. Cord. Used—Tested. Each: **\$5.95**  
**WIRE — COMBAT TYPE:** 2 Cond. twisted, rubber covered, medium weight. W-130 = 16 per ft. **FIELD WIRE:** 2 Cond. twisted, weatherproof, heavy duty. W-110, 525 Ft. Roll **\$4.75**



**TRANSFORMERS—110 V. 60 Cycle Pri.**  
**5 VOLT CT-25A—10,000 V. Ins. OPEN FRAME—** 3" x 5" x 4 1/2". **\$7.95**  
 Sec. Two 12 V. 4 A Winding—gives 12 V. 8 A. or 24 V. 4 A. **\$5.95**  
 Sec. 24 V. 1/2 A. **\$1.50** Sec. 24 V. 1 A. **\$1.95**  
 Sec. 24 Volt 6 Amps. **\$5.95**  
 Sec. 6-24 or 30 Volts. 8 Amps. **\$5.95**

**BLOWERS:**

115 Volt 60 cycle **BLOWER** (pictured) approx. 100 CFM Dis. 2 1/4" intake; 2" outlet. Quiet running. Motor size: 2 1/2" x 3 1/4". **NEW — Not Gov't. surplus** **\$8.95**  
 Order No. 1C939  
**DUAL BLOWER**—Same as RN-520 above, except has blower assembly in each side of motor. Order No. 1C880 **\$13.95**  
**COMPACT TYPE**—108 CFM, motor built inside squirrel case. 4 1/2" Intake; 3 3/8" x 3" Dis. Complete size: 4 1/2" W. x 9 3/8" H. x 8 1/2" D. Order No. 2C067 **\$11.50**  
**FLANGE TYPE—140 CFM, 3 1/2" Intake, 2 1/2" Dis.** Complete size: 8 1/2" W. x 7 1/4" H. x 6 3/8" D. Order No. 1C807 **\$13.95**  
**FLANGE TWIN—275 CFM, 4 1/2" Intake; 3 1/4" x 3" Dis.** Complete size: 11 3/4" W. x 9 3/8" H. x 8 1/16" D. No. 2C069. **\$21.95**



**MINIATURE BLOWERS:**

24 VDC; Oblong Outlet 1 1/2" x 3/8". Dual 10 CFM. **\$7.95.** Single 10 CFM. **\$5.95.**



**ANTENNA EQUIPMENT**

**MAST BASES—INSULATED:**  
 MP-22 MAST BASE—Insulated spring action. Direction of bracket can be lowered or raised easily. Receives mast sections listed below. Price **\$2.95**  
 MP-132 MAST BASE. **\$3.95**  
 MP-S-33 BASE—Insulated type with heavy coil spring and 5" dia. insulator. Requires 2" hole for mounting. Weight: 9 lbs. **\$5.95**  
 MP-9 BASE—Insulated type base with heavy coil spring. Requires 1 3/4" mounting hole. Weight: 11 lbs. **\$6.95**  
 MP-37 BASE—Insulated type with heavy coil spring; 7" dia. insulator; requires 1 3/8" hole for mounting. Weight: approx. 10 lbs. **\$8.95**

**MAST SECTIONS FOR ABOVE BASES:**  
 Tubular steel, copper, coated, painted in 3 ft. sections, screw in type. MS-53 can be used to make any length with MS-52-51-50-49 for taper. Any section. @ 50c each. Larger Diameter Section: MS-54 **\$1.25**

**COAXIAL CABLE & CONNECTORS:**



**CD-1071 CORD**—With PL-259 Plugs each end. Removable Vinylite Covering over Plugs. 50 ohm coax. 2 Ft. long. Price: 59c Each—Or Lots of 10 @ 50c Ea.  
**PL-259**—Plug ea. end & 32"—RG-54/U—58 ohm. 50c  
**UG-21/U**—Plug ea. end & 32"—RG-11/U75 ohm. 50c  
**UG-22/U**—with 1" Coaxial Cable. **50c**  
**RG-8/U (SPECIAL)** 51.5 ohm. Same size as RG-8/U. Prices: 1 to 100 ft. @ 8c per ft.—100 to 500 ft. @ 7 1/2c per ft.—500 to 1000 ft. @ 7c per ft.—1000 ft. (Rolls or more) @ 6 1/2c per ft.  
**RG-34/U**—71 ohm, 145 ft. length. **\$15.00**

**NEW—LOW—LOW PRICES**

**ARC-5 COMMAND EQUIPMENT:**  
 R-25/ARC-5 Rec. 1.5 to 3 MC. No Tubes. Used: **\$14.95**  
 R-26/ARC-5 Rec. 3 to 6 MC. No Tubes. Used: **7.95**  
 R-27/ARC-5 Rec. 6 to 9 MC. No Tubes. Used: **6.95**  
 R-28/ARC-5 Rec. 100 to 156 MC. No Tubes. Used: **12.95**  
 T-20/ARC-5 Trans. 4 to 5.3 MC. **New: 16.55**  
 T-22/ARC-5 Trans. 7 to 9 MC. **Used: 14.95**

**274-N COMMAND EQUIPMENT:**  
 BC-454 Rec. 3 to 6 MC. **Used: \$10.95**  
 BC-455 Rec. 6 to 9 MC. **Used: 9.95**  
 BC-458 Trans. 5.3 to 7 MC. **Used: 9.95**  
 BC-459 Trans. 7 to 9 MC. **Used: 14.95**  
 BC-456 Modulator. **Used: 2.95**  
 FT-225 Mtg. F/BC-456. **Used: 50c. New: .95**  
 FT-220 3 Rec. Rack. **Used: \$1.50. New: 2.50**  
 FT-221 3 Rec. Shock. **Used: 50c. New: .95**  
 BC-450 3 Rec. Cont. Box. **Used: \$1.50. New: 2.00**  
 BC-451 Trans. Cont. Box. **Used: \$1.00. New: 1.50**  
 PLUG—Male for rear of Rec. or Trans. **Used: .55**  
 DM-32 Dynamtr F/Rec. 24V. **Used: \$2.95**  
**New: 6.95**  
 DM-33 Dynamtr F/Modulator & Trans. **Used: 2.95**

**MOTORS: 24 VDC Reversible**

**MOTOR**—3.7 RPM, 40 lb. Torque Motor Size: 5 1/2" x 4 1/2" x 3 5/16". Shaft size: 21/32" x 5/16". Also operates 24 VAC. Philco No. 441-1008 **\$5.95**  
**27.5 VDC**—6000 RPM. 1.5 oz. in. Shaft Size: 1 1/4" x 1/4". Motor Size: 2 1/2" x 1 1/2". No. 5069-267 **\$6.95**  
**27 VDC**—10 HP—3500 RPM. Shaft Size: 5/8" x 1/4". Motor Size: 4" x 3 1/2". Air Assoc. No. EE-763. **\$6.95**  
**80 VDC**—1/50 HP—3000 RPM. Shaft Size: 3/8" x 1/4". Motor Size: 5" x 3". G.E. No. 5 PN381A10. **\$8.95**  
**28.5 VDC**—1/35 HP—2200 RPM. Shaft Size: 1 1/4" x 1/4". Motor size: 4 1/2" x 3 3/4". Electroflux No. 16878 **\$5.95**  
**2800 RPM Reversible Motor**—Size: 5 1/4" x 3 1/2". Shaft Size: 1" x 1/4". Emerson No. 186-0412—Price **\$5.95**  
**GEAR HEAD** for above motor. Ball Bearing Geared Shaft. 10 to 1 reduction. Price: **\$5.95**  
**COMBINATION:** Motor & Reduction Gear. **\$10.00**  
**21 VDC OPEN FRAME—20 IHP Double Shaft Back Gear Motor** with Disengage Clutch. Shaft size: 1 1/2" x 3/16". **\$6.95**  
**24 VAC OPEN FRAME—3 RPM Back Gear Motor.** Shaft size: 1 1/2" x 3/16". Price: **\$5.95**  
**24 VDC REVERSIBLE—6000 RPM** with Magnetic Brake. Flange Mount Spline Shaft—size: 5/8" x 3/16". Motor: 4" L. x 2 1/2" Dia. GE Motor only #5BA25AJ32A. Price: **8.95**  
**24 VDC AIRWAY MOTOR**—Model #Z-350. Approx. 5000 IHP. Motor size: 2 1/2" x 1 5/8". Shaft size: 1/2" x 1/4". Price: **4.95**  
**26 VOLT 60 CYCLE—80 RPM Synchronous Cramer Motor #1147.** Shaft size: 1" x 1/8". Price: **\$4.95**  
**110 VDC 1/70 HP, 1550 RPM.** Motor size: 4" x 2 1/2". Shaft size: 1" x 3/16". Redmond #157. **\$4.95**  
**6 VDC 1/20 HP, 4000 RPM.** Motor size: 5" x 3". Shaft size: 3/4" x 1/4". Redmond #E-56. Price: **\$4.95**  
**12 VDC 1/30 HP, 4500 RPM.** Motor size: 3" x 2 1/2". Shaft size: 1" x 3/16". Delco #5017520. **\$4.95**  
**A.C. INDUCTION MOTOR** 115 Volt, 60 cycles, 1.9 RPM—Torque Oz. In. 75; Watts—9; with variable Multiple Disc Coder Wheel and Micro Switch mounted on Bracket Assy. Holtzer Cabot Motor Type RWV 2505 **\$14.95**  
**GEARED HEAD MOTOR**—Heavy Duty, 24 VDC 8 Amp, 2 1/2" Dia. Torque: 100/200 RPM. Shaft size: 5/16" x 1". Right Angle Drive **\$8.95**

**INVERTERS:**

**5D21N13A—27 VDC input; output 110 Volt 400 cycle.** 1 Phase 485 VA. **\$39.50**  
**PE-109D—Input 13.5 VDC 29 A; output 115 V 400 cycle.** 1 Phase 1.53 Amps. **\$59.50**  
**PU-7/AP—Input 28 VDC 160A; output 115 V 21.6 A 400 cycle 2500 VA.** **\$89.50**  
**PE-118 Y—Input 28 VDC 100 A; output 115 V 400 cycle.** 1 Phase 1500 VA. **Used: \$14.95**  
**PE-218—Input 28 VDC 100 A; output 115 Volt 400 cycle.** 1 Phase 1500 VA. **Used: \$24.95**  
**NEW: \$49.95**  
**PE-115 or PE-206—Input 28 VDC 36 A; output 80 Volts 800 cycle 7.2 Amps.** Like New: **\$12.95**  
**TYPE 800-1-D—Input 28 Volts 62 A; output 115 V 7 Amps, 1 Phase 800 cycle.** **Used: \$39.95**  
**NEW: \$75.00**

**FREE SURPLUS CATALOG**

Full of Real "BUYS"! Send for your FREE copy now!

ADDRESS DEPT. E • All Prices Are F.O.B., Lima, Ohio • 25% Deposit on C.O.D. Orders

**FAIR RADIO SALES • 132 SOUTH MAIN ST. LIMA, OHIO**

**INDEX SEARCHLIGHT**

APRIL, 1954

This index is published as a convenience to the readers. Care is taken to make it accurate but ELECTRONICS assumes no responsibility for errors or omissions.

PROFESSIONAL SERVICES ..... 405

EMPLOYMENT  
 Positions Vacant.....406-415  
 Selling Opportunities Offered.....406, 412  
 Positions Wanted.....406  
 Selling Opportunities Wanted.....406

EQUIPMENT  
 (Used or Surplus New)  
 For Sale.....415-438

WANTED  
 Equipment.....414

**ADVERTISERS INDEX**

Aaron Electronics Sales.....434  
 Algeradio Electronics Co.....434  
 Allied Electronics Sales.....431  
 Alltronics.....434  
 Ansell Engineering Co.....406  
 Arrow Sales, Inc.....432  
 Associated Industries.....428  
 Avionic Associates.....432

Barry Electronics Corp.....429  
 Bendix Aviation Corp., Pacific Div.....410  
 Bendix Aviation Corp., Research Laboratories.....414  
 Bendix Aviation Corp., York Div.....411  
 Bendix Radio Div. of Bendix Aviation Corp.....413  
 B & B Distributors.....429  
 Blan.....428

Capchart-Farnsworth Corp.....415  
 Capt. Joe.....434  
 C & H Sales Co.....423  
 Chase Electronic Supply Co.....433  
 Collins Radio Co.....413  
 Communications Equipment Co.....420, 421  
 Communications Devices Co.....433  
 Compass Communications Co.....437  
 Connector Corp. of America.....427  
 Continental Radio Co.....430  
 Convoir.....411  
 Cornell Aeronautics Laboratory Inc.....411  
 Cramer Electronics Inc.....431

Dalmo Victor Co.....406  
 Delco Radio Division General Motors Corp. 410

Electronic Engineering Co. of California... 410  
 Electron Tube Wholesalers Inc.....432  
 Electroncraft Inc.....417  
 Electronics Inc.....433  
 Emelton Electronics Co.....433  
 Empire Electronics Co.....432  
 Engineering Associates.....429



# TO THE ADVERTISERS

APRIL, 1954

SEARCHLIGHT SECTION  
(Classified Advertising)  
H. E. Hilty, Mgr.



# COMPASS COMMUNICATIONS CO.

A Division of COMPASS ELECTRONICS CORP.

A WELL-INTEGRATED ORGANIZATION WITH FACILITIES AND  
TRAINED PERSONNEL FOR—

- DESIGN, MODIFICATION, PRODUCTION, AND TESTING OF COMMUNICATIONS AND RADAR EQUIPMENT
- SUPPLY AND DISTRIBUTION OF ALL TYPES OF EQUIPMENT AND TUBES

WE MAINTAIN OUR OWN FULLY EQUIPPED TESTING LABORATORY TO TEST AND GUARANTEE ANYTHING WE SELL

Fair Radio Sales..... 436  
Fay-Bill Distributors..... 424  
Finnegan, H..... 414  
Ford Instrument Co..... 412

Caucher, Louis E..... 414  
Goodyear Aircraft Corp..... 407

Harjo Sales Co..... 424  
Hershel Radio Co..... 418  
Hoffman Laboratories Inc..... 406  
Houde Supply Co..... 427

ISH Sales Corp..... 427

Kollsman Instrument Co..... 412

Lapirow Bros..... 427  
Lectronic Research Laboratories..... 419  
Legri, S. Co..... 431  
Liberty Electronics Inc..... 435

Maclen Corporation..... 406  
Martime Switchboard Co..... 426  
Maxson Corp., W. L..... 410  
Medical Salvage Co..... 428  
Melpar, Inc..... 408  
Merrick Electronics..... 429  
Milgray Electronics Inc..... 415  
M. I. T..... 408, 410  
Mogull Co., A..... 431  
Monmouth Radio Labs..... 430

National Cash Register Co..... 408  
New York Electronics..... 427  
Nibur Sales Corp..... 425

Pan-Electronics Corp..... 414

Radalab..... 422  
Radio Corporation of America..... 409, 412  
Radio & Electronic Surplus..... 434  
Radio Research Instrument Co..... 425  
Radio Shack Corp..... 426  
Railway Communications Inc..... 434  
Reliance Merchandizing Co..... 416  
R. W. Electronics..... 432

Semler Industries Inc..... 430  
Servo-Tek Products Co., Inc..... 428

"TAB"..... 438  
Trans-World Electronics Co..... 432

Universal General Corp..... 421  
U. S. Crystals, Inc..... 415

Victor-Bernard Industries..... 433

Western Engineers..... 422  
Weston Laboratories Inc..... 414, 426  
White-Rodgers Electric Co..... 414  
Wilcox Electric Inc..... 413  
Wright Associates..... 406

## THIS MONTH'S SPECIAL OFFERS

**TS-69/AP FREQUENCY METER**, Range 340-1,000 mcs. Uses 0-200 microammeter; Excellent..... **\$75.00**

**SN—RADAR—10 cm**—Compact, light and portable, ranges of 5 and 20 miles. Uses 5CPI scope. Operation is from 115 volts, 60 cycle, but we can supply converter for dc operation. **\$850.00 ea**

**ANTENNA ASSEMBLY**—Reflector is a light-weight parabolic cylinder, Ass'y has both manual and motor drive. Ideal unit for labs, classroom demonstration, small craft, etc. **\$99.50 ea**

**APR-4—38—4000 mcs.** precision receiver, complete w/5 tuning units. Operates on 115/1/60..... **\$1700.00 ea**

**MAG—10cm. remarkable link radar**, portable, operated from 6 volt battery, uses folding antenna and tripod. A pair at..... **\$1750.00**

**APS-3—3 cm**—Airborne radar for search and homing, 5-in. scope. 10 brand new sets at **\$750.00 ea**

**APQ-13**—Very late model airborne radar set, complete and new. One only at..... **\$2,950.00**

**SCR-545**—Complete radar set, less vehicle, antenna and power plant, pretty fair condition, sold as-is at..... **\$1,375.00**

## MOTOR GENERATORS CONVERTERS • INVERTERS DYNAMOTORS

We Have One of the Largest Stocks of Electrical Conversion Equipment in the East, including All Types of Rotating Machinery and a Variety of DC and AC Magnetic Starters and Controllers from 100 Watts to 100 Kilowatts

**MOTOR GENERATOR**, in 115 vac, out 220-250 vdc, @ 1/2 KVA..... **\$65.00**

**ESCO ROTARY CONVERTERS**—Mounted in Steel Drip-Proof Boxes—Type R-1-41. Filtered Input 110 volts, 2.5 amps, 3600 rpm. Output 110/1/60 @ 1.8 amps, 200 watts..... **\$45.00**

**ESCO MOTOR GENERATORS**—Dual unit (a) 1.5 amps, 165 va 150w, 1800 rpm. (b) Input 32 volts dc @ 16 amps. Output 260 volts, 1500 cycles @ 4 amps. Rating 1.05 kva, 3,000 rpm. Filtered. These two units are mtd. together on bed plate, complete with control panel containing switch & 0-50 v dc meter. **\$32.50 ea, part.**

**MOTOR - GENERATOR - ALTERNATOR**—Mfrg.—Quality Electric Co. Ltd. Input 115/1/60 ac @ 22.5 amps, 1800 rpm. Outputs: #1.500/1000 v dc, 0.25/0.3 amp., 0.125/0.3 kw. #2 150 v dc, 0.667 amp., 0.1 kw. #3. 115 v ac, 0.87 amp., 3000 cycles, 0.1 kva. PF-1..... **\$245.00**

**ESCO CONVERTER**—Input 110 volts dc. output 110 volts ac @ 1.2 amps. Brand new..... **\$45.00**

**ALLIS CHALMERS CONVERTER** 110 volts dc to 110 volts ac @ 1.25 kva output..... **\$165.00**

**PINCOR ROTARY CONVERTER**—Input 110 volts dc. Output 220/1/60, 300 kva, 90 pf; 3000 rpm; cont. duty, 40°C. Filtered for Radio use..... **\$60.00**

**CONTINENTAL MOTOR-GENERATOR** — 350 watts. Type CC-21991—Wt. 148 lbs. Input 115 volts dc @ 5.7 amps, 0.625 hp. Output 115 volts ac, 1 ph., 60 cycles @ 3.04 amps, 1800 rpm, 0.85 pf, 40°C temp. rise, sep. excited. Filtered..... **\$95.00**

**WESTINGHOUSE ELECTRIC GENERATOR—10 KVA—AC**. Output 115/1/60 @ 108.5 amps. 80 pf; 50°C; cont. duty 1800 fpm, sep. excited, 125 dc. DC generator Output 125 volts dc @ 8 amps. This generator is mounted on bed plate with room for motor mounting. It can be driven by any mechanically coupled motor, dc or ac on other drive..... **\$459.00**

**MOTOR GENERATOR 800-1D** — Input 24-28 volts dc. Output 115 v, 800 cycles at 10.5 amps. Small and compact..... **\$29.50**

**M-209—Holtzer-Cabot**—Filtered. Input 115/1/60. Output 115 volts, 3ϕ, 233 cycles; at 0.4 amps and 24 volts dc at 6.5 amps..... **\$125.00**

**MG-149**—Holtzer-Cabot Inverter..... **\$49.50**

**2J1F1 SELSYN**—115-57.5v. 400 cycles **\$4.45**

**SF, 5G—SYNCHRO**—115 v, 60 cycles **\$30.00**

**POWER UNIT TYPE 23**—Rotary transformer, filtered. Input 24 vdc. Output 6.3 volts at 2 amps and 200 volts at 30 ma..... **\$19.50**

And, of course, PE-73, PE-94, PE-98, DM-25, -28, -32, -33, etc.

## SPECIAL PURPOSE and TRANSMITTING TUBES

This Is A Sample Listing • Write for Other Items & Unlisted Prices

Tube #	Selling Price	Tube #	Selling Price	Tube #	Selling Price	Tube #	Selling Price	Tube #	Selling Price
O1A	write	2J56	145.00	4J29	175.00	415GL	37.50	833A	39.50
OC3	51.60	2J61	55.00	4J30	write	446A	2.00	836	3.95
OD3	1.50	2J62	55.00	4J31	175.00	446B	3.75	837	1.45
C1A	6.00	2K22	write	4J33	190.00	450H	45.00	843	5.00
C1B	7.00	2K25	26.00	4J34	195.00	450TL	45.00	849	27.50
C5B	2.95	2K26	100.00	4J42	225.00	464A	9.50	851	45.00
C6A	write	2K29	35.00	4J51	300.00	705A	3.25	860	5.00
C6F	12.50	2K36	write	4J52	285.00	706A-GY	45.00	861	25.00
C6J	write	2K45	100.00	5J23	write	707B	12.50	865	1.25
10Y	.90							872A	3.85
1R-92	4.90							874	1.50
1B22	3.95							889R	195.00
1B23	10.00							891R	210.00
1B24	write							892	150.00
1N23B	2.50							892R	250.00
2B22	4.95							2X2879	1.05
2B26	3.75							1616	2.75
2C40	18.00							1619	.75
2C44	1.20							1624	2.00
2C43	25.00							1625	.65
2D21	1.70							1626	.75
2D29								1629	.65
2E22	3.75							1636	1.50
2J21	17.50							1642	3.50
2J22	17.50	2K54	150.00	5J26	125.00	715B	17.50	2050	2.00
2J26	27.50	2K55	100.00	5J29	write	717A	1.50	5611	100.00
2J27	27.50	3B24	5.40	6C21	29.50	720Y	write	8012	4.25
2J31	27.50	3B27	10.00	100TH	9.00	720DY	90.00	8014A	55.00
2J32	27.50	3B28	5.00	204A	60.00	721A	3.75	8020	3.50
2J33	35.00	3C31	5.75	211	1.00	723A/B	25.00	8025	7.00
2J34	write	3E29	14.00	250TH	30.00	724B	6.50	9001	1.20
2J36	100.00	4C27	25.00	250TL	30.00	725A	write	9002	1.00
2J38	49.50	4C28	35.00	304TH	9.75	730A	45.00	9003	1.20
2J39	49.50	4D32	22.50	304TL	9.75	803	7.00	9004	.50
2J42	75.00	4E27	17.50	307A	5.00	807	1.65	9005	1.90
2J49	65.00	4J25	175.00	339A	35.00	813	9.00	9005	1.90
2J50	75.00	4J26	175.00	371B	2.50	829A	12.00	9006	.50
2J55	62.50	4J28	175.00	388A	2.75	832A	10.00		

**APPLY 15% REDUCTION TO ALL TUBE PRICES. WE WERE TOO LATE TO CHANGE THIS COPY.**

All Tubes Guaranteed • All Prices Are FOB Our Warehouse and Subject To Change Without Notice

OUR EXPORT DEPARTMENT AVAILABLE FOR SPECIAL SERVICE TO OVERSEAS CUSTOMERS

**393 GREENWICH STREET**      **NEW YORK 13, N. Y.**  
All phones: BEEKMAN 4-6509      Cable Address: COMPRADIO, N. Y.



SEARCHLIGHT SECTION

Industrials Write On Your Letter-head for Power Rectifier Catalog



SELENIUM RECTIFIERS

We specialize in Rectifiers and Power supplies to your specifications. Immediate delivery.

Table with columns: Current, Volt, Amps, Volts, Amps, Volts. Lists various rectifier specifications.

HIGH CURRENT PWR SUPPLIES

Table with columns: Stock Number, Rating, With Meters. Lists power supply models and prices.

RECTIFIER XFEMRS

Table with columns: Current, Amps, Volts. Lists rectifier specifications.

RECTIFIER CHOKES

Table with columns: Amp, Ohm, Price. Lists rectifier choke specifications.

OIL CONDENSERS

Table with columns: Stock Number, Rating, Price. Lists oil condenser models and prices.

OIL CONDENSER SPECIAL

10 MFD 600 VDC \$1.75 ea. LOTS OF 3.

CIRCUIT BREAKERS

Heinmann Miniature Amps 1/2, 3/4, 1, 2, 3, 4, 5, 10, 20, 30, 40, 80, 180 EA. \$1.69; 10 for \$15.98.

INFRARED SNOOPSCOPES

SEE IN DARK TUBE. Infrared Snoopscope Tube Hi-Sensitivity special design 2 dia.

THERMISTORS-VARISTORS

Table with columns: Part Number, Description, Price. Lists thermistor and varistor models.

MICROWAVE FLANGES AND WAVE GUIDE

Table with columns: Part Number, Description, Price. Lists microwave flange and waveguide models.

FLEXIBLE WAVE GUIDE

Table with columns: Part Number, Description, Price. Lists flexible waveguide models.

MICROWAVE

Klystron Mts Assy (723AB) & Coupling to Waveguide Co. Fitting - An Show \$132.98

CRYSTAL DIODES

Table with columns: Part Number, Description, Price. Lists crystal diode models.

TAB THAT'S A BUY

WATCH! THIS SECTION For Tremendous Bargain Prices

Table with columns: MFD, Volts, Freq, List Price, Tab Price. Lists mica condenser specifications.

VARIABLE VOLTAGE TRANSFORMERS

Table with columns: Case, Voltage, Price. Lists variable voltage transformer models.

DC POWER-SUPPLY

Table with columns: Model, Voltage, Price. Lists DC power supply models.

"TAB" BUYS

Table with columns: Part Number, Description, Price. Lists special buy items.

TUBES

"TAB" TESTED & GUARANTEED

PRICES SUBJECT TO CHANGE

WRITE FOR COMPLETE TUBE LISTING

Large table listing various vacuum tube types and their prices.

TRANSFORMERS

All 115 V. Cyc. Input TV & CR Pwr Xmr up to 50 tubes. Hi VOLTS to 20 KV w/quadrapler...

FILTER CHOKES

12 Hy/800mA/3K Vins... 2.25

FILAMENT TRANS.

2.5VCT/10A 5K VINS... 3.59

TRANSFORMER SPECIAL!

6.3 Volt 3 1/2 Amp CONTINUOUS DTY. 115VAC Input

STORAGE BATTERIES

2V/20AH Willard PL US 2V. Vibrator... \$2.98

PRECISION RESISTORS

FOUR MILLION IN STOCK All 1% Accuracy GVD. ORDER ANY VALUE. We have ITI REGULARLY SOLD FOR 60c AND UP

TACHOMETER GENERATOR-DC

MARK V STUD MTG GENERAL ELECTRIC Co. Part No 20M5-AAK-20. Brand New, Original Carton

HI-MEG HI-VOLT RESISTORS

Table with columns: Resistance, Voltage, Price. Lists HI-MEG resistor specifications.

NEW RELAY LIST

Tremendous Bargain Prices. R15T1 Stevens Arnold Resonant Relay... R2WE1 Western Elect Mercury Relay...

TUBE SOCKETS

CINCH-NATCO-JOHNSON-AMPH

EQUIV TO JOHNSON AS INDICATED

Table with columns: Part Number, Description, Price. Lists tube socket models.

POTENTIOMETERS

Table with columns: Resistance, Price. Lists potentiometer specifications.

TUBE SOCKETS

CINCH-NATCO-JOHNSON-AMPH

EQUIV TO JOHNSON AS INDICATED

Table with columns: Part Number, Description, Price. Lists tube socket models.

PRECISION LAB POTENTIOMETER

WIRE WOUND 20,000 OHM 25 WATT 1% 10 for \$30.00

NEW RHEOSTAT LIST

Priced Below Manufacturer

Table with columns: Resistance, Price. Lists rheostat specifications.

Large advertisement for TAB tubes with text: THAT'S A BUY "TAB" THAT'S A BUY. Dept. 4E 111 Liberty Street, New York 6, N. Y., U. S. A.

NEW RHEOSTAT LIST

Priced Below Manufacturer

Table with columns: Resistance, Price. Lists rheostat specifications.

PRECISION LAB POTENTIOMETER

WIRE WOUND 20,000 OHM 25 WATT 1% 10 for \$30.00

NEW RHEOSTAT LIST

Priced Below Manufacturer

Table with columns: Resistance, Price. Lists rheostat specifications.

Money Back Guarantee (Cost of Mds. Only) \$5 Min. Order FOB N. C. Add Ship. Charges or 15% Prepaid Mds. USA only. Prices Subject to Change Without Notice.





# Precision DC Power Supply for Electronic Equipment

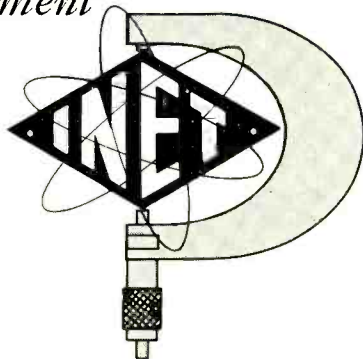
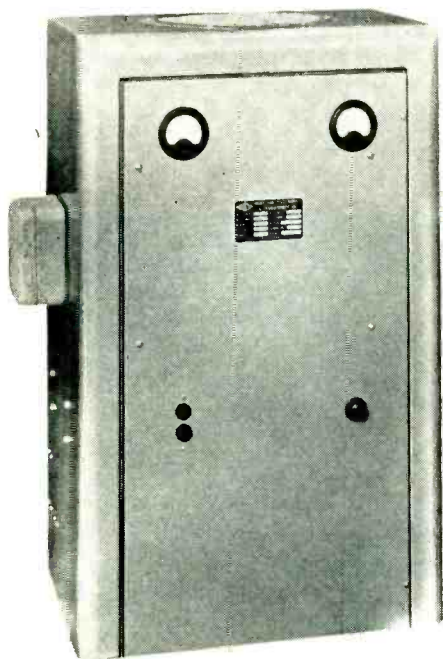

◆ Efficient, closely regulated selenium rectifiers for all types of computers, business machines and other electronic equipment.

Low initial cost... low maintenance, units have no moving parts or vacuum tubes.

Compact, completely self-contained, protected... magnetic amplifier controls... fully regulated DC power supply.

Optional steel cabinets for floor-standing, wall or caster-mounted.

Output ratings from 5 to 500 VDC at 5 to 200 Amps continuous.



Complete engineering specifications available upon request.

**DIVISION OF LEACH CORPORATION**  
4441 Santa Fe Ave., Los Angeles 58, Calif.  
Telephone LOgan 8-4771

Eastern Precision Resistor Co.	402
Eastman Kodak Co., Special Products Sales Div.	207
Edo Corporation	122
Eicor, Inc.	234
Eisler Engineering Co., Inc.	369, 404
Eitel-McCullough, Inc.	109, 327
Eleo Corporation	359
Electran Mfg. Co.	351
Electric Regulator Corp.	372
Electrical Industries, Div. of Amperex Electronic Corp.	123
Electrical & Physical Instrument Corp.	369
Electro-Measurements, Inc.	395
Electro Products Laboratories	365
Electro Tee Corp.	50
Electronic Transformer Co.	32
Electrons, Inc.	228
Elly Electronics Corp.	367
Engineering Research Associates, Div. of Remington Rand, Inc.	381
Epeo Products, Inc.	359
Erie Resistor Corporation	69

Fairchild Camera & Instrument Corp.	41, 45
Fansteel Metallurgical Corp.	314
Federal Telecommunication Laboratories	375
Federal Telephone & Radio Corp.	255
Freed Transformer Co., Inc.	125
Frenchtown Porcelain Company	365
Fugle-Miller Laboratories	267

Gabriel Electronics Div., Gabriel Co.	298
Gamewell Company	258
General Electric Co.	
Apparatus Dept.	75, 90, 215
Electronics Dept.	85
Tube Dept.	31
Gee-Lar Manufacturing Co.	300
General Ceramics & Steatite Corp.	100
General Industries Co.	329
General Magnetics Inc.	393
Giannini & Co., Inc., G. M.	390, 396
Gilfillan Bros.	352
Good-all Electric Mfg. Co.	112
Goodmans Industries Limited	62
Grayhill	385
Gray Research & Development Co., Inc.	103
Greater Lawrence Citizens Committee	357
Green Instrument Co., Inc.	357
Gries Reproducer Corporation	370
Guardian Electric Mfg. Co.	263

Hammarlund Manufacturing Co., Inc.	23
Haudy & Harman	319
Harder Co., Donald C.	381
Hart Manufacturing Company	318
Harvey Hubbell, Inc.	230
Haydon Company, A. W.	385
Heath Company	343
Heiland Research Corp.	204
Heinemann Electric Co.	63

## New Catalog answers O-ring questions

You'll find complete installation data—and the answers to most O-ring questions—in the new O-ring catalog 9-B given free by Minnesota Rubber. No matter how tough your O-ring problem, rest assured that Minnesota Rubber will find the best answer at the lowest possible cost.

Minnesota Rubber is the world's largest manufacturer of O-rings. Many are used today in the finest electrical systems. Write today for complete details. Don't forget to request your free catalog 9-B, "O-rings."

### Minnesota Rubber and Gasket Company

3630 Wooddale Avenue, Minneapolis 16, Minnesota,  
Dept. 311. Phone Mohawk 9-6781



Heldor Mfg. Corporation	49
Helipot Corporation, a Div. of Beckman Instruments, Inc.	199
Henry & Miller Industries, Inc.	404
Heppner Manufacturing Co.	284
Hewlett-Packard Company	41, 57
Heyman Manufacturing Co.	361
Hopkins Engineering Co.	355, 386
Hughes Aircraft Company	217
Hughes Research & Development Labs.	216
Hycor Sales Co. of California	300

Ideal Industries, Inc.	303
IlSCO Copper Tube & Products, Inc.	316
Industrial Condenser Corp.	208
Industrial Development Div., State of Florida	380
Indiana Steel Products Co.	52, 53
Industrial Hardware Mfg. Co., Inc.	369
Inet Div. of Leach Corporation	440
Infra Electronic Corp.	388
Instrument Resistors Co.	291
Insulated Circuits, Inc.	377
International Electronic Research Corporation	347
International Rectifier Corp.	96
International Resistance Co.	28, 29
Ippolito & Co., Inc., James	345
Iron Fireman, Electronics Div.	256

Jelliff Mfg. Corp., C. O.	384
Johnson Co., E. F.	348
Jones Div., Howard B. Cinch Mfg. Corp.	367

Kahle Engineering Co.	13
Kalbfell Laboratories, Inc.	325
Karp Metal Products Co., Div. of H & B American Machine Co.	297
Kartron	404
Kearfott Company, Inc.	356
Kellogg Company, M. W.	64A, 64B
Kepeco Laboratories	89
Kester Solder Company	243
Keystone Electronics Company	353
Kinney Mfg. Div., New York Air Brake Company	97
Knights Company, James	282
Kelied Kords, Inc.	310
Kollmorgen Optical Corp.	308
Kringel Manufacturing Co., Inc.	267

Laboratory for Electronics, Inc.	209
Lampkin Laboratories Inc.	357
Landis & Gyr, Inc.	391, 403
Lapp Insulator Co., Inc.	264
Lavoie Laboratories, Inc.	295
Lewis & Kaufman, Ltd.	201
Lindgren & Associates, Erik A.	395

what is

available from **Pyramid**

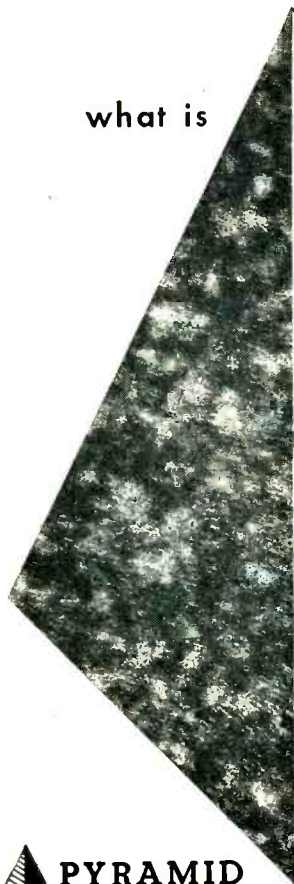

Burton Browne advertising

The security of experience. Pyramid has more experienced personnel (in years of actual designing and manufacturing of capacitors) than any other manufacturer.

The control of specially designed facilities. Pyramid is the only manufacturer of capacitors whose plants were planned and built specifically for the entire manufacturing process of capacitors from drawing board conception through reception of raw materials, fabrication, packaging and shipment.

The guarantee of one standard. All Pyramid capacitors are one quality, made of the same quality materials demanded by rigid military specifications. Pyramid capacitors have a low leakage factor due to the non-hygroscopic insulating material used on all production. Pyramid delivers the best at no premium.

A complete line of capacitors—full ranges in all ratings and types.



**PYRAMID**

**ELECTRIC COMPANY**

1445 HUDSON BOULEVARD • NORTH BERGEN, N. J., U. S. A.

**BOESCH**  
*Sub-Miniature Toroidal Coil* \*  
**WINDING MACHINES**

Model SM-A designed especially for winding of sub-miniature sized coils. Finished windings up to 1" O.D. to as small as 1/16" nominal hole size. Wire range #34 through #44 AWG. Speed variable.



\*Available to licensees of the Western Electric Co., Inc.

Designers and Builders of coil winding machinery, special machinery and equipment. Write for brochure.

**WORLD'S MOST VERSATILE WINDING MACHINES**





## feed-through insulators

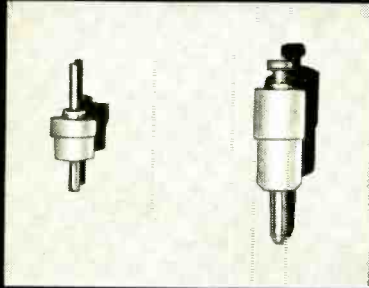

### COMPRESSION TYPE

Miniature, TEFLON insulated. Sturdy—shock and vibration proof. Enable quick easy miniaturization. Unexcelled electrical properties for high frequency, high temperature, high voltage use. Unaffected by a wide range in ambient temperatures, pressure altitudes and humidity. Press-fit fastening requiring no additional hardware.

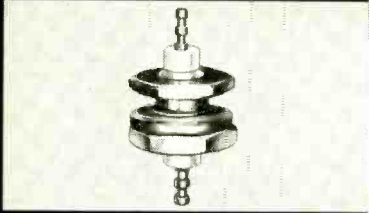

### THREADED BODY TYPE

Metal body fits through bed-plate and is fastened by hex nut. Terminal which passes through hollow body is spaced by TEFLON plug. Combines excellent insulating properties of TEFLON with mechanical ruggedness unusual in miniature insulator design.

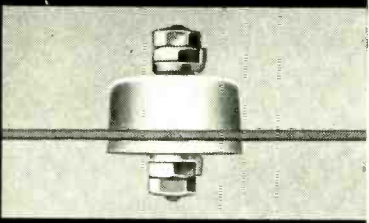

### GASKET TYPE

Moisture-proof and oil-proof TEFLON insulated sealed units utilizing silicone rubber "O" Rings. Withstand thermal and mechanical shock, vibration, extreme ambient temperatures and climatic conditions. Easy to assemble and disassemble.

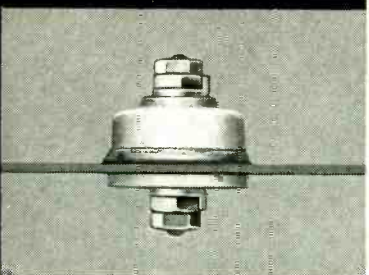

### HERMETIC SEAL TYPE

Provide a fluorocarbon-metal fused seal permitting the TEFLON insulators to be soldered directly to the deck. This seal is capable of holding a vacuum for sustained periods and of withstanding mechanical and thermal shock, vibration, high and low ambient temperatures and extremes of climate.

# UNITED STATES

FLUOROCARBON PRODUCTS INC. DIVISION  
CAMDEN 1, NEW JERSEY

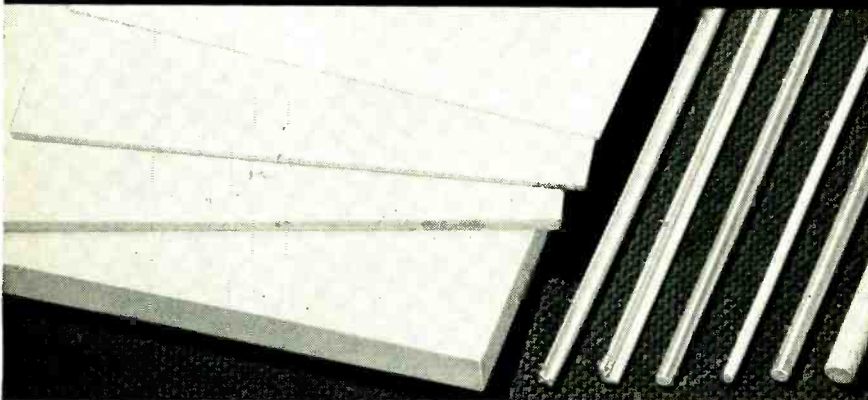

TEFLON sheets and a complete line of Rods, Bars, Cylinders, Tubing—are available for all electrical and electronic requirements.

Link Aviation, Inc.	70
Lockheed Missile System Division	378, 379
Lord Mfg. Co.	87

MacDonald Co., Inc., W. S.	383
Machlett Laboratories, Inc.	211
Magnatran Incorporated	287
Magnecord Inc.	254
Magnetics Inc.	203
Mallory & Co., Inc., P. R.	128, 195, 387
Marconi Instruments	102
Marion Electrical Instrument Co.	108
McCoy Electronics Company	278
McGraw-Hill Book Co.	398
Measurements Corporation	391
Mepeco, Inc.	271
Metal Textile Corporation	312
Metals & Controls Corp., General Plate Div.	54
Methode Manufacturing Corp.	362
Meyercood Co., The	363
Mica Insulator Co.	229
Mico Instrument Co.	385
Microdot Div. Felts Corp.	349
Microswitch, a Div. of Minneapolis-Honeywell Regulator Co.	48
Microwave Associates Inc.	101
Midland Mfg. Co., Inc.	225
Millen Mfg. Co., Inc., James	286
Millvac Instrument Corp.	344
Minneapolis-Honeywell Regulator Co. Aero Div.	360
Industrial Division	64
Minnesota Rubber & Gasket Co.	440
Minnesota Silicone Rubber Co.	343
Mission-Western Engineers, Inc.	336
Moloney Electric Company	116
Monsanto Chemical Co., Plastics Div.	257
Muirhead & Co., Limited	3

National Company, Inc.	354
National Moldite Co.	249
National Pneumatic Co., Inc., & Holtzer-Cabot Divisions	93
National Union Radio Corp.	79
Neomatic Inc.	361
New Hampshire Ball Bearings, Inc.	81
New Hermes Inc.	375
New London Instrument Co.	400
North American Research Labs, Inc.	392
Nothelfer Winding Laboratories	26

Ohmite Mfg. Co.	32A, 32B
Oster Mfg. Co. John	305

Panoramic Radio Products, Inc.	379
Peter Partition Corp.	287
Phalo Plastics Corporation	366



Phelps Dodge Copper Products Corp., Inca Manufacturing Div.....	82, 83
Pickard & Burns, Inc.....	326
Phileo Corporation.....	107
P M Industries, Inc.....	95
Polarad Electronics Corp.....	55
Polymer Corp. of Penna.....	250
Popper & Sons, Inc.....	389
Precision Apparatus Co., Inc.....	444
Precision Paper Tube Co.....	355
Presto Recording Corp.....	71
Prodelin, Inc.....	332
Progressive Manufacturing Co.....	262
Pyramid Electric Company.....	441
Pyroferrie Co.....	274

Quality Products Co..... 404

Radio City Products Co., Inc.....	341
Radio Corp. of America.....	265, 4th Cover
Radio Materials Corporation.....	259
Radio Receptor Co., Inc.....	118
Railway Express Agency, Air Express Div.....	233
Ram Meter, Inc.....	363
Raytheon Manufacturing Co.....	19, 337
Rees Mace Marine Ltd.....	106
Resin Industries, Inc.....	345
Resinite Corporation, Div. of Precision Paper Tube.....	400
Resistance Products Co.....	51
Resistoflex Corporation.....	342
Roanwell Corp.....	381
Royal Metal Mfg. Co.....	361

Sandia Corp.....	306
Sangamo Electric Company.....	328
Schwabacker & Co.....	401
Scientific Electric, Div. "S" Corrugated Quenched Gap Co.....	349
Scientific Radio Products, Inc.....	320
Servo Corporation of America.....	333
Shallcross Manufacturing Co.....	210, 321
Sigma Instruments, Inc.....	296
Signal Engineering & Mfg. Co.....	384
Simmons Fastener Corp.....	34
Sola Electric Co.....	56
Sorensen & Company, Inc.....	2
Southern Electronics Company.....	401
Sprague Electric Company.....	9, 99, 304
Stackpole Carbon Company.....	77
Standard Electric Time Co.....	40
Standard Piezo Company.....	359
Standard Telephones & Cables Ltd.....	266
Stanley Tools, Div. of Stanley Works.....	301
Stavid Engineering Inc.....	401
Sterling Engineering Co.....	275
Sterling Transformer Corp.....	291

# C hemelec

*stand-off insulators*

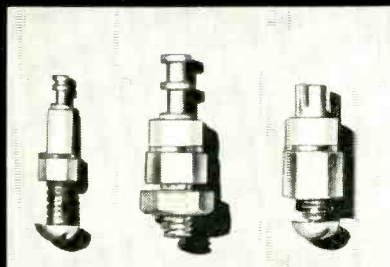

#### SCREW, STUD OR RIVET TYPE

These TEFLON insulated miniature stand-off insulators are designed for operation in pressure altitudes from 0 to 80,000 ft., ambient temperatures from minus 110°F to plus 500°F. Voltage breakdown after 95% humidity at 160°F is greater than 5,000 V-DC at sea level. Water absorption is zero.

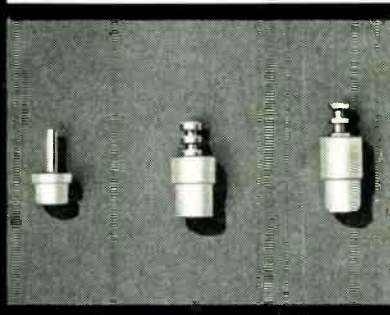

#### COMPRESSION TYPE

TEFLON Insulator body is compressed into mounting holes, making these miniature stand-off insulators self-fastening, requiring no additional hardware and speeding economical assembly. Electrical and physical characteristics are similar to insulator type mentioned above.

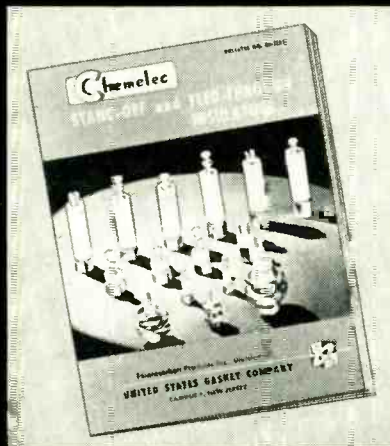

#### WRITE FOR NEW CATALOG

Bulletin No. EC-1153, a 12-page catalog on the complete line of C hemelec Stand-off and Feed-through Insulators—plus special electronic components and assemblies is yours for the asking. Write for your copy.



# GASKET COMPANY

FABRICATORS OF *du Pont* TEFLON, *Kellogg* KEL-F  
AND OTHER PLASTICS



Ask, also, about precision molded and machined TEFLON and KEL-F parts and special assemblies to customers' specifications.





# electronics READER SERVICE

FOR ADVERTISEMENTS IN THIS ISSUE ONLY

For additional information on any advertisement

**READERS MUST DESIGNATE PAGE NUMBER and ADVERTISER'S NAME**

This free service is designed to provide readers with a simple method of obtaining more detailed information on products or services advertised in ELECTRONICS. The two business reply postcards below (perforated for easy tear-out) are for your use and must be completely filled out according to the sample shown on the right and the instructions given below under "HOW TO ORDER". Each individual request is separated and sent to the manufacturer concerned. The information asked for is essential so that manufacturers can promptly and correctly address their replies to your request.

Please note sample with correct fill-in on the right. ➡

Request for "Ad" Information, Page No.	156	E-8
Advertiser	E. Warwick, Inc.	
Your Name	Henry Wriothesley	
Title	Electronic Engineer	
Company	Kings' Company, Inc.	
Co. Address	161 Avon St., Stratford, N. J.	

## HOW TO ORDER

Please read these instructions carefully. They provide a simple method which, if followed, will bring you the information you desire.

1. There are two business reply postcards on the right. Each one divided in four parts, thus providing space for eight individual requests.
2. Each request must be made separately and the required information must be completely given for each one. This is important, for these cards are cut apart and sent to manufacturers. Therefore, each one must have ALL the necessary mailing and addressing information.
3. This service applies only to the advertisements that appear in this issue. It does not apply to any part of the editorial content.
4. Please print as neatly as possible.
5. Use ink, as pencil is apt to smudge with handling.
6. Tear out complete postcard, even if all four portions are not used. Drop in the mail—no postage required.

## PLEASE NOTE:

In the event this copy of ELECTRONICS is passed along to other members of your company, please leave this sheet in for their convenience. This assures everyone in your plant the opportunity to fill in their requests. When the round is completed, cards can then be detached.

**GIVE ALL REQUIRED INFORMATION FOR EACH REQUEST YOU MAKE**

**THESE CARDS VOID AFTER APRIL 30**

Request for "Ad" Information, Page No.	Advertiser	Your Name	Title	Company	Co. Address	E-4-4
Request for "Ad" Information, Page No.	Advertiser	Your Name	Title	Company	Co. Address	E-4-4
Request for "Ad" Information, Page No.	Advertiser	Your Name	Title	Company	Co. Address	E-4-4
Request for "Ad" Information, Page No.	Advertiser	Your Name	Title	Company	Co. Address	E-4-4

**An electronics service designed**  
**FOR THE CONVENIENCE**  
*of*  
**READERS and MANUFACTURERS**

**FOR THE READER . . .**

ELECTRONICS fundamental policy has always been to supply its readers with all the pertinent and timely industry news. The ELECTRONICS Reader Service supplements this policy by offering the reader an easy and effective means of obtaining complete, up-to-the minute data on equipment, components, materials, instrumentation and allied products and, of maintaining at his fingertips comprehensive, practicable information on products and services in the industry.

**THESE CARDS VOID AFTER APRIL 30**

FIRST CLASS  
 PERMIT No. 64  
 (Sec. 34.9, P.L.&R.)  
 NEW YORK, N. Y.

**BUSINESS REPLY CARD**  
 NO POSTAGE STAMP NECESSARY IF MAILED IN THE UNITED STATES

— POSTAGE WILL BE PAID BY —

**ELECTRONICS**

**330 West 42nd Street**

**New York 36, N. Y.**

READER SERVICE DEPT.



FIRST CLASS  
 PERMIT No. 64  
 (Sec. 34.9, P.L.&R.)  
 NEW YORK, N. Y.

**BUSINESS REPLY CARD**  
 NO POSTAGE STAMP NECESSARY IF MAILED IN THE UNITED STATES

— POSTAGE WILL BE PAID BY —

**ELECTRONICS**

**330 West 42nd Street**

**New York 36, N. Y.**

READER SERVICE DEPT.



In every issue of ELECTRONICS there's complete coverage of the month by month development of manufacturers products. Some of these items will be of particular interest to specific design and plant engineers, buyers, executives and others of our readers. They will want to make further inquiry concerning the products advertised. ELECTRONICS Reader Service makes it easy for them to obtain in readily accessible and usable form the information they desire.

**FOR THE MANUFACTURER**

This Reader Service has also been designed as an aid to manufacturers who advertise in ELECTRONICS. Many of those manufacturers are desirous of placing the complete news of their product as well as their technical bulletins and catalogs in the hands of those members of the electronic industry . . . including design, electrical, and production engineers, researchers, physicists, executives and purchasing agents— who have a particular interest in, or represent a potential buying power for, their products. The Reader Service assures advertisers in ELECTRONICS the most effective method of achieving that purpose.



# New Switch on

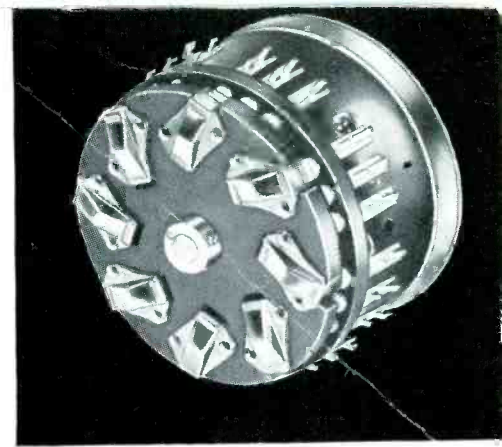

# SWITCHES

by **DAVEN**

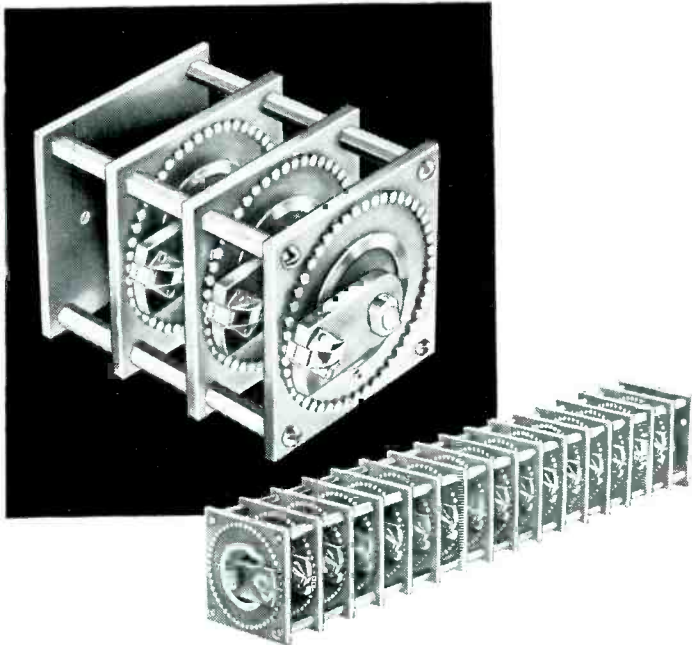

DAVEN not only supplies switches from its hundreds of standard units, but can also effect quick changes from standard units to special switches by using components at hand.

As a result, you are able to select, from thousands of variations, the right switch for your particular requirements.

And . . . here's a new switch for problems that defy solution with standard components. If your prototype is that of an unusual piece of equipment and requires a switch not yet developed, DAVEN will engineer it for you.

This is a service which DAVEN is singularly well qualified to perform by reason of its skilled engineering staff and exceptional facilities. For more than a generation, DAVEN has built up a Development Department that is second to none in solving difficult switch problems.

Furthermore, because only DAVEN has the patented "knee-action" rotor, units can be produced with a greater number of switch positions and poles in a smaller space than was ever possible before.



THE **DAVEN** CO.

191 CENTRAL AVENUE  
NEWARK 4, NEW JERSEY

Why not call on DAVEN today to assist with your development project, especially if you need switches that must render maximum performance in minimum space.

**It's FREE** Write for your copy of DAVEN's new, 28-page brochure on SWITCHES.



LONGER LIFE

SUPERIOR PERFORMANCE

AT NO EXTRA COST



## Built-in features make RCA Receiving Tubes your best buy

The peak performance you get from RCA tubes costs you no more. And—you can rely on their *built-in* quality for dependable service. Here's why . . .

RCA works closely with equipment designers—knows firsthand the design objectives of modern receiving tube circuits. RCA makes full use of this knowledge in constantly improving the tube types of interest to you—the equipment manufacturer.

### **RCA-6J6 features . . .**

- pure-tungsten heater for improved life
- special cathode material to help maintain tube characteristics throughout life of tube

—individual adjustment of each tube mount for increased uniformity of characteristics of each triode unit.

### **RCA-6CB6 features . . .**

- improved design of Grid-No. 2 for cooler operation and longer life
- special controls on materials and processing for improved uniformity of plate cutoff and for reduced variations in characteristics when heater voltage fluctuates.

### **RCA-6AU6 features . . .**

- double-helical heater for extremely low hum level
- inverted pinched cathode to reduce possible motion of tube elements, thus reducing microphonics.

Get the benefits of superior circuit performance. Reduce your factory-line rejects, and "in-warranty" failures. Specify RCA receiving-type tubes. They cost no more—actually cost less in the long run.

For technical information on RCA tubes, write RCA, Commercial Engineering, Section D19Q, Harrison, N. J. Or call your nearest Field Office.

**(EAST) Humboldt 5-3900**

415 S. Fifth St., Harrison, N. J.

**(MIDWEST) Whitehall 4-2900**

589 E. Illinois St., Chicago 11, Ill.

**(WEST) Madison 9-3671**

420 S. San Pedro St., Los Angeles 13, Cal.



**RADIO CORPORATION of AMERICA**

**ELECTRON TUBES**

**HARRISON, N. J.**