

electronics

A MCGRAW-HILL PUBLICATION

OCTOBER - 1953

PRICE 75 CENTS

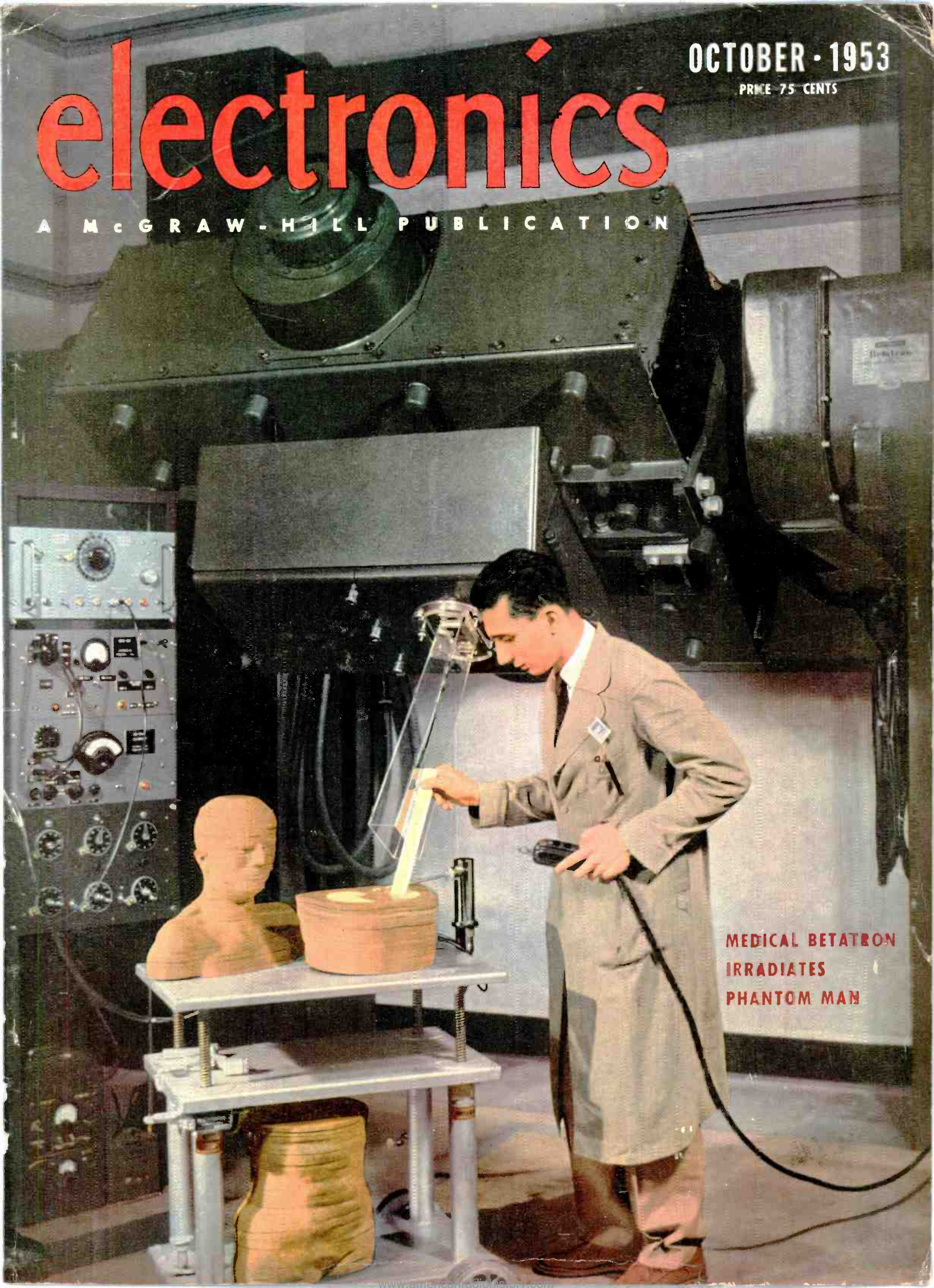

MEDICAL BETATRON
IRRADIATES
PHANTOM MAN



for Military Components

UTC was the largest supplier of transformer components in World War II. Present UTC production is on a similar basis. Illustrated below are a few of the thousand military types in UTC 1953 production.

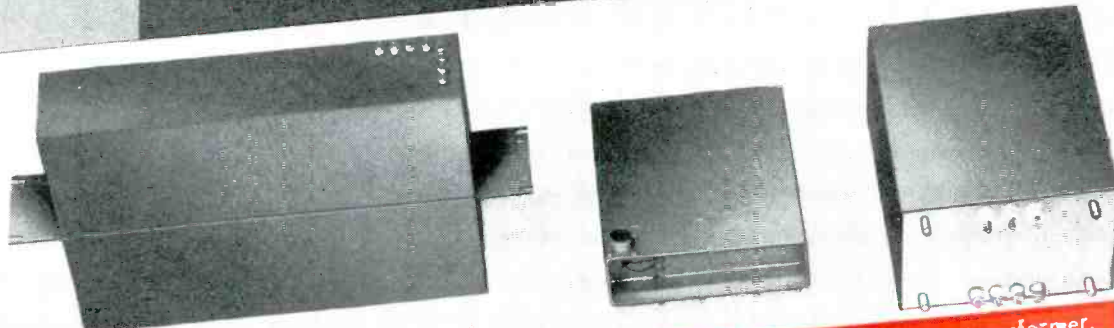

Carrier frequency filter..... Aircraft low frequency filter..... Plate transformer.



Typical hermetically sealed power transformers for 60 cycle service.



Hermetically sealed audio and pulse transformers.



60 cycle and 400 cycle components hermetically sealed and fosterized.



Miniaturized audio units, magnetic amplifiers, etc.

United Transformer Co.

150 VARICK STREET

NEW YORK 13, N. Y.

EXPORT DIVISION: 13 EAST 40th STREET, NEW YORK 16, N. Y.

CABLES: "ARLAB"

MEDICAL BETATRON IRRADIATES PHANTOM MAN—Preparing for test exposure to check distribution of high-energy x-rays from 24-mev betatron, designed especially for cancer therapy, at Memorial Center for Cancer and Allied Diseases, New York City. Wood and cork model simulating human body is constructed to allow insertion of anthracene crystal probe at selected spots. Photo by Syd Karsen. (See p 146).....COVER

FIGURES OF THE MONTH , includes Electronic Output Index.....	4
INDUSTRY REPORT , top-level news, trends and market interpretations.....	5
PRODUCTION TECHNIQUES IN TRANSISTOR MANUFACTURE , by James D. Fahnestock.....	130
BACKWARD-WAVE TUBE , by H. Heffner.....	135
REMOTE-CONTROL SYSTEM FOR F-M BROADCASTING , by A. V. Tidmore.....	139
MAGNETICS IN GEOLOGY , by Harold Mooney.....	143
HIGH-POWER BETATRON FOR CANCER THERAPY , by J. S. Laughlin, J. Ovadia, G. Shapiro and Z. Abdun-Nabi.....	146
MICROSECOND TIMER CHECKS CONCRETE BEAMS , by J. H. J. Filter.....	152
SIMULATING PIANO TONES ELECTRONICALLY , by Leon Katz.....	155
SMALL-SIGNAL TRANSISTOR OPERATION , by Abraham Coblenz and Harry L. Owens.....	158
SIGNAL-NOISE METER CHECKS TV LINKS , by Roy Moffett.....	164
NONLINEAR CAPACITORS FOR DIELECTRIC AMPLIFIERS , by George S. Shaw and James L. Jenkins.....	166
ELECTRON-BEAM HEAD FOR MAGNETIC TAPE PLAYBACK , by A. M. Skellett, L. E. Leveridge and J. W. Gratian.....	168
FLUOROSCOPE IMAGE AMPLIFYING TUBE , by Fitz-Hugh Marshall.....	172
BRIDGE-STABILIZED ULTRASONIC OSCILLATOR , by Louis W. Erath.....	174
MEASURING IMPEDANCE OF HIGH-FREQUENCY RESISTORS , by Charles L. Wellard.....	176
CERAMIC TILE SORTER , by F. Lepri and R. Sanna.....	180
TRANSISTORIZED RADAR SCOPE DISPLAY UNIT , by Raymond S. Markowitz.....	182
NEUTRALIZING PENTODES IN RADAR I-F STAGES , by Joseph C. Tellier.....	184
TELEVISION MONITORS ROCKET ENGINE FLAME , by Frank A. Friswold.....	187
CAPACITOR-MODULATED WIDE-RANGE F-M SYSTEM , by Maurice Apstein and H. H. Wieder.....	190
AUDIO TRANSFORMER DESIGN CHARTS , by Theodore Halabi.....	193
CROSSTALK129 ELECTRONS AT WORK198 PRODUCTION TECHNIQUES258 NEW PRODUCTS310	
PLANTS AND PEOPLE382 NEW BOOKS436 BACKTALK451 INDEX TO ADVERTISERS499	

W. W. MacDONALD, Editor; **VIN ZELUFF**, Managing Editor; John Markus, A. A. McKenzie, James Fahnestock, Associate Editors; William P. O'Brien, John M. Carroll, William G. Arnold, David A. Findlay, Assistant Editors; Marilyn Wood, Editorial Assistant; Gladys T. Montgomery, Washington Editor; Harry Phillips, Art Director; Eleanor Luke, Art Assistant

KEITH HENNEY, Editorial Director

H. W. MATEER, Publisher; **WALLACE B. BLOOD**, Manager; R. S. Quint, Buyers' Guide Manager; N. F. Cullinan, Promotion & Research Assistant; H. E. Hilty, Classified Manager; D. H. Miller, James Girdwood, New York; Wm. S. Hodgkinson, New England; Warren W. Shew, Philadelphia; Charles Wardner, James T. Hauptli, Chicago; J. L. Phillips, Cleveland; T. H. Carmody, R. C. Alcorn, San Francisco; Carl W. Dysinger, Los Angeles; Robert H. Sidur, Atlanta



October, 1953

ELECTRONICS
Member ABC and ABP

Vol. 26, No. 10



Published monthly with an additional issue in June by McGraw-Hill Publishing Company, Inc., James H. McGraw, 1860-1948), Founder. Publication Office, 99-129 North Broadway, Albany 1, N. Y.

Executive, Editorial and Advertising Offices: McGraw-Hill Building, 330 W. 42 St., New York 36, N. Y. Donald C. McGraw, President; Willard Chevalier, Executive Vice-President; Joseph A. Gerardi, Vice-President and Treasurer; John J. Cooke, Secretary; Paul Montgomery, Senior Vice-President, Publication Division; Ralph B. Smith, Vice-President and Editorial Director; Nelson Bond, Vice-President and Director of Advertising; J. E. Blackburn, Jr., Vice-President and Director of Circulation.

Subscriptions: Address correspondence to Electronics—Subscription Service, 99-129 N. Broadway, Albany 1, N. Y., or 330 W. 42nd St., New York 36, N. Y. Allow one month for change of address. Subscriptions are solicited only from persons engaged in theory, research, design, production, maintenance and use of electronic and industrial control components, parts and end products. Position and company connection must be indicated on subscription orders.

Single copies 75¢ for United States and possessions, and Canada; \$1.50 for Latin America; \$2.00 for all other foreign countries. Buyers' Guide \$2.00. Subscription rates—United States and possessions, \$6.00 a year; \$9.00 for two years. Canada, \$10.00 a year; \$16.00 for two years. Other western hemisphere countries, \$15.00 a year; \$25.00 for two years. All other countries \$20.00 a year; \$30.00 for two years. Entered as second class matter August 29, 1936, at the Post Office at Albany, N. Y., under act of Mar. 3, 1879. Printed in U.S.A. Copyright 1953 by McGraw-Hill Publishing Co., Inc.—All Rights Reserved. BRANCH OFFICES: 520 North Michigan Avenue, Chicago 11, Ill.; 68 Post Street, San Francisco 4; McGraw-Hill House, London, E.C. 4; Washington, D. C. 4; Philadelphia 3; Cleveland 15; Detroit 26; St. Louis 8; Boston 16; 1321 Rhodes-Haverty Bldg., Atlanta 3, Ga.; 1111 Wilshire Blvd., Los Angeles 17; 738-9 Oliver Building, Pittsburgh 22. ELECTRONICS is indexed regularly in The Engineering Index.

**when power
fluctuations
affect processes . . .
you NEED
SORENSEN AC
line regulators**

**here's a case
where installing a
SORENSEN
AC REGULATOR
saves \$\$\$
in an RF gluing
process**

Timber Structures, Inc., of Portland, Oregon, are the largest producers of engineered timber structures in the country. RF is used for pre-gluing scarf joints of lumber to be laminated into very large arches, and also for gluing the firm's "Timberib" barn rafters on a mass production basis. The RF presses were developed by Timber Structures, Inc., engineers.

Voltage to the four RF generators varied greatly due to constantly changing loads throughout the plant. The serious fluctuations necessitated the repair of 5% of total output and scrapping of another 5% as total loss. Unsuccessful attempts were made to remedy the condition through the use of additional and separate service transformers.

The local Sorensen representative surveyed the situation and recommended installation of a 15KVA Sorensen Regulator. The result — complete elimination of product loss or damage through erratic voltage.

The installation was made nearly five years ago. Since then — complete satisfaction! The only service required by the Sorensen Regulator during this period has been the installation of one set of new tubes.

We know that a great many manufacturing difficulties are caused by line fluctuations, most of which could be eliminated quickly and economically by Sorensen AC Regulators. Find out more about this, at no obligation, from your Sorensen representative — write us for his address. Sorensen & Co., Inc., 375 Fairfield Avenue, Stamford, Conn.

SORENSEN

375 FAIRFIELD AVENUE, STAMFORD, CONN.

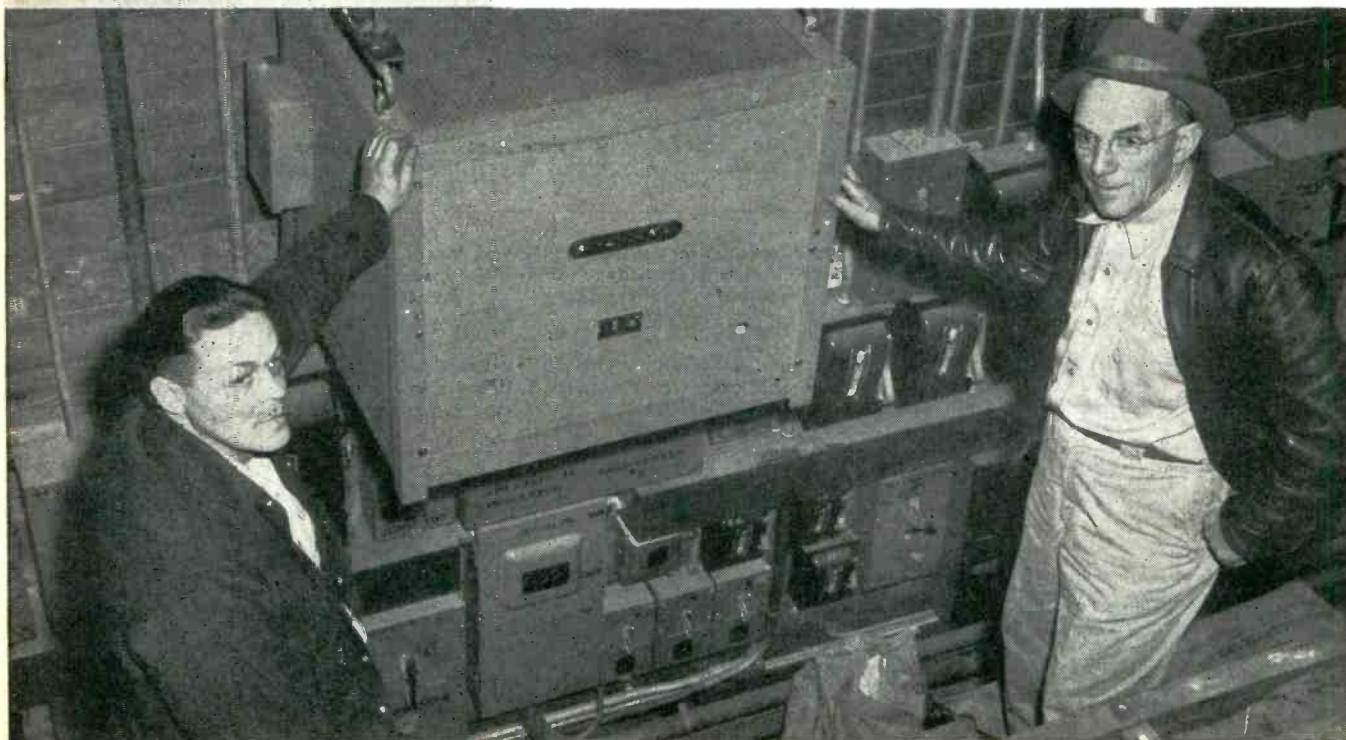



TAB RECEPTACLES

A-M-P

AIRCRAFT-MARINE PRODUCTS, INC.

2100 Paxton Street, Harrisburg, Pa.

Aircraft-Marine Products of Canada, Ltd.

1764 Avenue Rd., Toronto 12, Ontario, Canada

WHAT IS A "BLIND" RIVET?

It is a type of fastener used to rivet together two or more pieces of material when access to the work is possible from only one side.

But SOUTHCO "Blind" Drive Rivets do much more than that. They provide maximum strength and reduce production costs. For installation you just hit the pin . . . and the rivet is in. At the same time, a powerful pull-up force is exerted to produce the kind of a tight joint you get when a rivet is bucked from both sides.

There is no finishing operation required with SOUTHCO Rivets, no wasted material, no noise, no special tools to buy or maintain. Fastening metal parts is as simple as driving a nail.

FOR EITHER BLIND OR ACCESS APPLICATIONS

Even when there is access to both sides, SOUTHCO Drive Rivets are specified because they make a one-man job of a two-man operation. They are so simple that costs are reduced through faster riveting.

For the full story on SOUTHCO Drive Rivets, write to Southco Division, South Chester Corporation, 1417 Finance Bldg., Philadelphia 2, Penna.

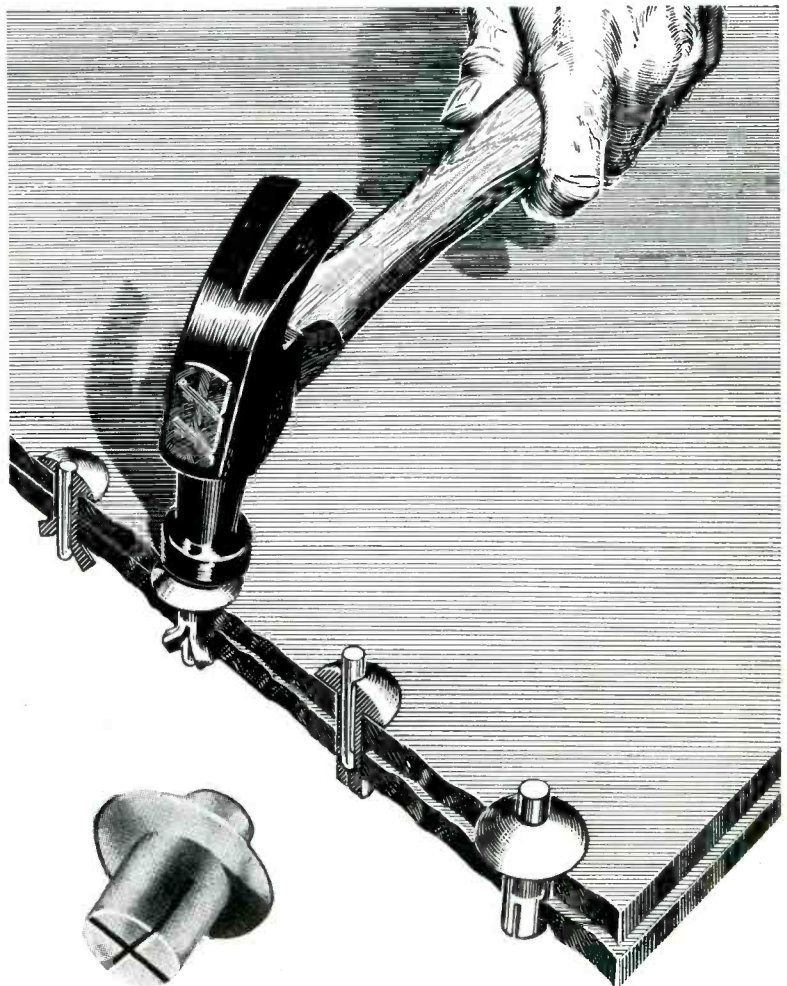

SOUTHCO

FASTENERS

**PAWL • SCREW AND SPRING •
DRIVE RIVETS • ANCHOR NUTS •
ENGINEERED SPECIALTIES**

OFFICES IN PRINCIPAL CITIES

©1953
Pat. No. 2640616
Other Pats. Pend.
Rivet and Mfg.

WHEREVER TWO OR MORE PARTS ARE FASTENED TOGETHER, STANDARD AND SPECIAL DESIGNS FOR IMPROVED PERFORMANCE AND LOWER PRODUCTION COSTS

PLUG INTO THE SKY

Well, not exactly, but you can hook-up to receive weather charts measuring 18" x 22" for hours at a time without an operator.

If the weather is your concern, or indeed if the transmission of any graphic material—drawings, newspapers, legal documents—is a problem, maybe we can help you; write now.

18" MUFAX CHART RECORDER TECHNICALITIES

Maximum chart size	18" wide x 22" long
Index of co-operation	576
Helix speed	1 or 2 r.p.s.
Scanning rate	96 lines/inch
Maximum input signal (black)	+5 to -15 db ref 1mW
Signal frequency	AM: 1500c/s FM: 1500c/s black 2300c/s white
Power supply	95 — 125V, 60c/s or 200—250V, 50 c/s.



92

MUIRHEAD & CO. LIMITED • BECKENHAM • KENT • ENGLAND

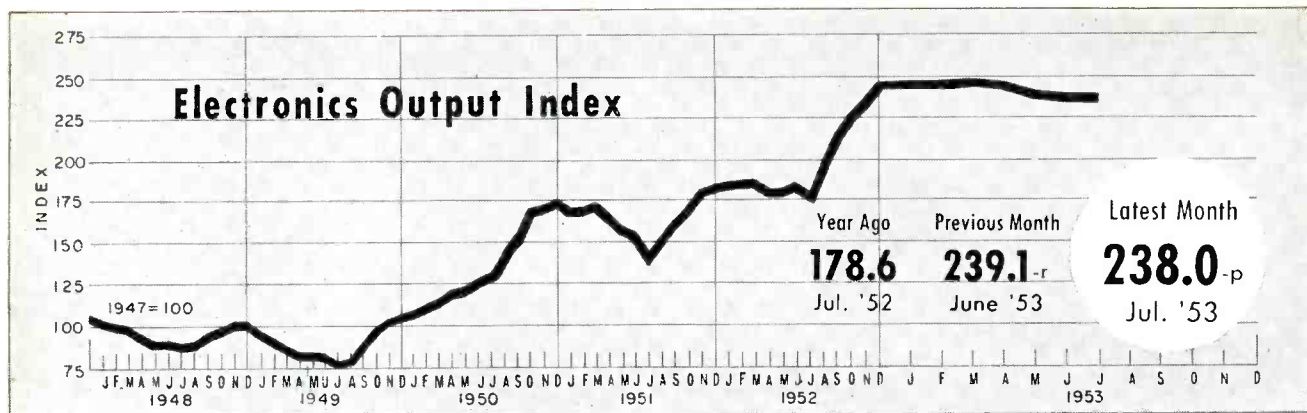

FIGURES OF THE MONTH

	Year Ago	Previous Month	Latest Month
RECEIVER PRODUCTION			
(Source: RETMA)	July '52	June '53	July '53
Television sets	198,921	524,479	316,289
Home sets	203,868	287,724	172,197
Clock Radios	61,295	131,144	87,620
Portable sets	81,353	239,189	78,434
Auto sets	95,220	505,774	336,208

	Year Ago	Previous Month	Latest Month
RECEIVER SALES			
(Source: RETMA)	July '52	June '53	July '53
Television sets, units	431,089	340,406
Radio sets (except auto)	449,116	366,666

	Year Ago	Previous Month	Latest Month
RECEIVING TUBE SALES			
(Source: RETMA)	July '52	June '53	July '53
Receiv. tubes, total units	20,944,831	42,505,685	26,462,069
Receiving tubes, new sets	11,504,503	26,478,801	15,393,307
Rec. tubes, replacement	6,795,252	12,965,382	9,480,208
Receiving tubes, gov't.	1,956,905	708,174	313,684
Receiving tubes, export	688,171	2,353,328	1,274,870
Picture tubes, to mfrs.	239,625	517,395	421,248

	Year Ago	Previous Month	Latest Month
SEMICONDUCTOR SALES			
(Source: RETMA)	July '52	June '53	July '53
Germanium Diodes	1,344,636	3,868,026

	Quarterly Figures		
	Year Ago	Previous Quarter	Latest Quarter
INDUSTRIAL TUBE SALES			
(Source: NEMA)	2nd '52	1st '53	2nd '53
Vacuum (non-receiving)	\$12,110,000	\$11,340,000	\$10,400,000
Gas or vapor	\$3,150,000	\$3,140,000	\$3,300,000
Phototubes	\$480,000	\$930,000	\$700,000
Magnetrons and velocity modulation tubes	\$9,830,000	\$10,070,000	\$10,500,000
Gaps and T/R boxes	\$2,140,000	\$2,050,000	\$1,700,000

	Year Ago	Previous Month	Latest Month
TV AUDIENCE			
(Source: NBC Research Dept.)	Aug. '52	July '53	Aug. '53
Sets in Use—total	18,354,300	24,519,000	24,895,000

	Year Ago	Previous Month	Latest Month
BROADCAST STATIONS			
(Source: FCC)	Aug. '52	July '53	Aug. '53
TV Stations on Air	109	224	253
TV Stns CPs—not on air	34	284	270
TV Stns—Applications	855	524	521
AM Stations on Air	2,356	2,466	2,476
AM Stns CPs—not on air	112	122	117
AM Stns—Applications	291	251	177
FM Stations on Air	622	578	579
FM Stns CPs—not on air	21	21	18
FM Stns—Applications	12	8	7

	Year Ago	Previous Month	Latest Month
COMMUNICATION AUTHORIZATIONS			
(Source: FCC)	June '52	May '53	June '53
Aeronautical	32,603	42,213	39,315
Marine	35,500	40,076	40,357
Police, fire, etc.	11,143	13,238	13,631
Industrial	13,680	16,850	17,378
Land Transportation	5,027	5,830	5,922
Amateur	113,092	111,011	111,289
Citizens Radio	1,401	2,124	3,829
Disaster	71	189	191
Experimental	488	439	414
Common carrier	985	1,193	1,214

	Year Ago	Previous Month	Latest Month
EMPLOYMENT AND PAYROLLS			
(Source: Bur. Labor Statistics)	June '52	May '53	June '53
Prod. workers, comm. equip.	268,200	408,200-r	400,200
Av. wkly. earnings, comm.	\$64.80	\$65.20-r	\$65.93
Av. wkly. earnings, radio	\$61.58	\$62.49-r	\$63.60
Av. weekly hours, comm.	40.5	40.0-r	40.2
Av. weekly hours, radio	40.3	39.3-r	39.5

	Year Ago	Previous Month	Latest Month
STOCK PRICE AVERAGES			
(Source: Standard and Poor's)	Aug. '52	July '53	Aug. '53
Radio—TV & Electronics	291.1	272.4	280.0
Radio Broadcasters	279.6	269.3	274.8

p—provisional; r—revised

FIGURES OF THE YEAR

	1952 Total
Television set production	6,096,279
Radio set production	10,934,872
Television set sales	6,144,990
Radio set sales (except auto)	6,878,547
Receiving tube sales	368,519,243
Cathode-ray tube sales	6,120,292

TOTALS FOR FIRST SEVEN MONTHS

	1952	1953	Percent Change
Television set production	2,517,157	4,150,525	+ 64.8
Radio set production	5,280,079	7,941,001	+ 50.3
Television set sales	3,116,306
Radio set sales (except auto)	3,383,862
Receiving tube sales	181,128,357	269,622,417	+ 48.8
Cathode-ray tube sales	2,084,934	4,571,931	+ 119.2

INDUSTRY REPORT

electronics—OCTOBER • 1953

Signal Corps Radio Uses Five Transistors

A WRIST radio worthy of mention in even the most imaginative comic strip has been developed by the Army Signal Corps.

Using five transistors and capable of receiving stations as much as 40 miles distant, the two and five-eighths ounce experimental receiver is contained in a plastic case two inches long, one and an eighth inches wide and three quarters of an inch thick. The small size is made possible through the use of transistors and miniature components, such as the mercury battery scarcely larger than the tip of a pencil. A printed-circuit chassis is used.

A short antenna and the cord connecting the hearing-aid type ear piece, are concealed by the user's sleeve. A miniature on-off switch and a frequency control knob on the face of the set are the only adjustments.

The set operates over the upper part of the standard broadcast band from 1,000 to 1,500 kc.

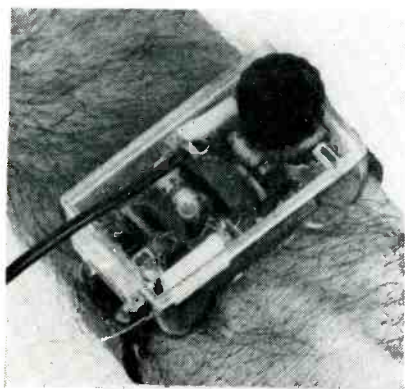

Five transistors are used in Signal Corps wrist radio, which can pull in broadcast stations 40 miles away



PROJECT TINKERTOY combines printed-circuit techniques and assembly equipment with a system of equipment design so that a . . .

Robot Plant Makes Electronic Gear

Joint NBS-BuAer project yields building-block system for design and production

DEVELOPMENT of a system for the automatic production of electronic equipment was announced September 19 by the Navy Bureau of Aeronautics and the National Bureau of Standards.

The program, code-named Project Tinkertoy, resulted in the simultaneous development of two systems: a production system utilizing automatic fabrication and assembly equipment, and a compatible, general system of electronic equipment design using a modular concept. The two systems exploit printed-circuit techniques, the use

of conducting paints for wires, thin ceramic capacitors, adhesive-tape resistors, and automatic dip soldering.

From June, 1950, through June, 1953, approximately \$4,700,000 was allocated by the Navy to the National Bureau of Standards for Project Tinkertoy. About 85 percent of this amount was expended in the procurement of equipment from industry largely through subcontracts.

► **Companies Involved**—Design and construction of most of the production equipment was done by the Kaiser Electronics Division of Willys Motor Co. Some special machines were also designed and built by the Doughnut Corp. of America

at Ellicott City, Md. Specially designed automatic production test equipment was obtained principally from Communication Measurements Laboratory, Inc. of Plainfield, N. J. Some major engineering applications to equipment were made by Sanders Associates, Inc., Nashua, N. H., including environmental studies of completed units. The Davis Laboratories, of Riverdale, Md. and the Navy Post Graduate School at Monterey, Calif. also rendered assistance in some phases of the work.

► **MDE Design System**—The Modular Design of Electronics system employs a series of mechanically-standardized and uniform modules (or building blocks), producible within a wide range of electrical characteristics.

Each module consists of 4 to 6 thin ceramic wafers, bearing various circuits associated with an electronic stage. Individual modules are combined to form a major sub-assembly of tubes and components.

► **MPE Production System**—The Mechanized Production of Electronics system consists of the mechanized production of ceramic wafers, titanate capacitors, and tape resistors and their automatic mechanical assembly and testing. The wafers and tube sockets are made from a controlled combination of talc, kaolin and barium carbonate. The three minerals are mixed, filtered and dried to a powder which is further refined and loaded into a mechanical device which presses the wafers or tube sockets and cuts riser-wire notches.

► **Automatic Inspection** — During each stage in the mechanized production provision is made for 100-percent automatic inspection by both physical gaging and electronic comparison. Printed circuits, resistors and capacitors are compared with their electronic equivalents both before and after assembly by use of electronic computers, bridge circuits and other comparison devices. The testing code is contained on punched cards that accompany the wafers all through the production process.

Color TV Timetable

INDUSTRY thinks FCC will formally adopt NTSC color tv standards before the end of 1953. At Commission's Sept. 8 deadline, no major objections had been filed against adoption. Interest now centers in date color receivers and color programs will be generally available.

sets at what price by when are variable . . . W. R. G. Baker of GE says up to 75,000 at \$800 next year . . . Emerson's Ben Abrams pledges a price only 25 percent above black and white 18 months after FCC decisions . . . CBS thinks first color receivers will be around \$1,000.

Commission is scheduling color demonstrations and tests to cover all possible conditions . . . various light levels . . . via coaxial cable and microwave . . . close-ups . . . indoor and outdoor shots, including rapid motion . . . slides.

Crux of getting color to the viewers soon seems to be cost of receiver tube and three-eyed tv camera . . . RCA color picture tube is quoted at anywhere from \$175 to \$250 . . . Lawrence tube is claimed possible at \$100 . . . CBS estimates cost of matched trio of camera orthicons at \$5,700.

Estimates on how many

Broadcasting Is Up On All Fronts

Income and employment as well as wages and taxes have moved up substantially since 1949

BROAD view of the financial pattern that radio and tv broadcasting has followed in the past 4 years is seen in figures recently released by the Department of Commerce.

People and pay have increased steadily. A total of 65,000 full and part-time employees, 11,000 more than were employed in 1949, were working for stations last year. Average annual earnings for full-time employees increased during the period, from \$4,469 to \$5,559.

► **Income**—Radio and tv broadcasters took in \$404 million in 1952. In 1949, the figure was \$262 million. Breakdown for last year's amount shows that broadcasting corporations paid out \$339 million in wages, salaries and extras; \$31 million in taxes; \$23 million in dividends, leaving \$7 million as undis-

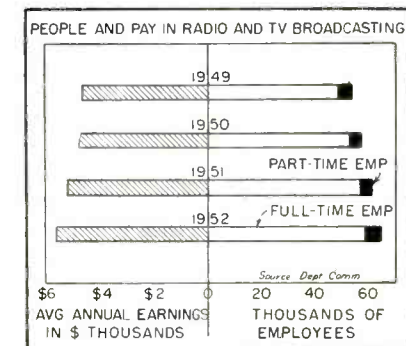

tributed corporate income. The remaining \$4 million represents income of unincorporated stations.

In 1949, the following payments were made: wages and salaries, \$227 million; taxes, \$16 million; dividends, \$8 million. Undistributed corporate income amounted to \$9 million. Unincorporated stations received the remaining \$2 million in 1949.

► **Corporations**—Most radio and tv stations are set up as corporate org-

(Continued on page 8)

Sylvania announces...

New Sylvania
1000-hour TR Tube,
1B63B

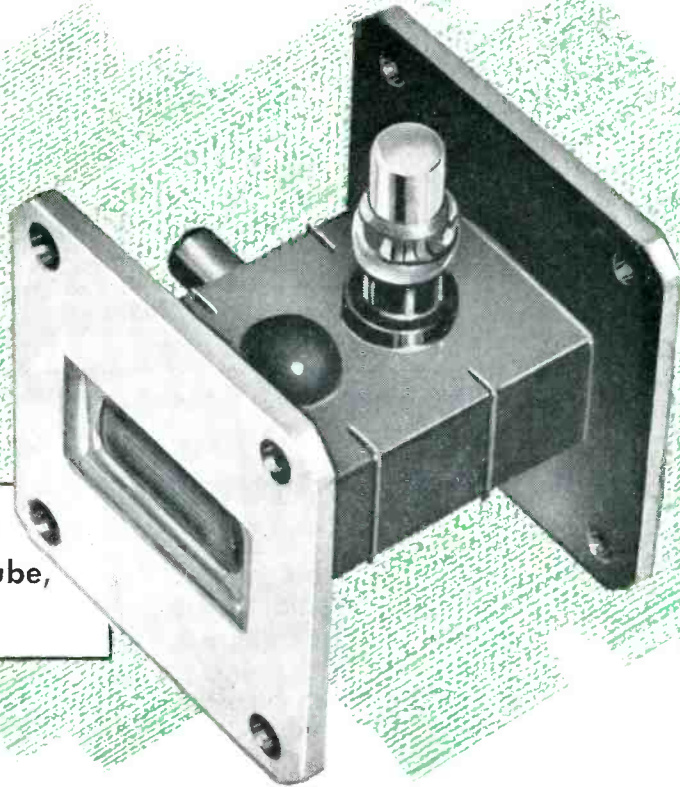

... the most important advance in TR Tube design in the past 4 years

Sylvania engineers are engaged in a continuing program to provide increased dependability and longer life to their electronic tubes . . . for both commercial and civilian applications.

One of the most important results of this program is the recent development of the cermet ignitor electrode. This new electrode is capable of withstanding extremely high temperatures for long

periods of time, thus making possible Sylvania's 1000-hour tube, the 1B63B.

This new ignitor is an important step forward in TR Tube design . . . one more reason why it pays to specify SYLVANIA!

For further information concerning the full line of Sylvania TR and ATR Tubes, simply mail the coupon.

SYLVANIA

LIGHTING • RADIO • ELECTRONICS • TELEVISION



In Canada: Sylvania Electric (Canada) Ltd.
University Tower Bldg.
St. Catherine St., Montreal, P. Q.

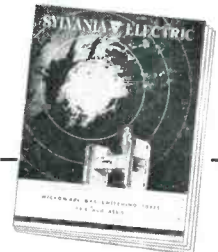

Sylvania Electric Products Inc.
Dept. 3E-1010, 1740 Broadway
New York 19, N. Y.

*Please send me further data on Sylvania's improved
1B63B Tube. Also new descriptive folder showing the
full line of TR and ATR Tubes.*

Name _____

Street _____

City _____ Zone _____ State _____

anizations at present. However, there are still a number of unincorporated stations. According to the Commerce Department, there are 1,000 stations in the U. S. owned by entrepreneurs or partnerships and the number has remained constant for the past 4 years. Nearly all new stations that have come on the air since 1949 have been set up as corporations.

U. S. Studies Electronic Employment Trends

HIGH employment in the electronics industry will not only be sustained throughout this year but may even go higher than the top 546,000 workers set in March of this year, if the brisk radio and tv market anticipated by manufacturers develops, according to a Labor Department study of employment trends in the industry.

While indications are that military contracts will begin to taper off the last of the year, it is expected that there will be substantial amount of military electronic production for several years, making use of a sizeable number of workers. In mid-1953, almost 200,000 workers were estimated to be engaged in military electronics production, according to the report.

► **Future**—Although radio and tv set production probably will employ a smaller proportion of the industry's work force in the years ahead than before Korea, the study concludes that it will be the most important determinant of electronic employment for the next decade. The report predicts that while electronic tube manufacturing is likely to decline moderately after the defense peak, it will remain at a high level due to the large replacement market for defense equipment along with growing civilian markets.

Commercial and industrial electronics manufacturing is seen as having great expansion in the future but the report notes that this segment of the industry employs only a relatively small part of the electronics work force.

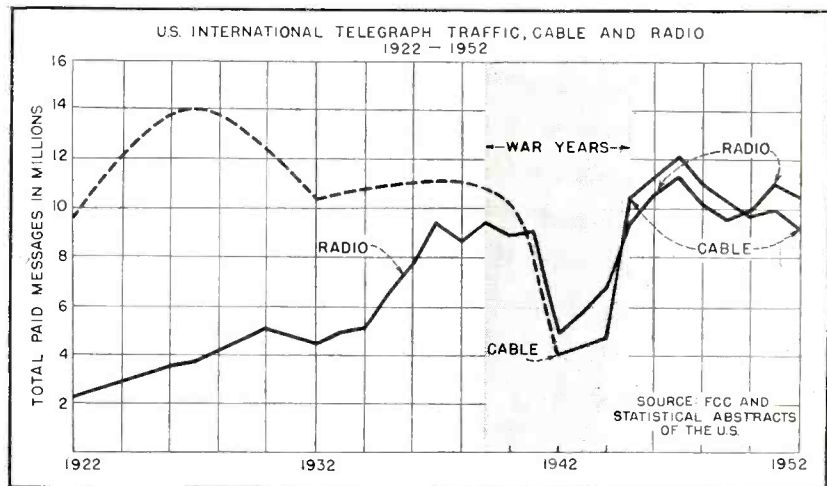

THIRTY-YEAR trend in transocean telegraph shows clear crossover point, as . . .

Wireless Finally Passes Cable

Radiotelegraph carriers handle most paid traffic; overseas phone calls rise

THREE dots picked out of the æther at St. Johns, Newfoundland a half century ago marked the birth of a precocious infant in the world of communications.

Proponents of transoceanic radiotelegraph were quick to foretell the demise of the ocean cable and the rapid ascendancy of the new art. However, change is not always accomplished overnight even in electronics and it has only been within the past two years that Marconi's brainchild, now matured to a mellow middle age, has become the prime carrier of international communications.

► **Trends**—The chart depicts thirty years of international communications in and out of the United States. A steady growth in radiotelegraph traffic is evident through the years.

The large decline in traffic during the war years may be misleading since only paid messages are counted. During the war, both radio and cable facilities were placed at the disposal of the government and total traffic for the period is not available. The smaller peaks and valleys primarily denote world business fluctuations.

The ocean-cable business, already

a mature industry in the early twenties, shows a slight decline. However, the cables are still vital and for several reasons, particularly their use in diplomatic communications, will retain an important role for many years to come. (Note: Prior to 1942 ocean-cable traffic figures were made available only at 5-year intervals.)

► **Radio Expansion** — Radiotelegraph carriers have been steadily expanding their plants. In 1948, 69 countries were linked with the U. S. by radiotelegraph circuits; by 1952 this had grown to 84. Traffic handling capacity has likewise been upped by increasing use of automatic equipment and various kinds of multiplex systems. Customer convenience has been enhanced by private-line arrangements that make international communications as simple as typing a memo.

► **Transients**—The marked postwar decline in cable traffic is largely accounted for by a reduction in the number of messages transiting the U. S. on their way to other countries. Traditionally these messages have made at least one leg of their journey over the important North Atlantic cable circuits. In recent years, there has been a trend to direct radiotelegraph communication even between the smaller coun-

(Continued on page 10)

DEPENDABILITY

is why Sprague
Type DFP Twist-Loks[☆]
are the preferred

ELECTROLYTIC CAPACITORS

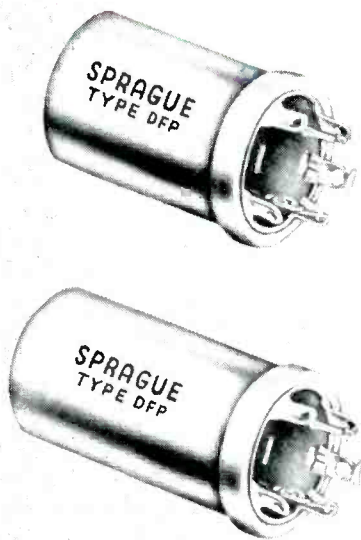

Leading television set makers rely on Sprague as their major source for electrolytic capacitors.

Stability under maximum operating conditions plus outstandingly long service life are the engineering reasons for this preference.

From the business standpoint, it makes good sense to deal with a supplier whose quality of product is uniformly excellent and who has the largest production facilities in the industry.

And now a new plant is being completed to permit Sprague to accept an even larger portion of your requirements.

SPRAGUE ELECTRIC COMPANY
35 Marshall St., North Adams, Massachusetts

[☆]Trademark

Sprague, on request, will provide you with complete application engineering service for optimum results in the design of equipment using electrolytic capacitors.

SPRAGUE

WORLD'S LARGEST CAPACITOR MANUFACTURER

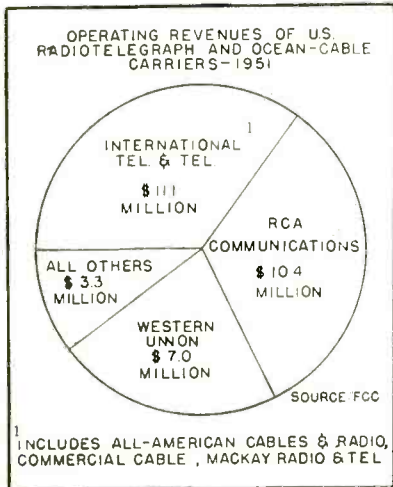

is now handled by radiotelegraph.

► **Telephone**—A bustling parvenu in the communications picture is radiotelephone. From a prewar average of 50,000 paid calls yearly, international telephone now handles nearly one million calls a year. Radiotelephone service is available to 93 countries as against 81 in 1948. Increasing use of single sideband and multiplexing equipment is an important trend in radiotelephone too.

► **Economics** — International telegraph is a thirty-million-dollar business. Profits accruing to the stockholders are, however frequently measured in only five figures—even for large companies. The pie-chart illustrates how the three largest interocean carriers divide the total.

tries of the world. A drop in cable traffic also occurred when the Commercial Pacific Cable suspended operations in November 1951. Transpacific traffic

Supply of Technicians Is Critically Short

Lack of subprofessional aids aggravates engineer shortage; training programs lagging

ELECTRONICS engineers are still critically short in number and college enrollment figures indicate that the shortage will persist at least through 1956. Industry can make the best use of available engineers by freeing professionally trained engineers from routine chores and aiding them in implementing their designs. Both these tasks require well-trained technicians and competent craftsmen. Unfortunately, the supply of qualified electronics technicians is also critically short and apprentice training has been on the downgrade for some time.

► **Technical Institutes**—Technician training is the function of 67 technical institutes throughout the U.S. Total enrollment, including part-time and evening students, is over 50,000. Eleven of these schools with a full-time enrollment of 1,858 and a part-time enrollment of 1,594 are devoted entirely to training electronics technicians; 38 other schools offer courses in electronics to their 13,303 full and 22,877 part-time students. The schools include state and municipal institutes, private endowed and proprietary institutes, extension divisions of colleges and universities and YMCA schools.

► **Management**—Proprietary institutes have long held the lead in electronics training. But the balance is shifting as college extension programs expand rapidly. In 1951, 90 percent of all electronics technicians came from proprietary schools as against 81 percent in 1952. Graduates of college extension programs accounted for 1½ percent of the class of 1951 and 11½ percent of 1952 graduates.

► **Curriculum**—Technical institutes offer intensive training in vacuum-

Where TV Sales Are Higher This Year

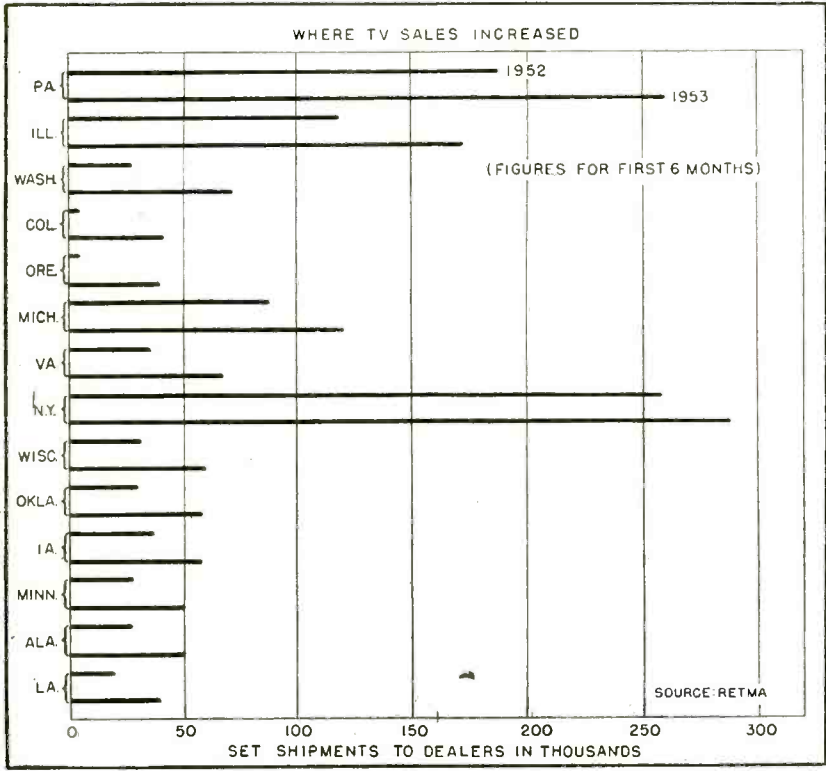

PENNSYLVANIA led all other states in increased tv set business for the first six months of 1953 with a 75,000 unit increase over shipments for the same period last year.

Thirteen other states, shown in

bar chart, had increases of over 20,000 sets each. Far and mid-west states fared best in increased sales. All states had a higher volume except Connecticut, Delaware, New Jersey and Rhode Island.

(Continued on page 14)

TO GAIN THE MOST IN

performance

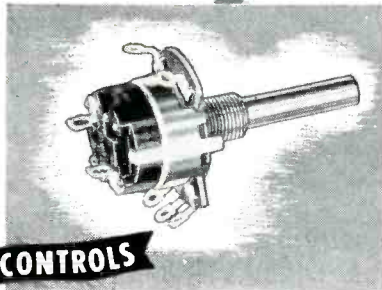

CONTROLS

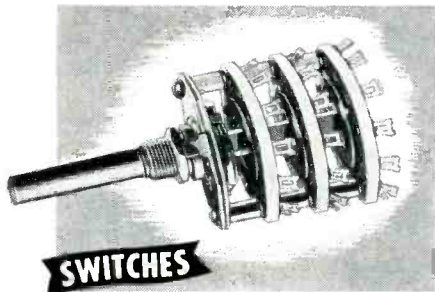

SWITCHES

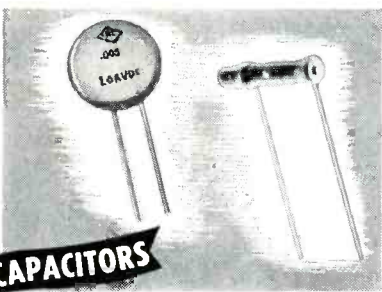

CAPACITORS

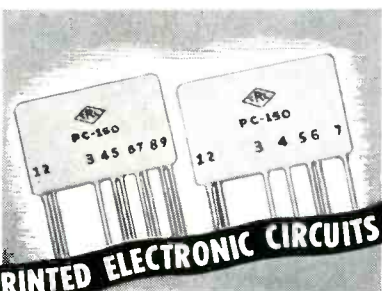

PRINTED ELECTRONIC CIRCUITS

...you're invited to concentrate your 5 major electronic component problems with the industry's most experienced and No. 1 electronic component source

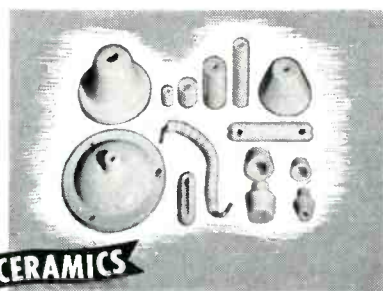

CERAMICS

see next 2 pages for details



1 VARIABLE RESISTORS

- to meet your requirements



Model 1 Radiohm®
Miniature

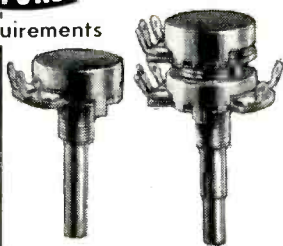

Model 2 Radiohm

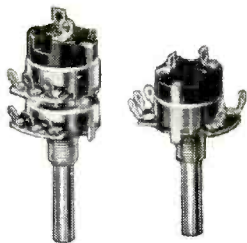

Model 2 Radiohm
(including JAN types)



Wirewound Radiohm
Three watts

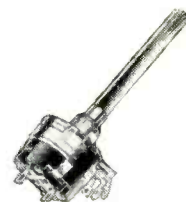

Model 2 EXPRESS (†)
for immediate
production needs



Series 20 Miniature
with a. c. line switch

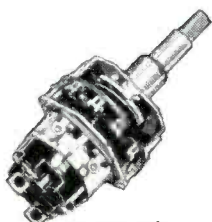

Series 30
Dual Concentric
Switch and Control

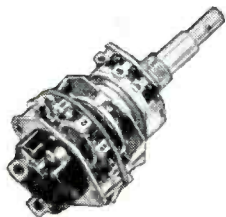

Series 30
Dual Concentric
Control and Switch

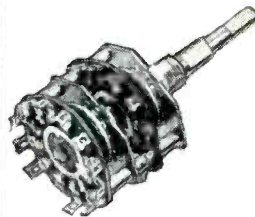

Series 30
Dual Concentric
Dual Switch

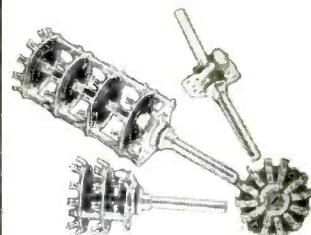

Standard Phenolic



Lever Switch



Slide Switch

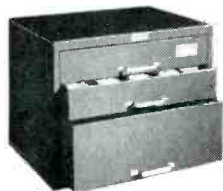

Industrial Switch Kit

3 CAPACITORS

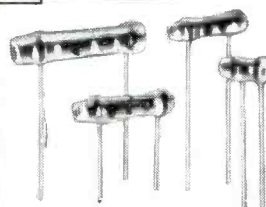

BC Tubular

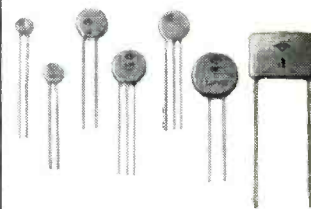

BC Discs

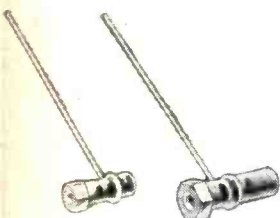

Stand-off

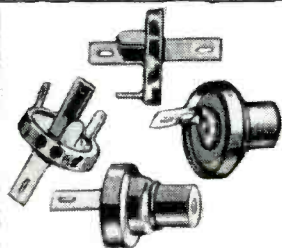

Button-Style



Feed-Thru HI-KAPS®



Miniature
Feed-Thru HI-KAPS®

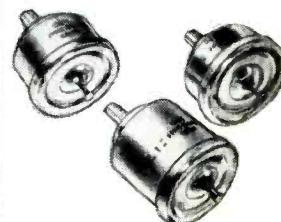

High Accuracy
Capacitors

4 PRINTED ELECTRONIC CIRCUITS

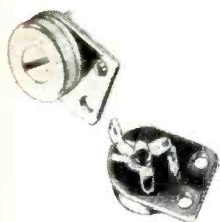

Ceramic Trimmers



Ceramic Min-Kaps®

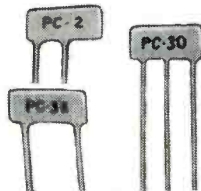

Miniature Resistor and
Resistor-Capacitor Units

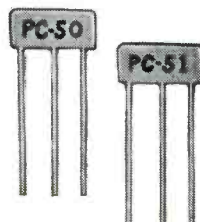

Filpec®
(balanced load
diode filter)



Standard Triode
Couplate®



Vertical Integrator

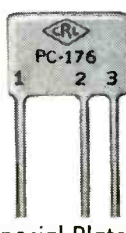

Special Plates
to suit manufacturer's
requirements

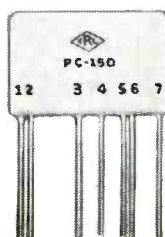

Audet®
Audio-detector plate

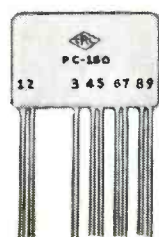

Pendet (†)
(Pentode detector
coupler)

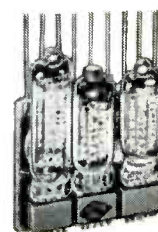

Model II Ampec®
Standard 3-stage
amplifier

2 SWITCHES

- 100's of variations possible

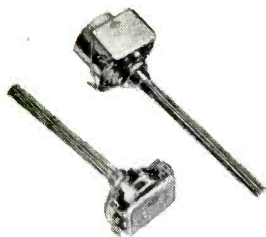

Compentrol (†)
Infinitely variable
loudness control

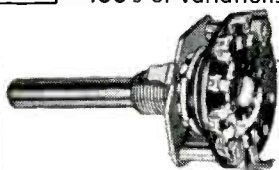

Series 20 Miniature
Phenolic insulation



Series 20 Miniature
Ceramic insulation



Standard Ceramic



Tone Switch

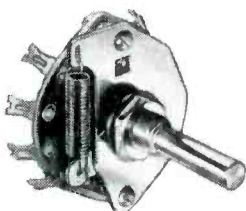

Spring Return Switch

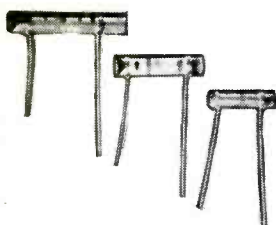

TC Tubular

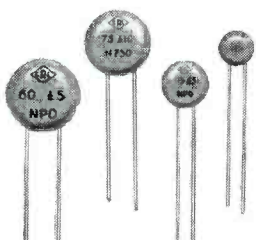

TC Discs



TV HI-VO-KAPS®

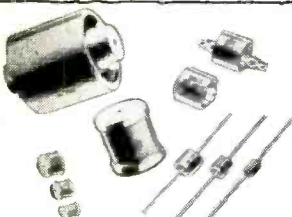

Transmitting
Capacitors

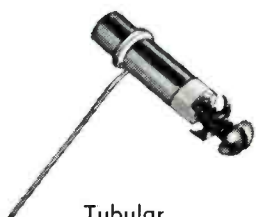

Tubular
Ceramic Trimmer

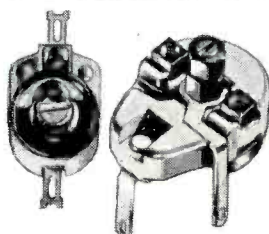

Ceramic Trimmers

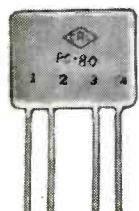

Midget Triode
Couplate (†)

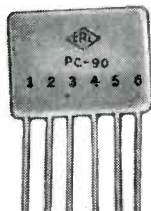

Pentode Couplates (†)

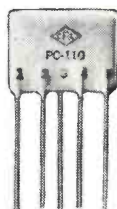

Filplate[®]
(by-pass & filter
application)

5 CERAMICS



Model III Ampec[®]
Miniature 3-stage
amplifier



Custom Ceramics
(Steatite, Centradite,
Zirconite.)



Metalized Ceramics

For Sale!

These and 100,001 other Centralab quality electronic components

WHETHER you buy electronic components in small lots or by the carload — no other single manufacturer can offer you such a *wide choice* in standard or special units. That's why Centralab is the industry's No. 1 electronic components source. Consider these facts:

- Centralab has pioneered more electronic "firsts" than any other manufacturer in the field.
- Introduced Printed Electronic Circuits — more than 30,000,000 in use, offering a new concept in reducing extra parts, time, errors and costs.
- Centralab ceramics are second to none — you can obtain grade L5 and L6 Steatite.
- You can count on the production facilities of seven conveniently located plants.
- Over 200 research and production engineers are constantly seeking to improve present CRL products.
- Unparalleled engineering assistance offered in the development of components for specific TV, FM, military and commercial electronic requirements.

You can rely on Centralab electronic components. Each is the result of more than 30 years' experience working in cooperation with manufacturers all over the world. For complete performance data on products shown — and engineering specifications — check information wanted and mail the coupon.

†Trademark

Centralab

A Division of Globe-Union Inc.
Milwaukee 1, Wisconsin
In Canada, Box 208, Ajax, Canada

Centralab, A Division of Globe-Union Inc.
914-J E. Keefe Ave., Milwaukee 1, Wis.

Please send me information on these Centralab products:
 Controls Switches Capacitors
 Printed Electronic Circuits Ceramics

Name.....Title.....

Company.....

Address.....

City.....Zone.....State.....

tube technology, basic science and mathematics. Options are available in radio and television, electronics, and industrial instrumentation. Graduates qualify for various positions in plants and laboratories. These positions range from production-line tester to junior engineer. Placement figures for a typical class in advanced electronic technology give the following percentage breakdown by job title:

Job Title	Percent
Junior engineer	8.8
Laboratory technician	37.0
Instructor	9.5
Transmitter engineer (radio)...	12.8
Tv technician (production).....	24.3
Tv final tester (production)....	7.6
	100.0

► **Typical School**—A branch of New York State University, the Long Island Agricultural and Technical Institute at Farmingdale offers study options in radio communications, electronic equipment and industrial instrumentation. Full-time students take an intensive two-year course that presents roughly the technical content of a four-year E. E. course less the advanced math and design problems. Since 1948, 274 students have been graduated in the electrical-technology curriculum.

► **Job History**—A typical 1948 graduate shows that his first job was as a production technician, later moving to production supervisor and finally taking charge of a line. Thirty-three 1952 graduates responding to a job questionnaire listed their occupations as follows: junior engineer, 2; customer engineer, 3; transmitter engineer, 1; instructor, 1; technician, 6; tester, 15; instrument repairman, 1; utility layout man, 1; meter man, 1; and electrician's helper, 2.

In addition, the institute runs an evening division in which electronics courses are also offered. About 250 students are participating. Regular courses include radio and tv servicing and are pursued both vocationally and avocationally. Special courses are frequently run in conjunction with local industry for upgrading personnel.

► **Craftsmen**—Industry is likewise plagued by a manpower shortage on the skilled craftsman level. Here

the shortage is being combatted chiefly through in-plant apprentice-training and skill-improvement programs. A survey of 510 electronics plants showed 1,756 apprentices training—largely in the metal trades. Other in-plant training, mostly short term, was being given

to 30,439 workers. Training programs are confined mainly to larger establishments; 62 percent of the plants with 5,000 or more workers maintained training programs while among plants having 100 or fewer employees, only 14 percent had training programs.

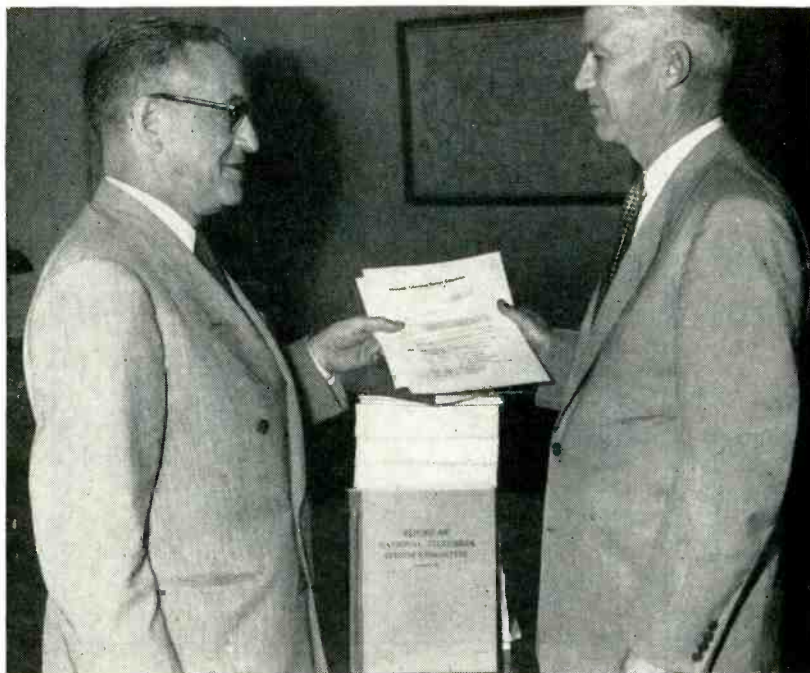

NTSC CHAIRMAN W. R. G. Baker presents FCC Chairman Rosel H. Hyde 52 pounds of technical documents supporting the NTSC-proposed color television standards while . . .

Hopes Run High For Color TV In 1954

Early adoption of new standards seen spurring receivers and programming

POINTING UP the electronic industry's almost unanimous support of FCC's proposed adoption of NTSC color television standards was the formal presentation of fifty-two pounds of technical documents. W. R. G. Baker, chairman of NTSC, handed over 3,823 pages of data representing a million engineering man-hours to FCC Chairman Rosel H. Hyde. The \$10 million cost of this research was borne by the industry.

Besides their concurrence in the NTSC petition, several companies independently filed endorsements.

They included Admiral, GE, Hazeltine, Motorola, Philco, RCA and Sylvania. CBS, whose incompatible system is favored by existing rules, came out strongly for the new standards.

Objections by U. A. Sanabria's American Television, Inc. were economic rather than technical; want the Department of Commerce to study the effect upon industry and the general economy before final FCC action.

► **Closing the Books**—Interested parties filed all petitions and comments with FCC by Sept. 23, at which time the books closed and the Commission began its final deliberations. In the opinion of

(Continued on page 16)

SHOCK - VIBRATION - NOISE ISOLATION NOTES

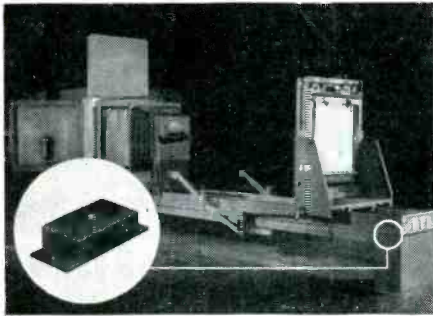

A PHOTO-ENGRAVER'S CAMERA "floated" on Barrymounts, is isolated from floor vibrations. Result: sharper images and faster operation.

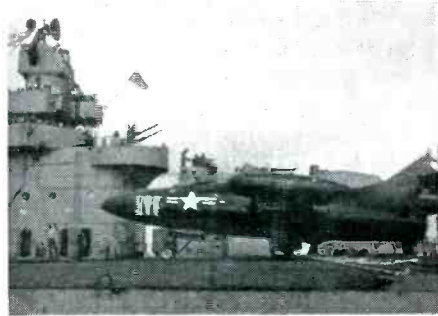

MEET DEMANDS OF MILITARY SERVICE

Barry unit vibration isolators and mounting bases protect delicate electronic equipment in military aircraft and in guided missiles.

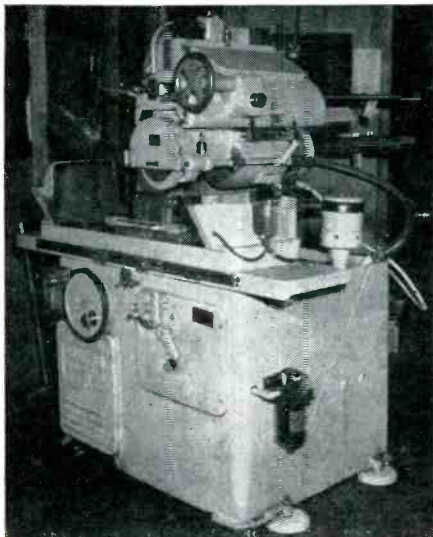

GRINDER ACCURACY PROTECTED

Barrymounts, used to isolate grinders from building-borne vibration, eliminate chatter marks. Result: higher output and better finish.

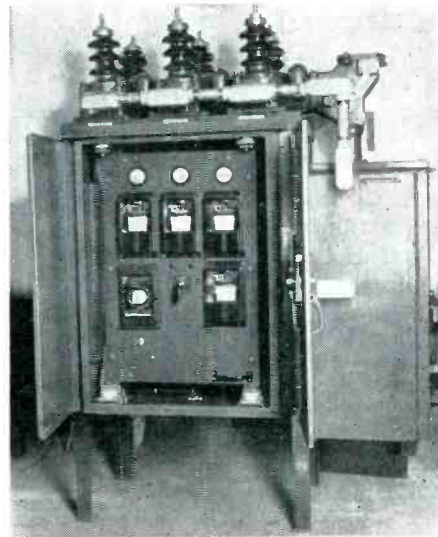

INSTRUMENT AND CONTROL PANELS

mounted on Barry isolators, are unaffected by vibration from nearby heavy machinery. Result: sensitive adjustments "stay put," and frequent recalibrations are avoided.

IN ANY FIELD OF MILITARY OR INDUSTRIAL INTEREST the wide range of Barry products, and the experience of Barry engineers, can help you solve shock, vibration, and noise problems. Call our nearby sales representative, or write directly to us.

THE **BARRY** CORP.

707 PLEASANT ST., WATERTOWN 72, MASSACHUSETTS

SALES REPRESENTATIVES IN

Atlanta Baltimore Chicago Cleveland Dallas Dayton Detroit Los Angeles Minneapolis New York
Philadelphia Phoenix Rochester St. Louis San Francisco Seattle Toronto Washington

industry leaders, the outcome is bound to be favorable, but will not be announced until around the first of the year.

► **Pioneer Lookers**—Because there are always lobbyists, engineers and others able or willing to pay some \$1,000 for an early model, the first color programs will not be seen merely by the vast audience with monochrome receivers. By the end of 1954, according to one estimate, there may be upwards of 75,000 color receivers in operation.

Engineers will have at least a year of grace in which to get the bugs out of their more complex equipment; studio technicians will learn to handle stronger lights.

Instrument Business Sets Volume Record

Shipments have increased \$100 million in 5 years and expansion continues

VALUE of electrical instrument shipments reached a total of over \$273 million last year, an increase of \$117 million over 1947 shipments, according to figures released by the Bureau of Census. The volume confirms the growth of the business that has been evident from the plant expansions and acquisitions of firms in the field during the past few years.

► **Breakdown**—Census divides measuring instruments into three groups, integrating instruments, test equipment and other instruments. Of the three, test equipment for testing electrical, radio and communications circuits and motors was the big item, accounting for \$139 million of the grand total last year. The other categories accounted for \$58 million and \$75 million respectively. In 1949 test equipment shipments were valued at \$54 million while integrating instruments totaled \$63 million and other measuring instruments reached a volume of \$37 million.

► **Companies**—Indication of how companies in the field fared last

year is seen in the following sales figures taken from a list compiled by the National City Bank of New York:

Company	1952 Sales (Thousands)
Applied Research Labs.....	\$2,954
Beckman Instruments.....	14,400
Consol. Eng. Corp.....	8,001
Norden Laboratories.....	3,252
Nuclear Instrument.....	1,178
Servomechanisms.....	10,152
Taylor Instrument.....	21,623
Telecomputing Corp.....	1,665
Tracerlab.....	12,275
Ultrasonic Corp.....	2,108
Victoreen Instrument.....	1,803
Vitro Manufacturing.....	2,240

► **Expansions**—Further indication of the growth of the instrument business is seen in the following plant expansions and acquisitions that have been announced since the

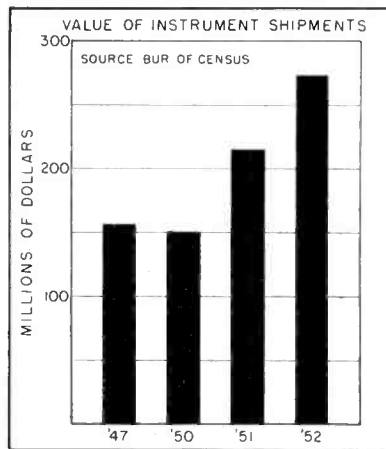

first of the year by companies in the field:

American Car & Foundry entered the business recently with the purchase of Avion Instruments; Beckman Instruments has announced plans for a \$2 million plant in California and has opened a large new plant in New Jersey; Bendix entered the field with the purchase of the Ultra-Viscoson, a device that meters fluid flow; DuMont opened a 118,000 sq ft plant for the manufacture of cathode-ray instruments this year; T. A. Edison acquired Measurements Corp.; General Instrument has acquired a fourth plant; G. M. Giannini built a \$500,000 plant and opened a European subsidiary; Texas Instruments is completing a \$1 million plant in Dallas.

► **Abroad**—Companies overseas are also cashing in on increasing instrument business. H. F. Dever,

president of Brown Instrument Division of Minneapolis Honeywell estimated that the use of instrumentation and automatic control equipment in Great Britain and on the continent had increased at least 50 percent since the end of World War II.

U. S. Surveys TV Purchasing Plans

More people plan to buy receivers this year than last and expect higher cost

PROPORTION of people planning to buy tv sets this year increased substantially over the proportion with such plans last year, according to the Federal Reserve's survey of consumer finances made early this year. The higher level of tv sales so far this year seems to substantiate the survey's results.

According to the study of all appliance purchases planned in 1953, ranging from tv to washing machines, plans to buy tv sets showed the largest increase along with furniture. The figure for those people with definite or probable plans to buy tv sets increased by 3 percent since 1951. The proportion of those people that only indicated uncertain tv spending plans also increased in the two-year period by 1.4 percent.

► **Cost**—Although the percentage of respondents to the survey expecting prices in general to be stable or to decline during 1953 was much larger than a year earlier, the amount to be spent on specific items was expected to be greater. For tv sets, people expected to spend \$250 in 1951, \$300 in 1952 and \$320 in 1953.

► **Income Factor**—The survey shows that in 1952 people with incomes of \$5,000 or more purchased tv sets much less frequently than in 1951 while the lower income brackets bought at about the same or a slightly higher rate. This difference probably reflects the ac-

(Continued on page 18)

Twice the Power for the Same Price

with the **NEW** type **V-2 Variac**

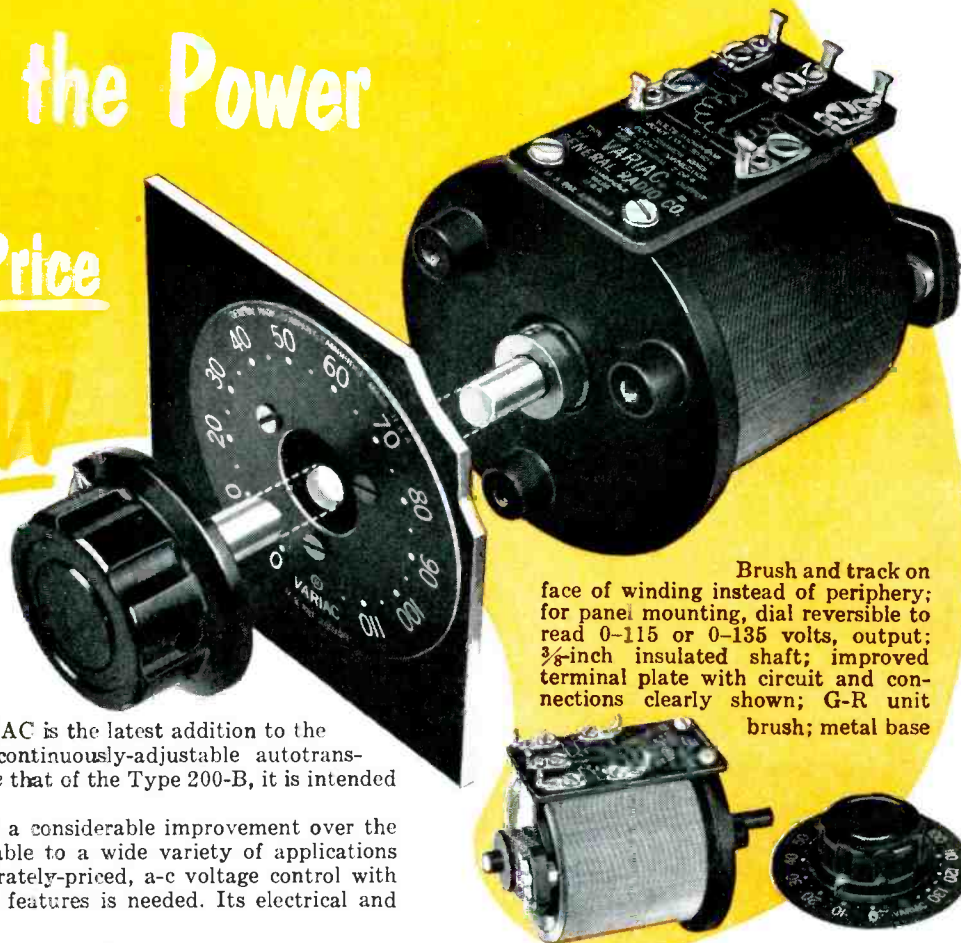

Brush and track on face of winding instead of periphery; for panel mounting, dial reversible to read 0-115 or 0-135 volts, output; 3/8-inch insulated shaft; improved terminal plate with circuit and connections clearly shown; G-R unit brush; metal base

The new Type V-2 VARIAC is the latest addition to the popular "V" series of VARIAC continuously-adjustable autotransformers. With a power rating of *twice* that of the Type 200-B, it is intended eventually to supplant the latter.

The Type V-2 represents a considerable improvement over the 200-B, making it even more adaptable to a wide variety of applications where a relatively low-power, moderately-priced, a-c voltage control with all of the latest exclusive VARIAC features is needed. Its electrical and mechanical features include:

New DURATRAK brush-track coating
Load rating of 0.345 kva
(instead of 0.17 kva)

Output voltages continuously adjustable
from 0 to 135 v, or 0 to 115 v.

Line frequency 50 to 60 cycles; no load
loss at 60 c.: less than 3.5 watts

- ★ Standard mounting holes
(interchangeable with Type 200-B)
- ★ Considerably less panel space
- ★ Metal Base for improved cooling
and added strength
- ★ More rugged stops
- ★ G-R Unit Brush construction

- ★ Terminal board with circuit and
connections clearly shown
- ★ Molded knob-pointer and reversible dial
plate for panel installation
- ★ Meets applicable requirements of Military
Specification for Transformers: MIL-T-27
- ★ Moderate Price: \$12.50



The new DURATRAK coating is one of the most important improvements in VARIACS; another step in the continuing process of development which makes the VARIAC the best voltage control available

NOW ALL "V" TYPE VARIACS HAVE **NEW Duratrak** CONSTRUCTION for Increased Performance Even Longer Life

The new DURATRAK brush-track coating eliminates all brush track oxidization problems which formerly might become critical under severe conditions of operation.

DURATRAK construction adds these features to increase the utility of VARIACS:

Long Life — insures a life as long as that of fixed-ratio power transformers

operated at rated loads

Unaffected By Surges — VARIACS with DURATRAK will withstand initial surges as high as ten times rated current

Minimum Maintenance — the brush track will not deteriorate under normal operation — only maintenance needed is occasional wiping of track with alcohol-moistened rag

Write for the NEW VARIAC BULLETIN for Complete Specifications



GENERAL RADIO Company

275 Massachusetts Avenue, Cambridge 39, Massachusetts, U. S. A.
90 West St. NEW YORK 6 920 S. Michigan Ave. CHICAGO 5 1000 N. Seward St. LOS ANGELES 38

Admittance Meters ★ Coaxial Elements ★ Decade Capacitors
Decade Inductors ★ Decade Resistors ★ Distortion Meters
Frequency Meters ★ Frequency Standards ★ Geiger Counters
Impedance Bridges ★ Modulation Meters ★ Oscillators
Variacs ★ Light Meters ★ Megohmmeters ★ Motor Controls
Noise Meters ★ Null Detectors ★ Precision Capacitors
Pulse Generators ★ Signal Generators ★ Vibration Meters ★ Stroboscopes ★ Wave Filters
U-H-F Measuring Equipment ★ V-T Voltmeters ★ Wave Analyzers ★ Polariscopes

quisition of sets by the higher income groups in previous years.

In early 1952, more than one-half of the respondents with incomes of \$5,000 or more owned tv sets as compared with much smaller proportions among the lower income groups.

► **Where**—Nearly one-half of the people surveyed in northeastern states owned sets in early 1952 in contrast to about three-tenths in the west and one-eighth in the south.

Electronic Firms Size Up The Sales Dollar

Material and labor costs took almost 90 cents from each consumer dollar collected

SHINY SALES FIGURES set down by companies in the electronics field so far this year lose some of their luster when an analysis is made of where sales dollars go. Last year, for every dollar collected from customers by eight major electronic manufacturers, only 2.5 cents was left, by the time all bills were paid, for payments to shareholders and for reinvestment in the business. This year, the amount may be even smaller if material and labor costs keep rising and cannot be offset by price increases.

In 1952, materials, supplies and services bought from outside suppliers by these companies took 52.8 cents out of each sales dollar. Employment costs took an additional 36.2 cents, taxes accounted for 6.3 cents, depreciation cost 2.2 cents for each dollar leaving 1.2 cents for shareholders and 1.3 cents for reinvestment in the business.

► **Companies**—Breakdown of expenditures for each of the eight firms varied considerably, however, for some of the items. For materials, top payment was 66.4 cents of each sales dollar. The low was 42.3 cents. Wages ranged from 28.2 cents to 41.5 cents. Taxes also varied widely from 2.1 cents to 16.4 cents. Payments for depreciation, to

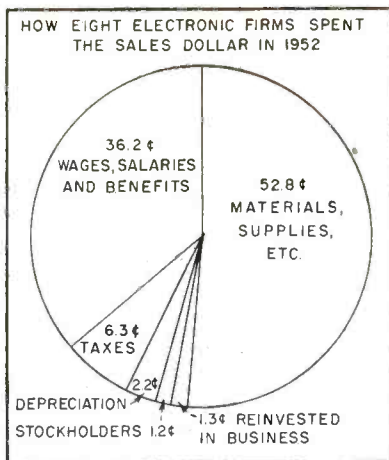

shareholders and for reinvestment in the business were relatively constant for the group during 1952.

► **Changes**—Compared to 1951, material costs for many electronic manufacturers went up substantially last year, as much as 5 cents for each sales dollar collected, in some cases. Higher sales volume last year over 1951 dropped labor's percentage of the sales dollar however, even though the total cost was higher. Other items showed relatively little change for the years 1951 and 1952.

Indications are that material and labor costs are taking a still bigger bite out of the sales dollar this year. Most recent price increases have been blamed on rising labor and material costs. However, rising sales may lower the percentage.

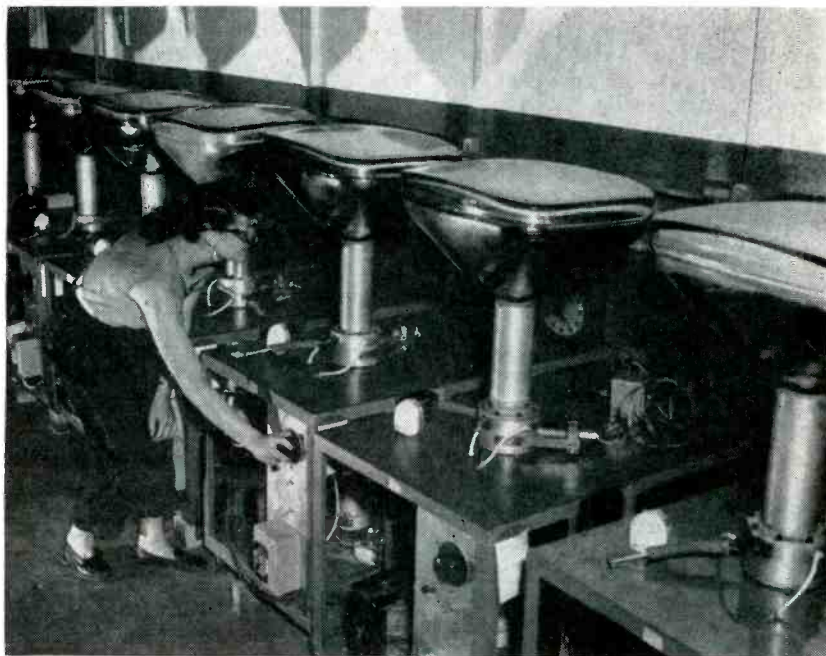

ALUMINIZED picture tube output gains in volume as . . .

Picture Tube Makers Expand Plants

Some tube manufacturers are jumping on the aluminizing bandwagon; others hold out

TELEVISION picture tube production is way ahead of last year's output yet some manufacturers are still expanding facilities and expect even greater production in the future. Output of picture tubes through July of this year is more than

double last year's production for the period.

► **Pro**—One reason for the plant expansions in the face of present high output is that some companies see a continuing rise in the demand for aluminized tubes from set-makers and they want to be ready for it. They feel that, like the rectangular

(Continued on page 20)

Designers—The right tube... find it with G.E.'s

NEW SPOT-RATING SERVICE ON THYRATRONS!



YOUR electronic circuit may require a control tube with special performance. Even General Electric's 36 thyratrons—largest choice in the industry—may not include a type whose published ratings are identical with the tube you need.

Here G. E.'s Thyatron Spot-rating Service takes over. Published tube ratings, such as those listed on this page, apply to *only one set of pre-established conditions*. Under different circuit conditions, a G-E thyatron's voltage or current capacity may be greater. For exam-

ple, if your peak voltage is less than 1250 v, Type GL-3C23 in practice may be found able to handle in excess of 1.5 amp current.

General Electric always is glad to recommend such possibilities, after study. You can have a thyatron that custom-fits your circuit—at the same time, one that's industry-tested for performance. You will save by installing a type already in large production!... With the list below as your guide, write pinpointing your thyatron needs! *General Electric Company, Tube Department, Schenectady 5, N. Y.*

FOR EVERY APPLICATION, A CHOICE OF **PROVED** G-E THYRATRONS!

Primary application and type number	Average amp	Peak amp	Peak volts, inverse	Primary application and type number	Average amp	Peak amp	Peak volts, inverse
MOTOR CONTROL				GL-393-A	1.5	6	1250
GL-C1J	1	8	700	FG-27-A	2.5	10	1000
GL-3C23	1.5	6	1250	GL-5728/FG-67	2.5	15	1000
GL-5720/FG-33 (3 electrodes)	2.5	15	1000	GL-5830/FG-41	12.5	75	10000
GL-5560/FG-95 (4 electrodes)	2.5	15	1000	HIGH CURRENT AMPLIFICATION			
GL-5544	3.2	40	1500	GL-5663	0.02	0.06	500
FG-172	6.4	40	2000	GL-2D21	0.1	0.5	1300
FG-105	6.4	40	2500	GL-5727 (special heater-cathode construction)	0.1	0.5	1300
GL-6044	6.4	77	500	GL-502-A (metal)	0.1	1	1300
GL-5545	6.4	80	1500	GL-2050 (glass)	0.1	1	1300
GL-414	12.5	100	2000	GL-627	0.64	2.5	2500
GL-5855	12.5	150	1500	GL-678	1.6	6	15000
WELDING CONTROL				FG-154	2.5	10	500
GL-5560/FG-95	0.5	30	1000	GL-5559/FG-57	2.5	15	1000
GL-5632 (gas)	2.5	30	1250	GL-672-A	3.2	40	2500
GL-6011 (gas and mercury)	2.5	30	1250	MODULATOR SERVICE			
FG-172 (metal)	2.5	77	750	GL-6130	0.045	35	3000
FG-105 (glass)	2.5	77	750	GL-5948	1	1000	25000
	4	16	10000	SPECIAL APPLICATIONS			
REGULATED POWER SUPPLY				*GL-5662	(fuse tube)		200
FG-81-A (3 electrodes)	0.5	2	500	**GL-885 (2.5-v heater)	0.075	0.3	350
FG-98-A (4 electrodes)	0.5	2	500	**GL-884 (6.3-v heater)	0.075	0.3	350
FG-97	0.5	2	1000	*for electronic-blanket control **for oscilloscope sweep circuits			
GL-5557/FG-17	0.5	2	5000				



GENERAL ELECTRIC

tube, the aluminized tube is here to stay and is a feature that will not be by-passed.

Aluminizing proponents estimate that it increases the light output by approximately 2 to 1 over nonaluminized tubes. They say that the tubes enable set makers to use smaller power tubes because of the increased brightness. One major tube maker now estimates that aluminized tubes account for half of its total production and may reach 75 percent when new facilities are completed.

► **Other side**—But not all tube manufacturers are convinced that aluminizing is worth the problems that it brings about. Dissenters point out that the aluminizing operation takes as much space as the exhausting operation and substantially decreases the number of tubes that can be produced in a day.

With rejects higher and costs up between 10 and 15 percent on each tube, these companies do not at present favor the operation. They say the difference in picture brightness is affected by viewing conditions so that in the wrong light, the difference in picture brightness is not noticeable. They also point out, that despite statements made by aluminizing proponents, the demand for the tubes has not been an important factor.

Radio-TV Fair Trade Hearing Set By FTC

THE Federal Trade Commission has announced a hearing on proposed business rules for the radio and television industry to be held in Washington at the Federal Trade Commission Building on October 8th.

The business rules represent a proposed revision and extension of rules promulgated in 1939 for the radio receiving set manufacturing industry (*ELECTRONICS*, March, 1952, p. 6). Rules have to do with misbranding, misrepresentation and deceptive selling methods.

The purpose of the proceedings is to provide for a cooperative prevention of unfair and deceptive

practices in the radio and television industry. Interested parties may submit their views not later than October 8th, at which time they will be given an opportunity to be heard orally. Copies of the proposed rules may be obtained from the Commission.

Industrial Television Sales Outlook Is Bright

Companies see \$6 million in sales for this year as applications and output increase

DESPITE the large amount of promotion that industrial television has received, sales of equipment in the past have not been large. But now, with more companies in the field, better equipment and lower prices, sales of the units have become substantial and manufacturers estimates indicate that sales this year may reach \$6 million, a ten-fold increase over last year's estimated business.

This year prices roughly average \$2,000 for a camera and the prediction of \$6 million in sales represents the beginning of sizable production. The vidicon tube has come down in price, from approximately \$500 at its introduction to a July price of about \$345. Sales managers and customers agree that similar price reductions have been a main factor accounting for sales increases this year. They expect prices to be even lower next year.

► **Applications**—Finding new ways to use tv is still a problem, despite price reductions. One company recently demonstrated that the equipment could be used in a butcher shop to show shoppers at the counter choice cuts of meat from inside the icebox. The military is also taking to tv. GI's trucked cameras to mock battle lines so that brass hats could witness the progress of battle as it took place.

Perhaps the most unusual application made recently took place in Hollywood, California. There the equipment was used to detect a

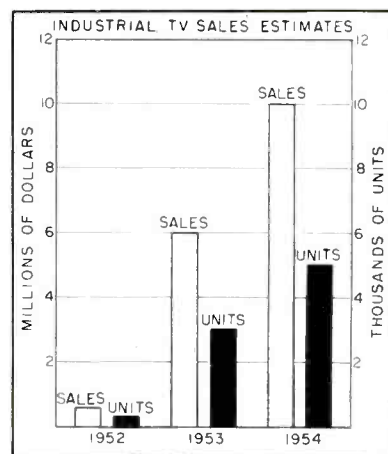

gang of thieves in the act of pilfering the stockroom of an RCA television service branch. The camera, concealed in the rafters and focused on the loading platform, gave Hollywood police watching a receiver in an upstairs room a front-row seat.

Financial Roundup

BRIGHT profits for this year continued to be reported by companies in the electronics field along with new security transactions. In almost every case, firm's reported earnings substantially above those for similar periods in 1952. For 19 companies, the net profit picture for six months looked as follows:

Company	Net Profit	
	1953	1952
American Phenolic	\$688,889	\$573,651
AT&T	204,994,197	174,946,339
Arvin (3 m)	910,596	778,639
Audio Devices	74,165	53,883
Bendix (m)	4,021,952	3,797,119
Clevite Corp.	2,015,419	1,786,379
CBS (26 wks)	4,003,377	2,851,415
Daystrom (3 m)	324,219	401,499
Decca Records	430,063	270,923
T. A. Edison	560,227	316,095
Federal Mfg. & Eng. (12 m)	176,783	212,696
General Precision	1,469,067	361,112
IBM	15,575,997	13,937,142
Sangamo Electric	1,186,714	1,027,749
Servomechanisms	183,716	179,040
Sperry	7,997,470	6,575,265
Standard Coil	2,736,431	1,490,547
Webster-Chicago	345,973	*272,432
*Loss		

► **Offerings**—G. M. Giannini offered an issue of 18,316 shares of common stock (par \$1) at \$12 per share. Proceeds will be used for general corporate purposes.

Soundsciber offered to common stockholders the right to subscribe for 15,588 additional shares of common (no par) at \$6.25 per share, at the rate of 1 new for 7½ shares

(Continued on page 22)

BIGGER—BETTER



Picture Tubes

FROM
THIS
NEW
PLANT

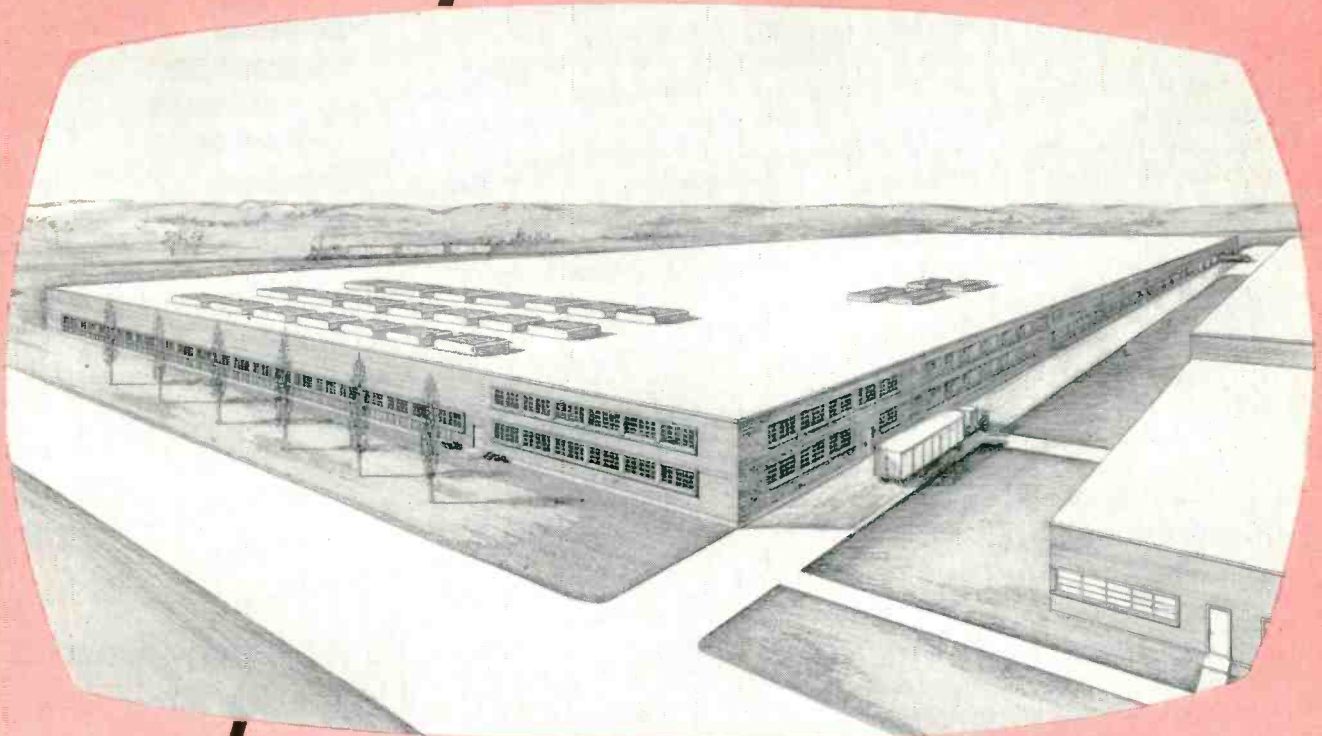

The very newest equipment, and the most advanced production techniques combine in this great new Raytheon plant, to produce the finest quality big screen (21", 24", 27") TV Picture Tubes ever made.

To make possible efficient mass production of giant size picture tubes, Raytheon had to originate specifications for some of the world's largest tube manufacturing units.

Under this one roof, to insure perfect screens and most economical production, you'll find

— THE WORLD'S LARGEST SETTLING CONVEYOR, capable of handling two hundred and ten 27" tubes at a time

— A BAKE-OUT OVEN 103 FEET LONG; the largest built

— THE BIGGEST EXHAUST MACHINE EVER BUILT; 303 feet long; a steel-lined, electrically fired beauty that conveys the big tubes smoothly on specially designed tube carriers supported from the side instead of on undesirable floor rails

Add to these major manufacturing miracles, mechanical handling, automatic testing and super-automatic processing equipment that (1) flashes the getter, (2) bases the tube, (3) solders the leads to the base, (4) sparks the tube, (5) ages the tube.

It totals up to this:

RAYTHEON PICTURE TUBES
are

Right for Sight!



Excellence in Electronics

RAYTHEON MANUFACTURING COMPANY

Receiving Tube Division — for application information call

Newton, Mass. Blgelow 4-7500 • Chicago, Ill. NAational 2-2770 • New York, N. Y. Whitehall 3-4980 • Los Angeles, Calif. Richmond 7-3524

RAYTHEON MAKES ALL THESE:

RELIABLE SUBMINIATURE AND MINIATURE TUBES • GERMANIUM DIODES AND TRANSISTORS • NUCLEONIC TUBES • MICROWAVE TUBES • RECEIVING AND PICTURE TUBES

held. Proceeds are for notes and general corporate purposes.

► **Filings**—Raytheon filed with SEC covering 6,000 shares of common (par \$5) to be offered at market (estimated \$9.75 per share). Proceeds are to be used for general corporate purposes.

Clary Multiplier filed with SEC covering 30,000 shares of common (par \$1) to be offered at market (approximately \$6.75 per share). Net proceeds are to be used for working capital.

Dynatronics of Reno, Nevada filed with SEC covering 200,000 shares of common stock to be offered at par (\$1 per share). Proceeds are to be used for working capital for electronic equipment.

British Setmakers Show Wares

Radio show spotlights \$350-million industry; export models featured

EARLY this month, Britain's electronics industry flexed its muscles at the 20th national radio and television show in London. Employing 135,000 workers, the industry produces \$350-million worth of equipment annually; nearly \$70 million of this is earmarked for export. Over 100 firms were represented at the show.

► **Television**—British setmakers are following U. S. trends in home-instrument design. Nearly every manufacturer is introducing a 17-inch table model this year and at least two firms have 21-inch sets. Rectangular tubes have now been generally adopted. Many tubes are both aluminized and provided with an ion trap to prevent screen burning. Major circuit improvement of the year is automatic picture control that keeps brightness and contrast despite signal-strength variation.

Although British sets generally have but one channel, multichannel sets made to both North American and European scanning standards

Sonic Research filed with SEC covering \$40,000 of 6-percent notes convertible into no par common to be sold at par in \$1,000 units. Proceeds will be used for working capital to develop sonic and vibration equipment.

AT&T plans to issue, in what is said to be the largest offering ever made by any company, about \$625 million of new convertible debentures, if stockholders approve. Proceeds are to be used to continue construction of new facilities to meet demands for telephone service. Some half-million people are waiting for service and over a million party-line customers want better service, the company said. The offering will help finance the expansion.

are being produced for export. Radio and tv home-instrument sales account for about 1/3 of Britain's electronics export business. In all, more than 120 television receivers were on display at the show of which more than half were making their commercial debut.

► **Electronics**—Other new devices shown included a public clock controlled by radio standard time pulses, medical electronic equipment for testing heart and lungs, electronic equipment for factory and office, a microscope with tv-sized screen and one of Britain's electronically-controlled guided missiles.

Several lines of improved electronic components were displayed and a strong trend towards miniaturization noted.

► **Poachers**—An interesting piece of equipment shown was a radio direction finder used by the General Post Office to ferret out operators of unlicensed television receivers. Britain's noncommercial tv service is sustained by an annual \$2.80 license fee collected by the GPO from each viewer.

An estimated 200,000 unlicensed sets are in operation. Licenses outstanding total nearly 2,500,000.

TV Equipment Makers Look Ahead

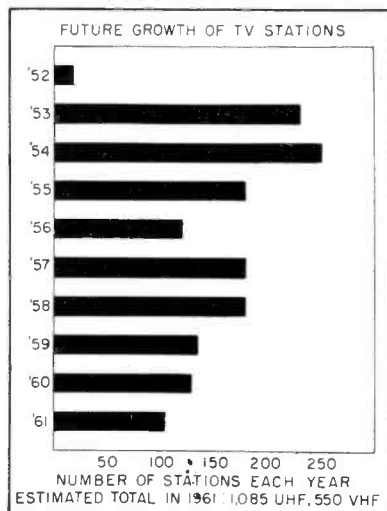

Major tv broadcast equipment manufacturers seem to agree in general with these station predictions made by one company in the field. Next year may be the peak for transmitter sales. At \$250,000 a station, this schedule could mean potential sales of nearly \$400 million for manufacturers over the next 8 years.

Radar Safety Beacons Urged For Aircraft

Equipment would be similar to ground racons that are now in operation

PRIMARY RADAR now in use at many airports has several limitations resulting from its basic nature. A revolving antenna sprays out high energy pulses and receives relatively weak pulses reflected from objects within its range.

Often weather fronts and precipitation adversely affect performance. Sometimes the antenna pattern has holes at certain angles and the aircraft is lost for a time.

Jet-turbine aircraft are so small that the radar often has difficulty obtaining sufficient reflection to track them. When a plane is flying near fixed obstacles it is sometimes obscured. And, worst of all, all blips on the airport primary radar look the same. The Radio Technical Com-

(Continued on page 24)

Newest in the line . . .

A *single* instrument for
Process control
Leak detection
Research

THE latest mass spectrometer in America's accepted standard line is the Consolidated Model 21-610, a precision electronic instrument with extreme stability for unattended process monitoring in the petro-chemical industries. Used with a hand-held probe it, operates as a detector for tracing leaks of any gas within its mass range. The Model 21-610 is suitable for qualitative and quantitative component determinations in gaseous and light-liquid mixtures. Moderately priced and economical to operate, needing no expensive refrigerants, this new instrument brings mass spectrometry as a control procedure within reach of small refineries and chemical manufacturers.

Write for Bulletin CEC-1824-X11.

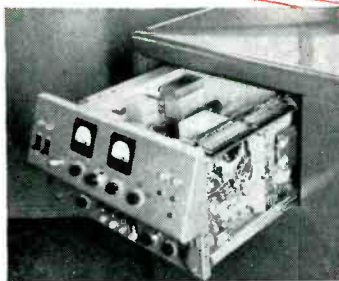
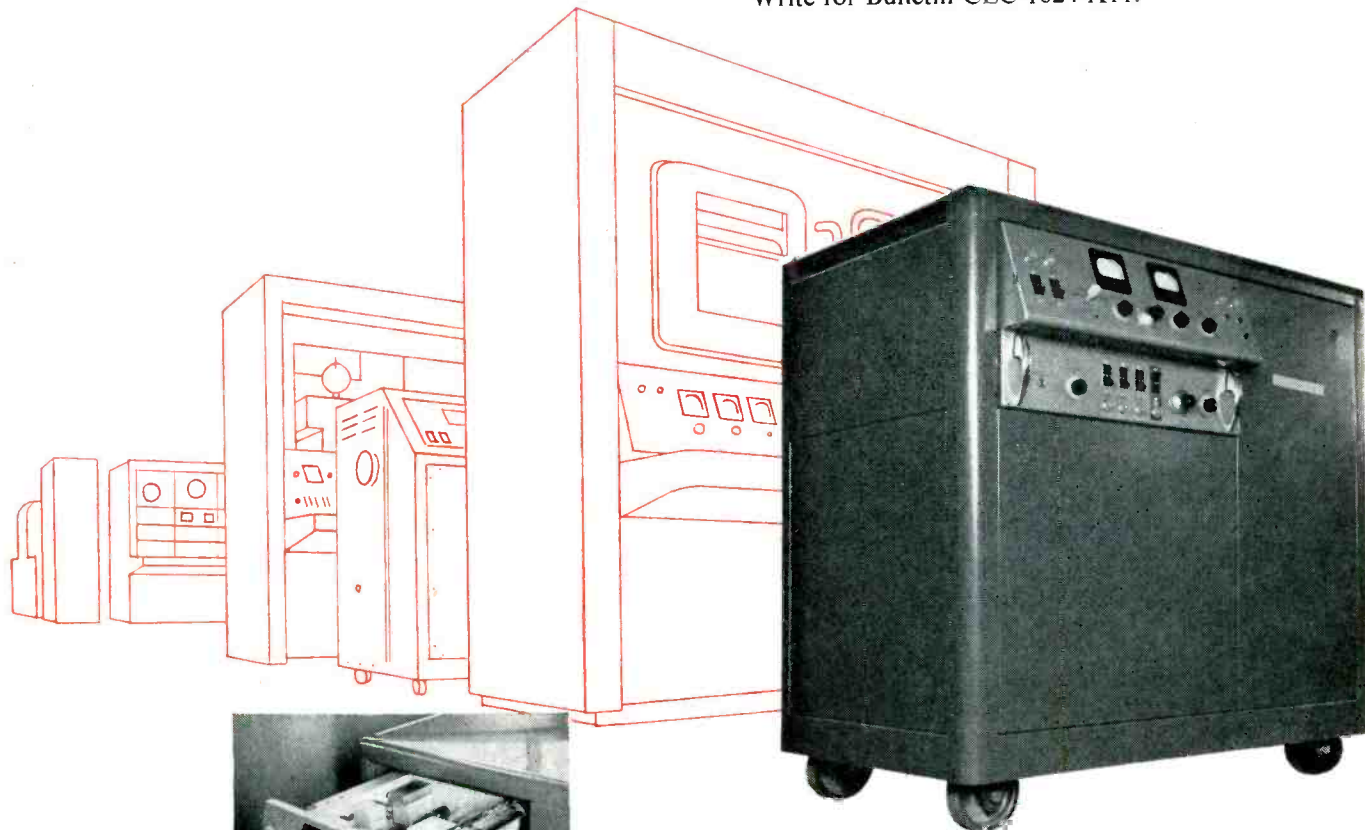

All components are accessible: either by removing side panels or by pull-out chassis containing circuits and controls.

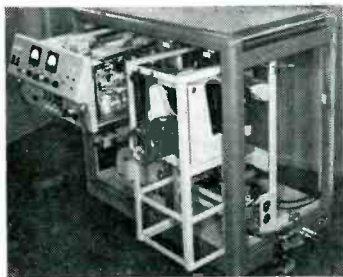

Electronic and vacuum/analyzer assemblies may be removed intact and operated independently.

Model 21-610 Mass Spectrometer

Consolidated Engineering

CORPORATION

300 North Sierra Madre Villa, Pasadena 15, California

Sales and Service through **CEC INSTRUMENTS, INC.**,
a subsidiary with offices in: Pasadena, New York,
Chicago, Washington, D. C., Philadelphia, Dallas.

analytical
instruments
for science
and industry

mittee for Aeronautics therefore urges that a plan be formulated for equipping aircraft with a special transmitter to send out a coded signal when triggered by the airport radar pulse.

► **Racons in Use**—This direct-transmission idea is not new, having been used during the war on military craft under the designation IFF (Identification Friend or Foe). The scheme is now being used in reverse to identify ground locations. Racons (Radar Beacons) are triggered by the radar pulses from aircraft or surface vessels and send out an identifying code.

At present, there is a total of 117 listed as operating throughout the world. Eight of them in the United States operate at 3,256 mc and 77 on 9,310 mc. There are seven in Alaska and the Pacific Isles. Twenty-five others are scattered throughout the world.

Insulating Materials Head For Big Year

ELECTRONIC manufacturers have been responsible for a large part of the record sales set by companies in the electrical insulating materials

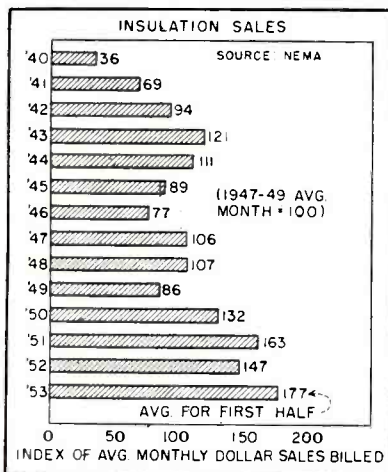

field during the first six months of this year.

Billings have been higher for the period than in any previous first half on record for laminated products, electrical mica, porcelain, varnished fabric and paper, vulcanized fiber and the other components that make up the NEMA index.

MEETINGS

- SEPT. 28-30: Ninth annual National Electronics Conference, Sherman Hotel, Chicago, Ill.
- SEPT. 29-OCT. 1: AIEE Middle Eastern District Meeting, Daniel Boone Hotel, Charleston, W. Va.
- OCT. 2-11: First Annual National Electronic Show, Santa Monica Pier, Santa Monica, Calif.
- OCT. 5-8: Fall Technical Meeting sponsored by Canadian National Committee, URSI and IRE Antenna Group, Ottawa, Canada.
- OCT. 13: Joint Meeting AIEE-IRE, Some Recent Advances in Microwave Tubes, Stewart Avenue School, Garden City, L. I., N. Y.
- OCT. 13-15: National Conference On Tube Techniques sponsored by the Subpanel On Tube Techniques of the Department of Defense, Western Union Auditorium, New York, N. Y.
- OCT. 14-16: Sixth Annual AIEE Special Conference on Machine Tools, Hotel Cleveland, Cleveland, Ohio.
- OCT. 14-17: Audio Fair And 5th Annual Convention of the Audio Engineering Society, Hotel New Yorker, New York, N. Y.
- OCT. 17-23: 35TH National Metal Congress and Exposition, Cleveland, Ohio.
- OCT. 20-22: Thirtieth Annual Session Of A.A.R. Communications Section, Hotel Plaza, San Antonio, Texas.
- OCT. 22-Nov. 1: First Brazilian Exposition of Radio, Television, Electronics and Telecommunications, Automobile Club of Brazil, Rio de Janeiro, Brazil.
- OCT. 26-28: Radio Fall Meeting, RETMA, RTMA of Canada and IRE, King Edward Hotel, Toronto, Ontario, Canada.
- Nov. 9-12: National Electrical Manufacturers Association, Haddon Hall Hotel, Atlantic City, N. J.
- Nov. 9-12: Conference on Radio Meteorology, Austin, Texas.
- Nov. 12-13: IRE Fourth Annual Meeting of Professional Group On Vehicular Communications, Hotel Somerset, Boston, Mass.
- Nov. 13-14: Annual Electronics Conference, Hotel President, Kansas City, Missouri.
- DEC. 8-10: Joint AIEE-IRE-ACM Computer Conference and Exhibition, Statler Hotel, Washington, D. C.
- SEPT. 13-24, 1954: First International Instrument Congress And Exposition, Commercial Museum and Convention Hall, Philadelphia, Pa.
- SEPT. 1954: International Scientific Radio Union, Amsterdam, Netherlands.

Industry Shorts

► **Combination** of the world's most powerful electron linear accelerator with a high-energy electron scattering apparatus that can peer 10 times deeper into the atom than ever before, enough to distinguish particles within nucleus only two one-hundredths of a trillionth of an inch apart, has been perfected by Stanford University physicists.

► **Air-conditioning** field garners another electronic manufacturer with Emerson introducing a line of units next spring.

► **Passengers** on Southern Pacific's "Cascade" streamliner are now able to talk by radio-telephone with any part of the world through facilities installed recently by Bell.

► **Number** of technical session, technical papers, exhibitors, booths and total attendance at the 1953 West-

ern Electronic Show and Convention all approximately doubled over those at the show held in 1951.

► **Intricate** laboratory apparatus, including a photometer and an oscilloscope, was used by GE scientists recently to determine that the average light output of Cleveland fireflies was 6-thousandths of a lumen, and the brightest produced 9-thousandths of a lumen.

► **Canadian Broadcasting Corp.** has selected Vancouver, B. C. as the site for its fourth tv station and has ordered complete equipment for it from Marconi.

► **Patent** held by Celanese Corp. on an electronic device designed for increasing efficiency in production of warp-knit fabrics is being made available on a royalty-free basis to the entire textile industry.

130° C.

WITH IMPROVED BH "649"

Laboratory tested for retention of flexibility
and original rated electrical protection after

130 C° — 1500 hours

150 C° — 500 hours

160 C° — 24 hours

232 C° — 3 hours

BH "649" is a braided Fiberglas sleeving coated with an improved vinyl-chloride formulation. Available in all standard sizes and colors, in grades A-1 (7000 V.), B-1 (4000 V.) and C-1 (1500 V.). Send for data sheets and samples from current production.

**BENTLEY, HARRIS
FIRST IN**

use of Fiberglas
heat-treated Fiberglas
true high temperature
flexibility
vinyl-coated Fiberglas
silicone rubber coating
colors in silicone rubber
true Class B (130°C.)
protection

Another Bentley, Harris First!

Bentley, Harris Manufacturing Co.
Conshohocken, Pa.
Address Dept. E-10

BH *Fiberglas** SLEEVINGS

*BH Non-Fraying Fiberglas Sleeveings are made by an exclusive Bentley, Harris process (U. S. Pat. No. 2393530). "Fiberglas" is Reg. TM of Owens-Corning Fiberglas Corp.

The Reader His Mark

THE ABC that appears in the symbol at the top of this page stands for Audit Bureau of Circulations. The symbol itself is an emblem of cooperation, in which every subscriber to this magazine has an interest.

The Audit Bureau of Circulations is a voluntary, non-profit, cooperative association. It was founded in 1914 and now consists of 3450 advertisers, advertising agencies and publishers in the United States and Canada. This magazine is proud to be a member.

ABC originally was set up to help take the racket out of publishing, to eliminate the waste and guesswork then so prevalent in publishing and advertising, to establish order and confidence in place of the misunderstanding and misrepresentation that arose from unverified circulation claims and dubious circulation practices. Its mission was to protect the interests of both readers and advertisers.

THIS IT DID by first defining the term "paid circulation." Then it established standards and rules to govern subscription sales practices and records. Finally it set up an auditing organization to verify the claims and report the facts concerning the circulation of each member publication. It now maintains on that job a working staff of sixty-five full-time auditors. So the ABC symbol has become the hallmark of circulation standards and advertising values. Each member publication must maintain those standards if it wishes to retain its membership and display the ABC symbol.

This ABC audit is no perfunctory affair. When a business publication, such as this one, becomes a member of the Bureau, it agrees that the auditors shall have "the right of access to all books and records." Their inspection, therefore, may cover any part of its operations. Original subscription orders, payments from subscribers, paper purchases, postal receipts, arrears of payments, and many more items are painstakingly checked by the auditors. In many instances they

go behind the records to seek verification from subscribers themselves as to the terms of their subscriptions.

IN DOING ITS JOB, ABC has created many values for both publishers and readers as well as for advertisers. That is because the publication that becomes a member of ABC thereby offers the strongest possible guarantee of its primary devotion to the interests of its readers. The function of a business magazine is to be useful to its readers. When this service is rendered by an ABC publication, it is constantly subject to the practical test of reader acceptance and approval. As each subscriber has the right to purchase or refrain from purchasing an ABC publication, that collective right confers upon the readers the power to say whether or not the publication will survive. Thus the report on its ABC audit provides the most direct assurance that a publication stays in business only because of a voluntary demand by readers who find its editorial service responsive to their needs.

Naturally, the editor of each business publication follows closely the score thus racked up by his paper in its ABC reports. In the scope and tone of his editorial coverage and treatment, in the selection and presentation of his editorial content, he must constantly labor to maintain and enhance the readers' acceptance of his efforts. That is why the editorial standards established by ABC publications set the editorial standards for all publishing. That is how the ABC constantly stimulates its member publications to become even more useful to their readers.

AND THAT IS WHY the ABC symbol has become the Mark of the Reader, a constant reminder that his willingness to pay for an ABC publication is the acid test of its value both to him and to its advertisers.

McGraw-Hill Publishing Company

Almost as easy as this...

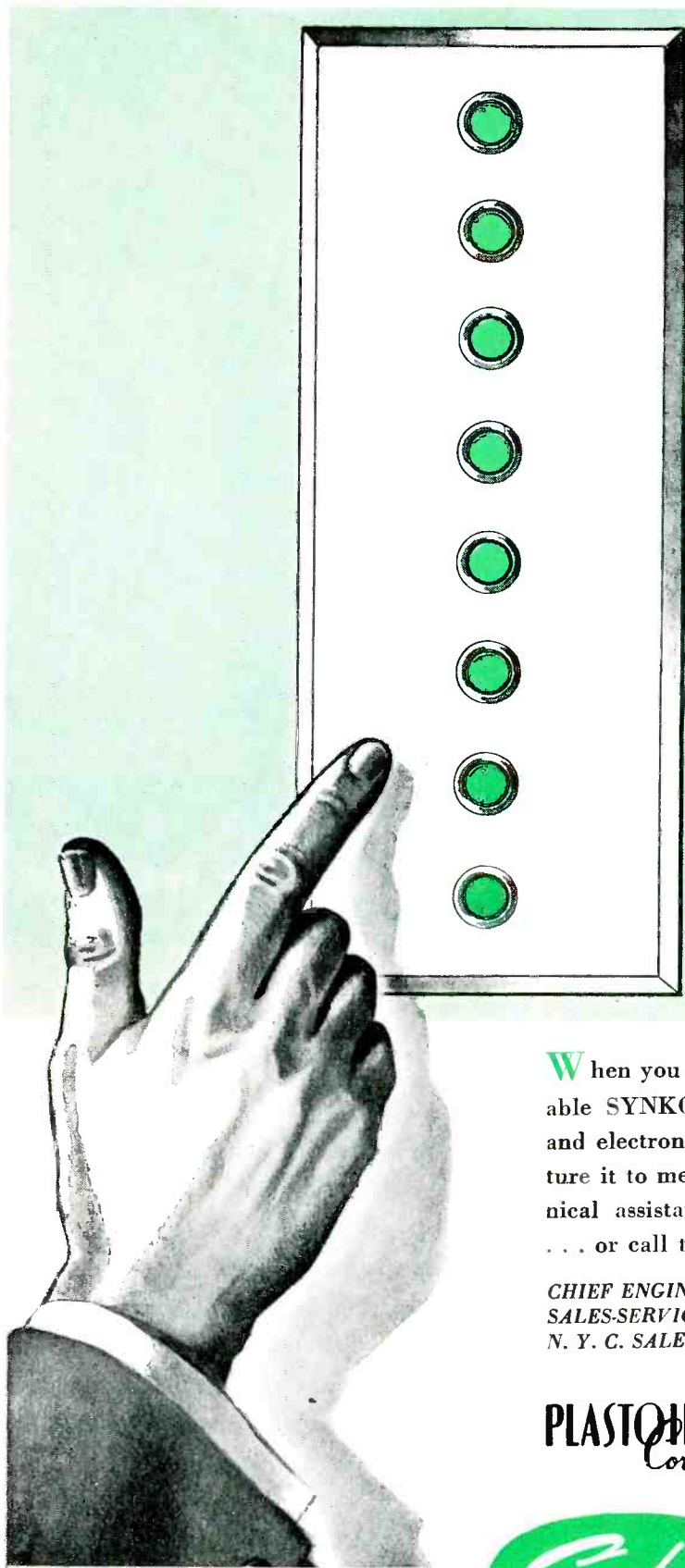

TV Wire

Coaxial Cable

Multi-Conductor Cable

Microphone Cable

Thermostat Wire

Hook-up Wire

Aircraft Cable

**High-Temperature
(Teflon) Wire**

When you need wire, it's good to know that there's a dependable SYNKOTE construction for every conceivable electrical and electronic use. If we don't have it in stock, we'll manufacture it to meet your requirements. For prices, samples or technical assistance, contact your nearest Plastoid representative . . . or call these men:

CHIEF ENGINEER: J. Tomey; phone: FRanklin Boro 7-2311 (New Jersey)

SALES-SERVICE: Don Nichols; phone: FRanklin Boro 7-2311 (New Jersey)

N. Y. C. SALES-SERVICE: W. Grant; phone: STillwell 6-6200 (New York)

PLASTOID

Corporation

• offices: 42-61 24th St., Long Island City, N.Y.
plant: HAMBURG, N. J.

MANUFACTURERS OF DEPENDABLE



INSULATED WIRE AND CABLE

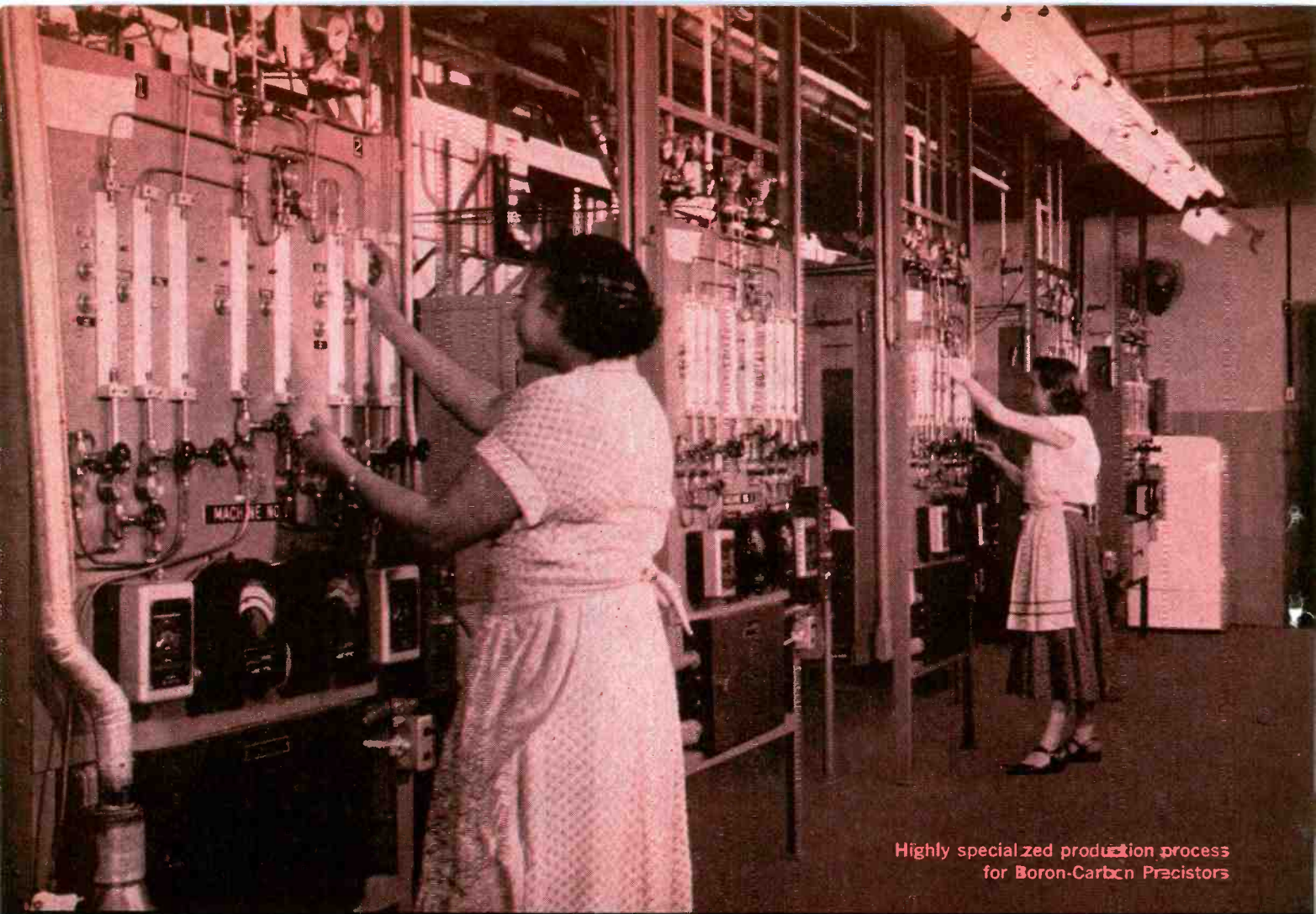

Highly specialized production process
for Boron-Carbon Precistors

ONLY FILM TYPE RESISTORS MEET HIGHER

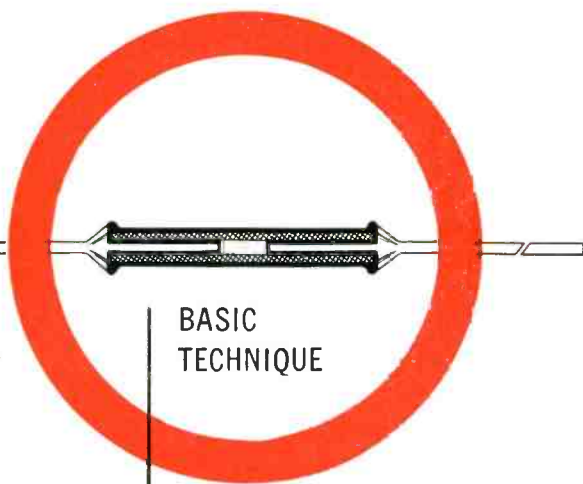

BASIC TECHNIQUE

A thin coating of pre-cured and stabilized resistance material is bonded to special glass or an inorganic core to form IRC's exclusive filament type element. This is in contrast to the carbon pill or slug principle of construction. Its uniformity and stability have proved superior since the earliest days of radio.

Advancing requirements of instrumentation, military electronics and television focus emphasis on greater stability for non-wire wound resistors. IRC believes its filament type construction offers the best answer to more exacting standards. For over 28 years the film type resistance element has proved its superior stability—even in today's newest IRC Boron-Carbon Precistor.

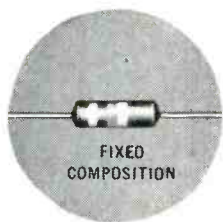

high popularity—high stability

More IRC Filament Type BT Resistors are used in radio and TV sets than any other brand. They meet and beat JAN-R-11 specifications, and have been tested and approved by most producers of government equipment. Exceptionally stable—in 1/8, 1/2, 1 and 2 watts. Send coupon for Data Bulletin.

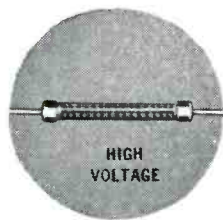

high voltage—high stability

IRC Type MV High Voltage Resistors offer outstanding stability even in very high resistance values. Filament resistance coating in helical turns on ceramic tube provides a long, effective conducting path. 2 to 90 watts. Check the coupon for detailed information.

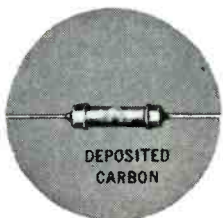

high economy—high stability

Type DC Deposited Carbon Resistors combine accuracy and economy with high stability. Excellent where carbon compositions are unsuitable and wire wound precisions too large or expensive. Available in 1/2, 1 and 2 watts. Use coupon for further facts.

STABILITY STANDARDS

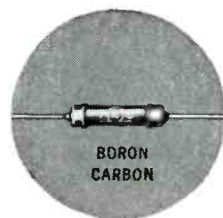

high accuracy—high stability

The ultimate in stable non-wire wound resistors, Type BOC Boron-Carbon Precistors conform to all requirements of MIL-R-10509. Voltage coefficient less than 20 parts per million per volt. Extraordinary load life. 1/2, 1 and 2 watts. Send for Bulletin.

Boron & Deposited Carbon Precistors • Power Resistors • Voltmeter Multipliers • Low Wattage Wire Wounds • Insulated Composition Resistors • Volume Controls •

Precision Wire Wounds • Ultra HF and Hi-Voltage Resistors • Low Value Capacitors • Selenium Rectifiers • Insulated Chokes • Hermetic Seal Terminals •

Wherever the Circuit Says



NEW
resistor



MOLDED
*boron-carbon
precistor*



Eliminates Possibility of End-Cap Trouble



Eliminates Danger of Mechanical Damage



Improved Electrical Characteristics

The new Type MBC 1/4 watt, 1% resistor offers the inherent superiority of a Boron-Carbon resistor plus the advantage of a fully insulated unit. Send coupon for full details.

INTERNATIONAL RESISTANCE CO.
403 N. Broad St., Philadelphia 8, Pa.

In Canada: International Resistance Co., Ltd., Toronto, Licensee

Send me full data on: DC Deposited Carbon; BT Insulated Filament Type Resistors; MV High Voltage Resistors; BOC Boron-Carbon Precistors; MBC Molded Boron-Carbon Precistors

Name _____
Title _____
Company _____
Address _____
City _____ Zone _____ State _____

A NEW TERMINATION TECHNIQUE FOR . . .

- COMPUTERS
- SWITCHBOARDS AND INSIDE PLANT EQUIPMENT
- RELAYS, SWITCHES, AND MULTI-CIRCUIT COMPONENTS

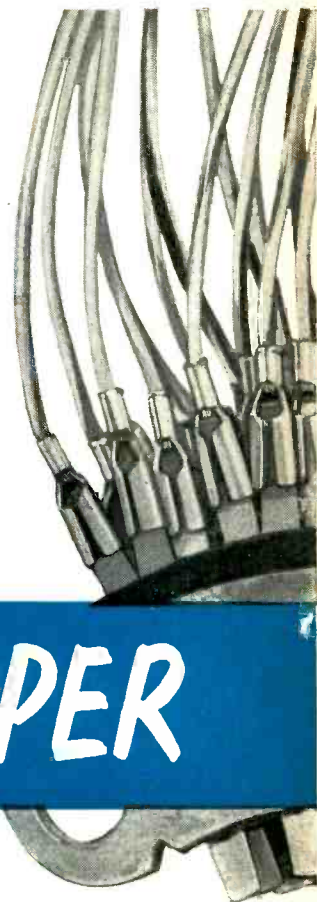

AMP

FLAT* TAPER

If you are concerned with the wiring of close spaced equipment, investigate the new AMP Solderless TAPER TAB RECEPTACLE for flat relay or switch tabs shown at right. It is self locking when installed on a male tab with matching $3\frac{1}{2}^\circ$ taper, yet can be removed and reconnected any number of times without solder or special tools. These terminals are supplied on reels in continuous strip. Customer crimps them on wires using AMP automatic machines at speeds up to 4,000 per hour!

Performance of these miniature connectors meets exacting requirements for millivolt drop, corrosion resistance, and vibration. They are suited for critical low level circuits or power circuits up to several amperes.

Write to AMP Electronics Division for complete information concerning AMP TAPER TAB RECEPTACLES . . . you will receive data and samples by return mail.

An example of the savings possible with Taper Tabs and Receptacles. This disconnect block in Remington Rand's new electronic computer had more than 1,000 wires soldered to tabs in a space approximately 5" x 9"—an assembly operation requiring two weeks' time. After tabs were modified to taper shape (See picture insert), the same operator can now assemble two blocks per day—a 20 to 1 increase—using A-MP's Taper Tab Receptacle No. 41355. There are neither loose wire ends nor drops of solder in the assembly to cause shorts nor cold or rosin joints to open up in the field. Installation is simply a mechanical operation requiring little operator skill, resulting in greater uniformity.

*For connector plugs and other applications where a round pin is more adaptable, see AMP taper pins.

PHOTO AT RIGHT SHOWS AMP SELF LOCKING TAPER TAB RECEPTACLES BEING APPLIED TO MATING TABS ON A STEPPING SWITCH. LOCKING ACTION GIVES MAXIMUM ELECTRICAL AND MECHANICAL SECURITY . . . CONNECTIONS ARE SUITABLE FOR CRITICAL LOW LEVEL CIRCUITS.

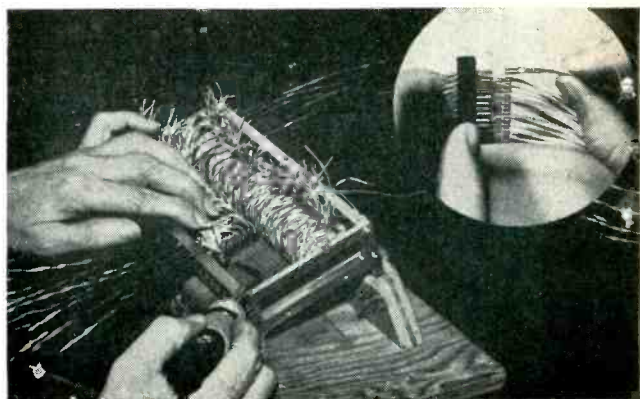
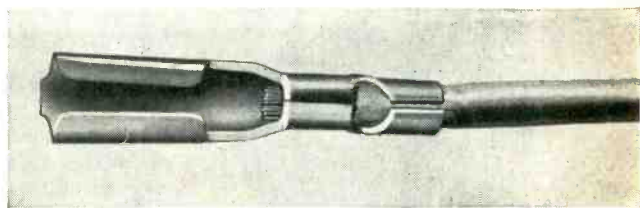

© AMP

AMP Trade-Mark Reg. U. S. Pat. Off.

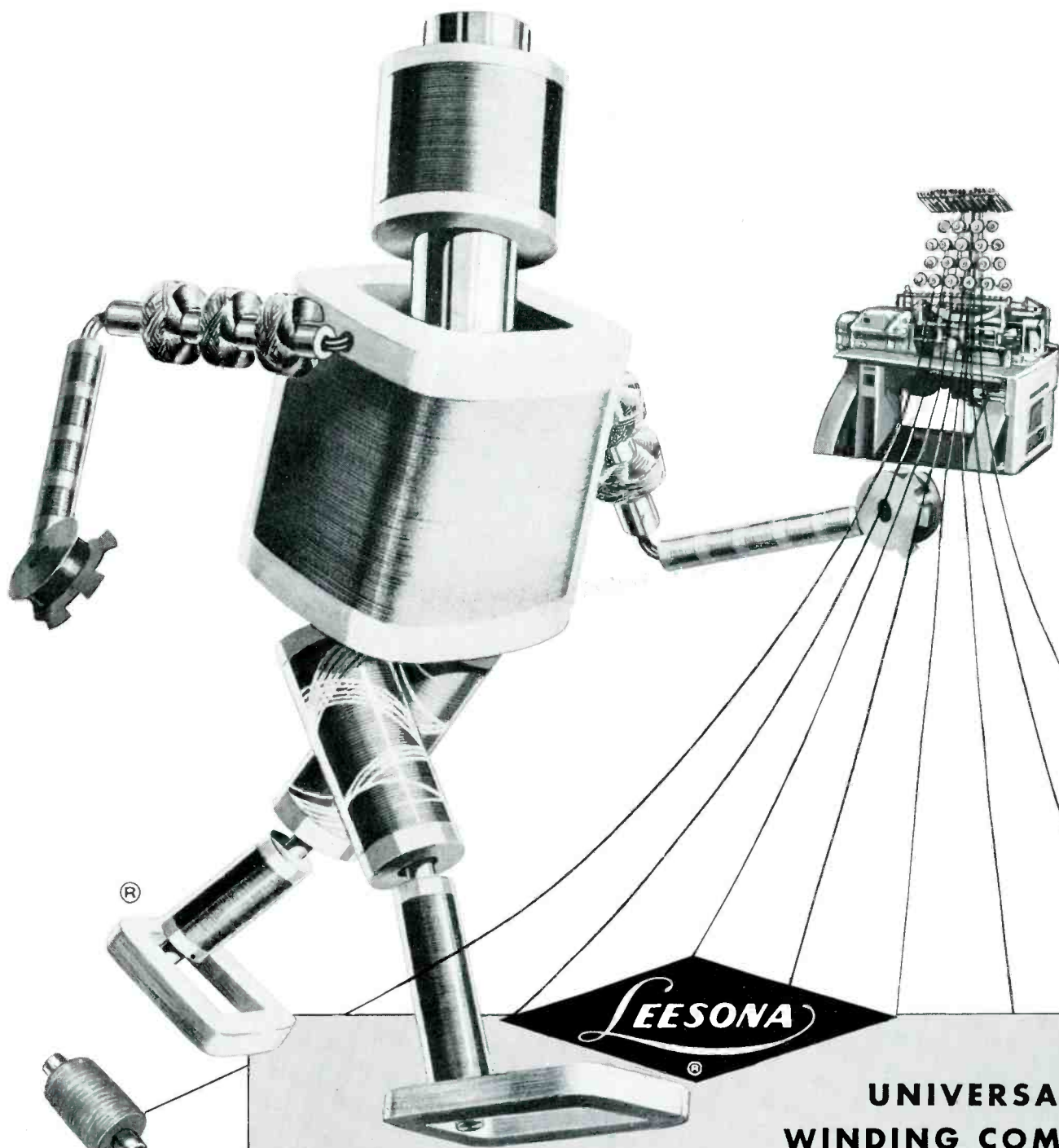

LEESONA[®]

**UNIVERSAL
WINDING COMPANY**

COIL WINDERS

Efficiently designed to meet coil-winding needs... safely, simply, economically

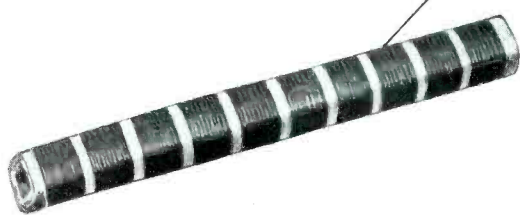

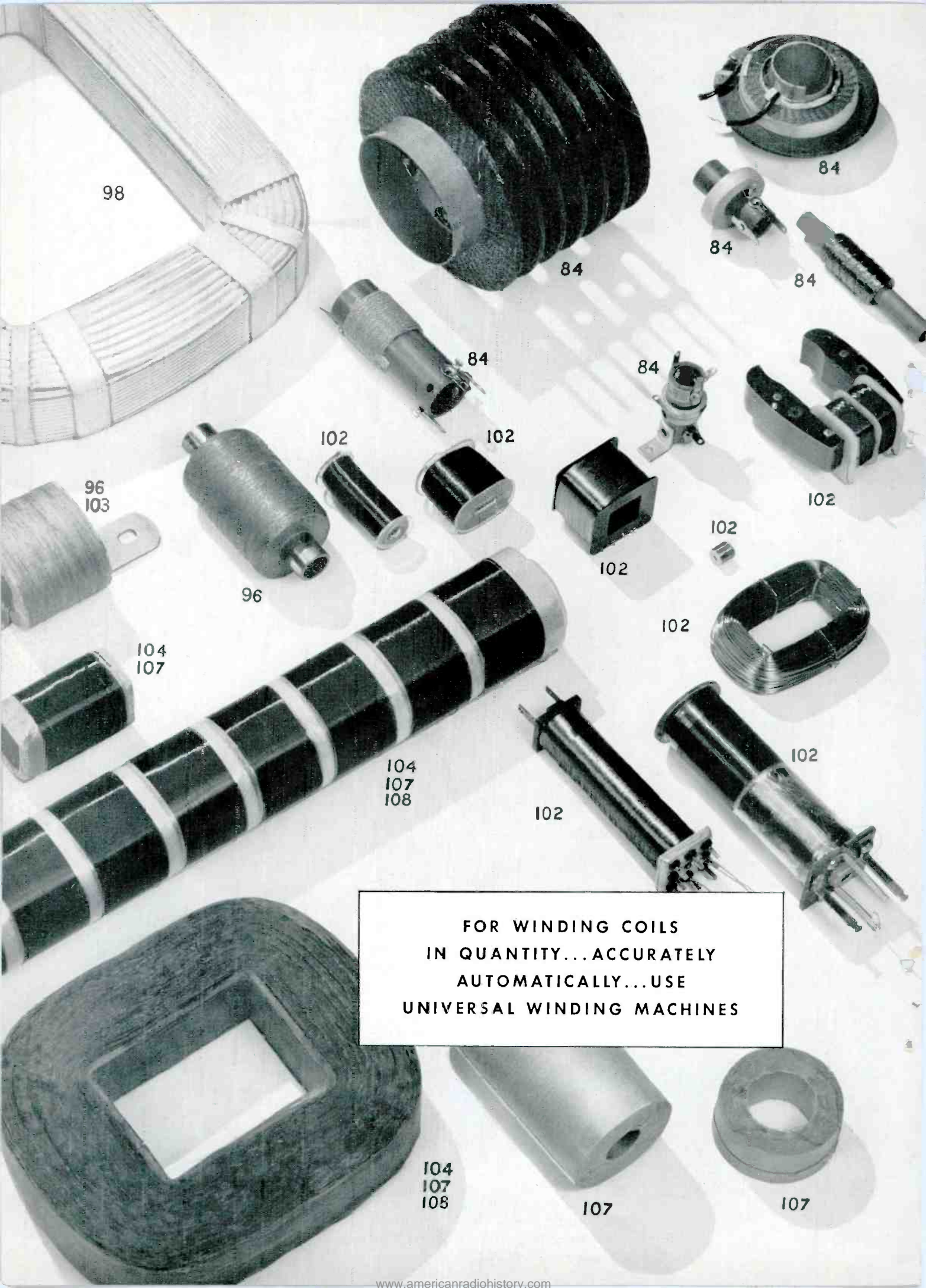

98

84

84

84

84

84

84

102

102

102

96

103

96

102

102

104

107

102

104

107

108

102

102

FOR WINDING COILS
IN QUANTITY...ACCURATELY
AUTOMATICALLY...USE
UNIVERSAL WINDING MACHINES

104

107

108

107

107

Numbers on coils opposite indicate machines on which they are wound.

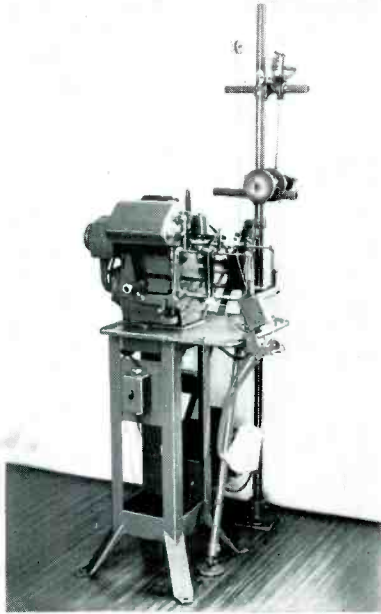

◀ **Layer-wound Cotton Insulated Coils** are automatically wound on this No. 96 Universal Coil Winder. Such coils include meter coils (square), solenoid coils (round) and meter potentiometers (flat wire).

This machine winds both cotton-interwoven and un-insulated coils. On cotton interwoven, it eliminates need for flanged coil bobbins, provides ample insulation where current is most apt to short circuit. It can also produce coils with Glassine or Kraft insulating papers (manually inserted) and is widely used for laboratory and experimental work as well as for quantity production.

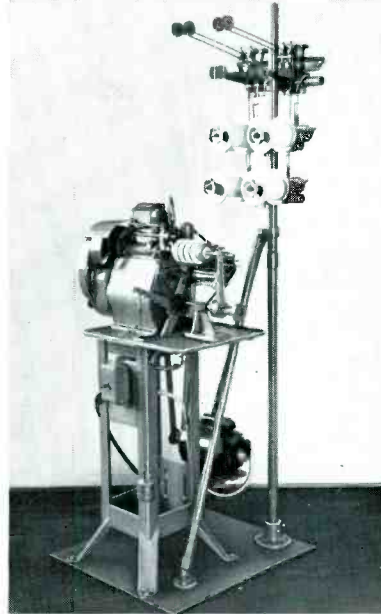

◀ **Cross-wound Coils for TV, Radio and General Electronics** are wound on this No. 84 Universal Coil Winder. Such coils include intermediate frequency transformers, television flyback transformers, progressive wound coils, linearity coils, large diameter pie-windings and peaking coils.

Producing up to four coils at once, the No. 84 machine gives a high rate of production. Coils are wound with extreme accuracy assuring highest efficiency and uniformity, thus reducing rejects.

▶ **Three to Fourteen Paper-insulated Coils in Stick Form** are wound simultaneously on the No. 104 Universal Automatic-Feed Coil Winder now equipped with an electronic drive. Such coils include round or square coils, fluorescent ballasts, oil burner secondaries, automotive ignition secondaries and outboard ignition secondaries.

This machine handles papers of various grades and thicknesses such as Glassine, Kraft and Acetate film.

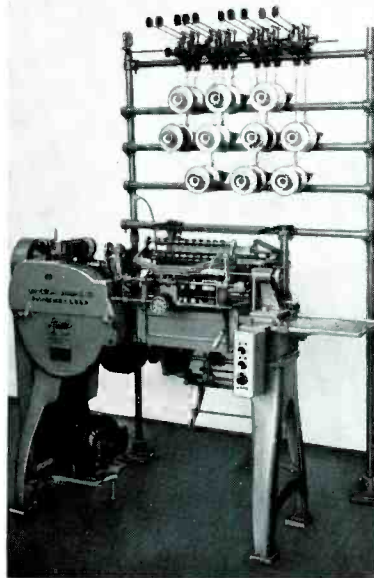

▶ **Hi-speed Spool-wound Coils** are produced on this No. 102 Universal Coil Winder. Such coils include those used in electric shavers, bell ringers, aviation and telephone relays (fine wire), and hearing aids.

This machine makes possible synchronized production of non-insulated coils at speeds up to 5000 rpm. The individually operated heads enable synchronizing winding and handling time thus increasing production per operator on high-turn coils, resulting in lower winding costs.

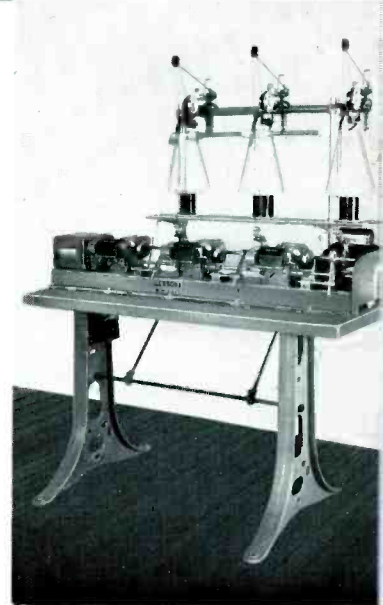

◀ **Four to Thirty Paper-insulated Coils in Stick Form** are wound simultaneously on the No. 107 Universal Automatic-Feed Coil Winder.

This machine provides the quickest, easiest way to wind paper-insulated coils accurately. You can safely handle wire sizes from No. 19 to No. 42 (B&S). The electronic drive assures a slow smooth start that results in less breaks when winding fine wires.

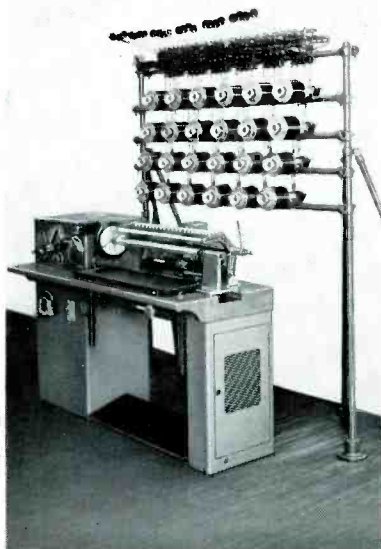

◀ **Four to Thirty Paper-insulated Coils in Stick Form** are wound on the No. 108 Universal Hand-Feed Coil Winder.

This machine meets the need for a modern hand-feed winder with quick set-up features where varied lot sizes and short runs are called for. Operator can make principle adjustments in three minutes with its easily operated external controls. No gears, or cams to remove. Set-up time is reduced to a minimum.

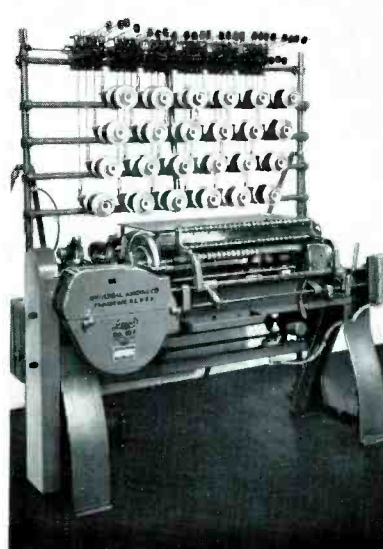

FREE! Separate, 4-page bulletins on each of the machines described above can be had by writing us direct. Bulletins contain detailed specifications.



Demonstration Room, above, located at the Universal Winding Co. plant, Cranston, Rhode Island. Chicago Demonstration Room is located at 9 South Clinton Street, Chicago, Illinois.

YOU'RE CORDIALLY INVITED to visit our Cranston and Chicago Demonstration Rooms.

Watch Universal Coil Winders in action — see for yourself the benefits of their individual features of design. Discuss your own coil-winding problems with the technically-trained Universal people in charge. If you wish, bring along samples of the coils you are now winding — or specifications of the coils you are considering winding.

You will find that Universal with their long experience in the coil-winding field can offer you helpful ways to improve your production. Our Demonstration Rooms are open daily, Mondays through Fridays. To arrange for a demonstration, write to: UNIVERSAL WINDING COMPANY, P. O. Box 1605, Providence 1, Rhode Island, or 9 South Clinton St., Chicago 6, Ill.

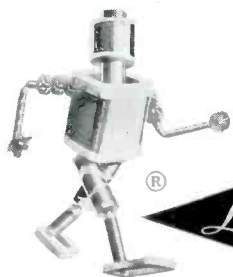

UNIVERSAL WINDING COMPANY

P. O. BOX 1605, PROVIDENCE 1, RHODE ISLAND

SALES OFFICES:

PROVIDENCE • CHICAGO • LOS ANGELES • PHILADELPHIA • MONTREAL, HAMILTON, CANADA

PRINTED IN U. S. A.

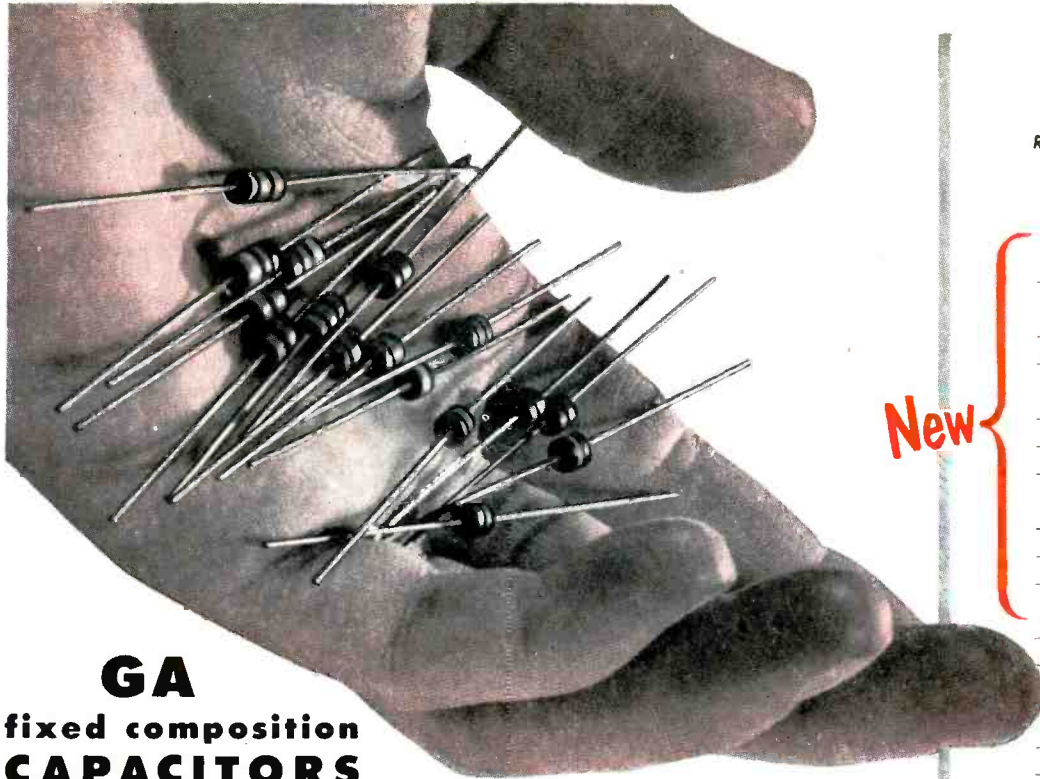

GA
fixed composition
CAPACITORS

22 new values

FOR THE ULTRA HIGHS

Stackpole GA fixed composition capacitors represent the simplest, most inexpensive capacitor design ever produced—and their operating stability is more than ample for the great majority of applications.

Pioneered by Stackpole, these sturdy little units are now available in an expanded range of values from 0.10 to 10.0 mmf. Insulated bodies, dielectrics and electrodes are integrally molded for maximum stability and durability. Leads are securely anchored and treated for easy soldering.

Although Stackpole GA capacitor bodies range only from 0.330" to 0.170" in length, they can now be supplied with as many as four easily distinguished color bands.

*Up to 4
Color bands*

New

STACKPOLE
TYPE GA
FIXED COMPOSITION
CAPACITORS
RTMA PREFERRED VALUES in mmf

20%	10%	5%
.10	.10	—
—	.12	—
.15	.15	—
—	.18	—
—	—	.20
.22	.22	.22
—	—	.24
—	.27	.27
—	—	.30
.33	.33	.33
—	—	.36
—	.39	.39
—	—	.43
.47	.47	.47
—	—	.51
—	.56	.56
—	—	.62
.68	.68	.68
—	—	.75
—	.82	.82
—	—	.91
1.0	1.0	1.0
—	—	1.1
—	1.2	1.2
—	—	1.3
1.5	1.5	1.5
—	—	1.6
—	1.8	1.8
—	—	2.0
2.2	2.2	2.2
—	—	2.4
—	2.7	2.7
—	—	3.0
3.3	3.3	3.3
—	—	3.6
—	3.9	3.9
—	—	4.3
4.7	4.7	4.7
—	—	5.1
—	5.6	5.6
—	—	6.2
6.8	6.8	6.8
—	—	7.5
—	8.2	8.2
—	—	9.1
10.0	10.0	10.0

Electronic Components Division **STACKPOLE CARBON COMPANY, St. Marys, Pa.**

STACKPOLE



NOW CELENAMEL IS AVAILABLE IN SIZES #40 TO #48

MAGNET WIRE
THAT CUTS YOUR
PRODUCTION COSTS!

No stripping problem. Celenamel Film removed when dipped in solder. Large economies effected in your production. New facilities make Celenamel available now in sizes 40 to 48.



OVER 50 YEARS
Wiremaker for Industry

Belden Manufacturing Co.
4625 W. Van Buren St.
Chicago 44, Ill.

Belden
CELENAMEL



Belden
WIREMAKER FOR INDUSTRY



TRADEMARK REGISTERED

powerstat

Variable Transformers

AN EFFICIENT, ACCURATE, DEPENDABLE SOURCE
of CONTINUOUSLY-ADJUSTABLE A-C VOLTAGES

any type

MANUALLY-OPERATED OR MOTOR-DRIVEN . . . LOCAL OR REMOTE CONTROL . . . WALL, BENCH or BACK-OF-PANEL MOUNTING . . . EXPOSED OR ENCLOSED TERMINAL BOARD . . . FUSED or UNFUSED . . . DIRECT WIRING OR CORD-PLUG WITH OUTPUT RECEPTACLE CONNECTIONS



TYPE 116

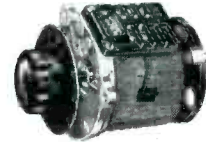

TYPE 116U

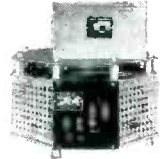

TYPE M-1256

any capacity

TYPE 10



FROM 150 VA TO 100 KVA . . .
SINGLE AND MULTIPLE PHASE DUTY . . . 120, 240
and 480 VOLT SERVICE . . . FREQUENCIES OF 25,
50/60, 400/800 CYCLES . . . FROM ZERO TO OR
ABOVE LINE OUTPUT VOLTAGES WITH THE MAXIMUM
OUTPUT CURRENT AVAILABLE AT ANY SETTING

TYPE MW1156-6

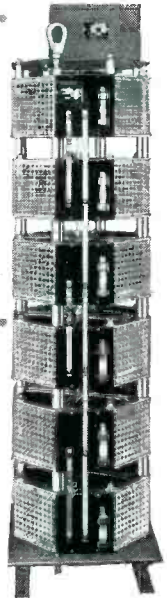

for any job

IN THE EXPERIMENTAL AND RESEARCH LABORATORY . . . THE TESTING AND INSPECTION DEPARTMENTS . . . ON THE PRODUCTION LINE . . . AS THE VARIABLE A-C VOLTAGE COMPONENT OF ANY EQUIPMENT . . . WHEREVER A CONTINUOUSLY-ADJUSTABLE VOLTAGE IS REQUIRED TO CONTROL HEAT, LIGHT, SOUND, POWER OR ELECTRONIC APPARATUS



under any conditions

AIR-COOLED ASSEMBLIES FOR NORMAL SURROUNDINGS . . . OIL-COOLED and EXPLOSION-PROOF UNITS FOR USE IN CORROSIVE or HAZARDOUS ATMOSPHERES . . . SPECIAL DESIGNS FOR SHIPBOARD, AIRBORNE and other MILITARY APPLICATIONS



TYPE 0-1126



TYPE X-1126



400/800 CYCLE
MIDGET
FRAME SIZE

and all featuring

EXCELLENT REGULATION . . . HIGH EFFICIENCY . . . CONSERVATIVE RATINGS . . . ZERO WAVEFORM DISTORTION . . . RUGGED MECHANICAL CONSTRUCTION . . . SMOOTH CONTROL . . . EASY MOUNTING

SEND NOW FOR COMPLETE INFORMATION

THE SUPERIOR ELECTRIC CO.
BRISTOL, CONNECTICUT



- STABILINE Automatic Voltage Regulators
- POWERSTAT Variable Transformers
- VARICELL D-C Power Supplies
- VOLTBOX A-C Power Supplies
- SUPERIOR 5-Way Binding Posts
- POWERSTAT Light Dimming Equipment



THE SUPERIOR ELECTRIC CO.
210 Mae Avenue, Bristol, Conn.

Please send literature on POWERSTAT variable transformers.

NAME _____
POSITION _____
COMPANY _____
CO. ADDRESS _____
CITY _____ ZONE _____ STATE _____

New Versatility in the Cathode-Ray Oscilloscope

Now a single cathode-ray oscilloscope with its associated plug-in pre-amplifiers does the work of three or more separate high-quality laboratory oscilloscopes.

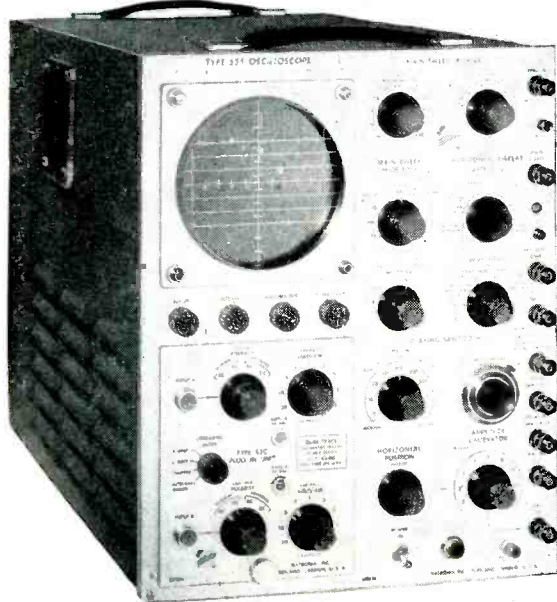

...the Tektronix Type 535

Quickly Adaptable to Changing Requirements with Plug-in Vertical Pre-amplifiers

1. Dual-Trace Unit—Performance superior to dual-beam scope in most applications.
2. Differential-Input High-Gain DC Unit—Sensitivity to 1 millivolt/cm.
3. Wide-Band DC Unit—10 megacycle bandwidth.

New Sweep Circuit Provides Widest Range Ever Offered

1. Accurately calibrated time bases from 0.02 $\mu\text{sec/cm}$ to 5 sec/cm.
2. New sweep delay permits jitter-free display of details in pulse trains.
3. Calibrated interval between sweeps.

High Intensity for Low Repetition Rates and Single Sweeps

1. 10 KV accelerating potential.
2. New Tektronix 5" flat-faced metallized cathode-ray tube.

The fast growth of the electronic industry is bringing more complex problems to the engineer every day. The need for an oscilloscope quickly adaptable to almost any phase of laboratory investigation is evident. The Type 535 Cathode-Ray Oscilloscope is designed to fill this need.

Plug-in vertical pre-amplifiers enable the Type 535 to cope with a wide variety of signals. Wide range time base has single shot,

recurrent, and triggered operation to permit observation of the very slow as well as the very fast. Flexible sweep delay circuitry provides both jitter-free delay and stable viewing of time-modulated or jittery signals. High crt accelerating potential increases the brightness at low repetition rates. With dual-trace plug-in unit precise time comparisons may be made, free from errors inherent in dual-beam cathode-ray tubes.

CHARACTERISTICS

Basic Unit

TIME BASE RANGE—MAIN SWEEP

24 calibrated time bases from 0.1 $\mu\text{sec/cm}$ to 5 sec/cm. Continuously variable uncalibrated time base from 0.1 $\mu\text{sec/cm}$ to 10 sec/cm.

SWEEP MAGNIFIER

Accurate 5x magnification on all ranges including the 0.1 $\mu\text{sec/cm}$ range.

DELAYING SAWTOOTH

Automatic main sweep lockout with controllable reset. Permits delaying the start of the main sweep from 10 μsec to 20,000 μsec in 9 calibrated ranges. Calibrated interval between sweeps, 20 to 20,000 μsec (50 cps to 50 kc).

TRIGGER SELECTION

Automatic triggering or amplitude selection.

BALANCED DELAY NETWORK

0.25 μsec , superior transient response.

10 KV ACCELERATING POTENTIAL

New Tektronix 5" metallized cathode-ray tube, Type 51P2.

AMPLITUDE CALIBRATOR

0.2 mv to 100 v square wave.

Price (with Type 53A Plug-in Unit)—\$1385

Plug-In Vertical Pre-Amplifiers

Type 53C—Dual-trace Unit

Two identical amplifier channels, activated on alternate sweeps—or nonsynchronously at approximately 100 kc.

Risetime—0.04 μsec .

Bandpass (with Type 535)—DC to 8.5 mc.

Sensitivity—0.05 v/cm to 20 v/cm, ac or dc, in 9 calibrated steps. 0.05 v/cm to 50 v/cm continuously variable. 4 position ac-dc and polarity reversal switches.

Price—\$275

Type 53D—Differential-input High-gain Unit

Sensitivity—1 mv/cm to 50 v/cm in 24 calibrated steps. Sensitivity variable between steps.

Bandpass—DC to 250 kc at 1 mv/cm to DC to 750 kc at 50 mv/cm and lower.

Price—\$145

Type 53A—Wide-band DC Unit

Risetime—0.035 μsec .

Bandpass (with Type 535)—DC to 10 mc.

Sensitivity—0.05 v/cm to 20 v/cm, ac or dc, in 9 calibrated steps. 0.05 v/cm to 50 v/cm continuously variable.

Two signal inputs—60 db isolation.

Price—\$85

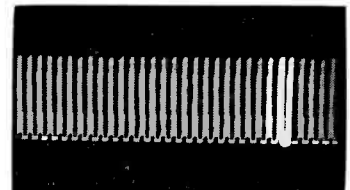

Input signal displayed on the delaying sawtooth. Position of the main sweep is indicated by a bright region on the delaying sawtooth.

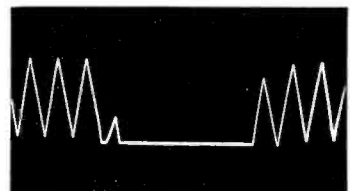

Same signal displayed on the main sweep. The main sweep may be ranged out along the delaying sawtooth and positioned to start after the desired amount of delay.

PLEASE WRITE FOR COMPLETE SPECIFICATIONS

Tektronix, Inc.

P. O. BOX 831A
PORTLAND 7, OREGON
Cable: TEKTRONIX

Waldes Truarc Ring Saves \$2.84 Per Unit, Cuts Labor-Time and Materials in Hydraulic Packing Unit

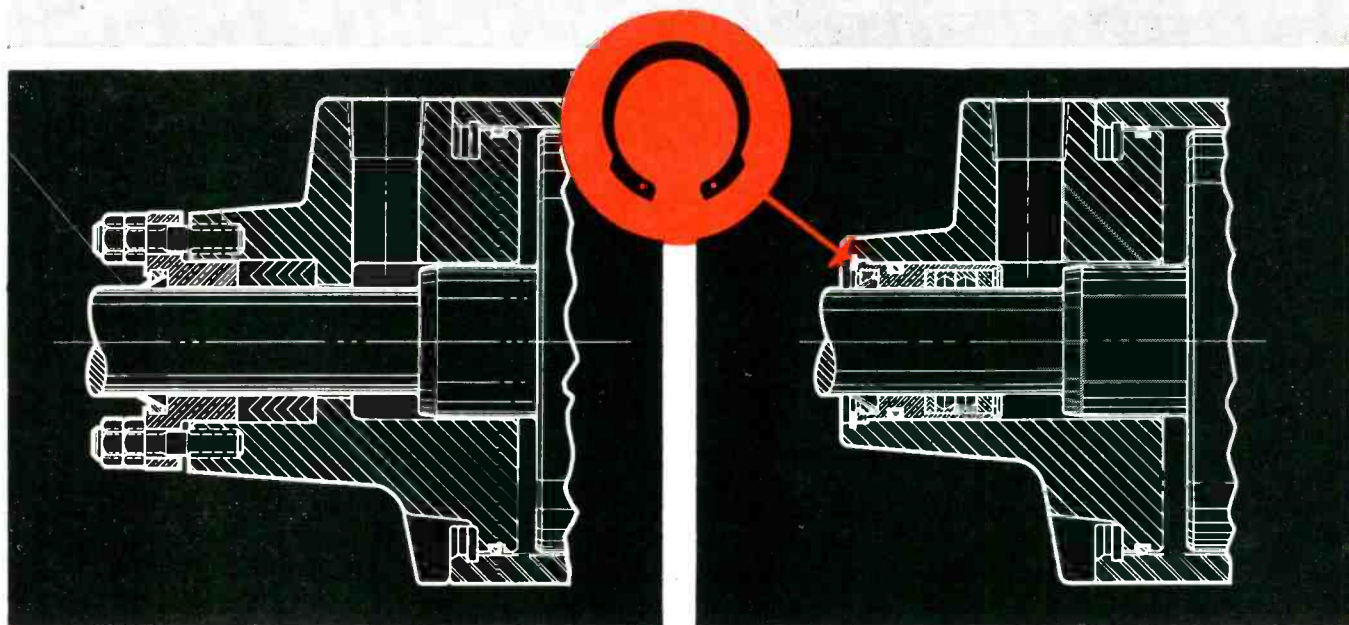

OLD STYLE stuffing box required skilled worker to install packing rings one at a time, then adjust packing glands by trial and error. Disassembly was equally difficult, time-consuming and costly.

NEW Monopak Cartridge is smaller, lighter, streamlined and installed with one Truarc Retaining Ring. Disassembly and reassembly with new cartridge takes unskilled worker just 1 minute.

Hydraulic Accessories Company of Van Dyke, Michigan, uses a single Waldes Truarc Inverted Ring (internal series 5008) to hold Monopak Cartridge in cylinder head.

New design eliminates costly machining and saves 2 1/8 lbs. of material. Re-design with Waldes Truarc Retaining Ring reduces stuffing box diameter from 3 1/2" to 2 7/8", and reduces length from 5 7/8" to 4 3/8". Allows savings in assembly, adjusting and testing.

NEW DESIGN USING WALDES TRUARC RING PERMITTED THESE SAVINGS PER UNIT

MACHINE TIME SAVED:

Chuckling, facing and boring	\$.72
Drilling and tapping 3 holes18
Drilling and counterboring 3 holes12
Assembling, adjusting, testing90

MATERIAL SAVED:

1 1/2 lbs. cast iron30
1/2 lb. bronze23
3 studs36
3 nuts03

TOTAL \$2.84

Waldes Truarc Retaining Rings are precision-engineered . . . quick and easy to assemble and disassemble. Always circular to give a never-failing grip. They can be used over and over again. There's a Waldes Truarc Ring to answer every fastening problem.

Find out what Waldes Truarc Retaining Rings can do for you. Send your blueprints to Waldes Truarc engineers for individual attention, without obligation.

For precision internal grooving and undercutting . . . Waldes Truarc Grooving Tool.

SEND FOR NEW CATALOG



**WALDES
TRUARC**

REG. U. S. PAT. OFF.

RETAINING RINGS

WALDES KOHINOOR, INC., LONG ISLAND CITY 1, NEW YORK

WALDES TRUARC RETAINING RINGS AND Pliers ARE PROTECTED BY ONE OR MORE OF THE FOLLOWING U. S. PATENTS: 2,382,947; 2,382,948; 2,416,852; 2,420,921; 2,420,341; 2,439,785; 2,441,846; 2,455,165; 2,483,380; 2,483,383; 2,487,802; 2,487,803; 2,491,306; 2,509,081 AND OTHER PATENTS PENDING



Waldes Kohinoor, Inc., 47-16 Austel Place, L. I. C. 1, N. Y.

Please send me the new Waldes Truarc Retaining Ring catalog.

(Please print) E-105

Name.....

Title.....

Company.....

Business Address.....

City..... Zone..... State.....

★

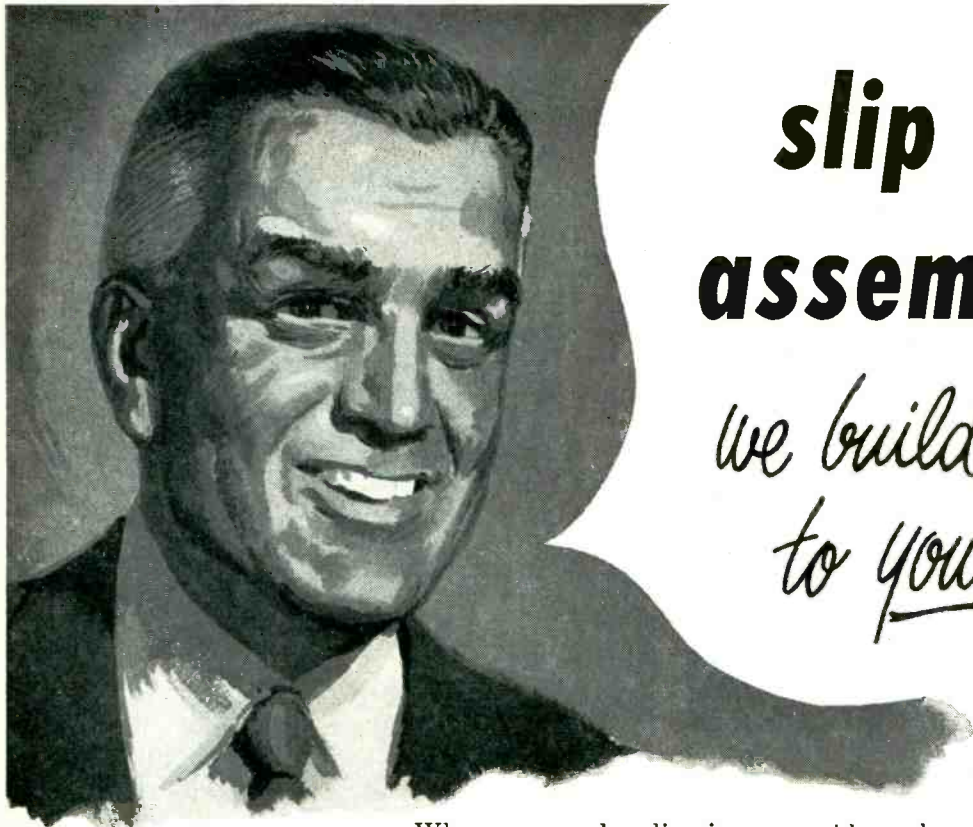

slip ring assemblies-

*We build them
to your specs*

When you need a slip ring assembly — large or miniature, complex or simple, of any capacity — PM Industries can be of value to you. We have pioneered in the development of slip ring assemblies to meet widely diverse requirements, both electrical and mechanical, and can put at your disposal over twelve years of design and manufacturing experience.

In meeting your specifications, we will employ the methods best suited to producing, at minimum cost, a unit that gives maximum performance. Your particular slip ring needs may require a molded rotor, a plated rotor, or a built-up assembly; we are set up to manufacture by any of these processes. Your specific electrical and mechanical requirements will be fulfilled through our design experience using all brush and ring materials and techniques. You will save time and save money by calling upon our skills.

The following summary indicates PMI's technical experience on production units. Our experimental work reveals that the values shown are conservative.

FREQUENCY: from DC to more than 60mc

VOLTAGE RANGE: from microvolts to more than 20,000 volts, corona-free

CURRENT RANGE: from microamps to more than 600 amps

NUMBER OF CIRCUITS: max. to date, more than 500 (space requirement the limiting factor)

BRUSH LIFE: min., 7 million linear ft.

SIZE: from synchro and resolver type rotors to 36" diam. x 8' height

NOISE LEVEL: at 600 amps, an average peak to peak amplitude of 0.15 volts; at microamp levels, noise not detectable

ENVIRONMENTAL SPECIFICATIONS:

High Altitude: to 60,000 ft.

Water-tightness: MIL-E-2036A

Shock and Vibration: MIL-T-17113

Fungus Resistance: acceptable to all Govt. agency requirements

Corrosion Resistance: 200 hour Salt Spray test

Whether your requirements are complex or simple, consult PMI. We'll be happy to discuss your problems without obligation. If you want preliminary information, write for our Facilities Report and our new brochure "Slip Ring Assemblies to Your Specs."

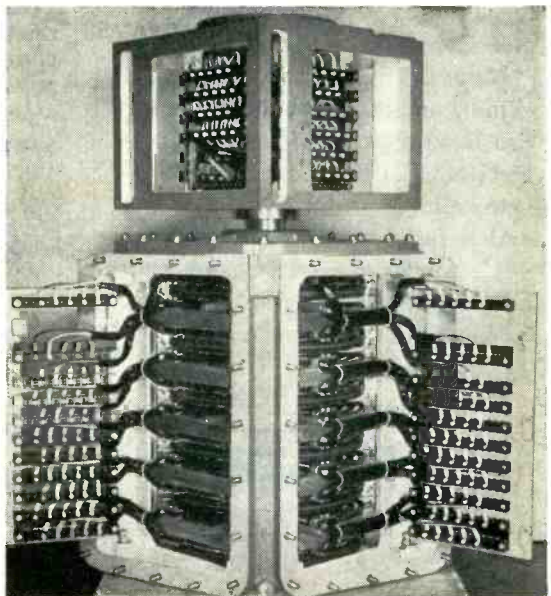

DESIGN • DEVELOPMENT • PRODUCTION

Industries Inc., Stamford, Conn.

Electro-mechanical devices • Engineered plastic-metal assemblies



C-D-F SPIRAL TUBING

A UNIFORM, HIGH QUALITY PRODUCT AT LOW COST

Good dielectric strength • Low dielectric loss properties
Good mechanical strength and moisture resistance

C-D-F is a dependable source of supply for all of your coil form spiral tubing needs. Uniform, high product quality is maintained by rigid standards of manufacture. C-D-F offers you fabricating skill, backed by exacting technical and inspection control. A recent C-D-F development is Grade 5 Constant Torque Tubing for use in coil forms. After the threaded iron tuning core is inserted and finally adjusted, you obtain the same stable torque rating.

Constant Torque features: exact internal threading . . . every thread engaged. 3-point contact with core prevents binding and permits positive tuning and re-tuning. Outer surface of tube has no weak spots, no external embossing to cause cement leakage. Available in lengths up to 14" to take .248" to .250" core with 28 threads per inch and also 6-32, 8-32 and 10-32 screw sizes. Write for samples.

Grade 5 Tubing is also custom-fabricated by C-D-F in conventional shapes to accommodate other sizes of tuning cores.

C-D-F produces spiral tubing in grades to meet most requirements. Use the Grade Selector Chart when requesting samples and additional information.

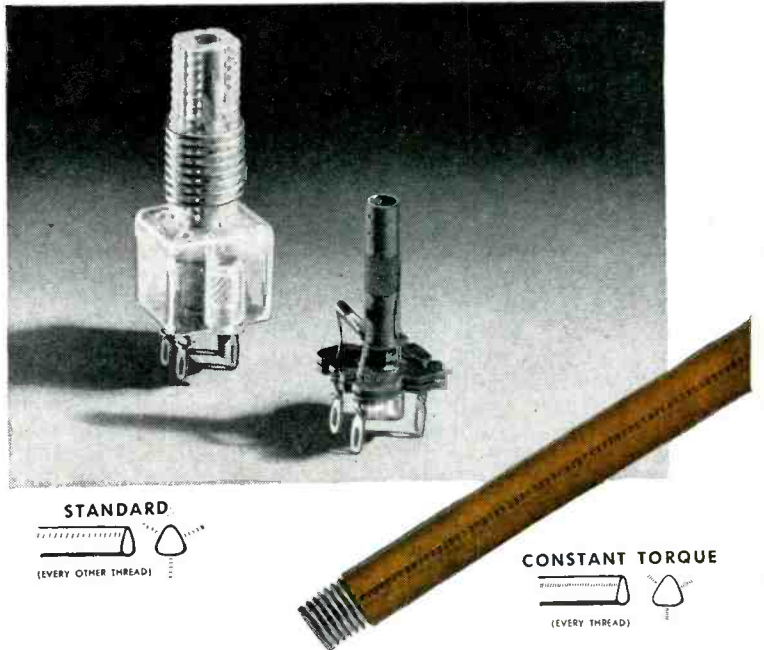

SELECTION OF THE PROPER GRADE

While the differences between some of the grades are not great, they are quite distinct when specific requirements are considered. For most uses, the proper grade can be selected from the descriptions, size range, and properties tables in our catalog. If this should prove difficult in some cases, it is desirable for our C-D-F sales engineer to have as much information as possible about the application, especially fabricating requirements, in order that we may make suggestions. Your blueprint is usually sufficient if it carries some indication as to the quality desired. In other cases, the following check list will be found to be helpful:

Type of Application.

Properties required or the customer's specification for the material. Fabricating quality desired. This is important where stapling, riveting, punching, or forming operations are to be performed by the customer.

Any unusual conditions which may affect the suitability of the material for the job. For tubing that is to accommodate tuning cores, actual samples of the cores are essential along with torque requirements (if known).

Get all the facts. Write for 8-page Technical Folder ST-53 describing standard grades of C-D-F Spiral Tubing, their properties, sizes and tolerances, and how to select the proper grade for your application. Free test samples are available upon request. Call your C-D-F Sales Engineer (offices in principal cities). He's a good man to know!

AVAILABLE GRADES

IMPREGNATED

- 1 General Electrical and Mechanical Grade.
- 1A Electrical and Mechanical Grade—Special Punching.
- 2 Mild Stapling, Riveting, and Post Forming Quality.
- 2A Intermediate Fabricating and Stapling Quality.
- 3 Severe Stapling, Riveting, and Post Forming Quality.
- 5 Constant Torque and Formed-to-Shape Coil Form Tubing.
- 6 Special for High Humidity Applications.
- 6A Extra Hard, High Strength Tubing.
- 7 Soft Varnished Kraft Tubing.
- 7A Hard, Rigid Rectangular Tubing.
- 8 Varnished Diamond Insulation—Tubing.
- 9 "Deflection Coil" Tubing.
- 10 Larger Size, Heavy Wall Tubing for Mechanical Uses.

UNIMPREGNATED

- 20 Special Wound in Specified Combinations of kraft paper, fish paper, etc.
 - 21 Plain Kraft Paper Tubing.
 - 22 Plain Diamond Insulation Tubing.
 - 23 Plain Chipboard Tubing.
- Round Formed and Notched Square, Rectangular
 Formed (fluted shape)

THE NAME TO REMEMBER  SPIRAL TUBING

Continental-Diamond Fibre Company

NEWARK 16, DELAWARE

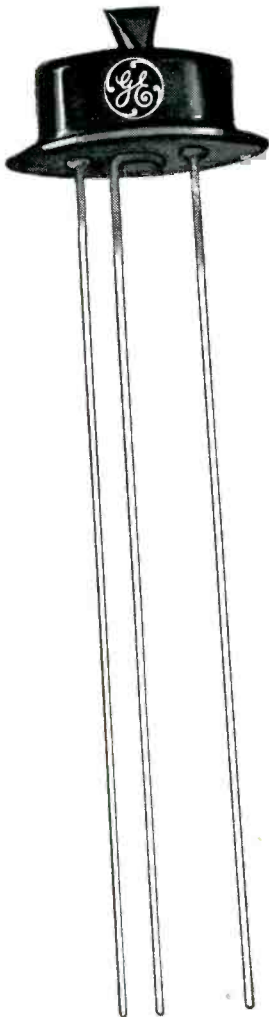

VACUUM

FIRST In Features:

Vacuum Sealed Junction

Welded Seam Construction

● **N**CE again you have proof of the inherent quality...superior performance...of a General Electric product painstakingly developed through intensive research. Not just an ordinary transistor to answer current application demands; new G-E vacuum sealed junction transistors represent a design with radically improved characteristics and keyed to the tools of mass production for *low component cost*.

First junction *diodes* and now junction *transistors*. This logical product sequence has given General Electric almost two years of production experience on junction devices *before* announcing junction transistors. The result: anticipation and solution of many problems *plus* the addition of unique features to enhance the range of application.

Your decision to use this new G-E product assures you of a basic component that is thoroughly tested and *proved superior in every performance characteristic!*

- **HERMETIC SEAL** ...unaffected by moisture.
- **VACUUM SEALED JUNCTION** ...contaminating gasses permanently eliminated!
- **WELDED SEAM CONSTRUCTION** ...free from solder-flux contamination.
- **HIGH POWER OUTPUT** ...Case design makes possible a collector dissipation of 150 MW.
- **HIGH FREQUENCY PERFORMANCE** ...Completely successful operation at audio and supersonic frequencies.
- **HIGH TEMPERATURE OPERATION** ...Rated for a maximum junction temperature of 100°C.
- **LONG LIFE** ...stable performance throughout the life of your equipment.
- **SMALL SIZE** ...extremely compact design provides added flexibility for all applications.

HISTORY
OF
ELECTRONIC
DEVELOPMENT



You can put your confidence in—

JUNCTION TRANSISTORS

**FIRST In Performance:
High Power Output**

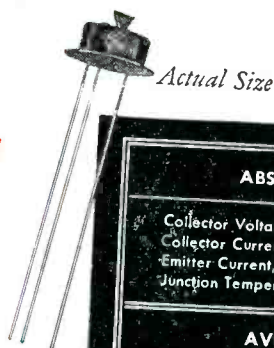

ABSOLUTE MAXIMUM RATINGS:				
Collector Voltage (referred to base), V_c	-45 volts			
Collector Current, I_c	-10 ma			
Emitter Current, I_e	10 ma			
Junction Temperature, T_j	100°C			
AVERAGE CHARACTERISTICS: (Common Base, $T_j = 30^\circ\text{C}$, $f = 270$ cps)				
	2N43	2N44	2N45	
Collector Voltage	-5.0	-5.0	-5.0	volts
Emitter Current	1.0	1.0	1.0	ma
Current Amplification (output short circuit), h_{21}	-0.98	-0.955	-0.92	
Collector Cutoff Current, I_{c0}	10	10	10	μa
Noise Figure ($V_c = -1.5\text{V}$; $I_e = 0.5$ ma; $f = 1\text{kc}$; BW, 1—), NF	22	22	22	db
Maximum Power Gain (Common Emitter)	40	39	38	db
Frequency Cutoff, f_{c0}	1.0	1.0	1.0	mc
Output Capacitance, C_c	40	40	40	mmf

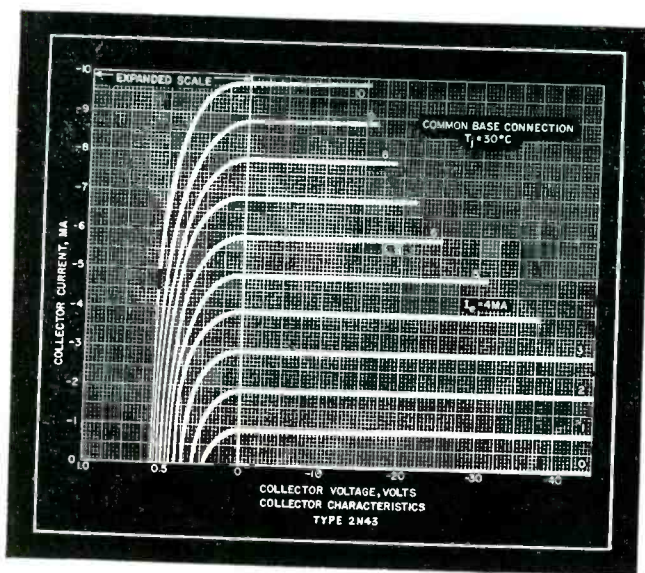

**NEWS FROM OUR
ADVANCED DEVELOPMENT LABORATORIES**

- Double-base junction diodes are semi-conductor devices having thyatron-like properties. Lab units have been used successfully in low-voltage circuits to switch currents larger than 1/2 ampere.

TRANSISTOR REFERENCE GUIDE and new TRANSISTOR BULLETINS NOW AVAILABLE!

Write to: General Electric Company, Section 4103, Electronics Park, Syracuse, New York.



GENERAL



ELECTRIC

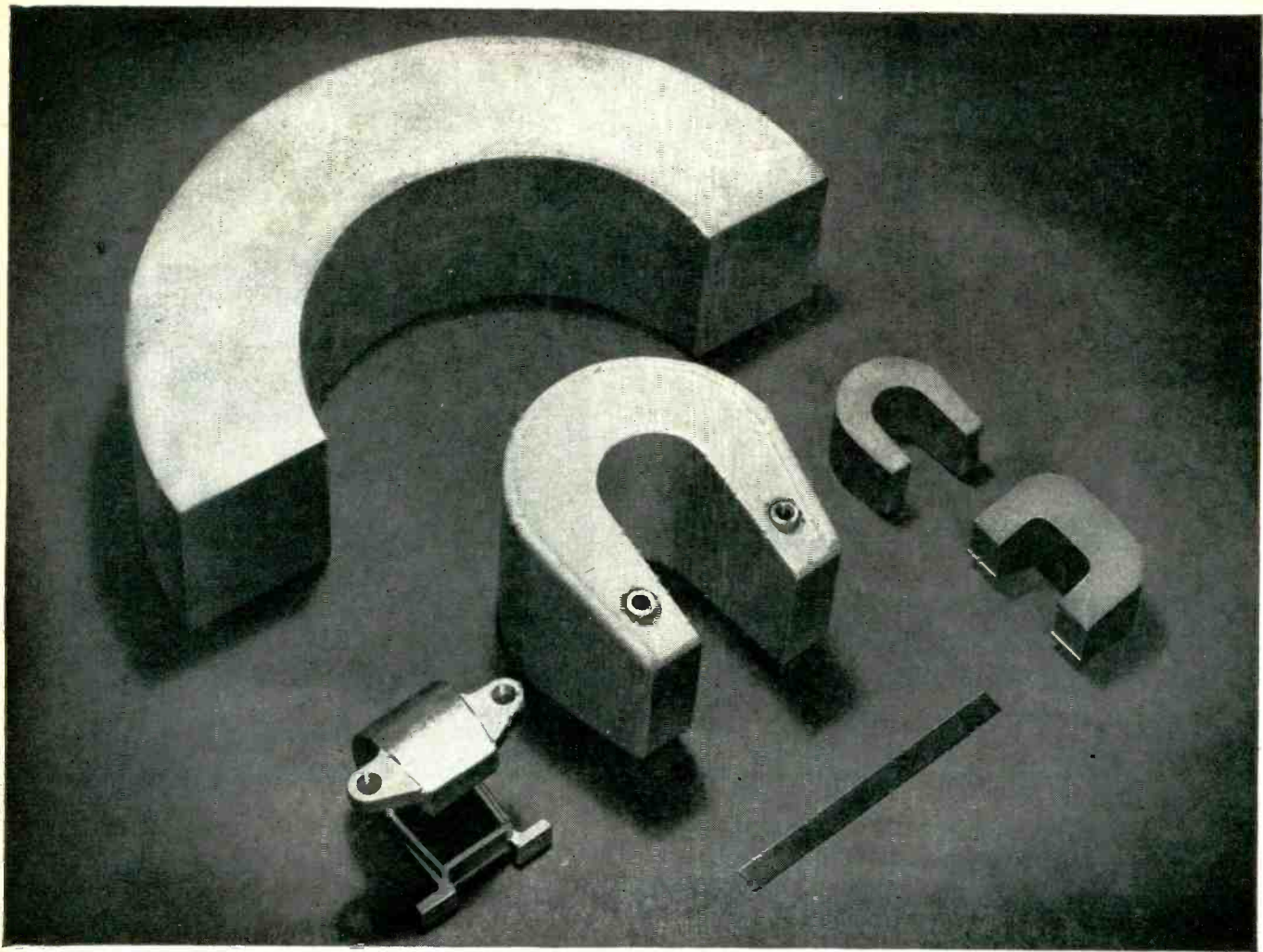

PERMANENT MAGNETS and ASSEMBLIES for Magnetrons and Traveling Wave Tubes

The group of magnets illustrated above, weighing from a fraction of a pound up to 75 pounds, are indicative of the wide range of Arnold production in this field. We can supply these permanent magnets in any size or shape you may need, with die-cast or sand-cast aluminum jackets, Celastic covers, etc. Complete assemblies may be supplied with Permendur, steel or aluminum bases, inserts and keepers as specified . . . magnetized and stabilized as desired. • *Let Arnold handle your magnetron and traveling wave tube permanent magnet requirements.*

WAD 4688

THE ARNOLD ENGINEERING COMPANY

SUBSIDIARY OF ALLEGHENY LUDELM STEEL CORPORATION

General Office & Plant: Marengo, Illinois

DISTRICT SALES OFFICES . . . New York: 350 Fifth Ave.

Los Angeles: 3450 Wilshire Blvd.

Boston: 200 Berkeley St.



*Made to your
Specifications*

**. . . ANY SIZE, SHAPE
OR COATING REQUIRED**

*★ We'll welcome
your inquiries*

One thing in common ...



Hoffman

Admiral

Magnavox

GREAT NAMES IN COMMUNICATIONS ...

RELY ON  **Midland** CRYSTALS

These companies—and many others in leadership position in the field—depend on Midland crystals for completely reliable frequency control in their products.

THAT FACT IN ITSELF is testimonial enough to the kind of performance Midland Quality Control has built into millions of crystals for every communications use.

*Whatever your crystal need, conventional or highly specialized
When it has to be exactly right, contact*



Midland

MANUFACTURING COMPANY, INC.

3105 Fiberglas Road, Kansas City, Kansas

WORLD'S LARGEST PRODUCER OF QUARTZ CRYSTALS

Do you have any of these problems?

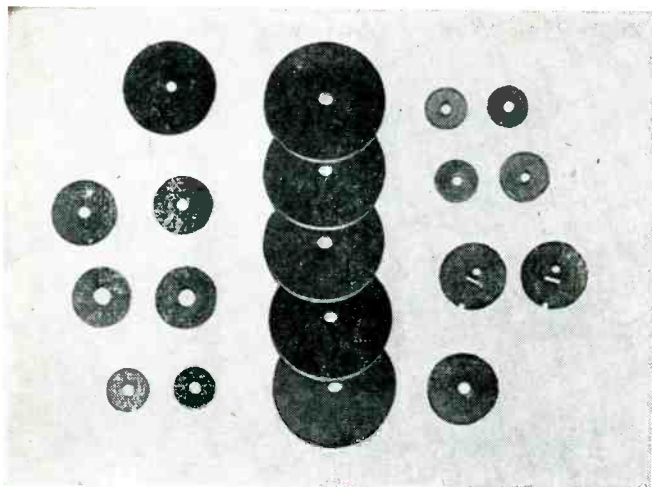

1. Need a combination of gasket sealing and mechanical and electrical properties? Various grades of LAMICOID®—laminated plastic made with organic and inorganic binders—are combined with natural or synthetic rubber to obtain the excellent insulating and mechanical properties of LAMICOID and the sealing properties of rubber.

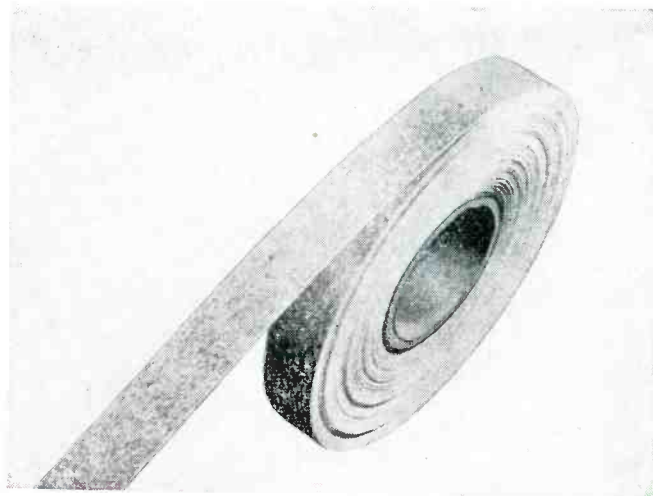

2. Need a mica tape that can be run on taping machines at high speed? ISOMICA® tapes are made from long rolls of thin continuous mica sheet... are more uniform in mechanical and dielectric strength... have no high spots or voids. For electrical insulation of class B or class H motors, generators and transformers.

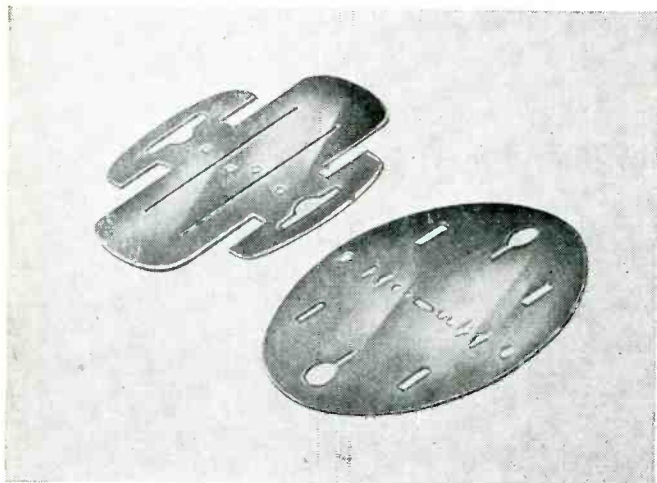

3. Need accurately punched mica stampings for filament, grid and plate supports? MICO produces mica stampings to extremely fine tolerances. Whenever you need precision-fabricated mica parts of the highest quality, call on MICO. We have 60 years of experience in this field.

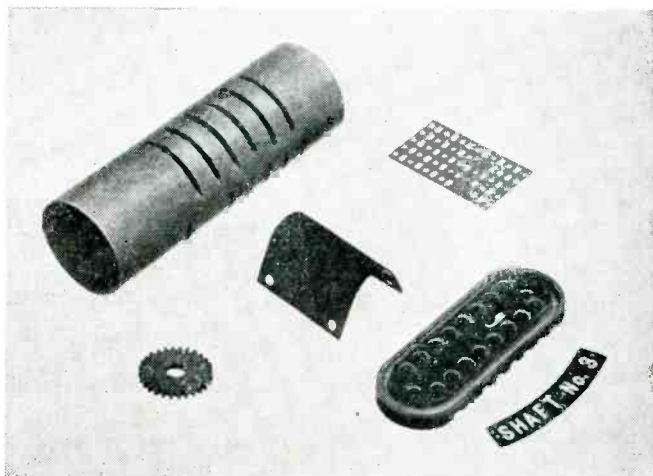

4. Need special mechanical and electrical properties for brackets, terminal blocks, access panels, etc.? LAMICOID® is half as heavy as aluminum and, weight for weight, stronger than steel. Offers high impact strength, high dielectric strength, excellent abrasion and moisture resistance.

Whatever electrical insulating materials you need, MICO makes them best. We manufacture all standard types and many special materials, and fabricate parts to your specifications. Send us your blueprints or problems today.

**Trademark*

1893-1953
60 Years
of Leadership
in Electrical
Insulation



MICA *Insulator* **COMPANY**

Schenectady 1, New York

Offices in Principal Cities

LAMICOID® (Laminated Plastic) • MICANITE® (Built-up Mica) • EMPIRE® (Varnished Fabrics and Paper) • FABRICATED MICA • ISOMICA®



PRECISION ENGINEERING
CUSTOM MANUFACTURING

WIDE-RANGE CONTINUOUS COVERAGE POWER OSCILLATOR

CONTINUOUS CONTROL WITHIN RANGES
FROM 300 to 900 mc and 900 to 2,500 mc
SEPARATE OUTPUT COUPLING CONTROL

300 to 2500 mc

More than 10w to 1200 mc

More than 2.5w to 2500 mc



\$2,285.00

F.O.B. MINEOLA, N.Y.



The 124A Power Oscillator consists of a grid-separation coaxial oscillator employing a 2C39A disc seal triode, an audio oscillator and modulation section, and a self-contained rectifier power supply. A selector switch is provided for the following: internal modulation of 400 or 1,000 cps, cw, or external modulation by pulse or square wave sources. Grid-cathode and grid-plate lines are coupled to a single tuning control, with provision for individual adjustment of the grid-cathode line when desired. Counter-type indicators show the position of the tuning elements. An output coupling control with counter indicator is provided.

This is one of a series of especially fine instruments and components that have been developed by AIL to meet our own exacting requirements. Our research and development work has demanded equipment not ordinarily available in the electronics market. Thus, we have developed devices that are considerably advanced over those usually available for purchase. Originally we were requested to produce limited quantities for our established clientele. The demand has grown to a point where limited production runs have become necessary. Under these circumstances immediate delivery is often possible.

We suggest that you write at once for specifications and delivery schedules.

Airborne Instruments Laboratory
INCORPORATED

160 OLD COUNTRY ROAD

MINEOLA, N.Y.

Perpetual Energy

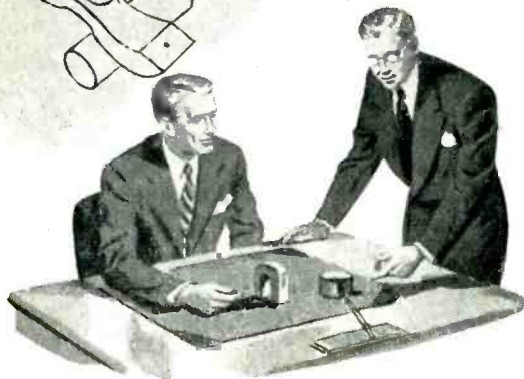
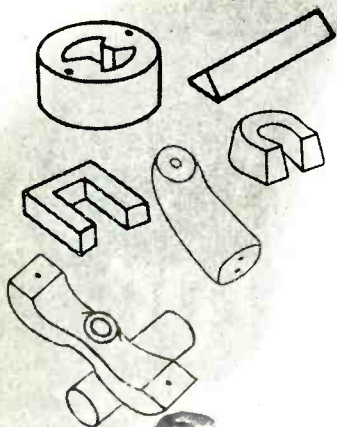

Consumer Market

Perpetual energy is at work all around us. Shown here are only a few of the many examples of permanent magnets at work—all of which *add to the salability* of the product.

Artificial Magnetic Eyes—

An artificial eye looks practically normal if it moves in unison with the natural one. To achieve this, a New York doctor developed an implant wherein is imbedded an Alnico permanent magnet.

After removal of a diseased or injured eye, recti muscles, originally attached to the natural eye, are attached to an implant, thereby imparting motility to this implant. Further operative procedure requires that the implant be covered with layers of tissue (tenons and conjunctiva) in order that the implant may be completely buried.

A custom-fitted plastic artificial eye is then made which also has a very thin Alnico magnet. As a result of the attraction between the magnet in the implant and the one in the artificial eye, and also due to the shape of the artificial eye, the eye can then move in unison with the natural one, as motility is imparted from the recti muscles to the implant and, in turn, to the artificial eye.

Applications: Among other consumer products that rely on permanent magnets are can openers with a magnetic lid-lifter, and the thermostat used in your home.

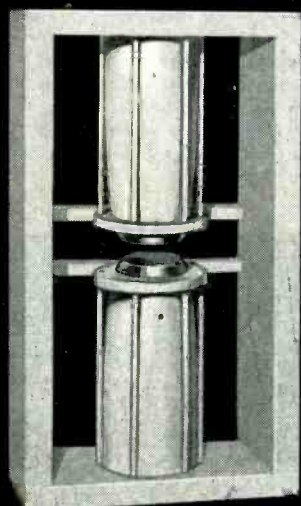
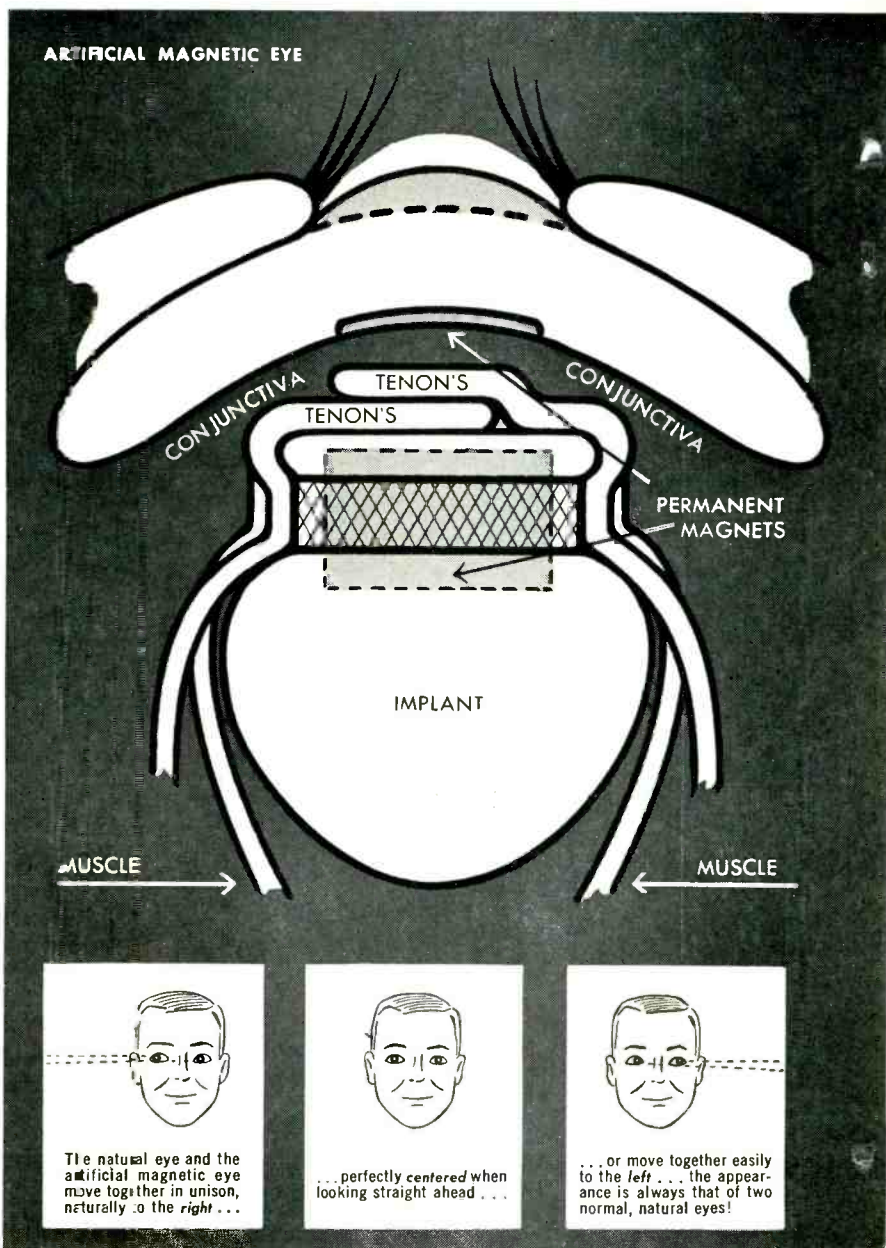

NUCLEAR RESONANCE RESEARCH ASSEMBLY

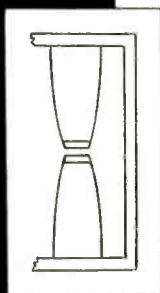

Basic Research

Research—A highly specialized example of the use of permanent magnets in research is the nuclear resonance assembly shown on the left.

The Alnico V permanent magnets used in this assembly built for the University of Chicago by INDIANA produce a field of approximately 5,500 gauss. The assembly not only is *much less costly* than the electromagnetic models but it also does not require much of the expensive equipment required to maintain a stable field.

Permanent Magnet

Can Work For You!

**Perpetual Magnetic Energy... a Timeless Force...
is hard at work in many fields and in many
products...from Artificial Magnetic Eyes
to Nuclear Resonance Research!**

You can't see it... smell it... or hear it. Nor can you taste it or feel it, but the "perpetual energy" of permanent magnets is at work for you in each one of these applications—and thousands more. Permanent magnets won't wear out. They can't be used up. They're a source of permanent energy instilled in your product "perpetually."

... *Unlimited are the future possibilities of permanent magnets in new product designs.* The field produced by the myriad of spinning electrons, the essence of permanent magnets, can work for you in these three ways: transformation of mechanical to electrical energy • transformation of electrical to mechanical energy • tractive effort. If you need a component to perform one of these three functions, INDIANA PERMANENT MAGNETS may be the solution to your design problem.

INDIANA provides you with the largest facilities in the world for the manufacture of permanent magnets and complete permanent magnet sub-assemblies. It will pay you to take advantage of INDIANA's wealth of experience, research leadership, and specialized engineering "know-how."

The Indiana Steel Products Co.
VALPARAISO, INDIANA

SALES OFFICES FROM COAST TO COAST—BOSTON • CHICAGO
CLEVELAND • NEW YORK • PHILADELPHIA • ROCHESTER • LOS ANGELES

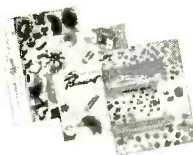

Write for
DESIGN MANUAL
No. 4-A10
CAST CATALOG
No. 11-A10
SINTERED CATALOG
No. 12-A10

Electrical
Industry

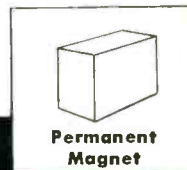

GENERATOR

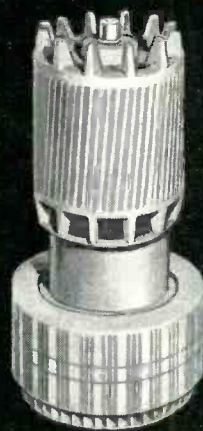

Generators—A well-known application in the electrical field is the permanent magnet generator. This 15 kva, 120/208-volt, 400-cycle model incorporates 28 Hyflux Alnico V, bar-shaped permanent magnets.

Long service and minimum maintenance are two things sought by users of generators. Permanent magnets help to provide these qualities. *Elimination of slip rings and commutators* means no sparking or radio interference. And there's no heat from the field coils nor is excitation power needed.

Applications: Magnetos, motors, gyroscopes.

In 24 Hours—You can have INDIANA PERMANENT MAGNETS for your experimental work

Loudspeakers—Typical of the applications in this field is this 15-inch high fidelity speaker which uses a 10½ lb INDIANA Hyflux Alnico V magnet to achieve a frequency range from 30 to 16,500 cycles per second! INDIANA Hyflux Alnico V provides an energy product of 5¼ million BH Max or more, thereby assuring a magnetic field of high strength. Permanent magnets, in this case, are a *functional necessity* to this design—no substitute can do the job.

Applications: INDIANA magnets are consistently doing an outstanding job in many other typical products in this field such as focusing coils, ion traps, centering devices, radar, and guided missiles.

Magnetic Separators—There is almost an endless list of mechanical or holding applications. One of the more widespread, industrial applications is this permanent magnet separator, using three or more Hyflux Alnico V, U-shaped magnets each of which can exert a pull of 150 lb.

Here permanent magnets exert an effective pulling force through a distance of several inches... permitting your product to do the job better and safer, insure *uninterrupted production flow* by snatching "tramp" iron from materials to be processed... thereby preventing damage to machinery. And permanent magnets *require no electrical power, no wiring*... hence, they never spark, eliminating a definite fire hazard.

Applications: Among the many mechanical applications are: magnetic conveyors, magnetic sweepers, magnetic chucks and clutches.

Watt Hour Meters—One of the hundreds of different instruments requiring permanent magnets is this single-phase, 15-amp, 240-volt rating for 3-wire services watt hour meter. It uses an Alnico 1, horseshoe-shaped magnet weighing only 0.2 lb.

Here, the high quality of this permanent magnet material provides the uniformity and stability of field so necessary for *maintaining the initial accuracy* of this meter over a long period of years.

Applications: Mass spectrometers, vibration pickups, galvanometers, medical instruments, speedometers. Fluxmeters.

Electronic
Industry

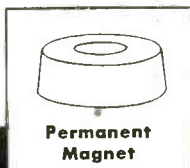

Mechanical
Industry



Instrument
Industry

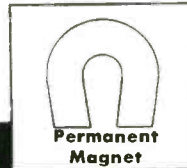

Why do so companies make

FOR one thing, it's *easy* to make an ordinary relay. Requirements are not rigid. Little equipment is needed. You can even *buy* the component parts in a pinch. Dozens of companies do a good job of making these relays, as long as the service requirements are not too severe.

But when you need top reliability, when you need relays that will withstand temperature extremes, tremendous shock loads, moisture, continuous service—come to an expert to get the kind of relay performance you need.

Union Switch & Signal has been making relays for over 70 years, most of them in vital railroad signaling service. Many of them operate continuously, yet remain unattended for years. In fact, we regularly encounter “Union” relays that have been in service for over 40 years. And they are still in good operating condition.

This vast relay engineering skill has been used to produce the “Union” type M miniature relay. Hermetically sealed, weighing only 3½ ounces, this 26.5 v.d.c. relay meets all requirements of Military Specifications MIL-R-5757 A & B.

“Union” type M relays are available in quantity *now*—in either 6-pole or 4-pole doublethrow models. Write for more information.

GENERAL APPARATUS SALES
UNION SWITCH & SIGNAL
DIVISION OF WESTINGHOUSE AIR BRAKE COMPANY

PITTSBURGH 18



PENNSYLVANIA

NEW YORK CHICAGO ST. LOUIS SAN FRANCISCO

many relays?

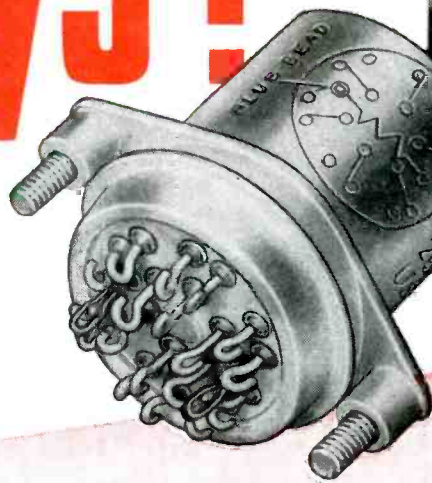

TYPICAL PERFORMANCE DATA

	-65°C to 125°C	-55°C to 85°C
Service Temperature		303085
Style FM (6-pole)	303125	325 ohms
Coil Resistance	325 ohms	26.5
Nominal Voltage	26.5	18
Max. Pull-In Voltage at Max. Rated Temperature	18	13
Max. Drop/Out Voltage at Max. Rated Temperature	13	

Service	Continuous
Shock	40 G's for 10 milliseconds
Vibration	10 to 55 cycles per sec.— 0.060 total excursion
Life Expectancy	1,000,000 operations minimum
Contact Rating	2 amps. at 26.5 Volts— Resistive Load
Breakdown Voltage at Sea Level	1000 volts a.c. between case and contacts or coil

General Apparatus Sales
Union Switch & Signal Division
Westinghouse Air Brake Company
Pittsburgh 18, Pa.

Please send additional information on "Union" type M relays.

Name Title

Company

Address

City, Zone & State

PROBLEM:

Reduce Fabrication and Assembly Costs for Electrical Contact and Switch Blade Assemblies

SOLUTION:

General Plate Provided the Solution with Fabricated Composite Contact Elements Ready for Assembly

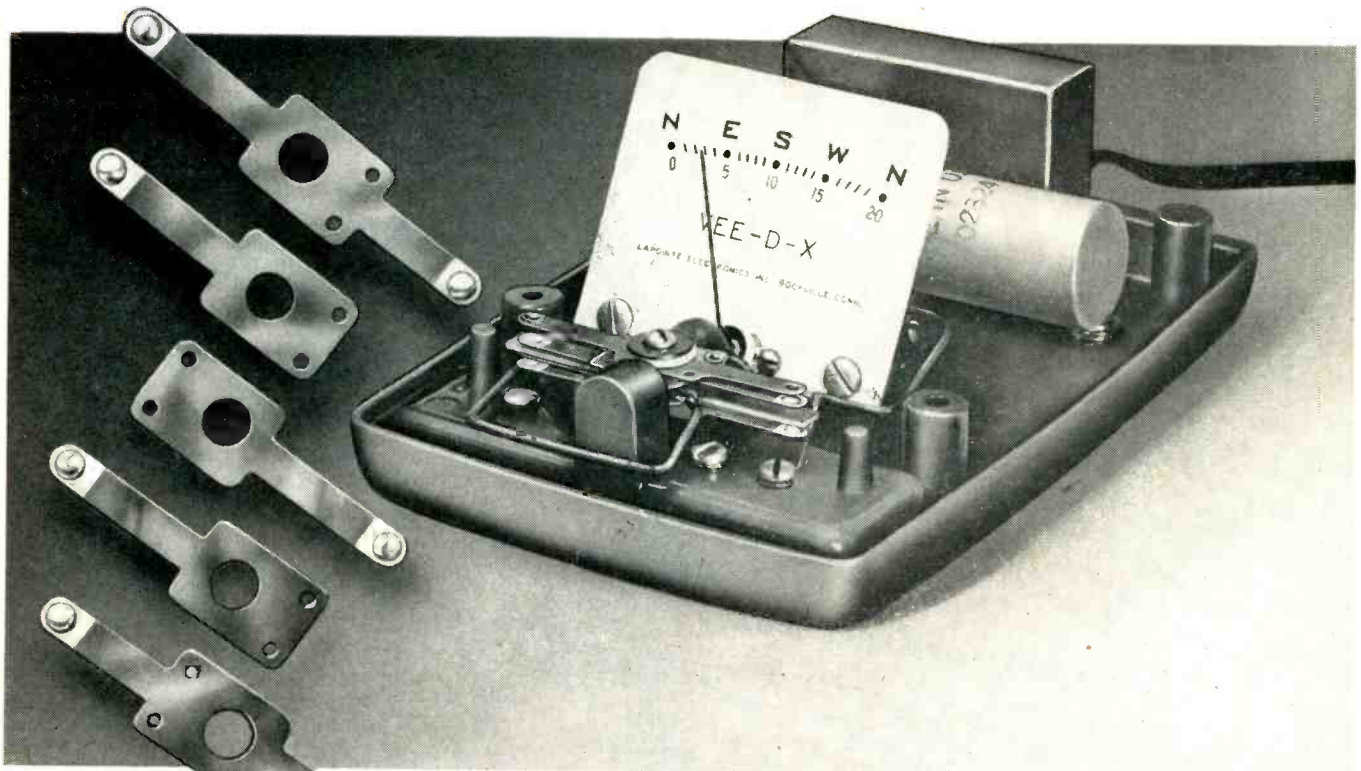

A leading manufacturer of Antenna Rotators required contact and switch blade assemblies for a control switch that operated two synchronized circuits. To produce the assemblies by attaching a separate contact, rivet or button to the spring blades meant high fabrication and assembly costs and special machinery.

The problem was presented to General Plate whose engineers provided an economical solution with fabricated composite contact elements ready for assembly.

The complete contact and blade elements are made from a General Plate striped composite metal. The contact is a silver alloy which gives the necessary electrical performance. The blade is phosphor bronze which provides the spring properties required for the contact supporting member.

The result — initial savings of \$7,000 in assembly costs alone by using General Plate fabricated composite contact elements.

By letting General Plate fabricate your complete contact assemblies, you will save money, time and trouble ... needless equipment cost and problems of scrap

disposal are eliminated ... contacts and/or contact assemblies made to your exact specifications are shipped to you ready for installation.

If you fabricate your own parts, General Plate Composite Contact Materials will still save you money and allow you to make contact assemblies superior to those produced by other methods.

The long experience, diverse facilities, and manufacturing skill of General Plate will benefit you in the form of service, quality, and savings.

Write for complete information and Catalog PR700.

**You can profit by using
General Plate Composite Metals!**

**METALS & CONTROLS CORPORATION
GENERAL PLATE DIVISION**

310 FOREST STREET, ATTLEBORO, MASS.

Another **NEW** Shunt Diode by **UNITED**

High peak power capabilities of type X-80 in relation to its physical size have been accomplished through an unusually forceful combination of design features.

1. Exclusive UNITED bonded *thoria tungsten core filament* for high electron emissivity.
2. Exclusive UNITED *graphite anode* for maximum thermal dissipation.
3. Exclusive UNITED *isolated getter traps* for retention of hard vacuum and high voltage internal insulation.

Type X-80 will serve importantly as a high current clipper tube in radar equipment employing the large hydrogen thyratrons, as well as in power supply rectifier applications.

Write for detailed specifications.

40
Kilovolts
Inverse Peak

80
Amperes
Peak Plate Current
as shunt diode

800 mAdc
(average)
as a rectifier

Filament
Ratings
11 Volts Nominal
15.5 Amperes

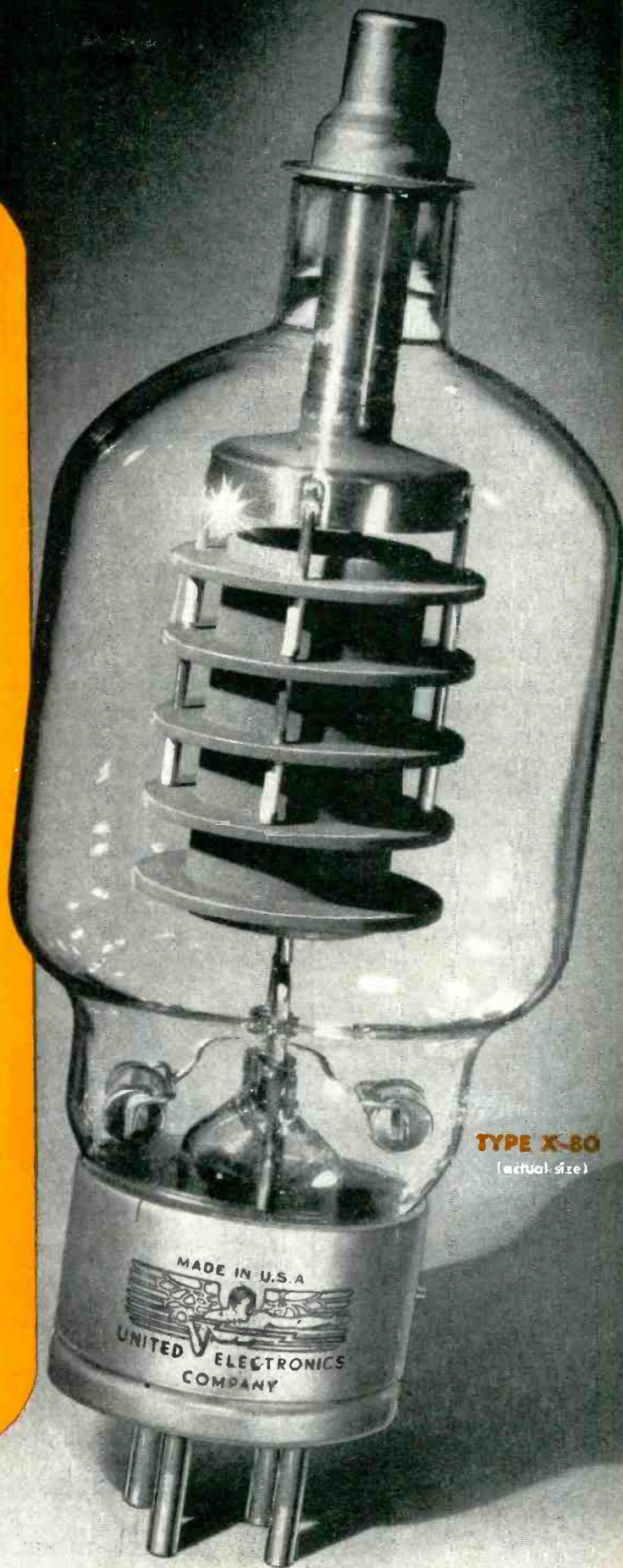

TYPE X-80
(actual size)

UNITED  **ELECTRONICS, 42 Spring Street, Newark 2, N. J.**
(TRANSMITTING TUBES EXCLUSIVELY Since 1934)



JETS GET OFF TO A *flying start* WITH



Jets must conserve their power for actual flight. Thus on the flying field the big engines are turned over by means of a starter.

Almost six years ago our customer, Ther Electric & Machine Works, Chicago, developed the portable jet engine starter pictured here, in cooperation with a famous engine manufacturer who was dissatisfied with previous units. Important components in each Ther starter are four Model FH1BA6S1G SELETRON selenium rectifier stacks.

Ther tells us the service record of the jet engine starters has been outstanding during six grueling years, and credits trouble-free SELETRON rectifiers for much of the top-flight performance. "They have proved far superior to other similar units."

When rectification is indicated, SELETRON engineers can certainly assist you with circuit information as well as the right type of SELETRON rectifier to do the job. We make them from the small half-wave ones for radio and TV, all the way up to giants for industrial use. See our catalog in Sweet's Product Design file—or write us.

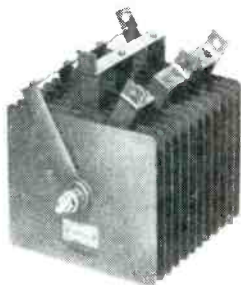
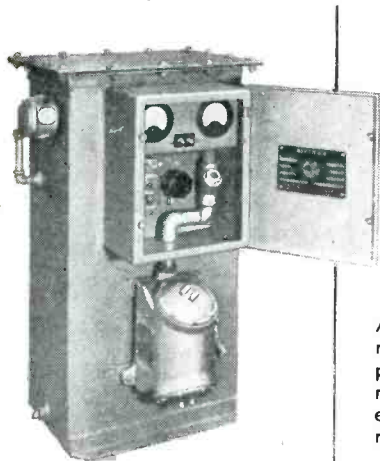

Also Ther-built with Seletron selenium rectifiers: an oil-immersed cathodic protection unit for the Navy, built for location in hazardous atmosphere. Arcing contacts are immersed in oil or in sealed-off explosion proof fittings. Includes 2 Seletron Model WH1BA2S1G rectifier stacks.

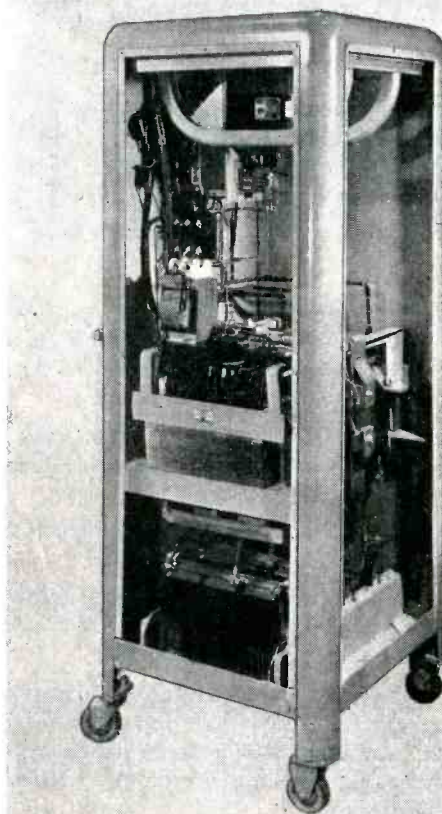

Ther's Portable Jet Engine Starter

750 amps; 24-30 volt DC output. Adjustable to compensate for line and load fluctuations. Includes four Seletron rectifiers, Model FH1BA6S1G.

*Seletron
and Germanium
Division*



Manufacturers also of Germanium Transistors and Diodes

RADIO RECEPTOR COMPANY, Inc.

Since 1922 in Radio and Electronics

SALES OFFICE: 251 WEST 19th STREET, NEW YORK 11 • FACTORIES IN BROOKLYN, N. Y.

Check these advantages of
ALSIMAG

- High surface resistivity
- High dielectric strength
- High mechanical strength
- High volume resistivity
- Low loss factor
- Low Porosity
- Dimensionally accurate
- Uniform
- Totally and permanently rigid
- Suitable as compression type or metallized for soft solder sealing
- Economically produced to your specifications in large or small quantities

Send blue print or samples and let us show you what we can do for you.

TRANSFORMER AND HIGH VOLTAGE CAPACITOR TERMINALS



METALLIZED HERMETIC TERMINALS

For sealing transformers and other electrical components
Custom made for your requirements.
Many standard designs shown in
Bulletin No. 524 sent on request.

VITRIFIED ALUMINA CERAMIC

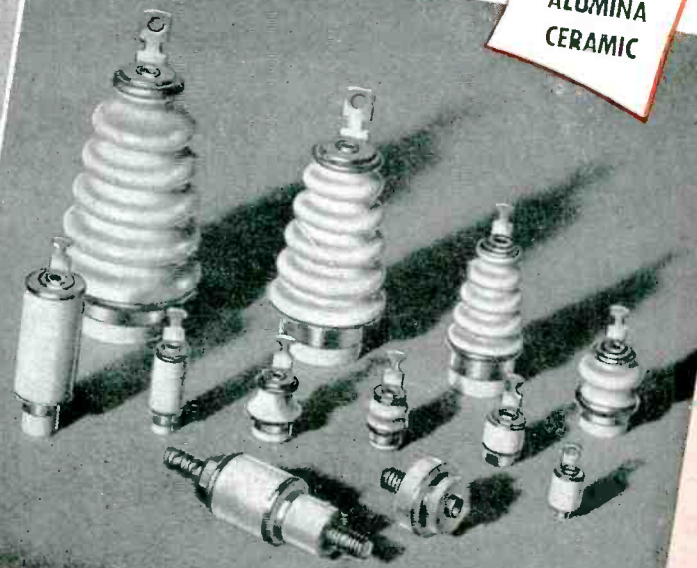

52ND YEAR OF CERAMIC LEADERSHIP

AMERICAN LAVA CORPORATION

CHATTANOOGA 5, TENNESSEE

A SUBSIDIARY OF MINNESOTA MINING AND MANUFACTURING COMPANY

OFFICES: METROPOLITAN AREA: 671 Broad St., Newark, N.J., Mitchell 2-4159 • SYRACUSE, N.Y.: 330 Arlington Ave., Phone 76-5068 • CLEVELAND: 5012 Euclid Ave., Room 2007, Express 1-6685
NEW ENGLAND: 1374 Mass. Ave., Cambridge, Mass., Kirkland 7-4498 • PHILADELPHIA: 1649 N. Broad St., Steveson 4-2823 • ST. LOUIS: 1123 Washington Ave., Gerfield 4959
CHICAGO: 228 N. LaSalle St., Central 6-1721 • SOUTHWEST: John A. Green Co., 6815 Criele Dr., Dallas 9, Dixon 9*18 • LOS ANGELES: 5603 M. Huntington Dr., Capital 1-9114

Rely on **PHELPS DODGE** for Magnet Wire and

THE RIGHT WIRE TRANSFORMER,

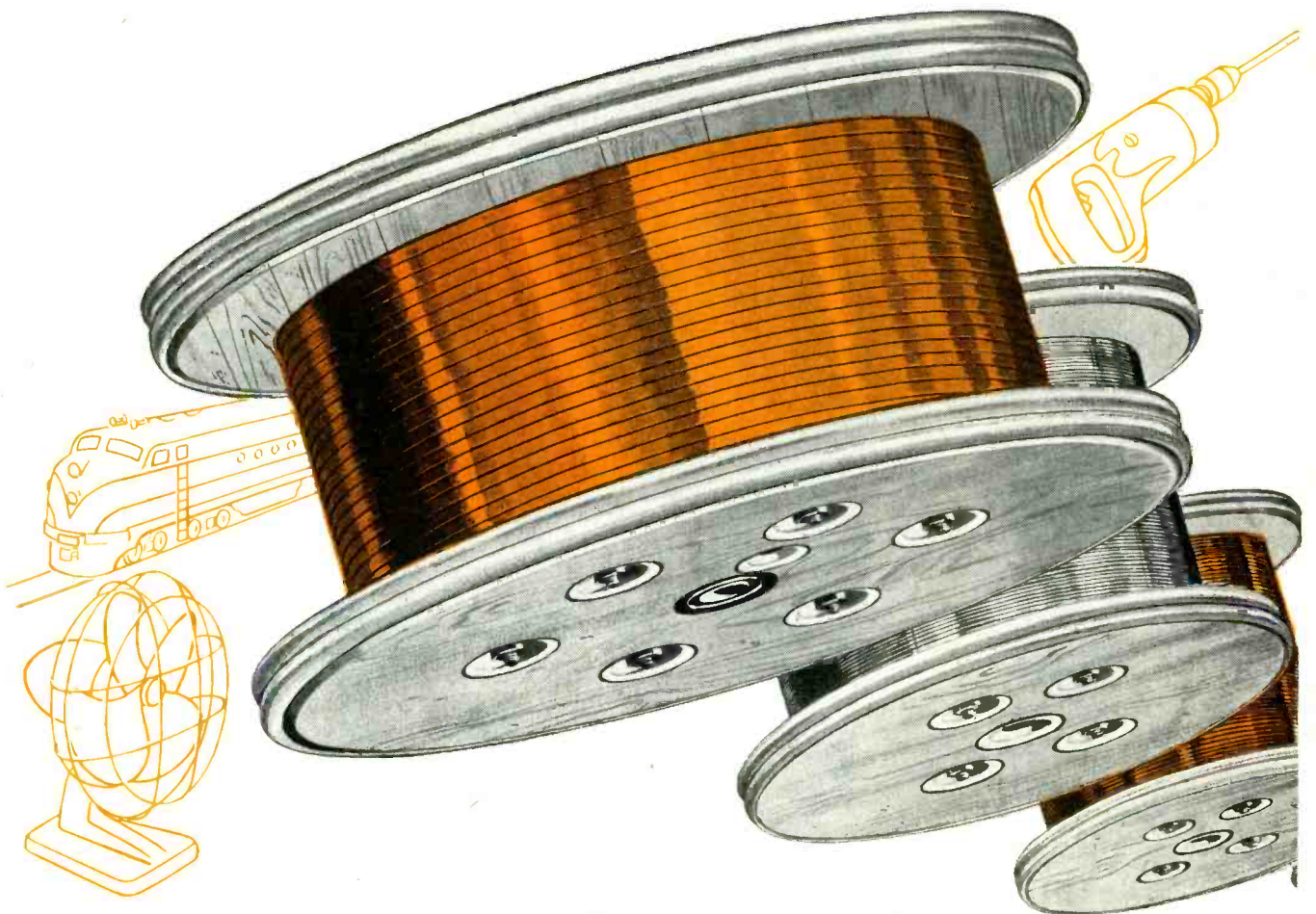

First for Lasting Quality—from Mine to Market!

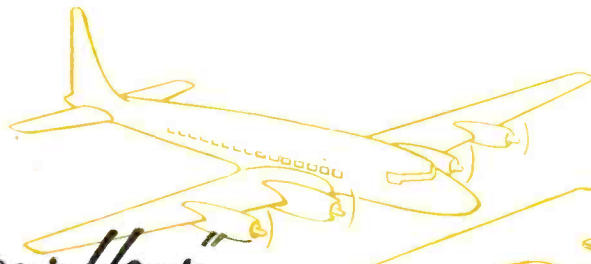

Application "Know-How" —

FOR YOUR MOTOR OR COIL!

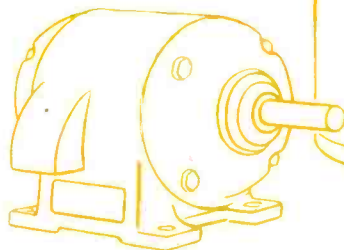
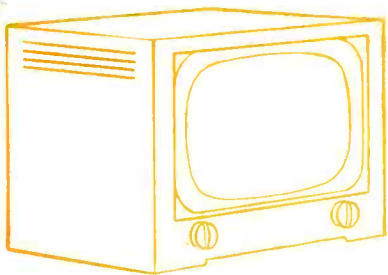
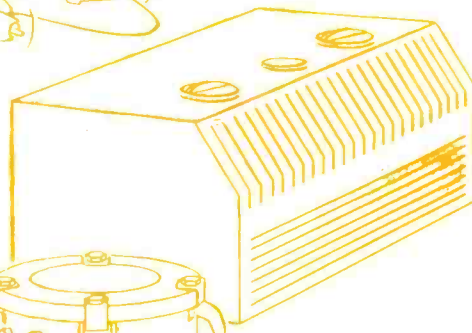

Vast and varied experience in every field of electrical and electronic manufacture.



Unexcelled research, manufacturing and quality control facilities—most complete and up-to-date line of magnet wire in the industry.



Practical help in selecting correct size, shape and insulation to meet exact design specifications.



PHELPS DODGE COPPER PRODUCTS **CORPORATION**

INCA MANUFACTURING DIVISION FORT WAYNE, INDIANA

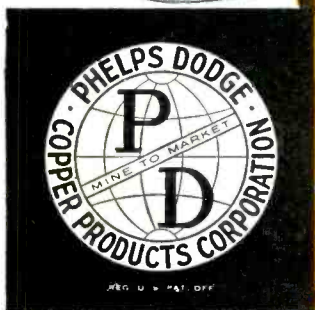

ALLIED CONTROL'S

NEW

✓ SIZE CUT 66%

✓ WEIGHT CUT 48%

✓ RELIABILITY DOUBLED

✓ WRIGHT FIELD APPROVED

ACTUAL SIZE



New MH-12 with
Interchangeable
Mounting

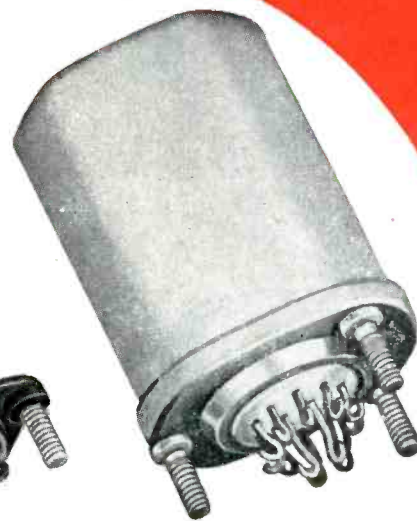

4-Pole Double-Throw
Miniature Telephone
Relay

Designed to withstand a shock of 50G, these new Allied Control double-throw miniature relays were developed to meet the rigid requirements of U.S.A.F. Specifications MIL-R-5757A.

Known as the Allied MH series, this new line of relays consists of the 6-pole MH-18, the 4-pole MH-12, and the 2-pole MH-6. Contacts are rated at 2 amps resistive or 1 amp inductive at 28 volts D. C.

The high performance of these relays has been achieved

in an extremely compact, unitized construction and parallels the most recent advances in airborne equipment design. The "actual size" photographs shown above highlight the 66% savings in overall size, the 48% savings in weight and the 30% reduction in chassis area.

For detailed specifications and drawings of these new relays, contact your local Allied Control Representative or write us for Bulletin 1002.

W

50 G MINIATURE RELAY

APPROVED MIL-R-5757A

SIX DIFFERENT MOUNTINGS

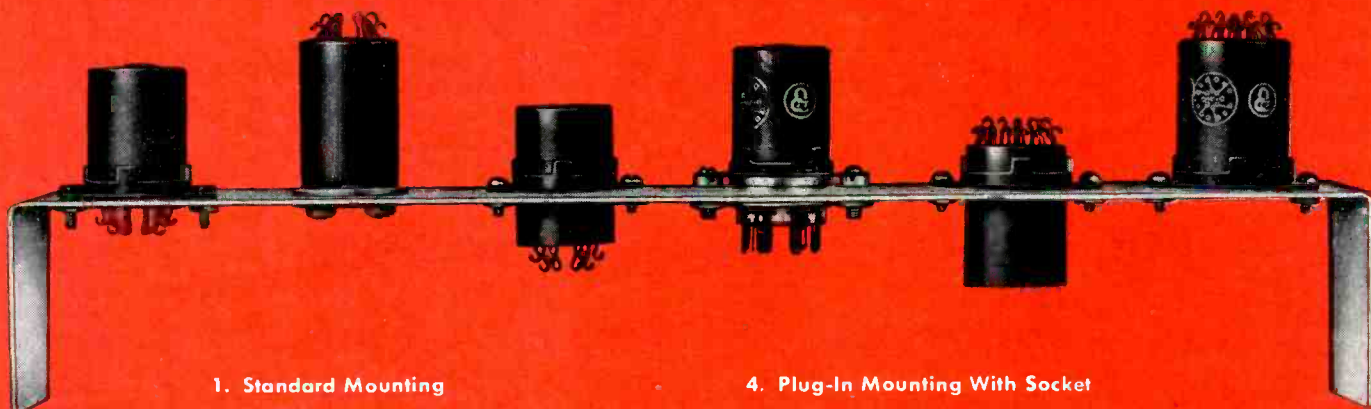

1. Standard Mounting
2. Flush Mounting—2 Studs at $\frac{5}{8}$ " Centers
3. Thru-Chassis Mounting—Terminals Down
4. Plug-In Mounting With Socket
5. Thru-Chassis Mounting—Terminal Up
6. Flush Ring Mounting



6-POLE
MH-18



4-POLE
MH-12



2-POLE
MH-6

FEATURES

- Wide Ambient Temperature Range:** 55°C to 85°C standard— 65°C to 125°C MHB-type
- Vibration Resistant:** 15G's vibration to 500 cycles • **Operating Shock:** no contact chatter to over 50G's
- High Altitude:** seal-tested to 70,000 feet
- Dependable Operation:** life expectancy of over 1 million operations at rated load
- High Speed:** operate-to-make time under 8 ms.
release-to-make time under 4 ms.
release-to-break time under 2 ms.

ALLIED CONTROL COMPANY, INC.
2 EAST END AVENUE, NEW YORK 21, N. Y.



Put your finger on

EXTRA DEPENDABILITY

by specifying...

CHESTER means dependability *plus* in wires and cables for every electronic and electrical application. The compounds used in all CHESTER Wire and Cable constructions are made in the CHESTER plant. Thus, complete control over selection of raw materials and manufacturing techniques, provides full control of quality... your assurance of uniformity in every foot of conductor bearing the CHESTER label!

CHESTER
plasticord-plasticote
WIRES & CABLES

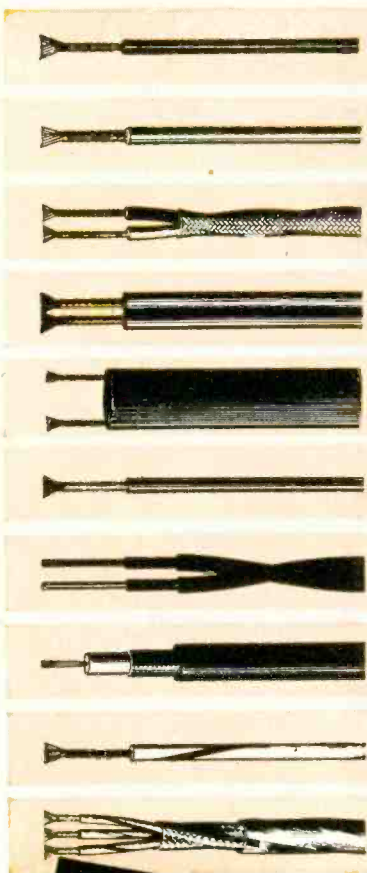

JAN-C-76 WIRES* SRIR, SRHV,
SRRF, WL

105°C, 90°C, 80°C, UL APPROVED, 120°C*

SHIELDED WIRES & CABLES

FLEXIBLE CORD

TV LEAD-IN WIRES

INSTRUMENT WIRES

COMMUNICATION WIRES & CABLES TO SPECIFICATION

COAXIAL CABLE

LACQUERED AND NYLON COVERED WIRES

SPECIAL WIRES & CABLES TO SPECIFICATIONS

*Solid colors or spiral marking

CUSTOM CONSTRUCTIONS
to specification using Polyethylene, Polyvinyl chloride, Nylon, Braided and Lacquered Wires, Special Insulating Materials, Glass, Yarn, etc. Inquiries invited.

ASK "Chester" FOR the New Chester Literature. Complete data on wires and cables for electrical and electronic wiring. Request yours, today!



REGISTERED U.S. PAT. OFF.

CHESTER CABLE CORP.

C H E S T E R • N E W Y O R K



ELECTRONICS PARK — G-E HEADQUARTERS FOR ELECTRONICS RESEARCH



Accessories include: External antenna mount (above), adaptor cable, and crystal ovens.

NEW! G-E FREQUENCY AND MODULATION METER

Measures both carrier frequency displacement and square wave modulation with direct reading on 2-range 3 1/2" meter

Here is a quality FM Communications instrument with features that are unmatched in the industry! The ST-13A is engineered to give you hairline accuracy . . . lowest possible cost . . . plus full provision with oven accessories for future split-channel adjustments. This unit meets today's demand for accuracy and economy and provides for tomorrow's more stringent needs. Two RF outputs for receiver testing and alignment. New case design is durable and good looking.

G-E OSCILLOSCOPE—MODEL ST-2A

Here's the ideal scope for shop and general laboratory use. Size and weight have been held to a minimum yet you are assured of quality G-E construction and materials. Features high sensitivity . . . exceptional stability. Special features include a DC vertical amplifier to adapt the equipment to a wide range of applications. Deflection pattern expands to several times tube diameter.

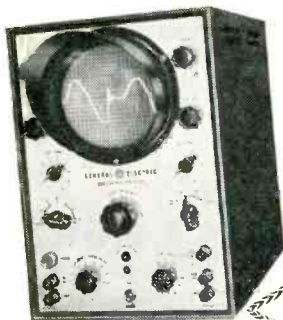

SPECIFICATIONS—MODEL ST-13A

FREQUENCY RANGES

One or two specified frequencies in the following ranges:
25 MC to 50 MC, 72 MC to 76 MC, 148 MC to 174 MC
Quartz crystal operating range: 4 MC to 6 MC

REFERENCE OSCILLATOR ACCURACY

.001% from 32°F to 122°F
Greater accuracy will be obtained over a more limited temperature range. External connection, internal wiring and a socket are provided for 6 V oven operation where wider temperature range with greater accuracy is available.

MODULATION ACCURACY

±(5% + 200 cycles)
On sinusoidal or square wave modulation (complete limiting).

METER RANGES

0 to 10 KC and 0 to 20 KC. These scales are calibrated in terms of carrier frequency displacement from the internal reference oscillator and deviation due to square wave modulation. Sinusoidal modulation is 1.57 times this value. A conversion curve appears in the cover.

INPUTS

Eighteen-inch collapsible whip antenna.
Fifty-ohm BNC connector. This input can handle only limited power as it is followed by a molded carbon potentiometer attenuator.

OUTPUTS

Low RF output—adjustable around 1 microvolt.
High RF output—adjustable from about 100 to several thousand microvolts, depending on frequency.
Both outputs come out on 50-ohm BNC connectors.

POWER—INTERNAL BATTERIES

2—45 volt batteries; 2—1.5 volt flash light cells; 2—1.5 volt pen light cells.

TUBE COMPLEMENT

2—1L4, 2—1U4

General Electric Company, Section 4103
Electronics Park, Syracuse, N. Y.

Please send me a copy of the following bulletins:
 ST-13A (ECL-15) ST-2A (ECL-9)

NAME.....
COMPANY.....
ADDRESS.....
CITY.....STATE.....



GENERAL ELECTRIC

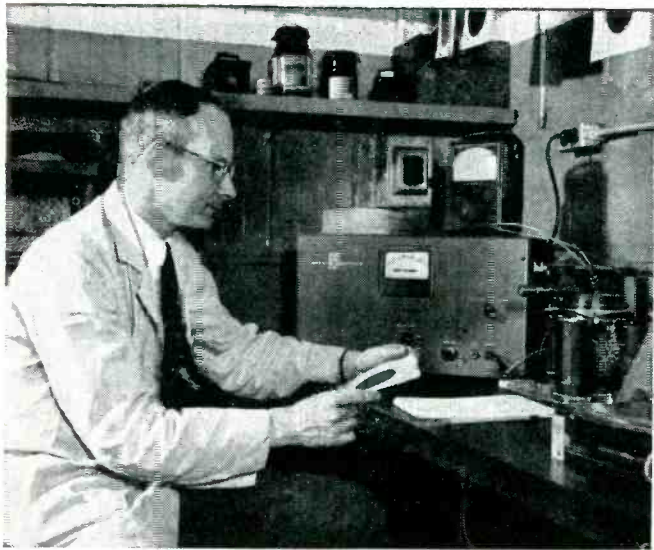

As a Direct-Reading Instrument The extreme sensitivity of the d-c amplifier is utilized to check plasticizer insulation resistance values in the megamegohm range.

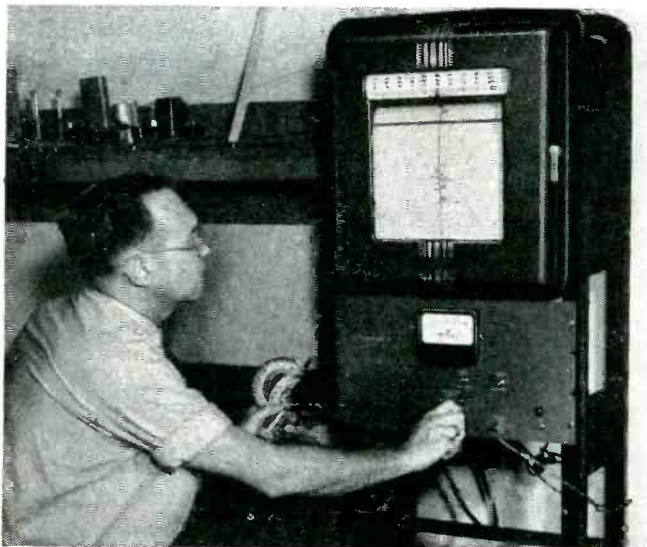

As a Recorder Preamplifier The rack-mounted amplifier above is being used to increase the sensitivity of a recorder in running special tests of switches.



As a Null Detector The d-c Amplifier is being used above for factory checking and calibration of instruments.

L&N Low Level d-c Amplifiers are

Triple Purpose... for Triple Service

● In response to the constant demand for versatility in precision instruments, these d-c Indicating Amplifiers combine the functions of three useful instruments in one:

1. A Direct-Reading Instrument that is always ready to use . . . never any readjusting of zero, either initially or during a series of readings. Simply select the range in which you want to work by turning scale-multiplier knob.

2. A Recorder Preamplifier — Values measured by Stabilized d-c Amplifiers can be recorded directly on Speedomax recorders.

3. A Null Detector more sensitive than most reflecting galvanometers, yet with full scale response time of only 2 to 3 seconds. These instruments are unaffected by vibration; leveling is not necessary. At the turn of a range knob, a wide choice of sensitivities can be obtained without external shunts. A non-linear response characteristic is also available for easy balancing.

These amplifiers are suitable for handling low level measurements with thermocouples, strain gages, bolometers—bridge and potentiometer circuits—ionization, leakage and phototube currents—almost any measurement of extremely small direct current or voltage.

Self-contained, the unit can either be used "as is" or removed from case and mounted on a 19" relay rack.

For details, including complete specifications, send for Folder EM9-51(1). Write our nearest office, or 4979 Stenton Ave., Phila. 44, Penna.

LEEDS  **NORTHROP**
instruments automatic controls • furnaces

JH. Ad. EM9-51(3)

BLOCKING
OSCILLATOR



DELAY
LINE

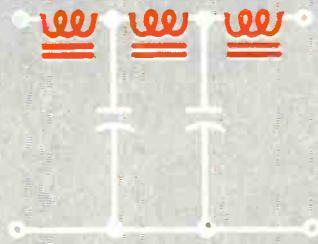

LOW LEVEL
FILTER

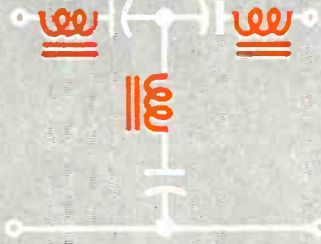

PULSE
TRANSFORMER



A HIGH - μ POT CORE

WITH GREAT VERSATILITY



...designed for modern miniaturization

Alert designers of electronic circuits are finding this versatile pot-core structure superior in a wide variety of applications. Of a size compatible with modern miniaturization requirements, this core assures high effective permeability with negligible external fields and low losses.

Extremely easy to use and install—mount Ferroxcube Part 7F160 anywhere with a single screw. It is being used with excellent results in single and multiple stacking arrangements. Some of the very successful large scale applications are: Blocking oscillators, Delay lines, Low level filters, Pulse transformers, etc.

Ferroxcube miniature pot core Part 7F160 is production geared for large quantity deliveries. For your convenience, nylon bobbins designed specifically for use with 7F160 are carried in stock too, to make your winding problem even easier.

The performance, versatility and usefulness of this part are unusual—it deserves careful investigation.

Write for detailed engineering bulletin giving complete data. Your copy will be sent to you at once.



WRITE FOR DETAILED ENGINEERING BULLETIN GIVING COMPLETE DATA.

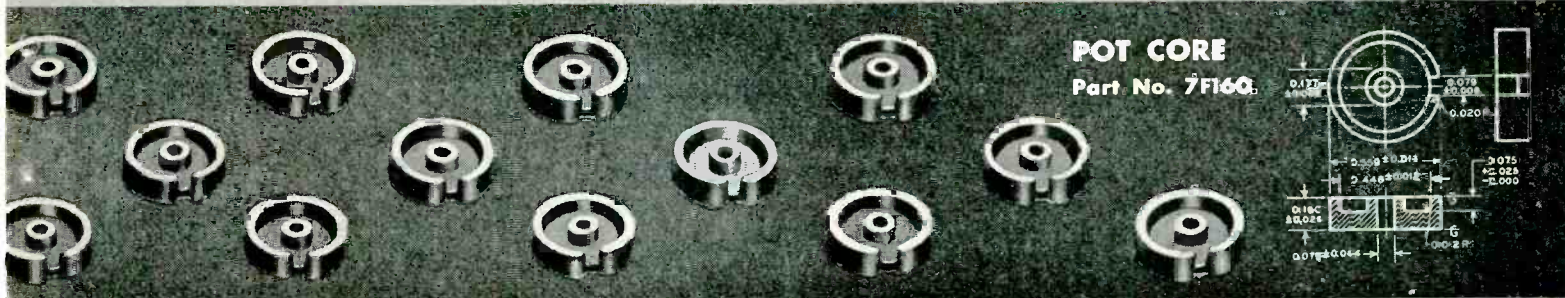

POT CORE
Part No. 7F160.

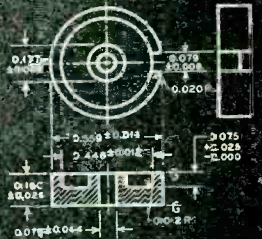

FERROXCUBE CORPORATION OF AMERICA

• A Joint Affiliate of Sprague Electric Co. and Philips Industries, Managed by Sprague •

35 EAST BRIDGE STREET • SAUGERTIES, NEW YORK

PREMIUM...

with COLLINS

Now available for incorporation into your own designs

Check the specifications on the chart below. If your equipment design calls for a stable oscillator in any of the frequency ranges shown, a major portion of your design problem is solved. Collins precision oscillators, long famous for their accuracy and stability, are now available for incorporation into your own designs.

The years of research and development work that have gone into every detail of these oscillators can im-

prove your equipment and effect a substantial saving in your development costs.

Collins oscillators are mechanically stable, sealed against atmospheric changes, compensated for changes in temperature and voltage. Their output frequency is essentially independent of environment. *We are now supplying engineering samples and quotations on production quantities.*

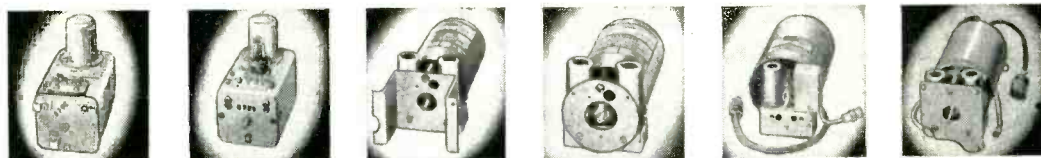

TYPE	70E-1	70E-8A/B	70E-12	70E-15	70H-2	70H-3
Frequency Range	1.0-1.5 mc	1.6-2.0 mc	1.955-2.955 mc	2.0-3.0 mc	2.455-3.455 mc	1.5-3.0 mc
Calibration Linearity . .	±750 cycles	±750 cycles	±1000 cycles	±750 cycles	±500 cycles	±1000 cycles
Maximum Frequency . . .						
Drift 40°F to 120°F . . .	250 cycles	400 cycles	600 cycles	400 cycles	100 cycles oven on	600 cycles
Max. Drift with ±10% Plate Voltage Change . .	75 cycles	75 cycles	150 cycles	150 cycles	100 cycles	100 cycles
RF Output	13-30v rms 25 mmf load	5.5-12v rms 33 mmf load	0.5-2.0v rms 15 mmf load	1.2-2.5v rms 100 mmf load	2v rms 1000 ohms	5-13v rms no load
Plate Power	250v @ 7 ma	180v @ 8 ma	150v @ 12 ma	150v @ 12 ma	180v @ 10 ma	150v @ 12 ma
Heater Power	12.6v @ 150 ma	6.3v @ 300 ma	6.3v @ 600 ma	6.3v @ 600 ma	6.3v @ 300 ma	12.6v @ 300 ma
Oven Power	none	none	none	none	26v @ 2.0 amp	26v @ 3.0 amp
Electrical Connections . .	plug	plug	solder	solder	plug	plug
Tubes	one 12SJ7	one 6SJ7	two 6BA6	two 6BA6	one 5749	two 5749
Shaft Size	0.1869-0.1873	0.2488-0.2498	0.1869-0.1872	0.1869-0.1872	0.1869-0.1872	0.1869-0.1872
Rotation for Increased Frequency . . .	clockwise	clockwise	counter- clockwise	counter- clockwise	counter- clockwise	counter- clockwise
Tuning Rate	50 kc/turn	25 kc/turn	100 kc/turn	100 kc/turn	100 kc/turn	150 kc/turn
Tuning Torque	3-4 inch oz	10 inch oz	10 inch oz	10 inch oz	10 inch oz	10 inch oz
Size	2 3/4" sq. x 5"	2 3/4" sq. x 4 1/8"	2 1/2" dia. 6 1/8"	2 1/2" dia. x 5"	3 1/2" dia. x 6-5/32"	2-27/32" dia. x 6 5/16"

Collins Radio Co., Cedar Rapids, Iowa

Please send complete information on your permeability tuned precision oscillators.

NAME _____

COMPANY _____

ADDRESS _____

CITY _____ STATE _____

COLLINS RADIO COMPANY
Cedar Rapids, Iowa

11 W. 42nd St.
New York 36

1930 Hi-Line Drive
Dallas 2

2700 W. Olive Ave.
Burbank



STABILITY and ACCURACY PERMEABILITY TUNED OSCILLATORS

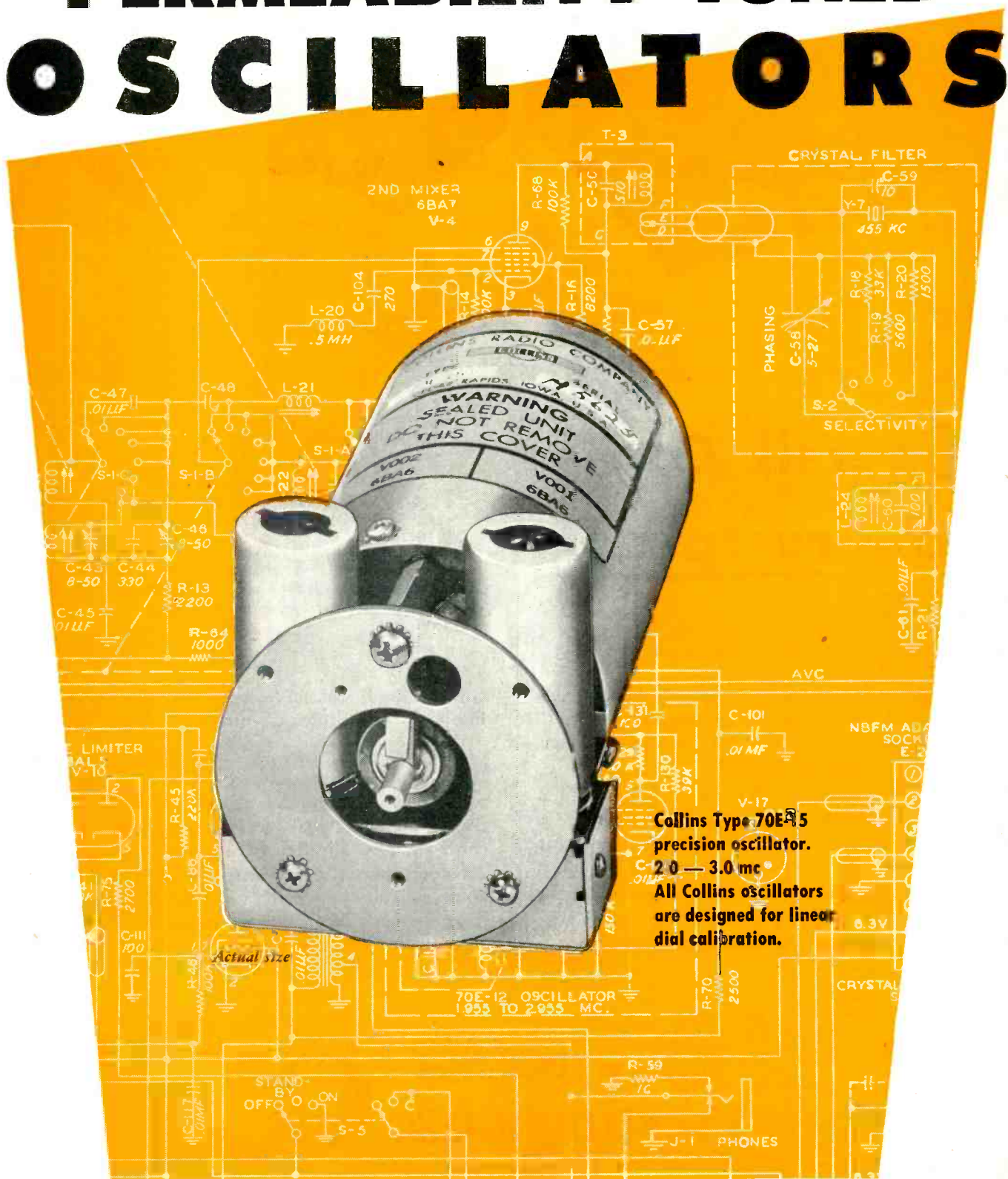

Collins Type 70E-15
precision oscillator.
2.0 — 3.0 mc.
All Collins oscillators
are designed for linear
dial calibration.

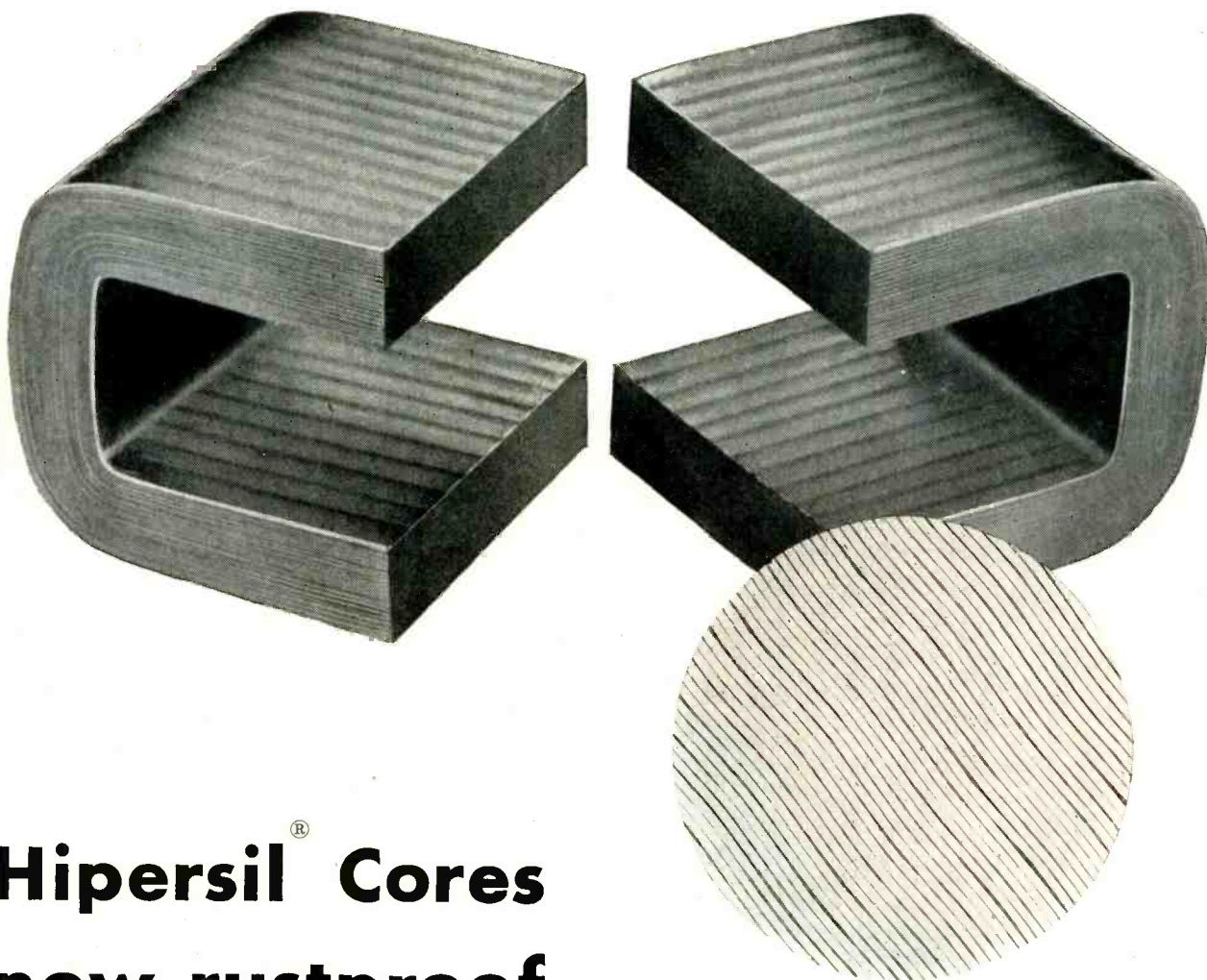

Hipersil[®] Cores now rustproof

Butt joint section of 5-mil Hipersil Core, magnified 10 times. Distinct separation between the laminations channels the flux, increases core efficiency.

A new process now coats a microscopic film of rust-proof iron phosphate on all Westinghouse Hipersil Cores. This coating will not chip, scratch or flake, nor will it affect core performance.

Rustproofing eliminates all possibility of deterioration. This means you can safely carry samples or a stock of cores in advance of immediate production needs . . . keep your assembly lines flowing smoothly.

This thin coat prevents any loss of the inherently high flux carrying capacity . . . another reason why Hipersil Cores make it unnecessary to design excess

core material, and, therefore excess size and weight, into your transformer assemblies.

Advancements like this continue to make the Westinghouse Hipersil Core the best on the market today. Because they are 100% active in carrying flux, they solve size, weight and loss problems for you. The simple, two-piece assembly helps cut your transformer fabricating costs. Get a more complete story by writing today for Booklet B-5402. Westinghouse Electric Corporation, P. O. Box 868, Pittsburgh 30, Pennsylvania.

J-70694

YOU CAN BE SURE...IF IT'S
Westinghouse



DESIGN and PRODUCTION NEWS

FOR ELECTRICAL AND ELECTRONIC ENGINEERS

Published by TECHNICAL SERVICE, Chemical Manufacturing Division, The M. W. KELLOGG Company

OCTOBER 1953

Precision Connectors Use Kel-F to Provide Superior RF Insulation ...5,000v. Capacity...Cut Moisture Dissipation

Consistently high RF insulation and dimensional stability were prime requirements for the dielectric inserts in connectors required for an Atomic Energy installation. "Kel-F" plastic was found to be the material answering these and other "tough" requirements.

"Kel-F" maintains high RF insulation under conditions that cause other materials to fail. It is readily molded or machined to within .002" of the critical dimensions required for the parts. And, because of its excellent wear characteristics, "Kel-F" maintains the precision of the critical insulators for a longer time. Frequent "connects", "disconnects" and operational vibration have negligible effect on the insulation because of the high strength—impact, compressive and flexural—of this fluorocarbon plastic. It takes rough handling without chipping, cracking or "freezing".

Exposure of the insulators made of "Kel-F" to high humidity fails to affect their dimensional stability or superior electrical properties. Zero water absorption and "non-stick" properties of this plastic reduce the need for maintenance by preventing the formation of fungus under high humidity or the accumulation of conductive residues.

The precision RF connectors illustrated are manufactured by the Dage Electric Company, Inc. of Beech Grove, Ind. for use in electronic equipment specified for nuclear studies. One of the insulating parts of "Kel-F" used is injection-molded for this company by the Brillhart Plastics Corporation of Mineola, N. Y. Another is machined from extruded Kel-F by Insulating Fabricators of New England, Inc., Watertown, Mass. The precision parts are then incorporated in special metal connector housings that are gold-plated.

Refer to Report E-115



Sea-Going "Pot" of Kel-F[®] Harnesses 10,000 Volt Currents...Maintains Hermetic Seal Under Shock and Vibration...At All Temperatures

At the polar cap or in the humid tropics, in the "moth ball fleet" or on the firing line, the variable capacitor "pot" shown here guards against leakage of 10,000 v. currents and loss or contamination of the insulating "potting" oil. Molded of "Kel-F" trifluorochloroethylene polymer plastic, this six-pound unit will maintain a high level of insulation resistance indefinitely due to the high dielectric strength of the plastic... at high

and low temperatures (—320 to 390°F) and in spite of salt-laden sea air. The chemical inertness of "Kel-F" polymer eliminates any corrosion from the insulating oil, loss of the oil or dimensional change resulting in a break in hermetic seal. The toughness—high tensile, impact and compressive strength—of the polymer prevents cracking of the pot or loosening of electrical leads under shock or vibration, even during "big gun" salvos.

The variable capacitor "pot", one of the heaviest single pieces ever molded from "Kel-F" trifluorochloroethylene polymer, is compression-molded for the Armed Forces by Fluoro Plastic, Inc. of Philadelphia, Pa. Mounting lugs, undercuts and the dimensions of the bore of the pot and cover are all provided for during molding, on standard molding equipment. The choice of "Kel-F" plastic was based also on its zero water absorption, non-porosity and "non-stick" properties which prevent any current shorting caused by water or exposure to high humidity.

Refer to Report E-113

(SEE REVERSE SIDE)



KEL-F

TRIFLUORO
CHLORO
ETHYLENE
POLYMERS

KEL-F

MOLDING
POWDERS

KEL-F

FLURO
CHLORO
CARBON
PLASTIC

KEL-F

DISPERSION
COATINGS

KEL-F

TRIFLUORO
CHLORO
ETHYLENE
POLYMERS

KEL-F

OILS
WAXES
GREASES

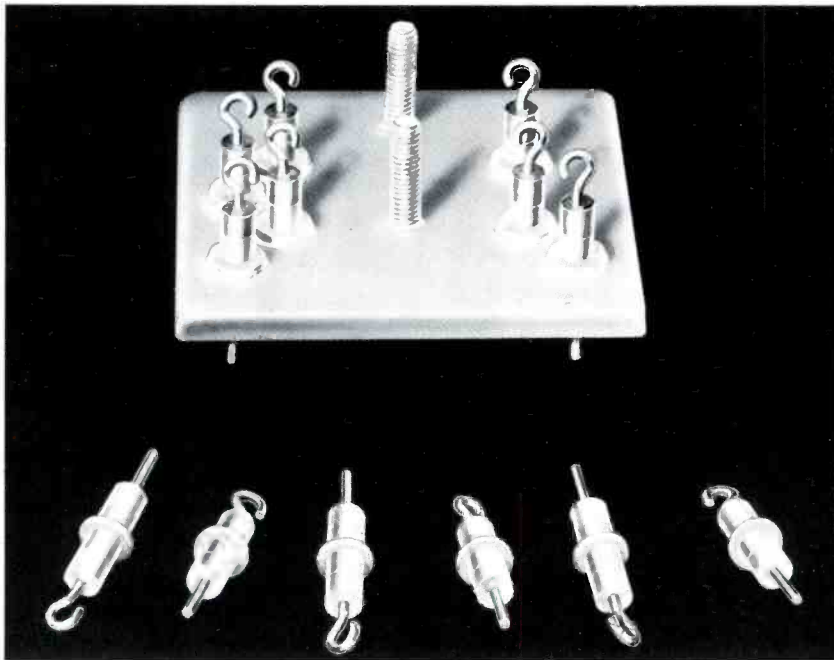

Improved Terminals Handle Currents up to 7500 Volts RMS Without "Flash"... Under High Humidity... Maintain Hermetic Seal Under Stress

Rough handling, severe operational current and temperature cycling and environmental restrictions are all taken in stride by the new hermetically sealed terminal pictured here. Two factors make this an outstanding terminal: The use of Kel-F® polymer plastic as the insulation and important refinements in the art of terminal manufacture.

"Kel-F" trichloroethylene polymer was chosen to insulate this terminal, enabling it to handle 15

ampere currents up to more than 2,000 volts RMS *without corona*... up past 7,500 volts RMS *without flash-over or tracking*. Injection-molded under precise control, these terminals of "Kel-F" have higher heat and cold resistance... providing perfect electrical insulation at minus 148°F. as well as at over 300°F. The consistent dimensional stability of "Kel-F" at both high and low temperatures, combined with a new method of crimping the conductor prevent loss of the vital hermetic seal—"Kel-F" refuses to shrink, swell or age and the special crimping prevents lateral or longitudinal movement of the conductor.

Brilhart Plastics Corporation, Mineola, N. Y., produces these improved terminals by injection molding, using standard methods and multi-cavity molds. All parts of the terminal, designated as the "Type BTX-1"* are made in this company's plant. The new terminal uses specially-designed parts and a "post-molding" treatment to achieve a hermetic seal that will pass a 20 psi pressure test after "wiggle" and "pull" tests that cause other terminals to fail.

*Patented

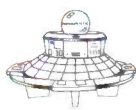

Remember
"Kel-F" at The
Chemical Show
in November...

Interesting and unusual applications of "Kel-F" polymer plastics in the chemical industries will be displayed at the "Kel-F" Booth Nos. 835, 839 and 843 at the 24th EXPOSITION OF CHEMICAL INDUSTRIES, November 30th to December 5th, 1953. The place: Commercial Museum and Convention Hall, Philadelphia, Pa.

Molders of the Month

Leading molders and extruders specialize in fabrication of materials and parts made of Kel-F... each month this column will spotlight several of these companies with their principal services and products.

Cinch Manufacturing Corporation Chicago, Ill.

Injection Molding
Electrical & Electronic Components
Tube Sockets & Connectors

Elastic Stop Nut Corporation of America Union, N. J.

Injection Molding
Elastic Stop Nuts & Fasteners

Industrial Coatings Corporation Chicago, Ill.

Dispersion Coating

Jet Specialties Company Los Angeles, Calif.

Extrusion
Rod & Tube

Juno Tool Corporation Minneapolis, Minn.

Compression & Transfer Molding
Injection Molding
Electrical & Electronic Components

Molding Corporation of America Providence, R. I.

Compression & Transfer Molding
Electrical & Electronic Components
Tubes, Sockets & Connectors
Terminals
Pump, Valve Diaphragms & Parts

For complete information regarding any item mentioned in DESIGN AND PRODUCTION NEWS, ask for detailed APPLICATION REPORTS, write

Technical Service CHEMICAL MANUFACTURING DIVISION THE M. W. KELLOGG COMPANY

P. O. Box 469, Jersey City 3, N. J.
or offices in Boston, Chicago, Dayton,
Los Angeles and New York



SUBSIDIARY OF
PULLMAN
INDUSTRIES

Refer to Report E-114

KEL-F

TRIFLUORO
CHLORO
ETHYLENE
POLYMERS

KEL-F

MOLDING
POWDERS

KEL-F

FLUORO
CHLORO
CARBON
PLASTIC

KEL-F

DISPERSION
COATINGS

KEL-F

TRIFLUORO
CHLORO
ETHYLENE
POLYMERS

KEL-F

OILS
WAXES
GREASES

TIME PROVED

Eimac 4W20,000A gives 25 kw peak sync power output through channel 13 with only 500 watts driving power

TYPICAL OPERATION

Class-B Linear Amplifier—Television Visual Service
(Per tube, 5 mc bandwidth, 216 mc.)

Load Impedance	650 ohms
D-C Plate Voltage	7000 volts
D-C Screen Voltage	1200 volts
D-C Control-Grid Voltage	—150 volts

	Peak	
	Sync Level	Black Level
D-C Plate Current	6	4.5 amps
D-C Screen Current	230	100 ma
D-C Grid Current	90	45 ma
Peak RF Grid Voltage	280	220 volts
Driving Power	500	300 watts
Plate Power Input	42	32 kw
Plate Dissipation	16	16.5 kw
Useful Plate Power Output	26	15.5 kw

FOR THREE YEARS THE EIMAC 4W20,000A has been proving itself an outstanding power tube in a variety of electronic applications. In VHF-TV operation it gives an easy 25 kw peak sync power output with only 500 watts driving power. This high power output with low driving power requirements is typical of Eimac radial-beam power tetrodes. Rugged 4W20,000A construction includes a ceramic envelope that minimizes losses and increases operational life. In pulse service, FM and TV operation the 4W20,000A is the only time proved tetrode in its power class.



Information about the 4W20,000A or any of Eimac's complete line of electron power tubes can be obtained by writing our Application Engineering department.

The Power for TV

ETEL - McCULLOUGH, INC., SAN BRUNO, CALIFORNIA

New Plant Locates in Telecasting Heart of U. S.

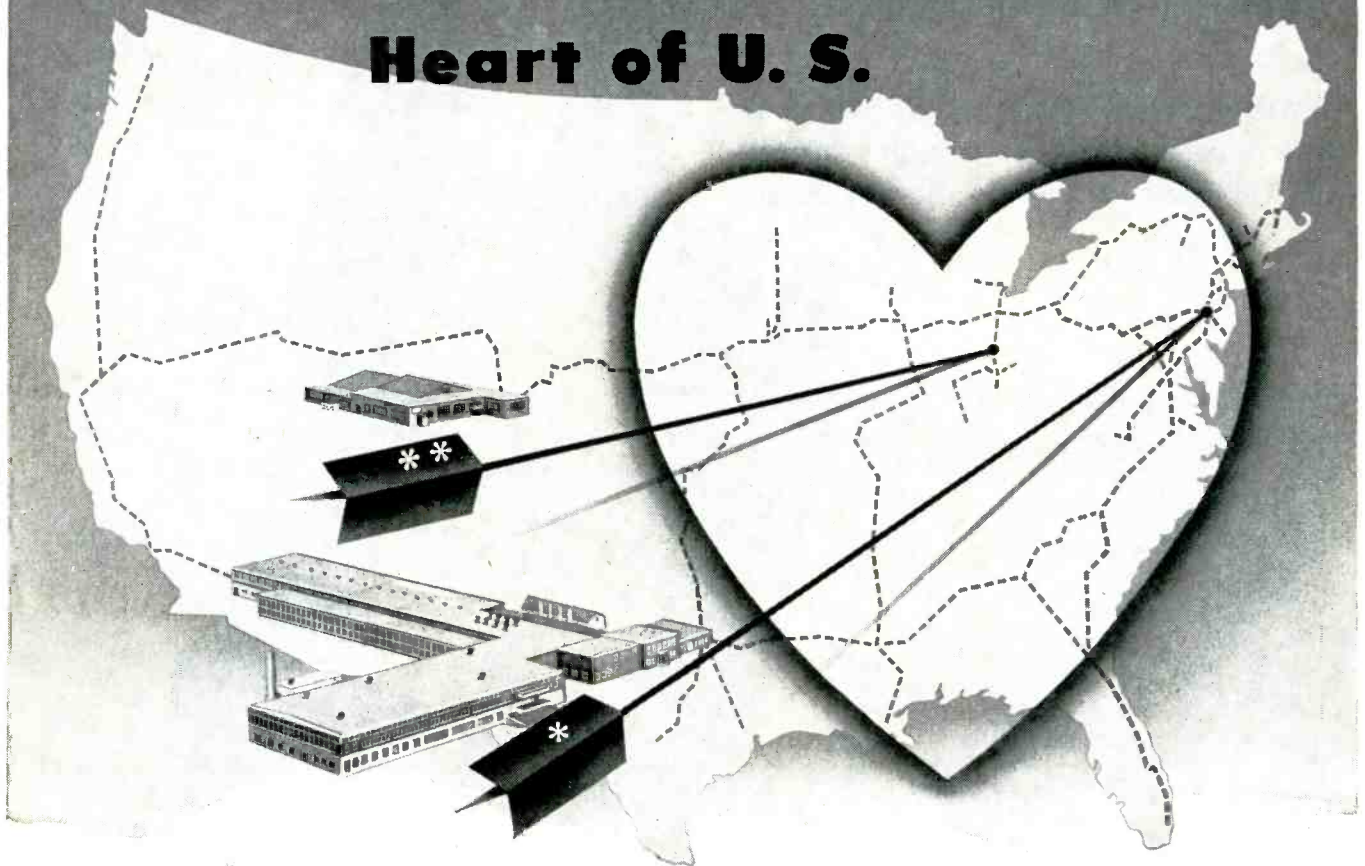

Things are humming in Wapakoneta, Ohio. There, about 10 miles west of the Dayton-Toledo coaxial cable is the new plant of Superior Tube Company. This plant complements the production capabilities of the Superior main plant, takes care of your ever-increasing demands for television and military purposes.

Superior nickel cathodes are made in a wide range of types, O.D.'s, wall thicknesses and lengths—with or without bead—and in active, normal and passive alloys, depending upon the application and the degree of emission required.

Superior produces both Seamless and Lockseam† nickel cathodes. For many electron tubes Lockseam

—made by a patented process from strip stock—has an economic advantage. Superior Seamless shows great advantages in uniformity, close tolerances, and small O.D. for sub-miniature tubes.

Superior equipment is more than matched by the care taken in production. Each melt of alloys is laboratory-checked for emission and performance. Many extraordinary precautions are taken in manufacture to avoid contamination.

Before you order cathodes, first see what Superior engineering, quality, and delivery can do for you.

Many other types of nickel cathodes—made in Lockseam† from nickel strip, disc cathodes, and a wide variety of anodes, grid cups and other tubular fabricated parts are available from Superior. For information and Free Bulletin, address Superior Tube Company, Electronics Division, 2500 Germantown Avenue, Norristown, Pa.

*Main Superior Tube plant at Norristown, Pa.

**NEW Superior Tube plant at Wapakoneta, Ohio

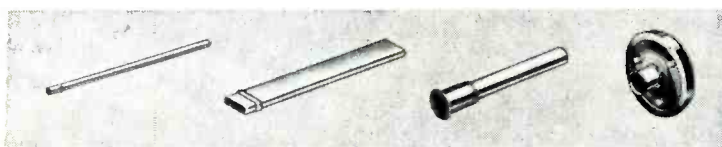

Seamless Nickel Cathode Round, single bead, .045" O.D. x .002" Wall. 27 mm long.

Lockseam† Nickel Cathode Rectangle, single bead, .030" x .100" O.D. x .0021" Wall. 13 mm long.

Seamless Monel, Expanded and flanged. (Exp. to .165"/.168" I.D.—Fl. to .230") .139 O.D. x .005" Wall x 1.100" long.

Disc Cathode .121" O.D. .312" long.

Superior
THE BIG NAME IN SMALL TUBING

All analyses .010" to 3/8" O.D.

Certain analyses (.035" Max. wall) up to 1 3/8" O.D.

†Manufactured under U.S. Patents



A Robot's Secret

Iron Fireman learned many years ago that the real secret of any automatic device is in the controls and instruments which regulate its operation. This is the reason that Iron Fireman has long had a separate division for producing the instruments, controls and motors used with its world-

famous heating equipment.

Today, many types of precision devices are mass-produced at the large Electronics Division plant—by people with a *quarter-century* of experience. This experience has made possible aircraft and electronics components featuring new and better designs.

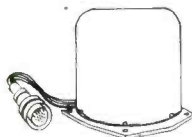

Vertical Gyros

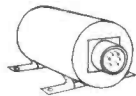

Motor-driven Timers

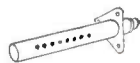

Fire and Heat Detectors

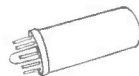

Hi-Speed Relays and Choppers

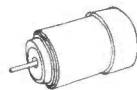

Spin Motors

For more information write

IRON FIREMAN *Electronics* **DIVISION**

2800 S. E. NINTH AVENUE, PORTLAND 2, OREGON

VOLTAGE REGULATED POWER SUPPLY

MODEL 700

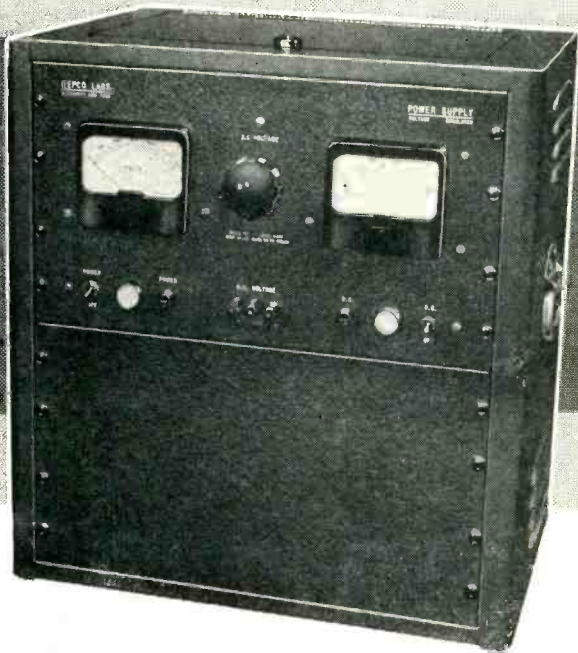

The Kepco Model 700 features one regulated voltage supply with excellent regulation, low ripple content and low output impedance.

SPECIFICATIONS

OUTPUT VOLTAGE DC: 0-350 volts continuously variable.

OUTPUT CURRENT DC: 0-750 milliamperes continuous duty.

REGULATION: In the range 30-350 volts the output voltage variation is less than 1/2% for both line fluctuations from 105-125 volts and load variation from minimum to maximum current.

RIPPLE VOLTAGE: Less than 10 millivolts.

FUSE PROTECTION: Input and output fuses on front panel. Time delay relay is included to protect rectifier tubes.

POWER REQUIREMENTS: 105-125 volts, 50-60 cycles.

OUTPUT TERMINATIONS: DC terminals are clearly marked on the front panel. Either positive or negative terminal of the supply may be grounded. DC terminals are isolated from the chassis. A binding post mounted on the front of the panel is available for

connecting to the chassis. All terminals are also brought out at the back of the chassis.

METERS:

Ammeter: 0-1 ampere, 4" rectangular.
Voltmeter: 0-500 volts, 4" rectangular.

PHYSICAL SPECIFICATIONS: Cabinet height 22 3/4", width 21 3/4", depth 15 1/4". Rack panel height 21", width 19", color gray, panel engraved.

CONTROLS: Power on-off switch, H.V. on-off switch, H.V. control.

ADDITIONAL MODELS AVAILABLE IN THE 700 SERIES VOLTAGE REGULATED POWER SUPPLIES

Volts	Current	Model
0-350	0-0.75 Amp.	700
0-350	0-1.50 Amp.	710
0-350	0-2.25 Amp.	720
0-350	0-3.00 Amp.	730
0-600	0-0.75 Amp.	750
0-600	0-1.50 Amp.	760
0-600	0-2.25 Amp.	770
0-600	0-3.00 Amp.	780

FOR NEW POWER SUPPLY CATALOG — WRITE DEPT. #1



KEPCO LABORATORIES

131-38 SANFORD AVENUE

FLUSHING 55, NEW YORK



Gems of Precision Engineering

GLASS-TO-METAL VACUUM SEALS COMPETITIVELY PRICED

These glass-to-metal vacuum seals are quality products manufactured from glass and metals carefully selected for their closely matched expansion coefficients. Thermal shock tests are performed on every seal during the hot tin dipping operation which is conducted at the extreme temperature of 530° F. This plating procedure insures clean parts which will solder readily whether heating is accomplished by hot plate,

soldering iron, hot strip, or soft flame, AND WITHOUT DANGER OF BREAKAGE DUE TO THERMAL SHOCK.

Experience, selected materials, engineering skill, and controlled manufacturing combine to make Constantin vacuum seals leaders for their sturdiness, long life, and excellent electrical performance.

Seals are available in both High Compression and Kovar to hard glass types.



MULTI-PIN CON PLUGS

A wide variety of standard sizes and configurations available. Leaders in the field specify CONSTANTIN CONNECTORS for their ruggedness and reliable performance.



MULTI-PIN HEADERS

Vacuum tight, glass-to-metal sealing makes CONSTANTIN HEADERS ideal for use in products demanding a stabilized atmosphere, and protection from temperature extremes and climatic conditions.



TRANSISTOR MOUNTS

Constantin glass-to-metal vacuum sealed transistor mounts are available as a standard line in various sizes and configurations. Other types may be fabricated to your design specifications.



TERMINALS

Available in all combinations of hooks, eyes, tubes and pierced flats. Precision built and especially noted for sturdiness and high electrical performance.



CONDENSER END SEALS

Manufactured to assure a stabilized atmosphere under any conditions, these seals are excellent for capacitors, filters, delay lines, and precision resistors.



Also manufacturers of —
CRYSTAL HOLDERS
VACUUM COATING EQUIPMENT

L.L. Constantin & Co.

MANUFACTURING ENGINEERS

Rt. 46 and Franklin Ave., Lodi, N. J.

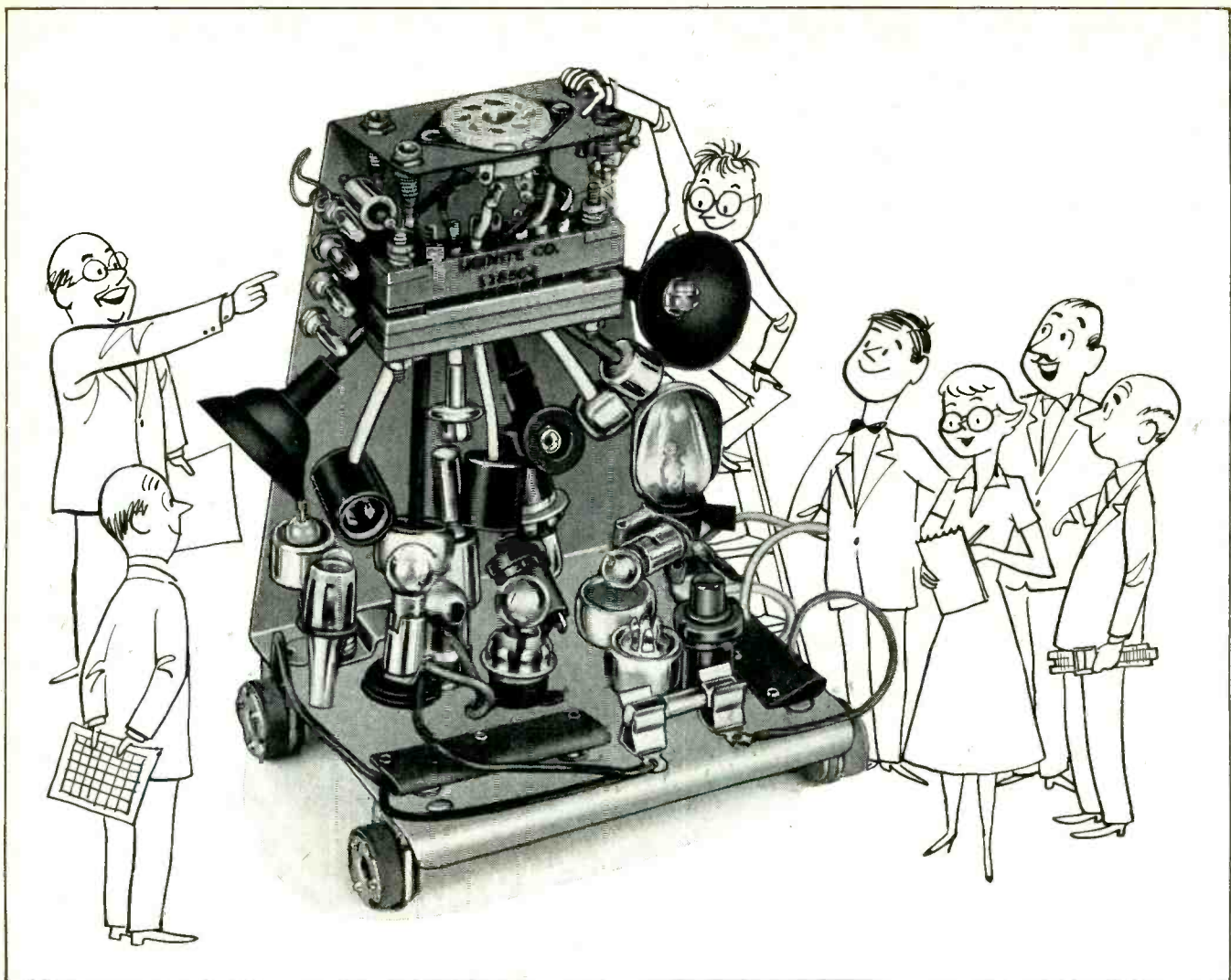

Robot Electronic Thermotipple...

Being the only *genuine* thermotipple in existence, she's apt to be temperamental. At low frequencies, her transient response gets so transient it takes a shot of plutonium to make her respond at all. The only thing that keeps her from being outright neurotic is the fact that all her components are standard Ucinite parts and assemblies. Switches, connectors, sockets, mountings . . . every one of the precision-made devices shown

here is evidence of our ability to fill the varied and highly specialized requirements of our customers.

With an experienced staff of design engineers . . . plus complete facilities for volume production, we are capable of supplying practically any need for metal or metal-and-plastics assemblies. Call your nearest Ucinite or United-Carr representative for full information, or write directly to us.



The
UCINITE CO.
Newtownville 60, Mass.
Division of United-Carr Fastener Corp.

}

Specialists in
ELECTRICAL ASSEMBLIES,
RADIO AND AUTOMOTIVE

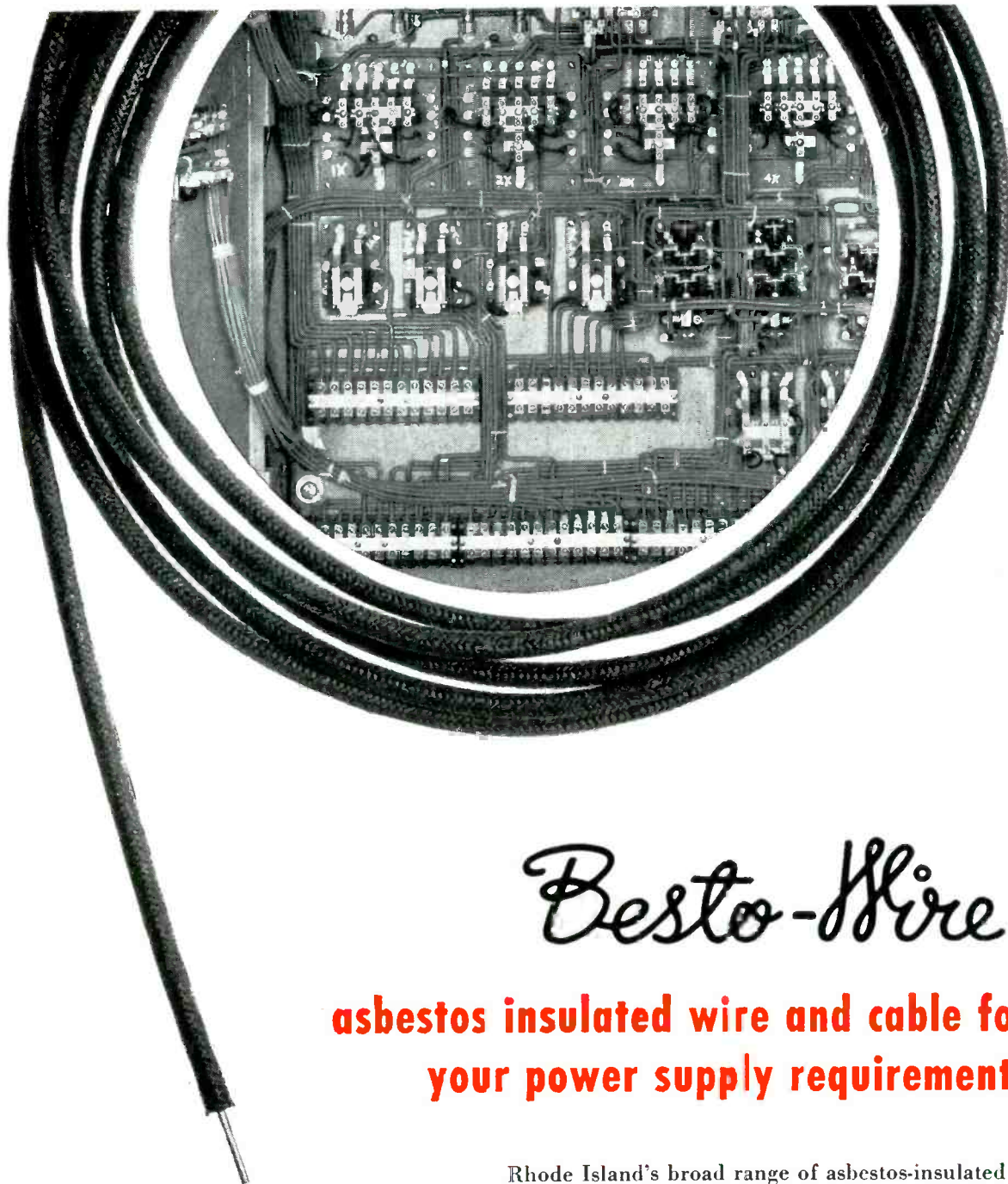

Besto-Wire

**asbestos insulated wire and cable for
your power supply requirements**

Rhode Island's broad range of asbestos-insulated Besto-Wire includes a variety of fixture wires, U. L. approved for 300-volt service at 150° C.... switchboard cables for 600 volts at 125° C.... heater cords for all types of appliances... specially constructed range wires for easy stripping and high heat applications.

Besto-Wire... time tested for consistently fine performance.

Write Dept. E-10
today for new
illustrated brochure



NATIONAL SALES OFFICES: 624 SOUTH MICHIGAN BLVD. • CHICAGO 5, ILLINOIS • HARRISON 7-6050

**RHODE ISLAND INSULATED WIRE COMPANY, INC.
50 BURNHAM AVENUE • CRANSTON • RHODE ISLAND**



New Multi-purpose

New!



-hp- 612A — VERSATILE, DIRECT READING. FOR UHF-TV, OTHER WORK 450 TO 1,200 mc

This master oscillator-power amplifier generator is especially designed for UHF-TV measurements including receiver and amplifier gain, selectivity, sensitivity and image rejection. It is also a convenient, direct-reading laboratory power source for driving bridges, slotted lines, antennas and filter networks. Both frequency and output are directly set on large, precisely calibrated dials. No charts or interpolation are required.

Model 612A has a maximum output of 0.5 volts into 50 ohms over its entire frequency range. The instrument also has low incidental fm and broad band modulation up to 5 mc. It may be modulated internally or externally, amplitude modulated, or pulse modulated (good rf pulses 0.2 μ sec or longer). Pulse modulation may be applied to the amplifier; or direct to the oscillator when high on-off signal ratios are required.

BRIEF SPECIFICATIONS

Frequency Range: 450 to 1,200 mc, 1 band.

Accuracy: Calibration $\pm 1\%$. Resettability better than 5 mc at high frequencies.

Output: 0.1 μ v to 0.5 v continuously variable. Calibrated in volts and dbm. Impedance 50 ohms. Max. VSWR 1.2. Accuracy ± 1 db entire range.

Modulation: Amplitude: From 0 to 90% indicated by panel meter.

Envelope Distortion: 2% at 30% modulation.

Internal: Fixed modulation frequencies, 400 and 1,000 cps.

External: Any frequency 20 cps to 5 mc.

Pulse Requirements, External Modulation:

Pulse to Amplifier: Good pulse shape at 0.2 μ sec length.

Pulse to Oscillator: 1.0 μ sec minimum.

Size: Cabinet 12" x 14" x 18" deep.

Price: \$1,200.00

10 TO 500 mc

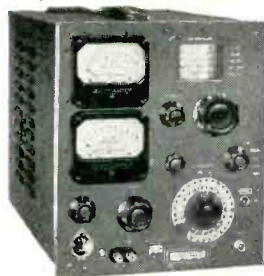

-hp- 608A VHF Signal Generator provides output ranging from 0.1 μ v to 1.0 v into 50 ohms. Accuracy is ± 1 db. Direct reading frequency and output calibration; no charts or interpolation required. Pulsed, cw or amplitude modulated output (50 cps to 1 mc). Resettability better than 1 mc. Has master oscillator-power amplifier for widest modulation capabilities. Constant internal impedance. Maximum VSWR 1.2. \$850.00

800 TO 2,100 mc



-hp- 614A UHF Signal Generator provides output ranging from 0.1 μ v to 0.223 v (1 mw) into 50 ohms. Accuracy ± 1 db. Has single dial, direct reading frequency and output, no charts or interpolation. Offers cw, fm or pulsed output. Widely variable pulsing, synchronizing, delay and triggering features. Extremely fast rise/decay time of 0.1 μ sec. Constant internal impedance. Maximum VSWR 1.6. \$1,950.00

Complete Coverage HEWLETT-PACKARD



SIGNAL GENERATORS

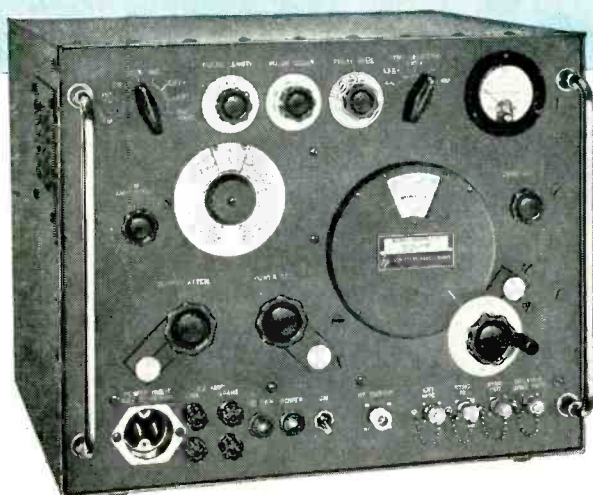

New!

-hp- 618B — VARIED PULSING CAPABILITIES, DIRECT READING. RANGE 3,800 TO 7,600 mc

Model 618B offers faster, more accurate measurement of component performance in radar, radio relay and TV carrier systems and similar field and laboratory applications. Frequency is generated in a reflex klystron oscillator; accuracy and stability are high throughout the instrument's wide frequency range. Frequency and voltage are directly set and read. Dial tuning is tracked automatically, and no voltage adjustment is required during operation.

Extremely wide pulsing capabilities have been built into -hp- 618B. The instrument may be internally or externally pulse modulated, internally square wave modulated and frequency modulated. The repetition rate is continuously variable between 40 and 4,000 pps. Pulse width is variable 0.5 to 10 μ sec. Sync-out signals are simultaneous with the rf pulse or in advance by any time-span from 3 to 300 μ sec. The instrument also may be synchronized with an external sine wave, or with positive or negative pulse signals.

BRIEF SPECIFICATIONS

Frequency Range: 3,800 to 7,600 mc. 1 band.

Calibration: Direct. Accuracy better than 1%.

Stability: Frequency: less than 0.006% per °C change.

Line Variation: ± 10 v causes less than 0.01% frequency change.

Output: 1 mw/0.223 v to 0.1 μ v into 52 ohms. (0 to -127 dbm).

Modulation: Internal or external pulse, fm, or internal square wave.

External Sync: (1) Sine wave 40 to 4,000 cps, 5 to 50 v rms.

(2) Pulse signals 40 to 4,000 pps, 5 to 50 v (pos. and neg.). Pulse width 0.5 to 5 μ sec. Rise time 0.1 to 1.0 μ sec.

Size: Cabinet 16 $\frac{1}{4}$ " x 13 $\frac{1}{2}$ " x 16" deep.

Price: \$2,250.00

Data subject to change without notice. Prices f.o.b. factory.

1,800 TO 4,000 mc

-hp- 616A UHF Signal Generator offers the same simple operation, wide pulsing capabilities, high stability and accuracy as -hp- 618B, but is designed for UHF frequencies. Output ranges from 0.1 μ v to 0.223 v (1 mw) into a 50-ohm load. Accuracy is ± 1 db. Output may be cw, fm or pulsed. Modulation and synchronizing features are similar with -hp- 618B. Oscillator section is a reflex klystron. Frequency changes are automatically tracked and no voltage adjustment is needed during operation. Frequency and output are directly set and read on large, carefully calibrated dials. No charts or interpolation are needed. \$1,950.00

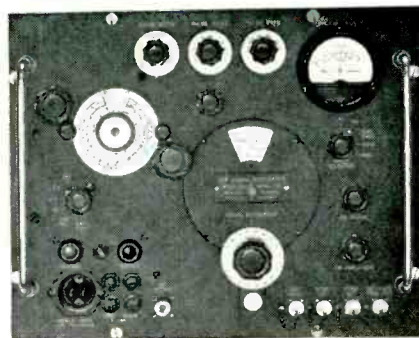

For complete details, see your -hp- field representative or write direct

HEWLETT-PACKARD COMPANY

2524A PAGE MILL ROAD • PALO ALTO, CALIFORNIA, U. S. A.

Export: FRAZAR & HANSEN, LTD., San Francisco • Los Angeles • New York



INSTRUMENTS

Complete Coverage



COMMUNICATIONS SUPERVISORS:

get **\$25,000**
coverage for **\$700!**

Here are the plain facts that speak for themselves of \$24,300 savings.

To increase the "talk-back" range of one-hundred cars from 20 miles to 25 miles—corresponding to an increase of 50% in area coverage—one-hundred 15 watt transmitters must be replaced with 60 watt transmitters . . . at an approximate cost of \$25,000.

You can get the same coverage by installing an Andrew 3000-type antenna for only about \$700.

One postcard can save you over \$24,000. Before you buy, write us for a complete analysis of costs and antenna types to meet your needs.

Andrew
CORPORATION

363 East 75th Street • Chicago 19

You Can Depend on COMMUNICATION ACCESSORIES for ADVANCED DESIGN

THROW AWAY the special washers and tubings used in your present mechanical mountings of toroids. C-A-C Advanced Design provides a molded-in brass bushing with center hole sizes to clear (type A) or tapped (type B) for a 6/32 screw.

PRESSURE ENCAPSULATION in low loss plastic provides a dense molding of extremely uniform dimension. We've cycled them from -73°C to 150°C —boiled them for hours in salt water—without any significant change.

TERMINALS are brass, silver-plated. Located for ease of connection. Any reasonable number of terminals may be provided. Units may be stacked and mounted with a single screw.

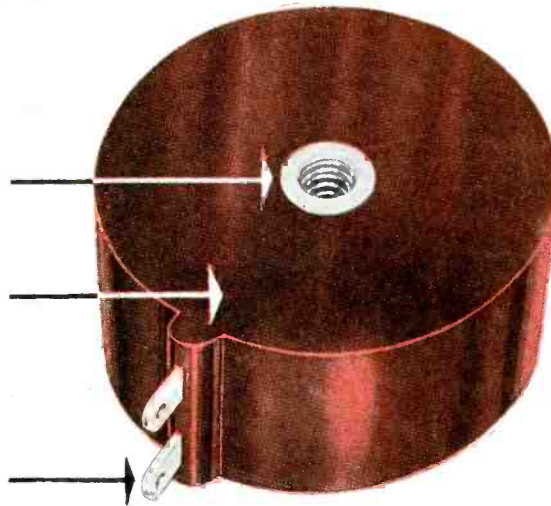

Compression MOLDED PLASTIC TOROIDS

THE C-A-C MP (molded plastic) Toroid is the result of years of development and exhaustive tests to determine the most suitable materials and method of manufacture. The small, extra cost of the molded unit is more than justified by the superior protection of the unit from damage in assembly and operation—and the elimination of complicated mounting arrangements. The assemblies are compact (see table for dimensions). Complete data available on request; samples will be furnished for your evaluation.

TOROIDAL INDUCTORS Data For Standard Types

Type	Normal Lmax.	Appr. Size O.D. x H	Useful Freq. Range	Qmax @ Freq.	lac.	T.C. ma
* 206	3.0 Hy	.90x .40	Up to 15 KC	140 @ 9	KC	1 23
** 930	17.5 Hy	1.20x .60	Up to 15 KC	170 @ 7.5	KC	1 42
	254 35 Hy	1.85x .85	Up to 15 KC	220 @ 5	KC	1 67
	466 60 Hy	2.15x 1.00	Up to 15 KC	260 @ 5	KC	3 95
* 848	1.4 Hy	.90x .40	10- 50 KC	170 @ 20	KC	1 33
** 395	8.0 Hy	1.20x .60	10- 50 KC	220 @ 20	KC	1 61
	381 17.0 Hy	1.55x .65	10- 50 KC	250 @ 17.5	KC	3 71
* 608	600 Mh	.90x .40	30- 75 KC	165 @ 60	KC	3 50
	579 7.5 Hy	1.55x .65	30- 75 KC	185 @ 30	KC	2 110
* 041	320 Mh	.90x .40	50-200 KC	115 @ 120	KC	3 68
	013 4.0 Hy	1.55x .65	50-200 KC	145 @ 70	KC	3 150

REMARKS

Qmax—Values taken at approx. .01 lac. Q decreases with increasing current to about .50 Qmax at 1.0 lac—higher inductance values have lower Qmax at lower frequency due to dielectric losses of winding distributed capacity. All values are for inductors wound with Heavy Formex wire.

T.C.—Temperature characteristics as follows:

1—approx. 100 ppm/ $^{\circ}\text{F}$

2— = .1% 55 to 90°F

3— = .1% 30 to 130°F

(most types with temp. characteristic 1 are available with characteristic 3 at no sacrifice in performance)

lac—r.m.s. current which raises 0.1 Hy inductor to max. (2% above initial) inductance — (1% increase occurs at approx 0.35 lac.

* FINISHED SIZE — 1-1/16" O.D. x 1/2" THICK

** FINISHED SIZE — 1-5/16" O.D. x 11/16" THICK

Via C.A.C. Beechcraft, we are only hours away from you—we solicit the invitation to discuss your problems across your own desk

COMMUNICATION ACCESSORIES Company

HICKMAN MILLS, MISSOURI

A N N O U N C I N G . . .

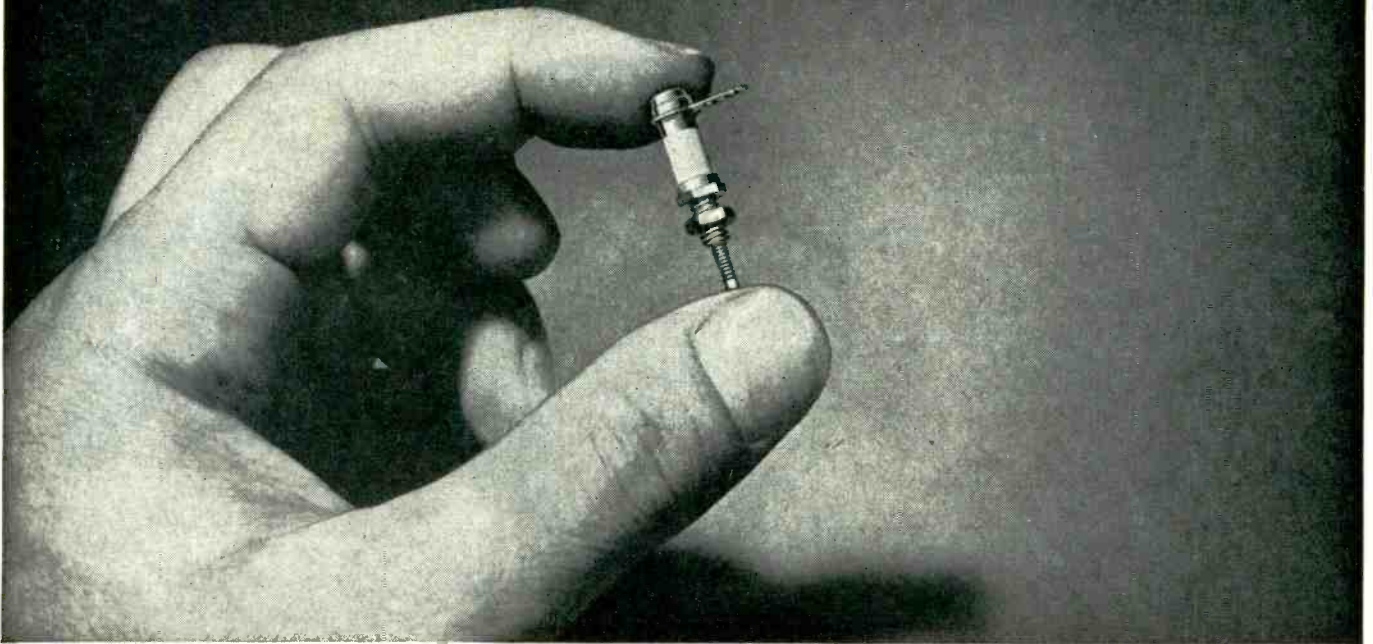

Shown approximately full size.

C.T.C.'s new CST-50 capacitor with greatly increased range, greater stability

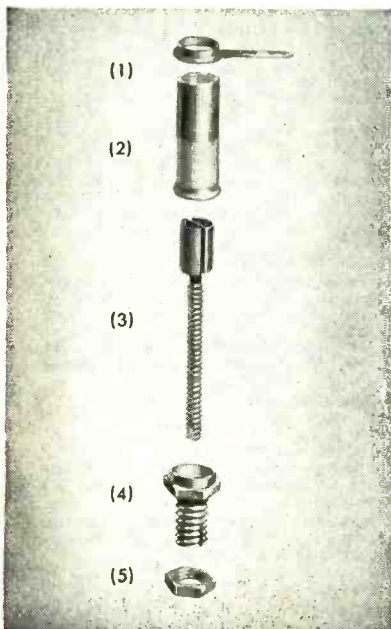

Exploded view of the CST-50 capacitor shows: (1) ring terminal with two soldering spaces; (2) metallized ceramic form; (3) spring-type S-shaped tuning sleeve*; (4) split mounting stud; (5) locking nut.

* Patent Applied For

Surpasses the range of capacitors many times larger in physical size.

The new CST-50 variable ceramic capacitor embodies a tunable* element of such unusual design it practically eliminates losses due to air dielectric. As a result, a large minimum to maximum capacity range (1.5 to 12 MMFD) is realized — despite the small physical size of the capacitor. This tunable* element is a spring-type, S-shaped tuning sleeve* which maintains constant maximum pressure against the inside wall of the ceramic form.

Other Design Features

The CST-50 stands only 19/32" high when mounted, is less than 1/4" in diameter and has an 8-32 threaded

mounting stud. The mounting stud is split so that the tuning sleeve* can be securely locked without causing an unwanted change in capacity. The tuning sleeve* is at ground potential. The CST-50 is provided with a ring terminal which has two soldering spaces.

All C.T.C. materials, methods and processes meet applicable government specifications. For further information on C.T.C. components and C.T.C.'s consulting service (available without extra charge) write us direct. Cambridge Thermionic Corporation, 437 Concord Avenue, Cambridge 38, Mass. West Coast manufacturers contact: E. V. Roberts, 5068 West Washington Blvd., Los Angeles and 988 Market St., San Francisco, California.

CAMBRIDGE THERMIONIC CORPORATION

custom or standard . . . the guaranteed components

Write for Free Catalog #400 containing complete data on the entire CTC line.



A Major Achievement in Molded Capacitor Construction and Performance

MINERAL OIL IMPREGNATED*

Extremely stable
over wide operating
temperature range.

BONDED SEAL

Positive, heat
resistant, non-
flammable bond
seals leads and
shell, locks out
humidity.

DRY ASSEMBLED

Insures uniform high
quality and uncon-
taminated capacitors.



†Trade Mark

TIGHT SEAL

... BONDED BLUE-POINT

TOUGH SHELL

... MOLDED PLASTIC TUBULAR

ATTRACTIVE YELLOW MOLDED PLASTIC SHELL

Non-flammable. Will not burn or
melt under soldering iron or flame.

FIRMLY SECURED LEAD

Can't be pulled out, even
under soldering iron heat.

PATENT
PENDING

BONDED SEAL

Positive, heat resistant, non-flammable bond
seals leads and shell, locks out humidity.

Now — Heat and Moisture PROTECTION To A Degree Never Before Possible!

Outstanding Performance in Hot and Humid Climates!

Here at last is a capacitor that affords *absolute protection* under every condition—a capacitor you can rely on completely—ASTRON BLUE-POINT, the *bonded* capacitor.

This capacitor is produced by an exclusive new design and manufacturing process (patent pending) developed by Astron engineers.

The all-important *blue point* which distinguishes this new capacitor actually *bonds* itself to the tough, heat-resistant outer shell and leads—forming the *tightest seal against moisture* ever produced!

The Blue-Point *dry-assembly* process—as used in hermetically sealed metal encased capacitors—prevents contamination, provides still further protection against moisture, and assures uniform *quality* and *dependability* for every Blue-Point.

The Blue-Point is mineral oil impregnated* for continuous operation at 85°C. The blue

point seal itself makes ingenious use of a special thermo-setting, heat-resistant, non-flammable *bonding agent* as a positive protection against moisture.

With the Astron Blue-Point, you may solder leads as close to the capacitor as you like. Leads will not pull out, nor will the heat of the soldering iron damage the lead or the connection.

Further, every Blue-Point is clearly marked with rated voltage and capacitance, and is imprinted with outside foil identification.

The Astron Blue-Point Capacitor gives you greater protection against heat and moisture at every stage—assuring long life and dependable performance from *every* unit—to a degree never before possible with molded plastic capacitors.

From now on, look for the Blue-Point—ask for exclusive Astron Blue-Point Capacitors by name... more than ever before, *depend on, insist on*... ASTRON!

*For bulletin AB-20A, with complete engineering data and listings, write: Astron Corporation, 255 Grant Avenue, East Newark, N. J.

Astron manufactures a complete line of dry electrolytic capacitors, metallized paper capacitors, plastic molded capacitors, standard and subminiature paper capacitors and RF interference filters for every radio, television and electronic use.

DEPEND ON — INSIST ON



PATENT
PENDING

Export Division: Rocke International Corp.,
13 E. 40th St., N.Y.C. In Canada: Charles W.
Pointon, 1926 Gerrard St., East, Toronto.

ASTRON CORPORATION • 255 GRANT AVENUE • EAST NEWARK • NEW JERSEY

MITCHELL-RAND

electrical insulation headquarters

features

MIRAGLAS-A fiberglass tapes

for general purpose class A electrical insulation

**COMPARED WITH COTTON
OR RAYON
FOR GENERAL PURPOSE
CLASS A APPARATUS**

**MIRAGLAS-A FIBERGLAS TAPES
ARE MUCH MORE ECONOMICAL...**
being half as thick they cover more area...
having twice the tensile strength they provide
longer life and better performance... woven of
long staple fiberglass yarn they withstand high
temperatures and won't burn or rot... and
MIRAGLAS-A FIBERGLAS TAPES are specially treated
for machine or hand winding.

MITCHELL-RAND CAN MAKE IMMEDIATE DELIVERIES

Specify

**MIRAGLAS-A FIBERGLAS TAPES
FOR CLASS A INSULATION USE**

TYPE	CX	plain weave	THICKNESS			.004"
Available Widths		1/2" 3/4"	1" 1 1/4"	1 1/2"		
Approx. Yds./Lb.		280 224	168 134	100		
		total ends	type yarn	nominal breaking strength		
WARP	}	1/2"	26	150 1/0 waxed	65	
		3/4"	38	150 "	90	
		1"	50	150 "	125	
		1 1/4"	62	150 "	150	
		1 1/2"	74	150 "	180	
FILLING		24 ends per inch—150 1/0 waxed yarn				

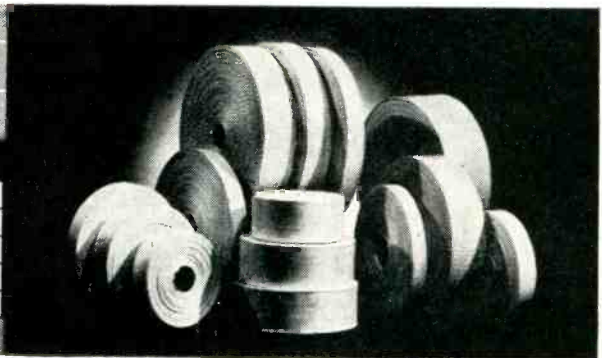

Write to MITCHELL-RAND for free samples and descriptive data.

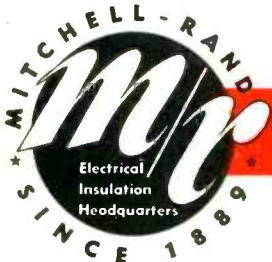

MITCHELL-RAND INSULATION COMPANY, INC.

51 MURRAY ST. • COrtlandt 7-9264 • NEW YORK 7, N.Y.

MIRAGLAS VARNISHED TAPES, CLOTHS AND SLEEVINGS • MIRAGLAS TAPES, BRAIDED SLEEVINGS AND TYING CORDS • MIRAGLAS SILICONE TREATED CLOTHS, TAPES AND TUBINGS • MICA TAPES, CLOTHS AND MICA-FIBERGLAS COMBINATIONS • FIBRE, PHENOL FIBRE AND MIRALITE POLYESTER RESIN SHEET INSULATING PAPERS—DURO, FISH, PRESSBOARD, ETC. • VARNISHED CAMBRIC TAPES, CLOTH AND SLOT INSULATIONS • COTTON TAPES AND SLEEVINGS • TWINES AND TIE TAPES • ASBESTOS TAPES, SLEEVINGS AND CLOTH, TRANSITE AND ASBESTOS EBONY • ARMATURE WEDGES AND BANDING WIRE • VARNISHED TUBINGS, HYGRADE, MIRAGLAS, HYGRADE VF, MIRAGLAS SILICONE • THERMOFLEX AND FLEXITE EXTRUDED PLASTIC TUBING • PERMACEL MASKING TAPES AND ELECTRICAL TAPES • BI-SEAL, BI-PRENE; FRICTION TAPES AND RUBBER SPLICE • COMPOUNDS—TRANSFORMER, CABLE FILLING, POTHEAD, ETC. • INSULATING VARNISHES OF ALL TYPES.

**you
don't
buy
one of
these
every
day!**

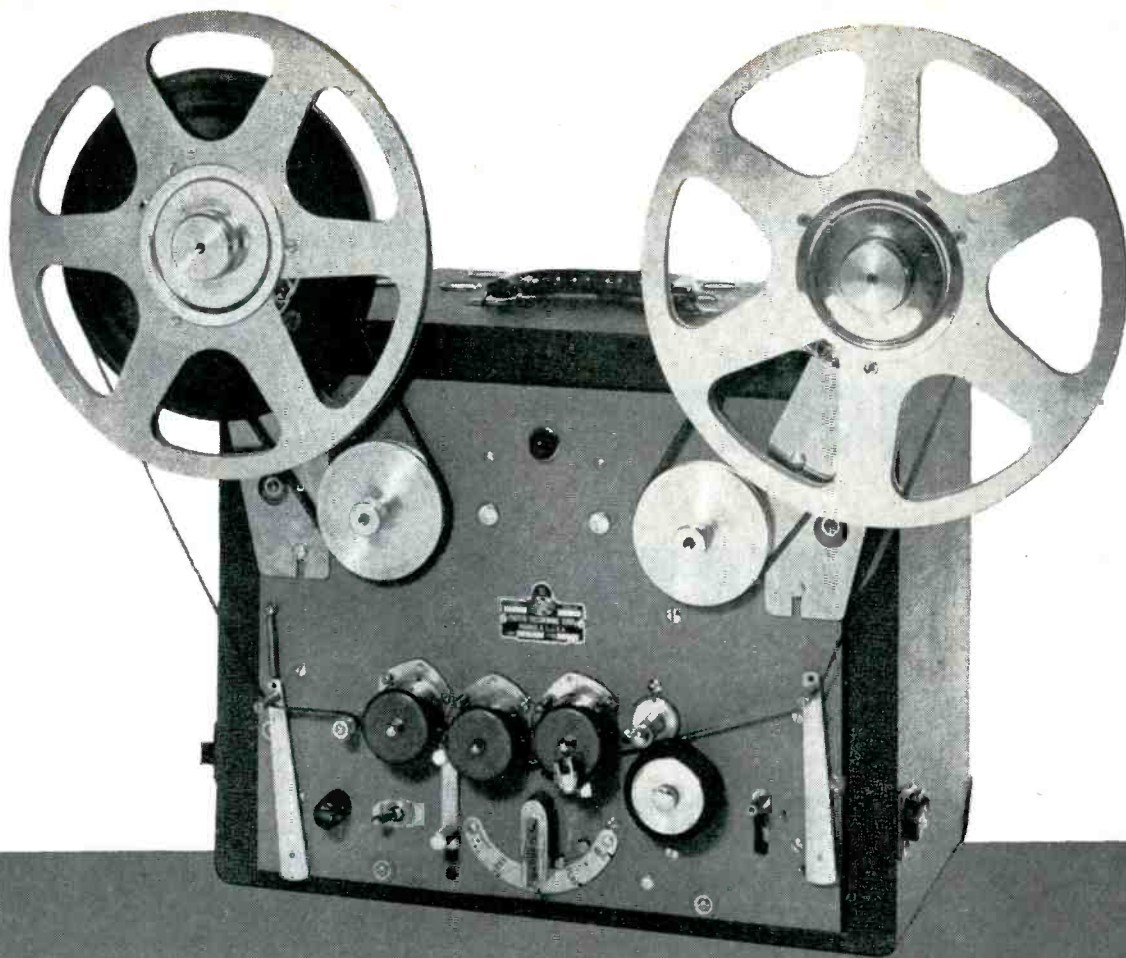

PRESTO RC-7 with RA-1 reel adapter

Compare these RC-7 features:

- Instantaneous speed accuracy
- Dynamic range better than 50db. at 3% distortion
- Three-motor drive
- No friction clutch or friction brakes
- Heavy duty construction throughout
- Separate-erase-recording-playback heads
- Twin speed: 7 1/2" /sec. or 15" /sec.
- Frequency response to 15,000 cps.
- Reel size: to 10 1/2" (with RA-1 adapter)

Purchase of a tape recorder is a major investment. And, with so many unproven brands on the market, it simply does not pay to select anything but a recognized, precision built and proven recorder.

The PRESTO RC-7 is just such a unit. Designed and manufactured by the world's foremost producer of precision recording equipment, the RC-7 with RA-1 reel adapter is today's No. 1 buy in fine tape recorders. Here is a unit that is fully portable for field recording, yet with the rugged construction and precision operation characteristic of the finest studio equipment.

If you're planning to replace an existing unit or add an additional tape recorder, your selection of a PRESTO RC-7 will pay long term dividends in faultless service, ease of operation and the genuine satisfaction of owning the best.

Do you own a Presto RC-7? The RA-1 adapter will allow you to use reels up to 10 1/2" diameter. Write for full details and price.



PRESTO RECORDING CORPORATION
PARAMUS, NEW JERSEY

Export Division:
Canadian Division:

25 Warren Street, New York 7, N. Y.
Walter P. Downs, Ltd., Dominion Square Bldg., Montreal

WORLD'S LARGEST MANUFACTURER OF PRECISION

RECORDING EQUIPMENT AND DISCS

WESTON Ruggedized Instruments

have **EXCLUSIVE**
zero correctors

*Ruggedized and Sealed
without any compromise!*

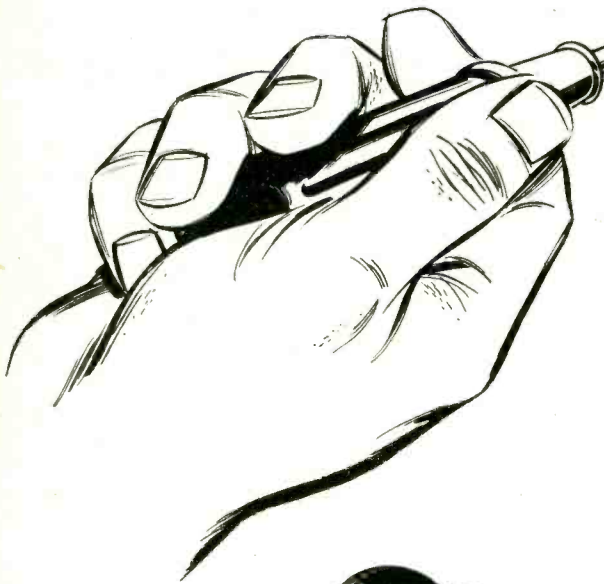
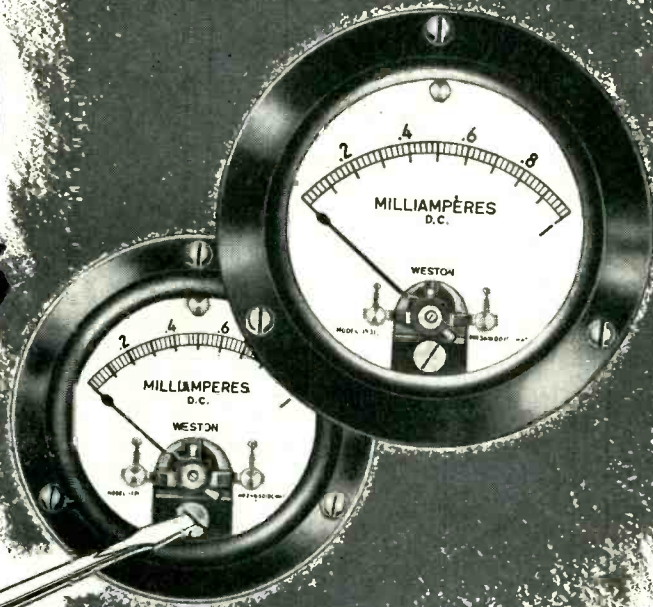

Connection terminals molded
into internal rubber
increase current carrying
capacity.



Tough, flat plastic windows
reduce glare and are
really shock resistant.



No desirable instrument features were sacrificed in order to produce these truly ruggedized and effectively sealed instruments. With typical WESTON thoroughness, every feature has been retained including even the zero corrector. And *true* ruggedness has been achieved by new but thoroughly proved design concepts, such as shock-resistant spring backed jewels . . . flat windows of tough, anti-static, and glare reducing plastic . . . new high-strength tubular pointers, and a method of shock mounting and sealing that assures accurate indications under extremes of shock, vibration, temperatures, humidity, and downright abuse. Available in 2½" and 3½" D-C, R-F, A-C movable iron and rectifier types. WESTON Electrical Instrument Corporation, 614 Frelinghuysen Avenue, Newark 5, New Jersey.

WESTON *Instruments*

DOW CORNING Silicone News

Vol. I, Number 1

PUBLISHED BY DOW CORNING CORPORATION, MIDLAND, MICHIGAN

New Pressure Sensitive Silicone Adhesives Stick To Most Surfaces; Retain Their Excellent Adhesive Strength From -55F To Over 250F

The newest products to come out of our development laboratories are pressure sensitive silicone adhesives that stick to almost any materials including silicones and Teflon. Adhesive strengths in the range of 1800 grams per inch at -55 F and over 1200 grams per inch at 265 F, are far superior to those of conventional pressure sensitive tapes. The adhesive strength between a stainless steel surface and glass tape coated with silicone adhesives is plotted against temperatures ranging from -75 to 285 F in this Figure.

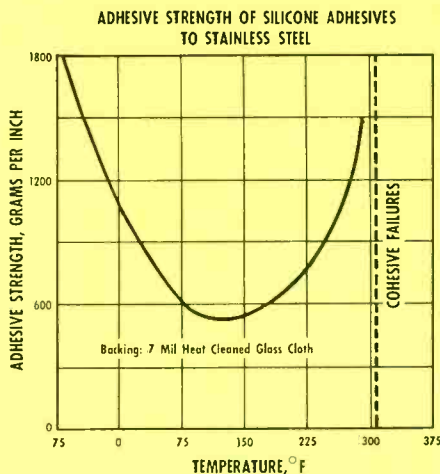

Uses for tapes coated with silicone adhesives include high temperature electrical and electronic applications; weather and moisture resistant wrapping and sealing tapes for low temperature applications. One electrical equipment manufacturer is already using these pressure sensitive adhesives to bond mica matt and integrated mica to glass cloth. No. 1

Silicone-based Aluminum Paints Outlast Organic Finishes 10 to 1 at Sterilizing Temperatures

Trays containing vials of aureomycin and other antibiotics at the Lederle Laboratories Division of American Cyanamid Company are loaded onto racks and sterilized for 3 hours at 446 F to destroy pyrogens.

The organic aluminum finish on these racks began to crack and peel, permitting rust to form, after 9 to 15

(continued page 2)

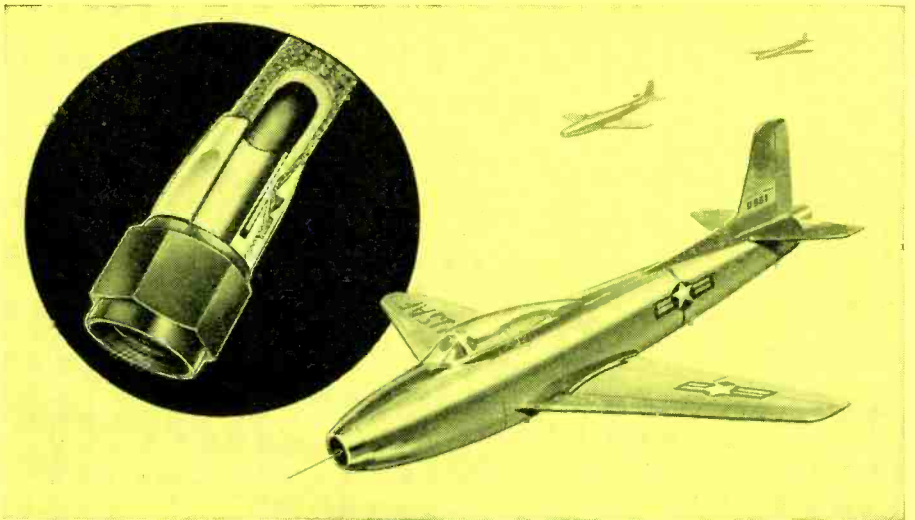

Flexible Silastic* Tubes Carry Air at 500 F; Prevent Engine Failure Due to Icing Over Jet Air Scoops

Reinforced with stainless steel braid, Silastic tubing requires minimum space; endures heat and high frequency vibration.

It was discovered shortly after certain jet engines were put into service that the formation of ice over air intake scoops could choke off the air supply and cause engine failure.

The obvious solution to this problem was to pipe air at 500 F from the compressor to the scoops. But that simple solution involved many problems.

The jet engines were so tightly fitted in their nacelles, that very little room was left for hot air ducts of any kind. High frequency vibration set up by the engine and plane introduced the problem of fatigue failure.

This was a job for a flexible tubing, a tubing that could carry hot air without melting, withstand the vibration and permit fast and easy assembly and disassembly. Engineers of the Aeroquip Corporation of Jackson, Michigan, solved the problem with flexible Silastic tubing. Reinforced with stainless steel braid, Silastic tubing is light and flexible. It is held mechanically to the stainless steel braid so tightly that the tube will not collapse even when subjected to a vacuum.

The high temperature problem of attaching a fitting to the hose was ingeniously solved by the new Aeroquip "Little Gem" fittings. The total assembly proved to be so effective that these anti-icing hoses have become standard equipment.

Despite internal and external temperatures as high as 500 F, the Silastic

hoses are still in excellent condition after hundreds of hours of service. Aeroquip has supplied thousands of them to jet manufacturers. From 5 to 20 are required per engine, depending upon its design.

The usefulness of Silastic in this application confirms data collected by our development engineers on effects of accelerated aging at high temperatures on the properties of Silastic. Heat resistant organic rubber becomes brittle in a few hours; Silastic 80 does not crack on flexing over a 3/8 inch mandrel, and hardness increases only 9 points after more than 670 hours of continuous aging with all surfaces of the test sample exposed in an air circulating oven at 480 F.

Silastic 80 readily meets SAE-ASTM Specification TA805 which requires that it have a minimum tensile strength of 500 psi; a minimum ultimate elongation of 50 percent. After 70 hours aging in an air oven at 450 F, increase in hardness is not more than 15 points; drop in tensile strength is less than 25 percent and loss of ultimate elongation, less than 40 percent.

In oil resistance tests, decrease in hardness is less than 45 points; increase in volume, less than 60 percent after 70 hours immersion in ASTM No. 3 oil at 300 F. After 70 hours immersion in ASTM No. 1 oil at 300 F, loss in tensile strength and ultimate elongation is less than 20 percent; decrease in hardness,

(continued page 2)

FOR DATA RELATING TO THESE ARTICLES, CIRCLE REFERENCE NUMBER IN COUPON ON NEXT PAGE

MORE

NEW DEVELOPMENT AND TECHNICAL DATA

For copies of any of the publications reviewed in this column or for data relating to any of the articles printed in this issue of the Dow Corning Silicone News, simply circle the corresponding reference number on the coupon below.

Expansive resins. Two new silicone resins, Dow Corning XR-543 and XR-544, can be expanded to produce heat-stable, non-flammable, unicellular foams with densities from 8 to 24 lbs per cubic foot. Highly resistant to thermal shock, these silicone foams show practically no structural or dimensional change after 20 hours at 700 F. Weight loss after 220 hours at 570 F is less than 2%; moisture absorption less than 0.05% after 7 days at 96% RH. Resins are easily foamed in place, made up as sandwich structures or machined with wood working tools. **No. 5**

Dow Corning 1109, a durable new silicone water repellent treatment for leather footwear, gloves, luggage and sporting goods; minimizes water absorption and transmission; improves resistance to oils and chemicals without changing the "breathing" characteristics of leather. **No. 6**

Now available, the new 1953-54 Reference Guide to Dow Corning Silicone Products summarizes properties and applications for commercially available silicones. A complete revision of previous guide which some designers have reported to be one of the most helpful catalogs ever produced. **No. 7**

Silastic 6-127 paste, an excellent cloth coating material and bonding agent for silicone rubber, retains good dielectric properties over a wide range of temperatures and frequencies. It has superior resistance to heat and moisture; remains flexible down to -100 F. **No. 8**

"**Tall Tales and Fabulous Facts**" is a new 24 page booklet built around the idea that, in our times, the tallest tales are told in technical terms. In this publication, the tall tales our ancestors told about such legendary characters as Paul Bunyan, Davy Crockett and Pecos Bill are related to some equally fabulous facts about Dow Corning silicone products. **No. 9**

Air drying silicone water repellent for application to glass, plastic and ceramic insulator bodies and to electronic parts and components maintains high surface resistivity under humid conditions; minimizes adhesion of dirt and chemical dust; reduces maintenance. **No. 10**

Small Electric Machines and Electronic Parts Can Now Be Designed to Operate at 180 C.

Life and reliability can be increased, or the size and weight of electronic devices and fractional or miniature motors can be reduced through the use of bare magnet wire insulated with Dow Corning 1360 Wire Enamel

Flexibility, scrape hardness and dielectric strength compare favorably with those of the best organic wire enamels. Dow Corning 1360 coated wire also shows superior resistance to a wide variety of solvents, oils and salt water.

The results to date of the accelerated life testing at temperatures in the range of 200 to 275 C of several electric motors wound according to standard commercial procedures with 1360 coated wire are plotted in the chart at right.

These data show that motors wound with magnet wire insulated with Dow Corning 1360 Wire Enamel have a life in the range of 1500 hours at 225 C (437 F), compared with 30 hours for identical motors wound with the best grade of Class A wire.

Based on the results to date of this motor test program, we expect that the

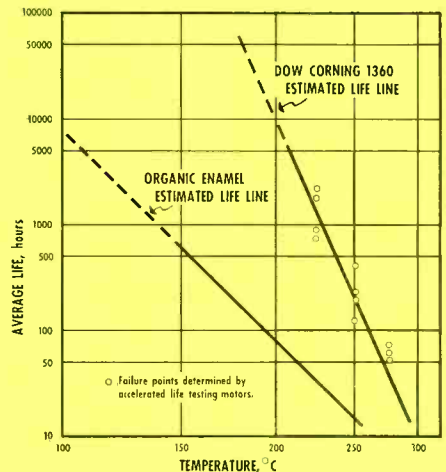

life of machines wound with 1360 coated wire at 180 C will be comparable to that of identical machines wound with conventional Class A wire at their maximum operating temperature of 105 C.

Extrapolating from the data plotted above, we find that the life expectancy at 180 C of magnet wire insulated with this new enamel is in the range of 50,000 hours compared with 200 hours for wire insulated with the best organic enamels. **No. 4**

SILASTIC *continued*

less than 15 points. It shows no shrinkage and swell is less than 20 percent.

After 168 hours immersion in water at 158 F, swell is less than 10 percent and decrease in hardness is less than 10 points. It does not become brittle on continuous exposure at -65 F.

Silastic 80 offers another advantage in that it can be blended with Silastic 50 to fabricate parts having any Shore hardness between 50 and 80. These stocks can be blended to fabricate parts that meet SAE-ASTM Specification TA604. Heat-stable pigments can be used to give these stocks almost any desired color.

In electrical applications such as wire covering and cable coating, Silastic 80 retains excellent dielectric properties over a wide range of temperatures and frequencies. Cable insulated with Silastic 80 has a dielectric strength of 450 volts/mil at 50 C; 430 volts/mil at 250 C. **No. 3**

PAINTS *continued*

hours of such service. That introduced a costly hazard because any bit of rust or paint chips in a tray could cause rejection of a whole rack of carefully prepared antibiotics.

Some time ago, the racks were sand blasted, sprayed with a silicone-based aluminum paint. So far, the silicone finished racks have endured 150 hours at sterilizing temperatures with no sign of deterioration. As a result of that experience, Lederle is now using silicone-based paint to refinish sterilizing equipment throughout their plant.

At temperatures in the range of 500 to 1000 F. silicone-based aluminum finishes are used to protect stacks, exhaust mufflers, dryers, and furnaces. Modified silicone enamels in a wide variety of colors are used to protect appliances such as stoves, space heaters and incinerators at temperatures in the range of 400 to 700 F. **No. 2**

DOW CORNING CORPORATION - Dept. BEI-10
Midland, Michigan

Please send me: 1 2 3 4 5 6 7 8 9 10

NAME _____
COMPANY _____
TITLE _____
CITY _____ ZONE _____ STATE _____



DOW CORNING CORPORATION

First in Silicones

Atlanta
Chicago
Cleveland
Dallas
Detroit
Midland, Michigan
Los Angeles
New York
Washington, D. C.
(Silver Spring, Md.)

Manufacturers of—

- Silicone Fluids
- Silicone Adhesives
- Silicone Release Agents
- Silicone Compounds
- Silicone Greases
- Silicone Water Repellents
- Silicone Bonding Resins
- Silicone Electrical Insulating Varnishes
- Silicone Molding Compounds
- Expansive Silicone Resins
- Silicone Defoamers
- Silastic

In Canada: Fibreglas Canada Ltd., Toronto
In England: Midland Silicones Ltd., London

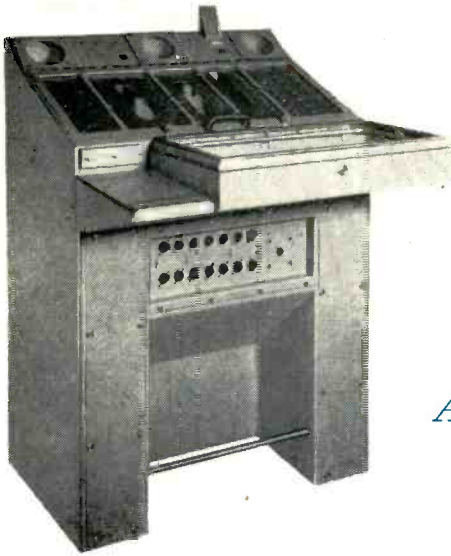

SOME of our customers are equipped to do their own sub-assembly work; others find it more economical to have us do it.

Either way, we deliver the finest in sheet metal cabinets, chassis, housings and enclosures.

If we do your sub-assembly, all that's left for you to do is that which you and you alone must supervise—the wiring, assembly and testing of *your* equipment. The result: faster, cheaper, more efficient assembly.

Another Karp facility—sub-assembly:

the gathering place for extra enclosure-economies

And like our Assembly Department, the entire plant is dedicated to the principle of producing the finest sheet metal cabinets, chassis, housings and enclosures *at the lowest possible price*. How well we live up to the principle is easily proved: simply send us your blueprints. We'll promptly quote prices and delivery.

KARP METAL PRODUCTS CO.

Division of H & B American Machine Company

215 63RD STREET, BROOKLYN 20, N. Y.



FACILITIES FOR ENGINEERED SHEET METAL FABRICATIONS: in aluminum or steel • long run or short • spot, arc, gas or heliarc welding • any type finish.

- Modern plant—3 city blocks long
- Thousands of dies available
- Most modern of sheet metal fabricating equipment
- U. S. Air Force Certified Welding Facilities
- Air-conditioned spray room... complete baking facilities
- Complete sub-assembly facilities

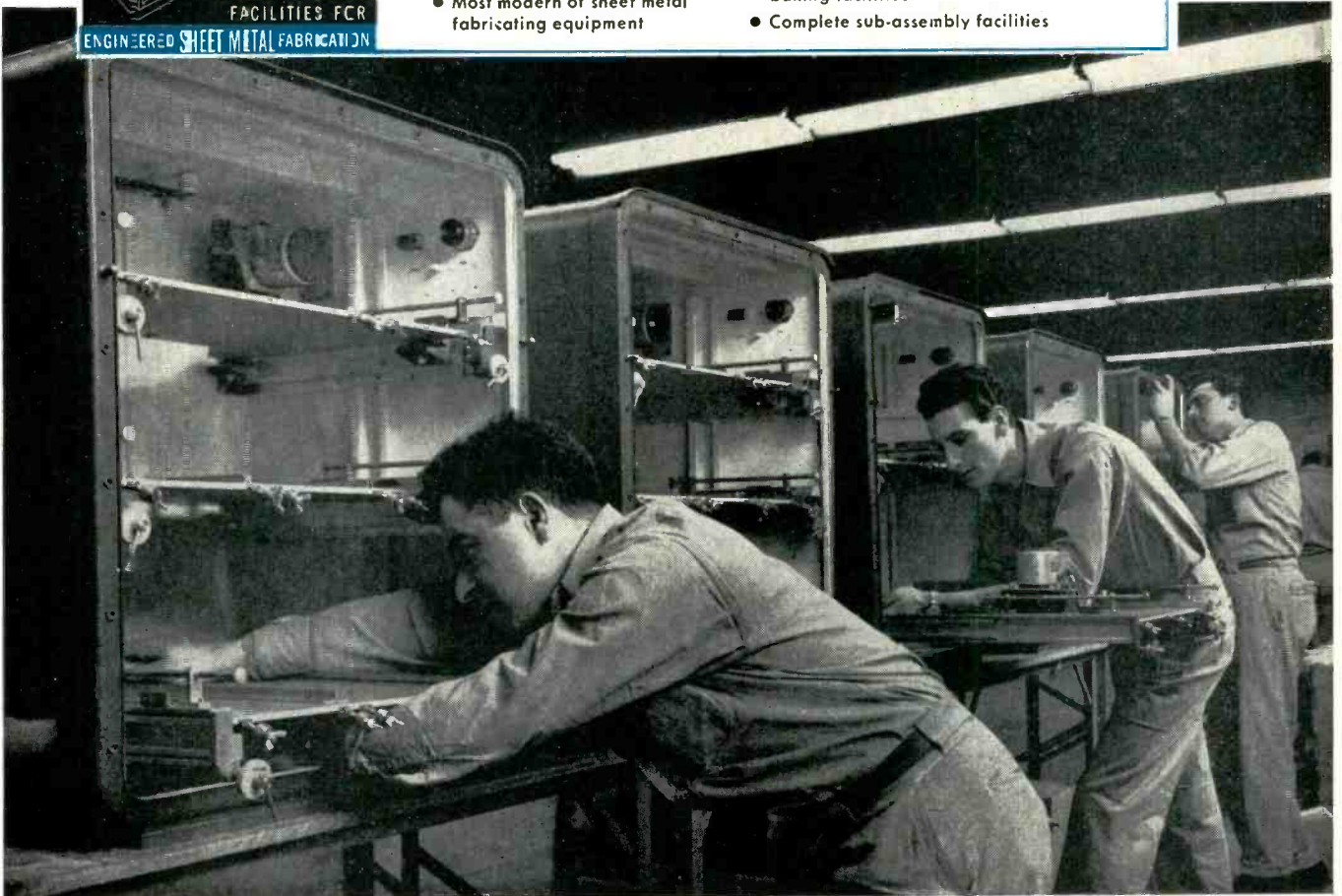



Products of Scientific Research

Products of Pye scientific research cover ever-widening fields of application. Information gained through experiment on each project is constantly used to develop and improve all allied manufactures. Through advances thus achieved Pye lead the world in quality and design of radio, television and telecommunications equipment.



TELEVISION CAMERAS



"REPORTER"
MOBILE V.H.F.
RADIO-TELEPHONE



INFRARED
SPECTROMETER



MULTI-WAVEBAND
RADIO RECEIVER

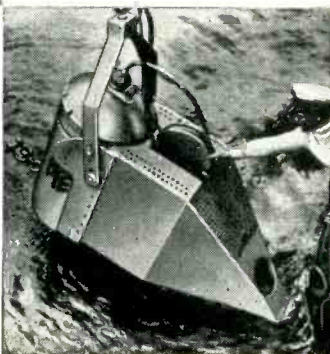

UNDERWATER
TELEVISION
CAMERA



pH METER AND
MILLIVOLTMETER

P Y E L I M I T E D  C A M B R I D G E E N G L A N D

when

and why...

to use Hermetic's New *Vac-tite* Compression Seals *

The following styles of proven VAC-TITE compression seals are available:

1. Individual terminals and feed-throughs with a full range of hooked, flattened and pierced, turret and lug-type terminations for every application.
2. All-glass construction multi-terminal headers featuring larger leakage paths and an absence of moisture pockets.
3. Individually glassed plates available in a multiplicity of standard designs and easily adaptable to special designs in a variety of shapes and sizes for every requirement.
4. Plugs for standard sockets in several mounting types . . . such as octal, 7-pin miniature, noval as well as rectangular shapes.

Write for complete information on how HERMETIC engineers can apply "All-Glass" Compression Seals to your regular or special applications. Available, too, is HERMETIC's Brochure CS on Compression Seals, as well as a 32-page catalog on its standard line.

when vacuum tightness is a requisite, HERMETIC's proven compression seals are guaranteed to be vacuum tight, as evidenced by Mass Spectrometer Test.

when a RUGGED seal is required for application under adverse design conditions, the massive compression construction resists destructive deflection and permits direct mounting of components on the metal body.



H-7007-10



SKA-7017



H-7024

*VAC-TITE is HERMETIC's new vacuum proof compression-construction glass to metal seal. *

HERMETIC SEAL PRODUCTS CO.,

31 South Sixth Street
Newark 7, New Jersey



A "BRAIN CELL" for the IBM "701"

Electronic Calculator by

ERIE

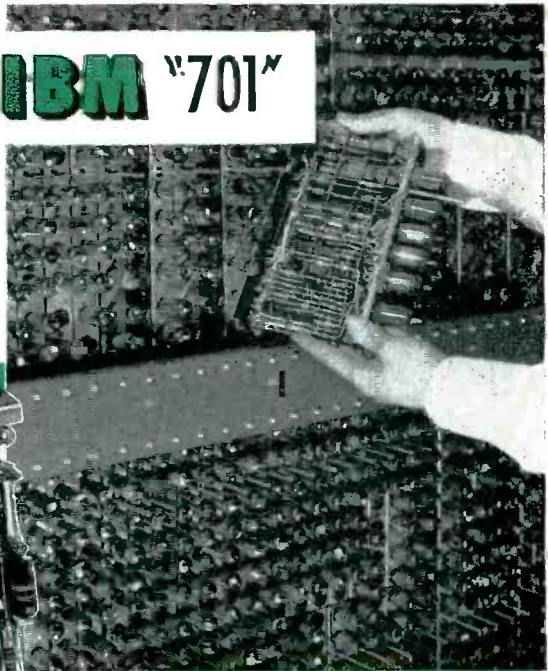
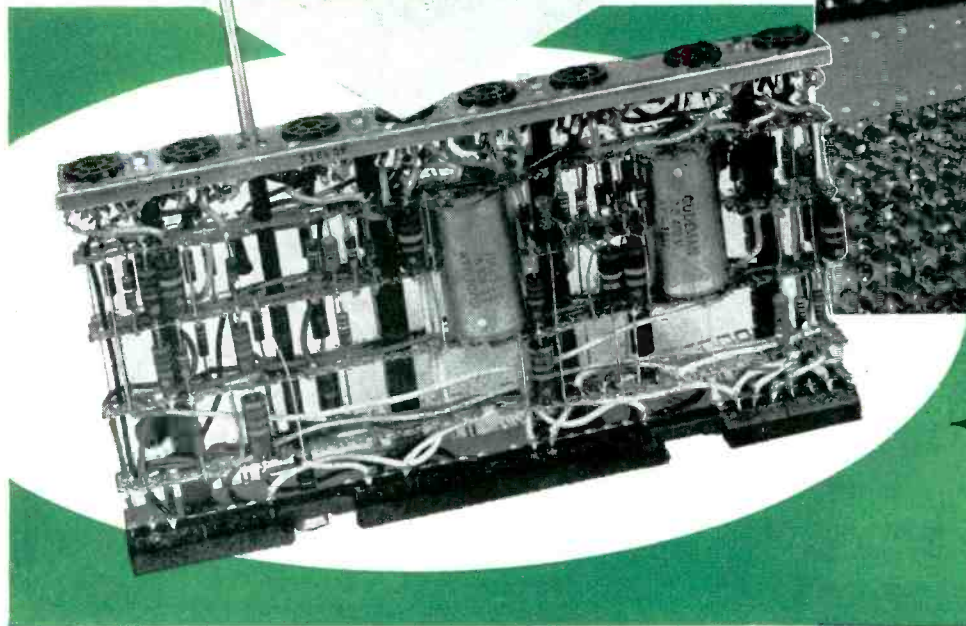

One of the units being installed in the Analytical Control Unit. ↑

← One of the 274 eight tube multiple pluggable units furnished completely wired and assembled by Erie for every "701".

↓ All the disc capacitors shown in this maze of back panel wiring are Erie Ceramicons.

IBM's "701," designed to shatter the time barrier confronting technicians working on vital defense projects, is the latest development in electronic calculators. Its overall speed is 25 times that of its predecessor, the IBM Selective Sequence Electronic Calculator, popularly known as "the electronic brain." The "701," known as the IBM Electronic Data Processing Machines, consists of eleven compact and connected units. It performs in a few minutes calculations which would require seven years for a competent operator using desk model calculating machines.

The actual calculations are performed in the Electronic Analytical Control Unit. Erie assembles and wires 274 different eight tube multiple pluggable units similar to that shown above for every IBM "701." Erie also furnishes the four tube units used in the tape amplifiers. Erie Disc Filter Capacitors are used on inputs of all the DC service voltages supplied to the pluggable units, and all ceramic capacitors in the Power unit are Erie products.

For several years Erie has had in operation a department engaged exclusively in electronic sub-assemblies of this nature.

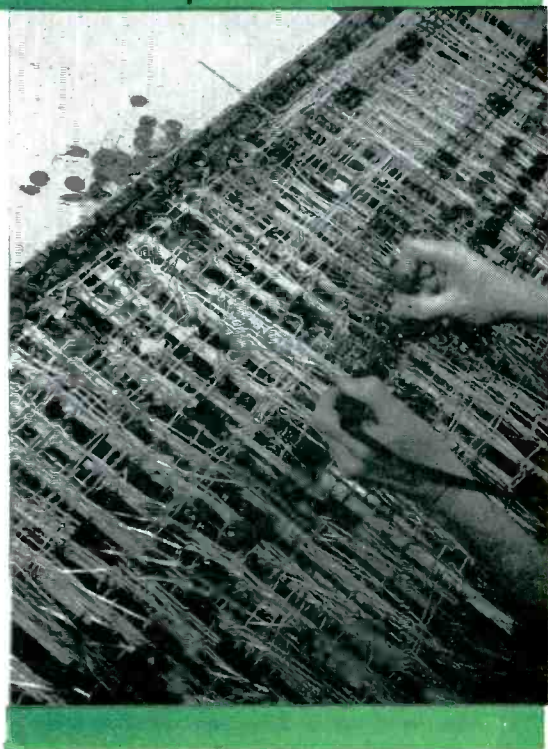

Write for further details.



ERIE RESISTOR CORPORATION . . . ELECTRONICS DIVISION

Main Offices: ERIE, PA.

Sales Offices: Cliffside, N. J. • Philadelphia, Pa. • Buffalo, N. Y. • Chicago, Ill. • Detroit, Mich. • Cincinnati, Ohio • Los Angeles, Calif.

Factories: **ERIE, PA. • LONDON, ENGLAND • TORONTO, CANADA**

when **PRECISION**
frequency control is **VITAL . . .**

NORTHERN RADIO NEW

VARIABLE MASTER OSCILLATOR

- 1 cycle per megacycle stability
- continuously variable to any frequency from 2 to 4 mc.



In addition to accomplishing these new highs in stability with variability, Type 173 Model 1 is so easy to operate that it can be handled by completely unskilled personnel.

It is excellent as the basic control oscillator for diversity receivers, HF transmitters, and other communication devices, or as a laboratory standard. It also provides both a crystal-controlled BFO and a time base 100 kc crystal oscillator as a secondary standard; stability of the latter is 1 part in 5 million.



NORTHERN RADIO COMPANY, inc.
147 WEST 22nd ST., NEW YORK 11, NEW YORK
Pace-Setters in Quality Communication Equipment

Northern Radio has long specialized in the design and construction of Frequency Shift equipment of the types listed below. Their dependable performance for U. S. and Allied Commerce, Governments and Armed Forces all over the world has earned for Northern Radio a reputation for unquestioned leadership in communications engineering and precision manufacture.

Write for complete information.

Frequency Shift Keys
Master Oscillators
Diversity Receivers
Frequency Shift Converters
Multi-Channel Tone Systems
Tone Keys
Demodulators
Radio Multiplex Systems
Monitors
Tone Filters
Line Amplifiers

These Industrial Timer Corporation timers provide accurate and highly dependable instruments for control of a single operation or multiple operations (simultaneously or in sequence).

OUTSTANDING FEATURES ARE:

- (1) the wide range of over-all time cycles obtainable from any one model;
- (2) the ease with which over-all time cycles can be changed;
- (3) the simplicity with which individual cams can be adjusted for ON and OFF periods, and positioned in specific timing sequence.

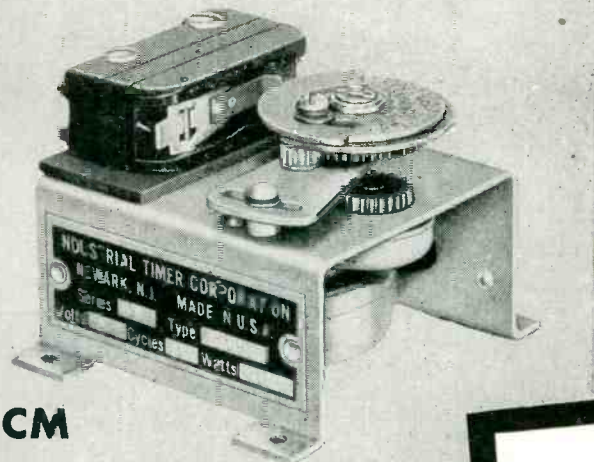

CM

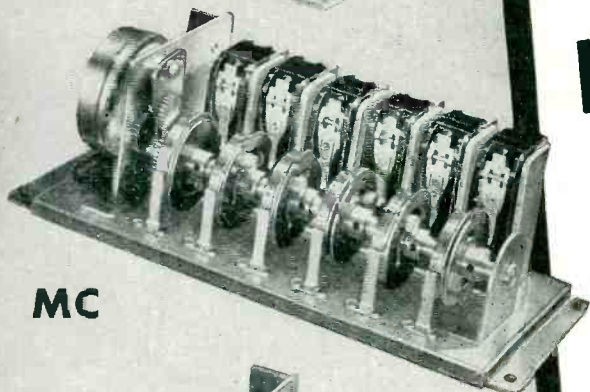

MC

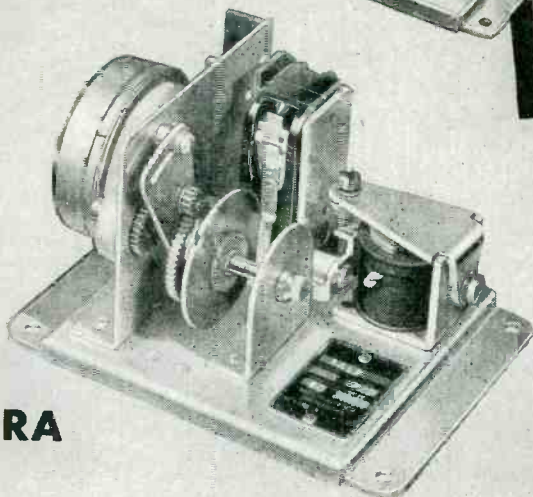

RA

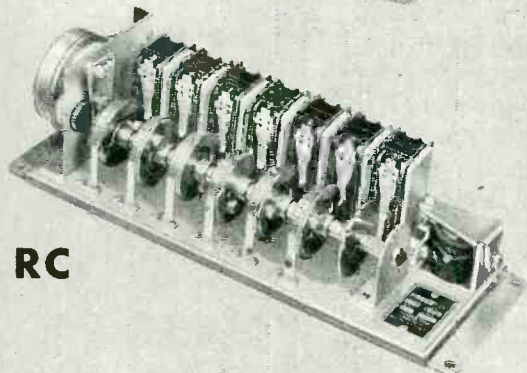

RC

Highly Dependable

Synchronous Motor Driven

Cam Timers

Series CM CAM RECYCLING TIMERS

The Series CM Cam Recycling Timer repeats a definite electrical ON and OFF time cycle continuously. The cam is coupled to the motor by means of a simple gear and rack assembly—and the over-all time cycle can be easily changed by substituting gear racks. (Bulletin 33)

Series MC MULTI-CAM TIMERS

The Series MC Timer is identical to the CM Timer, but operates 2 to 6 circuits. All cams are mounted on a single shaft, which assures a common time cycle for all circuits. Each cam, however, is independently adjustable for a specific timing sequence. (Bulletin 34)

Series RA SINGLE CYCLE CAM TIMERS

The Series RA Timer provides a single time cycle upon being actuated electrically from remote control. A pawl on the cam eliminates necessity for prolonged closing of relay switch when starting. (Bulletin 35)

Series RC SINGLE CYCLE MULTI-CAM TIMERS

The RC is identical to the RA, but operates from 1 to 6 additional circuits. Thus it provides all the features of the Series MC Timer, plus the single cycle control afforded by the RA. (Bulletin 35)

Send us specifications, and we shall make recommendations based on your particular needs. Bulletins sent free on request.

MANUFACTURERS OF THESE AND OTHER TIMERS AND CONTROLS FOR INDUSTRY— Time Delay Timers • Manual Set Timers • Tandem Automatic Recycling Timers • Running Time Meters • Instantaneous Reset Timers

*Timers that Control
the Pulse Beat of Industry*



INDUSTRIAL TIMER CORPORATION
131 OGDEN STREET, NEWARK 4, N. J.

Selenium available today is remarkably free of unwanted impurities. Bradley controls it still further through an exclusive vacuum process. This laboratory control method, applied at Bradley on a production line basis, is further assurance of uniform quality and more stable rectifier performance. You pay no more for this extra quality — frequently, less.

Vacuum Processed Bradley Rectifiers

a plus in your circuit but not in your cost

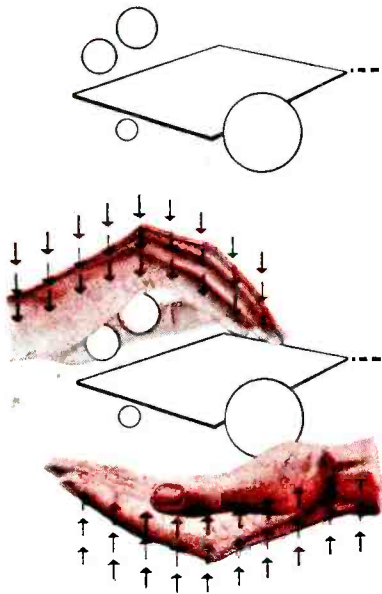

Plates for Bradley rectifiers — from miniature types to large power stacks — have selenium applied under vacuum. Vacuum processing removes undesirable impurities and permits closely controlled modification of selenium with desired "impurities".

Vacuum processing also prevents entry of atmospheric impurities during the crystallization of selenium on the plate — a most critical period. Better crystallization results and this, in turn, means a better rectifier.

RECTIFIER STABILITY, longevity and uniformity are the sum of many things. One determining factor is the quality of the selenium crystalline structure. The better or more closely controlled this structure, the better the rectifier.

Bradley, through its unique vacuum process, uses the most advanced safeguards to assure excellent crystalline structure. It's one big reason why we can rate our rectifiers conservatively, why you can be sure of Bradley stability and long life under operating conditions. Vacuum processing is coupled at Bradley with engineer inspection at all points of production. This laboratory control saves time and materials, which are translated into low unit cost to you. For a plus in your circuit but not in your cost, specify Bradley rectifiers.

For further information or consultation, write or phone our sales engineering department. Special problems are welcomed.

SELENIUM AND COPPER OXIDE RECTIFIERS

SELF-GENERATING PHOTOELECTRIC CELLS

VACUUM PROCESSED for PERFORMANCE AS RATED



The complete selenium rectifier line — from microamperes to thousands of amperes

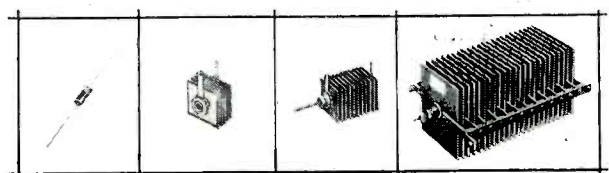

BRADLEY LABORATORIES, INC., 168E Columbus Avenue, New Haven 11, Conn.



DESIGNER'S

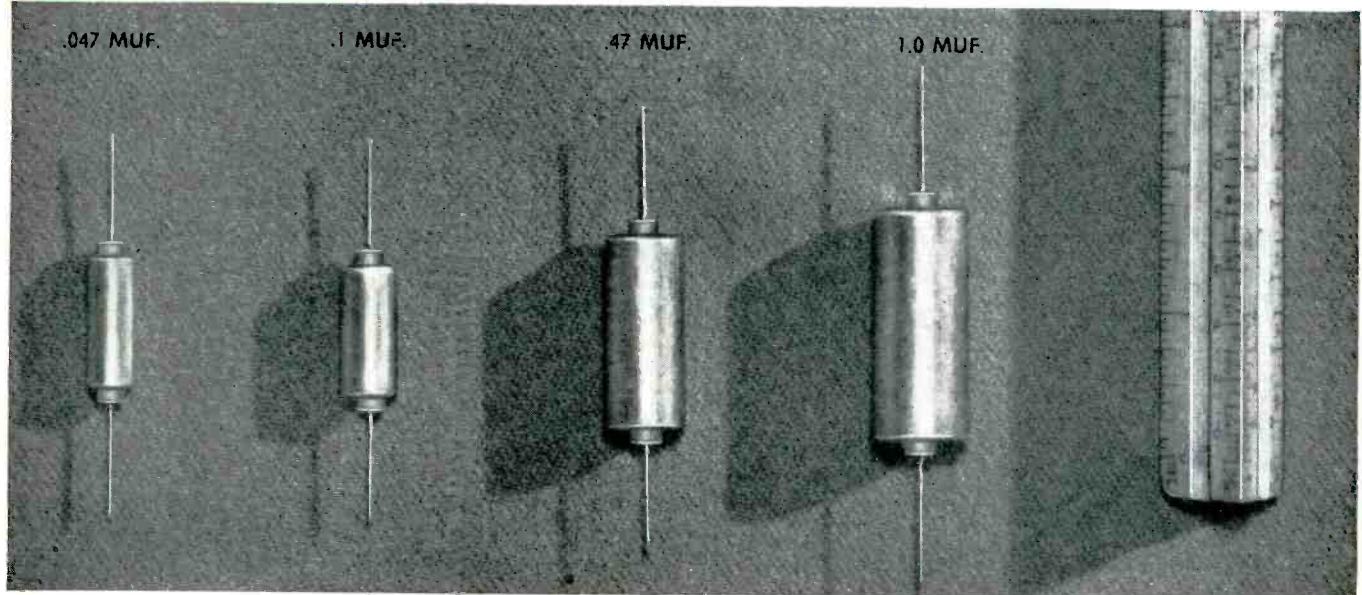

New metal-clad subminiature capacitors withstand extreme temperatures

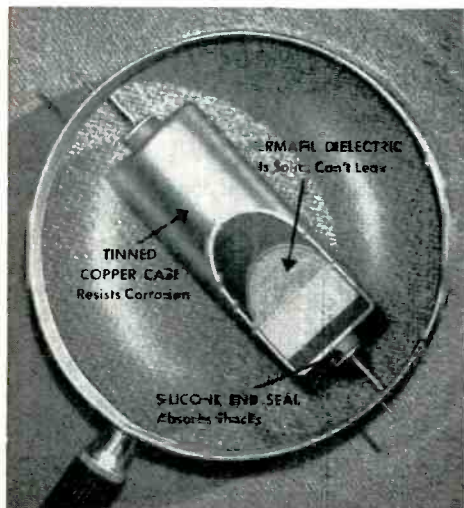

Permafil solid dielectric permits operation up to 125C without derating

Here's a complete new line of General Electric metal-clad subminiature capacitors designed to meet difficult operating conditions. Now you need no increase in capacitor size for applications with high working temperatures.

G.E.'s exclusive permafil solid dielectric eliminates the possibility of leakage without derating from -55C to +125C—and up to +150C with proper derating. Silicone bushings give high shock resistance—both thermal and physical—and leads can be soldered right up to the bushing.

Muf ratings range from .001 to 1.0 muf in 100, 200, 400 and 600 volts d-c working. They can be operated at full voltage up to altitudes of 50,000 feet.

If you need even smaller capacitors, G.E. has introduced another line of new Pyranol* (liquid-filled) metal-clad capacitors. These are designed for operation from -55C to +85C without derating and offer the same electrical advantages as their permafil cousins. For further information on permafil capacitors, send for new Bulletin GEC-987.

RUGGEDLY CONSTRUCTED G-E subminiature metal-clad capacitors meet all requirements of JAN-C-25 and the proposed MIL-C-25.



DIGEST

TIMELY HIGHLIGHTS ON G-E COMPONENTS

Compact high-voltage components built for extra long service life

These G-E high-voltage components offer a continuous-service life for long periods under extreme temperatures and mechanical shocks. All are oil-filled and hermetically sealed to resist moisture, dirt and dust. For applications 5000 volts and higher, where corona must be held to a minimum, a wide range of ratings can be tailored to meet your needs. In your inquiry, please include all functional requirements, any physical limitations, and expected quantities. Contact your G-E Apparatus Sales representative for more information.

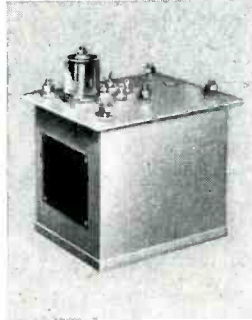

Rectifiers



Reactors



Transformers

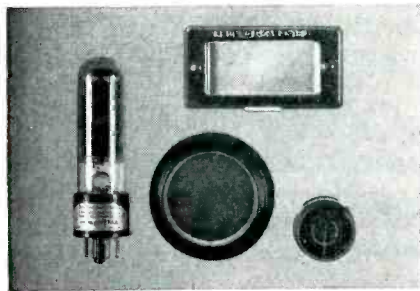

Detects, measures light accurately

G-E photovoltaic cells—for applications where electronic amplifiers are not practical—provide extra-high output with stability and long life in capturing light energy and converting it into electrical energy. This self-generating power plant can detect, measure, and control light—and can measure variations in colors. These G-E cells are available in a hermetically sealed series with standard mountings, and in a wide variety of mounted and unmounted sizes. See Bulletin GEC-690.

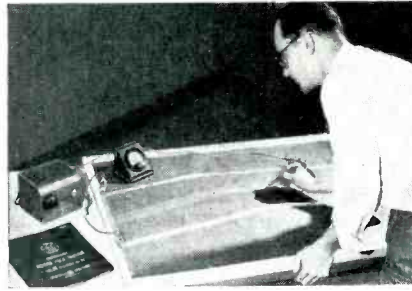

Speeds solution to field problems

The G-E analog field plotter offers a valuable aid to electronics equipment engineers in simplifying complex field studies. Problems in electrostatics, electromagnetics, and many other fields are rapidly solved with this sensitive, versatile plotting board and associated equipment. It needs only a low-voltage d-c supply, and is not affected by line-voltage variations. Explanation and instructions are covered in a 50-page manual accompanying plotter. For details, see Bulletin GEC-851.

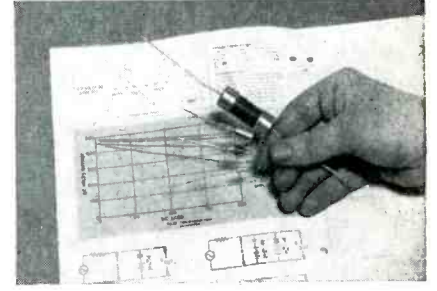

Cover wide temperature range

From -55°C through $+100^{\circ}\text{C}$ —that's the wide range covered by these new G-E miniature selenium rectifiers. Stacks—available for either lead or bracket mounting—have the same outstanding features as larger G-E selenium cells: long life, good regulation, high reverse resistance, and low heat rise. For protection, they are enclosed in either Textolite* tubes, or hermetically sealed in metal-clad casings. For more data, contact your G-E Apparatus Sales representative.



EQUIPMENT FOR ELECTRONICS MANUFACTURERS

Components

Meters, Instruments
Dynamotors
Capacitors
Transformers
Pulse-forming networks
Delay lines
Reactors
Thyrite*
Motor-generator sets
Inductors
Resistors
Voltage stabilizers

Fractional-hp motors
Rectifiers
Timers
Indicating lights
Control switches
Generators
Selsyns
Relays
Amplidynes
Amplistats
Terminal boards
Push buttons
Photovoltaic cells
Glass bushings

*Reg. Trade-mark of General Electric Co.

Development and Production Equipment

Soldering irons
Resistance-welding control
Current-limited high-potential tester
Insulation testers
Vacuum-tube voltmeter
Photoelectric recorder
Demagnetizers

General Electric Company,
Apparatus Sales Division, Section B667-26
Schenectady 5, New York

Please send me the following bulletins:

- for reference
 for immediate project
- GEC-690 Photovoltaic Cells
 GEC-851 Analog Field Plotter
 GEC-987 Permafil Capacitors

Name _____

Company _____

City _____

State _____



Lamson LIFE WITHOUT FASTENERS

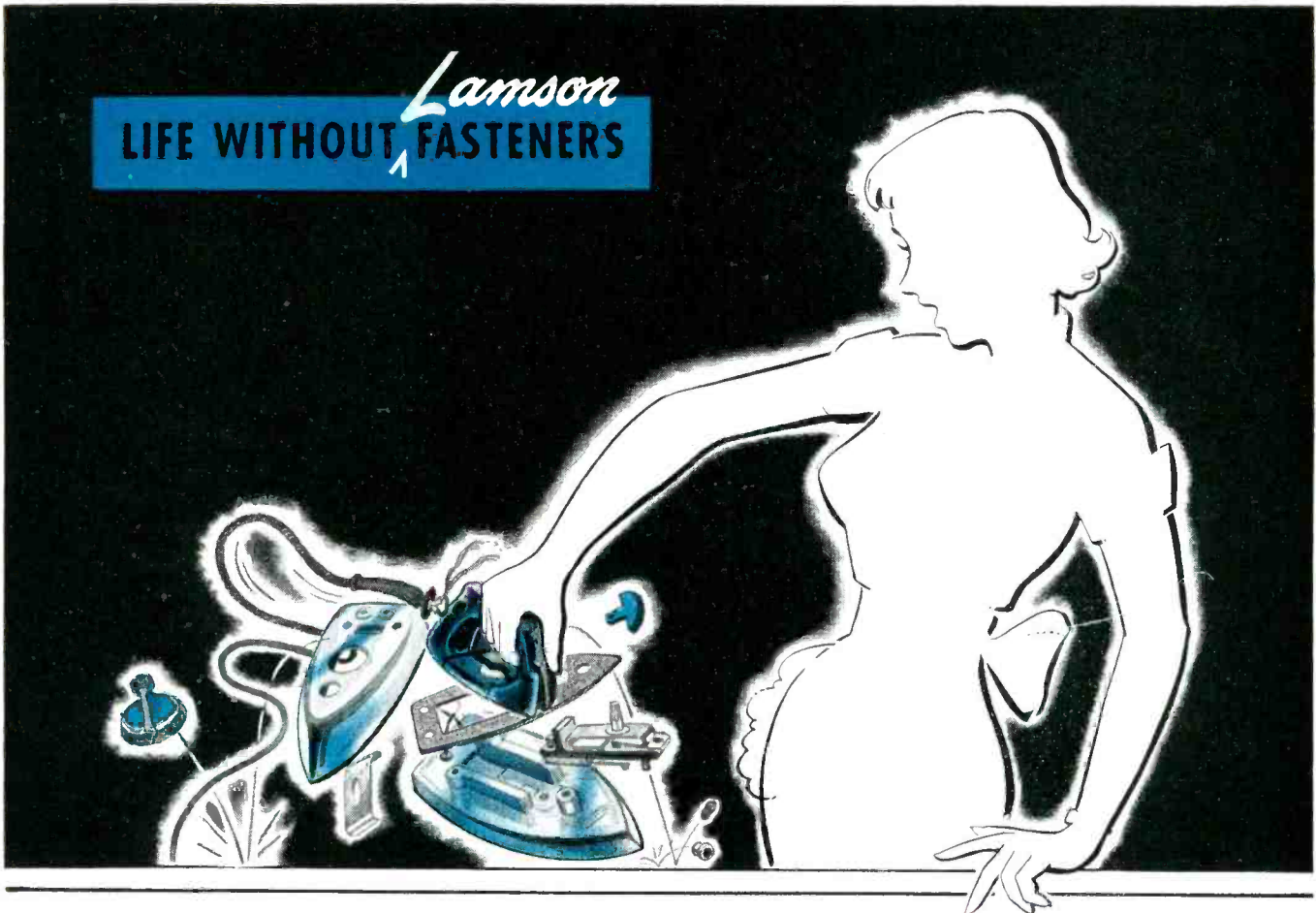

"Scrap" Iron!

This lady has "pressing problems". She's all set to iron but suddenly the fasteners that hold her gleaming new iron together have disappeared. Without them, her beautiful iron is just scrap.

This is graphic proof that the "unseen workmen"—the fasteners that hold your products together ARE important. Without them there is no product.

So take a tip from Lamson and pay attention to the bolts, nuts and screws that go into your prod-

uct. Chances are there are many opportunities for you to save time and money on the assembly line by using more efficient, or less expensive fasteners.

Lamson & Sessions will be happy to help you ferret out these opportunities for saving money on fasteners. Just call on us . . . anytime.



PHILLIPS HEAD SCREWS

Self-aligning and straight-driving features assure you of fast, economical assembly.

Their neat, modern appearance in the finished product show the potential customer the careful attention to detail spent on the product. Sales often "hinge" on just such attention.

Lamson & Sessions

The LAMSON & SESSIONS Co.

1971 West 85th St. • Cleveland 2, Ohio

Plants at Cleveland and Kent, Ohio • Birmingham • Chicago

FOR PROMPT DELIVERY AND HELPFUL SERVICE,
ORDER FROM YOUR LAMSON DISTRIBUTOR



MACHINE SCREWS

Precision made for fast, economical assembly.



PLUG NUTS

Ideal for blind or hard-to-reach places.



TAPPING SCREWS

Choice of round, pan, truss, flat oval, hexagon and Phillips heads.



CAP SCREWS

"1035" Hi-Tensile Heat-treated steel.



SQUARE AND HEX MACHINE SCREW NUTS

Also semi-finished, hot pressed and cold punched nuts.



LOCK NUTS

Economical, vibration proof. Can be used repeatedly.



COTTER PINS

Steel, brass, aluminum and stainless steel.



"1035" SET SCREWS

Cup point type, hardened and heat-treated.

Wide Selection of Material is Imperative to Lowest Cost Paper Tube Production

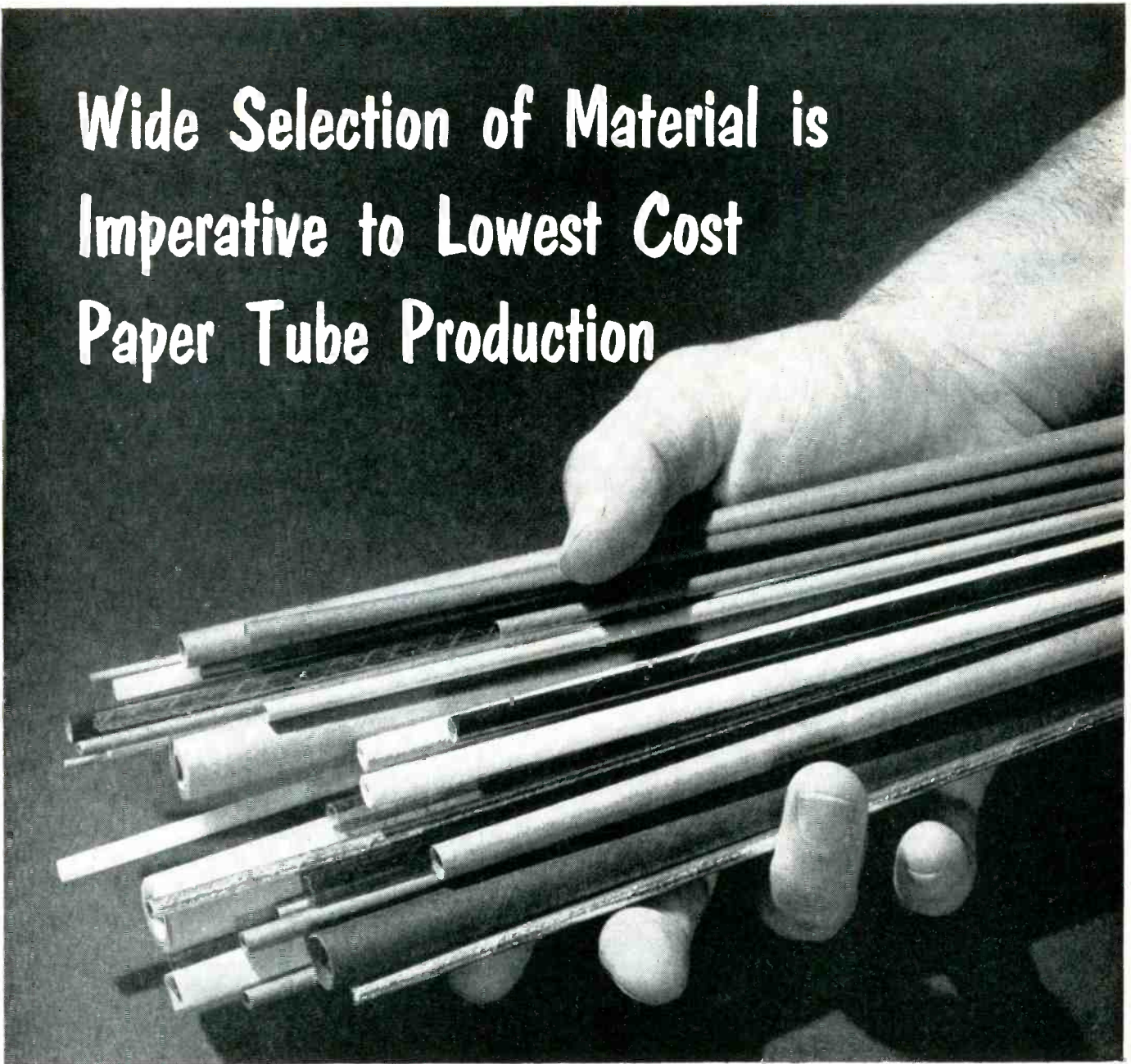

Actual size photograph unretouched

Stone has more than 200 kinds, grades and thicknesses of materials available for the production of your small diameter paper tubes.

This wide selection means that Stone spiral wound paper tubes have a flexibility of application not found in other more standardized materials. Naturally, this results in the lowest possible cost to you.

Included in this extensive selection of more than 200 stocked by Stone for immediate production are numerous grades of hi-c electric kraft, fish paper, absorbent papers, asbestos, and plastic films such as acetates and polystyrenes.

Stone's well known precision production methods guarantee that these materials will meet your most rigid specifications. Call or write us today for prompt attention.

STONE PAPER TUBE COMPANY, INCORPORATED **STONIZED PRODUCTS COMPANY, INC.**

900-922 Franklin Street, N. E., Washington 17, D. C.

MEPCO

PRECISION RESISTORS

MIL-R-93A NEW SEALED TYPES

Over 2 years of laboratory development and testing were required to achieve a sealed resistor design up to Mepco's standard of quality. No sacrifice of our standard time-proven features has been made in order to perfect this sealed resistor.

Completely hermetically sealed, these resistors provide perfect protection against immersion and high humidity.

All requirements of MIL-R-93A and JAN-R-93 are exceeded.

The operating temperature is -65°C to $+125^{\circ}\text{C}$. Temperature coefficients of $\pm .003\% / ^{\circ}\text{C}$ to $\pm .017\% / ^{\circ}\text{C}$ depending upon your requirements. (Refer to MIL-R-93A).

Other sizes available on special order.

MIL-R-93A JAN-R-93 STANDARD TYPES

Our standard time proven JAN, MIL and Commercial lug terminal resistor.

Manufactured and 100% tested in accordance with the applicable specifications, these resistors are used by every major electronic equipment manufacturer in the country.

Reversed and balanced PI-windings for low inductance, with use of only the finest resistance alloys.

Impregnated with approval fungus, moisture and salt waterproofing compounds.

JAN approved non-hygroscopic steatite bobbin, specially treated prior to winding in order to provide additional protection for fine enameled wire.

Protective fungi resistant acetate label.

Rigid hot solder coated brass terminals for easier soldering.

WIRE TERMINAL TYPES

Designed for direct connection into circuit without use of additional leads.

These resistors are of the same basic construction and materials as standard JAN and MIL types therefore providing equal dependability and long life.

Low Temperature Coefficient alloys provide $\pm .003\% / ^{\circ}\text{C}$ from -65°C to $+125^{\circ}\text{C}$ unless otherwise specified by your requirements.

Resistance tolerances range from $\pm 1\%$ down to $\pm .02\%$. Sets of matched resistors can be supplied $\pm .005\%$ or lower.

Special types not shown can be manufactured to your exact specifications.

JAN-R-29 METER MULTIPLIERS

Surpass all requirements of JAN-R-29

HERMETICALLY SEALED: Insures dependable operation under most severe moisture conditions.

STEATITE PROTECTIVE CASING: Glazed surface prevents high voltage leakage.

WINDINGS: "Certified" low temperature coefficient resistance alloys properly "aged" to provide long term stability.

REPLACEABLE INTERNAL SECTIONS: Eliminate complete loss of unit if damaged.

FERRULE TERMINALS: Heavy nickel plated brass. Corrosive resistant. Fit standard fuse clips.

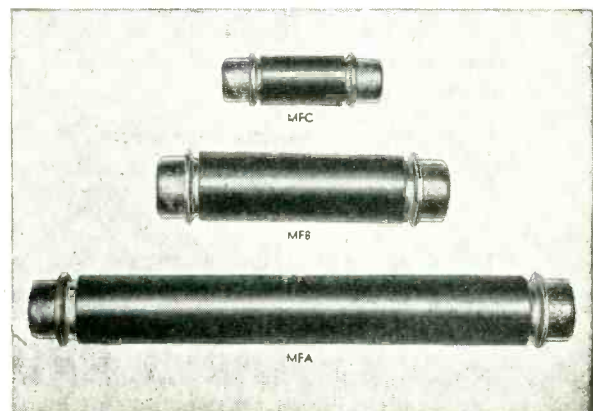
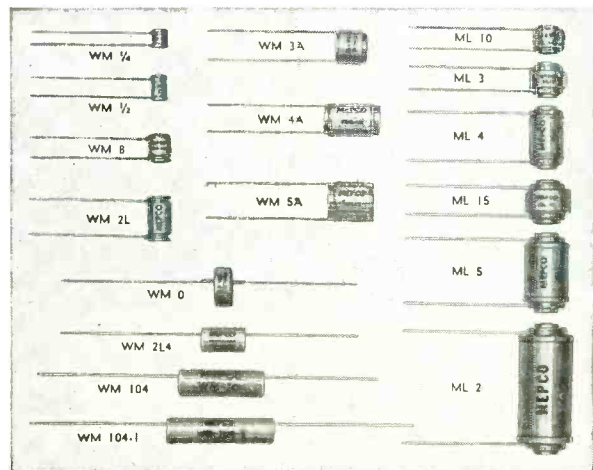
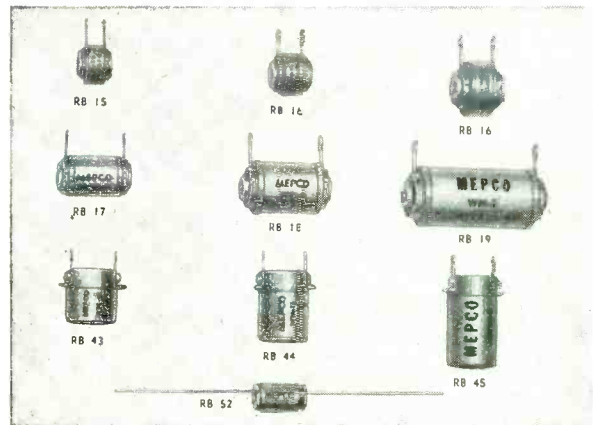
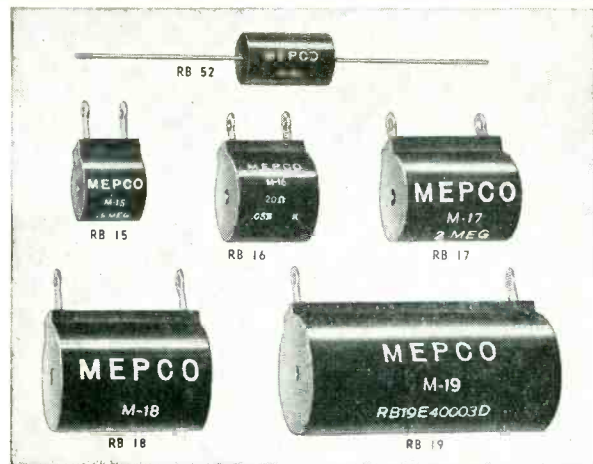

MEPCO, INC. MORRISTOWN, N. J.

class **h** insulation
 by National
 Vulcanized
 Fibre Co.

used by Pennsylvania
 Transformer Co. to build
 new, safe, and reliable Sealed
 Dry Type Transformers

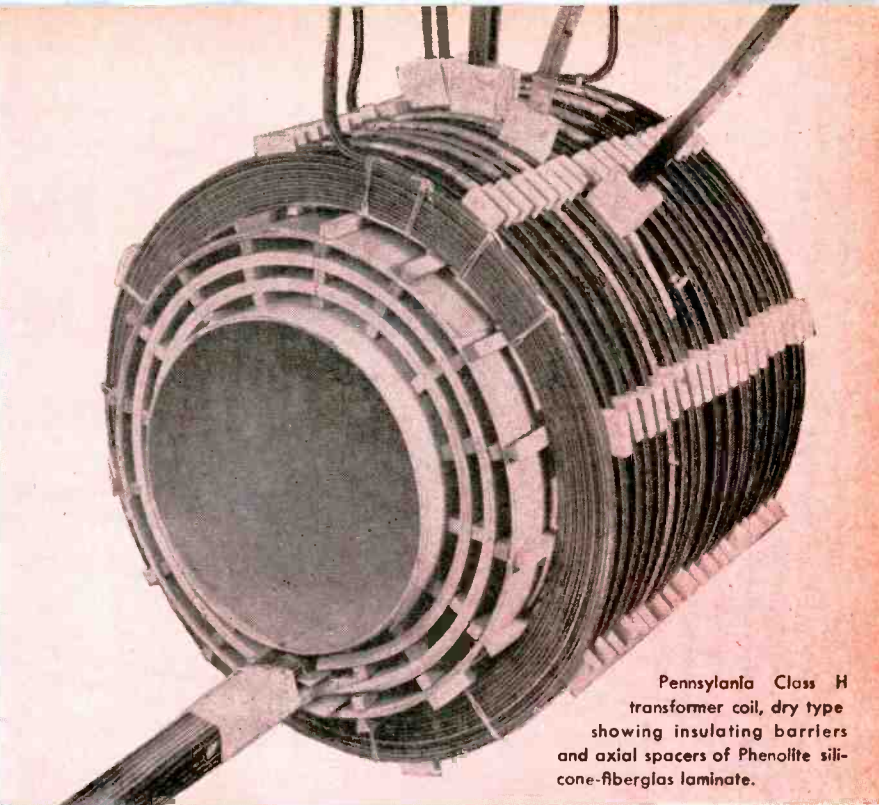

Pennsylvania Class H transformer coil, dry type showing insulating barriers and axial spacers of Phenolite silicone-fiberglass laminate.

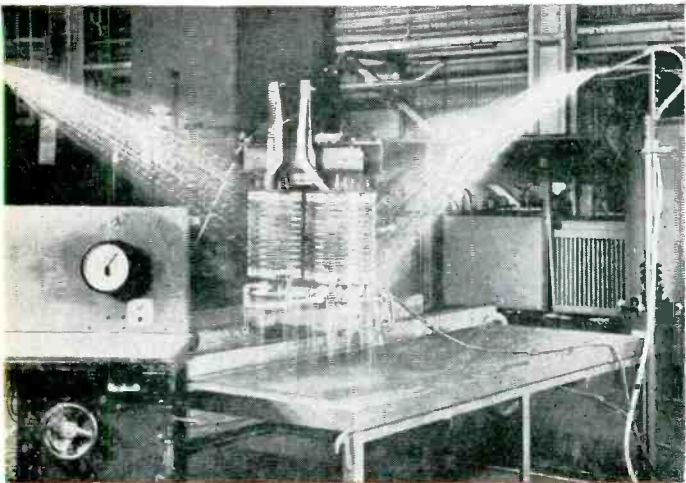

Transformers and coil assembly under full voltage excitation withstands heavy water shower. The insulation resistance remains at infinity megohms during the entire two-hour water test.

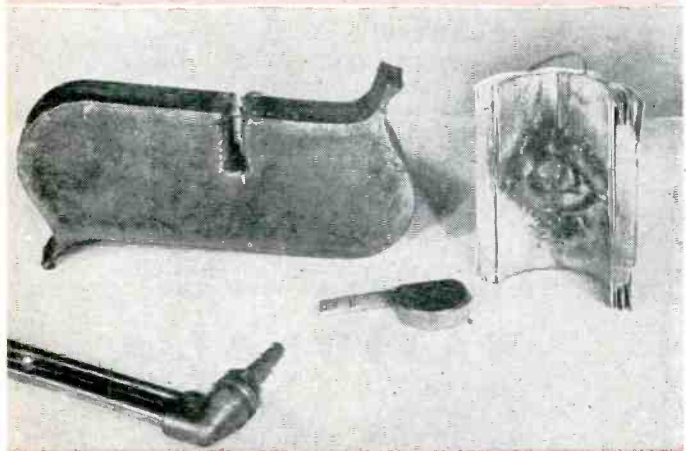

Class H insulation resists fire and combustion. The heat of the 5000° F. Oxygen-Acetylene torch, applied for the same interval, burned through the 2-inch steel plate, yet merely melted some of the glass fabric in the barrier.

Using Class H insulation (Phenolite silicone-fiberglass laminate), the Pennsylvania Transformer Company (a McGraw Electric Co. Division) builds Sealed Dry Type Transformers having many superior and safe operation features. The Class H Insulation eliminates the hazards of fire and explosion, permits up to 50 per cent weight reduction, makes possible efficient operation in humid atmosphere, reduces maintenance, allows operation at high temperatures, and permits frequent overloads. The coil barriers are made from 1/32 inch silicone sheets bonded with silicone rubber. The sheets are rolled directly onto the lathe during the coil winding operation, saving the high cost of a mandrel. Ideal for station auxiliary, unit substation and network service, these Sealed Dry Type Transformers are an outstanding example of National cooperative engineering and research. Perhaps you have an insulating problem where National Vulcanized Fibre Company can give you real help in solving your particular problem . . . economically. Write us—our engineering service is immediately available.

*National laminated plastics
 nationally known—nationally accepted*

**NATIONAL
 VULCANIZED
 FIBRE**

PHENOLITE
 Laminated PLASTIC

NATIONAL VULCANIZED FIBRE COMPANY
 Wilmington, Delaware



Offices in
 Principal
 Cities

Since 1873

Now— Moldite Dependability in all 3!

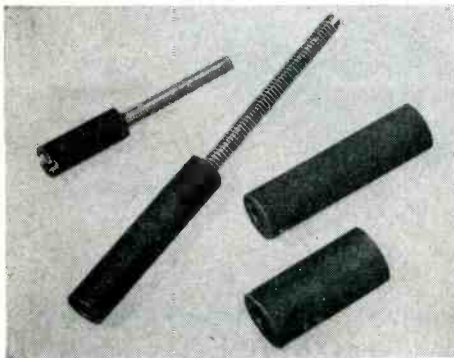

FERRICORES

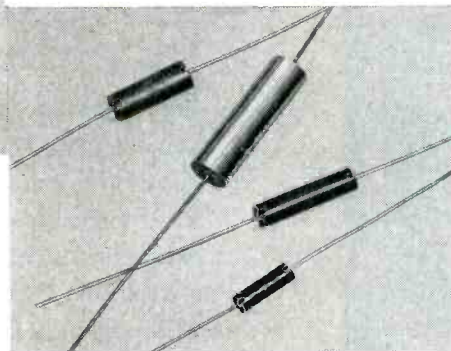

MOLDED COIL FORMS

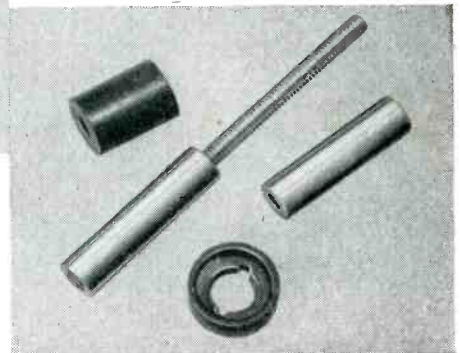

MAGNETIC IRON CORES

Moldite's famed precision production facilities are now devoted to 3 major types of electronic components —to give the industry a superlative core or coil form for every electronic application.

Through years of continued engineering and research Moldite has produced cores of guaranteed dependability, economy, quality and uniformity. Our customers' smooth running production lines tell the story best.

Specify a Moldite core specially designed and precision made for you, with absolute uniformity from first to last.



... Send for our new
Catalog No. 110 —
THE MOST COMPLETE
LINE OF CORES
IN THE INDUSTRY!

- FERRITE CORES
- MOLDED COIL FORMS
(iron and phenolic)
- MAGNETIC IRON CORES
- FILTER CORES
- THREADED CORES
- SLEEVE CORES
- CUP CORES

Samples promptly submitted upon request for design, pre-production, and test purposes

NATIONAL
MOLDITE
COMPANY
1410 CHESTNUT AVE., HILLSIDE 5, N. J.

Robert T. Murray 614 Central Ave. East Orange, N.J.	Jerry Golten Co. 2750 W. North Ave. Chicago 22, Ill.	Martin P. Andrews Mott Road Fayetteville, N. Y.	Perlmuth-Coleman & Assoc. 1335 South Flower Los Angeles, Cal	Jose Luis Ponte Cardoba 1472 Buenos Aires
-----------------------------------------------------------	------------------------------------------------------------	-------------------------------------------------------	--------------------------------------------------------------------	-------------------------------------------------

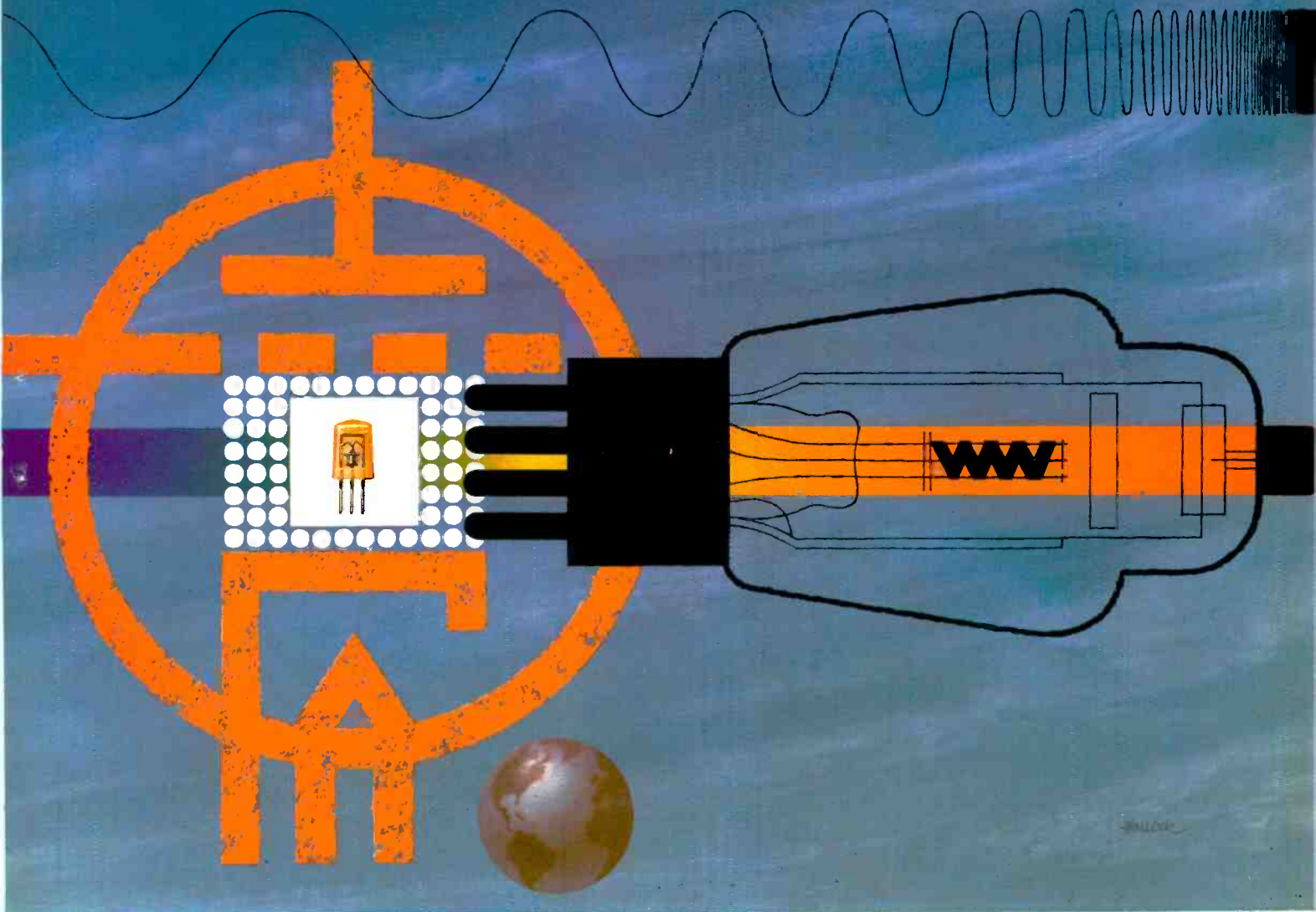

Electronics . . . and The National City Bank of New York

Midget electronic marvel is making science-fiction stories come true

A tiny electronic device called the transistor has brought the magical world of robots much nearer than most people realize. No bigger than half a pea, this electronic marvel may make it practical for mechanical brains to run factories, operate inventory and warehouse control systems, read utility meters, make out bills, and perform other equally amazing feats.

The transistor does about the same work as a vacuum tube. But it takes up much less space, uses much

less power, generates almost no heat, and lasts almost indefinitely. Consequently, it holds out the promise of smaller, lighter, more durable designs in electronic equipment like radio and television sets. It also extends the electronics frontier tremendously.

How rapidly that frontier has already been expanding may be gleaned from the fact that in 1952 total production of electronic equipment totaled about \$200 million. Last year production was over \$4.5 billion, and the total could reach more than \$5 billion this year.

Like fast-growing companies in other fields, electronics manufacturers have found National City's \$2 billion in resources, 141 years of

experience, and world-wide banking facilities invaluable. Facilities include 57 Branches overseas, and correspondent banks in every commercially important city of the world. In this country, National City has correspondent banks in every state and 68 Branches in Greater New York. For help in solving your banking or financial problems, large or small, write

The National City Bank of New York, 55 Wall Street, New York City.

Member Federal Deposit Insurance Corporation

First in World Wide Banking

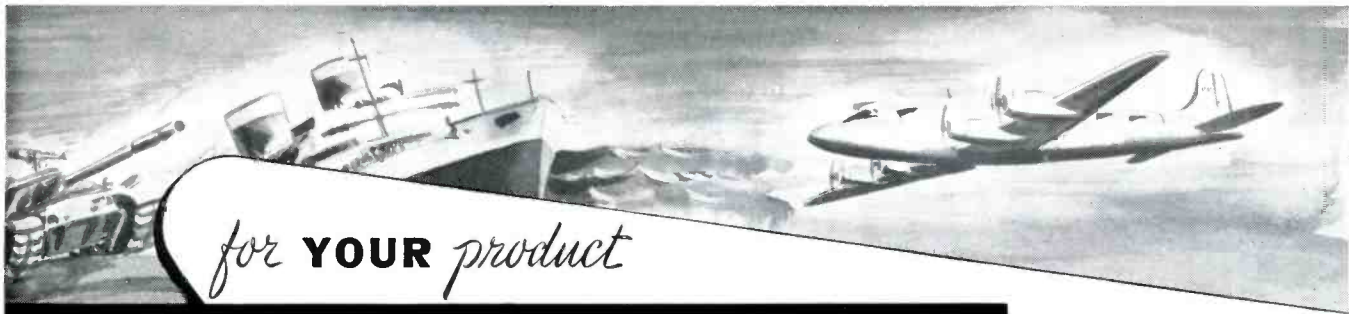

WHICH PILOT LIGHT DO YOU NEED?



THE BIG ONE

This Pilot Light Assembly was first made to accommodate the *S-11 lamp* and was intended for use in the cabs of great diesel locomotives.



ACTUAL SIZE
Cat. #613529-211

Dialco HAS THE COMPLETE LINE OF INDICATOR and PANEL LIGHTS

This **BIG** one

or

this **LITTLE** one

THE LITTLE ONE

The miniaturization program on defense products required the development of this *sub-miniature* light. It is used on communication equipment and aircraft. Midget flanged base bulbs to fit are rated 1.3, 6, 12, and 28 volts.



ACTUAL SIZE
Cat. #8-1930-621

Samples

to suit your own special conditions and requirements will be sent promptly and *without cost*. Just outline your needs. Let our engineering department assist in selecting the *right lamp* and the *best pilot light* for YOU.



Write for the Dialco HANDBOOK of PILOT LIGHTS

Foremost Manufacturer of Pilot Lights

DIALIGHT CORPORATION

60 STEWART AVE., BROOKLYN 37, N. Y.

HYACINTH 7-7600

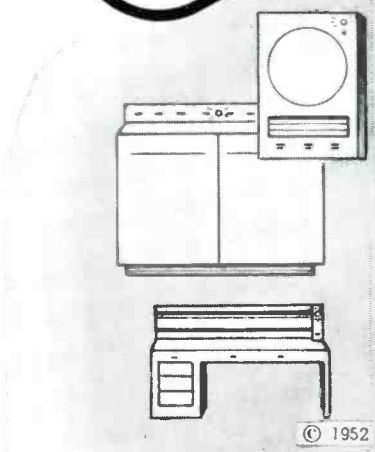

© 1952

Want more information? Use post card on last page.

* 4 WAYS to help speed defense production

You'll find SHAKEPROOF fastenings at many vital connection points on modern military equipment . . . from tanks to walkie-talkies. Those shown here, and hundreds of others, are used by the millions by leading manufacturers because they save assembly time and assure dependable performance. Whether your plant is engaged in military or civilian production—or both—Shakeproof engineers are at your service to help your staff develop fast, economical and acceptable solutions to specific assembly problems. Call them in today.

SHAKEPROOF®



"Fastening Headquarters"

DIVISION OF ILLINOIS TOOL WORKS
St. Charles Road, Elgin, Illinois • Offices in principal cities
In Canada: Canada Illinois Tools Limited, Toronto, Ontario

America's Great Resources Plus A Free Economy Made This Business Possible!

Free... TESTING SAMPLES

Samples of the Shakeproof products illustrated here are available on request. Make your own tests and see how you can save. Write today . . . specify the samples you want by name.

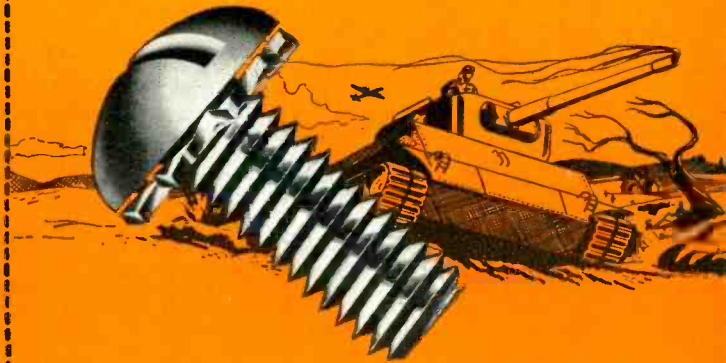

* SEMS-by-SHAKEPROOF

... pre-assembled screws and SHAKEPROOF Lock Washers eliminate separate washer handling, save assembly time.

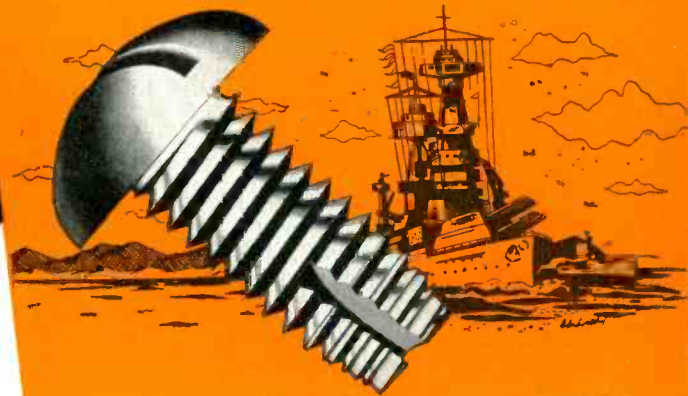

* SHAKEPROOF® THREAD-CUTTING SCREWS

... cut their own threads in metal or plastic, positively eliminate costly tapping operations.



* SHAKEPROOF® LOCK WASHERS

... hold vital connections tight, reduce equipment failures due to loose fastenings.



* KEPS®

... speed assembly operations because nut and lock washer are pre-assembled . . . every nut is locked against vibration loosening.

Transistors*

in instrumentation...

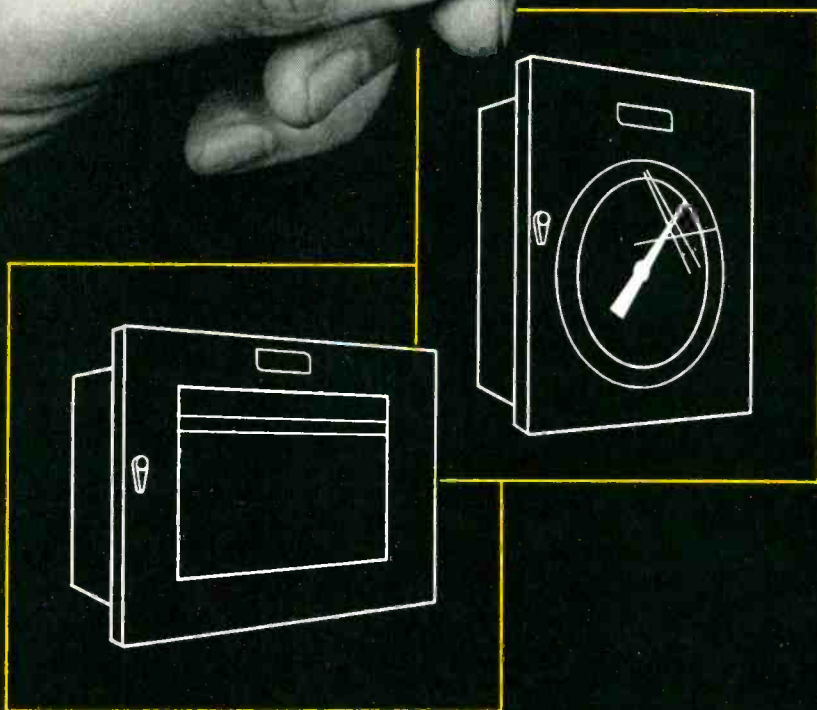
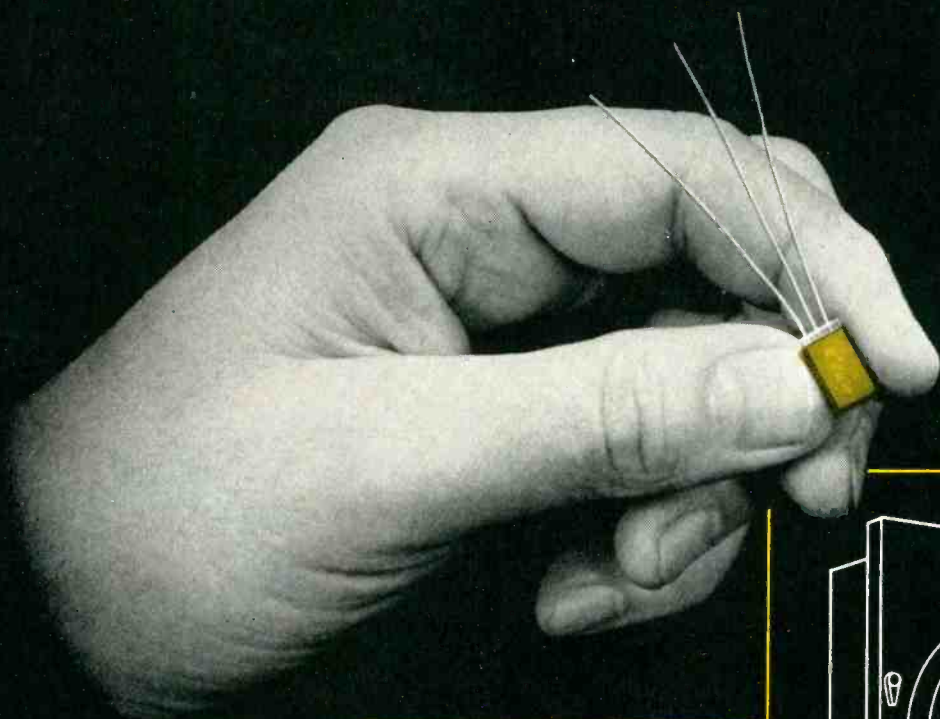

*Transistors are capsule-size assemblies which utilize the physics of semi-conducting solids to produce the same effects as an electronic tube ... but without cathode and/or filament and their circuitry components.

When ?

*A timely statement from Walter P. Wills,
Director of Research, Brown Instruments Division
Minneapolis-Honeywell Regulator Co., Philadelphia 44, Pa.*

"**P**ERHAPS you've wondered when transistors, with their widely publicized characteristics, will be put to work in industrial instrumentation. Naturally, I can speak only for my company, but I'd like to give you a research man's view on where transistors stand today.

"We agree that transistors have a tremendous future in all of electronics, including automatic control. Many problems, however, must yet be solved. Will they be made of germanium or silicon? Can they be made more reproducible and able to handle enough power at desired voltages? New circuits and new transistor types are needed. Today's costs are much too high. And let's not forget that the vacuum tube is still being developed after more than 40 years of existence.

"Even with extensive research and development programs, much more work remains before transistors can be broadly utilized in their natural markets—radio, television, and other communication equipment. Similarly, the few types now available do not nearly satisfy the requirements of industrial instrumentation.

"A 'tubeless' electronic instrument is theo-

retically possible today, and, on the basis of safety and reliability expected of modern instruments, it is anticipated that such a product is completely possible and practical in the future.

"So we're attacking the problem on a broad front. For upwards of five years, we've been devoting a large portion of our research facilities to studying ways to utilize transistors . . . looking on them not solely as replacements for tubes, but as the starting point for totally new instrument circuits.

"In addition, we have invested in the patent licenses and the know-how of Bell Telephone Laboratories, the pioneer of transistors. We have a large stake in providing instrumentation for the manufacture of transistors and hence are examining all facets of the transistor business . . . even to the extent of making some with our own hands.

"Honeywell instruments and other Honeywell controls using transistors will be on the market. When they are, you can be sure they will be great products—new, but the same kind of reliable, versatile, well-engineered products we sell today."



MINNEAPOLIS
Honeywell
BROWN INSTRUMENTS

First in Controls

"O.K. But what's your price for performance?"



Here's a purchasing agent buying resistors on a price basis. But doing it the *right* way.

Some day we may even be able to quote resistor prices in terms of performance — so many cents per thousand hours of trouble-free operation. Then we'll be able to tell you exactly how much *less* Ward Leonard resistors really cost than the so-called "bargain" resistors now on the market.

But until then, remember, it's *performance* you pay for when you're buying resistors. There's a lot more than just a few cents difference in the performance you'll get from the two resistors above.

The one made by Ward Leonard will perform at

its rated value for the life of the product it goes into. There's a chance the so-called "bargain" resistor will too. But you can't afford to take *any* chances on your product's failure — even once out of a hundred times. Not when you consider the actual cost of such failure, figured in terms of returned merchandise, replacement cost, customer and dealer dissatisfaction.

That's why, even on a price basis, the accuracy, dependability and uniformity of Ward Leonard resistors make them far better buys than any of the questionable bargains you'll find on the market. Send for *new* Resistor Catalog No. 15. Ward Leonard Electric Co., 31 South Street, Mount Vernon, N. Y.

3 • 18



WARD LEONARD ELECTRIC COMPANY

MOUNT VERNON, NEW YORK

Result-Engineered Controls Since 1892

This check list shows you how to get the most for your money in terms of resistor performance

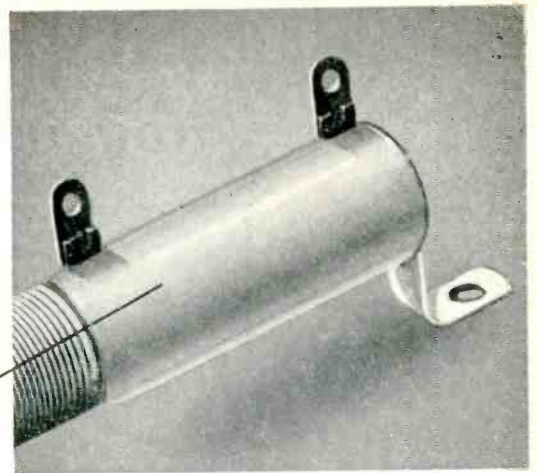
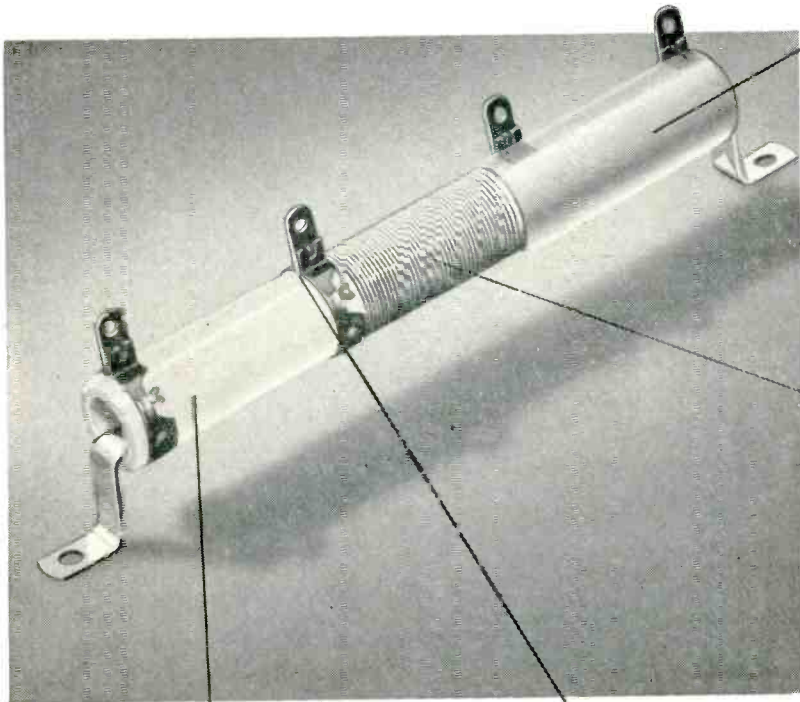

COATING. Vitrohm enamel coating of all Ward Leonard resistors provides a complete hermetic seal highly resistant to shock, high humidity, extreme temperatures, acids, alkalies, and electrolysis. Unlike most resistor manufacturers, we manufacture our own vitreous enamel.

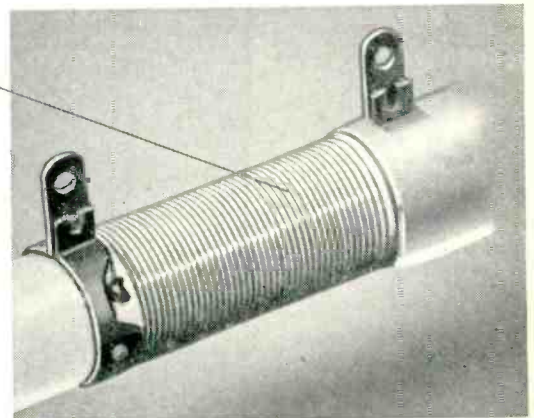

RESISTANCE WIRE. The resistance wire is drawn to Ward Leonard's own specifications for each particular resistor type. It is capable of withstanding heavy overloads, has a uniformly low coefficient of resistivity. Many of the "bargain" resistors are wound with resistance wire of ordinary grade.

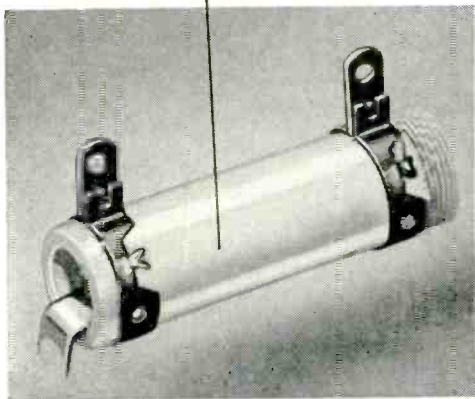

RESISTOR CORE. Ward Leonard's own manufactured cores upon which the resistance elements are wound consist of a perfectly cylindrical ceramic body of high density, low porosity, and high dielectric strength, with a thermal coefficient of expansion correlated to the expansion of the enamel.

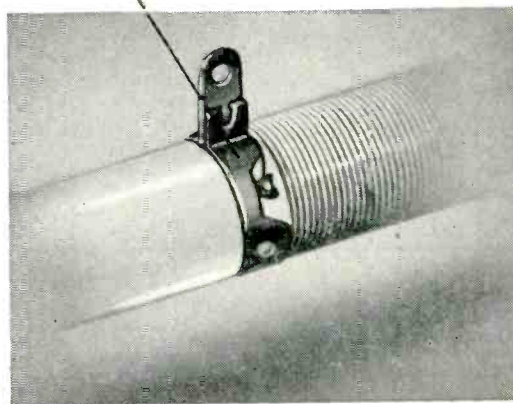

TERMINALS. In Ward Leonard resistors, special alloy terminals insure proper expansion and adherence to the enamel, are designed to provide strong anchorage. Every wire-to-terminal junction is joined mechanically first, then specially silver-brazed for lasting contact.



RHEOSTATS



RELAYS



MOTOR CONTROLS



CHROMASTER



Ward Leonard's complete engineering textbook, "Handbook of Power Resistors," \$3 per copy.

TO HIT TARGET from unstable decks of ship



**...and FORD
was asked to find
the answer**

A rolling, pitching ship... under attack from speedy, diving aircraft... counts on its anti-aircraft guns for protection... these guns must be able to stay on the target regardless of sea conditions. That's why the Ford Instrument Company was called on to design and build a control system that tracks and holds the target range with deadly accuracy.

This is typical of the problems that Ford has solved since 1915. For from the vast engineering and production facilities of the Ford Instrument Company, come the mechanical, hydraulic, electro-mechanical, magnetic and electronic instruments that bring us our "tomorrows" today. Control problems of both Industry and the Military are Ford specialties.

4

You can see why a job with Ford Instrument offers young engineers a challenge. If you can qualify, there may be a spot for you in automatic control development at Ford. Write for brochure about products or job opportunities. State your preference.



FORD INSTRUMENT COMPANY
DIVISION OF THE SPERRY CORPORATION
31-10 Thomson Avenue, Long Island City 1, N. Y.

TAYLOR Bone Grade Vulcanized Fibre

is an extremely tough and dense grade of vulcanized fibre. It is excellent for applications where difficult machining operations are required . . . resistant to organic solvents, oils and gasoline . . . has excellent electrical characteristics.

Want to make something of it?

Make it into gears, cams, fairleads, bushings and grommets, slot wedges, threaded and tapped pieces, rail joint insulation and other applications where mechanical strength, good finish and intricate machining are required. Color: gray.

Make it from sheets or rolls with these specifications:

SPECIFICATIONS

Thickness range	1/32" to 1/2"	Roll width	56" for thicknesses of 1/32" through .060".
Finish	Pressed and calendered		Coils down to 7/32" for thicknesses of 1/32" through .090".
Punching	Up to 3/16" thickness		
Sheet size	Approx. 56" x 90"		

PROPERTIES

Mechanical

Flexural Strength, psi
(Lengthwise) 14000 min.
(Crosswise) 12000 min.

Tensile Strength, psi
(Lengthwise) 7500 min.
(Crosswise) 5500 min.

Compressive Strength, psi
(Flatwise) 30000 min.

Izod Impact Strength, Ft.-Lbs./inch
(Lengthwise) 3.0
(Crosswise) 2.4

Electrical

Dielectric Strength, VPM
(1/32") 250 min.
Short Time Test (1/8") 175 min.
Arc Resistance, seconds 100

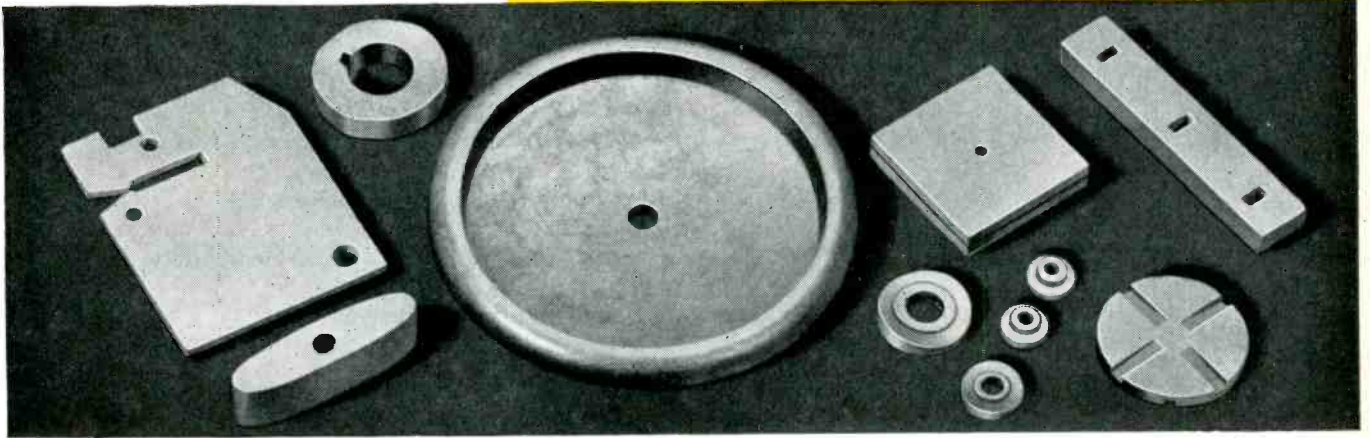

Make it from turned rods. Diameters from 1/8" through 1/2" with ground or buffed finish.

Make it easy for yourself the next time you are looking for an extremely dense, abrasion resistant material. Call your Taylor Engineer . . . he will be glad to work with you . . . go over your requirements . . . and help you select the correct grade of Taylor Vulcanized Fibre to fit your needs—Bone, Commercial, Super White, Abrasive and Built Up. Ask him about Taylor Laminated Plastics, too. He will be glad to give you samples of *Phenol, Melamine and Silicone Laminates* for your inspection.

Taylor Fibre Co., Norristown, Pennsylvania—La Verne, California

TAYLOR
Laminated Plastics
Vulcanized Fibre



We have used every type of GA & F Carbonyl Iron Powder thus far produced. The overall quality and batch-to-batch uniformity of your products have always been gratifying to us. Because of this product dependability, we feel that incoming inspection of your powders is unnecessary.

Richard D. Ponemon

President
Pyroferric Company, Inc.
621 East 216th Street
New York 67, N. Y.

GA & F. CARBONYL IRON POWDERS

—batch to batch uniformity that makes inspection unnecessary

G A & F Carbonyl Iron Powders are used to produce cores for transformer and inductor coils—to increase Q values, to vary coil inductances, to reduce the size of coils, to confine stray fields and to increase transformer coupling factors.

These powders are microscopic, almost perfect spheres of extremely pure iron. They are today produced in eight carefully controlled types, ranging in average particle-size from three to twenty microns in diameter. The Carbonyl Process assures the quality and uniformity of each type.

We urge you to ask your core maker, your coil winder, your industrial designer, how G A & F Carbonyl Iron Powders can increase the efficiency and performance of the equipment or product you make, while reducing both the cost and the weight. We also invite inquiries for powders whose performance characteristics are different from those exhibited by any of our existing types.

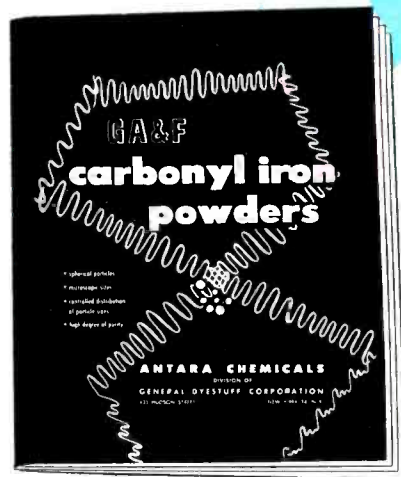

This 32-page book offers you the most comprehensive treatment yet given to the characteristics and applications of G A & F Carbonyl Iron Powders. 80% of the story is told with photomicrographs, diagrams, performance charts and tables. For your copy—without obligation—kindly address Department 56.



ANTARA® CHEMICALS

Division of GENERAL DYESTUFF CORPORATION
435 HUDSON STREET • NEW YORK 14, NEW YORK



Here's how to plot a plane's Angle-of-Climb...

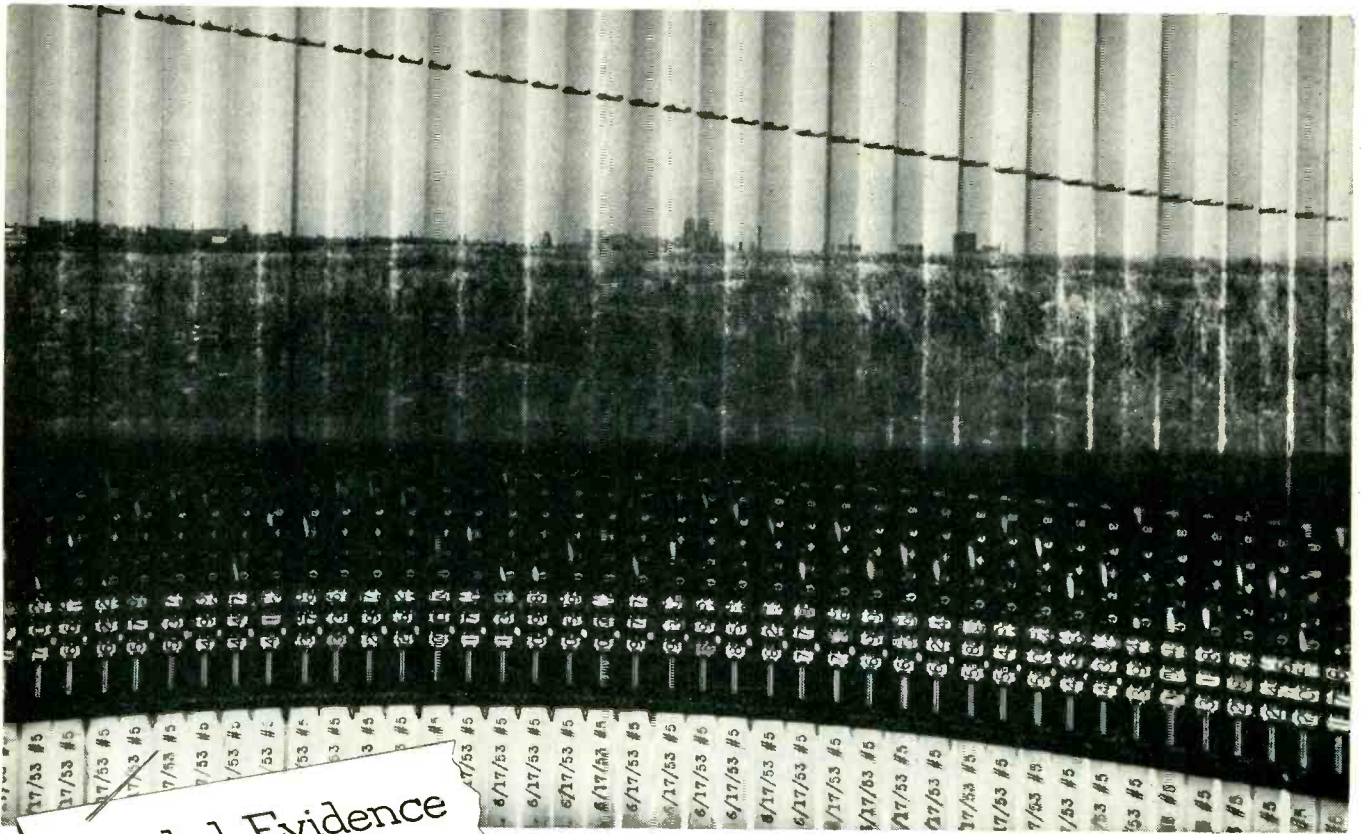

Photo by Sherman Fairchild & Associates' Flight Analyzer Camera, New York City

Everyone Can Count on **VEEDER-ROOT**

New take-off technique yields an 8° climb, as this progressive *single photo* shows. And this is 100% improvement over old techniques . . . increasing safety and decreasing noise-annoyance at city airports.

Here you actually see 53 separate exposures. And each, reading from bottom up, shows the date and number of the flight photographed. Next above is a device which records the time . . . exact to 1/1,000th of a second. And in the heart of this device is a Veeder-Root Counter.

So here again you see one of the heretofore uncounted ways in which "Everyone Can Count on Veeder-Root". What's *your* problem? Let us put our mathematical eyes on it. Write:

VEEDER-ROOT INCORPORATED
HARTFORD 2, CONNECTICUT

Chicago 6, Ill. • New York 19, N. Y. • Greenville, S. C.
Montreal 2, Canada • Dundee, Scotland
Offices and Agents in Principal Cities



"The Name that Counts"

ABOVE AND BEYOND MIL-R-93A SPECIFICATIONS

DURAMEG[®]

ACCURATE WIREWOUND RESISTORS

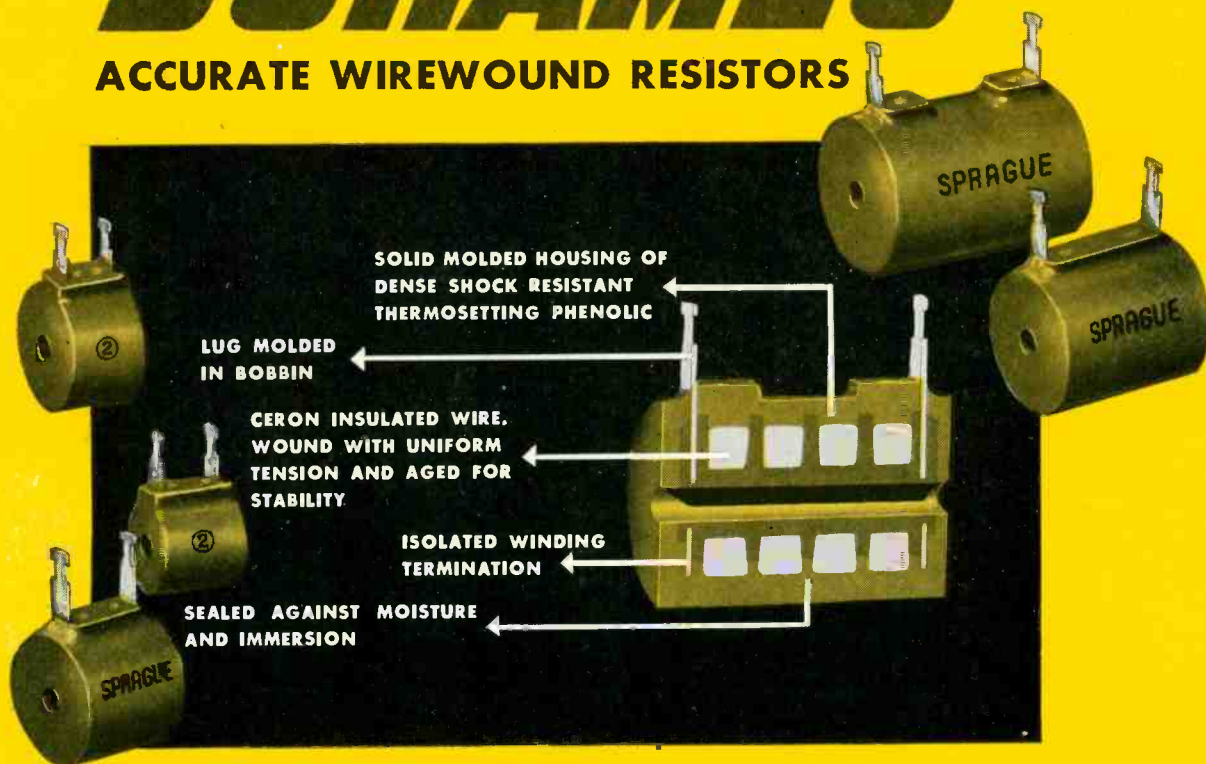

DURAMEG WATTAGE RATINGS ARE BASED ON FULL RATED DISSIPATION AT 105° AMBIENT. THESE RATINGS ARE FROM 4 TO 5 TIMES THE 85°C MIL RATINGS FOR THE BEST OF CONVENTIONAL RESISTORS.

The engineered combination of Ceron wire, Durameg molding technique and aging treatment permits dissipation of full rated wattage at 105°C—the same temperature at which MIL ratings prescribe zero dissipation.

Equipment designers who must consider initial resistance tolerance as well as shifts in resistance value with repeated temperature cycling and operation at full load, are using Duramegs with outstanding results.

Durameg long-term stability and positive protection against electrolysis failure enable you to design now for dependable, permanent, peak performance.

Duramegs are the first high-accuracy wirewound resistors to operate successfully up to a hot spot temperature of 150°C as against the usual 105° limit—made possible with Sprague's patented ceramic insulated Ceron wire.

Durameg molded phenolic housings are tough and resistant to mechanical damage—installations require no secondary insulation for mounting—they'll even withstand the salt water immersion cycling for characteristic A in former specification JAN-R-93.

Durameg Resistors are now available for commercial application in dimensions identical to MIL styles. We will be pleased to send you complete data upon request. ★ ★ ★ ★ ★

WRITE, WIRE OR PHONE FOR ENGINEERING BULLETIN 120

SPRAGUE ELECTRIC COMPANY 35 MARSHALL STREET NORTH ADAMS, MASS.



SPRAGUE

PIONEERS IN ELECTRIC AND ELECTRONIC DEVELOPMENT

EXPORT FOR THE AMERICAS: SPRAGUE ELECTRIC INTERNATIONAL LTD., NORTH ADAMS, MASS. CABLE: SPREXINT

For benefits* like these, use

Here are typical benefits which you can *expect and get* by using Carboloy permanent magnets in your electrical products.

Check these case histories. Maybe a Carboloy permanent magnet can improve *your* product, too. Why not contact a Carboloy magnet engineer without delay. He'll lend you a hand in magnet design and application. His services will cost you nothing.

Carboloy permanent magnets retain their efficiency under most conditions of temperature, shock and vibration . . . high resistance to demagnetizing influence of stray magnetic fields . . . provide *powerful, lasting* magnetic energy.

Available in all sizes and shapes; can be cast or sintered to your needs. Send coupon for catalog and for design manual.

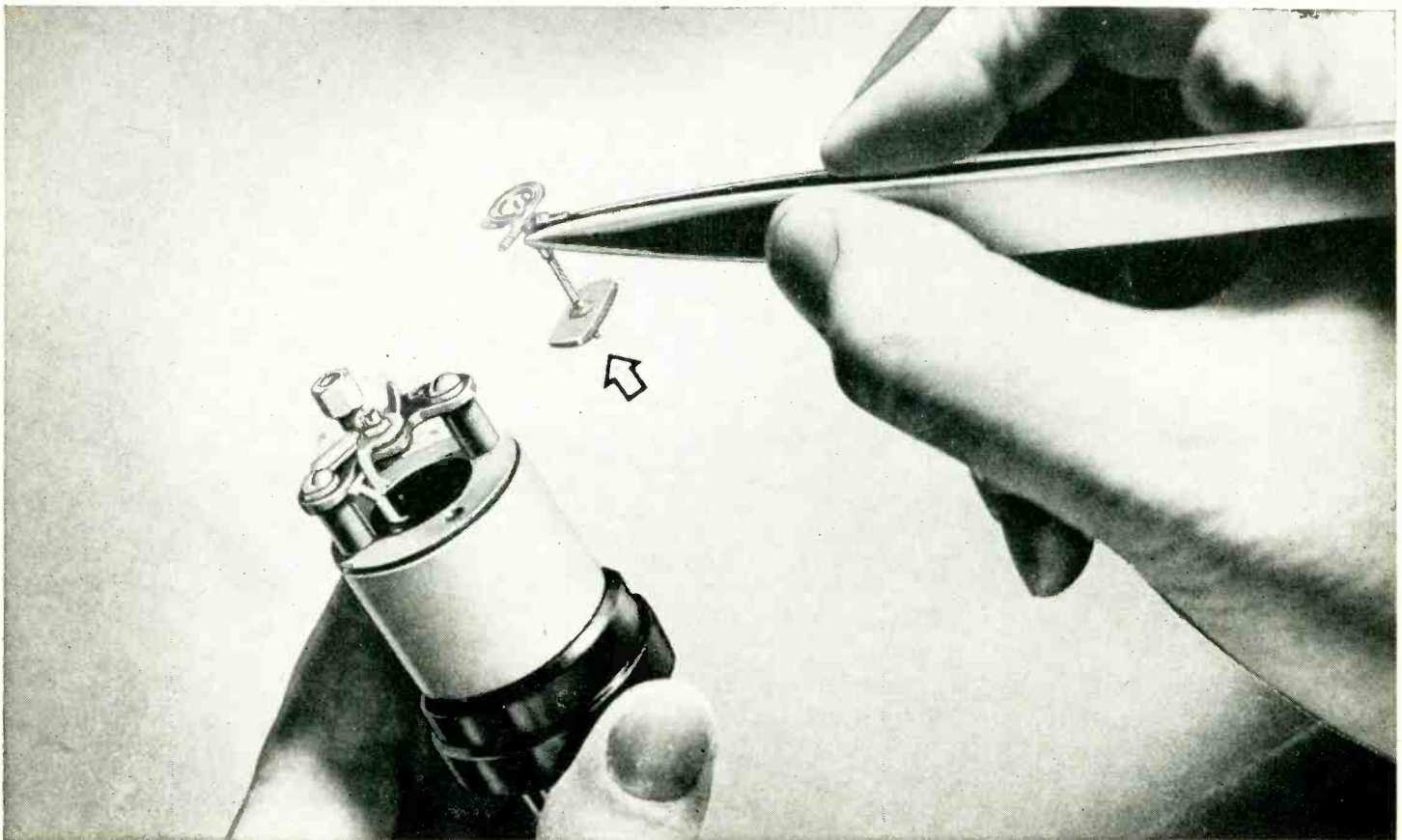

* *Finer product performance*

A small, powerful Carboloy permanent magnet enabled Thomas A. Edison, Inc. to design a revolutionary sensitive relay capable of operating from the current generated by a heated thermocouple. This power-packed magnet eliminated the need for electronic amplification, thus greatly simplified design of their aircraft fire-detecting system.

* YOU GET ALL THESE ADVANTAGES FROM CARBOLOY PERMANENT MAGNETS

- Cool—generate no heat
- Require no electrical energy
- Cost nothing to operate
- Eliminate coils, windings, wiring, etc.
- Need no maintenance—no coils to burn out, no slip rings to clean or replace, etc.
- Simplify mechanical assemblies—exert strong tractive force for holding, lifting and separating devices that eliminates component parts, makes product design and fabrication simple
- Save space—great magnetic strength in small sizes
- Powerful—and power is constant
- Combine electrical and mechanical features—transform electrical energy into mechanical motion; mechanical motion into electrical energy
- No power failures ever
- Resist moisture—no coils to collect dampness
- Give uninterrupted operation
- Create savings—often eliminate costly, power-supplying parts
- Simple—no operating parts
- Reduce weight, product size
- Supply a permanent source of energy

Carboloy® permanent magnets

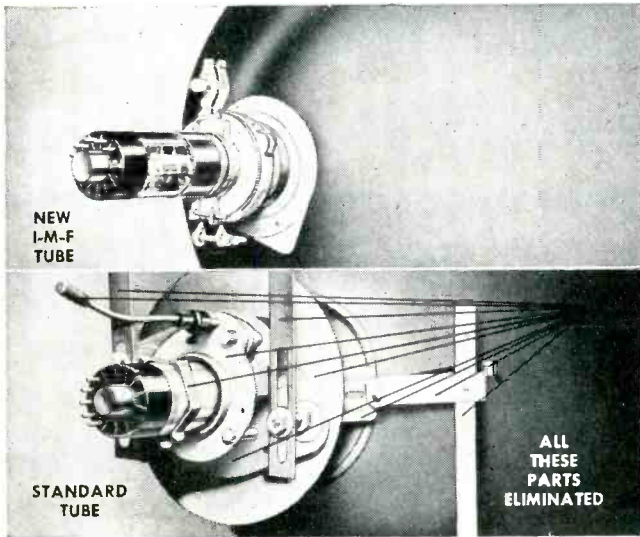

* **Fewer Parts**

New GE I-M-F television picture tube has its ion trap and magnetic focus device *inside end of tube*. Pictures are clearer, *prefocused* and many parts are eliminated . . . thanks to Carboloy permanent magnets.

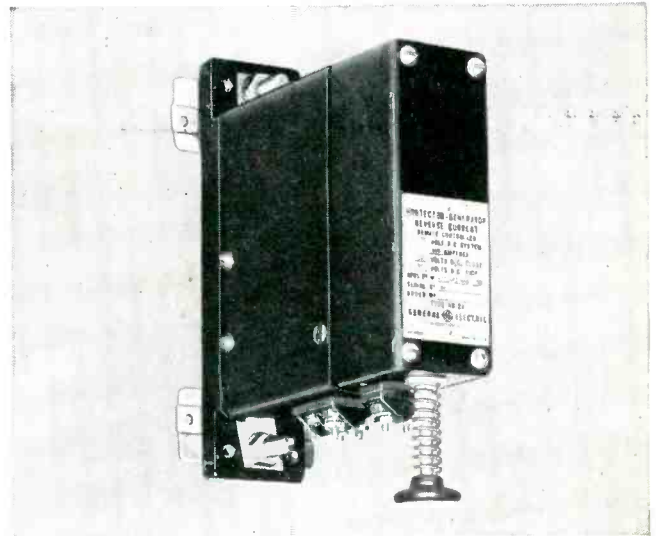

* **Improved Design**

In this circuit breaker a Carboloy magnet assembly simplifies the trip element. It eliminates a coil and polarizing connection . . . makes possible reverse-current tripping independent of system voltage.



* **More dependability**

New all-magnetic, all-transistor hearing aid (by E. A. Myers & Sons, Inc., Pitts.) uses magnets in *both* microphone and receiver. Hearing aid failure caused by operational heat and humidity is now eliminated.

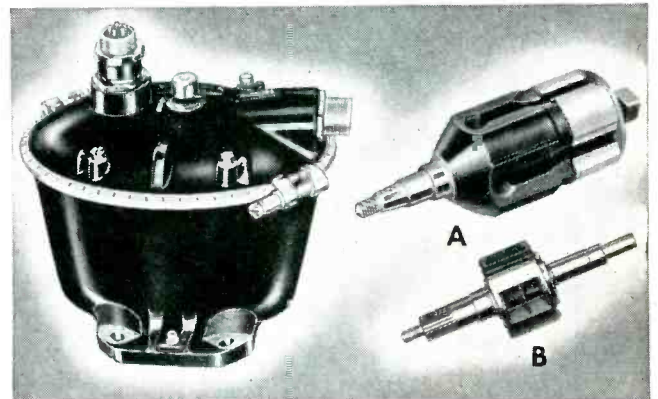

* **Less weight and space**

Fig. A shows chrome magnet rotor once used in Scintilla aircraft magneto. It weighed 4 lbs. 9 ozs. New rotor (Fig. B) is made of Carboloy Alnico. It weighs only 2 lbs. 4 ozs., is considerably smaller.



"Carboloy" is the trademark for the products of the Carboloy Department of General Electric Company

Carboloy Department of General Electric Company
11139 E. 8 Mile Ave., Detroit 32, Michigan

Rush me, without cost or obligation, copies of Permanent Magnet Design Manual PM-101 and Standard Stock Catalog PM-100.

Name _____ Position _____

Company _____

Address _____

City _____ Zone _____ State _____

If you use relays—Clare's New Plant is

CLARE RELAYS are now built in the most modern plant ever specifically designed for relay manufacture

Light eight times better than average for industrial plants—75 foot candles of shadow-proof light at bench level.



All air electrostatically washed—avoids danger of contamination in such operations as contact welding.



100% inspection of all Clare relays with most modern test equipment. Light on this test set gives 125 foot candles.



• Building of precision relays requires more than technical skill. It requires an atmosphere of utmost freedom from dirt. Air temperature and humidity must be closely controlled. Assembly of small parts must be done under powerful, yet shadow-free light.

All these important features and many more are provided in the new Clare relay plant. Never before have so many manufacturing advantages been provided in one plant—for one purpose—to give you relays of unequalled quality.

Quality and long-life dependability of Clare relays have made them first choice of designers as components for critical equipment. Wherever failure cannot be tolerated, when only the best is good enough, Clare relays are indicated.

Two important factors contribute to this Clare superiority. Production of relays has always been the exclusive business of

FIRST IN THE INDUSTRIAL FIELD

BIG NEWS!

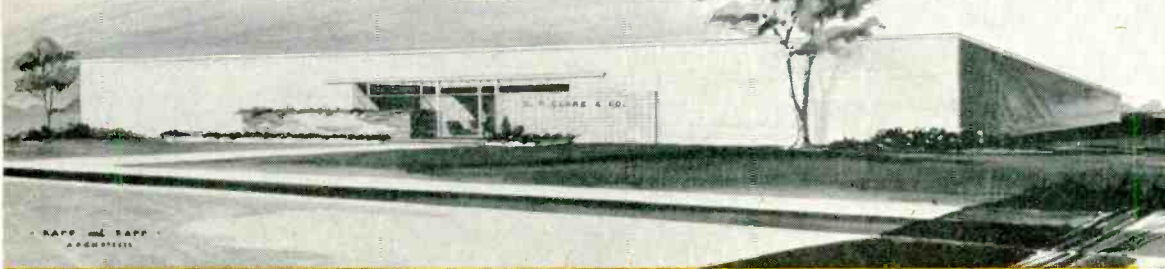

C. P. Clare & Co. This is a young-minded progressive organization, ever alert to discover and test new and better materials and manufacturing methods.

The new plant is the product of years of research and experiment. It is the natural development of Clare's unwillingness to offer their customers anything less than the most perfect relays that can be built.

...
If yours is a product whose long life, reliable performance and freedom from maintenance depend on the use of relays—it will pay you to know ALL about Clare relays. A sales representative, fully experienced in every type of relay problem, is located near you. Consult him, or write C. P. Clare & Co., 4719 West Sunnyside Avenue, Chicago 30, Illinois. In Canada: Canadian Line Materials, Ltd., Toronto 13. Cable Address: CLARELAY.

CLARE RELAYS



Automatic control of air temperature and humidity increases accuracy of assembly and adjustment of delicate parts.

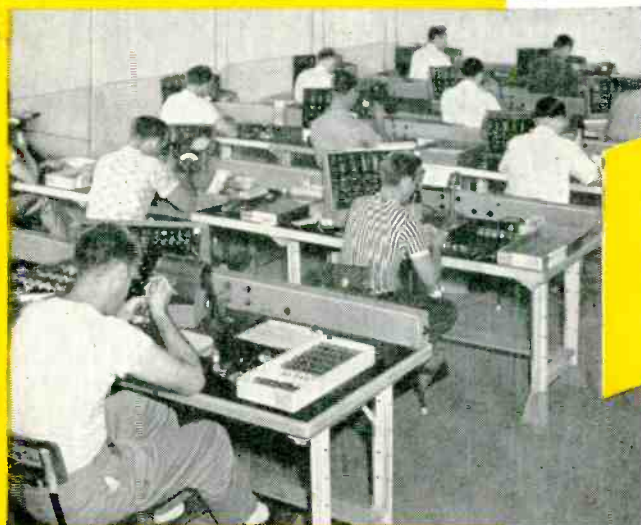

Multiple test circuits of variable voltages on bench channels facilitate adjusting of relays to customers' specifications.



Diminutive parts of high frequency impulse relay require laboratory-clean assembly conditions.



New G-E low-temperature Pyranol* subminiature capacitor averages 20% smaller than a comparable oil-filled unit. It is as small as the old subminiature wax unit, yet has superior life characteristics.

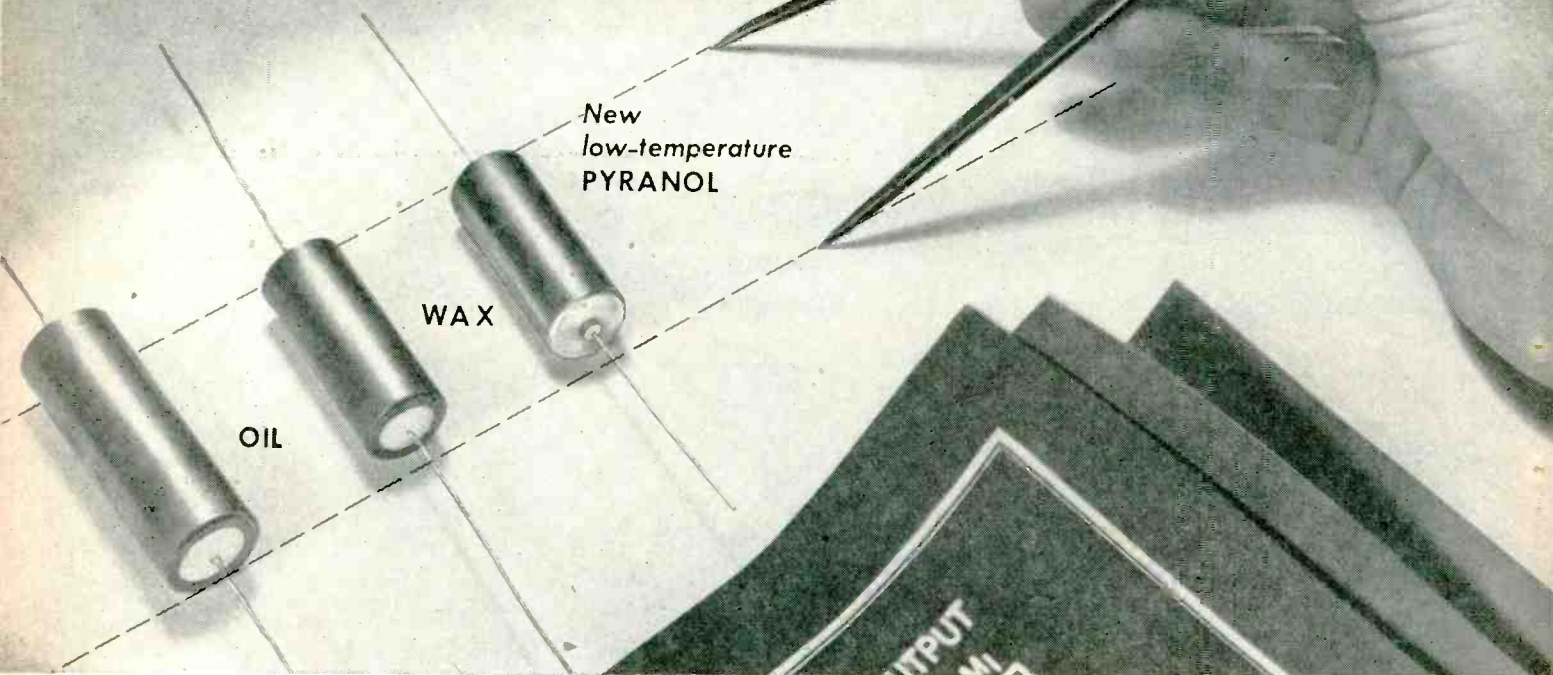

G-E subminiature metal-clad capacitors feature new *low-temperature* PYRANOL dielectric

NO DERATING OVER RANGE -55 TO $+85$ C

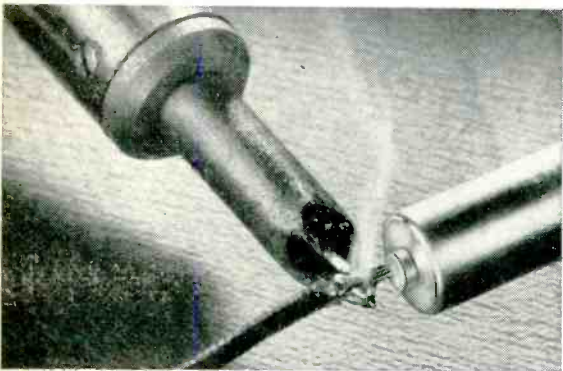

Solder right up to the bushing. No danger of cracking because G-E end seals are silicone rubber—not glass.

If you need a wax replacement because of the elimination of characteristic J (wax) from the proposed MIL-C-25 specifications, you need not go to a larger capacitor (or continue to use an unacceptable product). General Electric's new *low-temperature* Pyranol subminiature capacitors are as small as wax units, yet have superior life characteristics which make them a "natural" for military equipment.

High dielectric strength with exceptional stability is provided by new *low-temperature* Pyranol liquid dielectric. New, improved *low-temperature* Pyranol makes possible a small-size tubular capacitor with practically flat temperature vs. capacitance characteristics.

Silicone end seals, a G-E exclusive, provide exceptional resistance to physical and thermal shocks—and permit soldering right up to the bushing without danger to the seal.

Designed for applications in the temperature range from -55 to $+85$ C *without derating* these capacitors can be supplied in either tab or exposed foil designs in ratings from .001 to 1.0 muf. in voltages of 100, 200, 400, and 600 volts d-c working.

For high-temperature operation, -55 to $+125$ C *without derating*, another new tubular line—Permafil solid-dielectric subminiature capacitors, is available. These capacitors meet all requirements of JAN-C-25.

If your requirements demand the highest performance standards for subminiature capacitors, it will pay you to check with your nearest G-E Apparatus Sales Office, or write General Electric Company, Section 442-9, Schenectady 5, N. Y.

*Reg. trade-mark of General Electric Company.

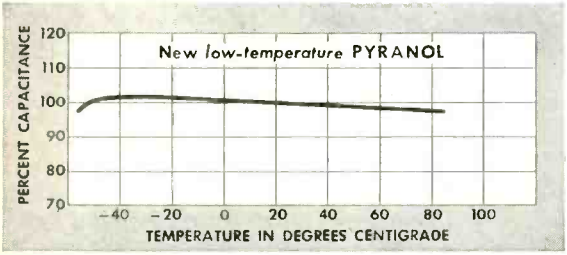

Capacitance vs. temperature is shown by this typical curve. G-E *low-temperature* Pyranol subminiature metal-clad capacitors have only a small capacitance change through the entire range from -55 to $+85$ C.

You can put your confidence in—



BRITONS CAN HAVE PROSPERITY

— If They Want It

What is required to get Britain, our key ally in the grand alliance of the free world, firmly back on her economic feet? The purpose of this message is to throw light on this crucial problem, which afflicts our other European allies also.

At the moment, Britain is enjoying a respite from the economic crises (of 1947, 1949 and 1951-52) which have plagued her post-war course. This respite may well continue for some time. But almost no one whose judgment is trustworthy believes that Britain has acquired sufficient economic strength to safeguard her against further economic crises in the years immediately ahead.

Two British Views

New and clear light on what should be done to that end has recently been shed by two noteworthy British publications. One is a book, "We Too Can Prosper," by Graham Hutton, distinguished British economic writer and administrator. The other is an article, "The Riddle of Prosperity," published by THE (London) ECONOMIST, Europe's most eminent economic journal.

Combined, these two publications present

in sharp relief the basic problem that must be handled successfully if Britain is to be safely solvent. As is implied by its title, *the Hutton book demonstrates that Britain can be made prosperous by readily feasible procedures, patterned on what has been done in the United States, to increase its industrial efficiency. But, says THE ECONOMIST, with Mr. Hutton's book in mind, this is not the most basic problem, which is, "How shall we make the British people determined to be prosperous?"* This is a problem of incentive or motivation.

Compared with that of the United States, average industrial efficiency in Britain, as in most of Western Europe, is low. In his book Mr. Hutton remarks that "fifty years ago an American industrial worker turned out roughly the same amount in a day as his opposite number in Britain, Germany or France. . . . Today, he turns out from two to five times as much."

In large part it is this lag in output per hour or "productivity," as the technicians call it, which makes Britain and other key countries in Western Europe a continuing prey to economic crises. Moreover, the great disparity in productivity between the U.S.A. and most

of Western Europe is a major barrier to knitting the free world into a smoothly working economic whole. As one observer put it, "when the American economy catches a cold, the European economy gets pneumonia." This is largely because Europe is so much weaker in productive strength.

No Shortage of Knowledge

Yet the knowledge which would enable the countries of Western Europe, and particularly Britain, to increase their industrial productivity has been mobilized and is readily available to them. It is with this process for Britain that Mr. Hutton's book is concerned. In the book he summarizes the findings and conclusions, virtually all of them unanimous, of 66 teams, composed of British industrial managers, technicians, shop workers and labor leaders. Over a period of three years these teams completed a comprehensive series of inspection and study trips in the United States under the sponsorship of the Anglo-American Council on Productivity. The product of that effort, he remarks, is "a set of documents the like of which, on such a scale and of such practical value, has never been seen in the history of international and cultural borrowing."

Psychology the Key

From study of these documents, Mr. Hutton concludes that better capital equipment is the key technical ingredient of higher industrial productivity in Britain, and constitutes "the most urgent . . . need of British industry." But he finds that *even without new capital equipment a "15% rise in productivity can still be achieved by reorganization of work," and that such an increase would "solve Britain's chief social and economic problems."*

Then why is not such an increase in productivity, demonstrated by the Anglo-American

productivity teams to be so clearly within technical grasp, promptly forthcoming? Mr. Hutton, quoting one of the team reports, remarks that, "*the greatest obstacles to increased productivity are psychological rather than technical.*" We have to deal first and foremost with men, not machines." And THE ECONOMIST, pursuing the line of inquiry suggested, reaches the conclusion that, by and large, the people of Britain do not want to prosper by being more efficient. THE ECONOMIST says:

"The real secret of American productivity is that American society is imbued through and through with the desirability, the rightness, the morality of production. . . . But in Britain, if any moral feeling at all survives about economic matters, it is usually a vague suspicion that economic success is reprehensible and unworthy. From this difference in attitudes everything else follows."

"How," asks THE ECONOMIST, "*shall we set about restoring some belief in the rightness of effort, the morality of success?*" For this question it has no ready answer. Neither have we. We are confident that the British people will neither be cajoled nor coerced into trying to match our productivity. Basically the problem seems to be to demonstrate clearly to them the truth of the proposition, set down by Graham Hutton, that "there is no goal, aim or end before a Good Society which the raising of that society's material productivity cannot render easier of achievement." Doing that in an old and settled country like Britain is obviously an extremely formidable undertaking. But *until it is done, the crucial job of getting Britain and the rest of Western Europe firmly on its economic feet will remain to torment all of us.*

McGraw-Hill Publishing Company, Inc.

twenty times
tested!



TWICE SIZE →

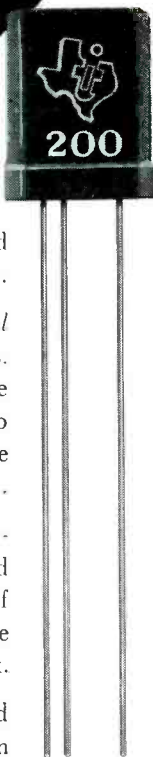

EVERY Texas Instruments grown junction and point contact transistor must pass more than 20 tests—in addition to continual visual checks—before it is granted the TI trademark and shipped to the user.

Texas Instruments inspects *all* transistors *all along* the manufacturing process. This 100% inspection insures that the completed product will adhere closely to published specifications (see distribution curves at lower right).

All TI transistors have moisture-proof glass-to-metal hermetic sealing. And they are *all* aged a minimum of 24 hours at rated output as a positive operating double-check.

If you want transistors of this insured high quality, they are now available from Texas Instruments Incorporated. Write for new junction transistor bulletin DL-S 310.

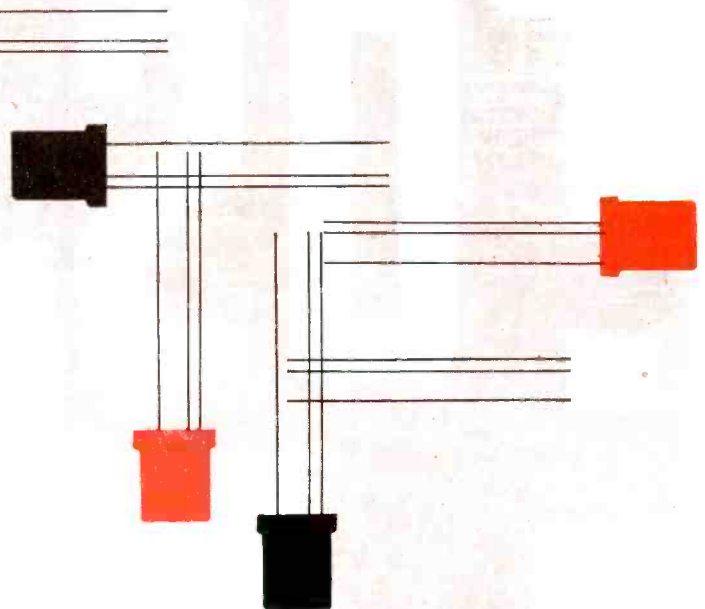

ELECTRICAL DATA

RATINGS, RECOMMENDED MAXIMUM:	n-p-n Junction	
	Type 200	Type 201
Collector Voltage	30 volts	30 volts
Collector Current	5 ma.	5 ma.
Collector Dissipation (at 30°C)	50 mw.	50 mw.
Ambient Temperature	50°C	50°C

AVERAGE CHARACTERISTICS (at 30°C):

Collector Voltage	5 volts	5 volts
Emitter Current	-1 ma.	-1 ma.
Collector Resistance (minimum)	0.2 megohms	0.4 megohms
Base Resistance	150 ohms	150 ohms
Emitter Resistance	30 ohms	30 ohms
Current Amplification Factor (minimum)	0.90	0.95
Collector Cut-Off Current	10 μ a	10 μ a
Collector Capacitance	12 μ fd.	12 μ fd.
Noise Factor (average value)	22 db.	22 db.

STATISTICAL DISTRIBUTION CURVES

Based on 250 Type 200 Transistors

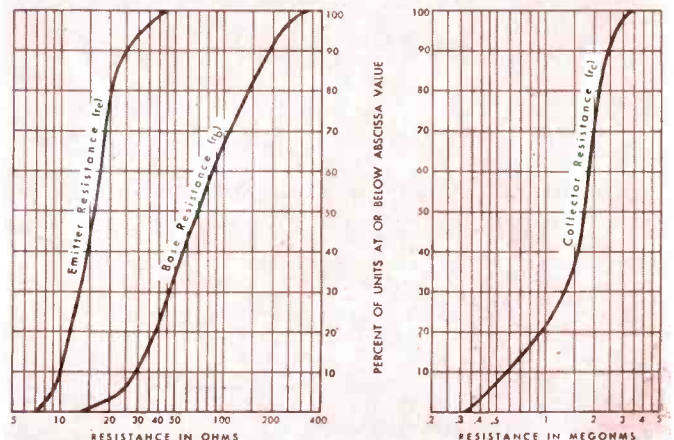

TEXAS INSTRUMENTS
INCORPORATED
6000 LEMMON AVENUE DALLAS 9, TEXAS



NOW

KEL-F* WIRE IN STRIPES

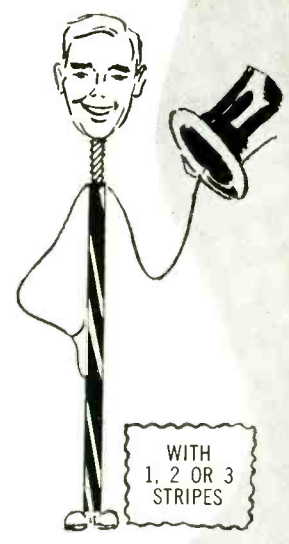
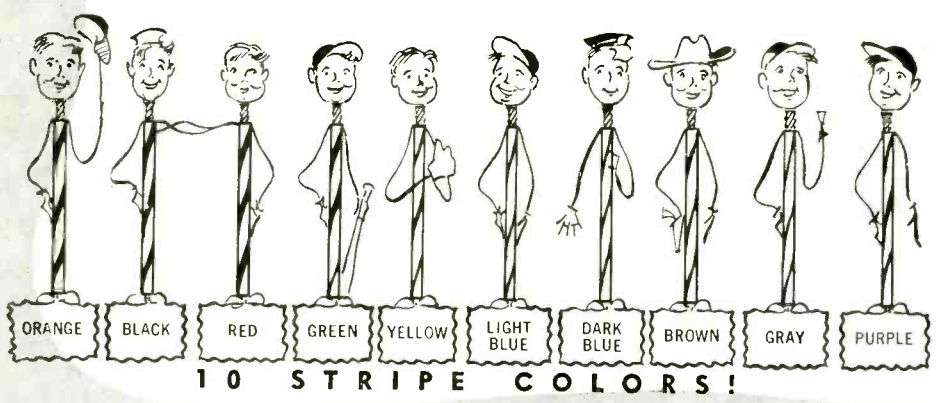

REX-KF[†] THE WONDER WIRE

(WITH KEL-F* INSULATION)

The Rex Corporation announces REX-KF Wire (Kel-F* insulated) with one, two, or three stripes in any combination of ten colors. Over 300 sharply distinguishing color codes are now easily available.

Striping removes the final obstacle to the broader use of wonderful trifluorochlorethylene insulation.

Write for full information on this remarkable advance in wire technology, and the story of REX-KF Wire, champion in every quality that makes wire good.

*T. M. of M. W. Kellogg Co.
†T. M. of The Rex Corporation
**Reg. U. S. Pat. Off.

THE REX CORPORATION

Insulated Wire Specialties, Microwall Wire, Cast Plastics, Rexolite U. H. F. Insulating Materials, Rextrude** 105 Electrical Tubing and Custom Plastic Extrusions.

WEST ACTON, MASSACHUSETTS



SYNTHANE — making bigger payloads pay off

Synthane bushings, spacers, and bearings in the landing gear of this giant of the skies share the landing shock loads of twenty-five tons. But Synthane parts have many virtues in addition to their ability to withstand the jolts of heavy landings.

Parts made of this hard-working laminated plastic are unaffected by oils, and are dimensionally stable. They resist abrasion, and weigh half as much as aluminum.

Because Synthane is so easy to machine,

it is appropriate for fair-leads and cable-sheaves in control systems. Because it is an excellent electrical insulator, you will find it at work in engine ignition systems, flight instruments, automatic controls, and radar sets. Because Synthane is light and corrosion-resistant, it's used for the flapper valves in fuel cell baffles.

Synthane has all these properties and many more. It might be a good material for you to try. Start by sending for the complete Synthane Catalog. Synthane Corporation, 17 River Road, Oaks, Penna.

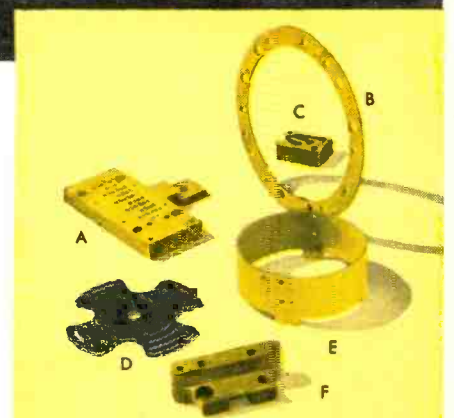

Synthane . . . in Aviation

- A Propeller brush block base
- B Separator ring for propeller hub
- C Propeller brake plug base
- D Brush carrier
- E Card drum
- F Propeller brush block base

Synthane—one of industry's unseen essentials

SYNTHANE

OAKS **S** PENNA.

LAMINATED PLASTICS

WIDE
RANGE

FAST-PULSE GENERATOR

PG-200A
Pulse Generator
PGA-210
Range Extenders



SPECIFICATIONS

PULSE POWER

- Amplitude 100 volts open circuit
- Continuously variable over a range of -10 db
- 50 db attenuation in steps of approx. 10 db
- Driving impedance 50 ohms or less
- Max. average current (50 ohms load) 0.1 amp. for pos. pulses, 0.07 amp. for neg. pulses
- Max. recurrence rate at least 20,000 pps
- Max. duty cycle 50%, min. pulse interval (trailing edge to leading edge) approx. 40 μ s

PULSE WAVEFORM

- Rise and decay times 0.03 μ s or less (10% to 90% amplitude)
- Crest and base line overshoots and ripple less than 5% of average pulse amplitude
- Duration calibrated 0.1 to 50 μ s, accuracy below 5000 pps within 5% or 0.1 μ s whichever is greater, accuracy above 5000 pps subject to additional 0.3 μ s error, min. pulse width less than 0.05 μ s (50% amplitude)

PULSE POSITION

- Delay after external sync signal fixed at approx. 10 μ s or adjustable from approx. 20 to 70 μ s
- Advance or delay with respect to sync out trigger calibrated 0.1 to 50 μ s, accuracy below 5000 pps within 5% or 0.1 μ s whichever is greater, accuracy above 5000 pps subject to additional 0.3 μ s error

RANGE EXTENDER

- 19 additional time increments of 50 μ s each
- Continuous calibrated coverage from 0.1 to 1000 μ s, accuracy within 5%
- Plugs into top of Pulse Generator directly above position or duration control

SYNCHRONIZATION

- Externally by almost any 5 volt waveform from essentially 0 to 20,000 per sec.
- Internal single pulses, power line freq. or adjustable from 20 to 20,000 pps
- Recurrence rate meter, accuracy within 5%
- Sync out trigger 50 volts, 1 μ s duration

features

- DURATION AND POSITION .05 TO 1000 μ s
- RISE AND DECAY TIMES CONSTANT .03 μ s
- SINGLE PULSES TO 20,000 PER SECOND
- 100 VOLTS, 50 OHMS DRIVING IMPEDANCE
- CALIBRATED WIDTH, POSITION AND RATE
- TRIGGER OR SINE WAVE SYNCHRONIZATION
- NEGLIGIBLE INTERACTION OF CONTROLS



TELETRONICS LABORATORY INC.

54 KINKEL STREET, WESTBURY, LONG ISLAND, NEW YORK

25% LESS WEIGHT!

castohm[®]

FIXED WIREWOUND POWER RESISTORS

... new homogeneous core and coating

✓ REDUCES SIZE AND WEIGHT
✓ ELIMINATES SHORTED TURNS



- 350°C hot spot operation
- Higher power dissipation with less weight, smaller diameters
- Higher maximum resistances
- Closer tolerances—to 1% (5% standard)
- Better heat conductivity
- Exceptional resistance to thermal shock

By eliminating the heavy ceramic core with the wire-bunching and shorted turns characteristic of vitreous enamel types, Shallcross has developed a radically new wirewound resistor that outperforms *all other* types of high temperature fixed power resistors. Through a unique process, the windings are imbedded in a special ceramic which forms an integral coating and core. Designed to MIL-R-10566 specifications, Castohms are destined to leave MIL-R-26A types far behind.

Find out how Castohms can reduce size and weight in your equipment - improve efficiency and reliability as well. Write, wire, or phone for details. Ask for Engineering Bulletin L-29. SHALLCROSS MANUFACTURING CO., 522 Pusey Avenue, Collingdale, Pa.

Shallcross

Designed to
MIL-R-10566
Specifications

R-30— 8 watts
R-33— 28 watts
R-37—125 watts
R-46—225 watts

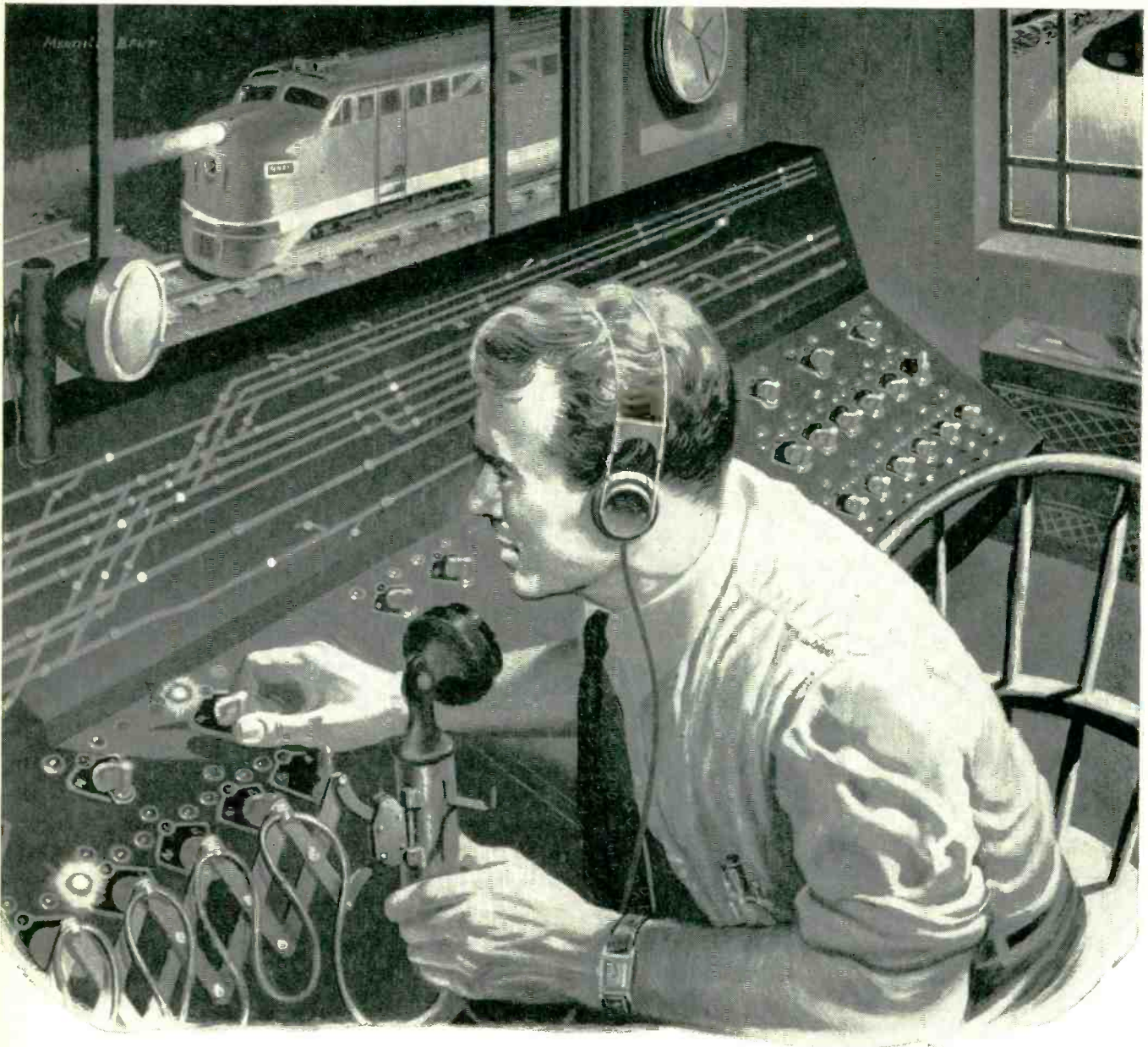

You know you're on the right track

Director of destinations, the towerman deftly sorts out traffic . . . fans it out far and wide, so that the right shipments get to the right places at the right time.

The same practiced precision goes into traffic control in the modern mills at Bristol. Here every operation is safe in hands that have the same deft touch . . . that keep things moving so that every shipment of Brass sheet, rod and wire gets through to its destination without switch-

ing, sidetracking, or running behind time.

And this is just *part* of what is meant by "Bristol-Fashion".

. . .

The BRISTOL BRASS CORPORATION, makers of Brass since 1850 in Bristol, Conn. Offices or warehouses in Boston, Chicago, Cleveland, Dayton, Detroit, Los Angeles, Milwaukee, New York, Philadelphia, Pittsburgh, Providence, Rochester.

"Bristol-Fashion" means **Brass at its Best**

NOW ANOTHER...

NEW MINIATURE added to HUSKY LINE OF TELEPHONE-TYPE RELAYS!

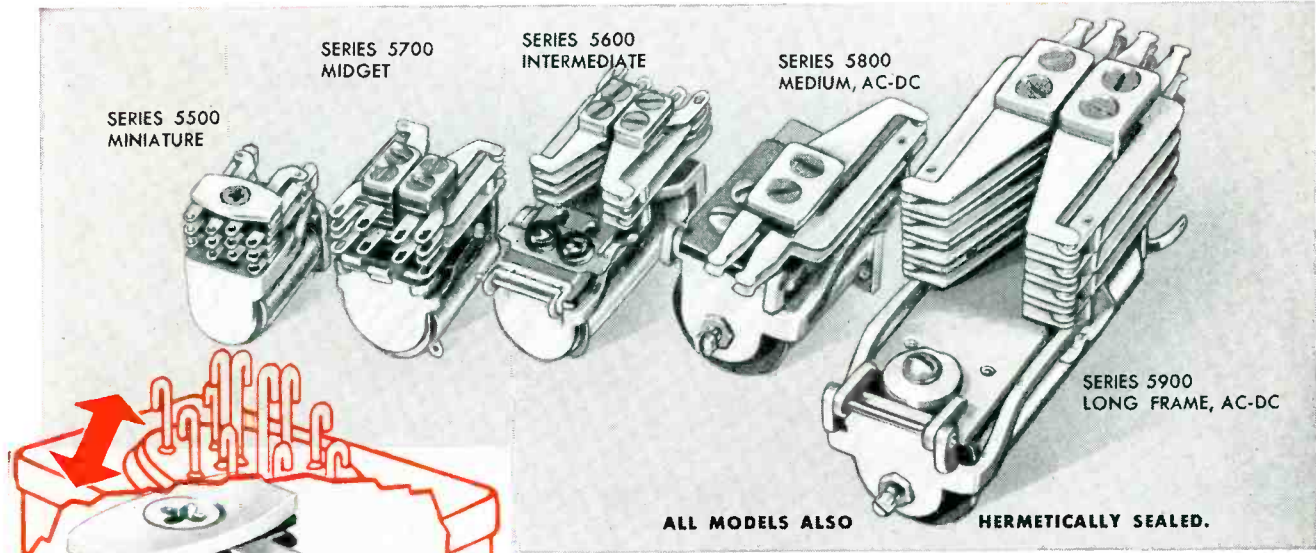

ALL MODELS ALSO HERMETICALLY SEALED.

SMALL! LIGHT! RELIABLE!

The latest addition to the Husky line of telephone-type relays, and our answer to the demand for smaller, lighter-weight aircraft relays is the series 5500—available in open style or hermetically sealed.

The series 5500 relay meets all applicable requirements of MIL-R-6106. It is a miniaturized conventional relay, designed to keep pace with the trend towards reduction in size and weight in electronic equipment, especially for aircraft applications.

HERMETICALLY SEALED

The 5500 HS (hermetically-sealed model) provides complete protection against tampering or harmful atmospheric conditions, including moisture, salt spray, dust and temperature extremes. Altitude tests reveal no leakage at 81,000 feet.

Unique Husky construction features:

1. Longer, more flexible contact arms, resulting in reliable operation with low coil wattage.
2. Single stack screw, with positive locating pins (in stack) assuring precision contact alignment.
3. Specially designed spring-tempered clamp plate and high tensile strength screw prevents loosening of stacks under severest conditions of shock, vibration and temperature variations.

Specify Husky Series 5500 relays for all applications where reliability, small size and light weight are prime factors. Write, wire or phone for further information . . . File 5500.

Shown 2 times actual size.

SPECIFICATIONS

OPERATING VOLTAGES: 6 to 48 volts DC.
 MAXIMUM COIL RESISTANCE: 5,000 ohms.
 CONTACT CAPACITY: Standard contacts are rated at 3 amps 115 volts AC or 24 volts DC, non-inductive.
 CONTACT COMBINATIONS: Up to 6 Form A, or 4 Form C (total of 12 springs).

1500 CHURCH, FREDERICK, MARYLAND

A NEW CTS FAMILY

Of Variable Resistors

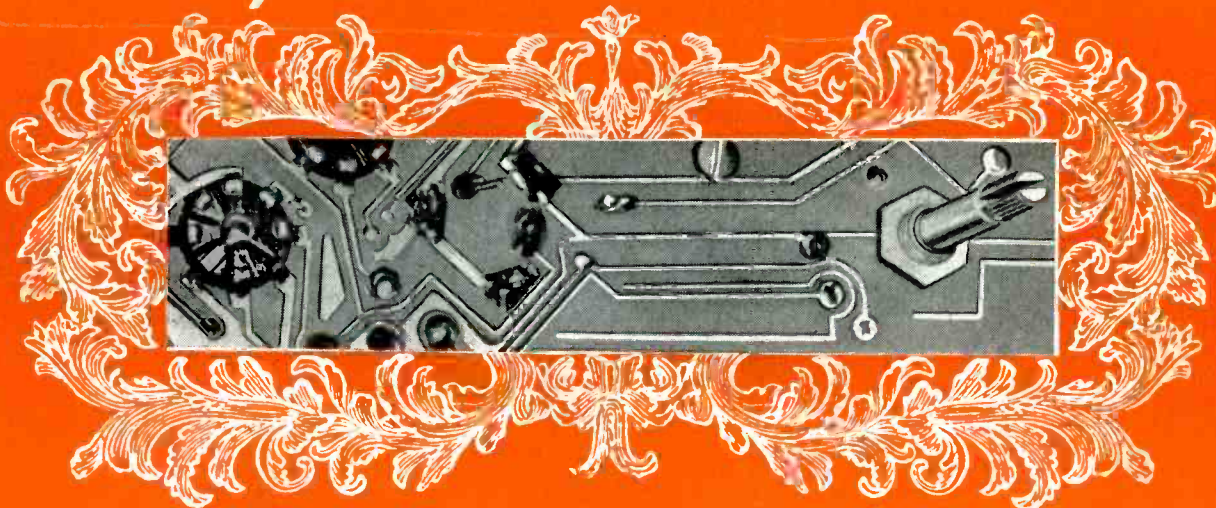

FOR PRINTED CIRCUIT APPLICATIONS

Note these unique design features:

- ① Protection against bending during handling is achieved by recessing each blade-type terminal in a notch in the bakelite base of the control.
- ② Valuable mounting space is conserved on the printed circuit panel by placing the terminals close in to the mounting bushing.
- ③ Adequate clearance for circuit paths is provided by ample spacing between terminals.
- ④ Available in *miniaturized* $\frac{3}{4}$ " diameter (U70) and in $\frac{1}{16}$ " diameter (U45, GC-U45, WF-U45).

For your printed circuit applications, CTS offers consultation without obligation.

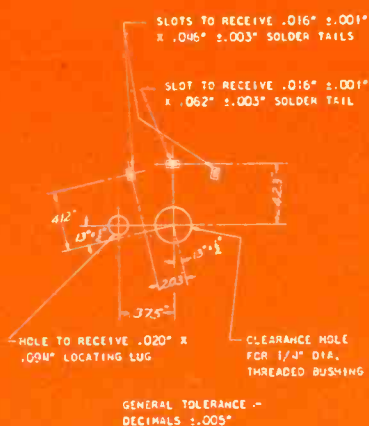

Ample spacing between printed circuit terminal openings for the miniature Type U70 series provides adequate clearance for circuit paths.

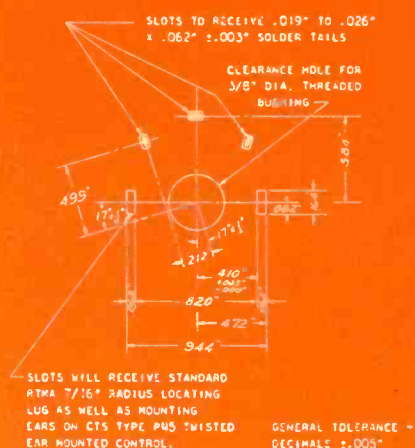

Ample spacing between printed circuit terminal openings for Types U45, GC-U45 and WF-U45 provides adequate clearance for circuit paths.

Type U70, 3/4" diameter *miniaturized* variable composition resistor with special printed circuit terminals. Wattage rating: .3 watt for resistances through 10,000 ohms, .2 watt with 350 volts maximum across end terminals for resistances over 10,000 ohms.

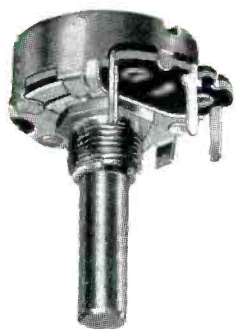

Type U45, 15/16" diameter, variable composition resistor with blade-type printed circuit terminals. Wattage rating: 1/2 watt for resistances through 10,000 ohms, 1/3 watt for resistances over 10,000 ohms through 100,000 ohms and 1/4 watt with 500 volts maximum across end terminals for resistances over 100,000 ohms.

Type GC-U45, 15/16" diameter, variable composition resistor with blade-type printed circuit terminals same as U45 except with attached SPST, 3 ampere, 125 volt "GC" type switch. Also available with type "WF", DPST, 3 ampere, 125 volt switch. (Variable resistor type WF-U45.)



CHICAGO TELEPHONE SUPPLY
Corporation

ELKHART • INDIANA

REPRESENTATIVES

Henry E. Sanders, McClatchy Bldg.
69th & Market St., Upper Darby, Penna.
Phone: Flanders 2-4420

W. S. Harmon Company, 1638 So. La Cienega Blvd.
Los Angeles 35, California • Phone: Bradshaw 2-3321

John A. Green Company, 6815 Oriole Drive
Dallas 9, Texas

IN CANADA

C. C. Meredith & Co., Ltd., Streetsville, Ontario

SOUTH AMERICA

Jose Luis Pontet
Buenos Aires, Argentina • Montevideo, Uruguay
Rio de Janeiro, Brazil • Sao Paulo, Brazil

OTHER EXPORT

Sylvan Ginsbury
8 West 40th Street, New York 18, N. Y.

Specialists in Precision Mass Production of Variable Resistors



**An Insulation
Warehouse As
Near As Your
Telephone!**

**Everything In Electrical
Insulating Materials**

**DEPEND ON IWI
FOR THESE PRODUCTS**

Varnished Cambric Products
Insulating Paper
Varnished Tubing
Saturated Sleeving
Insulating Varnish
Vulcanized Fibre
Phenolite
Fibre Wedges
Wood Wedges
Built-up Mica Products
Asbestos Insulation
Woven Glass Insulation
Pressure Sensitive Tape
Cotton Tape
Cotton Sleeving
Commutators Built To Specifications
Teflon
Silicone Resins
Silicone Insulations

INSULATION & WIRES INCORPORATED

Warehouses Strategically Located to give you service anywhere.

Nationally Advertised Quality Products, approved and used by leading electrical manufacturers everywhere.

Experienced Field Service Representatives offer technical assistance without obligation on any problem involving electrical insulating materials.

Large Stocks Of Production Materials in every warehouse. Quick delivery will eliminate many of your inventory problems.

Relay On IWI For Immediate Service, Dependable Quality

A NATIONAL NETWORK OF WAREHOUSES SERVING ELECTRICAL MANUFACTURERS

INSULATION AND WIRES INCORPORATED

3435 Chouteau Avenue • St. Louis 3, Missouri

Write For The Address Of The Warehouse Nearest Your Plant

Wrap up your circuitry in these tremendously flexible plug-ins to get these vital advantages!

- 1** GET "1-SHOT ENGINEERING" — you pre-solve Parts Design, Production Layout and Procurement all in "one shot".
- 2** SLASH ASSEMBLY COSTS — manufacture goes fast at low cost, because subdivided into units on which operations are simple and out-in-the-open.
- 3** YOUR CUSTOMERS SAY "WONDERFUL!" — Installation simplified to non-technical push-in connects done in the field as fast as unloaded. Reliability of service provided by 30-second plug in of replacement spares when tell-tales warn.

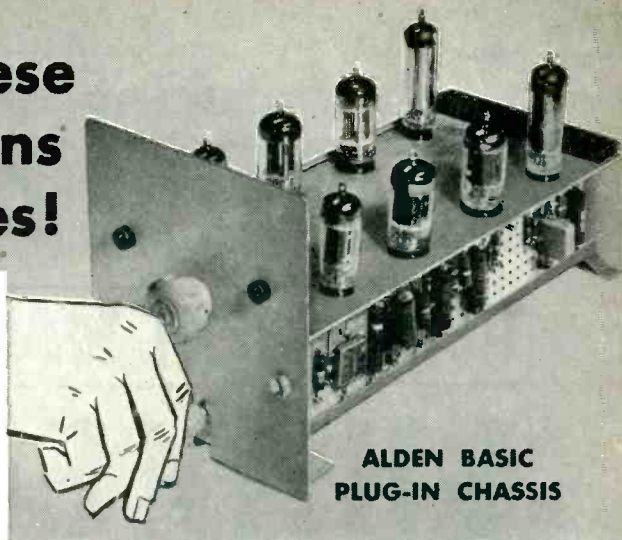

ALDEN BASIC PLUG-IN CHASSIS

To move circuitry from layout to completed equipment — IT'S AS SIMPLE AS THIS . . .

4 SIZES OF PLUG-IN PACKAGES

Alden standard Bases, Lids, Handles, Cans, Sockets for 7, 9, 11 and 20-pin packages house Terminal Card Circuitry with tremendous flexibility for endless variety of open and shielded packages . . . making it easy and inexpensive to give your equipment reliability in service with instantly replaceable plug-ins for all sub-units.

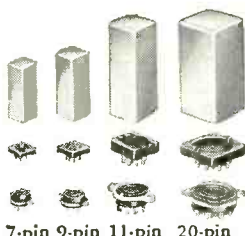

7-pin 9-pin 11-pin 20-pin
Package components and matching sockets.

4 SIZES OF ALDEN BASIC CHASSIS

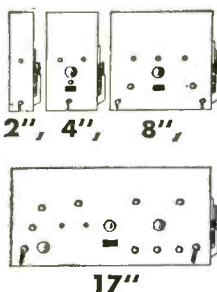

Your circuitry on Terminal Card strips snaps right into Alden Basic Chassis. Vertical mounting and hinged front panel give beautiful accessibility and space saving. Chassis can be plugged interchangeably into Standard Racks, Alden Uni-Racks, Alden Portable Cases. Alden Rack Adapter mates Standard Rack to Chassis.

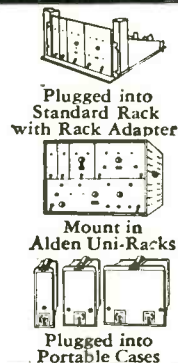

ALDEN PLUG-IN PACKAGE

Subdivided function by function, your circuitry drops naturally onto Alden Terminal Mounting Cards —

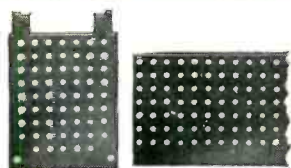

ALDEN PREPUNCHED TERMINAL MOUNTING CARDS cut to proper sizes for 7-pin, 9-pin, 11-pin and 20-pin packages. Or in 3' strips for chassis — cut it off as you require.



ALDEN MINIATURE STAKING TERMINALS Lay out in any pattern on Terminal Mounting Cards; ratchet slots hold elements for soldering without pliering or wrap-around.



ALDEN JUMPER STRIP stakes right under Terminals providing common circuit without soldering.



ALDEN CARD-MTG. TUBE SOCKETS for min. 7-pin, 9-pin and octal tubes.

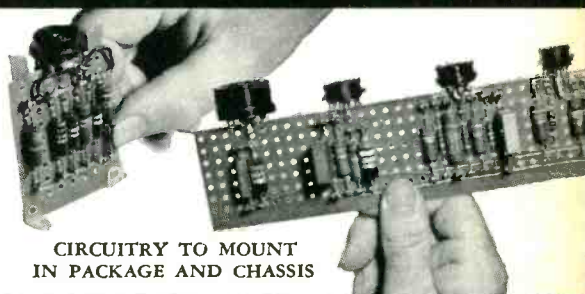

CIRCUITRY TO MOUNT IN PACKAGE AND CHASSIS

Your chassis circuitry is easily organized with 1 point of check and 30-second replacement —

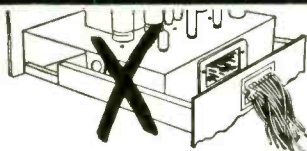

Alden's new concept in Rack-and-Panel Connectors, eliminates congested rats' nest of blind wiring and provides —

3. Critical voltages isolated by wide spacing.

4. Possible to jump contacts because both sides are instantly accessible.

1. Connectors are spread out in an orderly row, giving a central point of check.

2. All leads are instantly accessible, identified by number and color-coding.

All you need is this Kit —

3 Alden Serve-A-Unit Locks

2 Alden Lock Frame

4 Alden Back Connectors

1 Alden Slide Rails

It's as simple as this —

Arrange Alden Side Rails (1) and Alden Lock Frame (2) to suit your chassis. Alden Serve-A-Unit Locks (3) mount in your chassis to engage prepunched holes in Alden Lock Frame (2) to pilot, draw in, lock or eject.

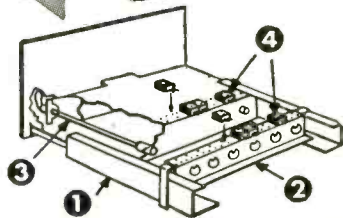

Tiny tell-tales assigned unit by unit spot trouble instantly —



See how compact front panel easily mounts six tiny Alden Sensing Elements—specifically designed to lick the problem of having only a small amount of space. Assembled by simplest methods.



ALDEN MINI-TEST POINT JACK
For checking critical voltages from front of panel.



ALDEN "PAN-i-LITE"
Miniature indicator light with unbreakable 1-piece light-lens unit replaceable from front.



ALDEN "FUSE-LITE"
Fuse blows — Lite glows. Simple unscrew 1-piece light-lens unit and blown fuse comes out with it.

GET THE COMPLETE STORY — REQUEST "ALDEN HANDBOOK" — SENT FREE

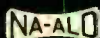

ALDEN PRODUCTS CO. 127 N. Main St., Brockton 64, Mass.



introducing the GOODMANS PERMANENT MAGNET SHAKERS

THESE shakers provide vibratory sinusoidal forces of frequency and amplitude by which specific vibratory conditions can accurately be simulated. They provide the means of assessing the effects of sudden acceleration on materials, structures and components; and are being extensively applied to FATIGUE TESTING, ELECTRICAL COMPONENT TESTING, FLEXTURE TESTING OF PLASTICS, ETC., and SPECIALISED GUIDED WEAPON RESEARCH. For certain pre-knowledge of vibration and its effects consult GOODMAN'S.

MODEL 390A A medium duty model producing an alternating force of approximately ± 25 lbs.
Thrust Force factor 4.7 lbs. per amp.
Max. Continuous Current Rating (R.M.S.) 2 amps. uncooled; 4 amps. with air cooling of approx. 5 lbs. per sq. in.
Stroke 0.5 in total excursion.
Impedance 8 ohms matching.
Frequency Range Up to 10,000 c/s.
Weight of Moving System 0.16 lbs.
Stray Fields Operating zone less than 100 gauss.
Flux Density 11,000 gauss.
Weight 26 lbs.

MODEL 790 For Vibrating heavy components, and is capable of producing a force of ± 50 lbs.
 This unit has a force factor of approximately 9.2 lbs. per amp. and a total current capacity, with air cooling, of 4 amps. (R.M.S.).
Stroke 0.5 in total excursion.
Impedance 24 ohms matching (approx.)
Frequency Range Up to 5,000 c/s.
Weight of Moving System 0.5 lbs. (approx.)
Stray Fields Operating zone less than 100 gauss.
Flux Density 11,000 gauss.
Total Weight (inc. trunnion) 70 lbs.

MODEL 8/600
 For the vibration of heavy loads or complete assemblies. Has a total force of approximately ± 300 lbs.
Stroke 1 in. total excursion.
Impedance to suit driving equipment.
Frequency Range Up to 3,000 c/s.
Weight of Moving System 6 lb. (approx.)
Stray Fields Operating zone less than 25 gauss.
Flux Density 10,000 gauss.
Total Weight (inc. trunnion) 4 cwt. (approx.)
 This unit can be fitted with (a) built in air cooling blower (b) switch to give high or low impedance armature coil and (c) pick-up unit for monitoring wave form and amplitude.

DRIVING EQUIPMENT

A range of appropriate driving equipments is available and takes the form of High-Power Amplifiers, Stabilised Power Supply Units and precision R.C. Oscillators specifically designed to give continuous power output to drive the particular shaker concerned.

MODEL V47 for the vibration of very light electronic components, optical-cell research, hair-spring torque testing etc.

Thrust Force factor 0.9 lbs. per amp.
Max. Continuous Current Rating (R.M.S.) 1.5 amps.; 2.0 amps. up to 2 min. duration.
Stroke 0.2 in total excursion.
Impedance Varies with frequency and load between 3 and 10 ohms. Up to 10,000 c/s.
Frequency Range Up to 10,000 c/s.
Weight of Moving System 6.5 grams.
Stray Fields Operating zone less than 25 gauss.
Flux Density 11,000 gauss.
Weight 2 lbs.



MODEL 390A

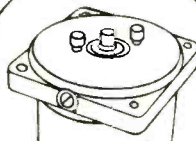

MODEL 790

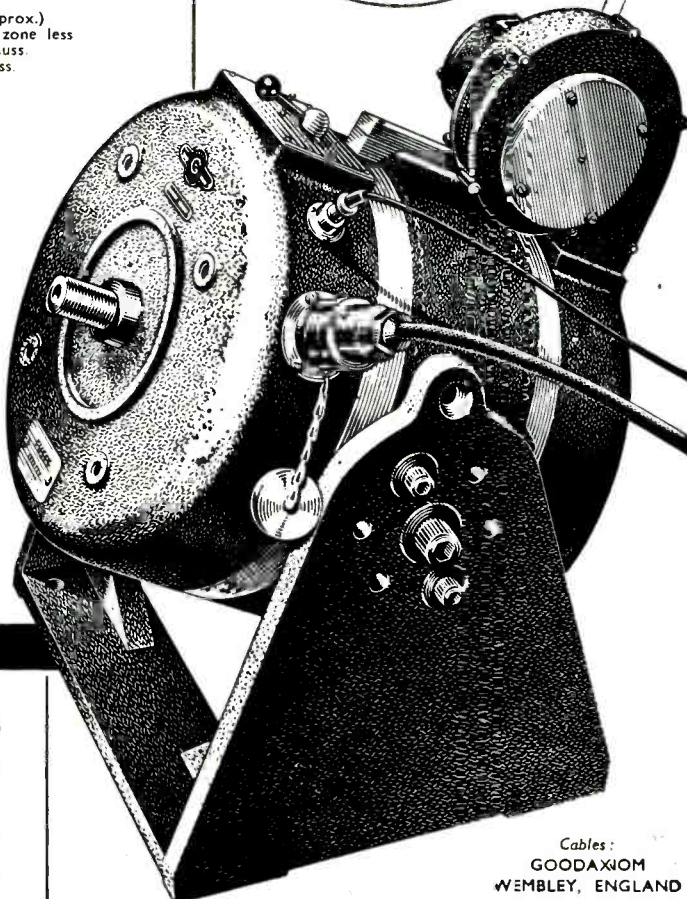
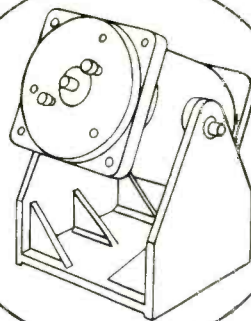

Cables:
 GOODAXIOM
 WEMBLEY, ENGLAND

GOODMANS INDUSTRIES LTD
 AXIOM WORKS · WEMBLEY · MIDDX · ENGLAND

MAIL THIS COUPON

To GOODMANS INDUSTRIES LIMITED
 AXIOM WORKS, WEMBLEY, MIDDX., ENGLAND

Please mail me your catalogue and technical data sheets in connection with your PERMANENT MAGNET Shakers.

NAME

COMPANY

CITY ZONE STATE E/U



TWO YEARS FIELD EXPERIENCE WINS TITLE... "H-H LONG-LIFE RESISTORS"

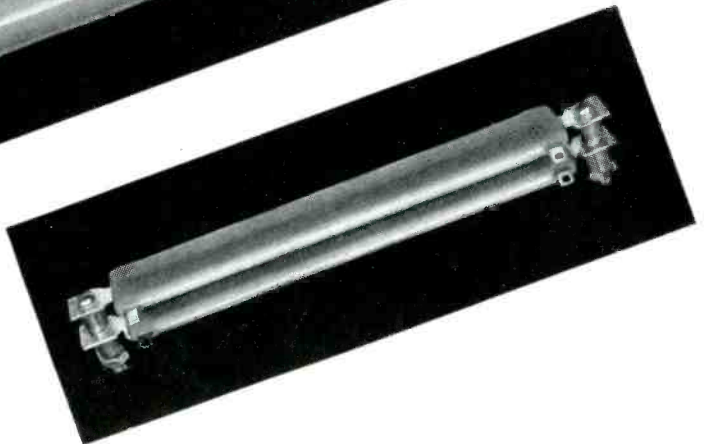

The greatly increased protection made possible by the development of our *high-temperature* gray enamel is the most important improvement of these resistors, but it is not all. True, this enamel is thermo-shock-proof and crazeless; but in addition

THESE RESISTORS OFFER . . .

- Stronger core with higher resistance to vibration and shock.
- Finer resistance wire—made to H-H specifications, especially adapted to these resistors. More uniformly wound, so that failures under stress are eliminated.

- Special alloy terminals more securely fastened to the ceramic body by spot-welding—highly resistant to corrosion.

- All wire connections are protected by a positive non-corrosive bonding.

The fixed, the ferrule and the flat types are especially designed for and manufactured in accordance with JAN-R-26A specifications.

HARDWICK, HINDLE, INC.

Rheostats and Resistors

Subsidiary of

THE NATIONAL LOCK WASHER COMPANY

Established 1886

Newark 5, N. J.

U. S. A.



the mark of quality

for more than a quarter of a century

Hardwick, Hindle, Inc.
40 Hermon St., Newark 5, N. J.

Please send additional information about your new resistors and rheostats.

Name _____

Title _____

Company _____

Address _____



*"Better take that one up with
ELECTRONIC TRANSFORMER COMPANY.
— When it comes to specials they're
always on the ball."*

Here at ETC we can start from scratch, assimilate your circuitry and follow through so that your special transformers are custom-designed and custom-built to your exacting requirements.

That's what we've been doing intensively since 1938 for both government and industry.

If the prints call for specials, our staff of highly trained transformer engineers is at your service. Supporting these experts is our modern laboratory as well as a production shop geared for transformer pilot production up to several thousand units.

Let us *prove* that we are on the ball. We'll gladly make recommendations without obligation if you outline your problem to us.

ELECTRONIC TRANSFORMER COMPANY

Transformers, Reactors and Filters Tailored to your Needs

209 WEST 25th STREET • NEW YORK 1, N. Y.

Telephone: WAtkins 4-0880

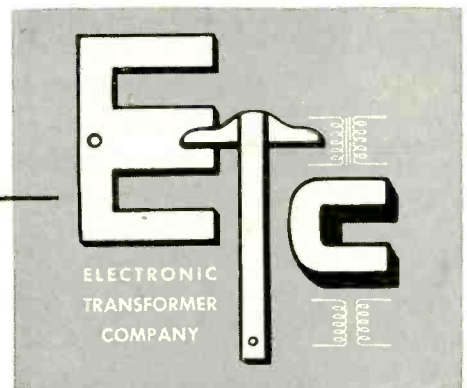



NOW in colors too ...

IRVINGTON extra-flexible Silicone Rubber-Coated Fiberglas* Tubing

The extreme flexibility of Irvington's Silicone Rubber-Coated Fiberglas—at both high and low temperatures—was an important factor in its acceptance by the electrical industry when this new Class "H" insulation was introduced almost two years ago.

Originally, Irvington Silicone Rubber-Coated Fiberglas Tubing was supplied only in white. Because of its rapidly growing use, Irvington has now taken steps to supply this tubing in a range of colors also—subject to minimum order requirements.

Immediate delivery can be made on white tubing for wire sizes from #24 to #0—prices and deliveries will be quoted on request on colored tubing.

For preliminary technical data, just mail the coupon below.

Look to
IRVINGTON
for Insulation Leadership
INSULATING VARNISHES
VARNISHED CAMBRIC
VARNISHED PAPER
VARNISHED FIBERGLAS
INSULATING TUBING
CLASS "H" INSULATION



*T. M. Reg. U. S. Pat. Off. by Owens-Corning Fiberglas Corp.

Send this convenient coupon now

Irvington

VARNISH & INSULATOR COMPANY

11 Argyle Terrace, Irvington 11, New Jersey

Plants: Irvington, N. J.; Monrovia, Calif.; Hamilton, Ontario, Canada

Irvington Varnish & Insulator Company
11 Argyle Terrace, Irvington 11, New Jersey

EL-10/53

Gentlemen:

Please send me technical data sheet on Silicone Rubber-Coated Fiberglas Tubing.

Name..... Title.....

Company.....

Street.....

City..... Zone..... State.....

Available sizes:
 4 watt...10 to 1000 ohms
 5/16" dia. x 1" long
 7 watt...10 to 5000 ohms
 5/16" dia. x 1 3/4" long

NEW!

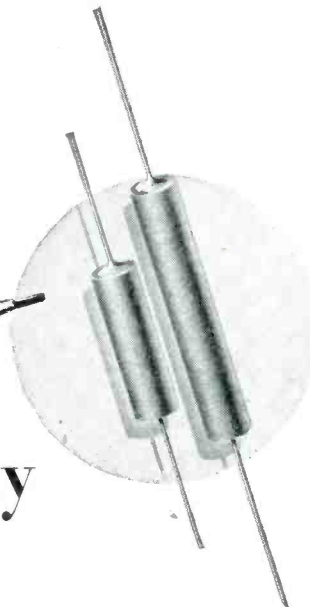

High Quality Axial-Lead Ceramic Resistors... That Are Low In Cost

THESE new resistors are designed especially for television and radio applications, where the combination of high quality and low cost is a prime requisite. They are conservatively rated... will withstand overloads up to 100% of rated value. Resistance values are held to $\pm 10\%$.

Check over these advantages... then be sure your next axial-lead ceramic resistors are Mallory.

Rigid resistance values are maintained over the entire operating range by the exclusive Mallory Yard-ohm wire. The wire is accurately wound on a braided Fiberglas core. There is no organic material to burn, blister or crack.

Securely clinched, high-grade tinned leads prevent open circuits, resistance changes and pull-outs. Resistor ends are sealed by special heat and moisture resistant compound that assures high stability... even in humid atmosphere.

Resistance element is securely held by special inorganic cement that prevents corrosion. The cement is injected under pressure to eliminate air pockets... assuring maximum heat dissipation and long life.

Sturdy, non-porous steatite tubes afford ample protection against thermal and mechanical shock.

Be sure and get in touch with Mallory engineers while your new models are still in the design stage. They will be glad to work with you... help you match related circuit components.

Expect more... Get more from **MALLORY**

Parts distributors in all major cities stock Mallory standard components for your convenience

P. R. MALLORY & CO. Inc.
MALLORY

SERVING INDUSTRY WITH THESE PRODUCTS:

Electromechanical — Resistors • Switches • Television Tuners • Vibrators
 Electrochemical — Capacitors • Rectifiers • Mercury Batteries
 Metallurgical — Contacts • Special Metals and Ceramics • Welding Materials

P. R. MALLORY & CO. INC., INDIANAPOLIS 6, INDIANA

MORE NEWS!

This factory assembled dual carbon control, with or without switch, is part of a completely new line of half-watt carbon controls for TV and radio service.

The line incorporates a new carbon element of unusual density and smoothness which assures a low noise level and greatly reduced resistance drift. They are available in resistances from 250 ohms through 10 megohms.



CROSS
TALK

► **TIMETABLE** . . . Everything points toward early adoption of NTSC-proposed compatible-color-tv standards by the FCC. The effect of the new standards upon our industry is already being widely discounted.

The speed with which color-tv will become a major factor in the market is a profitable subject for speculation. There are too many economic and technical problems still ahead to permit preparation of a bulletproof timetable, but we will say this: We're bullish on color-tv, won't sell it short.

► **ARMISTICE** . . . Since the Korean cease-fire many market forecasters have asked us how much electronics business is military and how much civilian.

The question is impossible to answer with accuracy because of the extremely varied nature of products within our field, the difficulty of determining end-point use in many cases and the fact that neither the military people nor our own draw a particularly fine bookkeeping line between electronic and allied products.

Some few manufacturers of electronic equipment are selling almost exclusively to the government, but it is our impression that these companies are for the most part small. Middle-size firms seem to have their hands about equally on both markets. Larger companies appear to be heavy on the civilian rather than the military side.

Estimates on the military slice of the overall pie range from about 20 percent to 50 percent.

We are inclined to believe that the first-mentioned figure is nearer the mark.



CURTIS WHITTLESEY MCGRAW

Everybody who knows ELECTRONICS has known Curtis McGraw, President and Chairman of the Board of the McGraw-Hill Publishing Company. The enduring mark of his leadership in the task of keeping business well-informed, shaping the technical development of industry, and holding the nation to an awareness of its power for greatness and goodness must remain on these pages. But it is something out of the lives of all of us that he died last month.

Production Techniques in

Point-contact and junction transistors require germanium slabs cut from single-crystals

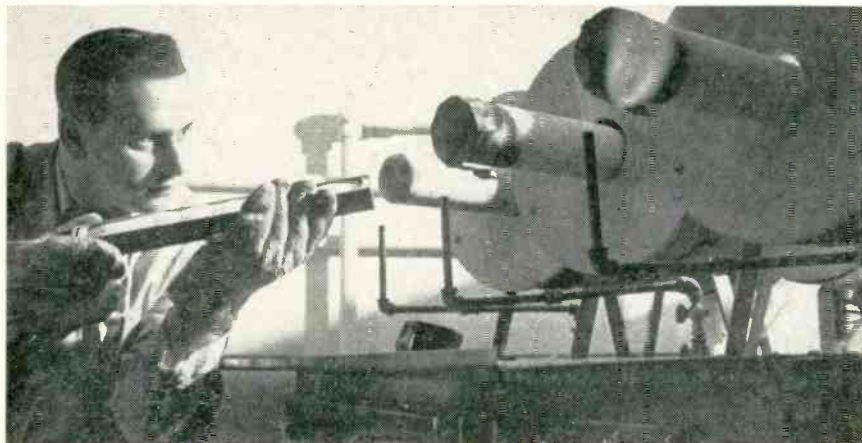

REDUCTION of germanium dioxide powder is achieved by heating in hydrogen atmosphere at carefully controlled temperatures up to 1,050 C. The metallic germanium undergoes a two-hour cooling period with the furnace turned off

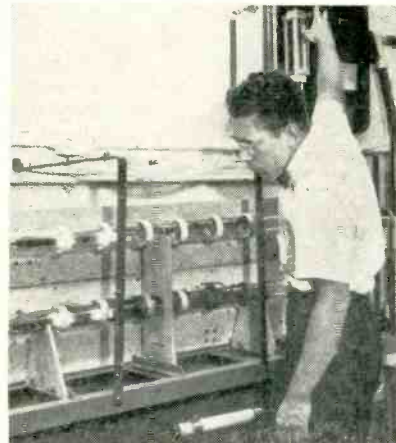

ZONE-REFINING process further purifies metallic germanium. Boats containing metal are pulled through six zones

Fabrication of point-contact units involves use of mechanical and optical aids that per-

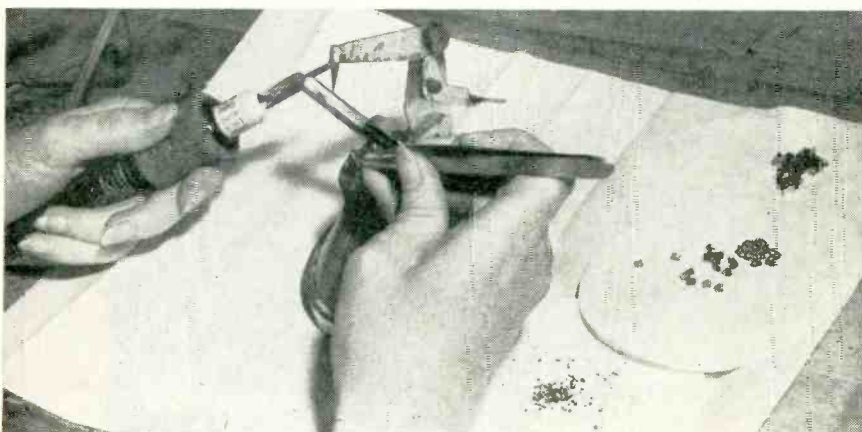

GERMANIUM PELLETS for point-contact transistor is held in place by needle-point fixture for welding to tinned shelf that also serves as base connection. Point-contact pellets are 0.045 in. square



ETCHING to ensure uncontaminated surfaces is achieved on merry-go-round fixture that moves pellets under acid

Care must be taken in encasing point-contact transistors to see that the points remain



ASSEMBLY of point-contact transistors is accomplished using high-power microscope and micromanipulator to set contacts at a tolerance of 0.00025 in.

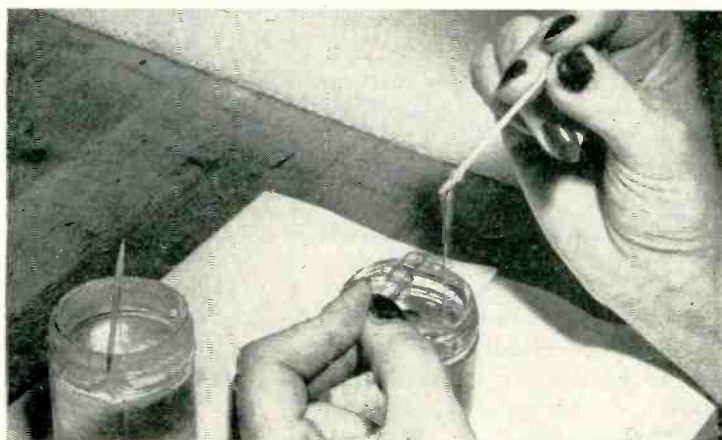

POLYISOBUTYLENE, a nonhardening resilient wax, is applied to the point-contact area to provide semi-fluid environment. A protective coating of quick-hardening polystyrene dope holds the wax in place

Transistor Manufacture

of controlled impurity . . .



GROWING of single germanium crystals comprises final step in germanium preparation. Subsequent process is sawing

mit close point spacing . . .

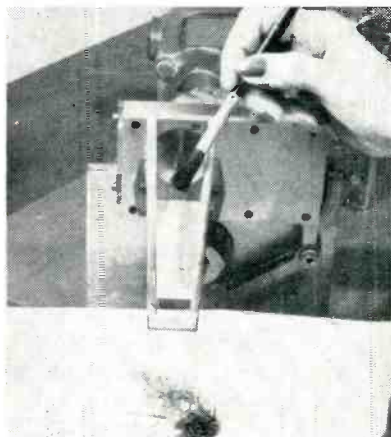

POINT CONTACTS are shaped in machine shown from spools of wire. Hair-thin contacts are visible as blur

fixed on base block . . .



ARALDITE, an opaque white plastic is poured over the transistor, using medicinal capsules as molds

Complete details of the many steps involved, including pertinent timing data, temperatures, materials, dimensions, etching and other special processes. First technical article describing transistor manufacture at RCA's Harrison plant

By **JAMES D. FAHNESTOCK**

Associate Editor, *ELECTRONICS*

ALTHOUGH TRANSISTORS are currently available on a commercial basis, many of the production methods used in their manufacture are small-scale operations in comparison with modern mechanized tube-making techniques. The processes to be described are those presently in use at RCA's commercial pilot-production setup at Harrison, New Jersey.

Industry needs for transistors are expected to exceed tens of thousands per day within a few years, and obviously automatic production methods will become mandatory to meet those demands.

Germanium Preparation

The first step in manufacturing transistors is the preparation of ultrapure germanium. The main source of germanium in this country is germanium dioxide, a by-product of the zinc-refining process. Removing the oxygen from the white germanium dioxide powder is accomplished by placing a boat containing approximately 450 grams of the oxide in a long tube inside a reducing furnace.

Inside the furnace a constantly circulating stream of dried and purified hydrogen is passed over the oxide. A cam-operated timing mechanism heats the germanium dioxide to a temperature of 650 C for 3 hours, 850 C for 1 hour, and

1,050 C for 1 hour. During this time the powder becomes metallic as oxygen is removed (in the form of water vapor) by the hydrogen.

The metallic germanium resulting from this preliminary purification process has a volume resistivity of between $1\frac{1}{2}$ and 3 ohm-cm, but is still much too variable in its characteristics for use in transistors. A second process, called zone refining, is used to further purify the metal to a volume resistivity of as high as 50 ohm-cm. The intrinsic volume resistivity for pure germanium is 60 ohm-cm.

In RCA's zone refining process, the semi-pure germanium from the reduction furnace is pulled through one of two tubes in a boat similar to the one used in the reduction furnace. The boat must pass through six sets of induction heating coils each of which heats the metallic germanium under its turns to the melting point.

As the germanium leaves the influence of each set of coils, it again cools and solidifies and since most of the impurities commonly found in germanium prefer to be in molten metal rather than in solid metal, these impurities actually move toward the trailing end of the boat in each melting zone.

The result of the zone refining process is a bar of germanium, roughly 65 percent of the weight of

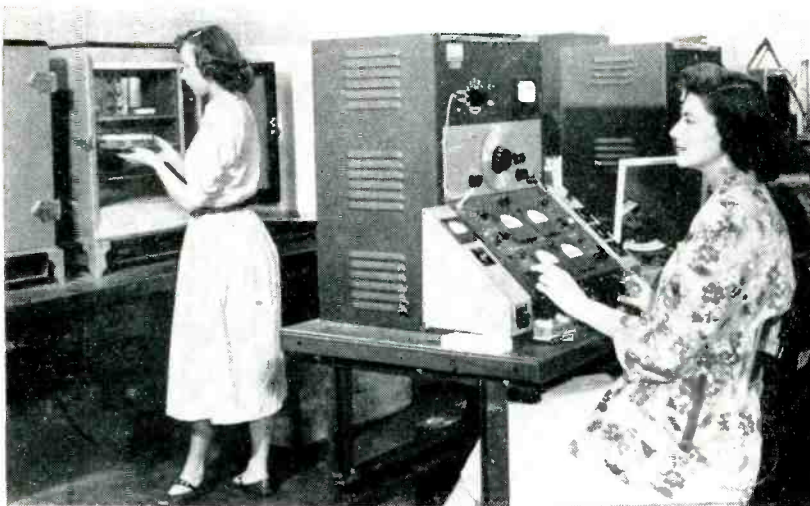

CURING AND TESTING comprise final steps in manufacture of point-contact transistors. Araldite polymerizes during 72-hour baking at 105 C. Shrinkage is held to about 0.5 percent. Testing position at right contains all necessary circuits for checking electrical parameters of transistors

eral hours. The result is a single crystal of germanium (some impurities are added prior to the growing process to obtain the desired characteristics) about as big as a thumb and six or eight inches in length. These bars are subsequently sawed with diamond wheels into minute pieces for use in transistors. The dimensions for the pellets used in point-contact transistors are 0.045 in. square by 0.010 in. thick and for the junction transistors the pellets are $0.090 \times 0.130 \times 0.005$ inch.

Point-Contact Units

The 0.045-in. square pellet coming from the diamond saw contains mechanical surface irregularities that cannot be tolerated in transistors. An even surface is obtained by placing the pellets in a pre-etch bath. After the etch, the pellet is soldered to a support that has previously been tinned (with pure tin). The tinned surface of the support is first coated with Divco No. 335 solder flux, the germanium pellet placed on this surface, and a small soldering iron is then applied underneath the support to form a bond between the pellet and the support without contamination.

The next process involves the squirting of a fine stream of hydrogen peroxide and hydrofluoric acid on the surface of the pellet as one of the final cleaning steps before

germanium dioxide used, with resistivity ranging from 50 ohm-cm at one end and falling off to about 30 ohm-cm two thirds of the way toward the end that trailed in traversing the furnace. The six-foot tubes in the zone refining machine are traversed in two to three hours in an atmosphere of 90-10 forming gas.

Crystal Growing

The proper amount of impurity is added and the bar of germanium formed into a single crystal for transistors, in the vertical "growing" machine. The zone-purified

germanium is melted in a hydrogen-atmosphere furnace. By a precise mechanical linkage a single germanium crystal or seed is carefully lowered onto the top of the germanium puddle. The germanium immediately begins to crystallize around this seed. Complete and instantaneous crystallization is prevented by mechanically pulling the crystallized part away from the melt while imparting a spinning motion. Pulling speed is approximately 0.032 inch per minute, and the forming crystal is spun about its axis at 60 rpm.

This growing process takes sev-

Processing junction transistors also requires close tolerances in dimensions, temperatures

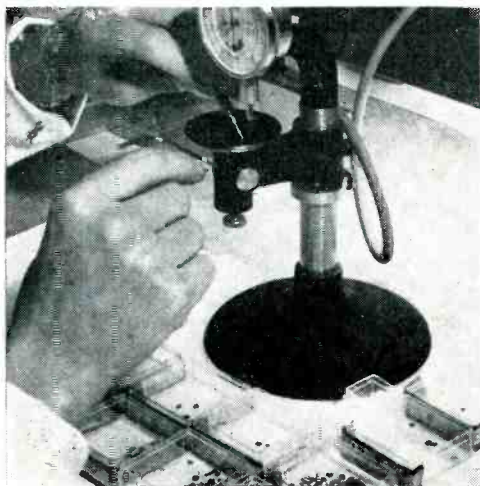

JUNCTION-TRANSISTOR base slabs are gaged to proper thickness by Ames gage. Thin slabs are rejected; thick slabs are re-etched

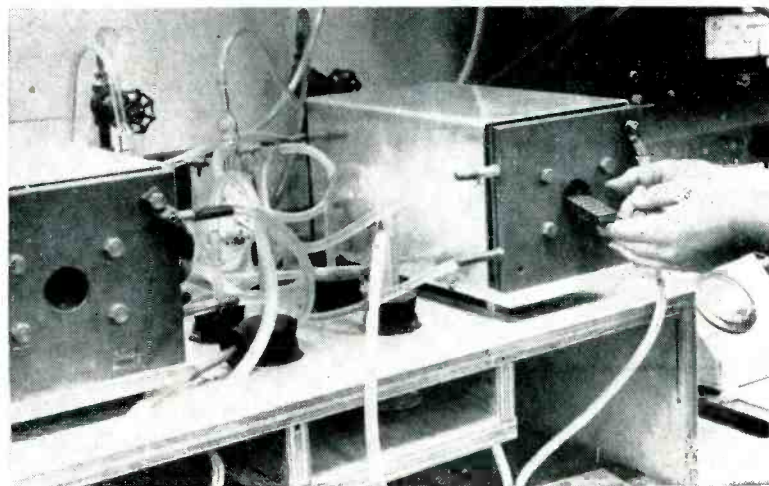

ALLOYING process takes place in hydrogen-atmosphere oven at about 550 C. Twenty-five base slabs are placed in machined holes in jig along with nickel tab that will serve as base connection

applying the point contacts. This special etching process is carried on in a merry-go-round device in which the supports are fixed to the spokes of a rimless wheel in such a way that when the wheel rotates the pellets come under the nozzles of the acid streams and subsequent wash-water streams.

Used acid is collected beneath the wheel, and only fresh acid touches the germanium. When the supports reappear at the opening, the pellets have been completely processed and are ready for the locating of cat-whisker emitter and collector and the base lead.

A preformed point subassembly comprises three parallel wires 0.018 inch in diameter and held together by a glass bead. The center lead is shorter than the two outside leads which are formed to meet at one end for temporary mechanical rigidity. This assembly is held firmly in the movable portion of a jig that also serves as one electrode of a precision resistance welder of the type commonly used in tube manufacture.

The first step in assembly is to weld the almost invisible preformed emitter and collector wires to the side rods. The latter operation is done with the aid of a 10-power microscope.

The germanium pellet and its support are next placed in the fixed portion of the jig, which is ar-

ranged to slide the points into contact with the germanium pellet. Again, using a microscope, the operator determines the position at which both emitter and collector points come in contact with the germanium plus 0.002 in., causing the cat-whiskers to exert slight pressure on the surface of the germanium. The base connection is then welded to the center lead of the glass bead assembly.

A third step in this operation, using a modified optical comparator, consists of bending the side rods closer together or farther apart to adjust spacing between the bevelled points. This process sets the spacing to within 0.00025 in. of the desired value, which is 0.0015 to 0.002 in. depending on the resistivity of the germanium.

The transistor is now assembled, but mechanical, thermal, moisture, and light protection must be added. First, a coating of polyisobutylene is applied to the contact area by an operator using a toothpick and a magnifying glass. Since this material is resilient, a protective covering such as quick-hardening Amphol 912 polystyrene is applied over it for mechanical protection. The latter hardens in air in about 3 minutes.

The point-contact transistor is finished by surrounding it with an ordinary medicinal capsule. A small paint brush and an ordinary

eye dropper are used to seal and fill the capsule with Araldite, an opaque white plastic chosen for its low shrinkage. The transistors are then baked in electric ovens for 72 hours at 105 C to polymerize the Araldite—by this treatment shrinkage is held to about 0.5 percent. The electrical forming process consists of discharging a charged capacitor across the collector-base terminals of the transistor a number of times to obtain certain specified electrical properties. This process has been discussed in the literature and will not be explained here.

Alloyed-Junction Transistors

The alloyed-junction transistor uses the same germanium base material as the point-contact transistor, but the dimensions are different as mentioned previously. A small slab 0.090 × 0.130 in. by 0.005 in. thick is desired. These slabs are saw cut slightly over-size, so that an initial etching process to obtain surface smoothness may be applied.

After this etching process, the individual slabs are gaged and divided, according to thickness, into ten groups. Those having thicknesses less than 0.0045 in. are scrapped. Those between 0.00475 and 0.00525 are suitable for use. Those thicker than 0.00525 in. are re-etched in batches for a length of

and timing. Testing before final fabrication saves time and minimizes rejects . . .

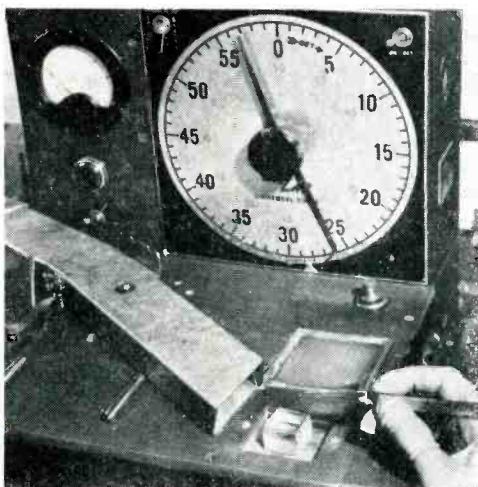

ETCHING position for germanium base with collector and emitter pellets in place. Wash bath and air blast are behind etch dish

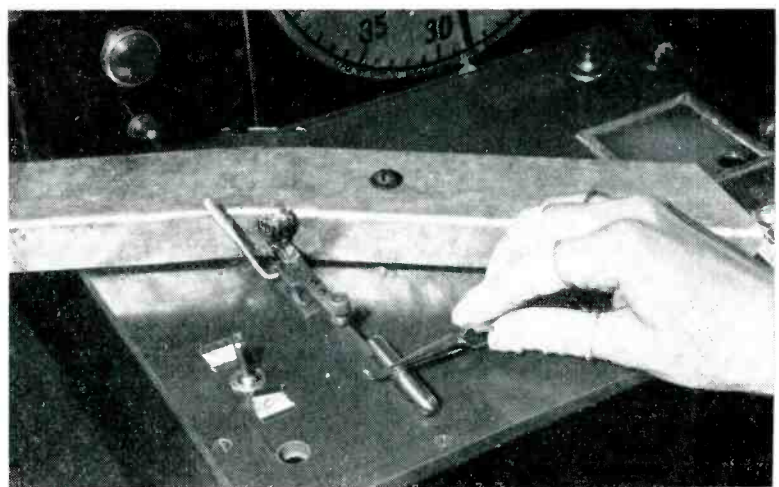

RESISTANCE of alloyed junctions is checked prior to assembly. Operator holds transistor base in tweezers that form one contact of ohmmeter which checks back resistance

Final operations on junction transistors are soldering, checking and electrical testing

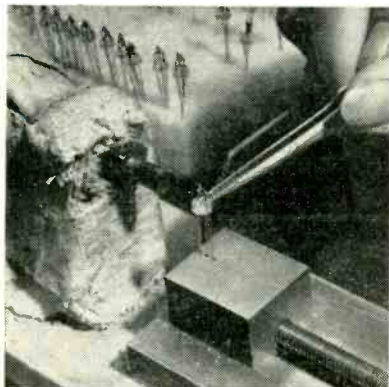

HOT HYDROGEN melts solder that attaches tinned wires to emitter and collector pellets on opposite sides of junction transistor base

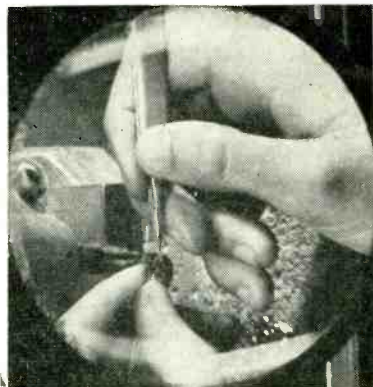

FINAL ASSEMBLY is checked for mechanical strength and arrangement of leads adjusted by inspector using pair of tweezers and magnifying glass



PLASTIC ENCASEMENT completes junction transistor manufacture. Junction is first dipped in polystyrene and then covered with black paint and Araldite

time depending on the amount of germanium to be removed. After the second etch, thickness is again checked. The slabs falling into the 0.0045 to 0.00475 in. category are held aside for a special subsequent processing.

Next comes the process in which emitter and collector pellets are fixed on opposite sides of the germanium slab. To make *pn*p junctions, indium pellets are used; for *npn* junctions, lead-antimony pellets are used. The pellets are cylindrical in shape, with an axial length thickness of 0.015 in. The emitter pellet has a diameter of 0.015 in., while the collector pellet is 0.045 in. in diameter.

Base Contact

Twenty-five of the germanium slabs are placed in precision slots in a jig. At the same time a tinned nickel tab is placed in contact with the germanium slab to serve as a contact point for the base connection. First, the collector pellets are brought into contact with one side of the wafers. The jig is then inserted in a close-fitting nichrome tube through which 100 amperes of current flows. The resulting heat penetrates the stainless-steel jig and fuses the tinned nickel tab and the collector pellet to the germanium slab.

The atmosphere in the furnace is one of purified and dehumidified hydrogen. The temperature is controlled in the range of 520 to 550 C to secure proper penetration of the

pellet material into the germanium slab. After 1½ minutes in the furnace, the jig is removed, turned over, and the emitter pellets are inserted in the smaller holes on the opposite side of the germanium. The jig is then returned to the oven for a 4-minute firing. Shorter times are used for the undersize germanium slabs.

The individual transistors are then immersed in an etch solution of nitric and hydrofluoric acids for 25 seconds to remove any contamination on the exposed junction surface, taking care not to dip the nickel tab in the solution with the accompanying possibility of cross deposition of the metal. The acid action is stopped by washing the transistor in a circulating bath of hot water and a blast of purified air removes water particles for the short-circuit test that follows.

Resistance Testing

To facilitate rapid testing for low barrier resistance, a special ohmmeter is adjacent to the etching position. The nickel tab is held in a pair of metal tweezers. The tweezers are placed across a metal bar which forms one side of a circuit containing a 3-volt battery and a 0 to 100 microammeter. The circuit is completed by bringing the collector pellet in contact with a spring contact.

A current reading of 6 μ a represents a collector barrier resistance of 500,000 ohms which is the low limit for acceptance on an initial

etch. If more than 6 μ a is indicated, the resistance is too low and the transistor is re-etched. If re-etching the second or third time is successful the transistor is accepted—if not, it is scrapped. A reversing switch on the tester permits testing of *npn* as well as *pn*p junctions.

The next step in the fabrication of RCA alloyed-junction transistors involves the connection of 0.005-inch copper-plated tungsten wires to the collector and emitter pellets and the base lead. This is accomplished by first tinning the ends of the wires with Cerrobend, a solder having a melting point of 90 C. The base wire is welded to the nickel tab by means of a small resistance welder. The emitter and collector wires, which have previously been welded to the base assembly, are brought into contact with the indium pellets in a stream of hot hydrogen. This operation is observed through a microscope to ensure a thorough bond. No flux is used in this operation. An inspector pulls on the soldered wires to insure firm mechanical bond.

The finished junction is then dipped in Amphenol 912 polystyrene. Because of the photosensitivity of the junction a coat of black paint is applied over the polystyrene and allowed to dry. The unit is then cast in room-setting Araldite using flexible molds similar to plastic ice-cube trays, to facilitate easy removal after the plastic hardens.

Backward-Wave Tube

Electron-stream amplifier utilizing backward-wave mode forms microwave oscillator continuously tunable over a three-to-one bandwidth by a single voltage control. Tubes have been built for frequency bands centering about 6,000, 10,000 and 50,000 mc

VARIATION OF electromagnetic waves along an electron stream is the principle underlying much recent work in broadband microwave amplifiers and oscillators.

The backward-wave tube is a wave-type device that can form a microwave oscillator continuously tunable over a three-to-one frequency bandwidth merely by varying a single voltage. The tube can also be made to function as an extremely narrow-band, high-gain amplifier likewise tunable by varying a single voltage. Power outputs range from milliwatts to watts.

Loaded Waveguides

Any loaded waveguide capable of slowing down an electromagnetic wave is a potentially useful circuit for a traveling-wave tube. These loaded guides can often be described simply in terms of the lumped-constant filter analogy. In a filter composed of many identical sections of the type shown in Fig. 1A, the phase shift per section is approximately given by

$$\sqrt{BX} = \omega \sqrt{LC}$$

where B is the shunt susceptance and X is the series reactance. For energy fed in at the left, the phase progresses to the right. Thus energy traveling to the right has a progression of phase or phase velocity to the right given by

$$v_p = \omega / \sqrt{BX} = \omega^2 / \sqrt{LC}$$

If L and C are made large enough, the wave travels slowly enough to keep in step with an electron beam. Figure 2 illustrates one method of loading a guide to slow down the phase velocity and indicates its equivalent lumped-constant filter circuit.

If the amplified output of the

By **H. HEFFNER**

*Bell Telephone Laboratories
Murray Hill, N. J.*

tube is fed back directly to the input, oscillations are built up at the frequency for which the output is in phase with the input. Although it would appear that the frequency could be continuously tuned by adjusting the phase shift in the feedback loop so that the total phase shift remained $2n\pi$ as frequency changed, in practice this scheme never worked very well. Since the circuit must be many wavelengths long to give reasonable gain, and the gain occurs over a large frequency range, one adjustment of the phase allowed favorable output-input addition at many different frequencies depending upon the number of wavelengths total phase shift. Thus as the phase shifter was tuned the oscillations would jump from mode to mode rather than tune continuously. Although several schemes were invented to circumvent the moding, they operated only over narrow bandwidths.

Energy traveling from left to

right along a filter composed of several sections of series capacitance and shunt inductance as shown in Fig. 1B experiences a phase advance to the right. The phase shift per section is approximately

$$-\sqrt{BX} = -1/\omega \sqrt{LC}$$

where B is the shunt susceptance and X the series reactance. The phase velocity of the wave is

$$v_p = -\omega / \sqrt{BX} = -\omega^2 / \sqrt{LC}$$

Unlike the previous case, the direction of the phase velocity is opposite to the direction of energy transfer. Thus, the circuit is said to support a backward wave.

Backward Wave

The phase velocity of a backward-wave circuit is a rapidly changing function of frequency as contrasted with forward-wave circuits, which may have an essentially flat velocity-frequency characteristic. Figure 3 shows typical variations of phase velocity with frequency for forward and backward-wave circuits. Despite the fact that a backward-wave circuit changes phase velocity rapidly with

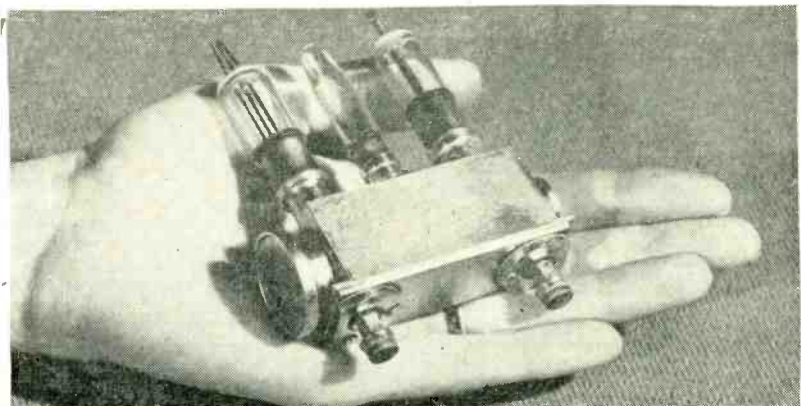

Millman 50,000-mc amplifier in which backward-wave oscillations were observed

frequency, over a large band the phase velocity may be much slower than the velocity of light.

Feedback Circuit

A backward-wave tube is shown schematically in Fig. 4. Consider a feedback loop composed of an r-f electromagnetic field propagating energywise from right to left and and r-f conduction current induced by this field flowing from left to right which itself induces the original field on the circuit.

The electric field traveling along the backward-wave circuit experiences a phase advance of $\omega L/v_p$ where L is the total circuit length and v_p the circuit phase velocity. The electric field velocity modulates the electrons within the beam traveling along with it. One quarter of a cycle later, these electrons by virtue of the speeding up or slowing down have formed bunches giving rise to an r-f current. Thus the r-f current lags the electric field by 90 deg or $\pi/2$ radians. This r-f current travels down the tube with the beam velocity, u_0 , and in a length L suffers a phase delay of $\omega L/u_0$. This r-f beam current in turn induces an electric field on the circuit. It can be shown that the conversion process introduces an additional 90-deg phase lag.

For the returned field to add in phase with the originating field, the total phase shift must be an integral number of cycles. Thus adding the phase advance on the circuit, the $\pi/2$ phase lag in converting electric field to current, the phase delay in the electron beam and the additional $\pi/2$ phase lag in converting again to the electric field gives

$$(\omega L/v_p) - \pi/2 - (\omega L/u_0) - \pi/2 = 2n\pi$$

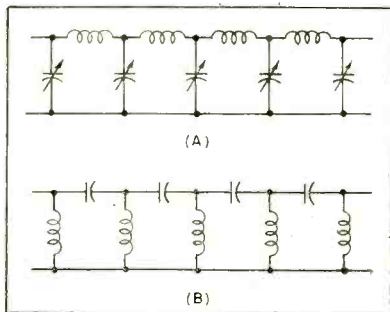

FIG. 1—Filter that propagates a forward-wave (A) and backward-wave (B)

or

$$(1/v_p - 1/u_0)\omega L = (2n + 1)\pi$$

as the condition for phase reinforcement.

Loop Gain

Integral phase shift is not the only condition for oscillation; loop gain must equal unity. Because there is loss inevitably present, the tube must amplify by traveling-wave-type interaction to satisfy this condition.

In any traveling-wave tube, the amount of amplification per wavelength is dependent upon the ratio of circuit impedance, Z , to d-c beam impedance V/I , and the difference between the electron velocity and the circuit phase velocity. The relative beam and circuit velocity is fixed by the condition that the feedback loop be an integral number of wavelengths. The condition to start oscillations is

$$ZN^3I/V = \text{constant}$$

where N is the length of the circuit in wavelengths and the constant depends upon which integer value of n is picked in the phase-reinforcement relation. As n becomes larger so does the value of the constant, indicating that more beam current is required to start oscillations for the higher oscillation points. This is to be expected since a larger value of n means that the difference between beam velocity and phase velocity is larger with the result that the wave and beam tend to get out of step, causing the amplification to fall off.

Backward-Wave Oscillator

If the beam current is adjusted to the value required to start oscillations for the $n = 0$ conditions, the

tube will oscillate at a frequency determined by the phase-reinforcement relation

$$\omega = \pi/(1/v_p - 1/v_0)L$$

When the beam velocity u_0 is changed by varying the beam voltage, the frequency also changes. Since the phase velocity of the circuit is a smoothly varying function of frequency, the frequency will be a smoothly varying function of beam velocity and the oscillator will exhibit no holes or jumps. It will be continuously voltage tunable.

Backward-Wave Amplifier

Such a regenerative-type oscillator acts as a high-gain amplifier when operated just below the start-oscillation current. The gain is a maximum for the frequency at which the length of the feedback path insures exact phase addition and falls off rapidly as the frequency changes and the feedback goes from positive to negative. Gains of 40 to 50 db can be achieved depending upon how close the beam current is to the start-oscillation value. Figure 5A shows a typical variation of gain as a function of current. The formal relation of gain as a function of current at the frequency of maximum gain may be expressed as

$$\text{Power-gain ratio} = K/(I - I_0)^2$$

where K is a constant depending upon the impedance and tube length and I_0 is the start-oscillation current.

Gain falls off rapidly away from the critical frequency-velocity point where the feedback is positive, that is, when circuit phase shift minus beam phase shift is equal to π . Since for many tubes, the magni-

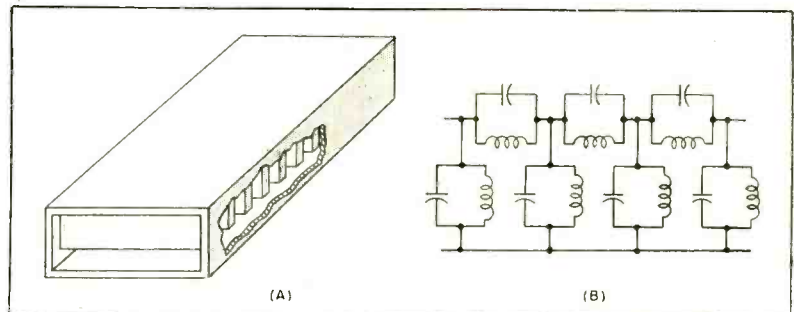

FIG. 2—Loaded waveguide (A) and its equivalent representation using the lumped-constant filter analogy (B)

tudes of these phase shifts may be near 100, it requires only a small frequency change to make their difference vary from π to 2π resulting in a change from positive regenerative feedback to negative degenerative feedback. The effective Q of the backward-wave amplifier is defined as the ratio of the frequency deviation required to reduce the gain by half to the frequency of maximum gain. On this basis, backward-wave tubes have been built which have values of Q running into the thousands. These tubes have been constructed not only in the centimeter-wave region but also in the millimeter-wave band where cavity Q's above several hundred are nearly impossible to attain.

Selectivity and Bandwidth

Figure 5B illustrates the variation in amplification with frequency in the backward-wave amplifier. As the beam current becomes closer to the start-oscillation value the maximum gain increases but in addition the gain curve becomes more sharply peaked indicating that the effective Q increases with increased current.

The phase-shift relation that insures regenerative feedback indicates that the entire gain curve can be shifted along the frequency axis by merely changing beam velocity. Thus it is possible to build a high-gain microwave amplifier that can be swept over a wide band at rates up to several million times a second and can distinguish with a high degree of resolution between two signals differing only slightly in frequency.

Bandwidth of a backward-wave oscillator depends upon the circuit

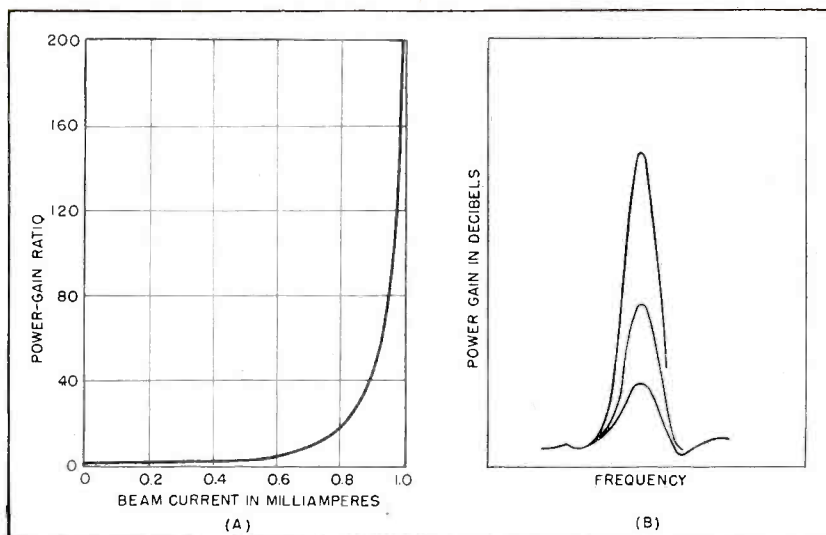

FIG. 5—Variation of backward-wave gain with beam current (A) and power-gain as a function of frequency (B)

used, its pass band and the detailed phase velocity variation of frequency. See Fig. 3. The oscillation bandwidth can be no greater than the circuit bandwidth, but it can be less. For example, the phase velocity can become so high that it is difficult or even impossible for electrons within the beam to travel fast enough to satisfy the phase relation for regeneration. Nevertheless circuits are known that allow the frequency to be tuned over a three or even four-to-one ratio. A backward-wave oscillator has been built that will tune anywhere from 3,000 to 9,000 mc.

Other Advantages

Another great advantage of the backward-wave tube is its immunity to frequency pulling. Unlike the magnetron and the klystron, the frequency of oscillation does not change as the impedance of the load is changed. This characteristic makes unnecessary the

insertion of an isolation element such as a fixed attenuator between oscillator and load.

The efficiency of early backward-wave oscillators, defined as the ratio of r-f power developed to d-c beam power, was low, probably less than one percent. Since then, by the use of better circuits and better focused electron beams, the efficiency and the power output have been increased such that a group working at Stanford University has reported continuous power outputs of 125 watts with 12-percent efficiency.

Frequency modulation of a backward-wave oscillator is obtained by varying the beam voltage, while amplitude modulation results from beam-current variations. The resultant modulation of the backward-wave oscillator, in common with most electron-beam-type oscillators, is not pure frequency or pure amplitude variation. There is a small amplitude variation as beam voltage is changed and a small frequency variation as beam current is changed. These effects are not so pronounced as they are in the klystron but under certain circumstances they may be troublesome enough to require correction.

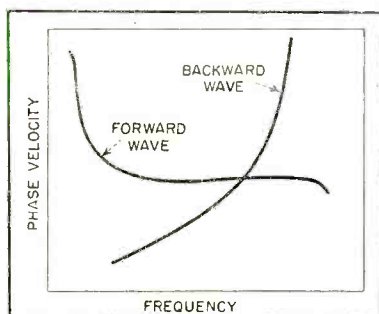

FIG. 3—Phase-velocity variation in forward and backward-wave circuits

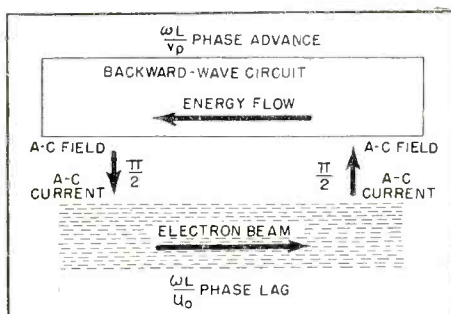
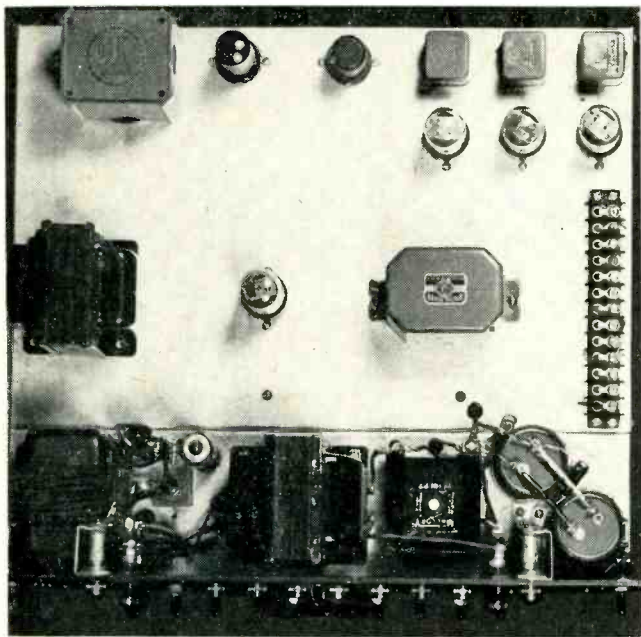

FIG. 4—Operating principle of backward-wave tube

BIBLIOGRAPHY

- S. Millman, A Spatial-Harmonic Traveling-Wave Amplifier for Six-Millimeters Wavelength, *Proc IRE*, p 1,035, Sept. 1951.
- H. Heffner, Stanford University E. R. L. Tech. Rpt 48, June 18, 1952.
- H. R. Johnson and J. R. Whinnery, Traveling-Wave Tube Tunes Electronically, *ELECTRONICS*, p 177, Aug. 1953.
- R. Kompfner, Backward-Wave Oscillator, *Bell Labs. Record*, p 231, Aug. 1953.



Top view of control chassis

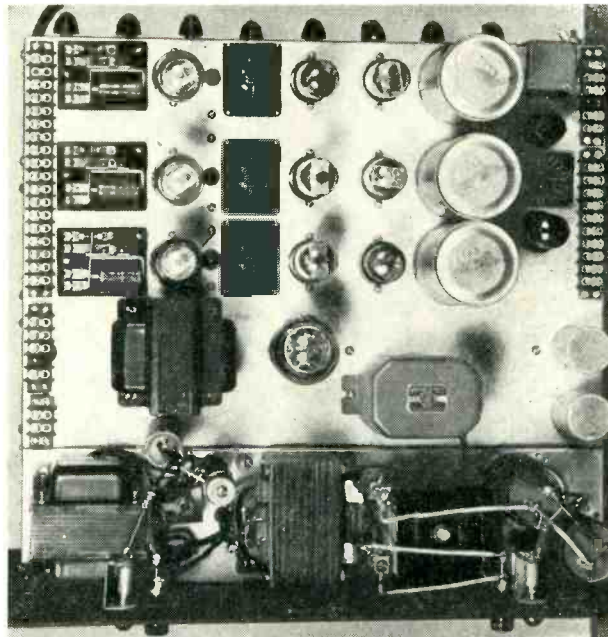

Top view of remote chassis

Remote-Control System

By A. V. TIDMORE

Owner and General Manager
WPPA
Pottsville, Pa.

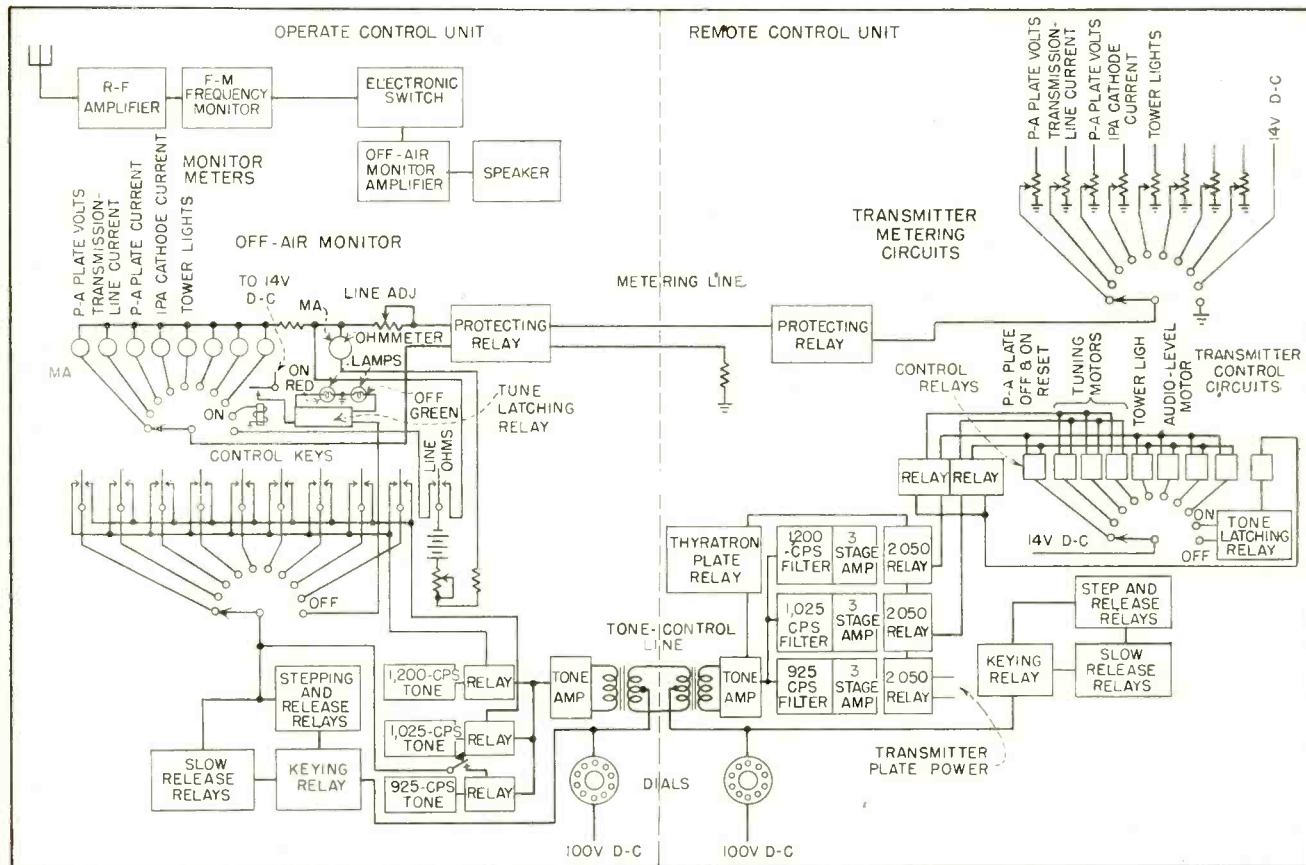

FIG. 1—Block diagram of complete transmitter remote-control system

TABLE I—FCC SPECIFICATIONS FOR TRANSMITTER
REMOTE-CONTROL EQUIPMENT

The equipment at the operating and transmitting positions shall be on the premises under the control and supervision of the licensee at all times and shall not be accessible to persons other than the licensee or his agents.

The control circuits from the operating position to the transmitter shall provide positive on-and-off control and shall be such that open circuits, short circuits, grounds or other line faults will not actuate the transmitter; and any fault causing loss of such control will automatically place the transmitter in an inoperative condition.

A metering system shall be provided so that the operator at the remote-control position shall have indications of the operating constants of the last radio stage (total plate current and plate voltage) and the r-f transmission-line meter reading.

Means shall be provided for calibration and adjustment of the metering system to provide the accuracy prescribed in the Standards of Good Engineering Practice concerning f-m broadcast stations.

Means shall be provided so that the operator at the remote-control position shall have an indication as to the condition of the tower lighting.

Frequency and modulation monitors shall be installed at the remote-control position to indicate continuously the carrier frequency and percentage of modulation.

Provision shall be made so that the necessary tuning of the transmitter and control of its output can be accomplished from the remote-control position

For F-M Broadcasting

Positive and fail-safe operation of remote f-m broadcast transmitter is achieved using stepping-switch function selector and audio-tone control working over telephone lines.

Remote metering circuits monitor five important circuit functions

REMOTE CONTROL of WPPA's transmitter is provided by the equipment to be described. The operate-control unit is located at the a-m transmitter site and the remote-control unit is installed at the f-m transmitter ten miles away. Two telephone lines are used to operate the transmitter. One line connects meters mounted on a panel at the operating location to appropriate circuits at the transmitter. The other carries dial impulses and audio tones to tune the transmitter. Output of the f-m transmitter is monitored off the air by a vhf receiver installed at the operating point.

Metering Panel

Six quantities are metered remotely: power-amplifier plate voltage, transmission-line current (in percent of maximum), power-amplifier plate current, intermediate-power-amplifier cathode current, number of tower lights lit

and resistance of the metering line. Lamps on the metering panel indicate the condition of the tuning-control latching relay. A red lamp indicates that the latching relay is in ON position and that the transmitter is tunable by remote control. The green lamp denotes that the relay is in OFF position and that remote controls are inoperative.

The function to be monitored is selected by a telephone-type dial that sends a series of d-c pulses over a phantom circuit on the tone-control line. The number of pulses corresponds to the number dialed and actuates a stepping-switch relay that selects the transmitter function to be monitored.

Tuning is accomplished remotely by a tone-control system. Transmission-line current and power-amplifier grid and plate currents are adjusted by tuning motors in the transmitter. Audio tones sent over the line in response to left or right motion of double-throw key-

type switches determine whether the tuning motors will advance the controls clockwise or counterclockwise. Audio tones are also used to turn the plate-reset relay off and on and to control tower lights. A separate audio tone holds the transmitter plate relay on and releases in case of control-equipment or line failure, putting the transmitter off the air.

Ten lamps on the control panel show what transmitter function is currently being monitored. Many of the fuses in the remote-control equipment are equipped with failure-alarm lamps to facilitate troubleshooting. Table I lists specifications for transmitter remote-control equipment as established by the Federal Communications Commission.

Dial System

The block diagram, Fig. 1, shows the operate-control unit at the a-m transmitter and the remote-control

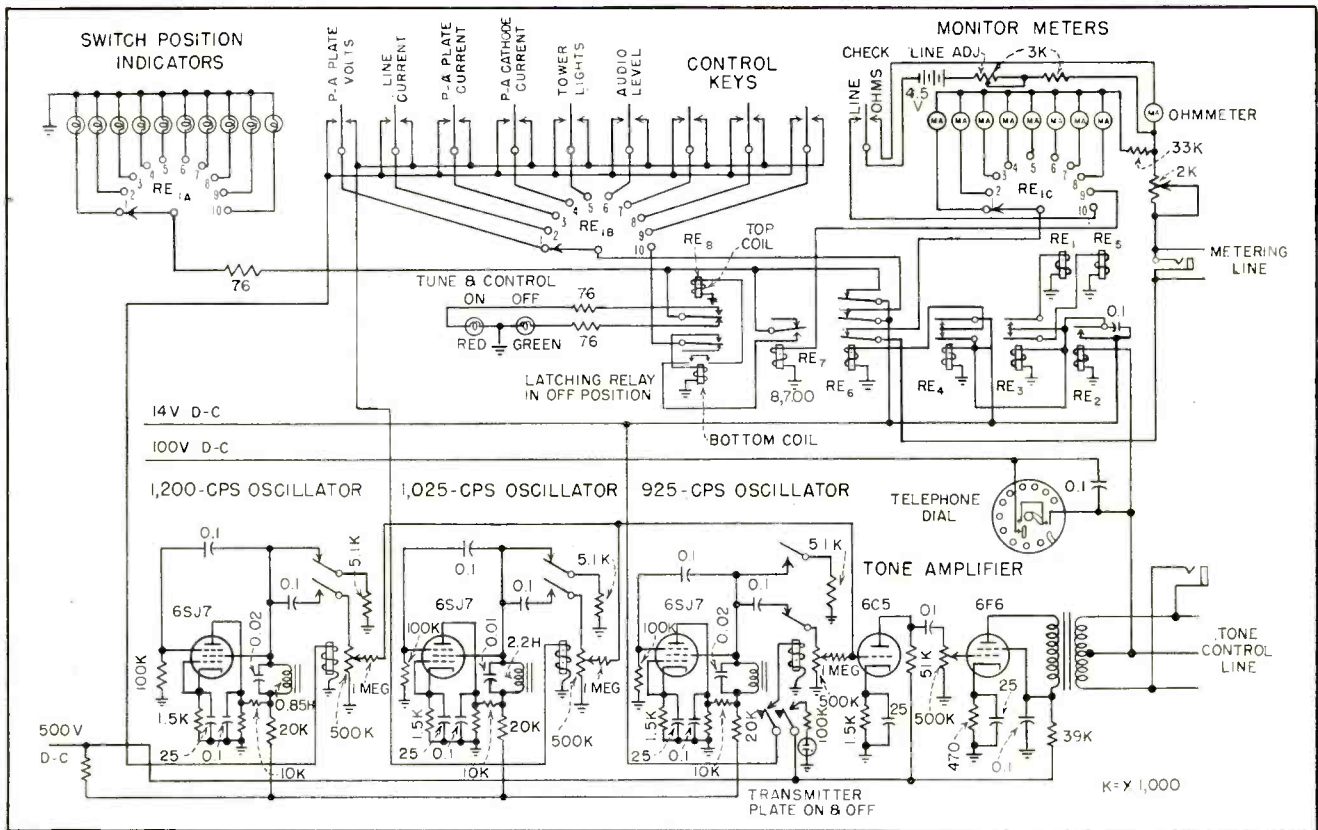

FIG. 2—Operate control unit includes three audio oscillators that provide control tones

unit at the f-m transmitter. Both are coupled to the connecting telephone line through transformers. The center tap of each transformer is connected to ground through a keying relay. Either telephone dial puts 100-volt pulses on both keying relays so the system can be operated from either the operate or remote-control point. This allows the engineer to check equipment performance by operating it at the remote site. Dial points and keying-relay contacts have 0.1- μ f capacitors connected across them to suppress arcing.

When either telephone dial is dialed clockwise, a pulse or pulse train is impressed from the center taps of both transformers to ground through the two keying relays. The keying relay in the operate-control unit is shown in Fig. 2 and the keying relay in the remote-control unit may be seen in Fig. 3. Both relays are designated RE_2 . Dialing circuits for both units are practically identical.

The keying relays close intermittently at both transmitter and control point in response to pulses from the telephone dial. This supplies 14 volts d-c to a pair of slow-

release relays, RE_3 and RE_4 . Protecting relays, RE_5 , prevent voltage from arcing on the contacts of the stepping-switch relay, RE_1 , during the switching operation. The protecting relays are energized through the normally-open contacts of slow-release relays, RE_4 , and are kept energized through the normally-closed contacts on the same relays while they are energized.

Before slow-release relay, RE_3 , can operate in response to the signal from the keying relay, the release relay, RE_5 , is actuated through the normally-closed contacts of the slow-release relay. The release relay resets the stepping relay, RE_1 , to its initial position. The stepping relay is then energized through the normally-open contacts on the slow-release relay, RE_3 , and the stepping switch is set to position 1.

When number 1 is dialed, no pulses are applied since the stepping relay is automatically set to position 1 as it comes to rest. The dial pulse consists of removing the 14 volts d-c for a fraction of a second.

When number 2 is dialed the counterclockwise movement of the

dial impresses one pulse on the tone-control line to ground and also across keying, stepping and slow-release relays. The dial pulse has no effect on the slow-release relays but actuates the stepping relay, moving the switch arm to position 2.

Ten positions can be achieved with nine pulses from the telephone dial. The stepping relay automatically resets on each clockwise motion of the dial. When the dial is at rest, all relays are deenergized. The pulses of the dial can be heard by connecting a pair of earphones from the center tap of either line transformer to ground.

Operate-Control Unit

The operate-control unit incorporates three audio oscillators that generate control tones for the f-m transmitter. Transistron oscillators tuned to 925, 1,025 and 1,200 cps are coupled to the tone-control line through a two-stage amplifier. The 1,025 and 1,200-cps tones control transmitter switches and tuning motors when actuated by tuning-control key switches. The 925-cps tone is always on the line when the transmitter is operating under remote control. It actuates the

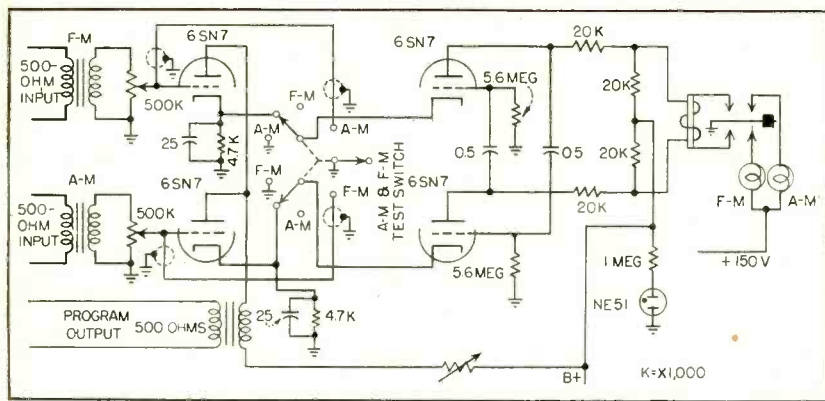

FIG. 5—Electronic switch permits simultaneous monitoring of α -m and f-m signals

control can be actuated, it is first necessary to place the latching relay in ON position. This is done by dialing number 9. This connects 14 volts d-c to the line to energize the sensitive relay, RE_7 , in the operate-control unit. The sensitive relay in turn applies 14 volts d-c to the latching relay RE_8 , turning it on. The ON position is indicated by a red lamp. With the tuning-control latching relay in ON position, RE_7 , and RE_8 , in the remote-control unit are energized. These relays are in the tuning-control circuits and permit the control relays to be actuated in response to tone signals.

When number 10 is dialed at either control point, the tuning-control latching relay is placed on OFF position.

Remote-Control Unit

The signals from the tone-control line are transformer-coupled to a two-stage audio amplifier. After amplification, the audio tones are separated by three parallel band-pass filters sharply tuned to 925, 1,025 and 1,200 cps respectively. The output each filter is amplified, rectified and applied to the grid of a 2050 thyratron. Each thyratron has a relay in its plate circuit that is energized when the tube conducts. The 925-cps tone is always on the line and the output of this channel keeps the transmitter plate relay energized.

The 1,025 and 1,200-cps channels carrying tuning control signals. The switch arm of deck number three of the stepping switch selects a set of relays from RE_{11} to RE_{13} depending upon the number dialed by the operator. These control relays actuate tuning motors or throw

switches depending upon the transmitter function being adjusted. The relays are energized when current flows in the thyratron relay tube and the frequency of the audio tone thus determines the direction of tuning-motor rotation.

Number-two deck of the stepping switch connects one of ten indicator lamps to give visual indication of the position of the arm. Number-one deck is connected to 8 potentiometers. One end of each potentiometer is connected to its individual transmitter metering circuit. The other end is connected to ground. The potentiometers are adjusted so that remote meter readings correspond to meter readings of the f-m transmitter. Transmitter meter readings are taken from the ground side of the transmitter circuits. Protective parallel resistors are placed in circuits where high voltage is found. Should one of the resistors open or become defective, high voltage will not appear in the remote-control units. Since it was impossible to get a true sampling current from the p-a grid and still keep one side

of the transmitter metering circuit grounded, the ipa cathode current is metered instead.

CONELRAD

The remote-control equipment complies with the CONELRAD requirement. The transmitter is taken off the air if any of the following units fail: tone-control line, two-stage tone preamplifiers, 6F6 plate-relay circuit (the 6F6 plate removes the 110 volts a-c from the thyratron), 925-cps sharp-band-pass filter, three-stage amplifier, thyratron control tubes or the d-c plate voltage supply.

R-F Amplifier

The frequency and modulation monitor is operated off the air by picking up the f-m signal on 101.9 mc, at the operate-control point using an eight-element Yagi antenna and amplifying the r-f signal in the four-stage r-f amplifier shown in Fig. 4. Several low-power tubes are used to reduce television interference. The r-f amplifier can pass f-m with sufficient bandwidth. The d-c power supply is electronically regulated.

Electronic Switch

The off-the-air audio monitor is operated by an electronic switch (Fig. 5) through the use of a multi-vibrator circuit. The f-m and a-m monitoring program is fed to the master monitoring amplifier with three-second periods of f-m alternating with three-second periods of f-m and a-m. Lamps indicate which program is in operation. The f-m and a-m signals can be monitored separately by turning the test switch to the left for f-m or to the right for a-m. The center position is used for the a-m and f-m monitoring.

Tower-Light Metering

The tower-light metering circuit is shown in Fig. 6. This consists of a current transformer and a full-wave selenium rectifier. This unit is calibrated to register on the meter the exact number of lamps lit. Arrangements are also provided for talking between operate and remote-control points by capacitively connecting a telephone to the metering line.

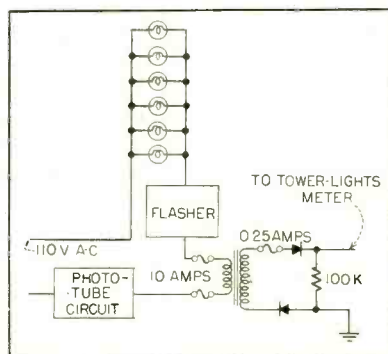

FIG. 6—Simple circuit indicates number of tower lights burning

Magnetics In Geology

Three-coil sensing head and bridge circuit measure the magnetic susceptibility of rocks in the ground for correlation with readings obtained with airborne magnetometer. Change in self-inductance of coil ordinarily caused by rock irregularities is avoided in design that is also independent of frequency

By **HAROLD MOONEY**

*Assistant Professor of Geophysics
University of Minnesota
Minneapolis, Minn.*

INTERPRETATION of aeromagnetic measurements must generally be made in terms of magnetic rock studies since the magnetic effect produced by a given structure depends upon the contrast between it and surrounding rock. The instrument to be described was developed for measuring magnetic susceptibility of rocks in place.

All previously published data on the magnetic susceptibilities of rocks have been based on laboratory methods using a few grams of sample. It has been shown¹ that many such measurements are needed to describe adequately the magnetic properties of a large rock body.

Reducing Errors

Measurements made on the rock in place should reduce sampling errors, since the effective volume of rock under measurement is several thousand times greater than for laboratory measurements. It should eliminate changes in magnetic properties produced by crushing or

grinding, eliminate demagnetization errors and permit direct correlation with geology.

The basic instrument consists of three coils and a portable bridge for measuring mutual inductance. Coils A and B are connected in series, so wound that their fields nearly cancel at the position of coil C. Mutual inductance between C and

the system A and B then reduces to a small value, about 200 μ h for the particular arrangement used here. When the assembly is placed on a rock surface, asymmetry of the coil system causes the mutual inductance to change. Magnetic susceptibility of the rock can be related to measurable electrical quantities through the following analysis.

The mutual inductance between two coaxial circular coils is

$$M = 8 \pi n_1 n_2 \sqrt{r_1 r_2} \left[\left(1 - \frac{t^2}{2} \right) K - E \right] 10^{-3} \mu\text{h}, \quad (1)$$

where $K(t)$ and $E(t)$ are complete elliptic integrals of the first and second kinds, $t^2 = 4 r_1 r_2 / [(r_1 + r_2)^2 + z^2]$ and n , r and z represent respectively number of turns,



Surveys with sensitive magnetometer suspended below plane indicate possible presence of iron ore and oil in land below

Table I—Coil Characteristics

	Coil A	Coil B	Coil C	
Radius in Cm	9.8	31.0	9.8	No. 29 Formex
Number of Turns	227	200	200	
Resistance in Ohms	39.1	109.0	34.5	
Self Inductance in Mh	27.2	74.9	18.539*	
Mutual Inductance with Coil C in Mh	-2.334	+2.543		*Effective value, determined indirectly Calculated

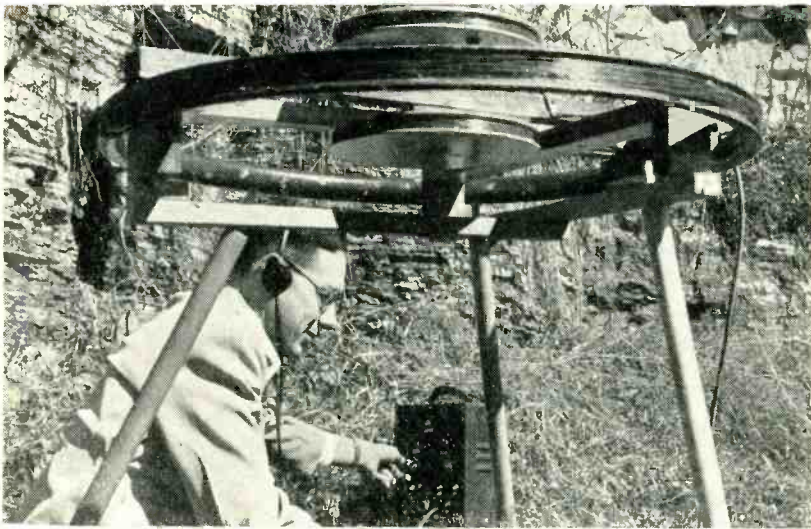

Analysis of airborne magnetometer findings depends upon field surveys. Portable instrument mounted on tripod is also used directly above rock formations

radius in cm, and axial offset in cm.

Smythe² derives an equivalent equation. The change in mutual or self-inductance owing to the rock can be calculated in terms of the mutual inductance between a particular coil and the image of the same or another coil. The image, of strength $2\pi k/(1 + 2\pi k)$ where k represents magnetic susceptibility, is located at the reflection position.

Inductance Calculation

To illustrate, the mutual inductance between two coplanar coils 5 cm above the level surface of a rock of susceptibility k would be determined from the above formula with $z = 0$. The change in mutual inductance ΔM due to the rock would be calculated by the same formula with $z = 10$ and M multiplied by $2\pi k/(1 + 2\pi k)$. A change in self-inductance can be computed as the mutual inductance between the coil and its image.

It is convenient to separate each of the results into a factor G dependent on the geometry of the system and a factor $k/(1 + 2\pi k)$ involving only rock susceptibilities. The effects produced by the rock can then be written as a change in mutual inductance $\Delta M = G_1 k/(1 + 2\pi k)$ and a change in self-inductance $\Delta L = G_2 k/(1 + 2\pi k)$, where each G is the sum of one or more terms in the form of Eq. 1. Typical values for G_1 and G_2 are 9,608 and 10,220 microhenrys, calculated for

the dimensions shown in Fig. 1.

Let it be assumed that the magnetic properties of the rock have changed the apparent coil constants to $M + \Delta M$, $L_c + \Delta L_c$, and $R_c + \Delta R_c$; the bridge is now found to balance at $R_1 + \Delta R_1$, $R_3 + \Delta R_3$. By substituting these new values into the balance conditions shown in Fig. 2 it may be shown that

$$\frac{\Delta R_3}{R_3} = \frac{M \Delta L_c - L_c \Delta M}{(L_c - M)(M + \Delta M)} \quad (2)$$

where the changes are not restricted to small values because products such as $\Delta R_3 \Delta M$ have not been dropped. Approximating $L_c - M$ by L_c , the final relationship becomes

$$\Delta R_3 = \frac{k}{1 + 2\pi k} \frac{\frac{R_2 R_3}{R_2 + R_3} G_2 - R_3 G_1}{M + G_1} \frac{1}{1 + 2\pi k} \quad (3)$$

The bridge readings give R_3 , ΔR_3 and (from the balance conditions) M . The unknown k can then be calculated from the electrical and geometrical constants of the system. In principle, M should be constant for a given coil arrangement, but temperature change and mechanical shock produce small changes that cannot be neglected.

For this reason each susceptibility determination is preceded by a base reading of R_3 , on a tripod well away from the rock. A small correction for the effect of the rock must be applied to the tripod reading. In practice, Eq. 3 is plotted as a calibration curve of k vs ΔR_3 , using three values of R_3 as param-

eter for each point of the curve.

The unusual coil arrangement of Fig. 1 minimizes an important source of error, that due to irregularities of the rock surface. The calibration equation assumes an infinite plane surface; failure to satisfy these assumptions may produce large errors.

Rock Irregularities

It has been shown¹ that, for this instrument, a hemisphere of 50-cm radius will approximate an infinite half space. In addition, Eq. 3 can be used to demonstrate that, with a proper choice of coil arrangement, the electrical change ΔR_3 produced by a given rock can be made to pass through a maximum as the coils are lifted from the rock surface. The maximum occurs at $F = 3.3$ cm in Fig. 1.

At the peak, therefore, small errors in measuring F produce only slight errors in ΔR_3 . This predicted effect has been verified experimentally. To the extent that surface irregularities are equivalent to an error in measuring F , the coil arrangement of Fig. 1 will minimize their effect.

Paterson³ and Duffin⁴ have described instruments for determining magnetic susceptibility on rock outcrops. Paterson measured the change of self-inductance of a coil laid on the rock; Duffin measured mutual inductance for the three coplanar coils of a model 625 mine detector. Maximum sensitivity for both instruments coincides with maximum variation with distance from the rock surface, as shown in Fig. 3. As a result, surface irregularities can cause large errors.

To provide comparative data on outcrop vs laboratory measurements, a laboratory instrument similar to one described by Duffin was constructed. Coils were so wound that the same measuring circuit could be used as for the outcrop instrument.

Circuits

The complete circuit shown in Fig. 4 includes oscillator, bridge and detector.

The null-measurement characteristic of a bridge was chosen over a direct-reading meter to avoid un-

certainties produced by variable oscillator output and variable amplification. The circuit, essentially a Heydweiller bridge, has three features desirable for this application: balance conditions are independent of frequency, so oscillator stability is not critical. Both variable adjustments are resistive and balance conditions are independent, which permits quick, accurate balancing.

To provide the desired accuracy, changes in R_3 must be measurable to about 1 part in 5,000 (although R_3 itself need not be known this closely). Resistance R_3 has been built up, therefore, as a series of five fixed and one variable resistor as shown in Fig. 4. Individual shorting switches across the fixed resistors permit coarse variation in R_3 . A type-A Helipot, linear within 0.5 percent, provides the required accuracy in the variable resistance.

Resistance R_1 includes components similar to R_3 . It has not proved necessary to measure the out-of-phase component given by R_1 , although this could be used to determine rock conductivity.

The chief requirement on the fixed bridge components is stability rather than precision, since the actual values can be measured on a laboratory bridge. Wire-wound resistors and a mica capacitor provide this stability.

Oscillator

The oscillator circuit includes a 1G6 duotriode oscillator, a 1G4 buffer-amplifier, and a 1G6 push-pull triode output. Requirements of the oscillator include low harmonic content, fair amplitude and frequency stability, frequency low enough to avoid effects due to rock conductivity and output voltage sufficient

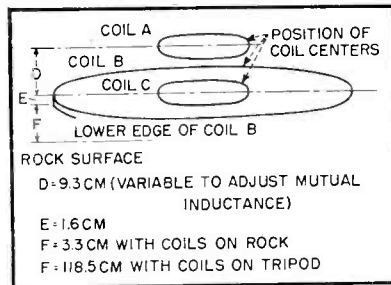

FIG. 1—Design of three-coil sensing head

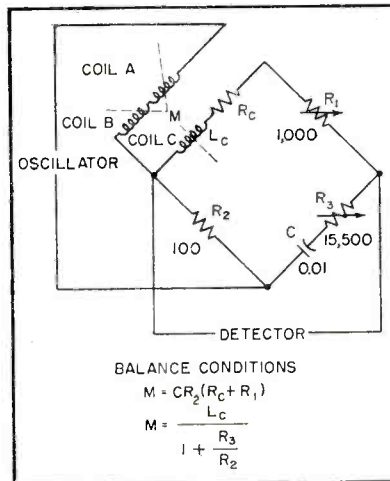

FIG. 2—Diagram of bridge circuit using three coils

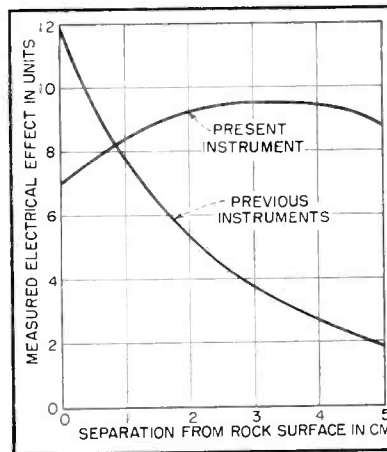

FIG. 3—Improved performance of new magnetic instrument shown graphically

to produce a magnetic field of 0.5 oersted near the coils.

Geologic considerations dictate the last requirement; rock susceptibility varies with field strength, so measurements should be made at a magnetic intensity roughly equal to that of the earth. This requires about 15 v input to the bridge circuit, a setting that is made by means of a dropping resistor at the grid of the buffer tube.

The oscillator combines simplicity with stability. The tuned grid circuit using a toroidal permalloy inductor determines the frequency of 975 cps. Cathode coupling introduces negative feedback for amplitude stability.

The buffer stage proved necessary to maintain good waveform. Power is supplied by three flashlight cells and a 90-volt battery. The oscillator is completely shielded.

Output from the bridge feeds through a step-up transformer and volume control to the grid of a 1U4. Two stages of class-A R-C amplification lead to a cathode follower, which provides an impedance match to the phones. The plate circuits are tuned to 575 cps, well below the oscillator frequency, to reduce harmonics. The maximum voltage gain is 1,325, input transformer to phones. This characteristic drops 0.5 db at 975 cps, 4 db at 1,950 and 25 db at 4,875 cps.

REFERENCES

- (1) H. M. Mooney, Magnetic Susceptibility Measurements in Minnesota. Part I, *Geophysics* 17, p 531, 1952, Part II, *Geophysics* 18, 1953.
- (2) W. R. Smythe, "Static and Dynamic Electricity". McGraw-Hill, 1950.
- (3) R. G. Paterson, Determination of Magnetic Susceptibilities of Rocks in Situ. *Am. Inst. Min. Met. Eng. Transactions*, 164, 1915.
- (4) R. J. Duffin, Measurement of Magnetic Susceptibility with the Hughes Induction Balance, *Terr Magn Elec* 51, p 419, 1946.

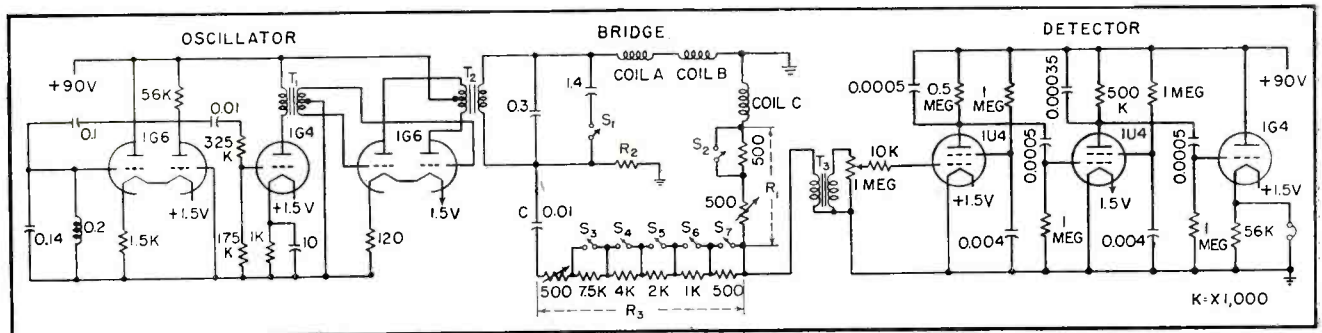
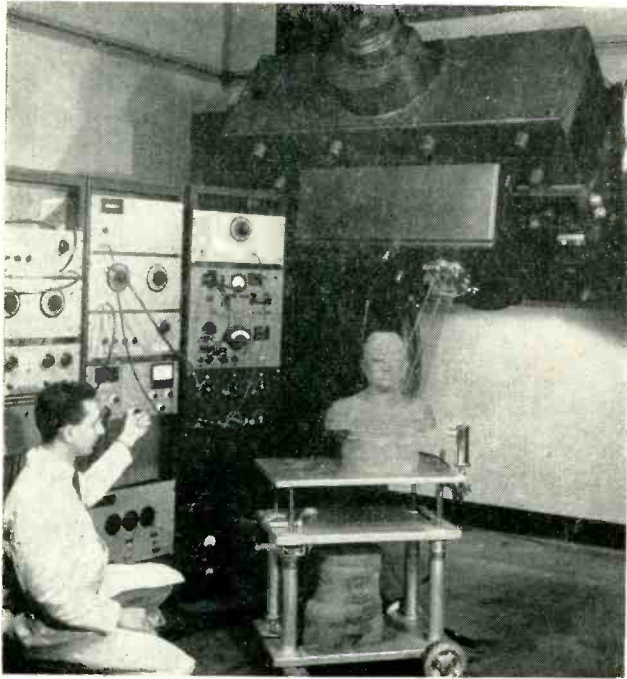

FIG. 4—Oscillator, bridge and detector units are battery powered for portability in the field



Wooden phantom constructed to simulate density of the human body is used to determine dosages from 24-mev medical betatron. Scintillation crystal placed within phantom transmits light to multiplier phototube in housing, right

THE BASIC BETATRON

The betatron is a magnetic-induction accelerator in which electrons are continuously accelerated in a circular orbit by a changing magnetic field. The evacuated acceleration chamber, or donut, has a toroidal shape. The time rate of increase of flux in the core of the magnet at the center of the donut produces a continuous increase in momentum of the electrons.

As the momentum of the electrons increases, the field intensity at the orbit must be increased to keep the electrons in a stable orbit of fixed radius.

Radial and vertical stability are obtained by shaping the magnet pole faces. At approximately 12 microseconds following zero field, electrons are injected into the donut. The injector consists of a tungsten filament mounted inside a molybdenum grid and plate structure having an opening in the direction of injection.

After the electrons have been injected, they are continuously accelerated by increasing magnetic flux. When the electrons have reached the desired energy they can either be brought out as a beam or caused to strike a target mounted in the donut and produce x-rays.

In the Memorial betatron, a shunt consisting of laminated magnetic material with high permeability and high limit of saturation is used to extract the beam. It contains a horizontal slot tangent to, and just outside the equilibrium orbit of the electrons. When the electrons have been accelerated to the desired energy, an automatic pulse through a coil inside the equilibrium orbit causes the instantaneous electron orbit to expand to larger radii. The

High-Power Betatron

Twenty-four mev medical betatron irradiates deep-seated tumors with minimum damage to surrounding tissue. Electronic equipment controls acceleration of electron beam and measures high-energy x-ray output

IN THE last two decades a variety of high-energy accelerators have been built to operate at continually increasing energies. Though most of these accelerators have been used almost exclusively for nuclear research, the betatron has found practical applications in medical therapy and diagnosis in hospitals and medical institutes.

Low-energy x-ray beams produced by ordinary medical x-ray equipment produce their maximum dose on the skin, do not penetrate to great depths in tissue, are not well defined because of scatter and are particularly destructive of bone. The high-energy x-ray beam pro-

duced by the 24-mev betatron at the Sloan-Kettering Institute, Memorial Center for Cancer and Allied Diseases, New York has been effective in irradiating deep-seated tumors in the human body with minimum damage to surrounding tissue. The electron beam of the betatron can be used in the treatment of lesions near the surface with a minimum of penetration.

Electronic Equipment

All of the timing and control operations of the 24-mev medical betatron, as well as associated instruments for various measurements, involve electronic circuits.

Accurately timed pulses a few microseconds in duration are required for injection of the electrons and expansion of the orbit. This pulse timing is critical and must be adjustable to a fraction of a microsecond.

Primary Power Circuit

The primary betatron power circuit is shown in Fig. 1. The primaries of the static frequency-tripling transformers are wye connected and the secondaries are in delta connection. In the saturation range of the silicon-steel tripler transformers, the third harmonic is approximately 60 percent

shunt provides a field-free region where electrons entering the slot can escape the guiding magnetic field.

The presence of this magnetic shunt inside the donut perturbs the orbit somewhat at injection time and prevents the capture by the orbit of all the injected electrons. This effect is minimized by placing around the shunt a coil that is energized at injection time in such a way as to oppose the magnetic field induced in the shunt.

X-rays are produced by having an accelerated beam of electrons strike a target. The relative efficiency of electrons for the production of x-rays depends on their energy and the atomic number of the target material. The higher the energy of the electron and the greater the atomic number of the target material, the greater is the percentage of the energy of the electron that will produce x-rays.

As is true of all x-ray spectra produced by electrons striking a target, the spectrum of x-rays from the betatron is continuous. The maximum energy of the x-rays is determined by the maximum energy of the electrons. Taking into consideration the relativistic change of mass of the electron, the maximum energy of the betatron is

$$E = 3 \times 10^{-4} Hr - 0.51$$

where H is expressed in gauss, r in cm, and E in mev. In the Memorial betatron, H is a little over 4,000 gauss, r is about 20 cm and the maximum energy is 24 mev. To reach this energy the electron makes approximately 250,000 revolutions during the quarter cycle of $1/720$ second



Betatron control room has water window through which operator can watch patient under radiation. High-energy x-ray beam makes possible treatment of deep-seated tumors with minimum damage to surrounding tissue

for Cancer Therapy

By J. S. LAUGHLIN, J. OVADIA, G. SHAPIRO and Z. ABDUN-NABI

*Department of Physics and Biophysics
Sloan-Kettering Institute
Memorial Center for Cancer and Allied Diseases, New York, N. Y.*

of the fundamental. The other harmonics are suppressed or negligible. A capacitor neutralizes the inductance of the tripling transformer. The capacitance in the tuned betatron circuit consists of four banks of air-cooled capacitors with approximately $41\frac{1}{2}$ μf in each bank.

An auxiliary transformer provides 180-cps power for other circuits. The betatron's main tuned circuit is resonated by varying the number of capacitors in the bank or by varying the inductance. The inductance can be adjusted by changing the air gap in the three legs of the betatron magnet.

Injection of electrons occurs in a burst a few microseconds in duration about 12 microseconds after the magnetic field passes through zero. Injection voltage and injection time are related so that the momentum of the injected electrons will equal the momentum equivalent of the magnetic field of the equipment.

Injection voltage is usually set somewhere in the neighborhood of 60,000 volts, which corresponds to 12 microseconds after zero-field time for the 24-mev betatron.

Figure 2, shows the essential features of the injection circuit. Capacitor C is periodically charged

through the power supply and is discharged when the 5C22 hydrogen thyratron is triggered. The capacitor discharges into the injector pulse transformer producing a secondary pulse of 60 kv, negative with respect to ground.

Pulsing

The output winding of the filament transformer is connected to the pulse-transformer secondary so that the betatron's filament is pulsed approximately 60 kv negative with respect to the plate which is grounded. A grid structure partially surrounds the filament and is attached to it. The grid focuses

the electrons from the filament towards the opening in the plate. The plate and grid are constructed of molybdenum, and the filament is made of thoriated-tungsten wire.

The trigger pulse originates in a secondary winding on a strip of high-permeability material across the gap of the pulse transformer in the primary betatron circuit. This strip is saturated during all of the cycle except when the current and magnetic field pass through zero. The reversal of flux in this strip at that time induces the trigger pulse at zero-field time. A bias winding fluxes the strip to change the time at which the strip actually passes through its zero-field value. By changing the current in the bias winding the pulse can be varied for approximately 40 microseconds on either

side of normal zero-field time.

Contraction

The entire injector structure is at a larger radius than the equilibrium orbit. If all the injected electrons are to be captured in the equilibrium orbit, it is important that they do not strike the injector structure on their first few revolutions after injection. This requires that their instantaneous orbit radius be rapidly contracted to the radius of the equilibrium accelerating orbit.

Contraction of the orbit of the rotating electrons at the critical injection time is facilitated by providing flux in opposition to the main field flux by the circuit of Fig. 3A. Two coils having a radius slightly greater than the normal orbit are located on the poles of the betatron, one above and one below the donut. When the GL-5632 thyatron is triggered, the contractor coils are essentially shorted through a 25-ohm resistor. The main magnetic-field flux passing through these coils will induce a counteracting flux in the opposite direction that serves to contract the orbit.

Since the thyatron is triggered at zero-field time when the time rate of change of flux is maximum, the contraction effect is also maximum at this time. As the magnetic-field intensity increases and the time rate of flux change decreases, this contraction effect becomes less important, disappearing by the time maximum acceleration is reached.

The thyatron is triggered by a

pulse from a winding on another strip of high-permeability material on the same pulse transformer used to trigger the injector circuit. A separate bias winding is provided for this strip so that the actual time at which the thyatron is triggered can be varied to produce maximum capture of electrons during injection.

Expansion

To produce x-rays the electrons are deflected from their normal equilibrium orbit and caused to strike a target. In this betatron the target is mounted on the end of the injector, just outside the normal equilibrium orbit. To strike the target, the radius of the beam orbit must be increased. The flux through the orbit is increased by passing a current pulse through two series-connected coils located above and below the donut on the poles of the betatron. The coils have a radius slightly smaller than the equilibrium orbit. Figure 3B shows the circuit employed to pass the current pulse through these coils.

Since the electrons have their maximum energy when the magnetic field has reached its maximum value, expansion is timed to occur at the end of the quarter cycle when the field is at its maximum. Capacitor *C*, of Fig. 3B, is periodically charged through an FG-280 mercury-vapor rectifier. The power source can be either the auxiliary transformer in the primary betatron circuit or a couple of windings around one of the legs of the betatron magnet. When the GL-415

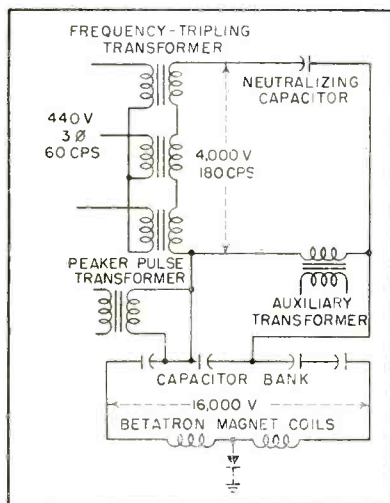

FIG. 1—Primary power circuit of betatron. Magnet coils and capacitor bank form 180-cps tuned circuit

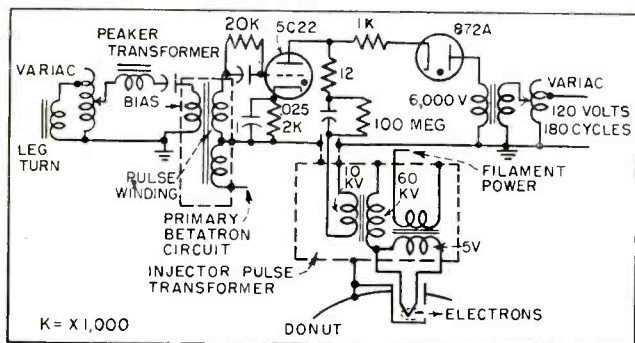
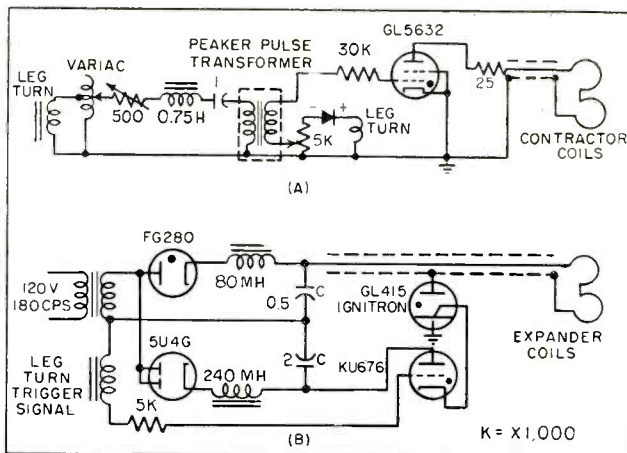

FIG. 2—Electron injection system. Electrons are injected into donut by 60-kv pulse every 1/180 second

FIG. 3—Contractor (A) and expander (B) circuits bring electron beam into proper orbit, expand it to hit x-ray producing target



cene crystal. Fluorescence caused in this crystal by absorption of the radiation is amplified by a 1P21 multiplier phototube. This signal is applied to the grid of a 6AK5 used as a cathode follower to feed an oscilloscope.

The anthracene crystal has a response time of 10^{-8} sec and radiation-pulse widths of less than a microsecond are easily displayed. The width of the betatron beam can be varied from less than a microsecond to over 100 microseconds. The injection pulse can be displayed simultaneously on the oscilloscope with the radiation pulse, and the time between these pulses, normally $1/720$ sec, can be measured.

Beam-Energy Control

The maximum energy of the x-ray beam or the absolute energy of the homogenous external electron beam can be varied from 2 to 24 mev. This is accomplished by varying the maximum amplitude of the magnetic-field intensity. The internal electron beam is still expanded against the target or into

the magnetic shunt, depending upon whether an x-ray or electron beam is desired, when the field is at its maximum. The energy is proportional to the value of this maximum-field intensity at the orbit.

Calorimetric Measurement

Although the output of the betatron is continuously monitored with an ion chamber, a further measurement is necessary for absolute calibration. This is accomplished by totally absorbing the x-ray beam in a thermally insulated absorbing block. Under certain conditions the total heat rise in this block is equal to the total energy absorbed from the beam.

The temperature rise in the absorbing block is measured with thermistors. A thermistor in one arm of a bridge circuit is mounted in the beam-absorbing block and a thermistor in a nonirradiated block is used in an opposite arm. Precision resistors are used in the other arms of the bridge and the unbalance of the bridge is amplified by a chopper amplifier.

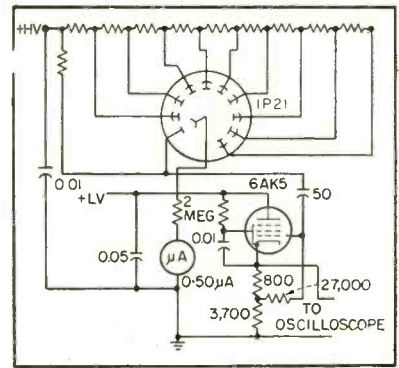

FIG. 5—Pulse monitor measures duration of radiation burst from betatron

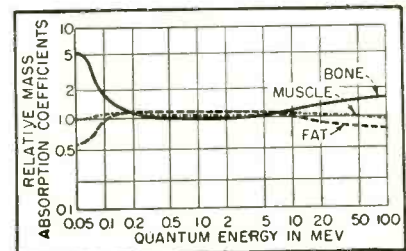
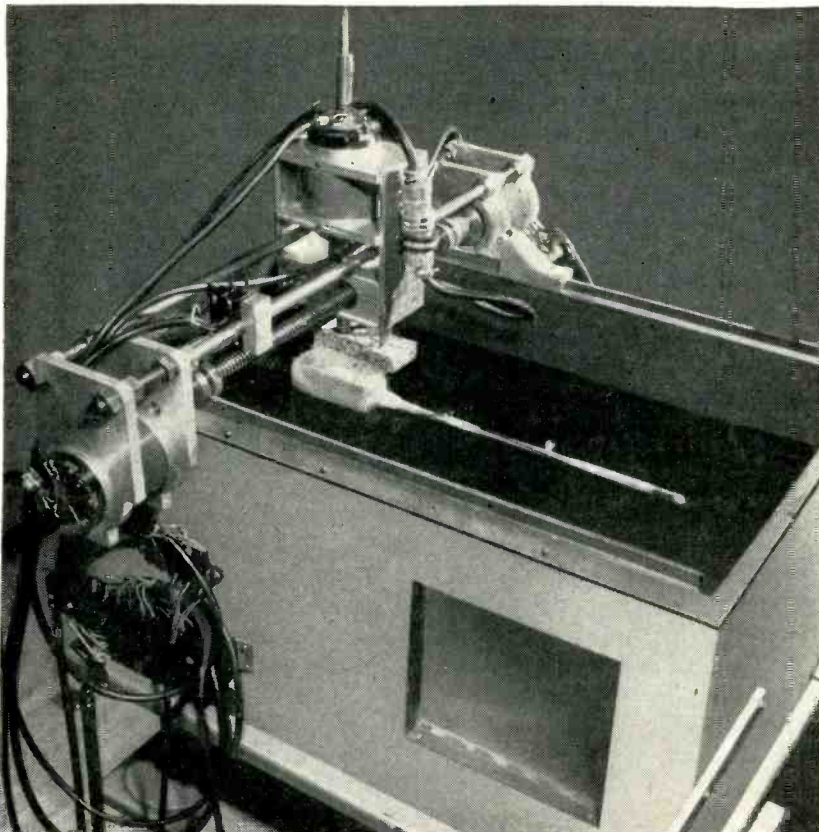

FIG. 6—Absorption coefficients of body tissues. At higher beam energies the absorption values are about the same

Use of a chopper amplifier makes it possible to utilize a-c amplifier stability for a small d-c signal. The output of this amplifier is recorded on a strip-chart recorder. It is possible to measure temperature changes of the order of 10^{-5} deg C with this calorimeter.

Automatic Isodosimetry

In conducting a cancer treatment with the betatron it is important for the doctor to know precisely what dose he is giving the lesion and any other irradiated portions of the patient's body. The absorption of radiation by the human body can be simulated very closely by water or with wood having a unit density. A large water bath used for dose measurements is shown in the photograph. A small ionization chamber is positioned inside the water tank, usually termed a water phantom, to measure ionization. An ion chamber is located on the end of a rod attached to a preamplifier. The output of the preamplifier goes to a d-c linear amplifier in the control room. The actual position of the small ion chamber in the water phantom can be controlled from the control room by synchro motors. The betatron output is measured by an ion cham-



Water bath with ion chamber used for plotting isodose curves that indicate regions of like dosage produced by x-ray beam

ber connected to another d-c amplifier and the ratio of these two ion currents is measured by a third amplifier. By making ratio measurements, fluctuations in the output of the betatron do not affect the measured dose distributions. A scintillation crystal and multiplier phototube can be used alternatively with the ion chamber and preamplifier.

A servo loop to balance the output of one amplifier against the other is used to obtain the ratio. By incorporating the position of the small detecting ionization chamber into the overall servo loop, a balance is obtained for any preset ratio. An isodose curve representing the contours of the region in which the dose is uniform, is obtained when the detector chamber is scanned across the x-ray beam. A complete set of isodose curves can be obtained automatically for a horizontal plane. As shown in the illustration, wood phantoms can also be used for determination of the dose at any desired point in a simulated human body. The lungs are represented with cork, and air passages are present as in the normal body. Films are also used as well as ion chambers and scintillation crystals in this phantom.

Medical Applications

Use of high energy betatron x-rays in cancer therapy has the advantage of low skin dose. Great penetration is also possible because of the high energy of the x-rays, making it possible to produce an effective dose at great depths in the body.

Maximum radiation dose is produced 3 to 5 cm below the skin of the patient and side scatter is negligible. At these energies the beam is well defined permitting effective localization of the dose. As indicated in Fig. 6, when high-energy x-rays are used, bone does not absorb any more per unit mass than tissue. This consideration removes a serious limitation present in lower-voltage therapy.

In Fig. 7, top, the path of a high-energy x-ray beam from the betatron is shown on a film. This film was mounted inside a block of tissue-like material and exposed

with the film parallel to the x-ray beam. The film density is proportional to radiation dose. The minimum dose on the skin, the maximum at a depth of a few cm, the lack of side scatter and the great penetration are evident. These factors make this type of beam particularly applicable to deep-seated lesions in the human body.

Absorption of Electrons

Absorption of electrons is quite different from the absorption of x-rays. In a substance of low atomic number such as water or human tissue, over 90 percent of the energy of the electron will be absorbed by ionization and excitation processes.

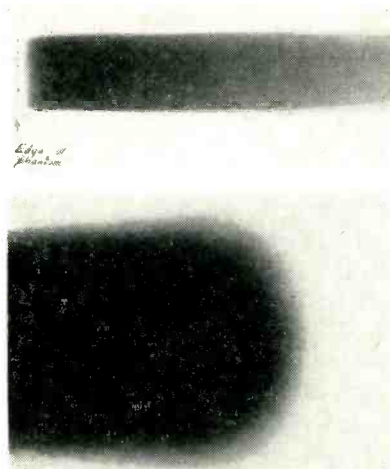

FIG. 7—The x-ray beam, top, produces a narrow beam of great penetration in phantom body with minimum exposure near the surface. High-energy electron beam, bottom, has uniform exposure to a definite, adjustable depth. Radiographs not to scale

These processes occur with uniform probability over most of the length of the electron track. As a consequence, the energy dissipated by the electrons is fairly uniform along the beam and terminates very abruptly at a definite range. The range of the electrons in tissue or water is directly proportional to the energy. An approximate rule is that the electrons penetrate 1 cm for every 2 mev of energy.

Figure 7 shows the density path in a film exposed parallel to a 17-mev electron beam from the betatron. There is a definite maximum depth of penetration proportional to the incident energy. The rate of decrease near the end of the penetration is steep, so that

healthy tissue at greater depths is not exposed. The dose is uniform from the surface to the end of penetration, making the high-energy electron beam applicable for the treatment of lesions adjacent to the body surface. The lesion will be exposed uniformly, from the skin to any desired depth, with rapid decrease of radiation dose immediately beyond the lesion.

Diagnostic Applications

High-energy x-rays also have diagnostic applications. Low-energy x-rays are absorbed in bone to a greater extent than in tissue. This is advantageous in making radiographs since the greater absorption in bone will cause the bone to stand out sharply relative to tissue. However, there are other applications in which it is desired that the contrast of bone not be great relative to tissue. For such applications, the high-energy x-rays produced by the betatron are advantageous.

BIBLIOGRAPHY

- D. W. Kerst, Acceleration of Electrons by Magnetic Induction, *Phys Rev*, 58, p 84, 1940.
- T. J. Wang, The Betatron, *ELECTRONICS*, 18, June 1945.
- J. Slepian, U. S. Patent No. 1, 645,304, (1927).
- R. Wiederhoe, *Archiv fur Elektrotechnik*, 21, p 387, 1928.
- E. T. S. Walton, *Proc. Cambridge Philosophical Society*, 25, p 469, 1929.
- M. Steenbeck, U. S. Patent No. 2, 103, 303 (1937).
- D. W. Kerst, and R. Serber, Electronic Orbits in Induction Accelerator, *Phys Rev*, 60, p 53, 1941.
- K. Gund and W. Paul, Experiments with a 6-mev Betatron, *Nucleonics*, 7, p 36, 1950.
- H. C. Pollock, M. H. Herbb and P. C. Noble, General Electric Rpt No. RL-S46, 1951.
- J. D. Lawson, H. E. Walford and J. H. Aram, Extraction of the Electron Beam from a 30-mev Synchrotron, *Nature*, 166, p 234, 1950.
- R. S. Foote, National Bureau of Standards Rpt No. 1,001, (1951).
- E. C. Crittenden, Jr. and W. E. Parkins, Methods for Betatron or Synchrotron Beam Removal, *J. App. Phys.*, 17, p 444, 1946.
- L. S. Skaggs, J. S. Laughlin and L. H. Lanzl, Technique of Producing an External Beam of Electrons from the Betatron, *Phys. Rev.*, 70, p 95, Jul. 1946.
- L. S. Skaggs, J. S. Laughlin and L. H. Lanzl, Technique of Producing an External Beam of Electrons from the Betatron, *Phys. Rev.*, 73, p 1,223, May 1948.
- L. S. Skaggs, Depth Dose of Electrons from the Betatron, *Radiology* 53, p 863, Dec. 1949.
- J. P. Girard and C. D. Adams, Application of the Betatron to Practical Radiography, *Trans. of the Amer. Ins. of Elec. Engrs.*, 65, 1946.
- R. A. Harvey, L. L. Hass and J. S. Laughlin, Betatron Cancer Therapy, *Radiology*, 58, 23, 1952.
- H. Quastler, et. al., Techniques for Application of Betatron to Medical Therapy, *Am. J. Roentgenol. and Radium Therapy*, 61, p 591, 1949.
- W. Heitler, "The Quantum Theory of Radiation", Oxford Press, 1944.
- J. S. Laughlin, "Physical Aspects of Betatron Therapy," Charles C. Thomas, Springfield, Ill., 1953.

Microsecond Timer

Velocity of shock wave traveling down a concrete beam is measured by microsecond interval timer during nondestructive elasticity test. Timer has one-microsecond accuracy and is useful in a wide variety of timing applications

By J. H. J. FILTER

National Physical Laboratory
South African Council for Scientific and Industrial Research
Pretoria, South Africa

ELASTICITY of concrete beams may be determined nondestructively by a microsecond-interval timer used in conjunction with two phonograph pickups. The timer operates by measuring voltage across a capacitor charged from a constant-current source during the interval of interest.¹ It has five ranges covering time intervals from 50 to 5,000 microseconds. Its accuracy, independent of tube characteristics, is \pm one microsecond or \pm two percent whichever is larger.

In a long thin beam $K = (E/d)^{1/2}$ where K = velocity of longitudinal compression waves in the beam; E , Young's modulus of elasticity; and d , density of the material.

The instrument measures the time taken for a longitudinal shock wave, applied at one end of the beam, to pass two phonograph pickups placed a convenient and known distance apart. Assuming d is known, K and hence E can be calculated. The instrument can also be used for a large variety of other timing applications.

Circuit Design

A block diagram of the system is shown in Fig. 1. The amplified pulses from the pickups actuate switching circuits that start and stop a constant charging current through a capacitor. The voltage across the capacitor is measured and is proportional to the time taken for the shock wave to pass the pickups.

The circuit is shown in Fig. 2.

Pentode V_0 controls the current through the timing capacitor, the voltage across which is measured by V_{10} .

Switching the current through a pentode can be done by any one or more of its three grids. However, the current through V_0 is switched by the control grid only; the magnitude of the current passed is regulated by adjusting the screen voltage. This has the disadvantage that the pentode cannot be completely cutoff as the screen is at a positive potential.

The charging current must be large so that the ratio of charging to discharging or cutoff current is large. Investigation of several pentodes showed that all types gave the same order of cutoff current. A type 6AG7 was chosen since it can handle fairly large currents and, because of its high transconductance, the bias voltage excursions can be relatively small. The plate

current of the 6AG7 is constant for fairly large variations in plate voltage, thus providing a good constant-current source.

For the vacuum-tube voltmeter V_{10} a differential amplifier was used to give a linear voltage scale and minimize the effect of changes in tube constants and of power-supply variations. Best results were obtained when the meter was more or less critically damped. Resistor R_1 provides damping and is also used as a fine-sensitivity control for one particular range. The maximum current that can flow through the meter, when the left-hand grid of V_{10} is at zero potential, is limited to approximately 700 microamperes, thus protecting the meter against overloads.

Switch S_0 connects various resistors between the cathodes to change the sensitivity, at the same time selecting the capacitor for the appropriate time scale. Electrical zero is adjusted by R_0 .

The switch circuit consists of two flip-flops V_7 and V_8 . The circuit components are so chosen that when V_{7A} and V_{8B} are both cutoff the voltage at the grid of V_0 is slightly positive. The low grid-input resistance for positive voltages minimizes the effect of any changes in plate voltage of V_{7A} and V_{8B} on the voltage at the grid of V_0 . When either V_{7A} or V_{8B} is conducting the resulting voltage at the grid is approximately -35 volts, cutting off V_0 .

When the RESET switch S_1 is in position a , resistances are connected in series with the negative

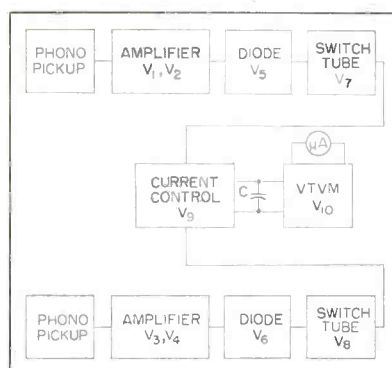

FIG. 1—Block diagram of test setup

Checks Concrete Beams

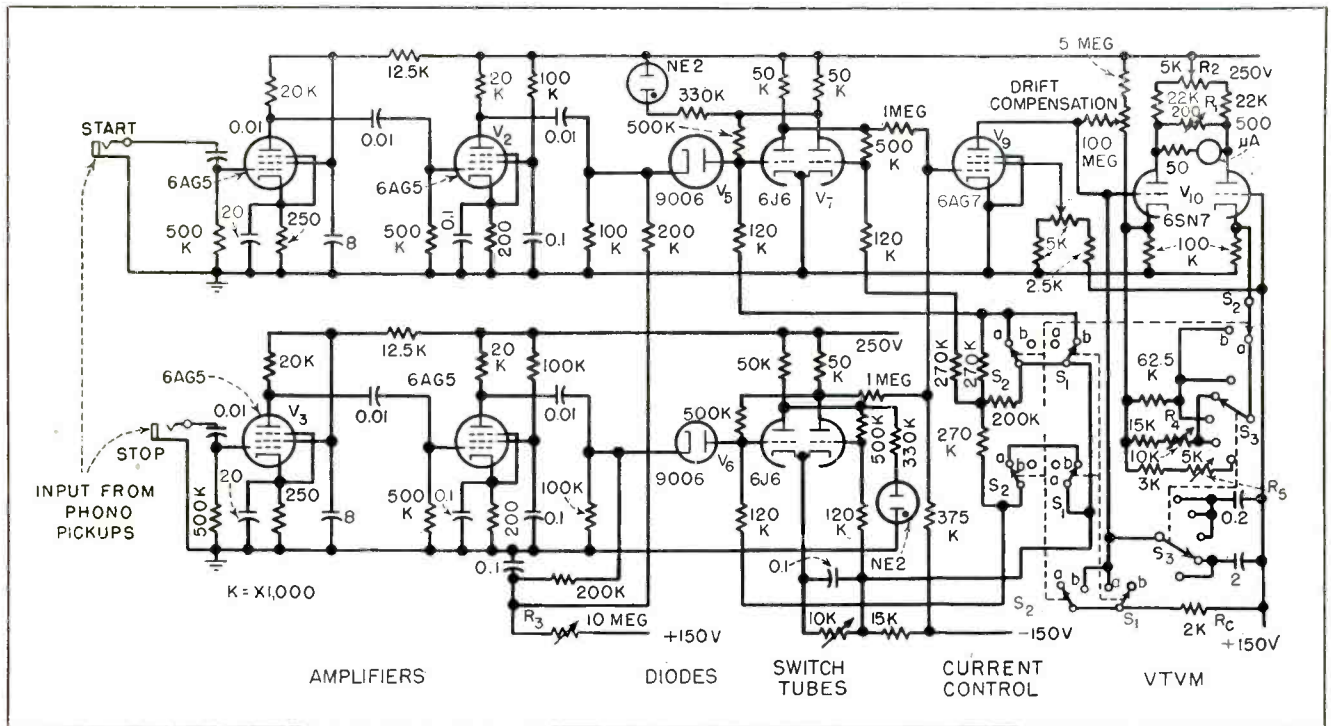

FIG. 2—Vacuum-tube voltmeter measures potential across capacitor charged from a constant-current source during interval of interest. Tube V_6 is the switch tube in the stop channel

supply to the grids of V_{7A} and V_{8A} , and the two triodes conduct. At the same time the capacitor is discharged through R_c . The flip-flops remain reset when S_1 is returned to position *b*.

A negative pulse through V_6 cuts off V_{7A} , the voltage at the grid of V_6 rises to zero, and the capacitor is charged through V_6 . A negative pulse through V_6 cuts off V_{8A} , V_{8B} conducts and V_6 is cutoff. Positive pulses and any subsequent negative pulses cannot alter the state of the flip-flops until they have been reset. Neon indicators show the state of the flip-flops, the circuit being reset when both neons glow.

Two-stage 6AG5 with high-frequency boost amplify the signals from the pickups that have to be so placed that a negative impulse is obtained when the compression wave arrives. The sensitivity is varied by changing the positive bias on the cathodes of V_5 and V_6 by R_3 .

Various currents, such as: leakage through the capacitor, switches and tube bases; cutoff current of

the pentode and grid current of the vacuum-tube voltmeter charge or discharge the capacitor. To reduce leakage, high-quality components were used. The vacuum-tube voltmeter could have been so designed that the grid current was either positive or negative, as required to balance all the currents for a certain potential at the plate of V_6 . This potential could then have been chosen as the zero of the vacuum-tube voltmeter. The potential was found, however, to vary with variations both in pentode cutoff and in vacuum-tube voltmeter grid currents due to changes in tube temperature, heater voltage and characteristics of different tubes.

Compensating Current

It was decided, therefore to balance the leakage currents by injecting an adjustable compensating current. As the leakage currents were found to be more or less constant with changes in potential at the left-hand grid of V_{10} the compensating current had to be more or less constant. To eliminate use

of a floating battery and to avoid to some extent the disadvantages of using a fixed voltage point, the compensating current is injected through a 100-megohm resistor from a voltage tapped between the plate and cathode of the vacuum-tube voltmeter. As the cathode follows to some extent the potential at the grid, especially when the cathode-to-cathode resistor is large, the voltage across the 100-megohm resistor tends to be more constant. This gives better compensation over the whole range, especially those ranges where the voltage changes at the left-hand grid have to be large, and the meter does not return to zero as quickly as when injecting current from a fixed voltage.

Range Constants

The values of the range constants are obtained from the equation: $V = I \times t/C$. Where: V = voltage across capacitor for full scale deflection of vacuum tube voltmeter; C , capacitance of capacitor; I , charging current; and t , full-scale time range. A capacitor charging

current of only 20 milliamperes was chosen due to limited power-supply regulation. The range constants were chosen as shown below:

Full-Scale Microseconds	Capacitor Microfarads	Voltmeter Sensitivity Volts for 500 μ A
50	0.2	5
200	0.2	20
500	0.2	50
2,000	2.0	20
5,000	2.0	50

Smaller voltages for full-scale deflection made the meter sensitive to plate-supply voltage and tube variations and use of larger voltages caused errors due to changes in charging current with plate voltage of the pentode.

Calibration Technique

Calibration is by a variable voltage supply and voltmeter connected across the grids of the vacuum-tube voltmeter with the negative to the left-hand grid. The range switch is set to either 500 or 5,000 microseconds. The voltage between the grids is set to 50 and the meter deflection to 500 microamperes with the shunting resistor R_s . The voltage is then adjusted to 20 volts for the 200 or 2,000-microsecond ranges and the meter again set to full-scale deflection using R_s . The process is repeated for the 50-microsecond scale with the voltage set to 5 and adjusting R_s .

If the capacitance of the timing capacitor is known, the exact value of the integrating current necessary to give the values in the table can be calculated. In this case two timing capacitors are used and thus two values of charging current are necessary.

The value of the calibrating resistor R_c is measured and the voltage drop across it calculated for the respective charging currents. This will be approximately 40 volts. When switch S_2 is in position *b* the flip-flops are switched so that the bias on V_0 is zero. At the same time the voltmeter is switched to 50 volts full scale and R_c is connected between the vtvm grids.

The current is then set to the desired value by adjusting the screen voltage of V_0 until the voltmeter is made to indicate the calculated reading.

Switch S_2 automatically returns to position *a* when released and its function is independent of the position of the reset switch S_1 .

Consider pentode V_0 to be a constant-current generator giving a current I and shunted with its plate resistance R_p . Let C be the capacitor connected in parallel with R_p , so that the pentode current charges C . The current flowing through the plate resistance $I = V/R_p$, where V is the voltage across the capacitor. The differential equation for the voltage across the capacitor is $dv = (1/C) (I - V/R_p) dt$. The solution is $V = IR_p(1 - e^{-(t/R_pC)})$.

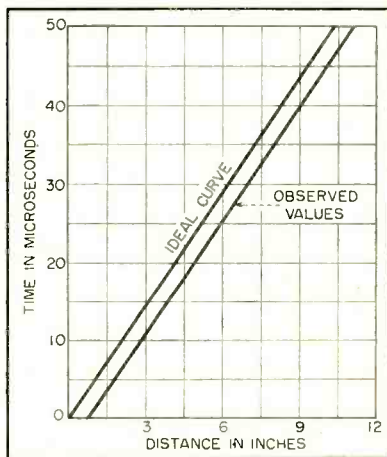

FIG. 3—Measured and calculated results show close agreement

Expanding the exponential term as a series

$$V = \frac{I \times t}{C} \left(1 - \frac{t}{2R_pC} + \frac{t^2}{6R_p^2C^2} - \dots \right)$$

Errors

The greatest error will be introduced for large values of V , that is on the 50-volt ranges; R_p was found to be approximately 250,000 ohms for the working range. Thus for $t = 500$ microseconds, $C = 0.2 \mu$ f; or $t = 5,000 \mu$ sec, $C = 2 \mu$ f; the meter will read 0.5 percent low at full scale. This was considered good enough.

The current gain of the vacuum-tube voltmeter is approximately given by

$$\frac{\text{Output current}}{\text{grid-to-grid voltage}} =$$

$$\frac{-\mu}{2 \left[R_p + \frac{(\mu + 1) R_k R_c}{2 R_k + R_c} \right]}$$

where R_p = plate resistance of triode; R_k , cathode-to-ground re-

sistor; and R_c , cathode-to-cathode resistor.

In the worst case, for the 50-microsecond range (R_c approximately 4,000 ohms, $R_k = 100,000$ ohms), the gain changes approximately 2 percent for a 10-percent variation in R_p for a 6SN7. As each range is adjusted at full scale, variations in sensitivity do not introduce a large absolute error for less than full-scale deflection. For the 20 and 50-volt ranges the change for a 10-percent variation in R_p is 0.6 percent and 0.2 percent respectively.

Tests

The instrument was tested by checking it against a steel rod in which the velocity of sound had been previously determined. Figure 3 shows an example of the results. The curve is displaced to the right of the ideal curve due to differences between the pickups. If the pickups are interchanged the curve lies to the left of the ideal curve.

The energy of the impact has to be fairly constant. An increase in energy tends to move the curve nearer to the theoretical curve. For each sample a zero correction has to be determined by taking readings for at least two different distances between the pickups. With these precautions an accuracy of ± 1 micro second or ± 2 percent, whichever is the greater, can be obtained.

The instrument is fairly independent of vacuum-tube characteristics and can be easily and accurately calibrated without the use of pulses of known time interval. The time scale is linear so that the scale need not be specially graduated or calibration charts used, and the capacitor holds its charge long enough for readings to be taken accurately.

Acknowledgements

The author wishes to thank members of the Electrical Standards staff for advice and help in the development of the instrument.

This paper is published by permission of the South African Council for Scientific and Industrial Research.

REFERENCE

(1) P. B. Weisz, Electronic Timer for Microsecond Intervals, *ELECTRONICS*, p 108, Apr. 1944.

Simulating Piano Tones Electronically

All-electronic instrument uses phase-shift oscillators and distortion amplifiers to simulate decay curve of piano notes. System duplicates three-string tonal timbre and provides controls for loud, soft and sustaining effects obtained from a standard piano

By **LEON KATZ**
New York, N. Y.

SIMULATING the tone of a particular instrument is achieved by producing a wave shape comparable to that instrument. This can and has been done by innumerable electrical, mechanical or electronic means.

Since the piano is a percussion and string instrument, it presents several difficulties. For many of the tones of the piano, three strings are used; for others, two, and for the very low notes, one string is used. The purpose of the multiple strings struck simultaneously by the same hammer is to render a dramatic quality to the sound through the production of beats. An extremely slight detuning of the two or three strings of the same note will produce the familiar throbbing sensation of the tone due to the subjective production of the beat frequency. This is due to the nonlinearity of the ear.

Although this is a subjective sensation, it is of the utmost importance in duplicating a true piano sensation. Two additional tone production systems must be added intentionally to produce slightly detuned signals. The three separate signals of one tone are, however, still combined by straight addition, not by heterodyning.

The second additional difficulty in reproducing a piano tone is in matching its amplitude-time envelope. Almost all stringed musical instruments, including the piano,

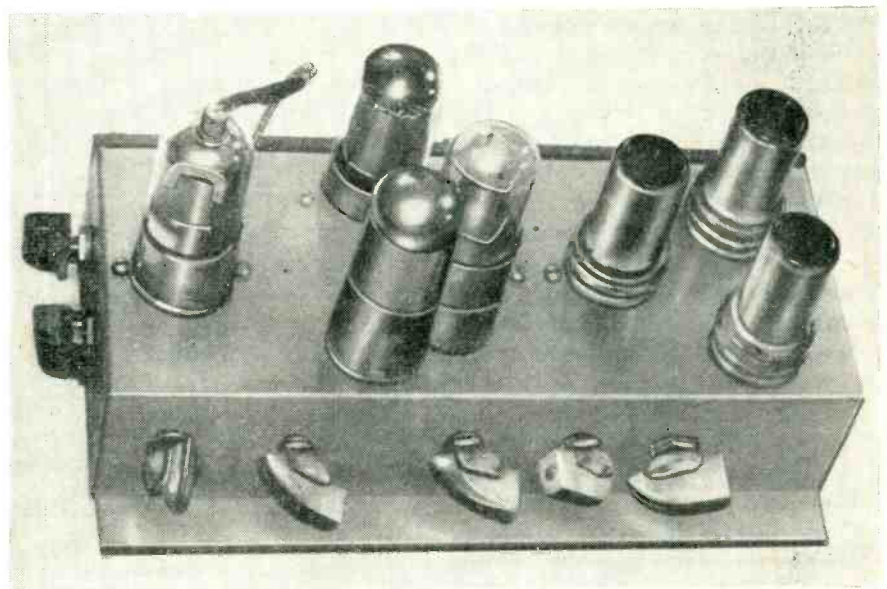

Chassis holds (left to right) keying tubes, distortion amplifiers, linear amplifier and cathode follower, resistance adder and phase-shift oscillators

contain one or more large radiating surfaces known as sound boards. The energy of the vibrating string is transmitted to the sound board by a mechanical structure common to the string and sound board known as the bridge. It is the sound board thus excited that radiates most of the sound energy.

Tone Curve

The decay curve of a piano tone depends on the absorption and radiation characteristic of all components. An idealized typical intensity time curve for the piano is shown in Fig. 1.

The ordinate is plotted to a decibel scale to give a rough indication of the sound sensation and to indicate the deviation from exponential response, which would

show as a straight line on a logarithmic plot.

An all-electronic method of producing a piano tone is shown in block diagram form in Fig. 2. Any audio frequency sine wave oscillator may be used.

For any particular note, for example 440 cps, the off-frequency oscillators are best detuned by ear. In general, detuning is a fraction of a cps. The distortion amplifiers used are overdriven amplifiers. Since the piano tone contains both even and odd harmonics, the distortion circuit should be proportioned to destroy half-wave symmetry that might tend to exist from symmetrical cutoff.

The standard piano is so designed that the string is struck near one end, about one seventh

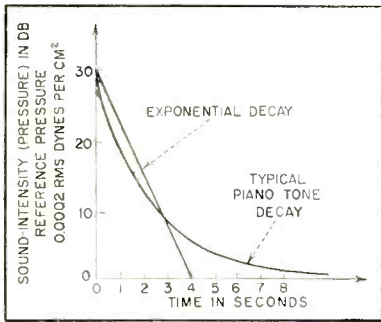

FIG. 1—Typical piano tone decay curve

to one ninth of the total length from that end, so that the resultant vibration is lacking only some of the higher frequency components.

The adding circuit may be any one of the many electronic adding circuits used in analog computer work, or addition may be done directly at the input of the keying circuit by means of a resistance adding network.

The keying circuit itself prevents a tone from being produced until the key is depressed and then gives the tone the proper amplitude-time envelope after the key is depressed.

Keying

The keying circuit depends on two properties of the pentode tube when used as an ordinary amplifier. First, within the limits of proper design, the gain is given by the well-known expression $K = -g_m Z_L$. Secondly, for pentodes the g_m may be considered a function only of grid bias, provided all signal voltages on the grids are small and plate voltage variations are not too large.

Thus for a pentode, variation of the bias of one of the grids will vary the gain; and therefore the signal voltage output will vary for fixed signal voltage input. This is the familiar principle of automatic volume control and the reactance-tube f-m modulator.

The keying circuit (Fig. 3) and the characteristic curves (Fig. 4) aid in showing how these principles are used in forming an intensity-time envelope approximating that of a piano. The note involved is prevented from appearing at the input of the linear amplifier by means of the hold-off bias of the keying tube (enough greater than the cutoff value to prevent even

the slightest conduction on the positive peaks of the signal) in spite of the continual appearance of the tone voltage in the grid circuit of the keying tube.

When the key corresponding to the tone is depressed, the capacitor which has been maintained at a steady d-c voltage somewhat below the hold-off bias is connected across the resistor in the grid circuit forming an RC discharge circuit. This brings the bias suddenly from below cutoff to a value only slightly negative. The discharge of the capacitor allows the bias to again approach the hold-off

value exponentially.

The variation of bias with time will vary the g_m of the tube and therefore the intensity-time envelope of the output will vary also, since $E_o = -g_m Z_L E_i$. (E_i is small compared to the hold-off bias).

Experimental adjustment of the hold-off bias, the peak voltage to which the C is charged, the RC time constant of the keying circuit, and the type and operating voltages of the tube used all provide endless variety to the amplitude-time curves available. Although the value of RC determines intensity-time envelope, a quick recharge in

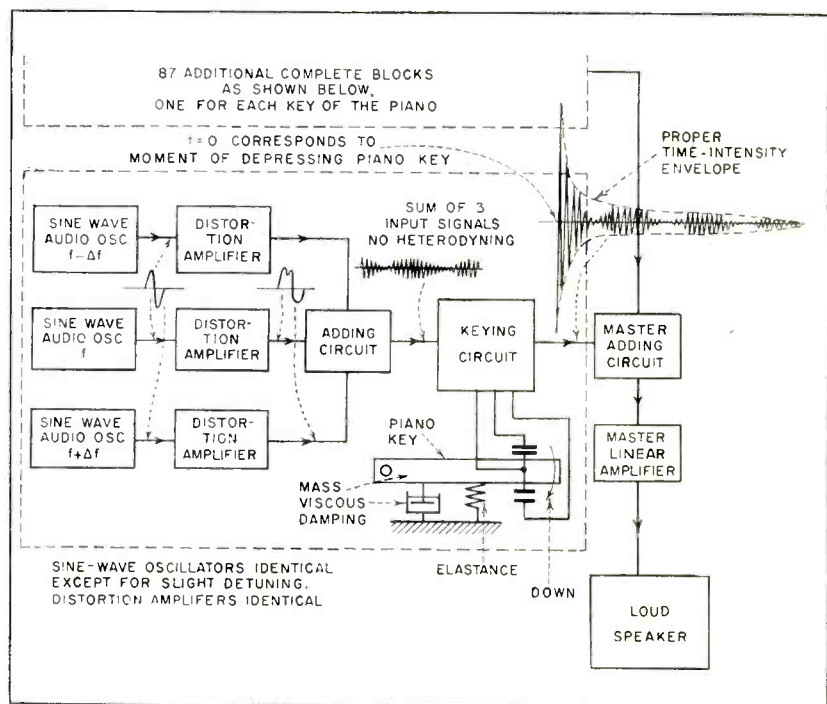

FIG. 2—Block diagram for one key circuit

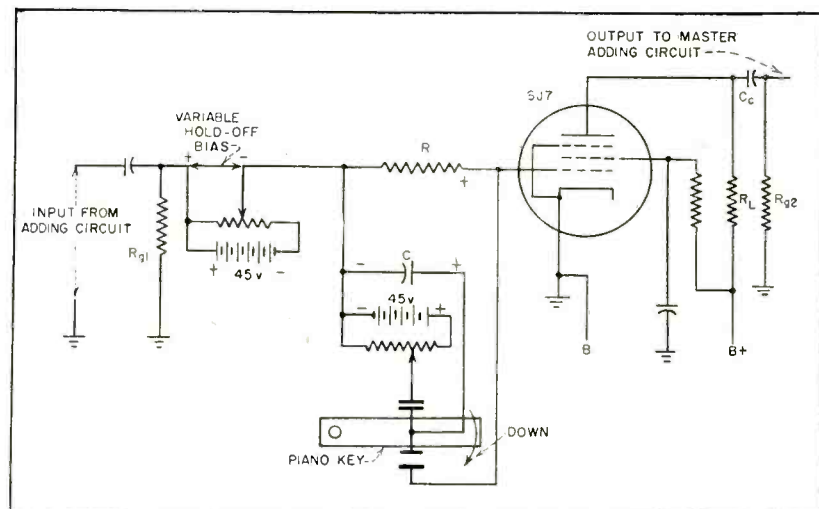

FIG. 3—Schematic of keying tube circuit

readiness for rapid restriking of the key dictates as large a value of R and small value for C as the grid circuit resistance limitations of the tube permit.

Typical operating values found to give fair simulation of the piano tone were with two sine-wave oscillators set at 440 cps feeding overdriven amplifiers each putting a 1 volt rms signal into the grid circuit of the keying tube, a hold-off bias of 19 volts, a charging voltage of 16 volts; a charging capacitor of 1 μ f, and discharge resistor of 2.5 megohms ($RC = 2.5$ seconds).

The sudden lowering of keying tube plate voltage due to the sudden application of the capacitor voltage to the grid circuit of the keying tube will produce momentary grid blocking of the following linear amplifier. This will be of negligible duration, however, if the time constant of the coupling circuit is made as short as possible and yet long enough adequately to couple the signal frequency into the grid circuit of the linear amplifier. These are not difficult conditions to meet.

Complete Circuit

The complete piano would consist of 88 combinations of oscillators, distortion amplifiers, and keying tubes, one set for each key. Only one linear amplifier is necessary

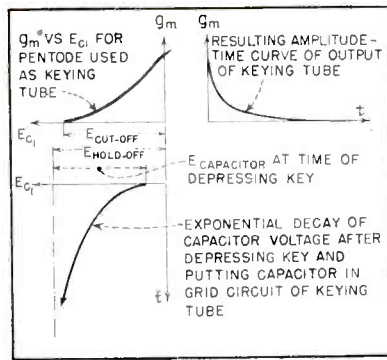

FIG. 4—Pentode characteristics in keying tube circuit

since the signals from the separate keying tubes are coupled to it by a straight adding circuit. The addition could also take place after one stage of linear amplification for each keying tube, acting as a buffer.

Dynamics could be handled in either of two ways. The first would be to control the gain of one of the overall linear amplifiers by varying its g_m with a bias voltage controlled by a pedal. The second method, which would more nearly approach the performance of the piano, would be to have the keying capacitor charged to a voltage which would depend upon the velocity of the key. This could be effected by having the charging voltage developed by electromagnetic induction. Such an arrangement would complicate the mechanical and electrical design of the key,

but would produce dynamics which would depend upon how each key is struck, which is the way dynamics are produced on the standard piano.

The effect of the loud pedal could be simulated by introducing a small positive voltage in the grid circuit of all the keying tubes when the loud pedal is depressed. This will produce the almost constant background of sound characteristic of the loud pedal of the piano.

The effect of the soft pedal would require only a reduction of the gain of the linear amplifier. The sostenuto effect would be accomplished by keeping the capacitor of any depressed key connected across its discharge resistor even after the key is released, provided the sostenuto pedal is held in the depressed position. The proper mechanical feel of the key or action, as it is called, can be obtained by providing the key with the mass, elastance, and viscous damping that the piano key has.

BIBLIOGRAPHY

- John Tyndal, "Sound," 3rd ed., D. Appleton & Co., New York, 1896.
- Erwin Meyer, "Electro-Acoustics," G. Bell & Sons Ltd., London, 1939.
- Harry F. Olson, "Elements of Acoustical Engineering," 2nd ed., D. Van Nostrand Co. Inc., New York, 1947.
- Samuel Seely, "Electron-Tube Circuits," McGraw-Hill Book Co., New York, 1950.
- Harry F. Olson, "Musical Engineering," McGraw-Hill Book Co., New York, 1952.
- B. F. Meissner, "Electronic Musical Instruments," *Proc. IRE*, 24, No. 11, p 1,427, 1936.

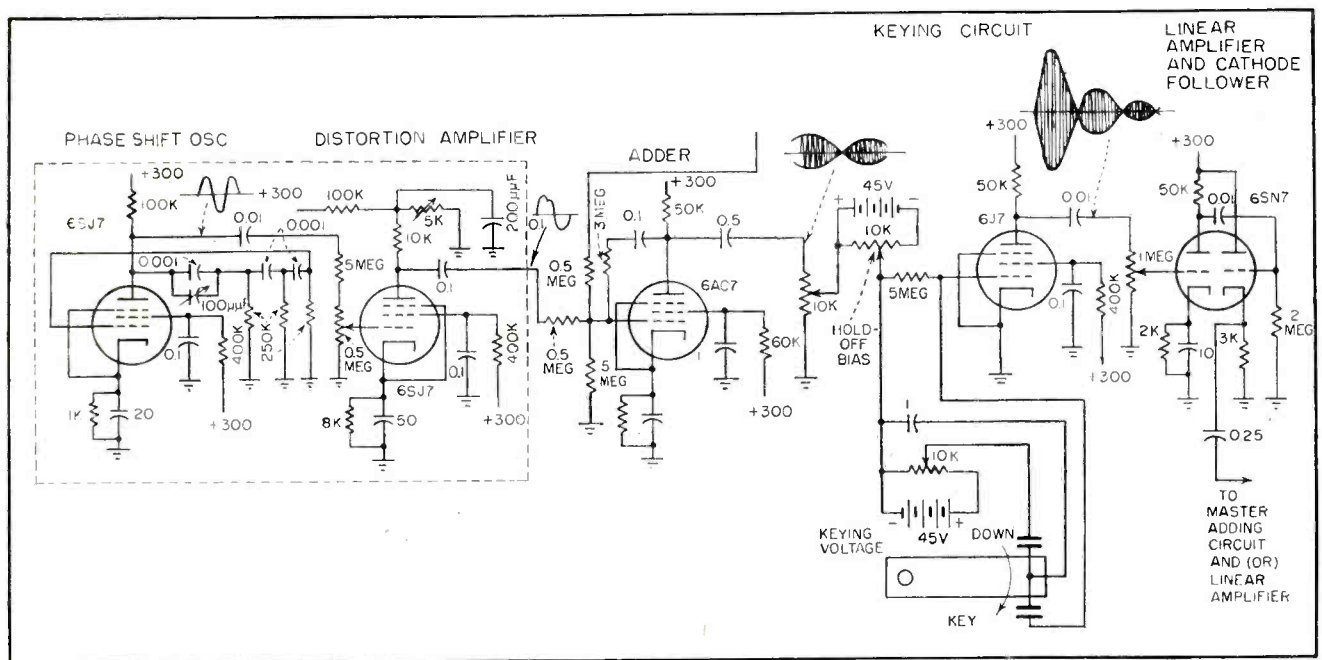

FIG. 5—Complete circuit diagram for one key ($f=220$ cps)

Small-Signal

Part VIII

By **ABRAHAM COBLENZ** and **HARRY L. OWENS**

Signal Corps Engineering Laboratories
Fort Monmouth, New Jersey

SMALL-SIGNAL parameters are of considerable importance in specifying transistor operation. Most of the parameters discussed thus far in this series are based on small-signal operation, and large errors can result from neglect of this qualifying phrase.

Power Gain

In Part VII of this series, equations were developed which express the input and output resistance and the voltage gain of point-contact and junction transistors. Typical numerical values were given to serve as a general orientation with regard to orders of magnitude (see Table I). The power gain of an electrical device is, obviously, an important concept to the design engineer and equations will be developed for computation of this parameter of a transistor.

Figure 1 shows the familiar circuit of a generator with voltage e_g and internal resistance R_g supplying a load whose resistance is

R_L . The maximum power that can be developed across R_L for a given generator may be found as follows: Since

$$E = \frac{e_g R_L}{R_g + R_L} \quad (1)$$

$$P_o = \frac{e_g^2 R_L}{(R_g + R_L)^2} \quad (2)$$

Differentiation with respect to R_L shows that the power delivered across the load will be a maximum if R_g is equal to R_L . Under these conditions the maximum possible power that can be drawn from generator e_g under any circumstances will be

$$P_m = \frac{e_g^2}{4R_g} \quad (3)$$

The power output of a grounded-base transistor amplifier (Fig. 2) is in general given by $i_2^2 R_L$ where i_2 is

$$i_2 = \frac{-e_g(r_b + r_m)}{[(R_g + r_b + r_o)(R_L + r_b + r_c) - r_b(r_b + r_m)]} \quad (4)$$

The power gain of the transistor will then be given by the ratio of $i_2^2 R_L$ to P_m , the maximum power which may possibly be drawn from the generator (generator internal resistance exactly matched by input resistance of the transistor). In general, this will not be the case and less power will be drawn from the generator than is indicated by Eq. 3. The power gain is given by

$$PG = \frac{i_2^2 R_L}{e_g^2 / 4R_g} = \frac{4R_L R_g i_2^2}{e_g^2} \quad (5)$$

The power gain so determined for a given value of i_2 and R_L will be a lower limit or a minimum value since the power expression in the denominator is the maximum pos-

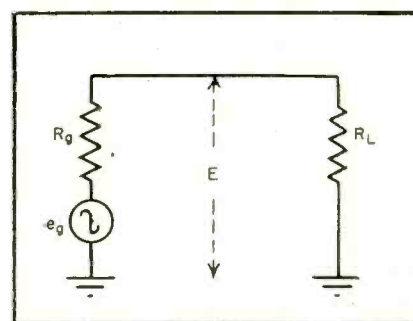

FIG. 1—Equivalent circuit illustrates condition for maximum load power

sible under these conditions.

Substituting the value of i_2 from Eq. 4 into the expression for the power gain in Eq. 5

$$PG = \frac{4R_L R_g (r_b + r_m)^2}{[(R_g + r_b + r_o)(R_L + r_b + r_c) - r_b(r_b + r_m)]^2} \quad (6)$$

This expression can be simplified somewhat since r_o is small compared to r_o or r_m (see Table I) and Eq. 6 becomes

$$PG = \frac{4R_L R_g r_m^2}{[(R_g + r_b + r_o)(R_L + r_c) - r_b r_m]^2} \quad (7)$$

Typical Values

Using the typical values of the parameters as given in Table I for the point-contact transistor, a typical power gain is very nearly 100 representing 20 db whereas for the junction type a typical power gain is very nearly 440 representing 46 db.

Importance of Alpha

It is often desirable to know power gain as a function of the alpha of the circuit. Dividing numerator and denominator of Eq. 6 by $(r_o + r_b)^2$

INDEX TO PREVIOUS ARTICLES IN THIS SERIES

Part I, p 98, March 1953.

Part II, p 138, April 1953.

Part III, p 162, May 1953.

Part IV, p 164, June 1953.

Part V, p 158, July 1953.

Part VI, p 156, August 1953.

Part VII, p 156, September 1953.

Transistor Operation

Different approaches to mathematical analysis of small-signal transistor operation are explained in detail, along with listings of advantages and disadvantages of each. Power gain and other important parameters are discussed.

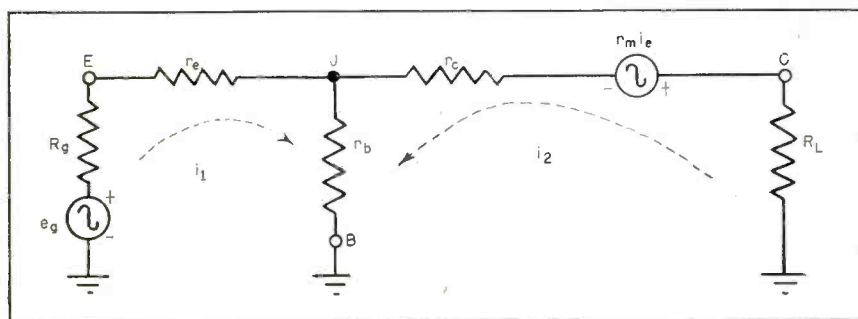

FIG. 2—Equivalent circuit of grounded-base transistor from which design equations for small-signal operation are devised

$$PG = \frac{4R_L R_g \alpha^2}{\left[(R_g + r_b + r_e) \left(1 + \frac{R_L}{r_e + r_b} \right) - r_b \alpha \right]^2} \quad (8)$$

Similarly, the power gain may be expressed as a function of VG and α .

$$PG = \frac{4R_g \alpha (VG)}{(R_g + r_e + r_b) \left(1 + \frac{R_L}{r_b + r_e} \right) - r_b \alpha} \quad (9)$$

Also, the expression for the VG obtained in the previous article¹ may be written as a function of α .

$$VG = \frac{\alpha R_L}{(R_g + r_e + r_b) \left(\frac{R_L}{r_b + r_e} + 1 \right) - r_b \alpha} \quad (10)$$

Equations 8, 9 and 10 show why alpha is one of the important parameters for evaluation and comparison of transistors. Also, the relation $\alpha = -i_c/i_e$ shows the further usefulness of alpha as a comparison number for current gain.

Grounded-Base Equations

In the previous article of this series¹, Eq. 11 and 12 were derived

to express conditions in the grounded-base transistor arrangement.

$$i_1(R_g + r_e + r_b) + i_2 r_b - e_g = 0 \quad (11)$$

$$i_1(r_b + r_m) + i_2(R_L + r_b + r_c) = 0 \quad (12)$$

If in Eq. 11 $r_e + r_b = r_{11}$ and $r_{12} = r_b$ according to the definitions laid down in the previous article¹, and $v_1 = e_g - i_1 R_g$, which is the net voltage acting at the transistor terminals, Eq. 11 becomes

$$v_1 = r_{11} i_1 + r_{12} i_2 \quad (13)$$

In deriving Eq. 12 it was assumed that there was no generator voltage acting in loop 2 of Fig. 2. If there were, Eq. 12 could be written as

$$r_{21} i_1 + i_2 R_L + i_2 r_{22} = e_{g2} \quad (14)$$

where again $r_m + r_b = r_{21}$ and $r_e + r_b = r_{22}$. As before, if $v_2 = e_{g2} - i_2 R_L$, the net effective voltage after the $i_2 R_L$ drop in Eq. 14 becomes

$$v_2 = r_{21} i_1 + r_{22} i_2 \quad (15)$$

Small-Signal Parameters

Consider a dependent variable y which varies with, or is a function of an independent variable x . Mathematically

$$y = y(x) \quad (16)$$

Differentiating both sides with respect to x

$$\frac{dy}{dy} = \frac{dy(x)}{dx} \quad (17)$$

Essentially, Eq. 17 is a tautology, or self-evident identity, and does not provide any particularly useful information. But in the form

$$dy = \frac{dy(x)}{dx} dx = y' dx \quad (18)$$

the equation states a very important and useful fact. Equation 16 will, in general, avoiding special curves, give a graph like in Fig. 3.

Equation 18 says that if, for a given or selected change in x , say of dx , it is desired to find the corresponding change in the value of y , when y depends on x in the manner shown in Fig. 3 and symbolized in mathematics shorthand by Eq. 16, the slope of the curve at the point in question is multiplied by the given value of dx .

If y is a dependent variable which varies with either or both of two parameters, x and z , Eq. 16

Table I—Typical Transistor Parameters

Parameter	Point Contact	Junction
r_e	150 ohms	25 ohms
r_b	120 ohms	500 ohms
r_m	35 kilohms	0.96 megohm
r_c	15 kilohms	1.0 megohm
R_g	500 ohms	500 ohms
R_L	20 kilohms	100 kilohms
α	2.3	0.96
e_g	0.01 volt	0.001 volt

will then become

$$y = y(x, z) \quad (19)$$

Since a change in y , dy , may now be due to a change in either or both of x and z , an equation entirely analogous to Eq. 17 would be Eq. 20

$$dy = \left. \frac{dy}{dx} \right]_{z-k} dx + \left. \frac{dy}{dz} \right]_{x-k} dz \quad (20)$$

This is usually written

$$dy = \frac{\partial y}{\partial x} dx + \frac{\partial y}{\partial z} dz$$

The dimension of each term on the right-hand side of Eq. 20 is dy , since dx and dz cancel—at least dimensionally. This must be so for any physically valid interpretation. Also dy/dx , the first term right-hand side, is not quite the same as in Eq. 17 because the change in dy is measured for a unit change in dx , while z is kept constant. A similar remark applies to dy/dz for $x = \text{constant}$.

In general, V_e , the d-c emitter voltage, will depend on the emitter and collector currents or on the operating point. Thus

$$V_e = V_e(I_e, I_c) \quad (21)$$

Applied to Eq. 19, $y \approx V_e$, $I_e \approx x$, $I_c \approx z$. The dependent variable is voltage V_e and the independent variables are I_e and I_c . This shows that the transistor is a current-operated device and the currents are the independent variables. In transistor work the currents are adjusted to the correct operating point, and the voltages appearing are then fixed by the current values.

To illustrate further the effect of this concept in practice, the static characteristics of transistors are plotted, by common consent, with current as abscissa and voltage as ordinate, in keeping with the mathematical convention of plotting the independent variable along the x direction.

Analogous to Eq. 20, obtained from 19, is Eq. 22 for Eq. 21.

$$dV_e = \left. \frac{dV_e}{dI_e} \right]_{I_c-k} dI_e + \left. \frac{dV_e}{dI_c} \right]_{I_e-k} dI_c \quad (22)$$

The d-c collector voltage also depends on emitter and collector currents, and

$$V_c = V_c(I_e, I_c) \quad (23)$$

Again on differentiating

$$dV_c = \left. \frac{dV_c}{dI_e} \right]_{I_c-k} dI_e + \left. \frac{dV_c}{dI_c} \right]_{I_e-k} dI_c \quad (24)$$

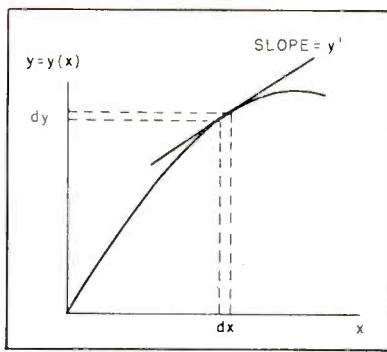

FIG. 3—Typical curve showing y as a function of x . Slope is $y' = dy(x)/dx$

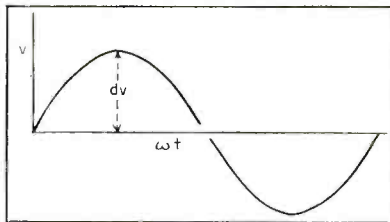

FIG. 4—Sinusoidal voltage (or current) used to simulate differential increments

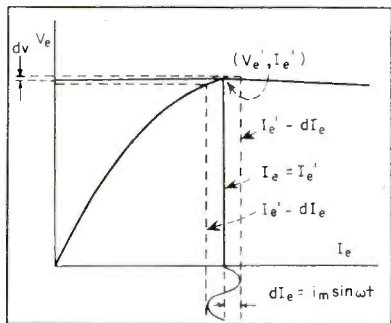

FIG. 5—Plot of emitter voltage versus emitter current

Equations 22 and 24 are extremely important in transistor analysis.

Small Changes

A simple explanation of Eq. 24 might be based on an a-c voltage and current wave as shown in Fig. 4, where the sinusoidal voltage wave $v = v_m \sin \omega t$ where $v_m = dv$.

In an interval $\omega t = \pi/2$, the amplitude changes from 0 to dv , and in the next interval of time from dv to 0, so that, disregarding the sign, the amplitude changes by dv for each $\frac{1}{2}$ cycle. In general, Eq. 22 and 24 apply properly if dv is actually infinitesimal, or extremely small, but in actual application a practical value of dv may be used.

In Fig. 5 is shown a possible plot of d-c values of voltage vs cur-

rent, say of the emitter voltage V_e and emitter current I_e for a transistor. Assuming the operating point of the transistor is at V_e' , I_e' , if the emitter current is modulated sinusoidally by a small signal so that I_e varies at most by dI_e , then I_e will vary from I_e' to $I_e' + dI_e$, from $I_e' + dI_e$ to I_e' , from I_e' to $I_e' - dI_e$, and so forth. The quantitative relation between the change dI_e in I_e' and the change dV_e in V_e , assuming that V_e depends on I_e alone, is

$$dV_e = \frac{dV_e}{dI_e} dI_e$$

as in Eq. 18.

Just as $dy/dx = y'$ is the slope of the $y = y(x)$ curve, so dV_e/dI_e is the slope of the characteristic curve of Fig. 5. (Note that dV_e/dI_e has the dimensions of a resistance, so that in this case the slope is a resistance, hence designated by R .) The slope of the curve must be taken virtually at a point if the relation is to be true.

$$dV_e = R dI_e \quad (25)$$

Signal Limitations

If in using Eq. 25 the slope over a large region is used the condition shown in Fig. 6 occurs. The slope at point (V_e', I_e') is actually S_1 as shown, but using a large swing about (V_e', I_e') gives a slope S_2 which is in general not equal to S_1 . Thus, using a large distance about the point in question to compute the slope may introduce large errors; the larger the distance used, the larger may be the error, particularly as the curve departs more and more from a straight line. If a sinusoidal current is used to simulate dI_e , it must be a very small current or signal, or else large errors may be introduced.

In view of these remarks, the differential quantity dV_e is representable, for purposes of a laboratory experiment, by an a-c voltage, and dI_e by an a-c current, provided they are suitably small.

Regardless of whether V_e is a function of one or two variables, the remarks about the size of the signal are still valid.

Equations 22 and 24 may be written (Eq. 26 and 27 respectively) in terms of small a-c v 's and i 's by applying the foregoing principles.

$$v_e = \left. \frac{v_e}{i_e} \right]_{I_c=k} i_c + \left. \frac{v_e}{i_c} \right]_{I_e=k} i_c \quad (26)$$

$$v_c = \left. \frac{v_c}{i_e} \right]_{I_c=k} i_e + \left. \frac{v_c}{i_c} \right]_{I_e=k} i_c \quad (27)$$

There are several comments which must be made about these two equations: (1) Note the use of small letters for a-c values, and capitals for d-c values, in keeping with the convention adopted by the authors for this series, and which is a proposed standard.

(2) Consider the $I_c = k$, $I_e = k$ factors of Eq. 26 and 27. If a change dI is representable by a small a-c current, $i \sin \omega t$, as has been shown, of amplitude i , then 0 change in d-c current, $I_c = k$, or $I_e = k$, will be represented by an a-c current of 0 amplitude. Using this fact we may properly write Eq. 26 and 27 as

$$v_e = \left. \frac{v_e}{i_e} \right]_{i_e=0} i_c + \left. \frac{v_e}{i_c} \right]_{i_e=0} i_c \quad (28)$$

$$v_c = \left. \frac{v_c}{i_e} \right]_{i_e=0} i_e + \left. \frac{v_c}{i_c} \right]_{i_e=0} i_c \quad (29)$$

(3) At $i_e = 0$, v_e/i_e is r_{11} as described in Part VII of this series.

$$r_{11} = \left. \frac{v_e}{i_e} \right]_{i_e=0} \quad (30)$$

Using the definitions laid down in Part VII

$$\left. \frac{v_e}{i_c} \right]_{i_e=0} = r_{12}$$

$$\left. \frac{v_c}{i_e} \right]_{i_c=0} = r_{21}$$

$$\left. \frac{v_c}{i_c} \right]_{i_e=0} = r_{22}$$

Hence Eq. 28 and 29 can be rewritten

$$v_e = r_{11}i_e + r_{12}i_c \quad (31)$$

$$v_c = r_{21}i_e + r_{22}i_c \quad (32)$$

Equation 31 states that a potential v_e is acting in a circuit and produces the two potential drops $r_{11}i_e$ and $r_{12}i_c$ which together make up v_e . Similar remarks apply to Eq. 32. Replacing subscript e in the emitter circuit by subscript 1, and subscript c by 2, Eq. 31 and 32 become

$$v_1 = r_{11}i_1 + r_{12}i_2 \quad (33)$$

$$v_2 = r_{21}i_1 + r_{22}i_2 \quad (34)$$

Equations 13 and 15 are identical to Eq. 33 and 34 respectively, but were arrived at by entirely different methods of reasoning. Equations 13 and 15 were obtained from a circuit analysis using Kirchhoff's law for the voltage loops; Eq. 33 and 34 were derived on a mathematical basis from the simple concept that V_e and V_c are dependent on both I_e and I_c in small-signal operation.

As has been mentioned, the ultimate fact mathematically expressed by these equations is that, given all the other data, it is possible to find two numbers, i_1 and i_2 , that satisfy these equations. The fact that they happen to represent a current, in milliamperes perhaps, does not influence the mathematical description of how to determine these two numbers. Since Eq. 33 and 34 are linear equations (that is, they contain no products like $i_1 \times i_2$, or i raised to some power) the delineation is unique; that is, the equations will define only one pair of values, i_1 and i_2 , and no other.

Consequently, whatever assumptions were made to find Eq. 33 and 34 are also binding on Eq. 13 and

15 because they represent the same numbers.

Assumptions

First, from the discussion in connection with Eq. 31 and 32, the parameters are open-circuit values, that is, $i_c = 0$, when measuring r_{11} and r_{21} and $i_e = 0$ when measuring r_{12} and r_{22} . This condition has already been met for Eq. 13 and 15'.

Second, from the discussion in connection with Eq. 26 and 27, the parameters are measured using ratios of a-c values. This condition has also been met'.

Third, the symbol convention that

$$v_1 = e_{o1} - i_1 R_{\theta}$$

$$v_2 = e_{o2} - i_2 R_L$$

assumed to obtain Eq. 13 and 15, is binding on Eq. 33 and 34.

Last, and probably most important, from the discussion in connection with Eq. 26 and 27, the use of small signals is assumed. This means that the four-pole parameters r_{11} , r_{12} , r_{21} and r_{22} are small-signal parameters.

In selecting an amplitude for the measurement of the four-pole parameters, several factors must be considered.

If the signal is not truly small, different signal amplitudes will give different values of parameters.

In practice, a signal of some convenient size is selected, and the parameter, say r_{11} , measured. Then the signal is reduced slightly, and the parameter measured again. If the value of r_{11} obtained in the second trial is close to the r_{11} originally obtained, within the accuracy desired, the signal is a small signal and conversely.

It might appear that there is no objection to using a very small amplitude signal originally, so that there is no question about the signal being small. If the V - I characteristic is very curved, it is very difficult to guess what constitutes a truly small signal. The test suggested above should therefore always be made. Too small a signal introduces measuring problems such as noise and the general difficulty of measuring fractions of a microvolt at a-c.

When feasible, the parameter may be measured by the volt-ammeter method tacitly assumed here,

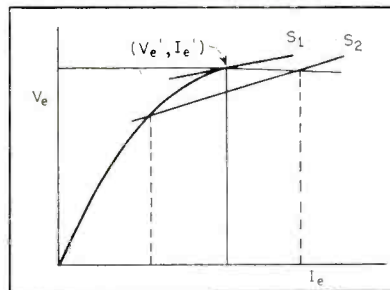

FIG. 6—Sketch shows error in determining slope with large signal input

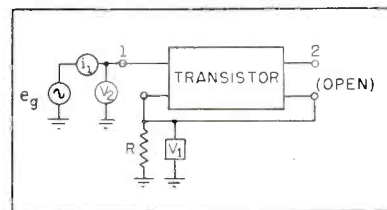

FIG. 7—Connections for measuring r_{11}

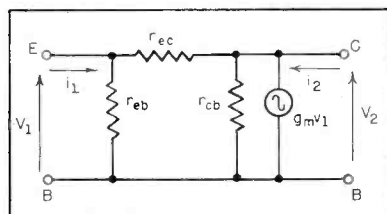

FIG. 8—Equivalent pi circuit of transistor

and the resulting value compared to that obtained by using an entirely different measuring scheme. Other possible methods include the bridge method, scope presentation, and variations and combinations of these. The results must compare within the accuracy desired if the signal is truly small.

Open Circuit

Let us now review in a general way the data that has been assembled regarding r_{11} , r_{12} , r_{21} and r_{22} . Because these parameters are so important in the specification of transistor characteristics, much experimental and theoretical work has been done and is continuing regarding these and other suitable parameters.

These parameters are called small-signal open-circuit grounded-base four-pole parameters. In this and previous articles the terms small-signal, grounded-base, and four-pole parameters have been explained. To understand the open-circuit term, consider Fig. 7 which shows the circuit arrangement for measurement of r_{11} .

Both V_1 and V_2 are vacuum-tube voltmeters, and R is a small resistance of known value placed in the signal generator return to measure the current $i_1 = V_1/R$. Voltmeter V_2 measures the voltage across the input of the transistor, and $r_{11} = V_2/i_1$. There is not a true open circuit across the output or collector circuit since whatever scheme is used to bias the collector, a d-c return path to the base is essential, and thus a d-c path is always present to act as a closed circuit across the collector. The internal resistance of the d-c bias supply may be made very high by using a choke of several hundred henries but not infinite. In most tests $f = 270$ cps.

Also, there is an a-c shunting path always present due to internal transistor and stray capacitance. The impedance of this shunting path decreases as the frequency increases.

A typical value of C_c , the collector capacitance, is 50 μf and a typical circuit may have an additional stray capacitance of 10 μf . At 270 cps, $X_c = 9.8$ megohms. If r_{22} were three megohms, at 270 cps

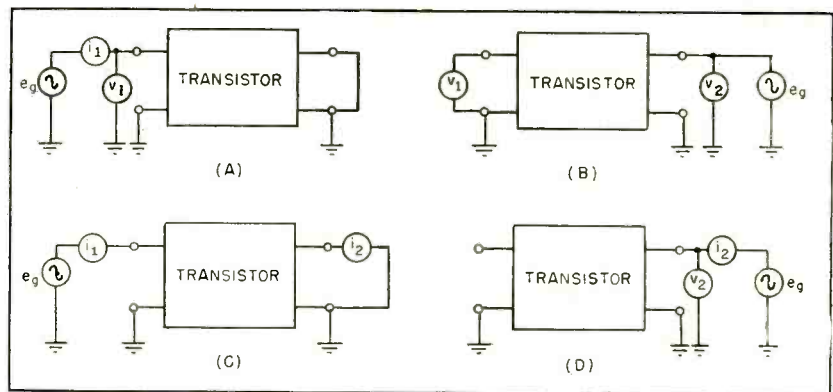

FIG. 9—Sketches show connections for measuring g 's or short-circuit conductances

the 9.8 megohms would represent a shunt path of some importance, and it is not true that measurements are being made under open-circuit conditions.

Two principal approaches to this problem have been adopted.

(1) The arbitrary convention that the circuit is open if the shunt resistance is fifty times the internal transistor resistance. Thus when measuring r_{11} and r_{21} , where the collector circuit must be open, the shunt path shall be $50 \times r_{22}$; and when measuring r_{12} or r_{22} the shunt path shall be $50 \times r_{11}$. Or, where feasible, the collector-to-base resistance (or emitter-to-base resistance) may be doubled. If the value of the parameter measured remains invariant within the accuracy desired, the circuit is truly an open circuit.

(2) Measurement of other parameters such as the g 's and h 's described below to characterize transistor operation, whose measurement does not require the use of an open circuit across high impedance elements. Then, if desired, parameters such as the r 's may be derived mathematically from the quantities measured. Or, the performance of the transistor may be expressed in terms of these new parameters directly, it being assumed that with experience engineers will readily compare transistor performance in terms of these parameters.

Conductances

It was mentioned that the equivalent T as characterized by Eq. 13 and 15 is not the only equivalent circuit for the specification of the

allegorical black box. The black box or transistor is equally well represented by an equivalent circuit which is a π network,² as in Fig. 8. This circuit is analyzed by means of Eq. 35 and 36 using conductances.

$$i_1 = g_{11}v_1 + g_{12}v_2 \quad (35)$$

$$i_2 = g_{21}v_1 + g_{22}v_2 \quad (36)$$

Using Eq. 35 and 36 all the four g 's can be measured. For illustration, setting $v_2 = 0$, $g_{11} = i_1/v_1$ and similarly one can find g_{12} , g_{21} and g_{22} ; see Fig. 9. These g 's are sometimes called the short-circuit conductances.

While it is true that resistances and conductances are reciprocals, the r_{11} which appears in Eq. 13 is not the reciprocal of g_{11} . In Eq. 13 r_{11} was obtained using an open-circuited collector, but g_{11} is obtained by using a short-circuited collector. Hence, r_{11} is not $1/g_{11}$ and is, in fact, given by

$$r_{11} = \frac{g_{22}}{g_{11}g_{22} - g_{12}g_{21}} \quad (37)$$

To obtain g_{11} , v_2 is set to 0. In other words, the output is short circuited. This does away with the need for establishing an open circuit. Like any other good idea in engineering, it has its drawbacks. To find g_{12} the emitter circuit may be shorted, making $v_1 = 0$, and so on for all the other parameters.

The disadvantage of the g method is that some point-contact transistors may be short-circuit unstable. If the input or the output is a-c short-circuited, the units may break into parasitic oscillations. Fortunately, the applicability of this method is greatest for junction types, where this instabil-

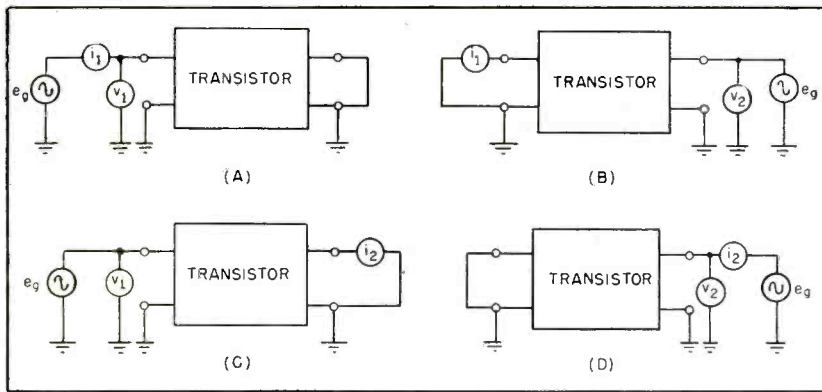

FIG. 10—Circuits for measuring h 's or hybrid transistor parameters

ity is not normally encountered. The inference is that for point-contact units, the r 's may be suitable, and with junction units, the g 's may be preferable.

Hybrid Parameters

Because the use of the g 's suggests that two different parameters are needed to take care of point-contact and junction units, an entirely different set has been suggested.³ These are the hybrid parameters, or h 's, characterizing the transistor by the following equations

$$v_1 = h_{11}i_1 + h_{12}v_2 \quad (38)$$

$$i_2 = h_{21}i_1 + h_{22}v_2 \quad (39)$$

To find h_{11} , the output is shorted, (see Fig. 10) $v_2 = 0$, and

$$h_{11} = \frac{v_1}{i_1} \quad (40)$$

The r_{11} of Eq. 13 was obtained with open-circuited output, hence h_{11} is not the same as r_{11} . As g_{11} was obtained with $v_2 = 0$, $h_{11} = 1/g_{11}$, so that the g_{11} of Eq. 35 is the reciprocal of h_{11} in Eq. 35; and since the reciprocal of a conductance is a resistance, h_{11} is of the nature of a resistance, dimensionally.

To find h_{12} , i_1 is made 0 by making the input an open circuit, placing the generator in the collector circuit, and measuring v_1 and v_2 . Then

$$h_{12} = \frac{v_1}{v_2} \quad (41)$$

As this is the ratio of two voltages, h_{12} has no dimensions. A similar analysis will show, for Eq. 39, that $h_{21} = i_2/i_1$ for a short-circuited

collector. This is α_{ce} by definition; $h_{22} = i_2/v_2$ is conductance but not identical with g_{22} of Eq. 36 since all the parameters of Eq. 36 are obtained under short-circuit conditions. Note that h_{22} is obtained under open-circuit conditions.

Thus the hybrid parameters contain two pure numerics, h_{12} and h_{21} , a resistance h_{11} and a conductance h_{22} . They possess, however, some of the advantages of both the r 's and the g 's:

(1) In the matter of avoiding the necessity for maintaining an open circuit in the high-resistance collector, the h method shares the advantage of the g system in that h_{11} and h_{21} are made with collector shorted.

In the matter of avoiding the necessity for maintaining a short circuit in the low-resistance emitter circuit, the h system shares the advantage of the r system, since both h_{12} and h_{22} are made with emitter open circuited. Since the input resistance of some transistors may be quite low, of the order of tens of ohms, difficulties are encountered in effectively a-c short circuiting such impedances. In the h system, the input is open circuited for such measurements (h_{12} and h_{22}).

(2) Measurements for alpha in the g and r methods are indirect. In the r method, r_{21} and r_{22} are found; their ratio is alpha = r_{21}/r_{22} . In the g method, alpha = g_{21}/g_{22} ; but in the hybrid parameter method, alpha = $-h_{21}$ directly.

The principal disadvantages of the h 's is that they are not directly amenable to circuit analysis. Whereas most engineers are acquainted with resistances and con-

ductances and use them readily in circuit analysis, few are prepared to use h 's directly. If transformations are necessary, and these are quite cumbersome, the advantages mentioned above may well be overshadowed. Engineers are currently studying the relative merits of each set of parameters. The indications are that considerable additional experience is needed before a single set of parameters to characterize transistors will be generally adopted.

Resume

In resume, the following are the salient points:

(1) Typical power gains that are possible with the grounded-base transistor connection are: point-contact, 20 db; junction, 46 db.

(2) In transistor terminology r_{11} , r_{12} , r_{21} and r_{22} are called small-signal, grounded-base, open-circuit, four-pole, equivalent-circuit parameters. Each part of the name has significance.

(3) A test to determine whether a signal is truly a small signal is to measure the parameters using a selected amplitude of signal, decrease the signal by approximately 50 percent and remeasure the parameters. The measured values must compare within the orders of accuracy required.

(4) Either the r 's, or the g 's or h 's may be used to characterize the transistor equivalent circuit. Considerations such as common usage, short-circuit stability, and effective open and short circuit are involved in selecting the parameters for a given analysis.

REFERENCES

- (1) Abraham Coblenz and Harry L. Owens, Equivalent Transistor Circuits and Equations, TRANSISTORS, Theory and Application, Part VII, ELECTRONICS, p 156, Sep. 1953.
- (2) L. J. Giacoletto, Junction Transistor Equivalent Circuits and Vacuum tube Analogy, Proc IRE, p 1490, v 40 11, Nov. 1952.
- (3) D. A. Alsberg of Bell Telephone Laboratories, Murray Hill, N. J., before IRE, March, 1953, in talk entitled "Transistor Metrology."
- (4) R. M. Ryder and R. J. Kircher, Some Circuit Aspects of the Transistor, BSTJ, p 367, 28, 3 Jul. 1949.
- (5) Measurement of transistor parameters, including the α 's, g 's and h 's, in Signal Corps Interim Basic Section on Transistors, entitled: "Transistors, Crystal Diodes, and Related Semiconductor Devices" MIL-T-12679 (Sig C). Requests from concerns and individuals actively engaged in semiconductor device activity should be addressed: Director, Evans Signal Laboratory, Belmar, N.J., Att'n: Thermionics Branch.

Signal-Noise Meter

Checks TV Links

Noise ratio of studio-transmitter microwave links, intraplant coaxial cables and other broadcasting equipment are determined with a single portable meter. Techniques and equipment applied to propagation studies on 7-kmc relay paths are applicable to broadband communications circuits

INCREASED USE of television program networks and improvement of transmission standards has created a need for a simple device for testing and maintenance of circuits. A signal-noise meter described below was used originally to align, test and maintain the NBC Philadelphia-to-Washington microwave relay. The technique depends upon using test tones in the region between 60 and 300 cycles and a noise amplifier with cutoff below 1,000 cycles. It can be employed to measure the signal-to-noise ratio of single or cascaded links. Noise measurements of coaxial cable lines within the television plant can likewise be made.

This meter measures the peak-to-peak signal to the peak-to-peak noise ratio in db. The signal-noise ratios measured between microwave facilities are usually about 10 db less than free-space calculations made on a power basis, that is, signal watts to noise watts. It should be noted that noise can be other than the thermal noise originating in the head-end of a receiver. For example, it could be interference from an f-m station introduced into the i-f amplifier of the receiver.

The noise on long runs of coaxial cable within a tv plant can also be measured using this equipment. Usually these cables are a few

hundred to a thousand feet long. The noise is of random nature and therefore a cro is used to measure the noise output of the amplifier. It is not necessary to use a 60-to-300 cycle test signal in this case. The noise is amplified to a one-volt level and the amplification required in db is the signal-noise ratio, since 1 volt peak-to-peak is standard picture level.

By ROY MOFFETT

Staff Engineer
Development Engineering
National Broadcasting Co.
New York, N. Y.

Elements of System

The block diagram of the signal-noise meter is shown in Fig. 1. The meter comprises a 60-db video attenuator that can be adjusted in 2-db steps, a 1-kc to 10-mc ampli-

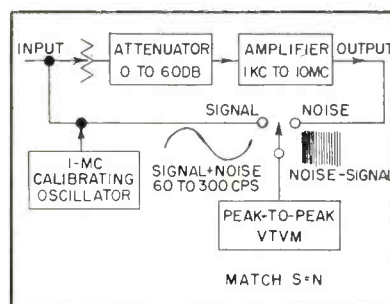

FIG. 1—Block diagram of signal-to-noise measurement meter used for tv

fier having a maximum gain of 60 db, a peak-to-peak vacuum-tube voltmeter and a 1-mc calibrating oscillator. The cathode and grid RC time constants of the amplifier were selected so that the amplifier has a cutoff below 1,000 cycles.

The schematic diagram of this test instrument is shown in Fig. 2. Filaments and plate wiring have been isolated by means of suitable filters. The plate supply with total drain of about 60 ma is regulated by means of a type VR-150. It is important that there be no feedback between the NOISE and SIGNAL sides of the switch to avoid oscillation.

Measurement Procedure

The meter can be calibrated in the following manner: arbitrarily set the attenuators for 50-db attenuation, turn on the 1-mc calibrating oscillator and read the level of the 1-mc calibrating signal on the vtvm with switch on SIGNAL; connect the vtvm to the output of the amplifier, switch on NOISE, and adjust the gain of the amplifier until the 1-mc signal level is the same as it was out of the oscillator. Note that the peak-to-peak vtvm is not calibrated in volts but is used to match the readings. The instrument is now calibrated and the 1-mc calibrating oscillator can be turned off.

The following procedure is used

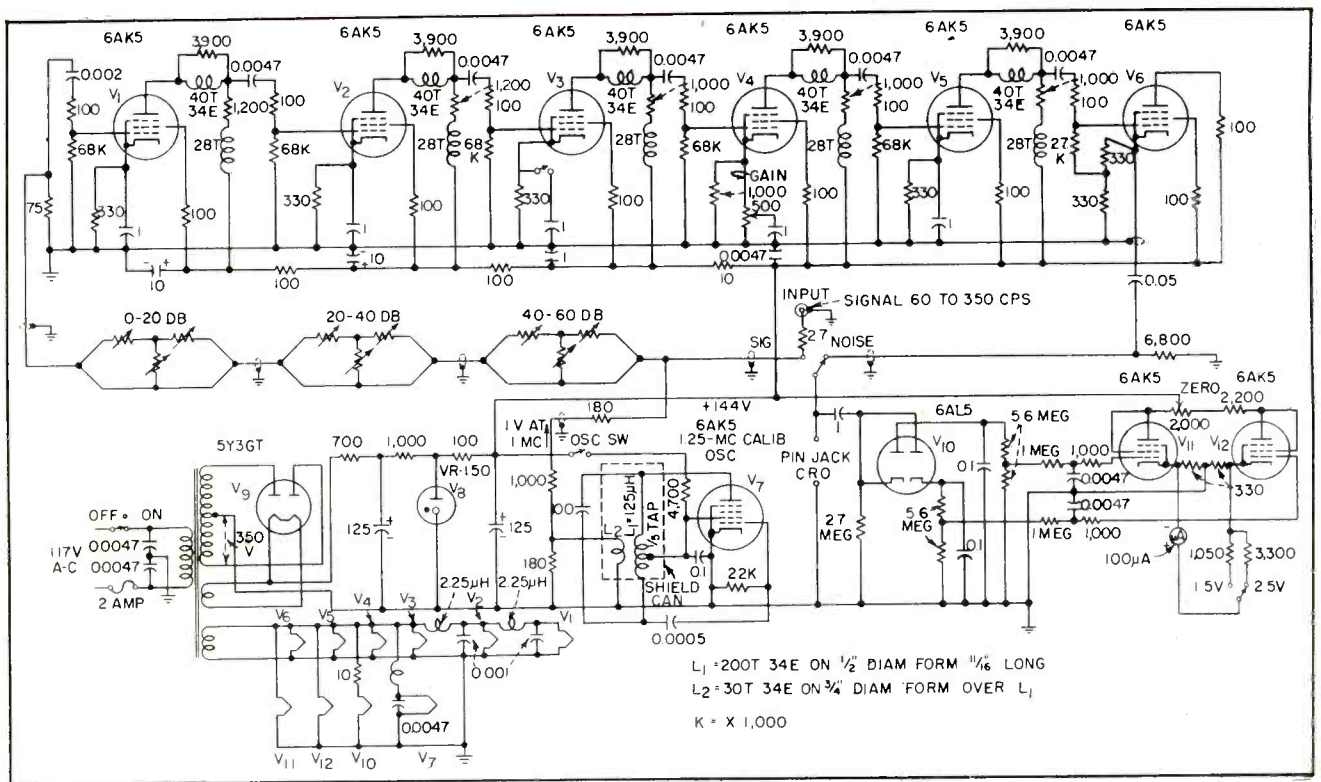

FIG. 2—Schematic diagram of portable meter used in lining up NBC microwave tv links

in making a signal-noise measurement on a studio-transmitter type microwave relay. Modulate the transmitter with an audio oscillator using a sine wave somewhere in the frequency range between 60 and 300 cycles and having the same peak-to-peak amplitude as the normal composite picture signal. The output signal from the microwave receiver is fed to the input of the signal-noise meter. Switch the vtvm to SIGNAL and note the scale reading. Now switch the vtvm to NOISE and then decrease the attenuators until the readings are the same within 1 db. The value in db removed from the attenuators is the signal-noise ratio in db. For example, if the attenuators were decreased from 50 db to 20 db, then the ratio is 30 db.

Field Measurements

Many measurements have been made during the last five years on television microwave relays in both the 2,000 and 7,000-mc bands. A plot of miles vs signal-to-noise ratio in db for 7,000-mc equipment is shown in Fig. 3. An arbitrary line has been drawn to average the individual measurements. A good

example of a relay path under different conditions of both transmission propagation and equipment is shown by the two dots plotted at 31 miles; there is a 6-db difference in the signal-noise ratios.

A bench test of microwave equipment, using an attenuating coupler that approximates 10 miles of transmission, is likewise plotted. Various equipments and attenuators were used in this example. It will be noted that there is a good 6-db spread between the various measurements. Both the output power of the transmitter and the noise factor of the receiver, beside variations in the attenuators, would account for the discrepancy.

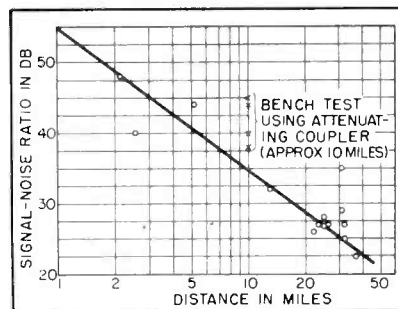

FIG. 3—Comparison of bench and field tests of 7-kmc equipment using 4-ft parabolic reflectors and about 0.1 watt

An attenuating coupler that has a known transmission-path attenuation in db or miles can be used to check transmitter and receiver. The transmitter and receiver are aligned and tuned using a sine-wave test signal and also a composite resolution test pattern. Modulation should be at the same peak-to-peak level with a 60 to 300-cycle sine wave.

Improvements

If the measured signal-noise ratio is below that expected, various portions of the system can be checked. The crystal in the head end of the receiver should be changed, and also the first and second tubes following the microwave converter, likewise the output klystron of the transmitter.

The transmission path is checked next. It is assumed that this relay path provides line-of-sight transmission. The parabolic reflector dishes should be panned in using the signal-noise meter for determining minimum noise. The signal should also be observed on a cro. This method is more accurate than using carrier meter on microwave receiver for checking signal.

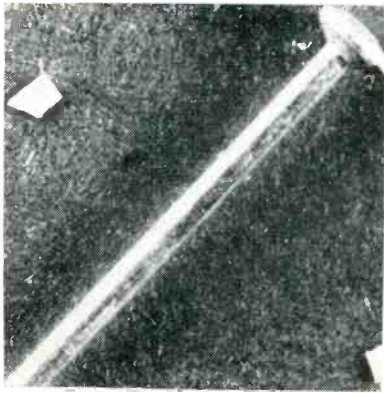

Tiny dielectric amplifier capacitors before mounting

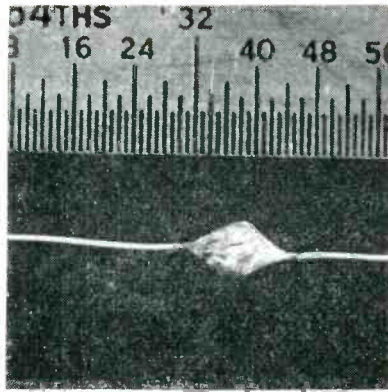

Dielectric with leads for applications where sealing is unnecessary

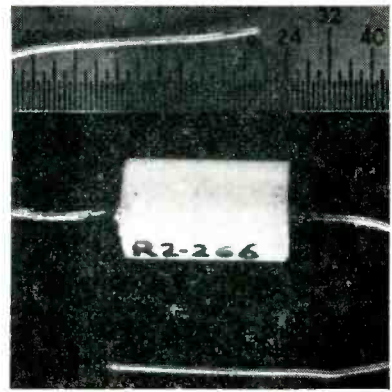

Complete hermetically sealed unit is shown at roughly half normal size

Nonlinear Capacitors for

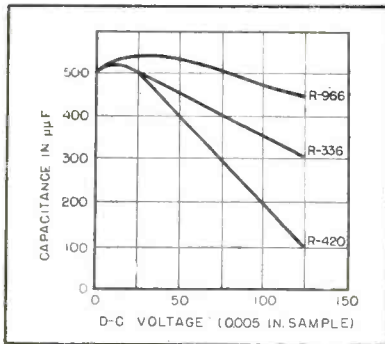

FIG. 1—Curves show incremental capacitance as a function of voltage for several typical dielectors

By **GEORGE S. SHAW** and **JAMES L. JENKINS**

*Radiation, Incorporated
Melbourne, Florida*

ALTHOUGH somewhat overshadowed in recent years by transistor developments, the dielectric amplifier still promises to be an important factor in the electronics industry of the future. Extremely versatile dielectric amplifiers have been built, but their operation is presently limited to environments of carefully-controlled conditions.

Continuing research for new and better materials for use in dielectric amplifiers is showing profitable results day by day.

Incremental capacitance is plotted as a function of d-c voltage applied to several typical dielectors in Fig. 1. Such information pro-

vides certain useful criteria for designing amplifiers and other circuitry. The linearity of this type of curve is a measure of linearity of the output signal of the amplifier. The gain of a dielectric amplifier is proportional to the slope of this curve which can be evaluated by defining δ as

$$\delta = \frac{2(C_1 - C_2)}{(E_1 - E_2)(C_1 + C_2)}$$

which is the mean fractional change in capacitance per unit change in bias voltage in the interval between E_1 and E_2 .

For certain compositions, values of δ of 0.08 have been obtained, with values as large as 0.1 being realized under special conditions. These bodies should by no means be

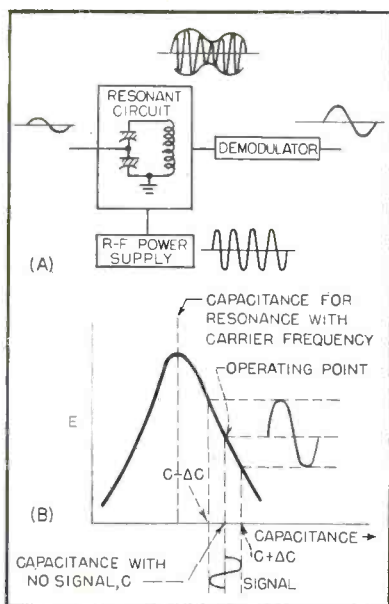

FIG. 2—Typical application for nonlinear capacitors is modulator circuit

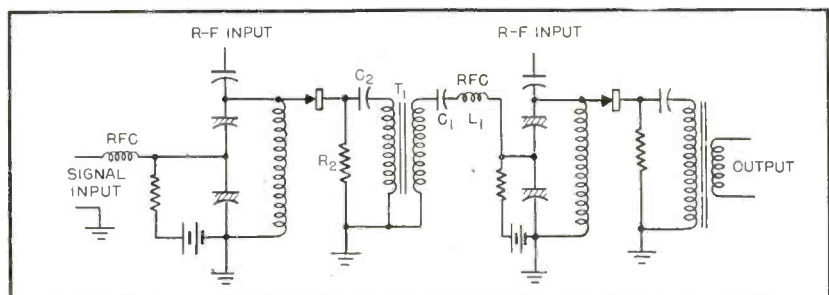
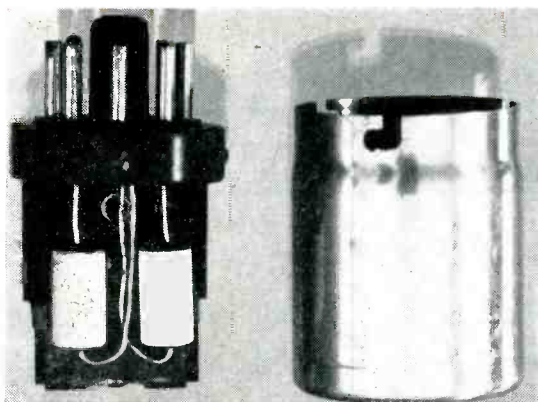
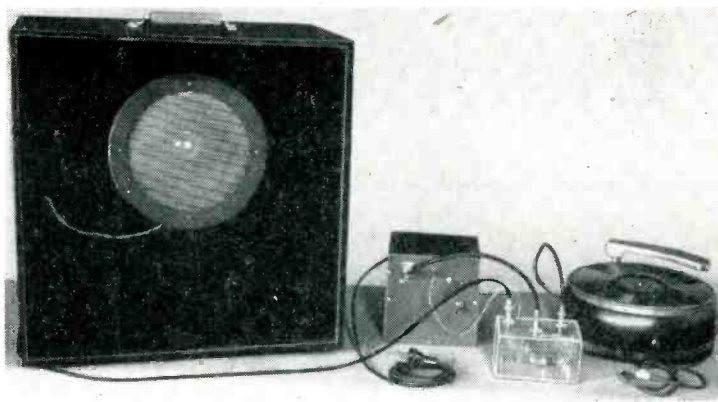

FIG. 3—Circuit of small broadcast receiver using dielectric amplifiers at r-f and a-f frequencies



Two dielectors are installed in temperature-controlled oven that maintains 90 deg C



Laboratory model of two-stage audio amplifier that gives 300 mw output. The r-f power source is shown at center

Dielectric Amplifiers

Using an r-f power source, a typical two-stage dielectric amplifier produces 300 milliwatts output from a 0.3 milliwatt signal source. Although still vulnerable to atmospheric conditions, progress is being made in developing new materials

considered as optimum since there is a great deal of research work yet to be done before the mechanism of voltage sensitivity will be fully understood and controllable.

At the present time, all of the dielectrics known to be appreciably voltage sensitive have dielectric constants in the order of 2,000 to 6,000. Dielectors suitable for circuit applications at the higher frequencies and with small signal voltages must have small capacitance values and must be made from thin dielectrics so that the signal voltage gradient will be adequate.

This immediately presents a problem since a capacitor having a value of 100 μf with a dielectric material 0.005 in. thick, and having a dielectric constant of 4,000 would be approximately 0.0236 inch square, or less than 1/32 inch on each side. This is small indeed and presents serious problems in manufacture and mounting. Nevertheless dielectors are currently being produced with a dielectric thickness as small as 0.005 in. and with zero-voltage capacitances as low as 100 μf .

At the present time, the voltage

sensitivity of the commercial dielectric amplifier capacitors shown in the photographs, varies somewhat with temperature. For operation in circuits where the sensitivity must be constant, the units may be operated in a small temperature-controlled oven as shown.

Circuit Application

Usable amplification is obtainable from dielectors in several ways. An example is shown in Fig. 2A, representing a typical arrangement for a modulator-amplifier. A qualitative explanation of the circuit can best be given by considering Fig. 2B.

A value of capacitance is chosen such that an operating point is established on one side of the resonance curve. If the capacitance is varied by some means, such as a small signal voltage applied to a dielectric, the voltage E will vary. Thus there is produced an amplitude-modulated r-f voltage which can be demodulated to recover the amplified signal. No energy is required from the signal except to replenish the small capacitor losses since all the energy supplied to the

load as an amplified signal comes from the r-f carrier supply. It is evident that the higher the Q of the circuit, the greater will be the change in voltage E for a small change in capacitance.

Figure 3 is a diagram of a two-stage audio-frequency dielectric amplifier which has been built that has an overall power gain of 30 db. The input signal power is 0.3 milliwatt and the power output is 300 milliwatts.

As a nonlinear circuit element the dielectric has possible applications other than in amplifiers; the more obvious being in multi-vibrators, memory and storage devices, frequency and amplitude modulators, and electrically-adjustable filters.

Appreciation is expressed to L. R. Culver of Radiation, Inc. for his suggestions and assistance, and to Josephine LeGault for the exhaustive experimental work entailed.

BIBLIOGRAPHY

- A. N. Solomon. Electrical Report 9, Titanium Alloy Mfg. Co., Sept. 17, 1942.
- E. Wainer, A. N. Solomon. Electrical Report 9, Titanium Alloy Mfg. Co., Jan. 9, 1943.
- A. M. Vincent. Dielectric Amplifier Fundamentals, Electronics, p 84. Dec. 1951.

Electron-Beam Head for

Standard magnetic tape run over neck of special miniature cathode-ray tube causes electron beam to deflect between two collecting plates alternately at the recorded audio rate, so that current output of tube is linearly proportional to magnetization on tape

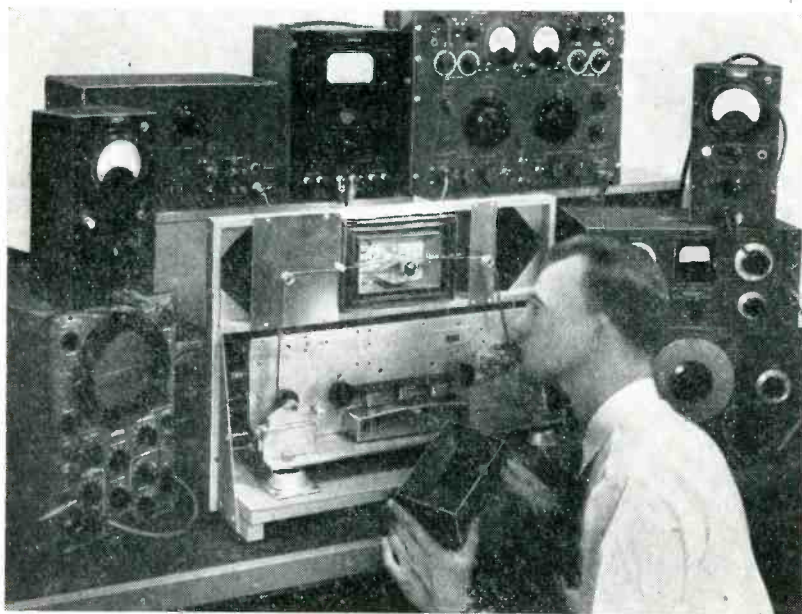

Bench setup used in obtaining performance characteristics of new tape playback head, just visible inside triple-shielded housing from which cover has been removed. Magnetic fields as weak as one-hundredth of the earth's magnetic field will give an output voltage, hence the need for magnetic shielding

SINCE THE TIME of Poulson's invention¹ of magnetic recording over 50 years ago only one principle of reproduction has been employed. This is the generation of a varying electric current in a coil by the variations of magnetic flux from the tape.

A disadvantage of this kind of reproduction lies in the fact that the output signal is proportional to the rate of change of the flux in the tape rather than to the instantaneous values. The resulting frequency characteristic increases from zero linearly until limited by

the gap size.² Since flux here is directly proportional to the input signal, the output from a conventional head is not a true reproduction of what was recorded. Equalizing networks must be incorporated in the reproducing circuits to restore the balance between low and high frequencies so the reproduction will sound like the recorded signal.

Beam-Type Head

In the new pickup head³ described herein, the magnetic flux in the tape is guided by a magnetic structure into a tiny cathode-ray tube

where it deflects the electron beam in proportion to the instantaneous magnitude of the flux. The magnitude of the output signal is independent of the recorded frequency and of the speed of the tape. In fact, if the tape is moved very slowly or even stopped altogether the amplitude of the output signal is not decreased. The tube also acts as a deflection type of amplifier, giving output voltages many times those from conventional heads.

Figure 1A shows a sectional view of the new type of reproducing head, with the old type shown in Fig. 1B for comparison. The new head has a conventional gap in contact with the tape, and a magnetic core structure which guides the flux through the glass walls of the tube. The internal magnetic pole pieces carry the flux into the deflecting region where it produces a magnetic field that deflects the electron beam.

Figure 1C shows a cutaway view of the tube. The miniaturized electron gun at the left sends a beam of electrons between the pole pieces toward the split target. The deflection of the electrons is at right angles to the flux and hence parallel to the pole faces. This property of magnetic deflection is advantageous in increasing the sensitivity since the pole pieces never get in the way of the deflected beam. The pole pieces are thin moly-permalloy and the other metal parts of the tube are nonmagnetic stainless steel.

Figure 2 shows the basic circuit connections. The small plate located just behind the slit between the target plates is grounded to repel

Magnetic Tape Playback

By **A. MELVIN SKELLETT**,
National Union Radio Corp.
Orange, N. J.

LAWRENCE E. LEVERIDGE
National Union Radio Corp.
Orange, N. J.

and **J. WARREN GRATIAN**
Stromberg-Carlson Co.
Rochester, N. Y.

those electrons that pass through the slit and thus reduces the effective slit width. For zero flux and zero deflection the beam is equally split between the output plates of the target, giving zero output voltage across the 100,000-ohm load

resistors. In operation the beam swings back and forth between the two plates depending on whether the flux is negative or positive. When the beam is deflected the target currents are no longer equal and hence a net output voltage is

developed across the two load resistors.

The output characteristic in Fig. 3 shows output voltage measured across the output plates for different values of flux in the beam-gap. The characteristic is linear

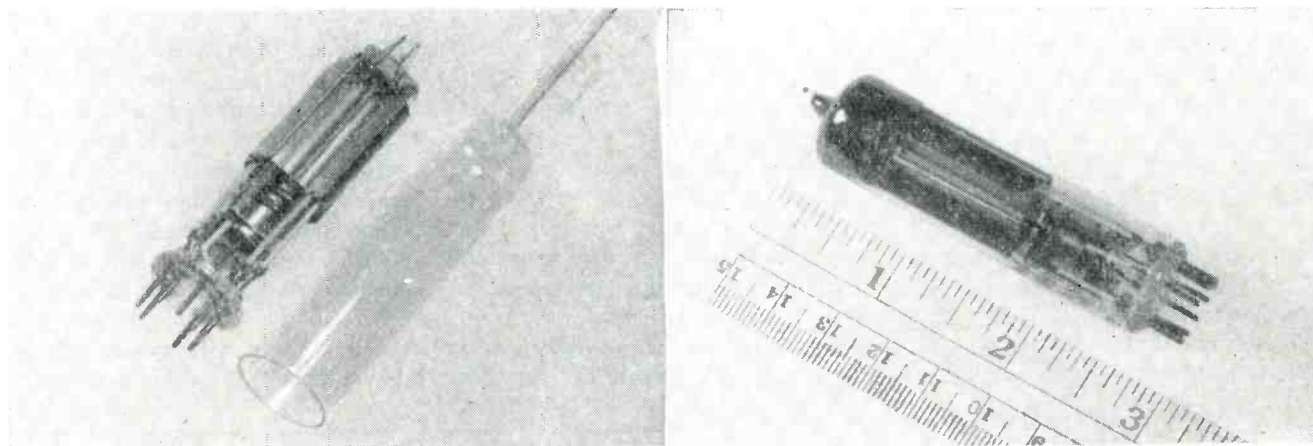

Tube structure and bulb before sealing

Miniature cathode-ray tube after sealing

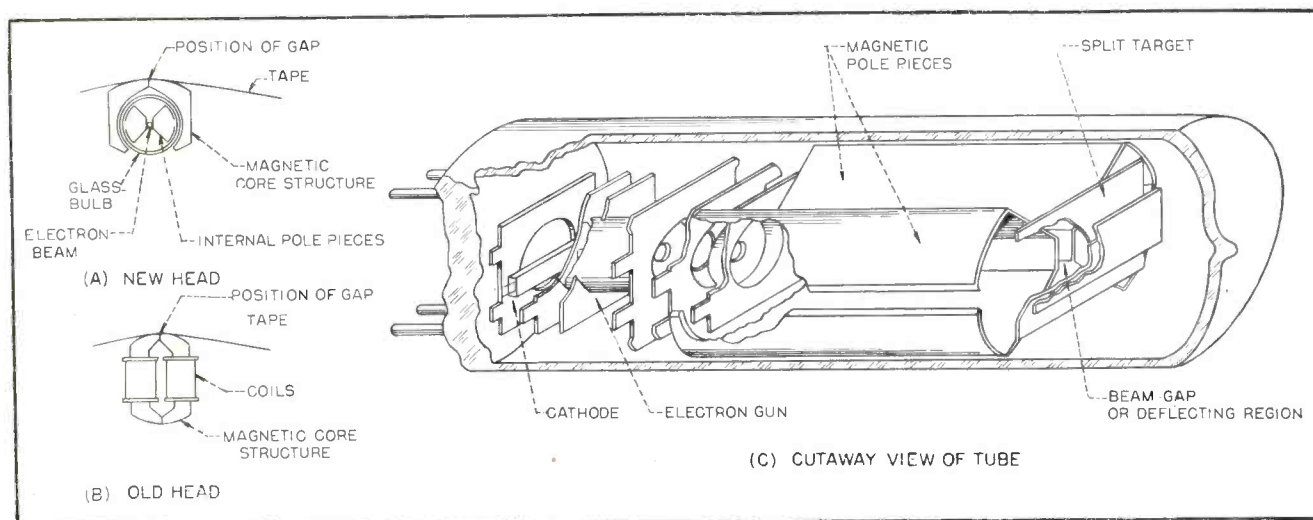

FIG. 1—Cross-sections of new and conventional magnetic tape playback heads, and cutaway view of cathode-ray tube used in new head

over a range of ± 1 gauss. This range is about 50 times greater than the maximum flux variation from standard $\frac{1}{4}$ -inch magnetic tape when used with the complete head under typical operating conditions.

Magnetic Structure

The magnetic head structure design of Fig. 1A was abandoned early in the work, in favor of the strip-type magnetic structure shown in Fig. 4. The magnetic gap caused by the deflecting region in the tube introduces a very high reluctance, making the reluctance of the elements in the magnetic circuit negligible in comparison with the beam-gap reluctance. The magnetic elements may therefore be reduced to the smallest practical dimensions without appreciable loss of flux. A single lamination of Mu metal 0.014 inch thick proved to be adequate.

The strip-type structure is assembled by using Hysol thermo-setting casting resin, which has good adhesion to the metal and is easy to handle. A molybdenum spacer 0.0003 inch thick controls the pickup gap. The wings of the head extend out in the direction of the tape to increase the effective length of the magnetic core, and also act to extend and flatten the low-frequency response of the

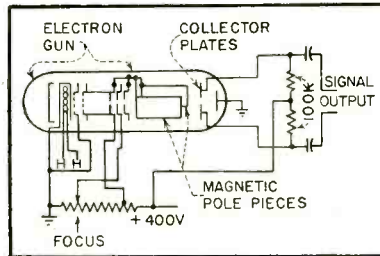

FIG. 2—Cathode-ray tube circuit

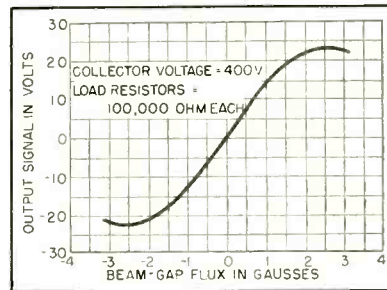

FIG. 3—Output characteristic of new electron-beam playback head

pickup, for improved performance.

Sensitivity

To determine the flux density at the electron beam, a calibrated vibrating probe was used to measure the flux density in the gap between a pair of dummy pole pieces mounted in proper relation to the external magnetic structure. With a saturated tape recording, a field intensity of approximately 0.04 gauss was available for de-

flection of the electron beam.

Reluctances and leakage factors of the various portions of the magnetic circuit were determined by additional measurements and calculations. Using these values, it was shown that the total flux in the beam gap should approximate 8 percent of that available from the recording. The cross-section area of the magnetic tape coating was approximately $1/1,200$ that of the beam gap. A saturated recording on a typical tape having a retentivity of 600 gauss should provide a beam-gap flux density of $600 \times 0.08 \times 1/1,200 = 0.04$ gauss, which is in agreement with the earlier measurements.

Tube sensitivity was determined by measuring the tube voltage output with a known applied magnetomotive force. The beam-gap flux density was calculated from the known mmf and previously determined magnetic circuit parameters, thus permitting the tube sensitivity to be expressed in terms of tube voltage output per gauss of beam-gap flux density. With the sensitivity of the tube equal to 15 volts per gauss and a beam-gap flux density of 0.04 gauss, a maximum output voltage of 0.6 volt peak plate-to-plate was expected. Tests with recordings on tape confirmed these figures within

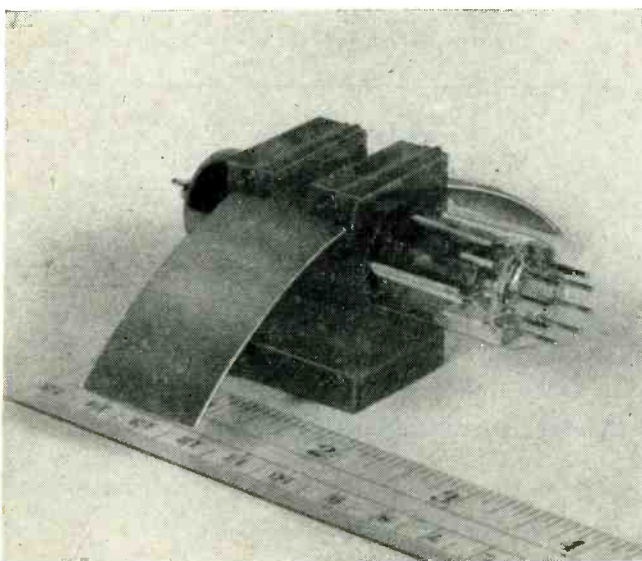

Complete head, with cathode ray tube in position. Tape runs over smoothly curved wings of core

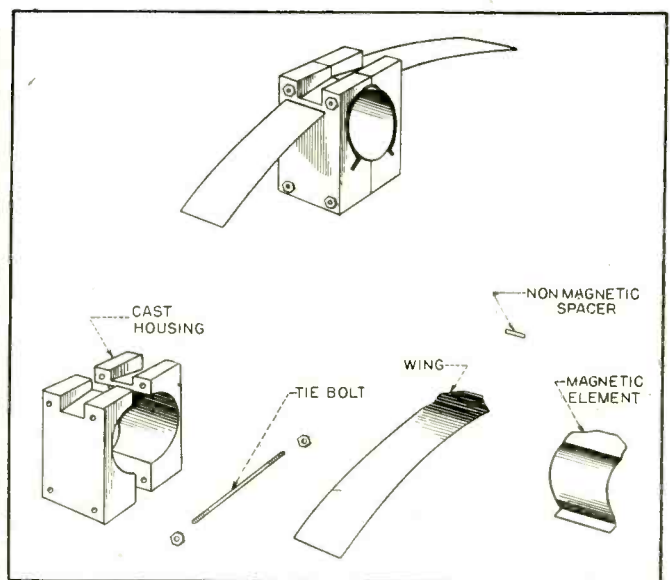

FIG. 4—Components and assembly of experimental winged core used with new head

experimental error.

These figures indicate the high sensitivity of the cathode-ray tube. It will give satisfactory output voltages on field strengths from one-tenth to one-hundredth the strength of the earth's magnetic field.

Frequency Characteristics

Curve A of Fig. 5 gives the frequency response of the new head without any equalization. Curve B, shown for comparison, is the frequency characteristic of a conventional pickup head, also without equalization. It should be noted that the scales are quite different for curves A and B. For example, the maximum output obtained by the conventional head is only 10 millivolts, whereas the level of most of the frequency range of the new head is about 0.2 volt. These curves were taken with conventional longitudinal recordings, and demonstrate the superior low-frequency performance of the new head.

At the upper-frequency end of the curves the deterioration in output is caused by the so-called gap effect which comes about because the gap itself is comparable in length with the wavelength of the recorded pattern. The curves show that this effect is more serious with the new type of head. The reason is that the steeply ascending curve of the conventional head partly compensates for this gap effect, whereas the flat characteristic of the new head has no compensating feature.

Calculation indicates that a simple single-section R-C equalizing network used in conjunction with the new head will modify the characteristic to curve C. A two section R-C filter will give an even better effect, as shown by curve D.

Magnetization Pattern on Tape

All of the discussion given above was based upon conventional longitudinal recording on the tape. For very low frequencies, corresponding to long wavelengths in the tape, this is not the optimum type of recording pattern. For the long

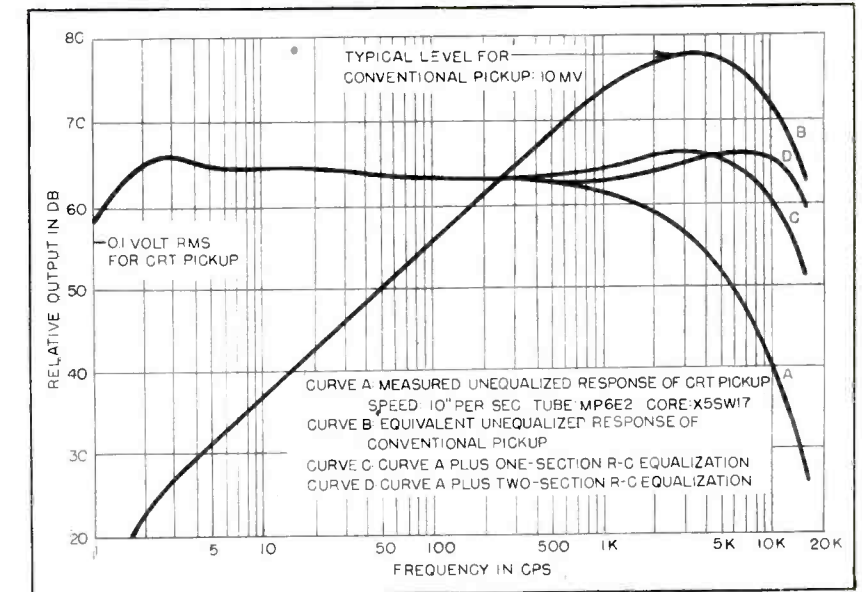

FIG. 5—Frequency response curves for cathode-ray and conventional heads

wavelength the gap has access only to the leakage flux near the center of the elementary magnet; therefore, as the head is moved slowly over a long recording, such as for a square wave, the response will be a maximum at the ends and a minimum at the center of the square pulse.

Either perpendicular or transverse magnetization would be more suitable, but both of these suffer at the high-frequency end. The work to date has been restricted in general to longitudinal recording since the overall response was more important than the low-frequency end of the spectrum.

Applications

Work is being carried on, however, on perpendicular recording involving magnetization through the tape. Indications are that this may be made to give much superior results at the low-frequency end without too great a loss at the high-frequency end of the spectrum.

This new type of head offers advantages over conventional heads in a number of uses. In spite of the excellent results obtained with well-equalized conventional recording of music, it is believed that ultimately the quality obtained with the new head will surpass that possible

with conventional types.

There are certain commercial and military applications where it is desirable to record very low frequencies, d-c levels or pulses without distortion. For these the new head is ideally suited, whereas the old type will not perform adequately without considerable complexity of the apparatus, such as the dithering head and the use of frequency modulation for d-c recording.

The inherent amplification of the tube and the cheaper equalization circuits required by the new head give rise to the hope that a simpler, cheaper magnetic tape recorder may be possible. This would further popularize and widen the field of magnetic tape recording.

This development has been sponsored by the Bureau of Ships of the United States Navy under Contract NObsr-57452. The tube has been under development at National Union Radio Corp. and the magnetic head structure at Stromberg-Carlson Co. This paper was presented at a meeting of the Institute of Radio Engineers in San Antonio, Texas on Feb. 7, 1953.

REFERENCES

- (1) V. Poulson, U. S. Patent No. 661,619, November 13, 1900.
- (2) S. J. Begun, "Magnetic Recording," p. 81, Murray Hill Books, Inc., New York City, 1949.
- (3) A. M. Skellett, U. S. Patent No. 2,165,307.

Fluoroscope Image

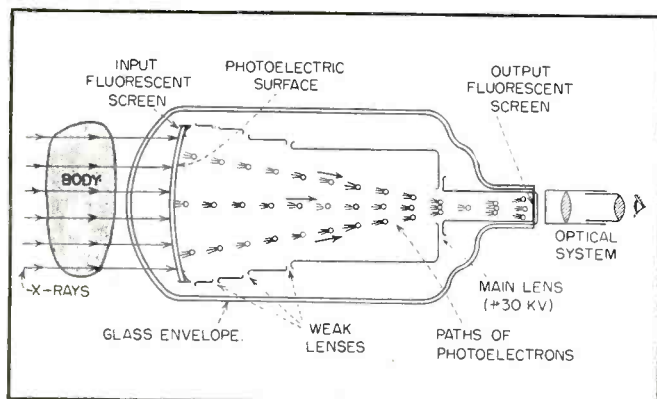
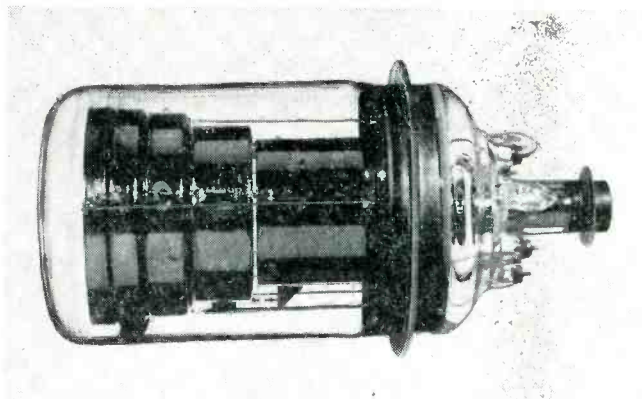

FIG. 1—Cross-section of image-amplifier tube, showing method of brightening x-ray image



Closeup of amplifier tube. Image is viewed on screen in neck of tube through lens system

THE ELECTRONIC fluoroscope is a device designed to replace the conventional medical fluoroscopic screen on which the physician sees the x-ray shadowgraph of the patient. It presents the x-ray image in the same size but increased in brightness by a factor of 200.

For a standard abdomen examination the best fluoroscopic resolution is about 20 lines per inch, obtained after several minutes of dark adaptation by the physician. The brightness amplification of the electronic fluoroscope doubles this, yielding 40 lines per inch without long dark adaptation.

Operating Principle

The heart of the new device is the large image tube shown in the photograph and Fig. 1. X-rays pass through the patient and through the glass window of the tube, to strike the input fluorescent screen, similar to a conventional fluoroscopic screen. The resulting light from the screen releases photoelectrons from a photosurface deposited on the back of the screen. Amplification is accomplished by accelerating the photoelectrons through a 30-kv potential difference. The accelerated electrons strike an output fluorescent screen, releasing more light than was released from the input screen by x-rays. The brightened output image on the other side of this screen is viewed through a system of

optical lenses and mirrors.

By present manufacturing specifications the total brightness amplification of the x-ray image tube is 200. However, true amplification by voltage acceleration accomplishes only about 10 of this amplification. The remaining factor of 20 is obtained by geometrical size reduction of the image. An electrostatic electron-optical system is used to form an output image reduced in size relative to the input image by a factor of about 4.5 in diameter, or 20 in area. Brightness, or emerging light flux per area, is thereby increased by a factor of 20. Light from the output screen emerges diffused into all forward directions.

The 20-fold increase in brightness is not lost when the image is magnified back to size in the light-optical system. The eye is effectively brought very close to the image at the output screen by a lens introduced to accommodate the focus of the eye. Brightness remains unchanged, for the increased magnification is exactly balanced by the increased solid angle of light intercepted by the pupil as the eye is brought closer. This action holds for any magnifier system having an exit aperture larger than the pupil of the eye.

Focusing Lenses

The main electron-optical lens of the image tube is an eighth-inch gap between electrodes across which

most of a 30-kv potential difference is applied. A partially satisfactory image can be obtained using only this main lens, but the resolution is good only at the center. The system of weak auxiliary electron lenses corrects the image for good resolution over its full diameter.

Screens

The input x-ray phosphor must have high efficiency and its light must be spectrally matched to the photosurface. Phosphors in the zinc sulfide and zinc cadmium sulfide family have given the best results.

The intermediate photosurface uses blue-sensitive cesium antimony which has a high threshold energy for escape of any large number of thermal electrons at room temperature. As a result, the output image shows no detectable background glow due to thermally emitted electrons, yet the threshold energy is not so high as to involve photoelectron velocities great enough to cause difficulty in focusing.

For the output electron phosphor, zinc cadmium sulfide was chosen because of high efficiency and because its yellow-green spectral output matches the response of the eye. This screen is aluminum-backed to increase forward light yield and prevent feedback of light.

The electron-optical demagnification ratio was determined from an estimate of the maximum magnifi-

Amplifying Tube

New tube converts x-ray image into photoelectron stream for intensification by 30-kv electron lenses. Resulting image on aluminum-backed output screen appears 200 times brighter than standard fluoroscope when viewed at original size through magnifying optical system

cation which could be expected from a satisfactory light-optical system.

Amplification in the image tube brought out a defect of phosphorescence in the input phosphor which was not anticipated. The zinc sulfide was shown to have a composite phosphorescence, with several different decay constants. It was found that persistence gradually builds up due to low-intensity components with very long decay constants. As successive patients were examined, the output image was so obscured by a general background glow that the tube became useless until the next day. The brightness of this persistence glow was too low to be seen directly at the blue-emitting screen itself, but it was brought out by the amplification of the tube. The defect was first corrected by the use of in-

By FITZ-HUGH MARSHALL

Research Department
Westinghouse Electric Corp.
East Pittsburgh, Pa.

frared light for quenching between exposures, but recent improvements in the cathode composition has reduced the persistence to satisfactory levels.

Amplification

Another problem encountered during development work concerned the difficulty of measuring the amplification of the tube. The conventional screen emits light on the green side of yellow-green, for best response of the dark-adapted eye. The output light of the electronic fluoroscope is on the yellow side of yellow-green, matching the unadapted eye.

Comparison photometry must be

done at some one brightness, but visual amplification varies with brightness level. With some spectral combinations amplification at high brightness has probably been as much as double the value at low brightness. However, apparent amplification also seems to vary with such observer factors as time in the dark, recent hours in bright sunlight and tendency to look off-center to bring in parafoveal vision, all of which influence the effective degree of observer dark adaptation.

Amplification also varies with quality of the radiation, as influenced by x-ray voltage and equivalent patient thickness. To avoid confusion, an arbitrary specification of conditions for amplification measurement has been adopted. The actual comparison measurements are now made by phototube.

A value of 500 was originally suggested as a reasonable practical amplification limit.¹ Actually, this amplification has been exceeded in some tubes under some conditions.

In the meantime, the Patterson B conventional fluoroscope screen has been superseded by the brighter Patterson B-2 screen, changing the comparison standard. Relative to the old standard, the present specified amplification of 200 would be nearer 300. The remaining difference represents an effort to be conservative, both in avoiding nontypical conditions of measurement and in accepting a production goal which can be met in reasonable quantity.

REFERENCE

(1) J. W. Coltman, Fluoroscopic Image Brightening by Electronic Means, *Radiology*, 51, p 359, Sept. 1948.

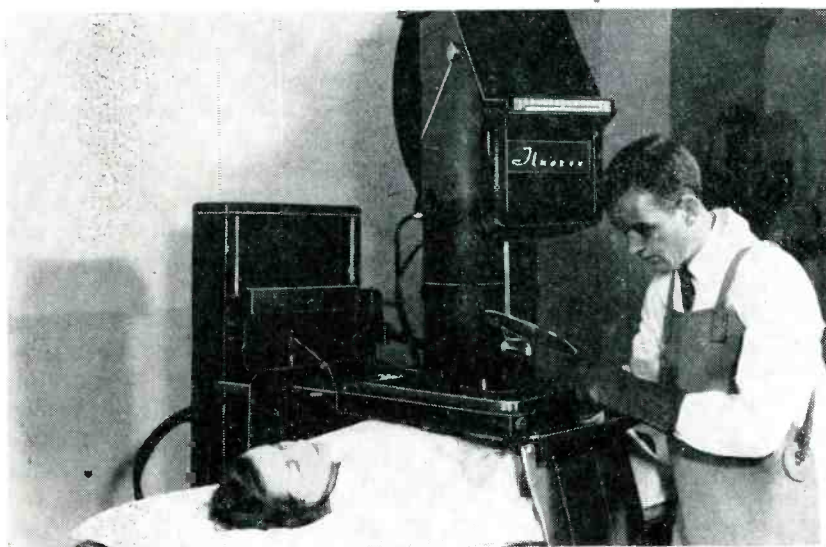

Image amplifier tube and optical system in housing over patient take the place of a regular fluoroscope screen. The X-ray tube is here located under the table. Intensified image, magnified by optical system at top of housing is viewed in mirror of Fluorex machine

By **LOUIS W. ERATH**

Vice-President
Southwestern Industrial Electronics Co.
Houston, Texas

BY modifying a conventional Wien bridge type of R-C oscillator so no arm of the bridge is shunted by a low impedance, the influence of vacuum tubes on the oscillator can be virtually eliminated. The only bridge shunting elements then are vacuum-tube grids. This unique arrangement gives extreme frequency stability and very low harmonic distortion. The oscillator has a small general drift for several hours due to warm-up, but the short-time frequency stability is of the order of 1 part per 100,000 over an operating range of 1 cps to 120,000 cps. One application for an instrument with this degree of stability is in conjunction with digital-type frequency counters used in designing sharply tuned filters. The wide frequency coverage, from 1 to 120,000 cps in five overlapping ranges, is useful as well for research in geophysics, medicine and ordnance.

A well-regulated power supply minimizes the influence of line voltage variations on frequency and contributes to a low hum level.

The type of output circuit used provides a low generator impedance. The output level control keeps the undesired voltages at a constant percentage of the desired output voltage, which may be as high as 20 volts.

Circuit Details

The oscillator circuit is composed of two separate amplifiers, joined together by a bridge network as shown in Fig. 1. This network is both frequency and amplitude sensitive with respect to the conditions of its balance.

The two amplifiers are entirely separate, except that the screens and cathodes of V_1 and V_2 are fed from the same points on the voltage-divider networks as are the corresponding electrodes of V_3 and V_4 . This is done to avoid the necessity of bypassing the a-c currents in these elements to ground with capacitors.

Four-terminal network *A-B-C-D*



Test setup, with R-C oscillator at left. Frequency ranges are so chosen that readings of single 1-120 scale on tuning dial are multiplied by powers of 10

Bridge-Stabilized

serves to connect the two amplifiers together. This network is a Wien bridge which has been modified to be amplitude-sensitive by the use of quasilinear elements in the resistive bridge arms. At zero and infinite frequencies, terminals *A* and *C* are at the same potential. Amplifier No. 1 then has its output connected directly to its input degeneratively, and the amount of negative feedback is equal to the gain of this amplifier alone.

At a frequency which is determined by the reactive arms of the bridge, the two amplifiers are coupled together regeneratively by a network having a loss which is less than the gain of the amplifiers; under these conditions, oscillations start. As the amplitude of the oscillations increases, the loss in the bridge network also increases until it has become numerically equal to the average gain of the two amplifiers. This is the stable operating condition.

The voltage across R_3 contains the fundamental frequency plus about $\frac{1}{2}$ percent of even-order harmonic distortion. The voltage across R_1 contains an out-of-phase fundamental component, but the even-order harmonic components

are in phase with those appearing across R_3 . A special amplifier having dual input circuits is used to combine these voltages into a single voltage with respect to ground, which is essentially free of even-order harmonic distortion.

Both the oscillator and the amplifier have been provided with overall d-c negative feedback, and the internal potentials of the vacuum tubes have practically no effect on the d-c operating potentials of the circuit. Approximately 40 db of negative a-c feedback is used in the amplifier, adjustable through choice of values for R_5 and R_6 . The net a-c gain of the amplifier is less than 2.

Tube V_5 has been used as a load resistor for V_6 so that all of the signal power may be delivered to the load.

The power line frequency comparator tube V_5 has its target powered by the low-angle peaks of the 450-volt power transformer secondary. This allows frequencies which are related to the power line frequency by the factors $\frac{1}{3}$, $\frac{2}{3}$, 1, 2, 3, 4 and 5 to be spotted with ease.

Performance

When the oscillator is operating properly, the harmonic content of

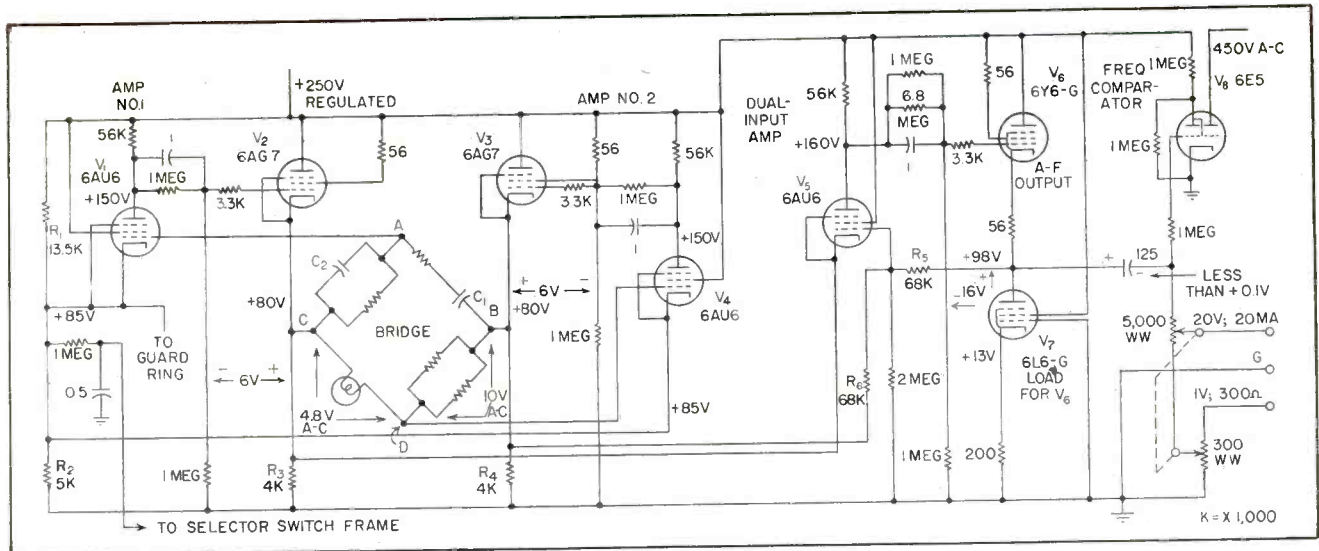

FIG. 1—Circuit of oscillator. Stabilized power supply, not shown, uses 5U4-G as full-wave rectifier with 900-v c-t transformer, with two 6Y6-G, one 6AU6 and one 0B2 in regulator circuit

Ultrasonic Oscillator

Two-amplifier variation of Wien-bridge R-C oscillator gives exceptional frequency stability and low harmonic distortion, for digital-type frequency counters as well as for audio and ultrasonic research. Five overlapping ranges cover 1 cps to 120,000 cps

the output voltage is about 0.1 percent in the range from 20 to 20,000 cycles per second. Above 20,000 cycles per second, the second harmonic increases slightly due to the increased loading by the stray capacitances to ground. Below 20 cps, the third harmonic increases slightly due to cooling of the thermal a-c element during the cycle. It reaches a value of about 1 percent at 1 cps.

Low distortion at low frequencies may be obtained by replacing the 6-watt 120-volt lamp in the bridge circuit (Fig. 2) with a 10-watt 120-volt lamp and changing R_7 to 560 ohms. Under this condition the output drops to about 6 volts, and the harmonic content at 1 cps is less than 0.2 percent. With the 10-watt lamp, the amplitude requires a much longer time to stabilize after a change in frequency is made, but otherwise the performance of the instrument is the same.

Extreme amplitude stability may be had at a sacrifice of good waveform at the lower frequencies by replacing R_5 and R_6 with a type 1C thermistor and leaving the 6-watt lamp in place. Under these conditions, the harmonic content at 10 cps is about 2 percent and increases

rapidly at lower frequencies. The distortion decreases at frequencies above 10 cps. The harmonic content may be observed by using a parallel-T null network to reject the fundamental and an a-c millivoltmeter for measuring the rms value of harmonics which remain.

Current passed by the 125- μ f electrolytic output coupling capacitor gives in the output a d-c voltage that is less than 1 percent of the output signal.

The 20-volt output circuit has a variable internal impedance which reaches a maximum of about 1,250 ohms when the control is set at half value. If a lower output impedance is desired, 2 volts can be produced across a 100-ohm resistor which is connected across the 20-volt output terminals. The 1-volt output circuit has a constant internal impedance of 300 ohms. Output currents up to 20 ma rms can be drawn without an increase in distortion.

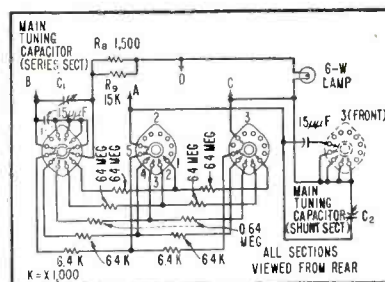

FIG. 2—Bridge circuit and range switch. The ten resistors in the frequency-determining legs of the bridge, below the switch, are all 1 percent deposited carbon units. Frequencies for the five switch positions are: 1—1-12 cps; 2—10-120 cps; 3—100-1,200 cps; 4—1,000-12,000 cps; 5—10,000-120,000 cps

Measuring Impedance of

Unknown resistor is connected across a special coaxial cavity that is fed by an unmodulated signal generator and is tuned linearly to resonance by an inward-projecting precision micrometer spindle. Resulting voltage across resistor is detected, measured and converted to impedance with accuracy better than 5 percent up to 400 mc

By **CHARLES L. WELLARD**

*International Resistance Co.
Philadelphia, Pa.*

MEASUREMENT of resistor impedance in the so-called middle band of frequencies around 400 mc necessitates the application of special techniques since this range is too high for conventional bridge methods and too low for convenient use of slotted line and waveguide techniques. The band of frequencies between 30 mc and 400 mc may be thought of as the region of transition from lumped parameters to distributed parameter circuits.

The special middle-band equip-

ment to be described uses a tuned coaxial cavity of the correct length for resonance at the desired frequency. Measurements are made at the discrete frequencies of 2, 10, 25, 50, 100, 200, 300 and 400 mc on impedances up to and including one megohm. The measurements at frequencies below 100 mc are obtained by adding lumped inductances on the end of the cavity.

An earlier cavity application for this purpose¹ allowed comparative measurements to be made at discrete points, namely 100, 200, 300 and 400 mc. One cavity was essentially designed for 200-mc operation, but by reducing the length of the inner conductor, satisfactory

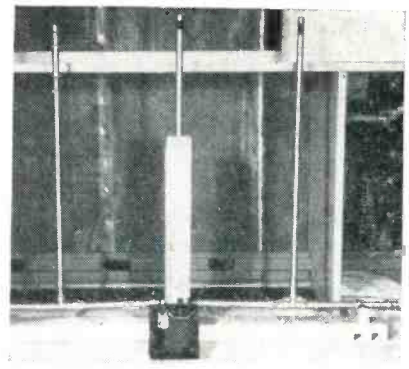

Adjustable padders and tuning stubs used across generator output line to vary cavity impedance

400-mc operation was attained. However, the cavity could not make use of the susceptance variation technique, and as such had to depend on a comparison with impedances established by other methods.

A number of other approaches to measurement of impedances in this frequency range have been tried,² but all of them had serious drawbacks. The cavity-type equipment described here overcomes these limitations and yet provides adequate range and excellent stability.

Theory of Cavity Operation

Consider a tunable resonant circuit connected to a generator of internal impedance $r + j\omega l$ as shown in Fig. 1. This circuit can be simplified in the successive steps of Fig. 1B and 1C to a resonant circuit fed by a current source I .

The unknown under consideration is indicated as R_x and C_x . The impedance R_0 of the tuned circuit at resonance is a function of the original tuned circuit and the internal impedance of the generator supply.

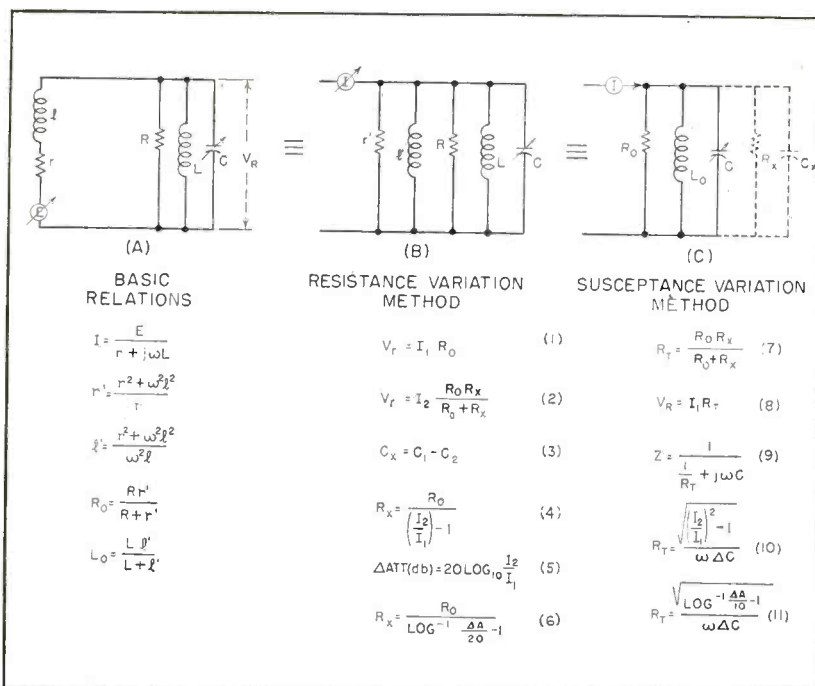
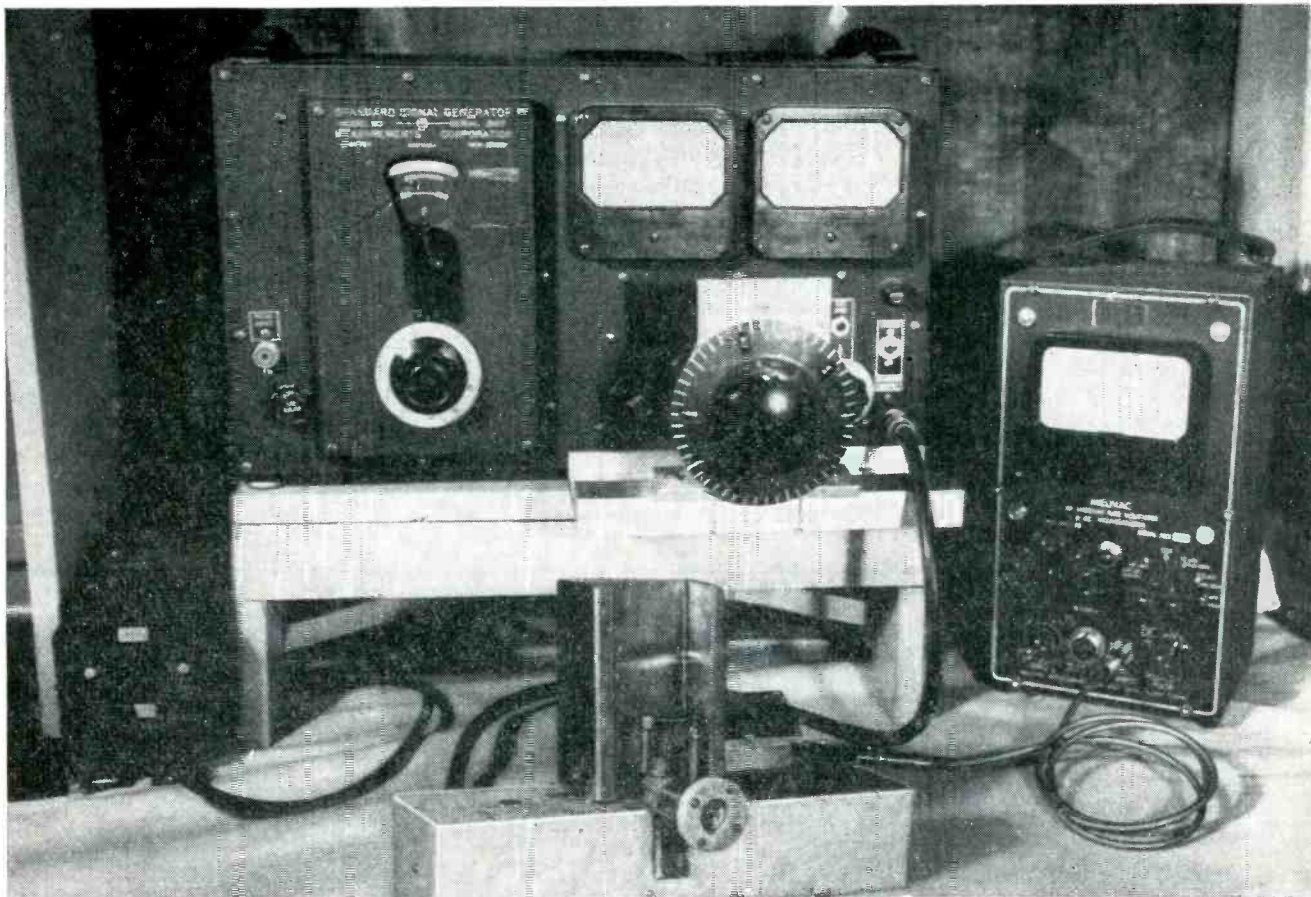

FIG. 1—Three-step simplification of tunable resonant circuit to arrangement fed by current source I , along with basic relations for the simplified circuits and the equations for two methods of using the circuit for measuring high-frequency impedance

High-Frequency Resistors



Complete measuring setup using modified Signal Corps Engineering Laboratories design of cavity (in foreground) which is permanently tuned to 400 mc. Signal generator is Measurements Corp. model 80, measuring instrument at right is Millivac vtm with built-in d-c amplifier. Calibrated attenuator is on wooden stand in front of generator

Essentially, the two methods which may be employed with such a setup to measure an unknown are the resistance variation method and the susceptance variation method.

Resistance Method

To understand the resistance variation technique, consider the resonant circuit of Fig. 1C. The circuit is tuned to resonance first without the unknown. The voltage V_r across the resonant circuit then is equal to $I_1 R_o$, where I_1 is the current from the source. The tuning capacitor is now at C_1 . Next, the unknown is inserted and resonance is again obtained by retuning the variable capacitor to C_2 . The current generator output I_1 is then increased to a value I_2 such that V_r is made equal to the same value as before the unknown was inserted. Equations 1, 2 and 3 in Fig. 1 por-

tray these conditions, and give Eq. 4 as the value of R_x . If an attenuator is employed on the generator, the ratio I_2/I_1 may be expressed in decibels as in Eq. 5, giving for R_x the more convenient expression of Eq. 6.

In this analysis R_o has been assumed constant, which requires the output impedance of the signal generator to be constant for all attenuator settings. A piston-type

attenuator essentially fulfills this requirement.

Susceptance Method

In the susceptance variation method, the parallel combination R_x of R_x and R_o is Eq. 7 of Fig. 1. At resonance, V_r is then given by Eq. 8. If the resonant circuit is now detuned by a known amount ΔC , Eq. 9 gives the circuit impedance.

If the output of the generator is next increased to some value I_2 such that the same value of V_r is maintained, then $V_r = I_2 |Z|$ where Z is given by Eq. 9. The two expressions for V_r can be equated, solved for R_x and simplified to the form of Eq. 10.

If the generator has a piston-type attenuator, Eq. 11 can be used. Here R_x is given in terms of the change in attenuator setting and the known change in ΔC . Since

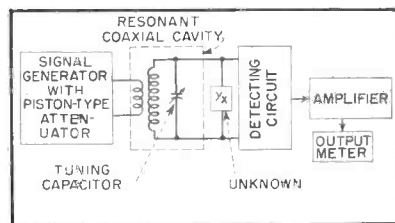

FIG. 2—Measuring setup, showing how unknown resistor is connected across resonant coaxial cavity

without any unknown impedance connected into the circuit $R_s = R_o$, this relationship may be utilized to measure the R_o of the resonant circuit. It may be desirable to prepare tables such that only a few seconds are needed to convert attenuator and capacitor readings into actual resistance values.

Circuit Arrangement

A block diagram of the equipment is shown in Fig. 2. A resonant coaxial cavity is fed by the unmodulated output of a signal generator equipped with a piston-type attenuator. The output of the resonant cavity is converted into a d-c voltage by a detector circuit, and amplified and measured by a commercially available d-c amplifier with built-in output meter.

For practical reasons, three separate cavities have been used. Although all are essentially the same in principle, they vary in design. The input is inductively coupled into the cavity, and the degree of coupling may be varied by rotating the coupling loop. Sections are available for operation at 100, 200, 300 or 400 mc, as shown in Fig. 3. In addition, a set of coils is available for measurements at 2, 10, 25 and 50 mc.

One cavity has been used principally for measurements at 2, 10, 25, 50 and 100 mc, because assembly and disassembly of the cavity results in a change in characteristics, particularly in R_o , necessitating a new determination of R_o for each use, while two others are left permanently at 200 and

400 mc respectively.

The capacitor design causes some trouble at 400 mc after long periods of use. This is because the electrical contacts become dirty, and is remedied by disassembly and cleaning.

Construction

The cavity has a center conductor that increases in diameter at one end to accommodate a linear capacitor. The center conductor has a coaxial hole bored down the center on the enlarged diameter end. A special micrometer for waveguide use is inserted in this hole to provide a linear capacitance variation of $5 \mu\text{f}$ per inch, which allows incremental values of capacitance as low as $0.001 \mu\text{f}$ to be measured. A capacitive probe provides the

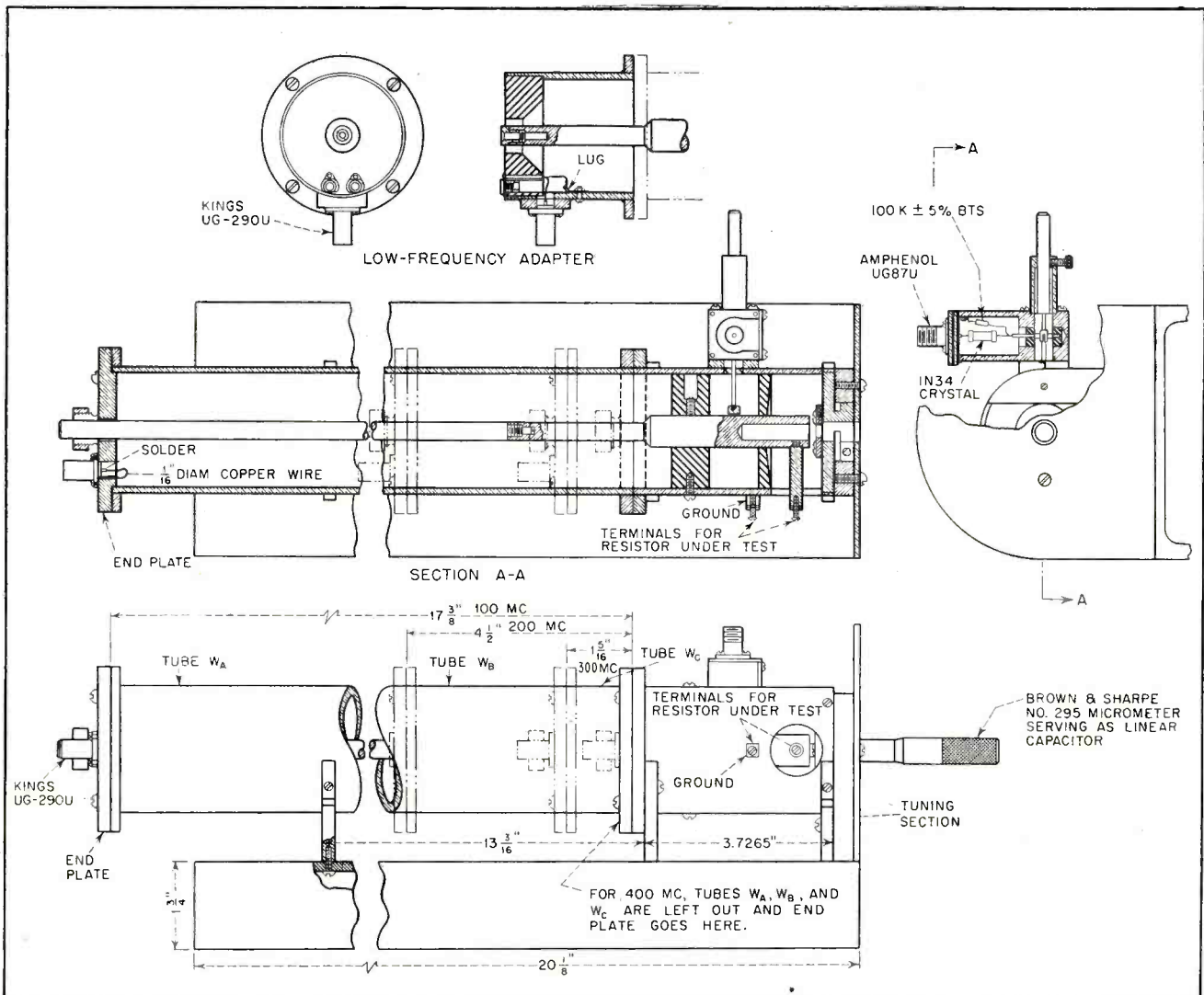
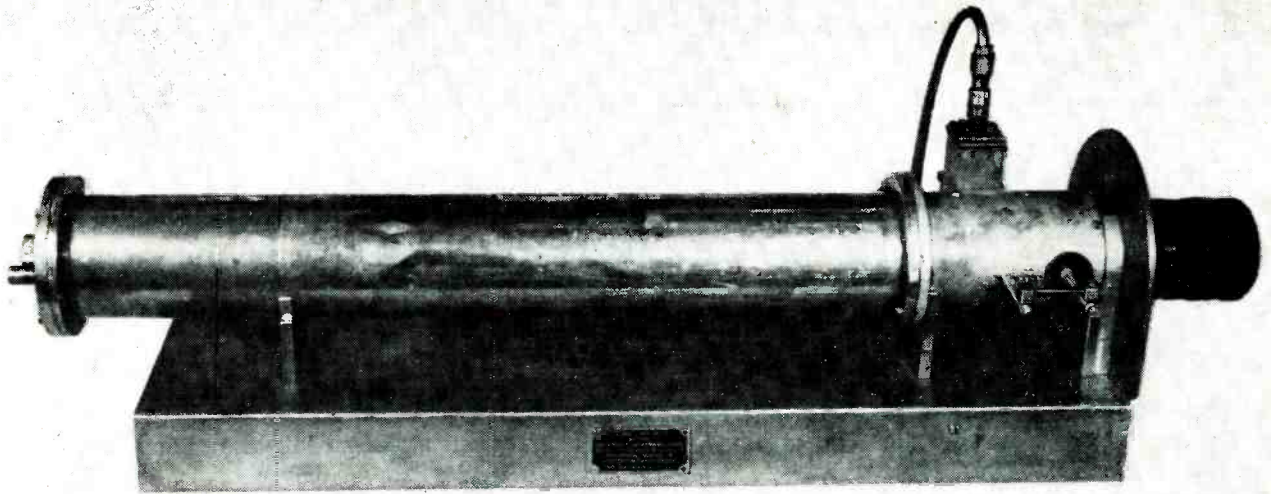

FIG. 3—Three views of coaxial cavity arrangement. For 400 mc, end plate at left is fastened directly to tuning section. For 300 mc, shortest tube is inserted between tuner and end plate. For 200 mc, medium-length tube is inserted. For 100 mc, largest tube is inserted. For still lower frequencies, low-frequency adapter having lumped inductances is used on 100-mc tube in place of end plate



Cavity setup for 100-mc measurements. Unknown resistor is connected between screw terminals projecting forward from tuning section at right; grounded terminal can be inserted in one of seven different holes to accommodate different lengths of resistors

input to the detector and is adjustable in position. A crystal arrangement is used as the detector.

One of the cavities is kept at the 100-mc position for measurements at 2, 10, 25, 50 and 100 mc. Two cavities of modified Signal Corps Engineering Laboratories design are permanently set, one at 200 mc and the other at 400 mc. A shield on each cavity eliminates the effects of variable stray capacitance.

Components of various diameters and lengths are accommodated by moving the ground terminal. Units of various sizes (within limitations) are all given the same lead length, same orientation and same parallel distance to a grounded conducting plane, all without adding losses to the system.

Cavity Impedance

The impedance R_0 of the 400-mc cavity is in the order of 90,000 ohms. Former cavities were limited to approximately 50,000 ohms at 400 mc. This increased R_0 comes as a result of special precautions in plating the interior of the cavity and improved mechanical connections of the cavity. It is important, however, to be able to control the R_0 of the cavity since the greatest accuracy occurs when the value of R_0 is near the value to be measured. To increase the range of R_0 , ma-

terially, simple adjustable padder and tuning stubs may be connected across the line from the generator to the resonant cavity. These give characteristic impedances of anything from a few thousand ohms to 12,000 ohms at 400 mc. The range attainable increases as the frequency decreases.

Results

Typical high-frequency performance curves obtained with this equipment are given in Fig. 4. It was found that in all cases performance suffered as resistance value increased. There are exceptions to this, but usually they are limited to performance over a very narrow bandwidth. The data on this curve may also be used to draw a composite curve which plots percent of d-c resistance versus fre-

quency times resistance if that type of relationship is desired.

The accuracy of this method of measurement is dependent only on the signal generator, the ability to accurately measure db, and the ability to calibrate a linear capacitor. The precision is a function of how well the attenuator, capacitor and output meter can be read. A consideration of the possible errors and a square-root sum-of-the-squares analysis indicate an accuracy no worse than 2.5 percent.

The work described was done under Signal Corps Contract W36-039-SC-44526, sponsored by Signal Corps Engineering Laboratories and the United States Air Force. Development of the cavity was done in cooperation with the Moore School of the University of Pennsylvania in the initial phases. Acknowledgement is made to the following individuals: I. Bady, Signal Corps Engineering Laboratories; R. Showers, University of Pennsylvania; W. Littleton, International Resistance Co.; S. Parker, formerly International Resistance Co.; E. Thompson, International Resistance Co.

REFERENCES

- (1) I. Bady, Techniques in the Measurements of Several Components, *Proc. Nat'l Electronics Conf.*, Chicago, 1951.
- (2) "Components Handbook", Vol. 17, MIT Radiation Laboratory Series, McGraw-Hill Book Co., New York, 1949.

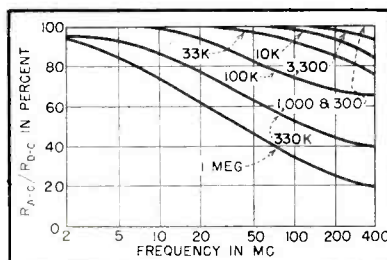

FIG. 4—Typical frequency characteristics for different values of special high-frequency carbon resistors, showing that highest ohmic values drop fastest with frequency

Ceramic Tile Sorter

Automatically matches colored bathroom and kitchen wall tiles against a standard, then accurately sorts into acceptable, light and dark glazes at speeds up to 60 tiles per minute.

Phototube output pulses feed special d-c amplifier which is free from slow drift

RANDOM CHANGES of color occur in ceramic tiles during the manufacturing process. Differences in temperature and atmosphere of baking ovens and variations in the biscuit base are some of the causes. The daily production of an average-size ceramic tile works ranges from 20,000 to 50,000 pieces, hence visual inspection and manual sorting are impractical. The problem led to development of a pulse-type electronic color comparator.

Principle of Operation

A standard tile of the desired color is placed in a receptacle of a gravity-roller conveyor, with its enameled face slightly below the upper edge of the rollers, as shown in Fig. 1. A parallel light beam is projected onto this standard surface, and the 45-degree reflected light is collected by a lens system for projecting through a colored glass filter onto the cathode of a high-vacuum phototube.

Samples to be checked roll over the standard surface, intercepting the light beam and substituting their reflected light for that of the standard during a short comparison time. Thus there appears across the phototube terminals an electric pulse having an amplitude and polarity which depend on the color difference between standard and sample. This pulse is measured after amplification in a memory-free pulse amplifier. The ordinate of the flat top of the pulse gives, by amplitude and sign, the amount of color difference between sample and standard.

The instrumental condition thus obtained is that of the best laboratory-type colorimeters, involving only one phototube, one lamp, one

By **F. LEPRI and R. SANNA**

*Coelectronic Co.
Rome, Italy*

beam and one filter. Moreover, the pulse-comparison principle enables the device to work in a condition known as suppressed zero without the need of a bucking emf. A further advantage is the absence of zero drift and instability.

Circuits

A first model employed a conventional R-C coupled negative-feedback pulse amplifier, followed by a double-triode symmetrical difference amplifier. Pulses of opposite signs coming off the plate circuits of this stage feed two externally-gated triode amplitude discriminators switched on during the middle portion of the pulse by means of a multivibrator. The latter is triggered by a mechanical switch located at a convenient point on the conveyor and operated by the samples in their run.

Positive pulses from the lighter samples start a control signal coming off the first discriminator, while

the darker samples operate the second discriminator. Two power tubes driven by the discriminators trigger an electromechanical three-way deviator located at the output end of the conveyor, effecting automatic direction of samples into three bins according to their color shade.

Although good sensitivity, stability and speed were obtained, the exceedingly slow recovery of the amplifier was a drawback. This consideration led to specifying direct-coupled amplifiers having the following overall characteristics: Gain—10,000 to 20,000 to obtain a 10-v output pulse corresponding to the slightest perceivable color difference of the darker samples; zero drift—less than 0.5 v output, or equivalent to a referred-to-input drift of less than 50 microvolts; frequency response—flat from zero to 1,000 cps or more, so the height of the flat top of the pulse is independent of the transit speed of the sample within the limits of 1.5 to 16 feet per second; recovery time— 10^{-2} sec, corresponding to a memory of the order of one tenth of the 0.1 to 0.5 sec pulse duration or less, or nearly null overshoot; overload—the amplifier must stand a severe overloading without blocking.

D-C Amplifiers

The absence of coupling and decoupling capacitors renders d-c amplifiers basically free from memory, averaging and blocking. However, conventional d-c amplifiers, even when equipped with the more elaborate antidrift provisions, have far too large a slow drift to be employed for factory equipment required to work continuously without attendance and to give uniform

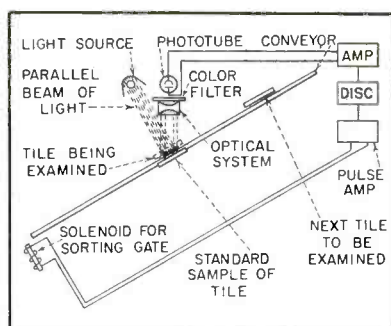

FIG. 1—Gravity roller conveyor carries tiles past photoelectric color comparator to sorting gates at bottom of conveyor

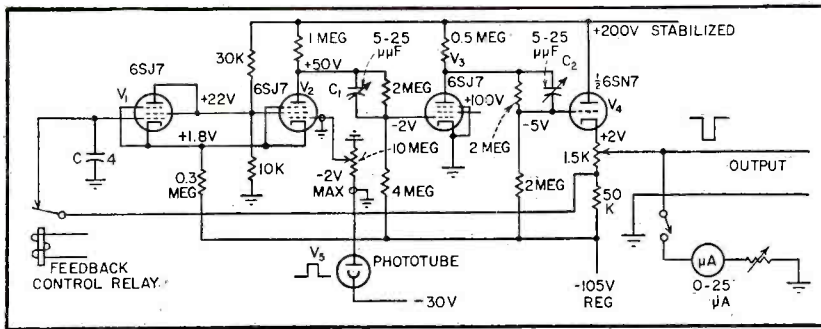

FIG. 2—Circuit of d-c pulse amplifier, showing use of negative feedback to one section of cathode-coupled double input tube. Phototube output pulse produced by sliding tile goes to other section of input tube. Snap-action switch actuated by tile operates feedback control relay as a tile reaches the color-comparing position on the machine

results within close tolerance limits.

The desired amplifier stability can be obtained with a d-c pulse amplifier in which overall negative feedback provides zero setting during the rest period between samples, while full gain is allowed during the operating period when the negative feedback loop is disconnected.

The d-c amplifier circuit used is shown in Fig. 2. The negative feedback is applied from the output terminal to the input grid of the amplifier through relay contacts that are closed during the rest period.

If no voltage is applied across the input terminals, the input and output levels are set by the negative feedback to a common value depending upon the characteristics of the coupling networks between the plate of the first tube and the grid of the cathode follower. Any change in output level due to heater voltage drift, changes in interstage coupling resistors or other causes is immediately counteracted by the negative feedback; the amplifier gain being very high, the output level drift is equal to the referred-to-grid drift of the first tube considered alone.

With the feedback relay contacts closed, capacitor C is in parallel with the cathode load of the cathode-follower output stage; when these contacts are open, C is simply in series with the input.

The function of C is to maintain the input grid bias during the operating time at the level reached during the rest time, this level being whatever is needed to counteract the output level shifts.

The cathode-follower output stage provides a low-impedance charging path for C ; if a 6SN7 is used, an equivalent resistance of some 1,000 ohms can be relied on in evaluating the time constant of this circuit. If $C = 4 \mu\text{f}$, 16 milliseconds is the reset time needed to compensate any output change due to drift.

The photoelectric input circuit is isolated from capacitor C and the negative feedback grid by using a cathode-coupled double input tube. Here V_1 is a cathode follower, the grid of which is connected to the negative-feedback network, while the input is applied to the grid of pentode V_2 . In this manner amplification between the grid of V_1 and the plate of V_2 is accomplished without inversion, which allows an even number of stages to be used with proper feedback.

No other special features are provided elsewhere in the circuit, which is a straight direct-coupled amplifier with interstage coupling circuits returned to a negative potential to obtain proper grid bias for V_3 and V_4 .

Stability against phase-shift oscillations is achieved by means of small adjustable capacitors C_1 and C_2 in parallel with the plate resistors of V_2 and V_3 . These capacitors are adjusted to overcompensate slightly the frequency characteristics of the interstage dividers, thus making the total phase shift less than 180 degrees when the high-frequency gain reaches unity. The proper setting is found experimentally by connecting the output to a cathode-ray oscilloscope having an input gain of 100. A saw-

tooth oscillation occurs at a frequency between 1,000 and 10,000 cps when the capacitors are both set to zero; the two capacitors are then adjusted until a stable non-oscillating condition is reached.

Sensitivity control is accomplished by means of a 10-meg attenuator in the control grid circuit of V_2 . The setting of this attenuator changes the input tube grid level (depending on steady current of phototube V_5) and hence the output level.

A reference-level potentiometer in the cathode circuit of V_4 is used in conjunction with a microammeter to adjust to zero the high output terminal. This potentiometer has to compensate for a maximum of up to 2 volts difference, corresponding to the maximum sensitivity setting and the maximum phototube illumination.

The microammeter also allows the amplifier to be used for steady-state comparison measurements of samples for standardization purposes. A full-scale sensitivity of 25 microamperes is enough to measure the slightest shade differences of the dark samples. With the feedback switch closed and the meter connected, the amplifier acts as a precision negative-feedback tube voltmeter of high stability.

Associated circuits serve for pulse comparison, for directing samples, for operation of the feedback control relay and for the generation of a single-shot sweep to be used with a cro for testing purposes.

The relay timing circuit and the single-sweep generator are conventional. Operation of both is started by a mechanical trigger consisting of a snap-action switch operated by the front edge of the sample at the correct location on the gravity conveyor.

Pulse-comparison is accomplished by an externally gated time selector circuit centered to operate at the middle of the pulse, followed by multiple comparison stages and power output stages feeding the electromechanical sorting devices. These circuits are conventional.

Direct coupling is employed integrally, and the recovery of all associated circuits is equally as fast as that of the amplifier.

Transistorized Radar

By
RAYMOND S. MARKOWITZ

Senior Engineer
Philco Corporation
Philadelphia, Pennsylvania

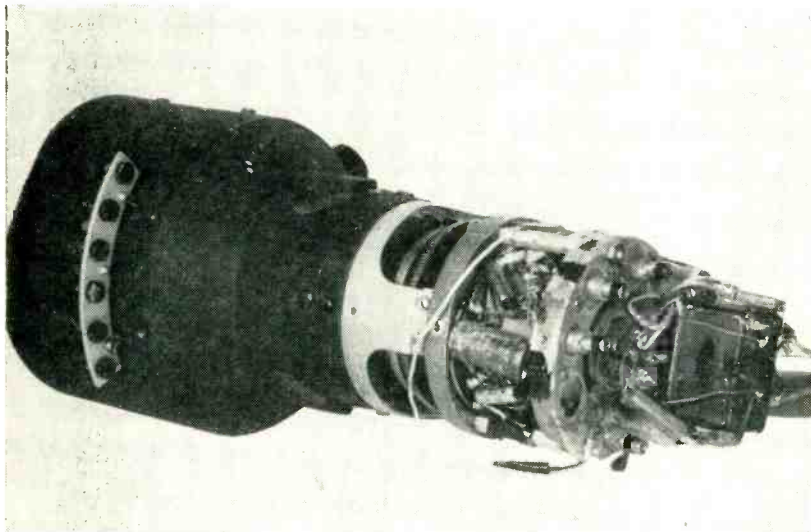

Transistorized scope display unit shows location of point-contact transistors around crt socket. Power consumption is one-tenth that of vacuum-tube predecessor

SUBSTITUTING four transistors and a crystal diode for the vacuum-tubes in a standard airborne radar indicator has reduced power consumption to one tenth without sacrificing performance.

Other advantages of the transistorized version are greater mechanical ruggedness and the possibility of increased miniaturization limited only by the size of other components which themselves may be derated in many cases because of the lower power and lower internal operating temperatures.

Frequency Response

It is worthwhile to review the basic frequency limitations of presently available point-contact transistors. The base, emitter and collector resistances are substantially independent of frequency, and the transistor frequency response can be expressed by the variation in r_M , a forward transfer impedance, or the current gain, alpha, as a function of frequency. Alpha cutoff, defined as the frequency where alpha is 3 db down from its low-frequency value, occurs as a result of the difference in the path length of the holes arriving at the collector. An approximation for transit time in seconds of the hole carriers going from emitter to collector is $\tau = S^2/\mu\phi I_e$, where S is the point spacing in centimeters, μ is the mobility in centimeters per volt second, I_e is the emitter current in amperes, ϕ is the germanium resistivity in ohm-centimeters and τ is an inverse function of frequency response.

Collector capacitance is generally negligible in point-contact transistors, except in the case of very high impedance circuits, while the

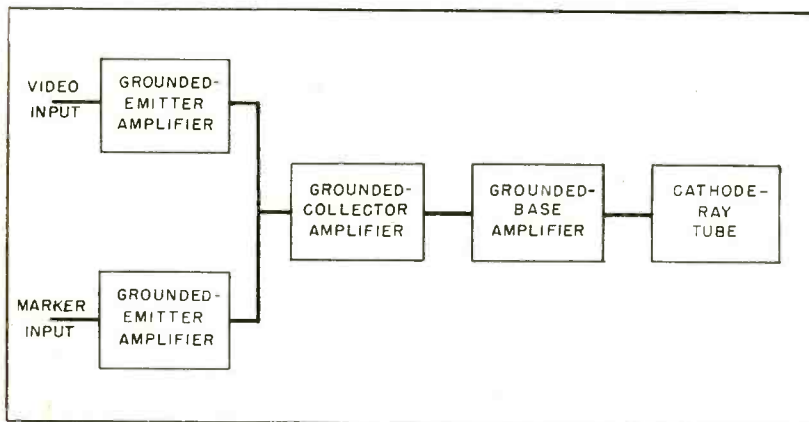

FIG. 1—Block diagram shows functions of four point-contact transistors in radar scope display unit

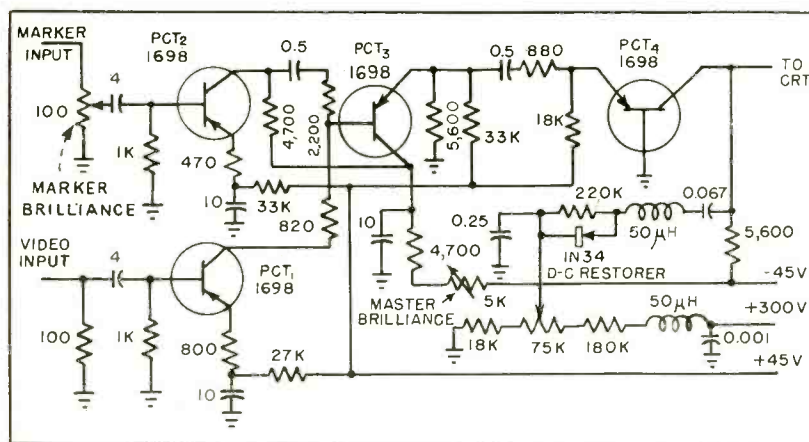

FIG. 2—Complete circuit of radar display unit. Two batteries were used to provide plus and minus 45 volts, but any 90-volt center-tapped d-c source could be used

Scope Display Unit

Four point-contact transistors and a crystal diode replace four tubes (two multipurpose) with accompanying simplification and reduction of power drain from ten watts to one watt. Reduced size and weight with increased ruggedness are added advantages

emitter impedance makes the emitter capacitance negligible also. Available point contacts for video application are rated at about 5 mc, but considerable selection is necessary to obtain usable transistors. Type 1698 transistors were employed in the indicator unit although other transistors having equally good high-frequency characteristics with much improved temperature coefficients will be available shortly.

General Description

The unit was designed to handle a maximum peak positive pulse of 2 volts, to drive the cathode of a 5BP7 display scope, requiring approximately 20 to 30 volts drive for blooming. The indicator is powered by two 45-volt batteries. The original model employed four tubes and six tube functions, including two d-c restorers; four transistors and a crystal diode (only one d-c restorer is needed) are used as the replacement. As shown, video and marker signals are separately amplified and combined, amplified again and coupled to the crt.

The unit is essentially a video voltage amplifier. The problem is to obtain stability at all levels and with all changes in operating point without overload and with minimum distortion, and still to achieve the required gain and bandwidth (4 mc) with polarity inversion. No attempt was made to achieve unrestricted transistor interchange, although design centers were chosen to allow a maximum of replaceability, at least without the introduction of instability among transistors having the required alpha cutoff.

Two grounded-emitter amplifiers

working into a common load impedance (the input impedance of the grounded-collector stage) are employed for video mixing, giving at the same time the required 180-degree phase reversal. The signal input stage is direct-coupled to the base of the grounded-emitter stage, whereas the marker stage is a-c coupled. This was done to minimize collector dissipation of the grounded-collector stage and make it easier to establish the optimum operating points of the respective stages. The mutual loading between the grounded-emitter stages necessitated the insertion of isolating impedances in the respective collector circuits. Since this reduces the gain somewhat, a more efficient mixing system has been devised employing a diode-coupling network.

The master brilliance control varies the collector potential of both the grounded-collector and the marker grounded-emitter stages, and though the control variation is rather nonlinear, it is the simplest method of variation in which the signal does not appear on the control itself (no tendency toward instability is encountered).

The grounded-collector stage, having a relatively high input impedance and low output impedance, is loaded by the grounded-base input impedance plus the series emitter impedance, which establishes the saturation level with a 3-ma emitter-current bias. The last stage has a voltage gain of 16 db, and can deliver approximately a 25-volt peak pulse to the crt.

The video signal is brought to the indicator through a cable terminated in 100 ohms. The problem of a-c coupling into the low input

impedance (300 ohms) of the grounded-emitter stage arises here. The most immediate solution is the use of tantalum capacitors having high capacitance and low voltage ratings plus small size. Future designs, however, will incorporate d-c coupling, but this is now difficult because of the nature of the operating bias at the cathode follower in the receiver video amplifier.

Temperature Test

The indicator was tested in accordance with standard temperature specifications. When the overall unit was operated at 70 C, a marked deterioration in gain resulted (18 db) because of the shift in operating point resulting in a decrease in r_c and an increase in alpha. As was expected, the greatest change occurred in the grounded-emitter and grounded-collector stages.

Up to about 60 C, the grounded-base stage remained practically unchanged. It appears that temperature-compensating circuitry plus optimization of operating point as a function of variation of alpha and r_c might stabilize the unit up to 60 C. However, reports of developmental 1689 and 1729 point-contact transistors having a temperature variation of -1 percent per degree for r_c as compared with -5 percent per degree with 1698, while performing a similar function, indicates that satisfactory operation at 70 C should be obtainable (although the temperature specification on transistorized equipment might be subject to change). The present model, however, is rated at 50 C maximum temperature.

Neutralizing Pentodes

Design procedure for canceling the effect of grid-plate capacitance in pentode amplifiers without use of additional components, tapped coils or balanced tuned circuits. Two experimental methods are given for determining proper capacitor values for radar and television applications

By JOSEPH C. TELLIER

Research Division
Philco Corp.
Philadelphia, Pa.

GRID-PLATE capacitance of pentode voltage amplifiers used in television and radar i-f stages, although relatively small, may have an appreciable effect on the stability and passband characteristics of the amplifier.

Where the plate tuned circuit of the amplifier is at resonance, a slight increase in the grid-to-ground voltage will result in a larger increase, of opposite polarity, in the plate-to-ground voltage. The net voltage change across the grid-plate capacitance is therefore much larger than the grid voltage increase alone, and more current flows in this capacitance than would flow if the amplifier had no gain. The value of the capacitance, as seen looking into the grid, is thus exaggerated.

The mathematics of this situation are well treated in the literature.^{1,2} From a purely physical viewpoint, however, it may be inferred that the effect of grid-plate capacitance is proportional to stage gain. Also, when the plate circuit is not resonant at the frequency of the grid input signal, the effect of grid-plate capacitance is lessened. Since the plate voltage is not in exact phase opposition with the grid voltage, a positive or negative resistive-damping term is reflected into the grid circuit in addition to the exaggerated capacitance.

These factors affect circuit de-

sign adversely because they produce interaction between amplifier stages that is a function of gain and frequency. If agc is applied to the amplifier, the effect on passband characteristics is ordinarily intolerable.

Neutralizing Circuit

A circuit which provides for the neutralization of the grid-plate capacitance without using additional components, tapped coils or balanced tuned circuits is shown in Fig. 1A. The screen neutralizing capacitor, C_N , occupies the position in the circuit normally assigned to the screen bypass capacitor. Basically, the circuit functions by providing slightly less than complete screen bypassing.

In determining the value of C_N , this circuit is usually assumed to

be a bridge, and the plate and screen are taken as the output terminals of the tube. Almost all of the output voltage occurs across inductance L . For a single-tuned stage, the bridge-circuit concept gives an accurate value for the neutralizing capacitor, but in double-tuned stages the error introduced by considering the plate and screen as the tube output terminals is considerable. The bridge circuit is most useful, therefore, in stages with single-tuned circuits.

The elements of the bridge are shown in Fig. 1B. Here, C_{gp} is the conventional grid-plate capacitance and C_o is the total output capacitance, including the input capacitance of the next stage and stray capacitances from plate to ground. The neutralizing capacitance is C_N . The portion of the input capacitance between grid and screen is C_{gs} . It is normally about one-third of the total input capacitance and for a 6CB6 is about 2.2 $\mu\mu\text{f}$.

The bridge theory states that for the voltage E_L , developed across L , to produce zero voltage from grid to ground, the balance relation is

$$C_N = \frac{C_{gs}}{C_{gp}} C_o$$

For a single-tuned stage using a 6CB6 tube, this gives

$$C_N = \frac{2.2}{0.02} \times 15 \mu\mu\text{f} = 1,650 \mu\mu\text{f}$$

When a double-tuned stage or an

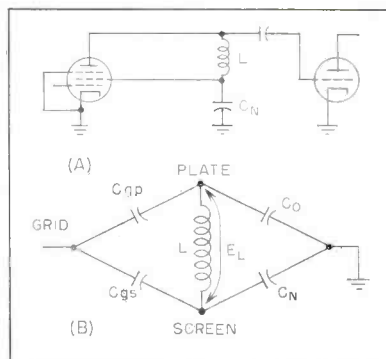

FIG. 1—Voltage-amplifier circuit (A) and equivalent bridge (B) used to calculate value of neutralizing capacitor

in Radar I-F Stages

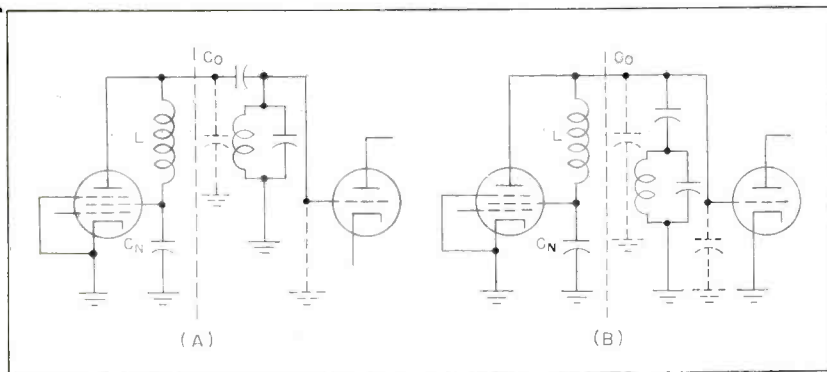

FIG. 2—Double-tuned (A) and absorption-trap (B) stages. In making calculations all capacitances to the right of dotted line must be substituted for C_o of Fig. 1B

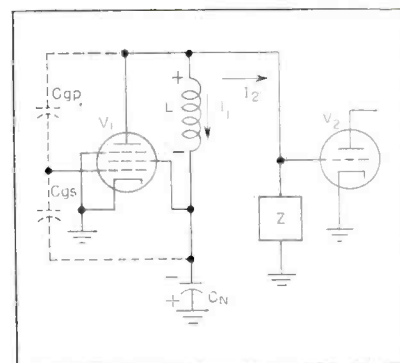

FIG. 3—Amplifier circuit having an output capacitance varying with frequency

absorption-trap stage is used, C_o is an effective capacitance varying with frequency, and the required value of C_N would apparently be a function of frequency. These stages are shown in Fig. 2A and 2B respectively. In both circuits everything to the right of the dashed line must be substituted for C_o in the bridge circuit of Fig. 1B.

A more accurate representation of the neutralizing circuit will show that no trouble is actually encountered from effective capacitance. It will also show that C_N is determined by the reactance of L , and this does vary with frequency. This variation is not as drastic, however, as the variation of the equivalent value of C_o in the circuits of Fig. 2.

In Fig. 3, regardless of the impedance of Z relative to L and C_N , some current I_1 will flow in the latter portion of the plate tank. This current will vary, as will I_2 , if Z varies rapidly with frequency, but whatever current flows through L will also flow through C_N . This is true because C_N is an order of magnitude greater than C_{ps} . The polarity of voltage drops across L and C_N will be as shown, and the screen side will be below ground potential when the plate is above. The grid of V_1 can be established at ground potential by choosing C_N such that the screen has the correct potential, since the grid is

established at a potential between plate and screen by the divider C_{gp} and C_{ps} . The required value of C_N is

$$\omega C_N = \frac{C_{ps}}{C_{gp}} \frac{1}{\omega L}$$

Although C_N will vary somewhat with frequency, over a relatively narrow band the change will be small. In the example given, a variation of 1 percent in frequency will cause a 2-percent change in C_N . It is more important that C_o does not appear in the expression.

In the single-tuned stage, over the bandwidth of interest, $1/\omega L$ can be closely approximated by ωC_o . When this substitution is made, the two formulas become identical.

Practical Considerations

Depending on the tube used, type of circuit and operating frequency, the calculated value of C_N may or may not be easy to obtain. For example, consider the value of 1,650 $\mu\mu\text{f}$ obtained previously for 6CB6 single-tuned stages. At 40 mc, the lead inductance of a capacitor of this value could be large enough to cause the combination to approach series resonance, increasing the effective value of the capacitor. In such instances a smaller nominal value must be chosen, such that the effective capacitance is the correct value for neutralization. Care must then be exercised to maintain control of lead lengths in order to ob-

tain the correct value consistently.

Occasionally, when a neutralizing capacitor is selected by experimentation, a value is found which is greatly different from the calculated value. If lead length does not account for the discrepancy, this is usually a sign that some form of feedback other than grid-plate capacitance is being neutralized, or that improper design has increased the effective grid-plate capacitance of the pentode.

The use of an unbypassed cathode resistor to neutralize variations of the input capacitance with bias has a slight effect on the neutralizing capacitance required. The effect is not very great unless the value of the cathode resistor becomes very large, or unless the suppressor is internally connected to the cathode.

A degree of neutralization may still be obtained in the latter case, but it is generally unsatisfactory and wherever possible a tube having the suppressor brought out separately should be used. The suppressor should then be grounded by the shortest possible lead to the chassis. The neutralizing capacitor should be returned to this same ground point.

Most of the output capacitance of a pentode is between plate and suppressor elements. Consequently, large values of current flow in the lead from suppressor to ground,

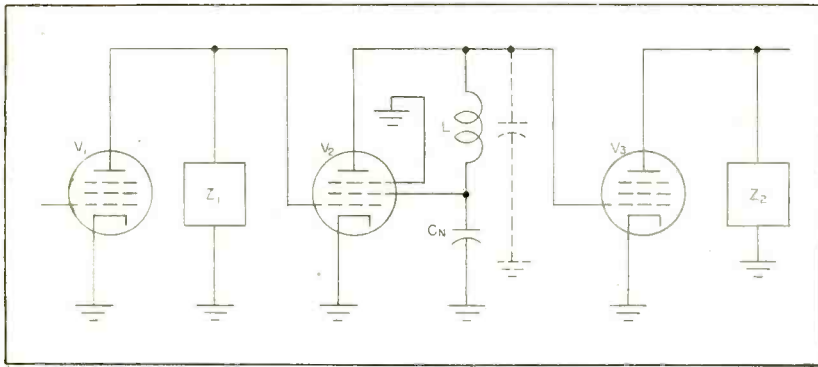

FIG. 4—Neutralization of stages in cascade. Two techniques for determining value of neutralizing capacitor are described in text

because this lead is part of the resonant plate tank circuit.

In tubes where the suppressor grid is brought out to a pin adjacent to the grid lead, the mutual coupling between the leads is sufficient at high frequencies to cause plate tank current to induce an appreciable voltage in the grid lead. As a result the effective grid-plate capacitance of the tube is increased, the added value being proportional to the square of the frequency.² For a 6BA6, the increase is from 0.0035 μmf at zero frequency to 0.008 μmf at 32 mc. In amplifiers for operation at 40 mc or higher, a tube having the suppressor lead well removed from the grid lead should be used.

It is difficult to neutralize tubes in which the nominal grid-plate capacitance is large. Under these conditions a very small value of neutralizing capacitance is called for, and as a result the screen is poorly bypassed. This not only leads to instability, but results in the effective grid-plate capacitance becoming larger, since the screen is no longer an effective shield.

Sometimes it is found that there are apparently two values of C_N which give neutralization. One of these, the larger, is the normal one. The second, usually much smaller, is caused by an increase in effective grid-plate capacitance due to poor shielding by the screen.

Test Procedures

The methods used to determine experimentally the optimum value of neutralizing capacitance are described with reference to Fig. 4. The tube to be neutralized is V_2 , and it is necessary that both plate

and grid circuits of this tube be operating normally.

The first method to be described is used when C_N is to be determined very precisely. A low-impedance signal generator, amplitude-modulated at a particular audio frequency, is connected to the grid of V_1 , effectively shorting out any frequency-selective circuits in the input of V_1 . Next, an i-f detector is coupled very lightly to the grid of V_2 . Two methods of coupling have been found satisfactory. When Z_1 is a single-tuned circuit, or any other two-terminal network, and the same signal exists at the plate of V_1 and the grid of V_2 , it is convenient to return the external shield of V_1 to ground through an impedance of several hundred ohms, and to connect the detector directly to the shield. Because of the capacitance between the plate of V_1 and the shield, an adequate signal will be presented to the detector. When Z_1 is a four-terminal network, such as a double-tuned transformer, it may be more satisfactory to connect the detector directly to the grid of V_2 through a 1- μmf capacitor.

The detector is followed by a high-gain audio amplifier, preferably tuned to the audio frequency with which the signal generator is modulated. If it is so tuned, high gain may be used without interference from hum or other sources of spurious audio-frequency signals. The output of this amplifier is then presented either as a scope or as a voltmeter indication. The carrier frequency of the signal generator is then adjusted to be within the i-f passband. The degree of neutralization is checked by

varying the tuning of the plate tank circuit of V_2 . If a change is observed in the output, neutralization is incomplete. The magnitude of the change is a measure of the departure from correct neutralization. The value of C_N is then varied, until a minimum change is noted.

It may be desirable, in searching for the correct value of C_N , to remove part or all of the damping from Z_1 , and from the tank circuit. This will greatly magnify the effect of grid-plate feedback, and will make the null point, as C_N is varied, much sharper. It will also be desirable, when the correct value of C_N has been found, to make a check of the completeness of neutralization by shorting coil L . If there is negligible difference in output between the conditions of normal L and shorted L , neutralization is good.

As a final step, the carrier frequency of the generator should be adjusted to various frequencies in the i-f passband, and the tests repeated to insure that neutralization is complete over the entire range of frequencies to be used. When the precision of measurement required is not so great, a second method of testing for neutralization is useful. In this method, the modulated signal generator is replaced by a sweep-frequency generator, connected to V_1 grid. The high-gain audio amplifier following the detector is replaced by an oscilloscope. When the frequency of the generator is swept, the response observed on the scope will be that of impedance Z_1 . In fact, the correct response may be observed by shorting the coil L , or connecting a 1,000- μmf capacitor from the plate of V_2 to ground. When L is unshorted the observed response curve should not change, and kinks and ripples should not pass through it when the tuning of the plate tank circuit is varied. When the curve remains unchanged under these conditions, neutralization is complete.

REFERENCES

- (1) J. Millman and S. Seely, "Electronics", p 533, McGraw-Hill Book Co., 1951.
- (2) F. E. Terman, "Radio Engineering", Third Edition, p 362, McGraw-Hill Book Co., 1947.
- (3) RCA Application Note AN-133, "Improved Arrangement of Base-Pin Connections in New Miniature Tube Types".

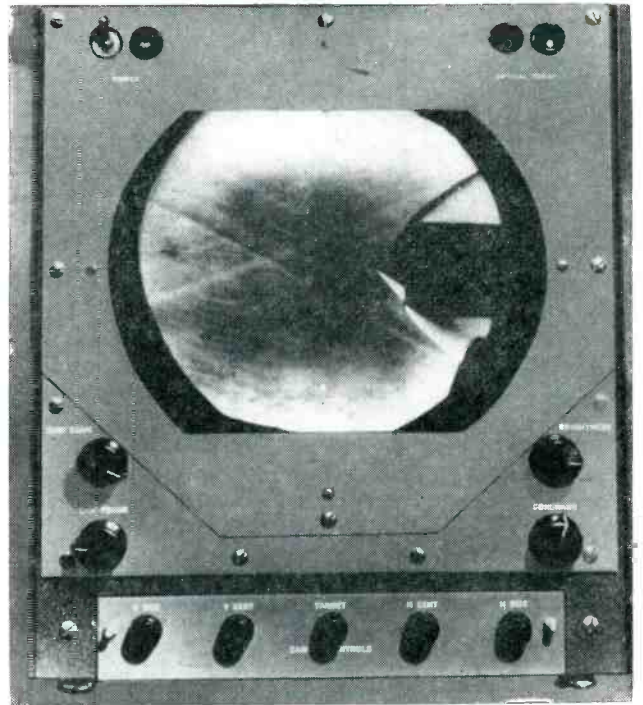
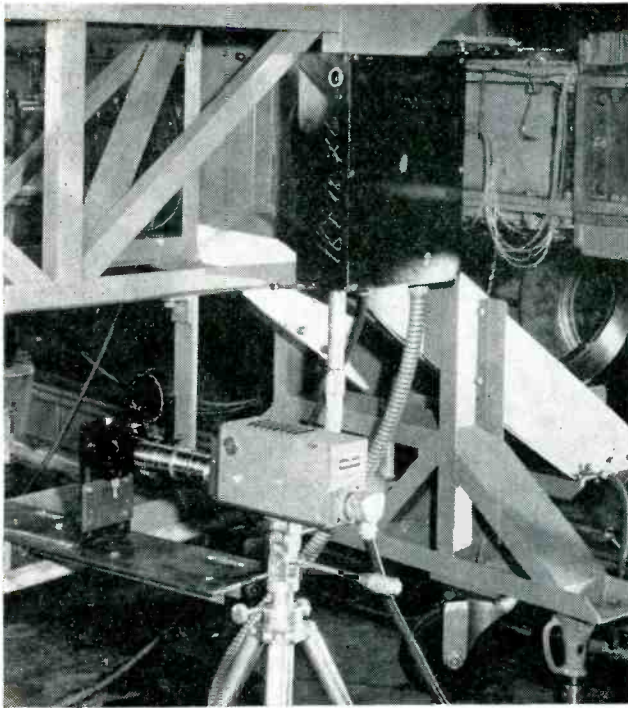

FIG. 1—Vidicon mounted in small supersonic wind tunnel (left) shows Schlieren picture of shock waves and airflow around supersonic probes (right)

Television Monitors Rocket Engine Flame

Industrial tv cameras used in propulsion research probe inaccessible locations, reduce personnel hazards and promote economy. Special design problems include high noise level, corrosive atmosphere and need for fine detail despite wide range of light intensities

MUCH functional know-how has been gained in recent years with television as an observation instrument. Television has been particularly useful in research, on rocket engines, where many untried propellants are poisonous and corrosive.

To insure safety of personnel conducting hazardous experiments with untried propellants, a remotely-located test cell has been equipped with television to permit remote viewing of the rocket in operation. A special cubical,

By FRANK A. FRISWOLD
*Aeronautical Research Scientist
Lewis Flight Propulsion Laboratory
National Advisory Comm. for Aeronautics
Cleveland, Ohio*

mounted on skids to facilitate moving, houses the television camera.

During a 30-second rocket firing, with scarce propellants, television can justify itself on a purely economic basis.

In one test, the television monitor warned that a propellant valve had failed to open and the operating

engineer immediately shut down the rocket. If the test had continued, a quantity of expensive propellant would have been wasted.

In another instance, while a remote-controlled rocket was being observed by television, observers saw a hole that had been burned through the injection head. Flame started to issue from this aperture and the test equipment was in danger of being seriously damaged; but quick action in shutting down the engine prevented a serious fire.

Liquified gases at very low tem-

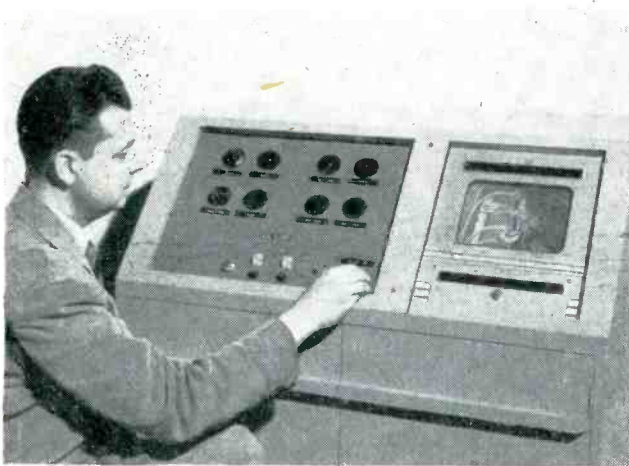

FIG. 2—Console for remote controls, 10-inch monitor and power supply for image orthicon equipment

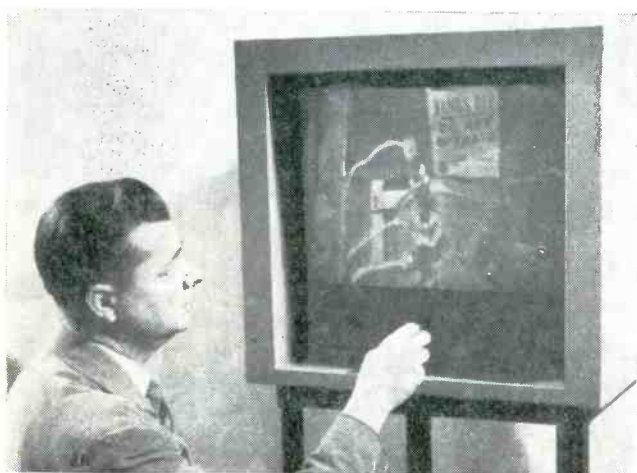

FIG. 3—Twenty-inch viewer for rocket specialists

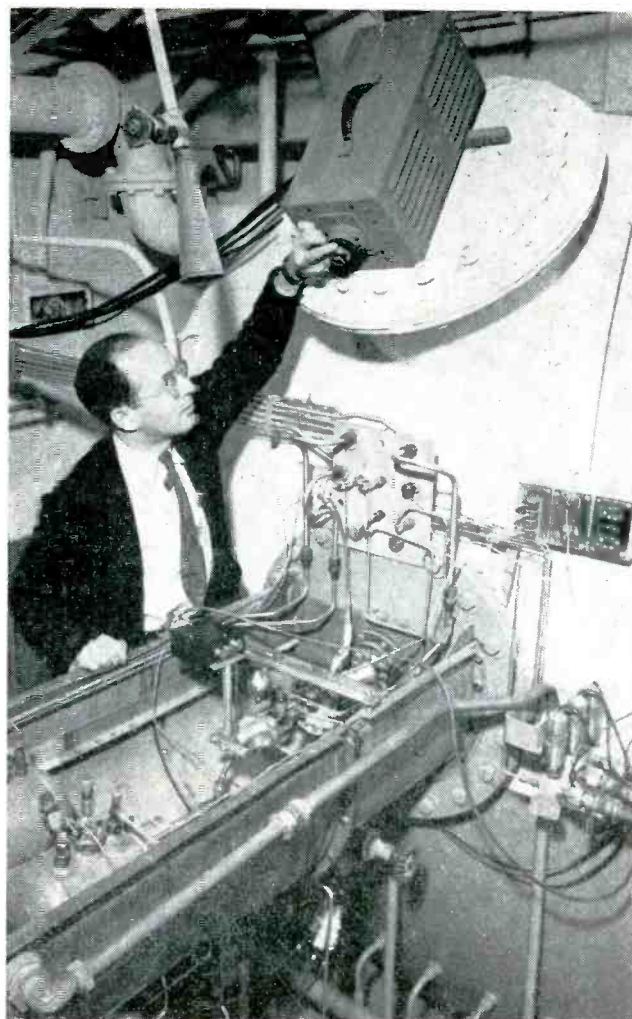

FIG. 4—Image orthicon camera televising rocket test

peratures for use as propellants warrant investigation. In one series of tests, to conserve expensive and scarce fuel, an inexpensive oxidant was injected first to reduce the temperature of the combustion chamber below that of the fuel. Spilling of the oxidant as a liquid rather than a vapor indicated the proper conditions. Television provided the most satisfactory and consistent means of monitoring this operation.

Camera Tubes

Cameras using an industrial-type vidicon, the image dissector and the image orthicon were tested to determine applicability under various conditions.

The industrial vidicon was first tried in a small supersonic tunnel (Fig. 1). Research on the design of supersonic probes was being carried on with the aid of Schlieren

apparatus. This equipment renders visible the shock waves and airflow around the probe. By observing the televised Schlieren image at the control room, the tunnel operator can easily control the airflow through the tunnel to obtain the required Schlieren pattern. Resolution was more than adequate; noise level was about 100 db and had no effect on the picture.

Observation of flame by television is always difficult because of blooming. When the vidicon was used, the blooming was not objectionable. The noise level on this particular test was in excess of 140 db and there were noise striations visible on the kinescope. An acoustic shield around the camera probably would have eliminated this difficulty.

Because the image dissector is not a storage-type device, it can cover a wide range of luminosity

without adjustment of controls. This is useful in observing flame since there is no blooming, and it is possible to observe a brilliant flame and still see details of the rocket engine and its auxiliary equipment which are at lower light levels. The image dissector is an instantaneous device and when it is observing rapidly-moving objects, a stroboscopic phenomena occurs. This effect was noticeable when the flame issuing from the rocket nozzle was televised, but was not considered detrimental. The pickup tube was not sensitive to noise in the 110-db range.

The image orthicon suffers from blooming and accordingly cannot be used successfully for flame studies. Because of the multiplicity of elements within the tube, it is prone to microphonism and is not recommended for use in high-noise-level areas. The resolution of

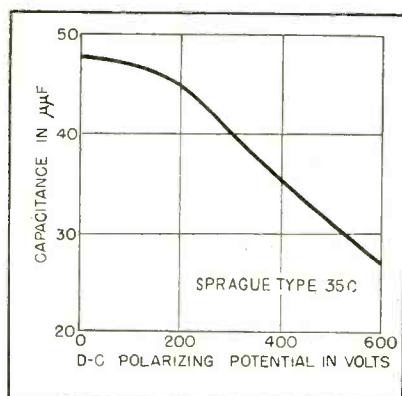

FIG. 1—Capacitance versus polarizing potential for barium titanate capacitor at 28 C

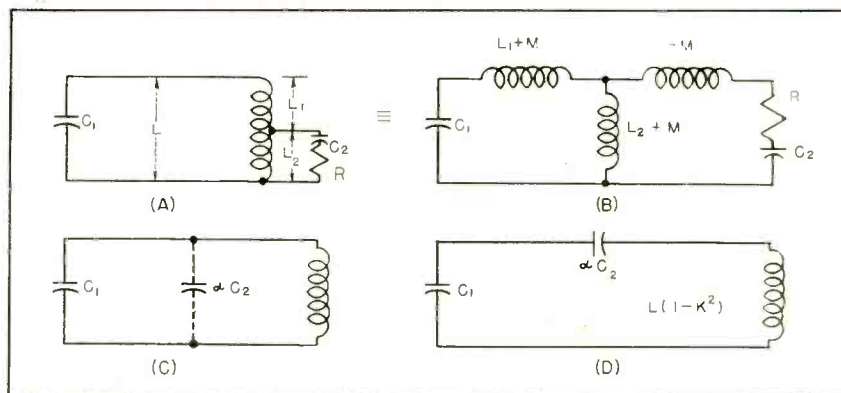

FIG. 2—Inductively coupled resonant circuit (A) and its equivalent circuit (B). Circuits (C) and (D) are equivalent circuits for the two possible operating modes of the resonant system

Capacitor-Modulated

Barium titanate capacitor coupled to oscillator tank circuit gives f-m deviations up to ± 2 percent of carrier frequency in 50 to 500 mc range. Response is flat to better than 100 kc. Multichannel telemetering systems, portable and mobile equipment are among applications

SEVERAL PAPERS on the behavior and applications of titanate dielectrics^{1,2} have suggested that the voltage coefficient of capacitance of these ferroelectrics be used as the basis of a simple frequency-modulation system. The system would employ a titanate ceramic capacitor as one element of an oscillator tank circuit, its capacitance being varied by means of a modulating voltage. Such a system would be useful in uhf and vhf applications where conventional reactance-tube and phase-modulation methods are unwieldy. However, the direct application has proved unfruitful because the dielectric constant of suitable titanates is so high that a practical capacitance for the high frequencies presents manufacturing difficulties. Additional difficulty is encountered in excessive r-f losses at high frequencies, and temperature variation of the capacitance value, as well as the voltage coefficient of capacitance.

This paper describes a method of coupling the titanate capacitor to

the tuned circuit in such manner that these drawbacks are largely overcome.

Capacitor Operation

The typical nonlinear behavior of a titanate ceramic capacitor as a function of the polarizing potential is shown in Fig. 1. The linear region of the curve is suitable for modulation purposes. The d-c polarizing potential impressed upon the titanate defines the operating point and a center value of capacitance C_0 . A superimposed a-c signal or pulse varies the capacitance about this operating point. The highest voltage coefficient of capacitance occurs at the Curie point of the ceramic, the Curie point being defined as the temperature at which the dielectric constant of the material is a maximum.

For f-m circuit applications, a nonlinear dielectric having a maximum voltage coefficient of capacitance and minimum temperature coefficient of capacitance is desired. By using a solid mixture of barium and strontium titanates with small

amounts of lead zirconate, a ceramic dielectric is obtained having a broad Curie point over an extended temperature range at the expense of only a slight decrease in the voltage coefficient of capacitance of the unit.³

A typical titanate material would require a 10- μ f capacitor for use at 100 mc to be a disk 0.010-inch thick and 0.04 inch in diameter. Use of such a minute capacitor at a temperature near the Curie point in a practical oscillator results in such severe local heating that a degenerative loss cycle results. As the temperature increases the losses become more severe, causing a further rise in temperature. This not only reduces the sensitivity of the titanate capacitor to the modulating voltage, but eventually causes permanent damage to the capacitor.

Transformer Coupling

For high-frequency applications of titanates, a circuit is required that effectively reduces the potential across the titanate to a low

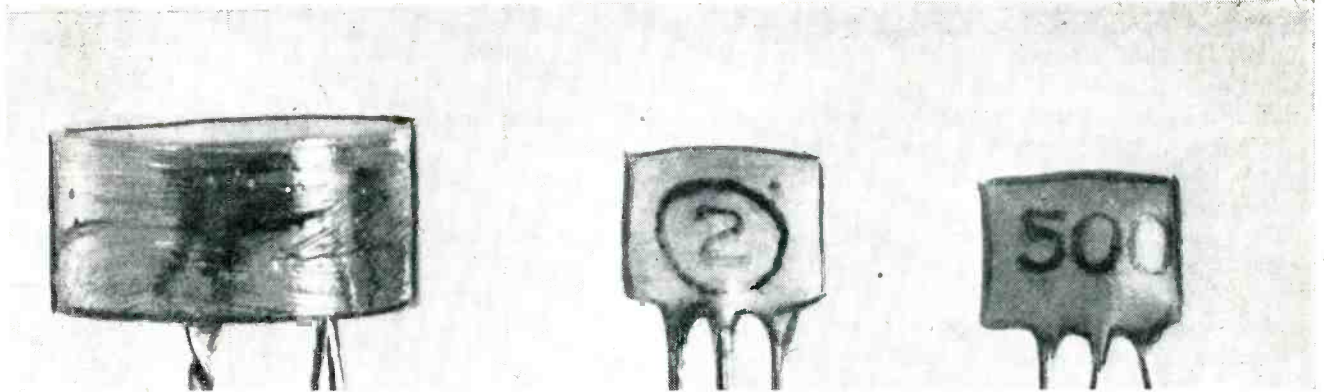

Potted ceramic capacitors used in f-m modulator make use of the nonlinear variation of capacitance with applied voltage exhibited by barium titanate. Capacitors at left comprise two series-connected 100 $\mu\mu\text{f}$ units. Center and right are dual units of 100 and 500 $\mu\mu\text{f}$, respectively

Wide-Range F-M System

By MAURICE APSTEIN and H. H. WIEDER

National Bureau of Standards
Washington, D. C.

value to minimize the dielectric heating effect while retaining its nonlinear characteristics.

Figures 2A and 2B show how the difficulties outlined above may be overcome by transformer-coupling the titanate capacitor to the resonant circuit. Such a circuit has two modes of operation depending upon whether the coupled resonant frequency is above or below the uncoupled resonant frequency of the circuit.

Operating Modes

The equations for the resonance modes of the circuit are

$$(\omega')^2 = \frac{1}{L(C_1 + \alpha C_2)} \quad (1)$$

$$(\omega'')^2 = \frac{1}{L_1 \frac{\alpha C_1 C_2}{C_1 + \alpha C_2}} \quad (2)$$

$$K = \frac{L_2 + M}{\sqrt{L L_2}} \geq 0.5 \quad \alpha = \frac{L_2}{L} \quad (3)$$

Figure 2C indicates the behavior of the circuit of Fig. 2A for the ω' mode. The titanate capacitor

C_2 will appear in shunt with the main tuning capacitor and have a value of αC_2 . For the ω'' mode, as shown in Fig. 2D, C_2 will appear in series with the main tuning capacitor, with α the transformation ratio. In addition, the total apparent inductance will be reduced by $L' = L(1 - K^2)$.

The Q 's corresponding to the two resonant modes are

$$Q' = Q_2 \left(1 + \frac{C_1}{\alpha C_2} \right)^{1.5} \quad (4)$$

$$Q'' = Q_2 \left[\left(1 + \frac{\alpha C_2}{C_1} \right) (1 - K^2) \right] \quad (5)$$

where Q_2 is the reciprocal of the loss tangent of the titanate capacitor.

If the circuit described above is used as the tank circuit of an oscillator, Eq. 4 and 5 determine the mode of operation. The circuit will oscillate in the mode having the higher Q .

Practical Oscillator Design

The oscillator shown in Fig. 3 was built using the tank circuit de-

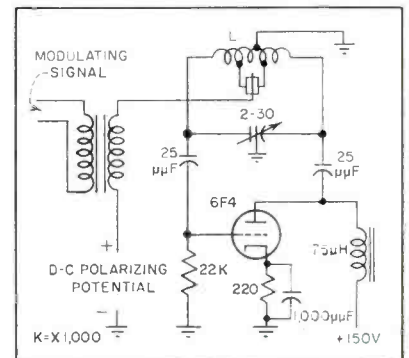

FIG. 3—Circuit of experimental f-m oscillator using transformer-coupled titanate capacitor modulator

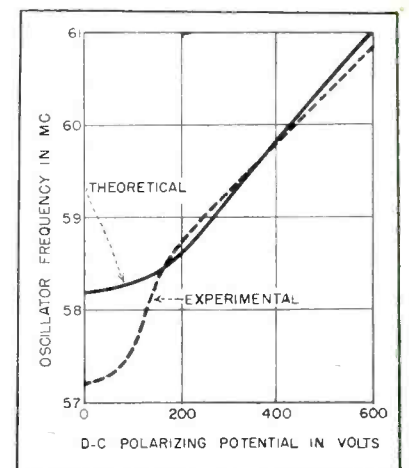

FIG. 4—Relationship of change in oscillator frequency to change in d-c polarizing potential

sign equations outlined above. The modulating capacitor is composed of two barium titanate ceramic capacitors, of the type shown in the photograph, connected in series with respect to the r-f potential and in parallel with respect to the modulating potential.

The polarization potential V_{d-c} defines the center value of capacitance C_0 . If a sinusoidal voltage is superimposed upon the d-c bias, the instantaneous capacitance of the titanate over its linear range is

$$C = C_0 \left[1 - \frac{n}{2} \frac{V_{max}}{C_0} \cos \omega_m t \right] \quad (6)$$

where $n = \Delta C / \Delta V$, f_m is modulating frequency and V_{max} the peak a-c modulating voltage. The instantaneous frequency for the ω' mode is $f' = f_c (1 + m_f \cos \omega_m t)$. The modulation index m_f is

$$m_f' = \frac{n V_{max}}{2 (C_1 + \alpha C_0)} \quad (7)$$

and f_c is the carrier frequency. For the ω'' mode, the modulation index is

$$m_f'' = \frac{n C_1 V_{max}}{2 C_0 (C_1 + \alpha C_0)} \quad (8)$$

Figure 4 indicates the static curves of frequency versus d-c polarization potential for the ω' mode. Good agreement was obtained between the measured and calculated curves. Similar results were obtained for the ω'' mode.

Figure 5 indicates dynamic measurements of deviation by the use of proper Bessel function harmonics for the ω' mode. Push-pull, cathode-coupled, and Colpitts resonant-line oscillator circuits gave essentially similar results. In the frequency range of 50 to 500 mc, deviations of ± 2 percent were obtained in either mode. Under

extreme conditions the a-m is appreciable but not serious for many applications. For smaller deviations the a-m is negligible.

The frequency deviation versus modulation frequency curve shown in Fig. 6 is for the ω' mode using the experimental oscillator described. Results indicate that excellent broad-band response is obtainable up to 100 kc. It has been experimentally verified that the modulation frequency may be raised to 500 kc for a pure sine-wave signal with good linearity response.

Temperature Compensation

No complete study of oscillator performance with respect to temperature has been made. However, the curves of Fig. 7 show that the nonlinear capacitors used have a considerable temperature coefficient. If the oscillator is to be used over an extended temperature range, a temperature-regulated enclosure operated at approximately 100 deg F would be required.

Problems of capacitance creep with age, electrostatic memory effects and other unsolved problems for the entire ferroelectric family of materials may make an additional means compensation necessary. There are a number of methods for obtaining temperature compensation with presently available materials. Use of a larger proportion of barium zirconate with barium strontium titanate will produce a nonlinear dielectric having a broader Curie region with only a slight decrease in the voltage coefficient of capacitance. If two or more capacitors having different

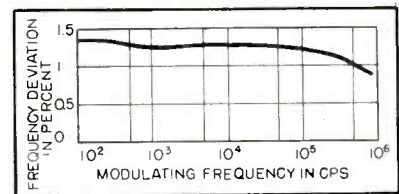

FIG. 6—Deviation in percent as related to modulating frequency

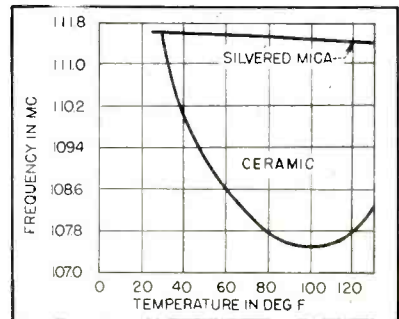

FIG. 7—Frequency-temperature characteristics of barium titanate capacitor

Curie points are connected in series, the Curie region can be staggered over a broader temperature range. Another method of compensation is to use a conventional afc system whose rectified output would be used to bias the titanate capacitor in such a manner as to keep the carrier frequency constant.

Conclusion

The system should find application in vehicular communication systems, portable uhf equipment and multichannel f-m telemetering systems that require both a wide deviation and broad frequency response.

The principle of coupling the nonlinear element into the main frequency-determining circuit can be extended to include distributed lines and cavity resonators. Preliminary experiments indicate that a reflex klystron can be successfully modulated by this method over a wider band than that obtainable by repeller voltage modulation alone.

REFERENCES

- (1) S. Roberts, "Barium and Strontium Titanates as Non-Linear Dielectrics"; D.Sc. Thesis, E. E. Dept., M. I. T.
- (2) A. I. Dranetz, G. N. Howatt and J. W. Crowover, Barium Titanates as Circuit Elements, *Tele-Tech*, June 1949.
- (3) "Development and Application of Barium Titanate Ceramics as Non-Linear Circuit Elements"; Glenco Corporation Final Report No. W 36-039-SC 44 606; Aug. 15, 1950.
- (4) H. L. Donley, Barium Titanate and Barium Strontium Titanate Resonators, *RCA Review*, 9, June 1948.

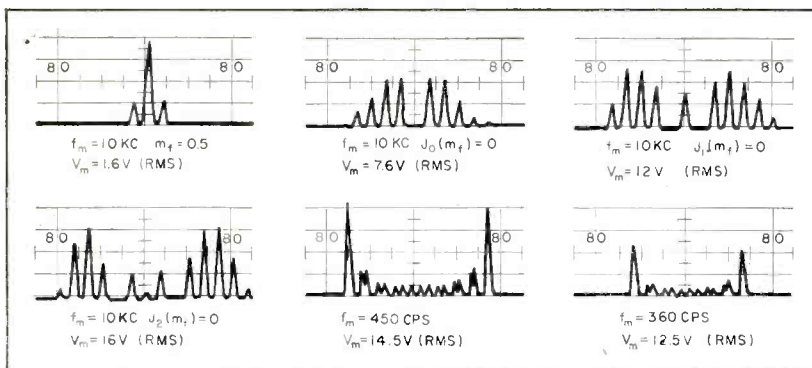

FIG. 5—Deviation in kc as a function of modulating signal on a 60-mc carrier with 450-volt polarizing potential

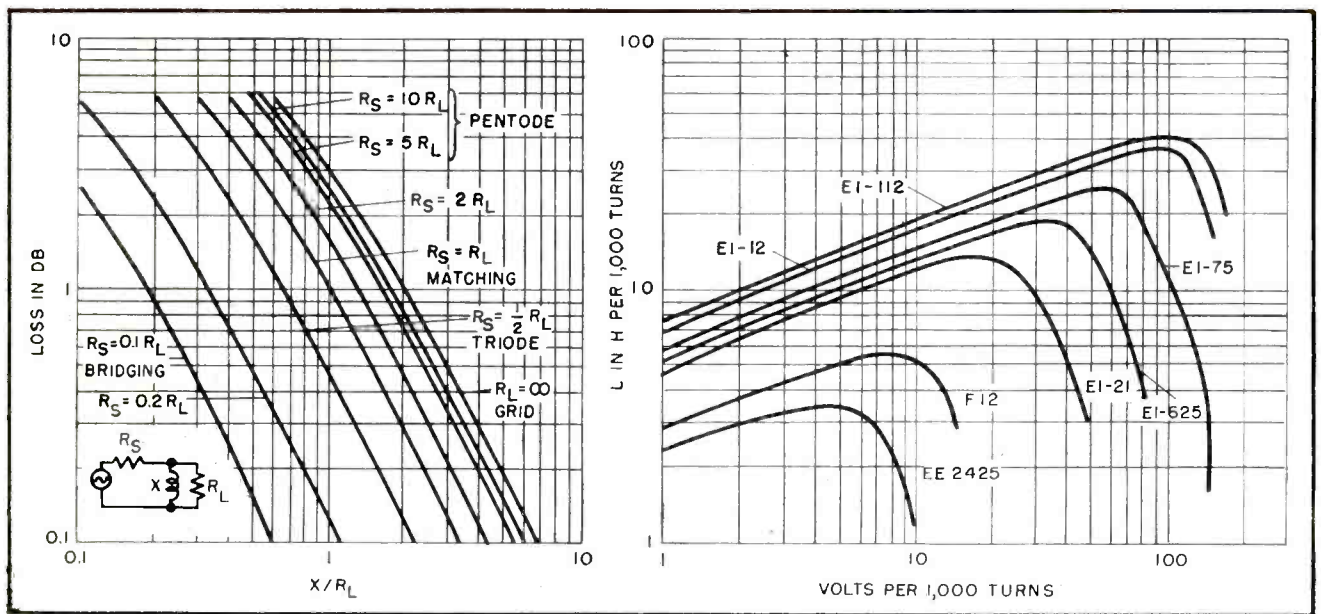

FIG. 1—Primary inductance insertion-loss curves. Curve marked grid refers to an abscissa for X/R_S

FIG. 2—Characteristics of several lamination types for 4-percent silicon steel, 29 gage, laminated 1×1 square stack only

Audio Transformer Design Charts

Six graphs showing primary-inductance insertion loss, 60-cycle inductance, leakage inductance, insertion loss from leakage inductance, phase shift and effect of open-circuit impedance on reflected impedance speed design of power and audio transformers

PROGRESS in transformers for electronic applications has kept well abreast of advances in electronics, but the art of their design has long been esoteric. In the past few years, several good books have been published that enable the average engineer, unfamiliar with transformers, to initiate an original product design.

Several time-saving charts for audio transformers used by the writer and other engineers are shown. Two of the curves are empirical while the others are calculated.

Figure 1 is a calculated plot of the familiar db or insertion-loss curve employed for low-frequency-response calculations. It is used primarily to find the inductance required for a given db loss. The ad-

By **THEODORE HALABI**

*Chief Engineer
A.I.F. Industries, Inc.
Brooklyn, N. Y.*

vantage of the curve in this form is that it covers all types of audio transformers on one graph. It includes matching transformers where $R_{LOAD} = R_{SOURCE}$; triode-output transformers where $R_{LOAD} = 2R_{SOURCE}$; pentode or beam-power-output transformers where $R_{SOURCE} = 5$ to $10R_{LOAD}$; bridging transformers where $R_{SOURCE} = 0.1R_{LOAD}$; and grid transformers where R_{LOAD} is infinite.

For pentode-output transformers where $R_{SOURCE} = 20R_{LOAD}$ the curve of $R_{SOURCE} = 10R_{LOAD}$ may be used in Fig. 1 since the curves practically coincide. Another advantage of Fig. 1 is that the unknown quantity X ,

the primary reactance, is found in terms of the load impedance instead of the source impedance as is often done. Specifying X in terms of the source impedance leads to confusion when the exact source impedance is unknown, as in numerous pentode output transformers. For grid transformers with an unloaded secondary, X is obtained from the chart in terms of the specified source impedance. A loaded grid transformer is treated as a matching transformer.

After obtaining the inductance from Fig. 1, the turns required to meet that inductance on a given lamination size can be calculated from two types of graphs. If there is a net unbalanced d-c in the transformer, Hanna's curves, or some variation of them, are most com-

monly used for the incremental inductance calculations. If there is no d-c in the coil the turns can be calculated from permeability curves. A faster method is the use of a set of graphs similar to Fig. 2. For comprehensive designs including all types of transformers a more complete set of graphs covering various types of steels and lamination sizes is necessary.

Figure 2 is an empirical set of curves of 60-cycle inductance on 29 gage silicon-steel laminations, interleaved 1 x 1. Its use is illustrated by the problem: find the inductance at 2 volts, 60 cycles of a 700-turn coil on an EI-75 lamination with a square stack. Two volts at 60 cycles on 700 turns is equivalent to 2.85 volts on a 1,000-turn coil for the same flux density. From the curve is obtained an inductance of 9 henrys per 1,000 turns.

Since inductance varies as the square of the turns, $L = 9(700/1,000)^2 = 4.4$ henrys. If the coil had been on a stack of $1\frac{1}{2}$ inch, the inductance would be found on the curve at 1.42 volts per 1,000 turns since the flux density is one half of that on a square stack. At this

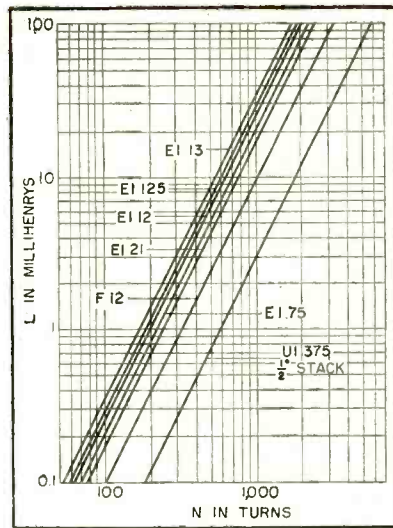

FIG. 3—Leakage inductance vs turns for square-stack layer-wound coils of two windings only

voltage L from the curves is 6.6 henrys per 1,000 turns. Hence the inductance of the coil is $(700/1,000)^2 \times 6.6(1.5/0.75) = 6.4$ henrys. This last calculation utilizes the fact that the inductance of a given lamination varies directly as the volume.

Figure 3 shows an empirical

graph of leakage inductance against turns as obtained from measurements on various transformers. Since the lines are so close together, the leakage inductance of standard lamination sizes that are missing can be extrapolated easily. This chart can be used to find the leakage inductance only for two winding coils, of square stacks, normal winding lengths and normal insulation between windings.

If the deviations for a given coil from these requirements are too great, the theoretical formulas as listed in standard reference handbooks should be used to calculate the leakage. In many cases, where the leakage inductance is sought, however, an approximate value will usually suffice. Hence if the coil margins are larger than normal or if there is unusual insulation in the transformer or if even part of the window space is occupied by a third winding, Fig. 3 can still be used to determine the order of magnitude of the leakage.

Leakage inductance obtained from Fig. 3 is employed mainly in audio-transformer design for predicting high-frequency response

(continued on p 196)

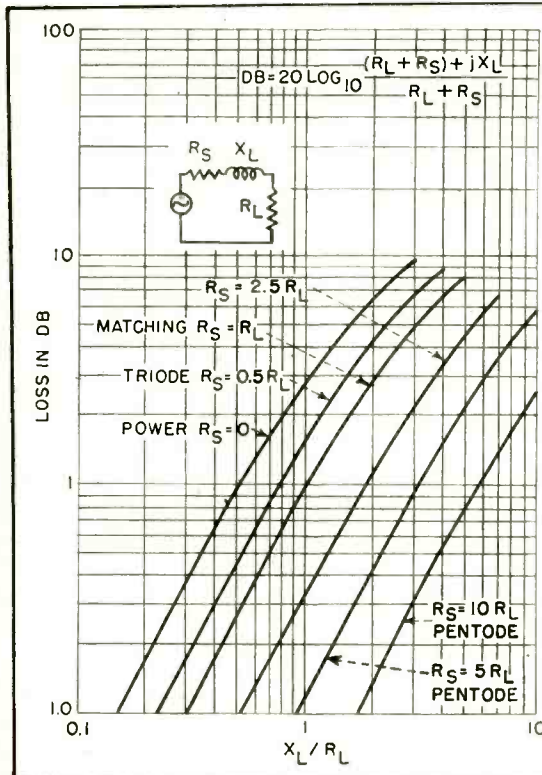

FIG. 4—Insertion loss due to leakage reactance for six different types of transformers

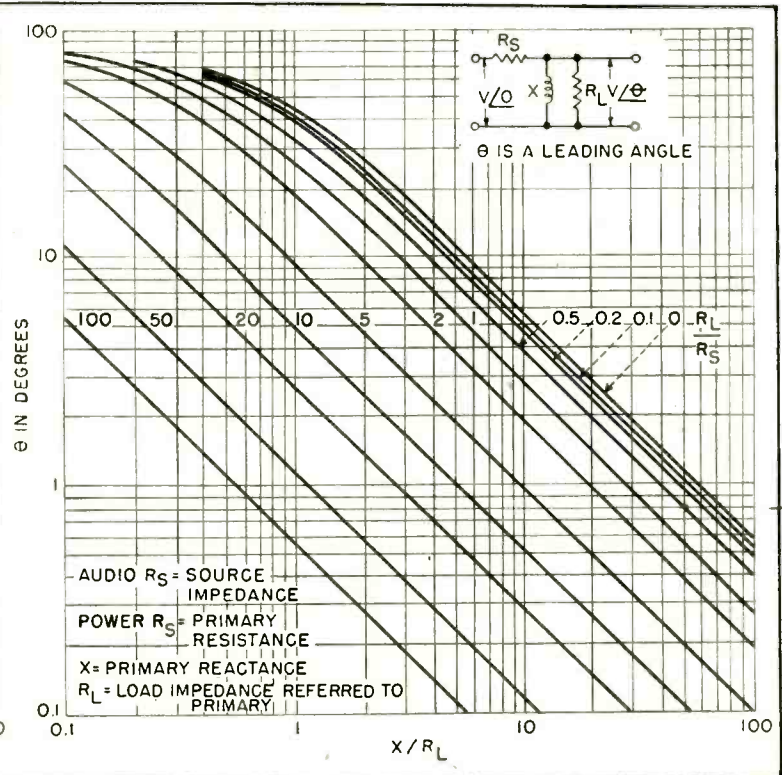

FIG. 5—Phase shift vs X/R_L for varying ratios of R_L/R_S as explained in the text

QUANTITY PRODUCTION OF LOW LOSS MICA COMPONENTS...*QUICKLY*

... exclusively a CINCH feature, and a factor in the choice of CINCH electronic components as STANDARD. CINCH constantly demonstrates ability to hold tolerances on Mica moldings . . . to mold high dielectric powders, and Mica . . . to meet the most exacting requirements in small metal plastic assemblies for components of higher quality materials held to closer tolerances.

SUB-MINIATURE
SOCKETS SHOWN
ENLARGED TWICE



CINCH components are
available at leading
jobbers — everywhere

The CINCH sub-miniature socket insures positive electrical contact, holds tubes securely in place, permits easy maintenance and replacement, yields maximum insulation resistance and minimum high frequency loss. And provides manufacturers of electrical controls, transmitters, receivers, trans-mitters, airbourne equipment, etc., and hearing aids . . . a labor saving chassis installation which serves terminal board functions while permitting designers to obtain maximum space afforded by the standard flat base tubes. For mounting perpendicular tubes, retainer rings and saddles are available, when socket cannot be staked. Contacts silver plated beryllium copper.

Sockets are available in quantities because of CINCH'S extensive and modern molding facilities for mica filled low loss bakelite.

For the Standard sub-miniature socket in *quantity, quickly,*



Cinch
ELECTRONIC
COMPONENTS

CONSULT CINCH
CINCH MANUFACTURING CORPORATION

1026 South Homan Ave., Chicago 24, Illinois

Subsidiary of United-Carr Fastener Corporation, Cambridge, Mass.

and Fig. 4 is used for these calculations. This type of curve neglects the capacitance in the windings and can be used with reasonable accuracy if the impedance of the transformer is less than 12,000 ohms or the highest frequency of the transformer is less than 10,000 cycles. These curves can also be used for power transformers with a frequency range of 50 to 2,400 cycles for estimating the voltage loss due to leakage inductance at the high-frequency end. For power transformers the loss in db as obtained from the curve is converted to percent voltage drop.

Figure 5 is a plot of phase-shift calculations at the low-frequency end of an audio transformer due to primary or open-circuit inductance. The graph may be also used for phase shift in power transformers between the primary d-c resistance and inductance, in which case R_s , the source impedance is actually the primary resistance.

Phase Shift vs X/R_s

Figure 6 can be used for quick and fairly accurate calculations of the shunting effect on reflected impedance R_L by the open-circuit inductance. The graph will not only give the total impedance but the phase angle, the resistive and reactive components. In instances where a more nearly exact impedance looking into the transformer is required, the primary shunt loss (core loss) and the leakage reactance must be added vectorially to the impedance from the curves.

The following example illustrates the use of five curves in a typical design. It is desired to design an output transformer for a beam-power tube, 7,000 ohms to 500 ohms, 5 watts output, 42 ma d-c in the primary and a tube plate resistance R_p of 75,000 ohms. The required frequency response is to be \pm one db from 300 to 6,000 cycles.

In Fig. 1 at $R_s = 10 R_L$, for 1-db loss, X/R_L equals 1.8 from which the necessary primary inductance can be calculated. At 300 cycles, $L = 1.8 \times 7,000 / 2\pi \times 300 = 6.7$ henrys. From tabulated data on output transformers, the lamination size is determined as an EI 625 (square stack) using 29 gage silicon steel. Hanna's curves for this

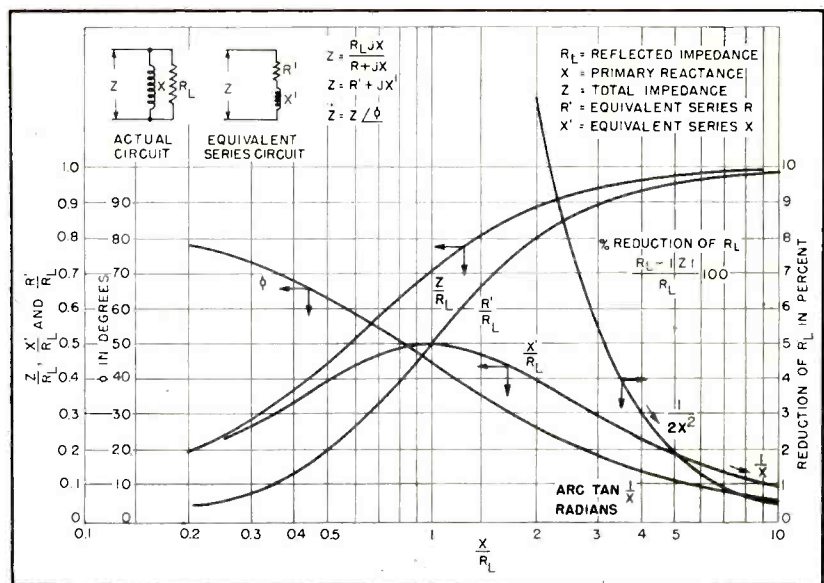

FIG. 6—Effect of primary inductance on reflected impedance

lamination size and 6.7 henrys of inductance indicate 2,600 turns for the primary.

For an impedance ratio of 7,000 on the primary and 500 ohms on the secondary, the secondary turns are then 700, since turns ratio equals the square root of impedance ratio. Assuming equal primary and secondary copper losses, the wire chart for an EI 625 shows 38 wire for the primary and 32 on the secondary. Primary d-c resistance is 580 ohms and that of the secondary 32 ohms. To check the high-frequency end of the transformer the leakage inductance of the transformer referred to the primary is found from Fig. 3. The EI 625 lamination is not listed but the inductance can be estimated as being roughly halfway between the EI 75 and the EI 21.

In addition, the turns listed do not go up to 2,600 on the chart but since L varies as N^2 the value at 260 turns can be used. This yields a leakage inductance of 130 millihenrys, which is equal to 4,900 ohms reactance at 6,000 cycles. Neglecting the d-c resistance, the ratio $X_L/R_L = 0.7$. From the curve $R_L/R_s = 10R_L$ in Fig. 4 loss due to leakage reactance is less than 0.1 db and therefore well within the 1-db requirement. Figure 5 shows the phase shift of the transformer at 300 cycles. For this case, the secondary resistance should be included in the calculations. The value of R_L is then 7,400 ohms or 500

ohms plus 32 ohms times the turns ratio squared.

The ratio X/R_L is 1.7 at which point on the curve $R_L/R_s = 0.1$ is found a phase shift of 28 degrees. This high phase shift results from the high plate resistance of the beam-power tube. A triode for the same response and load impedance would have a phase shift of 15 degrees. Figure 6 can now be used to check the primary impedance. For the impedance at 300 cycles, $X/R_L = 1.7$ where again R_L includes the secondary resistance. From the curve at this point, $R'/R = 0.75$ or $R' = 5,550$ ohms and $X'/R_L = j 0.44$ or $X' = 3,250$ ohms.

This represents the reflected impedance as viewed from the primary side of the transformer converted into a series value of resistance and inductive components. Adding the primary d-c resistance, $Z_{PRI} = 5,550 + 580 + j 3,250 = 6,800$ ohms. A more exact calculation of primary impedance would have required adding 130 millihenrys of leakage inductance and the shunt core loss vectorially.

BIBLIOGRAPHY

Reuben Lee, "Electronic Transformers and Circuits", John Wiley and Sons, New York, 1947.

MIT Dept. of E. E. Staff, "Magnetic Circuits and Transformers", Principles of Electrical Engineering Series, John Wiley and Sons, New York, 1943.

F. C. Connelly, "Transformers, Their Principle and Design for Light Electrical Engineers", Sir Isaac Pitman and Sons, London.

Federal Telephone and Radio Corp., "Reference Data for Radio Engineers", third edition, New York, 1951.



For Constant Voltages... Use Mallory Mercury Batteries

The constant discharge voltages shown in the curves are characteristic of the uniform, dependable power delivered by Mallory Mercury Batteries. This is especially important in mobile communications equipment, hearing aids, delicate optical equipment and many kinds of instruments in which constant discharge voltages are imperative for best performance.

This is only one advantage of Mallory Mercury Batteries, however. They operate dependably at microamperes or drains of 50 amperes... intermittently or continuously... always providing a dependable, uniform source of power—even after long periods of storage.

If these characteristics will improve the operation of your equipment, then let us send you complete information. Multi-cell battery stacks and packs can be designed to fit your exact needs.

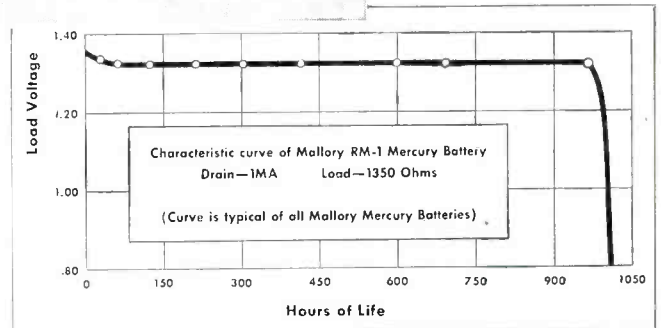

Use Mallory Mercury Batteries for applications where:

- Constant voltage or current is required
- Size and weight are important
- Long storage periods are involved
- Battery leakage cannot be tolerated
- Wide temperature and pressure ranges are encountered
- Severe impact and shock is expected

For Transistor Applications

Mallory Mercury Batteries are especially suited for transistor applications... where constant voltage and constant current are required.

P. R. MALLORY & CO. INC.
MALLORY

SERVING INDUSTRY WITH THESE PRODUCTS:

Electromechanical—Resistors • Switches • Television Tuners • Vibrators
Electrochemical—Capacitors • Rectifiers • Mercury Dry Batteries
Metallurgical—Contacts • Special Metals and Ceramics • Welding Materials

P. R. MALLORY & CO. INC., BATTERY DIVISION, NORTH TARRYTOWN, N.Y.

ELECTRONS AT WORK

Including INDUSTRIAL CONTROL

Edited by ALEXANDER A. MCKENZIE

Transistor Test Board Speeds Circuit Choice	198	Design Equations for Broadbanding by Stagger Tuning	220
ASR Using MTI Feeds PAR	198	Transmission Characteristics of Non-symmetrical Networks	226
Sync Circuit Noise Reduction	200	Shape Factor as a Criterion of Skirt Selectivity	232
Suppressor Grid Frequency Doubler	200	Loss and Singing Margins in Radio and Carrier Channels	238
Four-Track Film for Stereo Sound	200	Ferrite Applications at Microwave Frequencies	246
Kerosene Cooled Transistors	202	Microwave Frequency Standards	254
Increasing Range of Geiger Tubes by Pulsed Operation	206		
Commercial, Ruggedized, and Premium Tubes	212		

OTHER DEPARTMENTS

featured in this issue:

	Page
Production Techniques	258
New Products	310
Plants and People	382
New Books	436
Backtalk	451

Transistor Test Board Speeds Circuit Choice

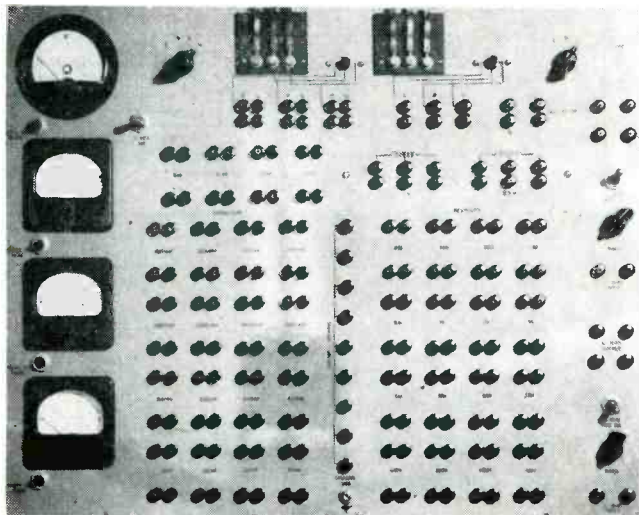

Front-panel view shows spring clips (top center) to hold transistor leads

By R. L. RIDDLE
Radio Corp. of America
Princeton, N. J.

IN TESTING a new electronic device it is often easiest to connect it directly into a circuit to determine its operating characteristics. For rapid fabrication of a multitude of transistor circuits the test board described below was constructed.

This board comprises two sets of transistor sockets, a metering circuit, bias supply controls and a selected group of circuit elements.

Of the two sets of transistor sockets one set is connected into a metering circuit that enables the measurement of emitter, collector and base currents and voltages. This circuit arrangement is shown

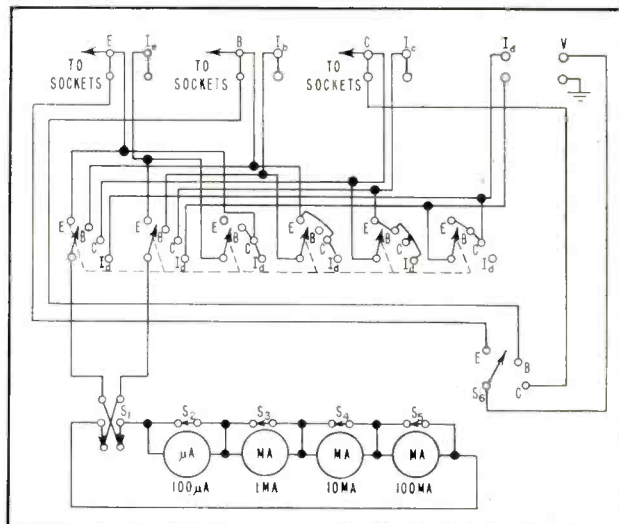

Fig. 1—Circuit of the transistor hookup device to speed testing employs switches

in Fig. 1 and the photograph.

In addition to the above-mentioned currents that may be measured, a set of terminals is included that permits the measurement of currents anywhere in the external circuit by inserting the appropriate leads in the terminals marked I_a .

The circuit components included are four decades of resistors, four decades of capacitors, a set of electrolytic capacitors and two center-tapped coils. These components permit the construction of many transistor circuits.

A second set of transistor sockets is included to enable two-stage transistor circuits to be constructed.

With the use of this test board

and simple external equipment the characteristics of transistor circuits may be obtained rapidly.

ASR Using MTI Feeds PAR

NEW AND IMPROVED airport surveillance radar system (ASR) recently installed at Norfolk, Va. Municipal Airport gives CAA traffic controllers a clearer picture of aircraft within a 60-mile radius. Equipped with moving-target-indicator (MTI) circuits, it automatically blanks out permanent or stationary radar targets and displays only moving aircraft. During periods of poor visibility the device helps the control tower feed

You can get complete FM-AM coverage

100 KC to 216 MC

The Type 202-B FM-AM Signal Generator and the Type 207-A Univerter provide complete FM-AM signal coverage from 100 KC continuously through 216 MC in two compact portable units.

The Type 202-B FM-AM Signal Generator was designed to meet the exacting requirements set forth by leading engineers throughout the country and has found widespread acceptance as the essential laboratory instrument for receiver development and research work.

The Type 207-A Univerter was designed to provide additional frequency coverage of commonly used intermediate and radio frequencies and enables the modulation and attenuation calibration features of the 202-B to be utilized at these lower frequencies.

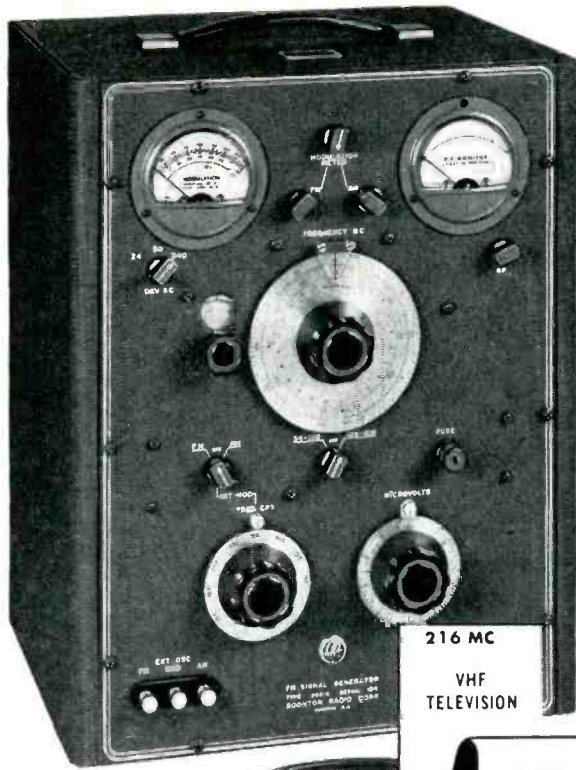

PRICE: \$975.00
F. O. B. Boonton, N. J.

FM-AM SIGNAL GENERATOR Type 202-B

SPECIFICATIONS

- FREQUENCY RANGE: 54—216 MC \pm 0.5%
- FM MODULATION: 0—240 KC continuously variable.
- FM DISTORTION: Less than 2% at 75 KC.
- AM MODULATION: 0—50% continuously variable.
- AM DISTORTION: Approximately 5% at 50% AM.
- INTERNAL MODULATING FREQUENCIES: 50, 100, 400 cycles; 1, 5, 7.5, 10, 15 KC.
- R. F. OUTPUT VOLTAGE: 0.1 to 200,000 microvolts continuously variable from source impedance of 26.5 ohms.
- POWER SUPPLY: 105—125 volts, 50/60 cycles (internally regulated)

UNIVERTER Type 207-A (When used with 202-B)

SPECIFICATIONS

- FREQUENCY RANGE: 100 KC—55 MC.
- FREQUENCY RESPONSE: Flat within \pm 1 db. over frequency range.
- FM-AM MODULATION: See 202-B.
- FM DISTORTION: No appreciable distortion at any level.
- AM DISTORTION: No appreciable distortion at carrier levels below 0.05 volt and modulation of 50%.
- RF OUTPUT VOLTAGE: 0.1 to 100,000 microvolts continuously variable from source impedance of 26.5 ohms; also approximately 1.5 volts from 330 ohms into open circuit.
- POWER SUPPLY: 90—130 volts, 60 cycles (internally regulated).

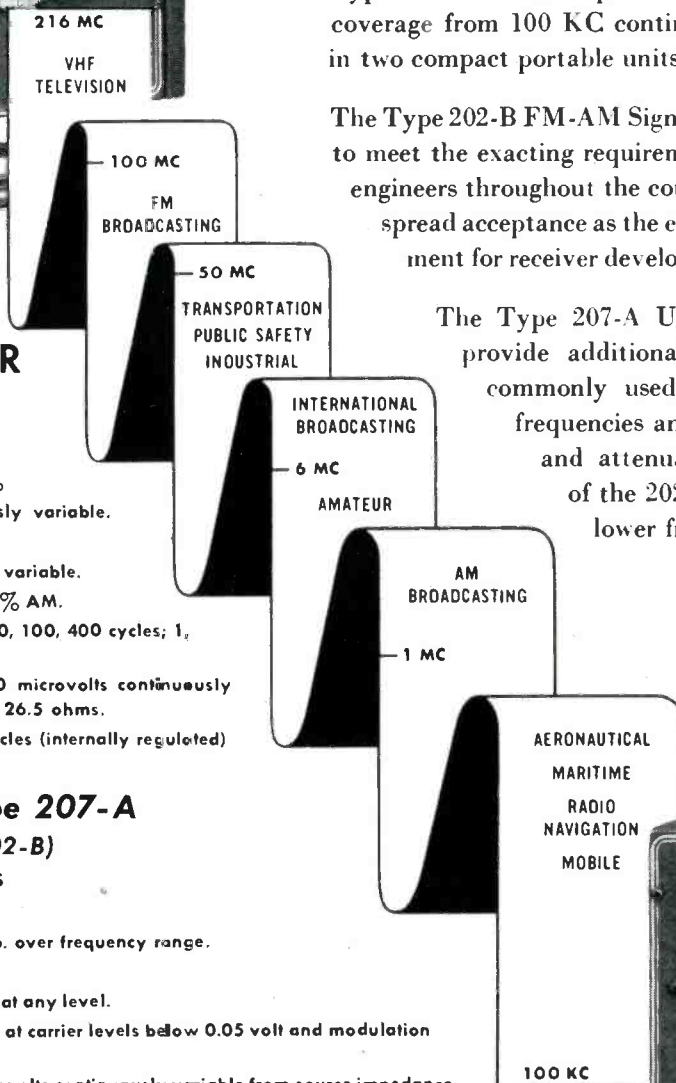

PRICE: \$345.00
F. O. B. Boonton, N. J.

BOONTON RADIO
BOONTON · N · J · U · S · A · *Corporation*



Write for CATALOG "J"



First of 23 GE surveillance radars for CAA was installed at Norfolk, Va. Only moving aircraft are displayed on controller's screen above

arriving planes into the precision approach radar system (PAR) most efficiently.

Map overlays show controllers the locations of obstructions dangerous to approaching aircraft. Two-way radio from ground to plane permits passing the information from airport to pilot.

The radar set and its rotating antenna can be located up to two miles from the airport control tower with incoming information to the viewing screen brought from the antenna by coaxial cable.

Sync-Circuit Noise Reduction

NOISE PULSES entering the sync circuit of tv receivers can be cancelled or greatly reduced by the circuit shown in Fig. 1. A noise pulse at the grid of the 3rd i-f will appear as a negative pulse at the screen grid. The same noise pulse will appear as

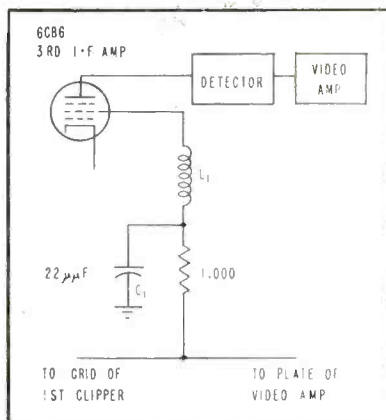

FIG. 1—Noise reduction circuit couples i-f screen to sync take-off point to cancel noise pulses

a positive spike at the sync take-off point in the plate of the video amplifier. By direct-coupling the 3rd i-f screen to the sync take-off, the noise pulse entering the sync circuit is reduced by the negative pulse from the screen.

A resonant filter, consisting of coil L_1 and capacitor C_1 , on the screen of the 3rd i-f bypasses the intermediate frequencies but does not lose sync and video frequencies.

The circuit greatly improves both vertical and horizontal sync stability, particularly in the medium fringe and fringe areas.

Another feature of this circuit is that no control is needed to adjust for different signal levels or various types of noise.

The circuit was developed by Albert Massman and Richard Kraft of Motorola, Inc.

Suppressor Grid Frequency Doubler

W. G. SHEPARD
Physical Research Unit
Boeing Airplane Company
Seattle, Washington

TOTAL CATHODE EMISSION in the type 6AS6 pentode is fairly constant for a fixed control-grid voltage, but the path that the electrons take is controlled by the suppressor-grid voltage. The main electron path is to the screen grid for a large negative suppressor voltage and to the plate for a zero or positive suppressor voltage. The suppressor grid, therefore, can act as a second control grid as far as plate current is concerned. These characteristics make the 6AS6 useful as a frequency doubler.

If 180-deg out-of-phase sine-wave signals are placed on the control grid and suppressor grid simultaneously, it will be found that although the total cathode current is a sine wave of the original frequency, the electron flow reaching the plate contains a large amount of second harmonic.

This may be explained by the fact that as the electron-flow cycle reaches its maximum the electrons are deflected to the screen grid because the suppressor grid is most negative at this time. This causes the plate current to decrease at the peak of every cycle of total elec-

tron flow as well as at the minimum of every cycle; thus accounting for the frequency doubling. If the incoming sine waves are of the proper amplitude, the fundamental is almost entirely eliminated, leaving a fairly good sine wave at the doubled frequency.

A practical circuit for frequency doubling is shown in Fig. 1. The unbypassed cathode resistor effectively develops the 180-deg out-of-phase signal on the suppressor even though the suppressor is grounded, because the cathode tends to follow the grid signal, and such a signal at the cathode has the same effect as a 180-deg out-of-phase signal placed directly on the suppressor. In the circuit shown, the input signal should be about 1.2 volts, which produces an output of approximately 2.4 volts.

A frequency doubler of this type will work down to the lowest frequencies, but its top useful fre-

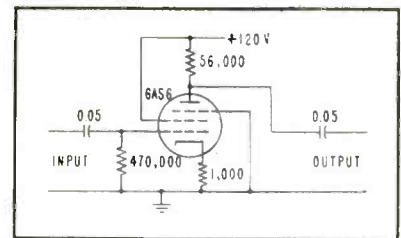

FIG. 1—Frequency-doubler circuit uses unbypassed cathode resistor to produce effect of 180-deg out-of-phase signal on suppressor grid

quency without employing tuned circuits is probably around 100 kc. Various capacitances interfere with proper operation at frequencies higher than this and other methods of frequency doubling are more satisfactory at these higher frequencies.

Four-Track Film for Stereo Sound

BY NARROWING the size of the picture frame and cutting the width of the sprocket holes along the edge of the film, four sound tracks for a stereophonic system can be placed on the same strip of film as the picture.

The new system permits the showing of films using stereophonic

Having the **RIGHT CONNECTIONS** is a big help!

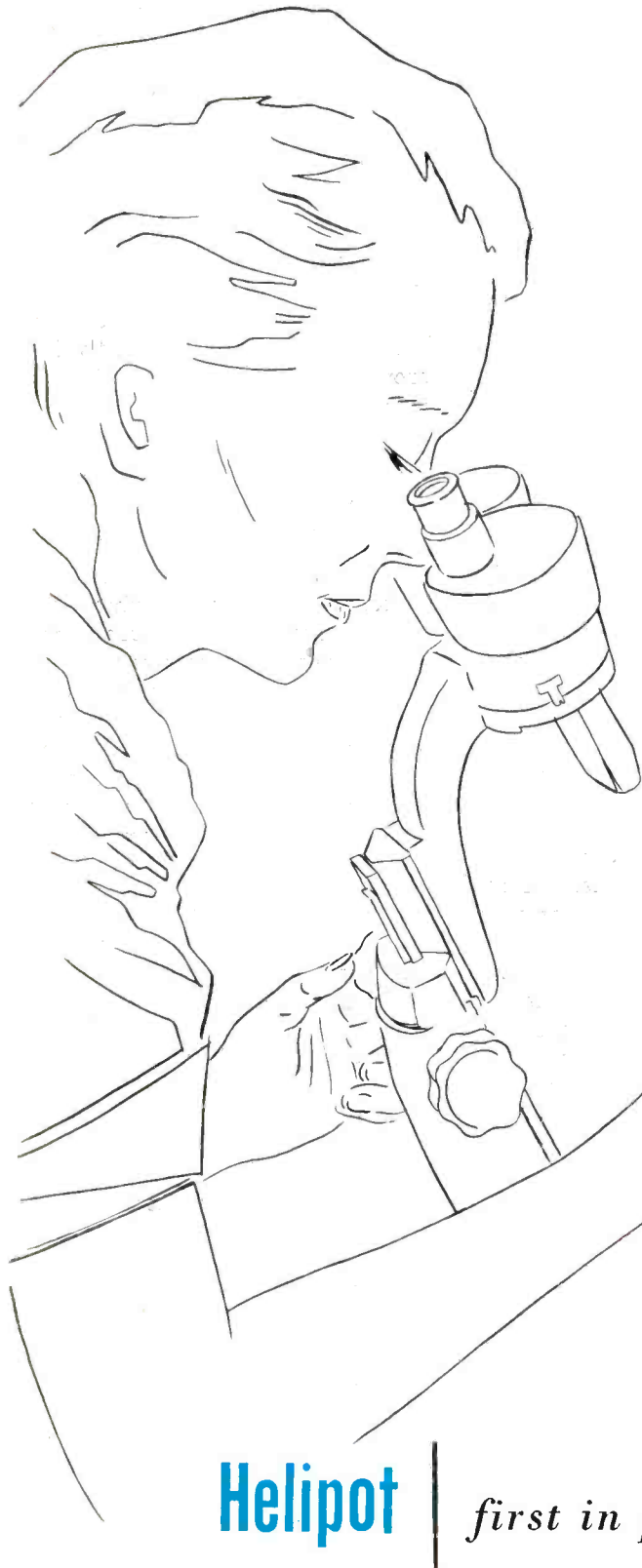

Helipot* . . . first in precision potentiometers . . . makes sure that, in *every* Helipot, you do have the right connections. No pressure-type connections are used in *any* Helipot. Tap connections are spot-welded by a Helipot-developed process, and other electrical connections are soldered . . . they all *stay put!*

The spot welding process is a particularly interesting one . . . and more important, it offers a very real advantage to users of Helipot precision potentiometers. Skilled workers, using binocular microscopes, employ a new technique in spot welding the very fine electrical connections. This technique assures that tap connections are attached to a single turn *only* of the resistance wire, rather than to several adjacent turns as is usually the case with the conventional method. Thus the high resolution, so important to the proper functioning of a precision potentiometer, is not reduced, and none of the wire turns adjacent to the one tapped are shorted out.

The spot welding process offers the further advantage of providing the strongest possible type of connections . . . vibration proof, shock proof, corrosion proof, unaffected by temperature and humidity changes. And to cap the climax, the new process is efficient and economical . . . another example of the Helipot policy offering the lowest price consistent with the high quality you expect in Helipot products.

For information about Helipot's complete line of precision potentiometers, call your nearest Helipot representative or write direct!

*T.M. Reg. U.S. Pat. Off.

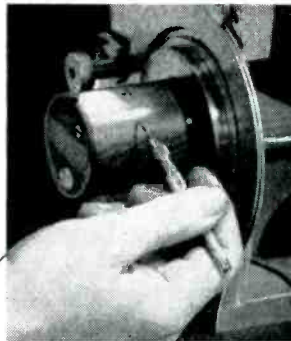

WRITE FOR YOUR COPY!

Your copy of the HELIPOT Condensed Catalog describing every model of HELIPOT Precision Potentiometers and Duodials is now ready. Please write for it on your company letterhead. Ask for Data File # 160-1002.

Helipot corporation

a division of **BECKMAN INSTRUMENTS, INC.**
SOUTH PASADENA, CALIFORNIA

PLANTS AT SOUTH PASADENA, CALIFORNIA & MOUNTAINSIDE, NEW JERSEY
ENGINEERING REPRESENTATIVES IN PRINCIPAL CITIES

Helipot

first in precision potentiometers

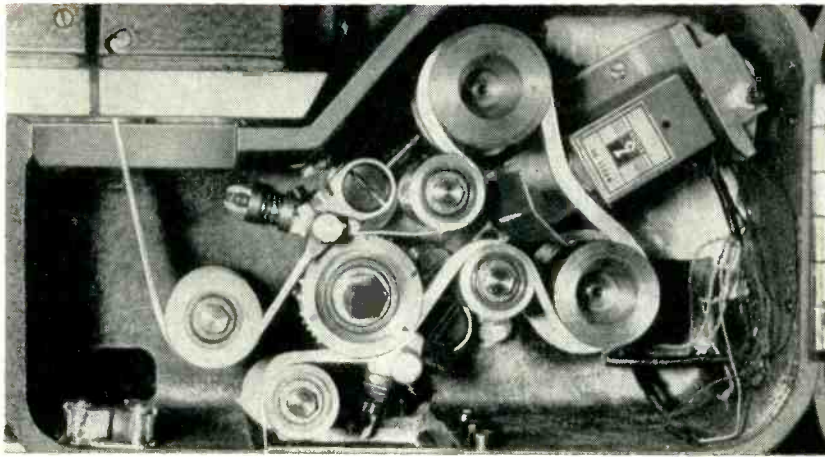

Path of film through magnetic-pickup unit. Rollers act as mechanical filter to prevent flutter and wow. Pickup head contains four pickup units side by side

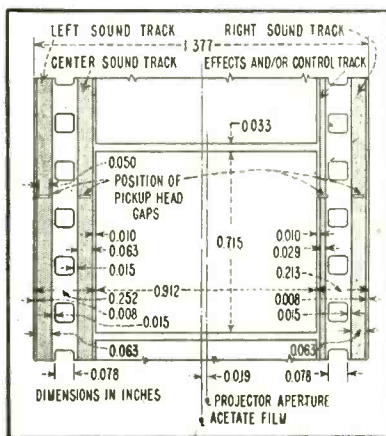

FIG. 1—Four magnetic sound strips are placed on same film with picture. Smaller sprocket holes are made possible by higher dimensional stability of new film materials

sound with minimum adaptation of projection room equipment. Changes required in the projector are the installation of the magnetic-tape pickup unit shown in the photograph and an alteration in the size and spacing of the film sprocket wheels. The alterations do not affect the running of regular

Kerosene Cooled Transistors

By J. E. MAYNARD and R. L. BROCK
Physical Research Unit
Boeing Airplane Co.
Seattle, Washington

A SOLUTION to the problem of self-heating of the contacts of point-contact transistors consists in the use of a fluid to remove heat. External means of cooling may be applied in addition in order to control ambient conditions. An indication

ms in the projector.

The new film, introduced by 20th Century-Fox for use with their Cinemascope wide-screen pictures is shown in Fig. 1. Three sound tracks 0.063 inch wide provide a separate channel for sound to speaker systems placed to the right, center and left of the theater. A fourth track, narrower than the others is used for recording background and special-effect sounds such as thunder or crowd noises.

Response of the tape tracks is flat to 8,000 cycles \pm 1 db, with a 50 db signal level as compared to 40 db for a regular optical sound track. The film is run through the projector at standard speed, giving a tape speed of 18 inches per second. Crosstalk between strips is down 40 db at 1,000 cycles.

The tape coating 0.005 to 0.007-inch thick is painted on the film in an acetate solvent. The solvent softens the acetate film base and when dry the magnetic-tape strip has become an integral part of the film.

of the problem of self-heating at the point contact may be gained from a calculation of the current density that may be encountered. With a contact area one thousandth of an inch in diameter and a contact current of three milliamperes, the current density would be 3,820 amperes per square inch. The essential feature of the transistor

unit described here is that kerosene coolant is circulated around the junction between the point contact wires and the germanium. Circulation is maintained by the natural convection currents set up in the fluid as a result of the temperature differential between the contacts and the surrounding fluid. Temperature rise at the contact point is considerably reduced.

During normal continuous operation the point-contact temperature is lower for given external ambient conditions than the contact temperature that exists when the transistor contacts are enclosed by a viscous or solid material. The measure of control over contact temperature achieved by convection cooling results in greatly improved stability of operation in transistor circuits, with some subsequent extension at the upper end of the allowable ambient temperature range.

Method of Stabilization

The transistor unit shown in the photograph is one in which the point contacts and surrounding region are fully exposed to the cooling fluid. Convection currents in the fluid minimize the initial temperature rise at the contacts and maintain continued reduced temperature contributing to more stable and predictable operation of the transistor.

Coolant

Cooling fluids having dielectric constants much greater than unity would introduce large, undesirable capacitance effects about the transistor elements. Low viscosity and a large thermal expansion coefficient are necessary to obtain satisfactory convection currents. A large thermal capacity is necessary to absorb rapid temperature rise in the contact region. Some of the

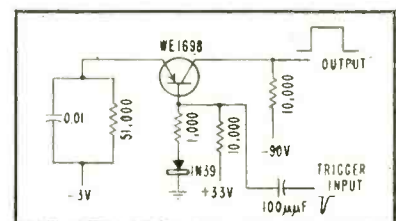
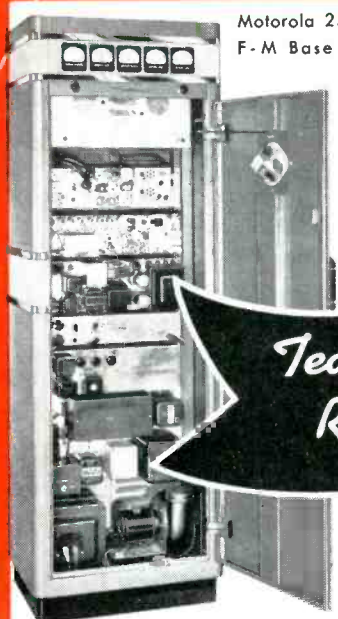
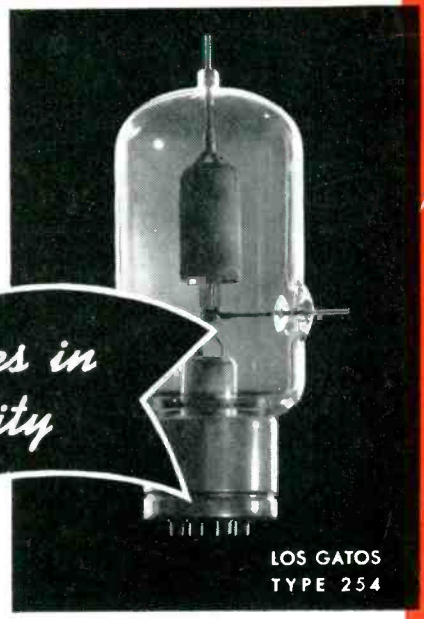

FIG. 1—Bistable multivibrator circuit used in temperature stability experiments



Motorola 250-Watt
F-M Base Station



LOS GATOS
TYPE 254

*Teammates in
Reliability*

MOTOROLA AND LOS GATOS WORK TOGETHER FOR RUGGEDNESS, CONTINUITY OF SERVICE

Two Los Gatos Brand Type 254 triodes, operating in push-pull, energize the 250-watt final r-f power amplifier in the Motorola "Research" line of 25- to 50-mc 250-watt f-m radio systems.

Because this equipment was designed to provide dependable two-way communication in mobile or point-to-point service, the choice of these long-lived Los Gatos tubes was natural.

A rear-view close-up of the power amplifier chassis with the two Los Gatos 254's in position is shown below.

If you have a problem calling for electron tubes with rugged dependability, check with Los Gatos — either through your nearby representative, or write:

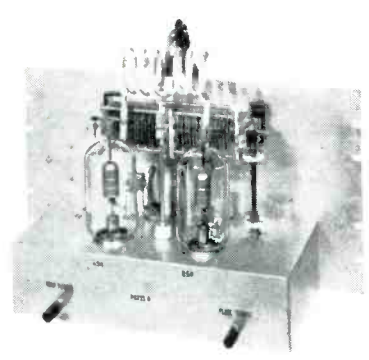

LEWIS and KAUFMAN, Ltd.

LOS GATOS 1

CALIFORNIA

Export Representatives: MINTHORNE INTERNATIONAL CO., INC.

15 Moore Street, New York 4, N. Y.

Cable: Address "Minthorne"



Leach

CONTROL RELAYS

FOR UNEXCELLED PERFORMANCE

Furnishing Relays that excel in performance is a *Leach* specialty. Their rugged strength and smooth endurance provide uniform control, protection and dependability.

No matter what your Relay application, we invite you to share our nearly four decades of experience and facilities as designers, engineers and manufacturers of a complete line of relays.



DIMENSIONS

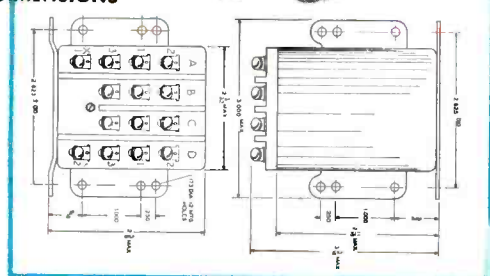

DIMENSIONS

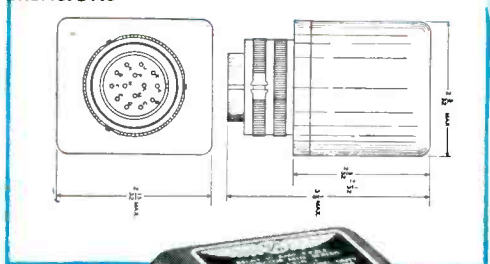

CHARACTERISTICS

Leach Part No. 9072 Hermetically Sealed, Screw Terminals.

CONTACTS:

Arrangement—4 Pole, Double Throw. Rating—10 amps resistive and inductive at 29 v d-c, 6 amps motor load at 29 v d-c, 10 amps resistive at 115 v a-c, 400 cps.

COIL: 135 ohms, 28 v d-c.

WEIGHT: .70 lb.

Also available with Solder Terminals—Leach Part No. 9039SS.

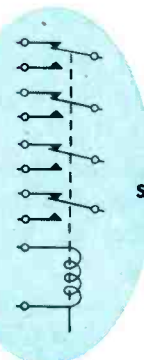

SCHEMATIC

Leach Part No. 9039 Sealed AN Connector Mounting. Same Characteristics as above.

APPROVED:

AN3310-1 part per spec. MIL-R-6106

WEIGHT:

.57 lb.

Hermetically Sealed and Sealed — Midgets — Circuit Controls — Aircraft Relays & Contactors — Special Purpose — Radio & High Frequency — Keying

For your specific requirements and for **BETTER CONTROLS THROUGH BETTER RELAYS**—Contact Leach

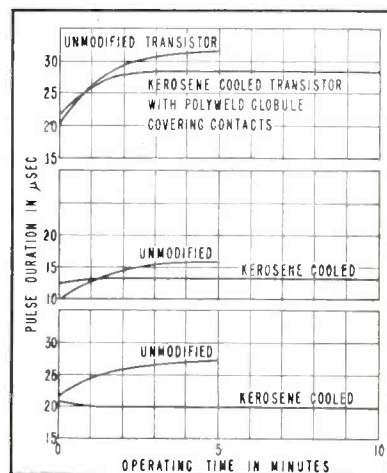

FIG. 2—Variation of pulse duration during warmup of transistor multivibrators

liquids that meet these requirements are light petroleum, turpentine, carbon tetrachloride, benzene, trichloro-ethylene and kerosene.

First laboratory tests were made with benzene as the coolant, but the benzene was found to attack the germanium surface. The aromatic hydrocarbons, of which benzene is a member, cause significant damage to the back-voltage characteristic of crystal diodes. The same action would be experienced at least qualitatively by a transistor immersed in such a liquid, and the results would be such as to impair greatly the ability of the transistor to perform as an amplifier.

Aliphatic hydrocarbons do not in general exhibit these effects. Kerosene, one of this group, was chosen as the coolant for the preliminary experiments. The results have been excellent with no deleterious effects observed in many hours of operation in the kerosene.

The experimental model used for testing the temperature stabilization process is a Western Electric type 1698 point-contact transistor having the insulation material removed by soaking in trichloro-

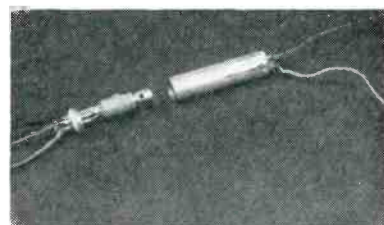

Kerosene cooled transistor unit removed from tube to show construction

LEACH RELAY CO.

5915 AVALON BOULEVARD • LOS ANGELES 3, CALIFORNIA

Representatives in Principal Cities of U.S. and Canada

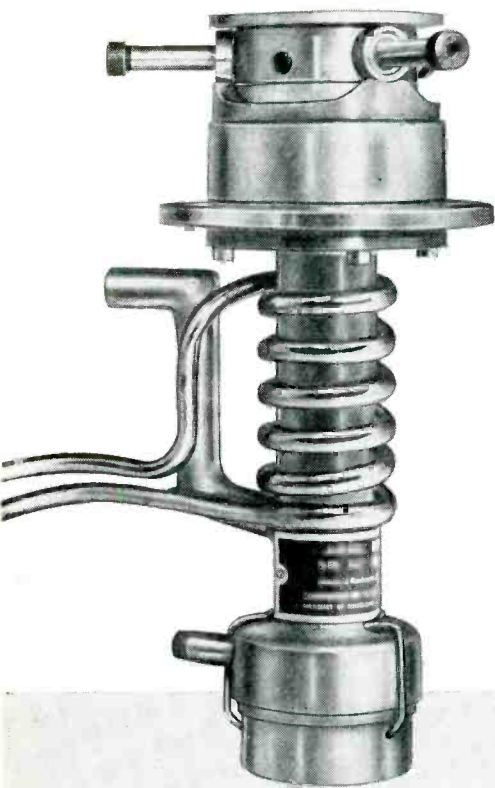

It's easy to convert tube exhaust systems with these pump and port units

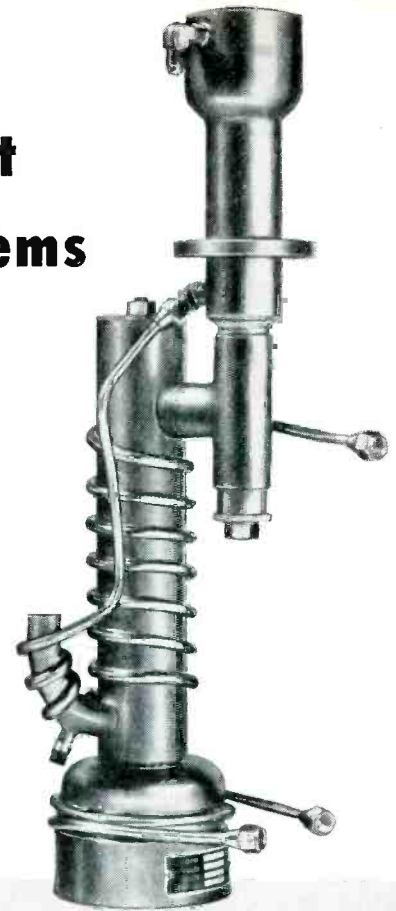

For most rotary exhaust machines—

CVC's Oil Diffusion Pump model MB-10 and port type TP-02 offer the maximum compactness and performance:

- Together they measure only 8¾" high; operate through any sweep and sliding valve combinations.
- The pump speed is 10 liters/second; ultimate pressure in the port is 10^{-3} mm Hg or lower; high limiting forepressure is 0.5 mm Hg.
- The two-position *mechanically* operated port and valve with its rugged mounting flange is easily attached to standard rotary machines.
- There's a readily removable jet assembly; jet parts separate to facilitate cleaning.
- The heater operates directly from any 115 volt power supply.

For large size TV picture tube exhaust—

CVC's Fractionating Oil Diffusion Pump type MCF-60 with the quick closing port produces pressures of 10^{-3} mm Hg and lower before getter flash in the large size picture tubes. Illustrated above is *CVC's* model MCF-60-013 (19½" high) having a rated speed of 60 liters/second and provided with:

- Water-cooled port for protection of rubber sealing gasket during bakeout.
- Quick opening compression type tubulation seal.
- Easily removable jet assembly.
- Properly located glass trap and clean-out port.

It's pumps like these that make *CVC* inline and rotary exhaust systems so efficient and economical to operate.

Whether you require just the pumps or a completely engineered exhaust unit, we welcome the opportunity of talking with you. *Consolidated Vacuum Corporation, Rochester 3, New York* (A subsidiary of Consolidated Engineering Corporation, Pasadena, Calif.)

Consolidated Vacuum Corporation
Rochester 3, N. Y.

formerly

Vacuum Equipment Dept.

designers and manufacturers of high vacuum equipment

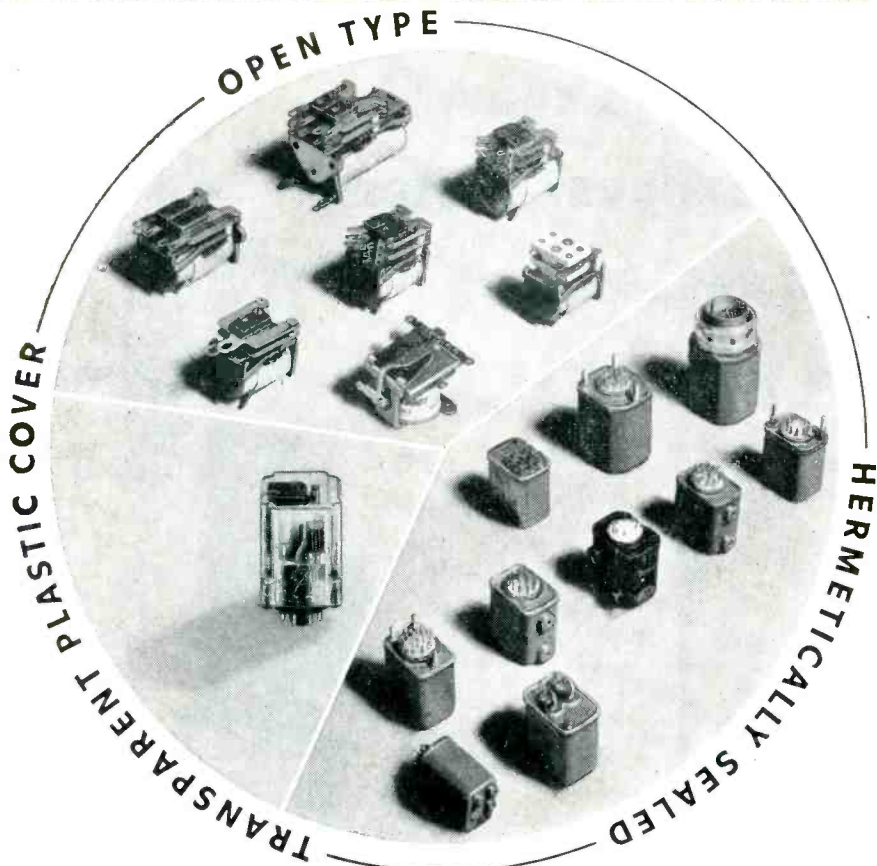
SALES OFFICES: PALO ALTO, CALIF. • CHICAGO, ILL. • CAMDEN, N. J. • NEW YORK, N. Y.



R-B-M Relays

FOR EVERY ELECTRONIC APPLICATION

Meeting Commercial and Government Requirements

OPEN TYPE. Circuit switching—power and dynamotor loads—plate circuit—low capacitance.

HERMETICALLY SEALED. Stud or bushing mounting—solder or plug-in headers—circuit switching—power—low loss applications.

TRANSPARENT PLASTIC COVER. Most R-B-M relays now available in low cost transparent plastic cover.

OTHER PRODUCTS: Motor starting relays and overload protectors for refrigeration, appliance and general purpose motors. Industrial contactors and across-the-line starters. NEMA size 1 and smaller. Low cost general purpose relays. Low voltage D.C. manual and magnetic devices.

Let R-B-M engineering and production facilities serve you. Contact us immediately—Phone 5121
Write Dept. B-10 For ASR Bulletin.



R-B-M DIVISION ESSEX WIRE CORP.
Logansport, Indiana

MANUAL AND MAGNETIC... ELECTRIC CONTROL... FOR AUTOMOTIVE, INDUSTRIAL, COMMUNICATION AND ELECTRONIC USE

ethylene. The transistor, mounted in a suitable socket, was inserted in a brass tube. The tube was then sealed at one end with a Kovar glass-to-metal seal and filled with kerosene. The other end was made with a tight fitting cover.

The monostable multivibrator circuit shown in Fig. 1 was used in the temperature stability experiments. The curves in Fig. 2 indicate the variation of time duration of the quasistable state of the multivibrator as a function of time elapsed after initiation of the supply voltages and trigger pulses. For the two transistors compared in the grease-filled and the kerosene-filled conditions there is essentially no significant thermal creep in pulse duration during or after warmup when operated in kerosene. The other transistor tested was given a small polyweld globule, covering a surface area of about 0.1 mm diameter, on the contact junctions and then immersed in the kerosene. The curves for this transistor indicate a small reduction in creep effect when operated in kerosene over that existing for grease-filled operation; comparison with the curves of the two other transistors clearly indicates the necessity for allowing the coolant to be in direct contact with the collector and emitter point contacts.

In further observations made with cooled transistors operating both in single and double transistor bistable multivibrator circuits, milliammeters in the collector circuits indicated an absence of the usually observed thermal creep.

The assistance of Robert C. McCarty and Tom Ross of the Physical Research Unit is gratefully acknowledged.

REFERENCES

(1) O. M. Steutzer, Junction Fieldistors, *Proc. IRE*, 40, p 1377, Nov. 1952.

Increasing Range of Geiger Tubes by Pulsed Operation

WHEN OPERATED at a constant potential, the upper limit of Geiger tube operation is governed by the time required for deionization of the gas after discharge. When the interval between counts approaches

Where precision pays off...

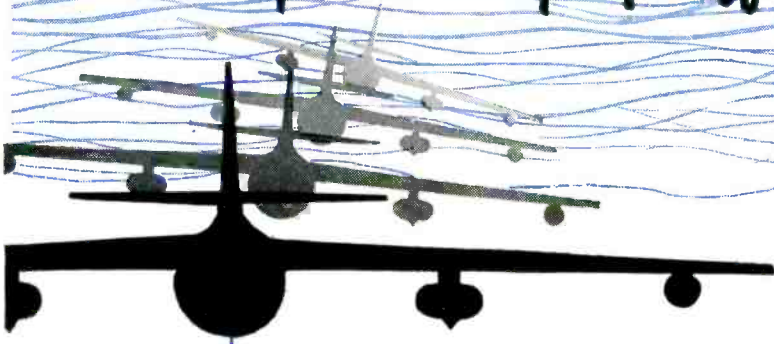

Accuracy as represented by integrating ranges of 300 to 1 is common to all modern flight simulators. But for reproducing the intricacies of supersonic flight the men who design and engineer Link Flight Simulators go further. A ten-fold increase in accuracy is built into Link ac analogue computer systems — which employ an electro-mechanical integrator with a 3000 to 1 speed range. And it really pays off! For example:

In order to produce realistic simulation for high speed flight, rates of descent as high as 30,000 feet per minute must be accurately computed. The conventional simulator integrating range of 300 to 1 cannot accomplish this without sacrificing accuracy at the slower speeds, e.g. — rates of descent less than 100 feet per minute. In Link's newest jet simulators, however, changes of altitude are computed over an integrating range of 3000 to 1, and thus accurately indicate rates of descent over the complete range of from 30,000 feet to as low as 10 feet per minute!

Equally important is the accuracy of dynamic performance which this integrating range provides. This provides the pilot with the actual "feel" of the controls in flight — making flight realism an inherent characteristic of today's Link trainers. *Precision pays off* — and nowhere more importantly than in training a pilot to make a controlled approach and instrument landing.

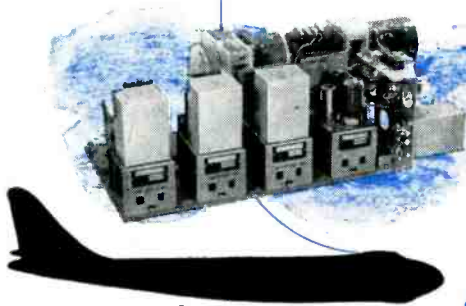

Link velocity servo-mechanism as used in the electro-mechanical integrations of the ac analogue computer systems of Link Flight Simulators.

*the connecting
Link between
ground and sky*



LINK invites employment applications from engineers and draftsmen.

the discharge time, saturation occurs. Further extension of the radiation intensity measuring range requires either the use of Geiger tubes having lowered sensitive volumes or their replacement with other devices more suitable for use in strong radiation fields.

Two methods developed by the Naval Research Laboratory¹ for extending the range of Geiger tubes use a pulsed voltage for tube operation. One method uses a pulsed voltage superimposed on a constant d-c potential to improve quenching action of the tube. The other method employs the pulsing voltage alone to gate the Geiger tube, permitting measurement of radiation only during the brief interval of pulse duration.

Continuous Sensitivity

The extension of range possible with the superimposed pulse method is illustrated in the graph in Fig. 1. The pulse acts as a catalyst, speeding recovery from discharge without materially affecting performance below the saturation point for d-c alone. The degree of range extension possible by this method is dependent on tube dead time, and the width, amplitude and repetition rate of the pulse.

Variation of the tube operating voltage within the Geiger operating plateau has only a small effect on the range extension, provided the pulse amplitude is maintained at not less than 20 percent of the tube voltage.

Pulse rate should be selected so that the period of the pulse is equal to the dead time interval of the tube. If the pulse period is longer than this the tube will become saturated and blocking up will occur. If the period is shorter there

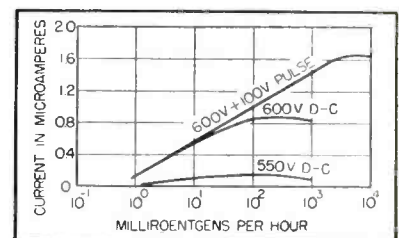
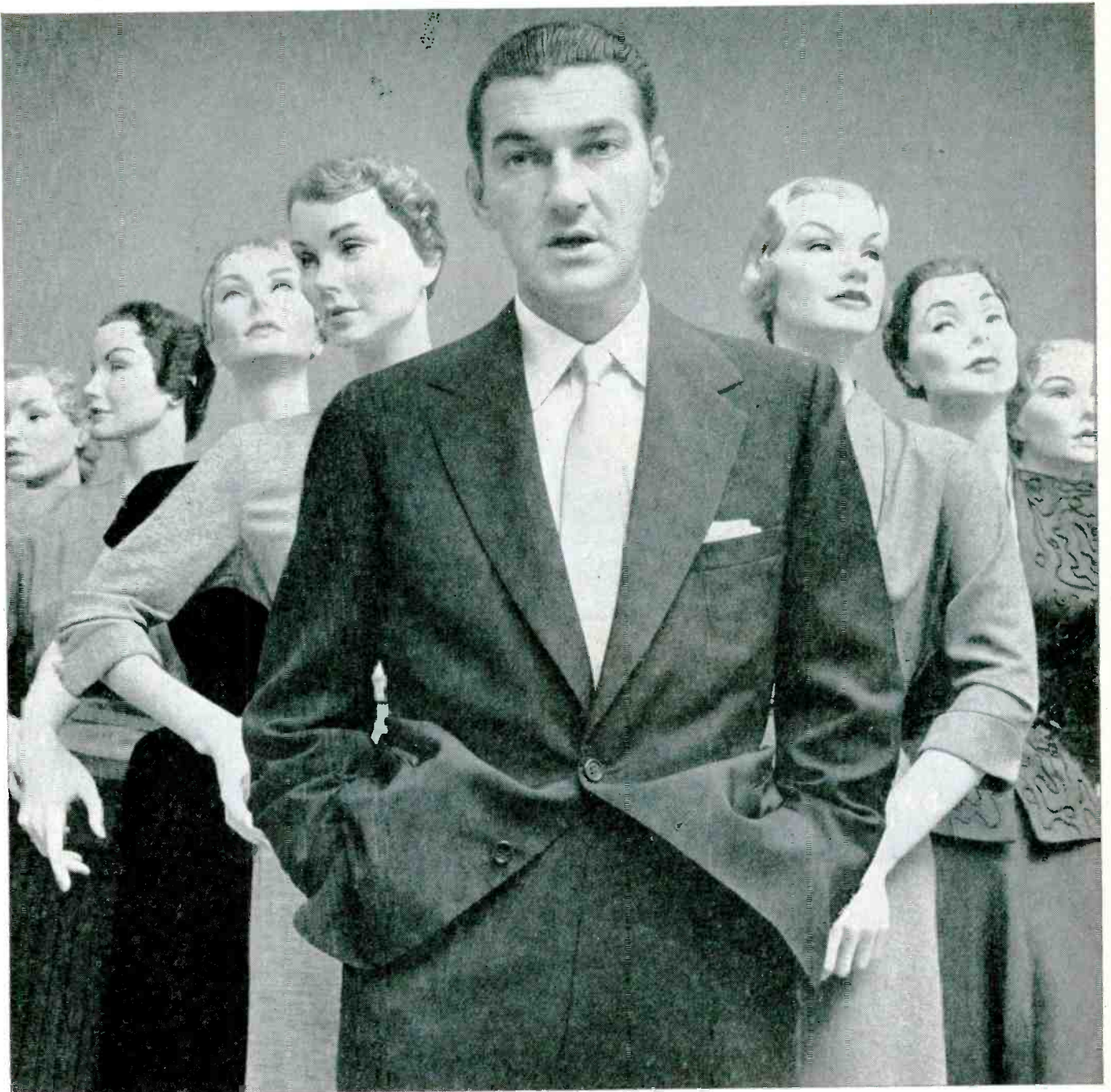

FIG. 1—Curves showing increase in tube current in a type GC-120 counter tube by use of superimposed 2,550-pps pulse. Pulse width is 20 μsec



Carl Rosen, President of Puritan Dress Company, tells how . . .

He leads the world's biggest dress parade!

"Fashions are perishable," says Carl Rosen, head of the world's largest women's dress house. "The season is short — *speed* is the essence.

"First we test new styles in key markets to see how they click. New dresses reach the stores on time — via Air Express.

"Then we release the best styles, timed to go on sale when our 2-page ads appear in Sunday papers all over the country. These dresses reach every part of the nation overnight — via Air Express. Finally, our efforts pay off in a flood of reorders!

"And again we turn to Air Express, to replace stocks as fast as they sell out. This dependable speed is the lifeblood of our business. It is absolutely essential to us.

"Yet the majority of our Air Express shipments go at *lower rates* than any other commercial air service.

"Buyers and salesmen know they can depend on us. We depend on Air Express!"

It pays to express yourself clearly. Say Air Express! Division of Railway Express Agency.



Air Express



GETS THERE FIRST via U.S. Scheduled Airlines

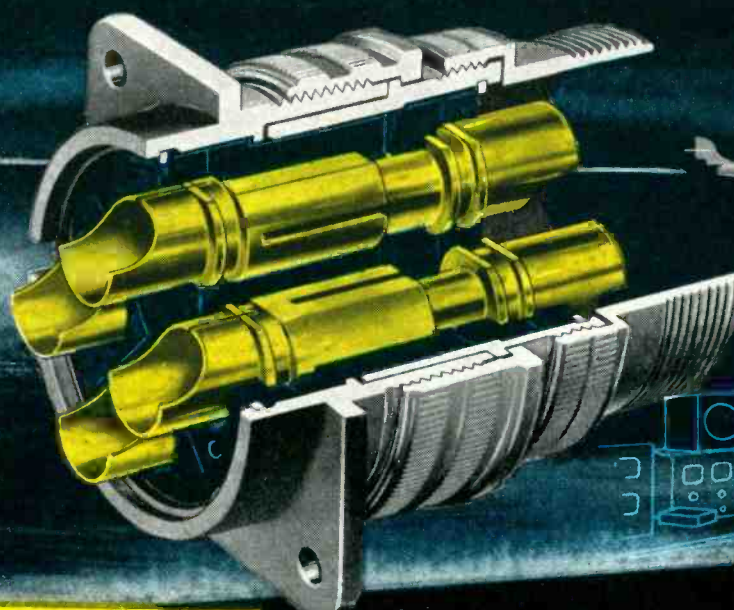

GOLD PLATED

CONTACTS

NOW STANDARD ON ALL AMPHENOL A N CONNECTORS

AMPHENOL has always led the way in every improvement on A N connectors. And, realizing from past experience the value of gold-plating contacts, AMPHENOL has pioneered a provision for gold-plating of contacts in government A N specifications. AMPHENOL is first again—and with gold-plated contacts as standard on all A N connectors now offers these added features:

GOLD

plated contacts give each AMPHENOL A N connector a superior contact surface, electrically and mechanically.

GOLD

plated contacts end forever the problem of oxidation, as with ordinary silver contacts. One result: like-new appearance and indefinite stock life.

GOLD

plated contacts make soldering easier and faster than with silver—no pre-tinning of solder cups is required.

AMPHENOL builds to the Future of Electronics—



Send for your copy of the new A N connectors and fittings catalog . . . write AMPHENOL today for your copy of catalog A-3.



AMERICAN PHENOLIC CORPORATION
chicago 50, illinois

AMPHENOL AN CONNECTORS

First with melamine inserts, first with the new improved dielectric material 1-501 diallyl phthalate, first with machined coupling rings. Amphenol now has made yet another improvement in AN connectors with the introduction of gold-plated contacts as standard. And, since Amphenol first began to manufacture AN connectors, the record has been one of constant improvements, leading to one result: superior efficiency in every application with the use of Amphenol AN connectors. Because of this record, Amphenol today is the leading manufacturer of approved AN connectors.

Every Amphenol AN connector is made to government specifications, but if alternate processes in manufacture are allowed, Amphenol has always adopted the highest quality interpretation. Thus, many features of Amphenol AN connectors exceed the requirements of the specifications and are unique with Amphenol. Gold-plating contacts is the newest Amphenol improvement in AN's and is representative of the plus values built into Amphenol connectors to save the user time and money and to assure the best possible performance.

For, not only in design are Amphenol AN connectors superior — but in performance, too. Highly trained personnel, modern manufacturing facilities and rigid quality control procedures combine to insure that every Amphenol AN connector will perform with precision — for years.

Amphenol AN connectors, while designed for the armed services, are ideal for commercial and industrial uses where the same dependability is mandatory. AN connectors are being widely employed in electrical and electronic industrial equipment, laboratory apparatus and therapeutic devices. Many industries — railroads, aircraft, textiles, radio and television — use types of circuits in which Amphenol AN connectors perform to great advantage.

ELECTRONS AT WORK

(continued)

will not be complete recovery between pulses with consequent lowering of the range and maximum Geiger current.

Pulse width must be much less than tube dead time. In experimental work improvement in measuring range was evident down to the narrowest pulse used, about one half microsecond. Theoretical work indicates that a reduction of pulse width will be accompanied by a corresponding increase in counting range until the pulse becomes sufficiently narrow as to approximate the transit time of the electrons. In this region the behavior of the counter tube would alter markedly in accordance with transit time theory. One of the changes would probably be a reduction in the influence of the pulses upon tube performance.

Intermittent Operation

The second method, using only a pulse voltage, extends the range of the tube by allowing it to measure the radiation for brief intervals at a periodic rate. When the pulse is used to trigger the tube in this manner the measured count rate will be a fraction of the count measured with constant voltage applied to the tube.

The ratio between the two count rates may be called the scale factor SF. Experimental work has shown that measurement rate varies directly with pulse width, repetition rate and the intensity level of the radiation field. For pulse widths considerably less than the tube dead time, SF is equal to the reciprocal of the duty factor

$$SF = 1/wf$$

where w is the pulse width and f is the repetition frequency.

This relationship shows that by pulsed trigger operation the total potential count at the tube is lowered by the duty factor wf . This feature for all practical purposes removes the saturation limitations of Geiger tubes in high radiation fields.

The trigger pulse repetition rate must not exceed the rate prescribed by the reciprocal of the deionization time of the tube. Otherwise the discharge will be reignited by the triggering pulse and will be self-sus-

**COMPACT
DEPENDABLE
EFFICIENT** *Rotary Power*
by **Carter**



THE NEW
Custom

DC-AC CONVERTER

These latest of all Carter DC to AC Converters are specially engineered for professional and commercial applications requiring a high capacity source of 60 cycle AC from a DC power supply. Operates from storage batteries, or from DC line voltage. Three "Custom" models, delivering 300, 400, or 500 watts 115 or 220 V. AC. Wide range of input voltage, 12, 24, 32, 64, 110 or 230 V. DC. Unequaled capacity for operating professional recording, sound movie equipment and large screen TV receivers. Available with or without manual frequency control feature.

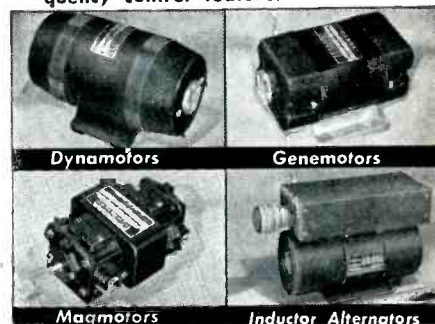

Dynamotors

Genemotors

Magmotors

Inductor Alternators

MAIL COUPON FOR CATALOG

Carter Rotary Power Supplies are made in a wide variety of types and capacities for communications, laboratory and industrial applications. Used in aircraft, marine, and mobile radio, geophysical instruments, ignition, timing, etc. MAIL COUPON NOW for complete Dynamotor and Converter Catalogs, with specifications and performance charts on the complete line.

Carter MOTOR CO.
2646 N. Maplewood Ave.
Chicago 47

Carter Motor Co.
2646 N. Maplewood Ave., Chicago 47
Please send new catalogs containing complete information on Carter "Custom" Converters and other Rotary Power Supplies.

Name _____
Address _____
City _____ State _____

Want more information? Use post card on last page.

Compact

Design

**GENERAL INDUSTRIES
MODEL SS
3-SPEED (2-POLE)
PHONOMOTOR**

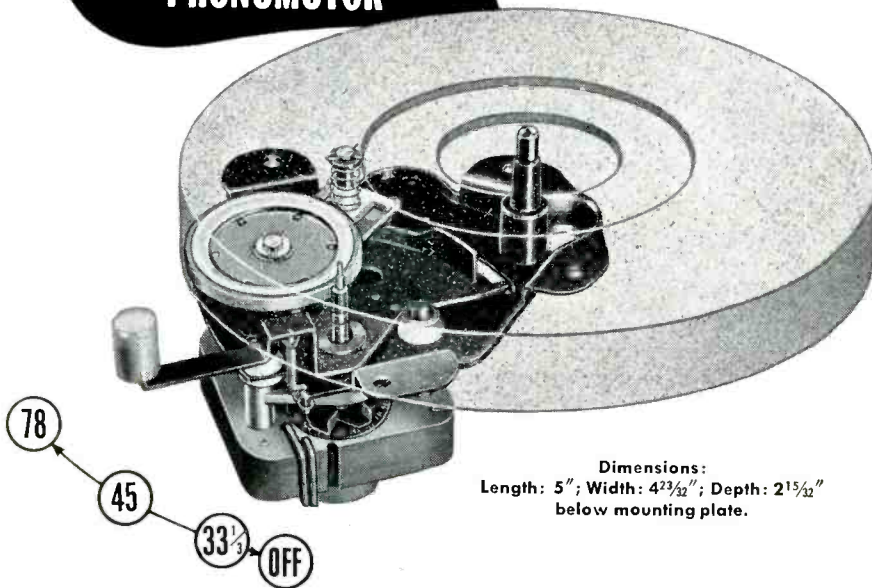

This compact 3-speed phonomotor is ideally suited for both phonographs and combinations in which quality reproduction and limited size are important prerequisites. Incorporating General Industries' novel vertical idler shifting principle, the Model SS provides smooth, dependable performance at all three operating speeds. Moving shift lever to "OFF" position automatically disengages idler wheel from motor shaft during non-operating periods.

Specifications and quantity price quotations on the Model SS, or its companion, the Model DSS, with 4-pole motor for high-fidelity reproduction, will be furnished promptly upon request.



THE GENERAL INDUSTRIES CO.
DEPARTMENT MA • ELYRIA, OHIO

tained at the trigger pulse rate.

The use of a narrow triggering pulse eliminates the possibility of gaseous discharge except where the pulse coincides with an external ionization source. This feature extends the counter operation far beyond the usual limitations imposed by the Geiger plateau. At these high overvoltages the ultimate limitation of the impressed voltage is determined by the insulating capabilities of the tube rather than by the restrictions imposed by the gaseous vehicle.

The use of higher voltages brings with it the benefit of dealing with larger charges from each counter pulse. If the triggering pulse is narrowed sufficiently the tube voltage can be raised to a region where tube current becomes largely independent of the amplitude of the impressed voltage. This characteristic may be useful in radiac designs by either reducing or eliminating entirely the dependence of instrument calibration upon tube overvoltage. It also furnishes a basis for dispensing with the need for high voltage stabilizers for counting tubes.

REFERENCES

- (1) S. W. Lichtman, Pulsed Geiger Tube Operation, Naval Research Laboratory Report No. 4013, July 25, 1952.

Commercial, Ruggedized and Premium Tubes

BY FLOYD A. PAUL

*Research Engineer
Jet Propulsion Laboratory
California Institute of Technology
Pasadena, Calif.*

VACUUM TUBES fall into three categories that are generally known as commercial, ruggedized and premium. The latter are also known as reliable and 5-star tubes. Furthermore, these tubes may be accepted as JAN tubes. Tubes are not, how-

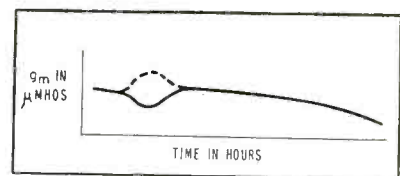
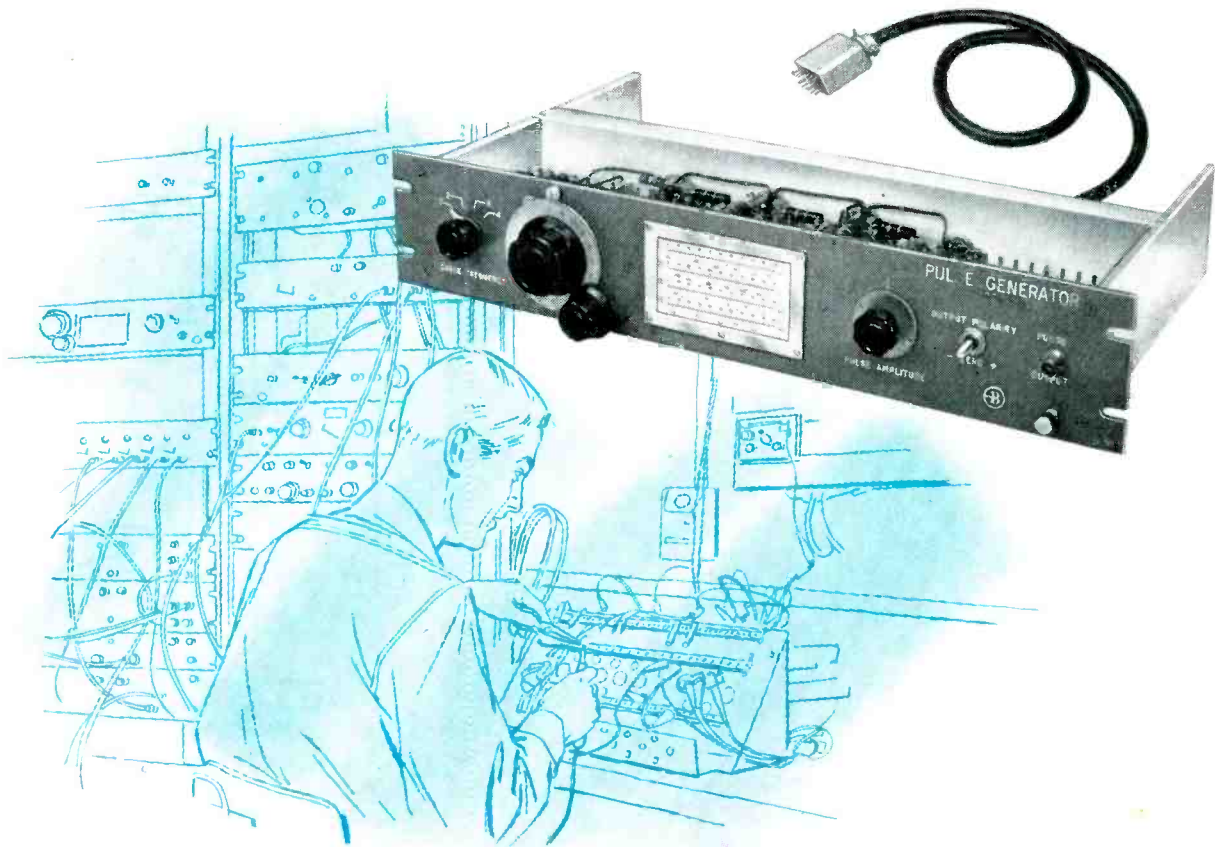

FIG. 1—Tube-aging curve with either type of protuberance is characteristic of new tubes



"Unitized" Pulse Control Equipment saves engineering time and money

WHEN you use Burroughs "Unitized" Pulse Control Equipment, you eliminate much of the costly, time-consuming work of developing electronic test circuits. There is a Burroughs pulse control unit for practically every basic function in pulse circuit engineering. You need only plan a block diagram of the pulse circuits you want, assemble the necessary Burroughs units in the plug-in rack and interconnect them with the various standard coaxial cables and accessories. This can be done because each unit performs *one basic operation* such as generating, counting, mixing, gating, or delay.

JUST "PLUG IN" A BURROUGHS PULSE GENERATOR

Any of the three pulse generators offered by Burroughs demonstrates the practical one-basic-function principle behind Burroughs "Unitized" Pulse Control Equipment... you simply select the pulse generator for the job and plug in the cables.

Burroughs Pulse Generator, Type 1002B, generates 0.1 microsecond pulses at frequencies continuously variable from 0.2 megacycles to 4.5 megacycles in four overlapping bands. A calibrated, L-C controlled, sine-wave oscillator controls

the frequency. Output amplitude, which is only affected by frequency changes in the ranges above 2 megacycles, can be varied from 10 to 32 volts and the polarity of the output pulse is reversible.

Like other Burroughs units, this pulse generator is designed and engineered so that it can be added to equipment now in use, selected as a basic component of new equipment, or used repeatedly for testing or as a component in future pulse control jobs.

For full information on Burroughs "Unitized" Pulse Control Equipment, write or call Department 12D, Electronic Instruments Division, Burroughs Corporation, 511 N. Broad St., Philadelphia 23, Pa.

PULSE GENERATORS
COINCIDENCE DETECTORS
PULSE DELAY CIRCUITS
FLIP-FLOP CIRCUITS
PULSE GATERS
CHANNEL SELECTORS
MIXERS

ELECTRONIC INSTRUMENTS DIVISION
Burroughs

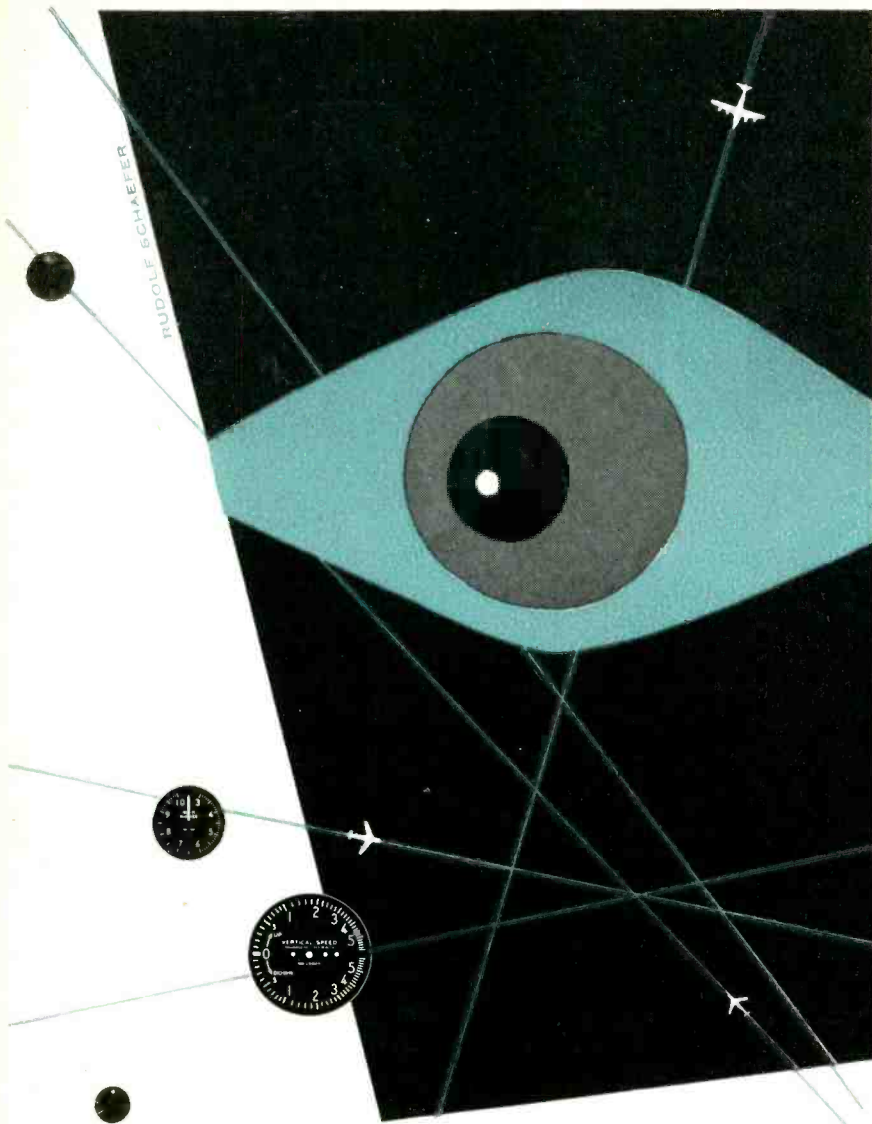

SEEING IS BELIEVING

Supplying the right answers to pilots and navigators by means of accurate, reliable instruments has been our work for more than twenty-four years.

- ✧ AIRCRAFT INSTRUMENTS AND CONTROLS
- ✧ OPTICAL PARTS AND DEVICES
- ✧ MINIATURE AC MOTORS
- ✧ RADIO COMMUNICATIONS AND NAVIGATION EQUIPMENT

Current production is largely destined for our defense forces; but our research facilities, our skills and talents, are available to scientists seeking solutions to instrumentation and control problems.

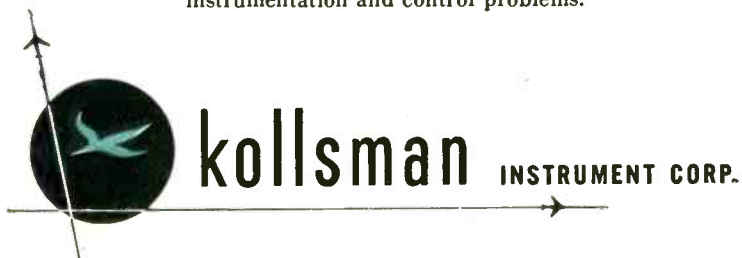

ELMHURST, NEW YORK • GLENDALE, CALIFORNIA • SUBSIDIARY OF *Standard* COIL PRODUCTS CO., INC.

Want more information? Use post card on last page.

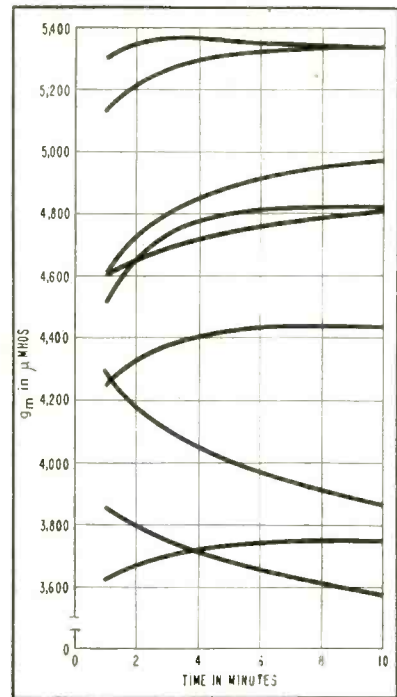

FIG. 2—Aging curves of nine 6AK5's show change in g_m

ever, JAN tubes unless they are inspected at the factory under a qualified inspector and labeled JAN, showing that sample batches have passed certain qualification tests.

JAN specifications state the conditions to be met before tubes can be stamped with the letters JAN. Since some commercial specifications are more rigid than JAN specifications, it has been suggested by tube companies that a JAN-stamped tube is not necessarily better than a commercial tube. Since ruggedized and premium tubes are improved commercial tubes, JAN specifications for these types are less meaningful than for commercial tubes.

Table I compares the various

Table I—Comparison of Tube Controls

	Com- mercial	Ruggedized	Premium
Visual inspection	limited	general	100 percent individual-element inspection
Electrical inspection	limited	limited	a mean reject limit and a cycled filament test
Aging	1 hr	1 hr	48 hr
Tube structure	original design	mechanically improved structures redesigned; better supports	mechanically improved structures redesigned; better supports

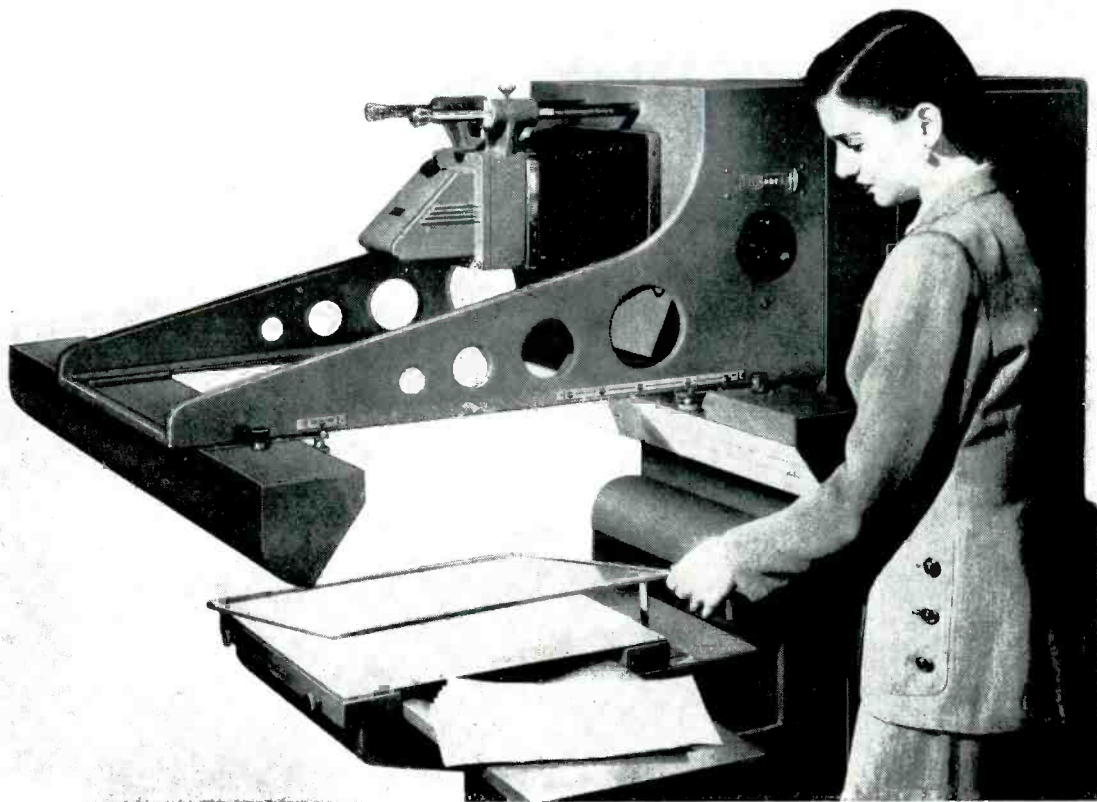

RESET TIMER INSURES ACCURATE PHOTOCOPYING ON REMINGTON RAND DEXIGRAPH

An outstanding feature of this versatile photocopying machine is the Cramer Reset Timer, which controls exposures to split-second accuracy and ensures copy prints of absolutely uniform quality. The Type RE Reset Timer is an ideal choice for this application. Its micrometer adjusting dial allows time settings to be changed

easily and quickly; yet setting can be made to a high degree of accuracy. A double pointer system is used which indicates not only the time setting but also the time remaining during any particular cycle. The push-button for starting the timing cycle is right on the front of the timer; a flick of the finger controls the machine. The convenient one-hole meter-type mounting also makes for easy assembly in your factory. Note, too, how well the timer blends in with the design of the machine itself.

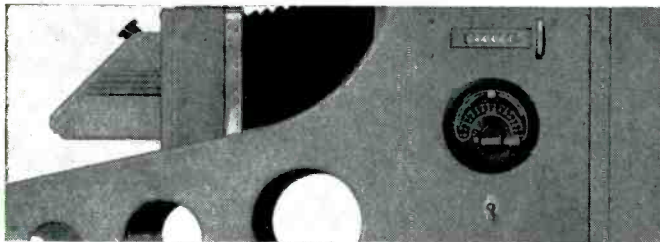

Remington Rand is only one of the many large equipment manufacturers who look to Cramer when they have a problem in time control. Cramer has a timer for almost any need, ranging from the simplest interval timers up to complex multi-circuit types. Why not consult Cramer for your timing needs?

S P E C I A L I S T S I N T I M E C O N T R O L

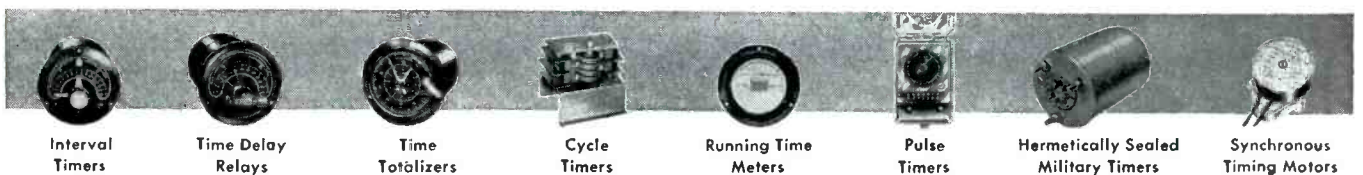

Interval Timers

Time Delay Relays

Time Totalizers

Cycle Timers

Running Time Meters

Pulse Timers

Hermetically Sealed Military Timers

Synchronous Timing Motors

the **R. W. CRAMER COMPANY, INC.**

BOX 3, CENTERBROOK, CONNECTICUT

10CR53

There's More to a Good Filter Than Meets the Eye!

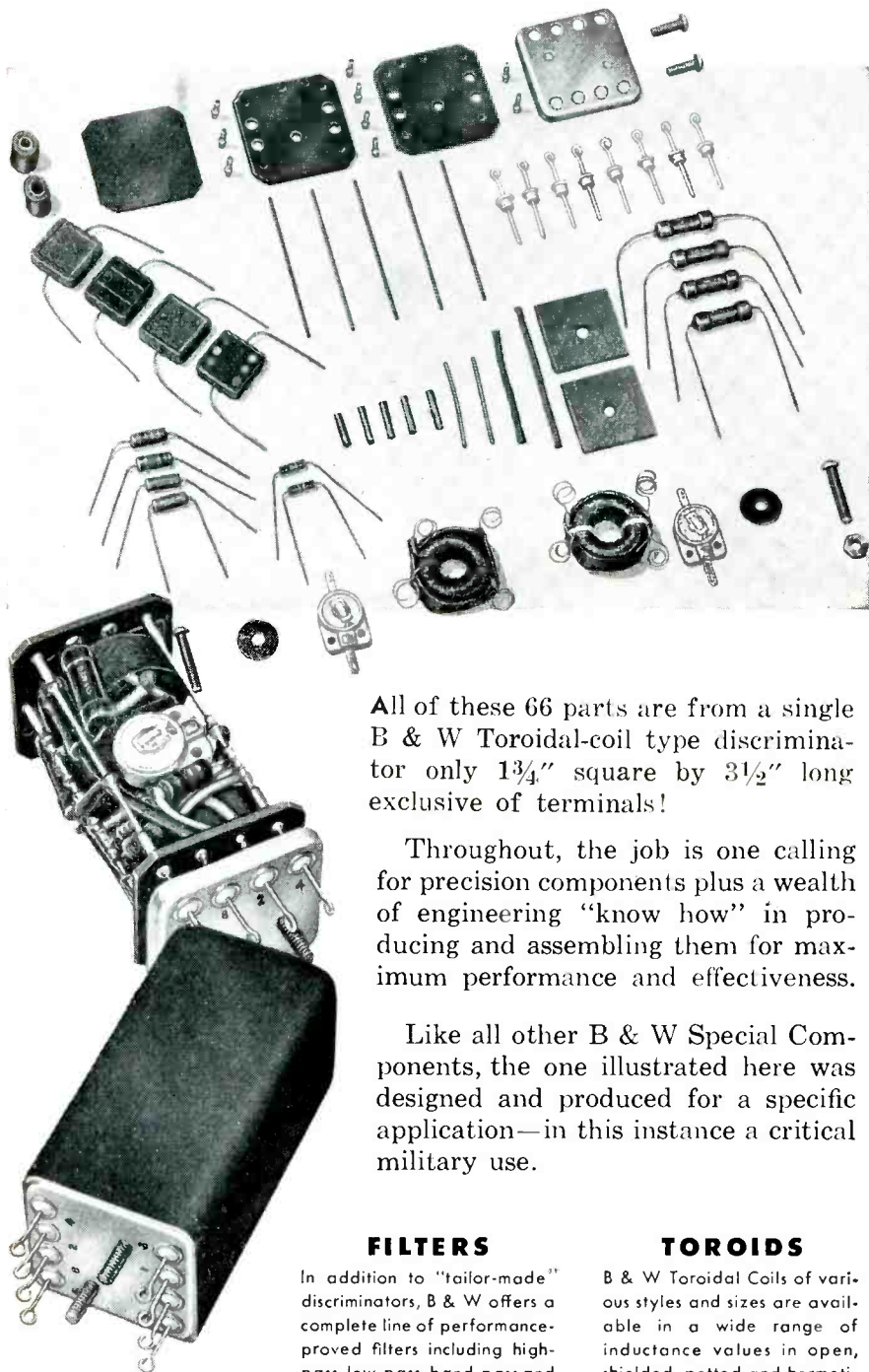

All of these 66 parts are from a single B & W Toroidal-coil type discriminator only 1¾" square by 3½" long exclusive of terminals!

Throughout, the job is one calling for precision components plus a wealth of engineering "know how" in producing and assembling them for maximum performance and effectiveness.

Like all other B & W Special Components, the one illustrated here was designed and produced for a specific application—in this instance a critical military use.

FILTERS

In addition to "tailor-made" discriminators, B & W offers a complete line of performance-proved filters including high-pass, low-pass, band-pass and band suppression types.

TOROIDS

B & W Toroidal Coils of various styles and sizes are available in a wide range of inductance values in open, shielded, potted and hermetically sealed types.



Barker & Williamson, Inc.

237 Fairfield Ave., Upper Darby, Pa.

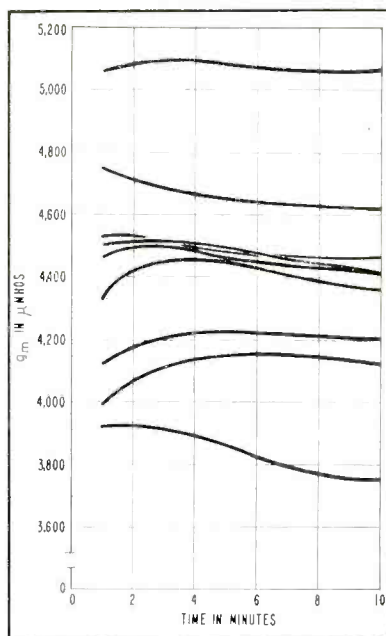

FIG. 3—Nine type 5654 tubes show aging characteristics

tests and the characteristics of commercial, ruggedized, and premium tubes as reported by tube manufacturers. From this comparison it can be generally concluded that premium tubes have better quality control than commercial tubes as well as the other advantages shown.

A sampling of 100 tubes of the commercial type 6AK5 and 100 tubes of the premium type 5654 was carried out at this laboratory. Table II shows the mean transconductance g_m of each group of tubes, and a calculation shows the standard deviation value of each group.

Most electronic systems using d-c amplifiers and r-f amplifiers require good electrical stability. If there is a change in tube characteristics, a variation of gain or an unbalanced condition could result. It has been known for some time that a tube-aging curve that plots g_m vs time of new tubes has a peculiar shape described in Fig. 1.

The reason for the projection in this curve other than aging is unexplained by tube engineers, but all

Table II—Mean Transconductance of Tube Groups

Tube	Quantity	Mean g_m in μ mhos	Standard Deviation in μ mhos
6AK5	100	4,717	484
5654 (Premium 6AK5)	100	5,041	375

JAN mean g_m is 5,000 μ mhos.



HIGH
Quality

CLEVELITE *
for **BETTER COMPONENTS**

Clevelite ensures satisfactory performance wherever high dielectric strength, low moisture absorption, mechanical strength, low loss and good machinability are of prime importance.

Clevelite is made in SEVEN GRADES — Time Tested!

GRADE	APPLICATION
E	Improved post-cure fabrication and stapling.
EX	Special grade for TV yoke sleeves.
EE	Improved general purpose.
EEX	Superior electrical and moisture absorption properties.
EEE	Critical electrical and high voltage application.
XAX	Special grade for government phenolic specifications.
SLF	Special for very thin wall tubing having less than .010 wall.

When you specify and use CLEVELITE you obtain
High Quality and Fine Service.

*Send for our new Clevelite
Folder just off the press.*

WHY PAY MORE? For the best . . . Call CLEVELAND!

* Reg. U. S. Pat. Off.

The **CLEVELAND CONTAINER Co.**
6201 BARBERTON AVE. CLEVELAND 2, OHIO

PLANTS AND SALES OFFICES at Chicago, Detroit, Memphis, Plymouth, Wisc., Ogdensburg, N. Y., Jamesburg, N. J.
ABRASIVE DIVISION at Cleveland, Ohio
CANADIAN PLANT: The Cleveland Container, Canada, Ltd., Prescott, Ontario

REPRESENTATIVES

NEW YORK AREA R. T. MURRAY, 604 CENTRAL AVE., EAST ORANGE, N. J.
NEW ENGLAND R. S. PETTIGREW & CO., 62 LA SALLE RD., WEST HARTFORD, CONN.
CHICAGO AREA PLASTIC TUBING SALES, 5215 N. RAVENSWOOD AVE., CHICAGO
WEST COAST IRV. M. COCHRANE CO., 408 S. ALVARADO ST., LOS ANGELES



New BALLANTINE SENSITIVE INVERTER

for the precise measurement of small DC potentials

from
10 μ v — 100v

Threshold Sensitivity
1 μ v

FOR USE WITH
Vacuum Tube Voltmeters
Oscilloscopes
Voltage Amplifiers
Multimeters
Servo-Amplifiers

MODEL 700

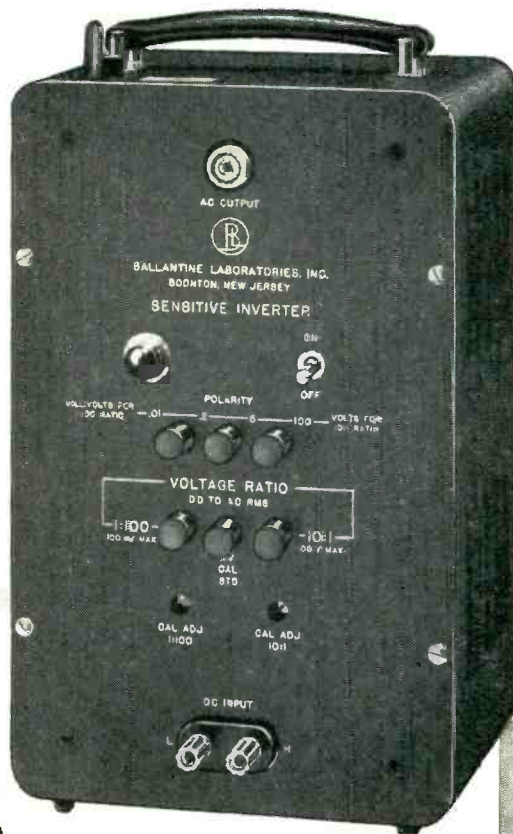

FEATURES

- Built-in Calibrator
- High Sensitivity
- High Input Resistance
- Distortion-free Output
- Low Noise Level
- Accurate for 50-70 cps Line Frequencies
- Polarity Sensing
- Immune to 60 cps Stray Magnetic Fields

SPECIFICATIONS—MODEL 700

INPUT VOLTAGE RANGE	10 μ v — 100 v DC (Sensitive to 1 μ v)
VOLTAGE RATIOS (DC input to AC RMS output)	1:100 & 1:10
INVERSION STABILITY (>100 μ v input)	0.1%
CALIBRATOR ACCURACY	0.25%
DC INPUT RESISTANCE	10 meg for 1:100; 50 meg for 1:10
AC INPUT IMPEDANCE	> 20K
INPUT NOISE LEVEL	Approx. 3 μ v
AC OUTPUT FREQUENCY	Line Frequency
MAX AC OUTPUT LEVEL	0 v RMS
TOTAL DISTORTION IN OUTPUT WAVE FORM	< 2%
RESPONSE TIME (90% of Final Amplitude)	0.25 μ s
POWER REQUIREMENTS	105-125 v; 50-70 cps; 15 watts

BALLANTINE LABORATORIES, INC.



100 FANNY ROAD, BOONTON, NEW JERSEY

Table III—Change in Transconductance

Quantity	Type	Hours Aged by Factory	Mean g_m in μ mhos	Average Change of g_m from First to Tenth Minute (%)
9	6AK5	1	4,500	5.3
9	5654	48	4,400	1.9
8	5654	500	3,700	1.9

agree that it exists. Its general location is in the 10-to-50-hour region. The apex of the projection may deviate from a fraction of a percent to several percent and either in the positive or the negative direction. This is one of the reasons why premium tubes are aged 48 hours. Some programs call for additional aging. Having been aged beyond this projection point, premium tubes can be expected to have a more stable electrical life than commercial tubes.

To compare the speed required for variously aged tubes to reach stability after application of JAN voltages, 26 tubes were used in a test that measured the g_m of each tube every minute for 10 minutes. The following tubes were used: nine 6AK5's, nine 5654's, and eight 500-hour 5654's. The individual curves of each tube showing g_m vs time are plotted in Fig. 2, 3 and 4, respectively.

Defining g_m stability in a vacuum tube as the time in which $\Delta g_m / \Delta t_{time} \leq 20$ percent/hr = 1 percent/3 min the graphs of the 26 tubes show that 6AK5's required 3.6 minutes

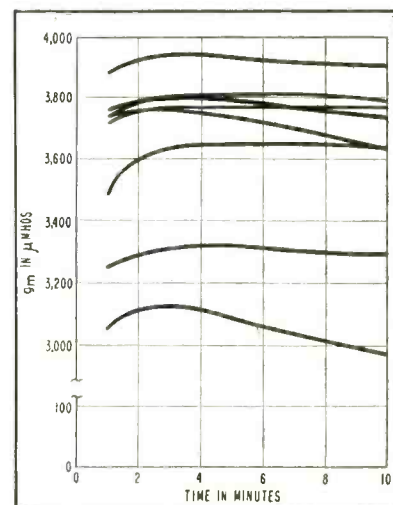

FIG. 4—Eight 500 hour 5654's show less aging than in Fig. 3

**Admiral's switch to
PLASKON ALKYD
jumps vital-part output
300%**

No Additional Equipment Required

When Admiral upped its production schedule to 1,000,000 television sets in 1953, faster production of its vital power tube became a "must."

So Admiral went to fast-molding Plaskon Alkyd. And Plaskon Alkyd gave Admiral 300% more power-tube bases in the same period of time and on the same equipment!

Plaskon Alkyd's dielectric strength, high resistance to arcing, heat resistance and dimensional stability, enable electronics engineers to design parts more compactly, without reducing margins of safety or performance.

These properties have earned Plaskon Alkyd increasing applications in TV electronics, as shown below. For information or technical assistance, write, today, to Plaskon Division, Libbey-Owens-Ford Glass Co., Toledo 3, Ohio.

**PLASKON ALKYD HAS BECOME THE
PREFERRED MATERIAL FOR TV...**

Miniature and Subminiature Precision Connectors
Tuners • Trimmers • Contact Plates • Tube Bases
Sockets • Tube Support Containers • Rectifiers
Coils • Trimmer Capacitors • Support Bracket
Trimmer Cups • Capacitors • Rotor Boards
Intermediate Transformer

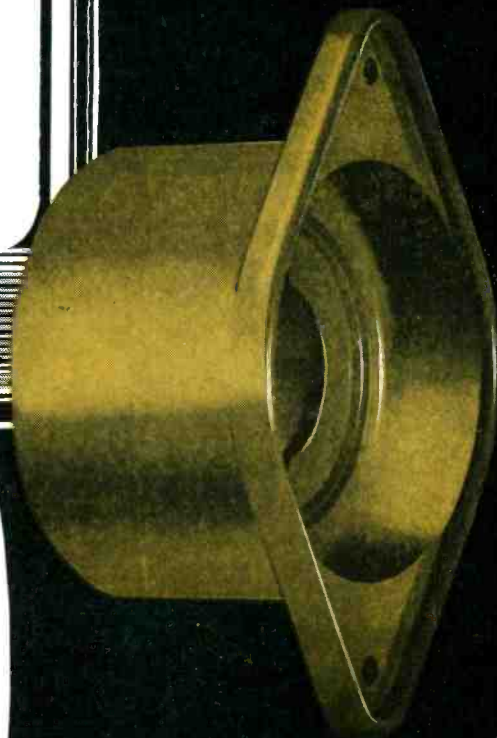

Molded by Central Molded Products
Chicago, Illinois

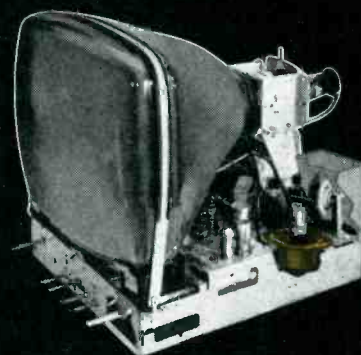

This power-tube socket, molded of Plaskon Alkyd, carries 1200 volts, and is riveted to the underside of the chassis in every Admiral television set. High dielectric strength and heat resistance, plus exceptional dimensional stability, make Plaskon Alkyd ideal for this TV application.

INSIST ON

PLASKON

ALKYD

FOR SUPERIOR ELECTRICAL PARTS



PLASKON DIVISION

Libbey • Owens • Ford
Glass Company

Toledo 3, Ohio

District Offices:

Boston • Charlotte, N. C. • Chicago • Cincinnati
Cleveland • Detroit • Los Angeles • New York
Philadelphia • Washington, D. C.

Manufacturers of Molding Compounds,
Resin Glues, Coating Resins

In Canada:

Canadian Industries, Ltd.
Montreal, P. Q.

PEM WELD FASTENERS

MAKE SENSE because
they SAVE DOLLARS

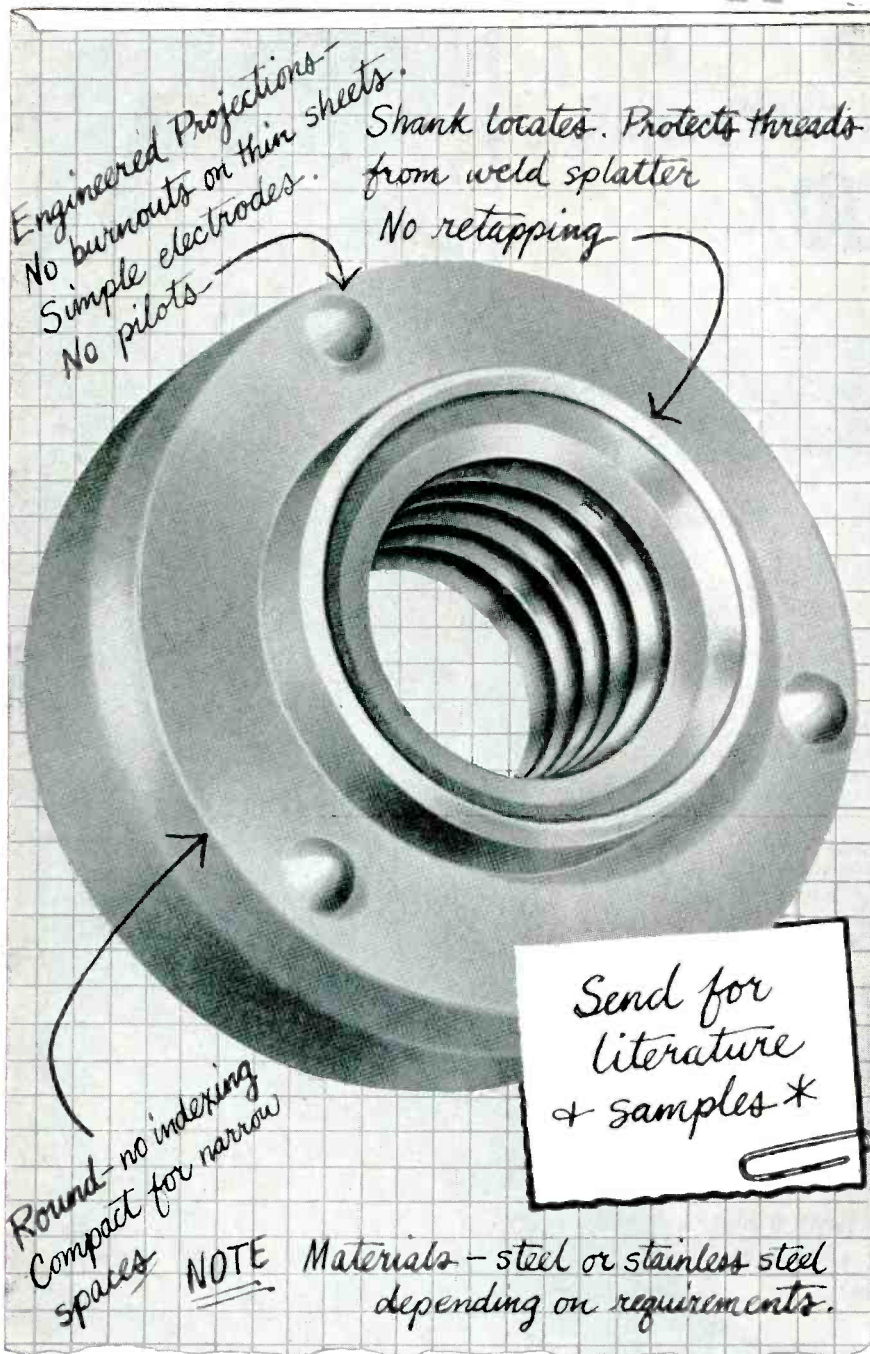
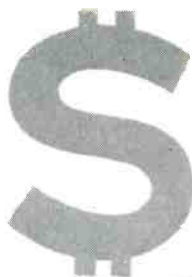

* Penn Engineering & Manufacturing Corp., Doylestown, Pa.

PEM



to stabilize, 5654's required 1.5 minutes, and 5654's (500 hour) required 1.8 minutes to stabilize.

Table III groups the 26 tubes by type and states the average percentage of change of g_m from the first minute to the tenth minute for each type.

An examination of the three groups shows the 6AK5's to have more g_m variation with time than the 5654's. Although the mean percentage of change of g_m from the first minute to the tenth minute for the 500-hour 5654's is not better than for the 48-hour 5654's, it appears that some 500-hour tubes that have extremely small changes of g_m after the first 3 minutes of warmup could be hand-selected.

An electronic system using numerous commercial tubes might suffer an extended unstable period if its tubes were aged to the protuberant condition while in operation. Premium tubes are aged beyond this condition.

Premium tubes, then, are to be preferred over commercial tubes.

This paper presents the results of one phase of research carried out at the Jet Propulsion Laboratory, California Institute of Technology, under Contract No. DA-04-495-Ord 18, sponsored by the Department of the Army, Ordnance Corps.

Design Equations for Broadbanding by Stagger Tuning

BY DOMENICK BARBIERE
Radiation Laboratory
Johns Hopkins University
Baltimore, Maryland

OBTAINING a broadband response by the staggering of single-tuned circuits requires that the poles of the individual circuits be arranged correctly in the complex Z-plane. Poles in the frequency plane may be obtained by the equation

$$f_n = f_o \left[\frac{Z_n}{2} + \left(1 + \frac{Z_n^2}{2} \right)^{\frac{1}{2}} \right] \quad (1)$$

The absolute value of f_n yields the center frequency of the n^{th} stagger while its imaginary component gives its bandwidth. For a Butterworth stagger the poles are arranged on a semicircle in the Z-plane, and for a Tschebyscheff stagger they are arranged on a

*Years of experience
proves to users . . .*



the dependability of

KOVAR

Glass-sealing Alloy

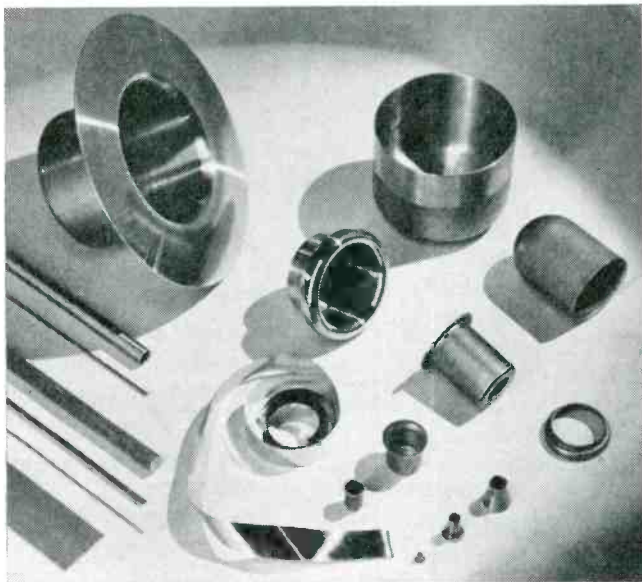

* Westinghouse Trade Mark No. 337,962

The ideal alloy for glass sealing, Kovar matches the expansivity of certain hard glasses over the entire working temperature range. It resists mercury attack, has ample mechanical strength and seals readily. A permanent and impervious bond is obtained by a closely controlled thickness of oxide on Kovar alloy interfused with hard glass.

Kovar is a cobalt, nickel, iron alloy, manufactured under very carefully controlled conditions, and supplied by Stupakoff in the form of: SHEET, ROD, WIRE, FOIL, TUBING, EYELETS, LEADS and FABRICATED SHAPES. The prominent users of KOVAR and the length of time they have employed this metal are convincing proof of satisfaction.

Full information on the use of Kovar is given in Stupakoff Bulletin 145, which we will send upon request.

Stupakoff CERAMIC & MFG. CO.

Latrobe, Pennsylvania

18 YEARS

18 YEARS

16 YEARS

12 YEARS

18 YEARS

13 YEARS

11 YEARS

15 YEARS

6 YEARS

18 YEARS

5 YEARS

18 YEARS

7 YEARS

13 YEARS

From Kitty Hawk Through the Sound Barrier

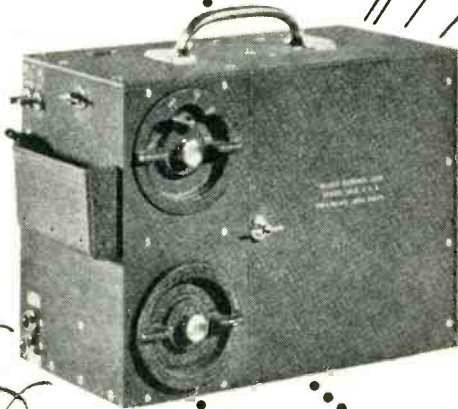

500B

RECORDING OSCILLOGRAPH

Since the Wright Brothers ushered in the age of flight, aviation has soared beyond the speed of sound and into the outer reaches of the earth's atmosphere. Heiland Recording Oscillographs are a vital factor in this dramatic conquest of the air. These highly sensitive, extremely accurate and dependable instruments enable testing engineers and scientists to solve the wide variety of aeronautical problems involving the measurement of physical phenomena such as strains, stresses, vibrations, pressures, temperatures, accelerations, impact, etc. This technical information, provided by Heiland Recording Oscillographs, makes possible the design and production of superior aircraft. Other industries the world over have proven these instruments to be invaluable in meeting similar demands in their applications.

FEATURES AND SPECIFICATIONS

Heiland Model 500B Portable Recording Oscillograph

- Compact and lightweight
- Provides maximum portability and versatility where desired to record up to 12 phenomena
- Direct monitoring while recording
- 4 record speeds instantly selectable

Galvanometers: Up to 12. Record width: 4". Magazine capacity: 100'. Record speeds: 3, 6, 12 and 24 inches per second selected by levers on control panel. Other speeds, ranging from 1/32" to 24" per second, can be obtained by changing drive sprockets and motor gear box ratios. Drive: Two-speed governor controlled motor. Power supply: 23.5 to 28.25 volts D.C. Timer: Chronometric timing unit projects 100 time lines per second across record width, the 1/10 second lines being heavier. 1/10 and 1 second time lines are available. Mounts: Detachable shock or vibration mounted base. Case dimensions: 6-3/4" x 9-13/16" x 12-3/4". Weight: 33 lbs.

Write today for free catalog of Heiland equipment including 500B and A-401 Portable Recording Oscillographs, "700" series Multi-Channel Recording Oscillographs, "82-6" Bridge Balance and Strain Indicator, Amplifier System, Galvanometers and accessories.

Heiland Research Corporation 130 East Fifth Ave.,
Denver, Colorado

semiellipse.

The procedure for finding the Z_n 's is not difficult and is discussed elsewhere^{1, 2}. Equation 1, however, is laborious to solve by brute force since it relates complex quantities. This is especially true when several stagger schemes must be computed to compare their relative merits.

In "Broadbanding by Stagger Tuning" (ELECTRONICS, p 118, Feb. 52) a nomograph for Eq. 1 is presented for the designer's use. The nomograph is difficult to read, however, for small values of $|Z_n|$ and also when the individual bandwidths of the stagger are small. The latter case usually arises in the Tschebyscheff stagger and also when the number of stages in the stagger is large. For example, a seven-pole Tschebyscheff stagger with a fractional bandwidth of unity and a gain tolerance of 1 db can not be read with sufficient accuracy from the nomograph.

In the method for obtaining f_n from Z_n given below the final Eq. 12 and Eq. 12' are exact, but an approximation is made in their solution. For $|Z_n| \leq 1$ the error in the worst case is no more than 3 percent. The specification that $|Z_n| \leq 1$ is a range large enough to cover most cases. For $|Z_n| \leq 1.5$, by the way, the error is no more than 8 percent in the worst case. Let

$$f_o = \text{center frequency of the overall response} \quad (2)$$

$$f_n/f_o = R_n < \psi_n, \text{ where} \quad (3)$$

$$R_n f_o = \text{center frequency of the } n^{\text{th}} \text{ stage, and} \quad (4)$$

$$2 f_o R_n \sin \psi = \text{bandwidth of the } n^{\text{th}} \text{ stage} \quad (5)$$

$$Z_n = \rho_n < \theta_n = \text{pole position of the } n^{\text{th}} \text{ stage in the } Z\text{-plane} \quad (6)$$

Instead of starting from Eq. 1, solve the inverse form

$$Z_n = \frac{f_n}{f_o} - \frac{f_o}{f_n} \quad (7)$$

From the substitutions into Eq. 7

$$Z_n = \rho_n < \theta_n = \rho_n \cos \theta + j \rho_n \sin \theta, \quad \theta_n = \text{Re}(Z_n) + j \text{Im}(Z_n) \quad (8)$$

and

$$\frac{f_n}{f_o} = R_n < \psi_n \quad (9)$$

obtain

$$Z_n = R_n e^{i\psi_n} - \frac{1}{R_n} e^{-i\psi_n} \quad (10)$$

or



YOUR FUTURE IS HERE

with new cost-saving **printed circuits**

Everyone in electronics today knows that printed circuits are the real answer to production speed-ups . . . lower costs . . . greater profits. Printed circuits can help you in numerous ways—regardless of the product you manufacture.

Davelle invites you to write today and learn how this latest scientific development can reduce costs and solve your production problems. Send us a

sketch or print of your product and our engineering staff will design a printed circuit layout for your application. In addition, if you desire price quotations, let us know the quantities involved.

You will find Davelle's printed circuits are priced lower while maintaining highest precision standards of workmanship.



SPRINGFIELD GARDENS 13, L. I., N. Y.



CNTI

Congratulations!

Hudson

RADIO & TELEVISION CORP.

Authorized Distributors of
Electronic Equipment and Components,
on the Opening of Their New Salesrooms in



NEWARK, N. J.
at 35 WILLIAM STREET

Everybody in Electronics welcomes the great new HUDSON Salesrooms just opened in the heart of the mighty New Jersey market—to provide the same Huge Stocks, Low Prices, and Superlative Service that have made our two New York Stores the Leading Electronic Supply Centers of the East!

Radio and TV Dealers and Servicemen, Industrial Users of Electronic Equipment and Components, Radio Amateurs, High-Fidelity Enthusiasts... all have come to learn that "HUDSON has EVERYTHING IN ELECTRONICS—at the LOWEST Published Price of Them All!" Visit our Newark Store, you Jersey Area Patrons—see our Huge Stocks and Facilities, meet our Friendly, Helpful People—you'll enjoy the experience!



These Nationally Famous Manufacturers of Standard Brand Top Quality Electronic Products and High Fidelity Components, whose Complete Lines are found in ALL THREE Great HUDSON Salesrooms, join in congratulating us on the Opening of the Newark Store:

- | | | | |
|------------------------------|-------------------------------|------------------------------|-------------------------------|
| Acro Products | Crest Transformer Corp. | I.D.E.A. Inc. (Regency Div.) | Presto Recording Corp. |
| Advance Elec. & Relay Co. | Croname Inc. | Insuline Corp of America | Pyramid Electric Co. |
| Aerovox Corp. | Dial Light Co. of Amer. | International Resistance Co. | Quam-Nichols Co. |
| Alliance Mfg. Co. | Dow-Key, Inc. | Jackson Industries, Inc. | Racon Electric Co., Inc. |
| Alpha Wire Corp. | R. L. Drake & Co. | Jersey Tech Labs | Radiart Co. |
| Altec-Lansing Corp. | Drake Electric Works | Jennings Radio Mfg. Co. | Radio Apparatus Corp. |
| American Elec. Heater Co. | Allen B. Dumont Labs, Inc. | Jensen Industries, Inc. | Radio City Products Co., Inc. |
| Amer. Telev. & Rad. Co. | Duotone Co., Inc. | Jensen Mfg. Co. | Radio Corp. of America |
| Amperex Electronic Corp. | Dynavox Corp. | JFD Mfg. Co., Inc. | Radio Craftsmen, Inc. |
| Amperite Co., Inc. | Hugh H Eby Inc. | E. F. Johnson Co. | Radio Mfg. Engineers, Inc. |
| Arco Electronics | Eitel-McCullough Inc. | Kester Solder Co. | Radio Receptor Co., Inc. |
| Arrow-Hart Hegeman Elec. Co. | Electronic Sold. Iron Inc. | Mathias Klein & Sons | Raytheon Mfg. Co. |
| Astatic Corp. | Electronic Indicator Corp. | Kraeuter & Co. | Reeves Soundcraft Corp. |
| Audak Co. | Electronic Instrument Corp. | La Pointe Electronics, Inc. | Rek-O-Kut Co., Inc. |
| Audio Devices, Inc. | El Menco | Littelfuse, Inc. | Howard W. Sams & Co. |
| Barker & Williamson, Inc. | Electro-Voice, Inc. | Livingston Electronic Corp. | Sangamo Electric Co. |
| Belden Mfg. Co. | Erie Resistor Corp. | Lysco Mfg. Co., Inc. | Sarkes-Tarjian Inc. |
| Bell Sound Systems, Inc. | Egipto Co. | P. R. Mallory & Co., Inc. | Walter L. Schott Co. |
| Berlant Associates | Espey Mfg. Co. | Mark Simpson Mfg. Co. | Shallcross Mfg. Co. |
| Birnbach Radio Co., Inc. | Eveready Batteries | Meissner Mfg. | Shure Bros., Inc. |
| Bliley Electric Co. | Fahnestock Electric Co. | Merit Transformer Corp. | Simpson Electric Co. |
| David Bogen Co., Inc. | Fairchild Recording | Morrow Radio Mfg. Co. | Herman H. Smith, Inc. |
| Brach Mfg. Corp. | Federal Telephone & Rad. | Mosley Electronics | Snap-On Drawer Co. |
| British Industries Corp. | Fisher Radio Corp. | Mueller Electric Co. | Sonar Radio Corp. |
| Brook Electronics, Inc. | Freder Transformer Co., Inc. | Multi Products, Inc. | Sprague Products Co. |
| Browning Labs. Inc. | G. & H. Wood Products | National Co. | Stanwyk Winding Co. |
| Brush Development Co. | Gem Elec. Mfg. Co., Inc. | National Union Radio Corp. | Stephens Mfg. Corp. |
| Burgess Battery Co. | General Cement Mfg. Co., Inc. | Ohmite Mfg. Co. | Stromberg-Carlson Co. |
| Cambridge Co. | General Electric Co. | Oxford Electric Corp. | Switchcraft, Inc. |
| Camburn, Inc. | Genl. Hardware Mfg. Co., Inc. | Par Metal Products Corp. | Sylvania Electric Products |
| Cannon Electric Co. | General Industries Co. | Park Metalware Co., Inc. | Taylor Tubes Inc. |
| Carter Motor Co. | Gonset Co. | Peerless Products Indust. | Tech-Master Products Co. |
| Centralab | Gordon Specialties Co. | Pentron Corp. | Triad Transformer Mfg. Co. |
| Cetron | Gray Research & Develop. | Perma-Power Co. | Triplett Elec. Instruments |
| Chicago Stand. Transformer | Greenlee Tool Co. | Permoflux Corp. | Turner Co. |
| Cinch-Jones Sales | Guardian Electric Mfg. Co. | Philmore Mfg. Co., Inc. | Ungar Electric Tools, Inc. |
| Clarkstan Corp. | Hallcrafters Co. | Pickering & Co., Inc. | Union Carbide & Carbon |
| Clarostat Mfg. Co., Inc. | Hammarlund Mfg. Co. | Pilot Radio Corp. | United Transformer Corp. |
| Consolidated Wire | Harvey-Wellis Electronics | Potter-Brumfield Co., Inc. | University Loudspeakers, Inc. |
| Continental Carbon, Inc. | Hickok Electrical Inst. Co. | Precision Apparatus Co. | Victor Electronic Co. |
| Cornell-Dubilier | Harvey Hubbell Co. | Precision Electronics, Inc. | Vibroplex |
| Cornish Wire Co., Inc. | Hyttron Radio & Electronics | Premax Products | Walter L. Schott Co. |
| | | Premier Metal Products | Webster-Chicago Corp. |
| | | | Westinghouse Elec. Corp. |
| | | | Weston Elec. Instrument Co. |

One Call for All...



Adjoining Radio City
48 West 48th St., N. Y. 36
Phone: Circle 6-4060

Downtown New York
212 Fulton St., N. Y. 7

NEWARK, N. J.
35 William Street
Phone: MArket 4-5151

write for complete,
new 1954 Giant
Hudson Catalog!
Dept. M-10

$$Z_n = \left(R_n - \frac{1}{R_n} \right) \cos \psi_n + j \left(R_n + \frac{1}{R_n} \right) \sin \psi_n \quad (11)$$

Equating imaginaries and reals yields

$$\text{Re}(Z_n) = \left(R_n - \frac{1}{R_n} \right) \cos \psi_n \quad (12)$$

$$\text{Im}(Z_n) = \left(R_n + \frac{1}{R_n} \right) \sin \psi_n \quad (12')$$

The quantities on the left-hand sides of the above equations are numbers that have already been obtained. The equations must be solved for R_n and $\sin \psi_n$ so that the center frequency and bandwidth of the n^{th} stage may be obtained.

The approximation is now made that $\cos \psi_n = 1$. Even when $\psi_n = 30$ deg, corresponding to a fractional bandwidth for the n^{th} stage equal to unity, $\cos \psi = 0.87$. Equation 12 is a quadratic, however,

$$\left(R_n - \frac{1}{R_n} - \frac{(Z_n)_{\text{real}}}{\cos \psi_n} = 0 \right)$$

of which $\cos \psi_n$ affects only one term, so that the error introduced in R_n by the approximation is much less than the error in $\cos \psi_n$ itself. With the approximation, it follows that

$$\text{Re}(Z_n) = R_n - \frac{1}{R_n} \quad (13)$$

$$\text{Im}(Z_n) = \left(R_n + \frac{1}{R_n} \right) \sin \psi \quad (13')$$

Equation 13 is a simple quadratic from which R_n may be readily obtained with the positive root only being retained. With R_n known, Eq. 13' may be solved for $\sin \psi_n$. The center frequency of the n^{th} stage is $f_0 R_n$, and its bandwidth is $2f_0 R_n \sin \psi$.

The above method was found useful in the design of a Tschebyscheff staggered octuple. Calculations were first made for a septuple with various gain tolerances, and it was found that the requisite gain could not be obtained. Calculations were then made for an octuple with various gain tolerances, and the smallest gain tolerance yielding sufficient gain was chosen. The computations would have been laborious indeed if Eq. 1 were solved for each case and each stage. Comparison of results obtained from Eq. 13 and 13' and those obtained from the original

New Ultra-Stable Microwave Oscillator



MODEL 803

Also Available: LFE Model 802 for ultra-stable microwave frequencies in the X-Band

The LFE Model 803 Stable Microwave Oscillator provides a source of highly stabilized microwave frequencies suitable for use as a local oscillator for microwave measurements, or in many other applications where a high degree of stability is required, such as Q measurements, SWR measurements and general narrow band design work. A dial accurately calibrated directly in frequency is an important feature. The main elements of the unit are a kylstron oscillator, a stabilizing monitor loop which consists of a calibrated dual-mode reference cavity, a feedback amplifier and a self-contained power supply. Means are provided for modulating the oscillator.

Specifications

- **Frequency Coverage**
2700 - 2950 Mc. — S-Band
- **Dial Calibration**
Calibrated directly in frequency — 1 Mc. per division.
- **Frequency Stability**
Short Term Deviation — less than one part in 10^8 .
Long Term Drift — less than 100 Kc/sec from original setting.
- **Modulation**
Can be modulated 25% when stabilized; 100% modulation possible when stabilization is removed.
- **Attenuation**
Attenuator provides 100 db. range of control.
- **Power Output**
15 milliwatts.
Output Connector — Type N.
- **Power Consumption**
150 watts.
- **Size**
10½" x 19" front panel, 14¼" deep, cabinet with rack mounting panel.
- **Weight**
100 lbs.

For complete information, see your LFE engineering representative or write—



LABORATORY for ELECTRONICS, INC.

75-3 PITTS STREET • BOSTON 14, MASS.

PRECISION ELECTRONIC EQUIPMENT • OSCILLOSCOPES • MAGNETOMETERS • COMPUTERS • SOLID DELAY LINES

Better See
H&D!



Coro Gated

Packing labor costs slashed 68%
Materials cost reduced 42%
Freight costs lowered 15%
Product cost cut 13%

H & D package engineering resulted in the above savings for Victor Insulators, Inc., manufacturers of high and low voltage electrical insulators. Write for booklet, "How to Pack It." Hinde & Dauch, Sandusky 10, Ohio.

our 65th year

H&D

HINDE & DAUCH

Authority on Packaging

17 FACTORIES AND MILLS • 40 SALES OFFICES

exact equation show an error of 3 percent for values of ρ less than or equal to 1. For ρ equal to 1.5 the maximum error was 8 percent.

REFERENCES

- (1) R. C. Wittenberg, Broadbanding by Stagger Tuning, *ELECTRONICS*, 25, p 118, Feb. 1952.
- (2) W. H. Huggins, The Natural Behavior of Broadband Circuits, Electronics Research Lab., ERL Report E5013A.

Transmission Characteristics of Nonsymmetrical Networks

BY HANS KLEIN
Siegfried Junghans
Schorndorf, Wuertemberg
Germany

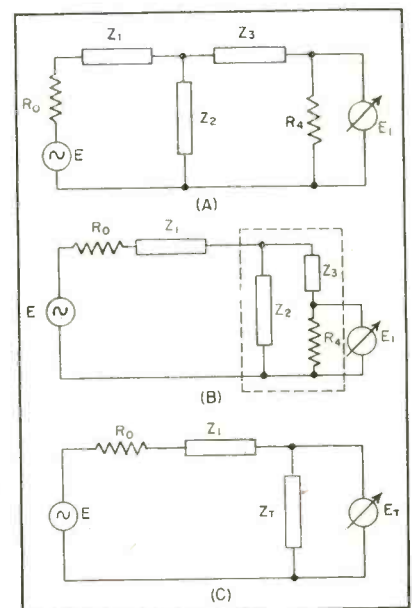

FIG. 1—Simplification of circuit for calculation of insertion loss

THOUGH FOUR-TERMINAL networks will usually be inserted between equal resistance terminations there are cases where this condition cannot be fulfilled. The E. J. Purington¹ paper provides an excellent means for an easy and rapid calculation of the transmission characteristic of four-terminal-networks that possess electrical and structural symmetry. It seems, therefore, reasonable to extend his method to the nonsymmetrical case.

This is done only for the T-configuration, inserted between non-equal resistance terminations, though the method is applicable to other forms of four-terminal networks. Three steps are necessary:

Mammoth CR Tube SEALING MACHINE Solves Challenging Production Problem

Kahle's new cathode ray tube Sealing Machine (Model 2307) is probably the largest built to date in the industry, taking tube sizes up to 27", diameter or diagonal or all 16 heads filled

Production rates of 140 (27") tubes per hour are easily obtained! New* design permits constant head speeds—even when indexing! Foot pedal allows instant control by operator. Steam pre-heater (electrical) is driven by the machine in synchronism. Takes larger tubes using alternate heads. Independent dual motor drive—one for the head; one for the indexing.

Model 2307 is another example of the 40 years of engineering ingenuity which keep Kahle far in advance as a leading

manufacturer of custom machinery for electronics and the glass industry.

If you have any production problems that can be solved with general purpose or special purpose machines, write Kahle now.

*And now for the first time, the Kahle NOVAR drive which means constant head speed. Constant while the turret indexes; constant while the turret dwells. As the turret slowly starts, accelerates, and slowly stops, there is absolutely no variation in the RPM of the heads. Friction clutch eliminates sudden starting of the head. For the first time in the history of the industry, a new and significant advance in machine engineering that ensures absolute uniformity and the nearest approach to perfection of sealing or other operations. Now available (optional) on all Kahle machines.

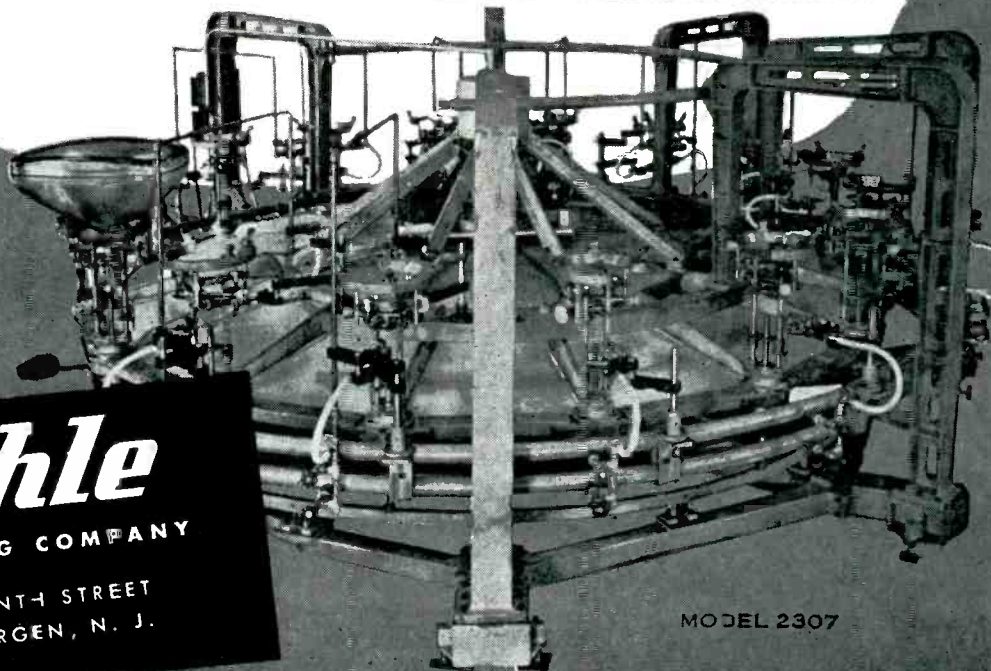

Kahle

ENGINEERING COMPANY

1310 SEVENTH STREET
NORTH BERGEN, N. J.

MODEL 2307

TAKE TIME
TO STUDY THE
DESIGN . . .

TAKE
HAYDON*

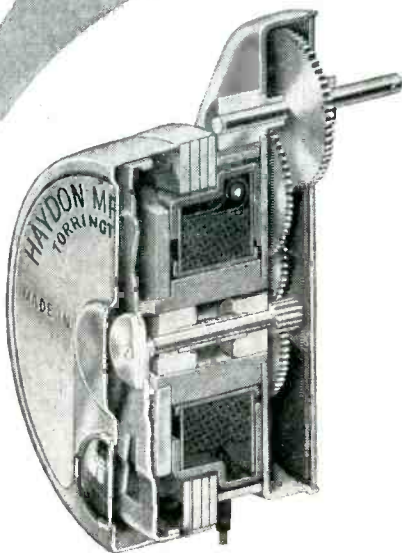

SYNCHRONOUS TIMING MOTOR

The basic HAYDON motor is unique in its field in the number of advantages it offers. Its performance is dependable, it is small in size, is totally enclosed, operates in any position, has controlled lubrication and its assembly is simple. The basic HAYDON motor offers a wide range of standard speeds from 1 second to 1 hour per revolution and other speeds down to 1 revolution in 4 hours in the 1600 Series, from 6 hours to 1 week in the 4400 Series.

Write for Catalog No. 322, Electric Timing Motors

Other literature available on request on Timing Devices, Clock Movements, 400 cycle Elapsed Time Indicators, 400 cycle Time Delay Relay, 400 cycle Motors, D.C. Motors.

*TRADEMARK Reg. U. S. Pat. Off.



HAYDON
AT TORRINGTON
HEADQUARTERS FOR
TIMING

HAYDON Mfg. Co., Inc.

Subsidiary of GENERAL TIME CORP.

2434 ELM STREET
TORRINGTON, CONNECTICUT

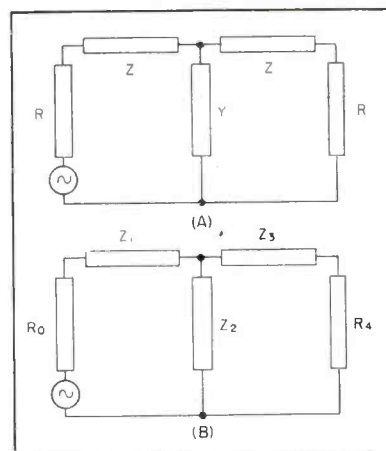

FIG. 2—Determination of T-network with desired characteristics

- (1) Calculation of the insertion loss of the T-network.
- (2) Determination of a T-network that will, for given terminals, produce the desired transmission characteristic.
- (3) Determination of the transmission characteristic of a given T-network provided that it satisfies a certain condition given below.

In the network of Fig. 1, insertion loss = $\frac{1}{2} \cdot \frac{E}{E_1}$ (1)

Rearranging Fig. 1A in the manner of Fig. 1B it is simple to obtain the insertion loss by considering voltage ratios in the different parts of the circuit. For this purpose the value of the impedance Z_T in Fig. 1C is needed. This can be obtained by simple comparison with Fig. 1B. From this follows

$$\frac{1}{Z_T} = \frac{1}{Z_2} + \frac{1}{Z_3 + R_4} = \frac{Z_1 + Z_2 + R_4}{Z_2(Z_3 + R_4)}$$

or

$$Z_T = \frac{Z_2(Z_3 + R_4)}{Z_1 + Z_2 + R_4} \quad (2)$$

From Fig. 1B and 1C

$$\frac{E_T}{E_1} = \frac{Z_3 + R_4}{R_4}$$

$$\frac{E}{E_T} = \frac{(R_0 + Z_1) + Z_T}{Z_T}$$

Therefore insertion loss =

$$\frac{E}{2E_1} = \frac{1}{2} \cdot \frac{Z_3 + R_4}{R_4} \cdot \frac{R_0 + Z_1 + Z_T}{Z_T}$$

Introducing the above value for Z_T insertion loss =



5881



6AX4
GT



TUNG-SOL
MADE IN U. S. A.

**TUNG-SOL DESIGNED
AND DEVELOPED**

**ACCEPTED
BY THE ELECTRONICS INDUSTRY**

You may have detailed information on these and other types upon request.
TUNG-SOL makes All-Glass Sealed Beam Lamps, Miniature Lamps, Signal Flashers,
Picture Tubes, Radio, TV and Special Purpose Electron Tubes and Semiconductor Products.
Sales Offices: Atlanta, Chicago, Columbus, Culver City (Los Angeles), Dallas, Denver, Detroit, Newark, Seattle



6U8

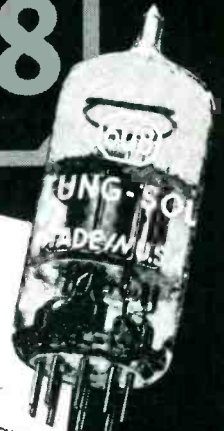

TUNG-SOL
MADE IN U. S. A.



6AU4
GT

TUNG-SOL
MADE IN U. S. A.



5687



5687
TUNG-SOL
MADE IN U. S. A.

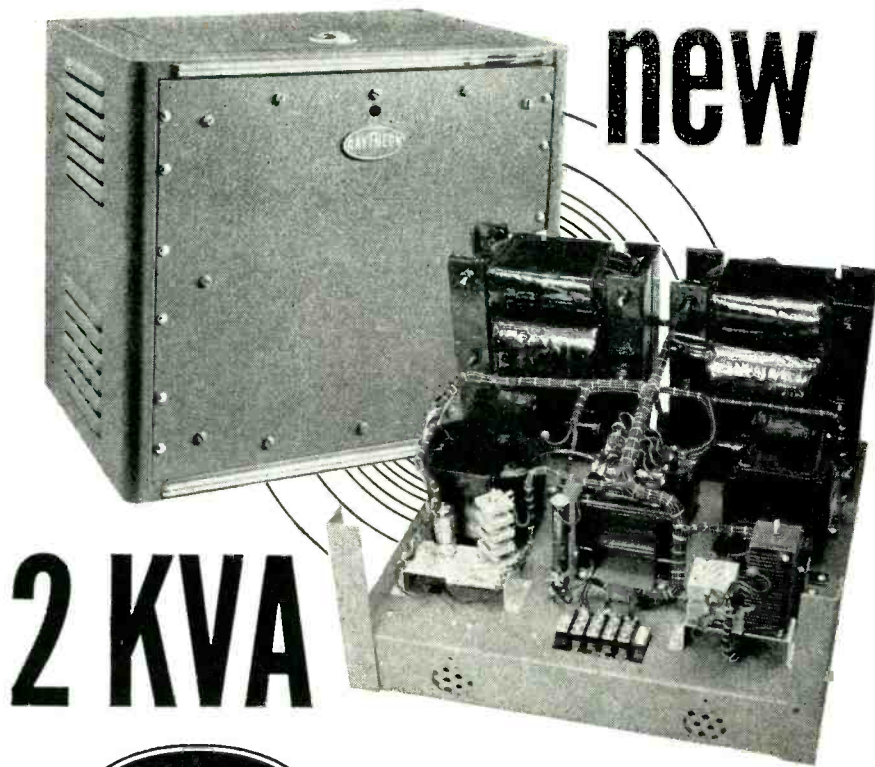

RAYTHEON MAGNETIC AMPLIFIER VOLTAGE STABILIZER

The new 2 KVA VOLTAGE STABILIZER with magnetic-amplifier control is the latest product of Raytheon's skill and experience in providing the electrical characteristics you want in the most convenient, compact and economical form.

Among the many advantages offered by this unit are lower harmonic content without special filters, less cubic space required and ability to take heavy overload without damage. Write for full information.

SPECIFICATIONS

- Input: 115 volts, $\pm 10\%$, 58-62 cycles, single phase.
- Output: 115 volts, 2000 va.
- Fixed load stabilized to $\pm 1/2\%$ for line change.
- Fixed load stabilized to $\pm 1\%$ for frequency change.
- No load to full load (85% power factor); 1% maximum.
- Temperature rise of components; 50°C maximum.
- Harmonics (at 60 cycles input); less than 5% total.
- Efficiency at full load (100% power factor); 90% minimum.
- Mounting: Bench, floor, wall or relay rack.

Raytheon Voltage Stabilizers rated from 15 to 2000 watts are carried in stock by 125 parts distributors from coast to coast. Custom-engineered units are also available.

RAYTHEON

MANUFACTURING COMPANY
EQUIPMENT SALES DIVISION

DEPT. 6270-A WALTHAM 54, MASSACHUSETTS

DISTRICT OFFICES: BOSTON, NEW YORK, CLEVELAND, CHICAGO, NEW ORLEANS, LOS ANGELES (WILMINGTON), SAN FRANCISCO, SEATTLE
INTERNATIONAL DIVISION: 19 RECTOR ST., NEW YORK CITY

RAYTHEON PRODUCTS INCLUDE: WELDPower* welders; Voltage stabilizers (regulators); Transformers; Sonic oscillators for laboratory research; Standard control knobs; Electronic calculators and computers; Radio, television, subminiature and special purpose tubes and other electronic equipment.
*Reg. U. S. Pat. Off.

BUILD



Excellence in Electronics

DEPENDABILITY
INTO YOUR
PRODUCTS

$$\frac{E}{2E_1} = \frac{1}{2} \cdot \frac{Z_3 + R_4}{R_4}$$

$$\left[1 + \frac{(R_0 + Z_1)(Z_2 + Z_3 + R_4)}{Z_2(Z_3 + R_4)} \right] \quad (3)$$

To solve the second problem, the determination of a T-network with a desired transmission-characteristic, the nonsymmetrical problem is reduced to the symmetrical with

$$R = \frac{1}{2} (R_0 + R_4) \quad (4)$$

Suppose

$$Z_1 = Z_3 = Z \quad Z_2 = Y \quad (5)$$

to be the desired solution, as indicated in Fig. 2A, which can be found by the method proposed by Purington, or by any other.

Conversion of this solution by the formulas given below, results in the T-network of Fig. 2B.

$$\begin{aligned} R_0 &= \lambda R & R_4 &= (2 - \lambda) R \\ Z_1 &= \lambda Z & Z_3 &= (2 - \lambda) Z \\ Z_2 &= \lambda (2 - \lambda) Y \end{aligned} \quad (6)$$

wherein

$$\lambda = \frac{2R_0}{R_4 + R_0}, \quad 2 - \lambda = \frac{2R_4}{R_4 + R_0} \quad (7)$$

To prove that the T-network of Fig. 2B has the desired transmission characteristic, the two insertion losses corresponding to the elements given by Eq. 5, 6 and 7 can be calculated. From Eq. 3 in the symmetrical case

$$\begin{aligned} \frac{E}{2E_1} &= \frac{1}{2} \cdot \frac{Z + R}{R} \\ &\times \left[1 + \frac{(R + Z)(Y + R + Z)}{Y(Z + R)} \right] \\ &= \frac{1}{2} \cdot \frac{Z + R}{R} \left[2 + \frac{R + Z}{Y} \right] \end{aligned}$$

The nonsymmetrical case gives

$$\begin{aligned} \frac{E}{2E_1} &= \frac{1}{2} \cdot \frac{(2 - \lambda)}{(2 - \lambda)} \cdot \frac{Z + R}{R} \times \\ &\left[1 + \frac{\lambda(R + Z)(2 - \lambda)[\lambda Y + R + Z]}{(2 - \lambda)\lambda(2 - \lambda)(Z + R)Y} \right] \\ &= \frac{1}{2} \cdot \frac{Z + R}{R} \left[1 + \frac{\lambda}{2 - \lambda} + \right. \\ &\quad \left. \frac{1}{2 - \lambda} \cdot \frac{R + Z}{Y} \right] \\ &= (2 - \lambda) \cdot \frac{1}{2} \cdot \frac{Z + R}{R} \\ &\times \left[2 + \frac{R + Z}{Y} \right] \end{aligned}$$

By comparison of the above equations, the insertion loss of the nonsymmetrical T-network is equal to $(2 - \lambda)$ times the loss of the sym-

QUALITY TOROIDAL COILS BY SICKLES

- High volume winding of toroidal coils to close inductance, balance and "G" tolerances.
- Design and assembly of precision wave filters or communication networks.
- Quality manufacture of pulse transformers.
- Magnetic memory units.
- Design and production of magnetic amplifiers.

The manufacture of coils must be founded upon a precise engineering base and precise engineering controls for quality mass production.

For 30 years Sickles has specialized in the design and manufacture of coils and coil assemblies. Now Sickles' vast experience and special skills are being applied to the techniques of components which require toroidally wound constructions.

To your problems Sickles brings unexcelled engineering and production techniques, extensive fabrication facilities, unusually complete instrumentation and test equipment, unique and high technical abilities.

More than a quarter of a million toroidal wound transformers by Sickles are already in service.

Write today to:
F. W. Sickles, Dept. 70
P. O. Box 330, Chicopee, Mass.



F. W. SICKLES

DIVISION OF GENERAL INSTRUMENT CORPORATION

CHICOPEE, MASSACHUSETTS

WORLD'S LARGEST MANUFACTURER OF INDUCTANCE COILS

ELECTRO MECHANICAL

Engineers

**For research and development
of electro-mechanical radar and
computing equipment.**

*Significant advancements
in the fields of airborne radar and
fire control systems are requiring further applications
of electro-mechanical techniques in the
Hughes Radar Laboratory.*

The company

Hughes Research and Development Laboratories, located in Southern California, form one of the nation's leading electronics organizations. The Laboratories are presently engaged in the development of advanced electronic systems and devices which are produced by the Hughes manufacturing divisions.

Areas of work

The work calls for devising reliable, maintainable, manufacturable designs for precision equipment developed in the Hughes Radar Laboratory. The equipment consists of mechanical, electronic and microwave devices and systems to be manufactured in quantity. The equipment designs require the use of such advanced techniques as subminiaturization, unitized "plug-in" construction, with emphasis on design for volume production. Knowledge of electronic components, materials, finishes and specifications is useful.

The future

Engineers experienced in the field of electro-mechanical design for production or those interested in entering this field will find outlets for their abilities and imagination in these activity areas. New electro-mechanical techniques are opening new applications for airborne electronic equipment. Hughes engineers will have the full benefit of working experience in these fundamental developments.

*Assurance is required
that the relocation of the applicant
will not cause the disruption of an urgent
military project.*

Address resume to **Scientific and Engineering Staff**

Hughes

Research and Development Laboratories

Culver City, Los Angeles County, California

metrical T-network.

Therefore, the two insertion ratios for the symmetrical and the nonsymmetrical T-network have the same value but for the mismatching factor $(2-\lambda)$. This factor cannot be avoided and will be equally present without inserting the T-network between the two terminal resistance.

The physical meaning of the conversion equations 6 and 7 is to maintain the same relative impedance-level throughout the nonsymmetrical network as in the symmetrical network. In both cases the amount of impedance is approximately the same because

$Z_1 + Z_3 = 2 Z_1 R_0 + R_4 = 2 R_1 Z_2 \approx Y$
as long as

$$\lambda(2-\lambda) = 4 \cdot \frac{R_0 R_4}{(R_0 + R_4)^2} \approx 1$$

The inverse problem, to calculate the transmission characteristic of a given nonsymmetrical T-network, can naturally only be solved if the two impedances Z_1 and Z_3 satisfy the condition

$$\frac{R_0}{R_4} = \frac{Z_1}{Z_3} = \frac{\lambda}{2-\lambda} = \text{real constant}$$

which implies that these impedances are of the same nature. In this case we can convert the nonsymmetrical T-network to symmetrical one by means of Eq. 6 and 7 and calculate the transmission characteristic by the method previously indicated.

REFERENCES

- (1) E. S. Purington, Symmetrical Electrical Systems, *ELECTRONICS*, 15, p 54, Nov. 1942.

Shape Factor as a Criterion of Skirt Selectivity

By JOHN J. DOUGHERTY, Lt. USN

*U. S. S. Bennington, CVA20
c/o FPO, New York, N. Y.*

SHAPE FACTOR is a term being used to specify the degree of skirt selectivity required of an i-f amplifier. It is defined usually as the width of the passband 60-db down from maximum response divided by the passband width 6-db down. Figure 1 shows the theoretically minimum shape factor obtainable from a given i-f transformer using equal

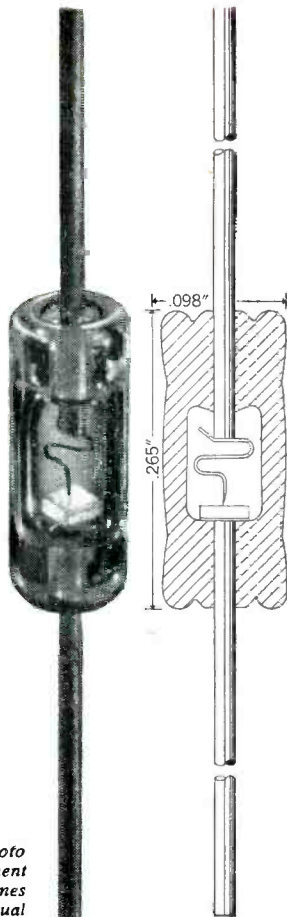

Photo enlargement six times actual size.

Hughes Diodes are **FUSION SEALED IN GLASS** for electrical stability

GLASS-TO-METAL fusion sealing for electrical stability is an exclusive feature of HUGHES GERMANIUM DIODES. The final seal in precision assembly operations is made at a temperature exceeding 700° C.

Proved in billions of vacuum tubes, the glass-to-metal seal has been incorporated to full advantage in diode manufacture for the first time by the Hughes-developed process of fusion sealing. The result is a unique germanium diode whose elements are encased in a rigid *one-piece* glass envelope, which assures permanent freedom from moisture penetration.

THE HUGHES GERMANIUM DIODE, developed by Hughes Research and Development Laboratories, employs no wax or solder, and has no mechanical joints or pressed-in parts to shift position.

To insure the satisfactory operation of HUGHES DIODES under adverse conditions of moisture, vibration, and severe shock, a 100 per cent testing procedure has been devised which *invites* instabilities to occur prior to shipment and assures rejection of every defective diode. *Each* HUGHES DIODE is humidity-cycled, temperature-cycled, and JAN shock-tested.

HUGHES GERMANIUM DIODES have proved consistently able to meet exacting requirements in airborne electronic equipment for navigation, fire control and guided missiles.

Volume orders for most types of HUGHES DIODES can be filled from stock. Diodes are also tested to special specifications, including high-temperature electrical requirements.

HUGHES GERMANIUM DIODE ELECTRICAL SPECIFICATIONS AT 25° C.

Description	RTMA Type	Test Peak Inverse Voltage* (volts)	Maximum Inverse Working Voltage (volts)	Minimum Forward Current @ +1 v (ma)	Maximum Inverse Current (ma)
High Peak	1N55B	190	150	5.0	0.500 @ -150 v
	1N68A	130	100	3.0	0.625 @ -100 v
High Back Resistance	1N67A	100	80	4.0	0.005 @ -5 v; 0.050 @ -50 v
	1N99	100	80	10.0	0.005 @ -5 v; 0.050 @ -50 v
	1N100	100	80	20.0	0.005 @ -5 v; 0.050 @ -50 v
High Back Resistance	1N89	100	80	3.5	0.008 @ -5 v; 0.100 @ -50 v
	1N97	100	80	10.0	0.008 @ -5 v; 0.100 @ -50 v
	1N98	100	80	20.0	0.008 @ -5 v; 0.100 @ -50 v
High Back Resistance	1N116	75	60	5.0	0.100 @ -50 v
	1N117	75	60	10.0	0.100 @ -50 v
	1N118	75	60	20.0	0.100 @ -50 v
General Purpose	1N90	75	60	5.0	0.800 @ -50 v
	1N95	75	60	10.0	0.800 @ -50 v
	1N96	75	60	20.0	0.800 @ -50 v
JAN Types	1N126**	75	60	5.0	0.050 @ -10 v; 0.850 @ -50 v
	1N127†	125	100	3.0	0.025 @ -10 v; 0.300 @ -50 v
	1N128‡	50	40	3.0	0.010 @ -10 v

*That voltage at which dynamic resistance is zero under specified conditions. Each Hughes Diode is subjected to a voltage rising linearly at 90 volts per second.

**Formerly 1N69A. †Formerly 1N70A. ‡Formerly 1N81A.

Semiconductor Sales Department

Hughes

AIRCRAFT COMPANY
CULVER CITY
CALIFORNIA

Address inquiries to Dept. E

"Color Television"



A special issue containing

• 15 N.T.S.C. Monographs—

The National Television Systems Committee has authorized IRE to publish its long awaited Monographs in the January 1954 special Color Television issue of "Proceedings of the I·R·E" — thus giving them industry-wide distribution for the first time in print.

• 25 additional Color TV articles—

will also appear in this issue, which brings the reader up-to-the-minute on the developments of Color Television. Copies of the first Color Television issue are still available and combined with this second Color Television issue will form a complete bibliography of major historical importance. Also included in the January issue will be a complete listing of the N.T.S.C. system specifications as submitted to the F.C.C.; and field test reports on the system's performance.

in "Proceedings of the I·R·E" January '54

Available to non-members for \$3.00. Extra copies to I R E members are \$1.25. All members get one copy free!

*Another
History
Making
Issue!*

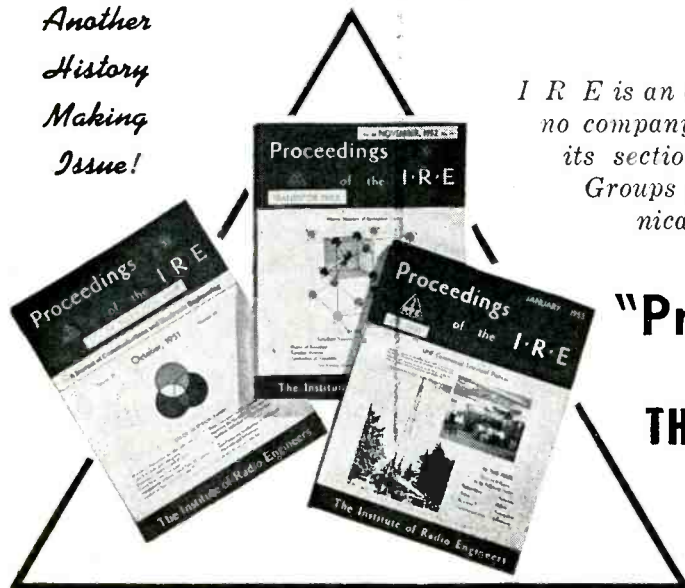

I R E is an organization of 33,312 member-engineers. There are no company memberships. Operating continuously since 1913, its sections meet in 78 cities. 21 specialized Professional Groups widen the scope of its member-services and 40 technical committees help the industry.

"Proceedings of the I·R·E"

Published by

THE INSTITUTE OF RADIO ENGINEERS

1 East 79th Street, New York 21, N. Y.

Please place orders before December 10th.

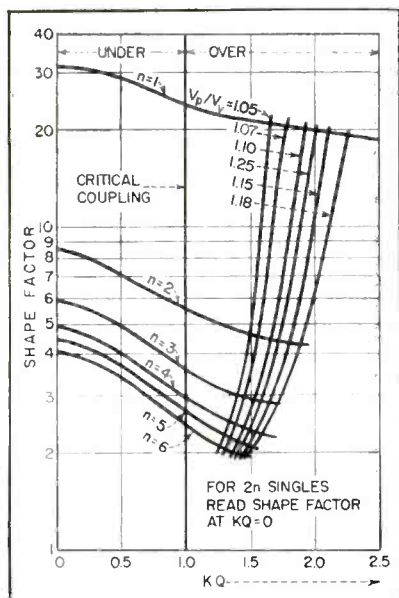

FIG. 1—Variation of shape factor, coupling, number of single or double tuned stages, and peak to valley ratio

Q , L , and C in the primary and secondary, and shows that shape factor improves as coupling is increased.

Shrinkage factor is the amount by which the 3-db passband width of a parallel resonant circuit is increased or decreased as an identical circuit is coupled to an increasing degree until critical coupling is reached, and then n such transformers are cascaded to form an i-f strip.

In a resonant circuit with a Q of 100, at 1 mc the expected passband would be simply the ratio of the two, or 10 kc. The resonant impedance would be Q times the inductive or capacitive reactance of either branch.

As the secondary is coupled, the response approaches that of two resonant circuits coupled by a very high impedance. If this impedance be a pentode, the response is that of a pair of cascaded synchronously-tuned singles. As coupling increases until critical is reached, the passband has increased by the square root of two. This is the shrinkage factor. The resonant impedance, due to the presence of the secondary, is decreased to half its decoupled value. If the tuned circuit is the plate load of a pentode, the gain is half its former value, but in i-f design, this decrease is compensated for by doubling the L/C ratio.

As n such transformers, sepa-

A link between sensors and recorders

Doelcam

VFDD

for

Flight Test Instrumentation

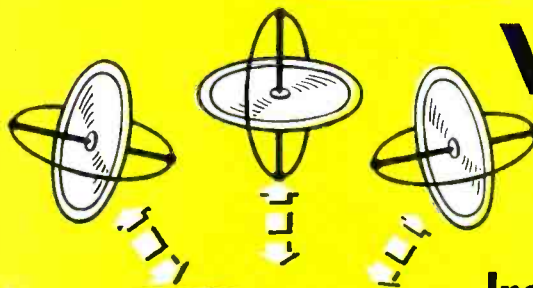

A precision
400 cps Power Supply
and 3-channel
Demodulator unit

- Voltage regulation
- Frequency stabilization
- Linear demodulation



Write for
Bulletin VF7

THE DOELCAM VFDD provides precise excitation to rate gyros, free gyros, position indicators or synchros for accurate measurement of flight parameters. In addition, the instrument includes 3 demodulator channels to transform 400

cps data to d-c signals for use with recording galvanometers.

Doelcam CORPORATION
SOLDIERS FIELD ROAD, BOSTON 35, MASS.
West Coast Office: 304 Tejon Pl., Palos Verdes, Calif.
Instruments for Measurement and Control
Gyroscopic Instrumentation • Servomechanisms
Synchros • Microsyns • Servo Motors



K GYROS for fire control computing, flight test instrumentation and control applications.



MICROSYN position indicators measure angular displacement for application in process control and data transmission.



SYNCHROS in 4 standard series transmit and receive electrical information with unsurpassed precision.

American Beauty

makes perfect soldered connections for

SYLVANIA

RADIO and
TELEVISION SETS

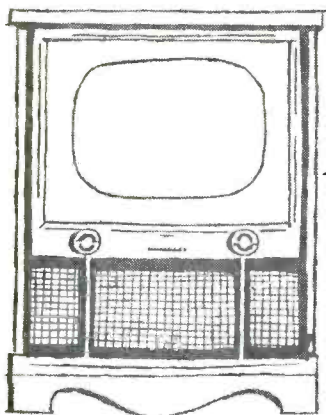

Pride of Brides for Three Generations, the famous American Beauty Electric Iron, made by the same specialists in electrical heating devices.



*Build better with Solder...
Solder better with
American Beauty*
Electric Soldering Irons—Since 1894

There are over 2,000 soldered connections in a good television receiver. Sylvania calls on American Beauty to help produce top quality products, maintain its reputation as a maker of expertly crafted receivers.

IN CHOOSING SOLDERING IRONS, look to the oldest, largest manufacturer in America. Look to **AMERICAN BEAUTY**, the Standard of Perfection on the world's production lines, and to these features that make **AMERICAN BEAUTY** the largest-selling of all soldering irons . . .

- Nickel-coated, corrosion-resistant tips, easily and quickly replaced
- Super-flexible cord, American Beauty-made, reduces worker fatigue
- Heating element of chrome-nickel ribbon resistance wire
- Insulated with pure mica
- Built-in connection for ground wire
- Six models . . . from 50 to 550 watts

A-108

AMERICAN ELECTRICAL HEATER COMPANY

DETROIT 2, MICHIGAN

rated by pentodes, are cascaded, the shrinkage factor decreases and becomes, for n such stages

$$S = \frac{\sqrt{2}}{1.1 n^{1/4}} \quad (1)$$

These factors can be combined into one simple equation giving the required tuning capacitance directly, providing that identical transformers and tuned circuits are used for primary and secondary. This equation is

$$C = \frac{S g_m n}{4 \pi B A} \quad (2)$$

where S is the shrinkage factor, B is the overall 3-db bandwidth desired and A is the overall gain, as a pure number, from the grid of the tube preceding the first transformer to the input of the tube following the last transformer. The output load must exceed by a factor of ten the load impedance of the transformer ($\frac{1}{2} Q X_L$).

The geometrical mean transconductance of tubes involved, g_m , is the n th root of the product of all transconductances involved. These may not all be the same. For example, if the first tube is a mixer, then its mutual conductance as a mixer must be used. And if the cathodes of the tubes to which age is applied are left unbypassed to minimize the Miller effect, then the g_m of those tubes must be decreased by that negative-feedback factor.

Having solved for the required tuning capacitance, the required inductance can be found from the resonance equation. All factors have now been found except the required Q of the coil being used. This is simply the ratio of the operating frequency multiplied by the shrinkage factor to the overall 3-db passband width.

$$Q_{coil} = \frac{S f}{B} \quad (3)$$

Should the inherent Q of the coils be much higher than this they may be loaded down by calculating a parallel resistance which will decrease the resonant impedance to the desired value, and connecting such a value across both primary and secondary.

If required to begin calculations with a required shape factor, then from Fig. 1 the required number

GATES

PLUG-IN AMPLIFIERS

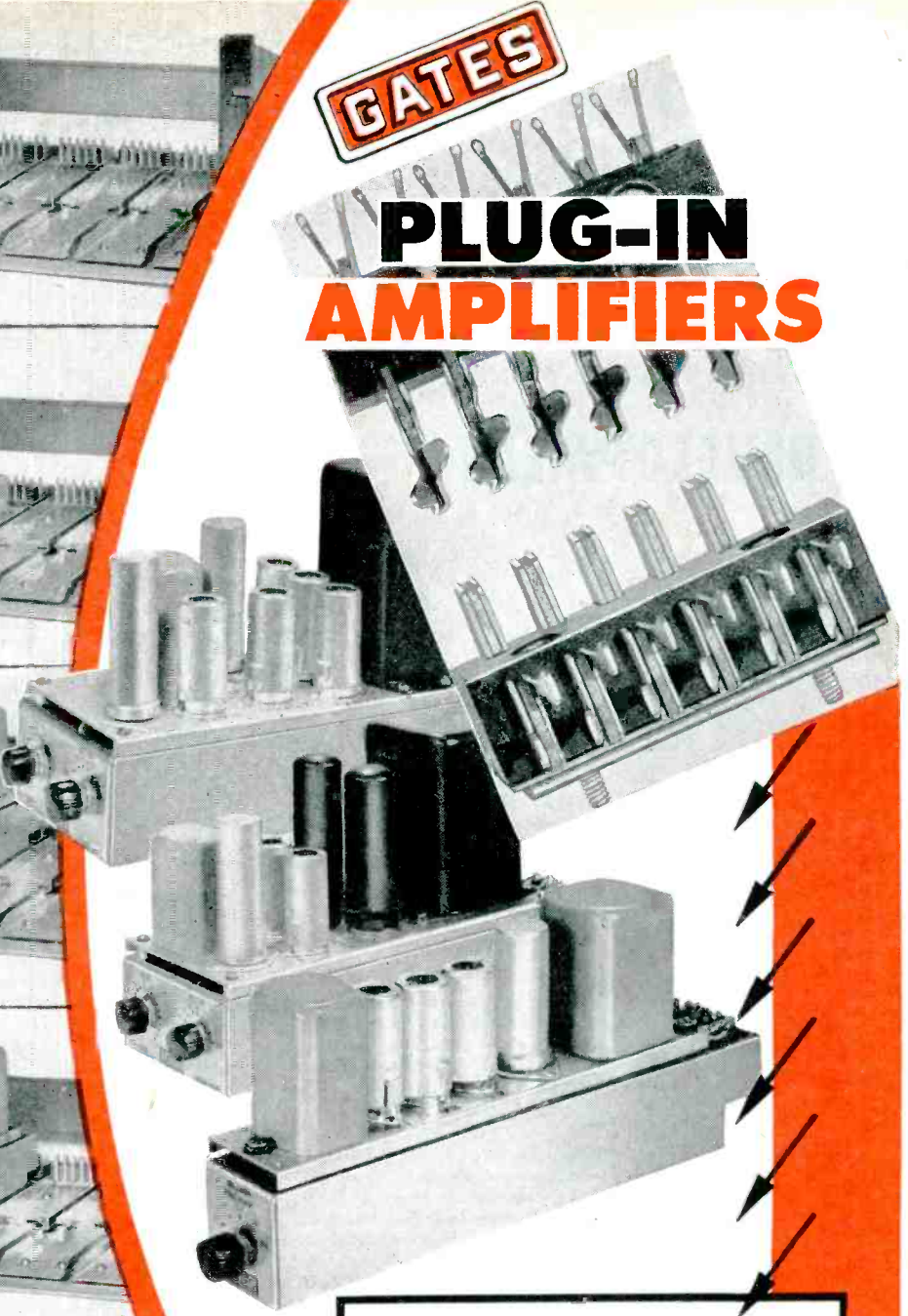
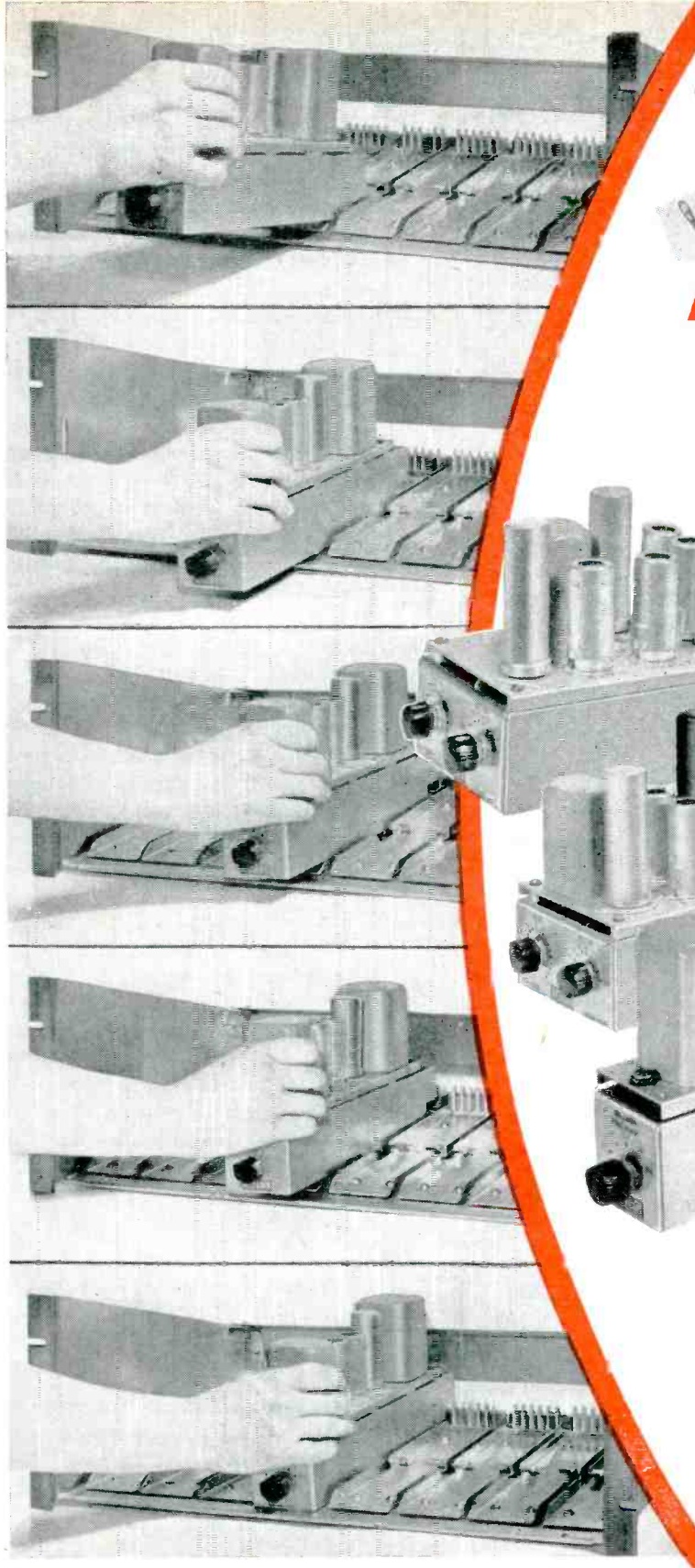

For the very finest in radio or TV audio systems, Gates offers a superb line of plug-in equipment. Large enough to provide quality, yet small enough to conserve space.

An eight-page brochure, yours for the asking, will reveal mechanical and performance specifications so drastically new and improved we know you'll be interested. Write or wire any Gates office listed below.

GATES RADIO COMPANY

QUINCY, ILLINOIS, U. S. A.

• 2730 Polk Avenue, Houston, Texas • Warner Bldg., Washington, D. C. • 51 East 42nd Street, New York City • 13th & Spring Streets, Atlanta, Ga. • 7501 Sunset Blvd., Los Angeles 46, Calif. • International Div., 13 E. 40th St., New York City • Canadian Marconi Co., Montreal, Quebec

CONSTANT

RESEARCH

and

DEVELOPMENT

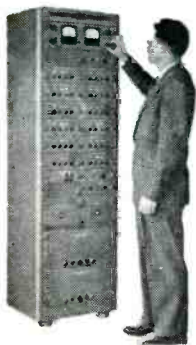

HAS ENABLED US TO PRODUCE ONE OF THE FINEST COMPUTERS AVAILABLE TODAY.

AMPLIFIER GROUP, TYPE 16-31C—provides 28 contact stabilized operational amplifiers for use as summers, differentiators, integrators, and inverters. Also in the cabinet are all necessary power supplies and a complete test panel.

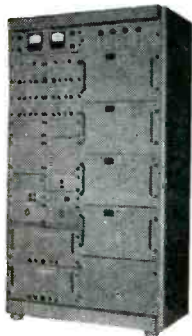

MULTIPLIER GROUP, TYPE 16-31L—is a servo-mechanical multiplier and incremental function generator. There are 20 channels, each of which is capable of multiplying four variables by a fifth.

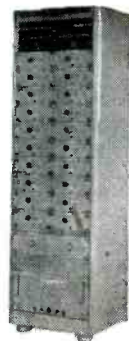

RESOLVER GROUP, TYPE 16-31D—furnishes 4 resolving channels and 12 operational amplifiers. Each resolving channel may also be used for multiplying three variables by a fourth. Furnished complete with test panel, reference supplies, and power supplies.



CONTROL CONSOLE, TYPE 16-24E—Houses the grounded metal problem board and its bay, attenuators, initial condition potentiometers, networks, limiters, and all operating controls.

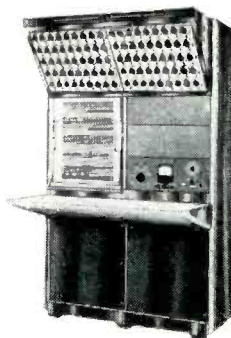

SERVO GROUP, TYPE 16-31P—For the operations of resolving and multiplying when used with external amplifiers. There are two resolving and four servo-multiplying channels. The equipment is furnished with test panel and power supplies.



INQUIRE SALES DEPARTMENT
LONG BRANCH, NEW JERSEY

of stages could be estimated and degree of coupling required. The curves show that a considerable improvement in shape factor is obtained by the use of critically coupled transformers over cascaded singles, and over under-coupled transformers. Since Eq. 1, 2 and 3 apply only to the critically coupled case, this simplified design would be a strong point in the favor of using critically coupled transformers. If, however, shape factor requirements are very stringent, a further improvement is possible by using overcoupled transformers, as well as an approach to the more desirable flat-top response. The solution here calls for a higher Q coil, and the solution for the circuit constants is simplified by readily-available nomographs covering overcoupled circuits.

Figure 1 can be used to estimate quite closely the degree of coupling of a given transformer. By merely taking its 6-db and 60-db bandwidths, dividing them, and entering the curves for $n = 1$, a value for QK is determined.

By using Fig. 1, and cooling techniques it was recently possible in a five-tube, five-transformer i-f strip to achieve a shape factor of 2.9, only seven percent higher than the theoretical minimum, with a stable gain of 140 db (ten million) at ten megacycles.

REFERENCES

- (1) Valley, Wallman, "Vacuum Tube Amplifiers" MIT Radiation Laboratory Series 18, p 201, McGraw-Hill Book Co., 1948.
- (2) Sturley, "Radio Receiver Design," p 300, Wiley and Sons, 1949.
- (3) Federal Telephone and Radio Corp., "Federal Band-Pass Nomographs 1-3."

Loss and Singing Margins in Radio and Carrier Channels

By HOWARD H. SMITH
*Federal Telephone and Radio Corp.
Clifton, N. J.*

BASICALLY, any radio or carrier circuit consists of two one-way transmission paths. At various places in the transmission path, the original voice-frequency currents may be changed into single or double-sideband carrier currents, pulse-modulation signals, or amplitude or frequency-modulated radio-frequency currents. The net

EXCLUSIVE WITH

N.U.

**UNION
DIODES**

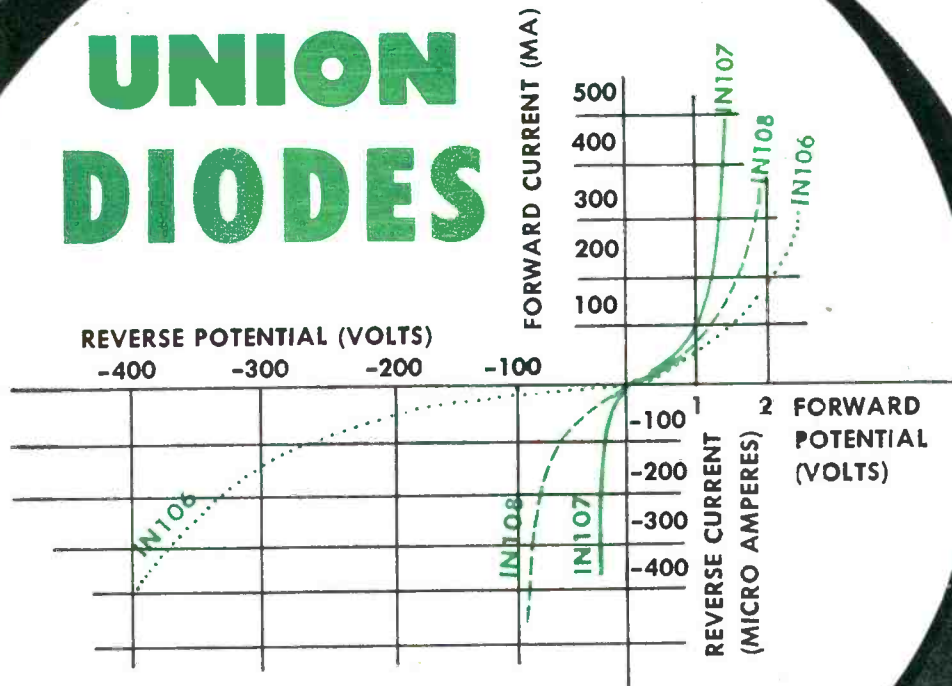

ACTUAL
SIZE

Union Diodes, produced by the electronics engineers who helped pioneer the original research and development, are small area junction diodes with characteristics superior to conventional point-contact germanium diodes.

These characteristics include ratios of back to forward resistance greater by an order of magnitude and capability of handling higher peak power levels. Of extremely small size, with distinctive shape to indicate polarity, they are able to withstand severe temperature and humidity cycling. Their switching and high frequency characteristics approach those of point-contact types.

NATIONAL UNION RADIO CORP.
HATBORO, PENNSYLVANIA



WATERS Miniature

POTENTIOMETERS for your

Toughest Requirements

RT- $\frac{7}{8}$
standard

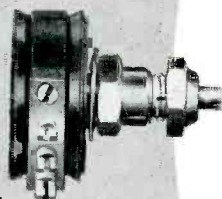

RT- $\frac{7}{8}$
special

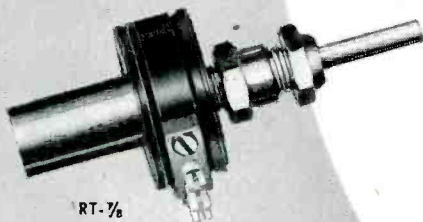

RTS- $\frac{7}{8}$
3-gang
standard



RTS- $\frac{7}{8}$
special



Packed into 1/4 of a cubic inch are all these features:

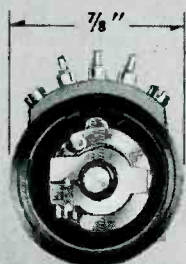

- 10 to 50,000 ohms resistance range.
- 0.002% per degree C temperature coefficient.
- -55 degrees C to +85 degrees C ambient temperature range.
- 3 watts dissipation at 80 degrees C.
- 1000 volts dc dielectric strength.
- 1,000,000 revolutions rotational life.
- *complete reliability.*

Write for full technical information and prices.



WATERS MANUFACTURING, inc.
Waltham 54, Massachusetts

APPLICATION ENGINEERING OFFICES IN PRINCIPAL CITIES

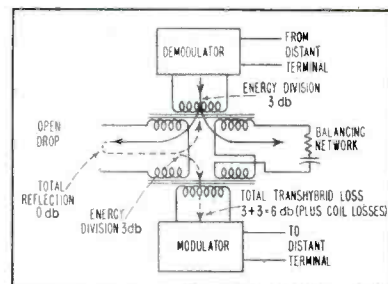

FIG. 1—Hybrid transformer circuit showing the effect of an open drop on the trans-hybrid loss

effect provides a stable voice-frequency transmission path between input and output terminals that may be adjusted to give an overall gain or loss as desired. The two one-way transmission paths together are known as the four-wire portion of the channel.

Carrier or radio channels must usually be connected to ordinary two-wire telephone circuits at both ends. If the sending and receiving circuits were merely connected in parallel to the two-wire circuits, part of the received speech would enter the sending circuit and travel around the circuit as circulating currents causing the circuit either to sing or be resonant and hollow sounding. A Wheatstone bridge or a differential-balance hybrid transformer circuit may be used to prevent this.

In either arrangement, the demodulator and modulator circuits are connected so that a null condition is obtained by balancing a dummy two-wire circuit against the real one. When balance is perfect no current can pass from the demodulator (oscillator or battery) to the modulator (detector or galvanometer). A Wheatstone bridge causes a 6 db loss, since the energy fed into it divides between four arms. A hybrid transformer circuit substitutes a pair of equal or differential windings for the ratio arms of a Wheatstone bridge, saving half of the energy loss. The output of the demodulator is divided equally between the drop and the balancing network. This reduces the theoretical loss to 3 db, but transformer losses usually raise the practical figure to 3.5 or 4 db.

This is the insertion loss to the

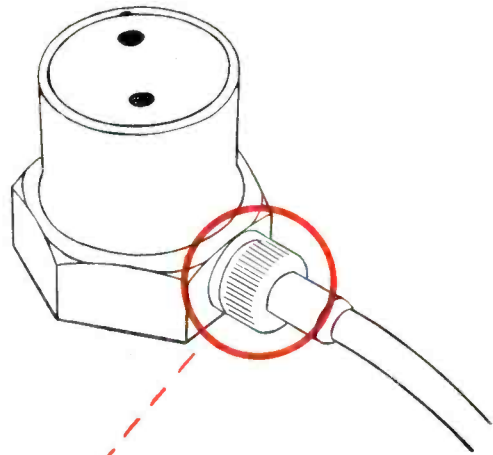

Du Pont TEFLON* provides excellent dielectric properties...

... heat resistance and strength
in new miniature parts

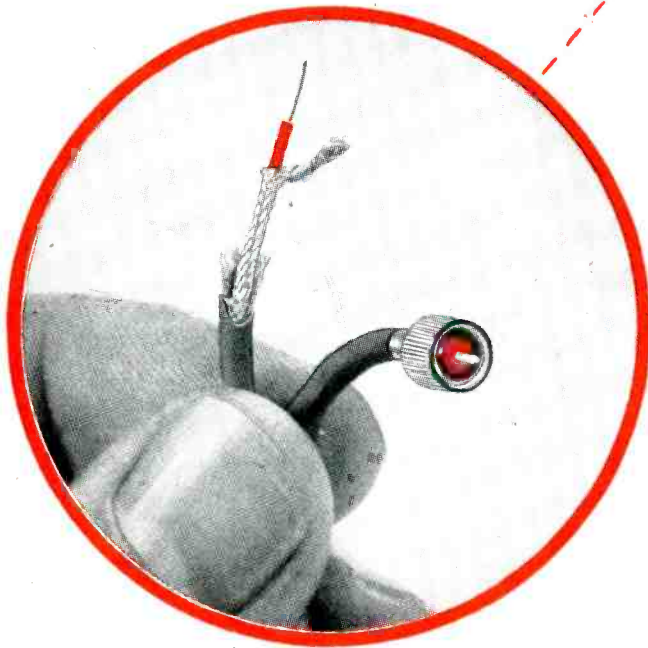

Coaxial connectors and cable
made by Microdot Division,
Felts Corporation, S. Pasadena, Calif.

The demand for micro-miniature components in scale with miniaturized circuit designs has created an insulating problem. Miniature circuits often develop high heat and carry an increased electrical load that can result in failure of these tiny components.

The Felts Corporation faced such a problem with its miniature coaxial connector. They needed a material for the connector and primary wire insulation that had good dielectric properties and a wide resistance to heat, chemicals and corrosion. It also had to be moisture-resistant and strong.

After testing many materials, they chose Du Pont "Teflon" tetrafluoroethylene resin. "Teflon" is an excellent insulator. It has a dielectric constant of 2.0 and a loss factor of 0.0005. Its power factor is less than 0.05% even at frequencies as high as 30,000 megacycles. And these dielectric properties are unaffected by temperatures from -80°F. to 500°F. Du Pont "Teflon" is inert to all chemicals except molten alkali metals and fluorine. It is tough and durable—will not crack or arc. "Teflon" has zero water absorption and helps reduce self-generated noise at high termination impedances.

Du Pont "Teflon" serves many uses in electrical equipment—stand-off and feed-thru insulator terminals, insulation for wire, cables and motor windings, and other parts where high temperatures, dielectric strength and durability are required. Perhaps "Teflon" can help you improve or develop a product. For full information, write: E. I. du Pont de Nemours & Co. (Inc.), Polychemicals Department, Room 2210T, Du Pont Bldg., Wilmington 98, Delaware.

*REG. U. S. PAT. OFF.



REG. U. S. PAT. OFF.
BETTER THINGS FOR BETTER LIVING
... THROUGH CHEMISTRY

Polychemicals
DEPARTMENT
PLASTICS • CHEMICALS

INSULATION FOR WATER-COOLED SYSTEMS

For carrying cooling water which must undergo a change in potential, use of Lapp porcelain eliminates troubles arising from water contamination and conductivity, sludging and electrolytic attack of fittings. Permanent cleanness and high resistance of cooling water are assured—for positive cooling and long tube life.

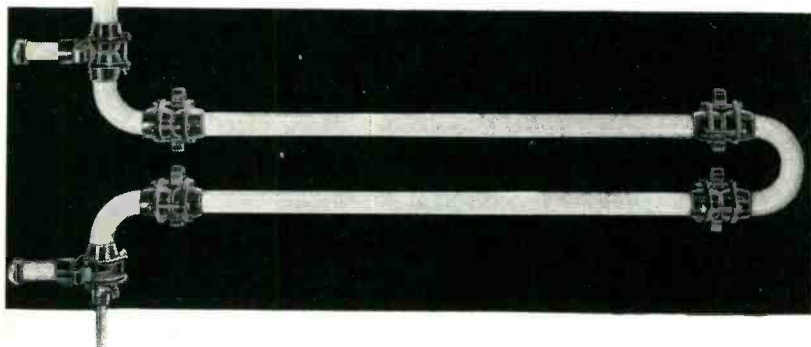

LAPP PORCELAIN PIPE

Inside diameters $\frac{3}{4}$ " to 3", in straight pipe, 90° and 180° elbows, fittings. Swivel-type connections. Standoff insulators attach directly to fitting bolts.

LAPP PORCELAIN WATER COILS

Twin-hole and single-hole models in sizes to provide flow of cooling water from 2 to 90 gallons per min. Cast aluminum mounting bases; lead pipe or flexible metal hose for attachment.

WRITE for Bulletin 301, with complete description and specification data. Lapp Insulator Co., Inc., Radio Specialties Division, 106 Sumner St., Le Roy, N. Y.

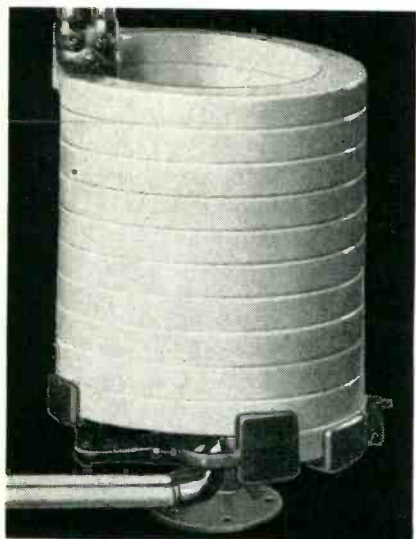

Lapp

speech currents passing through the hybrid circuit. Similar loss is introduced in the path from the drop to the input of the modulator, energy being equally divided between the modulator input and the demodulator output circuits. In passing over a channel from two-wire drop to two-wire drop, the speech currents pass through two hybrid circuits, with a total insertion loss of about 6 db. The four-wire circuit can be adjusted to obtain the desired overall net loss.

The null or balanced condition is reached only if equal speech voltages generated in the differential windings of the hybrid coil cause equal currents to flow in the drop and network circuits. This must be true for all frequencies that can pass over the four-wire portion of the circuit, usually a range of about 200 to 3,400 cps. Accurately matching the impedance of the actual drop over this frequency band requires a network including from three to five elements comprising resistance, capacitance and sometimes inductance. Such precision is seldom required except for hybrids associated with two-wire telephone repeaters where an overall two-wire gain up to 15 db or more must be obtained.

The impedance connected to the drop side of a channel hybrid through a switchboard may vary from an open circuit in the idle condition, to a few hundred or thousand ohms, including capacitance or inductance as well. Changing the network to match each different connection that might be made would be difficult, but if the channel is operated at an overall loss of several decibels or more the degree of balance is not critical. Circuits between switchboards may be operated with losses between 2 or 3 and 8 or 10 db, using a fixed network.

The effectiveness of the hybrid circuit in keeping the demodulator output out of the modulator input circuit is measured by its trans-hybrid loss. If the balance is perfect the loss is infinite; in actual practice it will be less. Worst balance usually occurs during idle condition when the drop circuit is

marion
 advancement
 in instrument
 design



IMPROVED SOLDERING OF SMALL PARTS AND ASSEMBLIES

Typical of the Marion developments that have helped make Marion stand for "advancement in instrument design" is the Marion Model PM1 Induction Soldering Unit. Originally designed and presently used by Marion for true glass-to-metal hermetic sealing of Marion meters, it also has proven to be a valuable production tool for many purposes. Illustrated above, for example, is Marion's use of the PM1 in the soldering of magnet assemblies where quality and uniformity result.

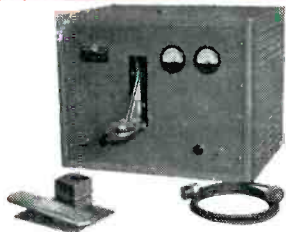

MARION MODEL PM1 INDUCTION SOLDERING UNIT

Low cost, low powered and portable. . . . Size 15 $\frac{3}{4}$ " x 21 $\frac{1}{2}$ " x 15". 150 lbs. Power supply: 115 volts 60 cycles. Draws 775 watts full load, 100 watts standby.

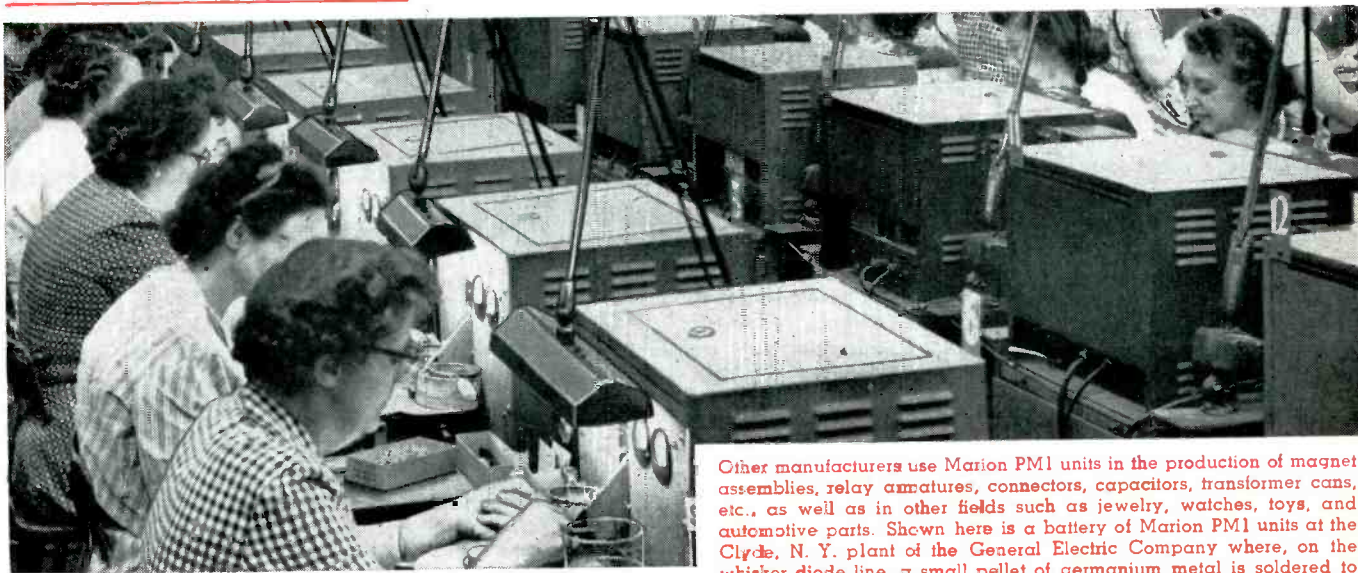

Other manufacturers use Marion PM1 units in the production of magnet assemblies, relay armatures, connectors, capacitors, transformer cans, etc., as well as in other fields such as jewelry, watches, toys, and automotive parts. Shown here is a battery of Marion PM1 units in the Clyde, N. Y. plant of the General Electric Company where, on the whisker diode line, a small pellet of germanium metal is soldered to the end of a nickel pin.

The Marion Model PM1 speeds up production, reduces costs and improves quality. Heat is generated within the work itself — even in parts otherwise inaccessible. Oxidation, scaling and damage to surface finish are minimized. Soldering of an entire seam or several jig-located parts at one time is readily accomplished.

This is an example of how Marion's belief in "Advancement in Instrument Design" has produced a production tool which not only improves Marion instruments but also provides other manufacturers with better soldering equipment. Marion Electrical Instrument Company, 401 Canal Street, Manchester, N. H.



Reg. U. S. Pat. Off.



marion meters

MANUFACTURERS OF RUGGEDIZED AND "REGULAR" METERS AND RELATED PRODUCTS

Copyright 1953 Marion Elec. Instr. Co.

Linear Versus Logarithmic Meter Dials

A New AC-VTVM Settles an Old Dispute

The new Millivac MV-12A AC volt-meter is an exceptionally versatile instrument. Designed to be used as an

AC-vacuum tube voltmeter,
AC-vacuum tube ammeter,
Scope-sensitizer,
Current in addition to voltage
wave shape observer,

it also has the new "Engel" dial which satisfies both logarithmic and linear scale requirements.



A logarithmic volt-scale unavoidably has heavy non-linear compression of its divisions in the upper region making reading difficult and inaccurate even if the instrument itself has an inherent high accuracy. A linear volt-scale, on the other hand, causes heavy logarithmic compression of DB divisions at the low end which is equally undesirable. The new Engel dial shown below meets both logarithmic and linear requirements by having a suppressed zero in much the same manner in which logarithmic volt-scales are suppressed. The resultant spreading of both volt and DB divisions improves the reading comfort of the instrument and makes it superior to the old straight logarithmic system, not only on volts but even on DB. Best proof of the easy reading of the new

dial is that without artificial galvanometer illumination it can be read from a longer distance than logarithmic dials with artificial illumination.

The MV-12A is an ideal scope-amplifier because it has no change-over switch for meter or amplifier operation. Simultaneous measuring and wave-shape observation is therefore possible. By plugging our MV-121 shunt box into the instrument, currents ranging from 1 μ A to 3 A can also be measured and their wave shapes observed.

Highest measuring accuracy and convenience in servicing are obtained by individual range calibration-controls in both the MV-12A voltmeter and the MV-121 shunt box.

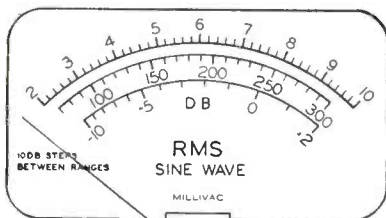

Specifications (MV-12A)

Total Ranges: 12, in 10 DB steps covering 700 μ V to 1 kV.

Frequency: 20 CPS to 250 KC.

Accuracy: 2% of full scale throughout entire voltage and frequency range.

Calibration: RMS Sine Wave, with instrument measuring full wave average.

Amplifier Output: 3 V corresponding to full scale reading, 60 DB gain.

Tubes: 7-6AK5, 2-6V6GT, 1-0B2, 1-6X4.

MAX. SCOPE SENSITIVITY: $\frac{1}{2}$ millivolt per inch on lowest 3 mV range.

MILLIVAC INSTRUMENT CORPORATION

BOX 997, SCHENECTADY, N.Y.

"Time Progresses And So Do We"

practically an open circuit. At this time energy entering the hybrid from the demodulator output tries to divide equally between the network and the drop, with a loss of 3 db. However, the open drop cannot absorb the energy and reflects it back into the drop windings of the hybrid. There it divides into two equal parts again, half going back into the demodulator branch and half going into the modulator circuit accounting for 3-db more loss. Thus the minimum transhybrid loss is about 6 db. With transformer losses, the figure will be nearer 8 db.

If the hybrid circuits at both ends of a circuit are unbalanced, a path exists for currents to circulate. If the sum of the net gains of the two sides of the four-wire portion is greater than the sum of the actual transhybrid losses of the two hybrid circuits, any sound starting around this path will increase in amplitude each time around resulting in a sustained oscillation. If the gains are slightly less than the losses, sounds will circulate for a long time, giving a hollow or mushy effect. If the gains are considerably less than the losses, circulating currents rapidly die out.

If the channel is adjusted for zero net loss, each side of the four-wire circuit will have a net gain of about 8 db, giving a four-wire loop gain of 16 db. This is just equal to the sum of the two transhybrid losses if both ends of the circuit are in the open-circuited idle condition. Thus the circuit is on the verge of singing, and will sound hollow. If the net loss is increased from zero to 6 db, the four-wire loop gain will be reduced by 12 db. The circulating current path now has a loss of 12 db, and will rapidly damp out circulating currents, resulting in a circuit virtually free from echoes.

For each decibel that the overall circuit net loss is increased above zero, the loss to circulating currents is increased two decibels. In the interests of stability and quiet operation, therefore, it is desirable to operate radio relay and carrier telephone channels at a fair overall net loss. A value of 6

Here's your **COMPLETE GUIDE** to— **PRECISION METAL PARTS by KAUPP**

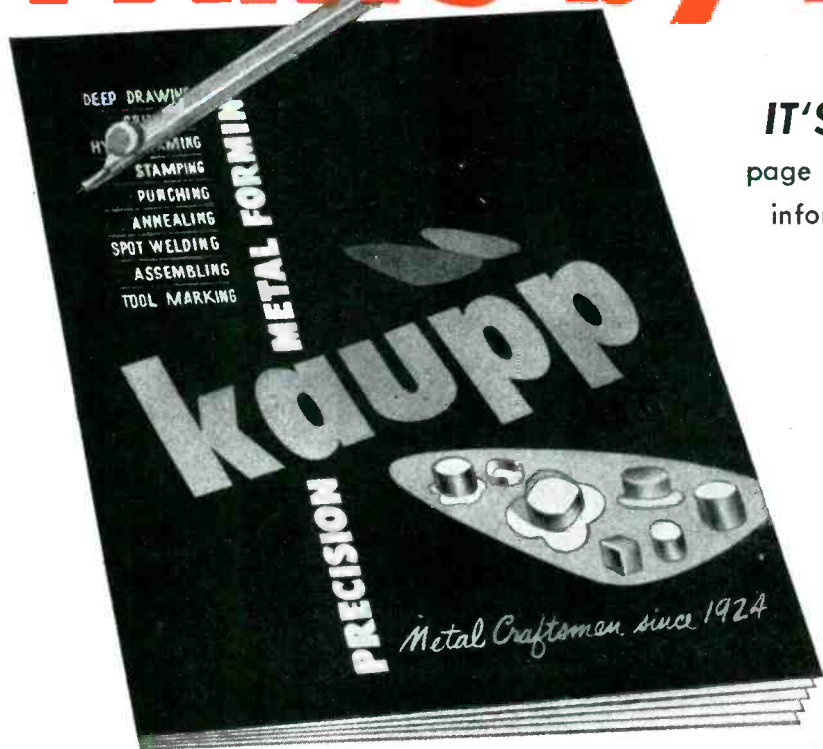

IT'S FREE! The new sixteen page brochure containing helpful information covering all phases of precision metal forming and sub-assembly work.

SPINNING

STAMPING

PUNCHING

DEEP DRAWING

HYDROFORMING

ANNEALING

SPOT WELDING

ASSEMBLING

TOOL MAKING

Designers, production engineers and purchasing staffs are invited to request their copies, now!

New! For Experimental and development engineers—
HYDROFORMING reduces costs, saves time on short runs and development components

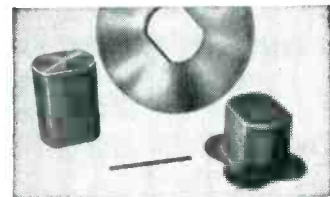

New process sharply reduces tooling time and tool costs. Punch and nest ring are the only tool requirements as hydraulic oil functions as the die member. Send drawings for quotations and information.

COMPLETE FACILITIES and over a quarter century of metal forming to close tolerances assure precision components for the most critical applications. Kaupp experience includes forming and drawing of intricate shapes in stainless, inconel, aluminum, cold rolled steel, brass and other alloys. Gauges from 1/32 sheets to 3/8 plates. For full details ask for your copy of the new brochure.

PRODUCTION AND DEVELOPMENT FACILITIES FOR THE ELECTRONICS, AVIATION, MARINE INDUSTRIES



C. B. KAUPP & SONS
NEWARK WAY • MAPLEWOOD • NEW JERSEY

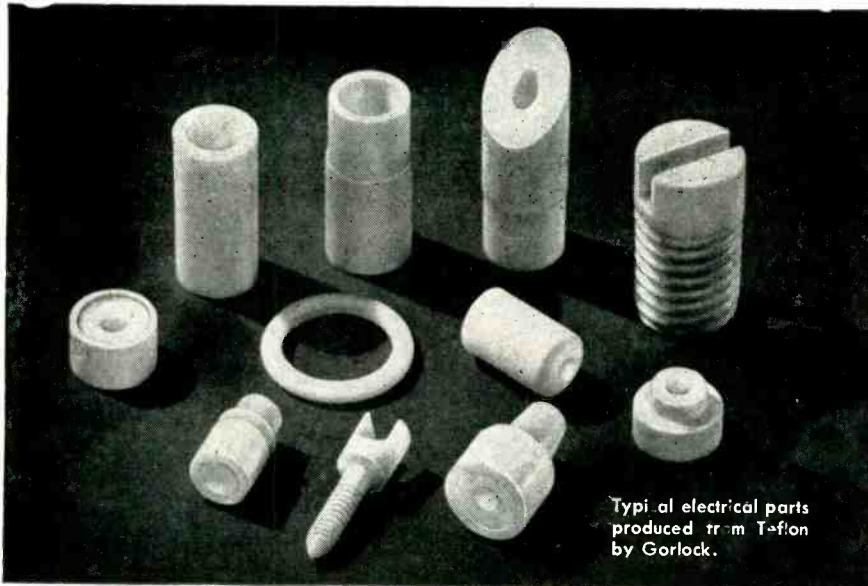

For Precision Electrical Parts
 Made of *Teflon*^{*}, Kel-F[†],
 Nylon, or Polythene . . .

SEND YOUR INQUIRIES TO GARLOCK

The Garlock Packing Company, manufacturers of mechanical packings since 1887, places at your disposal a completely-equipped, modern plastics plant under expert technical supervision. Our complete facilities enable us to mold, extrude, machine or otherwise fabricate (from powder) electrical parts to the same high quality standards to which Garlock has rigidly adhered for over 65 years.

Garlock, therefore, invites your inquiries on:

1. **Finished Electrical Parts**—molded or machined—of Teflon, Kel-F, Nylon or Polythene.
2. **Teflon Tape**—Electrical grade—pretested for dielectric fault (maximum 85 per 100 feet of 0.005" tape).

SHEETS, TUBES, SLEEVES AND OTHER SHAPES AVAILABLE IN TEFLON OR KEL-F

For fabricators of finished parts, Garlock can furnish Teflon and Kel-F in sheets, tubes, sleeves and a wide variety of other shapes. Teflon sheets can be supplied in sizes as large as 48" square; Kel-F sheets and discs as large as 48" diameter.

Mail Your Inquiries to Dept. 34, Palmyra, N. Y., or contact one of our branch offices shown below and a Garlock representative will call.

THE GARLOCK PACKING COMPANY, PALMYRA, NEW YORK

Branch Offices: Baltimore, Birmingham, Boston, Buffalo, Chicago, Cincinnati, Cleveland, Denver, Detroit, Houston, Los Angeles, New Orleans, New York City, Philadelphia, Pittsburgh, Portland (Ore.), Salt Lake City, San Francisco, St. Louis, Seattle, Spokane, Tulsa.

In Canada: The Garlock Packing Co. of Canada Ltd., Toronto, Ont.
 Branch Offices: Calgary, Hamilton, Montreal, Vancouver, Winnipeg

*du Pont's trademark for its tetrafluorethylene resin

†Registered trademark for M. W. Kellogg Company's trifluorochloroethylene polymers

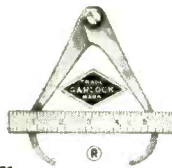

GARLOCK

MANUFACTURERS OF
 MECHANICAL PACKINGS
 SINCE 1887

to 8 db is generally quite satisfactory for use in average private communication systems.

To select the proper circuit net loss, several things must be considered. The microphone in a commercial telephone set gives considerable amplification. If two telephones are connected over a circuit with zero loss, the received speech will be very loud. Loss between telephones can be increased to 25 to 30 db or more if the circuit is not very noisy, and satisfactory conversations can be held.

In a private telephone system, where no telephone is very far from a switchboard, and where not more than two or three circuits will ever be used in tandem between switchboards, the net loss of individual circuits can be 6 to 8 db. Since this is in accordance with the desirable loss from a circulating current standpoint 6 to 8 db turns out to be the optimum range for such private systems. This avoids the need for adjustable balancing networks, and the overall performance of connections involving from one to three such circuits in tandem through switchboards will be quite satisfactory from a loss standpoint.

Ferrite Applications at Microwave Frequencies

BY DWIGHT CASWELL
Cascade Research Corp.
Los Gatos, Calif.

UTILIZATION OF THE unusual high-frequency characteristics of ferrite materials makes it possible to build transmission lines that will transmit energy in one direction and not in the other, or have different electrical lengths when measured in opposite directions. Switches and variable attenuators can be built with no moving parts, as well as antennas that may be electrically scanned.¹

The ferrites have high resistivity which classes them as dielectrics. They also exhibit the Faraday effect, characterized by a rotation of the microwave polarization when a magnetic field is applied in the direction of propagation or in the

RCA's newest aid for designers

Other Industry-Famous
RCA Technical Publications



RCA Tube Handbook HB-3. The bible of the industry. Over 3000 pages of data and curves on RCA receiving tubes and kinescopes, power tubes, cathode-ray tubes, phototubes, and special tubes. Available on subscription basis. Price \$13.50, including service for first year.



Popular RCA Receiving Tube Manual—RC-16. Latest data on more than 330 receiving tubes, including miniatures and kinescopes. Tube theory for the layman. Includes application data, circuits, etc. Price 50 cents.



Quick-reference data booklets—Power and Gas Tubes PG-101A (15 cents); Phototubes, Cathode-Ray and Special Tubes CRPS-102A (15 cents); Receiving Tubes for AM, FM, and TV Broadcast #1275-F (15 cents); RCA Interchangeability Directory of Non-Receiving Electron Tubes ID-1020 (15 cents); RCA Power-Tube Fittings PTF-1012 (25 cents); RCA Preferred Types List PTL-501B (Free).



Technical Data Bulletins on individual tube types, transistors, and crystal diodes are available free on request. Be sure to mention type desired.

prices apply in U. S. A. and are subject to change without notice.



Tmks®

RADIO CORPORATION of AMERICA

TUBE DEPARTMENT

HARRISON, N. J.

ELECTRONICS — October, 1953

Want more information? Use post card on last page.

1500-page Radiotron Designer's Handbook expands RCA's extensive technical service to electronic equipment designers

INSPIRED AND EDITED by F. Langford-Smith for engineers, students, and experimenters, this new expanded reference—4 times bigger than any previous Radiotron Designer's Handbook—includes 1000 illustrations, more than 2500 references, and hundreds of useful circuit designs, curves, drawings, and charts. Here's the technical book that treats circuit design from both the theoretical-mathematical standpoint, as well as the

practical viewpoint of the circuit man.

The 4th Edition of the Radiotron Designer's Handbook is a valuable addition to RCA's vast library of technical literature (which includes RCA's industry-famous Application Notes, Tube Handbook HB-3, Receiving Tube Manual, and many other well-known publications). Order through RCA Commercial Engineering, Section 42JR, 415 S. Fifth St., Harrison, N. J.

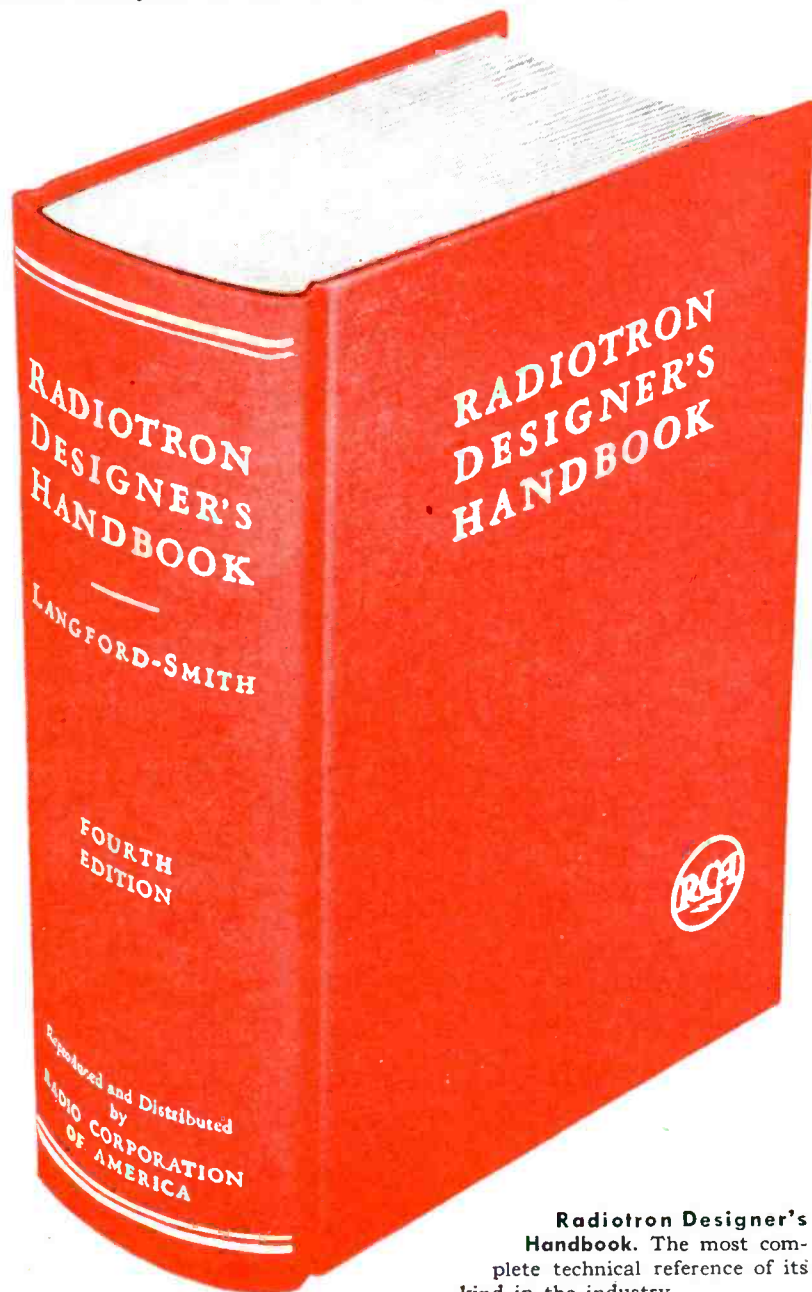

Radiotron Designer's Handbook. The most complete technical reference of its kind in the industry.

Price \$7⁰⁰

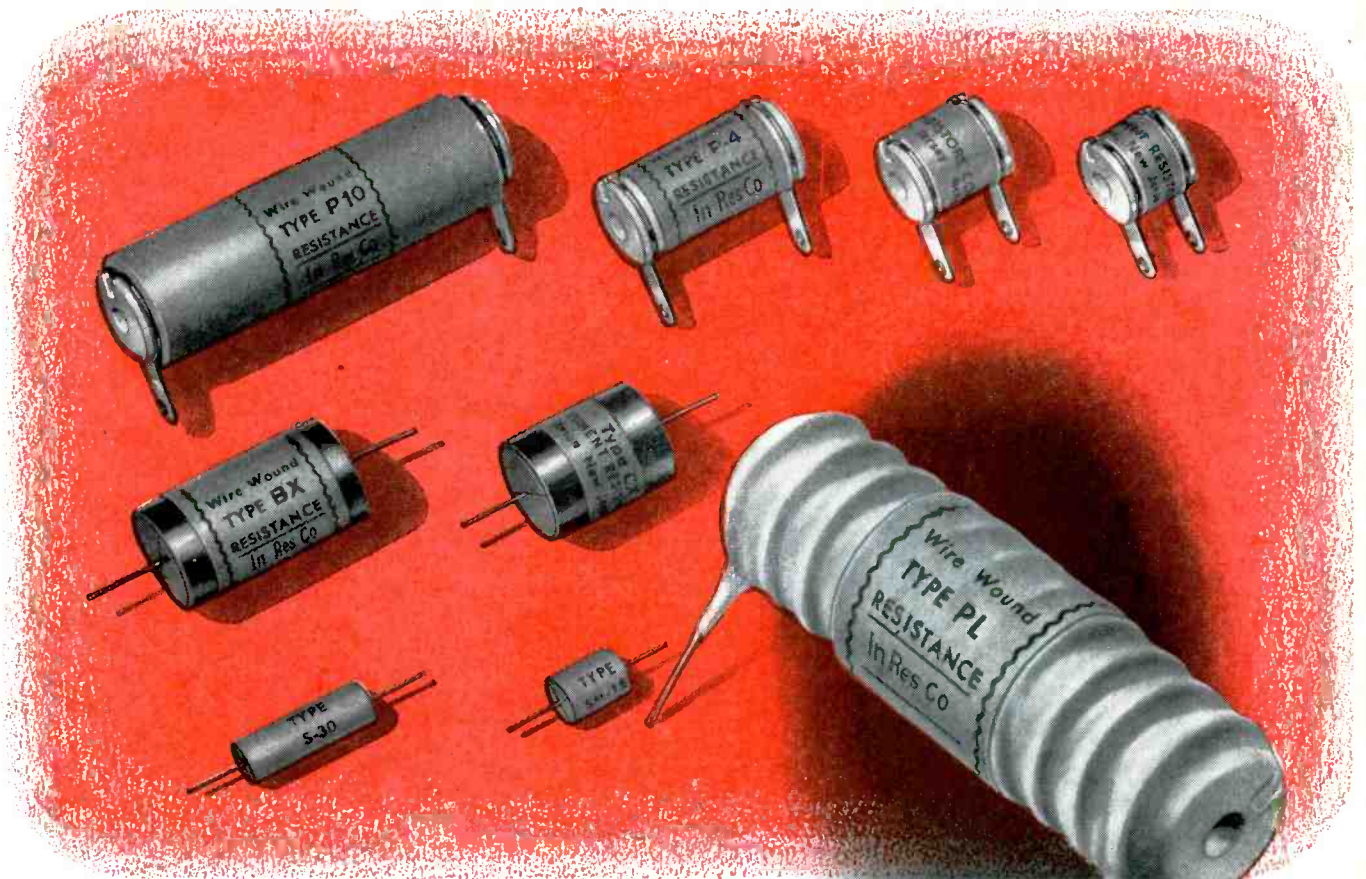

“For High-Accuracy, Long-Life Resistors we wind with **D-H** Electrical Alloy Wire”

...so states *INSTRUMENT RESISTORS COMPANY*, of Union, New Jersey, manufacturers of *IN-RES-CO* quality-built resistors for every electrical and electronic application

IN-RES-CO resistors are wound to meet the most critical requirements without excessive cost; standard inductive and non-inductive units are available in resistance ranges from 0.01 ohm to several megohms—with power ratings from a fraction of a watt to 10 watts. Included, are types especially suited to counter excessive humidity, fungus, space limitations, and temperature rise.

Says Instrument Resistors Company: “For 23 years, we have devoted our facilities exclusively to the development and manufacture of quality resistance components. The fact that today, with such a wealth of experience to our credit, we specify Nichrome, Karma, and D-H Manganin wire for wind-

ings, constitutes the strongest endorsement we can offer of these Driver-Harris products.”

Nichrome*, Karma*, and D-H Manganin deliver top-level performance—their characteristic electrical and physical properties remaining unchanged even under exceptionally exacting operating conditions. They are ready to go to work for *you*, too—as are more than 80 other Driver-Harris alloys. Profit by consulting with us. We shall be glad to make recommendations based on your particular needs . . . and are confident we can meet your resistance requirements with D-H alloys that will assure the best possible results.

Nichrome and KARMA are produced only by

Driver-Harris Company

HARRISON, NEW JERSEY

BRANCHES: Chicago, Detroit, Cleveland, Los Angeles, San Francisco

In Canada: The B. GREENING WIRE COMPANY, Ltd., Hamilton, Ontario.



*T.M. Reg. U. S. Pat. Off.

MAKERS OF THE MOST COMPLETE LINE OF ELECTRIC HEATING, RESISTANCE, AND ELECTRONIC ALLOYS IN THE WORLD

GEARS

DIAMETERS .125" to 60"

We
invite
your
inquiry

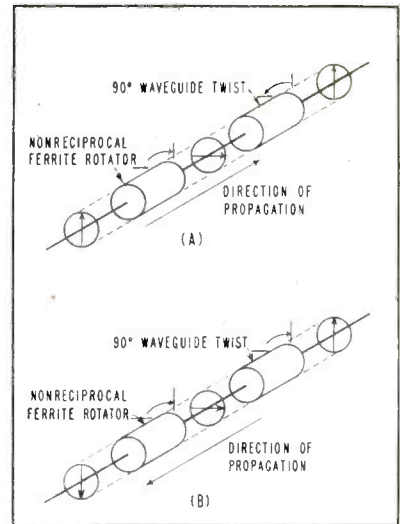
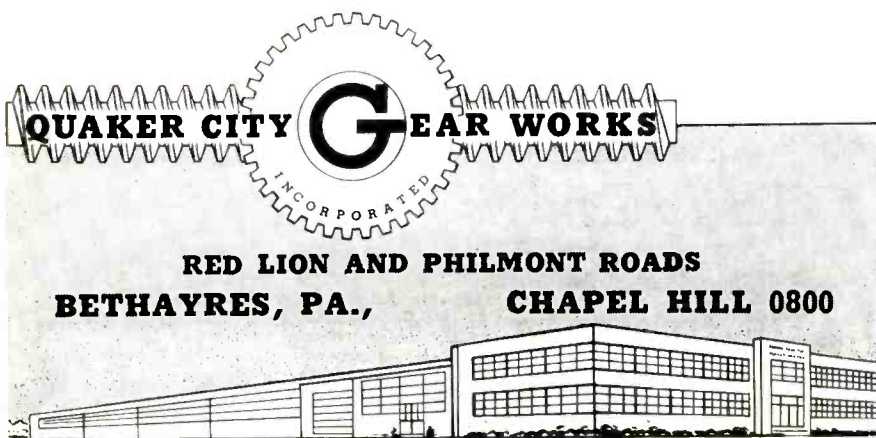

FIG. 2—Waveguide with ferrite rotator produces effect of longer electrical length in one direction by rotating wave 180 degrees

respect to the magnetic field, independent of the direction of propagation. This is shown in Fig. 1. A vane type absorber is located in the input end with the absorber lying in a plane perpendicular to the E-field of the input wave; in this position it does not absorb appreciable energy. The wave is then passed through a piece of ferrite located in the field of either a permanent or electromagnet that causes a rotation of 45 degrees. A transformer-to-rectangular waveguide or other output is provided at the second end at an angle of 45 degrees to the input. Energy is thus coupled out unattenuated. Energy traveling in the reverse direction, as shown in Fig 1B, is introduced into the cylindrical waveguide at 45 degrees to the input and is rotated an additional 45 degrees upon passing through the ferrite material. The E-field now lies in the plane of the absorber and is absorbed. This unit is particularly useful in isolating the load from a magnetron or klystron power source with essentially no power loss.

Microwave Gyration

The gyration is a microwave transmission line having an electrical length 180 deg longer in one direction than in the other. In construction it resembles the unidirectional transmission line except that the rotation introduced by the ferrite material is 90 degrees instead

ADLAK

dependability through extra value features...in Adlake Mercury Relays

Dependability is the sum of many things . . . and ADLAKE's dependability is built on a combination of plus features like these:

Positive leak-proof sealing—assured by the use of properly selected metals and glass components with properly matched thermal expansion characteristics.

Arc-resisting ceramics—ceramics with great temperature-resistance are used to reduce any destructive effect caused by the arc.

Liquid mercury-to-mercury contacts—completely eliminate failures caused by low contact pressure, contact burning, pitting and sticking . . . and the inherent high surface tension of mercury imparts an ideal snap action to contacts.

What's more, every ADLAKE Relay is absolutely safe . . . silent and chatterless . . . and requires no maintenance whatsoever. Get the complete story today . . . write for your free copy of the ADLAKE Relay Catalog. The Adams & Westlake Company, 1171 N. Michigan, Elkhart, Indiana; in Canada, write Powerlite Devices, Ltd., of Toronto.

**Every ADLAKE Relay is tested . . .
and guaranteed . . . to meet
specifications!**

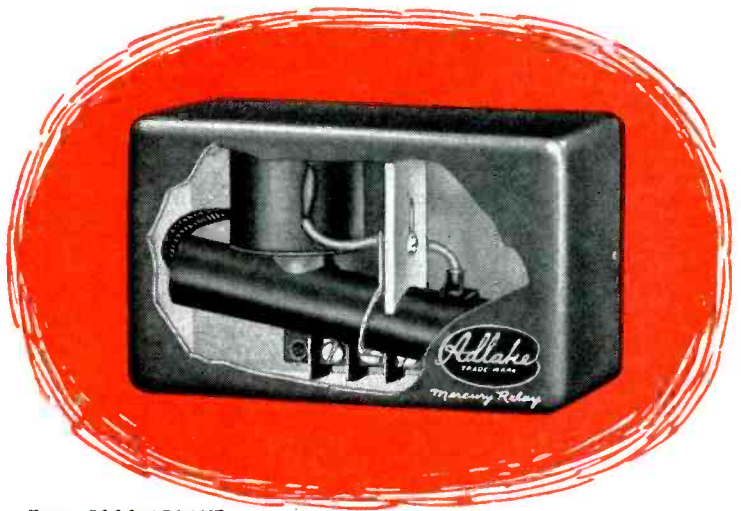

Type 5000 ADLAKE
Sensitive Relay Contact Normally Open or Closed



THE
Adams & Westlake
COMPANY

Established 1857 • ELKHART, INDIANA • New York • Chicago
Manufacturers of ADLAKE Hermetically Sealed Mercury Relays

GEARED TO SERVE the electrical industry

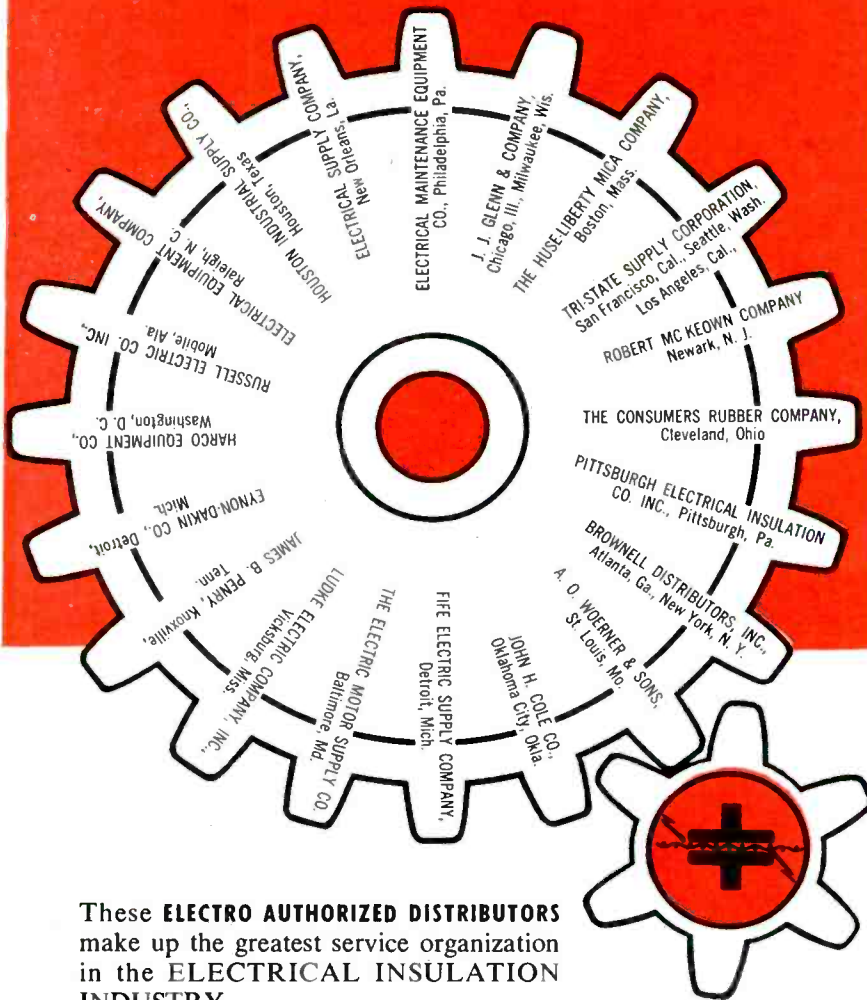

These **ELECTRO AUTHORIZED DISTRIBUTORS** make up the greatest service organization in the **ELECTRICAL INSULATION INDUSTRY**.

Today, design and maintenance engineers are confronted with the job of selecting trouble-free insulation materials. This task is made easier with **ELECTRO'S** dependable products plus engineering service and availability through **ELECTRO AUTHORIZED DISTRIBUTORS**.

Manufacturers of electrical equipment have two important rights: (1) To use the finest electrical insulation materials made, (2) To have the latest technical data concerning these products. Electro-Technical offers you both through their authorized distributors. Write for information and samples.

ELECTRO-TECHNICAL PRODUCTS

DIVISION OF SUN CHEMICAL CORPORATION

113 East Centre Street, Nutley 10, N. J.

of 45 degrees and no absorber is required. Operation is shown in Fig. 2. A 90 deg twist is provided so that the flanges will have similar orientations. If the E -vectors entering and leaving the gyrator are in the same direction when the propagation is from left to right, they appear to be an integer number of wavelengths apart. If the propagation is from right to left, the directions of the E -vectors are opposite, hence the electrical distance appears to be an integer number of wavelengths apart plus 180 deg. The difference in the electrical length of the line as measured in the two directions is 180 degrees plus an integer, with the integer normally equalling zero.

Microwave Switch

Operation of the microwave switch is based on the rotation of the plane of polarization of the microwave energy as a function of the applied magnetic field. This is illustrated in Fig. 3. With no magnetic field, guide A is excited so that energy is propagated in this guide and not in guide B. If a magnetic field is applied such that the plan of polarization is rotated 90 degrees, then guide B is excited and energy is propagated in this guide rather than in guide A. Switching action is thus accomplished.

Microwave Modulator

The modulator is similar to the microwave switch except that an absorber is placed on the output of one of the guides. The output in the other guide may be modulated by varying the applied electromagnetic field. In actual practice a vane type absorber and a single-

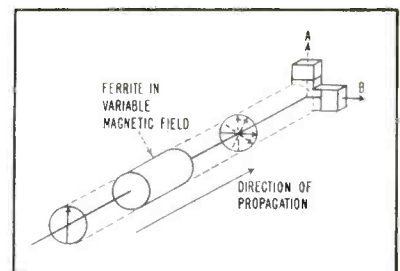

FIG. 3—Ferrite microwave switch rotates wave to selected guide, either A or B. Switch can be used as a modulator by varying the magnetic field producing the rotation



LOWREY ORGANO®

The Electronic Piano-Organ uses over 500 Bradleyunit Resistors

Lowrey Organo is the first electronic instrument to produce organ tonalities using the keyboard of any piano as the organ manual.

It has a key switch frame mechanism containing 60 switches which close and open as the various piano keys are depressed and released by the organist. The closing of a key switch energizes certain electronic tubes producing organ tones in single notes or full chords. The piano tones may be muted or retained in combination with the organ tones.

The Organo tone chassis, at left, has 68 tubes and over 500 Allen-Bradley Bradleyunit fixed resistors. Obviously, in a chassis of such complexity, reliability of performance and stability of characteristics are basic essentials. The failure of a single unit is a serious matter . . . particularly in an instrument often used for public performances by some of the world's leading entertainers.

Bradleyunit resistors are standard equipment on Organo electronic piano-organs because they are accurately and conservatively rated . . . rugged in construction . . . and with ample reserve capacity for emergencies. You can build reliability into your electronic devices, too, by standardizing on Bradleyunit resistors. Send for data, today.

Allen-Bradley Co., 110 W. Greenfield Avenue
Milwaukee 4, Wis.

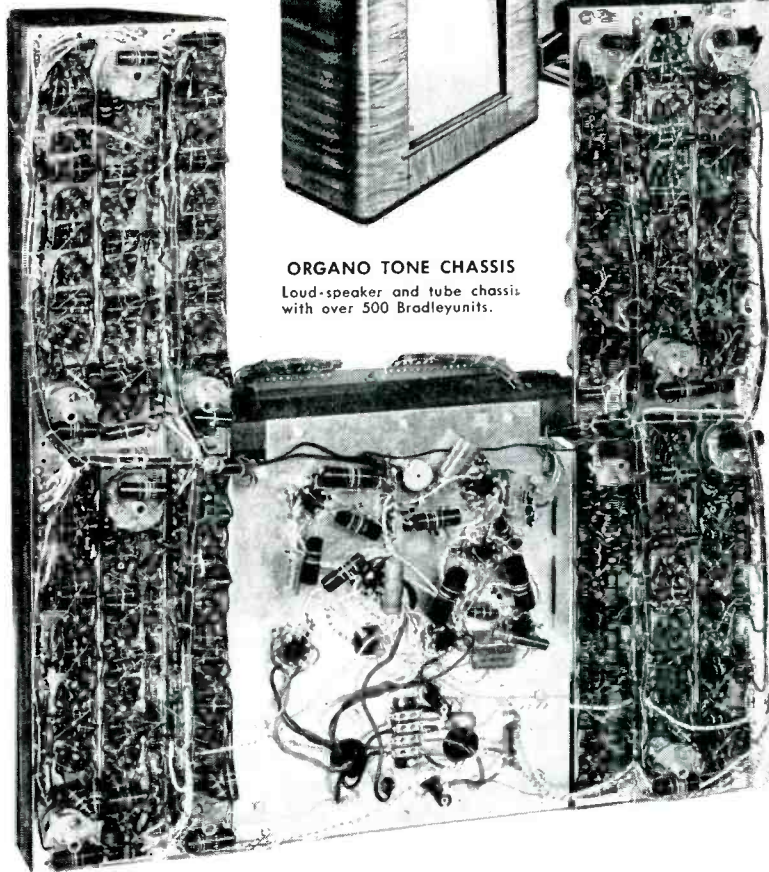

ORGANO TONE CHASSIS
Loud-speaker and tube chassis
with over 500 Bradleyunits.

BRADLEYUNITS are rated at 70C . . . not 40C
Molded fixed resistors are usually rated at an ambient temperature of 40C, but Bradleyunits are rated at 70C. They will operate at full rating for 1,000 hours with less than 5 per cent resistance change.

Bradleyunits need no wax impregnation to pass salt water immersion tests. The resistor leads are differentially tempered to prevent sharp bends.

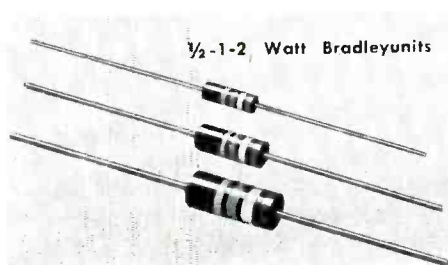

1/2-1-2 Watt Bradleyunits

ALLEN-BRADLEY

FIXED & ADJUSTABLE RADIO RESISTORS

Sold exclusively to manufacturers



QUALITY

of radio and electronic equipment

THE RELIABLE ELECTRONIC MEMORY

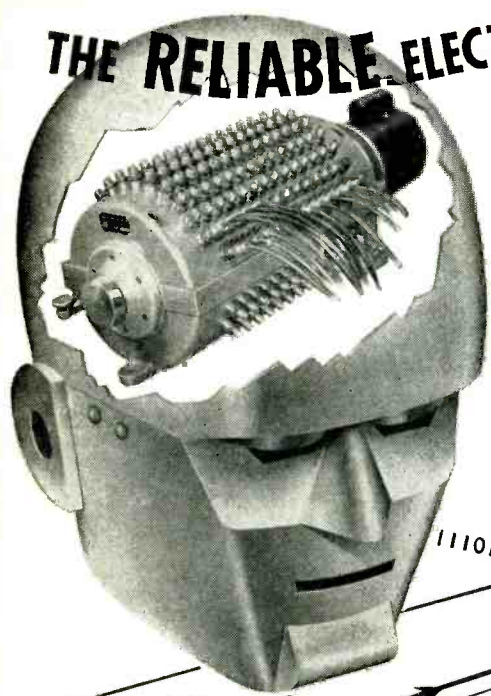

MAGNETIC DRUM STORAGE SYSTEMS

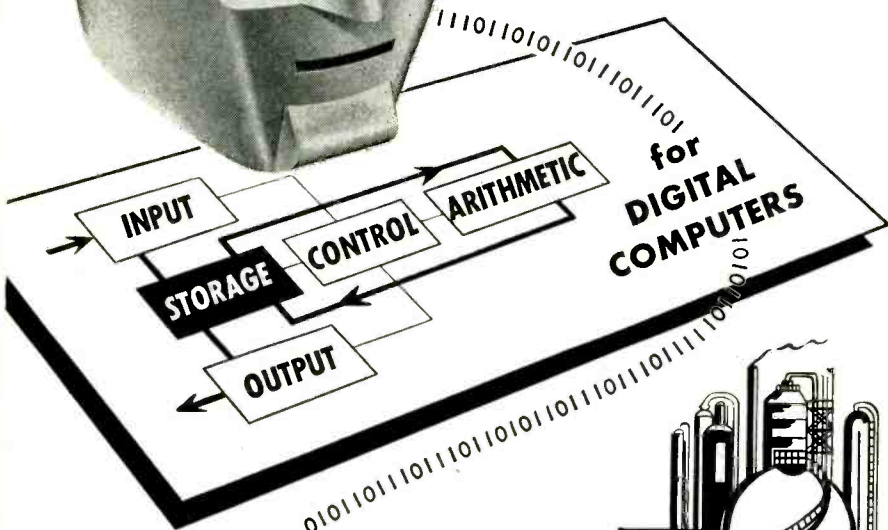

AUTOMATIC PROCESS CONTROL SYSTEMS



or other HIGH SPEED DATA HANDLING REQUIREMENTS

Investigate these *ERA* Magnetic Drum Storage advantages

- Proven dependability
- Large storage capacity
- Alterable yet non-volatile storage
- High-speed

Write today for this descriptive brochure



ENGINEERING RESEARCH ASSOCIATES

DIVISION OF **Remington Rand**

1902 West Minnehaha Avenue, Dept. E-16, St. Paul W4, Minnesota

DIGITAL COMPUTERS . . . DATA-HANDLING SYSTEMS . . . MAGNETIC STORAGE SYSTEMS . . . INSTRUMENTS . . . ANALOG MAGNETIC RECORDING SYSTEMS . . . COMPUTING SERVICE

output waveguide yields a simpler design. This may be used as a variable attenuator by controlling the magnetic field. It is thus possible to build a simple age circuit at microwave frequencies. One of the advantages of modulation at microwave frequency is that a reflex klystron may be operated c-w and the output modulated. This eliminates the frequency modulation which occurs when a square wave is applied to the reflector.

A coaxial microwave modulator² may be built by using a ferrite as the dielectric in a coaxial line. A magnetic field can be applied to adjust the frequency of the resonant absorption to that of the propagated frequency thus controlling the loss introduced. This may be used as an on-off switch.

A microwave magnetometer³ is similar to a switch or modulator except that the magnetic field is the unknown quantity and either the rotation or attenuation caused by the ferrite is measured. Continuous measurement of the magnetic field is possible. The output can either be read directly or used to control the magnetic field.

Electrically Scanned Antennas

The index of refraction of one circularly polarized component may be varied as a function of the applied magnetic field. This can be used to alter the phase of a received signal by varying the magnetic field applied to a ferrite. A microwave antenna may be scanned⁴ by adjusting electromagnetic fields to produce phasing of the antenna elements, or a microwave switch may also be used to switch antenna elements.

REFERENCES

- (1) C. L. Hogan, The Microwave Gyration, *Bell System Technical Journal*, 31, p 1, Jan. 1952.
- (2) Frank Reggia and Robert W. Beatty, Characteristics of the Magnetic Attenuator at UHF, *Proc. IRE*, 41, No. 1, p 93.
- (3) P. J. Allen, A Microwave Magnetometer, *Proc. IRE*, 41, No. 1, p 100.
- (4) N. G. Sakiotis, A. J. Simmons, and H. N. Chait, Microwave-Antenna Ferrite Applications, *ELECTRONICS*, 25, p 156, June 1952.

Microwave Frequency Standards

STANDARD FREQUENCIES in the microwave region are obtained at the National Bureau of Standards by frequency multiplication of the

Pick The Winner

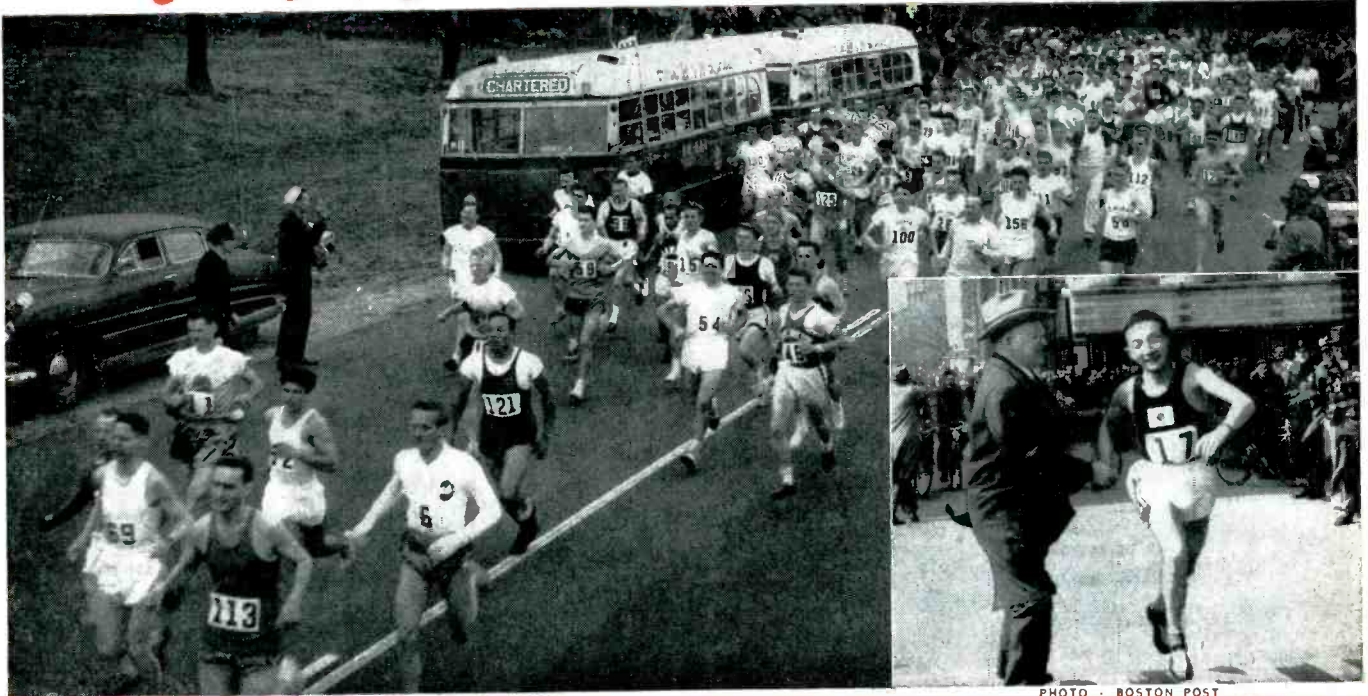

PHOTO - BOSTON HERALD

PHOTO - BOSTON POST

THEY ALL STARTED EQUAL . . . BUT ONLY ONE WON!

Yes, they all started equal in this year's Boston 26-mile Marathon. But only Keizo Yamada WON in the record time of 2 hours, 18 minutes and 51 seconds. Why? Because he had the capacity to run farther faster.

ALL CAPACITORS START EQUAL, TOO

. . . but El-Menco Capacitors always win because they're factory-tested at more than double their working voltage. You can know for sure that they have a wide margin of victory over the adverse conditions of any application.

So whether you pick the midget CM-15 (2-525 mmf. cap) or the mighty CM-35 (5-10,000 mmf. cap), you're sure of a winner . . . in any military or civilian service.

Jobbers and distributors are requested to write for information to Arco Electronics, Inc., 103 Lafayette St., New York, N. Y. — Sole Agent for Jobbers and Distributors in U. S. and Canada.

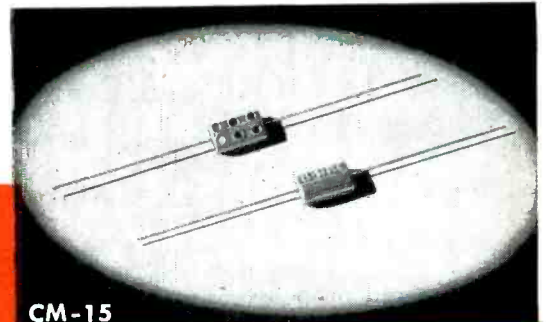

CM-15

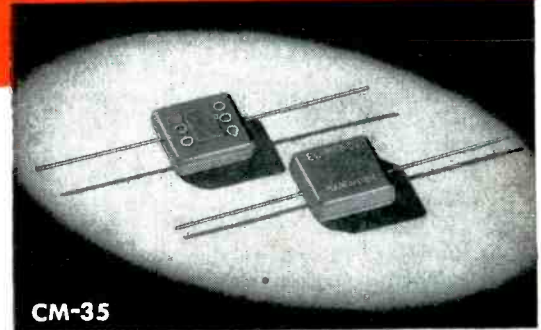

CM-35

MOLDED MICA **El-Menco** **MICA TRIMMER**
CAPACITORS

WRITE FOR FREE SAMPLES
AND CATALOG ON YOUR
FIRM'S LETTERHEAD

Foreign and Electronic Manufacturers Get Information Direct from our Export Dept. at Willimantic, Conn.
THE ELECTRO MOTIVE MFG. CO., INC. **WILLIMANTIC, CONNECTICUT**

We've Stepped-up Production!



NOW Sangamo HUMIDITITE* Mica

Capacitors are available in Quantity

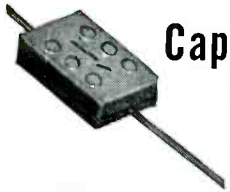

When Sangamo HUMIDITITE Molded Mica Capacitors were first put on the market, the great interest shown in these remarkably moisture resistant capacitors far exceeded our expectations.

We have increased our manufacturing facilities and our production capacity . . . initial demands have been met . . . and we can now handle quantity orders for Humiditite Micas with full assurance that delivery requirements will be met.

*what is HUMIDITITE?

Humiditite is the very effective new plastic molding compound, developed by Sangamo, that gives Sangamo Mica Capacitors moisture resistance properties far superior to any others on the market.

Sangamo Humiditite Micas, under the standard moisture resistance tests described in MIL-C-5A (proposed) Specification, tested in excess of 50,000 megohms—more than 500 times the specification requirements.

Humiditite is just another example of the advanced engineering that enables Sangamo to meet the existing and future needs of the electronic industry. For additional information about HUMIDITITE, write for Engineering Bulletin No. TS-111.

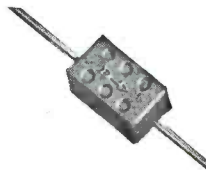

Those who know...  choose Sangamo

SANGAMO
ELECTRIC COMPANY
MARION, ILLINOIS

SC 68-9

signal from 100-kc oscillator used as a time and frequency standard. The frequency of this oscillator is measured to better than one part in a billion by comparison with other standard oscillators and astronomical observations made at the Naval Observatory.

The 100-kc oscillator, using a Meacham bridge circuit, has a short-time stability of one part in 10^{10} and a long-time stability of 10^6 .

Two multiplying systems are used to obtain the high-frequency standards. As a variable standard conventional tube circuits yield frequencies up to several hundred megacycles. For frequencies up to 25 kmc, klystron multipliers are used. Beyond 25 kmc the standard frequencies are obtained by crystal-rectifier harmonic generators. The desired frequency is selected through transmission cavity filter.

Fixed-Standard Method

The fixed-frequency standard, the second method used, gives a higher output than the variable standard but sacrifices versatility. The signal is obtained by mixing a number of standard frequencies. The strongest signals are obtained at the following mixing combinations: 10-mc intervals through 5,000 mc; 50-mc intervals through 25,000 mc; and 250-mc intervals through 40,000 mc. The klystron amplifiers and multipliers used are placed in a temperature-regulated oil bath and are operated well below their ratings in order to obtain good power stability and long life.

When relatively high power outputs, on the order of one milliwatt, are needed, c-w klystron oscillators are synchronized with the standard oscillator. There is some loss of precision with this method.

In calibration of secondary standards the signal from the primary standard and the output of the secondary standard are applied to a crystal-diode mixer that generates all the sum and difference combinations of the signals inserted. The signal wanted is selected by a tunable transmission filter. The resulting intermediate frequency is fed to a spectrum analyzer and the matching sections are adjusted for maximum signal strength.



A

NEW

TWIST

IN

TELEPHONY

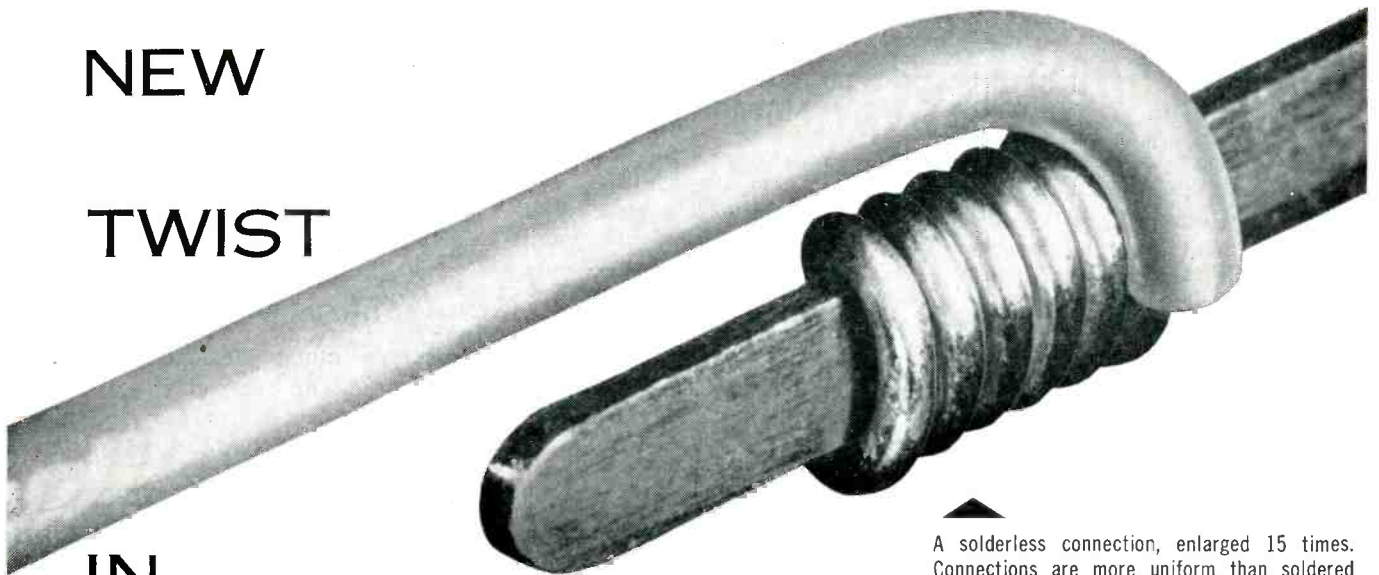

A solderless connection, enlarged 15 times. Connections are more uniform than soldered ones and only half as bulky.

For years the accepted way to connect wires to telephone apparatus was with solder. Now, Bell Laboratories engineers have discovered how to make connections faster and better—without solder.

Solder, they reasoned, wouldn't be needed if wire and terminal could be kept tightly pressed together. But, for economy, this had to be done with the wire alone—without complicating screws and springs.

They found the answer in using a properly dimensioned terminal with sharp edges . . . whipping the wire around it under high tension. The terminal bites into the wire, locking it securely into position. Thereafter the squeezed edges maintain a contact pressure of at least 15,000 pounds per square inch—even under vibration that cracks soldered joints.

The new connections can be made in half the time—a big money-saver in the billion connections that Western Electric makes each year for the Bell System. It's another example of the way Bell Telephone Laboratories works continually to keep costs low.

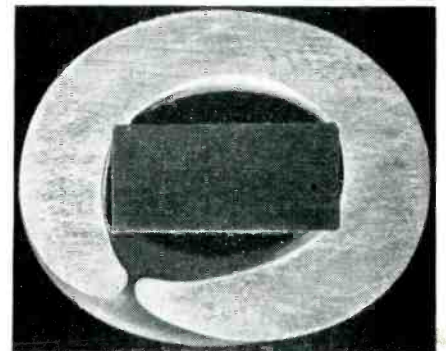

Cross section of solderless connection. Note terminal biting into wire. In a six-turn connection there are at least 20 clean contact areas impervious to moisture and corrosive gases, offering current a low resistance path.

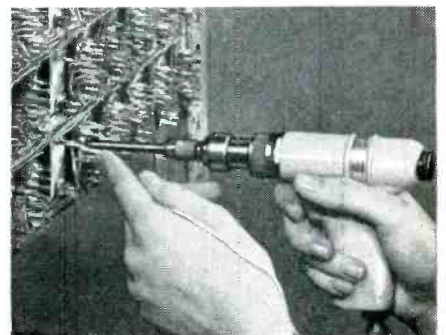

Power tool whips wire on terminal in fraction of a second. There is no heat which could damage miniature components . . . no dropped solder or wire clippings to cause trouble later.

BELL TELEPHONE LABORATORIES

IMPROVING TELEPHONE SERVICE FOR AMERICA PROVIDES CAREERS FOR CREATIVE MEN IN MECHANICAL ENGINEERING



Want more information? Use post card on last page.

Production Techniques

Edited by JOHN MARKUS

Annealing Nickel-Clad Copper Wire	258	Resistor Coating Techniques	280
Assembling for Dip-Soldering	258	Cutting Phenolic Plastic	284
Taking Temperature on Life Runs	260	Preparing Cable Leads	286
Moth Balls Protect Silver-Plated Cavities	260	Testing Tubular Paper Capacitors	290
Masking Capacitor Ends for Molten-Metal Spray	260	Interlocking Parts Trays	292
Water-Cooled Setup for Silver Brazing	262	Vacuum Cleaner Speeds Sealing of Packages	294
Cable Cutter	264	Stamping Tubular Paper Capacitor Cases	296
Visual Inspection of Mica	266	Tuner Shaft-Centering Jig	298
Applying Cement and Pitch	268	Bending Tiny Leads in Ceramic Molds	300
Production Control Chart	270	Knob Springs Installed with Arbor Press	302
Cutting Metal Tubing for Capacitor Housings	272	Testing High-Voltage Power Supplies	304
Insulating Cold-Headed Iron Core-Bobbin	274	Air-Operated Pot Jig	306

OTHER DEPARTMENTS

featured in this issue:

	Page
Electrons At Work	198
New Products	310
Plants and People	382
New Books	436
Backtalk	451

Assembling for Dip-Soldering

TO GUIDE OPERATORS who insert leads of component parts in the tubular terminals of the dip-soldered subassembly used in some GE



Inserting small parts in panel set into metal carrier on moving conveyor line. Sample panels hang from overhead wire. After all parts have been inserted, conveyor brings panel over pool of molten solder, and air cylinders bring up solder pot to solder all joints simultaneously

Annealing Nickel-Clad Copper Wire

CONSTANT WIRE SPEED through an electric annealing furnace is achieved by using rubber-covered pulleys for direct friction drive to the wire on the takeup spools, in an annealing setup at Sylvania's Warren, Pa. plant. The wires are pulled through the furnace from racks of 30 reels at the input of the furnace, which maintains a hydrogen atmosphere at 1560F for heat treatment of 0.01-inch diameter nickel-clad copper wire used in tube manufacture.

The rubber-covered wheels, ap-

proximately the size of automobile wheels, are located under the work table and are on shafts driven through gear reducers by variable-speed drives. The takeup spools are directly above, and individually pivoted. The spools rise as they fill, but always turn at constant speed because the rubber tire of the driving wheel is bearing against the wire on the spool. A traversing head in front of each spool is worm-driven from the main drive shaft; these heads therefore oscillate to wind the wire back and forth.

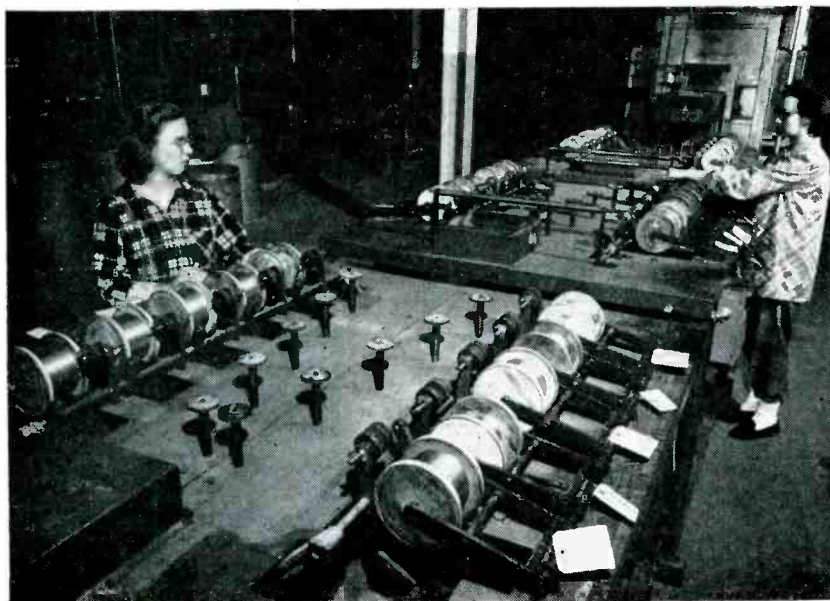

Constant-speed wire-pulling arrangement for spooling 30 individual wires simultaneously after annealing in furnace in background

television receivers, a sample panel is kept in front of each work position. Only the parts that are to be inserted at a particular position are mounted on the sample panel.

A stranded steel cable running the length of the assembly line just over the heads of the operators serves to support the panels, as well as schedule cards and other records applying to the job that is on the line. Wide spring steel paper clips slide along this line and serve to

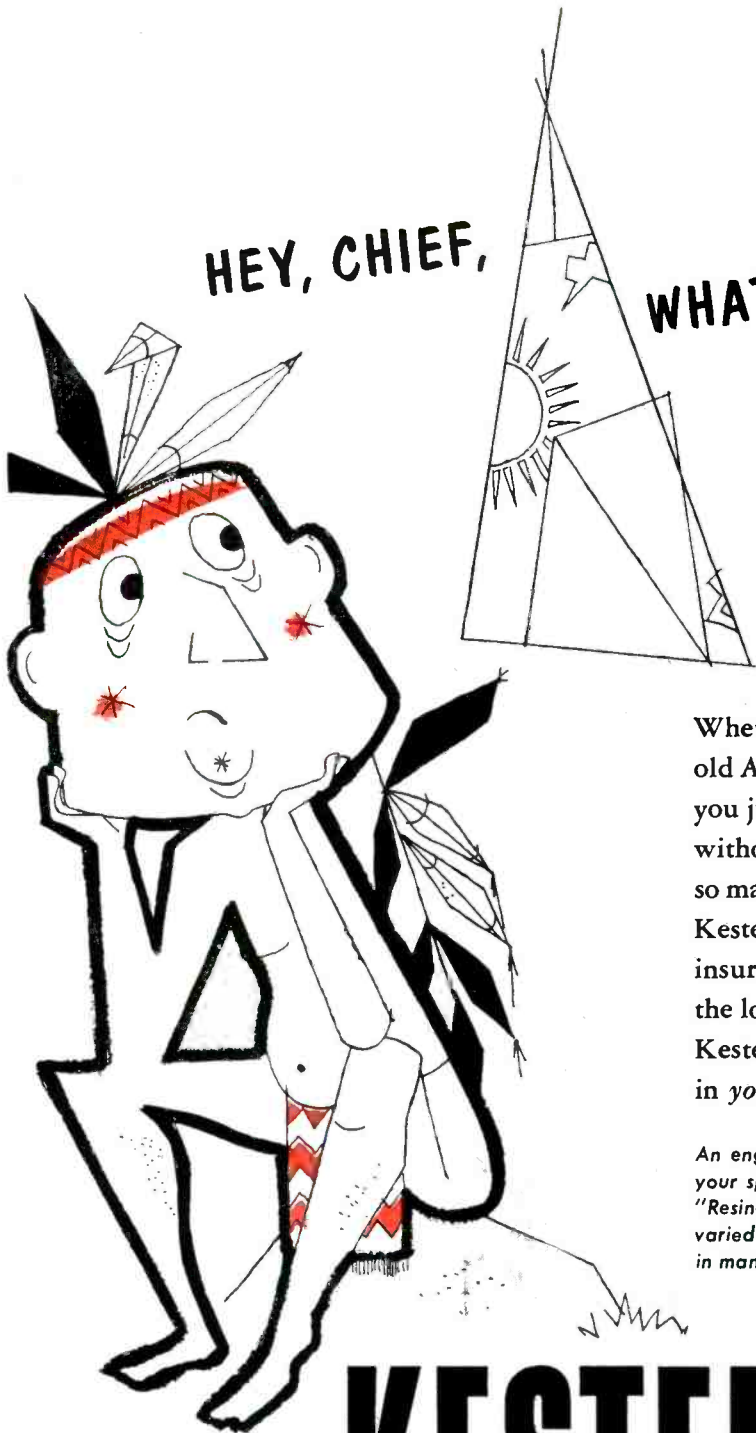

HEY, CHIEF,

WHAT'S A WIGWAM

WITHOUT WAMPUM?

Whether it's shells or beads — or good old American dollars, for that matter — you just can't operate successfully without showing a profit. That's why so many progressive companies depend on Kester quality and performance to insure maximum results in production at the lowest possible cost. And we'll bet Kester Solder can mean more "wampum" in *your* "wigwam," too!

An engineered adaptation can be made to your specific requirements with Kester "44" Resin, "Resin-Five" or Plastic Rosin-Core Solder . . . varied core sizes or flux-contents are available in many different diameters.

KESTER

S O L D E R C O M P A N Y

4204 WRIGHTWOOD AVENUE, CHICAGO 39, ILLINOIS
NEWARK 5, NEW JERSEY • BRANTFORD, CANADA



grip either panels or cards.

Since the leads of most parts have been cut and preformed in preliminary operations, operators are able to insert parts rapidly. To facilitate reaching for parts, special metal parts bins with larger openings are used on the mechanized dip-solder assembly lines.

Taking Temperature on Life Runs

TO OBTAIN temperature readings conveniently during life tests of a-c motor-starting capacitors, ordinary glass thermometers are fastened to the capacitor housings with masking tape. Each thermometer is positioned for maximum ease of reading before being taped.

In this particular test, full 115-volt a-c line voltage is applied for $\frac{1}{2}$

second every half minute. A two-watt neon lamp is connected to each capacitor to serve as a failure indicator in the East Newark, N. J. plant of Astron Corp.

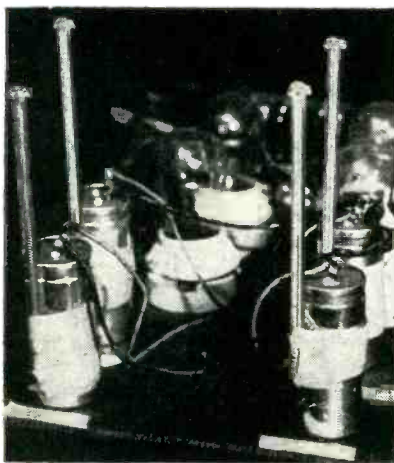

Taking temperature of capacitors on life runs with taped-on thermometers

Moth Balls Protect Silver-Plated Cavities

TO PREVENT SILVER-PLATED component parts of r-f coaxial tuners from tarnishing during pre-assembly storage, Motorola Inc. of Chicago packs standard home-variety

paradichlorobenzene moth balls in the closed containers used for the parts. Unless protected, the heavily silver-plated parts would tarnish quickly upon exposure to an indus-



Transferring silver-plated cavities from moth balls to soldering fixture built around work coils of induction heater controlled from pushbutton station at right on bench. Finished units go into vhf two-way radio tuner in operator's left hand

trial atmosphere containing gases of sulphur-bearing fuels. Tarnish interferes with efficient soldering by induction soldering units.

The necessity of replating the tuned cavities for appearance after soldering is eliminated by keeping the component parts within the vapor of the moth balls. Immediately following the soldering and assembly a protective lacquer is applied. If applied before soldering, this lacquer would interfere with soldering.

Masking Capacitor Ends for Molten-Metal Spray

TO PROVIDE a solid metallic surface to which connecting leads can be soldered, the ends of metallized



Applying masking tape to prevent sprayed molten metal from entirely covering ends of metallized paper capacitor units. Simple wood stand on bench, anchored by weight of solder spool, supports rolls of tape

paper capacitor units are sprayed with molten metal. Since impregnating compound must be able to penetrate between the layers of foil in a subsequent process, it is necessary to leave a portion of each end exposed.

This problem is solved at the Pyramid Electric Co. plant in North Bergen, N. J. by the use of masking tape. Before being sprayed with metal, the capacitor bodies are placed in a box-like band of corrugated cardboard so that both ends of the bodies are accessible. Pieces

FREED Instruments & Transformers

Famous For

QUALITY • DEPENDABILITY • ACCURACY



No. 1030
Low Frequency
"Q" Indicator

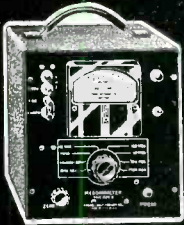

No. 1020B
Megohmmeter

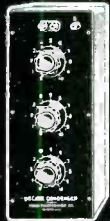

Decade
Inductors



No. 1040
Vacuum Tube Voltmeter

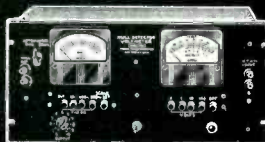

No. 1210
Null Detector &
Vacuum Tube Voltmeter



No. 1010
Comparison Bridge

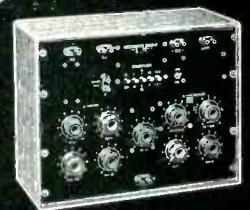

No. 1110A
Incremental Inductance
Bridge

FREED MINIATURE AUDIO TRANSFORMERS

PROFESSIONAL MINIATURE AUDIO TRANSFORMERS

These high quality, miniature transformers feature hermetic sealing for maximum protection from moisture penetration with subsequent electrolysis and corrosion of fine wires. While primarily intended for non-military equipment, these units are constructed in accordance with MIL-T-27 Specifications.

CATALOG NO.	APPLICATION	IMPEDANCE LEVEL OHMS		MAXIMUM POWER LEVEL V.U.*	MAX PRI DC PER SIDE UNBAL. Ma.	D.C. UNBAL. Ma.	FREQ. RESPONSE C.P.S.	CASE NUMBER
		PRIMARY	SECONDARY					
PMA 1	Line or microphone to single or push-pull grids	50/200/500	60,000 C.T.	+8	1:11	0	±2.0 DB 30-20000	DM-12
PMA 2	Dynamic microphone or speaker voice coil to single or P.P. grid	4/8	60,000 C.T.	+8	1:86.6	0	±2.0 DB 30-20000	DM-12
PMA 3	Line or microphone to single or push-pull grids. Magnetically shielded.	50/200/500	60,000 C.T.	+8	1:11	0	±2.0 DB 30-20000	DM-12
PMA 4	Single triode plate to single or push-pull grids	15,000	60,000 C.T.	+8	1:2	0	±2 DB 30-10000	DM-12
PMA 5	Single triode plate to push-pull grids	15,000	60,000 C.T.	+8	1:2	2	±2 DB 200-10000	DM-12
PMA 6	Single triode plate to multiple line	15,000	50/200/500	+8	5.48:1	0	±2 DB 30-20000	DM-12
PMA 7	Single triode plate to multiple line	15,000	50/200/500	+8	5.48:1	2	±1 DB 200-10000	DM-12
PMA 8	Push-pull triode plates to multiple line	30,000 C.T.	50/200/500	+8	7.75:1	2	±2 DB 30-20000	DM-12
PMA 9	Crystal mke or pickup to multiple line	60,000	50/200/500	+8	11:1	0	±2 DB 30-20000	DM-12
PMA 10	Mixing or matching	50/200	50/200/500	+8	1:1.50	0	±2 DB 30-20000	DM-12
PMA 11	Parallel Feed Reactor 1 mw. reference level.		40 hy. 3 ma dc,			3500 ohms D.C. resistance		DM-12

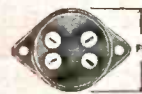
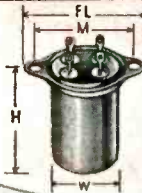

DM-12 CASE DIMENSIONS

FL - 1 1/2
FD - 1 1/32
W - 15/16
H - 1 15/32
M - 1 7/32

Screws - 4-40
Cut out - 7/8
Wgt. - 1.5oz.

Send for complete catalog on
Freed Instruments and Transformers

FREED TRANSFORMER CO., INC.

1722 WEIRFIELD ST. (RIDGEWOOD) BROOKLYN 27, N.Y.

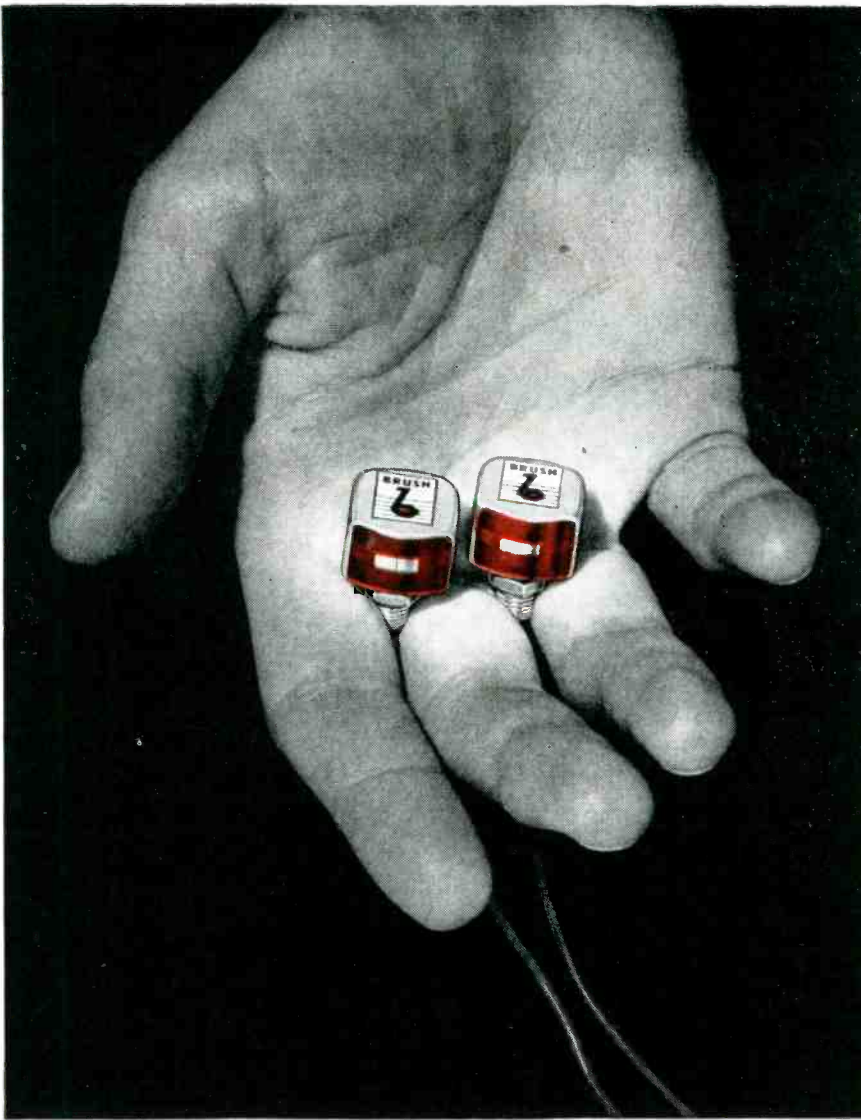

Meet the Redheads... tops for tape recording

See how the latest additions to the Brush family of magnetic recording components can improve your tape recorders!

The BK-1090 record-reproduce head has the standard track width designed for dual track recording on 1/4 inch tape. It provides unusually high resolution and uniformity over an extended frequency range. Cast resin construction assures dimensional stability, minimizes moisture absorption, and affords freedom from microphonics. Its balanced magnetic construction, precision lapped gap, Mu-metal housing, and single-hole mounting provide important design advantages.

The BK-1110 erase head has the same basic construction as the companion record-reproduce unit. Its outstanding feature is its efficient erasing at low power consumption—less than 1/2 voltampere.

Investigate these new "Redheads" for your magnetic recording. Your inquiries will receive the attention of capable engineers. Write Brush Electronics Company, Department K-10, 3405 Perkins Avenue, Cleveland 14, Ohio.

BRUSH ELECTRONICS

INDUSTRIAL AND RESEARCH INSTRUMENTS
PIEZO-ELECTRIC MATERIALS • ACOUSTIC DEVICES
MAGNETIC RECORDING EQUIPMENT
ULTRASONIC EQUIPMENT



COMPANY

formerly
*The Brush Development Co.
Brush Electronics Company
is an operating unit of
Clevite Corporation.*

of rolled cardboard are used to fill out empty spaces and prevent the molten metal from getting on the sides of the bodies. The box is then set on a wood jig that supports it at an angle within easy reach of the operator. Strips of quarter-inch masking tape are placed across the ends of the capacitors in such a way that a strip goes across the center of each end. The strips are anchored to the sides of the box, and are easily pulled off after spraying.

Water-Cooled Setup for Silver Brazing

AN IMPROVISED LATHE driven by an electric motor rotates a length of copper tubing slowly during the operation of silver-brazing brass ferrules to the ends of the tubing. Water-cooling arrangements prevent heat from traveling far in either direction from each joint.

In the operating procedure devised by Weller Mfg. Co. for its

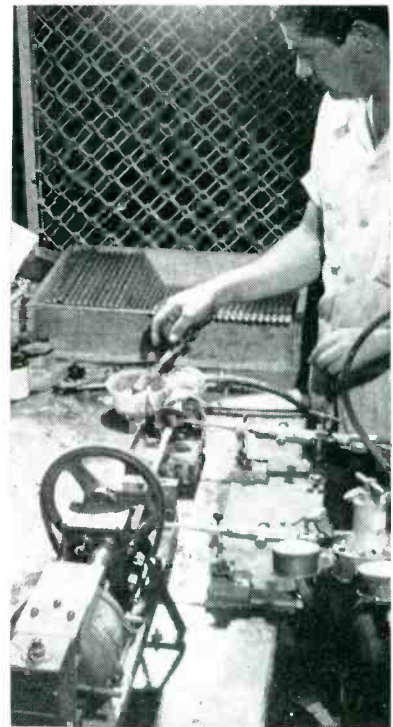

Setup for brazing ferrules for copper tubing. Air cylinder at tailstock end of lathe is operated by foot pedal to move tailstock in and out for easy loading and unloading. Operator applies silver solder flux with inexpensive paint brush while tubing is rotating slowly under the flames of the two acetylene torches, which can be swung out of the way when the desired flow of solder occurs

CUT COST

and **RETAIN QUALITY** with

Heldor



- **CANS & COVERS**
- **HERMETIC SEAL BUSHINGS**
- **COMPLETE ASSEMBLIES**

Today, more than ever before, lower production costs, consistent quality and delivery-on-time are the tools to meet competitive selling. And, HELDOR can be your answer . . . if you use hermetic-seal bushings, cans and covers built to meet MIL-T-27 or commercial specifications.

Many a prominent manufacturer of electronic components today uses Heldor's assembly service—bushings assembled to covers and, in many cases, all operations through the final hermetic sealing — to effect further production savings.

If you are cost-conscious and quality-minded, it will pay you to send us your specifications (or prints). Our quotation will amaze you. Do it today!

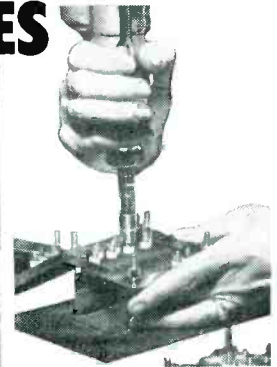

MAIL COUPON TODAY

Please send data on: Cans
 Assembly Service Bushings
Name Title
Company
Address

HELDOR MANUFACTURING CORPORATION

HELDOR BUSHING & TERMINAL CO., INC.

238 Lewis Street

Paterson, N. J.



'DIAMOND H' RELAYS



...now even
mightier
midgets

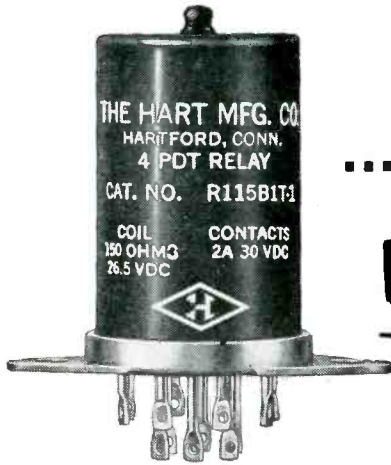

Shown Actual Size

NEW CHARACTERISTICS engineered into famous "Diamond H" Series R Relays have now broadened their adaptability for such applications as guided missiles, jet aircraft, fire control and fire detection, radar, communication, high speed camera, geophysical and computer apparatus . . . wherever positive operation is demanded under critical conditions.

A 4PDT hermetically sealed, miniature aircraft relay basically, they are now also available DPDT with two independent coils, either or both of which will operate the units.

In their field still the smallest and lightest, (1.6 cu. in. 3.76 oz.) combining highest operating shock resistance (to 50 "G" and higher), widest temperature range (-65° to + 200° C.) and greatest ability to break high currents and high voltages, Series R Relays consistently operate over 400,000 cycles without failure at 5 A. and go 3,500 or more under 30 A. at 30 V., D.C., resistive. They carry voltages up to 300 D.C. at 4/10 A. for more than 400,000 cycles. With low contact

loading, life expectancy is 10 million cycles or better.

Operating time is 10 ms. or less; drop out time 3 ms. or less. Coil resistances up to 35,000 ohms are standard; to 50,000 ohms available for special units. Sensitivity approaches 100 mw. at 30 "G" operational shock resistance. Inter-electrode capacitance is less than 5 mmf. contacts to case—less than 2½ mmf. between contacts, even with plug-in type relay and socket. Vibration range is from 0 to 500 cycles per second and upward at 15 "G" without chatter.

All standard mounting arrangements, including ceramic socket, are available. Uniquely simple design permits compact grouping . . . and a firm bond between relay and chassis.

Designed to meet all requirements of USAF Spec. MIL-R-5757B, they far surpass many. Bulletin R-150, giving basic performance data under varying conditions, is yours on request. Our engineers are prepared to work with you to develop variations to meet your specific requirements. Tell us your needs.

THE HART MANUFACTURING COMPANY

202 Bartholomew Avenue • Hartford, Connecticut

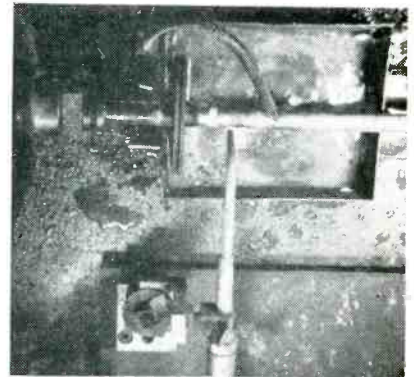

Headstock end of lathe, showing torch in foreground and stream of cooling water directed onto copper tubing at right of flame. Aluminum wheel rotating in water at left of flame cools end of brass ferrule, to prevent internal threads from oxidizing

plant in Bayamon, Puerto Rico, the operator assembles the brass ferrules and ring-shaped silver solder preforms on a length of tubing, inserts the tubing between aluminum discs on the headstock and tailstock of the lathe, then applies silver solder flux to each joint with a brush as the joints are heated by oxyacetylene torches. The discs rotate in pans of cold water and thereby serve to draw heat away from the ferrules. An electric motor drives the lathe through a gear box and speed-reducing belt.

The water-cooling arrangement is used to prevent the intense heat of brazing from discoloring the ferrules and tubing, and to prevent the internal threads of the ferrules from oxidizing. A stream of cold water is directed at each end of the copper tubing about an inch away from its torch flame. Thus, at each joint an aluminum disc keeps the ferrule end cooled on one side of the flame and the water stream cools the tubing on the other side of the flame.

After brazing, the tubing is bent to form the single-turn secondary winding for the Weller soldering gun.

Cable Cutter

MULTIPLE-CONDUCTOR cable is cut precisely to correct length with an Amphenol-recommended procedure that permits quick readjustment to any other length.

On the front of the bench allo-

Let's talk vacuum in your plant!

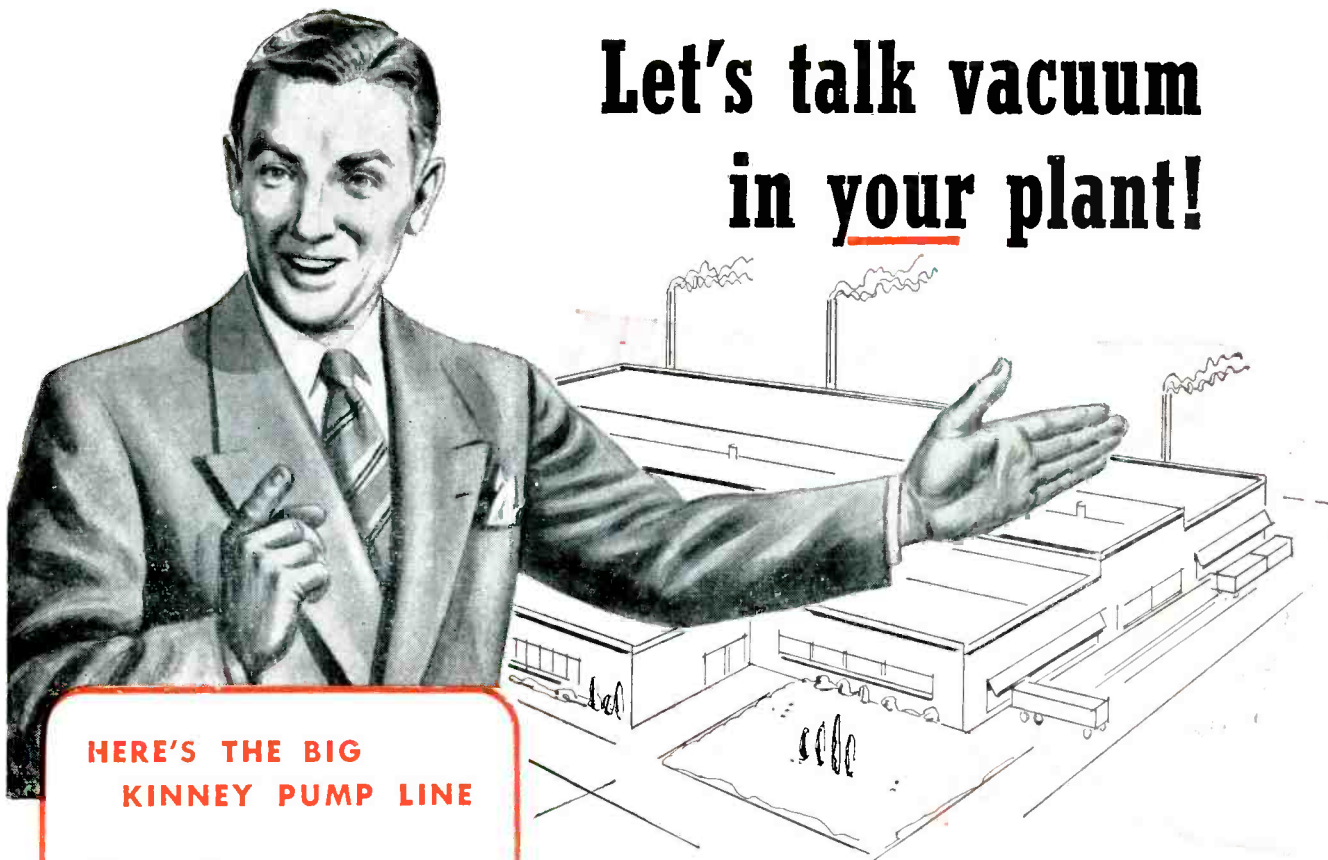

HERE'S THE BIG KINNEY PUMP LINE

Single Stage

Model DVH 27.20.34	1800 CFM
Model DVM 18.14.20	780 CFM
Model DVD 14.14.18	486 CFM
Model DVD 14.9.18	311 CFM
Model DVM 12.8.14	218 CFM
Model DVD 8.8.10	110 CFM
Model VSD 8.8.11	52 CFM
Model VSM 7.7.8	27 CFM
Model VSM 5.5.6	13 CFM

Compound

Model CVM 8.6.10	46 CFM
Model CVM 5.5.6	15 CFM
Model CVM 3534	5 CFM
Model CVM 3153	2 CFM

There's a qualified Kinney Vacuum Engineer in your region, ready to talk vacuum in your plant. Call on him, See how the BIG LINE . . . the Kinney line of vacuum pumps can be profitably used in exhausting lamps and tubes, freeze-drying pharmaceuticals and antibiotics, vacuum metallizing, vacuum production of titanium and other miracle metals, vacuum fumigation and impregnation — and in the countless other ways vacuum serves industry today. Kinney Manufacturing Co. — manufacturers of vacuum and liquid pumps. Boston, New York, Chicago, Detroit, Cleveland, Atlanta, Pittsburgh, Philadelphia, Los Angeles, Charleston (W. Va.), Houston, New Orleans, San Francisco, Seattle, and foreign countries.

2 IMPORTANT ANNOUNCEMENTS



GAS BALLAST

when applicable — All sizes of Kinney Vacuum Pumps can be equipped with gas ballast to assist in your water-oil contamination problems.



NEW MECHANICAL BOOSTER PUMP

Model MB 1200. "Clean" vacuum . . . extremely high pumping speeds (1000 CFM at 10 microns) . . . low power (15 HP) . . . particularly suited for metallurgical processes where large volumes of gases are liberated.

**FOR DETAILS WRITE KINNEY MANUFACTURING CO.,
3565 WASHINGTON ST., BOSTON 30, MASS.**

SOLID BRASS ELECTRONIC HARDWARE AND FITTINGS

for
Industrial
and Marine
Applications



Precision machined from solid brass
... plated to your requirements.

Spherical seat (ball and cone type). RF fittings including ferrules, adapters, couplings, nuts; receptacles, etc. Made in accordance with BuShips drawing RE-49A-501A for use with flexible metal hose, conduit, tubing, etc.

Rapid delivery on standard or special sizes. Let's discuss your needs! Write or phone, today.

HARDWARE DIVISION

HOPKINS
Engineering Co.

FACTORY: 2082 Lincoln Ave.
Altadena, Calif. Sycamore 8-1185
Offices in WASHINGTON, D. C.
and DETROIT



Cutting multiple-conductor cable with arbor press while second operator holds end of cable against stop in precision length-measuring trough

cated for cable cutting is a V trough consisting of a length of angle iron as long as the longest cable to be cut. A section of steel tape measure is bolted to the inside of this trough to provide an accurate, easy-reading length scale for the operators.

An adjustable cable stop is so machined that it slides freely on the trough but comes down over the outer sides and hence cannot be lifted off. A locking lever-handle screw pushes a V-shaped solid metal stop against the inside bottom of the trough to lock the stop in position at the desired point.

Two operators are needed for this cutoff arrangement. One runs the cable into the trough from a reel off to the left. The other brings this cable up to the stop and holds it there, after smoothing out any irregularities so the cable lies flat in the bottom of the trough. The first operator now operates a modified arbor press having a slicing blade that gives smooth, precise cutoff of the cable at the desired point.

Visual Inspection of Mica

A SINGLE SYLVANIA 14-WATT day-light fluorescent lamp mounted under a sheet of frosted glass serves as an inspection table for detecting defects in punched mica

ACME STAR COMPOUND FOR MIL-T-27, GRADE 1 CLASS A TRANSFORMERS



A Raytheon transformer molded with Acme Star Compound

NOTE THESE OUTSTANDING ADVANTAGES:

- Non-toxic
- Non-corrosive
- Eliminates Voids
- Thorough impregnation
- Simple one-phase molding process
- Tenacious adhesion to metal
- Assures complete moisture-proof seal

Acme Star Compound also passes Specification MIL-C-16923 (Ships), Compound, Embedding (Electronic Equipment), Type C.

Exterior cases are not required, as the compound alone provides protection.



ACME WIRE CO.
NEW HAVEN, CONN.

MAGNET WIRE • COILS
VARNISHED INSULATIONS
INSULATING VARNISHES

IDEAS that started in a BELLOWS

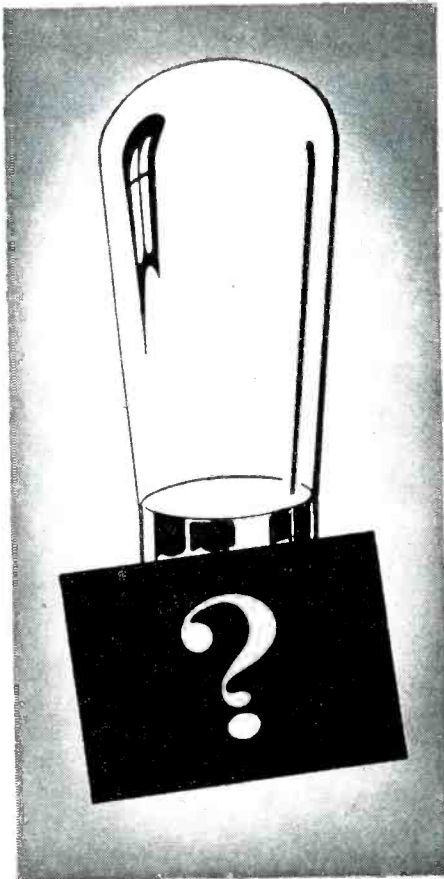

ONCE THOUGHT IMPOSSIBLE

How to reach into a high vacuum tube without breaking the seal — once stumped many an engineer.

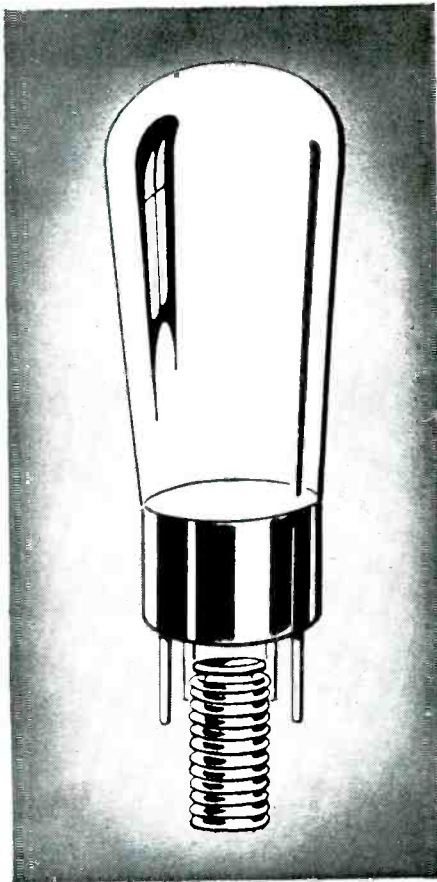

NOW "STANDARD PROCEDURE"

Today Clifford supplies a whole line of bellows to make a wide range of adjustments and settings inside a vacuum.

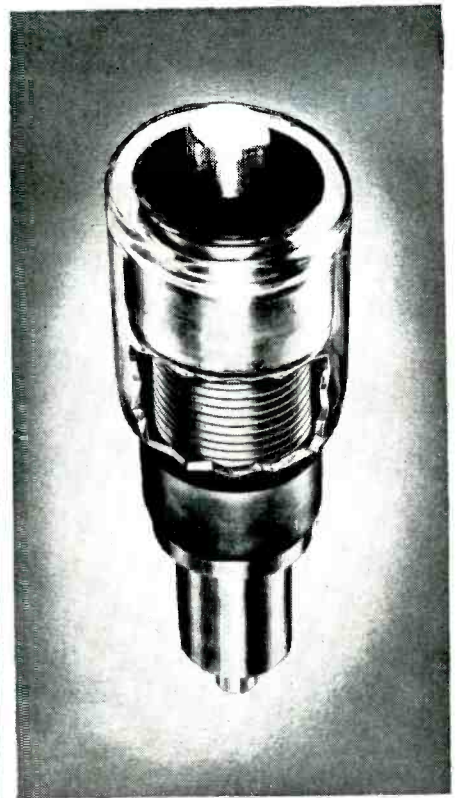

AND HERE'S THE ANSWER

Moving variable plate inside vacuum capacitor was the problem solved through the use of Clifford Hydron bellows assemblies by Jennings Radio Manufacturing Company. Being leak-proof and flexible, Clifford Hydron bellows form a perfect seal for the vacuum while permitting full movement of the variable plate.

Have you ever worked with Bellows?

"Bellows" haven't been in the engineering courses — but they have helped to solve some of today's knottiest engineering puzzles.

Clifford Hydron Bellows make flexible hermetic seals, permit extension, retraction and 360° rotation with 100% metallic seal.

In the electronic field Clifford Hydron Bellows are used for changing frequency inside magnetron tubes, making adjustments inside hermetically-sealed instruments, moving variable plates inside vacuum capacitors. They are also being used as expansion chambers in mercury-filled wave guides, oil filled transformers and other electronic and electrical equipment.

Clifford Bellows come in monel, stainless steel and other metals having very low gas transmission and emission properties. They are assembled to meet indi-

vidual requirements. Coupon will bring you additional information.

CLIFFORD MANUFACTURING COMPANY, 119 Grove Street, Waltham 54, Massachusetts. Division of Standard-Thomson Corporation. Sales offices in New York; Detroit; Chicago; Los Angeles; Waltham, Massachusetts.



CLIFFORD MANUFACTURING COMPANY

119 Grove Street, Waltham 54, Massachusetts

Gentlemen:

Please send me information on bellows application for vacuum tube adjustments. Also for:

- Transmitting motion between two mediums
- Controlling and indicating temperature
- Sealing rotary shafts or packless valves
- Transmitting motion hydraulically to remote points
- Providing for thermal expansion
- Providing shock mounting or vibration dampening
- Differential pressure maintenance

Name.....

Company Name.....

No. and Street.....

City..... Zone..... State.....

LORD MOUNTINGS PROTECT INSTRUMENTS and ELECTRONIC EQUIPMENT from VIBRATION and SHOCK DAMAGE • • •

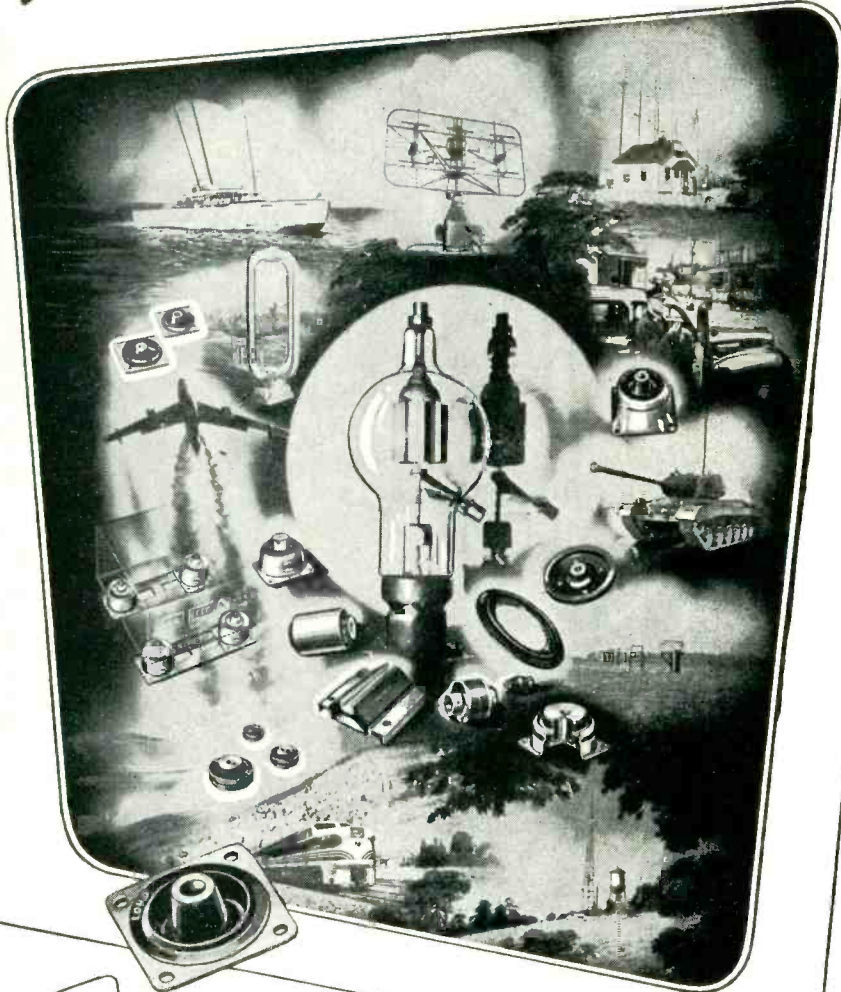

VIBRATION and shock are natural enemies of electronic equipment and precision instruments . . . To control the damage which these enemies can do, Lord Vibration Control Mountings and Bonded Rubber Parts are used to very profitable advantage. More than a quarter century's experience in dealing with vibration and shock is yours when you take advantage of Lord engineering assistance. The result of such consultation is full protection for electronic units and sensitive instruments by correctly designed and precisely manufactured Lord Mountings and Bonded-Rubber parts.

BURBANK, CALIFORNIA 233 South Third Street
 DALLAS, TEXAS 413 Fidelity Union Life Building
 PHILADELPHIA 7, PENNSYLVANIA 725 Widener Building
 DAYTON 2, OHIO 410 West First Street
 DETROIT 2, MICHIGAN 311 Curtis Building
 NEW YORK 16, NEW YORK 280 Madison Avenue
 CHICAGO 11, ILLINOIS 520 N. Michigan Ave. Room 811 Hanna Building
 CLEVELAND 15, OHIO

LORD MANUFACTURING COMPANY • ERIE, PA.



Headquarters for
VIBRATION CONTROL

spacers for tubes. The glass is set over a hole cut in the bench, with the lamp mounted about four inches below the glass under the bench, in the arrangement used by Sylvania Electric of P. R. Inc., Rio Piedras, Puerto Rico.



Frosted glass illuminated from below permits inspection for defects just as fast as operator can separate mica spacers with her nimble fingers

Applying Cement and Pitch

ENDS of tubular paper capacitors are sealed with creamy white cement at high speed in a special filling setup at Pyramid Electric Co., using 60 to 80 lb air pressure



Squirting cement into ends of tubular paper capacitors with high-pressure cement gun. Racks are inverted for filling other ends of units

TRU-OHM

Power Rheostats

NOW Available!

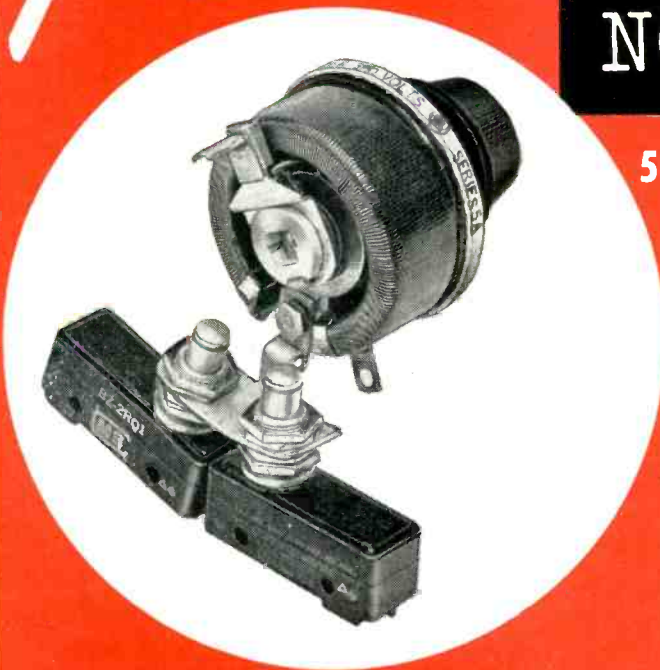

**50 watt - 75 watt - 100 watt - 150 watt
(25 watt available shortly)**

Special Features:

- ★ tapered windings
- ★ switch combinations
- ★ off positions
- ★ special shaft assemblies
- ★ tandem assemblies

May we have your prints for quotations and sampling? Prompt and courteous service is assured.



delivery we guarantee immediate delivery regardless of quantity, value and sizes.

price we guarantee that our prices will always save you money.



TRU-OHM VITREOUS ENAMELED RESISTORS
— A complete line ready for shipment!

quality we guarantee our engineering techniques and selection of materials will provide the finest products available.

approval we guarantee to meet the requirements of the most rigid specifications.

TRU-OHM RHEOSTATS and RESISTORS are approved by the foremost manufacturers for civilian and government applications.

TRU-OHM

PRODUCTS

Division of
Model Engineering
& Mfg., Inc.

General Sales Office: 2800 N. Milwaukee Avenue, Chicago 18, Ill.
Factory: Huntington, Indiana

MANUFACTURERS: Power Rheostats, Fixed Resistors, Adjustable Resistors, "Econohm" Resistors, "Tru-rib" Resistors



to force the cement out of the nozzle of a trigger-operated gun. The operator can aim and control the cement flow precisely, making it easier to fill the end of each unit completely and smoothly without overflow.

Capacitors are prepared for cementing by inserting empty cardboard tubes between the two wood strips of the rack, then tightening wing nuts just enough to hold the tubes in position. This loading is done over a jig that centers the tubes lengthwise. At another position, an operator inserts a rolled capacitor unit in each tube and bends its leads over metal rods. This insures that the rolled units will stay in place when the loaded rack is turned over for filling the other end of each capacitor. The pressure tank utilizes air from the master air pressure system of the plant.

Color Television

POWER SUPPLY

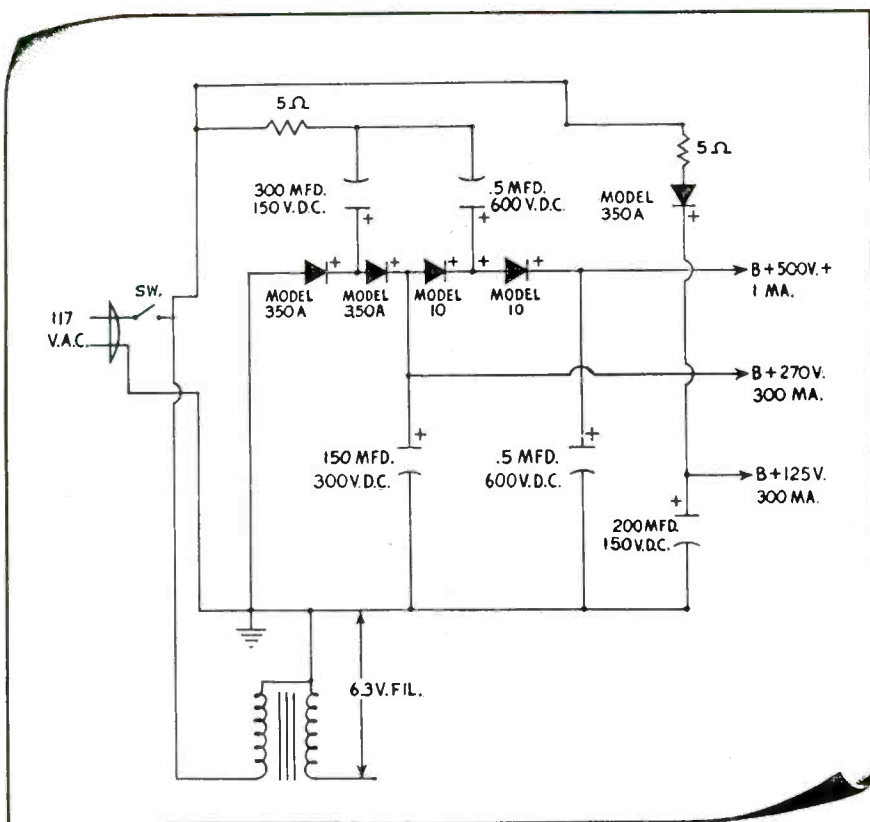

Write for further information.

Production Control Chart

WHEN DAILY PRODUCTION of each subassembly for a large electronic system is plotted on a vertical bar-type chart, subassemblies that are lagging behind the production schedule can be seen at a glance. The lowest bar also serves to tell

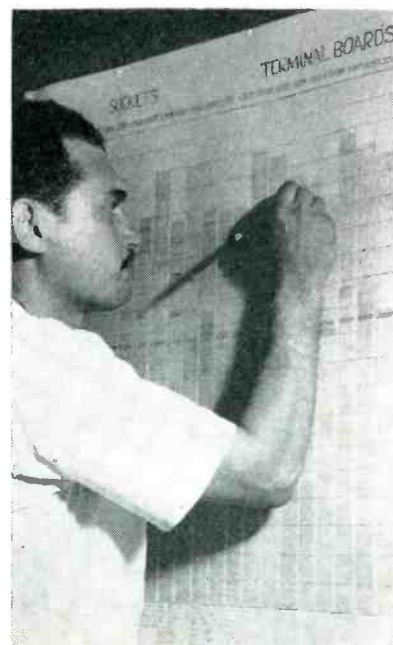

Foreman Victor Berlingieri increases height of bar for terminal board No. 5535 with blue pencil, to incorporate previous day's production of this unit of a military radar system



Rectifier Division

Dept. E5 415 North College Avenue
BLOOMINGTON, INDIANA
In Canada: 50 St. Clair Ave. W., Toronto

Are you overlooking the advantages of Corning metallized glass components?

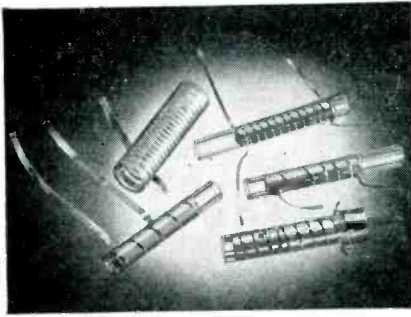

Corning Metallized Glass Inductances are noted for their exceptionally high electrical stability and negligible drift characteristics, even under widely variable ambient temperatures. High Q is inherent. They can be furnished with uniform, variable, or double-pitch windings and for fixed tuned, permeability tuned, or permeability tuned inductance trimmer combinations. They can be duplicated within very close tolerances in any quantity.

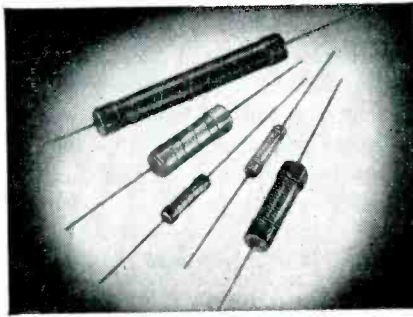

Corning Film-Type Resistors afford a tough unit with unusual stability and capable of withstanding high ambient and high operating temperatures. Type N has a resistance tolerance of 1% and is capable of operating at ambient temperatures up to 140° C.; Type S has a normal resistance tolerance of 2% and is capable of operating at ambient temperatures up to 200° C.

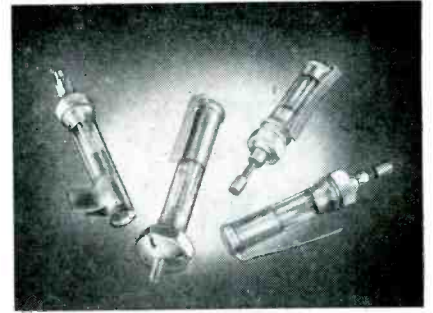

Corning Metallized Glass Midget Trimmer Capacitors have practically zero temperature coefficients in the VHF range. Capacity shift is negligible even with widely variable ambient temperatures. They are available in standard types from .3 to 12 u.f., or can be designed to meet your specific requirements. With direct traverse trimming, there is negligible capacity shift under vibrations, and an absolutely smooth capacity curve.

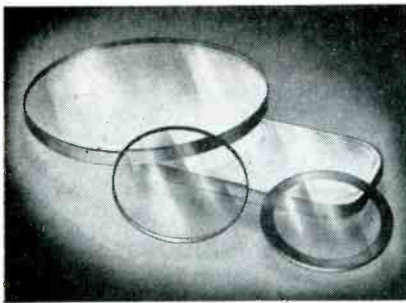

Corning Metallized Glass Instrument Windows are made of tempered glass with a metallized band on the edge. They are easy to solder, provide a perfect hermetic seal. Temperature and humidity changes resulting from leaks in gaskets, cements and oils are virtually eliminated. These windows are available in a number of standard sizes, or can be furnished to your specifications.

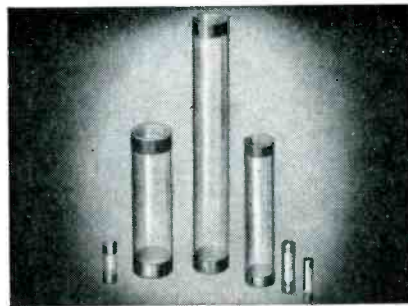

Corning Metallized Glass Tubes for hermetic encasement of capacitors, resistors, Selenium rectifiers and other electronic components offer a number of advantages. The metallizing makes possible a true hermetic seal, the electrical characteristics of the glass are excellent, transparency permits visual inspection, units are impervious to moisture, corrosive atmospheres, molds, etc. Available in 15 sizes ranging from 1 1/2" to 7" in length, O.D. 15", I.D. .295".

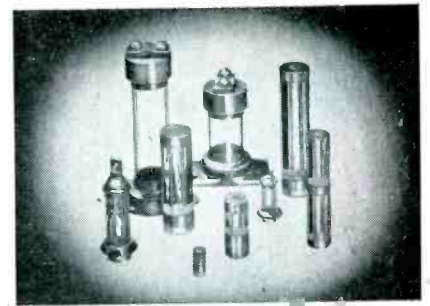

Corning Metallized Glass Bushings and Standoff Insulators are ideal for high voltage applications. The bushings provide hermetically sealed insulators for high-voltage capacitors and transformers, are available in 12 standard sizes ranging from 25/32" to 7/32" in length. Installation is fast and easy. The standoff insulators are made of tempered, low-loss glass, are completely nonhygroscopic. Both these components can be furnished in special sizes on order.

► *It will pay you to investigate the possibilities of Corning Metallized Glass Components. The coupon below will bring you the detailed information you need, or write and give us the details of the application you have in mind.*

Corning Glass Works

New Products Division



Corning means research in Glass

CORNING GLASS WORKS, Dept. EL-10, Corning, N. Y.

Please send me information on Inductances Resistors Copacitors Instrument Windows Tubes Bushings Standoff Insulators.

Name..... Title.....

Company.....

Address.....

City..... Zone..... State.....



THEY ARE WORTH MUCH MORE

CALIDYNE DOES

From time to time vacuum tube manufacturers and users have asked us if we make a standard shaker system or could build one for vibration testing vacuum tubes. The answer is that we do make one and can build others to suit your particular requirements. The value of such a system is obvious from both sales and use points of view.

VIBRATION IS OUR BUSINESS

Calidyne's business is to build shaker systems to meet individual needs. Wide frequency ranges are available. We build shakers to do frequency cycled tests varying from 10 to 1000 cycles per second. These give actual physical vibration in a linear plane. Acceleration levels go up to 15 g's on table loads of about 2 pounds. It is possible to develop a shaker that operates at frequencies up to 10,000 C.P.S.

VIBRATION-TESTED
VACUUM TUBES

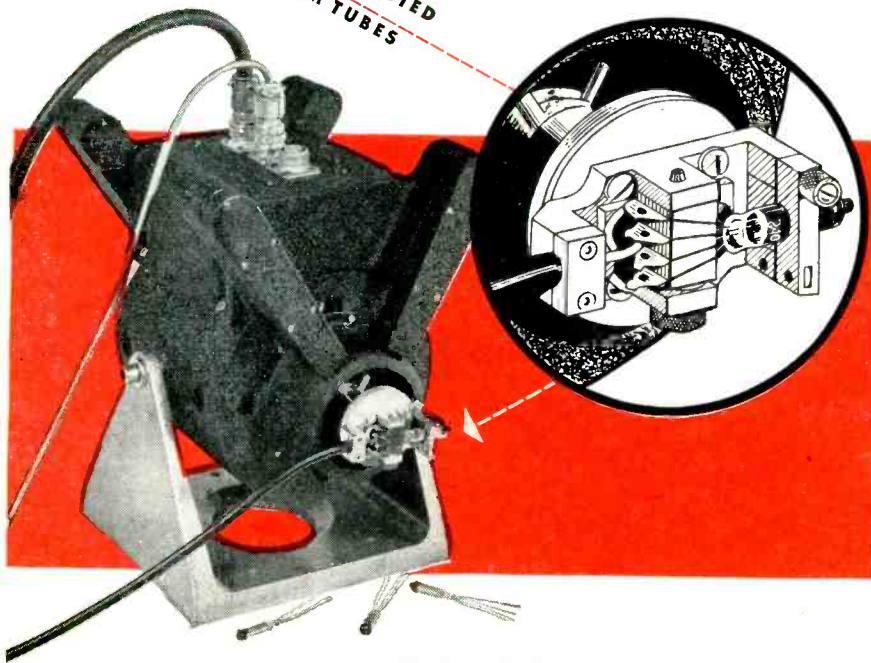

CALL ON CALIDYNE

If you make or use vacuum tubes for computers, guided missiles, radar, sonar or mobile applications, you must recognize the importance of dependable tubes proved by pretesting. Outline your problem in detail and let us see what we can do with it. You may then be able to *pretest* your vacuum tubes for vibration *before* putting them in the field.

SALES REPRESENTATIVES IN NEW YORK, LONG ISLAND, NEW JERSEY

G. C. Engel — Rector 2-0091 (N. Y.) • Ridgewood 6-7878 (N. J.)

CLEVELAND, OHIO

M. P. Odell Co.
Prospect 1-6171

DAYTON, OHIO

M. P. Odell Co.
Oregon 4441

HOLLYWOOD, CALIFORNIA

G. B. Miller Co.
Hollywood 9-6305

ALBUQUERQUE, NEW MEXICO

G. B. Miller Co.
Albuquerque 3-1998

751 MAIN STREET, WINCHESTER, MASSACHUSETTS

THE
CALIDYNE
COMPANY

WASHINGTON, D. C.

F. R. Jodon
Woodley 6-2615

FLORIDA

A. H. Lynch and Assoc.
Fort Myers 5-6762

CHICAGO, ILLINOIS

Hugh Marland Co.
Ambassador 2-1555

MINNEAPOLIS, MINN.

H. M. Richardson and Co.
Geneva 4078

DALLAS, TEXAS

John A. Green Co.
Dixon 9918

ARNPRIOR, ONTARIO, CANADA, Measurement Engineering Limited, Arnprior 400

WALTHAM, MASS., Robert A. Waters, Inc., Waltham 5-6900

PRODUCTION TECHNIQUES

(continued)

how many complete systems can be turned out with the subassemblies already produced.

In the plant of Caribe Aircraft Radio Corp. in Coamo, Puerto Rico, this type of chart is mounted on a large piece of plywood fastened to the end of one of the assembly lines. As soon as production figures for the day are available, the foreman increases the height of the bar for each subassembly in accordance with the number of subassemblies produced during the working day. The height of each bar then represents the total number of units produced to date.

Cutting Metal Tubing for Capacitor Housings

TWO METHODS of cutting metal housings for hermetically-sealed tubular capacitors are employed at the plant of Pyramid Electric Co. One method, used when trimming



Improvised lathe for cutting metal tubing to size for capacitor housings. Pressure of cutting tool makes arbor rotate tubing which is loosely held by right hand of operator

drawn cap-shaped housings to length for single-lead capacitors, employs an ordinary metal-working lathe and a disk-type cutoff tool. An arbor, grooved to the shape of the cutting blade, is mounted in the headstock of the lathe. The drawn brass housing is placed over the rotating arbor with the closed end firmly against the end of the arbor. The cutoff disk in the tool holder is then brought forward by depressing a foot pedal to cut off the excess metal. Pressure of the cutting tool against the housing

Zoom from 20mm to 60mm with

Pan Cinor[®]

Lens for TV Cameras

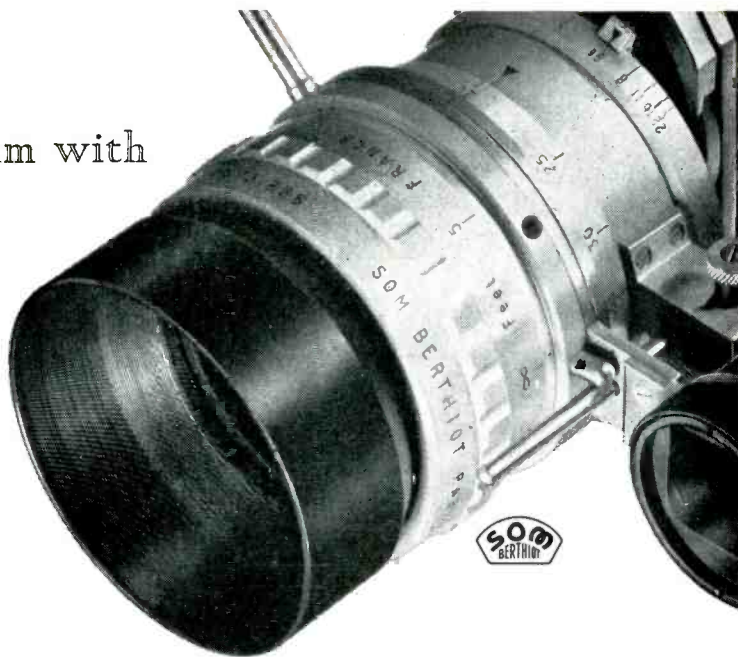

For broadcast TV... Industrial TV... open or closed circuits... more stations and industries are discovering the tremendous savings possible with this versatile lens!

Introduced a year ago, it has been a godsend to every budget-conscious purchaser.

At last the small station TV cameraman can *follow* action... *hold* action... *create* action and a virtually unlimited variety of special effects from one camera position! Rock-steady pictures are assured because dolly-ins are done optically. Zooming-in for close-ups is a 'must' in TV commercials. With the Pan Cinor, just a touch of the turret lever... and you're in!

The industrial user training his camera on factory operations or demonstrations can re-direct his attention from close-up to telephoto from a flat-footed stance. RCA reports most

focusing can be remotely controlled automatically, and Dage assures us they can operate the turret lever by push-button if desired.

In addition... the Pan Cinor has a standard "C" mount... it fits not only the Dage and RCA TV cameras, but can be used on a majority of the 16mm movie cameras used in studios and industry today.

Maximum aperture F:2.8. Focusing range: 5 feet to infinity. Diaphragm stops to F:2.2. Weight, including viewfinder, 2.1 lbs. All lens elements are coated. Complete with coupled viewfinder for use with 16mm movie cameras. Som Berthiot Pan Cinor lens

\$447⁵⁰

See your Bolex Franchised Dealer or write for illustrated pamphlet to: Sole U. S. Distributors, Paillard Products, Inc. 100 Sixth Ave., N. Y. 13, N. Y.

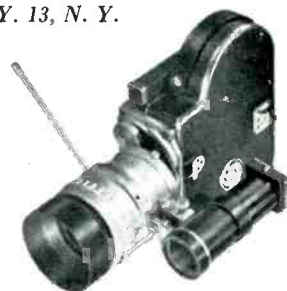

Pan Cinor Zoom-type lens with coupled viewfinder has standard "C" mount. Fits most 16mm movie cameras without modifications:

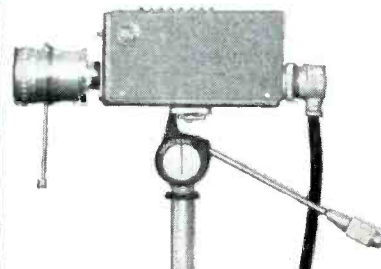

Budget size TV camera zooms in for a commercial close-up with the Pan Cinor Lens.

R.C.A. industrial TV camera with Pan Cinor.

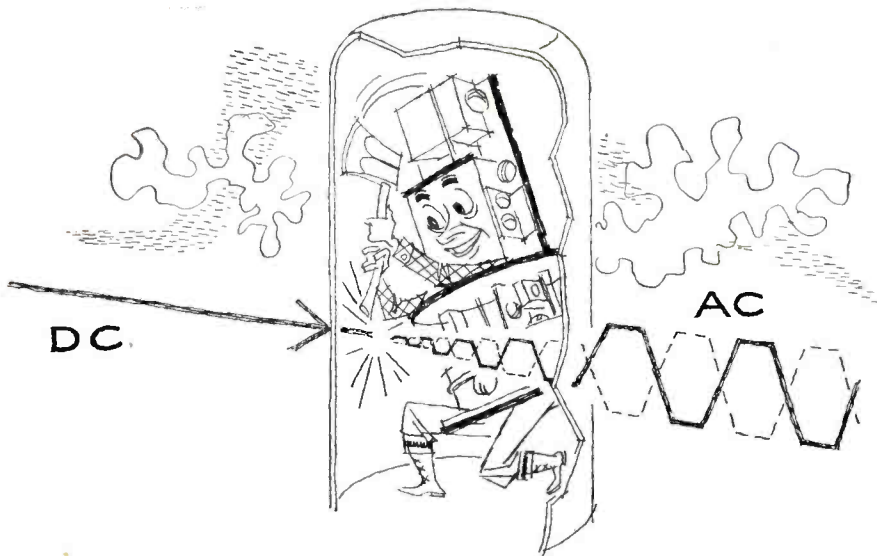

"Most consistent 'chopper' on the market"

That's what a lot of people who use vibrators say about the Honeywell Synchronous Vibrator WG-178.

They know from experience that performance is consistent from one unit to the next—a most important consideration. This high consistency in the performance of the WG-178 is a direct result of the quality of design and workmanship that is a distinctive feature of all products manufactured by the Honeywell Aero Division.

Here are some of the other characteristics of the little "chopper":

1. It's versatile, can be used as a DC-AC modulator, or as a rectifier.
2. It's longer-lived, operating for an average of 500 hours.
3. It's adjustable. Open and closed times can be varied.
4. It's tough. When shock mounted (in any position) it exceeds rigid Air Force environmental specs.
5. It's a precision instrument. Quality design guarantees exceptionally clean signals.

If you'd like to know more about the WG-178 Synchronous Vibrator, we'd be pleased to send details. The address is Honeywell Aero Division, Dept. 401 (E), Minneapolis 13, Minnesota.

MINNEAPOLIS
Honeywell



Aeronautical Controls

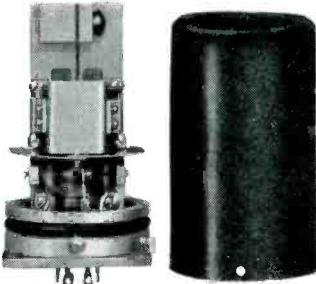

Specifications for Synchronous Vibrator WG-178

Coil Supply: Suggested supply voltage is 115 volts, 400 cps for WG-178A and 12.6 volts, 400 cps for WG-178B when suitable voltage-dropping resistors are included in the circuit with the field coil.

Power: Approximately 0.7 watts, excluding the phasing circuit.

Contact Rating: Contact rating depends on circuit in which units are used. All applications should be referred to our engineering department for approval. The devices have been used in circuits with approximately one milliamperes (nominal) current and up to 35 volts dc supply.

Environment: When used on a shock-mounted chassis type mounting the units conform to Spec 41065B as called for in AF27500D as follows:

Humidity Test: 10 day (24-hour cycle).

Temperature Test: -65°F. to 160°F. (-54°C. to 71°C.).

Altitude Test: 55,000 feet.

Vibration Test: Up to 200 cps (5G maximum). This is a modified test.

Sand and Dust Test: As specified.

Mildew Resistance Test: 28 days.

Salt Spray Test: 50 hours.

Weight: Approximately 0.5 lb.

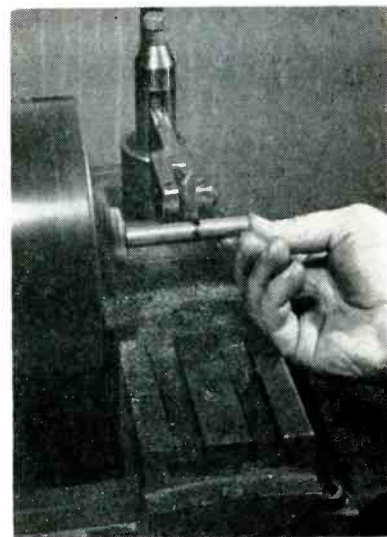

Lathe setup for trimming brass caps to length. After making a cut, the operator pushes off the finished housing and the waste metal with her fingers

gives the required friction between housing and arbor to get the rotation needed for cutting action.

The second method, for cutting tubing to short lengths for housings of two-lead capacitors, uses a drill chuck and motor mounted on a metal plate. A short grooved arbor is placed in the drill chuck. The foot-operated cutting disk works exactly the same as on the lathe. The length of the cut is governed by the distance of the cutoff tool from the jaws of the chuck. The position of the cutoff tool is adjusted by moving it along a shaft parallel to the arbor, and the arbor is then correspondingly positioned in the chuck.

Insulating Cold-Headed Iron Core-Bobbin

USE OF AN IRON core as its own bobbin for aircraft relays eliminated the cost and other drawbacks of separate bobbins but presented the problem of achieving adequate insulation between core and winding. This was solved in the plant of Phillips Control Corp. in San Juan, Puerto Rico, by using split acetate tubing and split fiber-base plastic washers.

The flanges that serve to hold in the winding are cold-headed on each end of the solid iron rod used as the relay core. One end of the core is

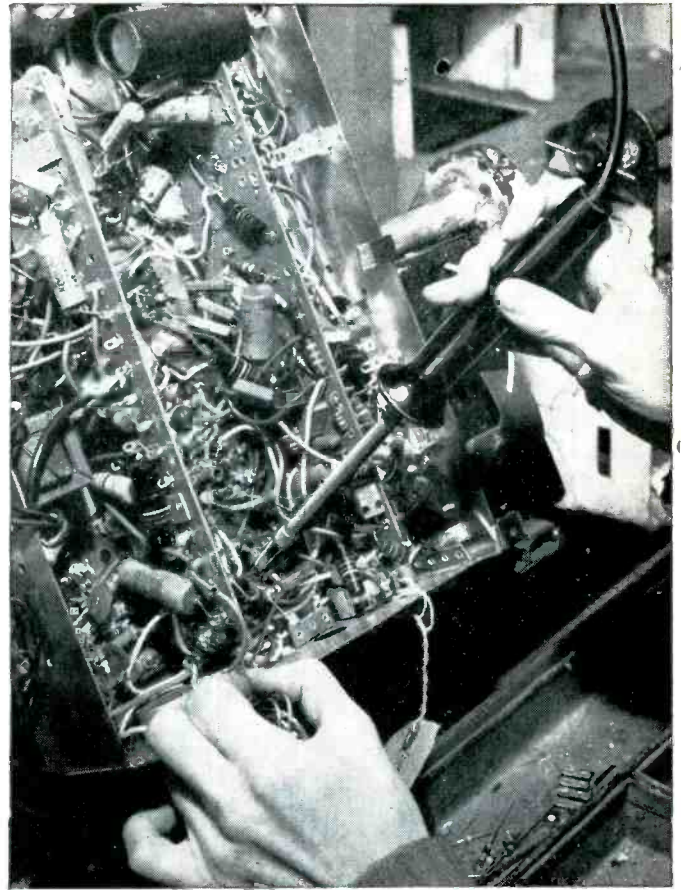
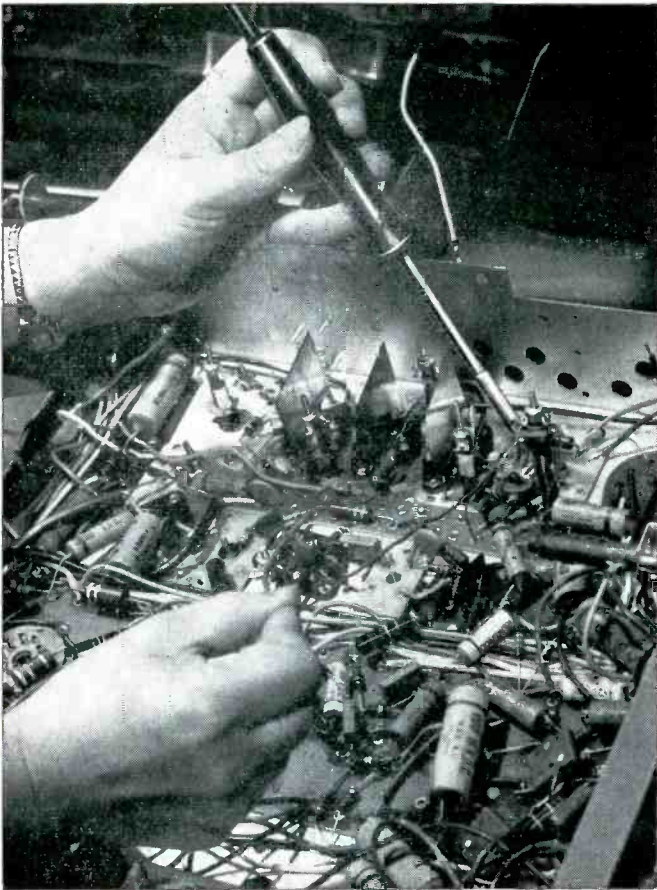

G-E MIDGET AND G-E LIGHTWEIGHT IMPROVE SOLDERING EFFICIENCY AND SPEED IN TIGHT PLACES.

Now—2 G-E Irons for Hard-to-solder Places

FAST PRODUCTION WITH THE G-E LIGHTWEIGHT

Quick heat recovery and easy handling combine to give you quality production at high speed. The thin, $\frac{5}{16}$ -inch diameter shank allows easy soldering where a bulkier iron can't reach or would cause damage to insulation and surrounding parts.

PINPOINT ACCURACY WITH THE G-E MIDGET

Soldering difficult joints is as easy as writing with a pencil when you use the slender, 1 $\frac{3}{4}$ -ounce, 6-volt midget iron. Power costs are cut to one-fourth those of a regular iron, and tip heat can be closely controlled with the optional four-tap transformer.

BOTH LIGHTWEIGHT AND MIDGET IRONS OFFER YOU:

Longer Service, Lower Maintenance—Extra long wearing Ironclad tips resist pitting and corrosion, giving you longer service for both high-speed repetitive production line soldering and intermittent work. General Electric Calrod* heaters provide dependable, efficient operation throughout their long life. The tip and heater unit is easily replaced by unscrewing it from the handle.

Reduced Operator Fatigue—Both irons are light in weight, well balanced, and have comfortable handles. Easy handling helps cut rejects and increase operator speed and efficiency.

SOLVE YOUR SOLDERING PROBLEMS TODAY

For the complete story on the G-E Lightweight and Midget soldering irons contact your G-E Apparatus Sales Office or Distributor. Additional information is yours by mailing the coupon below.

*Reg. Trade-mark of General Electric Company

Section C720-115
General Electric Co.
Schenectady 5, N. Y.

Please send me the following bulletins:

- For immediate project For reference
 GED-1583, G-E Lightweight Soldering Iron.
 GEA-4519D, G-E Industrial Soldering Irons.

Name

Company

Address

City State

You can put your confidence in—
GENERAL  ELECTRIC

Terminals are hermetically sealed by exclusive process developed for Cannon's widely acclaimed hermetically sealed electric connectors.

Insulation test: 1000v ac

The armature (plunger) and the anvil are high quality annealed Armco magnetic ingot iron.

Molded Nylon cap protects the terminals.

Molded "Silcan" cap protects the return spring and plunger end.

Silver brazed seals

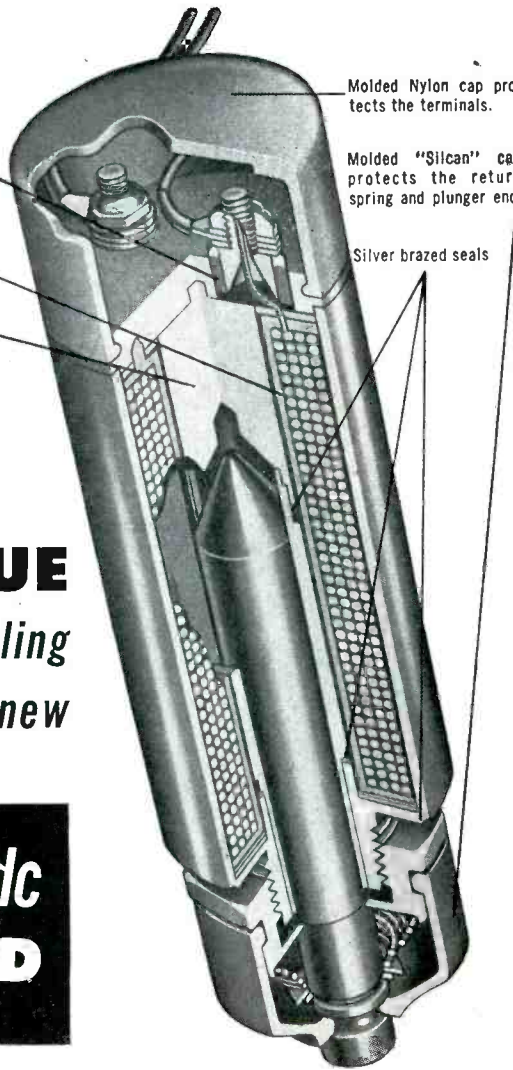

TRUE
hermetic sealing
in this new

CANNON dc
SOLENOID

For pressurized or corrosion resistant service, Cannon's dc Solenoids offer positive hermetic sealing, sound construction, painstaking workmanship and highest quality materials. A vitreous insulating material is heat-fused to shell and contact terminals, creating a perfect seal. Other parts are silver brazed. The entire solenoid is then copper-nickel-chrome plated to insure complete coverage, high corrosion resistance and long, trouble-free service. Solenoid No. 19760, above, the first hermetically sealed product of this type, is built for continuous duty on 28v dc systems. Fitted with other coils, it renders intermittent duty as characterized by the chart at right. Cannon's hermetically sealed solenoid series reflects the same uncompromising attention to details of sound design, engineering and workmanship that has made the name "Cannon" synonymous with "quality" for more than 38 years. For complete information write for new Solenoid Bulletin DCS4-1953 showing 105 different assemblies.

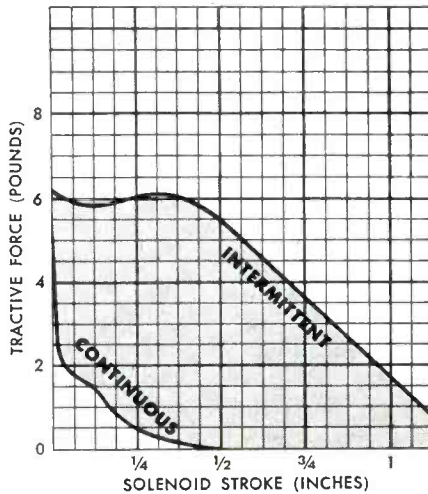

Solenoids of the hermetically sealed 19760 series, through modification of the coil windings, can meet various characteristics and specific applications within the limits indicated above.



Applying split acetate sleeve to iron core-bobbin



Placing split laminated washer over insulated core

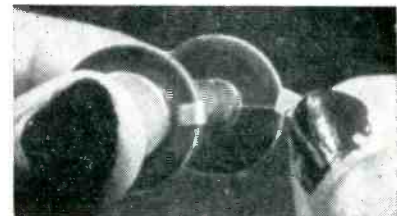

Applying tab of tape to hold together the two types of insulating washers

flush, while the other has an extension that is used later for staking the core to the relay frame.

The core is insulated first by slipping a length of split acetate tubing over the smaller headed end. This tubing has sufficient curl so that it laps over itself when on the core.

Two laminated fiber-base Bakelite header washers, each split along a radius, are next slipped over the insulated core and pushed against each header. Split acetate headers of similar size are put on next and pushed against each of the laminated headers, in such a way that the splits of adjacent washers do not line up. Finally, a small tab of Scotch No. 6 yellow

CANNON ELECTRIC

Since 1915



CANNON ELECTRIC COMPANY, LOS ANGELES 31, CALIFORNIA
Factories in Los Angeles, Toronto, New Haven. • Representatives in principal cities. Address inquiries to Cannon Electric Company, Dept. K-120, Los Angeles 31, California.

"miniaturized"

FOR MAXIMUM EFFICIENCY

EAD's

new versatile 1" motor

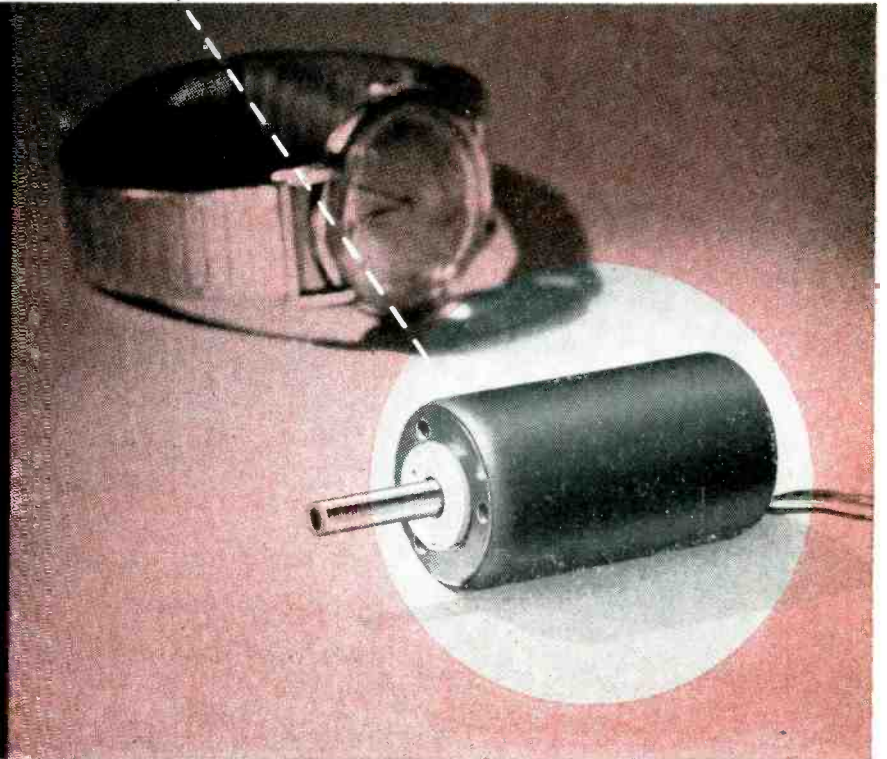

MODEL NO. D21UHP-1 (ACTUAL SIZE)

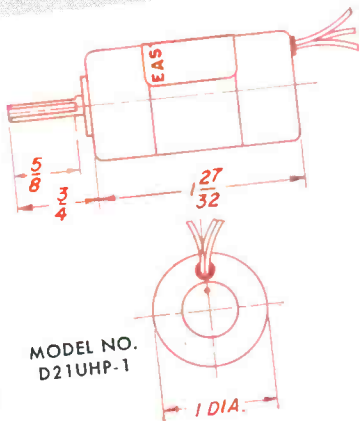

MODEL NO.
D21UHP-1

SPECIFICATIONS

Capacitor run induction motor, 115 volts, 400 cycles, single phase, 11,000 R.P.M., .1 Amp., 1/300th H.P., .1 MFD.-220 V., 35% efficiency, weight—3½ oz.

APPLICATIONS

Fans, blowers, instruments, controls and low power drives.

Another outstanding EAD contribution to the miniaturization program is this extremely small, precision motor. Engineered for *long life and high efficiency*, it is especially designed for operation in confined areas where minimum size and weight is essential.

Units are available in this small frame size for 400 cycle or variable frequency operation, with 400 cycle power ratings ranging up to approximately 1/100 H.P. Modifications include high ambient and high altitude versions as well as servo, synchronous and gear motors.

400 CYCLE OPERATING CHARACTERISTICS

APPROXIMATE R.P.M.	7,000	10,500	21,000
PHASES	1,2	1,2,3	1,2,3
INPUT VOLTAGE (MAXIMUM)	115	115	115



EASTERN AIR DEVICES, INC.

585 DEAN ST., BROOKLYN 17, NEW YORK

QUALITY is Foremost IN VICKERS RECTIFIERS



Vickers refines its own selenium for uniform, dependable performance

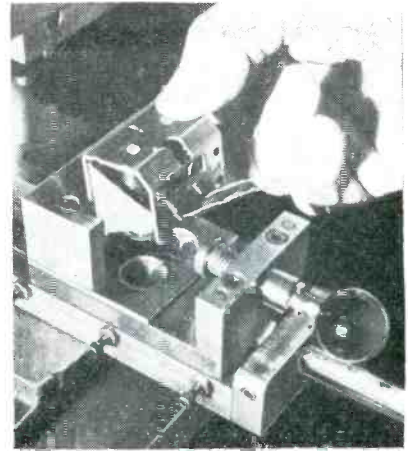

Method of inserting relay assembly in fixture preparatory to staking the two cores to the frame. Recesses in bottom of fixture serve to center the coils. Upper plunger is released by rotating back knob 90 degrees, to hold frame against fixture. Lower plunger is used to push sliding fixture in under staking dies of press

Automatic electro forming "pre-stresses" cells

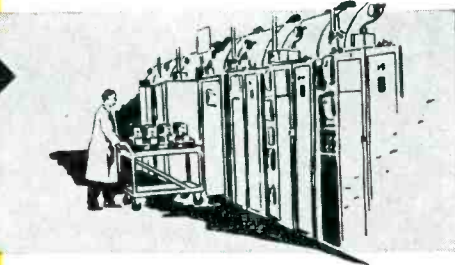

Performance matching of cells prevents overloading-overheating

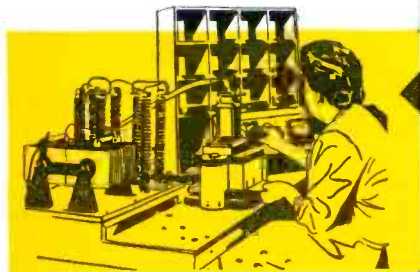

Hydraulic assembly assures constant mechanical strength and dimension



255 tests and inspections guarantee Vickers Quality

acetate tape is applied over the split in each acetate header and brought outward over the other type of washer to hold the two together. The insulated core is now ready for the winding machine.

The coils are wound on a Leeson No. 102 three-spindle semiautomatic winding machine modified to take the cold-headed bobbins. A typical coil would get 3,700 turns of No. 34 enameled copper wire.

While the machine is winding automatically, the operator keeps busy by soldering insulated lead wires to the enameled leads of previously wound cores. Other in-be-



These reasons alone would be assurance of Vickers rectifier superiority. Add the many other refinements of design and construction... the experience and careful workmanship... and you will be sure that Vickers is the best answer to your rectifying needs, large or small.

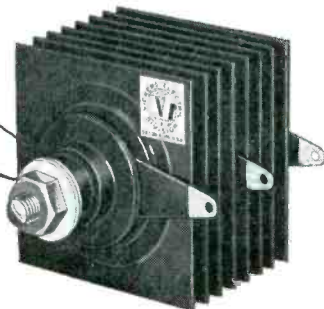

Write for Bulletin 3000. Vickers engineering service is available without obligation.

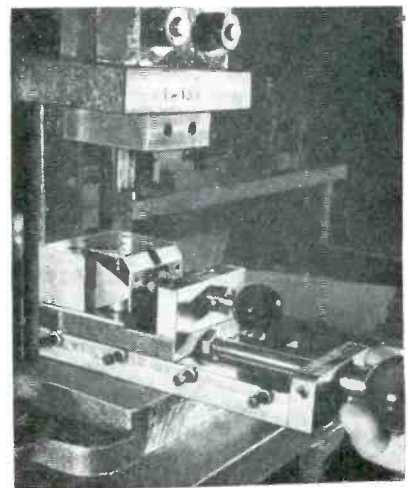

Operator withdraws slide by pulling out knob after press has staked cores to frame

VICKERS ELECTRIC DIVISION

VICKERS Inc.

UNIT OF THE SPERRY CORPORATION
1801 LOCUST STREET • SAINT LOUIS, MISSOURI

for **BRASS** Bridgeport *Service* CO.



OFFICES AND
WAREHOUSES IN
PRINCIPAL CITIES



BRIDGEPORT WAREHOUSE SERVICE

The Bridgeport warehouses are designed to supply from stock limited quantities of sheet, rod, wire or tubing. It is the policy of the company to maintain adequate warehouse stocks at all times so that small orders can be filled without delay.

The fabricator is in a position to obtain promptly metal to fill orders for experimental work or to start production runs, while waiting for mill shipments.

Bridgeport warehouses make every effort to carry the variety of alloys, sizes and gages which fulfill the requirements of the locality they serve.

To take care of the maximum range of widths of strip metal, slitting service is available—not only to serve warehouse stocks, but also to make customers' stocks of non-ferrous strip metal more flexible.

Bridgeport's Warehouse Stocklist carries weight tables and a technical digest giving the properties of the most popular copper-base alloys. If you do not have a copy, ask your nearest Bridgeport office.

Mills in Bridgeport, Conn. and Indianapolis, Ind.

In Canada: Noranda Copper and Brass Limited, Montreal

BRIDGEPORT BRASS COMPANY



30 GRAND STREET, BRIDGEPORT 2, CONNECTICUT

When VIBRATION AND SHOCK become a headache—

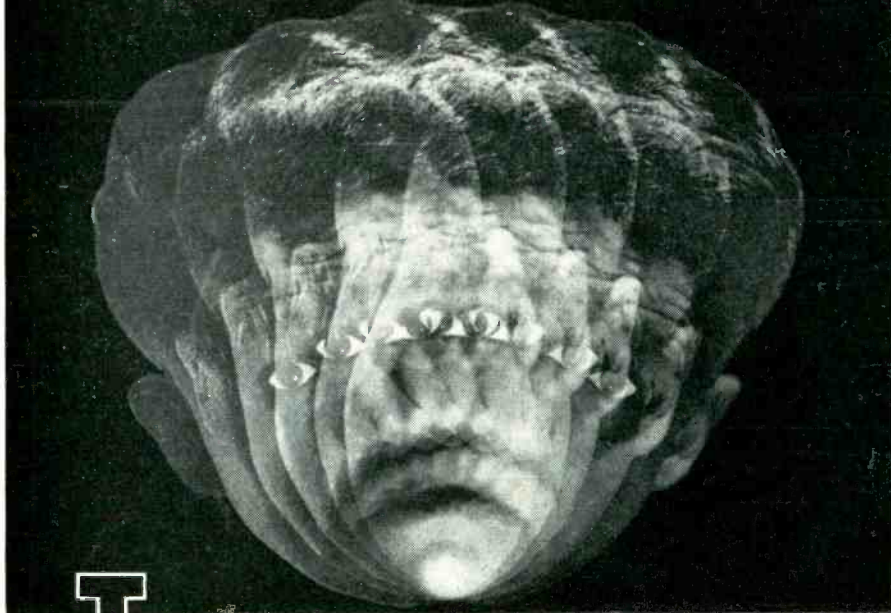

Turn to **FINNFLEX** for relief!

FINNFLEX offers MAXIMUM PROTECTION for VITAL EQUIPMENT by means of:—

**AIRBORNE MOUNTING BASES
VIBRATION ISOLATORS
SHOCK MOUNTS**

Conform to JAN-C-172A, but are actually made to exceed MIL-E-5400 (Superseding AN-E-19) Drop Test requirements.

FINNFLEX Mounts isolate vibration and shock from Electronic, Communication, and Control Equipment. They offer unimpaired efficiency from -80° to $+250^{\circ}$ F., "Selective Action" friction dampening, non-linear steel springs, and other features. Many sizes, load ratings available.

FINNFLEX 3-POINT SERVICE for SPECIAL PROBLEMS: (1) *Testing:* We have complete laboratory facilities for Vibration, Shock and Drop Testing... (2) *Designing:* We design and recommend a Shock or Vibration Mount best suited to your special needs... (3) *Manufacturing:* We have substantial facilities for manufacturing the desired unit in any quantity, economically, and on schedule. Send us your problem today, or write for Catalog MB-110.

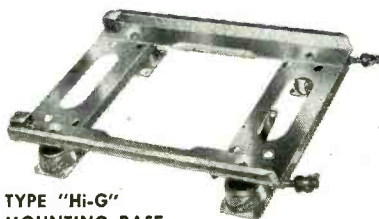

TYPE "Hi-G" MOUNTING BASE

These units have exceptional ruggedness, plus a special reinforced structure to withstand shock far in excess of 30 "G". This characteristic makes these bases ideal for use in carrier-based aircraft.

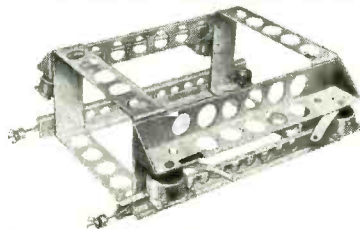

TYPE "CG" MOUNTING BASE

Especially designed for equipment having eccentric CG permitting a wide variation in the loads applied to the individual mounting. The use of FINNFLEX Vibration and Shock Material assures you of superlative Industrial or Governmental Bases and Mounts.

tween duties include cutting tabs of Scotch tape in readiness for anchoring the start and finish of each winding on the machine.

The next step is staking the cores into position on a relay frame. Each relay gets two coils. The projecting core ends are inserted in their frame holes and the assembly is placed in the slide of a holding fixture mounted on the bed of a punch press. A spring-loaded rod holds the frame in position. Re-



Machine used for winding three aircraft relay coils at a time on insulated solid iron core-bobbins

cesses in the fixture serve to center the lower ends of the coils precisely. The operator now pushes the slide in and operates the press. This stakes both cores in one operation. A spring-loaded pushrod in between the staking dies holds the frame tightly against the cores during staking.

Resistor Coating Techniques

MOTOR-STIRRED varnish dispensers and tilted drying racks permit efficient manual application of protective coatings to deposited carbon resistors at Radell Corp., San Juan, Puerto Rico.

One protective coating employed for this purpose is a mica-filled melamine varnish. This is applied cold but is kept thoroughly stirred by means of a stirring fan on the shaft of a fractional horse-power motor. The dispensing container is completely covered to prevent splattering as well as to minimize evaporation, with the exception of an opening only slightly larger than the resistor to be coated, located at the nozzle-shaped front end of the dispenser. The operator grasps



T. R. FINN & COMPANY, Inc.

Specialists in Vibration Control

333 JACKSON AVENUE, NEW YORK 54, N. Y.

Phone: CYpress 2-4192-3-4

**MOLONEY HiperCore
ELECTRONIC CORES**

CARE BUILDS BETTER CORES

Skill and care mark every operation in the meticulous manufacture of Moloney HiperCore Electronic Cores. Under the watchful eyes of conscientious craftsmen, the windings of cold-rolled, oriented silicon steel are annealed in an inert gas atmosphere at carefully controlled temperatures to relieve any stresses that might affect their superior qualities. To prevent physical distortion, the cores are impregnated with a thermo-setting resin that bonds the insulated laminations into rigid, heat resistant units. Because of this planning and care, Moloney HiperCore Electronic Cores can be accurately cut to eliminate many costly operations in your assembly line.

Because Moloney HiperCore Electronic Cores have lower losses and greater flux carrying capacities, they enable you to make a better product. Moloney HiperCore Electronic Cores are *wound* cores that offer the advantages of less weight, less bulk—plus the “extra” that is always found in Moloney products.

MEB3-20

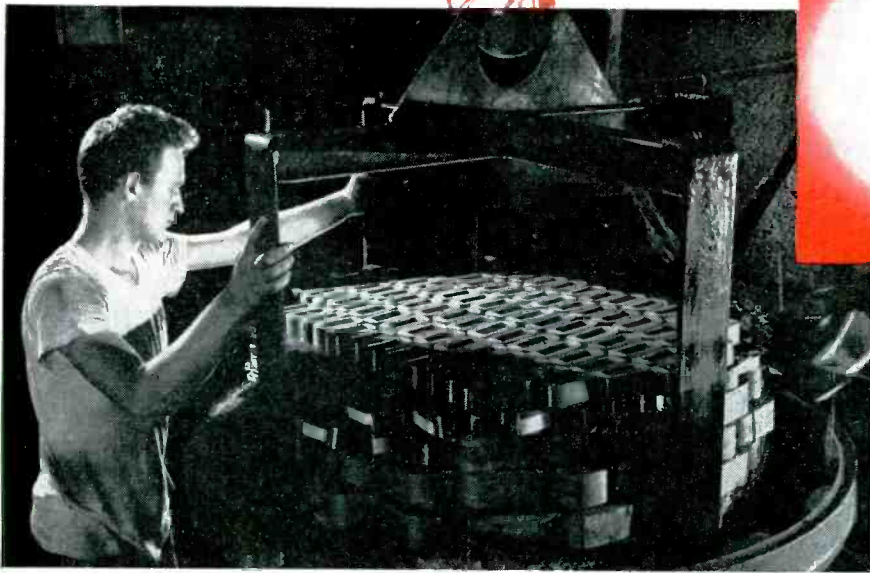
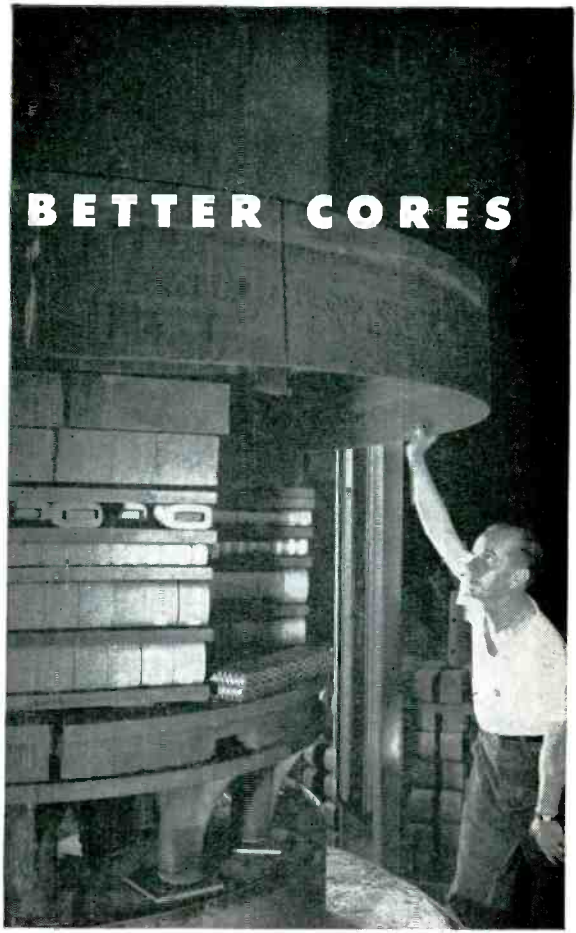

So if your product demands *better performance, smaller size and less weight*, specify Moloney Electronic Cores. Available in 1000 standard sizes—or built to your specifications.

Write today for Bulletin SR-205 containing specifications, performance data and prices.



MOLONEY ELECTRIC COMPANY

Manufacturers of Power Transformers • Distribution Transformers • Load Ratio Control Transformers • Step Voltage Regulators • Unit Substations

SALES OFFICES IN ALL PRINCIPAL CITIES • FACTORIES AT ST. LOUIS 20, MISSOURI AND TORONTO, ONTARIO, CANADA

NOW **R**apid, precise rpm measurement

accuracy of ± 1 rpm, at speeds to 100,000 rpm!
 direct-reading digital presentation!
 permanent printed record if desired!

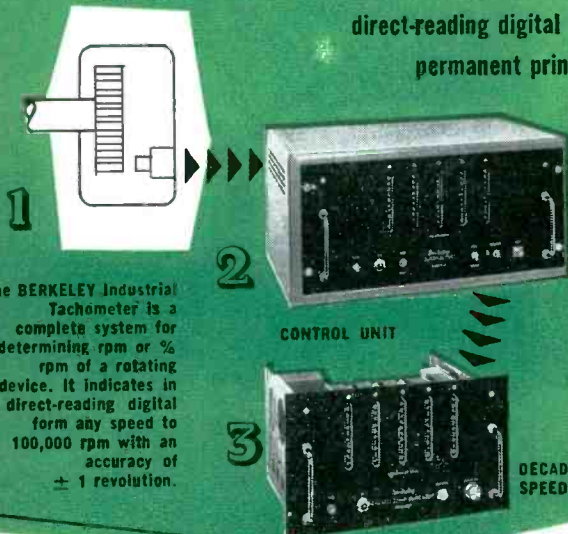

with the
Berkeley
 INDUSTRIAL
 TACHOMETER

Series
 5600

1 The BERKELEY Industrial Tachometer is a complete system for determining rpm or % rpm of a rotating device. It indicates in direct-reading digital form any speed to 100,000 rpm with an accuracy of ± 1 revolution.

2 CONTROL UNIT

3 DECADE SPEED INDICATOR

THE BASIC SYSTEMS INCLUDE

1

TACHOMETER PICKUP connected directly or indirectly to the rotating device to produce an electrical pulse at each revolution, or any desired fraction of a revolution. Standard BERKELEY magnetic and reflecting photoelectric types are available.

2

CONTROL UNIT receives pulses from pickup and amplifies them, passing them to the speed indicating device during the selected time interval (usually 1 second). Control Units are available with or without integral time base. The latter unit requires a Master Time Base, which is designed to drive a number of Control Units simultaneously. This provides greatest possible flexibility for multi-unit installations.

3

DECADE INDICATOR displays rpm in direct-reading digital form on a bank of five Decimal Counting Units. Display time is continuously variable from 1 to 5 seconds; unit may be recycled manually or automatically. Decade Indicator may be installed remote from pickup or Control Unit. BERKELEY Printed Readout may be added to provide permanent record on standard adding machine tape.

4

METER INDICATORS may also be used in conjunction with the system at any desired remote location, and is merely plugged in to Control Unit. 7" scale may be calibrated in rpm or fraction of rpm.

SPECIFICATIONS

Range: 0 to 100,000 rpm for Decade Indicator and Meter Indicator	Cabinet Size: EPUT Control Unit ... 20 3/4" x 10 1/2" x 15" Decade Indicator ... 16 3/8" x 10 1/2" x 13" Meter Indicator ... No cabinet Master Time Base ... 20 3/4" x 10 1/2" x 15"
Accuracy: ± 1 rpm for Decade Indicator $\pm 10\%$ for Meter Indicator	Price: Model 5600 Control Unit \$1375.00 Model 5601 Control Unit \$1160.00 Model 5621 Decade Speed Indicator \$ 740.00 Model 5621E Decade Speed Indicator with extinguishing feature \$ 840.00 Model 5623 Meter Indicator \$ 80.00 Model 5630 Master Time Base \$ 980.00 Model 461 Tachometer Pickup \$ 100.00 Model 464 Tachometer Pickup \$ 275.00 Model 465 Tachometer Pickup \$ 325.00 Model 440 Reflecting Tachometer Pickup \$ 135.00
Input Sensitivity: 0.2 volts rms to 20 volts rms maximum Designed to operate from Berkeley Tachometer Pickups	
Reset: Either automatic or manual	
Display Time: Continuously variable 1 to 5 seconds	
Panel Size: EPUT Control Unit ... 19" x 8 3/4" Decade Indicator ... 15 3/8" x 8 3/4" Meter Indicator ... 5 1/2" x 5 1/2" Master Time Base ... 19" x 8 3/4"	

Prices are f.o.b. Richmond, California. Specifications subject to change without notice.

APPLICATION ENGINEERING ASSISTANCE

The benefit of experience gained on scores of BERKELEY tachometry installations is yours for the asking. Our engineers will gladly assist you in planning instrumentation to meet your specific needs. For details, please request Bulletin G-10.

Berkeley

division
 BECKMAN INSTRUMENTS INC.
 2700 WRIGHT AVE., RICHMOND, CALIF.



Motor-stirred varnish dispenser for applying protective coatings to resistors. Boards with drilled holes, raised above the bench by end blocks, serve as self-counting trays for uncoated resistors

the resistor by its leads with gloved hands, holds it in the opening of the dispenser, and rotates it until the entire body is covered. The resistor is then placed on a draining rack mounted on an angle and designed in such a way that surplus coating flows down the rack rather than down the resistor lead.

After draining and drying in the air for about 1 1/2 hours, resistors are transferred to a clean rack for baking 30 minutes at 300 F to set the material. When a synthetic resin enamel is used as the coating, the motor-driven stirrer is not required but the remainder of the technique is the same.

Racks must be changed between drying and baking because once the



Method of rotating body of resistor in dispenser opening

Shrimp boats are a'comin'...

Shrimp boats encounter rough seas. Their safe return can depend upon the reliable electrical power supply, provided by Onan generators.

To insure performance for these and all AC and DC, military and commercial regulated power units they manufacture, D. W. Onan & Sons Inc., has standardized on Regohm voltage regulators. Whether on sea, land or air applications, this low cost, compact, electro-mechanical controller dem-



Powered by Onan Electric Generators

Controlled by

Regohm

Voltage Regulators

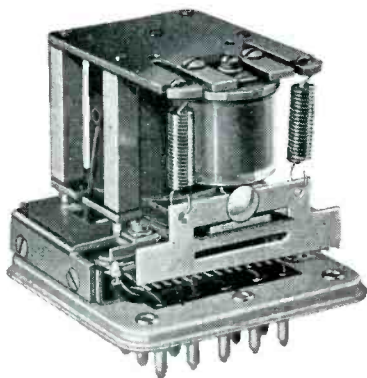

onstrates rugged ability to withstand severe vibration, shock or ambient temperature conditions. And you can't beat the band of Regohm's voltage regulation. Standard models provide constant voltage output within less than $\pm 2\%$.

Onan Engineers like these additional advantages of Regohm Voltage Regulators:

1. Size—Regohm is small in size, light in weight, but big in performance. It is a natural where economy of space and weight are major considerations.

2. Low Cost—Regohm costs less, does more, than the complex equipment that once was the only available solution to control problems.

3. System Stabilizing—With its high speed averaging effect and a built-in, thoroughly reliable dashpot, Regohm will stabilize control systems with widely varying characteristics.

4. Low Operating Power—Low signal power requirement of one watt for solenoid bias makes Regohm easily applicable to special units.

5. Long Life—In properly engineered installations, Regohm's life is measured in years. Shelf life is substantially unlimited.

6. Simplified Maintenance—Regohm's plug-in feature simplifies replacement and maintenance—there are no parts to renew or lubricate.

Call on our engineering and research facilities to help you develop optimum design for your equipment and system. Learn how Regohm can help you with your regulation problem. Write for Bulletin 505.00. Address Dept. E, Electric Regulator Corp., Norwalk, Connecticut.

REGOHM



CONTROL COMPONENT IN: Servo systems • battery chargers • airborne controls • portable and stationary generators • marine radar • inverters • locomotive braking systems • mobile telephones • guided missiles • signal and alarm systems • telephone central station equipment • magnetic clutches • railroad communication systems.

Just Off the Press



Send Today for your
FREE copy of the New
20 page Fusite Catalog

Your information on glass-to-steel hermetic terminals is not up-to-date until you have seen this new Fusite catalog. Many brand-new types of terminals and many new variations are now available in this most famous line. Write today for your copy, Dept. A-3.



THE FUSITE CORPORATION

6000 FERNVIEW AVE., CINCINNATI 13, OHIO

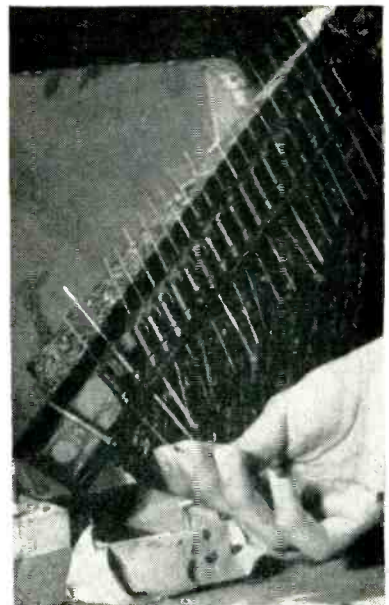

Placing resistor on slanting rack used for draining off surplus coating. Note that coating does not drain down the resistor leads. Wrapping paper fastened to benches with masking tape is replaced each day to give clean appearance to messy job

thermosetting material is baked onto a rack, it cannot be cleaned off with solvent.

Liquid level is maintained at the dipping opening of the dispenser by tipping the entire dispenser forward as the coating material is consumed. This is made possible by a mounting involving a shaft with locking wing nut.

Cutting Phenolic Plastic

MASKING TAPE and cardboard serve to improvise an inexpensive means of collecting the irritating phenolic dust produced when cutting off one section of a five-terminal molded plastic strip, in the San

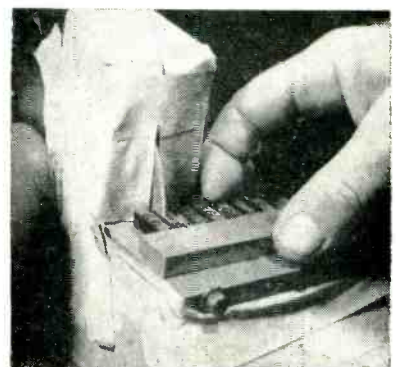

Dust-collecting setup used in cutting phenolic terminal strips

for stability plus

RMC DISCAPS[®] TYPE D

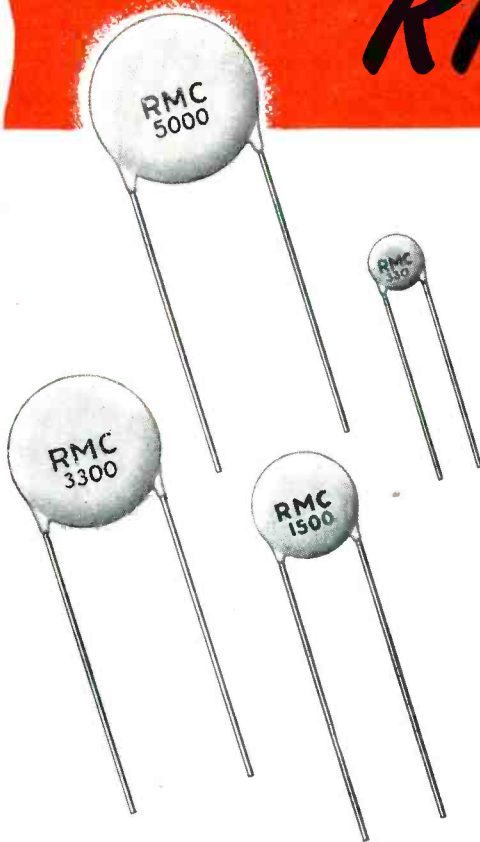

For applications requiring a really stable capacitor specify RMC Type D DISCAPS. Designed primarily for coupling, by-passing and filter networks, Type D DISCAPS have proven performance records where close tolerances are required over a wide temperature range. Capacity will not vary more than +15% —5% from 25° C value as temperature is varied from +10° C to +65° C (See Curve). Available in capacities between 220 MMF and 5000 MMF $\pm 20\%$ or GMV. Power factor 1% or less.

Type D DISCAPS are rated at 1000 volts D.C. working and are laboratory tested at *double* their working voltage to assure highest standards of performance. Rugged construction and lower initial cost offer production line ease and overall savings.

RMC engineers can help you with design problems requiring standard or special types of ceramic capacitors. Your inquiry is invited.

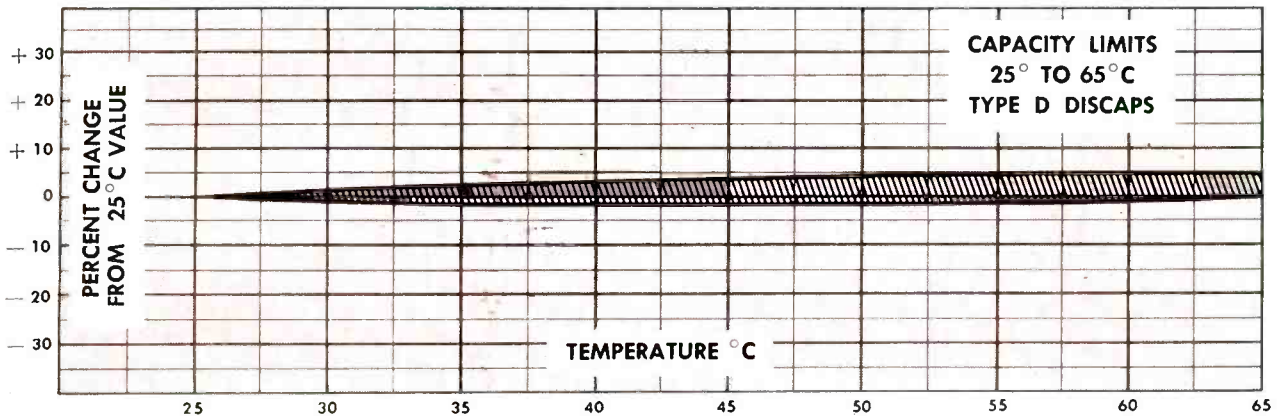

SEND FOR SAMPLES AND TECHNICAL DATA

DISCAP
CERAMIC
CONDENSERS



RADIO MATERIALS CORPORATION

GENERAL OFFICE: 3325 N. California Ave., Chicago 18, Ill.

FACTORIES AT CHICAGO, ILL. AND ATTICA, IND.

DISTRIBUTORS: Contact Jobber Sales Co., 146 Broadway, Paterson 1, N. J.

To telemeter changes.
Specify the new...

$$m \frac{d^2x}{dt^2} = -k_1x + k_2(x - X) - k_3 \frac{dx}{dt} + F_0 \sin \omega_1 t$$

Bendix-Pacific
RESISTANCE BRIDGE
OSCILLATOR
TOR-6

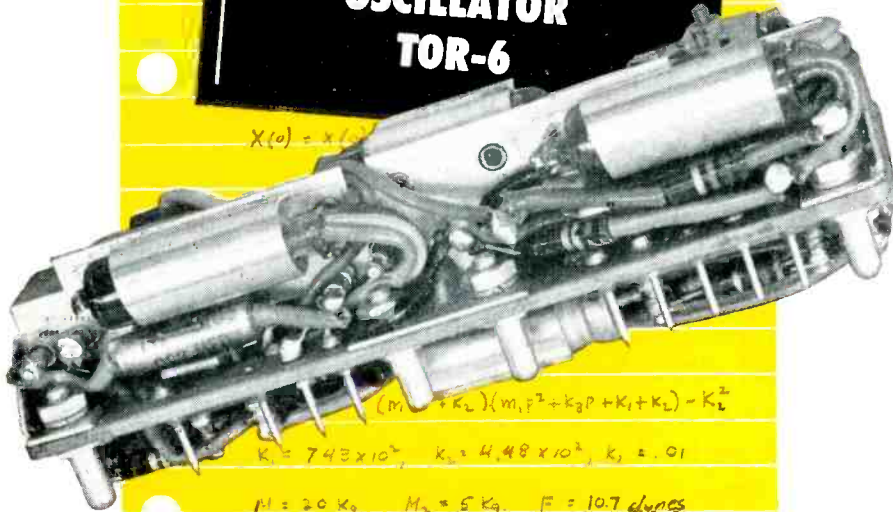

$$X(t) = x(t)$$

$$(m_1 + k_L)(m_1 F^2 + k_2 P + k_1 + k_L) - k_L^2$$

$$k_1 = 7.43 \times 10^2, k_2 = 4.48 \times 10^2, k_3 = .01$$

$$M_1 = 20 K_g, M_2 = 5 K_g, F = 10.7 \text{ dynes}$$

The new Bendix-Pacific TOR-6 Oscillator gives improved performance with resistance type strain gages and variable resistance type temperature pickups. The unit operates with unusual stability under extreme conditions of environment.

Unbalance of the resistance bridge provides a voltage which is used to change the frequency of the oscillator. The magnitude and direction of the frequency change is proportional to the magnitude and phase of the bridge output.

SPECIFICATIONS

Bridge Impedance: 120 ohm*
Sensitivity: ±7.5% change of f_0 for 0.125% change in resistance in each of four active arms*. (This is RDB specified subcarrier bandwidth)
Frequency Response: Flat within ±2.0% from DC to 10% of bandwidth.
Linearity: Within 1.0% of best straight line.
Stability: Drift less than 0.5% of bandwidth (0.07% of f_0) for 8 hours at 25° C. after 15 minute warmup.
Temperature Effect: f_0 changes less than 0.08% of bandwidth per degree centigrade.
Vibration Effect: 1.0% maximum noise at 10 g, 20 to 1000 cps.
Supply Voltage Effect:
 Plate Supply: Drift does not exceed 1.0% of bandwidth for ±10% change of plate supply voltage.
 Heater Supply: Drift does not exceed 1.0%

of bandwidth for ±10% change of heater voltage.
Output: 1.5 volts rms into 100 kilohms resistive load. Generator impedance 750 kilohms.
Harmonic Distortion: 2.0% maximum.
Power Requirements:
 0.015 A at 108 volts DC
 0.800 A at 6.0 volts DC or rms AC.
Bands of Operation: Standard RDB bands 1.7 through 14.5 kc*
Size: 4.5" long x 1.45" wide x 1.35" high; occupies 2 sections of Bendix TJS Component Mounting Assembly.
Weight: 0.4 pounds.

*Available for other bridge impedances, sensitivities, and bands of operation on special order. For temperature measurement, ±0.5% change of resistance in one arm produces ±7.5% change of f_0 .

Write for complete information.



EAST COAST OFFICE: 475 FIFTH AVE., NEW YORK 17, N.Y.
 EXPORT DIVISION: BENDIX INTERNATIONAL, 72 FIFTH AVE., NEW YORK 11 N.Y.

Juan, Puerto Rico plant of Phillips Control Corp. of P. R. The tape served to complete the enclosing of the cutoff wheel on the grinder. Cardboard combined with tape provided a dust-tight collecting box under the sliding holder on which the terminal strips were placed.

The cutoff operation permitted salvaging strips on hand for use in a redesigned product, without waiting for delivery of new strips.

Preparing Cable Leads

IN THE ASSEMBLY procedure recommended by Amphenol for preparing leads of multiple-conductor cables for soldering to the contacts of audio connectors, the cable is first cut to length and its outer jacket stripped off with an Artos auto-

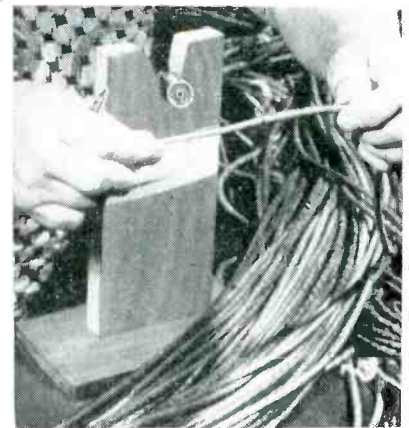

Recommended method of using gas flame for burning off excess strands of filler on multiple-conductor audio cable. Gas torch is supported in V notch of wood fixture

matic machine. The wrapping cord and filler are then unraveled and cut off. Under proper control, using the fixture shown, a gas torch can be used to burn off the excess strands of filler rapidly and cleanly.

The next operation involves cutting the individual leads and stay cords to length. A simple pattern drawn on paper and cemented to the workbench can be used to do this quickly and accurately. The operator places the outer jacket at the reference line on the drawing, places a heavy metal block over the cable to hold it in this position, then cuts each wire in turn to the indicated length with special Wiss in-

a paragraph worth reading
from the **BIG STORY** of
GRAMER
TRANSISTOR TRANSFORMER
"TINYFORMERS"

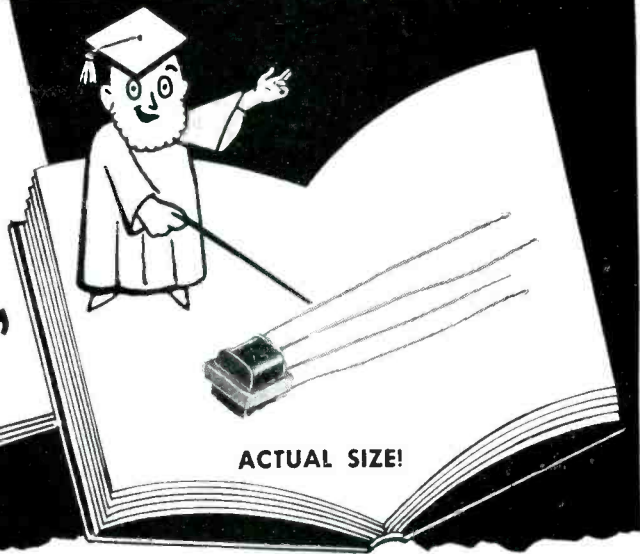

GRAMER
Hermetically Sealed
TRANSFORMERS

meet MIL-T-27
Grade 1 - Class A
Specifications with
in-plant testing facilities

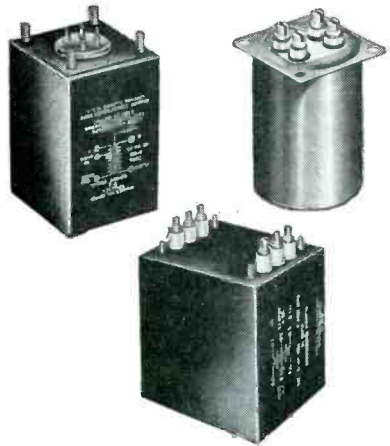

A
COMPLETE LINE
FOR
INDUSTRIAL
APPLICATIONS
UP TO
2 KVA



★ These mighty little TINYFORMERS have paced the use of Transistors with an uncanny ability to match power outputs at all points in any transistor circuit, with precision. For hearing aids, computers, pocket radios, F-M trancivers, telephone message recorders and miniature electronic airborne equipment there is no substitute for Gramer TINYFORMERS.

7 types available for immediate delivery!

PART NO.	TYPE	MATCH. IMPEDANCE		D.C. RESISTANCE		SIZE IN INCHES	WT. LBS.
		PRI.	SEC.	PRI.	SEC.		
M1	Interstage	20,000	1,000	1,150	175	11/32x3/8x3/8	.005
M2	Interstage	20,000	1,000	930	95	11/32x3/8x3/8	.005
M4	Output	600	50	66	7.7	11/32x3/8x3/8	.005
M5	Output	400	50	70	9.3	11/32x3/8x3/8	.005
M6	Input	200,000	1,000	2,600	135	11/32x3/8x3/8	.005
M7	Output	1,000	50/60	160	9	11/32x3/8x3/8	.005
M10	Choke	12 Hy. O.D.C.		830		21/64x3/8x3/8	.005

Order **GRAMER**
"TINYFORMERS"
the most efficient and smallest
TRANSISTOR TRANSFORMER

GRAMER TRANSFORMER CORPORATION

2734 NORTH PULASKI ROAD • CHICAGO 39, ILLINOIS

INTERNATIONAL RECTIFIER

C O R P O R A T I O N

1521 E. Grand Ave., El Segundo, Calif • Phone: ORegon 8-3778
CHICAGO: 205 W. Wacker Drive • Phone: Franklin 2-3889
NEW YORK: 501 Madison Avenue • Phone: Plaza 5-8665

**INTERNATIONAL
RECTIFIER**
CORPORATION

EL SEGUNDO
CALIFORNIA

SEND FOR
BULLETIN
C-349

EFFICIENCY to 87%
POWER FACTOR 95%
RATINGS to 250 KW

LARGEST
SUPPLIERS
OF INDUSTRIAL
POWER
RECTIFIERS

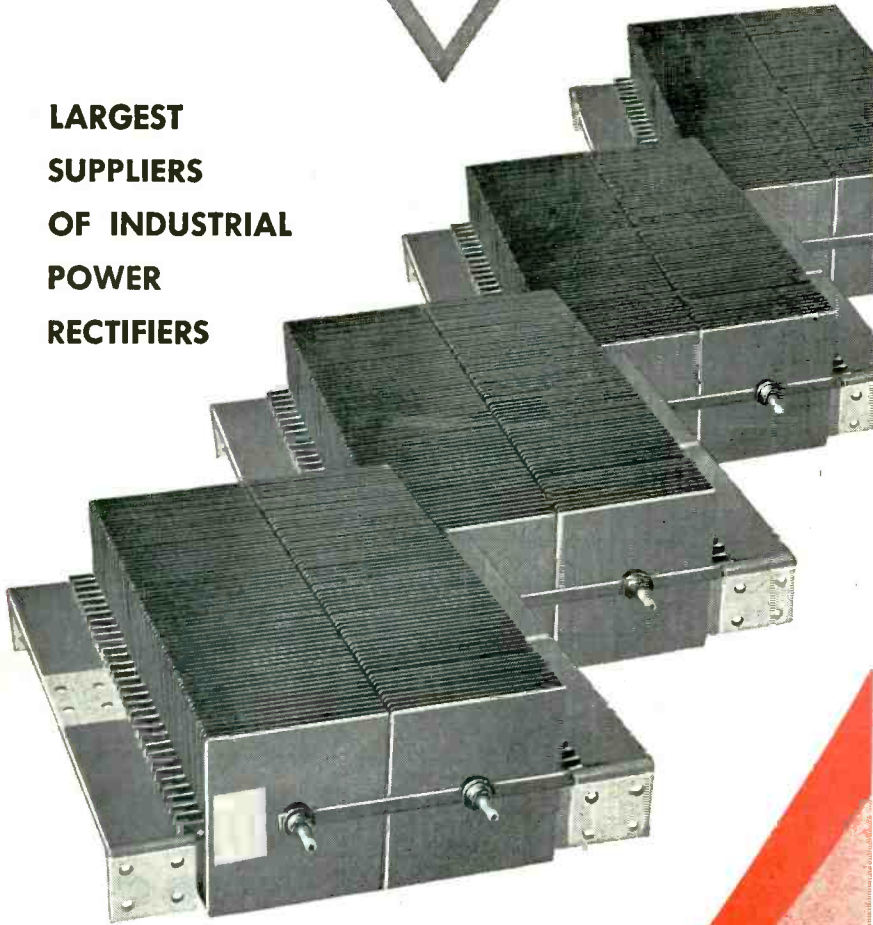

*Selenium
Rectifiers*

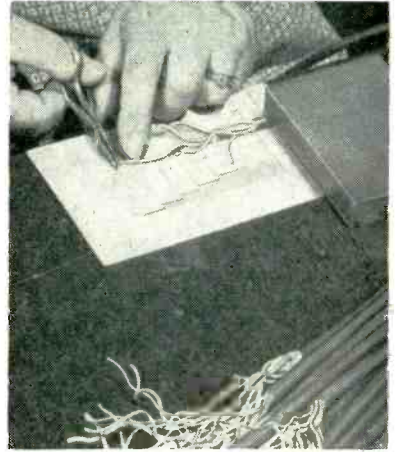

Using diagram cemented to bench as guide for cutting cable conductors to correct length while metal block holds cable in position

dustrial shears. If the conductors are color-coded, the drawing can be similarly colored. The stay cord is cut out at this time also, if it is not needed for strain relief purposes.

The next operation is stripping of individual conductors. This can be done either with a commercial hand-operated wire stripper or with the simple diagonal cutter setup shown. Here, one handle of an ordinary pair of diagonal cutters is welded to a metal plate that is clamped to the bench. A section of pipe welded to the plate provides additional support at the pivot of the cutters.

To use the stripping tool, the operator inserts a conductor in a notch in the cutter jaws, applies pressure with her left hand to the movable upper handle of the cutters to cut through the insulation, then pulls on the conductor to strip off the insulation. An upright metal plate, also welded to the base plate, serves as a stop or guide for insuring that exactly the correct length



Diagonal cutters, welded to metal plate that is clamped to bench, serve for stripping leads of audio cable. Cutter blades are notched to prevent damage to inner conductor

If You Use Dielectrics - Here's an Important NEW TECHNICAL BULLETIN ON GENERAL CHEMICAL SULFUR HEXAFLUORIDE

inert, non-toxic, dielectric gas

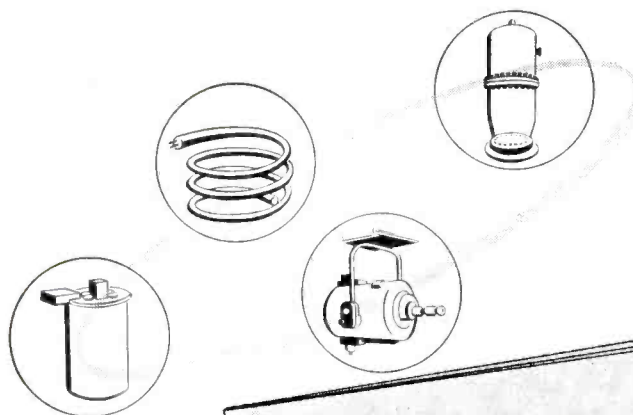

**Some Suggested
Uses Found for
Sulfur Hexafluoride**

In TRANSFORMERS
Oil- and gas-filled;
also dry types

**In CAPACITORS
& CONDENSORS**

In NUCLEAR RESEARCH
Van de Graaff
Electrostatic Generators
High Energy Positive-Ion
Accelerators

In X-RAY APPARATUS
For both large, high-
voltage, and small,
low-voltage equipment
used for diagnostic and
therapeutic purposes
For industrial radiography
High energy electron
equipment for sterilization
of pharmaceuticals and food

In ELECTRONICS
Co-axial cables for television,
etc. Radar equipment, wave
guides, similar apparatus

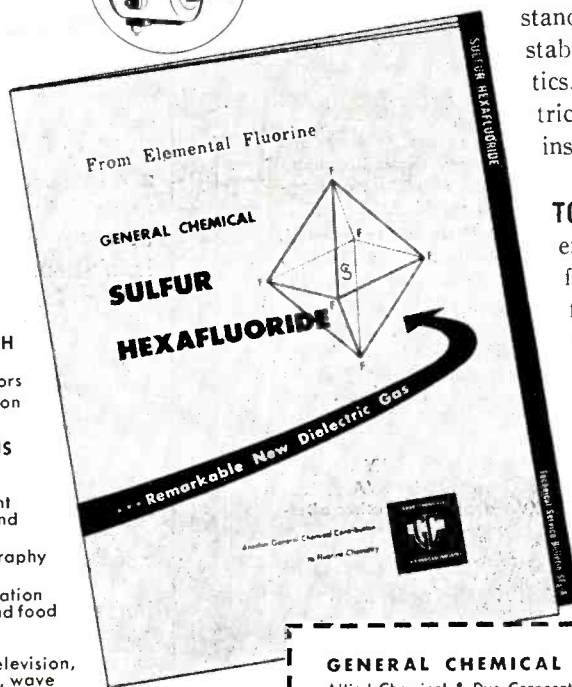

AN IMPORTANT NEW DIELECTRIC GAS,

General Chemical's Sulfur Hexafluoride is gaining attention for a wide range of high- and low-voltage electrical and electronic equipment. Many now consider Sulfur Hexafluoride to be superior to any other available gaseous insulation from the standpoint of dielectric strength, chemical stability, and non-condensing characteristics. Under certain conditions, the dielectric strength of SF₆ is superior to liquid insulating materials.

TO HELP YOU KNOW MORE about this inert, non-toxic gas, General Chemical is offering its specially prepared Sulfur Hexafluoride Technical Bulletin (SF₆A). The bulletin contains selected data on the physical properties of Sulfur Hexafluoride, as well as details concerning the advantages of its use for high voltage electrical equipment. The information in this bulletin may suggest applications for your products and processes which you will want to investigate further.

FOR YOUR FREE COPY of the
General Chemical
Sulfur Hexafluoride
Technical
Bulletin

**FILL IN AND
MAIL COUPON**



GENERAL CHEMICAL DIVISION

Allied Chemical & Dye Corporation
40 Rector Street, New York 6, N. Y.

Please send my free copy of your Sulfur Hexafluoride Technical Bulletin No. SF₆A.

Name _____

Title _____

Organization _____

Address _____

City _____ Zone _____ State _____

EL-10

"packaged"
high frequency
power supplies
for ground installations

American Electric supplies these complete, "packaged unit" power supplies for all high frequency requirements. Noted for their rugged, reliable performance, the amazingly low maintenance factor of American Electric alternators results from a unique and exclusive design principle: *a rotating inductor without coils; without springs, slip rings or brushes!* Nothing to wear out, nothing to service... *as maintenance-free as its two sealed ball bearings!*

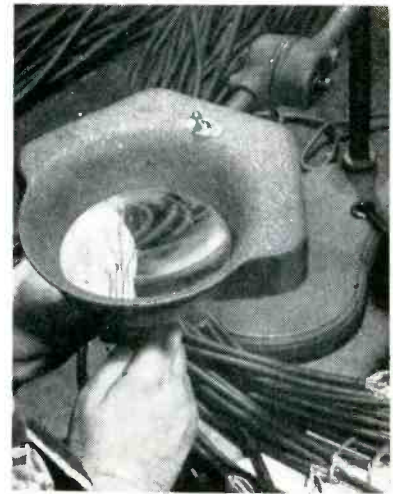

Inspecting tinned leads of cable with illuminated magnifier to make certain there is no damage to insulation

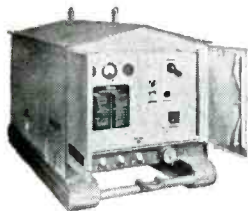

Semi-portable, skid-mounted missile launching power supply completely weather protected.

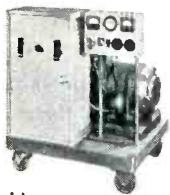

Portable, caster-mounted 400 cycle installation for production test equipment.



Stationary installation, vee belt drive, resilient mounted for laboratory h.f. test equipment.



Variable frequency installation for research test work.

Manufacturers Also of Miniature A.C. (All Frequencies) Electric Drive Motors, Blowers and Fans

Correct Power Supply for Every Installation

Portable, semi-portable or stationary types, open models or completely enclosed for weather protection. Caster or pneumatic tire mounts, skid mounts and resilient rubber mounts on stationary types.

Wide Frequency Ranges

Fixed Frequencies from 250 cycles to 2400 cycles (up to 4000 cycles in the lower ratings).

Variable Frequencies from 380 cycles to 1200 cycles and 1200 cycles to 2400 cycles.

Excellent Voltage Regulation: Standard $\pm 1\%$ to as low as $\pm .5\%$ depending upon choice of drive. Electronic regulators or magnetic amplifier regulators supplied.

Motor Drives—Common shaft, direct connected, Vee belt or positive, no-slip timing belt types. Variable speed on variable frequency models.

Low Harmonic Content

Less than 2% on single phase.

Less than 1% on three phase.

Exceedingly low harmonic content results directly from alternator design without use of filters.

Output Ranges

single phase—500 watts to 15 KVA

three phase—500 watts to 30 KVA

(outputs up to 75 KVA available in other alternator designs.)

WHATEVER YOUR GROUND POWER SUPPLY REQUIREMENTS

Ask American Electric for quotation

NOW! Ask for Details!

American Electric Auxiliary Airborne MISSILE POWER SUPPLIES



4811 Telegraph Road,
 Los Angeles 22,
 California

Engineering Representatives: TRAVCO ENGINEERING CO.
 Silver Spring (Md.), Chicago, New York, Los Angeles

of insulation is stripped each time for optimum soldering into connector contacts. The same procedure is used for stripping leads at the other end of each cable.

The next operation is tinning. If it is possible to position all conductors so they line up, they can be fluxed simultaneously and tinned by a single careful immersion in a solder pot.

After tinning, individual leads are inspected under an illuminated magnifying glass to make certain that there is no damage to the insulation.

The foregoing procedure is abstracted from a booklet, "OK Methods", available from American Phenolic Corp., Chicago 50, Ill.

Testing Tubular Paper Capacitors

Six electrodes arranged in the form of a two-runner slide permit checking paper capacitors at high speed for capacitance value and leakage at Pyramid Electric Co. The operator starts by holding the capacitor across the top electrodes of the slide. Here she glances at the meter on a resistance bridge to see if the unit is within tolerance. The capacitor is now slid down the slide to the middle pair of contacts for charging through a neon lamp to a predetermined voltage that is usually about twice the rated voltage. A normal capacitor here gives only a dim glow, whereas an excessively

RIGHT ON TOP

Burnell records a few of its most recent engineering achievements in Toroids and Filter Networks.



SIDE BAND FILTERS

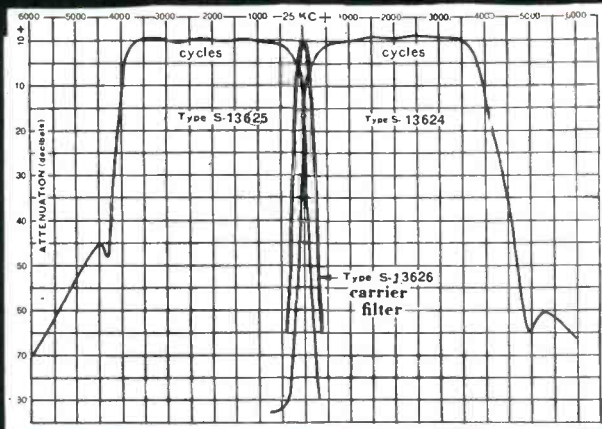

Our most recent engineering achievement in communications filters has already stirred the interest of the leading receiver manufacturers in the country.

Our new side band filters which eliminate, for most applications, the necessity for expensive crystal filters are expected to accelerate the advancement of single side band communications.

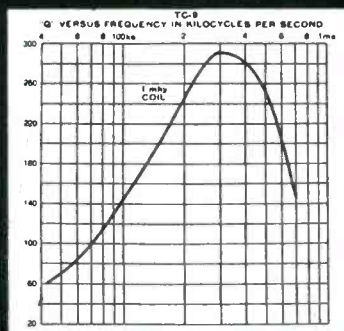

SUB MINIATURE TOROIDS

Toroids for intermediate frequencies of 100KC to 1 megacycle. A wide variety of coils ranging in size from 1/2 inch provides high Q in the frequency range between audio and RF.

The tiny toroid about the size of a dime has been welcomed by designers of sub miniature electronic equipment for the transistor, guided missile and printed circuit field.

PLUG IN DECADES

An entirely new development in inductance decades eliminating disadvantages of switch boxes. Inductance units plugged together in various combinations providing decade steps of inductance with minimum number of units required.

MINIATURE TELEMETERING FILTERS

In recognizing the need for miniaturization of the presently bulky telemetering equipment, our engineering staff has succeeded in reducing the size of telemetering filters to as little as 25 to 50% of the original volume.

BURNELL & COMPANY is very pleased to announce that it now has available a 12 page catalog which includes valuable and complete information on toroids, high quality coils, and various audio filter networks.

The catalog includes complete descriptions, attenuation and Q curves that will prove valuable for equipment design engineers.

Write for Catalog 101-A.



Burnell & Company
YONKERS 2, NEW YORK
CABLE ADDRESS "BURNELL"

**Exclusive Manufacturers of
Communications Network Components**

THERE'S MUCH THAT'S NEW IN THE FIELD OF MAGNET WIRE



**OUR SPECIALIZED
EXPERIENCE
MAY BE HELPFUL**

Today, with many new types of insulation available . . . new standards and specifications . . . new test and quality control procedures . . . Wheeler's 43 years of experience as magnet wire manufacturing specialists may be very helpful in deciding the best type of wire to use for your particular applications.

Wheeler, as a division of The Sperry Corporation, has developed an engineering staff exceptionally skilled in the magnet wire needs of precision electrical and electronic equipment manufacturers, with special emphasis on the smaller wire sizes and close control of electrical specifications. Production-wise, our exceptional facilities carry through from raw copper wire to the finished, insulated and tested product . . . under one roof and under one high standard of quality control every step of the way.

Your problems in Magnet Wire may safely be entrusted to our experts . . . whether standard or special . . . and including completed coils, transformers and other wire-wound components. We welcome your inquiries.

**SEND FOR
NEW MAGNET
WIRE SHEETS**

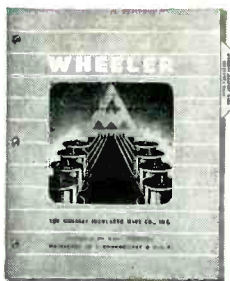

We will be glad to send you this practical engineering data folder. Just give us an outline of your standard or special needs.



**MAGNET WIRE
COILS
COMMUNICATIONS
EQUIPMENT
TRANSFORMERS**

MAKES THESE PRODUCTS A

Specialty

THE WHEELER INSULATED WIRE COMPANY, INC.

Division of The Sperry Corp. • 1101 EAST AURORA ST., WATERBURY 20, CONN.

13WH53



In the position shown here, the capacitor in the fingers of the operator is being discharged by the lowest electrodes on the slide. Where capacitance need not be checked, only the two lower pairs of electrodes on the slide are used

leaky or shorted unit gives a bright glow that is easily recognized by the operator. The charged unit is then slid down onto the third pair of electrodes for discharging through a resistance load.

In practice, a capacitor is moved from the top to the bottom of the slide in one steady motion. This permits testing at a production rate that can be as high as 50 per minute.

Interlocking Parts Trays

SMALL TRAYS MADE from galvanized sheet metal by Caribe Aircraft Radio Corp. of Coamo, Puerto Rico, are so designed that any desired number can be quickly locked together to hold the various parts



Method of locking trays together. Pieces of masking tape applied to front, bottom and rear end of tray serve as easily changed identifying labels for contents

Accurate Field Testing of X-Band Radars

WITH MICROLINE* TEST SET
AND RANGE CALIBRATOR

Included in Sperry's complete line of Microline instruments are the 38A Test Set (TS 147B/UP) and the AN/UPM-11 Range Calibrator for the accurate testing of X-band radars. These equipments, of rugged design for field usage, can also be employed in laboratory and production testing.

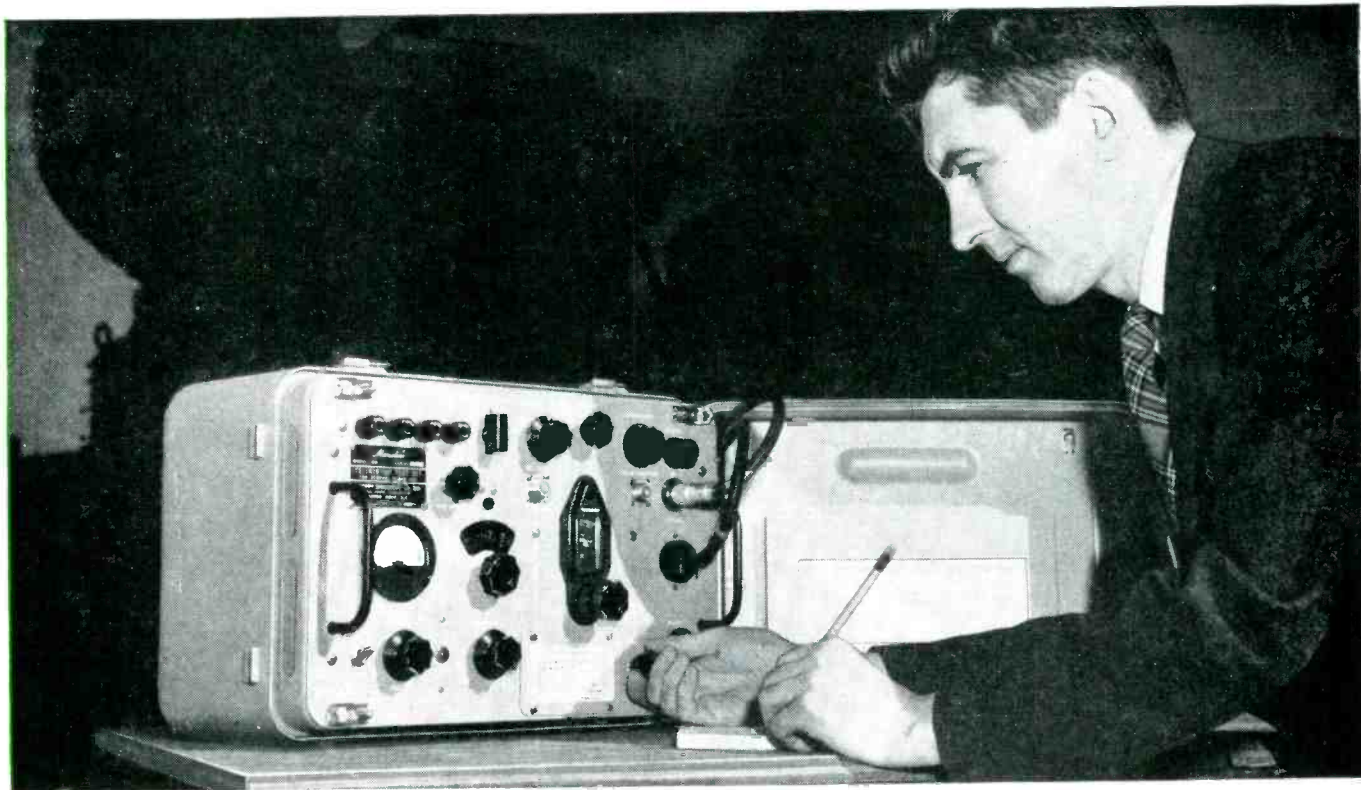

MODEL 38A Test Set (TS 147B/UP)

This portable test set is suitable for measurements on all radar, beacon or missile systems in the 8500-9600 mc. range. It supplies microwave signals of known frequency and power, either continuous wave, frequency modulated or externally modulated. It also measures the power and frequency of external signals in the above frequency range. Model 38A contains a direct reading frequency meter, wattmeter and signal generator which allow the measurement of power and frequency of radar transmitters as well as receiver sensitivity, bandwidth, recovery time and AFC action. Tuning of the frequency meter is accomplished with both a direct and a 5 to 1 reduced drive mechanism for ease of determining narrow pulsed signals as short as 0.2 microseconds.

SPECIFICATIONS:

R-F Power Output: Adjustable from -7 to -85 dbm (decibels relative to one milliwatt).

R-F Power Input: From $+7$ to $+30$ dbm.

Accuracy: ± 1.5 db. A calibration chart is supplied.

Frequency Meter Accuracy: ± 2.5 mc. absolute at 25°C and 60% RH. Calibration point 9310 ± 1.0 mc.

Our nearest district office will be happy to supply further information on these and other Microline instruments.

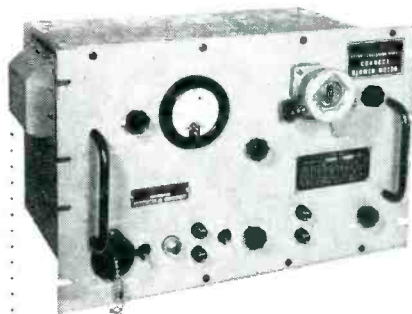

MODEL AN/UPM-11 RANGE CALIBRATOR

This instrument is used to test X-band fire-control radars which operate in the 8500-9600 mc. frequency band. It receives microwave signals from a radar and responds with accurately spaced pulses thereby providing a

means of calibrating the radar range. It can also be used to boresight the antenna axis of any X-band radar system.

SPECIFICATIONS:

Range Markers: 200 to 50,000 yds. depending on delay line

Accuracy: ± 5 yards

Repeatability of readings (same radar system): ± 1 yard

Tuning: Manual or AFC

* T. M. REG. U. S. PAT. OFF.

SPERRY *GYROSCOPE COMPANY*
DIVISION OF THE SPERRY CORPORATION

GREAT NECK, NEW YORK • CLEVELAND • NEW ORLEANS • BROOKLYN • LOS ANGELES • SAN FRANCISCO • SEATTLE
IN CANADA • SPERRY GYROSCOPE COMPANY OF CANADA, LIMITED, MONTREAL, QUEBEC

needed at a particular work position during production of small job-lot quantities of electronic subassemblies.

The tray design, shown on the accompanying diagram, permits fabrication without need for soldering or riveting. After bending the cut-out sheet, the tray is ready for use. The locking cuts on the sides at the rear serve to lock adjacent trays together.

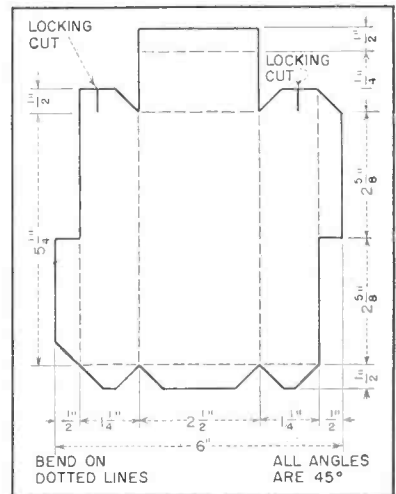

Pattern for self-locking nesting trays

Vacuum Cleaner Speeds Sealing of Packages

AS AN AID in obtaining climate-proof packaging of electronic equipment, air is evacuated from the outer wrapper of the package with a vacuum cleaner just before heat sealing, in the Brooklyn, N. Y.



Removing air and moisture from carton bag before final heat-sealing on machine standing over conveyor. Vacuum cleaner is under conveyor

KEN-SEAL Molding Process is Simple and Positive

1. Units are pre-heated for moisture removal.
2. Open transformer is inserted, in molds.
3. Ken-Seal is poured at room temperature.
4. Vacuum is created to impregnate filled molds.
5. Molds are removed from vacuum tanks and baked.
6. Unit is taken from molds and baked for final curing.

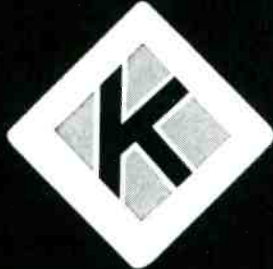

KEN-SEAL MOLDED TRANSFORMERS

No matter what your transformer requirements may be contact Kenyon first. Our engineers will endeavor to show you how you can increase efficiency at low cost by choosing a transformer from the complete Kenyon line.

Kenyon Transformer Co., Inc., 840 Barry St., New York 59

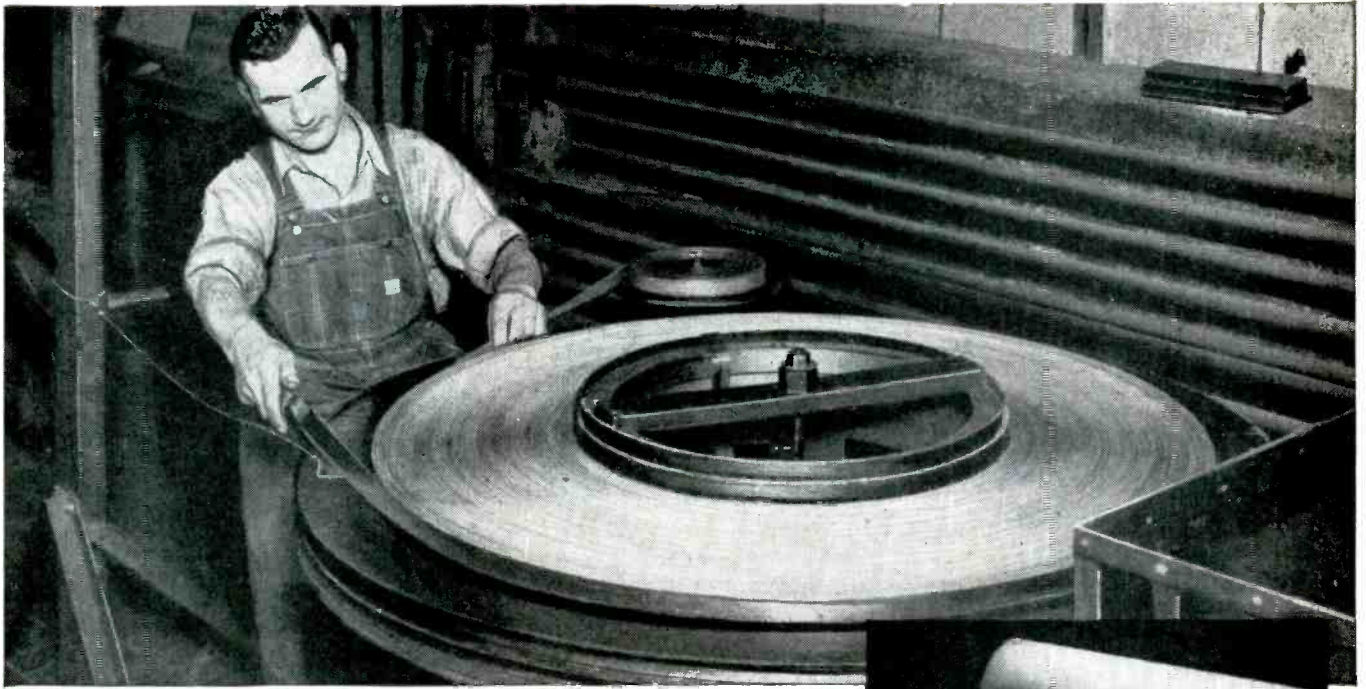

How Cutler-Hammer, Inc.
protects coils of
giant Supermagnets

with **Quinorgo[®]** electrical insulation

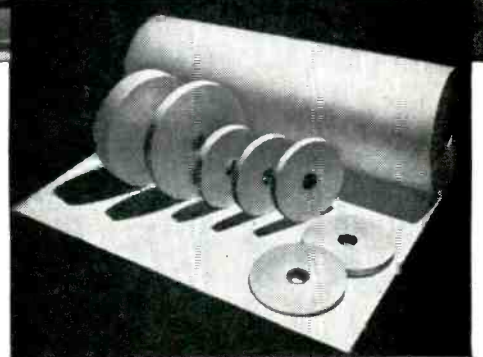

Quinorgo Electrical Insulations are high dielectric, heat-resistant sheet materials made of purified asbestos for use on equipment up to 130 C. Available in tape and roll forms.

PROTECTING COILS in giant C-H Supermagnets is difficult because of the heat generated by the tightly packed pancake coils. This problem is complicated by the need to utilize every bit of space to gain maximum lifting power. After experimenting with many insulating materials, including coatings, Cutler-Hammer chose Quinorgo No. 3000 for Supermagnet strap insulation.

Quinorgo fully meets the exacting requirements of Cutler-Hammer — as well as those of other well-known electrical manufacturers. Quinorgo is a moderate priced, high-temperature insulation, for

use alone or in "composites." Available in two types with slightly different impregnation characteristics. Both types combine high dielectric and mechanical strengths, with uniform texture and caliper. They maintain these properties under operating temperatures up to 130 C.

Quinorgo Electrical Insulations may lower your production costs and improve product performance. For more information write for the 32-page booklet "PYROLYSIS PROTECTION PAYS WELL" (EL-40A) Johns-Manville, Box 60, New York 16, N. Y. In Canada, 199 Bay Street, Toronto 1, Ontario.

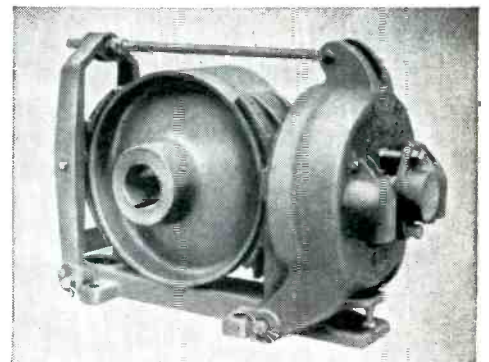

Cutler-Hammer's success with Quinorgo No. 3000 on giant Supermagnets led the company to use this insulation as a component of the series wound Type "M" magnetic brakes which are so widely known throughout the industry.



Johns-Manville ELECTRICAL INSULATIONS

WHY WIRE?

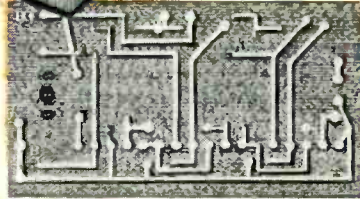

- Lower Wiring Costs
- Reduced Assembly Time
- Circuit Reproducibility
- Improved Reliability
- Miniaturization... are assured with

"PHOTOCIRCUITS PRINTED CIRCUITS"

PACKAGED

Electronic Sub-Assemblies

... to your specifications!

Let us quote on manufacturing your sub-assemblies. Use our complete production facilities for **PRINTING • ETCHING • PLATING • LAMINATING • FABRICATING • MACHINING • FORMING • ASSEMBLING • DIP SOLDERING • ENCAPSULATING**... as well as **DESIGN DEVELOPMENT • ENGINEERING • DRAFTING.**

For full information
call or write

photocircuits

CORPORATION

Dept. E-10, GLEN COVE, NEW YORK

Glen Cove 4-4000 • Flushing 3-5050

Pioneers in Cost-Cutting
Printed Circuit Techniques



*Trade Mark

BOSTON: 25 HUNTINGTON AVENUE • Copley 6-7705
CHICAGO: 4258 W. IRVING PARK RD. • PAlsades 5-1170
PHILADELPHIA: 1531 SPRUCE STREET • Kingsley 5-1205
ROCHESTER, N. Y.: 3 JUNIPER STREET • CULver 7635
TORONTO, CAN.: 290 LAWRENCE AVE., W. • ORchard 3003

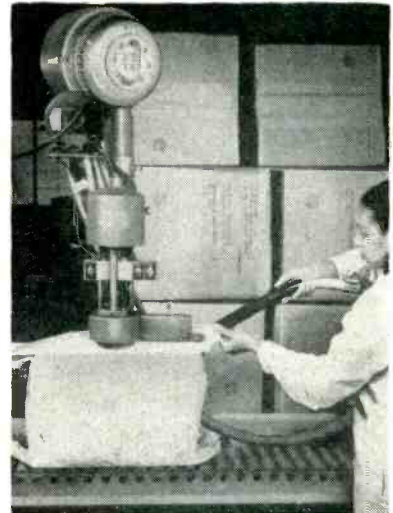

Method of extracting air from bag during packaging of control box for electronic equipment. Here the vacuum cleaner is mounted directly on top of the automatic heat sealer

plant of Cargo Packers, Inc.

The flat nozzle of an ordinary vacuum cleaner is inserted in one of the flaps of the moisture-proof wrapping material and left there throughout the sealing operation on the automatic sealing equipment. This removes air and moisture from within the bag.

Stamping Tubular Paper Capacitor Cases

STAMPING of part numbers and capacitance ratings on metallized capacitors is accomplished rapidly on a jig used at Pyramid Electric Co.

A rubber-stamp holder slides on

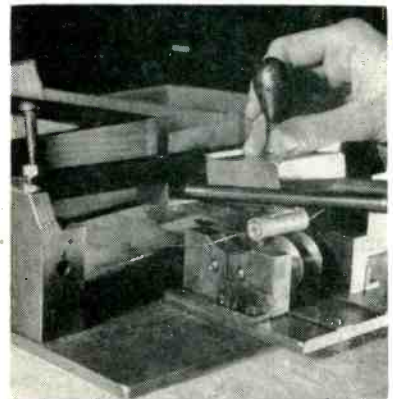

Jig used for stamping ratings and type numbers on capacitors. Pressure of rubber stamp rotates capacitor as stamp is moved

How can

GLOBAR[®]

**VOLTAGE
SENSITIVE
RESISTORS**

cut your product's
cost...yet add
to its reputation?

OUR ENGINEERS will be glad to show you, without obligation, how GLOBAR Ceramic Resistors can help you make a better product at less cost. Write, giving details of your problem, to The Carborundum Company, Dept. E 87-313, Niagara Falls, New York.

● Engineering data on these and other important uses for GLOBAR Type BNR resistors... in Bulletin GR-2. Write for your copy.



➔ Many manufacturers count on GLOBAR type BNR voltage sensitive resistors to reduce surge voltages and contact arcing time—in both AC and DC circuits. Because their resistance decreases sharply as applied voltage is increased, BNR resistors:

Reduce surge voltage peaks from 50% to 90%. This feature permits use of lower voltage ratings in your components... saves product costs.

Reduce contact arcing time up to 95%. By drastically limiting the duration of arcing after a circuit break, contacts last much longer... with less pitting, less sticking. Cuts maintenance costs for your customer, helps give your product a better reputation.

Used in low voltage devices, BNR resistors also substantially reduce radiations which interfere with radio and television receivers.

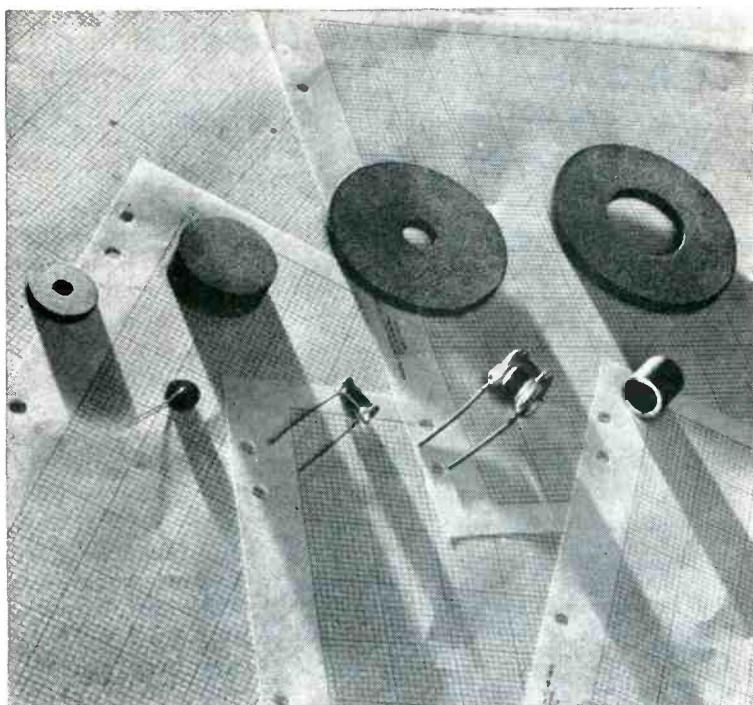

GLOBAR Type BNR resistors are built for long life. They withstand repeated high voltage stresses without danger of sudden failure. They are manufactured in both cylindrical and disc shapes... to meet your *exact* circuit and engineering requirements.

GLOBAR[®] Ceramic Resistors

CONVENTIONAL • TEMPERATURE SENSITIVE • VOLTAGE SENSITIVE

by **CARBORUNDUM**

REGISTERED TRADE MARK

D.C. to 5-MEGACYCLE SCOPE

model

OA-16

for

MEASUREMENTS
OVER
WIDE RANGES



Self-contained... Calibrated...

D.C. "BUCK-OUT" VOLTAGE

permits **HIGH GAIN** examination of small
D.C. level shifts
and hard-to-see
A.C. COMPONENTS

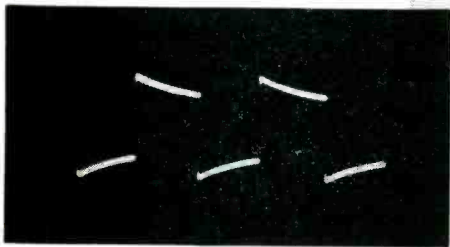

The above photograph shows a 5-volt peak-to-peak signal at a D.C. level of 400 volts. By bucking out the 400-volt component, high gain can be used to give a large image for detailed study. With such a presentation, a D.C. level shift of as little as 0.25% is readily observable.

- 5X sweep expansion
- Trace position stability
- Broadband X axis amplifier
- Accurate X and Y axis calibrations
- Triggered or recurrent sweeps

MODEL OA-16
OSCILLOSYNCHROSCOPE

\$745⁰⁰

f.o.b. Winchester



BROWNING
Laboratories, Inc.
Winchester, Mass.
ENGINEERED FOR ENGINEERS

Write for detailed
literature

SPECIFICATIONS

- Vertical amplifier — D.C. to 5 megacycles — .08 μ sec rise time — sensitivity 50 millivolts peak-to-peak/inch — signal delay line.
- D.C. "buckout" voltage up to 600 volts depending on vertical attenuator setting.
- Triggered or recurrent sweeps — 10 seconds total sweep time to 0.4 microseconds per centimeter.
- 5X sweep expansion.
- Horizontal amplifier — D.C. to 1 megacycle — sensitivity 120 millivolts peak-to-peak/inch.
- Regulated plate and heater supplies for best trace stability.
- Flat-faced 5" cathode-ray tube. Deflection plates brought out for direct connections.
- Vertical deflection calibration accuracy 5%. Sweep calibration accuracy 10%.
- Blower cooling.
- Edgelighted rule screen.



Springs on edges of rack prevent capacitors from coming in contact with each other while varnish coating is drying

two rods projecting from a metal frame. The capacitor is placed on two pairs of rotating disks beneath the stamp-pad guides. When slid down the track toward the frame, the rubber stamp rotates and imprints the capacitor.

A screw and locknut at each end of the frame permit raising or lowering of guide rods to accommodate various sizes of capacitors.

After stamping, the capacitor markings are coated with varnish. To keep the units from touching each other while the varnish is still wet, a rack is used having a coil spring stretched along each side and one in the center. When placed in the rack, the leads of the capacitors lay within the turns of the spring.

Tuner Shaft-Centering Jig

INSTALLATION of uhf tuners in cabinets is expedited by slipping a tapered wood jig over the tuner shaft from the front of the cabinet after placing the tuner in position;

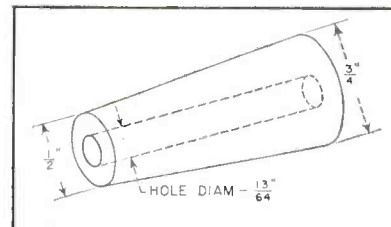

Shaft-centering jig which can be turned down from a piece of broom handle

Now available

the revolutionary
ELECTRO TEC
process* for your
LARGE
SLIP RING ASSEMBLIES

featuring

- LOWER COST • CLOSER TOLERANCES
- ONE-PIECE CONSTRUCTION • JEWEL-LIKE FINISH • UNIFORM RING HARDNESS
- REDUCED WEIGHT



◆ An assembly with 14 concentric, hard silver rings electro deposited into machined plastic blank. Dovetail locks rings in place. Machined blank insures accuracy. Diameter approx. 1 1/2", thickness approx. 5/16".

◆ Cylindrical assembly with 25 rings. Three wide rings accommodate large contact area brushes for high current capacity. Length 1 1/4", O.D. approx. 5 3/8".

◆ An assembly with 30 rings of various widths to accommodate various current requirements. Unit is approx. 4-5/16" long, designed for flange mounting.

◆ Cylinder type assembly approx. 3 3/4" long with 24 hard silver rings. 1 3/8" O.D. with wall thickness less than 1/4".

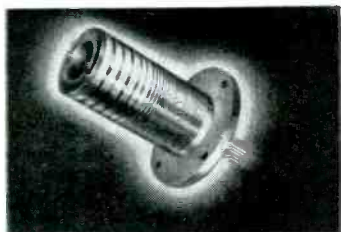

*PATENTS PENDING

Our Engineering Department is available for consultation on any of your slip ring problems without obligation.



ELECTRO TEC CORPORATION
SOUTH HACKENSACK • NEW JERSEY

Now a Complete Service
in all sizes of Slip Ring Assemblies

ELECTRO TEC is now tooled up, with new expanded facilities for production of large Slip Ring Assemblies to exact customer specification. Sizes range up to 24" in diameter, either cylindrical or disc type.

The exclusive ELECTRO TEC PROCESS*—the electro-deposition of hard silver rings into an accurately machined plastic blank—consistently yields a high degree of dimensional accuracy, excellent concentricity, and a jewel-like ring finish. This process also eliminates expensive tooling and mold charges, frequently lowers costs to 30% of other methods of manufacture. The silver rings are uniformly hard for long life—75-90 Brinell.

ELECTRO TEC one-piece construction precludes dimensional variation due to accumulated errors. The plastic base is fully cured before rings are plated into it, thus preventing separation of base material from the rings.

ELECTRO TEC LARGE SLIP RING Assemblies are widely used in Radar Equipment, Fire Control Systems, Test Tables and many other critical applications. Light weight combined with rugged durability recommends their use in airborne applications.

Every user knows the ELECTRO TEC reputation for quality and superiority in miniature and sub-miniature slip ring assemblies.

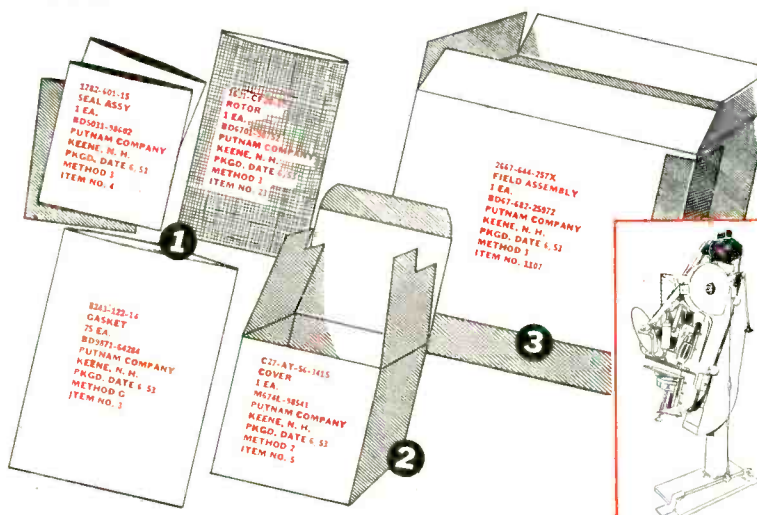
MARKEM**SOLVED THIS MARKING PROBLEM****IDENTIFICATION MARKING
FOR CONTRACT AND OVERSEAS PACKING**

In contract and export packing of parts, assemblies, etc., certain JAN specifications call for three packaging stages: (1) enclosure in scrim-back or polyethylene lined *heat sealing* envelope, (2) intermediate packing in a folding box, (3) final packing in corrugated carton. Each of these three types of containers must be marked for instant and *permanent* identification. Many manufacturers, dissatisfied with conventional marking with crayon, stencil, labeling or other form of hand stamping, have not only found great savings in time and money, but also obtained more legible, longer lasting identification using a Markem Method. *One* Markem machine (with appropriate Markem type and Markem ink) prints desired information on *all three* containers. The vapor barrier of the envelope is not broken. Desired information is changed rapidly. By printing quantities of containers as and when needed, inventory problems are minimized. In this way, the Markem Method insures *positive identification* when the items reach their destination.

MARKEM**MARKS THEM ALL****CAN MARKEM
HELP YOU?**

Identification printing for contract and overseas packaging is but an example of how Markem solves industry's marking problems. Markem has been providing industry with production techniques and equipment to identify, decorate or designate its products, parts and packages since 1911. Markem also provides technically trained men who are available in your area to assure *continued* satisfaction with Markem methods and equipment.

When you have a marking problem, tell us about it and send a sample of the item to be marked. Perhaps a complete Markem Method has already been developed to solve your problem. If not, Markem will work out a practical solution.

Markem Machine Company, Keene 5, N. H., U.S.A.

MARKEM
... TO MAKE YOUR MARK

when the jig is pushed into the cabinet hole, the shaft is precisely centered. The jig leaves both hands free for tightening the mounting screws. The idea is the suggestion of Parke M. Good of Lancaster, Pa., and received a Philco Idea Award.

**Bending Tiny Leads in
Ceramic Molds**

LEADS of components for subminiature subassemblies are precision-bent on specially designed ceramic

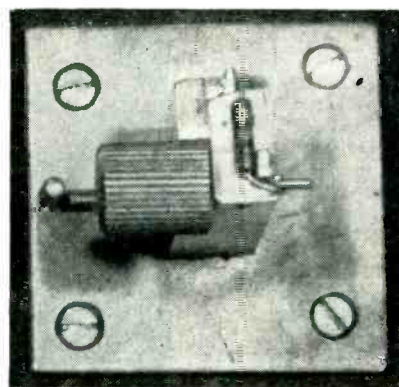
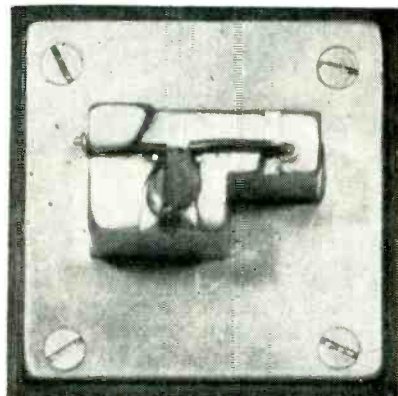
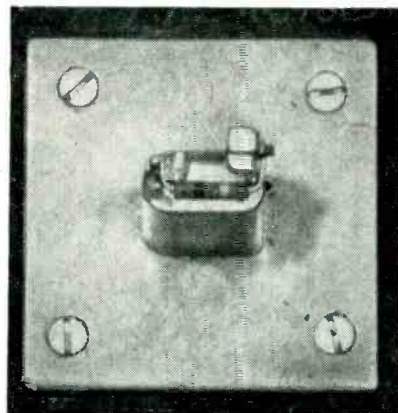

Examples of ceramic molds used for pre-forming leads of small parts. Hooks at ends are formed around steel pins embedded in the molds. Where pins are at right angles as in bottom mold, one is made movable and spring-loaded so it can be retracted to remove finished component after bending

For *Critical* Applications
Triplett 630-A Has No Counterpart

Accuracy
 to 1½%

Readability
 with a Mirror-Scale

Adaptability
 with ½% resistors

Try This Volt-Ohm-Mil-Ammeter
 at your distributor's

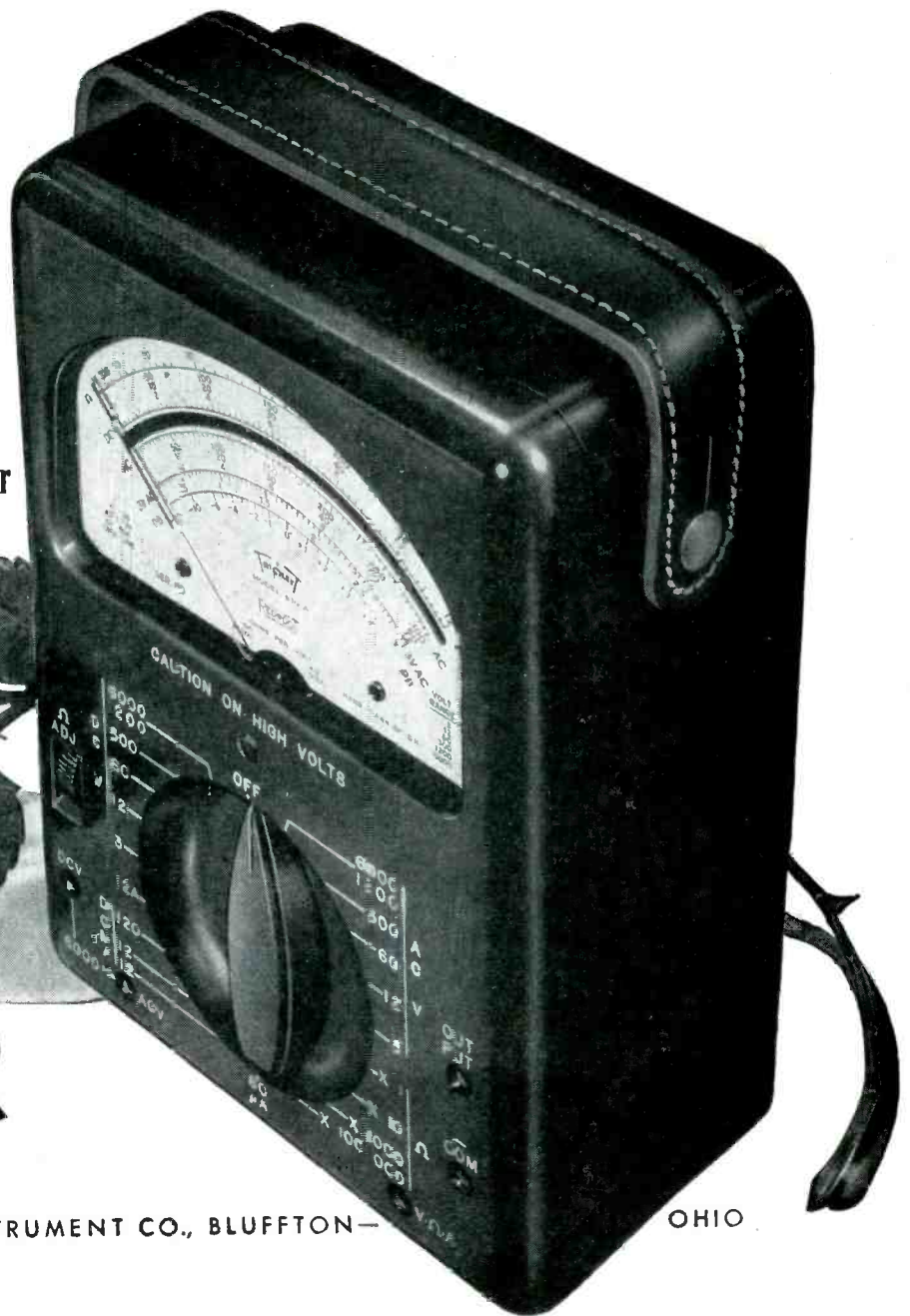
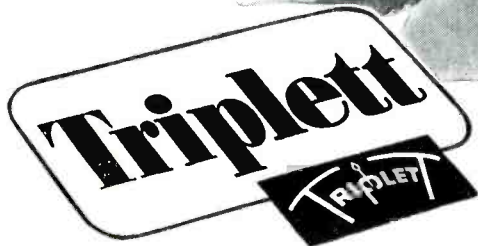
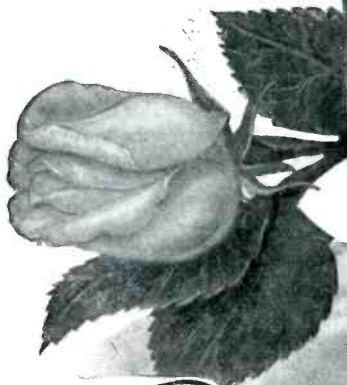

TRIPLETT ELECTRICAL INSTRUMENT CO., BLUFFTON—

OHIO



PRODUCTS

Speeding Electronic Progress

through crystal research

This new JK G-12 is designed for ultra stable frequency control in applications such as frequency standards, timing and counting circuits, broadcast equipment and frequency monitors. Electrodes are deposited directly on the large, precision-made quartz plate shockmounted in an evacuated glass envelope. Frequency range 500 kc to 1500 kc. Crystal may be desined for a minimum temperature coefficient of from 0°C to 50°C or for temperature controlled operation at 60°C with a JKO7E-115V Oven. Approximate height above chassis, 2³/₄". Maximum diameter of octal base, 1³/₄". Consult us on specific applications.

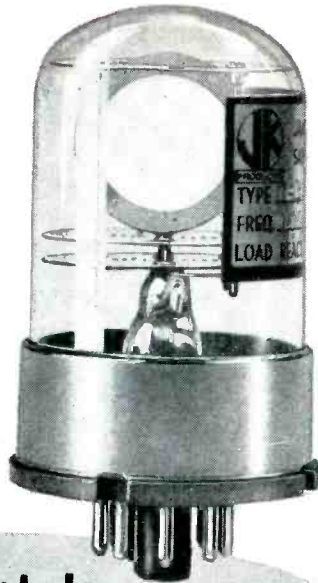

JK STABILIZED G-12 CRYSTAL
For the "Difficult" 500 kc to 1500 kc Range

Tomorrow's Crystals

The increasing demand for ultra-stable frequency control to meet today's new requirements has necessitated a new approach to crystal design. Evacuated glass envelopes — for maximum protection and freedom from contamination — are a part of the new design of JK Crystals for the Critical. Consult us on your requirements for crystals of this advanced design.

THE JAMES
KNIGHTS COMPANY,
SANDWICH, ILLINOIS



molds in Raytheon's Brighton, Mass. plant. The leads then fall automatically into the correct positions for soldering when assembly workers place them inside a crowded chassis with tweezers. Preforming of leads in this manner eliminates the necessity of providing room for inserting pliers or fingers, and thus reduces the overall size of the product.

Ceramic molds were used for preforming because they could be duplicated in any quantity once the master was made. Individual machining of the required curved molds from steel would have proved much more costly. Each mold is cemented on a metal plate which in turn is fastened to an appropriately labeled plastic base.

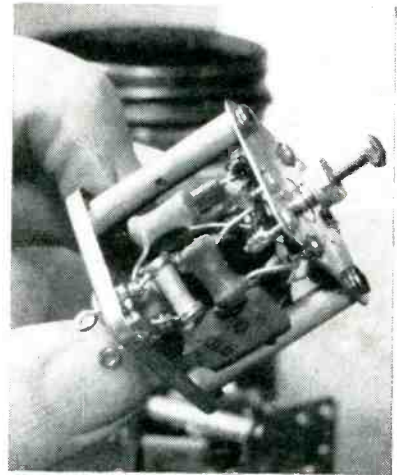

Example of subassembly requiring preformed leads on miniature components. This discriminator transformer is assembled with tweezers, needle-nose pliers, soldering pencils and additional special tools

Knob Springs Installed With Arbor Press

ALTHOUGH insertion of springs in television receiver tuning knobs is a relatively simple operation, repetition of this task hour after hour results in operator fatigue and a sore thumb. Changeover to an arbor press simplifies the operation, improving operator morale, speeding output and reducing rejects.

A fixture was made for the base of the press to hold the front face of the knob securely without scratching it. The operator places a knob in this fixture, drops a spring into the hole with her left



One-Stop shopping

for brass rod and bar

You can get rod or drawn bar of Chase Free-Cutting Brass, Copper or a wide variety of other copper alloys at one stop — *the Chase Warehouse nearest you!*

When you want free-cutting materials, it pays to buy Chase — for Chase rod and drawn bar yield the shorter chips that make for *easier machining, longer tool life*. They produce smooth, clean-surfaced products — less expensive to buff or polish before lacquering, enameling or plating.

And when it comes to re-ordering, remember that Chase alloys are uniform — repeat orders of the same alloy always have the same cutting characteristics.

Chase BRASS & COPPER

WATERBURY 20, CONNECTICUT • SUBSIDIARY OF KENNECOTT COPPER CORPORATION

The Nation's Headquarters for Brass & Copper

Albany †	Cleveland	Kansas City, Mo.	New York	San Francisco
Atlanta	Dallas	Los Angeles	Philadelphia	Seattle
Baltimore	Denver †	Milwaukee	Pittsburgh	Waterbury
Boston	Detroit	Minneapolis	Providence	
Chicago	Houston	Newark	Rochester †	
Cincinnati	Indianapolis	New Orleans	St. Louis	(† sales office only)

ATTENUATION HITS

New High!

IN NEW SHIELDED ENCLOSURE

Air-Conditioned • Portable • Weatherproof

Now! Attenuation of radio frequency energy higher than ever before . . . attenuation over the widest frequency range . . . attenuation beyond measure over 1 mc with present instruments.

All this becomes reality in the new RFI Shielded Enclosure. Built of heavy copper sheet panels—solid floors, solid walls, solid ceilings—this new enclosure shuts r-f interference in or out more effectively than any other type of structure. The reason? Patented Lindsay Construction—in which solid cop-



This unique construction also offers you the greatest strength-to-weight ratio. Superior rigidity enables you to mount the enclosure on a truck as a mobile unit. Or, carry it to a testing station. Unload it. And later move it to another location, all without disassembling.

Weatherproofed, RFI Shielded Enclosures can withstand the rigors of climates hot or cold, damp or dry. For warmer climates, they can be air-conditioned with units of any size.



per panels are joined at rigid, copper-plated steel channels and tightly bolted together. Tensioners at the seams, further serve to stop any interference that might find its way through the almost leak-proof channel and panel joints.

The result is a revolutionary advancement in shielding effectiveness. An independent laboratory conservatively plotted it for 100 db from .15 mc to 1000 mc.

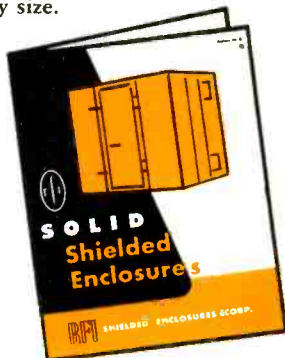

Actually there's no end to the many advantages you'll find in this new type of shielded enclosure. Bulletin No. 2 gives most of the details. Write, wire, or phone for your copy now!

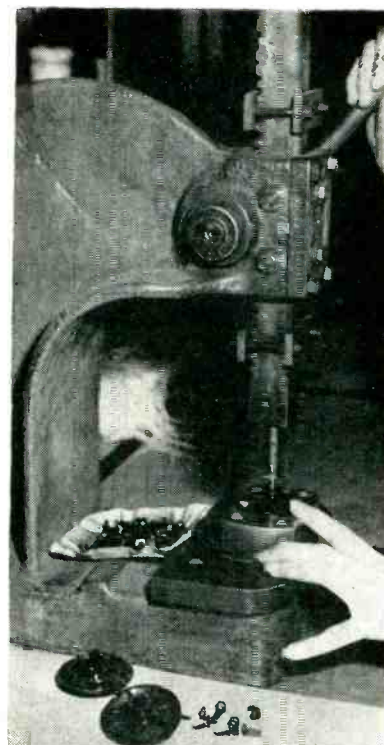

Using arbor press to force spring into tuning knob

hand, then operates the lever of the press with her right hand to drive the pin home. The end of the moving arbor is appropriately machined to do this without damaging the plastic knob.

Testing High-Voltage Power Supplies

POWER supplies used to provide the accelerating potentials for four different types of Tektronix cathode-ray oscilloscopes are production-tested with a single compact

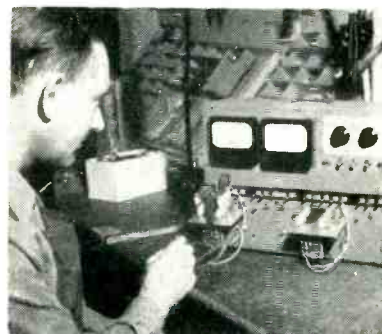

Power supply tester in use at Portland, Oregon plant of Tektronix, Inc. Unit at right has its own leads. Unit at left has only terminals hence clip leads were attached to these for the test. Only one unit is tested at a time

rfi RFI SHIELDED ENCLOSURES CORPORATION

3634 N. Lawrence Street • Philadelphia 40, Pa. • Phone: REgent 9-2537

the new **cae** oscilloscope (type 104) performs the functions of several types



By using interchangeable D.C. Amplifier and Time Base Units, one CAE Oscilloscope performs the operations of several different types of oscilloscopes resulting in a considerable *saving in capital expenditure*.

Highly functional, it is constructed on the unitized principle and its unique system of controls makes it simple to operate with highly accurate results.

the **cae** Oscilloscope (TYPE 104)

INTERCHANGEABLE
AMPLIFIERS provide
suitable combinations of—

- wide band, from D.C. up to 10 MC/S
- rise time down to 0.05 micro-seconds
- voltage gain up to 500,000
- inherent noise as low as 1 micro-volt

INTERCHANGEABLE
TIME BASE UNITS provide
suitable combinations of—

- sweep velocity 10 cm/micro-seconds
to 5 cm/seconds
- triggered or continuous sweeps
- automatic synchronization
- linearity 1%
- voltage, frequency and
time calibration accuracy 2%

Canadian Aviation Electronics, Ltd.

8280 St. Lawrence Boulevard, Montreal
Toronto • Winnipeg • Vancouver

Ask for Bulletin No. SIE-30101

For complete details of CAE Oscilloscope, Type 104, call or write the CAE office nearest you.

newest aid

to users of fasteners

Everyone who designs, specifies or purchases needs this useful

RIVET SELECTOR!

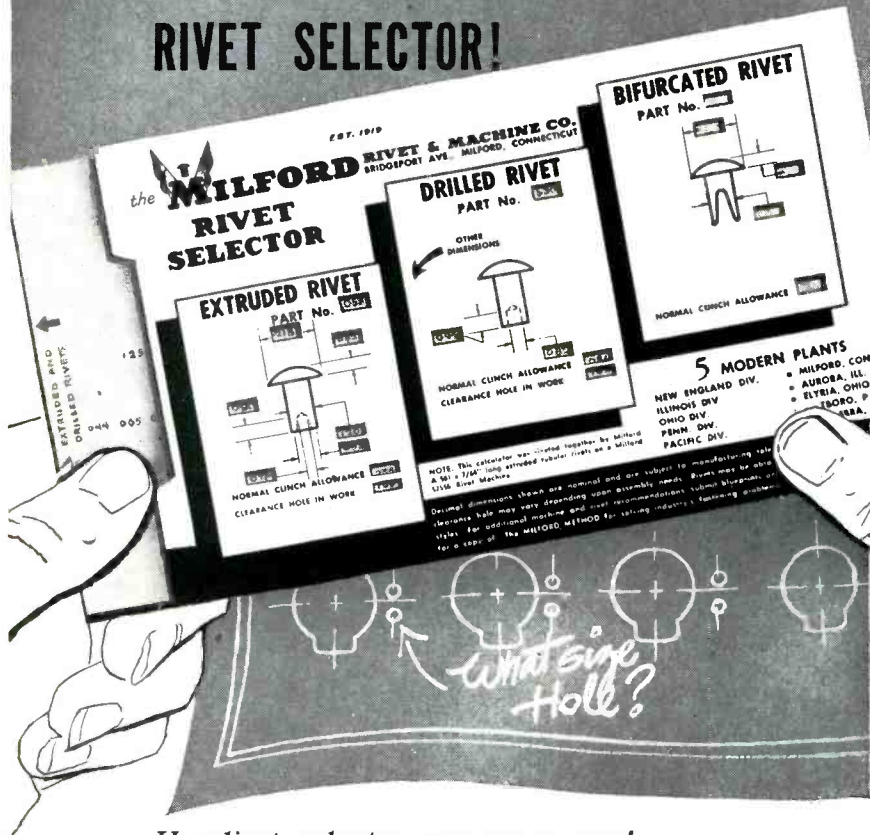

Handiest selector you ever saw!

Simplifies your job; saves time, speeds choice of right fastener. Easy to read, easy to use, handsomely lithographed in red, white and blue. Shows various tubular and split rivets, part catalog number, normal clinch allowance, size of clearance hole in work and other details to aid your product manufacturing. Sturdily riveted together for lasting use. Write for yours today!



EST. 1919

The name to RIVET in your memory for fasteners.

THE MILFORD RIVET & MACHINE COMPANY

855 BRIDGEPORT AVENUE, MILFORD, CONNECTICUT
 806 ILLINOIS AVENUE, AURORA, ILLINOIS
 1106 WEST RIVER STREET, ELYRIA, OHIO
 26 PLATT STREET, HATBORO, PENNSYLVANIA
 715 SO. PALM AVENUE, ALHAMBRA, CALIFORNIA

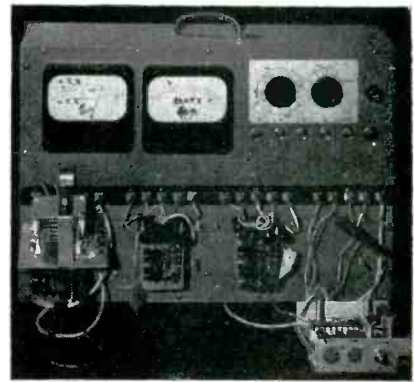

Closeup of tester, showing how four different types of power supplies for cathode-ray oscilloscopes are connected to the test positions. Meter at left reads output kilovoltage, and meter at right reads average oscillator current

test set having quick connectors. In practice, only one of the four test positions is used at a time, for checking a production run of one particular unit.

When changing to a different unit, the meters are switched to a different set of clips and the controls are reset for the required new test voltages and current ranges. Even though possible, testing of different units one after another would be confusing to the operator because each unit has different output voltages and loads the oscillators differently.

Use of Grayhill No. 2-0 panel mount test clips contributes to the high testing speed of less than one minute per unit.

Some or all of the oscillator circuit components are mounted on the high-voltage unit. These are connected into the tester's oscillator tube circuit when the unit is being tested. Plate, screen and bias voltages are provided by the tester. Rectifier filament voltage for each high-voltage unit is supplied from a winding on its own transformer. Measurements are made of positive and negative d-c output voltages and average oscillator current.

Air-Operated Pot Jig

IN SUBASSEMBLY work involving assembly and soldering of leads and small parts on combination volume controls and on-off switches for a-m radios, an air-operated diaphragm is used to hold seven controls at a time in a wood jig.

A flip of the foot pedal opens the



AVIATION



MARINE

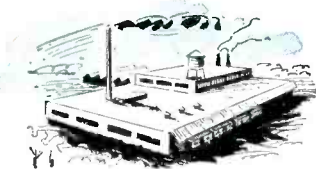

INDUSTRIAL



BROADCASTING



RADIO-TV LEAD-INS

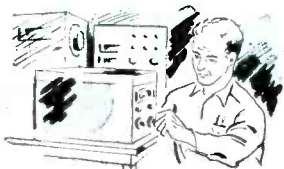

TEST EQUIPMENT



RADAR, PULSE,
EXPERIMENTAL EQUIP-
MENT AND SPECIAL TYPES



TRUSTWORTHY TRANSMISSION

For Every HF • VHF • UHF Application

With *Federal's* QUALITY-CONTROLLED COAXIAL CABLES

Whatever your field of application . . . whatever your transmission line requirement . . . Federal is ready to serve you. If the cable you need doesn't exist, Federal will cooperate with you in developing and producing it in any quantity!

Federal offers you one of the nation's most diverse stocks of RG type cables—including the Federal-developed low-temperature, non-contaminating thermoplastic jacket.

Quality-controlled throughout the entire manufacturing process, Federal cables bring *trustworthy transmission* to every electronic application . . . *plus* top flexibility and superior resistance to abrasion, weathering and corrosion.

Before you specify cable—or complete cable assemblies—for any general or military application, get the facts and figures from Federal. *We have the answer or we can get it!*



FEDERAL HAS A NEW CABLE CATALOGUE

This new 28-page buying guide contains a world of up-to-date information on Federal's quality-controlled cables, plus numerous useful tables and diagrams. For your free copy, write to Federal today, Dept. D-715.



Manufacturer of America's most complete line of solid dielectric cables

Federal Telephone and Radio Company



SELENIUM-INTELIN DEPARTMENT • 100 KINGSLAND ROAD, CLIFTON, N. J.

In Canada: Federal Electric Manufacturing Company, Ltd., Montreal, P. Q.
Export Distributors: International Standard Electric Corp., 67 Broad St., N. Y.

DC-AC CHOPPERS

Triple Certified for Military Use

0-500 CPS

Each production lot sampled and life tested to prove 1000 hours life while cycled -55°C. to +85°C. No guesswork.



Every Chopper given not only 1 but 2 complete operating tests at -55°C. +25°C. +85°C. before shipment. Double proof of stamina. Nothing left to chance.

Gold contacts are used for superior results in the vital 0-1½ volt d-c range. No other material will match this fine performance.



Also available
60 cycle types.

All military specifications met. Liberal safety factors to meet emergency conditions.

EXAMPLES:

- Frequency tolerance 0-500 cps.
- Coil Voltage Tolerance:
+ 30% - 20%
- Noise level 200 microvolts.

Write today for complete information.
Catalog 280B 0-500 cps
Catalog 246D 60 cps

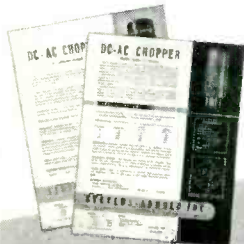

STEVENS-ARNOLD
INCORPORATED

22 ELKINS STREET, SOUTH BOSTON 27, MASS.



Foot-operated air valve controls opening and closing of jig for holding radio controls. Also showing is strap iron holder used throughout plant for keeping soldering-iron cord out of way

jig, allowing the operator to remove completed units and insert new controls. Another tap on the foot switch then moves the diaphragm downward, applying pressure to the upper wood block of the jig. The wood grips the threaded bushings of the controls to prevent them from turning, but does not damage the threads. This holding jig is in use at a large number of work positions in the Long Island City plant of Olympic Radio & Television, Inc.

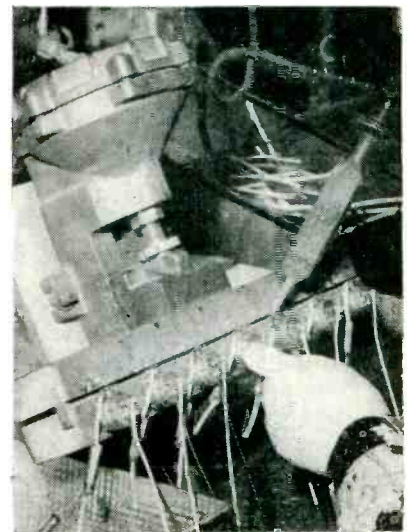

Close-up of holding jig in use for sub-assembly work, showing how air unit (made by W. R. Brown, Chicago) applies pressure to upper block

FREQUENCY STANDARDS

Modular system

DESIGNED AS A

The Type 2001-2 series provides frequencies from 30 to 30,000 cycles with an accuracy of .001% (at room temperatures) in units suitable for integration with instruments of your own design — or for panel rack mounting with your own power sources — or for line operation.

WHICH WILL MEET YOUR
CUSTOM NEEDS
FROM A COMBINATION OF
STOCK UNITS

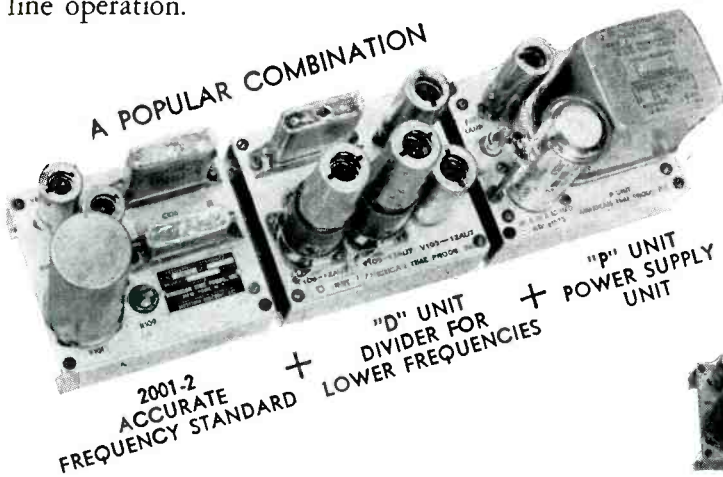

TYPICAL COMBINATIONS

2001-2	2001-2 + M
2001-2 + L	2001-2 + M + P
2001-2 + L + P	2001-2 + L + P + R
2001-2 + H	2001-2 + H + P + R
2001-2 + H + P	2001-2 + M + P + R

TYPE "2001-2" FREQUENCY STANDARD

Frequencies, 200 to 3,000 cycles. Output, approximate sine wave at 5 volts.

■ — ACCESSORY UNITS — ■



"L" UNIT. DIVIDER, (MULTI-VIBRATOR TYPE)
Provides frequencies from 30 to 200, controlled by the 2001-2 unit. Output, approx. 5V. Approx. sine wave.



"M" UNIT AMPLIFIER
Provides 2 watts at 6 and 110 volts.



"D" UNIT. DIVIDER, (COUNTER TYPE)
Provides 40 to 200 cycles controlled by the 2001-2 unit. (fail safe)



"P" UNIT POWER SUPPLY
Provides power for combinations of units illustrated, if other sources are inconvenient or not available.



"H" UNIT MULTIPLIER
Provides frequencies from 3,000 to 30,000 cycles, controlled by the 2001-2 unit. Output, approximately 5 volts.



"R" UNIT PANEL MOUNTING
Accommodates up to three units. Standard size is 8¾ inches high, 19 inches long.

For details, please request our "Type 2001-2" Booklet.

American Time Products, Inc.

580 Fifth Avenue

New York 36, N. Y.

OPERATING UNDER PATENTS OF WESTERN ELECTRIC COMPANY

NEW PRODUCTS

Edited by WILLIAM P. O'BRIEN

Control, Testing and Measuring Equipment Described and Illustrated . . . Recent Tubes and Components Are Covered . . . Fifty-Eight Trade Bulletins Reviewed

OTHER DEPARTMENTS

featured in this issue:

	Page
Electrons at Work	198
Production Techniques	258
Plants and People	382
New Books	436
Backtalk	451

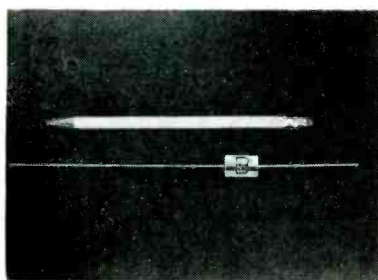

SELENIUM RECTIFIERS are glass-encased

BRADLEY LABORATORIES, INC., New Haven, Conn., is producing a new series of glass-encased high-voltage selenium rectifiers, dubbed the SE6L. It is hermetically sealed in a $\frac{3}{8}$ -in. diameter high-strength glass (pyrex) tube which has fewer high-voltage installation problems than the metal tube with glass-to-metal sealed end caps. The units are rated 1.5 milliamperes d-c and have maximum peak inverse ratings up to 6,000 volts. They meet government requirements for high-voltage hermetically sealed rectifiers.

E-A circuit analyzers. The new unit provides both a-c and d-c test voltages, permitting an extremely wide range of resistance and continuity tests and increases the sensitivity of the aforementioned models to over 200 megohms. It features a miniature selenium rectifier and dual-capacitor R-C filter network in a special circuit, which permits testing of capacitors for leakage with actual d-c voltages applied and quick indication of intermittently open capacitors with a-c applied. It will withstand direct short and all output terminals may be safely grounded without damage.

length and $2\frac{1}{4}$ in. in diameter. Instruments for operation to 285 C are available. Standard units for operation at normal ambient temperatures can be fluid filled.



TRANSDUCERS of the potentiometer type

RAHM INSTRUMENTS INC., 12 W. Broadway, New York 7, N. Y. The S series potentiometer pressure transducers include a number of instruments in the 0 to 5 and 0 to 30-psi range for the measurement of gage, differential or absolute pressure. The brush of a precision potentiometer is actuated by a change in pressure to produce a change in resistance-ratio or voltage. Small size is effected without sacrifice of resolution or linearity. All instruments in this series weigh 0.43 lb and are 2 in. in



MAGNETIC RECORDER with slanted top design

AMPEX ELECTRIC CORP., 934 Charter St., Redwood City, Calif. Model 350 magnetic recorder for professional and semiprofessional use features a new cabinet design. Sloped at a 30-deg angle, the tape transport mechanism is within easy reach of an operator, sitting or standing. The electronic control panel, also slanted, is just in front of the tape transport. Since all operative units are contained in the upper portion of the console, the machine may be placed on a desk or table if the user does not desire to use the base which is furnished. Pushbutton control permits rapid shuttling between fast forward and rewind, facilitating rapid editing. A two-speed machine, it may be ob-

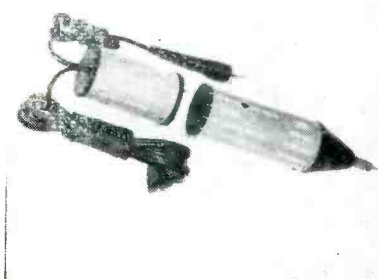

POWER SUPPLY for circuit analyzers

LEE ELECTRONIC LABS., INC., 233 Dudley St., Boston 19, Mass., have developed a new miniature electronic power supply, model PS-1 for use with their model E-C or

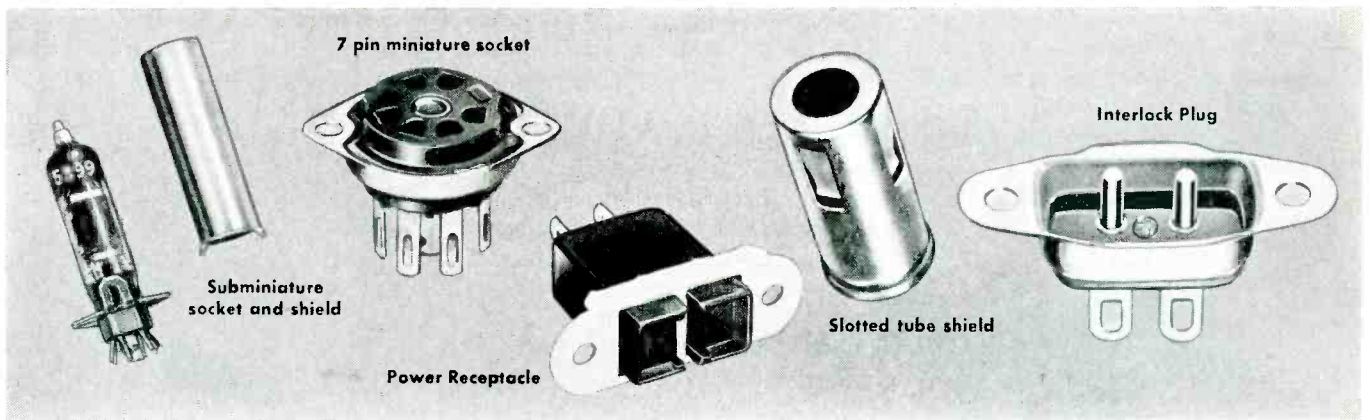

IMPROVED ELECTRONIC COMPONENTS FROM SYLVANIA

S YLVANIA's complete line of electronic components now includes tube sockets, shields, plugs and connectors . . . either standard or precision-made to your own specifications.

The tube socket line includes both molded and laminated types, supplied for either top or bottom mounting, a wide variety of saddles and with or without center shield and ground connections. Brass, phosphor bronze or beryllium copper contacts are

either cadmium or silver plated. Socket insulators include general purpose phenolic, low-loss phenolic, ceramic or NEMA grade laminated phenolic.

Sylvania plugs and connectors are offered to meet every electronic designer's need.

For complete information on any of Sylvania's quality electronic components, write today to: Sylvania Electric Products Inc., Dept. 3A-1010, 1740 Broadway, New York 19, N. Y.

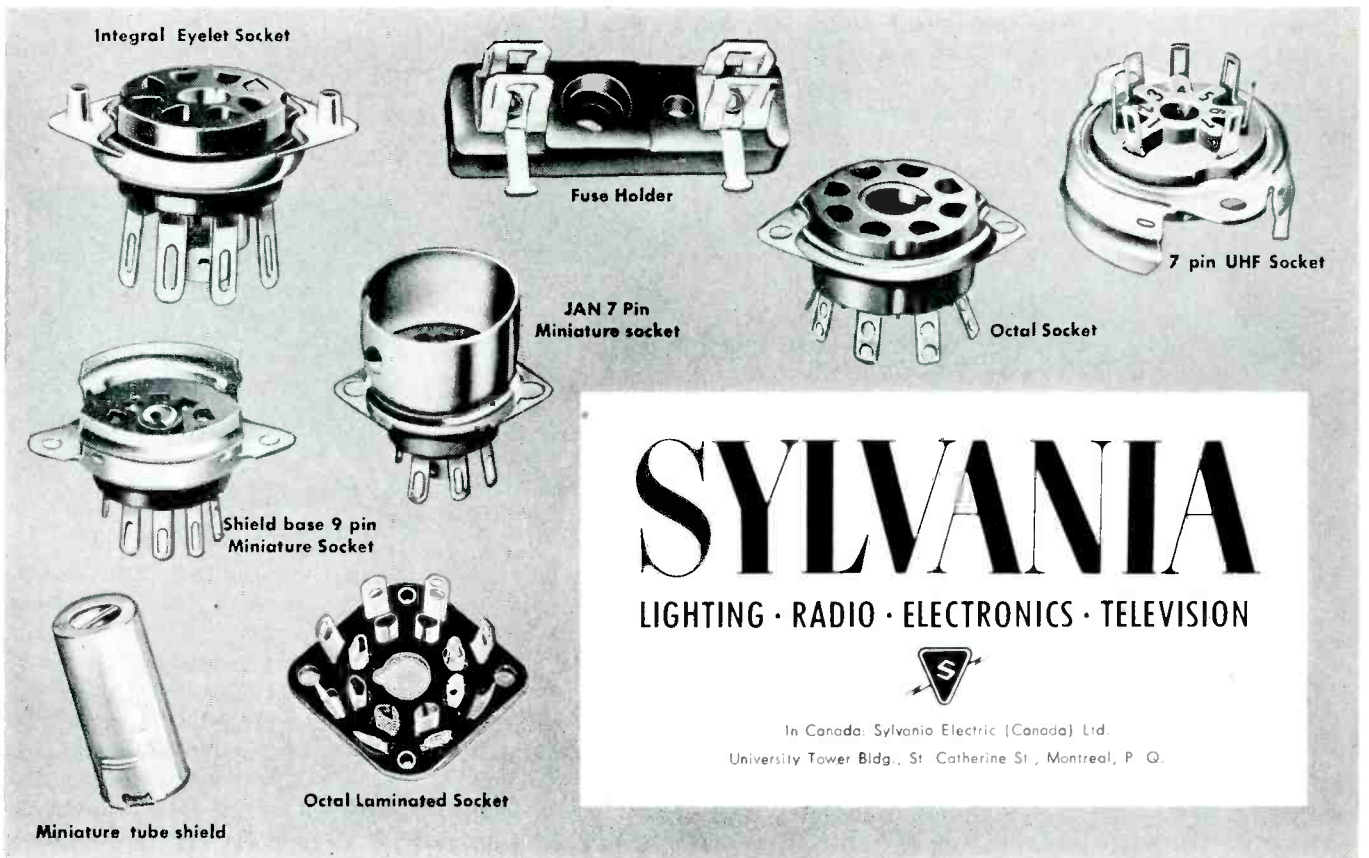

SYLVANIA

LIGHTING · RADIO · ELECTRONICS · TELEVISION



In Canada: Sylvania Electric (Canada) Ltd.
University Tower Bldg., St. Catherine St., Montreal, P. Q.

tained to operate at $3\frac{1}{2}$ and $7\frac{1}{2}$ ips, or at $7\frac{1}{2}$ and 15 ips. Frequency response to 15,000 cps is available at both the $7\frac{1}{2}$ and 15-in. speeds. At the $3\frac{1}{2}$ -in. speed, response is flat from 50 to 7,500 cps.

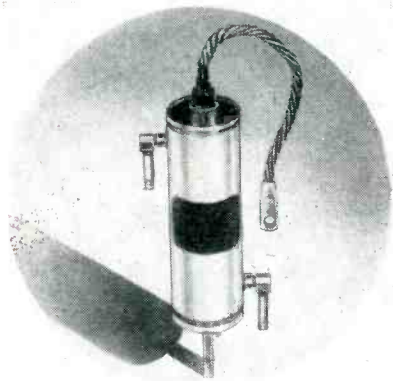

IGNITRON for a-c control use

NATIONAL ELECTRONICS, INC., Geneva, Ill., has added a new class-B ignitron to its line of industrial tubes. The NL-5551 is a metal, water-cooled, mercury-pool tube designed especially for welder control and similar a-c control applications. Its rating is approximately equivalent to a 300-ampere magnetic contactor. The tube is a strong, compact design of stainless steel, seam-welded construction. The mercury-pool cathode permits the tube to handle extremely high currents on an intermittent basis.

already available in the U. S. The Douglas and Macadie dual-head coil winder is designed for the winding of coils where the setup time is long compared to the actual winding time. While one coil is being wound, the other can be finished and replaced by a new bobbin ready to start another coil. This durable high-speed production machine features a predetermined revolution counter, magnetic clutch for positive control, lead-screw traverse, easily changed gears for quick setup, micrometer traverse adjustment, foot control and tension devices of an advanced design. One of the operating features of the coil winder is a rapid change of direction of the traverse at the end of each layer. This prevents any risk of the wire piling up against the cheeks of the coil. The winder will handle round, square or rectangular coils from $\frac{5}{16}$ in. to 4 in. in length and up to 2 $\frac{1}{2}$ in. diameter or diagonal. It will handle wires from 47 gage to 26 gage.

per second. Brakes and capstan pressure pulley are actuated by solenoids, making the unit ideal for remote control.

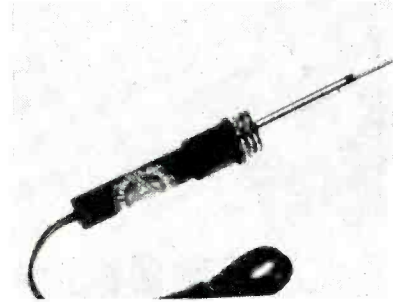

SOLDERING IRON is extremely lightweight

THE LENK MFG. CO., 30-38 Cummington St., Boston 15, Mass., announces a new pencil-type electric soldering iron for industrial, professional and hobby use. The tool weighs 2 oz and is available in two popular wattage ratings—25 w and 40 w. The handle is made of plastic; the tip is $\frac{1}{8}$ in. in diameter; and the unit measures $7\frac{1}{2}$ in. overall. It is especially recommended for soldering electronic components, precision instruments, radio and tv parts on a continuous speedy production-line basis. Outstanding feature is light weight and perfect balance—both of which materially reduce worker fatigue.

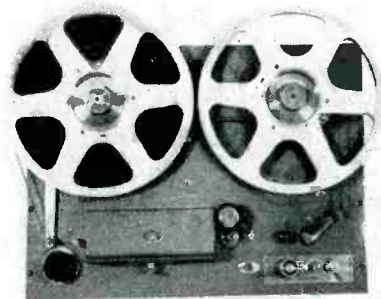

TAPE RECORDER is self-contained unit

PRESTO Co., Paramus, N. J. Model RC-11 is a tape-transport mechanism of almost absolute accuracy, with separate heads for recording, playback and tape erasing. Built on a unitized construction principle it employs a capstan drive unit containing a precision motor, endless nylon belt, brass flywheel, capstan shaft, pressure pulley and solenoid. The entire unit is self-contained and instantly removable for maintenance or replacement. It accommodates reels up to 10 $\frac{1}{2}$ -in. diameter and will record at $7\frac{1}{2}$ or 15 in.

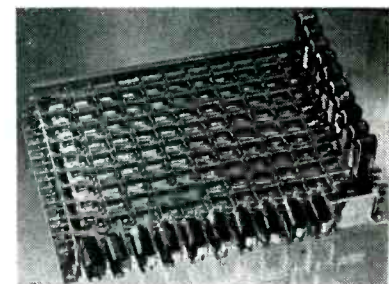

CROSSBAR SWITCH adaptable to many uses

JAMES CUNNINGHAM, SON & Co., INC., Rochester 8, N. Y., has announced a new type of crossbar switch adaptable to a wide range of uses in multiple switching of audio and video circuits, in computer systems and many other applications. The switch is especially distinguished by its ability to handle high frequencies, its extremely low

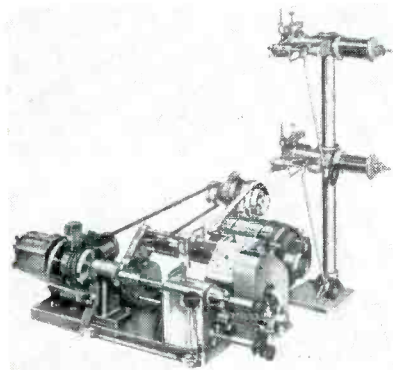

COIL WINDER features dual head

BRITISH INDUSTRIES CORP., 164 Duane St., New York 13, N. Y., has added a new AVO coil winding machine to the more than 30 models

Now... The Most Compact and Only Complete VOR System

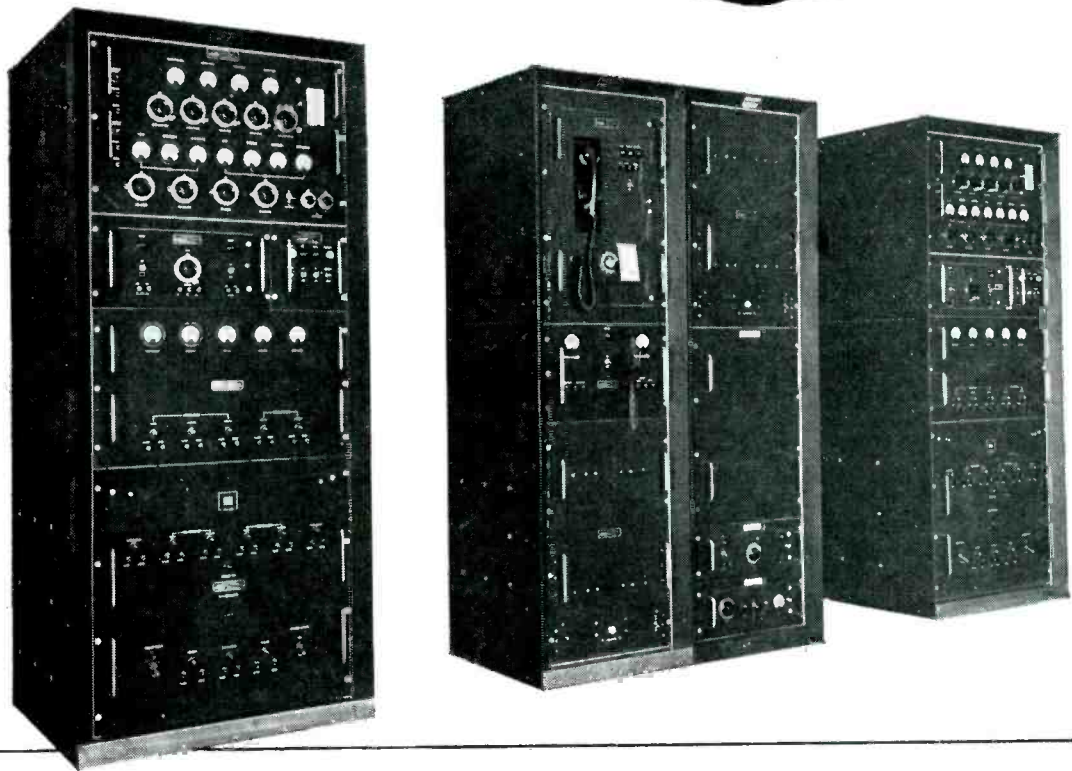

Another Lavoie First

Lavoie, and only Lavoie, manufactures a complete VOR System for short range aircraft navigation. By its use, accurate course, bearing and position are easily determined.

As perfected by Lavoie Laboratories, Inc., two fields are radiated by the system. One rotates at 30 revolutions per second; the other carries a reference 30 cycle signal in all directions. Only one small control panel in the control tower console, plus an extremely compact amplifier monitor are all that are required for complete, efficient transmitter control. The transmitter itself may be located up to 30 miles from the tower. All control functions, including voice modulation from the tower, are handled by one telephone pair.

Built to military standards of ruggedness and precision, the Lavoie VHF Omni Range system may be used with maximum efficiency in any part of the world. A mobile unit is also available.

We shall be glad to give you complete details on this unique, compact, thoroughly reliable Omnidirectional Radio Range System.

SPECIFICATIONS:

Frequency Range: 112 to 118 megacycles

Frequency Control: Crystal accuracy 0.001%; crystal frequency 12.4444 to 13.1MC.

Power Output 200 watts; power in sidebands 25 watts.

Modulation: Speech 30% AM; Identification Code, 10% AM at 1020 cycles; Reference Signal, 10 KC subcarrier at 30%; frequency modulated ± 480 cycles at 30 cycle rate. Equipment is capable of 85% modulation.

Power Requirements: 230 volts, 60 cycles single phase, maximum demand 6 kilowatts, normal demand 4 kilowatts, power factor approx. 85%.

Total Weight: 2250 pounds less antenna equipment.



Lavoie Laboratories, Inc.
MORGANVILLE, NEW JERSEY

Designers and Manufacturers of Electronic Equipment



NOW WE ARE CROWING AND WITH GOOD CAWS...

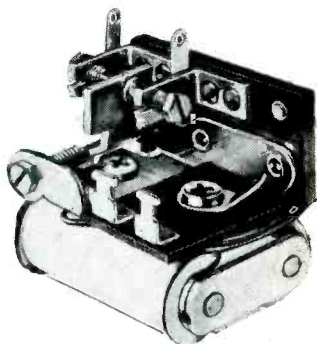
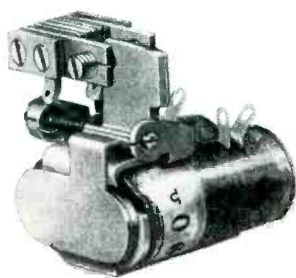

The relay on the right may be recognized as a Sigma Type 5F. In 1943 we regarded it as quite an achievement. Over

the intervening years it has done us yeoman service and kept a charmingly large segment of our customers in a state of dithers. (Sometimes because they couldn't get Type 5's, other times because they wished they hadn't!)

But we had come to feel it was, if not obsolete, at least no longer newsworthy, so we don't often speak of it in our advertising. Perhaps we were wrong, because we now observe the very creditable effort of an esteemed competitor (left above) to which he is devoting prominent attention in publicity. His specifications are good, too. 60,000 ohms winding resistance is offered publicly. (We do that sort of thing only on special request. We hate to encourage the philosophy leading to such a requirement.) Maximum sensitivity is given as 1 to 2 milliwatts. We assume they are being conservative because we feel the design is appropriate for 1/2 milliwatt sensitivity when well executed and well applied (not when used on an airplane!).

The competitor is to be complimented, too, for designing around our patent, a feat he has probably achieved at little or no sacrifice in most applications. We are flattered that he should think our patent strong enough to worry about.

Maybe our venerable workhorse has more glamour than we thought.

SIGMA

SIGMA INSTRUMENTS, INC.

62 PEARL ST., SO. BRAINTREE, BOSTON 85, MASS.

crossstalk level, its rapid operation and its compactness. It is available with 4 or 10 link levels, and either 10 or 25 line levels. Each circuit may have up to 3 conductors. Excellent transmission is achieved at frequencies as high as 70 mc. Bridging capacitance between adjacent conductors is 15 μ f. Crosstalk level between two circuits with common ground, and adjacent in both line and link levels, is down more than 65 db at 10 mc. The unit is particularly suitable for application to tv circuits for studio or master control, monitoring or other purposes. Computers, lab test apparatus, radar monitoring equipment and other devices requiring multiple switching in complex patterns and at high frequencies, also are uses to which the crossbar switch can be applied.



METER measures phase shift

INDUSTRIAL TEST EQUIPMENT CO., 55 E. 11th St., New York 3, N. Y. Model 200A Phazor phasemeter readily permits accurate phase-shift measurements even though the input signal is complicated by noise and harmonic voltages. The device is extremely useful in the measurement of phase shift in transformers, amplifiers, filters and phase-displacement networks. It can also be employed to measure either in-phase or quadrature voltage components. Self-calibrating action assures high accuracy. It measures 0 to 360 deg. Readings are not affected by noise and harmonics. Some other features are high sensitivity, broad frequency range, high input impedance, wide input voltage range and electronic limiting to prevent instrument

C-D consistently dependable

C-D CERAMIC CAPACITORS

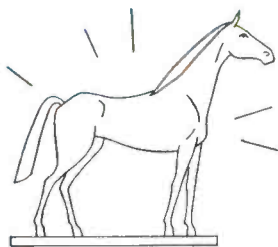
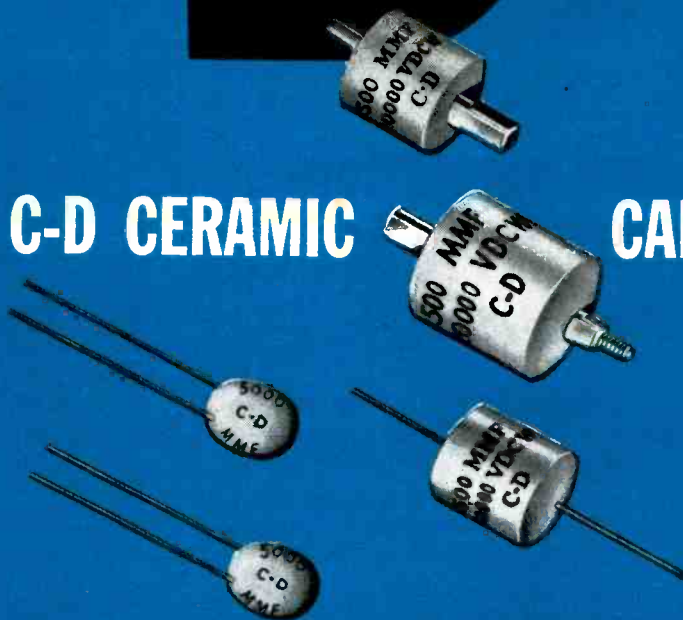

The ceramics with the "million dollar" body! Even the body is made by C-D, in the newest, most modern ceramic body plant in the world. You'll be as thoroughly "sold" on C-D ceramics as you are on C-D Dykanols*, micas and electrolytics. Write for Engineering Bulletins to: Dept. K-103, General Offices, Cornell-Dubilier Electric Corp., South Plainfield, New Jersey.

CORNELL-DUBILIER

world's largest manufacturers of capacitors

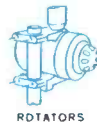
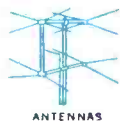

SOUTH PLAINFIELD, N. J. • NEW BEDFORD, WORCESTER AND CAMBRIDGE, MASS. • PROVIDENCE, R. I. • INDIANAPOLIS, IND. • FUQUAY SPRINGS, N. C. • SUBSIDIARY, THE RADIART CORP., CLEVELAND, O.

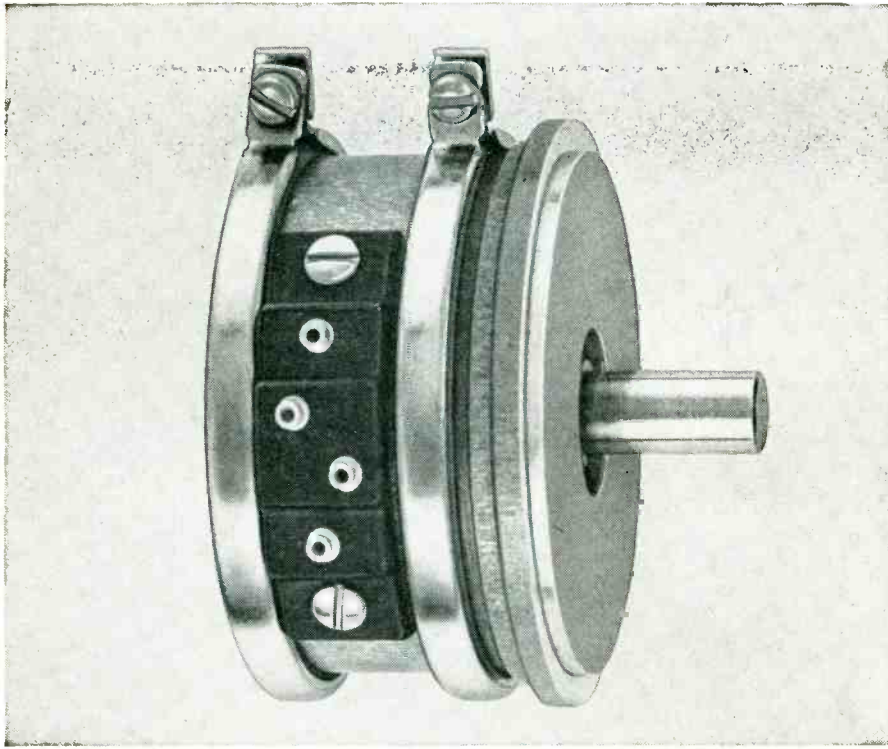

TYPE 756— Fairchild's latest single-turn PRECISION POTENTIOMETER

Gives you all these advantages...

- 1** Extremely low noise level and longer life with sustained high accuracy result from improved windings and wiper design. These improvements also permit higher rotational speeds with minimum of wear.
- 2** Higher resolution (0.05% at 2,000 turns) and close functional tolerances (linear $\pm 0.25\%$; non-linear 0.35% with 3:1 slope ratio in high resistance ranges) give higher point-to-point tracking qualities.
- 3** Standard electrical functional angle is 320 deg. nominal with ORV tolerance of $\pm 5\%$ in resistance range from 800 to 40,000 ohms. Electrical functional angle of 350 deg. nominal with ORV tolerance of $\pm 3\%$ in resistance ranges of 50 to 45,000 ohms can be supplied on special order.
- 4** Greater flexibility—For non-linear functions as many as 13 taps can be provided by adding extra terminal boards.
- 5** All the desirable qualities of the well-known Type 746 unit, including easy and more accurate phasing, ganging up to 20 units on a single shaft, all-metal precision-machined housing and shaft, low torque, etc., are included in the Type 756.

Full information about the entire line of Fairchild Precision Potentiometers, including specifications of the Type 756 unit and how we can help solve your potentiometer problems, is available for the asking. Write to *Potentiometer Division, Fairchild Camera and Instrument Corporation, Park Avenue, Hicksville, Long Island, New York, Department 140-39A 2.*

FAIRCHILD
PRECISION POTENTIOMETERS

overload. Dimensions are 9 in. high \times 15 in. wide \times 8 in. deep.



DECADE INDUCTOR with toroidal construction

TOROCOIL Co., 1374 Mobile Court, St. Louis 10, Mo., has available a line of decade inductors that are particularly adaptable to design problems involving the need for precision, high-Q inductors such as wave filters, tuned circuits, and elements in oscillators and analyzers, where the advantage of a simple method for component substitution can be obtained over a wide range. The four basic decade steps: 1 to 10 mh, 10 to 100 mh, 100 to 1,000 mh and 1 to 10 henrys, are available as single units. Each range is encased in a heavy drawn metal container which protects it at all times from possible damage, and at the same time acts as an efficient electrostatic shield.

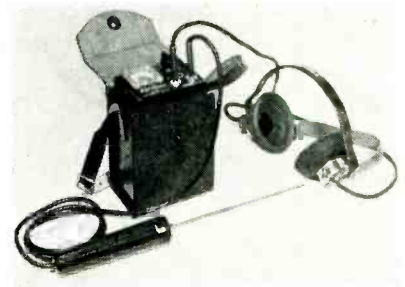

NOISE DETECTOR has audio-video features

ANCO INSTRUMENT DIVISION, AMERICAN NAME PLATE & MFG. CO., 4254 W. Arthington St., Chicago 24, Ill., has introduced the Elec-Detec

G-E Photoelectric Relays Sort, Count, Signal — Automatically

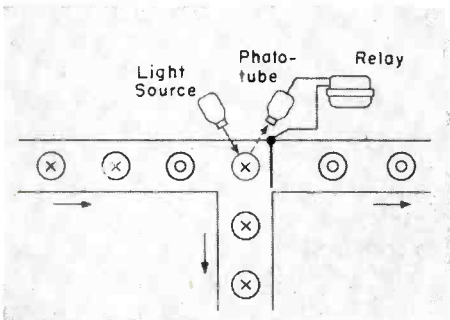
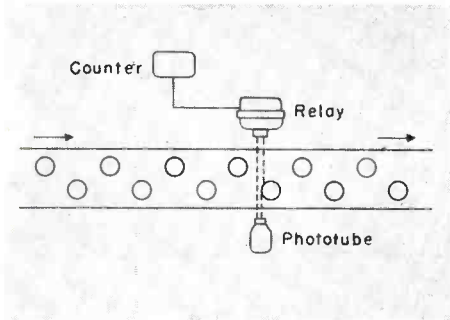
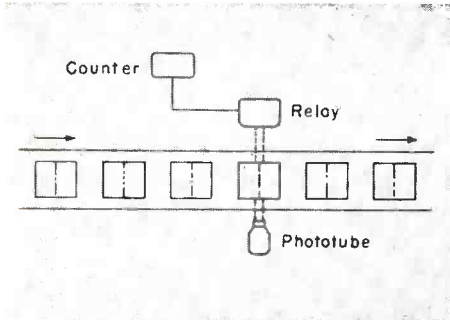

CR7505-K100

Simple, Inexpensive, Dependable

Ideal for applications not requiring extreme accuracy or extra high speeds, the K100 can relieve costly personnel for more productive jobs. A good example is the application at left, where this relay is being used to operate a counter on a conveyor line. The K100 is furnished in a sturdy NEMA Type I enclosure. *Bulletin GEA-3533D.*

CR7505-K201

High-quality, General-purpose Relay

The K201 photoelectric relay, shown at left counting small cans on a high-speed conveyor line, offers sufficient sensitivity and operating speed for most applications.

The K201 is available in either weather-resistant and dust-tight (NEMA III and V) or explosion-proof (NEMA VII) or water-tight (NEMA V). *Bulletin GEA-5920.*

CR7505-N210

High Speed, High Sensitivity

The N210 relay is an extremely sensitive device designed for operation at very high speeds.

In the example shown here, it is used on a conveyor to separate cans according to markings. It can also be used to sort unlabeled cans from correctly labeled ones. Available in same enclosure types as K201. *Bulletin GEA-5921.*

SPECIFICATIONS

Maximum operating speed:

K100: 150 per minute
K201: 450 per minute
N210: 600 per minute

Maximum operating distance:

K100: 30 feet
K201: 70 feet
N210: 210 feet

Sensitivity*:

(Minimum light intensity at phototube for successful operation)

K100: 40 fc.
K201: 3 fc.
N210: 1 fc.

* Depending on combination selected.

High contact rating

Can start 1/2-hp motors directly, and operates all a-c motor starters through NEMA Size 4, without additional relay. Meets all NEMA standards.

ELECTRONIC TIMER CR7504-A142



Handles timing over three ranges. .06-1.2, .6-12, 6-120 seconds. Highly accurate, versatile. *Bulletin GEA-5255.*

ELECTRONIC RELAY CR7511-A126G2

A versatile new relay which operates wherever there is sufficient change in circuit resistance. *Bulletin GEA-5893.*

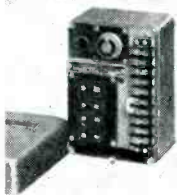

FOR MORE INFORMATION, contact your nearest G-E Apparatus Sales Office or authorized G-E distributor, or write General Electric Company, Section B 785-8, Schenectady 5, New York for the following bulletins:

- | | |
|--------------------------------------------------------------|------------------------------------------------------|
| <input type="checkbox"/> GEA-3533D, Photoelectric Relay K100 | <input type="checkbox"/> GEA-5255B, Electronic Timer |
| <input type="checkbox"/> GEA-5920, Photoelectric Relay K201 | <input type="checkbox"/> GEA-5893, Electronic Relay |
| <input type="checkbox"/> GEA-5921, Photoelectric Relay N210 | |

NAME _____ TITLE _____

COMPANY _____

ADDRESS _____

CITY _____ STATE _____

ELECTRONIC DEVICES

GENERAL ELECTRIC

Forging Stronger Links in Microwave Relay

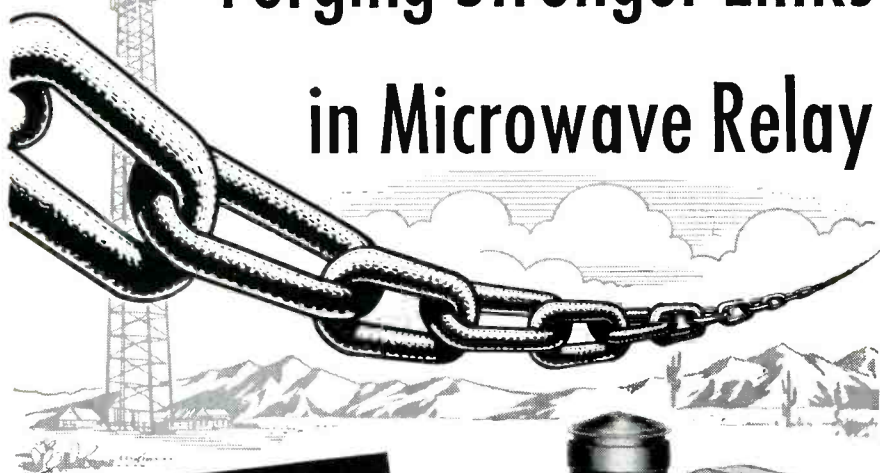

**ONAN
STANDBY
ELECTRIC
PLANTS**

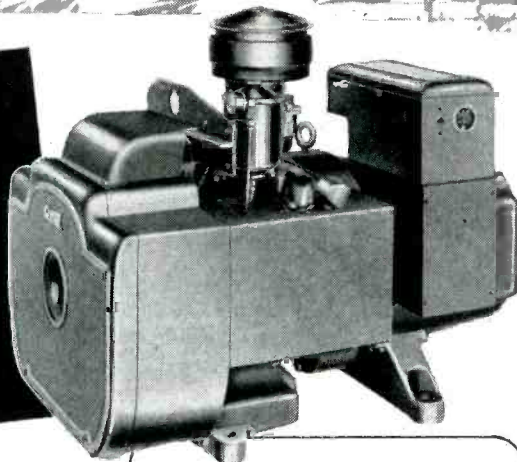

Microwave transmission is only as dependable as each of its relay links. If one repeater station cannot operate, messages do not get through.

To assure electric power for transmission, hundreds of microwave relay stations across the country are equipped with Onan Standby Electric Plants. When central station power is interrupted, the Onan plant starts automatically, supplies power for as long as the emergency lasts, then stops automatically. Controls are available to provide a time interval between power interruption and starting.

Onan Standby Electric Plants have been proved indispensable in installations serving oil and gas pipelines, utilities, railroads, TV networks, police and other government law enforcement departments.

If you have a problem in standby power for microwave radio, or any application, write our sales engineers. Onan Standby Electric Plants range from 1,000 to 35,000 watts.

New 5CW 5,000 watts A.C. Air-cooled GASOLINE POWERED

- **COMPACT**—Take less than one cubic yard of space. Easier to install. Connection box provided for quick hook-up.
- **UNI-DUCT COOLING**—Cooling air is drawn by vacuum through generator and over engine. All heated air is expelled through one small vent which also discharges engine exhaust. Quiet operating. No liquid coolants to freeze or leak.
- **BUILT FOR HEAVY DUTY**—Smooth-running, twin-cylinder, horizontally-opposed, 4-cycle air-cooled engines deliver rated horsepower at moderate speed. Unusually large bearing surfaces for long life.
- **DE LUXE EQUIPMENT**—Nothing extra to buy. Impulse-coupled, high-tension magneto, radio shielded. Oil-bath air cleaner, fuel filter, oil pressure gauge, fuel tank, muffler and exhaust tubing. All heated and moving parts safely enclosed.

A size and model for every standby application!



3,500 watts A.C.
2-cyl. air-cooled

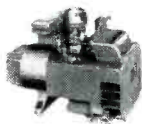

10,000 watts A.C.
2-cyl. air-cooled



5 to 35 KW A.C.
Water-cooled

Write for specifications

D. W. ONAN & SONS INC.



7036 No. University Ave. S. E. • Minneapolis 14, Minnesota

NEW PRODUCTS

(continued)

model V, a portable electronic instrument designed for locating noise sources in all types of mechanical equipment. The unit includes a milliammeter for checking sound impulses visually, in addition to the standard headphones for audible operation. The accurate performance of the new video unit is assured by the use of a highly stable germanium crystal diode in the circuit. This crystal serves to rectify the current to record the electrical impulses accurately on the d-c milliammeter, and to provide the wide frequency response required.

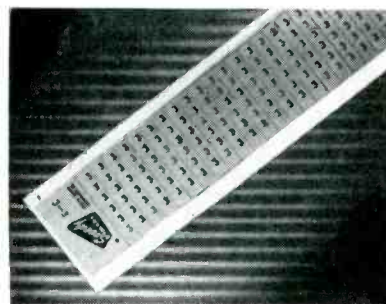

ADHESIVE MARKERS simplify identification

THE NORTSHORE NAMEPLATE CO., Glenwood Landing, L. I., N. Y., announces a new line of Speedy Marx identification markers. Using an adhesive stock, these markers can be supplied in easy-to-read type styles, resulting in a simple and permanent marker for wire, transmission cable and other electronic products. Standard cards are available in black-and-white or in any regular NEMA colors. Special coating cards in any size, color or design are also available.

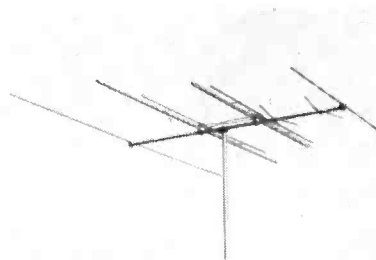

TV ANTENNA designed for fringe areas

WELLS & WINEGARD, TELEVISION ACCESSORY MFG., Burlington, Iowa,

Standardized! To save you time and money— **E-I** HERMETICALLY SEALED LUG-TYPE, LEAD-THRU INSULATORS

—for condensers, transformers
and general applications

- RATINGS FROM 2000
TO 4000 VOLTS (rms.)
- COMPRESSION SEALED
- PRACTICALLY
INDESTRUCTIBLE
- MOUNT FROM INSIDE
OR OUTSIDE OF CAN
- LEAD THRU WIRES
UP TO .060

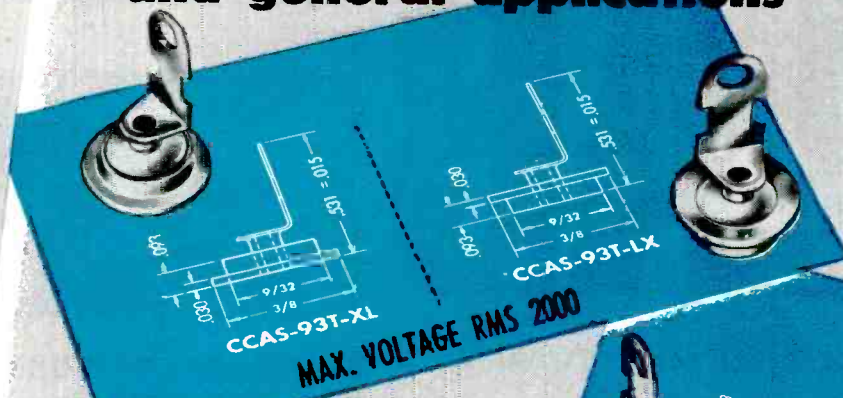

PHOTOS APPROX.
TWICE ACTUAL SIZE

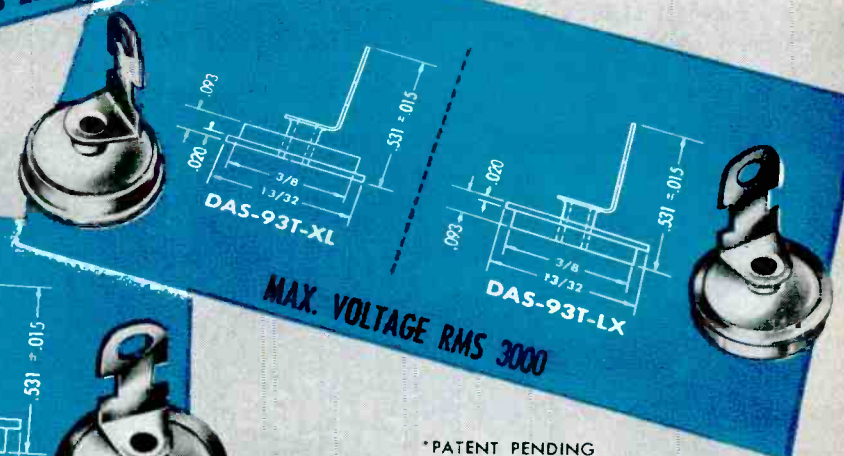

*PATENT PENDING
ALL RIGHTS RESERVED

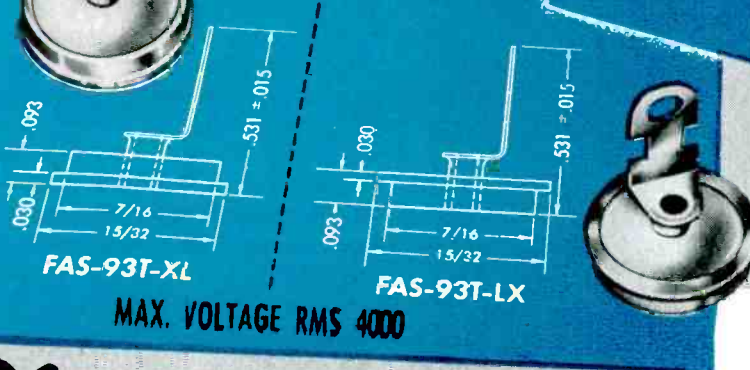

Plus HUNDREDS OF STANDARD
TERMINALS WITH MANY OPTIONAL FEATURES

Designers and engineers can rely on E-I for a quick, economical solution to practically any sealed terminal requirement. More than a dozen years of specialized manufacture assure performance that exceeds specifications. When unusual design requires custom engineered terminals these can be produced by E-I, at unit costs that reflect mass-production methods. Call or write for complete catalog.

E-I STANDARD TRANSISTOR CLOSURES



(SHOWN ACTUAL SIZE)

offering reduced size with soldering dimple, and hole for easy sealing. Available from stock TC-1C can, TB-1B base with long leads. Specify TB-1A for plug-in type. Samples on request. Production from stock.

DIVISION OF AMPEREX
ELECTRONIC CORP.



ELECTRICAL INDUSTRIES

44 SUMMER AVENUE, NEWARK 4, NEW JERSEY

EXPORT AGENTS

PHILIPS EXPORT CORP., 100 EAST 42nd STREET, NEW YORK 17, N. Y.

CONVAIR

Consolidated Vultee Aircraft Corporation is one of the many famous manufacturers who consistently use nationally-known KAY-LAB PRE-CISE ELECTRONIC INSTRUMENTS.

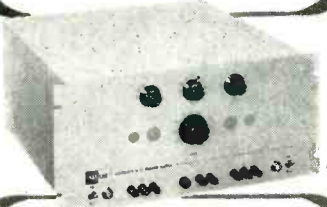
**KAY-LAB ABSOLUTE D. C. POWER SUPPLIES**

These units are absolute sources of D.C. voltage independent of output load and line voltage variations. The output voltage is constantly compared against the internal standard cell and thus, absolute calibration and stability with reference to the cell is insured.

SPECIFICATIONS:

Long Time Drift Stability: .01%
Output Voltage Calibration: to .01%
Output Impedance: 0.1 ohm
Output hum and noise: Under 1 millivolt
Output Voltage: Models from microvolts to kilovolts
Output Current: Models from ma to amps

KALBFELL LABORATORIES, INC.
1090 MORENA BLVD.
SAN DIEGO 10, CALIFORNIA

*precisely!***KAY
LAB****SEND NOW FOR COMPLETE DETAILS FREE!****for electronic instruments**

has added the model CP-1 Clipper to its antenna line. The Clipper, a high-gain fringe-area unit engineered for complete coverage of all vhf channels, offers high uniform gain, perfect 300-ohm match, one major forward lobe, a narrow beam to reduce ghosts and noise pickup and high signal-to-noise ratio. Good front-to-back ratio also eliminates troublesome cochannel interference. Other outstanding features are its light, rigid construction and easy assembly. The Clipper can be quickly installed to any height, and because of its compactness, offers unusually low wind resistance.

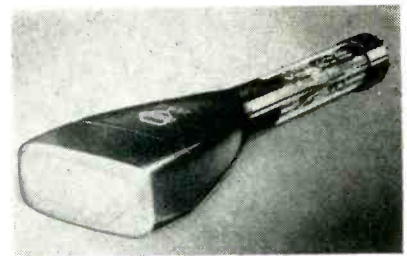
**OSCILLOGRAPH TUBE**
has 6 in. x 2 in. screen area

MULLARD LTD., Century House, Shaftesbury Ave., London WC2, England, has available the DG16-21 rectangular oscillograph tube. Although developed primarily for radar azimuth-trace applications, this tube should also find use in more conventional oscilloscopes where the packing factor in the horizontal plane is of importance. It has a screen area of 6 in. x 2 in. and is characterized by a high deflection sensitivity and small spot size.

**DRUM CALCULATOR**
for data processing

INTERNATIONAL BUSINESS MACHINES CORP., 590 Madison Ave.,

**Saratoga
Industries**

**STAR PERFORMANCE AS
MANUFACTURERS OF TRANSFORMERS,
REACTORS, FILTERS, TOROIDAL
COILS FOR THE ELECTRONICS INDUSTRY**

Now in its ninth year of operation, Saratoga Industries, Inc. has built a solid reputation for the manufacture of precision windings. Approved for in-plant testing under MIL-T-27, Saratoga Industries, Inc. is also prepared to handle all types of commercial production. Saratoga engineers invite your inquiry to help solve your problems relating to reactors, transformers, filters and windings of all types.

SARATOGA INDUSTRIES, INC., SARATOGA SPRINGS, N. Y.

HALLETT

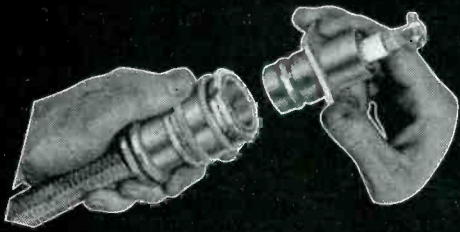

HALLETT

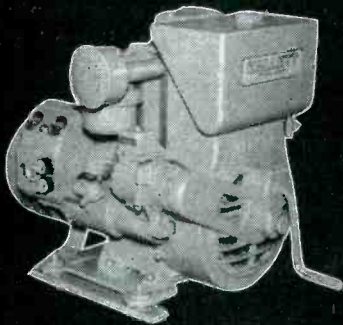

HALLETT

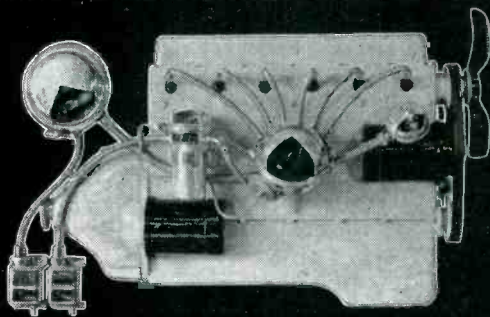

HALLETT MANUFACTURING COMPANY

Main Plant: 1601 West Florence Avenue, Inglewood, California, Oregon 8-4751; District Sales Offices: Washington, D.C., 13th and E Streets, District 7-0217; Detroit, Mich., Book Tower Bldg., Woodward 1-9553; New York, N.Y., Grand Central Bldg., Murrayhill 3-4752; Chicago, Ill., 600 South Michigan Blvd., Wabash 2-1343

QUICK DISCONNECT COUPLINGS FOR COAXIAL CABLE USE

Investigate the advantages of compact, lightweight Hallett Quick Disconnect Couplings for coaxial cables, TV and radio installations, computers, etc. Manufactured to meet rigid military specifications and all vibration and thermal shock tests. Write for catalog and prices.

DIESEL ELECTRIC GENERATOR SETS

Hallett dependable full Diesel power from 2½ KW to 10 KW in both water and air cooled models for standby power, portable, mobile and stationary units — also available, bare engines with power take-offs for all power applications from 5 HP to 18 HP. Write for catalog concerning your power requirements.

RADIO INTERFERENCE REDUCTION AND CONTROL EQUIPMENT

Stock kits for most engines and tailor-made for special applications. Hallett radio interference reduction and control equipment is the standard of the industry — positively shields out all noise indefinitely. Manufactured in accordance with Government specifications. Technical data upon request.

Gentlemen: Please send me more information concerning:

- Hallett Diesels
- Quick Disconnect Couplings for Coaxial Cable Use
- Radio Interference Reduction and Control Equipment

Name _____

Firm Name _____

Address _____

City _____ Zone _____ State _____

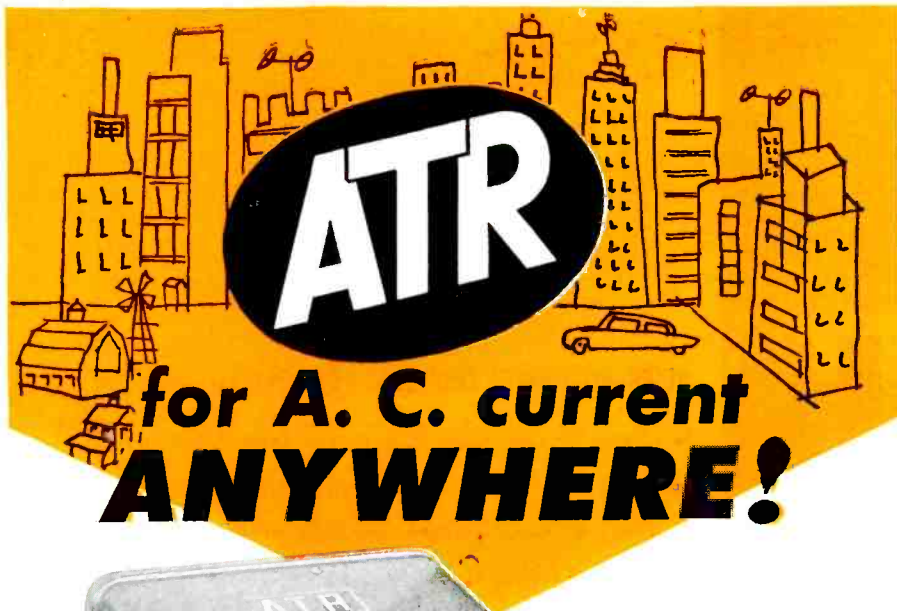

ATR

for A. C. current ANYWHERE!



AT NEW
LOW COST

\$25⁵⁵
And Up
Retail Price

INVERTERS

For Inverting D.C. to A.C. . . . Specially Designed for operating A.C. Radios, Tape Recorders, Wire Recorders, Record Changers, Television Sets, Amplifiers, Address Systems, Radio Test Equipment and most small electrical and electronic devices from D. C. Voltages in Vehicles, Ships, Trains, Planes and in D. C. Districts.

Type	Input DC Volts	A.C. Output 60 Cycles	Output Int.	Wattage Cont.	Consumer Net Price
6-LIF	6	110 volts	40	35	\$25.55
12-LIF	12	110	50	35	25.55
* 6-RSD	6	110	85	75	39.25
*12-RSD	12	110	125	100	39.25
32-RSD	32	110	150	100	39.25
110-RSD	110	110	250	150	39.25
*12T-HSG	12	110	250	200	98.45
110AT-RHE	110	110	325	250	56.95

There is an ATR model for most any application.
* Available with leather carrying handle at \$1.00 additional—optional.



NEW MODELS
NEW DESIGNS
NEW LITERATURE

See your jobber
or write factory

ATR

"A" Battery Eliminators, DC-AC Inverters, Auto Radio Vibrators

AMERICAN TELEVISION & RADIO Co.

Quality Products Since 1931

SAINT PAUL 1, MINNESOTA—U. S. A.

New York 22, N. Y., has introduced the magnetic drum calculator, a new machine that combines one of the advanced memory devices and the stored program concept of IBM's 701 with new high speed reading capacity in the conventional punched card equipment to achieve a powerful data processing machine for commercial and engineering requirements. In addition to its usefulness as an accounting and computing tool, the calculator will be a vital factor in familiarizing business and industry with the stored program principles fundamental to electronic data-processing equipment. A numeric decimal machine, it has up to 20,000 memory positions and can accept as many as 2,000 individual operating instructions to facilitate commercial and scientific computations. It consists of three units: a magnetic drum unit with electronic calculating components, an input and output unit, and a converter.

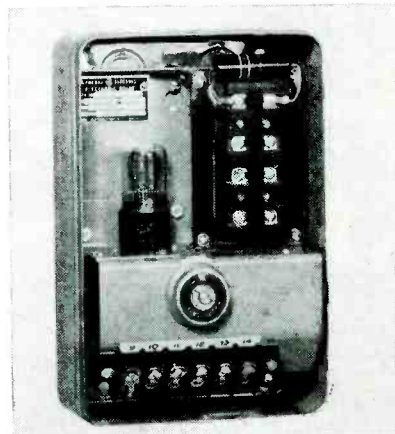

ELECTRONIC RELAY is resistance sensitive

GENERAL ELECTRIC Co., Schenectady 5, N. Y., has announced a new electronic relay that is highly sensitive to resistance changes and can be varied by a stepless dial. It may be used to start or stop a fractional-hp motor directly when a contact-making ammeter, voltmeter or wattmeter reaches a required meter reading. Other uses include liquid-level control, sorting of small parts, and operating of lights, solenoids and contactors wherever there is sufficient change in the resistance of a circuit. Two spdt con-

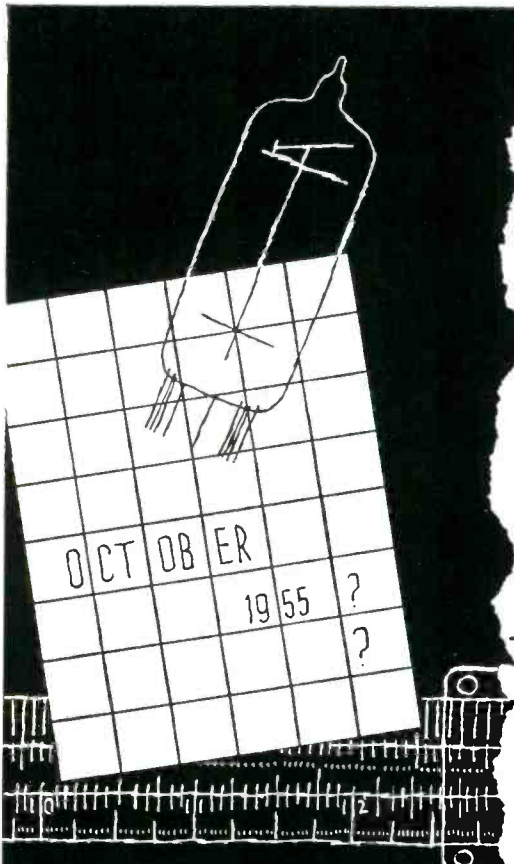

to
9 ENGINEERS
 who are charting
 their future
 in the
 electronics
 industry...

The work of the Westinghouse Electronics Division, located in Baltimore, is well balanced between civilian and military production. We are expanding, and currently there are several excellent key openings which are both stimulating and challenging. The rewards offered are exceptional, and include : Open salaries, commensurate with experience and ability; a patent-award plan famous throughout the industry; opportunities for advanced degrees; relocation expenses; and exceptional opportunities for advancement.

TWO OPENINGS

POSITION: Low Noise Microwave Receiver Designer
DUTIES: Microwave techniques and measurements. Mathematical analysis of crystal mixer performance. Coordination of T-R cavity, crystal mixer and receiver input circuit designs to obtain best possible noise figure. Knowledge of microwave mixers is important.

REQUIREMENTS: Three or more years' experience and a BS degree in Electrical Engineering or in Physics.

TWO OPENINGS

POSITION: Antenna and Waveguide Plumbing Designers
DUTIES: Microwave techniques and measurements. Development and design of radar antennas and necessary associated waveguide and transmission line equipment. Involves mathematical design and analysis and experimental work.

REQUIREMENTS: Three or more years' experience and a BS or Advanced Degree with specialities in the field of antennas, waveguides, electromagnetic theory, or boundary value problems.

THREE OPENINGS

POSITION: Systems Engineer
DUTIES: Systems analysis and evaluation; systems coordination; and systems test planning. Involves feedback systems, computers, video systems, indicators, switching, etc.

REQUIREMENTS: Three or more years' experience and a BS Degree in Electrical Engineering or in Physics.

TWO OPENINGS

POSITION: Mechanical Engineers
DUTIES: Mechanical design of efficient, compact, accessible electronic apparatus. Structural design of radar antennas and supporting structures.

REQUIREMENTS: Three or more years' experience and a BS Degree in Mechanical Engineering.

We are prepared to pay interviewing and relocation expenses to qualified men. To apply, send resume to
 R. M. Swisher, Jr.

Employment Supervisor, Dept. OE
 Westinghouse Electric Corporation
 109 W. Lombard Street
 Baltimore 1, Maryland



BALTIMORE, MARYLAND

Circuit Magnification Meter TF 329G



For the measurement of the Q of a circuit, there are no better instruments than Marconi. Model TF 329G applies to the frequency range 50 kc to 50 mc. In addition to direct Q readings, the TF 329G can be used for a considerable range of indirect measurements carried out by the normal resonance methods. These include inductance of coils, capacitance and phase defect of condensers, the characteristics of transmission lines. Special jigs are available for investigating dielectric losses.

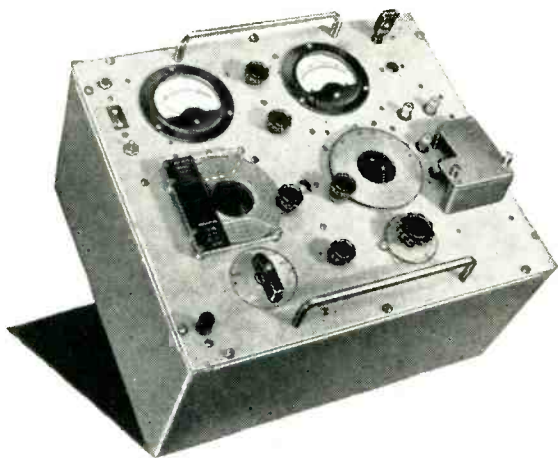

MARCONI INSTRUMENTS

SIGNAL GENERATORS · VACUUM TUBE VOLTMETERS
FREQUENCY STANDARDS · OUTPUT METERS · WAVEMETERS
WAVE ANALYSERS · Q METERS · BEAT FREQUENCY OSCILLATORS

23-25 BEAVER STREET · NEW YORK 4

CANADA: CANADIAN MARCONI CO., MARCONI BUILDING, 2442 TRENTON AVENUE, MONTREAL
ENGLAND: HEAD OFFICE: MARCONI INSTRUMENTS LIMITED, ST. ALBANS, HERTFORDSHIRE

Managing Agents in Export:

MARCONI'S WIRELESS TELEGRAPH COMPANY LIMITED, MARCONI HOUSE, STRAND, LONDON, W.C.2

tacts permit control of independent systems, and a simple jumper change sets the relay for normal or reversed operation. Selection of the most favorable relay operating point is facilitated through a sensitivity dial located on the front of the unit. The dial may be remotely controlled from as far away as 500 ft, and may be locked when set.

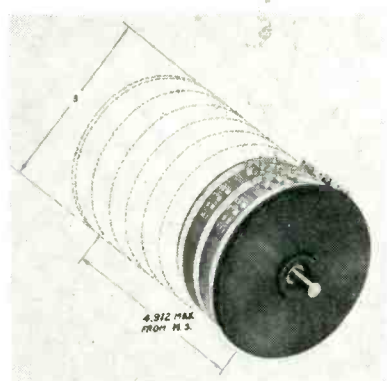

POTENTIOMETERS feature high precision

HELIPOT CORP., South Pasadena, Calif., is producing the model L series of 360 deg, continuous rotation, 3-in. o.d., high precision potentiometers. Variations on the basic design include the model L with bushing mounting and sleeve bearings, model LS with servo lid mounting and Oilite bearings, and model LSP with servo lid mounting and ball bearings. Models L and LS have standard linearities of ± 0.5 percent in resistance ranges from 10K to 100K ohms. Other versions with linearities as high as ± 0.1 percent (5K ohms and above) can be manufactured to order.

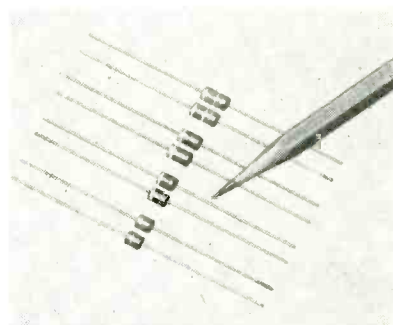

CAPACITORS for uhf applications

STACKPOLE CARBON Co., St. Marys, Pa., has added to its lines 39 new

PRECISION 60-CYCLE POWER SUPPLY

Accurate 60-cycle frequency stabilization with up to 70 watts power output is furnished by the Ampex 375. To provide frequencies other than 60 cycles, the power amplifier section may be independently driven by an external signal generator instead of by the built-in tuning fork oscillator.

The 375 was originally designed to provide the precise 60-cycle power required by Ampex tape recorders. Hence it is ideally suited to any application where constant speed of electric motors is a prime requisite. Typical of these are precision electric motor drives for turntables, stroboscopic timing devices, time bases, time-keeping, high-speed cameras, chronographs, astronomical units, geophysical units and viscometers.

**AMPEX MODEL
375**

GENERAL PERFORMANCE CHARACTERISTICS & SPECIFICATIONS

OUTPUT POWER:	70 watts
OUTPUT FREQUENCY:	Precise 60 cycles using built-in tuning fork oscillator (temperature coefficient 5 parts per million per degree Centigrade) 50 to 400 cycles using external signal oscillator
OUTPUT VOLTAGE:	0 to 135 volts, continuously adjustable
INPUT FREQUENCY:	50 to 400 cycles
INPUT VOLTAGE:	115 to 125 volts
INPUT POWER:	275 watts
DIMENSION & WEIGHT:	Standard 19-inch rack mounting Panel Height: 12¼ inches Weight: 60 pounds

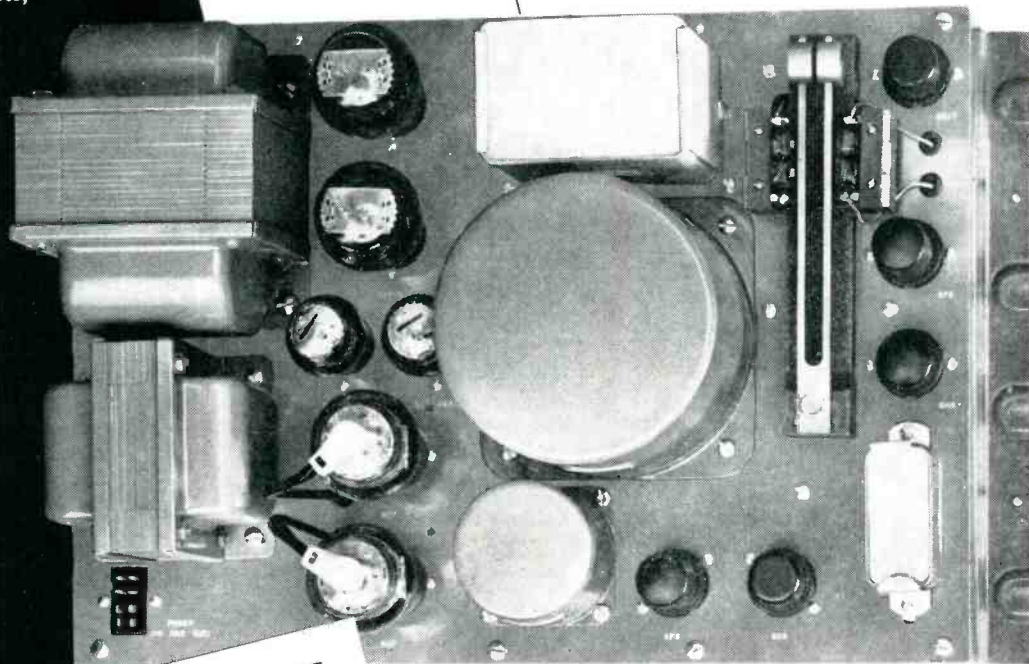

AMPEX
ELECTRIC CORPORATION

Write Dept. E-1038 today for further information

AMPEX ELECTRIC CORPORATION
934 CHARTER STREET • REDWOOD CITY, CALIF.



CAROL RG 59/U COAXIAL CABLE

Strict control over every phase of manufacture assures you of highest performance from Carol RG 59/U Coaxial Cables. The dielectric is Carol Polyethylene, extruded by precision methods under accurate temperature control... to guarantee perfect "end to end" uniformity, solidity, and flexibility.

The cable is jacketed in Carol Vinyl—especially compounded in our laboratories for maximum oil resistance, abrasion resistance, and ability to withstand exposure to acids, alkalis, moisture and flame.

A selection of RG types is available. We also manufacture special coaxial cable to your own specifications.

For details on our complete line of cable for electronic equipment, write or call Carol today.

CAROL
CABLE DIVISION
of The
CRESCENT COMPANY
INC.

Pawtucket, Rhode Island

Want more information? Use post card on last page.

NEW PRODUCTS

(continued)

values in fixed composition capacitors (type GA). The complete range now includes 46 RTMA preferred values from 0.10 μf to 10.0 μf , in standard tolerances of 5, 10 and 20 percent. The many new values are designed to meet the growing need for inexpensive, low-value fixed composition capacitors for communications and uhf tv applications. The body of these tiny capacitors measures only 0.160 in. in diameter by 0.150 to 0.400 in. long depending on capacitance. Rated for a working voltage of 500 v d-c, the type GA capacitors are molded from titanium dioxide or other high dielectric-constant body material to provide insulation resistance in excess of 1,000 megohms. Temperature coefficient is less than ± 2 percent of 20C value from -55C to $+85\text{C}$.

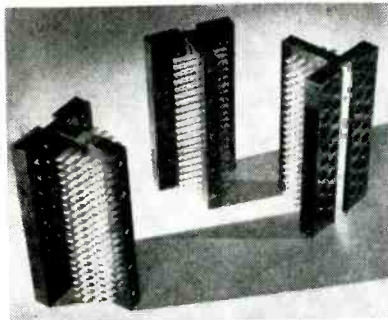

TERMINAL BLOCKS have phenolic structure

LENKURT ELECTRIC Co., County Road, San Carlos, Calif., has available phenolic terminal blocks for electronic and communications equipment. Four different arrangements are offered providing 40, 60, 80 or 100 pre-tinned, double-notched terminals securely fastened between phenolic strips. The terminal assembly is fastened to a base of the same material. Advantages provided by all phenolic block construction are excellent electrical characteristics, clean design, high structural stability and low water absorption. Specifications and prices are given in bulletin B1-P2.

MOLDING COMPOUND is moisture resistant

SANGAMO ELECTRIC Co., Marion, Ill., has developed Humiditite, a

Your BLOWER PROBLEM is our BUSINESS

DC
12 or 27
Volt



AC
115 V.
400 Cps



AC
208 V.
400 Cps

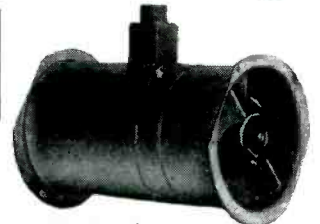

Single Stage & Multi Stage
Diameters 2" thru 20"

- HIGH PRESSURES
- HIGH EFFICIENCY
- LIGHT WEIGHT
- COMPACT PACKAGE
- SPECIAL SHAPES
- DEPENDABILITY

Since 1942 we have specialized in Aircraft and Electronic Blower Applications. This 11 years of "Know-How" is yours when you call us in on your Blower Requirements.

We have 100 Active Models which can be adapted to your specific requirements.

We manufacture the entire unit, including the motor, so responsibility for warranty rests squarely with us and schedules are met.

"THE BLOWER YOU NEED
IS GUARANTEED!"

DYNAMIC AIR
ENGINEERING Inc.

7412 Maie Avenue, Los Angeles 1, California
Want more information? Use post card on last page.

October, 1953 — ELECTRONICS

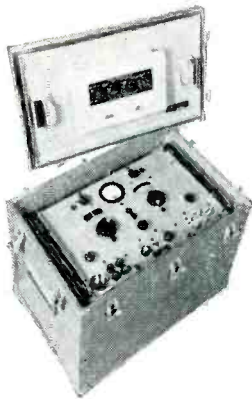

TS-419/U SIGNAL GENERATOR

This compact portable Signal Generator is a self-contained, directly calibrated generator of continuous-wave or pulse modulated radio frequency signals. It is a reliable source of accurate signals for:

- testing radio and radar equipment in the frequency band from 900 to 2100 MC/S (single dial control directly calibrated to $\pm 1\%$),
- receiver measurements and other applications that require less than one milliwatt of CW or pulsed type r-f signals in this band,
- generating delayed and undelayed video pulse that can be used by external equipment,
- accurate determination of small increments of frequency, as required in certain types of selectivity and filter characteristics.

Specifications:

Frequency Range	900 to 2100 mc/sec in one band.
Frequency Stability	Warm up drift less than 0.2%; ambient drift less than 0.005% per °C.
Power Output	Zero dbm to -120 dbm continuously adjustable.
Output Impedance	50 ohms with VSWR of 2:1.
R. F. Pulse Shape	(a) Rise time: less than 0.5 microseconds. (b) Decay time: less than 0.9 microseconds. (c) Flatness: within 10% of amplitude of initial rise.
Modulation	(a) by external pulses, positive or negative. (b) by internal pulse generator. (c) by synchronization to an external pulse generator. (d) by synchronization to an external sine wave generator.
Power Requirement	115 V \pm 10%, 50 to 1600 cycles, single phase, 200 watts.
Size	17 $\frac{1}{8}$ inches wide, 10 $\frac{1}{2}$ inches high, 12 inches deep.
Weight	43 pounds (less transit case).

We will gladly furnish all details regarding specifications, prices and delivery.

Write, wire or telephone for information.

NORTHEASTERN

Manchester, New Hampshire

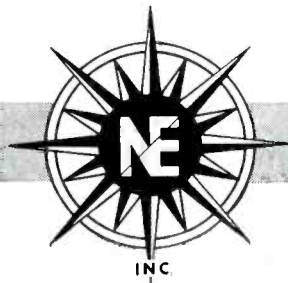

ENGINEERING

Telephone 2-6485



RELAYS

you can rely on!

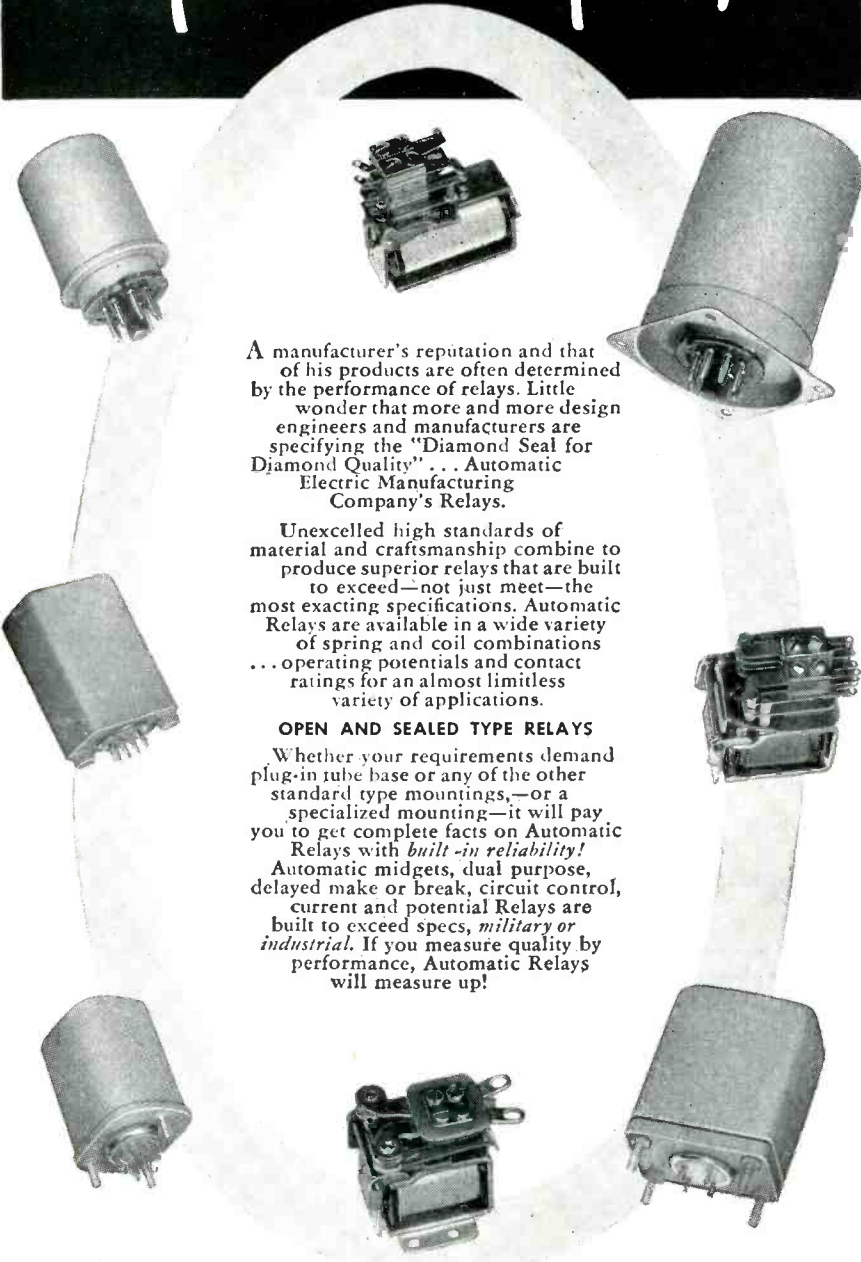

A manufacturer's reputation and that of his products are often determined by the performance of relays. Little wonder that more and more design engineers and manufacturers are specifying the "Diamond Seal for Diamond Quality" . . . Automatic Electric Manufacturing Company's Relays.

Unexcelled high standards of material and craftsmanship combine to produce superior relays that are built to exceed—not just meet—the most exacting specifications. Automatic Relays are available in a wide variety of spring and coil combinations . . . operating potentials and contact ratings for an almost limitless variety of applications.

OPEN AND SEALED TYPE RELAYS

Whether your requirements demand plug-in tube base or any of the other standard type mountings,—or a specialized mounting—it will pay you to get complete facts on Automatic Relays with *built-in reliability!* Automatic midgits, dual purpose, delayed make or break, circuit control, current and potential Relays are built to exceed specs, *military or industrial*. If you measure quality by performance, Automatic Relays will measure up!



The complete line of Automatic Relays are available to meet military specifications. The facilities of our engineering department are at your disposal. Write, wire or phone. All inquiries will receive prompt attention.

Automatic Electric MFG. CO.

62 STATE STREET • MANKATO, MINN.

new molding compound for capacitors used where high moisture resistance is required. The standard moisture-resistance test described in MIL-C-5A (Proposed) Specification requires mica capacitors to offer at least 100 megohms of insulation resistance after ten 24-hour cycles in a humidity chamber at 90 to 95-percent relative humidity. Humidite micas all tested in excess of 50,000 megohms of insulation resistance. Continued tests — beyond the requirements — proved them capable of withstanding from 21 to 52 cycles (from smallest sizes to the largest) before failure to measure 100 megohms. Engineering bulletin TS-111 contains complete information.



CAPACITOR is adjustable ± 1 percent

SOUTHERN ELECTRONICS Co., 239 W. Orange Grove Ave., Burbank, Calif., recently developed a capacitor that is being used in high accuracy computation work. Its dielectric material is polystyrene. Capacitance is adjustable ± 1 percent from the mean value and is resettable to one part in 10,000. Its dielectric hysteresis, insulation resistance, dissipation factor and temperature coefficient are equal to the highest values obtainable in polystyrene. The 1- μ f 330-v hermetically sealed unit measures 2 in. \times 2 in. \times 1 in.

SILICONE COATINGS have high strength

MICA INSULATOR Co., Schenectady 1, N. Y., has available a new class

Meet the New President of Sealtron

*This is the story of Bill Sage . . .
pioneer of the hermetic seal.*



William C. Sage

It all started with Pearl Harbor. Electronic equipment designed for temperate climates was rushed to the South Pacific, was put to the test of destructive humidity, fungus, temperature extremes—and failed! The country needed good hermetic sealing and needed it fast!

So, one night, Bill Sage got together with an old friend, an electronics manufacturer, and they thrashed out the knotty problem of providing practical air-tight, water-tight, moisture-tight, insulated terminals—to feed current into hermetically-sealed transformer “cans,” sorely needed by the Armed Forces.

Combining his experience in the technical phases of glass making and his training in electrical engineering, Bill saw a way that glass might solve the problem. He worked long nights and before long was “cooking” America’s first glass-to-low-carbon-steel hermetic seals, right in the oven of his kitchen stove.

These home-made seals were the forerunners of production-line versions that gave top sealing and insulating performance—stood up under severest tests. * Soon they were on the job out in the Pacific. Bill Sage was in the hermetic seal business for certain now, and he succeeded in helping establish a business that specialized in hermetic seal work.

The more he worked with seals, the more he realized their possibilities in electronics were *limitless*. One large company making complicated radar gear was having trouble soldering miniaturized terminals into a compact panel. Bill suggested using seals as feed-through and stand-off terminals and *further sug-*

gested that Sealtron install the seals in the panel for them. After all, Sealtron technicians with their specialized experience in seal work could do the job faster and cheaper, could take a difficult production problem off their hands.

The manufacturer agreed—and the Sealtron Seal Assembly was born. Since then Sealtron has produced thousands upon thousands of such assemblies, large and small, simple and complex, for leading electronics manufacturers ** all over the country—and saved them countless man-hours and many dollars besides.

Another large radar manufacturer was having trouble with the “close-quarters” soldering of lead wires onto multiple header pins. Bill showed them how Sealtron could butt-weld flexible lead wires onto the pins for them, could save them valuable space with this less bulky connection. Now all they do is slip “spaghetti” sleeving right over the “built-in” flexible leads and connect directly into electronic assemblies.

Today, Bill Sage is realizing the dream that most of us have—he’s the head of a Company that exists largely through his own efforts. That’s something for Bill to be proud of. And rest assured we’re mighty proud of Bill.

* Typical tests—

Pressure—up to 5000 lbs. per sq. inch without failing.

Thermal Shock—dry ice to boiling water.

Insulation—100,000 megohms after water immersion.

**Names on request.

S E A L T R O N C O R P O R A T I O N

9701 READING ROAD, CINCINNATI 15, OHIO



If silicone-rubber-coated glass cloth insulation with unusually high dielectric strength and increased tensile strength. Both the electrical grade, E-944, and the mechanical grade, E-959, have a dielectric strength approximately twice that required by military specification MIL-C-2194A which requires the material to withstand at least 500 v per mil after conditioning of 96 hours at 25 C and 96-percent relative humidity. Both grades also possess excellent bending qualities due to a high tensile strength. Data sheets are available.

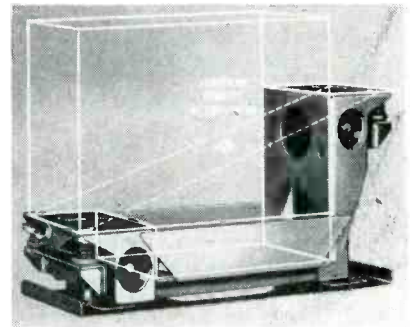

MOUNTING SYSTEM for vibration control

ROBINSON AVIATION INC., Teterboro, N. J., has designed a center-of-gravity type mounting system for use as vibration and shock control in combat aircraft. The MET-L-FLEX (fabricated steel wire) resilient cushions are located at the top and bottom of the the assembly in such a way that the diagonal plane between the top and bottom cushions passes through the center of gravity of the equipment. This provides maximum protection and stability.

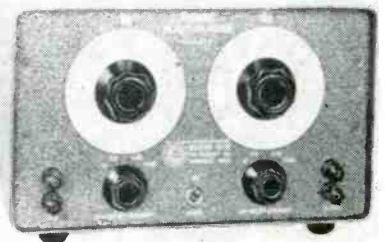

REJECTION FILTER for 20 cps to 200 kc

KROHN-HITE INSTRUMENT Co., 580 Massachusetts Ave., Cambridge 39,

October, 1953 — ELECTRONICS

LEDEX ROTARY SOLENOIDS

... double efficiency and **LOWER COST 70%**
for The Cincinnati Time Recorder Company

The compact, powerful number five Ledex Rotary Solenoid is used to replace the bulky old type solenoid in the Cincinnati series 800, Automatic Time Recorder. By comparison Ledex Rotary Solenoids have 1/7 the weight . . . produce twice the power output with the same electrical input . . . proved to be more dependable and easier to install . . . and reduced the cost of this component 70%. The actual size illustration of the solenoids show the advantage of Ledex compactness . . . 1/6 the volume.

Let Ledex Engineers assist you in choosing rotary solenoids that will save production costs and help increase the efficiency of your products. Six basic models range in diameters from 1 1/8" to 3 3/8", with torque values from 1/4 to 50 pound-inches. Various power linkages and types of mountings are available. Write today for descriptive literature.

G. H. Leland INC.

123 WEBSTER STREET, DAYTON 2, OHIO

The *NEW* magnecord "M-80"

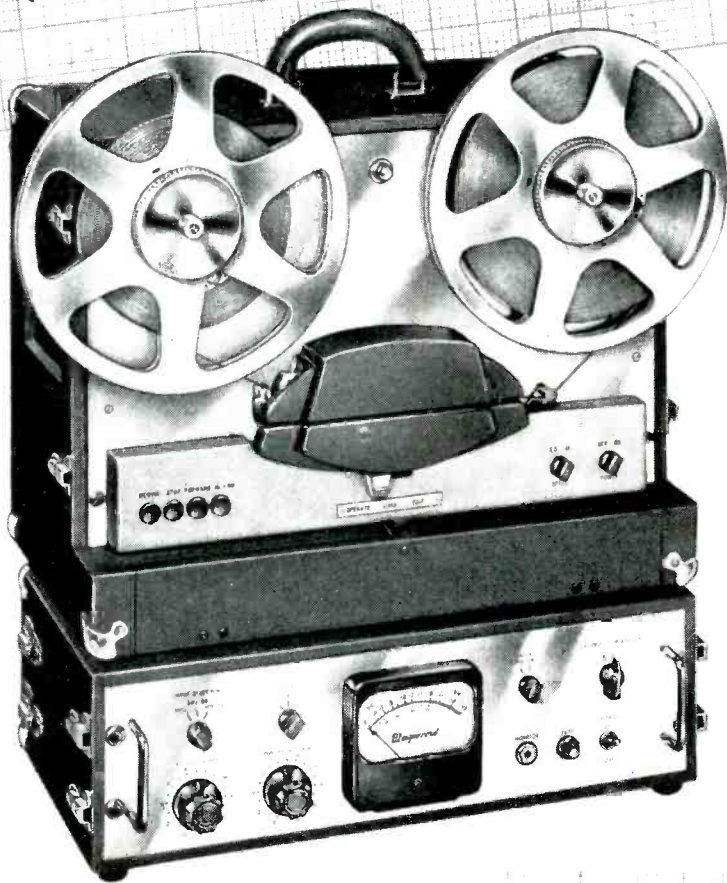

*World's Most
Versatile*

**professional
tape recorder**

- ★ Slot-loading, easiest tape handling-editing.
- ★ Push button operation and full remote control.
- ★ 15,000 cps at 7½ inches

**Check these outstanding
new features!**

- ★ 30-15,000 cps, ±2 db at 15" per sec.
- ★ 50-10,000 cps, ±2 db at 7½" per sec.
- ★ 50-15,000 cps, ±4 db at 7½" per sec.
- ★ Timing accuracy ±3 sec. in 30 min.
- ★ Signal-to-noise exceeds 58 db
- ★ Flutter less than 0.1% RMS at 15 ips.
- ★ Standard NARTB playback curve
- ★ Instant dual speed selection
- ★ Microphone and bridging inputs
- ★ Full or half track operation
- ★ Case, rack, or console mounting

See and operate the brilliant new
Magnecord M-80 at your dealer's,
Look in the classified directory
under "recorders".

Magnecord INC.

Dept. E-10 225 West Ohio Street,
Chicago 10, Illinois

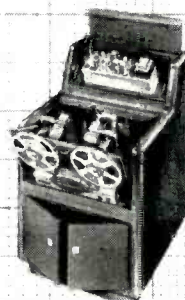

The new
M-80 Console

Amplifier and mechanical
unit inverts for servicing. No mounting screws
to remove.

YOU CAN ALWAYS RELY ON EDISON COMPONENTS

for Electronic
and
Communications Equipment
Because of:

HERMETICAL SEALING in rigid glass.

TAMPER-PROOF stability that defies time and abuse.

ACCURACY. Patented feature permits calibration *after* sealing.



THERMAL TIME DELAY RELAYS

Cathode and filament protection • Gyro Erection • Prevent surges and false starts in sensitive auxiliary equipment • Miscellaneous circuit switching

SPECIFICATIONS

Standard Octal Base

Delays ... 2 seconds to 5 minutes
Heater ... 5 watts nominal, continuous operation
Voltages: 6.3, 26.5 and 117
Contacts ... 6 amps maximum, 3 amps to 450 volts a.c. or d.c.
Vibration ... 1/16" amplitude at 55 cps. 50g shock.
Ambient ... -60 to +85°C Seated Height ... 3 1/4 max.

Miniature 7-Pin Base

Delays ... 5 seconds to 75 seconds
Heater ... 2.5 watts nominal, continuous operation
Voltages: 6.3 and 27.5
Contacts ... 2.5 amps max. 1 amp at 125 volts d.c.
Vibration ... 1/16" amplitude at 55 cps. 50g shock.
Ambient ... -60 to +85°C Seated Height ... 2 1/4 max.

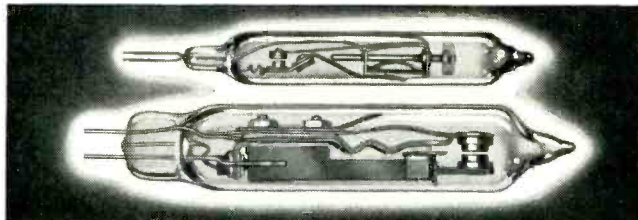

SEALED THERMOSTATS

Ambient protection for frequency standards • Precision heat control for electronic laboratory instruments • Overheat detection and fire alarm

SPECIFICATIONS

Heavy duty—type D8

Max. temp. ... 320°C
Max. watts ... 1000
Max. amps. ... 8.0 d.c.
Calibration tolerance ... ±2.5°C
Length, 2 3/4"; dia., 9/16" (approx.)

Precision control—type S1

Max. temp. ... 190°C
Max. watts ... 150
Max. amps. ... 1.0
Control differential at 1/4 amp = 0.1°F
Length, 2 1/2"; dia., 3/8" (approx.)

Write for free bulletins and application data to:

Thomas A Edison
INCORPORATED

Instrument Division

DEPT. 54, WEST ORANGE, NEW JERSEY

YOU CAN ALWAYS RELY ON EDISON

NEW PRODUCTS

(continued)

Mass. Model 360-A adjustable rejection filter provides either a rejection band in which the gain falls at a rate of 24 db per octave or a sharp single-frequency null. A peaking factor is used to reduce the attenuation at the cutoff frequencies. Both the high and low cutoff frequencies are independently adjustable from 20 cps to 200 kc. Rejection bandwidth is thus continuously variable up to the maximum width covering the entire range from 20 cps to 200 kc. The sharp null may be obtained at any frequency from 100 cps to 50 kc. The unit is especially useful for any audio or ultrasonic work requiring selective amplification and for stabilization of a-c servos. The complete instrument weighs 14 lb.

SELENIUM RECTIFIER rated up to 130 v a-c

BRADLEY LABORATORIES, INC., New Haven, Conn., has announced a new series of hermetically sealed selenium rectifiers. The new series, designed SE3P, offers greater efficiency and much better heat dissipation than previous similar hermetically sealed units. Rated up to 130 v a-c, 12 milliamperes continuous d-c, the rectifier will meet JAN and MIL specifications for high temperature, vibration, shock and salt spray. SE3P's are designed for use in d-c relays, bias supply and surge suppressors. The unit measures 1 1/16 in. in diameter and is 7/8 in. long.



LEAKAGE TESTER is high-potential unit

CINETECH Co., INC., 106 West End Ave., New York 23, N. Y., has

FILLING STATION

... FOR LONG-LIFE
LUBRICATION

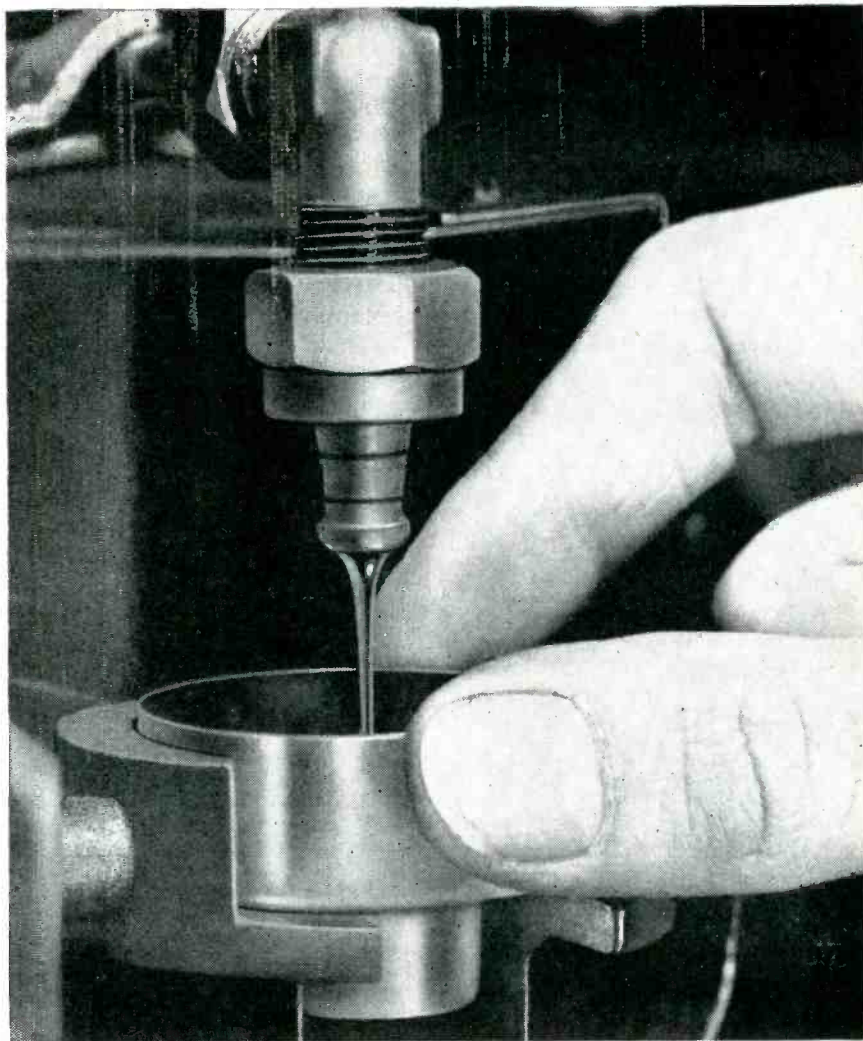
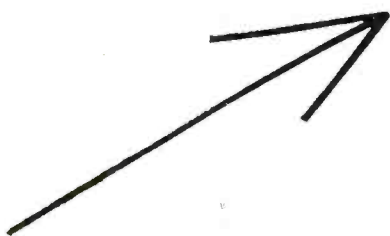

Telechron Synchronous Timing Motors

Seal the oil in with the moving parts, and they'll both last longer. That's the simple reason behind the long, dependable life of Telechron Synchronous Timing Motors.

Into each motor goes a measured amount of special oil—carefully formulated for the particular service the motor is to perform. Then the unit is sealed. Dirt and dust can't get in. Lubricant is lifted by capillary action from the reservoir to all bearings, and flows continuously to all gears, efficiently . . . so efficiently, in fact, that many Telechron motors are still operating accurately and dependably after 20 years of continuous use.

There are other advantages, too, in Telechron Synchronous Timing Motors. Quick starting, due to the lightweight rotor. Power-line accuracy, because of true synchronous operation. Cool running, with the field coil isolated from the rotor unit. Altogether, a combination of worth-while features unique in the field of electric timing.

Telechron motors are available in a wide range of speeds and torque ratings, and for any standard AC power source. Get full details. Write Telechron Department, General Electric Co., 410 Homer Ave., Ashland, Mass.

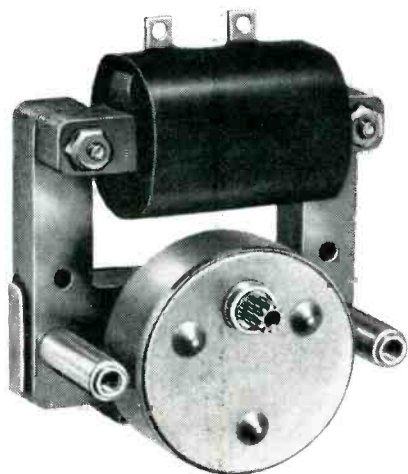

MODEL H-10. Low-cost, light-duty motor capable of handling high momentary peak loads. Ideal for washing machines, dish-washers, refrigerators, and other appliance timer uses.



available a nondestructive device that will determine leakage at elevated potentials in delicate and expensive equipment. The instrument will indicate satisfactory performance when connected to an equivalent resistance of 100,000 to 110,000 ohms at one of three available voltage ranges—300, 1,000 and 1,500 v a-c. It will reject instantly without destructive effects to the equipment under test, when the equivalent resistance of the tested material is less than 100,000 ohms with high voltage applied. This action is so fast that complete safety to the equipment under test as well as to the operator is always assured because the high voltage normally present is immediately removed.

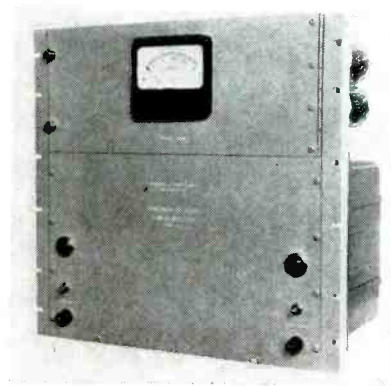

POWER SUPPLY a variable frequency unit

INTERNATIONAL RESEARCH ASSOCIATES, 2221 Warwick Ave., Santa Monica, Calif. Model D-50 variable frequency power supply can furnish 500 w of power at 115 v a-c. Output voltage is adjustable by means of a level control from 0 to 125 v a-c. The frequency required can be supplied either by a tuning fork, if extreme accuracy is mandatory, or by a variable frequency audio oscillator capable of supplying 3v rms. The unit can be employed for continuous-duty cycles and for applications such as servospin tables or "G" tables.

C-R OSCILLOGRAPH in rack-mounted version

ALLEN B. DUMONT LABORATORIES, INC., 760 Bloomfield Ave., Clifton, N. J. The type 304-AR rack-



Quick way to measure low currents

Here's a simple way to measure currents down to 10^{-14} ampere. A Keithley Electrometer and Shunt give fast results, accurate to within 3%.

The Keithley Vacuum Tube Electrometer is a compact vacuum tube voltmeter with an input impedance greater than 10^{14} ohms. It is quickly converted to a highly sensitive direct-reading micromicroammeter by clipping an accessory shunt over the high terminal. When an ammeter drop of 0.5 volt is available, the Electrometer outperforms wall galvanometers in speed and sensitivity.

Seven standard shunts provide a measurement range from 10^{-8} to 10^{-14} ampere. Uses include measuring capacitor and insulation leakages, currents in photocells, ion chambers, and vacuum-tube grids.

Voltage, Resistance, Capacitance and Static charges are also easily measured by the Keithley Electrometer and accessory equipment. For complete literature, write—

KEITHLEY INSTRUMENTS
3868 Carnegie Avenue
Cleveland 15, Ohio

Want more information? Use post card on last page.

SHURE
THE "Field-Proved" STANDARD
IN COMMUNICATIONS...
INTRODUCES A NEW

TELEPHONE HANDSET

...the first Handset specially
engineered for two-way
communications

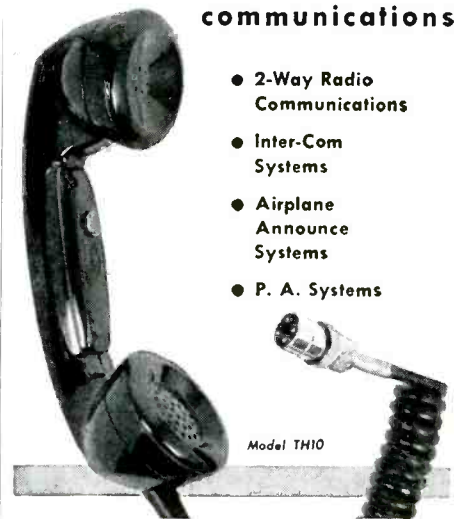

- 2-Way Radio Communications
- Inter-Com Systems
- Airplane Announce Systems
- P. A. Systems

Specially Designed to Suit Your Specific Applications

Here is a truly modern functional handset specifically designed for 2-way communications! A product of the Shure Laboratories with many years of experience in safety mobile communications, the TH10 Handset brings you these features: ... the field-proved *controlled reluctance* assembly as a receiver ... high output *balanced response* carbon transmitter ... oversize switch cavity providing flexibility in stacking of famous Shure long-life leaf blades ... cored handle for maximum number of conductors ... no solder connections ... rugged shock resistant handle ... design smart to the eye, natural in the hand. The answer to your complex circuitry!

SHURE

For more complete information
write to

SALES DIVISION
SHURE BROTHERS, Inc.

Manufacturers of Microphones & Acoustic Devices
225 W. HURON ST., CHICAGO 10, ILL.

Cable Address: SHUREMICRO

Want more information? Use post card on last page.

October, 1953 — ELECTRONICS

For problems here

you'll find the answers here

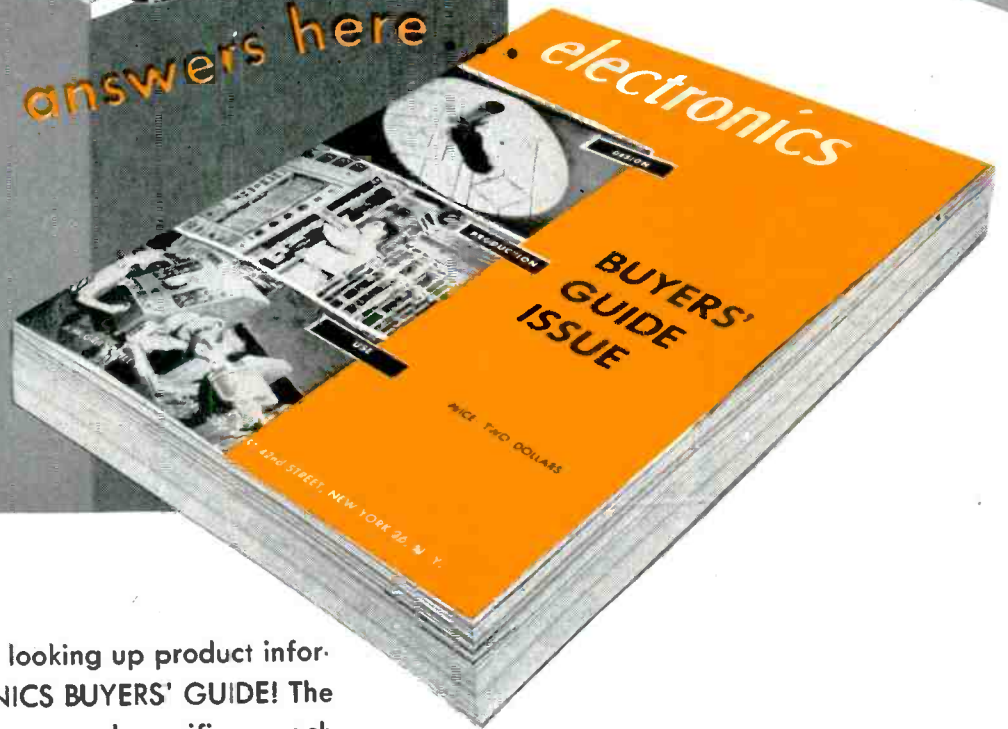

It's become a habit . . . looking up product information in the **ELECTRONICS BUYERS' GUIDE!** The fact is, designers, engineers and specifiers reach for the Guide as they reach for their slide rule. They just naturally keep the Guide close by them as they work at their breadboards. Designing electronic equipment necessitates fitting in the correct component that is required in the circuitry. What they need is a ready source of information . . . product information that is essential in their work. That's why they always reach for the Guide.

You, too, can solve your product problems and save countless hours of trial-and-error searching by getting in the habit of looking it up in the Guide. It's the most convenient, finger-tip method of locating product information.

Get into the habit of LOOKING IT UP IN "THE GUIDE"

The most reliable source of product information in the field . . . the most complete, most accurate reference book. 1520 product listings — complete in every category — amply cross indexed . . . the entire electronic industry is in the habit of looking in the Guide for immediate answers to its product problems.

ABD electronics **BUYERS' GUIDE** **ABC**

330 WEST 42ND STREET • A MCGRAW-HILL PUBLICATION • NEW YORK 36, NEW YORK

from
millivolts to hundreds
of volts
AIRPAX CHOPPERS
operate well
and reliably

**A-580
400 CYCLES
120 VOLTS**

Normal angle is 80°, with an external .039 capacitor a ZERO angle is obtained, drive to square wave. Hermetically sealed, SPDT contacts. Contacts are rated at 2ma, 100 volts. Voltage may be as high as 200.



**A-586
60 CYCLES
6 VOLTS**

Remarkably long life chopper! Hermetically sealed with a 6.3 volt coil; adjusted to a 45° phase lag at 60 cycles; contact dwell time about 160°. Operates over tremendous temperature range of our other units.



**A-589
400 CYCLES
6 VOLTS**

Withstands 10g vibration operating; 50g non-operating; can be used reliably from -70 to 100° C. Phase lag 65°, drive to square wave, adjusted for 350 to 420 cycles. Hermetically sealed; rugged, stable.



positive performance
from 70° below
to 100° C
or while being
vibrated or shocked
far beyond
usual test extremes!



mounted version of the 304-A c-r oscillograph features the same built-in voltage calibration. The illuminated screen is calibrated by a pushbutton control on the operating panel which applies a standardizing potential to the screen. The oscillograph requires only 8 3/4 in. vertically in a standard relay rack. Voltage reading range on a 4-in. scale is from 0.10 v to 1,000 v, full scale. Frequency response is flat at d-c and extends to 300 kc, 50 percent down. Overall dimensions are: height, 8 3/4 in., width, 19 in., depth, 19 1/2 in. Weight is 50 lb.

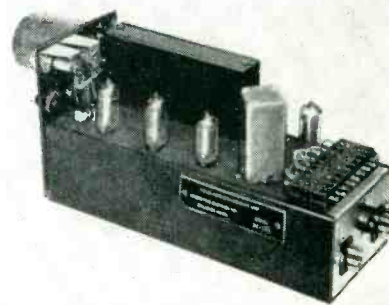

**MEMORY UNIT
in 1 plug-in type chassis**

COMPUTER CONTROL Co., 106 Concord Ave., Belmont 78, Mass. Model 3C1-384 memory unit is composed of a solid acoustic delay line and associated circuitry. The unit is a complete package ready for installation in a computer. The design includes the entire memory circuit in one plug-in type chassis. The unit stores 384 bits at a pulse repetition rate of 1 mc. Input voltage requirement into write-erase gate is 10 v. The reshaped output signal level is 15 v into a 100-ohm impedance load. Carrier frequency is 20 mc. All circuits are degenerated, with reserve gain in the wide band i-f amplifier. There is a gain control for initial adjustment of the i-f stage. No tuning is necessary. The unit is especially fitted for airborne use and is insensitive to shock.

**SHIELDED ROOMS
suppress r-f radiations**

ACE ENGINEERING & MACHINE Co.,
3644 N. Lawrence St., Philadelphia

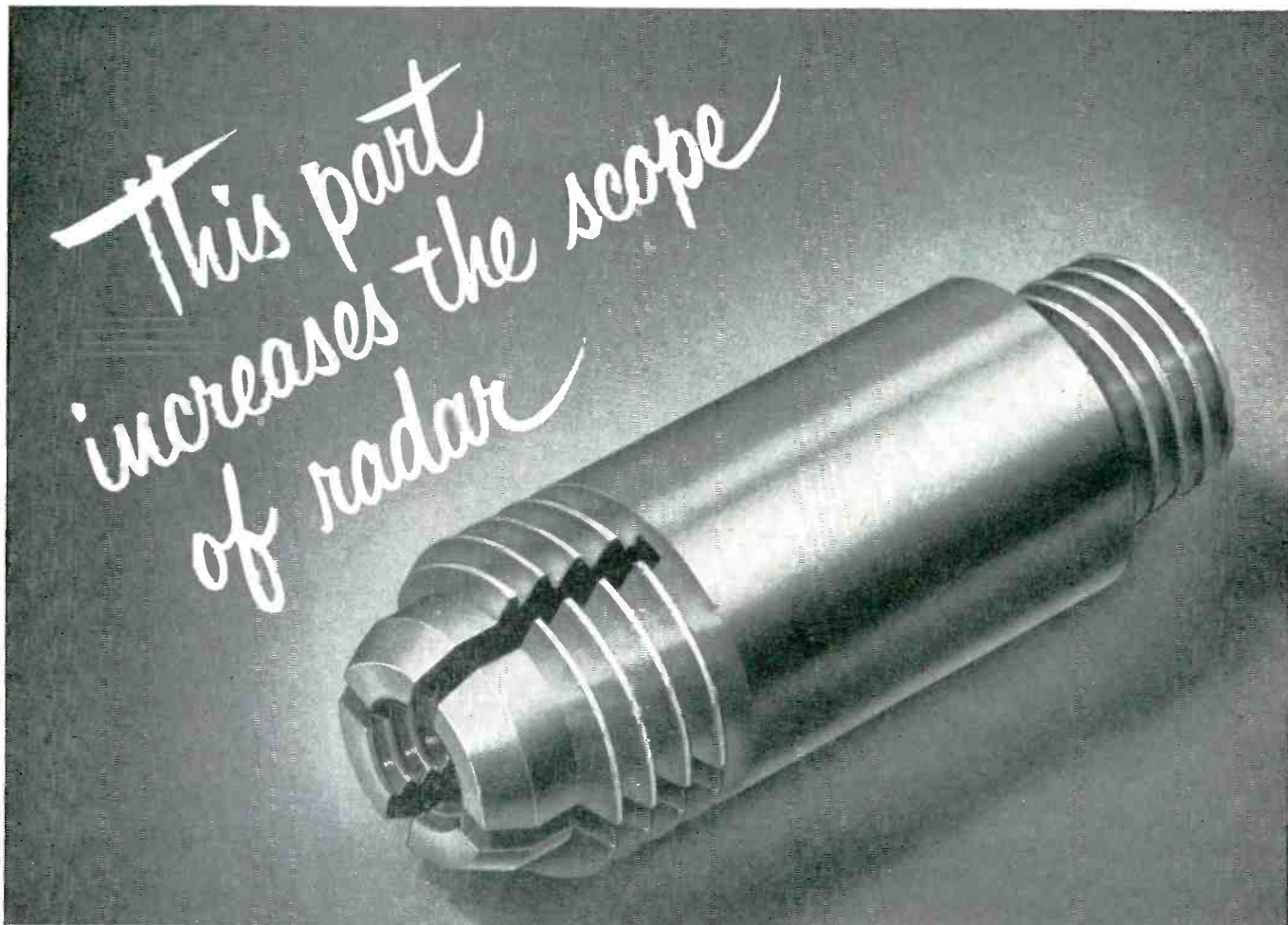

Fabricated by Micro-Matic Screw Co., Inc., Linden, N.J.

IT'S MADE OF **BERYLCO** BERYLLIUM COPPER

This critical connector, used in new, improved radar devices, is made of Berylco beryllium copper for its many recognized advantages. Beryllium copper offers the designer desirable combinations of properties such as strength, spring action and formability in high degree.

As in all radar and electronic equipment, the material used for connectors, plugs, adapters, etc., must have current-carrying capacity. Berylco certainly has that. It must also retain firm contact pressure for a long time; it must be noncorrosive; it must be indifferent to wide temperature variations; it must not be subject to fatigue.

Berylco offers all these qualities to a superlative degree. For this particular part, which must be turned and threaded to close tolerance, machinability is important. In this respect beryllium copper offers special advantages through its age-hardening feature. This means that parts can be readily machined in a relatively soft condition and then hardened to give the desired combination of final properties.

You will undoubtedly want to include Berylco beryllium copper in your plans for the future if you have not already done so. Take advantage of the know-how of the world's largest

producer. Call or write any of the offices below for sample material or engineering help.

VALUABLE ENGINEERING INFORMATION on Berylco beryllium copper is contained in a series of technical bulletins, published monthly. To receive your copy regularly, write on your business letterhead.

TOMORROW'S PRODUCTS ARE PLANNED TODAY—WITH BERYLCO BERYLLIUM COPPER

BERYLCO

THE **BERYLLIUM** CORPORATION

DEPT. 3-J, READING 21, PENNSYLVANIA

New York • Springfield, Mass. • Rochester, N. Y. • Philadelphia • Cleveland • Dayton • Detroit • Chicago • Minneapolis • Seattle • San Francisco • Los Angeles

Representatives in principal world-trade centers

PHEOLL'S

Complete line
of
SCREWS • BOLTS
NUTS

**Supplies ALL of Your
Fastener Needs...Saves
Orders and Follow-Up**

CALL ON PHEOLL FOR:

Machine Screws
Sems
Wood Screws
Tapping (Sheet
Metal) Screws
Cap Screws
Thread-Cutting
Screws
Set Screws
Thumb Screws
Drive Screws
Phillips Recessed
Head Screws
Hi-Shear Rivets
Aircraft Screws
and Nuts
Threaded Rods
Stove, Carriage, Ma-
chine, Lag Bolts
Machine Screw
Nuts
Semi-Finished
Nuts
Cold Punched
Nuts
Wing, Cap,
Knurled Nuts
Brass Washers
Special Fasteners



PHEOLL
Manufacturing Company
5700 Roosevelt Road, Chicago 50, Ill.

**SCREWS
BOLTS
NUTS**

NEW PRODUCTS

(continued)

40, Pa., has announced a complete line of galvanized single-shielded enclosures for suppressing the r-f radiations of induction heating, dielectric sealing, diathermy, and other industrial and laboratory equipment. They provide more than 40 db attenuation from 14 kc to 400 mc. Up to 66 db attenuation at standard vhf-tv frequencies can be expected. The enclosures consist of a number of standard size panels rigidly bolted together from the inside. Each panel is a frame work of klin-dried, select white pine covered with a single layer of 22-mesh galvanized steel screening. The entire enclosure is easily erected, enlarged or dismantled in just a few hours.

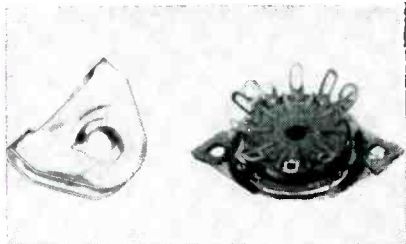

SOCKET SADDLE NUTS give self-locking action

VECTOR ELECTRONIC CO., 3352 San Fernando Road, Los Angeles 65, Calif., has available a new U-nut that slips on the saddles of octal, loctal and miniature sockets. By its use a No. 4-40 mounting screw may be easily driven in without separately holding the nut. It is especially applicable to bottom-mounted sockets and is particularly useful for mounting turret-type sockets as illustrated. The nut is of the helical-depression type and provides self-locking action.

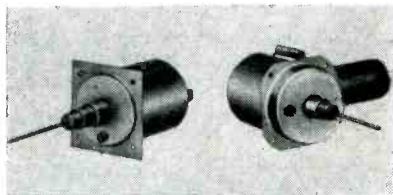

TUNED ELEMENTS available in two types

GRANCO PRODUCTS, INC., 36-17 20th Ave., Long Island City 5, N. Y., announces the availability of two

Available! HUMPHREY LINEAR POTENTIOMETER



Resistance values
to 13,000 ohms/inch
...higher in
special units

1/2" Diam. for strokes up to 3"
3/4" Diam. for strokes over 3"
Dual element construction

NOW FOR THE FIRST TIME...a rugged Potentiometer that will give long, noise-free performance when subjected to vibration, dither and other environmental conditions.

Absolute precision linearity with clear, sharp signal, because the Humphrey unit is exclusive in internal design. It is fully tested and has been qualified for use in many military applications. Humphrey design service is available to meet your special requirements.

Also available are Humphrey Rate and Free Gyros and Accelerometers. Special Potentiometers Custom-built.

WRITE OUR NEAREST OFFICE, DEPT. E5

Pacific SCIENTIFIC CO.

1430 Grande Vista Ave., Los Angeles 23, Calif.
25 Stillman Street, San Francisco 7, California
1915 1st Avenue, South, Seattle 4, Washington

Want more information? Use post card on last page.

October, 1953 — ELECTRONICS

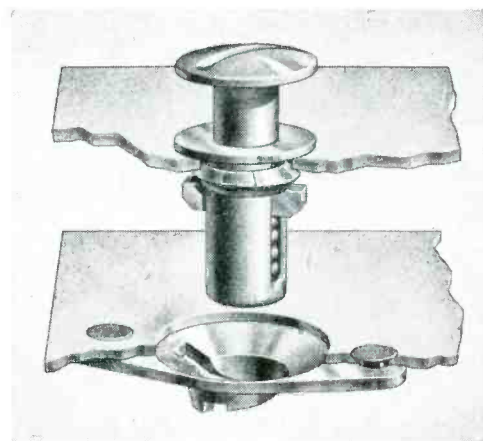
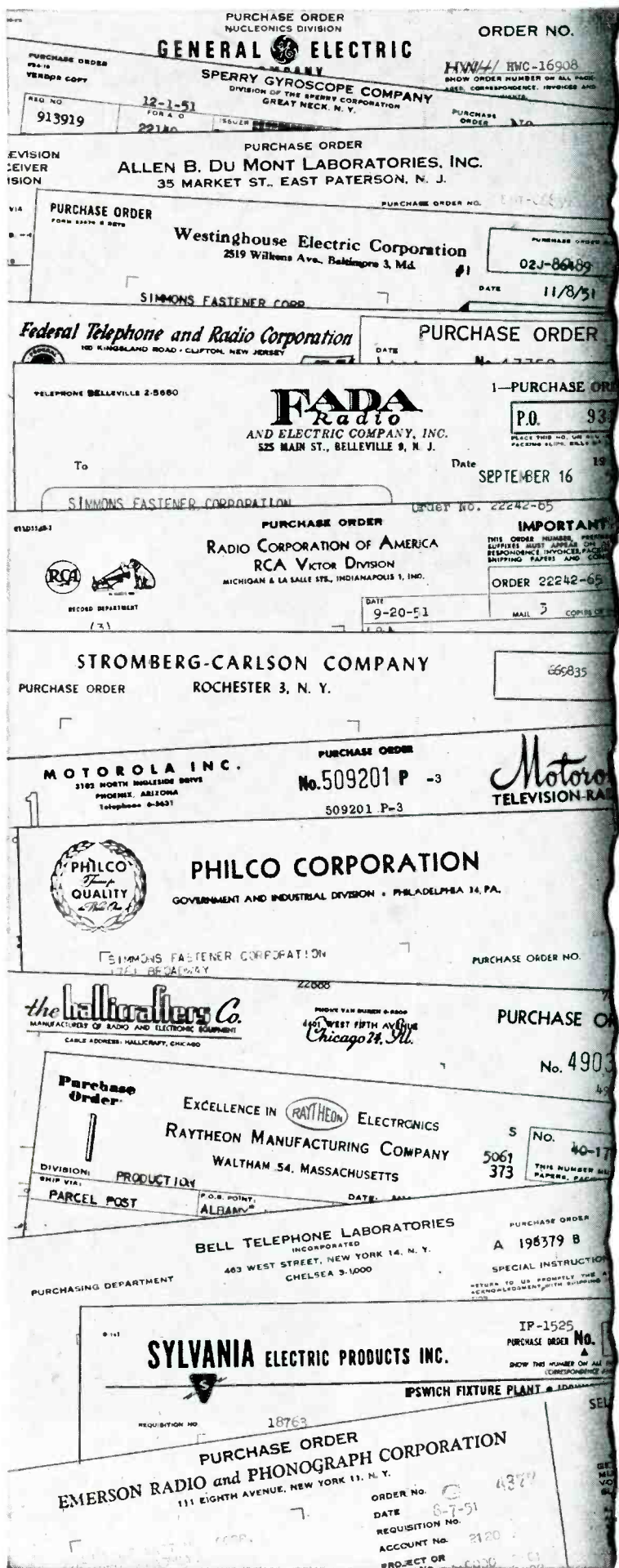

For Electronics: Faster Assembly... Better Design

Why do leading electronic manufacturers order and re-order Simmons' QUICK-LOCKS in quantity? For good dollar-wise reasons:

IN ASSEMBLY—

- No special tools are needed for installation.
- Flexible mounting takes care of curved sheets and misalignment.
- Various material thicknesses can be handled.

IN DESIGN—

- Initial loads taken by helical spring. Increased loads carried on solid supports.
- 90-deg. rotation locks and unlocks fastener.
- Stud is self-ejecting when unlocked.
- Stud is self-aligning. Makes mounting and de-mounting detachable panels simple.

QUICK-LOCK can help reduce your assembly costs and can add unusual advantages to your designs. Send for data and samples today.

SIMMONS FASTENER CORPORATION
1750 No. Broadway, Albany 1, New York

Simmons

- QUICK-LOCK
- SPRING-LOCK
- ROTO-LOCK
- LINK-LOCK
- DUAL-LOCK

JUST OUT!
NEW 36-PAGE CATALOG WITH APPLICATIONS.
SEND FOR IT!

Fasteners that improve products and reduce assembly costs.

talk about a beating!
multiplex radio telephony systems
must take it...

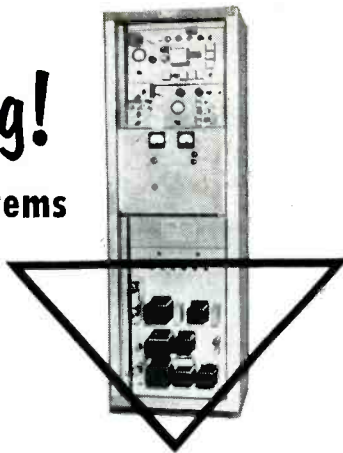

that's why REL specifies

CHICAGO

World's Toughest Transformers

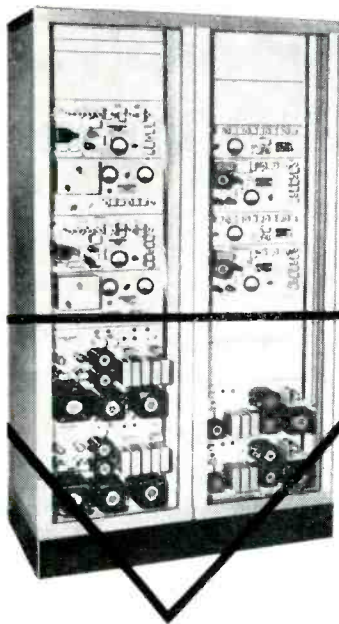

Absolute dependability under the most rugged operating conditions is a prime requirement in all REL Multiplex Radio Telephony Systems. That's why you'll find CHICAGO "Sealed-in-Steel" transformers used throughout REL equipments. These world's toughest transformers are available in 3 mountings, each featuring one-piece seamless design enclosing an electronically perfect construction. Available for every application: Power, Bias, Filament, Filter Reactor, Audio, MIL-T-27, Stepdown. Ask for them at your electronic parts distributor.

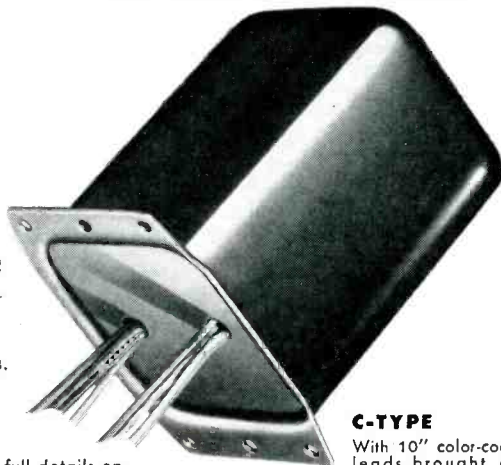

C-TYPE

With 10" color-coded leads brought out through fibre board base cover. Lead ends are stripped and tinned for easy soldering. Flange-mounted unit.

Illustrated above at right: REL 900 MC Transmitter, Series 707-757. Illustrated immediately above: REL Model 759 70 MC Dual Transmitters and Receivers. These systems make wide use of CHICAGO C-Type "Sealed-in-Steel" transformer units.

Free "New Equipment" Catalog

You'll want the full details on CHICAGO'S New Equipment Line—covering the complete range of "Sealed-In-Steel" transformers designed for every modern circuit application. Write for your Free copy of this important catalog today, or get it from your electronic parts distributor.



Export Sales Div.:
Scheel International, Inc.
4237 N. Lincoln Ave.
Chicago, Ill., U.S.A.
CABLE ADDRESS:
HARSHEEL

CHICAGO TRANSFORMER
DIVISION OF ESSEX WIRE CORPORATION
3501 ADDISON STREET, CHICAGO 18, ILL.

types of uhf coaxial tuned elements. Model UHO is an oscillator element with a built-in 6AF4 tube. Model UHR is a preselector element. Both models incorporate resonant-cavity tuning which features a moving plunger permitting coverage of the entire uhf-tv band. All elements are completely wired and tested.

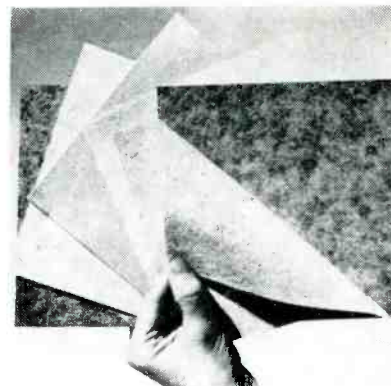

INDUSTRIAL PAPERS
made of fibrous glass

OWENS-CORNING FIBERGLAS CORP., Toledo 1, Ohio, manufactures a fibrous glass which, in its wool form, can be processed and made into incombustible, inorganic industrial papers for the filtration of hot and/or corrosive air, gases and liquids. The papers are also finding application as base sheets in specialty electrical laminates as gasketing material, and as plate separators in aircraft and other special batteries. In such applications, the inherent high temperature resistance and excellent electrical-chemical properties of the product are very desirable.

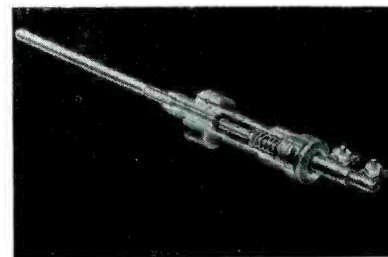

THERMAL SWITCH
for superhigh temperature

CONTROL PRODUCTS INC., Sussex St., Harrison, N. J. The ASA-21-2 is a 2-wire thermal switch designed

All these from one experienced source

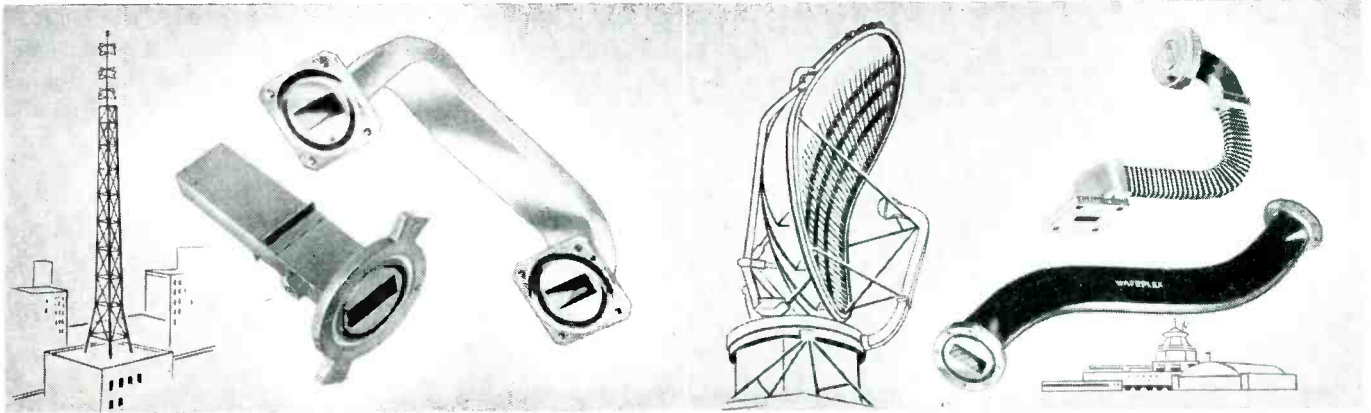

TITIFLEX DESIGNS AND MANUFACTURES—to customer specifications—rigid waveguides and combinations of rigid and flexible waveguides. Where there is, or should be, no movement, or where complicated accessories must be connected, Titeflex *rigid* waveguides are specially recommended.

WAVEFLEX® FLEXIBLE WAVEGUIDES are fabricated to retain critical dimensions — regardless of twisting or bending. Waveflex waveguides make assembly easy, improve design, compensate for expansion or movement. Rubber jacketing protects against weather, corrosion, physical abuse.

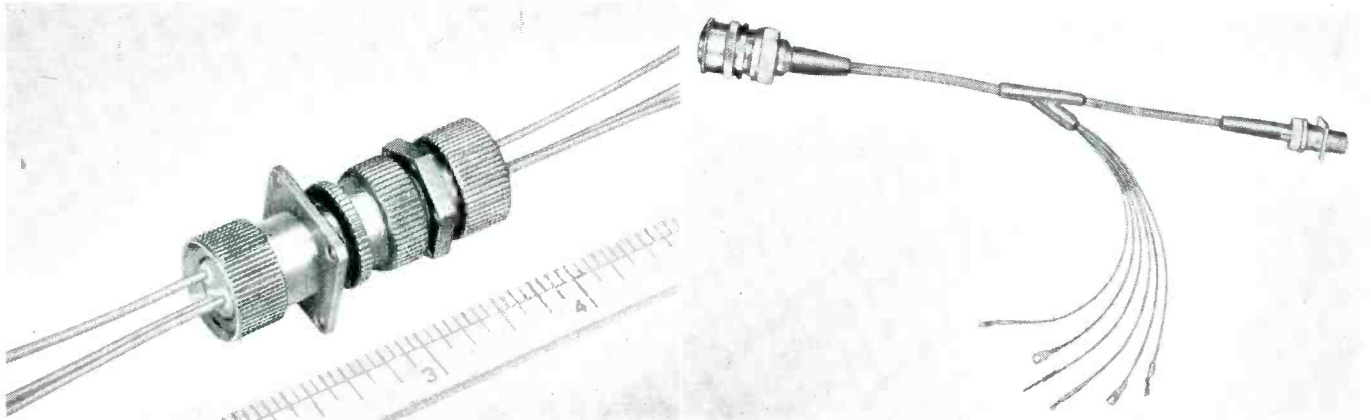

TITIFLEX CONNECTOR—lightweight, corrosion and moisture resistant with temperature ranges of -65°F. to $+400^{\circ}\text{F.}$ This connector's insulation properties will permit 3500 volts at sea level, 1200 volts at 50,000 feet altitude. Connector is available with 2 or 3 pins. 7 amperes. Weight $\frac{3}{8}$ of ounce. Size 2" in length.

TITIFLEX CUSTOM WIRING SYSTEMS are corrosion resistant, moisture proof, pressure-tight and efficient at temperatures of -65°F. to $+400^{\circ}\text{F.}$ Can be furnished with Titeflex or standard AN connectors for a wide range of service requirements. Can be sheathed with metal braids, fiber glass or nylon—and jacketed with silicone or other compounds.

MORE THAN 37 YEARS of developmental experience make Titeflex a logical source of the components pictured on this page. We are currently in a position to supply connectors and wiring systems to makers of aviation and electronic equipment. If you have a problem requiring our unusual combination of products and engineering, let us quote on your requirements. The coupon will bring you information on our products.

Let Our Family of Products Help Yours

Titeflex

✓ Check products you are interested in.



SEAMED AND SEAMLESS METAL HOSE

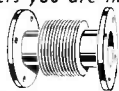

PRECISION BELLOWS



IGNITION HARNESS



IGNITION SHIELDING



ELECTRICAL CONNECTORS



RIGID AND FLEXIBLE WAVE GUIDES



WIRING SYSTEMS



FUSES

TITIFLEX, INC.
524 Frelinghuysen Ave
Newark 5, N.J.

Please send me without cost information about the products checked at the left.

NAME _____

TITLE _____

FIRM _____

ADDRESS _____

CITY _____

ZONE _____

STATE _____





FAIRCHILD

Complete—all
calibrating circuits
built-in. Needs only
standard DC oscilloscope.

Transistor Analyzer



Developed by Fairchild in its program for transistorizing Missile Guidance Systems and other intricate electronic circuits.

Rapidly Plots Static and Dynamic Characteristics of ALL Transistors... point contact and junction. Designed on basic principles, to meet future transistor needs.

Complete Families of Curves obtainable in 10 incremental steps for each of 5 ranges. Sweeping technique shows up anomalies.

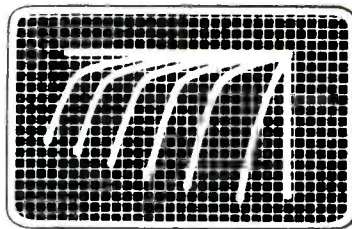

Presents on the Scope:

- Alpha vs. Emitter Current
- Collector, Emitter and Transfer Characteristics
- Collector Characteristics in Grounded Emitter Connection

WRITE FOR DETAILED
TECHNICAL BULLETIN



ENGINE AND AIRPLANE CORPORATION
FAIRCHILD

Guided Missiles Division

Wyandanch, L. I., N. Y.

Other Divisions: Aircraft Division, Hagerstown, Md.

Engine Division, Farmingdale, N. Y.

for extremely high temperature applications in jet engines, gas turbines, afterburner controls or wherever temperature warning is required to 2,000 F. It is a non-grounded switch and has maintained set calibration for 100 hours at 1,500 F with a variation of only 10 F. It will withstand any degree of overshoot or undershoot up to the ability of the metal to stand the temperature rise, and offers maximum vibration resistance. Contacts are welded on flexing arms for long life.



TAPE RECORDER weighs only 19 lb

AMPLIFIER CORP. OF AMERICA, 398 Broadway, New York 13, N. Y., has available the Magnematic 110 v a-c portable tape recorder that weighs 19 lb and attains a frequency response of 50 to 15,000 cycles at 7½ ips. Completely operated by push-button control, it features solenoid operated clutch controlled capstan drive to start and stop tape travel within 1/20th of a second. It incorporates relay operated modified Geneva movement to control high speed rewind and 60 ips fast-forward functions. A built-in preamplifier provides for low level, low impedance microphone input.

COIL WINDERS have variety of uses

REX RHEOSTAT Co., 3 Foxhurst Rd., Baldwin, L. I., N. Y. A line of automatic toroidal coil-winding machines designed and made in Germany is available in 4 sizes for a minimum inner

CONNECTORS

by **KINGS**



UG-569/U



UG-572/U



UG-643/U



UG-571/U



UG-573/U



UG-564/U



UG-565/U

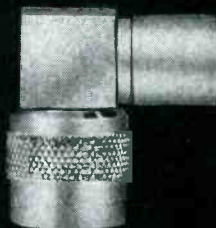

UG-567/U

C Series Connectors are a greatly improved mechanical and electrical type of co-axial connector. They are constant impedance and are designed for use with 50 ohm, middle size RF cables.

The C Series like every co-axial connector made by Kings is the result of constant research and development. Engineering ingenuity and precision manufacture have put "Connectors by Kings" in the front-line of communications equipment for industry and the armed services.

If you have a connector problem consult Kings. You'll be glad you called on Kings first.



KINGS *Electronics* CO., INC.

40 MARBLEDALE ROAD, TUCKAHOE, N. Y.

**PERFORMANCE
PROVED...**



**JOHNSON
SPECIAL SOCKETS**

*Engineered for longer life
Designed for top performance*

JOHNSON electrical components include a complete line of special sockets for virtually every electronic application. Engineering skill, the result of years of specialized experience, and the most modern manufacturing facilities assure you of stock or custom-fabricated sockets that are both durable and dependable.

The special sockets shown here, variations of JOHNSON standard types, were designed to meet the punishing requirements of the 100 hour salt spray test. Construction successfully resists salt water corrosion, moisture condensation, and fungus growth; all contacts and contact springs are heavily silver plated to insure low loss and a positive electrical connection. Terminals are hot tin dipped, bases are of grade L-4 Steatite insulation with glazed top and sides. To provide added protection, all other surfaces are DC-200 impregnated.

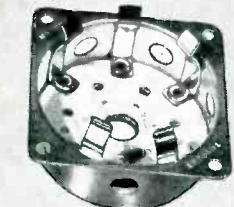

122-101-14



122-217-8



122-211-14

122-101-14—Designed for Septar base tubes such as the 826, 829, 832, etc., this special socket has an anodized aluminum shell and provision for mounting mica button capacitors directly to the socket base. Five nickel plated, phosphor bronze retaining springs hold tubes securely in place and permit trouble-free operation in any position. A recessed base, solidly mounted on fungus resistant, phenolic washers, positively eliminates any contact movement.

122-217-8 thru 122-228-8—A series of ceramic wafer sockets designed to accommodate standard receiving tubes. Locating grooves speed tube insertion . . . beryllium copper retaining springs hold tubes firmly in place. Recessed phosphor bronze contacts

prevent movement; countersunk rivets and boss located mounting holes permit sub-panel mounting.

122-211-14—A bayonet type socket for all tubes equipped with "50 watt" bases. Double beryllium copper filament contacts (.0005" silver plated), and hot tin dipped integral solder terminals insure positive contact with a minimum loss. Brass shell is .0003" nickel plated—ceramic base extends beyond contacts, increasing breakdown voltage rating.

JOHNSON special sockets, made to order in production quantities, meet all JAN material specification requirements. The complete JOHNSON standard socket line is listed in catalog 973, available on request.

Inquires are invited, and wherever possible we will gladly quote on "specials" to meet military requirements.



E. F. JOHNSON COMPANY

CAPACITORS, INDUCTORS, SOCKETS, INSULATORS, PLUGS, JACKS, DIALS, AND PILOT LIGHTS

228 SECOND AVENUE SOUTHWEST

WASECA, MINNESOTA

NEW PRODUCTS

(continued)

diameter of $\frac{5}{16}$ in., $\frac{1}{2}$ in., $\frac{3}{8}$ in. and $\frac{1}{8}$ in. after winding. They are used for winding toroidal coils, filters, variable transformers, rheostats and potentiometers. Rings are revolved automatically through an adjustable gearing, and the feed is adjustable during operation. An adjustable brake is provided. Coils can be wound continuously around 360 deg or in sector forms.



**SIGNAL BOOSTER
provides extra i-f stage**

GRAYBURNE MFG. CO., INC., 4-6 Radford Place, Yonkers, N. Y., announces production of model TSB-1, an i-f signal booster for uhf and vhf. The unit provides an extra stage of i-f to amplify both uhf and vhf signals without switching. The booster, which is supplied in adaptor form, is installed in an existing tube socket and requires but one wire connection to ground. It is designed to improve performance in near fringe areas, increase picture brightness, amplify signals over 20 percent and clear snow effects.

**MEGOHMMETER
tests leakage resistance**

FREED TRANSFORMER CO., 1718 Weirfield St., Brooklyn 27, N. Y. Type 1020-B megohmmeter is a self contained and a-c operated instrument equally useful in the lab or for production testing of the leakage resistance of insulation materials, capacitors, cables, motors and transformer windings. Re-

N.L. Instr't

MEASURING INSTRUMENTS by New London

FM Signal Generator **100C** 25 to 216 mc (single range)

FM Signal Generator 100C uses a novel circuit with a variable permeability modulator and a single stage r-f.

There is no beating and no multiplication, eliminating spurious frequencies. Output is from 0.02 microvolts to 0.1 volts. Frequency deviation is from 0 to 250 kc.

FM Signal Generator **I-208-D** 1.9 to 4.5 mc and 19 to 45 mc

With a marker every 2 kc on the low band and every 20 kc on the high, the I-208-D has 1300 calibration points. This requires 25 feet of film—each individually calibrated. Accuracy is kept within 0.03%. Output voltage is from 0.2 microvolts to better than 0.6 volts.

Signal Generator and Power Meter **TS-155C/UP** 2700-3400 mc (S Band)

As a signal generator, the TS-155C/UP, with an output (50 ohms impedance) of -20 to -100 dbm, is widely used for testing radar receivers and transmitters. It can be pulse modulated internally or from an external trigger source.

As a power meter, the TS-155 measures power from +20 to +100 dbm (or up to 200 milliwatts).

Leakage is low—less than 95 dbm.

Panoramic Adapter **BC-1031** 250 kc to 470 kc

The Panoramic Adapter BC-1031 operates on an input frequency of 450 kc to 470 kc with a maximum sweep width of 200 kc.

Used extensively for rapid visual spectrum scanning, it also enables the operator to determine whether transmission is by cw, am, fm, or pulse modulated signals.

The BC-1031 is also used for deviation measurements of FM waves by the methods of dropouts.

Square Wave Generator **150A** 50 cycles to 1 mc

Square wave generator 150A provides waves at five spot frequencies from 50 cycles to 1 mc with a maximum rise time of 0.05 microseconds. Continuous frequency variation can be obtained by using an external frequency control capacitor. A pulse for oscilloscope synchronization is available.

Output is controllable from 0-20 volts peak to peak and is constant at all frequency settings.

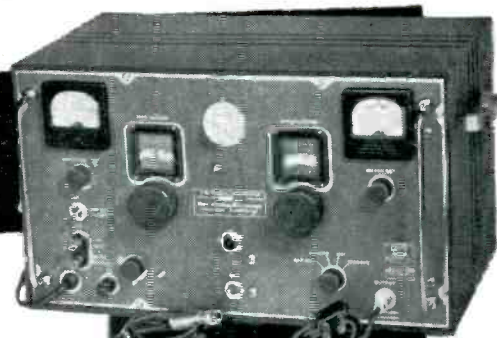

100C

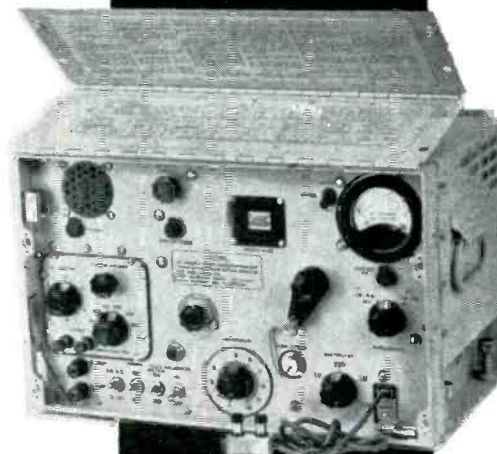

I-208-D



TS-155C/UP



BC-1031

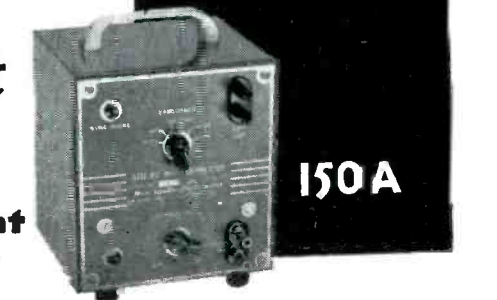

150A

for data on our
UHF TV Measuring Equipment
see page 450 of this magazine

**WRITE FOR
COMPLETE CATALOG
OF OUR MEASURING
EQUIPMENT**

New London Instrument
NEW LONDON 1 - CONN. *Company*

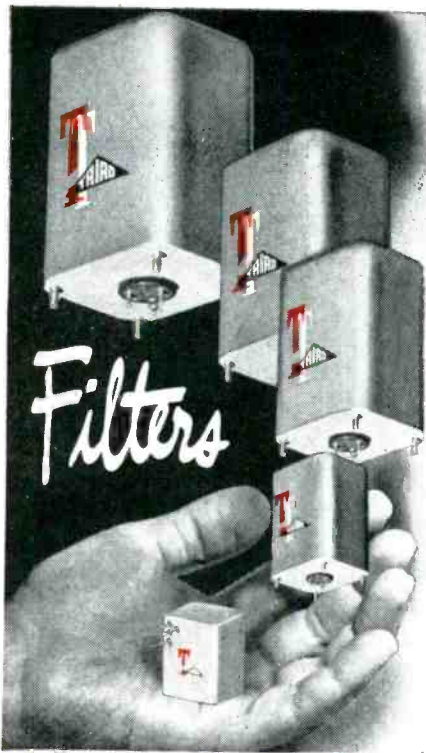

by **TRIAD**

Designed by Triad to meet exacting military requirements for airborne telemetering equipment, the tiny electric wave filter shown above actually contains eleven precision components: 2 toroidal inductors, 5 JAN-C-5 capacitors, and 4 precision wire-wound resistors. The resulting attenuation slope is over 50 decibels per octave.



The same brilliant design and controlled manufacturing that goes into Triad's distinguished line of hermetically sealed military transformers is available to you for licking the toughest wave filter problems. Call Triad first!

For specifications and prices on Triad's general line of transformers, write for Catalog TR-53G



Want more information? Use post card on last page.

NEW PRODUCTS

(continued)

istance values are indicated directly on a 4-in. meter protected against overload. It is rapid and safe to use, with test voltage removed from terminals and capacitive component discharged to ground in all positions of multiplier switch. Low resistance in series with components under test provides very short charging time for even the very largest capacitors. Calibration position is provided to check accuracy of 500 v d-c potential. The 500-v test supply is electronically regulated. The megohmmeter's range is from 1 megohm to 2,000,000 megohms in six overlapping ranges selected by a multiplier switch. The unit weighs 18 lb, and measures $9\frac{1}{2} \times 10\frac{1}{2} \times 8$ in.



D-C POWER SUPPLY
uses semiconductor diodes

ELECTRONIC RESEARCH ASSOCIATES, Box 29, Caldwell, N. J., announces a new dual tubeless regulated d-c supply especially designed for transistor applications. The new design utilizes semiconductor diodes in a bridge rectification circuit together with saturable reactors to provide for input line regulation. Good d-c regulation results from low diode voltage drop, coupled with the use of low-resistance filter components. Output No. 1, which is rated at 60 ma maximum can be adjusted for any of three ranges: 0 to 1, 0 to 10 or 0 to 100 v. Output No. 2, also rated at 60 ma maximum, yields an output of from 0 to 100 v d-c. Internal impedance is low, being approximately 100 ohms or less. Ripple measures less than 0.01 percent for an input variation of 95 to 125 v, 60 cycles. Maximum power consumption is 20 w. Dimensions are

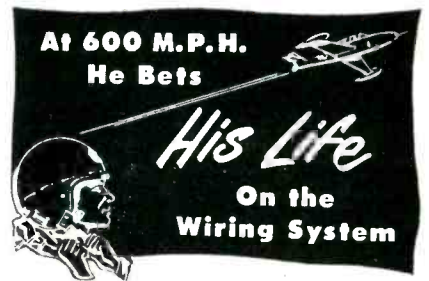

For Dependable
Electronic Wiring
Leading Manufacturers Choose
UNILECTRIC Wiring Systems

Year after year . . . for over ten years . . . UNILECTRIC has produced millions of wiring systems for over 150 leading manufacturers of electric and electronic products. If you still fabricate your own electronic wiring it will pay you to investigate UNILECTRIC.

There is Only ONE
Standard of Quality at
UNILECTRIC

This intricate wiring harness for a jet auto pilot must meet the most rigid specifications. A pilot's life and perhaps a major battle depend on it.

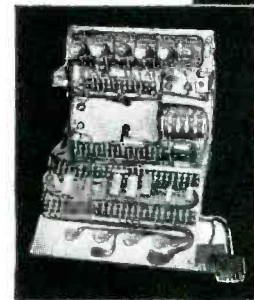

The same workmanship . . . the same standards of quality protect your product wiring and your product's reputation for dependability.

To assure utmost dependability plus cost saving engineering assistance, low-cost production, and "on-schedule delivery", investigate UNILECTRIC today.

UNILECTRIC
QUALITY
Protects Your
Products

Investigate UNILECTRIC Today!



Manufactured by
UNITED MANUFACTURING & SERVICE CO.
405 South 6th Street • Milwaukee, Wisconsin

Want more information? Use post card on last page.

Vacuum Fusion Gas Analyzer

with complete installation and instruction

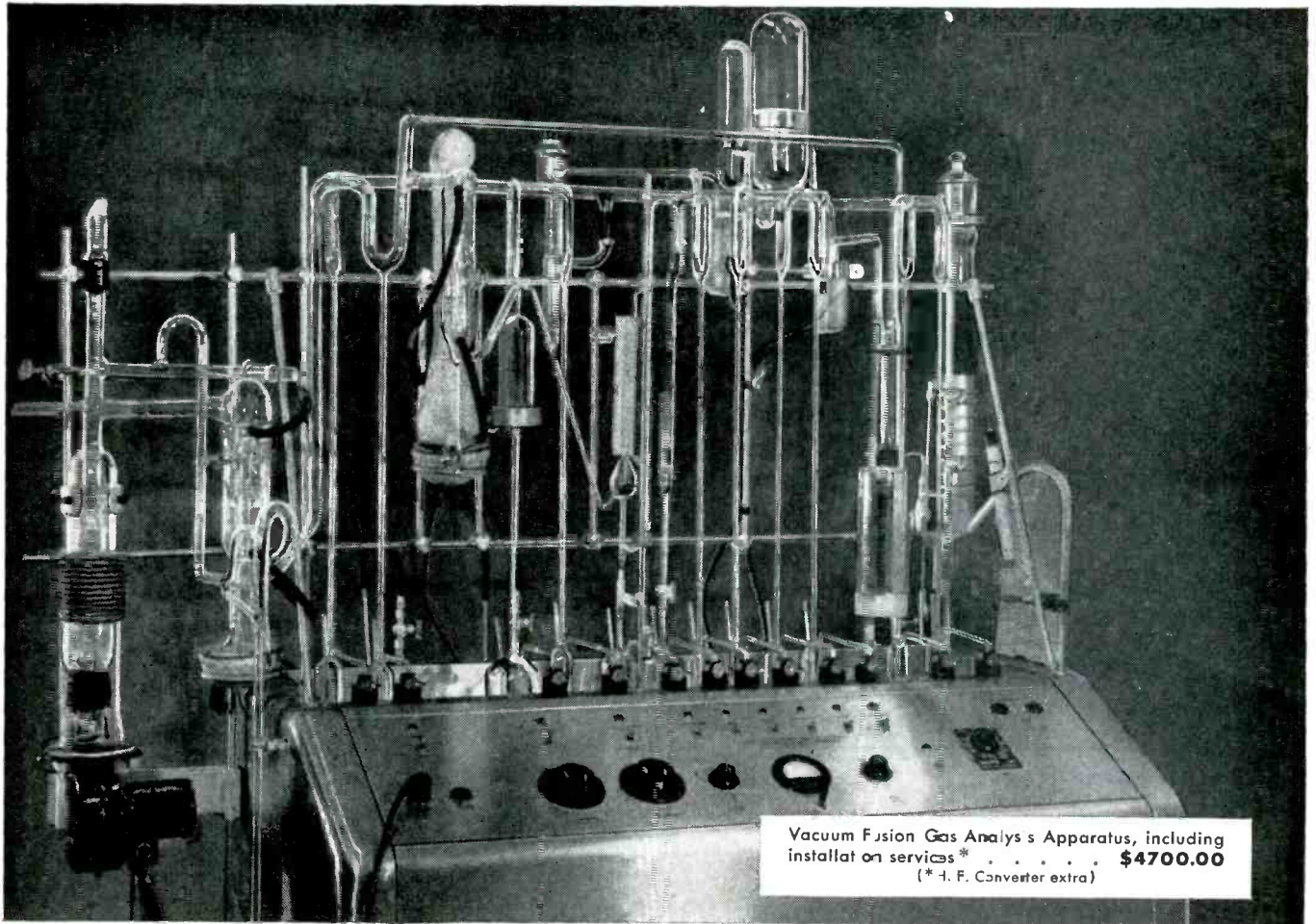

Vacuum Fusion Gas Analysis Apparatus, including installation services* **\$4700.00**
(* F. Converter extra)

A packaged unit to determine the content of oxygen, nitrogen and hydrogen in metals

A wide variety of metals and alloys can be analyzed to determine the amount of oxygen, nitrogen and hydrogen contained either as combined or dissolved gas, in the range from one per cent to approximately 10^{-4} per cent by weight.

The oxygen and hydrogen content of titanium is reported within the same range of accuracy as for other metals.

The apparatus incorporates the best features and techniques reported in the literature or known to our laboratory and has been employed for some time in connection with our own metallurgical research activities.

Operating procedure is relatively simple and can be readily mastered. Installation, final testing and instruction of your operator is performed by one of our trained analysts.

Write for details of Type 09-1240 Vacuum Fusion Gas Analysis Apparatus.

ANALYTICAL SERVICE

Write for information about NRC Gas Analysis Service if your requirements do not justify the purchase of an instrument.

INDUSTRIAL RESEARCH

CHEMISTRY, METALLURGY
HIGH VACUUM ENGINEERING



PROCESS DEVELOPMENT

PHYSICS, DEHYDRATION
DISTILLATION, VACUUM COATING

National Research Corporation

EQUIPMENT DIVISION

SEVENTY MEMORIAL DRIVE, CAMBRIDGE 42, MASSACHUSETTS

MORE WAYS TO SQUEEZE PENNIES OUT OF UPSET SPECIALS COSTS

Specially designed upset products are solving thousands of problems. Dozens of design pointers on them are yours for the asking. Send us your sketches, prints, finished products for suggestions.

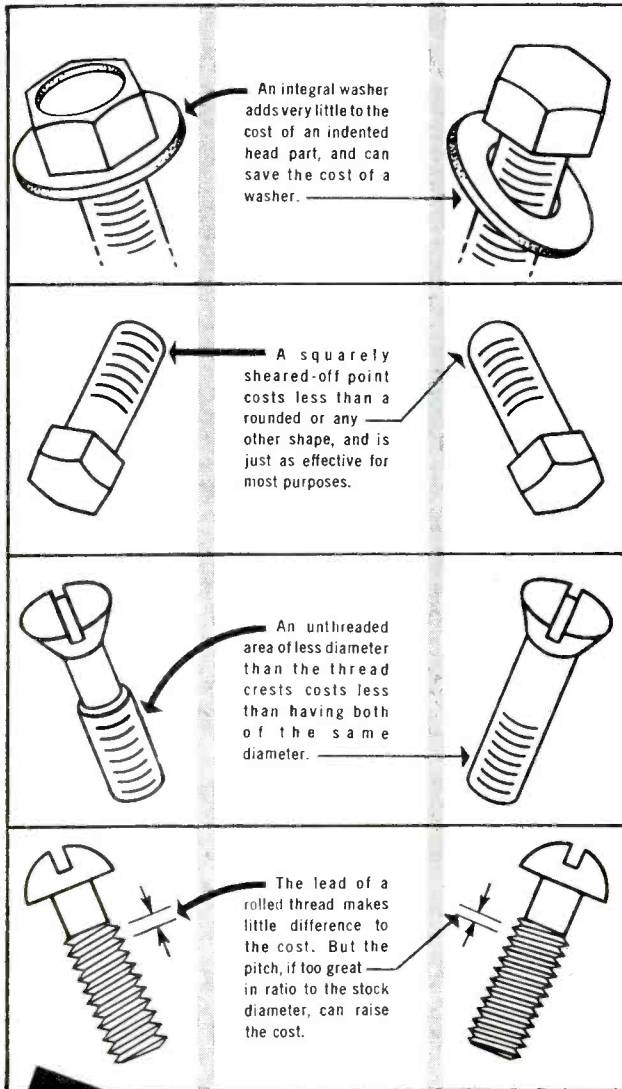

REPRINTS

of this chart are available on request for use in drafting and purchasing departments.



MACHINE SCREWS AND SPECIAL FASTENERS ARE OUR BUSINESS



WRITE FOR OUR CATALOG

**THE PROGRESSIVE
MANUFACTURING COMPANY**
50 NORWOOD ST., TORRINGTON, CONN.

Want more information? Use post card on last page.

NEW PRODUCTS

(continued)

19 in. × 5½ in., with a 7-in. dust cover depth. Weight is 24 lb.

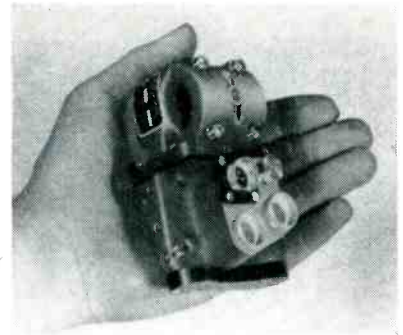

TINY SERVOVALVE weighs 2.8 lb

MIDWESTERN GEOPHYSICAL LABORATORY, 3401 S. Harvard, Tulsa, Oklahoma. Model 4 miniature single-stage uncompensated servo valve was designed for use in hydraulic servosystems where fast response, reliability and small size are prime considerations. Due to its balanced symmetrical twin-piston design, it will operate smoothly under adverse vibration and lateral acceleration conditions. The valve has no external leakage (a small drain line returns leakage oil to the sump). Both pistons are readily accessible for mechanical actuation and may be utilized for safety limit stops in servosystems. The body and pistons are hardened, precision-lapped alloy steel which insures dependable servo valve operation under dirty oil conditions. The model 4 servo valve may be manifolded directly to the load actuator.

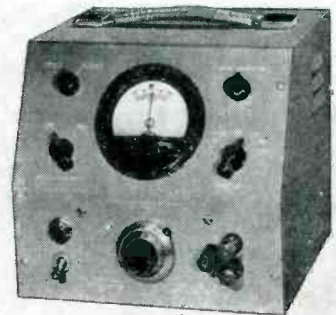

D-C VOLTMETER is lab standard unit

COMPUTER CORP. OF AMERICA, 149 Church St., New York 7, N. Y. Model PVM-4 laboratory standard d-c voltmeter features a resolution

Now... another 

JAN TYPE

1N34A

with the **PLUS** factor of
polarity at a glance or touch

Germanium
Diode for
military use



To the list of Radio Receptor diodes that can be designated JAN type comes another important model — 1N34A. Built to the high standards of this designation, 1N34A as well as *all* Radio Receptor diodes gives you simplified polarity identification. The tapered case speeds up assembly, reduces possibility of error in connecting the diodes into the circuit, which all adds up to lowered production costs.

These JAN type diodes
now available for
prompt delivery

1N69
1N81

1N70
and now 1N34A

Many other types of diodes are available too, including a range of computer diodes made to meet special requirements. Radio Receptor also makes Germanium Transistors and SELETRON Selenium Rectifiers. Our engineers will gladly study your problems without obligation and submit their recommendations.

**Seletron
and Germanium
Division**

RADIO RECEPTOR COMPANY, INC.

 Since 1922 in Radio and Electronics 

SALES DEPT: 251 West 19th Street, New York 11, N. Y. • FACTORY: 84 North 9th Street, Brooklyn 11, N. Y.

LOOK!

CORROSION-RESISTANT PYGMY MOTOR GENERATORS

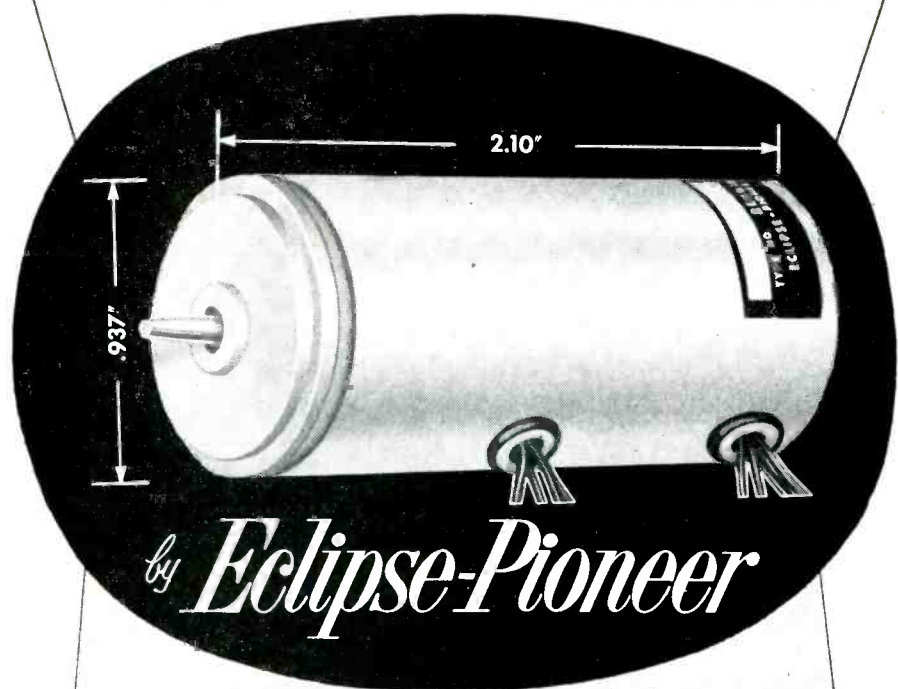

TYPICAL ELECTRICAL CHARACTERISTICS

GENERATOR DATA

Linearity— $\frac{1}{2}$ of 1% to 4000 rpm
Output—300 mv/1000 rpm with 18 volt, 400 cycle excitation
Null—10 mv or less

MOTOR DATA

18 or 26 volt, 400 cycle, 2-phase low inertia motor

As one of the world's oldest and largest producers of synchro-type equipment, we are ideally qualified to provide you with the right answer to your motor generator needs. Why not take advantage of our long, practical experience? Call on us for recommendations based on handling your individual problem most efficiently.

ECLIPSE-PIONEER DIVISION OF

For full details, write Department C.
TETERBORO, N. J.

Export Sales: Bendix International Division, 205 East 42nd St., New York 17, N. Y.



of better than 50 mv over the entire range of 0 to 600 v. The 0 to 10-v scale affords resolution of better than 5 mv in that range. Accuracy is better than 0.2 percent. Linearity is better than 0.1 percent. Input impedance is infinite. The unit is extremely rugged, completely protected against overload, and simple enough in operation to be equally suited to laboratory or production line use. It is expected that the PVM-4 will find wide application, particularly in the testing of power supply regulation, analog computer measurements, meter calibration, capacitor storage measurements and battery voltage measurements.

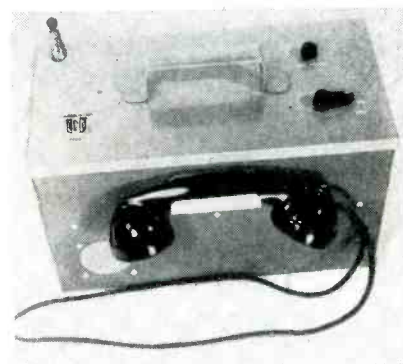

RADIOPHONE weighs only 14 lb

COMMUNICATION RESEARCH & DEVELOPMENT Co., INC., 9530 Aurora Ave., Seattle 3, Wash. Model B-3 emergency radiophone is completely self-contained and weighs only 14 lb. The set utilizes portable-radio batteries and can be supplied for any frequency from 2 to 30 mc with crystal control of both sending and receiving.

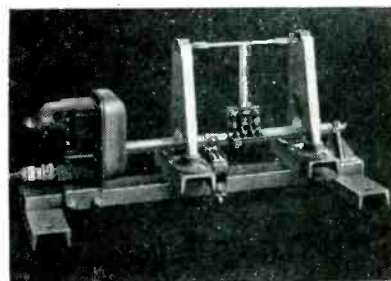

SHORTING SWITCH for transmission lines

TRYLON TOWER DIVISION, WIND TURBINE Co., West Chester, Pa., has introduced a new h-f shorting

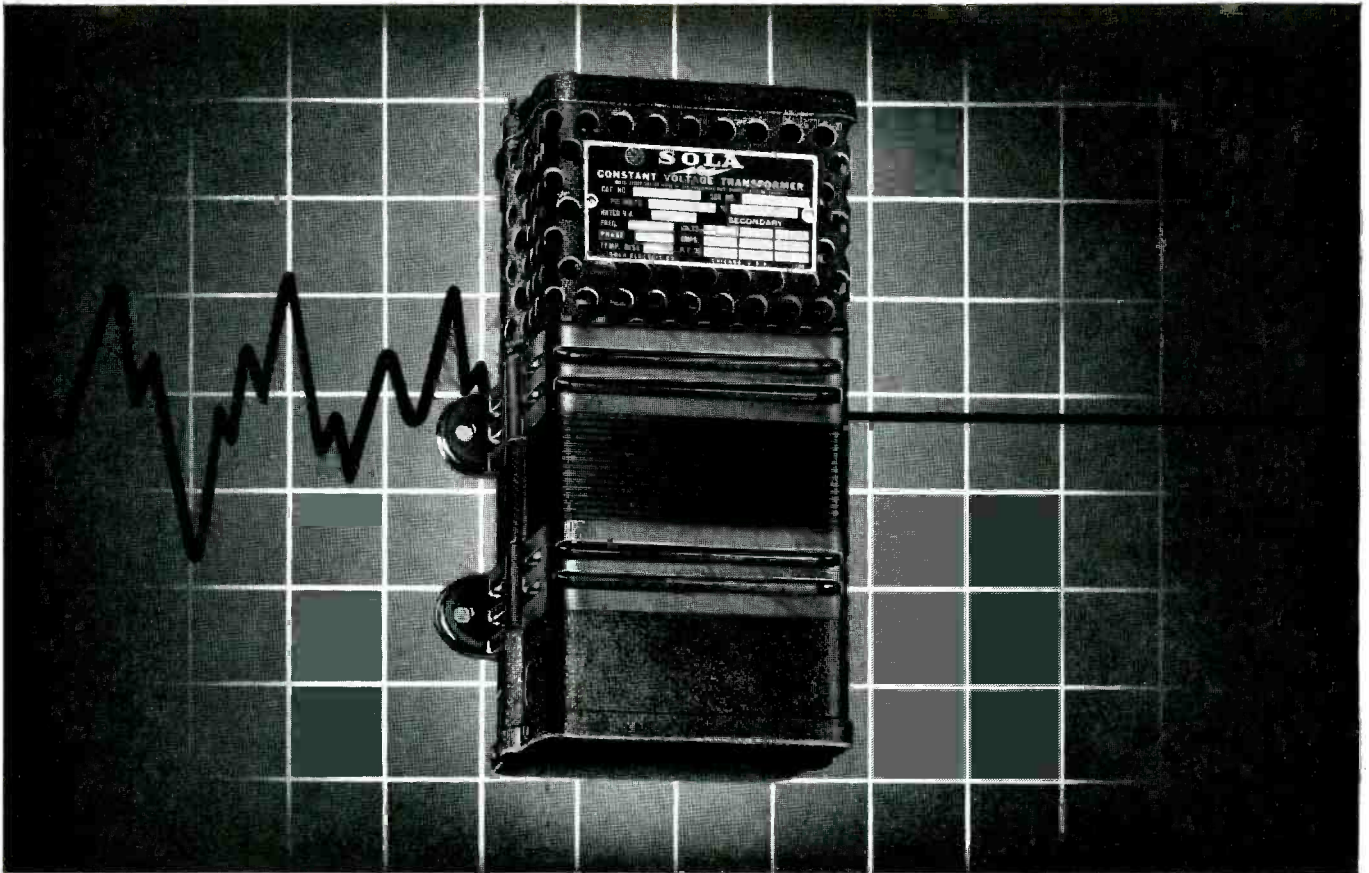

Automatic, maintenance-free, instantaneous voltage stabilization

Static-magnetic constant voltage transformers are a practical and efficient solution for controlling input voltage to voltage-sensitive electrical and electronic equipment.

Sola Constant Voltage Transformers are widely used both as built-in components and as accessory units. They differ from regulators which depend solely upon saturation of core materials for their regulating action, or electronic types employing tubes. Sola Constant Voltage Transformers have the following characteristics:

1. Regulation within $\pm 1\%$, with primary voltage (transient or continuous) variations as great as 30%.
2. Response time less than $1\frac{1}{2}$ cycles.
3. No moving or wearing mechanical parts, nor vacuum tubes; requires no manual adjustments.
4. Completely automatic, continuous regulation.

5. Self-protecting against short-circuits on output.
6. Current-limiting characteristics protects load equipment.
7. Can often be substituted in place of conventional non-regulating transformers.
8. Generally smaller than other types of regulators for similar duty.
9. Isolates the input and output circuits.

Forty-three Sola stock units are available in a wide variety of ratings, voltages and types. In addition, custom-designed units can be manufactured (in production quantities) to meet specific requirements.

The experience of the world's largest manufacturer of constant voltage transformers is available to you. We invite you to discuss your voltage stabilizing problems with a Sola Sales Engineer.

SOLA *Constant Voltage*
TRANSFORMERS

WRITE FOR LITERATURE. Sola Constant Voltage Transformers are completely described in a 24 page manual. Write for a copy of D-CV-142 on your letterhead, please.

Transformers for: Constant Voltage • Fluorescent Lighting • Cold Cathode Lighting • Mercury Vapor Lighting • Luminous Tube Signs
SOLA ELECTRIC CO., 4633 W. 16th Street, Chicago 50, Illinois, Blshop 2-1414 • NEW YORK 35: 103 E. 125th St., Trafalgar 6-6464
 PHILADELPHIA: Commercial Trust Bldg., Rittenhouse 6-4988 • BOSTON: 272 Centre St., Newton 58, Mass., Bigelow 4-3354
 CLEVELAND 15: 1836 Euclid Ave., Prospect 1-6400 • KANSAS CITY 2, MO.: 406 W. 34th St., Jefferson 4382 • Reprs. in Other Principal Cities

All business is specialized

*... and nothing
specializes
on your business
like your business paper*



You can sell suntan lotion on Broadway or Beacon Street, but this seagoing salesman can sell a whale of a lot more . . . because he *specializes*.

Your business is specialized, too. That's why it pays to keep up with your business paper. It specializes on business problems you meet every day. It helps you do a whale of a lot better job by keeping you posted on your whole field. You can *move ahead* when you know what's ahead; you can make quicker, surer decisions when you have a clear perspective on what's happening; and you get all this from your business paper.

Every page counts. The editors gather facts, weigh and interpret them. The advertisers line up new products,

materials and equipment . . . tell you what they do and where to buy them. To know what's new that's important to you, read *every* issue—thoroughly! It will keep you one of the best informed people in your field.

This business paper in your hand has a plus for you, because it's a member of the Associated Business Publications. It's a paid circulation paper that must earn its readership by its quality . . . And it's one of a leadership group of business papers that work together to add new values, new usefulness, new ways to make the time you give to your business paper still more profitable time.

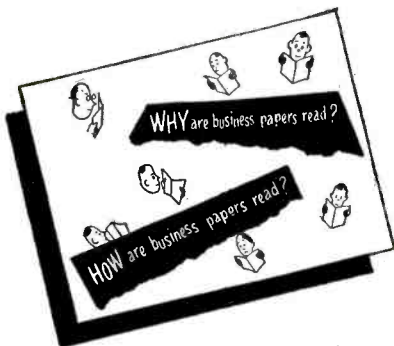

A copy of this quick-reading, 8-page booklet is yours for the asking. It contains many facts on the benefits derived from your business paper and tips on how to read more profitably. Write for the "WHY and HOW booklet." Room 2710.

McGRAW-HILL PUBLISHING COMPANY
330 West 42nd St., New York 36, N. Y.



One of a series of advertisements prepared by THE ASSOCIATED BUSINESS PUBLICATIONS

PRECISION

IS THE WATCHWORD
TODAY IN ELECTRONICS

... as technological
advancements call for
circuits of increasing accuracy
and dependability!

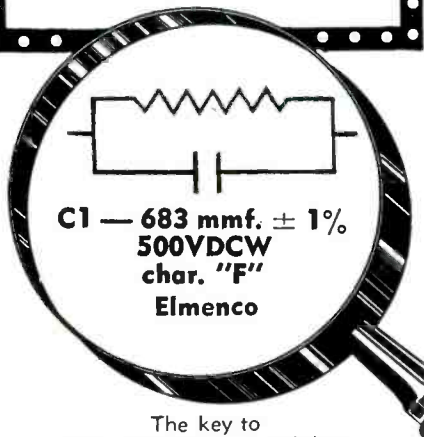

The key to high precision and stability lies in proper selection of mica capacitors, made possible through our ability to provide ANY CAPACITY at ANY TOLERANCE with the highest characteristics within the ranges specified for molded mica capacitors.

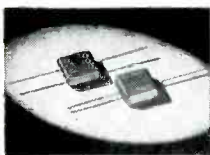

SINGLE UP TO
15000 MMF



DUAL UP TO
30000 MMF



TRIPLE UP TO 45000 MMF

Any Capacity
Any Tolerance (to $\pm 0.5\%$)
JAN Characteristic "F" or Better
for Most Capacity Values.

All capacitors are ELMENCO and are manufactured in accordance with JAN-C-5 specifications. Known the world over for their reliability under all operating conditions, ELMENCO CAPACITORS are chosen by manufacturers requiring the highest quality components for their products.

Write for our free descriptive catalog and for information regarding your special product requirements.

**ARCO
ELECTRONICS INC.**

103 Lafayette St., N. Y. 13, N. Y.

Want more information? Use post card on last page.
ELECTRONICS — October, 1953

NEW PRODUCTS

(continued)

switch for two-wire open transmission lines having 12-in. spacing. Designed for flexible remote control in antenna "parks," the switch can be used for short circuiting two or more frequency tuning stubs; shorting transmission-line accept-reject circuits; or as a grounding device for transmission lines or other high-voltage a-c or d-c circuits. The switch causes a minimum of line disturbance in the open position and is conservatively rated to handle 30 kv wire-to-wire or 15 kv to ground. The heavy steatite-insulated shorting bar is controlled by a low-voltage d-c motor equipped with limit switches and an electromechanical brake that stops the motor instantly at the end of the stroke.

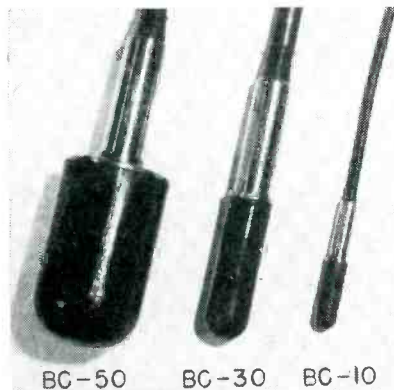

TRANSDUCERS

useful as pressure pickups

ATLANTIC RESEARCH CORP., Alexandria, Va., presents a new series of barium-titanite pressure transducers, models BC-10, BC-30, and BC-50, that are generally useful as transient pressure pickups in liquid and gaseous systems. The gages produce large voltage response (up to 0.6 v psi) flat over wide frequency ranges (3 cps to 75 kc, 1 cps to 40 kc and 0.5 cps to 30 kc, respectively). Sensitive elements of the instruments are hermetically sealed and covered with tough neoprene sheath. Construction eliminates possibility of water leakage. The d-c input resistances are maintained above 500 megohms. These models have withstood transient pressures of 10,000 psi and static pressures in excess of 5,000 psi. The gages are particularly suitable for underground-

6.0 kc/s @ -6 db
7.2 kc/s @ -60 db

TO

0.4 kc/s @ -6 db
1.2 kc/s @ -60 db

SIGNAL SPLITTER

JAM-FREE BANDWIDTHS!

CONTINUOUSLY VARIABLE

FROM JAMMING!

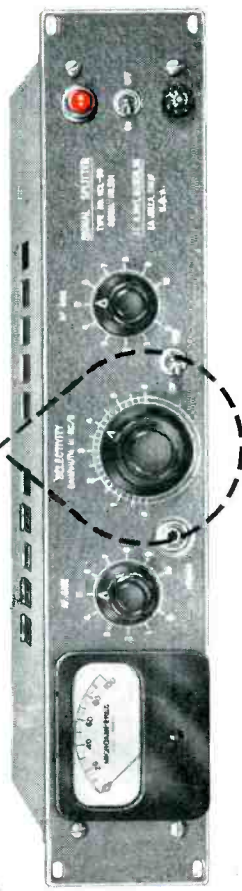

MCL-50

New Freedom

THIS NEW CONTINUOUSLY VARIABLE BANDWIDTH CONVERTER stops jamming, carriers and heterodyne-beat interference which normally mar reception of long-distance CW and AM signals. Carriers as close-in as 500 c/s can be separated and the undesired ones reduced 60 db. . . . Special wave filters provide a flat-topped selectivity curve with steep vertical sides, and a bandwidth adjustable to pass only the desired signal. SIGNAL SPLITTERS are world-known for reliable anti-jamming performance by both military and commercial companies. They are employed with AM radio-receivers located in some of the toughest signal jamming spots in the world by governments, airlines and telephone/telegraph companies. Special SIGNAL SPLITTERS are available for use with modern high-quality single-sideband receiving equipment to eliminate signal jamming in the selected sideband. A general purpose radio-communications receiver with built-in SIGNAL SPLITTER features will also be available shortly.

J. L. A. McLAUGHLIN CORPORATION
LA JOLLA, CALIFORNIA, U. S. A.

Want more information? Use post card on last page.

underwater explosion studies, sonar and geophysical exploration.



PRESSURE SWITCH is 2½ in. in diameter

G. M. GIANNINI & Co., INC., 117 E. Colorado St., Pasadena 1, Calif. Model 44517 pressure switch, of very simple construction and 2½ in. in diameter, is comprised of a pressure responsive element which actuates a switch that can be set at the factory to a predetermined pressure. It can be used in applications that include control system actuation and pressure warning or shut-off devices. The unit will operate within a temperature variation of -54 to +71C and at altitudes up to 50,000 ft. It can withstand and operate under 0.032 in. double amplitude vibration from 10 to 55 cps. The switch section will handle 5 amperes at 125 or 250 v a-c and 3 amperes inductive motor load at 30 v d-c, sea level.

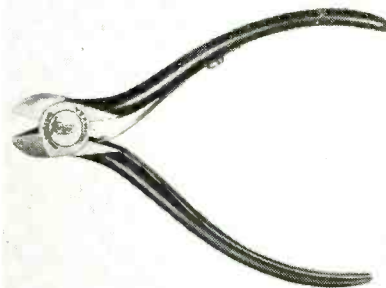

NEW PLIER shears hardest wire

MATHIAS KLEIN & SONS, 3200 Belmont Ave., Chicago 18, Ill., offers a new kind of plier specially de-

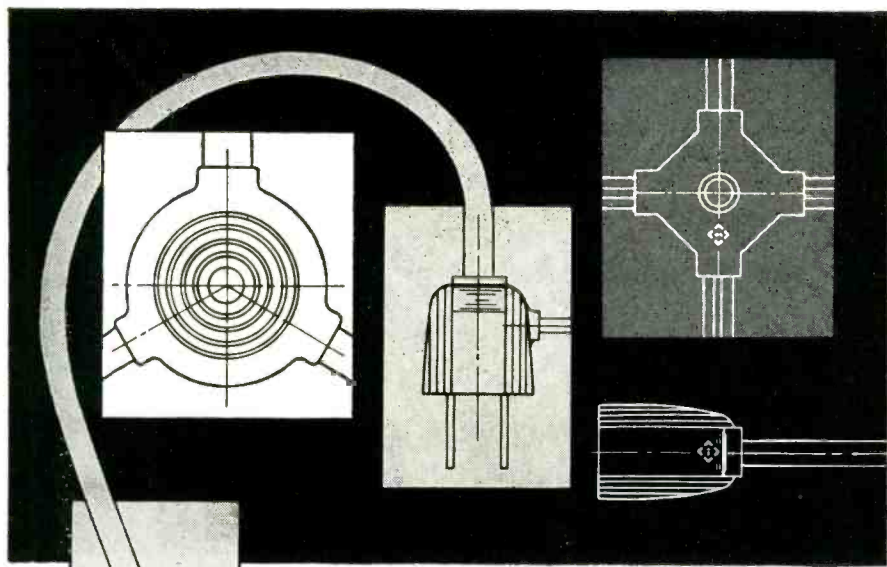

"Special" CORD SETS
WITH
MOLDED FITTINGS
FROM
WHITNEY BLAKE

Whitney Blake Company is equipped to mold rubber and plastic fittings onto flexible cord, shielded communications wires and multiple conductor cables — in addition to making the cordage itself.

Whitney Blake has wide experience in designing and manufacturing shielded multiple conductor cables and assembling intricate connectors for electronic applications. Skilled workers, modern equipment, efficient production methods and careful quality control assure dependable, first quality cord sets.

Where standard molds are unsuitable, Whitney Blake will design and make special plugs, connectors, strain reliefs and junction box blocks that provide the water- and impact-resistance, small size, light weight and protection from tampering required for many new applications.

For help with your special cord set problems, contact us for the address of your nearest Whitney Blake representative. He will be glad to work with you. If your product is in the design stage, information on its intended use may enable him to suggest a cord set construction using conventional parts at savings to you.

WELL BUILT WIRES SINCE 1899



WHITNEY BLAKE CO.

NEW HAVEN 14, CONNECTICUT

for **PROVEN RESULTS** specify

McGRAW-HILL

Mailing Lists

You can save time, avoid needless expense, increase your results by having McGraw-Hill Lists do your mail advertising job!

Three quarters of a century of practical experience is made available to you when you turn your direct mail jobs over to McGraw-Hill. And these seventy-five years of leadership in the development and perfection of lists assure you the maximum results at the lowest cost per order or inquiry.

Those who are acquainted with mailing lists know that year-after-year acceptance of lists does not come by chance or luck. Accepted lists, like McGraw-Hill's, hold their places by merit alone. Nor does success one day guarantee success the next. Vigilant eyes must constantly add new names, delete, change, check, recheck, etc. Inferior lists are dropped as soon as shortcomings are noticed . . . "good lists" yield to better lists.

For seventy-five years expert list users have preferred McGraw-Hill by long odds. No matter how few names you use—whether your business is large or small—the best lists, McGraw-Hill Lists, are the most economical in the long run.

The world-wide reputation McGraw-Hill has earned as builders of the finest mailing lists was born of constant research in our office and in the field—constantly adding new names . . . developing new markets, new avenues of revenue for direct mail list users.

McGraw-Hill Mailing Lists are built—and constantly maintained—to provide, as accurately as humanly possible, complete rosters of the industries we serve.

Investigate their tremendous possibilities in relation to your own product or service. Your specifications are our guide in recommending the particular McGraw-Hill lists that best cover your market. When planning your industrial advertising and sales promotional activities, ask for more facts or, better still, write today. No obligation, of course.

Proven Results

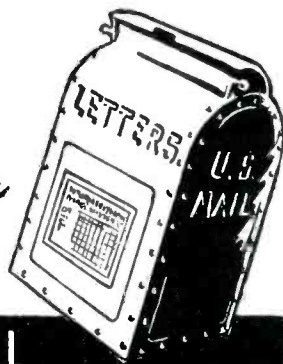

McGRAW-HILL
DIRECT MAIL LIST SERVICE

McGraw-Hill Publishing Co., Inc.

DIRECT MAIL DIVISION

330 W. 42nd Street, New York 36, N. Y.

Direct Mail Division, McGraw-Hill Publishing Co.
330 West 42nd Street, New York 36, N. Y.

Please send me, at no cost, mailing list information that will cover my markets.

Name Title.....
Company
Address
City and State.....
Product or Service.....

STOP RF LEAKAGE ON THE DRAWING BOARD

... WHEN YOU DESIGN METEX ELECTRONIC WEATHERSTRIPPING INTO YOUR EQUIPMENT YOU GET ITS POSITIVE SHIELDING EFFECTIVENESS — AT MAXIMUM OVERALL ECONOMY

Plan now to take full advantage of *Metex Electronic Weatherstripping's* unusual effectiveness in shielding all types of electronic equipment. Because it is made of knitted wire mesh, *Metex Electronic Weatherstripping* is both conductive and resilient. It assures positive metal-to-metal contact between all mating surfaces. And being resilient it accommodates itself positively to surface inequalities.

In reality, *Metex Electronic Weatherstripping* can do more for you than just shield RF leakage. It can cut the cost of machining mating surfaces to close tolerances. It can eliminate the need for extra fasteners and many other costly means of making joints RF tight.

To get the best results and lowest production costs, design with *Metex Electronic Weatherstripping*, available in 3 basic forms:

- 1 Continuous lengths in various cross sectional shapes with or without fin for attachment.
- 2 Die-formed shielding gaskets, and
- 3 Sealing gaskets where the knitted wire gasket is combined with a sealing medium.



For detailed information on METEX ELECTRONIC PRODUCTS, write for FREE copy of "Metex Electronic Weatherstrips" or outline your SPECIFIC shielding problem — it will receive our immediate attention.

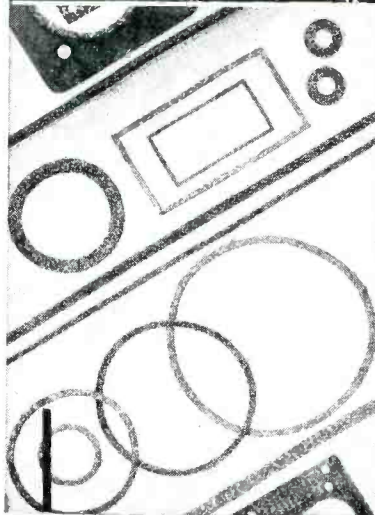

METEX ELECTRONIC WEATHERSTRIPPING

For shielding on all types of electronic and electrical equipment

Each of these is made in various sizes and shapes which are readily adaptable to practically any equipment. The resiliency can be varied where necessary to meet specific requirements.

Applications in which *Metex Electronic Weatherstripping* has already proved its effectiveness include pulse modulator shields, wave-guide choke-flange gaskets, local oscillators on TV sets, dielectric heaters, etc.

METAL TEXTILE CORPORATION

KNITTERS OF WIRE MESH FOR MORE THAN A QUARTER CENTURY

Roselle, New Jersey



veloped for cutting tungsten filaments, music wire, springs and other hard wire. It operates on a shearing principle which eliminates the need for regular cutting knives. No adjustment is required even if accidentally nicked. A replaceable tempered steel spring keeps the plier in open position, ready for immediate use. Overall length is approximately 5½ in. Refer to No. 053-L for plier with leaf spring and 053 for plier without leaf spring.



HIGH-SPEED COUNTER requires 100-mv input

DECADE INSTRUMENTS Co., Box 153, Caldwell, N. J. The Decavider 100-1 is a precision high-speed counter for use in extending the range of standard 100,000-cycle counters to 1 mc. One of the new features consist of an output circuit providing square waves at one-tenth of the input frequency. Another output circuit furnishes sharp positive— or negative—going pulses having a rise time of 0.25 μ sec at an amplitude of 40 v. Input requirements are 100 mv, 100 cycles to 1.2 mc. Dimensions of the unit are 18 in. wide x 10 in. high x 12 in. deep.



POWER SUPPLIES for h-v r-f use

NEUTRONIC ASSOCIATES, 83-56 Victor Ave., Elmhurst 73, N. Y., have added four new models to their line

of high-voltage r-f power supplies. The new models are unusual in that they may be reversed in polarity by a conveniently located lever on the front panel. The reversible feature is useful where data are needed for both positive ground and negative ground hookups, or where quick reversing in polarity is desirable in the kilovolt range. A further advantage offered is the increased usefulness to the laboratory of a single power supply with both positive and negative output. The additions consist of two regulated and two unregulated bench type models.



H-F ALTERNATOR
is a tiny, high-speed unit

D & R, LTD., 402 E. Gutierrez St., Santa Barbara, Calif. Very high power outputs for their size and weight characterize a new line of miniaturized high-frequency alternators. Operating shaft speeds are from 10,000 to 50,000 rpm. The present line includes units with power output ratings from 125 to 4,000 w at 5,000 cps. As an example, the model A-17 illustrated is 2½ in. in diameter, weighs 22 oz, and delivers 350-w output at 5,000 cycles with a shaft speed of 25,000 rpm.

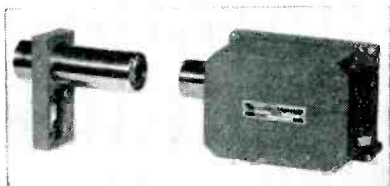

PHOTOELECTRIC UNIT
for plate-circuit control

THE AUTOTRON Co., Box 722-H, Danville, Ill. Actuation of electric

BEST ALL-AROUND TESTER ON THE MARKET

USE IT FOR:

- TV SETS
- RADIOS
- TRANSMITTERS
- BROADCASTING EQUIPMENT
- HOME APPLIANCES
- TWO-WAY RADIO COMMUNICATIONS SYSTEMS
- PHONE LINES
- AIR CONDITIONING SYSTEMS
- STARTER CONTROLS
- AUTO IGNITIONS, GENERATORS, BATTERIES
- MOVIE EQUIPMENT
- PANEL INSTRUMENTS
- TV CAMERAS
- AUTO LIGHTING SYSTEMS
- GENERATORS
- VOLTAGE SOURCES
- "HAM" RADIO EQUIPMENT
- CABLES
- CONNECTORS
- AUDIO FREQUENCY SOUND CURRENTS

... and write for your complimentary copy of "1001 Uses for the Simpson Model 260" - 50 pages of uses.

RANGES:

- 20,000 OHMS PER VOLT DC
- 1,000 OHMS PER VOLT AC
- VOLTS, AC AND DC: 2.5, 10, 50, 250, 1,000, 5,000
- OUTPUT: 2.5, 10, 50, 250, 1,000
- MILLIAMPERES, DC: 10, 100, 500
- MICROAMPERES, DC: 100
- AMPERES, DC: 10
- DECIBELS (5 RANGES): -12 TO +55 DB
- OHMS: 0-2000 (12 OHMS CENTER), 0-200,000 (1,200 OHMS CENTER), 0-20 MEGOHMS (120,000 OHMS CENTER)

SIMPSON ELECTRIC COMPANY
5200 W. Kinzie St., Chicago 44 • EST. 1921
In Canada, Bach-Simpson, Ltd., London, Ont.



Simpson
Model 260
VOLT OHM-MILLIAMMETER

\$38.95 Dealer's net.

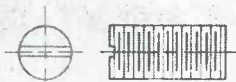

THREADED I. F. CORE



SLEEVE CORE



"E" CORE



TOROID

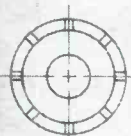

CUP CORE



DUMBBELL CORE



IRON CORE COIL FORM



PLAIN CORE



INSERT CORE



TUNING CORE

Radio Core Quality Control

All Radio Cores manufactured are produced with special attention to both mechanical and electrical tolerances, resulting in lower incoming inspection and assembly costs on the part of the customer.



Detailed Radio Core information, samples, designs and specific costs may be obtained by writing Department No. E-10-53S

Write for "Engineered Radio Cores" Technical Data Booklet No. E-10-53

FREQUENCY STANDARD for the 200-11,000 mc range

PRESTO RECORDING CORP., P.O. Box 500, Paramus, N. J. Model 100 microwave secondary frequency standard provides a versatile instrument to generate accurate test signals over the range of 200 to approximately 11,000 mc. Accuracy is ± 0.005 percent. The unit delivers to the 50-ohm input of a typical microwave receiver an uninterrupted series of c-w signals spaced every 100 and 200 mc over the complete frequency range, and 50-mc marker output useful up to approximately 9,000 mc. Signals are all delivered simultaneously without any frequency tuning. The only variable adjustment on the front panel of the instrument is an output level control. Identification



Radio Cores, Inc.

9540-50 Tulley Avenue Oak Lawn, Illinois



of signals in any 200-mc sector is accomplished by comparing their relative amplitudes since the amplitude of the 200-mc signals is greater than the 100-mc signals and the 100-mc output is greater than the 50-mc output.



MINIATURE GEARBOX
designed for 300 to 1 ratio

BELOCK INSTRUMENT CORP., 13-11 111th St., College Point, N. Y. The new miniature gearbox features stainless steel construction and ball bearings used throughout. It is designed to meet aircraft vibration specifications and is built to take the Kearfott R-118-1B motor. It can be supplied with any potentiometer having a 1/8-in. shaft to form a packaged miniature servo system. Integrally cut cluster gears substantially reduce backlash to a minimum. The following data were taken while the unit was operating on standard 28-v aircraft supply: output torque, 8 in. oz with maximum backlash of 0.007 in. at the input; starting voltage, 1.5 v; and operation in temperatures from -65C to +125C. Life expectancy is 2,000 hr under normal applications and running conditions. The present design is for a 300-to-1 ratio.

POWER SUPPLY
is voltage stabilized

POWER DESIGNS INC., 119-22 Atlantic Ave., Richmond Hill 19, N. Y. Model 351 voltage stabilized power supply is designed to furnish d-c power to equipment where unusually close performance tolerances, rapid recovery time and freedom from transient responses are required. Rated for 100-percent

the **Waterman**

RAYONIC

CATHODE RAY TUBES

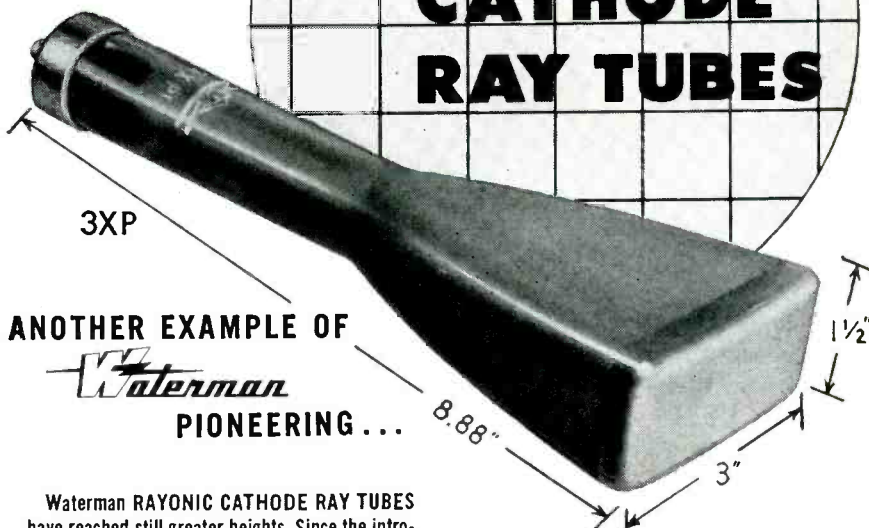

ANOTHER EXAMPLE OF

Waterman

PIONEERING ...

Waterman RAYONIC CATHODE RAY TUBES have reached still greater heights. Since the introduction of the Waterman RAYONIC 3MP1 for miniaturized oscilloscopes and the Waterman developed rectangular 3SP CATHODE RAY TUBE, scientists in our laboratories have diligently searched for a more perfect answer to the perplexing problem of trace brightness versus deflection sensitivity. The 3XP RAYONIC CATHODE RAY TUBE is their answer to providing a brilliant and sharply defined trace and high deflection sensitivity at medium anode potentials. When the 3RP or 3SP tubes are operated at 1000 Volts second

anode and compared against the 3XP at 2000 Volts on the second anode, the results are astonishing. For the same size spot, the 3XP light output is improved by a factor of 4 and its vertical sensitivity is improved by a factor of 2, with the horizontal sensitivity remaining equal to that of the other tubes. Because the 3XP is enclosed in a shorter envelope and is equivalent to the 3RP and 3SP with respect to interelectrode capacities, it lends itself readily for high frequency video work, as well as for low repetitive operation.

3XP TECHNICAL DATA

SIZE:	FACE	1 1/2 x 3 inches
	LENGTH	8.875 inches
	BASE	Loctal
TYPICAL OPERATING CONDITIONS		
	FILAMENT	6.3 Volts
		0.6 Amps.
	ANODE # 2	2000 Volts
		Max. 2750 Volts
	ANODE # 1	400 to 690 Volts
	GRID # 1	-22.5 to -67.5 Volts
	DEFLECTION FACTOR IN VOLTS/INCH	
	D 1 to D 2	68 to 92
	D 3 to D 4	25 to 35

AVAILABLE in P1, P2, P7, and P11 Phosphors

WATERMAN PRODUCTS CO., INC.

PHILADELPHIA 25, PA.

WATERMAN PRODUCTS INCLUDE

CABLE ADDRESS: POKETSCOPE

- 3JP1 & 3JP7 JAN RAYONIC CR TUBES
- 3JP2 & 3JP11 RAYONIC CR TUBES
- 3MP7 & 3MP11 RAYONIC CR TUBES
- 3RP1, 2, 7, 11 RAYONIC CR TUBES
- 3SP1, 2, 7, 11 RAYONIC CR TUBES

POCKETSCOPES PULSESCOPES
RAKSCOPES

And Other Associated Equipment



WATERMAN PRODUCTS

SAVE WITH S.S. WHITE REMOTE CONTROL FLEXIBLE SHAFTS



THE PROBLEM

DEVELOPING A SENSITIVE 90° CONTROL

A manufacturer of analytical balances wanted to provide his equipment with a vernier slide control which could be operated outside the case in which the balance was housed. He found that he could do this by mounting a control knob on the side of the case, but by so doing the axis of the control knob would be at right angles to the vernier control shaft. The problem was how to make the necessary 90° turn with a coupling that would have minimum "backlash" and would still be easy to assemble. He found the answer in —

THE LOW-COST SOLUTION

AN S.S. WHITE REMOTE CONTROL FLEXIBLE SHAFT

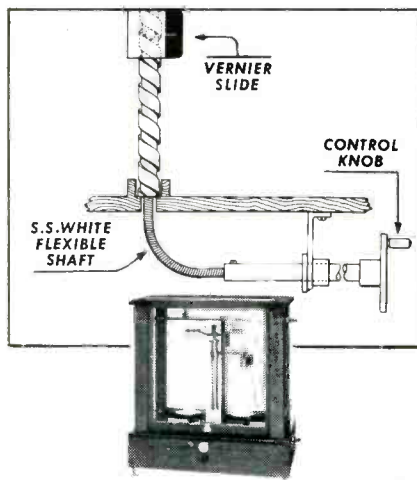

As shown by the drawing at the left a single, easily installed .130" diameter shaft was all that was needed. This shaft has negligible deflection characteristics and met all requirements of the application including sensitivity, simplicity and **low cost**. Why not discuss your remote control problems with S.S. White engineers. They can suggest many ways in which flexible shafts can be used to reduce costs and improve product design.

Send for the Flexible Shaft Handbook

It has full information on flexible shaft selection and application. A free copy will be sent if you write for it direct to us on your business letterhead.



THE S.S. White INDUSTRIAL DIVISION
DENTAL MFG. CO.



Dept. E, 10 East 40th St.
NEW YORK 16, N. Y.

Western District Office • Times Building, Long Beach, California

duty cycle, regulation is held to ± 0.1 percent for line variations from 150 to 125 v, and load variations from 0 to maximum output current ratings. Ripple and noise level is less than 1 mv; internal impedance, less than 0.4 ohm; recovery time for instantaneous application of full load from a no load condition, less than 8 milliseconds; and stability, guaranteed to within 0.5 percent per day. Operating range is 150 to 350 v d-c with a load of 0 to 150 ma maximum.

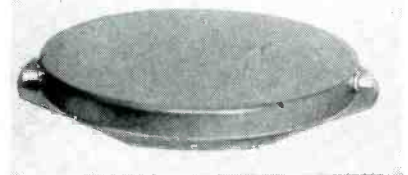

SOLID DELAY LINES utilize fused quartz

LABORATORY FOR ELECTRONICS, INC., 75 Pitts St., Boston 14, Mass., has announced that its new solid delay lines are now available for applications such as video integration, computers and time markers. These ultrasonic delay lines utilize fused quartz as a delay medium. A delay time of 1 to 3,000 μ sec can be provided with a high degree of accuracy. Frequency range specifications are from 5 to 100 mc. Spurious response is up to 60 db below desired signal. The delay lines are of minimum size and weight, and offer many advantages in obtaining precise delay intervals for pulse or modulated signals.

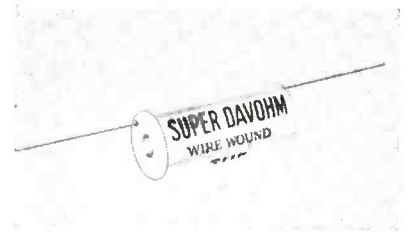

PRECISION RESISTOR is noninductively wound

THE DAVEN CO., 191 Central Ave., Newark, N. J., has developed the type 1119 precision wire-wound resistor especially for application where a high value of resistance is necessary in a very small resistor

size. The new resistor, although it measures only 21/64 in. diameter \times 25/32 in. long, is available in values up to 1,000,000 ohms. This unit is rated at 1/4 w and is noninductively wound. Standard resistance tolerance is ± 1.0 percent; however it can be supplied in accuracies to ± 0.05 percent. The unit is designed to withstand severe shock and vibration and will function satisfactorily under conditions of high humidity and extreme temperature changes.

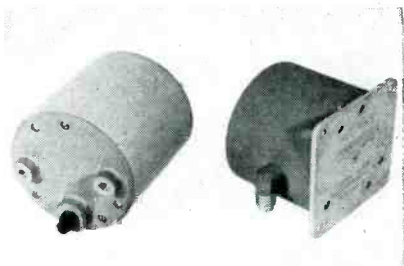

TRANSDUCERS
measure altitude, airspeed

RAHM INSTRUMENTS INC., 12 W Broadway, New York 7, N. Y., has available a series of potentiometer transducers for the measurement of altitude, rate-of-climb and airspeed, in which the brush of a precision potentiometer is actuated by a change in pressure to produce an output linear with altitude, rate-of-climb or airspeed. Indicators of the ratio type are available as monitors. The altitude transducer series covers the ranges from 0 to 70,000 ft; linearities of $+0.5$ percent over full range are standard. The airspeed transducer series in the 50 to 700 mph range exhibiting ± 0.75 -percent linearity and 0.25-percent resolution over full range are standard.

C-R OSCILLOSCOPE
for tv alignment

THE HICKOK ELECTRICAL INSTRUMENT Co., 10514 Dupont Ave., Cleveland 8, Ohio. Model 665 is a 5-in. cro with a frequency range from 0.5 cycle to 700 kc, down 3 db. It has excellent stability, no drift, less than 1-percent tilt, and less than 2-percent overshoot. The accelerating potential is 1,775 v and power consumption is 35 w. Square

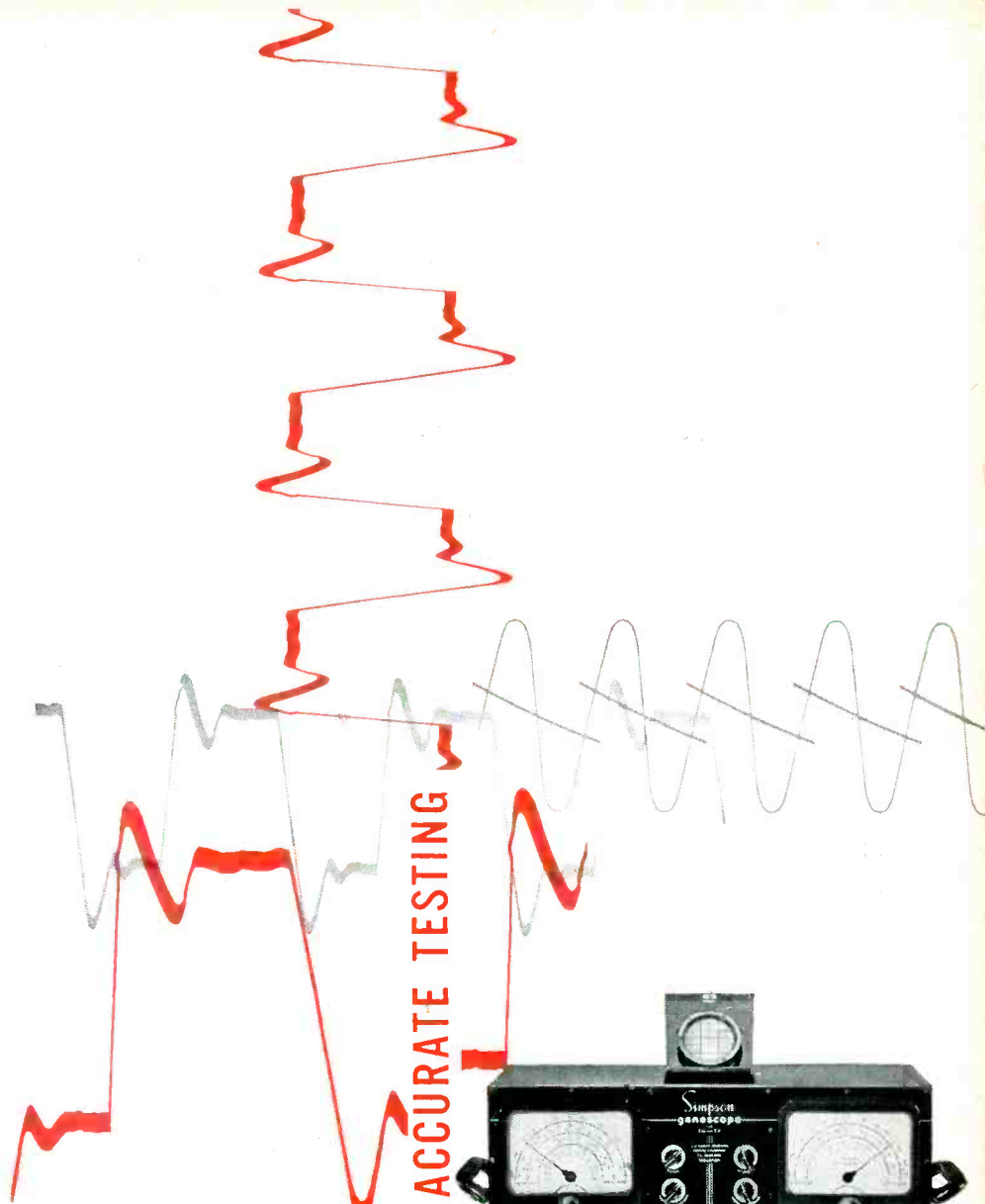

SIMPSON MODEL 480 GENESCOPE FOR ACCURATE TESTING

approved by
service managers of:

- admiral*
- zenith*
- motorola*
- emerson*
- hoffman*
- hallicrafters*

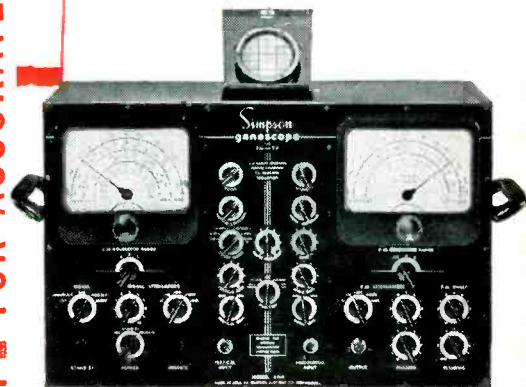

- All the necessary signal sources for alignment of FM and TV receivers • Includes the Simpson High Sensitivity Oscilloscope and high frequency crystal probe for signal tracing • Independent, continuously variable attenuators and step attenuators for both AM and FM units offer complete control of output at all times • 0-15 megacycle sweep is provided by a noiseless specially designed sweep motor based on D'Arsonval meter movement principles • The exclusive Simpson output cable (illustrated) includes a variable termination network, quickly adapted to provide open, 75 or 300 ohm terminations —the addition of a pad provides attenuation and isolation. Use of appropriate resistors across certain terminals will provide any other termination required. A .002 MFD blocking condenser can be added on any termination for use on circuits containing a DC component • The FM generator output voltage is constant within .2 DB per MC of sweep.

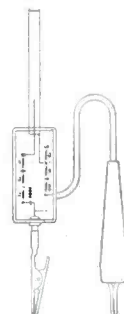

dealer's net \$475.00

TIE-TALKS

FEATURE

ANALOG COMPUTATION *with* TIE PRECISION POTENTIOMETERS

The type RVP3-S121 solves the following mathematical equation:

$$\frac{E_o}{E_{in}} = \left(\frac{\theta}{180}\right)^2 \quad -180^\circ \leq \theta \leq +180^\circ$$

SPECIFICATIONS

- Total resistance: 2500 ± 5%
- Conformity to function: ± 0.25% E_{in}
- Function Angle: ± 180°
- Mechanical Rotation: 360°
- Dissipation: 2 watts at 25°C.
- Life: 1,000,000 cycles
- Diameter: 3"

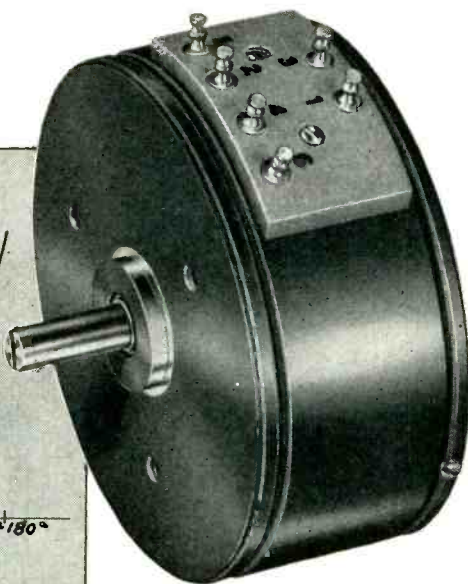
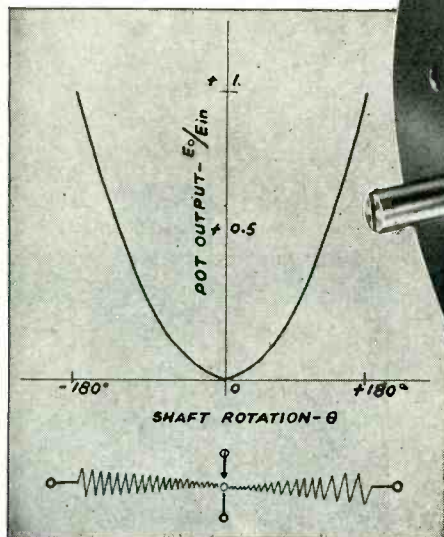

Your analog computations in control processes, computers, servomechanisms, and telemetering may likewise be solved by Technology Instrument Corporation precision potentiometers, with ease, economy and extreme accuracy. Precision non-linear potentiometers may be designed to meet your requirements from either implicit functions or empirical data. Submit your problem today for our analysis and recommendations.

A complete line of standard sizes is available, ranging from 7" to 1/2" in diameter. Greatly expanded facilities plus mass production techniques will meet your volume needs yet maintain precision tolerances in both linear and non-linear potentiometers. Write for catalog for complete information.

Engineering Representatives

Cleveland, Ohio — Prospect 1-6171
Chicago, Ill. — Uptown 8-1141
Rochester, N. Y. — Monroe 3143
Canaan, Conn. — Canaan 649
Dayton, Ohio — Michigan 8721
Baltimore, Md. — Plaza 7694

Arnprior, Ont., Can. — Arnprior 400
New York, N. Y. — Murray Hill 8-5858
Cambridge, Mass. — Eliot 4-1751
Hollywood, Cal. — Hollywood 9-6305
Dallas, Texas — Dixon 9918
Binghamton, N.Y. — Binghamton 3-1511

TECHNOLOGY INSTRUMENT CORP.

535 Main Street, Acton, Massachusetts, Phone Acton 3-7711

NEW PRODUCTS

(continued)

wave response is flat from 60 cps to 100 kc. A dual fuse is provided so that the B-plus line is entirely fused. The scope withstands shock, vibration and humidity, and has been designed with push-pull amplifiers with a vertical sensitivity of 0.020 mv per in. Horizontal sensitivity is 0.030 mv per in. Vertical input impedance is 15 μf, 2.2 megohms; horizontal impedance, 52 μf, 0.1 megohm.

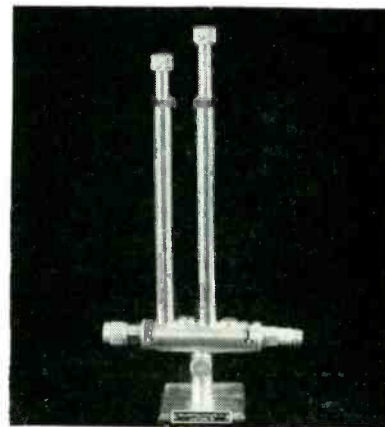

DOUBLE STUB TUNER for coaxial lines

WEINSCHEL ENGINEERING & MFG. CORP., 10513 Metropolitan Ave., Kensington, Md. Model DS-109 coaxial double stub tuner is designed to match a wide range of impedances to a transmission line. This is done by adjusting the tuning elements to provide a variable shunt susceptance across the line. The unit comes with one male and one female type-N connector. The stand can be adjusted for use on lines from 2 1/8 in. to 3 1/4 in. in height. The stubs have a travel length of 5 1/8 in. giving the unit a frequency range of 1 to 10 kmc. The stubs have adjustable stops which can be locked for operation at a fixed frequency with a fixed load. A 1/4-in. Allen wrench for a No. 8 screw is enclosed to lock adjustable stops.

ACCELEROMETERS are potentiometer type

RAHM INSTRUMENTS INC., 12 W. Broadway, New York 7, N. Y. A line of linear acceleration transducers are potentiometer type in-

struments in which the brush of a precision potentiometer is actuated in response to linear acceleration. Special emphasis is placed on a number of low response instruments in the ± 1 g to ± 5 g range. Damping of all the instruments in this series is accomplished by means of an encapsulated fluid system. All units are 2.5 in. in diameter and between $3\frac{1}{4}$ in. and $3\frac{1}{2}$ in. in length and weigh $1\frac{1}{2}$ to 3 lb.



MICROPHONE SWIVEL
for desk or floor stand

ATLAS SOUND CORP., 1451 39th St., Brooklyn 18, N. Y. Model SW-1 Gyromatic swivel offers a great many applications in microphone positioning due to its ability to adjust to any angle with any microphone. It swivels through 360 deg and can be used on any desk stand or floor stand. It locks safely in any position by a turn of the locking knob. Length is $4\frac{1}{2}$ in. Male and female threads are $\frac{5}{8}$ -27.

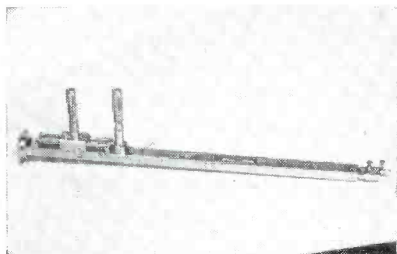

VSWR CALIBRATORS
for 8,500-9,600 mc range

TECHNICRAFT LABORATORIES, INC., Thomaston-Waterbury Road, Thomaston, Conn., has developed and



Technology Instrument Corp. Presents a
Compactly-Built Wide-Band Decade Amplifier

Featured by its wide band response, high input impedance, low output impedance, and compact dimensions, TIC's Type 500-A wide band decade amplifier is excellent as a general purpose laboratory instrument. Here is an instrument for special applications requiring a zero phase shift and high stability of gain. TIC increases the general utility of this amplifier by including a self-contained power supply and cabinet or rack mounting.



SPECIFICATIONS:

Amplification: 10, 100 and 1000 times, selected by 3-position rotary switch.
Frequency Response: Flat to $\pm .5$ db from 5 cycles to 2 mc on gain of 10; Flat to $\pm .5$ db from 5 cycles to 1.5 mc on gain of 100; Flat to $\pm .8$ db from 5 cycles to 1 mc on gain of 1000.

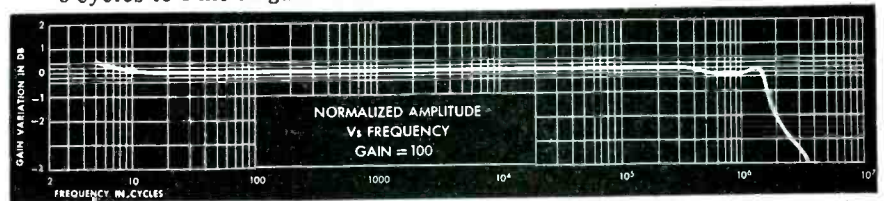

Amplification Accuracy: $\pm 2\%$ of nominal — dependent on precision resistors only; Unaffected by normal tube characteristics or line variations.

Phase Shift on All Ranges: 0 to $\pm 2^\circ$ from 20 cycles through 100 kc
Gain Stability on All Ranges: Constant with line voltages of 105 to 124 volts.
Noise and Hum: 60 db below maximum output voltage with input shorted.
Input Impedance: Approximately 160 megohms shunted by $7\mu\text{f}$.

Output Impedance: Approximately 200 ohms.
Output Voltage on All Ranges: 20 volts maximum output across a load of 20 k Ω or greater.

Power Supply: 105-125 volts, 50-60 cycles self-contained power supply requiring approx. 30 watts. (230 volt, 50-60 cycles models available).

Mounting Dimensions: Single, in cabinet: $13\frac{1}{4}$ " wide x 5" high x $9\frac{3}{8}$ " deep. ($11\frac{1}{4}$ " x $3\frac{1}{2}$ " panel) Single, for rack: 19" wide x $3\frac{1}{2}$ " high x $8\frac{1}{2}$ " deep.

The low distortion is a feature much desired in amplifiers of this type.

Further information and details gladly sent upon request.

Engineering Representatives

- Chicago, Ill — UPTown 8-1141
- Cleveland, Ohio — PROspect 1-6171
- Waltham, Mass. — WALtham 5-6900
- Rochester, N. Y. — MONroe 3143
- Dayton, Ohio — MICHigan-8721
- Arnprior, Ont., Can. — ARnprior 400
- Hollywood, Cal. — HOLlywood 9-6305
- Dallas, Texas — DIXon 9918
- Roseland, New Jersey — CALdwell 6-4545
- Wyncote, Pa. — Oqontz 8805
- Silver Spring, Md. — SLIgo 7-550

TECHNOLOGY INSTRUMENT CORP.

535 Main Street, Acton, Massachusetts, Tel. ACTon 3-7711

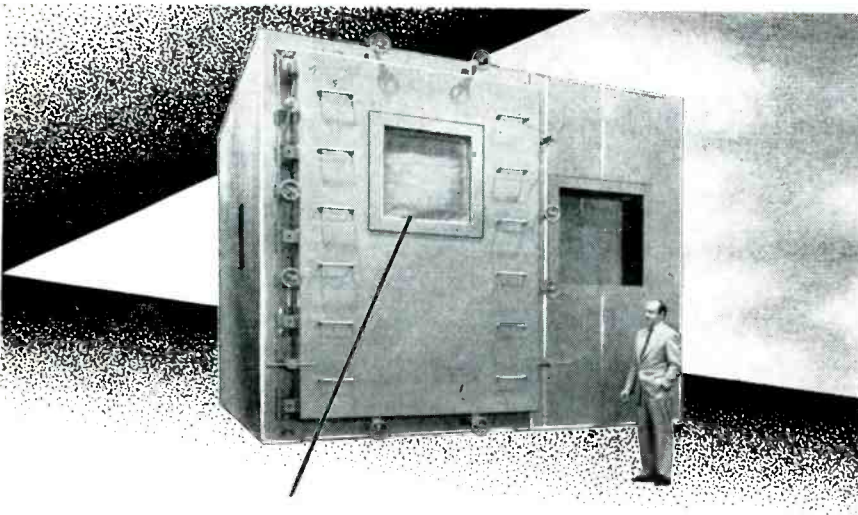

"EXTRAS" ARE STANDARD WITH BOWSER

Bowser test chambers have the engineered "extras" as standard equipment. Bowser engineers have designed their units with your needs in mind.

Consider, for example, lights in the Bowser high altitude chamber shown above. They are swivel type for convenient operation . . . vapor proof and recessed in stainless steel to permit full utilization of test area.

Performance characteristics of this Bowser chamber include:

- Temperature range from -100°F to 185°F .
- Altitude simulation up to 85,000 feet.
- Evacuation rate of 5000 F.P.M.

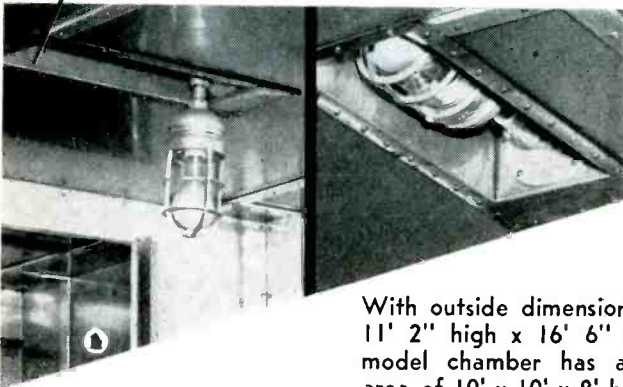

With outside dimensions of 13' 2" wide x 11' 2" high x 16' 6" long, this standard model chamber has an interior working area of 10' x 10' x 8' high. Door is 5' wide x 8' high, its window 30" x 30", and wall window 36" x 36".

Whatever your needs in environmental test chamber equipment . . . high altitude, humidity, sand and dust, explosion, non-magnetic, etc. . . . check with Bowser, the pioneer.



BOWSER TECHNICAL REFRIGERATION

DIVISION BOWSER, INC. TERRYVILLE CONNECTICUT

produced a new precision instrument for calibrating and checking waveguide vswr measuring equipment. Supplied calibrated for use over the frequency range of 8,500 to 9,600 mc, the device permits the operator to produce with microscopic accuracy known reflections and determine if the measuring equipment is giving true readings of vswr. Model C64G is currently available for use with test sets incorporating RG-52/U (WR-90) waveguide and, with the addition of a transformer, may also be used with RG-51/U (WR-112) waveguide.

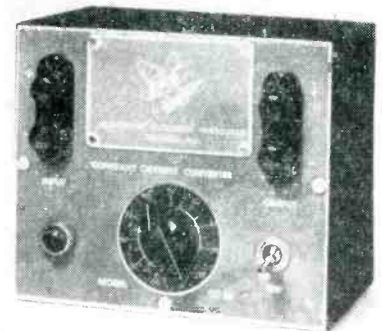

CONVERTER for transistor applications

ELECTRONIC RESEARCH ASSOCIATES, INC., Box 29, Caldwell, N. J., announces the model CC-60 constant-current converter. It is designed to convert a standard power supply into a constant-current generator for transistor and other applications where constant current is required. The converter is connected externally in series with the standard supply and no rewiring or other modifications are necessary. Substantially constant current is maintained independent of a wide range of load variation. Also, inverse current feedback is utilized which further increases the internal impedance and provides for long-term current stability. Input voltage to the unit can be fixed at any value in the 85 to 300-v range. Output constant current is continuously adjustable from 0 to 50 ma, the higher current being obtained at 300 v input. Current regulation is such that current variation is maintained within 2 percent for output voltage varia-

let **WILLIAMS**
help you apply

ferric oxides

to the manufacture
of your

FERRITES

You'll be well repaid by getting the facts on a special group of Pure Ferric Oxides, developed by Williams especially for use in the manufacture of ferrites.

Williams Ferric Oxides analyze better than 99% Fe_2O_3 . They contain a minimum of impurities. They are available in a broad range of particle sizes and shapes. Among them, we're certain you'll find one that's "just right" for your requirements. The proper application of Ferric Oxides to the manufacture of Ferrites is our specialty.

Tell us your requirements . . . we'll gladly send samples for test. Chances are good that our Ferric Oxide "Know How" can save you considerable time and money. Address Dept. 25, C. K. Williams & Co., Easton, Pa.

WILLIAMS
COLORS & PIGMENTS

C. K. WILLIAMS & CO.
Easton, Pa. • East St. Louis, Ill.
Emeryville, Cal.

P.S. We also produce IRN Magnetic Iron powders for the Electronic Core Industry, the Magnetic Tape Recording Industry and others. Write for complete technical information.

Want more information? Use post card on last page.

ELECTRONICS — October, 1953

NEW PRODUCTS

(continued)

tion, 0 to 150 v. The unit is housed in a 4 in. x 5 in. x 6 in. cabinet and weighs about 3 lb.



TRANSDUCER is altitude controller

RAHM INSTRUMENTS INC., 12 W. Broadway, New York 7, N. Y. The altitude controller illustrated is a potentiometer type transducer in which the brush of a precision potentiometer is actuated by a pressure difference. Equal pressure is maintained on each side of the pressure sensitive diaphragm until a solenoid valve is closed entrapping a fixed reference pressure on one side of the diaphragm. The instrument then responds to and indicates differential changes from the reference pressure. Specifications and installation drawings are given in bulletin 653-6 now available.

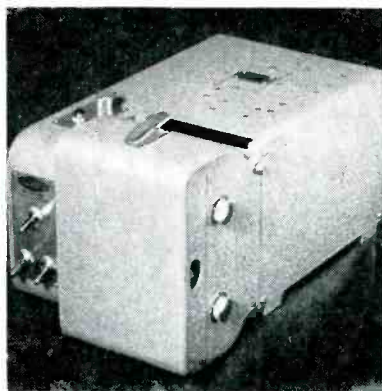

OSCILLOGRAPH for flight testing

MIDWESTERN GEOPHYSICAL LABORATORY, 3401 South Harvard, Tulsa, Oklahoma. Model 580 oscillograph was designed for dependable operation as a flight-test instrument, although it is equally useful in

NEW...

MICRODUAL TWO-SPEED PRECISION DRIVE

(Patents U.K.,
U.S., etc.)

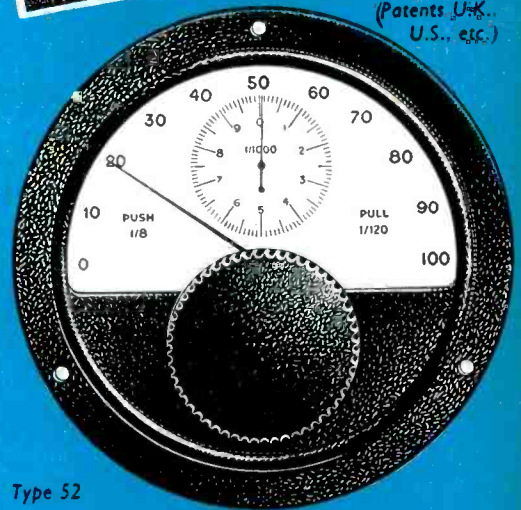

Type 52

TWO SPEEDS • SINGLE CONTROL FREE OF BACKLASH

- Accuracy of scale reading 100%
- Coarse searching speed plus fine setting control.
- Single control knob displaced axially to select the speed ratio,
- Spring-loaded gears with automatic take-up of any wear or play between primary and secondary drives.
- Pointers geared directly to centre spindle.
- Security in operation: friction clutch obviates overdriving.

TYPE No.	NUMBER OF DIAL MARKINGS	EFFECTIVE SCALE LENGTH	SPEED RATIOS	
			COARSE	FINE
52	1,000	3.3 feet	1 : 8	1 : 120
53	1,000	3.3 feet	1 : 8	1 : 120
57	2,000	6.6 feet	1 : 15	1 : 200
56	2,000	6.6 feet	1 : 15	1 : 200
53	2,000	6.6 feet	1 : 15	1 : 200

We are specially organized to handle direct enquiries and orders from U.S.A.

Billed in dollars. Settlement by your check.

CABLE OR AIRMAIL TO-DAY

TRANSRADIO LTD

CONTRACTORS TO H.M. GOVERNMENT
138A CROMWELL ROAD, LONDON, S.W.7., ENGLAND
CABLES — TRANSRAD, LONDON

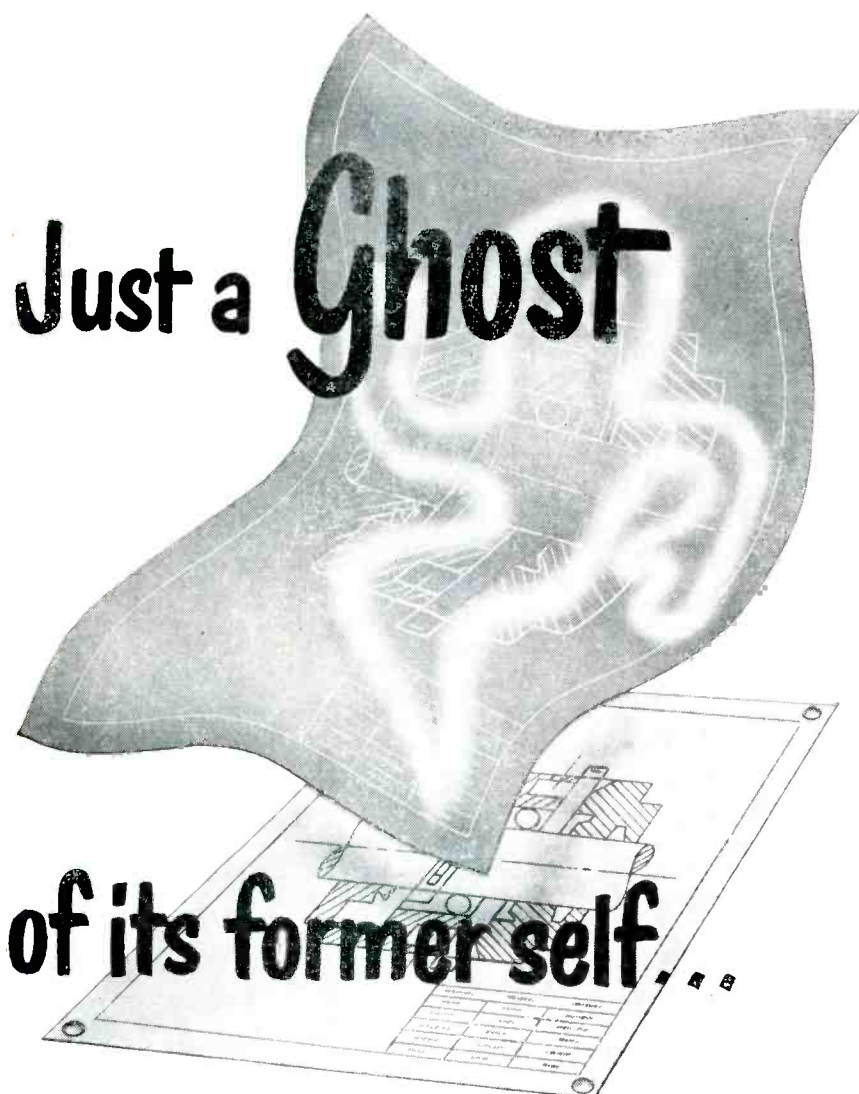

Just a Ghost
of its former self

You have to expect some erasures here and there on your drawings. But watch out! When those drawings get to the blueprint stage, lines can become weak and washed out . . . just *ghosts* of their former selves.

That's why Arkwright Tracing Cloth is preferred by so many architects, engineers and draftsmen. Arkwright is especially treated to take all the erasing you'll normally ever give it . . . and still provide good, clear blueprints.

Arkwright supplies a perfect working surface . . . free of heavy threads, pinholes and other imperfections. And Arkwright defies old age, too. Edges never get ragged; drawings never turn yellow or brittle. They retain their transparency, year after year — giving you the permanency you want.

Here's a fair offer. At our expense, accept a free sample of Arkwright Tracing Cloth. Work with it. See if you don't agree that Arkwright has well-earned the title "America's Standard". Arkwright Finishing Co., Industrial Trust Building, Providence, R. I.

ARKWRIGHT
Tracing Cloths

AMERICA'S STANDARD FOR OVER 32 YEARS



other field and lab applications. Among its more important features are: (1) 14 channels of separate data; (2) rigid cast aluminum alloy construction; (3) full-width timing lines at 0.01 sec with ± 0.1 sec lines accentuated or 0.1 sec lines only; (4) shutter-type g proof precision timer; (5) trace identification (beam-interrupter type); and (6) record numbering. The oscillograph speeds may be varied through a wide range by a positive gear drive. The company offers a wide variety of precision galvanometers for use in this oscillograph which have undamped natural frequencies up to 3,500 cps.

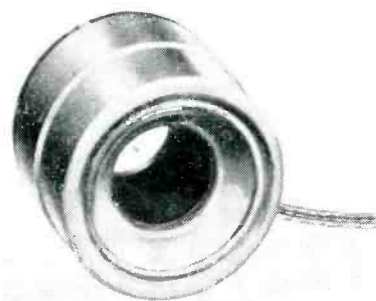

TESTING YOKE eliminates down time

SYNTRONIC INSTRUMENTS, INC., 100 Industrial Road, Addison, Ill. Costly down time is completely eliminated in testing c-r tubes with the new magnetic deflection yoke now available. From 150,000 to 250,000 tubes may be continuously tested without yoke damage or failure. Three types, identical except in deflection angle, are available. Type Y29 has a deflection angle up to 50 deg, type Y29-2 up to 70 deg and type Y29-4 up to 90 deg. The three types are available in 8.5-mh, 13.5-mh and 24-mh horizontal impedances, and in 3-mh, 40-mh and 60-mh vertical impedances in any combination. Any $1\frac{1}{2}$ in. neck diameter c-r tube may be tested.

Literature

Relays and TV Deflection Yokes. Davis Electric Co., 230 N. Spring St., Cape Girardeau, Mo. An illustrated catalog of Decohm products

is now available. The 8½ x 11-in. booklet is printed in three colors and lists complete technical data regarding the various molded-coil type open relays, hermetically sealed cannister type relays and tv deflection yokes. Information is included on the operating characteristics, range and sensitivity of the devices.

Magnetic Deflection Yokes. Syn-
tronic Instruments, Inc., 100 In-
dustrial Rd., Addison, Ill. Three
new deflection yokes for military
and oscilloscope applications are
described in a new catalog page
now available. Type Y15-5 is illus-
trated. Complete technical infor-
mation is given, including dimen-
sional drawing, electrical and
mechanical data, and complete
tables of push-pull and single-
ended deflection coil data.

Servocalculator. Technology In-
strument Corp. 531 Main St.,
Acton, Mass. Laboratory Report
No. 7 features the theory and ap-
plication of the Servocalculator.
Derivation of Servocalculator
scale, as well as examples of basic
equation and its solution by the
device are explained. Accuracy
limitations are defined, with ex-
planatory reference to treatment
of functions with end resistance
and changes of slope sign.

Transducers. Rahm Instruments
Inc., 12 W. Broadway, New York 7,
N. Y. Catalog 653 details a num-
ber of types of potentiometer
transducers for the measurement
of pressure, altitude, airspeed and
acceleration. It gives an illus-
trated description, along with per-
formance data and environmental
data for each. The information
contained therein may be aug-
mented by a request for detailed
specifications covering any instru-
ment of the general types outlined.

Shop Equipment. The Industrial
Bench & Equipment Mfg. Co., 98
South St., New Britain, Conn., has
issued catalog No. 653 describing
its steel shop equipment. The
catalog features many new items
in laminated wood top benches,
smooth top steel benches, pressed
steel bench legs, steel bench
drawers, all steel work stands, all

PRECISION *Servo* *Systems* AND COMPONENTS

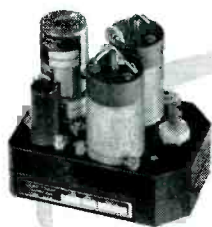

MOTOR-DRIVEN
INDUCTION GENERATOR
GEAR TRAIN & SYNCHRO
COMBINATIONS

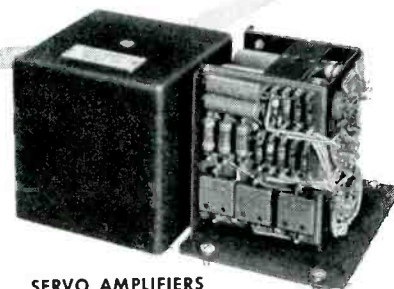

SERVO AMPLIFIERS

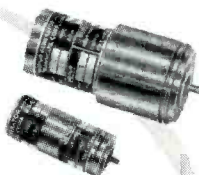

MOTOR-DRIVEN
INDUCTION GENERATORS

PLUG-IN ASSEMBLIES OF
CONTROL MOTOR, GEAR
TRAIN, POTENTIOMETER &
SYNCHRO

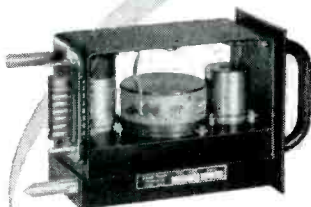

Transicoil servo systems feature integrated design—every component is made to match all the others . . . coordinated to insure maximum efficiency and top performance.

For systems of your own design, Transicoil can supply precision components designed to meet your requirements . . . their effectiveness limited only by the restrictions you impose.

Complete data will be sent on request.

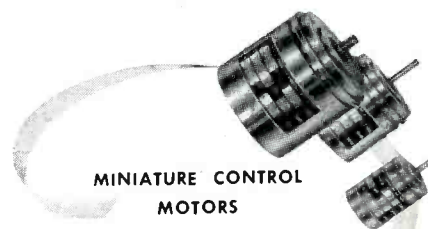

MINIATURE CONTROL
MOTORS

TRANSICOIL CORPORATION

107 Grand Street
New York 13, N. Y.

Engineering-Sales Representatives In:

Boston, Mass. • Buffalo, N. Y. • Chicago, Ill. • Cleveland, Ohio • Dallas, Tex.
Kansas City, Mo. • Los Angeles, Calif. • Minneapolis, Minn. • Netcong, N. J.
Philadelphia, Pa. • Phoenix, Ariz. • San Francisco, Calif. • Seattle, Wash.
Syracuse, N. Y. • Washington, D. C.

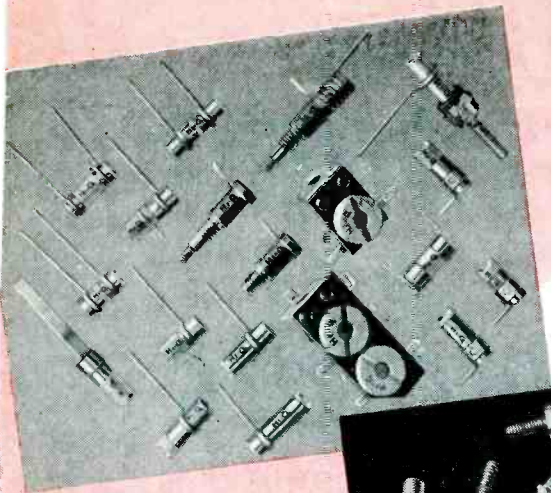

ceramic capacitors



FUNCTION FITTED

... to your needs

*Not mere ceramic capacitors but units engineered to your circuitry, associated components and operational conditions.

Hi-Q specialists are ready to collaborate with your engineers for the ideal application.



These trimmers, stand-off capacitors and resistor-capacitor combinations are typical of Hi-Q special components developed largely to meet special needs. They suggest what Hi-Q specialists can accomplish in designing and producing ceramic units for any and all purposes.

Capacitor elements in Hi-Q special components meet all requirements as established by RTMA for Class 2 ceramic dielectric capacitors specifically suited for by-pass and coupling applications, or for frequency discriminating circuits where Q and stability of capacitance are not of major importance. Where Class 1 capacitors are required, Hi-Q specialists are again ready to study your most rigid specifications.

HI-Q CERAMICS—WILKOR RESISTORS

Hi-Q[®] DIVISION

AEROVOX CORPORATION CLEAN, N. Y.

AEROVOX
CORPORATION
NEW BEDFORD, MASS.

ACME
ELECTRONICS INC.
PASADENA 4, CALIF.

In Canada: AEROVOX CANADA LTD., Hamilton, Ont. JOBBER ADDRESS: 740 Belleville Ave., New Bedford, Mass.
Export: 41 E. 42nd St., New York 17, N. Y. • Cable: AEROCAP, N. Y. •

NEW PRODUCTS

(continued)

steel machine stands, steel tote boxes, welding benches, bench parts and accessories. Construction, sizes, styles and other data are included.

Voltage and Current Standard. Radiation, Inc., Melbourne, Florida. A single-page bulletin illustrates and describes the type M-DC-2, super-regulated voltage and current standard. The instrument discussed is designed for general laboratory and production use, and replaces the potentiometer and its accessories, such as galvanometers, standard cells, power supplies and precision resistors. Complete technical specifications are included.

TV Film Accessory Equipment. Radio Corp. of America, Camden, N. J. Catalog B.375 covers a line of Neumade film accessories designed and selected to accommodate practically every editing and film handling need of tv broadcasters for 16-mm programming. The new equipment listed includes film splicers, rewinds, viewers, measuring machines, editing tables, storage cabinets, reels and other handy accessories.

"Dag" Dispersions for Industry. Acheson Colloids Co., A Division of Acheson Industries, Inc., Port Huron, Mich. A 4-page folder lists 37 products of its current "dag" dispersions for industry. The tabulated data gives information on dispersed substance, carrier, solids content, particle size, consistency, density, diluent agitation before use and typical applications. The pamphlet is available upon request.

Transformer Catalog. Chicago Standard Transformer Corp., Elston & Addison, Chicago 18, Ill. A new 24-page booklet carries complete electrical and physical specifications on almost 500 transformers for radio, tv, high fidelity, amateur, military and other electronic applications. There are 25 new units listed, including 13 tv components and 5 transistor transformers. The tv section has been increased to 4 pages, listing 129 tv components. The high-fidelity sec-

tion has been expanded to include the new miniature audio transformers and more detailed information on the Stancor-Williamson amplifier. A cross index chart between obsolete power transformers and the current 8400-series power transformers has been included.

Power-Line Carrier. Westinghouse Electric Corp., 2519 Wilkens Ave., Baltimore 3, Md. A 16-page booklet describes the new type FD power-line carrier equipment. The carrier assemblies most commonly used for such functions as relaying, telemetering, supervisory control, remote control, teletypewriter service and telephone service are described, with photographs of the assemblies. Such features of the equipment as crystal control, selectivity and sensitivity are discussed. Ask for booklet 84-000.

Electric Test Equipment. Industrial Instruments, Inc., 89 Commerce Road, Cedar Grove, N. J. Catalog No. 19A is a 12-page electric test equipment booklet now being offered by the company. A large selection of electric test instruments for both laboratory and production applications are listed along with full specifications on each. In addition to the instruments, necessary accessories and test jigs are listed and described.

Ceramic Products. Stupakoff Ceramic & Mfg. Co., Latrobe, Pa. Bulletin 653 is a 4-page brochure on the company's products for the world of electronics. Included are photographs and descriptive details on: glass-to-metal seals, steatite and other ceramics, printed circuits and ceramic-metal assemblies. A section also is devoted to a description of the characteristics of Kovar glass-sealing alloy.

Electrolytic Capacitors. Astron Corp., 255 Grant Ave., East Newark, N. J., has announced availability of its new catalog supplement, AC-3A, for its expanded line of twist-prong electrolytic capacitors. The new supplement provides complete listings of catalog numbers, capacitance and voltage ratings, case sizes and list prices of all

FUNCTION-FITTED*

Wave Filters



Type S-525: Band Pass 8 KC Filter . . .

Impedance: 600 ohms, in and out
 Insertion Loss: 2 db @ 8 KC
 Response: plus/minus 1.5 db 7700 cps to 8300 cps;
 minus 28 db or more @ 8750 cps and 7250 cps
 Effective Magnetic Shielding: (minimum) minus 40 db



Type S-528: Band Pass 32 KC Filter . . .

Impedance: 5000 ohms, in and out
 Insertion Loss: 1 db @ 32 KC
 Response: plus/minus 1 db 22 KC to 42 KC;
 minus 80 db or more @ 77 KC and 87 KC
 Phase Shift Difference between units does not exceed 0.5°.



Type S-531: Low Pass Filter . . .

Impedance: 6000 ohms; in and out
 Insertion Loss: 4 db @ 500 cps
 Response: minus 40 db or more @ 100 cps ref. to 500 cps
 minus 15 db or more @ 400 cps ref. to 500 cps
 minus 45 db or more @ 1000 cps ref. to 500 cps
 minus 55 db or more @ 1500 cps ref. to 500 cps
 Phase Shift: Change less than 5° from minus 55° C to plus 85° C,
 and 2° or less with change of input level from 2 volts to 4 volts.



Type S-921: High Pass 70 Cycle Filter . . .

Impedance: 0 to 1100 ohms input; 10,000 ohms output
 Insertion Loss: 0.3 db or less at 1 KC
 Response: 0.4 db or less @ 70 cps
 minus 20 db or more @ 40 cps
 minus 70 db or more @ 10 cps
 Response Characteristics: Maintained, with input impedance
 varying from 0 to 1100 ohms.



* FUNCTION-FITTED

Send us your filtering problems. Acme has a standard unit available or will develop and build a special unit, either way, function-fitted to your precise needs. Literature on request.

Specify "ACME". That means mobilizing a corps of specialists to work on your wave-filter problems and requirements. Two exceptionally-equipped laboratories are ready to develop all varieties of filter designs. Adequate production facilities can swing into action to meet any quantity and quality requirements. Depending on required frequencies, Acme can supply standard or miniaturized filters with either toroidal or laminated inductors for airborne radar, sonar, communications systems of all categories, and all other applications. Representative units shown herewith are typical of Acme's versatility and convenience to you.



AEROVOX CORPORATION
 PASADENA, CALIF.

Hi-Q® DIVISION
 OLEAN, N. Y.

AEROVOX CORPORATION
 NEW BEDFORD MASS.

In Canada: AEROVOX CANADA LTD., Hamilton, Ont. JOBBER ADDRESS: 740 Belleville Ave., New Bedford, Mass.
 Export: 41 E. 42nd St., New York 17, N. Y. • Cable: AEROCAP, N. Y. •

STACKED UP CALLS STEALING OPERATING EFFICIENCY?

Now you can solve your problem *economically* with RyCom CFD-B Packaged Units that add 4 additional voice channels to each of your present lines. RyCom Carrier Telephone Equipment *pays for itself* quickly by drastically reducing long distance telephone costs.

Check These RyCom Features:

- Built-in Measuring Panel—for fast over-all system line-ups, even by non-technical personnel. Eliminates need for expensive test equipment . . . testing trips up and down the line.
- Built-In Slope Control—to equalize non-conforming lines.
- Pilot Panel automatically regulates transmission during changing weather conditions.
- RyCom separate panel construction provides maximum accessibility for easy inspection and maintenance.
- Packaged in a single rack. Saves space, saves installation time. Shipped complete in one package ready for easy installation.

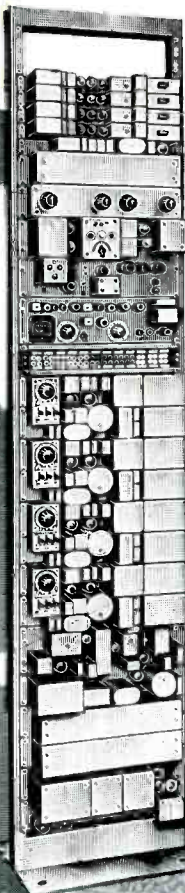

Immediate deliveries now being made.

RyCom engineers will be glad to discuss *your* particular installation needs. Write or phone today for complete details, specifications and prices.

**Rely on RyCom
for Highest Quality
at Minimum Cost**

RyCom
RAILWAY COMMUNICATIONS, INC.
Raytown, Missouri, U.S.A.
Phone FLEMing 2100

Export office: 13 East 45th St., New York 16, N. Y.

standard twist-prong capacitors to fulfill every radio and television replacement need.

Precision Potentiometers. The Gamewell Co., Newton Upper Falls 64, Mass. A new booklet describes the company's line of linear and nonlinear precision potentiometers. In addition to descriptions of standard products and condensed specifications, the booklet discusses windings available and contains a glossary of terms used by engineers working with potentiometers.

Magnetic Ferrites. Mullard Ltd., Century House, Shaftesbury Ave., London WC2, England, has issued a comprehensive source of reference on Ferroxcube magnetic ferrites. This 46-page publication should prove of considerable value to the equipment designer. It comprises five chapters. The first chapter gives an historical survey of magnetic ferrites followed by details of their physical structure. The second chapter deals with the electrical and magnetic properties of Ferroxcube. Subsequent chapters are devoted to the mechanical properties of the material, application data and standard core shapes and dimensions.

Electronic Control Equipment. Haledy Electronics Co., 57 William St., New York 5, N. Y., has available a new 4-page folder, No. 453, that describes and illustrates the use and application of controls for industrial and test equipment, featuring electronic counters, photoelectric equipment, relays, timers and liquid-level equipment.

Electronic Design & Production Facilities. Manson Laboratories, 207 Greenwich Ave., Stamford, Conn., have released an 8-page booklet describing their facilities devoted to special projects for the design and production of electronic and electromechanical instruments for laboratory and industrial use. A number of their products are illustrated, and pertinent data are given regarding their specifications and performance. Notable among the products described and illustrated are: regulated d-c power

supplies and h-f pulse and multiple-pulse generators with a wide variety of characteristics; transmitting-tube checkers and modulators for testing magnetrons, pulse and microwave components at all power levels up to 40 megawatts peak power; and test equipment for the wire and cable industry.

Fiber Glass Yarns. Libbey-Owens-Ford Glass Co., Toledo 3, Ohio, has announced a new folder giving technical data on fiber glass yarns for electrical insulation. Tensile strength of the yarns described (250,000 lb per sq in.) permits tight, fast wire covering and coil taping even at extremely high operating temperatures. The folder contains complete information on standard packaging yarn specifications, and data on thermal conductivity, heat and acid resistance, moisture absorption, insulation resistance, dielectric strength, and cites numerous specific applications.

Transistor Bulletins. Electronic Research Associates, Inc., P.O. Box 29, Caldwell, N. J., offers a new bulletin on available types of transistors, manufacturers and other supplementary data. Also available is a several-page bulletin on the model TT-11 transistor tester. Data are also available on the model CC-60 constant current converter and the model-110 transistor power supply.

Electronic Load Weighing. Baldwin-Lima-Hamilton Corp., Philadelphia 42, Pa. How to weigh the contents of tanks, bins and hoppers electronically with type SR-4 load cells is explained in bulletin 4106, a new 8-page, illustrated brochure. The bulletin covers installation design considerations, such as mountings, temperature effects and vibrations; indicating and recording instruments; weighing accuracy; and the company's engineering services. A questionnaire designed to provide the data needed in specifying proper SR-4 weighing equipment is included.

Design Engineering. Designers for Industry, Inc., 2915 Detroit Ave., Cleveland 13, Ohio, has pub-

EACH CORE SHOWN BELOW IS PHOTOGRAPHED THREE TIMES ACTUAL SIZE TO SHOW DETAIL



We make powdered iron cores for all miniature applications

Our design engineers have an impressive record of success in developing new miniature types of cores for highly specialized applications, and are ready to take on your toughest problem jobs. Our engineering consultant service is yours without cost.

Pyroferic works to closest electrical and mechanical tolerances, on newly-developed pilot models and quantity production runs. You are assured of uniformity, strict quality control and rigid conformity to specifications.

Pyroferic makes iron cores in a complete size range from the smallest to the largest, for all applications. M. P. A. data sheets and tables give complete information including recommended sizes and tolerances as well as a cross-reference index of manufacturers' material designations.



PYROFERRIC
 PYROFERRIC BLDG. | BRONX BOULEVARD
 at 216th St., N.Y.C. 67

Please send me M.P.A. data sheets and tables No. 305.

Write on your letterhead for latest Catalog No. 230

NAME _____ TITLE _____
 FIRM _____
 ADDRESS _____ CITY _____ STATE _____

Want more information? Use post card on last page.

FILTERS

when you choose them, don't overlook the thinking behind them.

To the coils and capacitors that normally comprise a filter, Lenkurt adds something extra — **specialized engineering experience**. This means consistent laboratory quality even in mass production quantities. And in filter design problems, Lenkurt offers sound background experience combined with a fresh creative approach.

An excellent example is furnished by a recent filter miniaturization problem. A 140 kc low-pass filter was required to isolate signals up to 140 kc from others over 164 kc. Lenkurt engineers succeeded in reducing it to 1/10th the normal size for such a filter. Subminiature toroids were used and a series-derived network eliminated many capacitors.

For its performance see the accompanying graph.

Lenkurt can serve both your routine filter requirements and your special needs. Write today for further information.

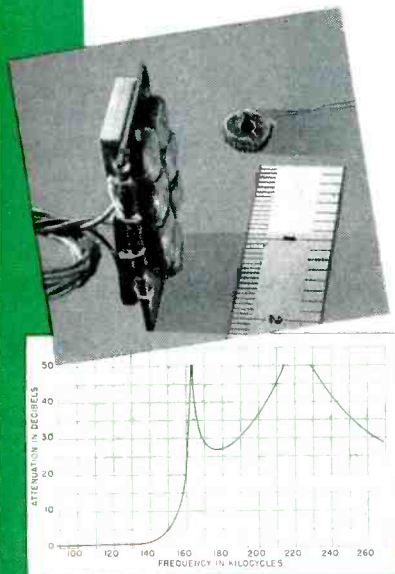

Photo shows a miniaturized filter — an example of Lenkurt engineering development.

Performance chart of the Lenkurt miniaturized filter (described in the text).

lished a 4-page folder that describes the importance of designing industrial products for both function and appearance in meeting required standards of performance, size, weight and cost. It includes all the steps involved in design engineering, from preliminary design through the building and testing of prototypes. Three typical products are pictured with descriptions of design features, plus a partial listing of over 70 designed and commercially developed products.

Measurement Instruments. Brush Electronics Co., 3405 Perkins Ave., Cleveland 14, Ohio. "Instruments for Modern Measurements" is the title of a new 34-page book published in two colors. It illustrates and describes over 37 different instruments, especially engineered and produced for: electrical measurements, physical measurements, resistance-welding measurements, textile measurements, ultrasonic energy applications and electro-acoustical measurements. The booklet will be of special interest to research engineers, methods and production engineers, factory superintendents and other production and research executives.

Plastic Components. Tri-Point Mfg. & Development Co., 401 Grand St., Brooklyn 11, N. Y., offers a new 4-page brochure describing and illustrating the company's various types of plastic components. Plastics such as Teflon, Kel-F, Nylon, Formica, Rexolite, polystyrene, polyethylene and laminated phenolics are covered. The brochure tells how tolerances of 0.001 are held on production runs on components made in standard sizes or to specification.

Picture Tube Substitution. CBS-Hytron, Division of Columbia Broadcasting System, Inc., Danvers, Mass., has compiled a time-saving substitution chart for tv picture tubes. The chart includes all electromagnetically deflected tubes, regardless of make. An index leads to the proper substitution group listing all readily interchangeable types, and from this

Lenkurt

LENKURT ELECTRIC SALES CO.
SAN CARLOS, CALIFORNIA

group one can pick an available type with the least number of necessary service adjustments. Outline and basing diagrams are included.

Amplifier Instruction Sheet. Standard Transformer Corp., 3580 Elston Ave., Chicago 18, Ill. A revised edition of the Stancor Williamson amplifier instruction sheet has been issued. It is complete with performance curves, schematic, parts list, chassis layout and diagrams. The sheet notes that the excellent frequency-response curve recorded at the 8-watt level remains unchanged at the low level of 0.5 w, a factor frequently overlooked in amplifier evaluation. It points out that intermodulation distortion measures only 3 percent at 8-w output, and total harmonic distortion at 1,000 cycles is extremely low and may be considered nonexistent below the 10-w power level.

Mica Review. Mica Fabricators Association, 420 Lexington Ave., New York 17, N. Y., has published the first issue of the Mica Review. It is the intention of the members of the M.F.A. to include in the Review practical information for purchasing agents, engineers, and all those who handle the mineral mica. The Review will be concerned with only the two major types of mica—Muscovite and Phlogopite. The first issue discusses sources of supply, size, thickness and quality.

Taper Technique. Aircraft-Marine Products Inc., 2100 Paxton St., Harrisburg, Pa. An 8-page fully illustrated folder deals with new electronic uses for an old principle of mechanics. It covers a line of self-locking taper terminals that combine miniature size with remarkable electrical characteristics. Included are development information, test results, applications, specifications and catalog numbers for taper pins and taper tab receptacles.

Meter Calibrator. Kalbfell Laboratories, Inc., 1090 Morena Blvd., San Diego 10, Calif. A recent mailing piece illustrates and describes a meter calibrator that produces an absolutely calibrated d-c voltage,

TAKING THE SHACKLES OFF MICROWAVE

Until a few years ago, full utilization of microwave communications was hampered by the lack of multiplexing equipment which provided necessary transmission quality and flexibility of arrangements. Lenkurt helped remove these "shackles" by providing multiplex equipment for radio using frequency division techniques to achieve the desired objectives.

Frequency division multiplexing, highly developed for wire-line and cable telephone carrier equipment, has many advantages for microwave systems. With each channel occupying a separate portion of the frequency spectrum, individual channels or groups of channels can easily be dropped out at repeater points and terminated or arranged for party-line operation. Total frequency spectrum is conserved because groups of channels can be transmitted with much less r-f bandwidth than is required for other multiplexing methods.

Radio channelizing equipment by Lenkurt, leading independent manufacturer of telephone carrier systems, provides from 4 to 72 toll-quality voice channels over a single radio transmission path. It is widely used with the VHF and microwave equipment of major radio manufacturers.



LENKURT

LENKURT ELECTRIC CO.
SAN CARLOS 1, CALIFORNIA

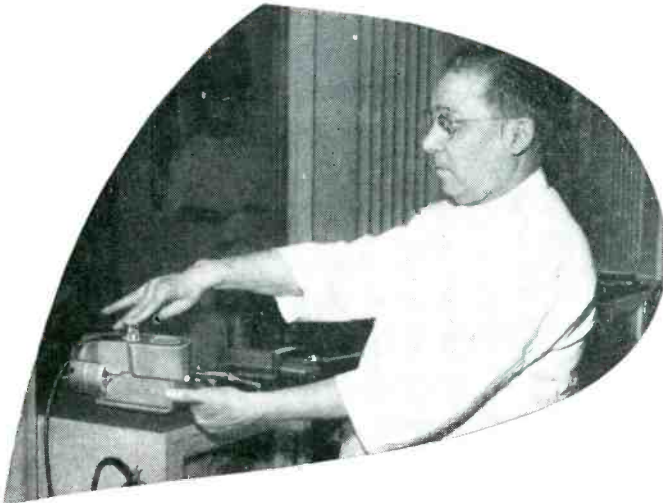

How a HONEYWELL Mercury Switch contributes to your barber shop shave

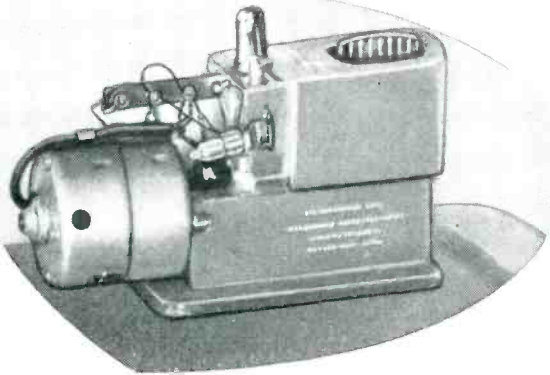

Lather that oozes into your barber's hand from his counter dispenser, does so because of the action of a **HONEYWELL MERCURY SWITCH**.

Depressing the plunger on the top of this dispenser, made by Campbell Products Company, tilts a mercury switch. This starts the motor and a plastic worm screw forces the lather from the device.

Honeywell Mercury Switches meet the special demands of this equipment because the glass-enclosed contacts are unaffected by the moist environment in which the switch must operate. The tiny switch fits easily into the streamlined design.

There is a Honeywell Mercury Switch to meet the requirements of every type of application where tilt motion can be supplied and where conditions indicate a mercury switch as the proper switch unit. MICRO field engineers, experienced in every type of switch problem, are available to help you select the proper switch to meet your needs. Write or call the nearest MICRO branch office:

MICRO A DIVISION OF
MAKERS OF PRECISION SWITCHES MINNEAPOLIS-HONEYWELL REGULATOR COMPANY
FREEPORT, ILLINOIS



independent of input line voltage and output load variations. Included are an illustration, wiring diagram and complete technical specifications. The company invites you to write for a bulletin on this unit, as well as such other precision electronic instruments as a decade amplifier, Micro-Miker, super regulator and absolute d-c power supplies.

Instrumentation for Industry. Beckman Instruments, Inc., South Pasadena 1, Calif. The growing importance of instrumentation to nearly every modern industry, large or small, is dramatized by actual case histories appearing in the latest "Beckman Bulletin", a house organ. An instrument for analyzing flame color, for instance, enabled American Potash and Chemical Corp. to cut control time on its main product—potassium chloride—by a factor of eight. Another article summarizes the advantages found by a brewery in using a spectrophotometer for routine color control of beer. To find out about other applications ask for bulletin BB-11-59.

Engineering Reports. Polytechnic Research & Development Co., Inc., 202 Tillary St., Brooklyn 1, N. Y., has available a line of reports published quarterly designed for engineers, scientists and interested persons in industrial or educational organizations. The bulletins cover such subjects as frequency measurement devices, noise figure and some measurement aspects, microwave power measurements, metalized glass microwave attenuators, ridged waveguide, and a wideband sweep generator for both uhf and uhf tv. The bulletins are completely illustrated and give technical specifications. Write to the company and get your name on the mailing list.

Feed-Through Bushings. Thor Ceramics, Inc., 225 Belleville Ave., Bloomfield, N. J. A complete line of standard Steatite miniature feed-through bushings for efficient low and high-frequency equipment is illustrated and fully described in catalog bulletin No. 153. Complete

with full engineering data, specifications and dimensional drawings, it covers the company's standard miniature feed-through bushings, made to conform to government and commercial specifications.

Tower Lighting. Crouse-Hinds Co., Syracuse 10, N. Y., has issued booklet 381-F, a 20-page publication entitled "Tower Lighting", that describes methods and materials necessary for installing obstruction lighting equipment on radio, tv and microwave relay towers. It includes layout drawings with complete bills of material for lighting towers of all heights. All information meets the requirements of the FCC and CAA. For example, a complete line of alarm relay equipment is available for remote indication of lamp failure as required by the FCC for unattended stations.

Tower Bulletin. Blaw-Knox Co., Farmers Bank Building, Pittsburgh 22, Pa., has published a 20-page bulletin, No. 2417, describing its a-m, f-m, tv, microwave, communications and radar towers. Various types of guyed and self-supporting towers are described. A photograph of the company's testing frame is shown. By use of this frame, any combination of loads representing wind and antenna load can be applied to a tower. Actual deflection and twist can be measured and tower tested to destruction if desired. The RETMA standard specifications are given in the bulletin.

Ground Station Receiver. Collins Radio Co., Cedar Rapids, Iowa, has issued a 2-page bulletin dealing with the 51N-2 ground station receiver, a unit that is engineered for unattended continuous airline duty and other applications calling for A1, A2 and A3 reception at any one frequency within the range of 2 to 24 mc. Included are illustrations, a complete description, technical specifications and information on operating conditions.

Frequency Meter. Nassau Research & Development Associates Inc., 66 Main St., Mineola, N. Y. A one-page brochure illustrates and

VICTOREEN'S VOLTAGE REGULATOR TUBES

Cover the Range from
50 Volts to 20,000 Volts.

A single voltage regulator tube may readily replace a complex and expensive regulating circuit. Investigate the advantages of a reliable, long-life Victoreen tube • for voltage regulation of power supplies • as voltage reference for control of higher currents • for voltage limiting to prevent circuit overloading • in voltage adjustment for fine control of precision power supplies. A single VR tube is space saving, too.

HIGH VOLTAGE REGULATORS 5000 to 20,000 Volts		Maximum current 1000 μ a Regulation 1.5% per 250 μ a
HIGH VOLTAGE REGULATORS 3000 to 5000 Volts		Maximum Current 250 μ a Regulation 5-55 μ a is 1.5%
HIGH VOLTAGE REGULATORS 400 to 2500 Volts		Maximum Current 100 μ a Regulation 5-55 μ a is 1.5%
GLOW TUBES 57 Volts		Maximum Current 800 μ a Regulation 200-800 μ a is 3.0%
ADJUSTABLE REGULATORS 645 to 705 Volts		Maximum Current 55 μ a Regulation 5-55 μ a is 3%

DISTRIBUTORS

Allied Radio Corp., Chicago, Illinois
W. D. Brill Co., Oakland, California
Gifford-Brown, Des Moines, Iowa
Harrison Equipment Co., Houston, Texas
Industrial & Electronics Supply, Dallas, Texas
Radio Shack Corp., Boston, Massachusetts
Southeastern Radio Supply Co., Raleigh, No. Carolina
Terminal Radio Corp., New York City, New York
W. & W. Distributing Co., Memphis, Tennessee

WEST COAST REPRESENTATIVE

Carlton Engineering Co.
Los Angeles-San Francisco, California

EXPORT DISTRIBUTOR

Terminal Radio Corp., New York City, New York
Cable TERMRADIO

WRITE FOR FACTUAL DATA SHEETS ON THESE AS WELL AS
YOUR OTHER COMPONENT REQUIREMENTS



The Victoreen Instrument Co.

3800 PERKINS AVE. • CLEVELAND 14, OHIO

**LET ME
BRING YOU UP-TO-DATE
ON
"Lavite" FERRITE
COMPONENTS**

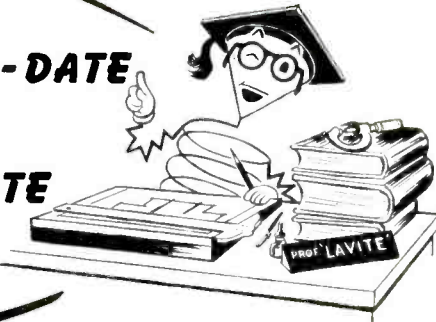

Let me first emphasize the essential difference between "Lavite" Ferrites and general Ferrites. When you use "Lavite" Ferrites, you first have all of the desirable basic advantages of this type of material. These advantages are many varieties in composition to better meet specific electrical properties that may be required as to high saturation, higher permeabilities, high Q and FM frequencies, low temperature coefficient, etc.

Ask for general characteristic data on all "Lavite" Technical Ceramics — ("Lavite" Stealite, "Lavite" Titanates, "Lavite" Ferrites, and others).



To this is added the plus value of:

1. Steward's private research and development,
2. Steward's modern and highly efficient facilities to produce your "Lavite" Ferrite components to greater accuracy in both material and size,
3. Interestingly low production costs of these parts, and
4. Prompt delivery.

And in addition to all this, you are invited to consult Steward engineers, without obligation, for scientific answers to your specific problems. Send me your specifications.

**D. M. STEWARD
MANUFACTURING CO.**

3604 Jerome Ave, Chattanooga, Tennessee,
Sales Offices in Principal Cities

describes the model 802 frequency meter designed for the 2,400 to 10,200-mc range. Accuracy of the unit discussed is 0.2 percent, and sensitivity is 10 mw to 5 w.

TV Transformer Replacement. Chicago Standard Transformer Corp., Addison and Elston, Chicago 18, Ill., has available the first edition of the 1953 Stancor tv transformer replacement guide. The 32-page reference book contains transformer replacement information on over 5,600 tv models and chassis. It covers 101 brands of tv sets, in alphabetical order, by model and chassis number. A special catalog section lists electrical and physical specifications on 125 Stancor tv replacement components.

Components and Products Catalog. Waldom Electronics, Inc., 911 North Larrabee St., Chicago 10, Ill. Catalog No. 5C3 lists more than 2,000 electronic components and Croname products. Included are tuner assemblies; mask, glass and escutcheon kits; title plates, dial and switch plates; knobs; instrument drives and dials; terminal lugs, cases and dial locks; terminal strips; pushbutton and control knobs; tv replacement items and accessories; sockets and shield bases and other components.

Titanium. Mallory-Sharon Titanium Corp., Niles, Ohio. A recent technical booklet, "Properties of Titanium and Titanium Alloys," provides current information on different production methods, general properties of various alloys, standard production classifications and testing procedures, and specific qualities of the five types of titanium and its alloys supplied by the company. Presently, titanium and its alloys are being used or considered as a replacement material for stainless steel and aluminum because of its high strength-to-weight ratio.

Locknuts and Collars. Standard Pressed Steel Co., Box No. 596, Jenkintown, Pa. Two four-page bulletins, one on Flexloc self-locking nuts and the other on Hollowell steel shaft collars, have been prepared. Both give information in

text and illustrations on product properties and applications. The Flexloc locknuts described are one piece and all metal, do not have to seat to lock, and can be used as stop nuts because they will stay put at any point on a bolt or stud. Steel nuts are unaffected by temperatures up to 550 F, and corrosion-resisting steel nuts up to 750 deg. Sample applications are shown. The bulletin on steel collars lists the 42 standard sizes for shafts from $\frac{1}{8}$ in. to 3 in. in diameter. It shows the Hallowell collar in use in various applications.

External Phasing Potentiometer. DeJur Amsco Corp., 45-01 Northern Blvd., Long Island City 1, N. Y. Bulletin 100 is a single-sheet publication illustrating and describing the series C-200 external phasing potentiometer. Eighteen features of the unit are outlined. Also included are dimensional diagrams and general specifications.

Technical Ceramics. American Lava Corp., Chattanooga 5, Tennessee. Bulletin No. 533 describes and illustrates technical ceramics for use in the electronic and electrical fields. The purpose of the 12-page primer is to tell some of the outstanding advantages of AlSiMag technical ceramics quickly and in nontechnical terms.

Hermetically Sealed Transistors. Texas Instruments Inc., 6000 Lemon Ave., Dallas 9, Texas. Two new production types of hermetically sealed, grown-junction transistors are covered in bulletin DL-S 310. It describes the types 200 and 201—both *npn* triodes with glass to metal hermetic sealing—which differ principally in collector resistance and amplification factor. The new bulletin contains two pages on the theory and application of junction transistors, as well as detailed specifications and curves on the company's units. Alpha (current amplification factor) is a guaranteed minimum of 0.90 in type-200 and 0.95 in type-201 transistors.

Electrical Insulating Materials. Insulation and Wires Inc., 3435 Chouteau Ave., St. Louis 3, Mo.,

REON

PRECISION wire wound RESISTORS

presents its new...



compact AXIAL LEAD SERIES

Designed for:

- Tight spaces
- Terminal board mounting
- Printed Circuits
- Hard usage

Dependable

- Conservatively rated
- For JAN-R-93A spec.
- Type RB-51
- Temp: Range -55°C to $+105^{\circ}\text{C}$
- Humidity Proof

Specifications:

- Power Rating: $\frac{1}{4}$ to 1 watt
- Resistance Range: 1 ohm to 2 megohms
- Size: $\frac{1}{4}$ " Dia. \times $\frac{1}{2}$ " Long to $\frac{7}{16}$ " Dia. \times $1\frac{1}{4}$ " Long
- Tolerance: 1% to .05%
- Non-Inductive Winding

Available with high stability type "E" 20 ppm/ $^{\circ}\text{C}$ wire.

Prompt delivery of needed samples in approx. two weeks; production quantities in four weeks. Write or phone for complete specifications or samples of the axial lead series or for information on any standard, commercial and special types. Request our application sheet.

REON PRECISION WIRE WOUND RESISTORS are dependable under the most adverse conditions.

- HEAT
- COLD
- OVER-LOADING
- HUMIDITY
- AGING

REON RESISTOR CORP.
117 STANLEY AVENUE, YONKERS, N. Y.

Some REON types

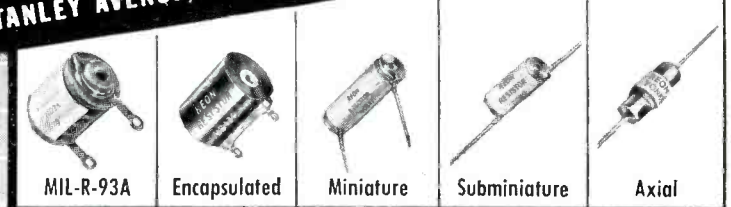

has available a 48-page catalog dealing with a wide line of electrical insulating materials. Over 225 items are indexed. Descriptions, specifications and prices are included. This catalog is published periodically and so kept up to date on prices.

Portable pH Meters. Beckman Instruments, Inc., South Pasadena 1, Calif., has released a 4-page folder designed to simplify the choice of pH equipment. Salient performance features and pictures distinguish the four pH meters in the series. They include a highly accurate instrument for laboratory and research studies; a line-operated model for routine measurements in the control laboratory; and two lightweight portables for plant and field applications. The booklet also lists typical industries where these instruments are used. Ask for bulletin 322-59.

UHF Transmitter. Allen B. DuMont Laboratories, Inc., 1500 Main Ave., Clifton, N. J. Bulletin No. TTD-T201 covers the company's 1-kw uhf tv transmitter. It outlines the design and operational features of the unit. Block diagrams, photos and graphs explain the basic circuitry of the visual and aural transmitters that make up the 1-kw transmitter. In addition, information required by FCC Form 301, Section V-C is provided for the convenience of station applicants.

Coaxial Cable. Andrew Corp., 363 E. 75th St., Chicago 19, Ill. Bulletin 48-A is a 4-page folder illustrating and describing a $\frac{1}{4}$ -in. diameter, semiflexible coaxial cable (type 737). It gives power ratings, mechanical and electrical characteristics, and a table of attenuation and efficiency. Included are a page of applications with typical bills of materials, installation information and an illustrated list of accessories.

Picture Tube Components. Sylvania Electric Products Inc., Towanda, Pa. Tungsten and chemical components for tv picture tubes are described in a 4-page booklet. Among the components described are screen phosphors, potassium



First in

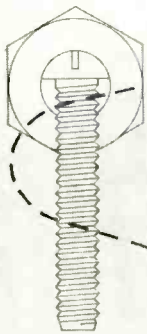

stainless steel

fastenings



● behind this symbol is an on-hand inventory of *more than 9,000 items and sizes* of stainless steel fastenings. Ready for immediate shipment, this stock is the largest and most complete in the industry. In addition, a production capacity for large or small quantities of special orders is at your service! A good reason — when you think of stainless steel fastenings — to think **FIRST** of Anti-Corrosive! *Send for Catalog 53F today!*

ANTI-CORROSIVE METAL PRODUCTS CO., INC.
Castleton-on-Hudson, New York

silicate for screen settling, tungsten wire for cathode heaters, and triple carbonate cathode coatings. Also included is a description of stranded tungsten coils and filaments for vacuum metallizing. They are used in the aluminizing of picture tube screens.

Wire Identification. Alpha Wire Corp., 430 Broadway, New York 13, N. Y. One of the many new features contained in the 28-page catalog No. 53 is a 2-page identification chart for electronic wire and cable. It is designed to allow even the inexperienced to correlate positively and quickly an Alpha product from a vague general description.

Equipment Catalog. Perma-Power Co., 4727 North Damen Ave., Chicago 25, Ill., has published a 4-page, multicolored catalog on its complete line of electronic equipment. Items listed in the catalog include a new tv voltage regulator; a new model tv tube brightener; a tv insulated high-voltage grid cap assembly; a tv high-voltage spring clip assembly; a tv replacement socket; tv tube extensions; and the three battery eliminators—models A, B and E.

Remote Control Equipment. The Hammarlund Mfg. Co., Inc., 460 W. 34th St., New York 1, N. Y. A new 4-page 2-color bulletin describes the Multi-Gate remote supervisory control system designed for use by petroleum refineries, pipeline, railroads, power companies, and other organizations that have widespread physical facilities. The equipment described is designed for operation over wirelines, microwave, or radio lengths, or combinations of these to provide on-off control, switching or signaling at one or several remote points. Control of a given station or other remote point may be exercised from one or more control centers; and report back on the operations may likewise be obtained at any or all of the controlling stations.

Screen Rooms. Erik A. Lindgren & Associates, 4515-17 N. Ravenswood Ave., Chicago 40, Ill., has issued a pamphlet on its double-shielded type, heavy duty portable



Photo Courtesy Dalmo-Victor

Miniaturized Antenna Motor Filter

Eliminates Interference . . . Fits Existing Mounting Bracket

PROBLEM—A large radar antenna manufacturer wanted to use a certain motor to train radar antennas. However, the motor brushes caused serious radio interference as the equipment was pulsed.

SOLUTION—The motor manufacturer's engineers contacted Sprague's Radio Noise Suppression Laboratories in Culver City to design a noise filter to meet a tight deadline. The unit would have to (1) reduce the interference to meet the requirements of MIL-I-6181, (2) fit the existing mounting bracket on the motor. The solution, outstanding for its superior attenuation characteristics, is shown in the photo.

RESULT—Production motors for this application are now supplied with the Sprague filter attached.

PRODUCTION SCHEDULES for such filters designed by Sprague's California labs are regularly met by Sprague's extensive pilot plant and mass-manufacturing facilities, the former for those sizzling rush orders, the latter for volume needs. For help with your radio noise filter applications, write, wire, or phone Sprague Electric Co., 11325 Washington Blvd., Culver City, Calif. (TEexas 0-7491) or North Adams, Mass. (North Adams 423).

Sprague on request will provide you with complete application engineering service for optimum results in the use of radio noise filters.

YOU CAN DEPEND ON
SPRAGUE

it's easy—and **SAFE**

...to bottle a bang!

with a **Tenney**

EXPLOSION CHAMBER

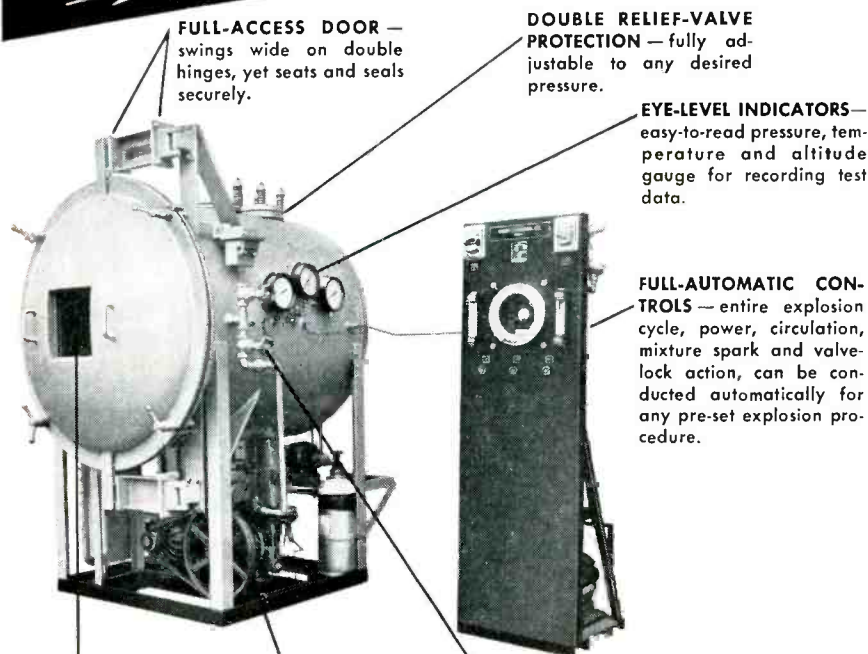

FULL-ACCESS DOOR — swings wide on double hinges, yet seats and seals securely.

DOUBLE RELIEF-VALVE PROTECTION — fully adjustable to any desired pressure.

EYE-LEVEL INDICATORS — easy-to-read pressure, temperature and altitude gauge for recording test data.

FULL-AUTOMATIC CONTROLS — entire explosion cycle, power, circulation, mixture spark and valve-lock action, can be conducted automatically for any pre-set explosion procedure.

PRESSURE-PROOF VIEWING PORT — for completely safe checking of explosive action.

POSITIVE EVACUATION AND CIRCULATION — oversize pump, circulation and compression system for maximum efficiency and protection.

COMPLETELY SAFE VALVE SYSTEM — bleed valve for re-admitting air — positive shut-off valves for locking-in pressure, sealing off chamber.

... the difference is Design

In this 4' dia., 5' long chamber you can simulate the effects of explosions of any predetermined magnitude at pressures of any altitude up to 80,000 feet — with maximum accuracy and safety. Using commercial Butane gas, thoroughly mixed by blower and fan, explosions are ignited by a timed spark and controlled (manually or automatically) throughout all phases of synthesis and evacuation. For maximum versatility and action tests, two 100-point terminal pads (25 amps., 230 volts AC), as well as two hand turning shafts, are provided as accessories.

Control of explosions is only one of the many phases of Tenney's experience in

designing and building precision atmospheric test equipment. Others include all types of environmental testing chambers — temperature, humidity, altitude, vacuum — to provide manufacturers and researchers with the most accurate means of predetermining behavior of products under unusual conditions. From the early days of this now-vital industry, Tenney engineers have been meeting and solving problems with challenging specifications by imaginative design and skilled craftsmanship. It is this background that assures more and more product planners that the right way to right results is to "talk it over with Tenney."

For further information and bulletin write:



Tenney
ENGINEERING, INC.

Dept. A, 26 Avenue B,
Newark 5, N. J.

3345

Plants: Newark, N. J., Union, N. J., and Baltimore, Md.

Los Angeles Representative: GEORGE THORSON & CO.

Engineers and Manufacturers of Automatic Environmental Test Equipment

construction screen rooms that feature minimum r-f interference. The illustrated brochure describes such features as easy assembly, leak-proof doors, ball bearing hinges, heavy-duty latches and floor panels that are faced with $\frac{3}{4}$ -in. waterproof plywood and are laid over the double screened, sectional substructure. Complete specifications are included.

High-Temperature Alloy Fastenings. The H. M. Harper Co., Morton Grove, Ill. Bulletin HTA covers high-temperature alloys such as Refractaloy, Discaloy, Inconel, Hastelloy and Austenitic alloys, with a special section on titanium. This bulletin contains data on these superalloys, together with a section on the characteristics of high-temperature bolting. Tables give mechanical properties and chemical composition of various alloys and illustrate many types of fastenings produced from super alloys and titanium.

Public-Address Equipment. Newcomb Audio Products Co., 6824 Lexington Ave., Hollywood, Calif., announces a new 20-page catalog of public-address equipment. It contains illustrated information on all three lines of Newcomb amplifiers, portable systems and accessories, as well as rack and panel assemblies.

Electrical Insulation. L. Frank Markel & Sons, Norristown, Pa., have published a technical bulletin on improved types of a class H insulating tubing made of fiber glass base sleeving coated with Silicone rubber. It includes information on grades and electrical characteristics, thermal and chemical characteristics, flexibility, abrasion resistance, flammability, fungi resistance and sizes.

Carbon and Graphite Products. Stackpole Carbon Co., St. Marys, Pa. Standard and special carbon and graphite components and materials for chemical, electrical and mechanical applications are described in catalog 40A. Recently revised and enlarged, the 44-page catalog contains a wealth of data

on carbon and graphite as applied to products ranging from battery and welding carbons to tube anodes, electrical contacts, bearing materials, seal rings, rail bonding molds, graphite for spectrographic analysis and many others. It is designed more as a guide to the many uses of carbon and graphite than as a restrictive listing of standard products. As a result, there is considerable engineering information on the physical and electrical properties of carbon and graphite as compared with metals and other refractory materials.

Beam Switching Tubes. Burroughs Adding Machine Co., Research Div., 511 N. Broad St., Philadelphia 23, Pa., has available the reprint of an article by one of its engineers dealing with multi-output beam switching tubes for computers and general purpose use. The booklet contains a well illustrated technical description along with a history of beam switching tubes.

Polyester Film. E. I. DuPont de Nemours & Co., Wilmington 98, Del., has issued a technical bulletin containing 14 pages of information on the physical, electrical and chemical properties of Mylar polyester film, and suggested applications. It is complete with charts, diagrams and tables. The electrical properties section covers such things as dielectric strength, insulation resistance, and volume and surface resistivity.

The Engineering Profession. Stevens Institute of Technology, Castle Point, Hoboken, N. J. An increasing interest in engineering, shown by high school students of late, has led to publication of a new booklet about the profession. Designed to answer questions about the work engineers do, the 16-page publication also discusses the scholastic attainments and special aptitudes which indicate whether a student should seek admission to an engineering college. The booklet, entitled "What's Engineering?", was written with an eye to aiding both students and counselors.

Burton brovine advertising

James is the complete source for all vibratory products!*

THE ENGINEER'S STANDARD SINCE 1936

*Send your engineering problems to us

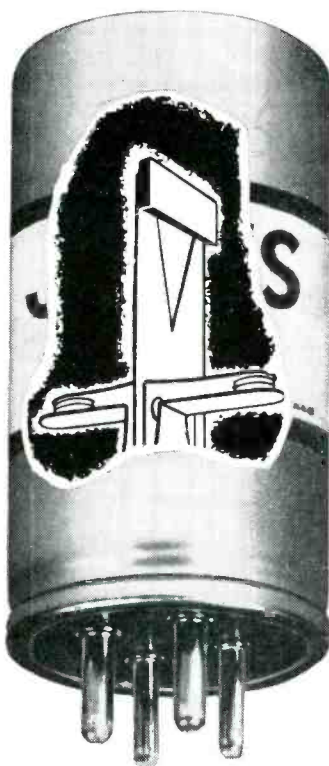

The new James Angle Drive Interrupter Vibrator is now available in manufacturer's quantities at competitive prices.

Dependable starting, long life, hushed performance are inherent features of this new vibrator. Write for engineering samples and circuit consultation.

JAMES
VIBRAPOW
4038 N. Rockwell St. • Chicago 18, Ill.
COMPANY

AUTO VIBRATORS • COMMUNICATIONS VIBRATORS • VIBRATOR POWER SUPPLIES • CHOPPERS • VIBRATORY COAXIAL SWITCHES

PLANTS AND PEOPLE

Edited by WILLIAM G. ARNOLD

Everitt To Receive IRE Medal Of Honor

WILLIAM L. EVERITT, Dean of the College of Engineering, University of Illinois, has been named to receive the Institute of Radio Engineer's medal of honor for 1954. The Institute gave the award "for his distinguished career as author, educator and scientist; for his contributions in establishing electronics and communications as a major branch of electrical engineering; for his unselfish service to his country; for his leadership in the affairs of the IRE."

Dr. Everitt had held teaching posts at Cornell University, University of Michigan and Ohio State University before coming to the University of Illinois in 1945 as head of the department of electrical engineering. He was appointed Dean of the College of Engineering in 1949.

In 1940 Everitt became a member of the Communications Section

of the National Defense Research Committee and during World War II served as Director of Operational Research in the Office of the Chief Signal Officer. In 1950 he served as a member of the Senate Advisory Committee on Color Television. In April of this year, the IRE nominated him to serve on a committee of scientists formed to study the National Bureau of Standards.

The presentation of the medal of honor will be made during the annual banquet at the Waldorf-Astoria Hotel, New York, N. Y. on March 24, 1954 during the IRE National Convention.

RETMA Committee Chairmen Named

FOLLOWING THE ACTION of the Radio-Television Manufacturers Association in changing its name

to the Radio-Electronics-Television Manufacturers Association and approving a reorganization plan which established a Radio-Television Industry Committee and an Electronics Industry Committee of the board of directors, board chairman Robert C. Sprague appointed the following committee chairmen:

F. R. Lack, vice-president of Western Electric Co., was appointed temporary chairman of the electronics industry committee and has designated himself as temporary chairman of the radio-television industry committee, pending election of permanent chairmen of both committees.

Leslie F. Muter of The Muter Co. was reappointed chairman of the annual awards committee. The committee has the responsibility for nominating the recipient of the RETMA medal of honor, presented annually to the person, company or organization which, in their opinion, has made the greatest contribution to the radio-television-electronics industry.

John B. Swan, Jr. of Philco Corp. and William L. Fogelson of P. R. Mallory & Co. were appointed chairman and vice-chairman respectively of RETMA's traffic committee.

The committee and its subcommittees will continue to work during the coming year to promote and protect the best interests of the industry in the field of traffic problems.

Paul V. Galvin of Motorola was reappointed chairman of RETMA's committee to survey subscription television. During the coming year, the committee will continue to study the nontechnical phases of subscription television with particular reference to its possible effects on the telecasting of sports, theatrical presentations and other

OTHER DEPARTMENTS featured in this issue:

	Page
Electrons At Work.....	198
Production Techniques ..	258
New Products	310
New Books	436
Backtalk	451

Elgin Watch Seeks Electronics Firms



Elgin National Watch Co. is actively seeking companies in the electronics and precision instrument fields with "a view to affiliation," J. G. Shennan, president, recently announced. Reasons why the 89-year-old company wishes to enter the electronics field are pointed out above by president Shennan who said the prime motives are need for higher return on capital and greater long-term stability. The company plans continued aggressive activity in its basic field of watchmaking



WORLD'S MOST WANTED AUTOCHANGER

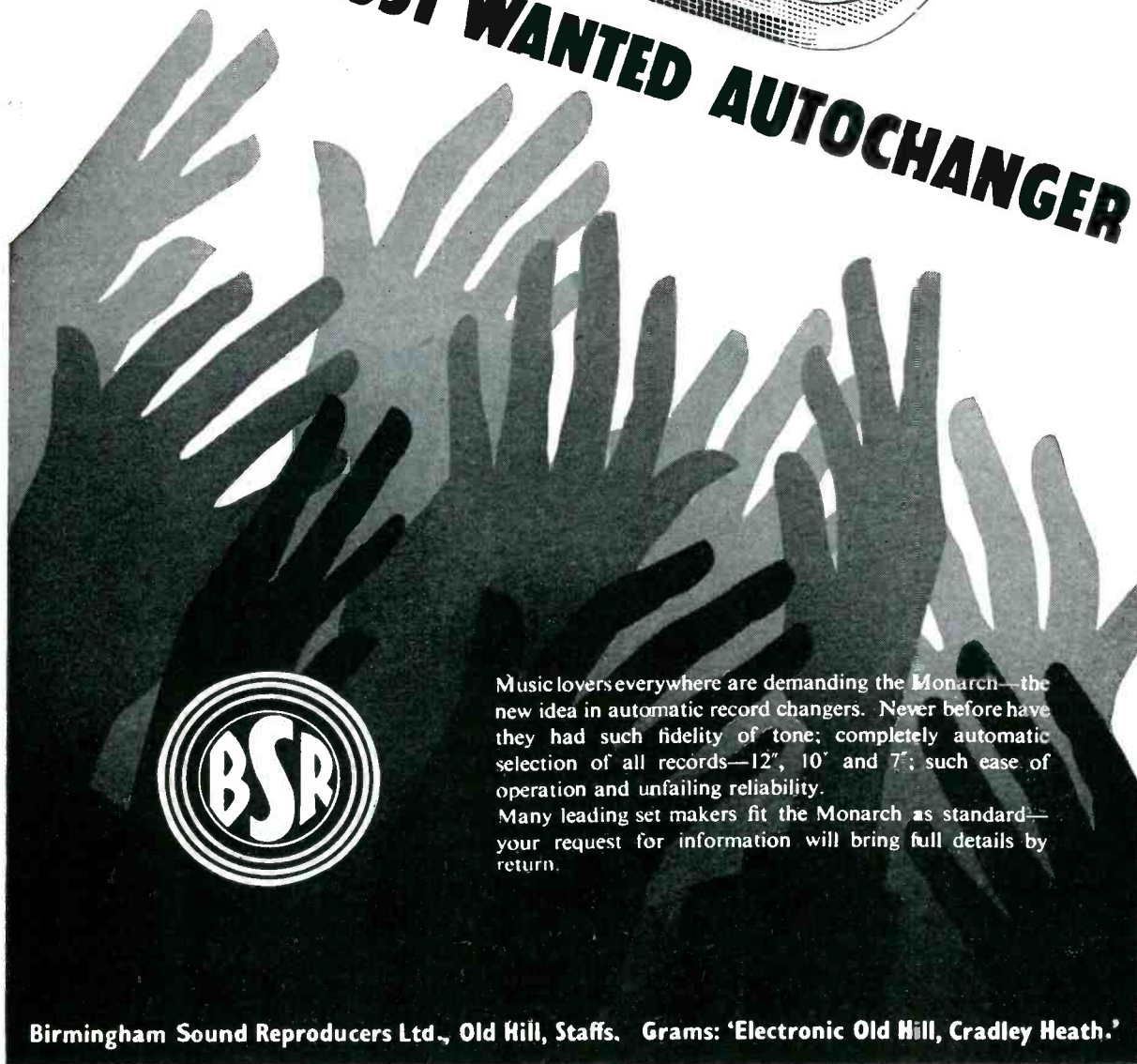

Music lovers everywhere are demanding the Monarch—the new idea in automatic record changers. Never before have they had such fidelity of tone; completely automatic selection of all records—12", 10" and 7"; such ease of operation and unfailing reliability. Many leading set makers fit the Monarch as standard—your request for information will bring full details by return.

Birmingham Sound Reproducers Ltd., Old Hill, Staffs. Grams: 'Electronic Old Hill, Cradley Heath.'

entertainment activities.

H. A. Pope of National Union Radio Corp. was reappointed as chairman of the association's credit committee for the coming fiscal year. During the coming year the group will continue its active surveillance of the credit position of both manufacturers and distributors in the electronics field for circulation within the electronics industry.

Glen McDaniel, as general counsel of RETMA, was reappointed chairman of the association's legal committee for fiscal year 1953-54. During the coming year the committee will continue to watch state and local legislative proposals which affect the radio-tv electronics industry. It also will continue to work with the RETMA tax committee on current tax problems and to keep the association's members informed of various other legal matters of industry-wide interest.

A. M. Freeman of RCA Victor was reappointed chairman of the tax committee. The group will continue its work to keep the membership informed on current federal tax developments and to present the association's position on tax matters before appropriate federal agencies or the Congress.

W. R. G. Baker of GE was reappointed chairman of the television committee. The committee will continue to operate as the association's top policy group on television matters and formulate recommendations in this field for submission to the board of directors.

Frank W. Mansfield of Sylvania Electric was reappointed chairman of the industry statistics committee for the coming year.

Leslie E. Woods of Raytheon was reappointed chairman of the association's industrial relations committee for the ensuing year. One of RETMA's largest and most active groups, the committee is credited with many outstanding accomplishments in industrial and labor relations.

Harold J. Schulman of the Allen B. Du Mont Laboratories has been appointed chairman of the service committee. He succeeds R. J. Yeranko of Magnavox. The group has done much to improve service relations.

Quarles Appointed To Defense Post

DONALD A. QUARLES, vice-president of Western Electric Co and president of its subsidiary, Sandia Corp. of Albuquerque, New Mexico has been named by President Eisenhower as assistant secretary of defense, for research and development. He formerly served as chairman of joint RDB electronics committee.

Mr. Quarles graduated from Yale in 1916, was a graduate student at Columbia for the next four years after which he joined Bell Labs as an engineer. In 1948, he became vice-president of the company, leaving in 1952 to become vice-president of Western Electric.

Audio Convention Sets Technical Program

ARRANGEMENTS HAVE been completed for 28 papers to be delivered at the Audio Engineering Society's forthcoming Fifth Annual Conven-

tion and Audio Fair to be held in New York City October 14-17, 1953.

Three papers on loudspeakers will be delivered at the morning session on Oct. 14. In the afternoon audio-system design session, four papers will be delivered.

On Oct. 15, four papers on disc reproduction and others on new audio developments will be presented.

Friday, Oct. 16, amplifier circuit design and home music systems will be discussed.

Multichannel sound reproduction papers will be given on Oct. 17.

Westinghouse Makes New Moves

WESTINGHOUSE ELECTRIC CORPORATION has purchased the large government-owned plant in Lansdowne, Md., which the company has operated under lease since its construction in 1942.

The plant is a large-scale producer of electronic equipment for the armed services and for indus-

Sylvania Has Produced Five Million TV Tubes

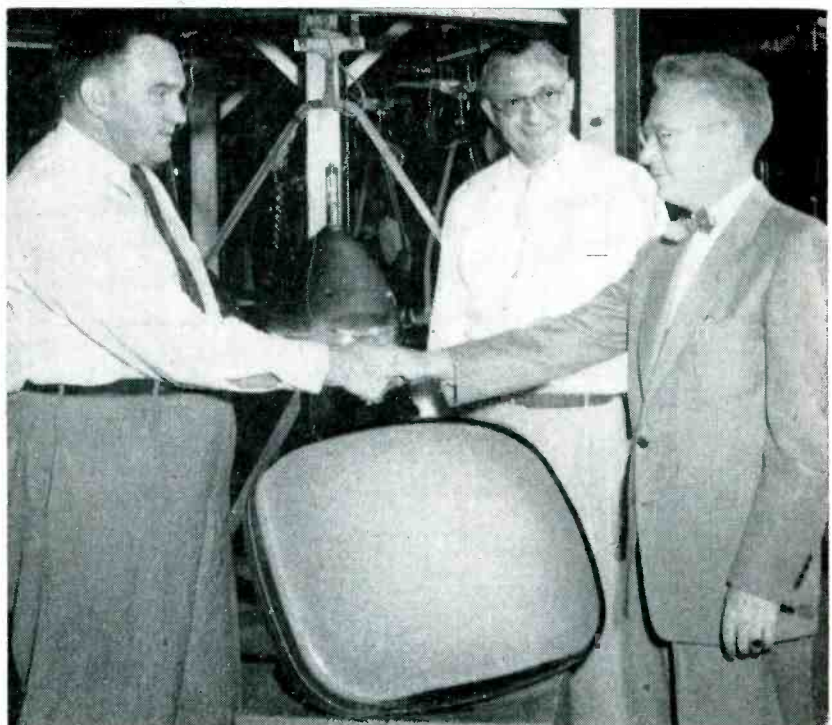

Mayor of Seneca Falls W. J. Cousin (right) congratulates Sylvania's division general manager, W. H. Lamb (left) on the production of the five-millionth picture tube to be made at the company's two picture tube plants in Seneca Falls, N. Y. and Ottawa, Ohio. Willis C. Toner, Seneca Falls plant manager (center), stands behind the 27-inch tube. The company also announced that another cathode-ray-tube plant will be built at Fullerton, Calif.

RCP VTVM

Model 655

**READS PEAK-TO-PEAK
VOLTAGES DIRECTLY**

ACCURATE MEASUREMENT OF COMPLEX WAVESHAPES

SINE WAVE

RMS or Peak-To-Peak...
Useful and Necessary—Read
Directly With Model 655

PEAKED SAWTOOTH WAVE

TV Horizontal Signal...
Peak-To-Peak Reading Re-
quired—Easily Done Directly
with the Model 655.

PULSE WAVE

TV Horizontal Deflection...
Peak-To-Peak Measurements
Needed—Read It Directly
on the Scale—Model 655.

COMPOSITE VIDEO WAVE

Video Amplifier... Peak-To-
Peak Measurements A Must
—Do It Directly With The
Model 655.

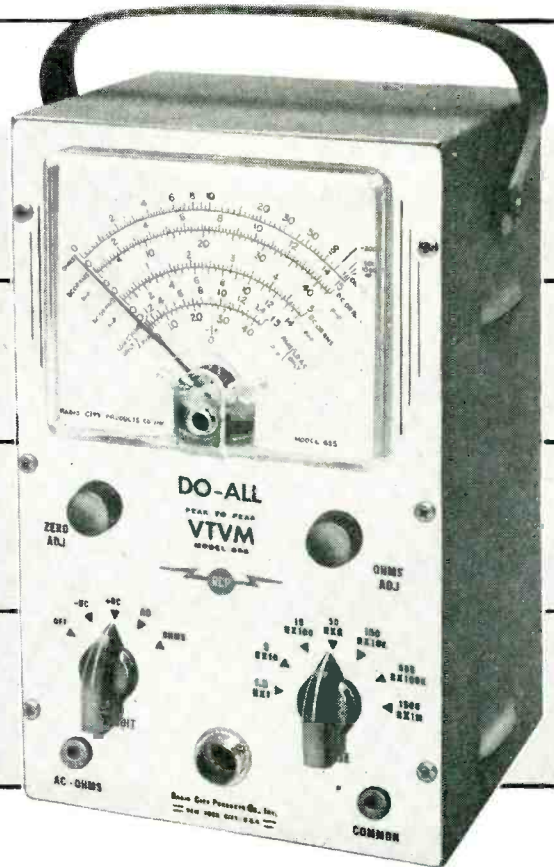

Quickly... Accurately

DO-ALL Model 655.

ONLY \$59.50

... gives a true reading measurement of complex and sinusoidal voltages with necessary peak-to-peak or RMS value read directly, for the analysis of waveforms in video, sync and deflection circuits.

Now TV efficiency is given greater effectiveness because sets can be serviced as the manufacturers say—the peak-to-peak way. The combination of this P. to P. meter and service notes to match, take the guesswork out of service and speed up your service operation.

Versatility of measurement, built into each Model 655, serves a variety of industrial applications in the service of vibrator power supplies, AC generators and all equipment utilizing any type of waveform or DC.

Match the Model 655 with any peak-to-peak VTVM—You will find that comparable performance can only be found

in much higher priced instruments. Of high impedance design, the Model 655 makes use of an electronic balanced push-pull circuit and peak-to-peak rectification. The result is an absence of circuit loading, waveform error or frequency distortion.

This handsome looking unit has a brushed aluminum panel, etched for durability and uses an attractive clear plastic meter. Comes complete with our new "RCP SOLDERLESS TEST LEADS" for operation on 105 to 125 V AC.

FOR TELEVISION SERVICE AND INDUSTRIAL MAINTENANCE

- PEAK-TO-PEAK AC measurements of from .2 V to 4200 V on 7 ranges.
- AC RMS measurements of .1 V to 1500 V on 7 ranges.
- DC measurements of from .02 V to 1500 V on 7 ranges.
- RESISTANCE measurements of from .2 ohms to 1000 Megohms on 7 ranges.

Remember You can do more with a "DO-ALL".
See your local parts distributor or write for Catalog E-10

RADIO CITY PRODUCTS CO., INC.

152 WEST 25th STREET • NEW YORK 1, N. Y.



PULSE

CAPACITORS

25 to 100 KV
50 megawatts



Designed for extremely low temperature rise when used in pulse-forming networks above 25,000 volts. Can pass 2500 amperes at 0.0005 duty cycle.

Catalog No.	Mfd.	Peak KV	Body Dimensions (in.)
RPC-906000*	0.0006	90	5 x 8 x 9
GPC-601672	0.0167	60	7 x 8 x 24
RPC-402502	0.025	40	6 x 7 x 24 ^{5/8}
RPC-402202	0.022	40	6 x 7 x 24 ^{5/8}
APC-401672	0.0167	40	5 x 6 x 24
RPC-4026251	2 x 0.00625	40	6 x 7 x 18
KPC-357501	0.0075	35	5 x 7 x 8 ^{3/8}
RPC-321252	0.0125	32	5 x 6 x 9 ^{3/4}

Used on secondary of pulse transformer to limit rise time of current pulse.

Write for data sheet listing pulse capacitors and standard pulse-forming networks.



TOBE DEUTSCHMANN
CORPORATION
NORWOOD, MASSACHUSETTS

trial and commercial customers. The plant is now producing induction heating equipment, radio transmitters and certain radar components.

Increasing peacetime electronic demands on the plant's facilities was an important factor in the company's decision to buy the 60-acre installation. Westinghouse built the plant for the government during World War II to fill the urgent need for electronic equipment for defense. Recent peacetime demands for electronic equipment have caused that type of production at the plant to equal its military output. In view of the fact that this would have necessitated an eventual expansion of the plant's manufacturing capacity, Westinghouse decided to acquire the property.

In another move in the electronics division, Robert C. Cheek has been appointed to the newly-created post of assistant manager of engineering of the division, according to an announcement by F. S. Mabry, division engineering manager.

Prior to his present promotion, Cheek was assistant division sales manager. In his new capacity, he will supervise administrative and organizational activities under Mabry. He joined Westinghouse in 1939 and was a specialist in carrier and microwave applications. In 1949, he was named "outstanding young electrical engineer", by the Eta Kappa Nu national technical fraternity.

In the company's electronic tube division, Clarence M. Clark has been appointed manager of the division's plant at Bath, N. Y. He has been manager of accounting at the Elmira plant and joined the electronic tube division last May. Formerly with the company's special products division at Pittsburgh, Pa., he has been associated with Westinghouse for 27 years.

Rand Receives ARRL Merit Award

PHILIP S. RAND, a project engineer at the Remington-Rand Laboratory of Advanced Research at South Norwalk, Conn., was recipient of

AIR-MITE

AIR CYLINDERS

Single Acting
and
Double Acting

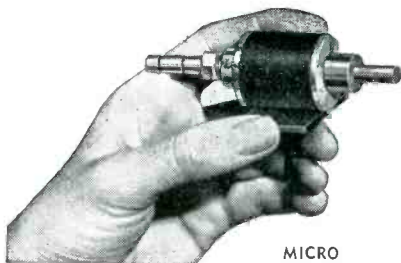

MICRO



CLEVIS

Worth Their Weight in
GOLDen Man Hours!

Save time, spoilage, cost . . . speed production . . . reduce fatigue . . . on all drilling, reaming, tapping and processing jobs. Available in 1", 1½", 2¼", 3", 4" and 5" diameters; stroke length optional. Single or double action; all mountings.

Write for complete catalog of Air Cylinders and Air Arbor Presses.

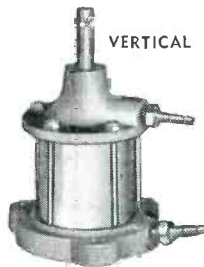

VERTICAL

AIR-MITE

4417-F W. Carroll Ave.
Chicago 24, Illinois

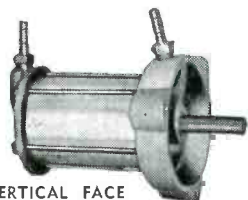

VERTICAL FACE

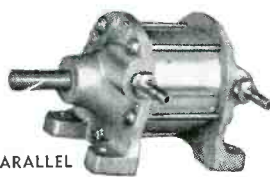

PARALLEL

WAVEGUIDE

Components

TO SPECIFICATIONS
SINCE 1943

Tees	Bends
Mixers	Ratracces
Duplexers	Cavities
Rotating Joints	Pads
Filters	Phasers
Attenuators	Flanges
Electronic Assemblies	
Special Purpose Components	

For the complete story on Premier's fully integrated engineering, production and testing facilities, write Dept. E today for our new brochure.

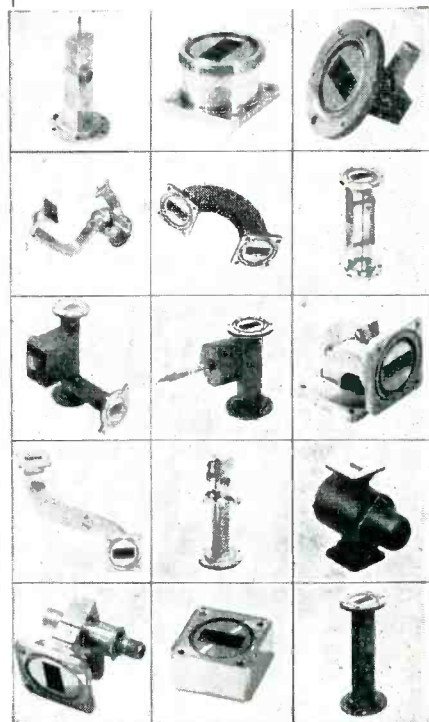

Watch
TENSOLITE
for progress in
ELECTRONIC
WIRING!

For High Dielectric
Strength, specify -

TENSOLON TEFLON-INSULATED WIRE & CABLE

- THIN WALL
- 14 COLORS
- FREE-STRIPPING
- EXTRA FLEXIBILITY
- TOUGH TEFLON INSULATION
- TEMPERATURE RATING:
-90° to +250°C

For an extra margin of dependability at maximum operating temperatures, specify these rugged Teflon insulated hook-up wires. Available in stranded sizes from 20 to 30 AWG with shields and teflon jackets or lacquered braids. Constructed to meet highest government and commercial standards, Tensolon Wires feature the new Tensulanted-Teflon covering that eliminates pin holes and other imperfections.

ASSORTED TENSOLON HIGH-TEMP WIRES
IN LABORATORY AND TEST QUANTITIES

An economical sample kit for designers, engineers, testing departments and development laboratories. Prices on request.

WRITE FOR CATALOG TODAY

TENSOLITE INSULATED WIRE CO., INC., TARRYTOWN, NEW YORK



PREMIER INSTRUMENT CORP.

52 West Houston Street
New York 12, N. Y.

precision electronic instruments by **DeJUR**

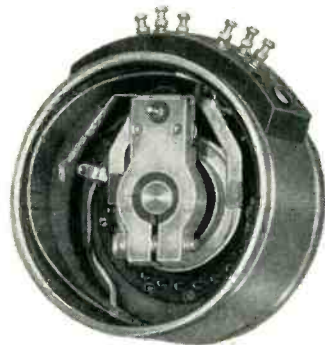

non-linear
function

C-200

external phasing
potentiometer

- Logarithmic, sine-cosine and other shape functions
- Multiple, adjustable taps
- Unitized design for universal coupling
- Precision machined aluminum housing
- Servo or single hole mounting

For further information write
DeJUR-Amsco Corporation, Dept.
EP-10, 45-01 Northern Blvd., Long
Island City 1, N. Y.



YOU'RE SURE WITH DeJUR
POTENTIOMETERS • CONNECTORS • METERS
DeJUR-AMSCO CORPORATION
45-01 NORTHERN BLVD., L.I.C. 1, N. Y.

DeJUR

the American Radio Relay League's merit award given at the Seventh ARRL National Convention in Houston, Texas. Goodwin L. Dosland, president of the ARRL, presented a plaque to Rand in recognition of his advancement of the welfare of amateur radio through outstanding leadership and technical accomplishment in reduction of tv interference.

Program Announced For Radio Fall Meeting

TECHNICAL PROGRAM of the Radio Fall Meeting sponsored by the RETMA engineering department, the RTMA of Canada and the IRE Professional Groups Committee has been established. The meeting will be held at the King Edward Hotel, Toronto, Ontario, Canada on October 26, 27 and 28.

Electronic Parts Show Elects Officers

HARRY A. EHLE of International Resistance Co. was elected president of the Radio Parts and Electronic Equipment Shows, sponsors of the Electronic Parts Show, at the annual meeting of the show board.

H. M. Carpenter of Thorow Distributors was chosen vice-president; Francis F. Florsheim, Columbia Wire and Supply Co., secretary; Bernard L. Cahn, Insuline Corp. of America, treasurer.

The 1954 show will be held at the Conrad Hilton Hotel in Chicago May 17 to May 20.

Air Materiel Command Reorganizes

AIR FORCE SECRETARY Harold E. Talbott announced that the Air Materiel Command, the U. S. Air Force's logistical arm, will eliminate seven of its subordinate headquarters by December 31, 1953.

Lieutenant General E. W. Rawlings, AMC's commander, said: "We have been making thorough studies of our operations and organization to comply with new Air Force programs. Consequently we have come up with this plan which not only will result in substantial

SPECIALTY TRANSFORMERS

HIGH QUALITY DESIGNS FOR MIL-T-27

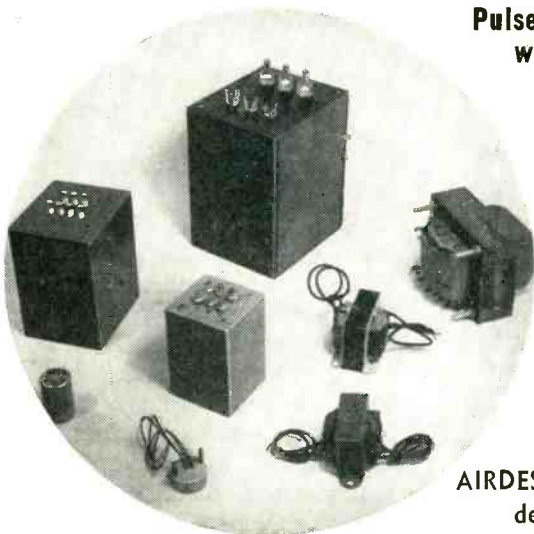

Pulse & Filter Networks
with Ferrite Cores

**AUDIO
POWER
CHOKE
MODULATION**

Facilities also
available for
COMMERCIAL UNITS

AIRDESIGN averaged 30 day
delivery during 1952

UNUSUALLY SHORT DELIVERY ON PREPRODUCTION MODELS

A RELIABLE SOURCE
SINCE 1941



AIRDESIGN, INC.

241 FAIRFIELD AVE., UPPER DARBY, PA.
Telephone: GRanite 4-8000



they
can't
shake
loose...

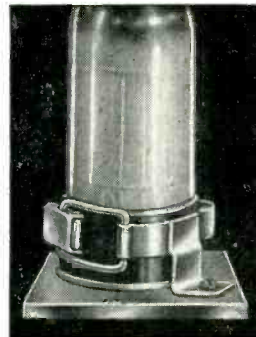

**HOLD
THEM
TIGHT
with a**

BIRTCHER CLAMP

There is a Birtcher Clamp... or one can be designed... for every tube you use or intend to use.

Regardless of the type tube or plug-in component your operation requires... and regardless of the vibration and impact to which it will be subjected... a Birtcher Tube Clamp will hold it securely and rigidly in place.

Catalog and samples sent by return mail.

The BIRTCHER CORPORATION
4371 Valley Blvd.
Los Angeles 32, Calif.



Please send catalog and samples by return mail.

Company _____ E-10-3
Attention of: _____
Address _____
City _____ State _____



There's a
RAPID Bench Rectifier
for YOUR application...

Rapid Electric Co. makes Bench Selenium Rectifiers in 18 standard models--each covering a different DC output range and each completely portable. You buy the model that exactly fits your needs. If one of our standard models can't do the job, we can design and build special equipment that will.

ALL Rapid Rectifiers require no warmup, no maintenance, have long life even in continuous full load service, are easy to operate; with regulation, ripple and efficiency to meet your specifications. Cost is low, too--prices start at \$79.50 with full controls.

Write for Catalog S.



THE NAMEPLATE THAT MEANS "More Power to You!"

RAPID ELECTRIC CO.

2879 MIDDLETOWN ROAD, NEW YORK 61, N.Y.

Phone: Talmadge 8-2200

ENGINEERING OPPORTUNITIES

WITH THE
PACEMAKER IN
AVIATION PROGRESS



NEEDS MISSILE

Engineers and Technicians

For Field Test Positions

IN

NEW MEXICO

"The Land of Enchantment"

ON

GUIDANCE

FLIGHT TESTING

SERVOMECHANISMS

TELEMETERING

TEST EQUIPMENT

AIRBORNE ELECTRONICS
EQUIPMENT

IDEAL WORKING CONDITIONS

WRITE:

Field Test Director
Bell Aircraft Corporation
Post Office Box 391
Holloman Air Development Center
Alamogordo, New Mexico

★ model 1200

★ continuous duty

REVERSIBLE DC MOTORS

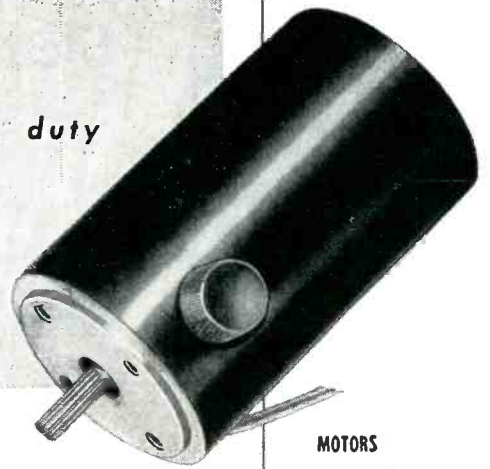

18 to 30 volts with
or without brake . . .

- Ambient temperature: -55°C to $+105^{\circ}\text{C}$.
- Size: 1.25 in. diameter, 2.18 in. long.
- Weighs 5.3 ounces . . . without brake.

We can manufacture these motors to meet your specifications. This particular motor is used on an actuator for aircraft use.

Let's discuss your need!
Write or wire us, TODAY

MOTORDYNE

Dept. J, 2661 S. Myrtle Ave.
MONROVIA, CALIFORNIA

MOTORS
GENERATORS
RELAYS
TRANSFORMERS
SPEED CONTROL
GOVERNORS
MAGNETIC
SERVO AMPLIFIERS
MAGNETIC
CONTROLS & CIRCUITS



IN-RES-CO TYPES SM-15 & SM-30 WIRE WOUND RESISTORS

SUB-MINIATURE
weather-tested midgets

Type SM-15 and SM-30 Resistors offer three vital advantages — sub-miniature size, weather resistant construction and high resistance. The elimination of center hole mounting and the inclusion of axial leads increases winding area and results in 25% greater resistance value than resistors of standard design. Special coating is moisture and fungus proof and designed to meet JAN-R-93 specifications. Sealed in Bakelite construction affords additional climatic protection. As ratings are conservative, types SM-15 and SM-30 can be specified with confidence for service under rigorous conditions.



TYPE SM-15
5/16" DIA. x 3/8" LG.



TYPE SM-30
5/16" DIA. x 3/4" LG.

ASK FOR THE NEW RESISTOR HANDBOOK —

Contains complete data on resistors for every purpose and their recommended applications. Please make request on company letterhead.



INSTRUMENT RESISTORS CO.

COMMERCE
AVENUE



UNION
NEW JERSEY

APPLICATION-DESIGNED RESISTORS FOR ELECTRONICS AND INSTRUMENTATION

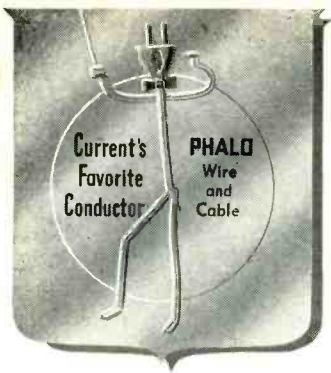

A
Standard
of
Quality



**CUSTOM-
MADE
CORD SETS BY
PHALO**

Just a short time back the custom-made cord set shown here did not exist! It was custom created and produced for a very special application by PHALO!

PHALO has an industry-wide reputation for designing and producing the unusual in cords and cord sets . . . and in so doing, solving the "unsolvable" problems!

See the PHALOCORD section of the new PHALO CATALOG for details. ASK FOR CATALOG.

ASK ALSO FOR THE NAME OF YOUR NEAREST PHALO SALES REPRESENTATIVE IN THE FOLLOWING CITIES:

New York, N. Y.	Cleveland, Ohio
Rochester, N. Y.	Houston, Texas
Philadelphia, Pa.	Phoenix, Ariz.
Greensboro, N. C.	Chicago, Ill.
Wichita, Kansas	Detroit, Mich.
Natick, Mass.	Los Angeles, Cal.
San Francisco, Cal.	



PHALO PLASTICS CORPORATION

CORNER OF COMMERCIAL ST. • WORCESTER • MASS.

Insulated Wire and Cables — Cord Set Assemblies



Morton B. Kahn

ment and industry.

At the same time, announcement was made of the establishment of the electronics division of Otis, of which Morton B. Kahn, president of TEMCO, will be manager. The electronics division will execute existing government contracts held by Otis for electronic bomber and navigational trainers and other contracts for electronic equipment under negotiation. In addition, it will carry on research and development work for Otis in the field of electronics. The electronics division will be located in Brooklyn, N. Y.

Mr. Kahn, who founded TEMCO in 1936, will continue as president. The company will remain in operation to complete its existing contracts.

IRC Builds Second North Carolina Plant

CONSTRUCTION OF A plant located in Boone, North Carolina has been started by the International Resistance Co. of Philadelphia. The plant, to be situated on a 20-acre tract recently purchased by IRC, will have 40,000 sq ft of work space. Building cost has been estimated at \$400,000. Completion and actual production in the plant is expected by January 1, 1954.

Initially, IRC will employ approximately 200 persons. Eventually about 500 workers will be employed, of which 80 percent will be women. Various types of power wire-wound and precision resistors

6 OUTSTANDING FEATURES of the ROBINSON Metering Pump

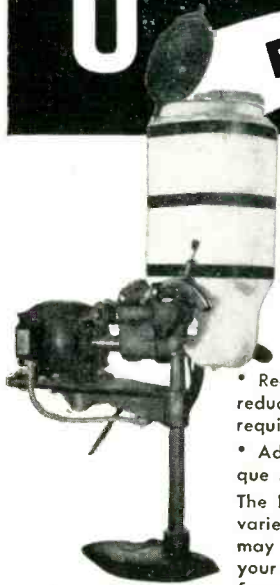

- Forcibly ejects fluid compounds . . . not a gravity dispenser.
- Thermostatically controlled heat . . . maximum temperature 450° F.
- $\frac{2}{3}$ Second per ejection . . . motor driven, clutch actuated.
- Variable discharge . . . speed of ejection changed in 2 seconds without tools.
- Reduces unit costs . . . saves material, reduces rejects . . . no skilled operator required.
- Adaptable to any production technique . . . easily installed.

The Robinson Metering Pump has a wide variety of applications and, therefore, may be instrumental in solving some of your problems. Write us for further information.

EDWARD E. ROBINSON
INCORPORATED
P.O. Box 147

95 PARK AVENUE - NUTLEY 10, N. J.
Telephone NUTley 2-4510

This book will save you 30 Minutes a day

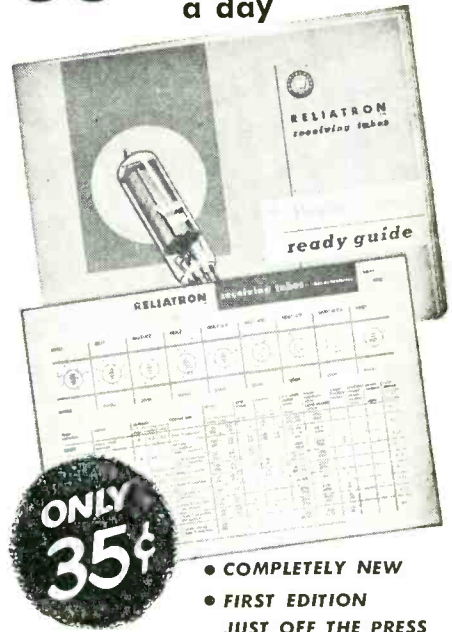

- COMPLETELY NEW
- FIRST EDITION
- JUST OFF THE PRESS

FIND TUBE RATINGS, CONNECTIONS IN SECONDS

This big new Westinghouse Ready-Guide is a completely new kind of handbook of receiving tube data. Designed to save time for busy servicemen and engineers. Eliminates "squinting" at tiny data listings.

BIG - BOLD - CLEAR

Just 9 tube types are listed on each 8½" x 11" page. Not 30 or 40 tiny type listings as in most condensed data books. Best of all, large clear base diagrams are located on the same page as ratings. Bothersome cross referencing, footnotes cut to the bone.

COMPLETE, ACCURATE, UP-TO-DATE

This new Westinghouse Ready-Guide lists complete data on receiving tubes which account for more than 98% of tube usage. 48 pages. 385 pictures and diagrams. 342 types listed.

SPECIAL: 3 for \$1.00

This Ready-Guide is being sold at less than cost as an introductory offer only. Price is only 35¢—3 for \$1.00. Order from your nearest RELIATRON Tube Distributor or mail coupon below.

ET-95038

Westinghouse
RELIATRON TUBES™

Westinghouse Electric Corporation
Electronic Tube Division, Dept. A-210
Box 284, Elmira, N. Y.

..... Enclosed is \$1.00 for 3 copies of Ready-Guide
..... Enclosed is 35¢ for 1 copy

NAME.....
ADDRESS.....
CITY.....STATE.....
Please Print

BUILD YOUR OWN Heathkit TEST EQUIPMENT

Heathkits are completely engineered instruments supplied unassembled. Every kit goes together smoothly and easily. All drilling, punching, and painting has already been done for you. All parts are furnished and are of highest quality.

Detailed construction manual shows clearly where each wire and part goes and tells exactly how to build the kit. Write for free catalog.

HEATH COMPANY
BENTON HARBOR 14, MICHIGAN

EXPORT AGENT:
ROCKE INTERNATIONAL CORP.
13 East 40th Street
NEW YORK CITY (16)

- AUDIO GEN. KIT \$29.50
- R. F. SIGNAL GEN. KIT \$19.50
- 5" SCOPE KIT \$43.50
- SIGNAL TRACER KIT \$22.50
- BATTERY ELIMINATOR KIT \$24.50
- VACUUM TUBE VOLTMETER KIT \$24.50
- IMPEDANCE BRIDGE KIT \$69.50
- TUBE CHECKER KIT \$29.50
- CONDENSER CHECKER KIT \$19.50
- GRID DIP METER KIT \$19.50
- T.V. ALIGN. GEN. KIT \$39.50

will be produced in the new plant.

John Kane, who has been associated with IRC in Philadelphia for many years, has been appointed plant manager.

The plant is the second in North Carolina for the company. In March of this year, IRC started production of volume controls in its Asheville, N. C. plant.

Rectifier Corp. Opens Puerto Rican Plant

BEGINNING of operations in a new plant located in Fajardo, P. R. was announced by Rectifier Corp. The new company has been incorporated under the Island's laws to manufacture selenium rectifiers and related electronic equipment.

Lloyd J. Hughlett, president of the new company, announced that the plant's facilities have been organized to produce a complete line of radio stacks for radio and tv receivers and comparable equipment requiring current conversion. Markets will be on the mainland, Hughlett stated, and delivery from the Island to points on the Eastern seaboard and Midwest can be as rapid as from suppliers in the States.

Magnavox Elects Two New Vice-Presidents



John A. Rankin

ELECTION OF John A. Rankin and John S. Sturgeon as vice-presidents of the Magnavox Co. was announced by Frank Freimann, presi-

Precision ATTENUATION to 3000 mc!

- VSWR less than 1.2 at all frequencies to 3000 mc.
- TURRET ATTENUATOR featuring "Pull - Turn - Push" action with 0, 10, 20, 30, 40, 50 DB steps.
- Accuracy $\pm .5$ DB, no correction charts necessary.
- 50 ohm coaxial circuit. Type N Connectors.

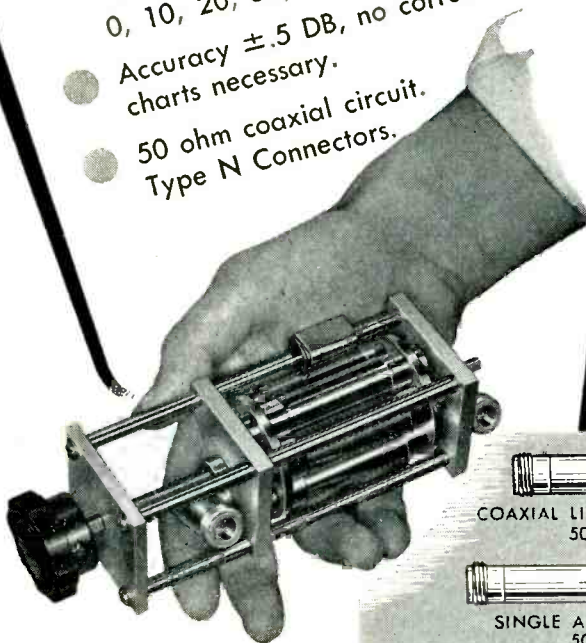

COAXIAL LINE TERMINATION
50 ohms

SINGLE ATTENUATOR PAD
50 ohms

VSWR ± 1.2 to 3000 mc.
One watt c.w. power dissipation

Inquiries are invited concerning single pads and turrets having other characteristics

STODDART AIRCRAFT RADIO CO., INC.
6644-A SANTA MONICA BLVD., HOLLYWOOD 38, CALIFORNIA
HOLLYWOOD 4-9294

High Sensitivity . . . Logarithmic AC VOLTMETERS

SELF CONTAINED
ALL AC OPERATED
UNITS
NO PREAMPLIFIERS
NEEDED

These extremely sensitive and highly stable instruments serve simultaneously as voltmeters and high gain amplifiers. Built-in limiting circuit protects mirror scale indicating meter against all overloads (maximum input voltage on most sensitive range)

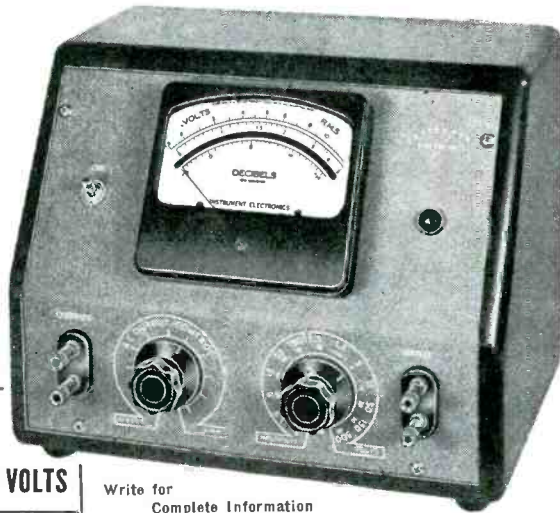

MODEL 47 →
±2% 15C to 30 KC
50 MICROVOLTS to 500 VOLTS

Write for
Complete Information

Mod.	Voltage Range	Frequency Response	Input Impedance	Approx. Feedback	Overlap Scale	Amp. Gain
45	.0005-500	5C-1600KC	2 Megohms 12 MMF	22 DB	NO	1600
45B	.0005-500	10C-250KC	5 Megohms 12 MMF	39 DB	NO	1600
47	.00005-500	15C- 30KC	1 Megohm 15 MMF	29 DB	10 DB	23000
47B	.00005-15	15C- 30KC	50 Megohms 15 MMF	27 DB	NO	23000
53	.00015-500	10C- 250KC	5 Megohms 12 MMF	35 DB	10 DB	5300

Instrument Electronics Corp. 90 MAIN ST.
PORT WASHINGTON, N. Y.

MAGNATRON

PRODUCTS ARE BETTER★

For HEAVY DUTY HIGH VOLTAGE

YES . . . WE BUILD BETTER EQUIPMENT
BASED ON MANY YEARS OF EXPERIENCE

★While this word has been overworked in many instances, we will be pleased to demonstrate the extras built into our transformers to make them better.

← NEW UNITIZED RECTIFIERS

For high voltage D.C. sources . . . lower initial cost . . . minimum upkeep . . . convenient — ready to connect to AC. line and D.C. load . . . compact — requires minimum floor space.

AIR . . . OIL . . . ASKAREL

Plate Transformers . Filament Transformers . Filter Reactors . Modulation Transformers . Distribution Transformers . Pulse Transformers . Testing Transformers . Precipitation Transformers . General Purpose Transformers . Hi-Voltage Transformers.

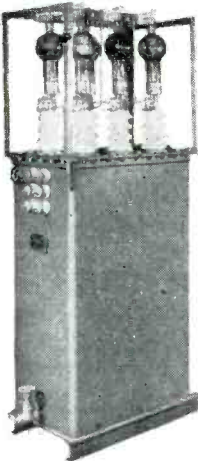

34 KW 17,000 V.D.C.



Askarel Immersed
Filter Reactor
50,000 Volt Test

WRITE FOR DETAILED INFORMATION

MEETS STANDARDS OF AIEE-NEMA

A NAME SYNONYMOUS WITH EXPERIENCE

MAGNATRON INCORPORATED

TRANSFORMERS AND ELECTRICAL EQUIPMENT

WALTER GARLICK, JR., PRESIDENT

246 SCHUYLER AVE., KEARNY, NEW JERSEY



if you are
concerned with
**POWER
SUPPLIES**

you should have
the new and
comprehensive

LAMBDA
catalog

of electronically
regulated
laboratory

power supplies.

Manufactured by
one of America's
pioneer specialists,
this field-proven
precision equipment
is priced
surprisingly low.



SEND FOR NEW CATALOG

Lambda Electronics Corp.
103-02 Northern Blvd., Corona 68, N. Y.
Please send me the new Lambda Power
Supplies Catalog as soon as it comes off
the press.

Name _____
(Please print)

Title _____

Company _____

Street _____

City _____ Zone _____ State _____ F-10
1953

Electronic

BUILDING BLOCKS

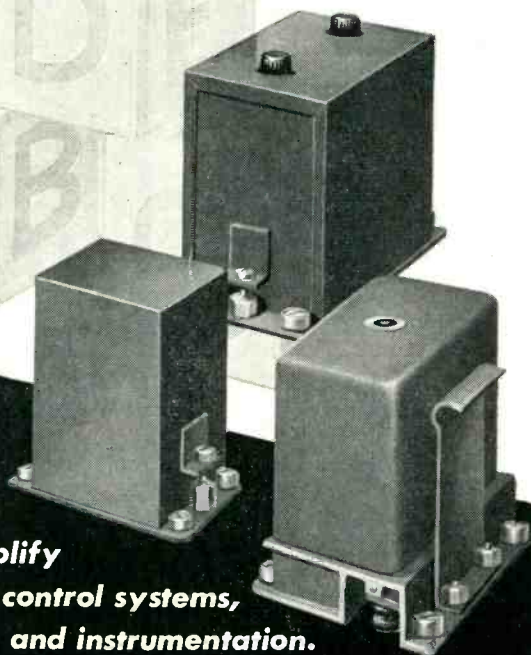
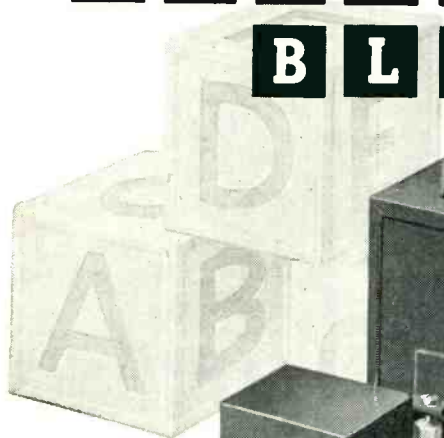

... to simplify
electronic control systems,
computers and instrumentation.

Servomechanisms, Inc. "building block" or packaged function technique reduces intricate "all in one" systems into simple, standard electronic components which plug into pre-wired chassis. This advanced design philosophy provides **reliability, interchangeability, and ease of maintenance.**

The same concept has been applied to
Servomechanisms, Inc. expanding
line of transducers.

Universally accepted and proven in combat, these "building blocks" are available for 60 and 400 cycle applications. Write to Dept. CLO-4 for complete information.

A typical Servomechanisms, Inc. analog computer and transducer for aircraft instrumentation.

SERVOMECHANISMS INC.

Westbury Division
Post and Stewart Aves., Westbury, N. Y.

El Segundo Division
316 Washington St., El Segundo, Calif.

POSITIONING MECHANISMS • SERVO AMPLIFIERS • MODULATORS • POWER SUPPLIES
SERVO MOTORS • ADAPTERS • TRANSDUCERS • MECHANICAL DEVELOPMENT APPARATUS

Want more information? Use post card on last page.

PLANTS AND PEOPLE

(continued)

dent, late this summer.

Sturgeon is treasurer of the tv and radio-phonograph concern, while Rankin serves as director of engineering.

Sturgeon joined Magnavox in 1940 as comptroller and in 1949 was elected treasurer. Prior to that he served as senior accountant with Price, Waterhouse and Co. in Chicago for six years and in a similar capacity with Haskin and Sells.

Rankin joined Magnavox in 1951 as director of engineering. He is in charge of development, design and engineering for production of all civilian and military equipment.

Prior to joining Magnavox he served for a number of years as an executive engineer in the radio and electronics industry, including prominent positions with Belmont Radio Corp. and RCA.

The new vice-presidents will make their headquarters at the company's main office in Fort Wayne, Indiana.

LaPointe Buys Printed Circuit Company

LaPointe Electronics has purchased a 95 percent interest in Circuitron, manufacturer of printed circuits, it was announced by Jerome E. Respass, president. "By acquiring and managing Circuitron," Mr. Respass stated, "LaPointe is assured of a continuing supply of the printed circuits used in the Vee-D-X Mighty Match and other tv accessories. In addition, LaPointe will manufacture printed circuits for a wide variety of fields within the electronic industry."

Circuitron is being moved to Rockville, Conn. where it will take over space in another factory building near the main LaPointe plant. Initially, approximately 50 people will be employed to operate Circuitron, with additional personnel being acquired as expansion continues.

GE Plans Increase In Aluminized TV Tubes

A FIFTY-PERCENT increase in its production of aluminized tv picture tubes is expected by GE when a multimillion-dollar retooling project, now under way at its Buffalo

... TO A
**SENIOR
 ENGINEER**

**Interested In a
 Challenge As Great
 As All Tomorrow**

If . . .

you're the man we hope you are, you now have a good position. Perhaps you have not thought of a change but will consider the right opportunity.

You have at least five years of experience in electronics or an allied field. You desire to do more than just carry assignments to satisfactory conclusions. You have a burning desire to blaze new trails on the horizon, and feel yourself ready to do it.

You would appreciate an opportunity and the "go ahead" to pioneer . . . at your own pace. You've matured in engineering . . . you know where you've been . . . you now want to know where you're going . . . and what you personally can achieve through your creative engineering talent.

If you fill these qualifications, we have an opportunity that will fascinate you. You will work with one of the foremost engineering teams in the world, and enjoy rare freedom and encouragement. The last word in equipment would be at your fingertips. No richer benefits are offered anywhere . . . regardless of the standards by which you measure.

Are YOU the man we hope you are? If so, write us with full trust.

Send your resume to:

JOHN C. WELD
 Supervisor of Employment
 254 Rano Street, Buffalo 7, New York

DONALD BRADLEY
 Personnel Supervisor
 70 Forsyth Street
 Boston, Mass.



**SYLVANIA
 ELECTRIC PRODUCTS INC.**

RADIO AND TELEVISION DIVISION
 254 RANO STREET
 BUFFALO 7, NEW YORK

ZOPHAR

WAXES

COMPOUNDS

Zophar Waxes, resins and compounds to impregnate, dip, seal, embed, or pot electronic and electrical equipment or components of all types; radio, television, etc.

Cold flows from 100°F. to 285°F.

Special waxes non-cracking at -76°F.

Compounds meeting Government specifications plain or fungus resistant.

Let us help you with your engineering problems.

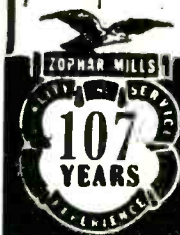

ZOPHAR MILLS, INC.
 112-130 26th Street,
 Brooklyn 32, N. Y.

"STOCK" SHIELDS AVAILABLE



Now Multi-Metal offers you "STOCK" magnetic shields—for immediate delivery. These shields are accurately fabricated to meet your highest standards of quality and provide maximum production economy. Let us quote on your requirements.

Multi-Metal also serves your special needs for custom-built shields, cabinets, chassis, panels and other sheet metal components, including large assemblies . . . long or short runs. Our engineering staff will help you solve design and production problems. For prompt quotations, send us your blueprints and specs.

PRECISION FABRICATION

Cabinets • Chassis
 Shields • Panels
 Dust Covers • Racks
 Brackets • Dial Plates

You Can Depend on

Multi-Metal

FABRICATION IN ALL METALS

MULTI-METAL COMPANY
 1350 Garrison Avenue • New York 59, N. Y.

Winchester Electronics

INCORPORATED

MINIATURE CONNECTORS*

are employed in many advanced, quality designs of AIRBORNE ELECTRONICS EQUIPMENT to meet miniaturization requirements

MINIATURE HIGH-VOLTAGE Type "PM"

SHOWN HALF SIZE

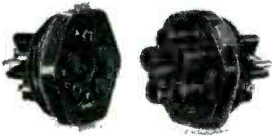

These Miniature Connectors are available with various numbers of contacts. Please send your inquiries for variations of these types...or for entirely new designs...to our Engineering Department.

MINIATURE Type "M"



ACTUAL SIZE



(USED WITH TYPE M RECEPTACLE)

HERMETIC MINIATURE PLUG Type "HM"



SUB-MINIATURE RECTANGULAR Type "SMRE"

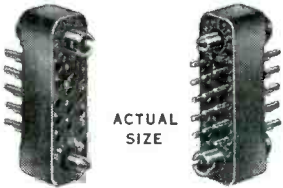

ACTUAL SIZE

MINIATURE RECTANGULAR Type "MRE"

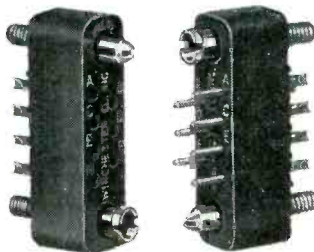

ACTUAL SIZE

(USED WITH TYPE MRE RECEPTACLE)

HERMETIC MINIATURE RECTANGULAR PLUG Type "HMRE"



WINCHESTER PRODUCTS AND WINCHESTER DESIGNS Are AVAILABLE ONLY FROM WINCHESTER ELECTRONICS INCORPORATED

MINIATURE INSERT in PRESSURE-TIGHT SHELL Type "B"



SHOWN HALF SIZE

* "MONOBLOC" CONSTRUCTION * PATENTED AND PATENTS PENDING

WINCHESTER ELECTRONICS INCORPORATED

GLENBROOK, CONN., U.S.A.

West Coast Branch (Engrg. & Sales Offices): 1729 Wilshire Blvd., Santa Monica, Calif.

WRITE OR WIRE TODAY FOR FULL DETAILS

PLANTS AND PEOPLE

(continued)

and Syracuse plants, is completed.

Almost three-quarters of GE picture-tube production then will be in the aluminized tubes, according to J. Milton Lang, general manager of the GE tube department.

Lang said increased production of the tubes is necessary because the company presently cannot meet the demand for them in both initial equipment and replacement use.

The retooling operation affected more than 60 percent of the Buffalo plant equipment, and about 90 percent of the Syracuse plant equipment. Work began early this year, and a major share of the project was completed at both plants during the two-week vacation shutdown early in July.

The tube department is also converting a former GE dishwasher plant at Scranton, Pa., for full-scale production of hydrogen-thyratron tubes for the nation's radar fence.

Clevite Elects Operations V-P



Herman L. Weckler

ELECTION OF Herman L. Weckler as vice-president, operations, of Clevite Corp. was announced by James L. Myers, president.

Weckler retired on April 30 from Chrysler Corp. where he was vice-president, general manager and a director for the past 13 years. In his new post he will have general responsibility for the operations of Clevite Corp's manufacturing and selling units including Cleveland Graphite Bronze Co., Brush Electronics Co., Harris Products Co.,

(Advertisement)

NONINDICATING METER-RELAY



1% accuracy — 0.2 microampere sensitivity — 100 watts load contact rating. These are some of the features you get in a nonindicating meter-relay like the one in the photo. It is a moving coil relay and it will do things you never expected without vacuum tubes.

Accuracy

Factory adjustment is within 2% of the specified current or voltage for most units. It can be adjusted at installation to better than 1%. In fact, one customer (name on request) reports ¼% on a battery charger shutoff.

Sensitivity

Any setting between 0.2 microamperes and 50 amperes, or from .05 millivolts to 500 volts can be furnished. Higher ranges can be made with external multipliers. The sensitivity is adjustable at installation over a wide range to meet specific needs.

Contacts

S.P.S.T. or S.P.D.T. in several ratings. Normal contacts have ratings up to 100 DC milliamperes for "make" only. Heavy duty contacts are rated 1 ampere at 115 V. AC or 32 V. DC for "make" or "break." The diagram shows the internal arrangement and auxiliary equipment needed for the heavy duty contacts.

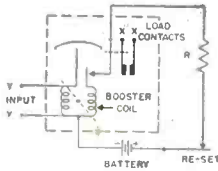

Speed

Design variations allow for a range of response time from 1 millisecond to 10 seconds on most sensitivities.

Case Style

The clear plastic case shown is in production. It is approximately 2½" cube, including terminals. This relay is adaptable to other mountings, including hermetically sealed plug-in cans.

Shock & Vibration

Samples have withstood roll and pitch tests required for shipboard use. Internal shock mounting might be used to make it stand most shock and vibration tests. For further specifications, write or call Bradley Thompson at Assembly Products, Inc., Chagrin Falls 43, Ohio; phone CH 7-7374.

SMALL METAL STAMPINGS

Send your prints for regular or special stamping jobs to Patton-MacGuyer where specialized engineering experience and tool-making skill combine to produce stamped metal parts accurately, economically, promptly. A dependable source for over 35 years, P-M is completely equipped in an extensive modern plant for large volume production to meet the most exacting requirements. Moderate die charges; precision work; prompt service.

P-M welcomes the opportunity of working with your engineers in the initial stages of their special stamping designs when the accumulated specialized knowledge of our Technical Staff will aid them in obtaining the most efficient stamping at the lowest cost.

TERMINALS for ELECTRIC WIRES

Specializing in terminals, P-M has dies to produce over 400 different kinds of terminals. We also provide pre-soldered and solder terminals supplied on reels, with machines that attach and solder at rates up to 1200 perfect terminations per hour. Send for catalog.

PATTON-MacGUYER COMPANY

201 Chapman Street, Providence, R. I.

STEADY as she goes!

GYROMECHANISMS, INC.

HALESITE • LONG ISLAND • NEW YORK

GYROSCOPES • POTENTIOMETERS • ELECTRONIC AND HYDRAULIC DEVICES

for Instrumentation and Control

WRITE FOR DETAILED INFORMATION

DEPEND ON

Bendix

Red Bank

RELIABLE ELECTRON TUBES

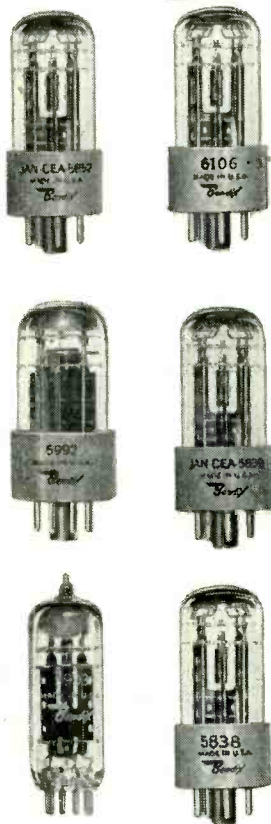

With electronic controls taking over more and more operational functions in aircraft, it's becoming increasingly important that the electron tubes used be dependable under conditions of high altitude, continuous vibration, varying voltages and frequent shock. Because of their advanced design and construction . . . born of never-ceasing research and special production skills . . . Bendix Red Bank Reliable Electron Tubes have the dependability necessary to meet these severe operating conditions. You can depend on our long, specialized experience to give you the right answer . . . for all types of regular as well as special-purpose tube applications. Call on us for full details.

*Manufacturers of Special-Purpose Electron Tubes,
Inverters, Dynamotors and Fractional D. C. Motors*

TYPE AND MODEL INDEX				TYPICAL OPERATING CONDITIONS		
Bendix No.	RTMA No.	JAN No.	General Type	Heater Voltage	Plate Voltage Per Plate	M.A. Load
TE-2		5839	OCTAL FULL WAVE RECTIFIER	26.5	350	70
TE-3	5838		OCTAL FULL WAVE RECTIFIER	12.6	350	70
TE-5		5852	OCTAL FULL WAVE RECTIFIER	6.3	350	70
TE-10	5993		MINIATURE FULL WAVE RECTIFIER	6.3	350	70
TE-22	6106		OCTAL FULL WAVE RECTIFIER	5.0	350	100

BEAM POWER AMPLIFIER TUBE	
SPECIFICATIONS	
BENDIX NO.	TE-8
RTMA NO.	5992
HEATER VOLTAGE	6.3 V
PLATE VOLTAGE	250 V
SCREEN VOLTAGE	250 V
GRID VOLTAGE	12.5 V
G. M.	4000
PLATE CURRENT	45 MA
POWER OUTPUT	3.5W

Bendix

Red Bank

DIVISION OF



EATONTOWN, N. J.

Export Sales: Bendix International Division, 205 East 42nd St., New York 17, N. Y.

Clevite Service and Clevite of Canada.

At Chrysler Mr. Weckler was made vice-president for labor relations in 1935, and the same year was also put in charge of the De Soto division. In 1940 he became vice-president, general manager and director of Chrysler Corp. During World War II he served in addition as president of the Dodge division.

Westinghouse Patents For Public Use

WESTINGHOUSE ELECTRIC CORP. recently turned over to U. S. Patent Office for public use 231 patents, primarily related to the electronics field. These patents may be used by anyone, without license or payment of royalties.

On the list are a number of patents dealing with electronic-discharge devices, transformers, amplifiers, resistors, rectifiers, circuit breakers and dynamo-electric machines.

A complete list of patents as well as a pamphlet with 609 patents previously available for free unrestricted use may be obtained without charge from the U. S. Patent Office, Washington 25, D. C.

Mullard Appoints Joint Lab Managers

P. E. TRIER and G. Knott have been appointed joint managers of the Mullard Research Laboratories in England.

Trier was engaged at the Admiralty Signal and Radar Establishment from 1941 until 1950. During the War he developed direction finding techniques in the meter and centimeter-wave regions. Later he was head of the vhf communications group. He joined Mullard in 1950 as head of the communications and radar division.

In his present appointment, Trier will direct the electronics laboratory and be responsible for work in the fields of communications, radar, special-circuit techniques, particle accelerators, special components and materials, tube applications, ultrasonics and metal physics. He will also act in the capacity of plant head.

Knott commenced his career as

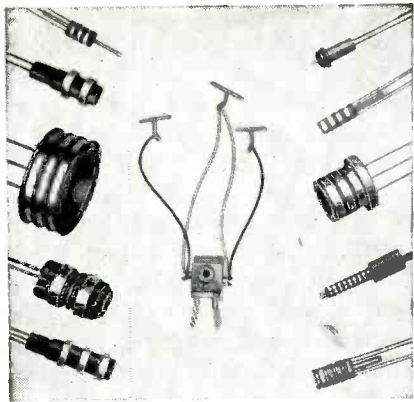

Miniature and Sub-Miniature
SLIP RING ASSEMBLIES
BRUSH BLOCK ASSEMBLIES
COMMUTATORS

and other
 Electro-Mechanical Components

**PRECISION MADE
 TO YOUR OWN SPECIFICATIONS**

Precision molded products with exacting tolerances in precious and non-precious solid metals of all alloys. All types of Thermo-Plastic and Thermo-Setting materials.

Slip Ring Assemblies fabricated or one-piece precision molded to your specifications in Nylon, Kel-F, Mineral filled Mellamine, Phenolic, and other materials. Rings and leads spot welded or brazed together for positive electrical circuit.

Our Swiss methods and techniques are geared to meet exacting requirements. We invite your inquiries.

COLLECTRON CORPORATION

Murray Hill 2-8473 • 216 East 45th Street • New York 17, N. Y.

**MAKING
 TRANSFORMERS
 IS OUR
 BUSINESS**

• For more than 35 years Acme Electric transformers have become components of all types of electrical and electronic equipment. The vast technical experience accumulated during this time is now available to west coast manufacturers through our Los Angeles branch.

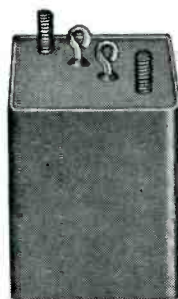
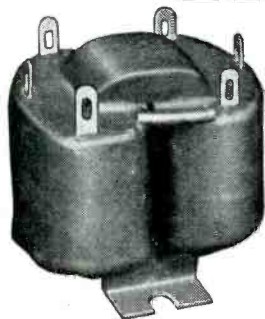

ACME ELECTRIC CORPORATION
 MAIN PLANT: 3110 Water Street • Cuba, N. Y.

West Coast Engineering Laboratories: 1375 W. Jefferson Blvd. • Los Angeles, Calif.
 In Canada: ACME ELECTRIC CORP. LTD. • 50 North Line Rd. • Toronto, Ont.

Acme  Electric
 TRANSFORMERS

336K Multimeter Kit \$12.90
 Wired \$14.90
 1000 ohms/volt



425K 5" Scope
 Kit \$44.95,
 Wired \$79.95.



YOU BUILD

EICO

**KITS
 IN ONE
 EVENING-**

**but they
 last a lifetime...
 and you
 save 50%**

24 INSTRUMENTS -
 the Industry's most complete
 line of **MATCHED
 TEST INSTRUMENTS**

1/4 - million EICO Instruments are now in use the world over! That's the proof of EICO's leadership in Value.

For latest precision engineering, finest components, smart professional appearance, lifetime performance and rock-bottom economy—see and compare the EICO line at your jobber's today before you buy any higher-priced equipment! You'll agree with over 100,000 others that only EICO Kits and Instruments give you the industry's greatest values at lowest cost.

Write NOW for
**FREE latest Catalog
 E-10**



625K Tube Tester
 Kit \$34.95,
 Wired \$49.95.



221K VTVM Kit \$52.95,
 Wired \$49.95.



565K Multimeter Kit \$24.95,
 Wired \$29.95,
 20,000 ohms/volt.



NEW 377K
 Sine & Square Wave Audio Gen.
 Kit \$31.95. Wired \$49.95.

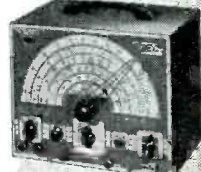

340K Sweep Gen.
 Kit \$34.95. Wired \$49.95.



1G40K Battery Elim.
 Kit \$22.95. Wired \$34.95.

**Laboratory
 Precision
 at Lowest Cost**

Prices 5% higher on West Coast.

EICO

©1952 **INSTRUMENTS & KITS**
ELECTRONIC INSTRUMENT CO., Inc.
 84 Withers Street, Brooklyn 11, N. Y.



Capacitors

MIFILM SUBMINIATURE CAPACITORS WITH PLASTIC "MYLAR"*** DIELECTRIC

Good-All production techniques make it possible for MIFILM capacitors to be available in sizes smaller than other miniaturized brands. All Good-All MIFILM miniaturized metal enclosed hermetically sealed capacitors normally operate between -65°C and $+150^{\circ}\text{C}$. Insulation Resistance, 10^{15} ohms. Power Factor less than .5%. Sizes from .173" dia. x $21/32$ " long (.001 mfd, 600 VDC) to .750" dia. x $1-15/16$ " long (1 mfd, 600 VDC) slightly larger sizes to 1000 VDC. We invite sample orders for your inspection.

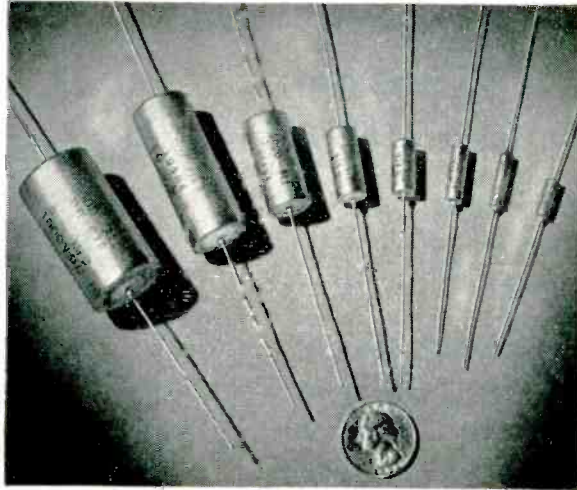

MARBELITE

"Hard as marble," and popularly priced, this Good-All development is the standard for leading Radio and TV manufacturers. Generally smaller than RTMA specifications MARBELITE capacitors normally operate in the -30°C to $+100^{\circ}\text{C}$ range. Built for any climate, MARBELITE capacitors can be further miniaturized to meet your needs. Standard sizes from .001 mfd to 1 mfd in 100 to 1000 VDC. Write for catalog sheets M-503.

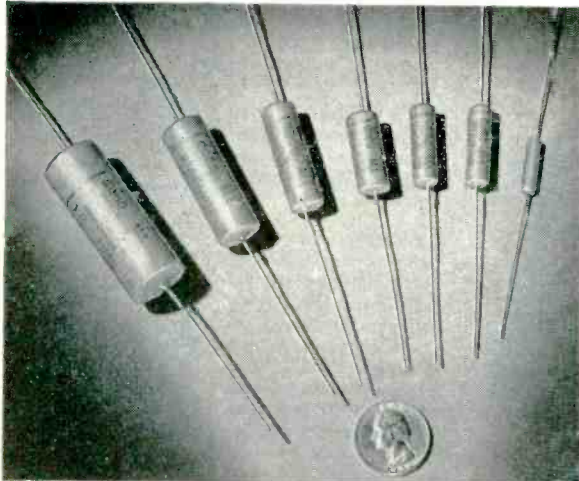

MIRACLE X

Paper dielectric, metal enclosed, hermetically sealed, MIRACLE X impregnated capacitors. Capacity change less than 5% from -50°C to $+125^{\circ}\text{C}$. Meets or exceeds size requirements of MIL-C-25. Available with all type mounts. Sizes from .235" dia. x $11/16$ " long (.001 mfd, 600 VDC) to 1" dia. x $2-3/16$ " long (1 mfd, 600 VDC).



*DUPONT'S
Trademark
for its
POLYESTER FILM

Capacitors are wound on Good-All developed, enclosed, automatic winding machines—no finger acid, dirt or dust. Good-All engineers invite your inquiries and problems regarding tubular capacitors. The difficult and unusual interest us.

Write for complete catalog covering all Good-All long life capacitors.



ELECTRIC MFG. CO.

114 W. FIRST ST. Phone 112-113 OGALLALA, NEBR.

ROBERT A. GOODALL, President

Cable Address, "GOODALLA"

a physicist to the Calico Printers Association in 1935. From 1937 until 1940 he was engaged in research on x-ray crystallography at Cambridge University.

In 1940, he joined Mullard first as development engineer on transmitting tubes and later on vhf tubes. He was placed in charge of the Mullard vacuum physics laboratory when it was formed in 1946. He will continue to direct the work of this laboratory in his new appointment and will be responsible for vhf tubes, gas discharge tubes and photoelectric devices.

Minnesota Mining Buys Irvington Varnish

PURCHASE OF IRVINGTON Varnish and Insulator Co. of Irvington, N. J., by Minnesota Mining & Manufacturing Co. was announced.

Herbert P. Buetow, 3M president, said the directors of 3M have approved a \$7-million agreement by which Irvington becomes a division of 3M. Mr. Buetow said Irvington stockholders will receive 3M common stock and cash in exchange for their Irvington stock.

Buetow and Arthur E. Jones, Irvington president, said the move is a natural one in view of their respective interests in the field of electrical insulation.

"Like 3M, Irvington Varnish and Insulator Co. has had a long-term research program aimed at improving existing products and developing new products," Buetow said. "We think it is of tremendous importance to our company's continued growth to expand our services to the electronics industry. This industry is already one of the largest in America even though many phases of its development are just getting started."

According to president Buetow, 3M has no plans to change Irvington Varnish and Insulator's operating policies or its management team. Jones will continue as president of the division. All other officers and executives will continue in their present capacities.

Robert L. Westbee, who was recently elected a vice-president of 3M, will be responsible for liaison between the parent company and

TEST CHAMBERS



Send for complete illustrated brochure



HIGH & LOW TEMPERATURES

CONTROLLED HUMIDITY

- -150°F. to +200°F.
- 20% to 95% R.H.
- 1 cu. ft. to 75 cu. ft. cabinets.

**Walk-in Rooms
Temperature Baths**

Electronic or pneumatic recording or indicating control systems

**CUSTOM CHAMBERS
built to specifications.**

Years of satisfactory service!

55 Washington Avenue
Carlstadt, New Jersey

WAVEGUIDE and MICROWAVE COMPONENTS

for **ATTENUATORS
and TERMINATIONS**

- SIGNAL SOURCE
- IMPEDANCE MEASUREMENT
- FREQUENCY MEASUREMENT
- TRANSMISSION LINE COMPONENTS
- DETECTION and POWER MEASUREMENT

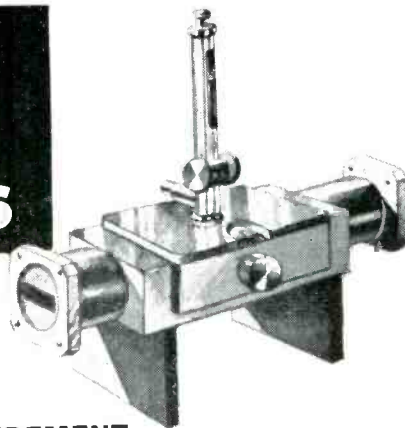

...the emblem associated with
PRECISION...DEPENDABILITY

Our engineering staff will cooperate in making custom components to your specifications
write now for complete information to:

UNIVERSAL MANUFACTURING COMPANY, INC.
• MICROWAVE DIVISION •
410 Hillside Avenue — HILLSIDE, NEW JERSEY

PRECISION

SYNCHROS SERVO MOTORS RATE GENERATORS

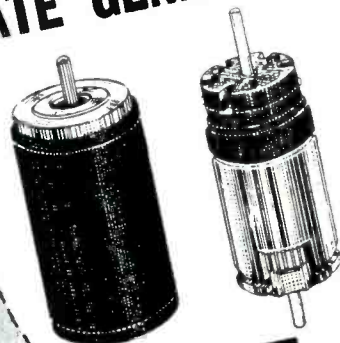

Infra Electronic Corporation is playing an important part in the precision manufacture and assembly of electronic and electro-mechanical system components for the Military.

We invite your inquiry when commercially available units will not meet your system demands.

Custom design, development, and manufacture of Test Sets, Kits and Consoles for pre-flight check out and ground maintenance of airborne systems.

INFRA

Electronic Corp.

== Roseland, New Jersey ==
Manufacturers of Precision Synchros

MOTOR DATA
No. 125

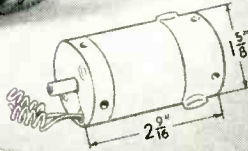
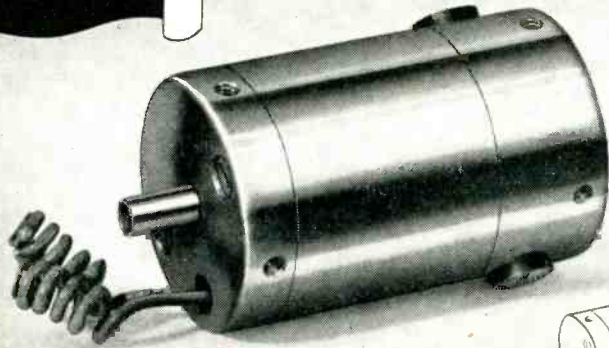

EICOR

1600 FRAME MOTOR

Torque 4.5 in. oz. at 5800 RPM

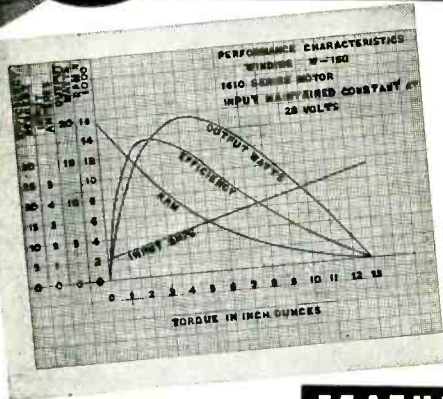

The power output of this precision motor is exceptionally high in proportion to its light weight and small size. Originally developed for numerous aircraft and portable applications, the characteristics of its performance can readily be modified for a variety of new uses.

FEATURES

- | | | | |
|-------------------------------|-------------------------------|-------------------|---|
| ↓ | ELECTRICAL | MECHANICAL | ↓ |
| Series or shunt wound | Completely enclosed | | |
| Unidirectional or reversible | Adaptable for any mounting | | |
| High starting torque | Laminated field poles | | |
| Low starting current | Stainless steel shaft | | |
| Low RF interference | Two precision ball bearings | | |
| Armature and field windings | Mica insulated commutator | | |
| Varnish impregnated and baked | Permanent end play adjustment | | |

1600 FRAME MOTORS		Series	Shunt
Watts Output, Int.	(max.)	22	
Watts Output, Con.	(max.)		5
Torque at 8500 RPM	(in. oz.)	3	
Torque at 5800 RPM	(in. oz.)	4.5	1
Lock Torque	(in. oz.)	12	3
Volts Input	(min.)	5	5
Volts Input	(max.)	32	32
Shaft Diameter	(max.)	.250"	.250"
Temperature Rise		50°C.	40°C.
Weight		12 oz.	12 oz.

Eicor, Inc. 1501 W. Congress St., Chicago 7, Illinois

DYNAMOTORS · INVERTERS · ELECTRONIC CONTROLS · ALTERNATORS · MOTORS

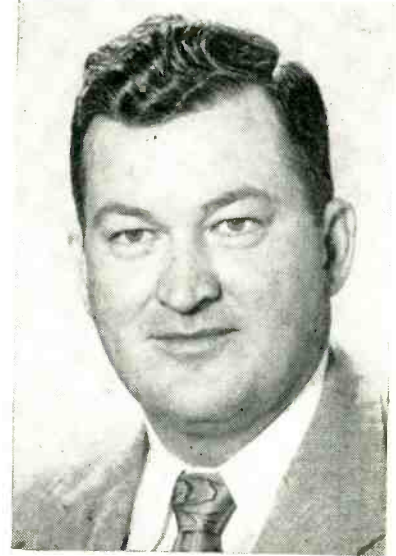

Robert L. Westbee

the new division. He heads 3M's newly created electrical products division. This new organization includes the electrical insulation and sound-recording tape division and the American Lava Corp. in addition to Irvington.

Mr. Westbee joined 3M as a technician in 1933, shortly after graduation from the University of Minnesota. In 1940 he was assigned to electrical-tape engineering. He was named sales manager of the electrical insulation and sound-recording tape division in 1944 and has been general manager of that division since 1948.

Paul D. Miles Rejoins FCC

PAUL D. MILES has been named engineering assistant to Rosel H. Hyde, chairman of the Federal Communications Commission.

Miles has rejoined the Commission staff after a leave of absence of more than five years, which enabled him to serve as a member of the International Frequency Registration Board (IFRB) of the International Telecommunication Union (ITU) with headquarters at Geneva, Switzerland.

From November 1945 to December 1947 he had been chief of the Frequency Allocation Service of the FCC's then Engineering Department. A graduate of the U.S. Naval Academy in 1927, Miles served in various Naval posts and

Ultraviolet Laboratory Equipment

UTILITY MODEL QUARTZ LAMP



A high pressure, quartz mercury arc lamp. It is ideally applicable for use with the microscope, polarimeter, spectrometer, and general laboratory applications.

INSPECTOLITE



A source of "black light" for making rapid qualitative analyses by visual observation.

OPTOSIL



1787

Fused quartz suitable for many optical uses. Hanovia's special manufacturing process greatly reduces the size and number of air bubbles as compared to general commercial grades. Higher optical grades available.

Write for technical data on these or other ultraviolet laboratory equipment.

HANOVIA
CHEMICAL & MFG. CO.

(Special Products Division)

100 CHESTNUT STREET, NEWARK 5, N. J. — Dept. E-1053

U. G. CONNECTORS

*Our Coaxial Cable
Connectors Meet All
Government Specifications*

★ ALL ORDERS DELIVERED PROMPTLY ★

*Manufacturers of
Highest Quality Connectors*

ALLIED INDUSTRIES, INC.

1023 S. 21st STREET
LOUISVILLE 10, KY.

Phone Arlington 4640

For the
**FIRST
TIME**

LOW COST SCREEN ROOMS

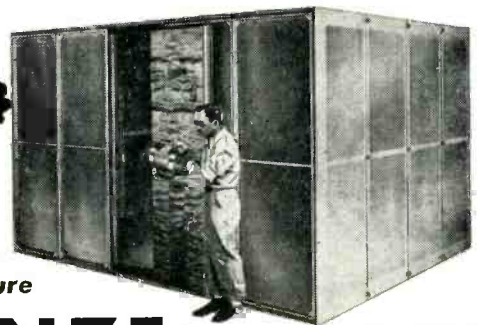

PATENT PENDING

A Sturdy Double-
Shielded Enclosure

in BRONZE

Guaranteed attenuation 126—128 DB in Bronze . . . 142—146 DB in Copper. Used by world's largest industrial and electronic equipment manufacturers and U. S. Government engineers. Meets military specifications. Available with double or single frame models. Complete line of portable standard sizes . . . or special sizes. MAIL COUPON for illustrated circular with construction diagrams and performance charts.

. . . COPPER BRONZE . . .

ACCURATE *Lindgren* SHIELDING ENCLOSURE

4515-17 N. RAVENSWOOD AVE.
CHICAGO 40

Sales and Engineering
Representatives throughout
the United States

ERIK A. LINDGREN & ASSOC. (MFRS.)
4515-17 N. Ravenswood, Chicago 40

Please send illustrated circular, construction diagrams, and performance charts on the NEW Lindgren Screen Rooms.

ANOTHER

QUALITY

PRODUCT

NAME

ADDRESS

CITY

STATE

GM DIESEL *Stand-by* GENERATOR SETS

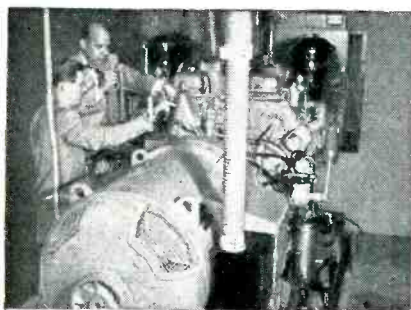

WJR—Detroit, Michigan, uses 200 kw. GM Diesel generator set as stand-by power for 50,000-watt transmitter. Compactness of unit permitted installation in garage adjoining transmitter building—eliminating cost of a specially designed building.

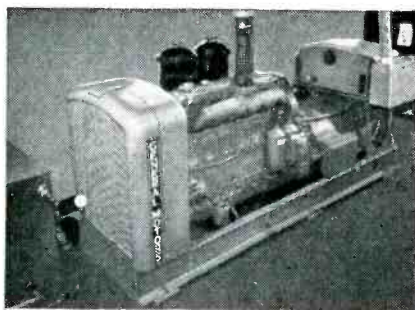

WKTV—UTICA, N. Y., uses a 100 kw. General Motors Diesel generator set for stand-by power. Set can be started remotely from the control room. Low vibration characteristic of engine permitted installation in room adjacent to transmitter and within 30 feet of studio.

If you are planning stand-by power, be sure to check the advantages of General Motors Diesel generator sets, listed briefly below. GM Diesel generators are meeting the exacting requirements of military service in all parts of the world. They supply emergency power for more than 1100 telephone and telegraph exchanges—for microwave relay stations, for hospitals, government buildings, banks, airports. There is a GM Diesel distributor near you who will analyze your power requirements and make his recommendations without obligation. Look in the yellow pages of your phone book for his listing, or write direct to us.

- Wide range of models—12½ to 200 kw., 220 or 440-volts, single or three-phase current.
- Excellent frequency and voltage regulation for the most exacting requirements.
- Powered by General Motors Diesel engines—dependable, smooth 2-cycle operation—low cost maintenance—easy to service.
- Built by one manufacturer—one warranty, one responsibility for both engine and power generator.
- Instant push-button power starting on safe Diesel fuel—or fully automatic starting. Immediate power, no "warm-up" period.
- Dependable starting—no spark-ignition system to fail because of dampness or corrosion—always ready to start.
- Easy to install—compact—lightweight—requires no special building, no special base. Complete instrumentation provided.
- Distributors and Dealers throughout the country.

DETROIT DIESEL ENGINE DIVISION

GENERAL MOTORS • DETROIT 28, MICHIGAN

SINGLE ENGINES . . . 16 to 275 H.P. MULTIPLE UNITS . . . Up to 840 H.P.

It pays to Standardize on

Write for Generator Set Catalog 6 SA 20.



then with Mackay Radio and Hearst Radio. Returning to the Navy in 1941 he became assistant chief and later chief of the Frequency Section of Naval Communications in the period to 1945. His naval service won him the Legion of Merit.

Answers From A Computer 500 Miles Away



A. W. Jacobsen, director of the Wayne University Computation Laboratory in Michigan, left, and Harry Huskey, technical director, watch as a test problem is fed to the teletype by research technician Gerald Licht. The message went instantly into the Burroughs Corp. electronic digital computer (right) in the firm's Philadelphia Research Laboratory where it solved the problem in seconds and sent the answer back to the teletype receiver at Wayne. Remote-control operation of the Burroughs computer will enable students attending a special two-week course on computers to gain practical experience in the use of giant calculators

Stanford Research Expands Air Lab

THE ENGINEERING DIVISION of Stanford Research Institute has revised and expanded the organization of its aircraft radiation systems laboratory.

Thomas H. Morrin, director of engineering research, has announced that expansion of industrial services in aircraft and communications programs has necessitated regrouping of related technical sections under a radio systems laboratory, by which name the new arrangement will be known.

Morrin has further announced that the broadened scope of research and development on the areas of radio communications at



TAXI! TAXI!

You may save money by using our precision equipment and experienced personnel on a "taxi" basis.

You may profit thus by avoiding investment in plant and machine tools and people, and in painful experimenting.

Our motor is warm, we know our way around, and we charge only for actual mileage that you use.

CONRAD & MOSER

*Workers in Aluminum,
Brass, Steel & Plastics*

DESIGNING
ENGINEERING • MANUFACTURING
MECHANISMS • MACHINES
PARTS • TOOLS • DIES • MOLDS
STAMPINGS • CASTINGS
MACHINING • SHEET METAL
ENCLOSURES & CHASSIS
1/8 to 1/2 NAVY SPEC ALUMINUM
SPOT WELDING AND HELIARC
WELDING.

2 Borden Ave.
Long Island City 1, N. Y.

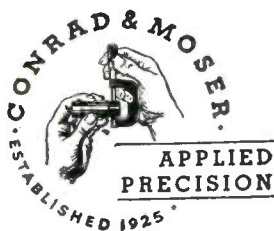

encapsulated

PULSE TRANSFORMERS

wound to your requirements

SMALL IN SIZE

Weight—1/3 oz.

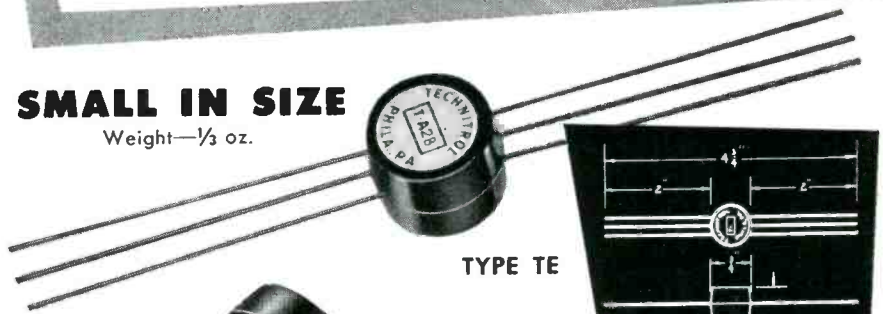

TYPE TE

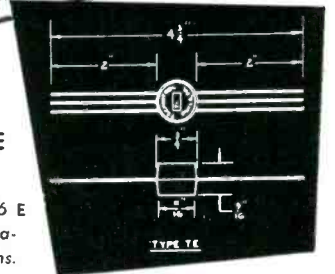

TYPE TE

TYPE TP



Write for Bulletin 166 E
for additional information
and specifications.

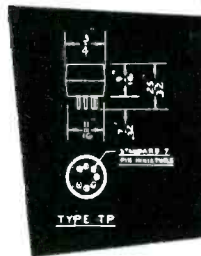

TYPE TP

SMALL IN PRICE

As low as \$5.00 each in quantity
lots. One to three—\$7.50 each.



TECHNITROL

ENGINEERING COMPANY

2751 N. 4th St., Philadelphia 33, Pa.

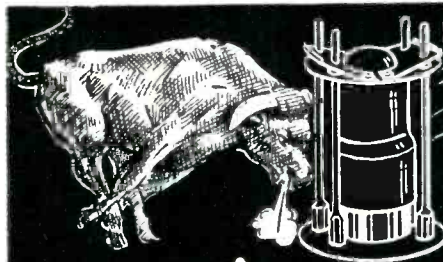

SHOCK PROOF

VACUUM TUBE RETAINERS

These retainers are used to secure Vacuum Tubes and to resist side motion of Vacuum Tubes used in radio equipment which is subject to shock and vibrations. These retainers meet the requirement of all JAN specifications. The insulated portion is made of a melamine base Fibre Glass Phenol which provides 300 volts insulation to ground and withstands a temperature of 350 F. The insulated plate can readily be fastened or released by hand.

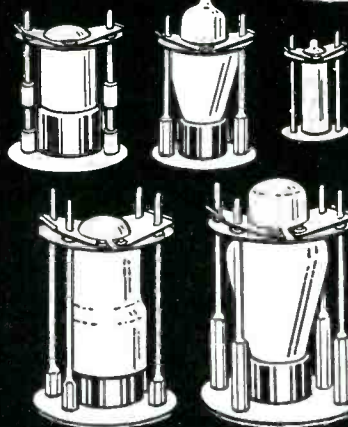

Available for envelope types T7, T8, MT8,
T9, T12, ST12, T12ZDL, ST14, S14, ST16,
T5 1/2, T6 1/2, MT-IC, ST19, T14, ST128CT-9.

Manufacturers of
Electronic Components

JAMES IPPOLITO & CO., INC.

401 CONCORD AVENUE, BRONX 54, N. Y.



*offers many
exclusive advantages
in..*

Receptacles & plugs

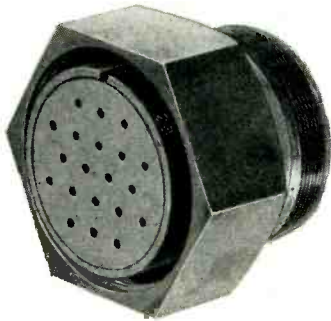

Pressurized & Waterproof
RECEPTACLES

Cable Type
RECEPTACLE & PLUG

Waterproof **CAPS**

Special Waterproof
CABLE CLAMPS

High Voltage
RECEPTACLE & PLUG

Capacitor Type
RECEPTACLE

New catalog literature is available on the outstanding, quality line of **RECEPTACLES & PLUGS** offered by HHB.

These quality parts are available in standard sizes, and arrangements, (AN types), or special arrangements to meet your requirements.

We invite inquiries . . . no obligations.

H. H. BUGGIE Inc.

TOLEDO 4, OHIO

Sales Engineers in All Principal Cities

Skilled in Electronic Component Parts
**RESEARCH • DESIGN
ENGINEERING
MANUFACTURING**

the Institute has made it desirable to change the name of the single sideband communications group to the communications group. Formerly a separate research section, the communications group will henceforth be a part of the radio systems laboratory.

Heading the new structure will be J. V. N. Granger, assistant chairman of the engineering department. Assistant head is John T. Bolljahn.

The groups now assigned to the radio systems laboratory are: communications, John F. Honey, head, and F. W. Clelland, supervisor; antenna research, J. T. Bolljahn, head; antenna development, Allen Ellis, head; airborne applications, D. R. Scheuch, head, Henry Blanchard, supervisor; microwave, Seymour Cohn, head.

Morrin has emphasized that the revamped organization indicates no reduction in the scope of work for the aircraft industry.

Leeds & Northrup Elects New President

THE ELECTION OF I. Melville Stein as president of Leeds and Northrup Co. was announced by the board of directors. Stein, formerly executive vice-president, succeeds C. S. Redding who, after 14 years as president, becomes chairman of the board, a post that has been vacant since the death of Morris E. Leeds in 1952.

Other changes in management responsibilities also were announced. D. H. Schultz, who has been secretary and treasurer since 1940, succeeds Stein as executive vice-president while retaining the duties of treasurer. George W. Tall, Jr., vice-president, assumes the additional post of secretary.

Stein joined Leeds and Northrup as a salesman in 1919. During World War I he had been personal assistant to Thomas A. Edison when the inventor was chairman of the Naval Advisory Board. In 1928 he was appointed director of research at Leeds and Northrup. He was elected a vice-president in 1944, and in 1951 became executive vice-president.

Redding, now chairman of the board, first joined the company in

is this your timing problem?

Sorry! A. W. Haydon Company Can't Help Your Timing Here.

Only a "pro" and practice can straighten you out!

But

We are the "pro's" for precision timing. Come to us with these timing problems. You'll find that we have solved more complex A.C. and D.C. timing problems than just about anybody else. Maybe we have already solved yours. It costs you nothing to find out. Write for catalog.

The
A. W. HAYDON
COMPANY
235 NORTH ELM STREET
WATERBURY 20, CONNECTICUT
Design and Manufacture of Electro-Mechanical Timing Devices

2 OUT OF 3 Engineers Depend On BURGESS BATTERIES

FOR INDUSTRIAL ELECTRONIC APPLICATIONS

Independent surveys show 2 out of 3 engineers prefer BURGESS BATTERIES over other industrial dry batteries. There's an important reason for this popularity! BURGESS BATTERIES are backed by more years of engineering "know-how" than any other dry batteries. More and more engineers are switching to Burgess, exclusively, because they know what to expect from every BURGESS BATTERY they buy . . . top performance and long life. Whatever the application, Burgess is completely equipped to meet your exact, dry battery requirements.

Burgess provides its customers with a FREE engineering manual listing the complete line of BURGESS BATTERIES and specifications. Also a check sheet to enter new battery specifications. Write to Burgess for the name of your local distributor or, if you have a special application, write for the FREE check sheet.

BURGESS BATTERIES
BURGESS BATTERY COMPANY
FREEPORT, ILLINOIS

No. 4FH

No. Z30NX

LOW CAPACITY PRECISION WIRE WOUND RESISTORS

Manufacturers of Precision Designed Wire-Wound Products
EASTERN PRECISION RESISTOR CORP.
EPR RICHMOND HILL 18, NEW YORK
precision • quality • service

New Booklet on Gamewell Precision Potentiometers

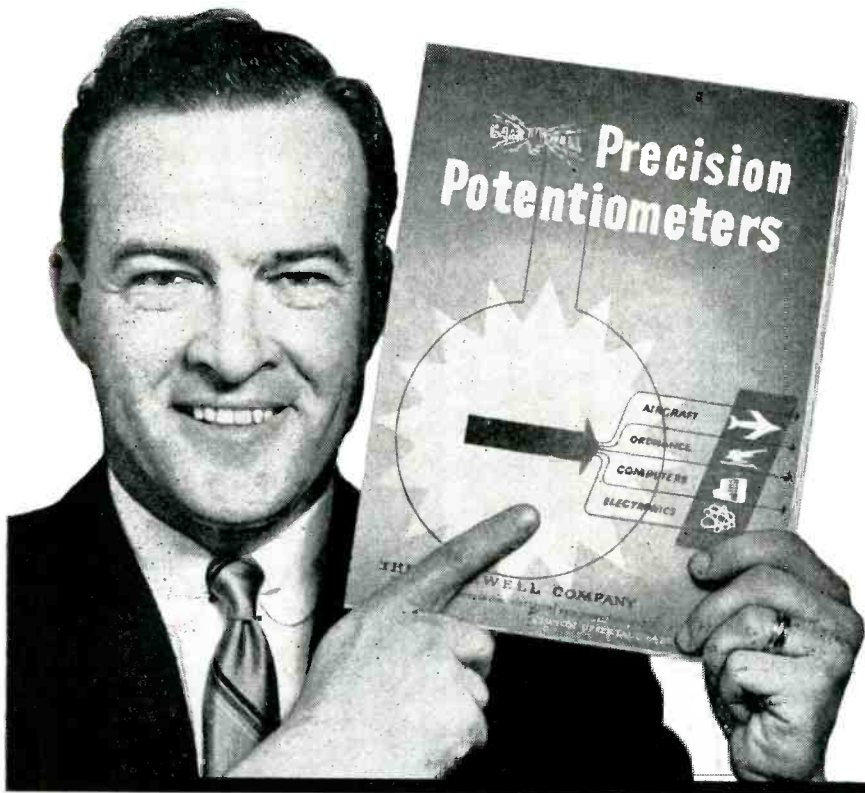

CONTENTS

- Methods of Manufacture
- Windings Available
- Linear Potentiometers description condensed specifications
- Non-Linear Potentiometers description condensed specifications
- Special Applications
- Glossary of Terms Used
- Information Required with Orders

For your copy of this new Gamewell Precision Potentiometer booklet, just send us a note on your company letterhead. Your copy will be mailed immediately, at no obligation to you.

THE GAMEWELL COMPANY • Newton Upper Falls 64, Massachusetts



Manufacturers of precision electrical equipment since 1855

1901 as a draftsman. He rejoined the company in 1909, was appointed associate sales manager in 1917 and held successively more important executive posts in the company. He was elected president just before the company was plunged into the whirl of production for World War II. Under his leadership Leeds and Northrup made its contribution to the allied war effort, including the manufacture of thousands of precision instruments used in the atomic-bomb project.

GE Resumes Latin-American Broadcasts

ROBERT B. HANNA, manager of GE broadcasting stations, announced that programs beamed at Latin America will be resumed from GE shortwave station KGEI in San Francisco.

KGEI suspended broadcasting June 27 after the Federal government curtailed the Voice of America program. The station had been America's voice in Latin America and parts of the Far East for 11 years.

Programming is being resumed on a three-hours-a-day basis under the noncommercial sponsorship of GE, Hanna said. He added that the company decided to replace the former government-sponsored programs because of the continued need for good will and understanding among the peoples of the world.

GE started shortwave broadcasting from the San Francisco Bay area in 1939 at the Golden Gate International Exposition. KGEI was the first international broadcasting station west of the Mississippi. After two years at the exposition, KGEI's transmitter was moved to San Carlos, near San Francisco and was boosted in power to 50,000 watts.

JFD Appoints Carpenter And Hall

DOUGLAS CARPENTER has been named chief antenna development engineer of JFD Manufacturing Co. He is inaugurating an expanded engineering program at the company, incorporating new high-gain designs into its antenna line.

Carpenter previously served as

New

SWITCHCRAFT[®]
INC.
"MINI-MIX"

**MINIATURE 2-INPUT
AUDIO MIXER**

- Size—Only 2 1/16" x 1 13/16" x 1 1/16".
- Weighs only 3 ounces.
- No external cables—connects directly to equipment.
- Many other new exclusive features.

LOW COST \$7⁹⁵

U.S.A. LIST PRICE

Ideal for use with Tape, Wire or Disc Recorders; Amplifiers, Musical Instruments, etc. Separate gain controls for mixing. Short lead lengths inside shielded housing minimizes "Stray Pickups". No bothersome projections. Gain control knobs located directly "in line" with inputs eliminates confusion in selection. Attractive brown finished case—nickel plated accessories. Write for details.

**SWITCHCRAFT "ADAPTERS"
Big Time Savers**

Simplify the connection of equipment having different type connectors.

**7 Different
"Adapters"
Available**

Complete description and dimensional drawings will be found in our Catalog No. S-52. Send for copy.



No. 344

Phone Jack Connector Input to Phone Plug Output.



Part No. 310
"Mini-Mix"

Phone Jack inputs with Phone Plug output fitting standard jacks.

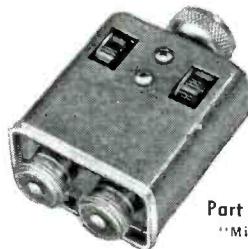

Part No. 320
"Mini-Mix"

Microphone connector input and output mating with standard mic connectors.



1336 N. Halsted St., Chicago 22, Ill.
Canadian Representative: Atlas Radio Corp., Ltd.,
560 King St., W., Toronto 2B, Canada

AVAILABLE AT ALL LEADING RADIO PARTS JOBBERS •

UNIFORMITY • DEPENDABILITY • SERVICE • ECONOMY
in **SPECIAL FASTENERS**

Get all 4 with **WESTFIELD METAL PRODUCTS**

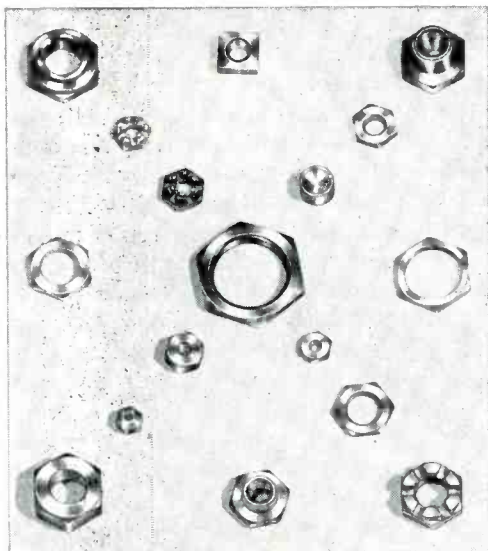

- ★ **MATERIALS**—Steel, brass, stainless steel, bronze and aluminum.
- ★ **CAPACITY**—From 3/16" hexagon to and including 1-1/16" hexagon across flats, from 1/16" thick to and including 3/4" thick.
- ★ **THREAD SIZES**—From #2 up to and including 7/8" diameters, any pitches desired.

SEMI-FINISHED MILLED-FROM-THE-BAR STANDARD AND SPECIAL NUTS
•
HEXAGON OR SPECIAL SQUARE NUTS
•
SCREW MACHINE PRODUCTS
•
PLATING AND HEAT TREATING

Write to Dept. A
for **NEW**
ILLUSTRATIVE
FOLDER

WESTFIELD METAL PRODUCTS CO., INC.
WESTFIELD, MASS.

HOW
Barnstead
PURE WATER
HELPS **RCA**

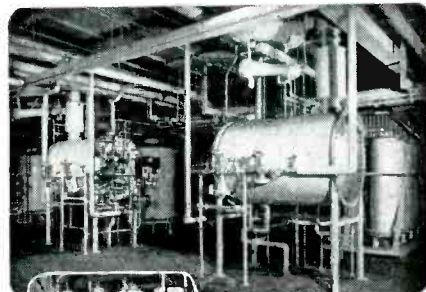

RCA requires Pure Water... copper-free to an extreme degree and free from organic impurities for trouble-free TV picture tubes. That is why RCA makes use of Barnstead 200 gph double-effect Stills in combination with Barnstead 1000 gph Demineralizers.

LIKE RCA...
THOUSANDS OF
PLANTS THE WORLD
OVER MAKE USE OF
BARNSTEAD EQUIP-
MENT FOR OBTAINING
PURE WATER

If you use water, in any of countless manufacturing and processing operations, you will find that Barnstead equipment producing either demineralized or distilled water, or both, will insure better products, consistent results, fewer rejects; and will cut your costs in many ways. Join the thousands of companies the world over who look to Barnstead for the solution to their Pure Water problems. Write today stating your problem. Our engineers will make recommendations without obligation... recommendations that will cut costs and increase production.

The Right Equipment For Your Pure Water Needs

B
75
Years of Progress
in
Pure Water

We Make Both... Stills and Demineralizers



84 Lanesville Terrace, Boston 31, Mass.

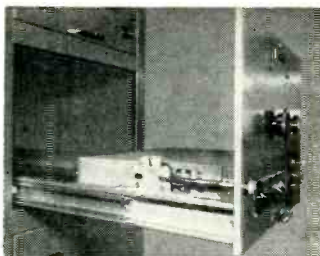

1. FULL EXTENSION — Continuous ball bearing action permits smooth, non-jar chassis removal. Locks in fully extended position, must be unlocked to return.

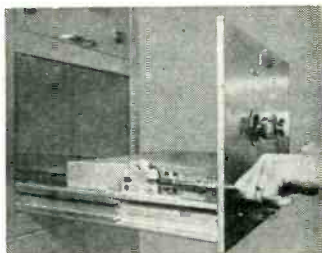

2. PIVOT RELEASE — Withdrawing release rods disengages them from quadrant mechanism, enables perfectly balanced unit to be tilted by simply raising.

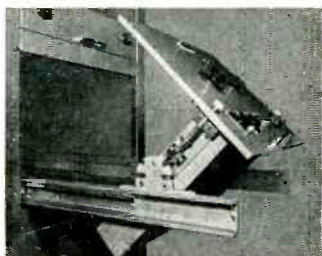

3. 45° PIVOT — Unit locks in 45 degree or 90 degree position. Special pivoted positions can be obtained to fit individual requirements.

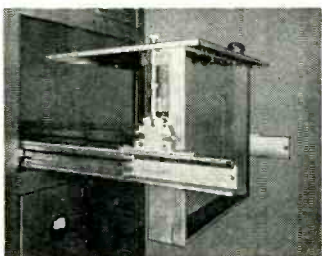

4. FULL TILT — Maintenance and repairs easily made. Access to component is gained in a few seconds. Special slides can provide plus or minus 90° tilt.

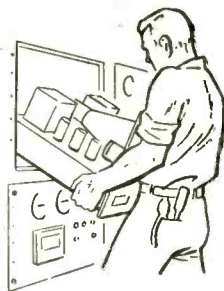

*Why put up
with this costly,
time-wasting step
any longer?...*

Design accessibility into your equipment

When repairs and maintenance of electronic equipment are needed, wasted time costs money! Alert manufacturers have totally eliminated the laborious step of "getting at" vital components by installing Grant Industrial Slides. Is your equipment mechanically up to its high electronic standards? If not, Grant offers you: Stock Slides. A great variety of types, suitable for most needs available for immediate delivery. Custom Slides. Our engineering staff will assist you at your plant and develop slides that fit your requirements perfectly.

Grant Industrial Slides



*Write for our complete Industrial Slide Catalog.
Grant Pulley and Hardware Corporation
31-73 Whitestone Parkway, Flushing, New York*



Douglas Carpenter

chief engineer for the Vee-D-X division of La Pointe Electronics, the Summit Engineering Co. and McMurdo-Silver, all in Connecticut.

James Hall has been appointed associate antenna test engineer at JFD, assisting Carpenter in development and field testing of antennas. He was previously associated with the CAA and the aviation electronics operations of the U. S. Navy as a design and research engineer.

Battelle Names Stone And Moncreiff

JAMES STONE and Bruce Moncreiff have joined the staff of Battelle Institute, Columbus, Ohio.

Stone will conduct engineering research leading to the development of digital computing systems and components for the handling of both technological information and mathematical problems. Prior to joining Battelle, Stone was employed as an electronic development engineer at the Oak Ridge National Laboratory. It was while there that he developed what is now called the Oak Ridge National Laboratory reactor-controls computer—an analog-digital computer with special applications in the study of reactors.

Previously, he was senior electronics engineer on the NEPA project conducted by the Fairchild Engine and Airplane Corp. at Oak Ridge.

Moncreiff's principal interest at the Institute is in the development of information-handling devices

TERMINAL BLOCKS NAVY TYPE



Shaw terminal blocks, produced to Navy specifications are now available from stock.

Supplied with complementary hardware if desired.

Shaw's reputation as an experienced custom molder assures you the highest quality precision-made terminal blocks.

Write to
Shaw today
for complete
specifications
and prices.



**SHAW
INSULATOR
COMPANY**

151 COIT ST., IRVINGTON 11, N. J.
SINCE 1892

HYCOR
Precision Wire-wound

Resistors

LET'S FACE FACTS!

Most manufacturers of precision wire-wound resistors offer products having similar physical appearances and electrical characteristics. Our claim to individuality is based upon **RELIABILITY OF PRODUCT**. The formula to obtain **RELIABILITY** is: *Skilled, painstaking attention to EVERY detail in EVERY step of fabrication!*

Our steady customers tell us that the formula works!

Our newly expanded production facilities now enable us to offer rapid delivery.

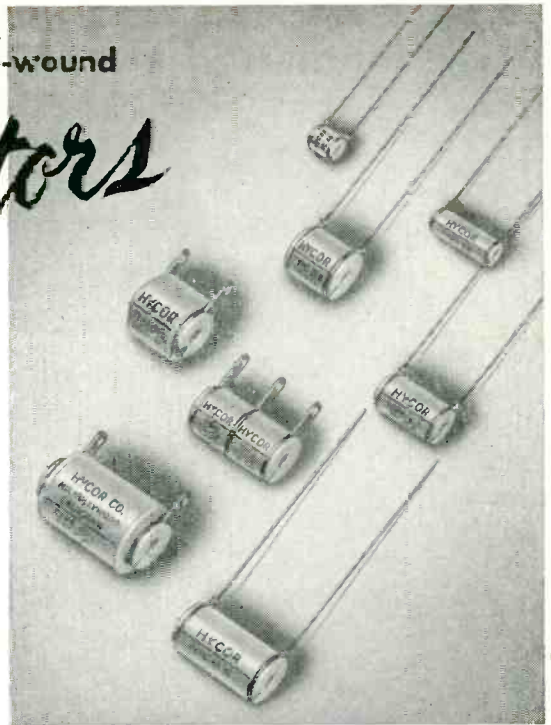

11423 VANOWEN ST., NORTH HOLLYWOOD, CALIFORNIA

HYCOR
Company, Inc.

SUnset 3-3860

Manufacturers of Precision Resistors, Toroid Inductors and Electric Wave Filters

REPRESENTATIVES:

Jack Beebe, 5707 W. Lake Street, Chicago, Illinois
George E. Harris & Co., Box 3005, Municipal Airport, Wichita, Kansas
Marvin E. Nulsen, 5376 E. Washington St., Indianapolis 19, Indiana
Burlingame Associates, 103 Lafayette Street, New York City
Canada: John R. Tilton, 1166-A Lake Shore Road, Long Branch, Ontario

For further information
contact your nearest
Hycor representative or
write for Bulletin R.

New 800-2600 mcs FREQUENCY METERS

Lightweight — Portable Units

SPECIFICATIONS

- 1. ACCURACY**
Better than .05% from 20°F to 120°F
- 2. SENSITIVITY**
Usable indication with 1 milliwatt input
Adjustable for higher levels
- 3. INDICATOR**
50 Microammeter
- 4. INPUT**
50 Ohm Type N Connector
- 5. EXTERNAL DC OUTPUT**
Pin Jacks
- 6. EXCURSION OF MICROMETER**
One-half inch
- 7. MICROMETER SCALE**
at 1000 Mc —
1 Division equals 290 KC
at 1400 Mc —
1 Division equals 350 KC
at 2000 Mc —
1 Division equals 450 KC
at 2600 Mc —
1 Division equals 555 KC
- 8. EXTERNAL SIZE**
6½ x 9¾ x 7"
- 9. WEIGHT**
Four pounds

... For Field and
Laboratory Use!

Models
FS-C-171-A 800-1200 MCS.
FS-C-172-A 1200-1600 MCS.
FS-C-173-A 1600-2250 MCS.
FS-C-174-A 1700-2600 MCS.

Units consist of cavity body, micrometer control, crystal, suitable connectors and calibration chart. Write for specifications and prices.

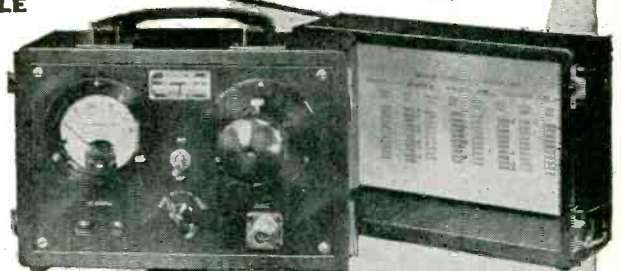

frequency standards

(Cavity units are also available for custom housing)

P. O. Box 504.
Asbury Park, New Jersey

Hammarlund's Newest ...

THE HQ-140-X

**For those who appreciate
Professional Standards**



A modern Communications Receiver

With Complete New Tube Line-up Including separate oscillator and mixer!

The "HQ-140-X" is a new superheterodyne receiver that incorporates all the advantages of modern professional design and circuitry. In addition, all the outstanding features that have made Hammarlund "HQ's" famous for quality and performance have been retained.

It is ideally designed for either professional or amateur use. Frequency coverage is continuously tunable from 540 Kc to 31 Mc (555 to 9.7 meters) in six bands with selectivity that makes it possible to read the desired signal when the band is extremely congested.

IMPROVED DESIGN

The special patented Hammarlund crystal filter (the same one that's in the "SP-600") provides extreme selectivity for the high attenuation of closely adjacent interfering signals. Improved sensitivity, stability and image ratio are featured in this receiver.

Band-spread tuning is available on the four higher frequency ranges, with direct calibration for the 80, 40, 20, 15, and 10 meter amateur bands.

MODERN FEATURES

Use of a separate mixer (6BE6) and oscillator (6C4) contribute to the high degree of oscillator stability. 6BA6's are used for the RF amplifier and for all three stages of IF amplification for maximum efficiency.

Large, comfortable and conveniently positioned controls, in addition to the many other outstanding features, make it a truly professional type receiver, the ideal instrument for operating in today's crowded shortwave bands.

For Detailed Information Write For Bulletin H1.



HAMMARLUND

THE HAMMARLUND MANUFACTURING CO., INC.
MAIN PLANT & OFFICES: 460 W. 34th St., N. Y. 1, N. Y.
Mid-West Sales Office: 605 N. Michigan, Chicago 11, Ill. • Export Sales Office: 13 E. 40th St., N. Y.

and techniques for applying them to problems of business and industry. He comes to the center from the Prudential Insurance Co. of America where he was employed as senior methods analyst. While there, he supervised research aimed at finding applications for digital computers in the company's clerical operations. Prior to joining Prudential Moncreiff was engaged in operations planning at GE.

Noebels Heads Beckman Applications Division



Henry J. Noebels

APPOINTMENT OF Henry J. Noebels to head the applications engineering division of Beckman Instruments has been announced by W. H. Steinkamp, vice-president and general sales manager.

Mr. Noebels has been associated for the past eight years with the Heyden Chemical Co., in charge of the physical instrumental analytical research lab. He worked also as Adjunct-Professor of Analytical Instrumentation at the Newark, N. J. College of Engineering. His appointment follows a set-up in applications engineering activities at Beckman.

Motorola Establishes New Test Lab In Ohio

A NEW TEST LAB for Motorola products is being established at Loyal Oak, Ohio, it was announced by A. T. Alexander, national service

Engineering

WRITERS

ENGINEERS, E. E. or PHYSICS GRADUATES, for preparation of technical manuals...

HUGHES RESEARCH AND DEVELOPMENT LABORATORIES' expanding program for production of radar, electronic digital computers, guided missiles and other military advanced electronic systems and devices requires the following:

1 ELECTRICAL ENGINEERING AND PHYSICS GRADUATES to prepare operating, servicing and overhauling instructions for complex electronic equipment. Those with previous maintenance experience on military equipment preferred. Writers will participate in a three-month program in our technical training school to become familiar with the latest Hughes equipment prior to writing assignments.

2 ENGINEERS EXPERIENCED in the writing and preparation of maintenance manuals for electronic equipment or guided missiles. These specialists will work step-by-step with the people designing, developing and manufacturing the products involved. Experience in the writing of engineering reports is of value.

HOW TO APPLY

Write full details of your qualifications to

HUGHES

Research and Development Laboratories

SCIENTIFIC AND ENGINEERING STAFF
Culver City, Los Angeles County
California

Assurance is required that relocation of the applicant will not cause disruption of an urgent military project.

SYNCHRONOUS MOTORS 2 INCHES IN DIAMETER

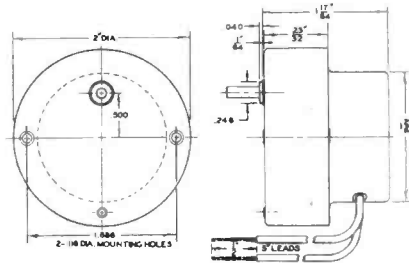

"CIRCLE B" TIMING MOTORS — Provide exceptional power. Up to 16 in. oz. torque continuous duty, and 84 in. oz. intermittent duty at 1 r.p.m. Compact — 2" diameter by 1 17/64" deep. Speeds from 1/6 r.p.m. to 1800 r.p.m. Operate in any position.

ELAPSED TIME INDICATORS — For industrial or laboratory applications. 2" diameter by 2 1/8" deep.

LOW SPEED MOTORS — Ranging from 10 revolutions per hour to 1 revolution per month. 2" diameter by 1 3/8" deep.

Bristol Motors are available for 24, 110, or 220 volts, 50-60 cycles. They are widely specified for timing devices, motion displays, defrosters, clocks, washers, ranges, dryers, time delay relays, general control equipment, and many other applications.



Write for folder B-1

BRISTOL MOTOR DIVISION
VOCALINE COMPANY OF AMERICA, INC.
254 Coulter St., Old Saybrook, Conn.

Fine Aluminum Wire

• To meet the growing demand from producers of light-weight, high-frequency Galvanometer movements, we have expanded our facilities designed to process Wire of 2S Aluminum... This wire can be supplied in diameters ranging from approximately .001 inch through .005 inch... Anodized with an exceptionally thin and flexible dielectric coating.

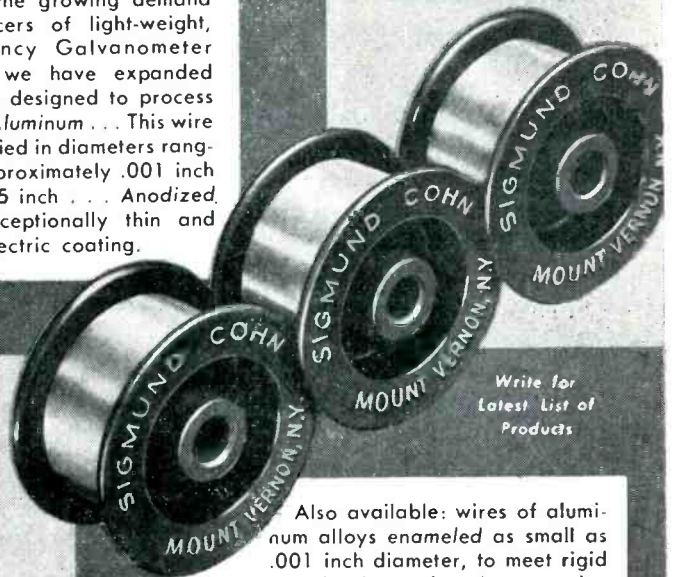

Write for Latest List of Products

Also available: wires of aluminum alloys enameled as small as .001 inch diameter, to meet rigid specifications of resistance, size and straightness.



SIGMUND COHN CORP. 121 So. Columbus Avenue • Mount Vernon, N.Y.

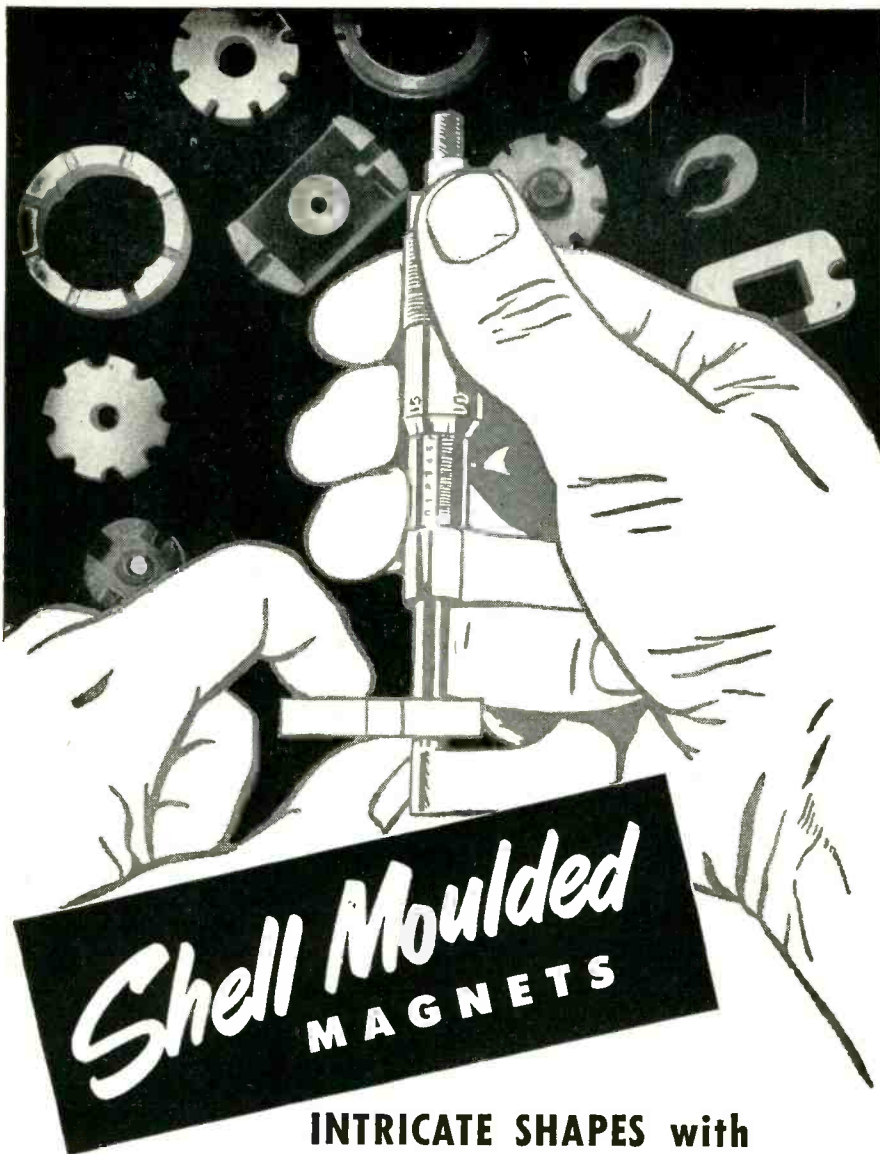

**INTRICATE SHAPES with
tolerances often as close as $\pm .005$
without Grinding or Finishing!**

The costly headaches and limitations of loose tolerances—which have vexed the engineer with variations of $1/32''$ in permanent magnet design—have been virtually eliminated by Thomas & Skinner, specialists in magnetics for more than half a century.

Now your engineers can specify the intricate casting shapes—with sharply defined relief—which in the past have been too difficult or too expensive to produce. Through radically new techniques, Thomas &

Skinner permanent magnets are cast with such close precision that little or no grinding and finishing is required for dimensional accuracy.

Call in a Thomas & Skinner engineer—let him work with your own development specialists—learn how your permanent magnet problems of close tolerances and intricate designs may be solved by the new Thomas & Skinner technique—now! Write today—ask for the new Thomas & Skinner Permanent Magnet Bulletin, No. 151.



THOMAS & SKINNER Steel Products Company
1120 East 23rd Street • Indianapolis, Indiana

director. Although the site is especially suited to tv testing because of the number of vhf and uhf stations in the area, the company will also test its home and auto radios there.

Each week sets picked at random will be shipped to the Akron suburb to undergo quality-control checks. Arthur Pape of Motorola's service department will supervise testing operations. Up to the time of the move, testing was conducted in Lakewood, N. J.

RETMA Sets Plans For TV Service Course

TELEVISION TECHNICIANS in the New York area selected by the New York Trade School to participate in RETMA's first training course will learn modern service techniques by working on the latest tv sets and utilizing the most modern test equipment.

RETMA member companies have donated approximately \$80,000 in money and equipment for the course. The pilot program is designed to develop an industry-approved upgrading course for tv service men to be used in trade and vocational schools throughout the country. It is expected that it will improve the technical proficiency and business technique of practicing tv servicemen.

CBS-Columbia Names Three Engineers

LEOPOLD M. KAY, vice-president of engineering of CBS-Columbia, announced the appointments of Jerome Goldman, Eugene Lieberman and Robert S. Sterling to the company's engineering staff.

Goldman, who has been appointed senior electronic engineer on government equipment, was formerly associated with Tele King Corp., where he worked on uhf tuners. He also was an engineer with Western Electric Co. and with Techno Scientific Co.

Lieberman, who was named liaison engineer for the product engineering staff, will be in charge of coordinating activities between the engineering, production and quality-control departments. He was

The S.S. WHITE 80X HIGH VOLTAGE RESISTOR

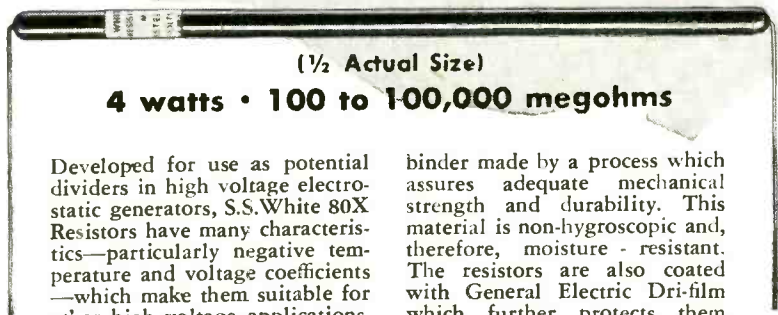

(1/2 Actual Size)

4 watts • 100 to 100,000 megohms

Developed for use as potential dividers in high voltage electrostatic generators, S.S. White 80X Resistors have many characteristics—particularly negative temperature and voltage coefficients—which make them suitable for other high voltage applications.

They are constructed of a mixture of conducting material and

binder made by a process which assures adequate mechanical strength and durability. This material is non-hygroscopic and, therefore, moisture - resistant. The resistors are also coated with General Electric Dri-film which further protects them against humidity and also stabilizes the resistors.

WRITE FOR BULLETIN 4906

It gives complete information on S.S. White resistors. A free copy and price list will be sent on request. Send for a copy.



THE S.S. White INDUSTRIAL DIVISION
DENTAL MFG. CO.



Dept. R, 10 East 40th St.
NEW YORK 16, N. Y.

WESTERN DISTRICT OFFICE: Times Building, Long Beach, Calif.

for maximum economy... 5KW VACUUM TUBE BOMBARDER OR INDUCTION HEATING UNIT

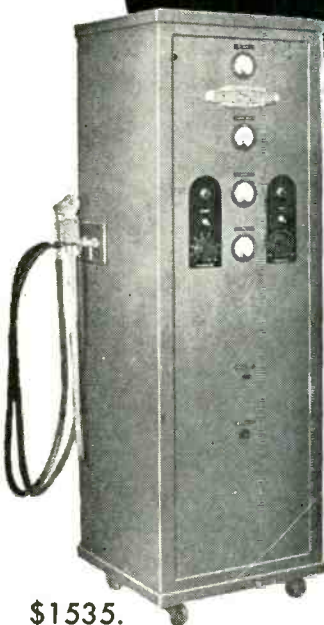

\$1535.

Simple... Easy to Operate... Economical
Standardization of Unit Makes This New Low
Price Possible.

Maximum economies can be obtained only by use of correct frequency and power combinations when applying the techniques of induction heating to manufacturing processes.

It is significant that only Scientific Electric in the present market, can offer you a selection of frequencies depending on power required, in wide power range. 2-3 1/2-5-6-7 1/2-10-12 1/2-15-18-25-40-60 KW (all units above 60 KW are considered custom built). This means that electronic heating equipment produced by Scientific Electric is tailored to your needs... fitted perfectly to the task entrusted to it, enabling you to keep your initial investment in equipment to a minimum while affording you all the proven advantages of electronic heating.

Write now for complete information or send samples of work to be processed. Specify time cycle for your particular job. We will quote on proper size unit for your requirements.

DESIGNERS AND MANUFACTURERS OF HIGH FREQUENCY AND HIGH VOLTAGE EQUIPMENT SINCE 1921

Scientific Electric

105-119 MONROE ST



GARFIELD, N. J.

DURANT MFG. CO. Specials

For RADAR, ELECTRONIC
and INSTRUMENT APPLICATIONS

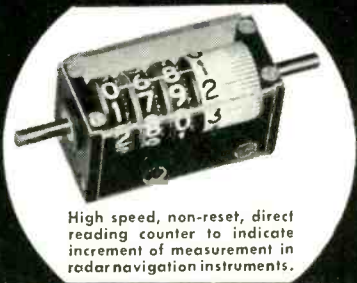

High speed, non-reset, direct reading counter to indicate increment of measurement in radar navigation instruments.

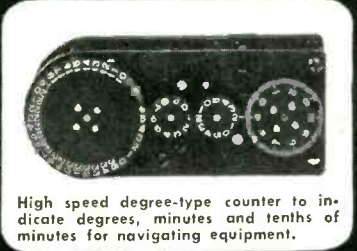

High speed degree-type counter to indicate degrees, minutes and tenths of minutes for navigating equipment.



"Y" 2-figure Rotary Counter used in navigating instruments.

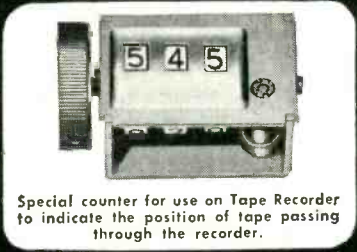

Special counter for use on Tape Recorder to indicate the position of tape passing through the recorder.



Special high speed Y-type counter for Goniometer application.

WRITE FOR LITERATURE
DURANT MANUFACTURING CO.
1912 N. Buffum St., Milwaukee 1, Wis.
112 Orange Street, Providence 3, R. I.

PRODUCTIMETERS
SINCE 1879 *Count Everything*

KEARFOTT GYROS

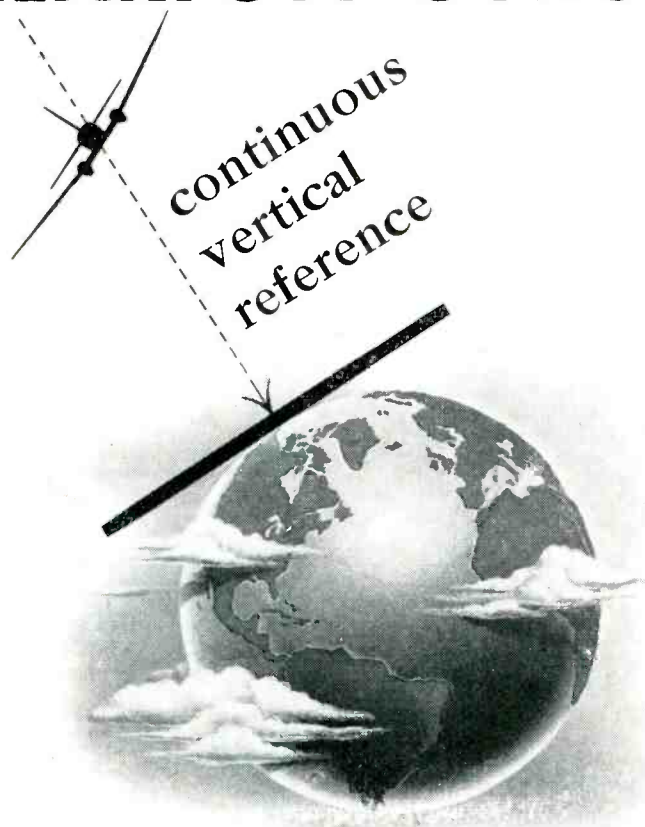

KEARFOTT vertical gyros providing continuous vertical reference within two minutes of arc under bench conditions typify the engineering know-how and production skills available to you in the field of precision gyros for airborne control applications.

Designed for particular applications with stringent performance requirements, a wide variety of free, vertical and rate gyros now in production are being used extensively in aircraft and missile control systems demanding the most precise gyro reference obtainable.

Kearfott gyros incorporate many unique features permitting operation under extreme operational or environmental conditions. A true hermetic seal in dry inert gas provides positive environmental protection. Synchro pick-offs and rigid structural elements assure performance during adverse conditions of vibration or shock.

If you require gyros with these highly desirable characteristics, we would be happy to review your application to the end that these problems may be resolved. Please write today for Bulletin #53 describing our products and facilities. Technical data on all products is available and will be sent on request.

KEARFOTT COMPONENTS INCLUDE:

Gyros, Servo Motors, Synchros, Servo and Magnetic Amplifiers, Tachometer Generators, Hermetic Rotary Seals, Aircraft Navigational Systems, and other high accuracy mechanical, electrical and electronic components.

Kearfott

SINCE 1917

CREATIVE ENGINEERING
PRODUCTION ACHIEVEMENT

KEARFOTT COMPANY, INC., 1150 McBride Ave., Little Falls, N. J.
Midwest Office: 188 W. Randolph St., Chicago 1, Illinois
West Coast Office: 253 N. Vinado Ave., Pasadena, Calif.
A General Precision Equipment Corporation Subsidiary

formerly with Emerson Radio in the test engineering department.

Mr. Sterling, who was appointed electronic engineer assigned to military equipment projects, formerly was with the Link Radio Corp. where he worked on communications equipment.

Commander Sergeant Joins Navy's Electronic Supply



Commander R. C. Sergeant

COMMANDER RUSSELL C. SERGEANT, USNR, has reported to the Navy's Electronic Supply Office, Great Lakes, Ill. to assume the position of technical division officer. His duties will include technical and engineering research relating to procurement, inventory control and distribution of electronic material. He will also serve as a liaison officer between the Navy and the electronics industry.

The Electronic Supply Office is the control point of the entire electronic supply system of the U.S. Navy.

As a Signal Corps enlisted man in the 1920's Commander Sergeant was operator in charge of the Nome, Alaska radio station.

Before entering the Naval Service in 1940 he was employed by the Mackay Radio and Telegraph Co. for 14 years, first as a radio operator and later as radio supervisor of the San Francisco office.

During World War II, he served in the Aleutians, on the staff of

INTER-METALL semiconductor research—and fabrication program comprises diodes, transistors and related devices as well as subsidiary equipment for production and testing of semi-conductors as Ge, S and intermetallic compounds

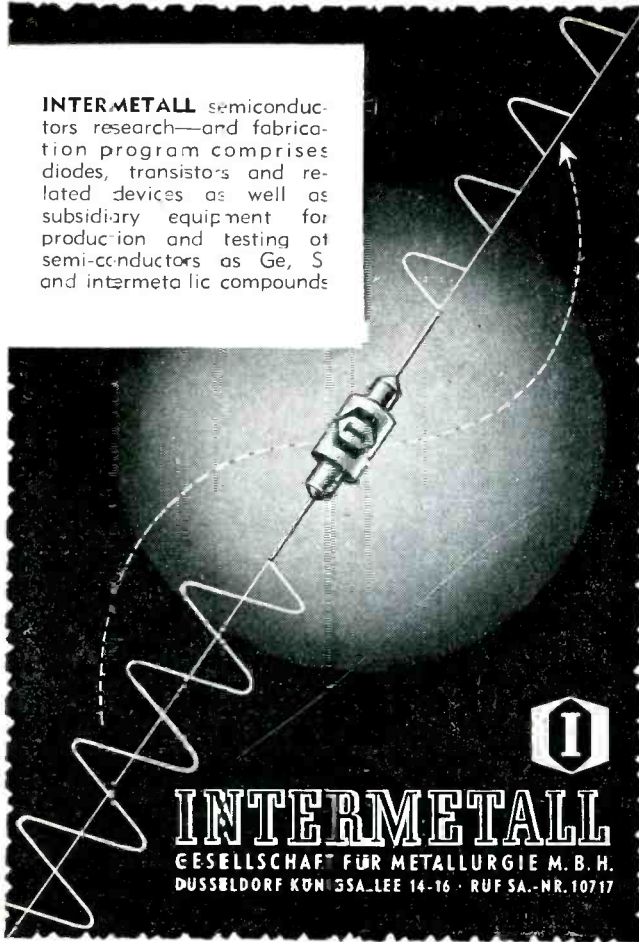

INTERMETALL
 GESELLSCHAFT FÜR METALLURGIE M. B. H.
 DUSSELDORF KÖNIGSPLATZ 14-16 · RUF SA.-NR. 10717

HOW TO INAUGURATE **COLOR TV** WITH MINIMUM INVESTMENT

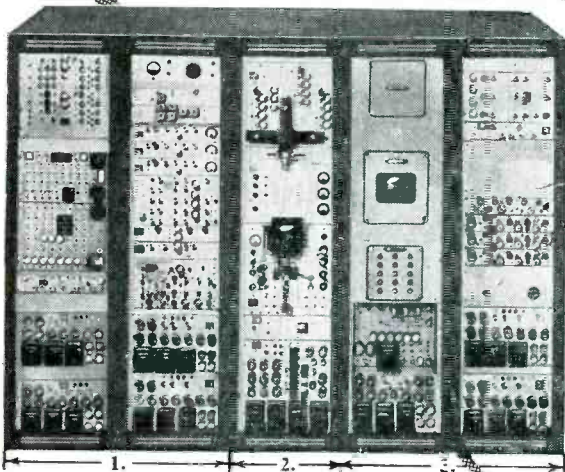

In Use by Leading Receiver, Tube and Component Mfrs.; TV Broadcasters; Research Laboratories

By Acquiring Units as Your Requirements Develop.

1. **BASIC EQUIPMENT**
 Produces NTSC encoded signals from color bars.
2. **SUPPLEMENTAL EQUIPMENT**
 Creates accurately certified NTSC encoded pictures from color transparencies. Feeds phase equalized picture and sound transmitter.
3. **RECOMMENDED EQUIPMENT PLUS FULL FACILITIES**
 Transmits, receives, monitors and analyzes, composite NTSC color pictures.

Illustrated Literature on Request

TELECHROME
 INCORPORATED

The Nation's Leading Suppliers of Color TV Equipment
 88 Merrick Road Amityville, N. Y.
 AMITYVILLE 4-4446



DOUBLE FEATURES
 Create demand for
**U.S.C. 980 Series-
 12-18-24-34
 CONNECTORS**

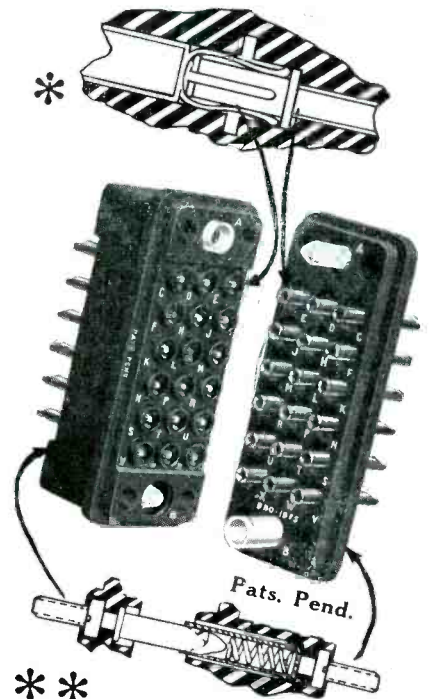

- *Double wiping (internal & external) contacts assure positive contact under all conditions.
- **Spring loading on guide contacts reduces the separation force in disengagement of connectors. Also provides additional guide contact dependability.

U.S.'s complete engineering, tooling and production facilities are geared to produce quality connectors, allied components and assemblies.



U.S.C. 980 series
 Brochures available
 on request

U. S. COMPONENTS, Inc.
 Associated with U. S. Tool and Mfg. Co., Inc.
 454-462 East 148th Street, New York 55, N. Y.
 CYpress 2-6525-6

TRANSFORMERS

PLANTS AND PEOPLE

(continued)

the Commander-in-Chief Pacific and in 1946 he reported to the Office of the Chief of Naval Operations where, for 7 years, he was engaged in the research and development of electronic countermeasures equipment.

For two and a half years, Commander Sergeant was chairman of the Panel on Electronic Warfare, under the Joint Chiefs of Staff.

Kimble Readies New TV Bulb Warehouse

SCHEDULED FOR COMPLETION this month, a new warehouse, to be used for storage of all-glass tv bulbs, is under construction at the Kimble Glass Co. plant in Columbus, Ohio. The one-story building will provide 200,000 sq ft of floor space.

Emerson Promotes Stanley Abrams

STANLEY L. ABRAMS, director of purchases of Emerson Radio, has been promoted to director of the Material Division, it was announced by Benjamin Abrams, Emerson's president.

The director of the newly created division will supervise overall logistics at Emerson and is charged with the duty of maintaining a constant and smooth flow of all materials throughout the organization. Included in the division will be the departments of expediting, inspection, stock control and production planning.

Mr. Abrams joined Emerson in 1946. In 1948 he was appointed manager of the purchasing division which post he held until January, 1952, when he was advanced to Emerson's director of purchases.

Robert J. Bahr, formerly manager of purchasing and traffic of GE's Electronics Division, has been named director of purchases succeeding Mr. Abrams.

Allied Radio Moves To New Building

THE ALLIED RADIO CORP. moved into its new \$2-million building in Chicago. The two-story structure, with a total area of 147,000 sq ft, covers a square block in the geo-

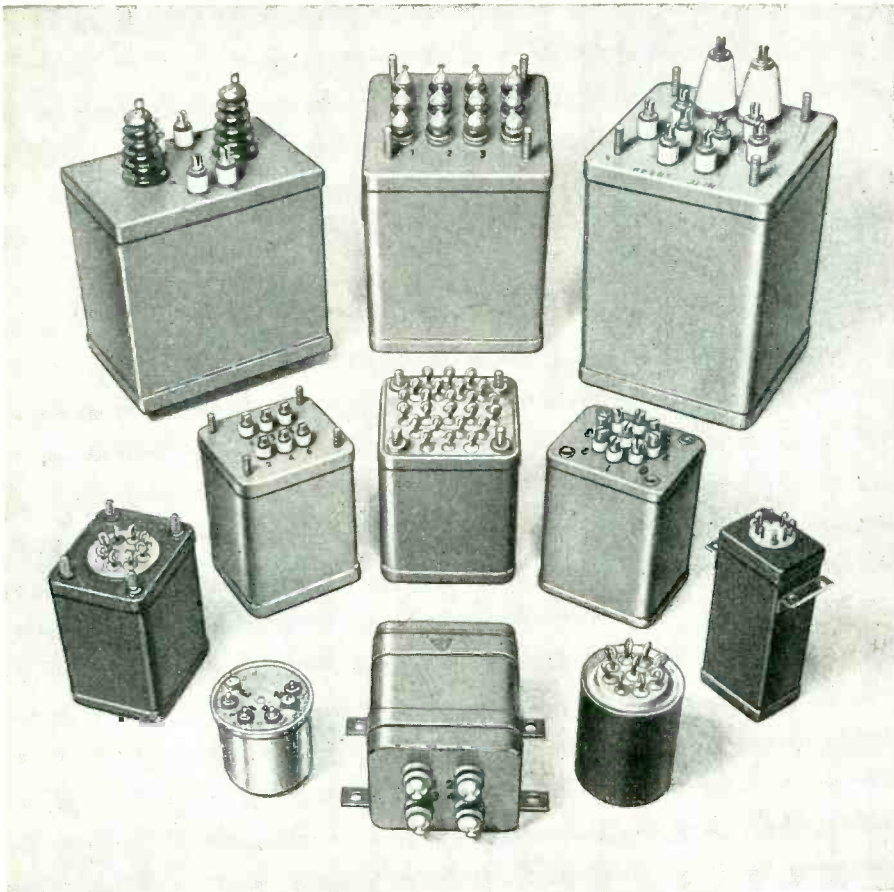

HERMETICALLY SEALED TO MIL-T-27 SPECIFICATIONS

NYT offers a wide variety of transformer types to meet military and civilian specifications, designed and manufactured by specialists in transformer development.

Latest NYT service for customers is a complete test laboratory equipped and approved for on-the-spot MIL-T-27 testing and faster approvals.

**NEW YORK
TRANSFORMER CO., INC.**
ALPHA, NEW JERSEY

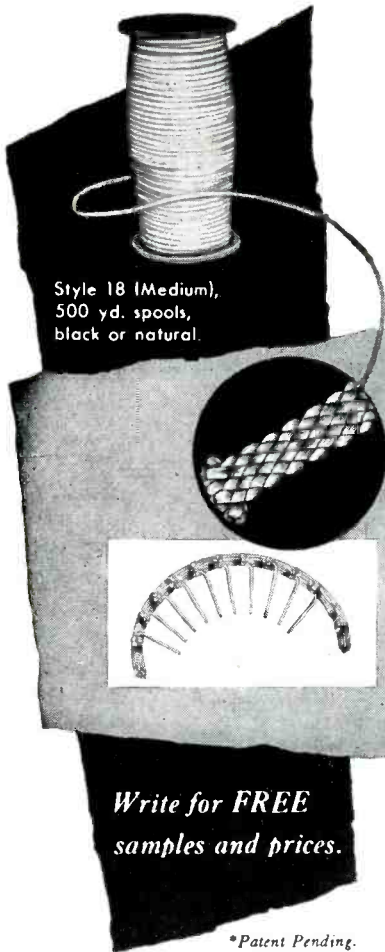

for lacings that stay put!

GUDELACE

BRAIDED NYLON LACING TAPE*

A New and Revolutionary Type of Lacing

- Saves time, saves money, greatly reduces the number of rejects
- Won't "bite through" insulation
- Won't cut wiremen's fingers or cause dermatitis
- Ties easier, ties tighter and cuts down on slipping of knots

Let GUDELACE answer your lacing problems.

Write for **FREE**
samples and prices.

GUDEBROD BROS. SILK CO., INC.

Electronics Division, Dept A

Main Office: 12 South 12th Street, Philadelphia 7, Pa.

225 West 34th Street, New York 1, N.Y.

*Patent Pending.

R. F. WATTMETER ME-82/U

Model MM-625 Series 50 to more than 1000 MCS.



This series of instruments was designed to measure RF power up to 400 watts, and serve as an excellent dummy antenna load over the frequency range 50 to more than 1000 MCS in 52 ohm coaxial line circuits.

Some of the outstanding features are:

1. Directional coupler pick-up probe which eliminates high frequency resonant responses and errors due to slight deviations in the load impedance.
2. Rugged construction for field and laboratory use.
3. Hermetically sealed and ruggedized indicating instrument in accordance with specifications MIL-M-10304.
4. Two spare crystal rectifier supplied with each instrument.
5. Model MM-625 has recently been assigned the Armed Forces nomenclature ME-82/U.

SPECIFICATIONS

Impedance	52 Ohms
Frequency Range	50 to over 1000 MCS.
Maximum VSWR	1.2
RF Power Scale	
Model MM-625	120 watts
Model MM-626	40 watts
Model MM-627	400 watts
Accuracy	±5% of full scale
RF Connector	Type C (Adapters available for other types)
Size	6 x 7 1/8 x 13-9/16
Weight	9 1/2 lbs.



M. C. JONES

ELECTRONICS COMPANY
BRISTOL, CONNECTICUT

Distributed outside of Continental U.S.A. by
RCA International Div., N.Y., N.Y., U.S.A.

60-DAY FREE TRIAL

of America's most popular
bench assembly stool



A tired worker costs **MUCH**
more than a good chair

- 4-way adjustable backrest
- Scroll shaped posture seat
- Tamper-proof tubular all-welded construction
- Adjustable height ranges from 17" to 25" or 24" to 32"

Now test Royal's famous No. 515 stool in your own plant without cost or obligation. See why the country's top firms choose it for superior versatility and durability. Write for free trial stool today!

metal furniture since '97



Royal Metal Manufacturing Co.

175 North Michigan Avenue, Dept. 2110, Chicago 1

Factories: Los Angeles • Michigan City, Indiana
Warren, Pa. • Walden, N. Y. • Galt, Ontario
Showrooms: Chicago • Los Angeles • San Francisco
New York City • Authorized Dealers Everywhere

MAIL TODAY

Royal Metal Mfg. Co., 175 N. Michigan Ave., Dept. 2110, Chicago 1, Ill.

- We want to test your No. 515 stool for 60 days without obligation. Send short _____ tall _____ model.
- Please send your new catalog of industrial seating.

Name _____

Firm Name _____

Address _____

City _____ Zone _____ State _____

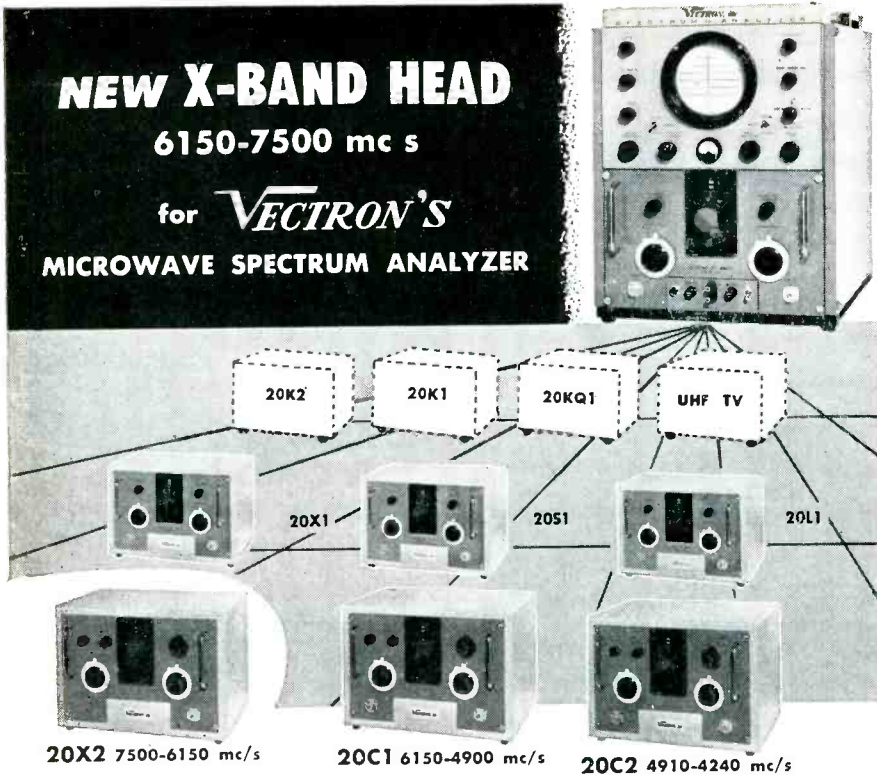

THE NEW 20X2 R. F. HEAD provides band coverage from 6150 to 7500 mc/s. With the recently announced 20C2 (4240-4910 mc/s) and 20C1 (4900-6150 mc/s) Vectron's Microwave Spectrum Analyzer now provides a choice of operating frequencies from 4240 to 7500 mc/s. Additional X-band operating frequencies, 8500 to 10,250 mc/s, are covered by the 20X1 R. F. head and its variants. Other R. F. assemblies are available for L-band (20C1) and S-band (20S1).

VECTRON'S R. F. HEADS are all interchangeable and ready for immediate operation in the Display Unit SA20, without conversion or adaptation. Display Units and R. F. Heads can be purchased separately as needed without the bulk and expense of equipment covering large areas in unused bands.

Early Delivery . . . Individual R. F. Heads and SA20 Analyzers are available for early delivery. Other new Heads are well along in development and will be announced soon. Send for Bulletin SA20 (see below) and specify the frequencies you need.

For Microwave Radar and Communications Equipment The Vectron SA20 Spectrum Analyzer presents visually the frequency distribution spectrum of the power output of pulsed or CW microwave oscillators and can be used as a sensitive R. F. detector for checks and measurements in the design, production and maintenance of microwave radar and communications equipment and components.

Vectron's development program includes additional R. F. Heads to cover microwave frequencies newly opened for military and civilian use. For information on these additional R. F. Heads and for complete engineering data, send for Bulletin SA20. Write today and be sure to specify the operating frequencies you need.



FEATURES	
Large, clear 5" oscilloscope pattern	Standard bezel to accept camera, hood or filter
Minimum number of controls . . . maximum operating convenience	Double conversion assures I. F. alignment stability
Built in regulated supply for Klystron oscillator	Easy access for maintenance or adjustment
New Provision for D.C. Filament supply for Klystron oscillator	
SPECIFICATIONS	
Overall Gain—130 decibels	Sensitivity—At least 60 dbm for 1 usec. pulse—80 dbm for CW
IF Bandwidth—Choice of 50 kc, recommended for CW and 0.2 to 2 usec. pulse widths, or 20 kc bandwidth to 5 usec.	Sweep Frequency—10 to 30 cps standard—available to 2 cps and with long persistence tube
Power supply 105-125V, 50-400 cycles	New Low-noise 20kc IF strip for higher useable gain.

graphic center of the city.

A. D. Davis, president, pointed out that the need for Allied's new facilities was dictated by the growth of the electronic parts industry. Shortly after World War II, the company carried about 8,000 separate stock items. Allied's 1954 catalog will list over 20,000 separate items. An increase of 25,000 items is anticipated within a few years.

Harvard Names

F. V. Hunt

F. V. HUNT, Gordon McKay Professor of Applied Physics and wartime director of the Harvard Underwater Sound Laboratory, has been named Rumford Professor of Physics at Harvard University, Provost Paul H. Buck announced.

Hunt succeeds retiring Rumford Professor E. L. Chaffee in the 137-year-old chair. He will continue as Gordon McKay Professor of Applied Physics.

A member of the Harvard faculty since 1927, Hunt organized in 1941 and directed until 1946 the Harvard Underwater Sound Lab. which, operating with the Office of Scientific Research and Development, developed an efficient sonar system for detecting the presence of enemy submarines. For his part in the development of the bearing deviation indicator which enabled sonar operators to train their sound projectors on submarines with greater speed and accuracy and his work with acoustic torpedoes, he received a presidential Medal for Merit in 1947.

Since the war, Hunt has been continuing his acoustics research for the Navy and is a member of the National Research Council Committee on Undersea Warfare. During 1947-49 he served as chairman of the Panel on Acoustics of the Research and Development Board.

Philco International Promotes Jeffery

SYDNEY L. CAPELL, president of Philco International Corp., announced the promotion of W. H. Jeffery to vice-president and general manager of Philco Corp. of

VECTRON, inc. Electronic and Electro-Mechanical Equipment
 404 MAIN STREET, WALTHAM 54, MASS.

Vectron invites your inquiries regarding the development and manufacture of:

Gyro-mechanisms	Precision Mechanical Devices	Synchros and Servomechanisms	Microwave Equipment
Gyro-stabilized Platforms	Computers and Calculators	Electronic Systems	Microwave Test Equipment
Gyros and Gyro Systems	Gear Assemblies	Precision Electronic Components	Radar Units and Systems
Aircraft Instruments	Test Instruments	Communication Networks and Filters	Echo Boxes

GOLD BONDED

Germanium Diodes

... designed for
Superior Service

The smallest, most efficient and economical diodes commercially available, Transistor Products germanium diodes offer superior advantages in many applications.

All TP diodes have uniform characteristics and low shunt capacity; specific types meet highest forward current requirements and have a minimum voltage drop.

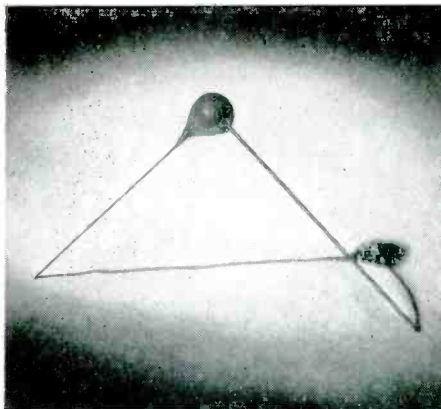

Transistor Products germanium diodes give dependable performance because they are designed and assembled for maximum mechanical strength. These diodes have the gold electrically bonded to the germanium — creating a welded alloy which meets shock resistance requirements. Only $\frac{3}{16}$ " in diameter, they are compact and ideal for sub-miniature assembly. TP germanium diodes also have tinned copper leads which permit easier soldering in production lines.

For data sheets and complete information on Transistor Products diodes, transistors and transistor test set, write Dept. E10.



TRANSISTOR PRODUCTS, INC.

SNOW AND UNION STREETS, BOSTON 35, MASSACHUSETTS
AN OPERATING UNIT OF
CLEVITE CORPORATION

ELECTRONICS — October, 1953



PANTOGRAPHIC PROFILING ON METALS AND PLASTICS

rapidly done by unskilled labor with

NEW HERMES *Engravo*
graph

Write direct to us for Literature.

Bench Type Model H 29 (weight 200 lbs.)

Portable Model IM also available

NEW HERMES, INC. 13-19 University Place, N. Y. 3

Representatives in all principal cities. Canada—359 St. James St., Montreal

ARCTIC COLD
or
TROPIC HEAT

In every corner of the globe . . . Standard Piezo Crystals are functioning with complete fidelity . . . just as faithfully as they did in their final, comprehensive inspection in our plant. Standard Piezo Crystals are truly masterpieces of precision . . . the rugged, accurate and dependable end-product of an exacting and vigorous system of manufacture, inspection and quality control. Quality is standard with Standard Piezo.

Let our engineers help you with your Crystal needs. Send specifications or an outline of your requirements.

Synonymous with Quality

Standard Piezo Co.

CARLISLE PENNSYLVANIA
Phone 1495

Want more information? Use post card on last page.

PRINTED WIRING IS *Competitive* NOW

Utilization of Printed Wiring Panels offers the volume electronics manufacturer competitive advantage now — even in the infancy of this new concept, the user will find overall costs comparing favorably with conventional assembly methods which have been in process of refinement for many years. The advantages in experience and refinement of design and assembly technique accruing to pioneer users are obvious.

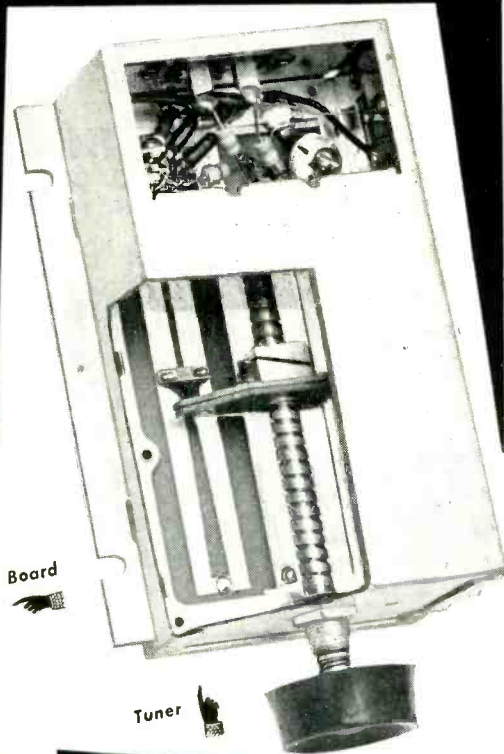

Illustrated is the Rex Electronic Corp. ingenious UHF tuner utilizing a "printed" tank circuit which is tuned by sliding silver contacts. Etched conductors extend to the socket aperture in order to minimize lead lengths from tank circuit to tube. Remarkable for its efficiency, stability and simplicity, the tuner represents a significant and interesting application of prefabricated circuitry.

It is to the user's advantage that the manufacture of printed wiring panels is already a crowded and competitive field, a situation which stimulates rapid advancement. A foresighted study of the possibilities for printed wiring in most mass-produced electronic devices is indicated. Similarly, analysis of Methode's combination of experience and demonstrated ability in this line warrants study where volume requirements are under consideration.

We invite your inquiries.



METHODE Manufacturing Corp.

2021 West Churchill Street • Chicago 47, Illinois

Geared to produce Plastic and Metal
Electronic Components

Canada, located in Toronto.

This position was previously held by Mr. Capell who transferred from Toronto to Philadelphia to become president of Philco International and assume direction of all Philco manufacturing and sales activities outside the U. S. At that time, Mr. Jeffery was named general manager.

Mr. Jeffery has been associated with Philco of Canada since 1945, first as a division manager and later as general sales manager. Before joining Philco he was associated with British Columbia Power Corp. as sales engineer and with the Canadian National Steamship Co.

New Company Enters Electronics Industry



F. Gordon Schermerhorn

A NEW COMPONENT manufacturer, Bradford Components, has entered the electronics industry to develop and produce wire-wound precision resistors of low and medium power, wind precision coils and handle component subassemblies of all types.

The firm has a completely renovated plant of approximately 12,000 sq ft located in Bradford, Pa.

The company is headed by F. Gordon Schermerhorn, president, who has had many years of executive experience in the electronic-component manufacturing industry. For several years he was production manager and production-control manager of the Hi-Q division of the Aerovox Corp. Recently, as division manager of the Speer Resistor Corp., he was re-

H-16 CHECKS the CHECKER

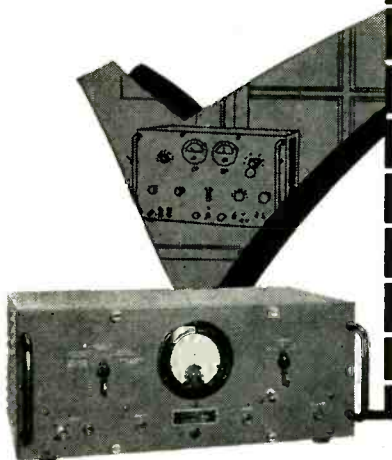

ARC Type H-16 STANDARD COURSE-CHECKER

For Omni Signal Generators

▣ This newly developed instrument is a means for checking precisely the phase-accuracy of the modulation on VOR (Omnirange) Signal Generators. Now that the use of omnirange receivers and signal generators is so widespread, it is necessary to have a means of measuring the phase differences between the 30 cps envelope of the 9960 \pm 480 cps reference modulation, and of the 30 cps variable modulation when that difference is required to be 0, 15, 180 or 195 degrees.

■ An important feature of the H-16 is a built-in self-checking circuit to insure .1 degree accuracy. Errors may be read directly on a 3-inch meter, calibrated to read \pm 4 degrees.

Write for detailed specifications



Dependable Airborne
Electronic Equipment
Since 1928

Aircraft Radio Corporation
BOONTON NEW JERSEY

GRC

ZINC ALLOY FASTENINGS



GRC WING NUTS

Exclusive, finger-grip design; easy to assemble, disassemble; brightly finished; clean threads.



NEW! GRC WING SCREWS

A steel screw combined with GRC's attractive finger-grip wing-nut.



GRC CAP NUTS

Die Cast, not turned! Free of tool marks, and cut-off burrs; class 2 threads tapped square with face of nut.



GRC SMALL TUBULAR RIVETS

Die cast, not headed! Closer tolerances, more uniform heads for greater riveting efficiency. Dia. up to 9/16"; lengths to 5/16".

- RUSTPROOF
- DEPENDABLE
- DURABLE

Gries die cast zinc alloy fastenings are durable, rustproof . . . economical, too! All Gries fastenings may be used without protective finishes in most applications. Furnished in all commercial finishes when desired. Prompt delivery on standard sizes—specials to order.

WRITE TODAY FOR SAMPLES AND PRICES



GRIES REPRODUCER CORP.

151 Beechwood Ave., New Rochelle, N. Y. • Phone NEW Rochelle 3-8600



STERLING

A DEPENDABLE SOURCE FOR TRANSFORMERS MIL-T-27 & COMMERCIAL

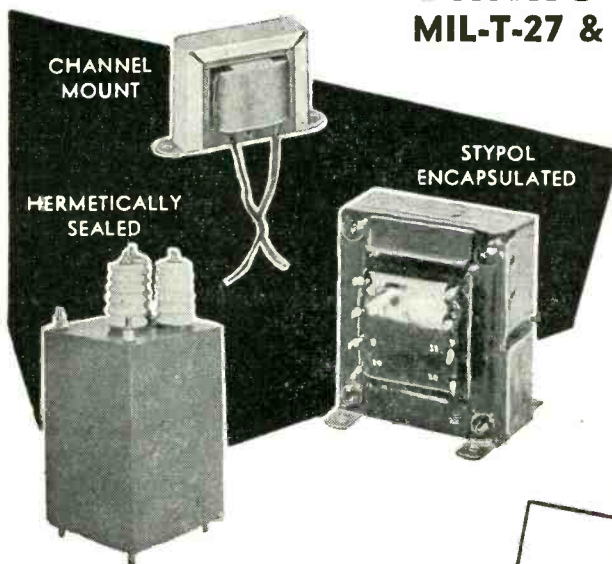

- Pulse
- Audio
- Power
- Filter Choke
- Filament
- RF Coils

Custom Built to
your Specifications



297 North 7th St., Brooklyn 11, N. Y.

WE SOLICIT
SAMPLES AND SHORT
RUN PRODUCTION

Fansteel Fabrication of Tungsten & Molybdenum Components

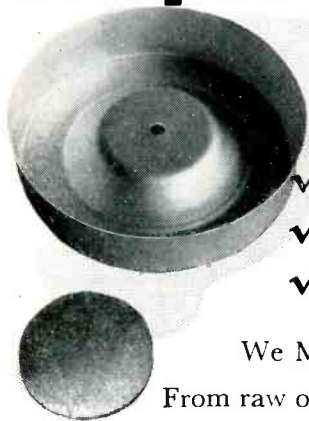

means

- ✓ one responsibility
- ✓ one price
- ✓ one standard of quality

We MAKE both Tungsten and Molybdenum.

From raw ore to finished ingot, bar, rod or sheet, you can *expect* us to know more about these metals—about forming them, about stamping, bending, deep drawing, machining, forging, brazing or welding them.

LET

Fansteel

INSURE YOUR COST CONTROL of TUNGSTEN and MOLYBDENUM COMPONENTS

You can *expect* us to arrive at the best way of making your component, to produce it at the least cost—to guarantee you, when we do your fabrication, against the vagaries of rejects, scrap loss, equipment and personnel tie-up.

Bluntly, you can expect us to be experts. For, in all modesty, that's just what we are. And our experience is yours for the asking.



Write for Free Booklet!
"FANSTEEL TUNGSTEN AND
MOLYBDENUM"

FANSTEEL
WORLD'S LARGEST
PRODUCER OF
REFRACTORY
METALS

TUNGSTEN & MOLYBDENUM

32501C

Fansteel Metallurgical Corporation NORTH CHICAGO, ILLINOIS, U.S.A.

responsible for the completion and organization of their new composition-resistor manufacturing unit at Bradford, Pa.

The company's director of engineering is Lawrence Lopez, who has been associated with the electronic-component industry for over twenty years. He recently was project and development engineer in charge of coils and resistors for the Hi-Q division of the Aerovox Corp. Prior to that he was president and general manager of the R.K.L. Electro Winding Corp. at Delevan, N. Y. Before that he had many years of engineering and executive experience with such firms as General Winding Co. and Cornell-Dubilier Corp.

Albuquerque Set For TV Network Connection

DIRECT CONNECTIONS with national television networks and additional long-distance telephone facilities will be available to Albuquerque, N. M. by mid-1954, according to Wayne Coy, president and general manager of the Albuquerque Broadcasting Co., which owns and operates stations KOB and KOB-TV.

Making the new service possible is construction of AT&T's coaxial cable from Oklahoma City to Amarillo, and a microwave relay system from Amarillo to Albuquerque, and on to the Pacific Coast through Phoenix.

Albuquerque, which has been getting its TV shows on film for the last five years, with an average time lag of a week, will have three tv stations on the air when the new facilities are completed. KOB-TV will be affiliated with NBC and Du Mont; KOAT-TV, which plans to be on the air this fall, will be affiliated with ABC; and KGGM-TV, which has set a November opening date, is linked to CBS.

General Instrument Elects Hutchison

MALCOLM C. HUTCHISON has been elected a director of the General Instrument Corp., it was announced by Abraham Blumenkrantz, chairman of the board.

Hutchison is a former vice-presi-

For SPECIFIED PERFORMANCE Specify JELLIFF RESISTANCE WIRE

COMPLETE CONTROL OF MANUFACTURE . . .

A WIDE RANGE OF EXPERIENCE . . .

A WIDE RANGE OF ALLOYS . . .

make JELLIFF the ideal source of
Resistance Wire to assure your Product's

Performance According to Specs.

Precision resistors—rheostats—
relays—thermocouples—ohmmeters
—bridges—high-temperature fur-
naces can all benefit from the
PLUS-PERFORMANCE of
JELLIFF RESISTANCE WIRE



Detailed Enquiries Welcomed. Address Dept. 25

EXACTLY your type and size in Spiral Wound PAPER TUBES

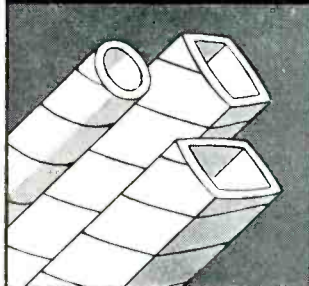

SQUARE, RECTANGULAR, ROUND

Standard-type PARAMOUNT paper tubes used for millions of coil forms and other applications. Hi-Dielectric. Hi-Strength. Kraft, Fish Paper, Red Rope, Acetate, or any combination wound on automatic machines. Any size from 1/2" to 30" long, from .450" to 25" I.P. Produced from wide range of stock arbors or specially engineered for you.

NEW "PARAFORMED" TUBES SQUARE OR RECTANGULAR

Entirely new technique in tube making developed and perfected by PAKAMOUNT. Perfectly flat side walls, sharp square inside corners, and very small radius on the four outside corners. Spiral wound, not die formed. No sharp outside edges to cut wire. No need for wedges to tighten winding on laminated core. Full rigidity and physical strength. Permits winding coils to closer tolerances. Allows faster automatic stacking of coils. Approved and used by leading manufacturers. *No extra cost!*

PARAMOUNT PAPER TUBE CORP.

616 LAFAYETTE ST., FORT WAYNE, IND.

Standard of the Coil Winding Industry for Over 20 Years

WRITE ON COMPANY
LETTERHEAD FOR
STOCK ARBOR LIST
OF OVER 2000 SIZES

2 MUSTS

For Low-Cost Servicing
of Mobile Radio Systems

Lampkin equipment gives you the lowest cost per channel, whether you supervise a large multiple-frequency system, or whether you service numerous smaller installations! Lampkin equipment measures center frequency and modulation deviation, to FCC specifications!

The Type 205 FM Modulation Meter
For Multiple Mobile Frequencies.



The Type 205 FM Modulation Meter measures peak frequency swing due to voice modulation of FM transmitters, as required by the FCC. Indicates 0-25 KC. deviation. Instantly tunable to any frequency from 25 MC. to 200 MC. Simple to use. Direct reading. No charts. Price Net \$240.00.

For Any Number of Frequencies,
AM or FM. The Type 105-B
Micrometer Frequency Meter



The Type 105-B Micrometer Frequency Meter measures center-frequency deviation on any number of transmitters, from 100 KC. to 175 MC.; also precisely simulates weak transmitter signals, for mobile receiver alignment, 20 MC. to 175 MC. Overall accuracy within 0.0025%, with spot check on WWV. Price \$220.00., net.

Return coupon TODAY for complete literature.



LAMPKIN LABORATORIES, INC.
Instruments Div., Bradenton, Florida

Please send me complete technical literature and delivery information on the following Lampkin instruments:

- Type 205 FM Modulation Meter
 Type 105-B Micrometer Frequency Meter

Name

Address

City Zone State

now...TEFLON* with Certified performance

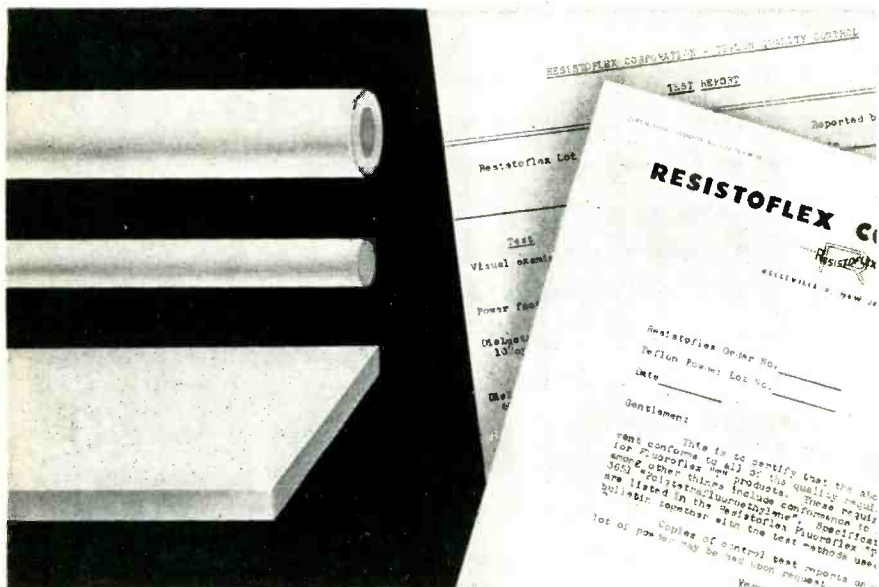

*Conformance to specifications assured
in FLUOROFLEX®-T rod, sheet, tube*

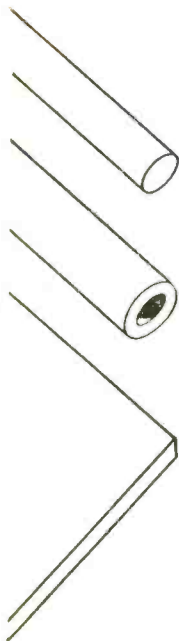

Resistoflex will certify each shipment of "electrical grade" Fluoroflex-T products on six vital physical and electrical properties. Qualification tests are performed on all incoming Teflon powder to determine whether it will yield rods, tubes and sheets which are in conformance with specification AMS-3651 "Polytetrafluoroethylene." Processing under a quality control and inspection system approved by the USAF under MIL-Q-5923 specification maintains the identity of each lot of material through all stages of manufacture — from virgin powder to finished product.

An affidavit accompanies each shipment attesting to its conformance with AMS-3651. Certified test reports of the actual properties of any shipment will be furnished whenever they are requested.

Be sure of optimum performance in Teflon by specifying electrical grade Fluoroflex-T. Remember, too—Fluoroflex-T products are non-porous and stress-relieved. This means better dimensional stability, less costly machining and fewer rejects. For more details, write or phone...

*DuPont trade mark for its tetrafluoroethylene resin.
®Resistoflex trade mark for products from fluorocarbon resins.

RESISTOFLEX

corporation

Belleville 9, N. J.

dent of the Irving Trust Co., from which he retired last May after more than 30 years service. He also is a director of the American Colortype Co., the Bankers Commercial Corp., the Longines-Wittnauer Watch Co. and Seeman Brothers, wholesale grocers.

Raytheon Wins Hearing-Aid Award

THE 1953 ENGINEERING award of the Society of Hearing-Aid Audiologists has been presented to Raytheon Manufacturing Co. The professional group, comprising some 500 dealers and consultants engaged in the hearing-aid business, made the award "in recognition of Raytheon's outstanding achievement in transistor design and production."

The company announced the availability of junction transistors for hearing aids in September 1952, began shipments in January of this year, and has since shipped well over 100,000 of them.

Greenhouse Joins Ferroxcube Corp.

HAROLD M. GREENHOUSE, formerly of the Ohio State University Research Foundation, has joined the research department of the Ferroxcube Corp. of America. Greenhouse will be employed in research on development of new types of ferrite magnetic materials, it was announced by W. W. Stifler, Jr., general manager.

Simpson Doubled Production Facilities

WITHIN the past year, facilities for the production of electrical testing equipment of the Simpson Electric Co. have doubled, according to Robert Brand, factory manager of the company's Chicago plant.

The company recently extended its Lac du Flambeau plant in Wisconsin, one of three now operated by the firm for the production of testing equipment.

At the plant, which is on the Lac du Flambeau reservation, home of the Lake Superior Chipewewa Indians, the company is uti-

MIDGET TELEPHONE TYPE RELAYS

in hermetically sealed containers



Surface mounting, open type, Series 80 Relay — size: $1\frac{1}{32}$ " l. x $\frac{5}{8}$ " w. x $1\frac{25}{64}$ " h.

Compact, multiple contact with vibration and shock-proof characteristics. Designed to meet various operating requirements typical of Armed Services applications.

Unique pile-up arrangement reduces width below the conventional relay, thereby reducing over-all space volume.

Coils are varnish-impregnated to resist high humidity conditions. All ferrous parts are treated to pass salt-spray tests.

Engineering Representatives in Principal Cities

WRITE FOR
BULLETIN
MTR-6

Wheelock RELAYS
SIGNAL
ENGINEERING & MFG. CO.
154 WEST 14TH ST. NEW YORK 11, N.Y.

HERMETIC SEALS

- Vacuum Tight—Glass to Metal
- Standard Types from Stock
- Special Designs to Fit Your Product
- Write or Call for Full Information

Sales Agency:

WESTERLUND & CO.

618 Calvert St.

Baltimore, Md.

SCIENTIFIC ELECTRONIC LABS, INC.

866 Bergen St.

Bigelow 8-6553

Newark 8, N. J.



MINIATURE 20
TIN HEADER

$2\frac{3}{4}$ MILLION IN STOCK!

WHY EthoLoc[®] CABLE CLIPS?

1. Made of tough, durable Ethyl Cellulose plastic—no danger of shorts or grounds
2. Flexible and easy to apply—no sharp edges
3. Light in weight
4. Low in cost

15% reduction in prices on many popular sizes. We thank our customers for large volume that made price reductions possible.

Write for Sample and Full Information

WECKESSER CO.

5267 N. Avondale Ave. • Chicago 30, Ill.

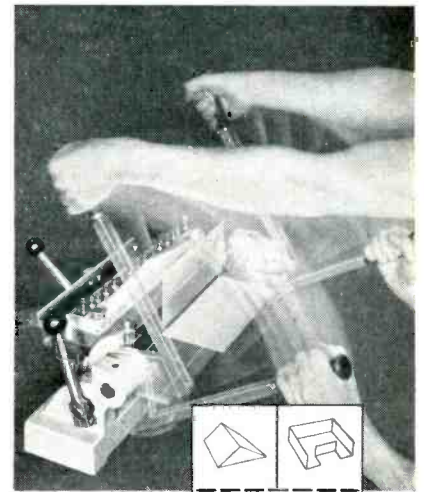
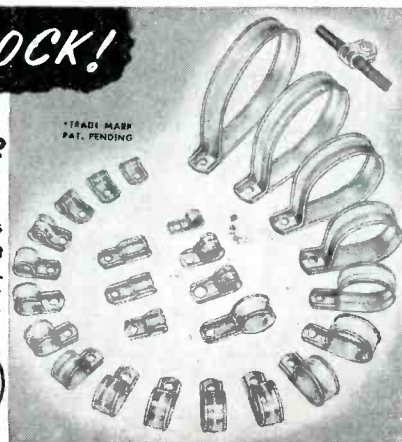

a4in1

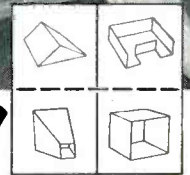

metal working tool!

di-acro[®] BOX FINGER BRAKE

Accurately, Easily, Quickly Form and Duplicate a Wide Variety of Shapes in Metal as Heavy as 16 Gauge—Widths up to 24" —with Versatile Di-Acro Brakes.

A number of forming jobs can be done with the Di-Acro Box Finger Brake, by simply adjusting or changing the type of mounting bar on the contact surface. Di-Acro Finger Brake is:

- **Box and Pan Brake** — when equipped with a complete set of Box Fingers.
- **Open End Brake** — when Open End Finger is installed in place of Box Fingers.
- **Bar Folder** — when an Acute Angle Bar replaces the Box Finger Bar mounting.
- **Standard Brake** — when a Forming Bar is mounted for heavy operations.

Di-Acro Standard and Radius Brakes are also available. Ten models in all.

[®]pronounced Die-ack-ro

WANT MORE INFORMATION?



Send for New 32-Page Catalog

Gives facts on Di-Acro Brakes and also both hand and power operated Di-Acro Benders, Notchers, Punch Presses, Rod Parters, Rollers and Shears. Mail your request today.

Creators of "Die-Less Duplicating"

O'NEIL-IRWIN
MFG. CO.
321 Eighth Ave.
Lake City, Minn.



Precision Crystal Oven

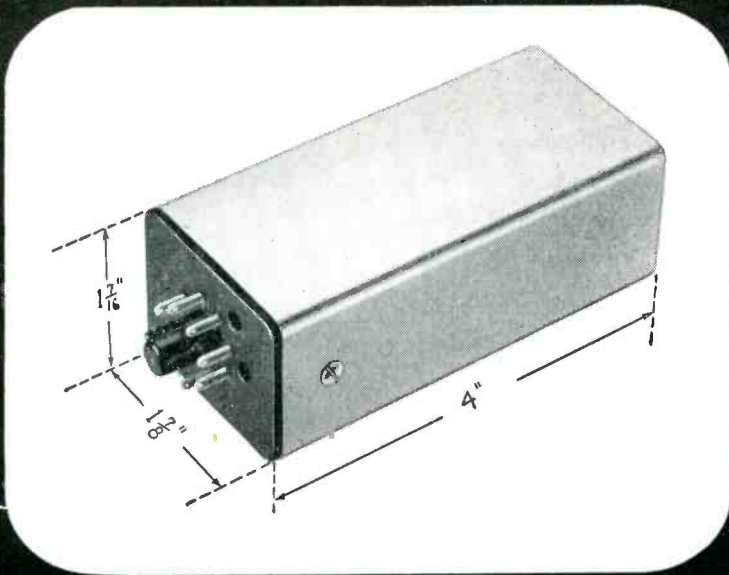

Maintains Crystal Temperature—
to within 0.025°C at normal room temperature
—to within .15°C over outside range
from -40°F. to 150°F.

SPECIFICATIONS:

Operating temperature 75°C or 85°C

Warm up time for stable operation at -25°C — 7 minutes

Operates on 110 V, AC or DC (also in 6, 12, or 24 V models)

Mounting: standard base octal socket

Dimensions: 4" high—1 7/16" wide—1 7/16" deep

Crystal holder type: HC-6

Meets applicable requirements of Mil-T-945A

Withstands 10 day humidity cycle at 95% relative humidity, in accordance with SC-D-15914

Vibration test method 10 to 33 CPS at 0.06 inch excursion

Operates in horizontal or vertical position

Standard finish as per U. S. A. specs 72-53 Type 1; or any finish to meet purchaser's requirements

For further information, call or write

Caribe Aircraft Radio Corp., Coamo, P. R. or Philip H. Harrison & Co., Matawan, N. J.

The Caribe Aircraft Radio Corporation's new crystal oven was engineered to military specifications for use in secondary frequency standards. Its unusual ability to maintain crystal temperatures within such precise tolerances is due to its unique low mass thermostat, large expanding element and high lever multiplication, minimizing contact wear, giving long life and freedom from drift.



lizing the dexterity of the Indians in mass-production techniques. About 95 percent of the plant's employees are native members of the Chippewa tribe on the reservation.

In appreciation for the opportunities given the Flambeau Indians, both Raymond Simpson, founder of the company, and Wallace Carroll, current president and owner of the firm, have been adopted as honorary members of the Tribe.

Corbett Retires From Sparks-Withington



William J. Corbett

WILLIAM J. CORBETT, vice-president of The Sparks-Withington Co., Jackson, Mich., was guest of honor at a dinner given by business associates and friends in Jackson on the occasion of his retirement from the company at the completion of 44 years service.

He was a member of the board of directors for 33 years and 28 years vice-president of The Sparks-Withington Co. He has been president of the firm's automotive division since 1938.

Machine Works Forms Electronic Division

HUFFORD MACHINE WORKS of El Segundo, Calif. has formed a new electronic division, according to J. A. Helget, president.

Located in a new 10,000 sq ft plant in Los Angeles, the new division will specialize in the development and production of d-c regulated and unregulated rectifier-type

DEPENDABLE *Miniature*
RADIO FILTERS



Type 111

- Saves space !
- 115 V ac/dc, 20 amp.
- Excellent attenuation
- Feed through installation
- Flange mounting bracket
- Corrosion & fungus resistant

If you have radio interference problems, write or wire us, TODAY !

HOPKINS
Engineering Co.

FACTORY: 2082 Lincoln Ave.,
Altadena, Calif. SYcamore 8-1185
Offices in WASHINGTON, D. C.
and DETROIT

WHAT
CLAMP
TO USE
WHERE
TOLERANCES
ARE LARGE

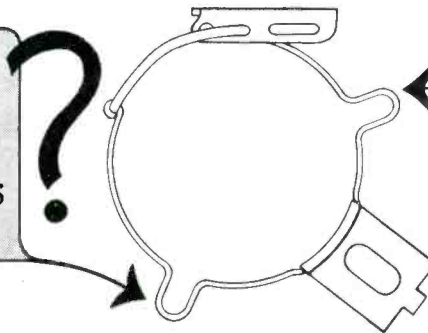

AUGAT'S
NEW
TWO TENSION
LOOP
CLAMPS

Augat two-tension loop clamps are the long-sought answer for uses where tube base tolerances vary up to .040. The bands of these sturdy clamps are made of Beryllium copper, heat treated to retain original tension and nickel plated to withstand a 96 hour salt spray test with no adverse effect.

The remaining parts of Augat's two-tension loop clamps are made of 18% nickel silver.

Write today for catalog and samples.

AUGAT BROS. INC.
31 PERRY AVENUE • ATTLEBORO, MASS.

PHAZOR **PHASE**
Pat. Pend. **METER**
MODEL 200A



\$34950

F.O.B. New York, N. Y.

Measures phase shift in transformers, amplifiers, filters, and phase displacement networks.

- Measures from 0 to 360 degrees.
- Readings not affected by noise and harmonics.
- Phase shifts of the order of .01 degree can be measured employing special circuit techniques.
- Measures in-phase and quadrature components separately.

SPECIFICATIONS

Accuracy—Basic accuracy plus or minus 2 degrees. Plus or minus 1 degree due to meter error.

Noise and Harmonic Rejection.....40 db, down
Sensitivity.....6 millivolts full scale
Maximum Input Voltage.....125 volts RMS
Peak Input Signal.....400 volts
Frequency Range.....20 to 20,000 cps.
Input Impedance.....

High Gain.....2.0 megohm shunted by 25 mmfd.
Low Gain.....2.5 megohm shunted by 10 mmfd.
Reference Input Impedance.....4000 ohms
Power Supply.....105 to 125 volts, 60 cps., 25 watts
Dimensions—Length 15 in., Hgt. 9 in., Depth 8 in.
Weight.....25 pounds

INDUSTRIAL TEST EQUIPMENT CO.
55 EAST 11th ST., N. Y. 3 - Tel: GR. 3-4684

SECON

**DEVELOPMENT and PRODUCTION
METALLURGISTS**

Fine wire and ribbon in base, rare, and precious metals, and alloys for new and highly engineered applications. In small units and sizes, and to close tolerances.

Further details on request.

SECON

SECON METALS CORPORATION
7 Intervale Street, White Plains, New York
White Plains 9-4757

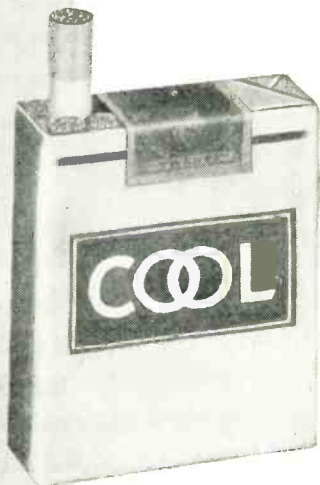

**PRECISION BUILT
FOR POSITIVE ACTION**
MINIMUM WEIGHT: 4 OUNCES

Compact LOW-INERTIA SERVO MOTORS



WE CUSTOM-BUILD MOTORS to meet Your Specs and All Government Specs

The servo motor shown on this page is representative of the many types we manufacture that combine low weight and compactness with rigidly exact performance.

It is available for two phases, 60 to 400 cycles, in 2-, 4-, 6- and 8-pole construction. It can be supplied with low-backlash precision gear head. It can be built to meet any military specifications with regard to humidity, high ambient temperature, vibration and altitude.

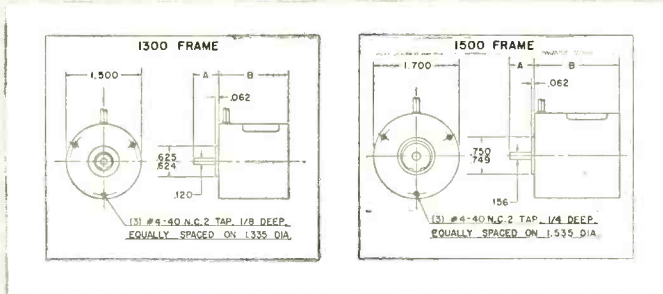

We specialize in the design and production of servo motors, actuators, gear motors and torque motors. IMC motors are widely used in aircraft control, guided missiles, gunfire control, rocket control, industrial control and many other servo and instrument applications that require motors of 1/1000 to 1/10 horsepower.

*For applications that require any type
of fractional or subfractional horsepower
motor . . . check your specs with*

INDUCTION MOTORS CORP.

55-15 37th AVE., WOODSIDE 77, NEW YORK

power supplies, magnetic-amplifier controls, magnetic servo amplifiers and transformers.

Officers of the division are J. C. Washington, sales manager; B. J. McComb, chief engineer and J. R. Frost, in charge of government negotiations.

Du Mont To Sell Dage TV Equipment

THE TELEVISION TRANSMITTER DIVISION of Allen B. Du Mont Laboratories will sell the broadcast tv cameras and camera equipment of Dage Electronics Corp., it was announced by C. J. Harrison, marketing manager of the division.

Availability of the Dage equipment through Du Mont, Harrison said, will provide an extra service to station owners and applicants by supplementing Du Mont's own complete line of image-orthicon camera units with the lightweight, ultraportable and inexpensive Dage units which employ vidicon tubes.

Atomic Instrument Elects Collier

DONALD W. COLLIER, director of research for Thomas A. Edison, has been elected a director of the Atomic Instrument Co. of Boston, it was announced by L. W. Cronk-hite, president.

As head of Edison Laboratory, Collier, 33-year-old research chemist, occupies the position created and held by the late Thomas A. Edison.

Sangamo And Southern Illinois Set Research

A new agreement between Southern Illinois University and the Capacitor Division of Sangamo Electric Co. will provide funds for a research program and scholarships for students majoring in physics.

The agreement calls for a joint research board including one University member and three members appointed by the manager of Sangamo's Capacitor Division. Sangamo will also supply financial aid, equipment, samples and technical information.

The new research unit will be



Mark your own symbols, numbers, lettering, on your small parts, tools, identification and name plates . . . easily, simply, quickly . . . tracing from a master with the GREEN ENGRAVER.

Widely used in electronic and plastic fields, in machine tool shops and wherever permanent marking is needed. The GREEN ENGRAVER engraves equally well on metals, plastic, wood, hard rubber and glass.

✓ Fact-filled folder on request . . . showing how economies in costs, labor and time are achieved with the GREEN ENGRAVER.

✓ Routs ✓ Models ✓ Profiles ✓ Engraves Etching attachment and other special equipment for industrial uses are available.

Green Instrument Co.
INCORPORATED

363 PUTNAM AVE., CAMBRIDGE, MASS.

Visit us: National Instrument Exhibit, Booth 262

New Technitrol Variable Pulser



- * Wide pulse repetition frequency range from 20 cps. to 2.0 mcs.
- * Pulse rise and fall times are symmetrical at 0.05 μ s.
- * Duration of pulse variable from 0.2 μ s to 5.0 μ s in steps of 0.1 μ s.
- * Stable pulse duration controlled by electric delay lines.
- * Low impedance output, amplitude continuously variable from 0 to 40 volts without distortion.
- * Trigger pulse precedes output pulse.

This reliable and versatile instrument, developed for our own use, has wide possibilities for application in many laboratories.

Write for Bulletin 186E.

TECHNITROL
ENGINEERING COMPANY
2751 N. 4th St., Phila. 33, Pa.

FOR EASY TUBE SIDE TESTS



SAVE TIME EFFORT MANY USES

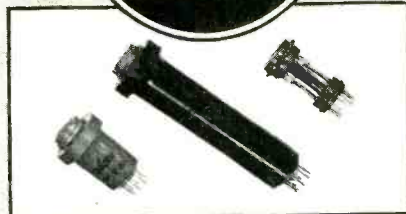

TEST ADAPTERS

Vector Test Adapters are ideal for making measurements from the tube side of electronic equipment. The adapter is inserted between tube and socket, completing the circuit and providing test tabs. The short type (left) is most popular, but for some hard-to-reach locations a long type with shielded leads is available (center). For breaking circuits or changing connections the open "experimenter" type is useful (right). All types are available for octal, 7-pin miniature and 9-pin noval sockets. Kit T-789 combines the three short types in handy carrying case. Available at most distributors.

Send for catalog showing complete line of adapters, socket-turrets, plugs and plug-in units.

REPRESENTATIVES

B. B. Taylor Co.
241 Sunrise Highway, Rockville Centre, N. Y.
R. J. Magnuson
4258 West Irving Park Road, Chicago 41, Ill.
David H. Ross Company
534 El Camino Real, San Carlos, California

Vector Electronic Co.

3352 San Fernando Road, Los Angeles 65

PRECISION TRANSFORMERS

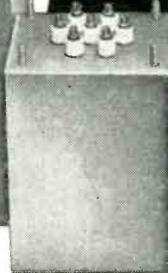
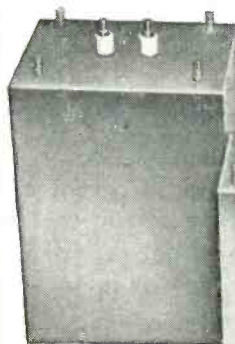

...built to fill your exact requirements... and to all government specifications. No job too big or too small.



Development and design facilities available.

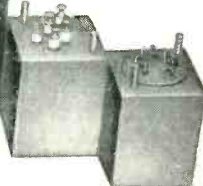

We specialize in **MAGNETIC AMPLIFIER** development

YOU can improve the performance, life and reliability of your circuits . . . eliminate costly equipment maintenance and replacement part costs by using ATLAS Magnetic Amplifiers for:

1. Low level amplification
2. Regulated DC power supplies
3. Motor drive controls
4. Thermocouple and photocell to relay applications

We welcome inquiries. Send sketches of your circuit and list desired performance characteristics . . . we'll do the rest.

CONSTRUCTION TYPES:

- Hermetically sealed
- Fosterite
- Scotch Cast
- Open types

ATLAS

ATLAS ENGINEERING CO., Inc.

3 EDGEWOOD ST., ROXBURY, MASS.

under the direction of Dr. Otis B. Young, who will be working under Dean Willis G. Swartz of the SIU Graduate School.

Ampex Electric No Longer Electric

AMPEX ELECTRIC CORP. of Redwood City, Calif. is now the Ampex Corp. George I. Long, general manager, explained that the board of directors changed the firm's name "because of the expanding scope of Ampex activities, which makes the term "electric" no longer descriptive of the company's business."

Heldor Moves To New Location

HELDOR MFG. CORP., maker of transformer cans, capacitor cans, component parts, and national sales agent for Heldor compression-type hermetic seal bushings and terminals, have announced the moving of their plant and offices to Patterson, N. J.

H. F. Elberfeld, president of Heldor, stated: "Our new plant provides more working space, better stock facilities, closer supervision of operations and quicker deliveries."

Keeping Cool At North American



Electronic brains under development in North American Aviation's electromechanical engineering department at Downey, Calif. undergo cold tests in the firm's weather laboratory. Company employee Mary Chastain removes a frosty electronic computer unit from the cold chamber where tests are made of advanced equipment being developed for a long-range guided-missile program

**KNOW
THESE IMPORTANT FACTS
ABOUT
PREDETERMINED
COUNTERS!**

Potter



WHEN SPECIFYING A PREDETERMINED COUNTER

for any application, check the reasons why a *Potter Instrument* is the only logical choice. There are important differences among predetermined counters—basic differences in simplicity of operation, in ease of maintenance, in reliability, and in versatility.

THE SIMPLEST CIRCUIT

Potter Predetermined Counters use the "complement" circuit. Any count from one to ten can be set in the simple, straightforward four tube decade. A single output is operated when the predetermined count is reached. Other methods require the sensing of many "on" conditions. A typical three-sequence predetermined counter with four decades would require sensing 48 "on" conditions with separate tubes.

THE GREATEST RELIABILITY

The Potter system provides automatic indication of tube

failure and stops automatically when failure occurs. Rugged, approved industrial tube types and switches, minimize maintenance, help assure trouble-free operation.

MAXIMUM VERSATILITY

Potter Predetermined Counter Decades are especially adaptable to multiple-sequence counting. Only 12 tubes, for instance, are needed for counting in a dual-sequence, 0 to 1000 count, unit. Other systems need up to 24 tubes, yet do not equal the Potter method in performance, in space and power economy, and ease of maintenance.

GET THE COMPLETE STORY

Get the complete story on Predetermined Counters for every application involving counting, sorting, batching, and measuring length, weight, volume, and speed. Along with it, let us prove, in detail, the superiority of Potter Instruments. For information on a unit or a system, write Department 10-C



POTTER INSTRUMENT CO., INC.

115 CUTTER MILL ROAD

GREAT NECK, N. Y.

118

VULCAN

ELECTRIC HEATING UNITS

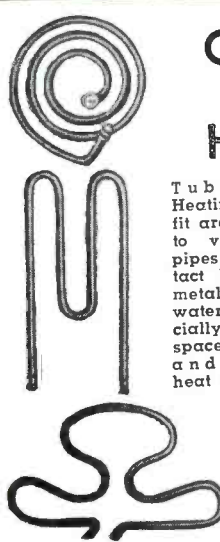

Coils of Heat

Tubular Electric Heating Units that fit around or clamp to vessels, tanks, pipes, etc. for contact heating of metals, oils, air and water . . . especially where little space is available and considerable heat is needed.

Can be bent into almost any shape.

STANDARD SIZES or made to your requirements.

VULCAN

ELECTRIC COMPANY

DANVERS 10, MASS

BOESCH

Semi Automatic Type Toroidal Coil

WINDING MACHINES *

Designed primarily as a laboratory machine. This assembly has found extensive use as a production winder. Provides for the winding of a wide range of wire and coil sizes. Can be provided with variable speed control.

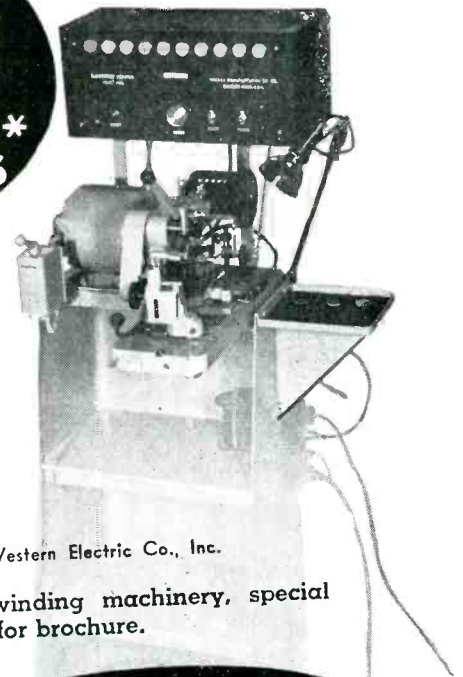

*Available to licensees of the Western Electric Co., Inc.

Designers and Builders of coil winding machinery, special machinery and equipment. Write for brochure.

WORLD'S MOST VERSATILE
WINDING MACHINES

BOESCH

MANUFACTURING CO., INC.
DANBURY, CONN.

for the ELECTRONIC INDUSTRIES

Quality

Ribbons STRIPS

**MOLYBDENUM
TUNGSTEN
TANTALUM
FORMED PIECES**

Your Special Metals Rolled to Thin Sizes & Close Tolerances

YOUR INQUIRIES WILL RECEIVE PROMPT ATTENTION

H. CROSS CO.

15 BEEKMAN ST., N. Y. 38, N. Y.
WOrth 2-2044 and COrtlandt 7-0470

EXTREME FREQUENCY RANGE SQUARE WAVE GENERATOR

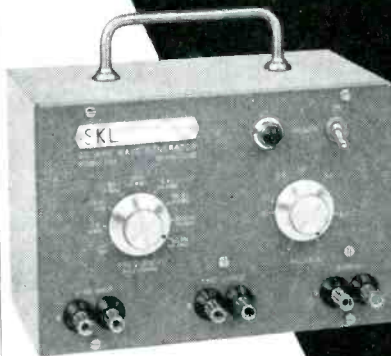

Features

- FREQUENCY RANGE = 0.5 CPS to 1 MEGACYCLE
- RISE TIME LESS THAN 30 MILLIMICROSECONDS
- MODERATELY PRICED
- SQUARE WAVEFORM
- LIGHTWEIGHT

Price \$135

f.o.b. Cambridge

The new SKL Model 504 Square Wave Generator is a moderately priced, compact, lightweight, high quality laboratory instrument. A square waveform with very short rise time makes the SKL Model 504 Square Wave Generator useful in obtaining a rapid determination of the transient response of electrical networks.

Other features of the SKL Model 504 Square Wave Generator are: frequency range from 0.5 cps to 1 megacycle in eight steps; provision for the generation of a square wave of any intermediate frequency; a synchronizing pulse output and external sync input to permit use with auxiliary equipment; and a self-contained regulated power supply.

SKL SPENCER-KENNEDY LABORATORIES, INC.

186 MASSACHUSETTS AVE., CAMBRIDGE 39, MASS.

Designed for



Application



The No. 90901
One Inch
Instrumentation Oscilloscope

Miniaturized, packaged panel mounting cathode ray oscilloscope designed for use in instrumentation in place of the conventional "pointer type" moving coil meters uses the 1" 1CPI tube. Panel bezel matches in size and type the standard 2" square meters. Magnitude, phase displacement, wave shape, etc. are constantly visible on scope screen.

**JAMES MILLEN
MFG. CO., INC.**

MAIN OFFICE AND FACTORY
MALDEN
MASSACHUSETTS



NEW BOOKS

Television and Radio Repairing

By JOHN MARKUS. McGraw-Hill Book Co., New York, 556 pages, 1953, \$7.95.

THERE is so much good practical information in this new book, that it is a little unfortunate the author thought it necessary to oversell and oversimplify the business of servicing television receivers.

The book supplies the first real comprehensive description of how to get started in the service business. Even though we must disagree with the opinion that one can start with a cash investment of less than a hundred dollars, if necessary, and his idyllic and hardly realistic description of what it means "to be your own boss" in the service business, we still feel that a beginning student can get a pretty good idea of the service business by reading this book carefully.

The basic premise of the author is that a student with average intelligence can learn to handle up to 75 percent of the repair jobs that come to the average radio and television shop. While the exact percentage may be a little high, there is no doubt that the application of the knowledge found in the book's pages will enable a serious student to start right in handling service work.

This book can fill a practical need in new television areas or in existing areas where there just are not enough good servicemen to go around. For the good of the industry, though, it is hoped that most readers of this book will continue on with further studies, since this book doesn't get into circuit theory with any depth at all. A serviceman cannot be considered competent in his field until he knows quite a bit more about radio or television than is available in the text.

We believe that the book does accomplish its stated goal. It gives practical how-to-do information that can be applied to actual receivers right from the start. A serious-minded, ambitious student should be encouraged by the progress he makes as he applies the sug-

CUSTOM *Molded* POWDERS

WE CAN MOLD
ANY POWDER
INTO YOUR DESIRED
SHAPE and SIZE

Send us your powder molding problems and let us help you solve them.



WE SPECIALIZE
IN ALL TYPES OF
POWDERED GLASS



FOR
HERMETIC SEALS

**IRON SEALING and
KOVAR SEALING GLASS**

Close tolerance maintained . . . the highest precision to satisfy your specifications.



(Quick
Delivery)

- Sintered powders
- Ceramic bodies
- Cold mold plastics



13 VALLEY STREET
BELLEVILLE, NEW JERSEY

SPECIALISTS FOR THE TRADE

Want more information? Use post card on last page.

October, 1953 — ELECTRONICS

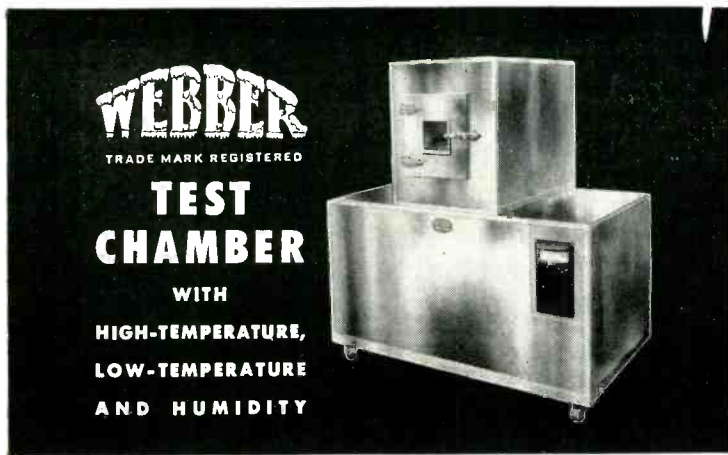

★ This Webber test unit, designed for production and experimental testing, has a temperature range from +250°F., to -100°F. The pull-down to -100°F., is achieved in 45 minutes, and can be cycled from -100°F., to +250°F., in 30 minutes. 95% relative humidity is provided at temperatures between 75°F., and 95°F. Vacuum equipment can be added to simulate high altitudes. The test chamber, provided with a moisture-proof light for illumination, is 4½ cubic feet, 20 inches high, 20 inches wide, 20 inches deep. High and low temperatures are governed by a temperature controller with scale range from -200°F., to +400°F., with a 3 degree control point differential, 1½ degrees plus and minus. The humidity is regulated by a wet and dry bulb controller. Unit size is 60" long, 45" wide, 74" high. Apertures in left side of cabinet provide for electrical cables to energize equipment being tested. Webber offers a complete line of test units for various applications.

Write for more complete information

INDUSTRIAL FREEZER DIVISION
WEBBER MANUFACTURING COMPANY, INC.
(Formerly Webber Appliance Co., Inc.)
 2745 MADISON AVENUE • INDIANAPOLIS 3, INDIANA

Every DANO Coil is Custom-Made

In electronic equipment success or failure is often determined by coil function. Every Dano coil is made to customer requirements and is delivered to you fit as a fiddle and

ready to serve you and your products with perfect, trouble-free performance.

Send us samples or specifications with quantity requirements for our recommendations. No obligation!

Also, Transformers Made To Order

- Form Wound
- Paper Section
- Acetate Bobbin
- Molded Coils
- Bakelite Bobbin
- Cotton Interweave
- Coils for High Temperature Application



THE DANO ELECTRIC CO.
 MAIN ST., WINSTED, CONN.

NO HEAT is required for **BARCO** Metal Degreaser Fluid



... for Electronic and Allied Industry

Removes all oil, grease, waxes, etc. Does **NOT** burn. No heat required. Non-corrosive. Used by leading electronic and Television manufacturers for production and maintenance.

SAFE-UNDERWRITERS LAB. APPROVED.
 Write for full information TODAY!

BARCO CHEMICAL PRODUCTS CO.
 701-703 S. LA SALLE Chicago 5, Illinois

Two Pictures ... ONE IS ART

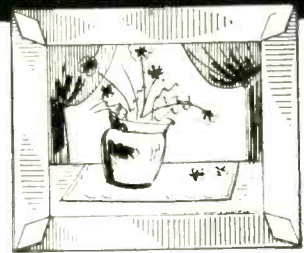

Oster
REG. U.S. PAT. OFF.

Thousands of paintings have been put on canvas, but only the select few have the lasting quality of great art.

We're not artists, but we do know something about quality. Osters have produced top-notch products for over a quarter of a century. We have a group of well-trained, conscientious engineers who will design and produce what you want in

**BLOWERS • MOTORS • ACTUATORS
 SERVOS • SYNCHROS**

You'll find we're as precise as the old masters about the quality of our product.

You Can Depend on SAFER Flight ... EXTRA Flight with OSTER Products

JOHN OSTER
 MANUFACTURING COMPANY
 AVIATION DIVISION
 RACINE, WISCONSIN

Corrections of Product Listings for the 1953-1954 Electronics Buyers' Guide

The additions and corrections listed below apply to the current issue of the **GUIDE**.

ALTEC LANSING CORP.

9356 Santa Monica Blvd.,
Beverly Hills, Calif.

MICROPHONES—Condenser,
not MICROPHONES—Carbon

THE LENK MFG. CO.

30-38 Cummington St.
Boston 15, Mass.

Listing under SOLENOIDS is incorrect. Listed under IRONS—Soldering only.

FEDERAL TEL. & RADIO CORP.

88 Kingsland Rd., Clifton, N. J.
(Additions as follows:)

AMPLIFIERS—Magnetic
AMPLIFIERS—Servo
CONTROLS—Temperature,
Electronic
COUNTERS—Photoelectric
REGULATORS—Voltage Regulator and Stabilizer

J-B-T INSTRUMENTS, INC.

431 Chapel St., New Haven 8, Conn.
(Addition as follows:)

SWITCHES—Toggle and Pushbutton

ERIK A. LINDGREN & ASSOC.

4515 N. Ravenswood Ave.,
Chicago 40, Ill. (Addition as follows:)

ROOMS—Screen

MINNESOTA MINING & MFG. CO.

900 Fauquier Ave., St. Paul 6, Minn.
(Additions as follows:)

INSULATION PARTS
TAPES—Insulating

POLARAD ELECTRONICS CORP.

100 Metropolitan Ave.,
Brooklyn 11, N. Y. (Addition as follows:)

RECEIVERS—Microwave

STAR EXPANSION PRODUCTS CO.

147 Cedar St., New York 6, N. Y.
(Addition as follows:)

STRAIGHTENERS—Pin, Tube



Bold facing and advertising page number are omitted in the following:

WEINSCHEL ENGINEERING CO., INC.

10511 Metropolitan Ave.,
Kensington, Md. Advertising Page 36

ATTENUATORS—Microwave
Coaxial Fixed
ATTENUATORS—Microwave Step
OSCILLATORS—Audio Frequency



In the following, the correct advertising page should be page 344, not 334:

REON RESISTOR CORP.

117 Stanley Ave., Yonkers, N. Y.

RESISTORS

Wire Wound
12. 2 Watts and under
13. 4 to 35 Watts

17. Precision Low Voltage
18. Precision High Voltage
19. Rf non-inductive

RESISTORS—Sub-Miniature



ABC

electronics

ABP

BUYERS' GUIDE

A MCGRAW-HILL PUBLICATION, 330 WEST 42nd ST.

NEW YORK 36, N. Y.

NEW BOOKS

(continued)

gested techniques found in each chapter.

The book starts out by describing how you get started in servicing, what tools you need and how to make a service call. It describes briefly how television and radio sets work, including a brief discourse on electricity and magnetism.

Then the book shows you how to use a multimeter and, in three chapters, covers the subject of tube testing and replacing.

The beginner is taught how to solder, and how to test and replace the various components found in modern receivers. The chapter on phono pickups and needles is extremely valuable because this information is rarely found in such detail in servicing texts.

Chapters on repairing cabinets, and the installation and repair of radio and television antennas complete the book.

The text is very clear and easy reading. Paragraph headings, ample photographs, and review questions after each chapter add to the instructional value of the text.

Summing up the review, we find that despite some of the distortions and over simplification mentioned earlier, a beginner will be able to pick up from this book lots of good practical information he will need in servicing—information that might otherwise take months of practical experience and guidance to acquire.

HAROLD J. SCHULMAN,
Allen B. Du Mont Labs., Inc.

Introduction to Solid State Physics

BY CHARLES KITTEL. *John Wiley & Sons, Inc., New York.* 396 pages, 1953, \$7.00.

IN RECENT years the attention of engineers and scientists has been focused more and more sharply on the study of solid-state physics. While results have not been so spectacular or so influential in world affairs as those in nuclear physics, they are of particular interest in the field of electronics.

Early in World War II, when need for a thorough understanding of the crystal detector arose, specialists in solid-state physics were able to clarify experimental data

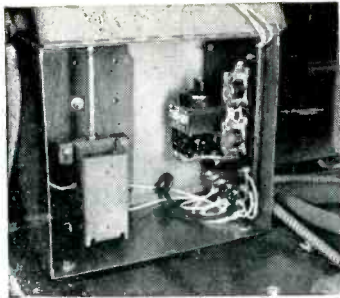

"Years of service—
and over a million
operations a year"
D. W. Onan & Sons Inc.

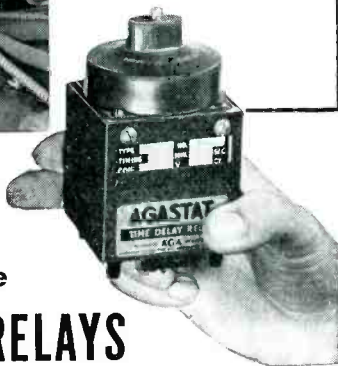

AGASTAT

light . . . versatile

TIME DELAY RELAYS

AGASTATS are used by Onan to prevent starting of their standby plant on momentary power failure, to prevent stopping of the plant until power has returned for a given time, and on some lugging presses that operate over a million times a year. Onan reports several years of service with a minimum of attention.

AGASTATS are solenoid actuated and pneumatically timed. They are light, compact, dustproof and can be furnished to operate mounted in any position. There is an AGASTAT model that is right for your needs.

Write for Bulletin
Dept. A2-104

AGA

Division of Elastic Stop Nut Corporation of America
1027 Newark Avenue, Elizabeth 3, New Jersey

In More and More
TV Installations
Across the Country

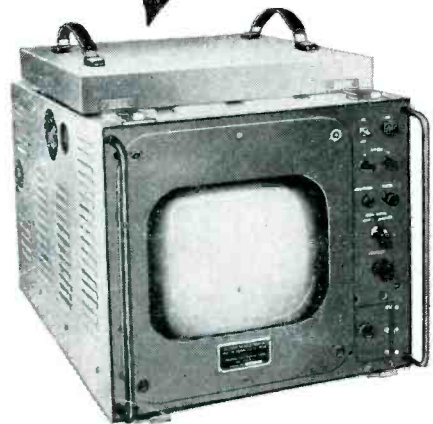

POLARAD'S MODEL M-105
IS A HIGHLY VERSATILE PICTURE
MONITOR FOR BOTH COLOR AND
BLACK AND WHITE STANDARDS.
USED IN NTSC AND CBS SYSTEMS

FEATURES:

High resolution in excess of 450 lines
12½" Kinescope
Unusually short retrace time
Excellent vertical and horizontal
linearity
Light weight
Complete with internal power supply
Minimum of Maintenance

SPECIFICATIONS:

Input Video Signal... 0.25 to 2.0 volts
peak to peak
Signal Polarity..... Positive, Negative
or Balanced
Input Impedance..... 66 MMF across
470,000 ohms
Input Power..... 105-125 volts,
2 amps, 50/60 cps
Resolution..... Greater than
450 lines

Kinescope
(Aluminized back).... 12KP4A
Retrace Time..... 4.2 microseconds
Focus..... Magnetic
Linearity..... Better than 2%
across raster
horizontally and
vertically
Weight..... 60 lbs.
Size..... 19"x19"x20"
Tube Complement... 3-1X2A; 1-5R4GY;
2-6AC7; 1-6AH6;
1-6BG6; 1-6BL7GT;
1-6CD6; 7-6SN7;
1-6X5; 1-12KP4A

"Nielsen" COMPRESSION SPRING DRAW PULL CATCHES
WITH SPRINGS CONCEALED

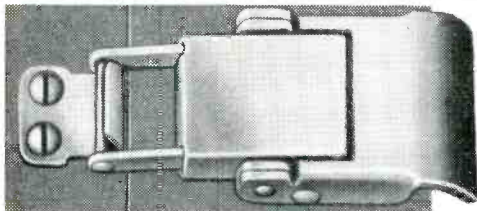

SIZE: 2¾" LONG X 1½" WIDE

Get our Folders on Standard Catches and Draw Bolts and other Compression Spring Catches

NIELSEN HARDWARE CORP. 770 Wethersfield Ave., HARTFORD 14, CONN.
AFFILIATED WITH NIELSEN TOOL & DIE CO.

FOR QUALITY HARDWARE — GOOD SERVICE TO YOUR SPECIFICATION

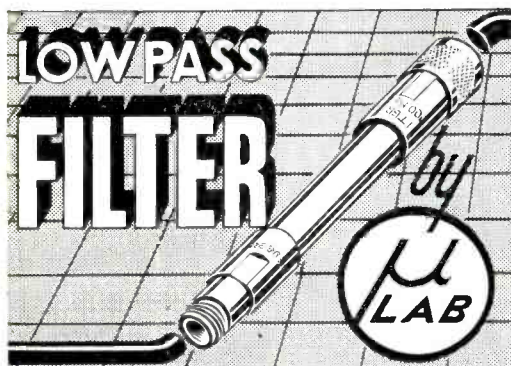

CUTOFF FREQUENCY
100-4000 Mc.

PASS BAND ATTENUATION
0.1 db. max.

PASS BAND VSWR
1.4 max.

PRICE \$30.00 - \$40.00

Other models to specifications

Phone: South Orange 2-7422

MICROLAB 301 SOUTH RIDGEWOOD ROAD
SOUTH ORANGE, NEW JERSEY
COAXIAL COMPONENTS and TEST EQUIPMENT



POLARAD ELECTRONICS CORP.

100 Metropolitan Avenue, Brooklyn 11, N. Y.

Export Dept., 13 E 40th St., N. Y. 16

REPRESENTATIVES: Albuquerque · Atlanta · Boston ·
Chicago · Cleveland · Fort Worth · Kansas City ·
Los Angeles · New York · Ontario · Philadelphia ·
San Francisco · Seattle · Syracuse

WHAT'S MAKING THAT NOISE?



finds out for
UNDERWOOD
CORPORATION

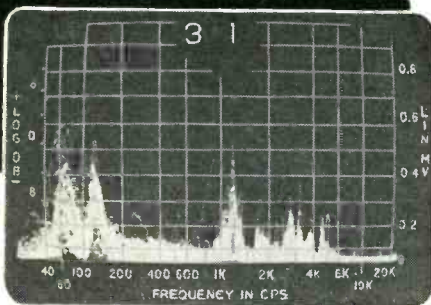

UNDERWOOD CORPORATION
GENERAL RESEARCH LABORATORY
56 ARBOR STREET, HARTFORD 6, CONNECTICUT

The Panoramic Sonic Analyzer is used in the Sound Laboratory of Underwood Corporation's General Research Laboratory to study the various products and development models.

Since the noise is generally neither rhythmic nor cyclic, a photograph of the Analyzer screen is taken on a fairly slow film over an appreciable time period while the machine is in operation. In this way an integrated analysis of the sound distribution is obtained.

A study of this distribution indicates whether the noise is pleasant or disagreeable to the operator and also gives designing engineers clues as to the source of the noise.

R. W. Woodward, Director
Electronics Division
Underwood Corporation
General Research Laboratory

PANORAMIC SONIC ANALYZER, MODEL **AP-1** provides Sound and Vibration Analysis

for Product Development
Quality Control
Improvement

the pioneer
is the leader



The ever increasing importance and volume of work in noise and vibration analysis necessitates simple high speed analyzers to assure maximum efficiency and economy both in the laboratory and on the production lines. The Panoramic Sonic Analyzer truly meets these requirements. In a matter of seconds, the AP-1 automatically visualizes the frequency distribution and amplitude of complex waveform components between 40 and 20,000 cps. The AP-1 is a dual duty instrument. It is designed for investigations of research level yet it is so simple to operate that it is widely used by non-technical personnel for production line testing.

Let us help solve your noise and vibration problems

Write for complete details today.

10 So. Second Ave., Mt. Vernon, New York

so completely that engineers were able to produce these devices in required quantities. The transistor, announced five years ago, provided an even greater impetus for becoming better acquainted with many of the concepts of solid-state physics, without which an understanding of transistor action cannot be had.

Interest on the part of electronics engineers in solid-state physics is not, of course, confined to its bearing on semiconductor devices such as crystal diodes and transistors. The electron theory of matter, especially as it relates to metals and insulators, electron emission, and the phosphors used in fluorescent lamps and cathode-ray tubes, is basic to much of our work in electronics. It has, in fact, been proposed by people in the field that semiconductor engineering be established as a recognized profession.

Professor Kittel's book is intended, presumably, to provide a working knowledge of the concepts in that branch of science we now call solid-state physics. For a reasonably complete understanding of the material, a knowledge of physics and mathematics beyond the first few years of college work is required. The book is, in fact, intended for senior and first-year graduate students in physics and chemistry. Electrical engineers will be able to study it with profit if they are already familiar with some concepts in modern physics such as the Bohr atom model and the wave equation for free particles.

The book contains five chapters on such topics as general properties, lattice characteristics, and thermal properties of solids; six on electric and magnetic properties including superconductivity; and five more on topics of special importance in electron devices, including the electron theory of metals, semiconductors, and the highly interesting and important effects of imperfections in solids.

Arrangement of the material in the book is admirable. The principles of solid-state physics are not easily made clear, and the result achieved in producing a text book on so difficult a subject is

Replaces a Chain of 10 to 20 Relays!

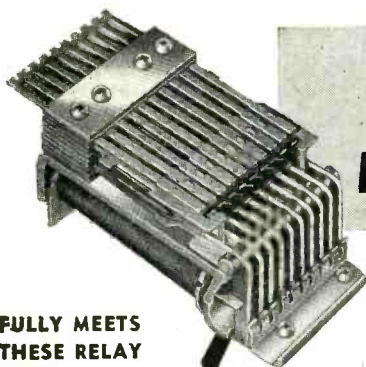

KELLOGG

Magnetic Impulse Counter

FULLY MEETS THESE RELAY SERVICE REQUIREMENTS

- ON-OFF
- DIFFERENTIAL
- INTERLOCKING
- SELECTOR
- STEPPING
- SEQUENCE
- LATCH-IN
- COUNTING
- MARKING

... A SEQUENTIAL RELAY THAT COUNTS, STORES AND "REMEMBERS"!

Small! . . . Simple! . . . Saves money! The Kellogg *Magnetic Impulse Counter* provides an ingenious and reliable answer to a host of electro-mechanical switching problems. Readily performs the counting and marking function of 10 to 20 relays or a two-magnet ten-point stepping switch—at a lower cost! Rapid operation—up to 30 pulses per second. Occupies the space of only two telephone relays. Never needs lubrication—service life is virtually unlimited. Delivers top performance in a wide variety of industrial and commercial applications where service, speed, size and price are vital factors. Get the facts—write for complete information today!

KELLOGG

A Division of International Telephone and Telegraph Corp.

KELLOGG SWITCHBOARD AND SUPPLY COMPANY
Dept. 26J, 79 WEST MONROE STREET, CHICAGO 3, ILLINOIS

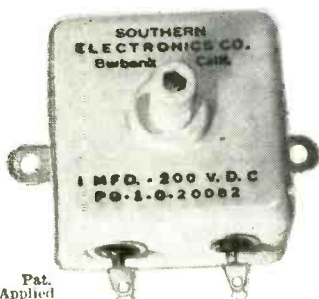

ADJUSTABLE POLYSTYRENE PRECISION CAPACITOR

Capacitance Available—1 to 10 UFD.
Voltage Available—100 to 400 VDC.
Insulation Resistance—10⁶ MEG./MFD.
Temp. Coeff.—100 P.P.M. Per °C (—20 °F to 140 °F)
Dielectric Absorb. .015%; Dissipation .0002
1% Nominal Tolerance—Resetability: ±.0001 MFD.

Ideal as **SECONDARY STANDARD** or for **TEST EQUIPMENT**

Pat. Applied for
NOW BEING USED BY LEADING ANALOG COMPUTER MFRS., including Reeves Inst. Corp.; Convair, Goodyear Aircraft; Beckman Inst.; Jet Prop. Lab.; Electronic Associates.

SOUTHERN ELECTRONICS COMPANY

239 W. Orange Grove Ave.

Burbank, Calif.

PIX

WIRE FORMING SPECIALISTS

Precision Parts to meet your Production and Engineering needs. From .002" dia. to .125" dia. Radio tube parts—Stampings—Drawings Modern facilities, high-production equipment.

Metal Crystal Holder Parts

Send sketch or print for quotation.

PIX MANUFACTURING CO., Inc.

24A Bedford St. Newark 3, N. J.

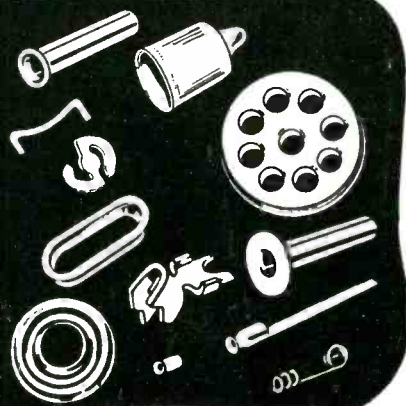

Don't be afraid to change that Package Design

BRADLEY

has a rigid plastic box for your product . . .



Series 300
8 1/4" x 4 1/4" x 1 1/4"
(assorted compartments)

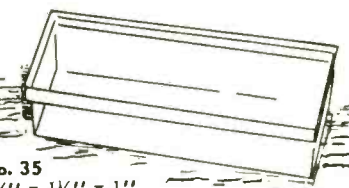

No. 35
4 1/4" x 1 1/2" x 1"

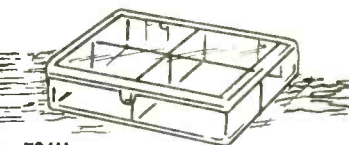

No. 704H
2 7/8" x 2" x 1 1/2"
4 compartments.

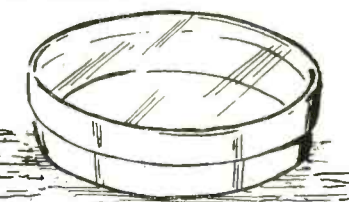

No. 32
2 3/4" diam. x 5/8" deep

Industrial manufacturers, especially of components, are utilizing our boxes for packaging. We have over 500 rigid polystyrene boxes available FROM STOCK MOLDS, or we will design a box to meet your specific requirements.

Send for illustrated catalog, showing box dimensions . . . you're cordially invited to visit our new factory and showrooms when in Chicago.

World's Largest Assortment of Rigid Plastic Boxes



BRADLEY INDUSTRIES

1650-58 North Damen Ave.
Chicago 47, Ill.

largely a matter for the reader to decide for himself. In this reviewer's opinion, Professor Kittel has done an excellent job of orderly, logical exposition; his book is certain to be widely used.—G. D. O'NEILL, *Sylvania Electric Products Inc., Bayside, N. Y.*

Microwave Spectroscopy

BY WALTER GORDY, WILLIAM V. SMITH AND RALPH F. TRAMBARULO. *John Wiley and Sons, Inc., New York, 1953, 446 pages, \$8.00.*

THE ANNOUNCED scope, and approach, of this first book on microwave spectroscopy are indeed ambitious. The wonder is that it comes so close to attaining its objective. The subject matter runs the gamut from mechanical recorders to the physics of spectroscopy, all in quite condensed form. The reader is duly warned concerning what is to come by a statement in the preface, "It is readily apparent to anyone who reads this book that microwave spectroscopy is not a single subject but rather a common method which can be applied to the study of various problems in physics, chemistry, electronics, and even astronomy."

The tremendous range of subject matter makes imperative a condensed style of presentation and places a premium on conciseness; yet the book neither looks, nor reads, like a handbook. Because page space is so important some readers will wonder about necessity for including certain items.

For example, the statement on page 11 that, "Commercially available recorders such as the Brown, the Leeds and Northrup Speedomax, and Esterline and Angus are satisfactory," while quite likely correct, somehow adds little to an understanding of the problems of spectroscopy—but does use space. Much of page 29 is used to show a dimensioned sketch of a magic tee, a standard microwave component, which immediately becomes nearly useless because iris thickness dimensions are omitted. The original source is given but a comparison soon reveals that certain dimensions differ by the waveguide wall thickness—a formidable discrepancy at K-band.

Occasionally certain parts in the microwave and electronic sections

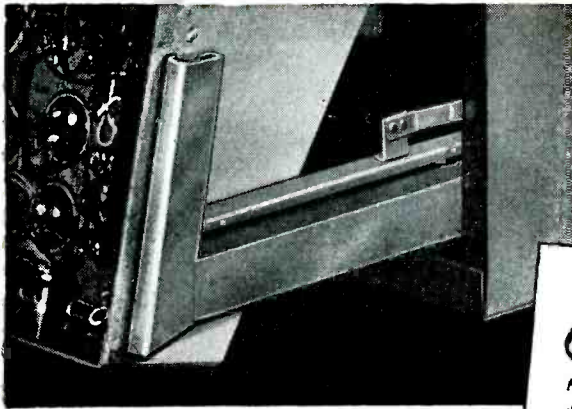

Try Remler for
Service-Tested
"Hard-to-Get"
Components

*Custom
Components*

Metal-plastic components designed and manufactured to order. Write for quotations specifying electrical and mechanical characteristics. Describe application. No obligation.

FOR EFFICIENT MAINTENANCE SPECIFY REMLER TILT-UP EQUIPMENT SLIDES

Remler slide rails for rack or cabinet mounting permit complete withdrawal or inspection of top and bottom of apparatus chassis. Positive . . . self-locking. Full roller type . . . handles

equipment up to 75 lbs. Stainless steel for military applications. Nickel plated brass rollers; roller studs in stainless or copper flashed cold rolled steel. **\$15.95 per pair**

Remler Company Ltd. 2101 Bryant St. San Francisco 10, Calif.

Write for quantity prices.

Remler

Since 1918 PIONEERS IN ELECTRONICS AND PLASTICS

a midget in size . . .

*a GIANT in
performance!*

KEYSTONE piezo crystals

Yes, they're tiny — but they carry a GIANT RESPONSIBILITY for critical frequency control in military and commercial equipment — where utmost accuracy and utmost stability are a "must".

Depend on KEYSTONE for the best in quartz crystals, plated or pressure mounted, to meet YOUR specific job!

Write for Keystone
Crystal Literature

KEYSTONE ELECTRONICS COMPANY
114 Manhattan Street Stamford, Connecticut

are emphasized in a way which almost seems to promise striking results which then are not forthcoming. For example, small but important space is used on page 11 to call attention to the relation between spectrograph sensitivity and bandwidth appearing later (Eq. 1.32, 1.33) on page 64. Inspection of the two equations indicates the not entirely unexpected dependency of the sensitivity on the square root of bandwidth.

Statements like, "Seldom are all components of the absorption line moved completely out of the range of the source frequency during a period of modulation," (page 64) should perhaps be revised to make life a little easier for the reader. Then sometimes, in attempting to be brief, unwarranted generalizations appear. To illustrate, (page 80 in section 1.6b) the statement concerning the spacing of side frequencies from the integral harmonic frequency is not general. It can be true but only in particular cases. Such particular systems require harmonic generators with input-output characteristics such that the predominant output term is the first order side frequency of the harmonic. In addition this predominance must be maintained in the detection system which follows. Another small example of larger implication is in the last paragraph on page 3. A system of time as defined by a spectral line probably does wend its way toward infinity with more uniformity than in a system defined in more conventional astronomical fashion. However, it is a little hard to see why it should be that time intervals defined by the first system should necessarily be more "accurate" when the particular use for the interval so defined is completely unspecified, especially when intervals defined by the older system are presumably simultaneously available to all users of such information. A simple statement that time defined by a spectral line progresses more uniformly than time defined by astronomical methods, might lead to more agreement.

These cited cases are random

COAXSWITCH

COAXIAL SELECTOR SWITCH

CUT-A-WAY VIEW, MODEL 74

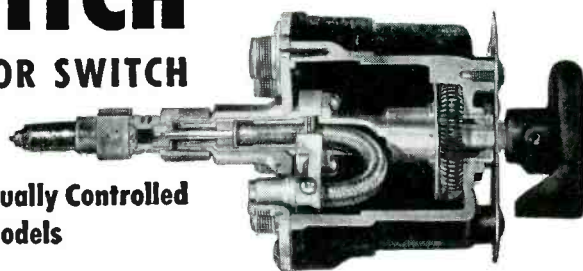

50 Ohms —
Type N Connectors—Manually Controlled
Low VSWR—4 Models

The COAXSWITCH is an RF switch for use in coaxial circuits where it is important that the 50 OHM impedance of the cables be maintained. In a circuit sense, this switch consists of two pairs of "N" connectors spaced $4\frac{1}{2}$ " apart using RG-8/U as the connecting link. The COAXSWITCH itself introduces no VSWR other than that of connectors. Characteristic impedance is maintained thru all switch details. Cut-a-

way view shows that shield as well as center conductor is switched. Beryllium copper contacts, on the gooseneck, mate directly with male "N" (Type UG-21B/U) connectors, which connect directly to back plate of switch. Since all connectors come out in line with axis of switch, right angle connectors are usually unnecessary.

Literature Gladly Sent

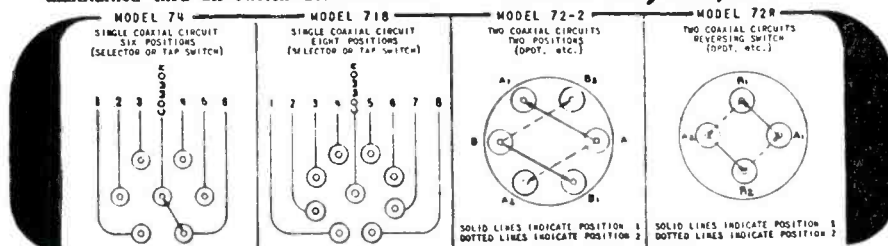

BIRD
ELECTRONIC CORP.
 1800 EAST 38TH ST., CLEVELAND 14, OHIO
TERMALINE Coaxial Line Instruments

NEELY ENTERPRISES
 Hollywood • San Francisco
 Albuquerque
EARL LIPSCOMB ASSOCIATES
 Dallas • Houston

Saratoga Industries

STAR PERFORMANCE AS
 MANUFACTURERS OF TRANSFORMERS,
 REACTORS, FILTERS, TOROIDAL
 COILS FOR THE ELECTRONICS INDUSTRY

Now in its ninth year of operation, Saratoga Industries, Inc. has built a solid reputation for the manufacture of precision windings. Approved for in-plant testing under MIL-T-27, Saratoga Industries, Inc. is also prepared to handle all types of commercial production. Saratoga engineers invite your inquiry to help solve your problems relating to reactors, transformers, filters and windings of all types.

SARATOGA INDUSTRIES, INC., SARATOGA SPRINGS, N. Y.

STANDARD SIGNAL GENERATOR

2 Mc. - 400 Mc.

Model 80

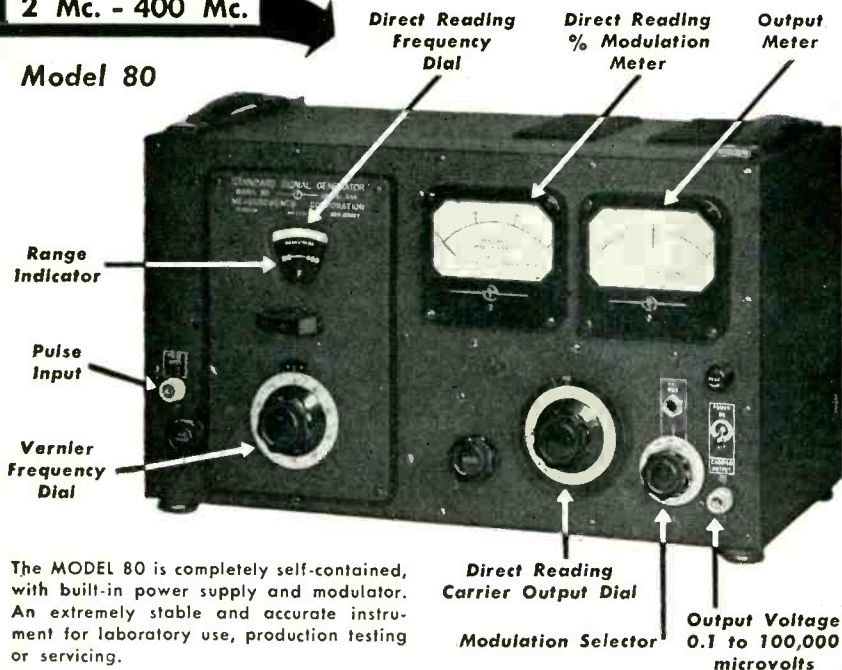

The MODEL 80 is completely self-contained, with built-in power supply and modulator. An extremely stable and accurate instrument for laboratory use, production testing or servicing.

Complete data on request

MEASUREMENTS CORPORATION
BOONTON NEW JERSEY

NEW BOOKS

(continued)

and isolated but typical of others. The objections are relatively minor. The book contains a tremendous amount of preponderantly well presented information. The style, because of the scope of the effort, is somewhat dogmatic, but the statements are well buttressed and fortified by an excellent bibliography which in itself would almost justify the appearance of this book. —L. E. NORTON, *RCA Laboratories Division, Radio Corporation of America, Princeton, N. J.*

Treatise on the Theory of Antenna Systems with Complete or Partial Rotational Symmetry

(*"Bidrag til teorien for antennesystemer med hel eller delvis rotations-symmetri"*) BY H. LOTTRUP KNUDSEN, 228 pages + figures, I Kommission Hos Teknisk Forlag, Copenhagen, 1953.

THIS BOOK, written in Danish, is the most complete treatise published to date on antenna systems possessing rotational symmetry. Radially oriented dipoles arranged like the spokes of a wheel, tangentially oriented dipoles forming the equivalent of a loop, and obliquely oriented dipoles situated in planes tangential to a circular cylinder are some of the forms analyzed. Cases are treated where the elements are all in the same phase and also where the phase increases progressively around the array. In general, the pattern is expressed by a principal term which is independent of the number of elements and correction terms which are a function of the number. Turnstile and helical antennas are included in the discussion and one chapter is devoted to supergain.

The book is restricted to antennas, such as mentioned above, possessing at least partial rotational symmetry and the author has combined, with numerous references to the literature, the results of many investigators and has integrated them with contributions of his own. The book includes a 7-page summary in English. It is illustrated with many antenna patterns and contains an extensive bibliography. The author, H. Lottrup Knudsen, is lecturer at the Royal

CATHODE-RAY TUBE JAN BEZEL FOR FLAT OR CURVED FACE TUBES

Cast aluminum bezel with black wrinkle enamel finish. Supplied complete with green plastic screen having engraved calibrations, buna-S black synthetic rubber shock mount and mounting screws.

STOCK DELIVERIES

— Other JAN Products —



MuMetal & Nicoloi Cathode Ray Tube Shields

Trimmer Covers Panel Bearings with Stainless Steel Shafts



Shaft Locks



Bushing Extenders



Offset Extension Shaft Couplers



High Voltage Insulated Couplings



STANDARD TYPE
Cat. No. 13549-1,
Curved Face 5" CRT
Cat. No. 13549-2,
Flat Face 5" CRT

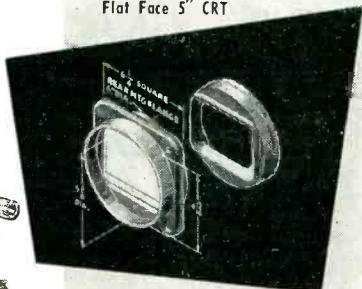

CAMERA MOUNT TYPE
Accommodates all Standard
Camera Mounts
Cat. No. CP13584-1,
Curved Face 5" CRT
Cat. No. CP13584-2
Flat Face 5" CRT

JAN HARDWARE MANUFACTURING CO., INC.
25-30 163rd Street • Flushing 58, N. Y. • INdependence 1-1200

Illustrated Literature and Data Sheets on Request. Write Dep't. "L"



TRANSFORMERS

" Fill Your Need to a "

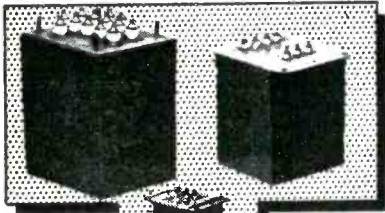

For INDUSTRIAL and ELECTRONIC EQUIPMENT

SAMPLE SHORT and LONG RUNS

Let us quote on your Specifications, no obligation

Delivery as Promised!

DESIGNED TO COMMERCIAL AND MILITARY SPECIFICATIONS (MIL-T-27 and AN-E-19)

EPCO Products Inc.
2500 Atlantic Ave.
Brooklyn 7, New York

Equal to 800,000 Operations

GRAYHILL
Series 4000
Push Button
Switch

THINK YOU'LL NEED MORE? THAT'S THE APPROXIMATE LIFE EXPECTANCY OF THIS RUGGED NON-SNAP ACTION, MOMENTARY CONTACT S.P.S.T. SWITCH — WHEN USED AT THE FACTORY RATING. SOLDER TYPE TERMINALS ONLY. HOUSING AND BUTTON ARE BOTH MOLDED PHENOLIC. RATED 1/2 AMP. 115 V., AC, NON-INDUCTIVE. BUSHINGS 15/32-32 NS-2 THREAD. AVAILABLE AS NO. 4001 NORMAL OPEN—OR, NO. 4002 NORMAL CLOSED.



Write or phone for complete data

Grayhill

523 Hillgrove Avenue LaGrange, Illinois
Phone: LaGrange 8000

HICKOK

Model 539A

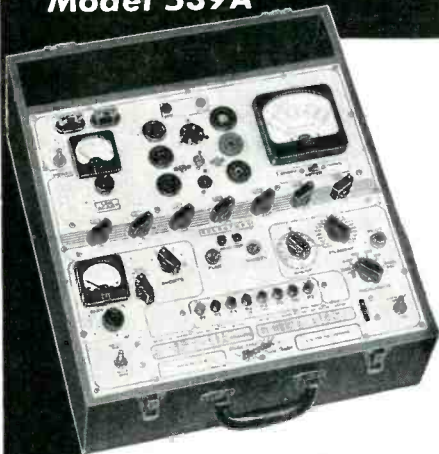

Most Accurate LABORATORY PORTABLE TUBE TESTER

- Accurately tests all Receiver tubes including high-gain types.
- Choice of 3 AC Signals and 3 micromho ranges.
- The leading tube tester in the industry.
- Write for technical details...

THE HICKOK ELECTRICAL INSTRUMENT CO.
10527 Dupont Ave. • Cleveland 8, Ohio

BIRNBACH

Electronic

WIRE & CABLE

For ALL Your Wiring Needs!

GOVT. SPEC. HOOKUP WIRE

- JAN-C-76 SRIR-SRHV PLASTIC Solid Colors or Spiral Markings
- WL-EXTRUDED NYLON JACKET Solid Colors or Spiral Markings
- AIRCRAFT WIRE-NYLON JACKET MIL-W-5086 (Supersedes AN-J-C-48a) also MIL-C-7078 (with shield).
- 105° C. U.L. APPROVED Thermoplastic Hookup Wire
- JAN C-76 WL-GLASS BRAID Solid or Tracer Colors
- MULTICONDUCTOR SHIELDED CABLES 1 to 8 cond., Rubber covered, shielded & unshielded.

COMPLETE WAREHOUSE STOCKS

- Vinyl Extruded and Radio Grade Tubing
- Multiconductor Rubber Covered Cables
- Tinned & Bare Wire
- Magnet Wire
- Formvar Wire
- Shielded Wires
- Insulated Hardware
- Plugs, Jacks, Sockets
- Test Leads, Switches
- Insulators, Steatite, Ceramic
- Terminal Strips

Quality Products for the Electronics Industries since 1923

BIRNBACH RADIO CO. Inc.

145 HUDSON STREET
NEW YORK 13, N. Y.

WRITE FOR CATALOG 53-E

AMPLIFIES INPUT SIGNALS 1,000,000 TIMES!

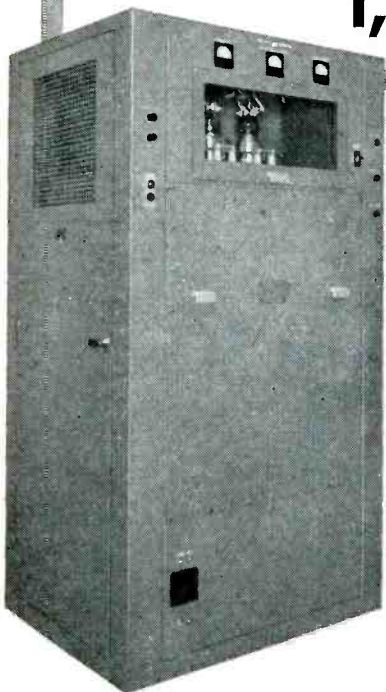

Look at the extremely high power output of this new Westinghouse Type FG variable-frequency amplifier. It can take an audio signal of about 10 milliwatts from any conventional 30 to 20,000 cps source . . . and build it up to 5 or 10 KW with uniform response and low distortion.

This suggests uses such as: powering vibration shakers . . . powering supersonic transducers . . . exploring high-frequency vibration phenomena . . . producing supply power at any audio frequency . . . testing equipment under laboratory-controlled conditions.

The Type FG amplifier is completely self-contained, and self-protected against overload or blower failure. Easily installed, the unit requires only 23 square feet of floor space. Conversion from 5 KW to 10 KW is simple. For information write Westinghouse Electric Corporation, Electronics Division, I.E. Devices Section, 2519 Wilkens Avenue, Baltimore 3, Maryland.

YOU CAN BE SURE... IF IT'S **Westinghouse**

J-02275

Precision PAPER TUBES

2000 SIZES
in any shape
ID or OD

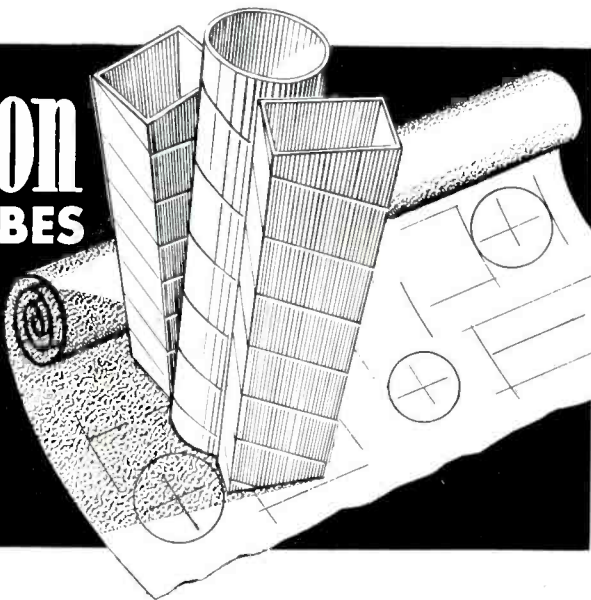

Whatever your specific needs, depend on PRECISION PAPER TUBES to meet all requirements. Spirally wound under pressure, PRECISION PAPER TUBES are subjected to rigid tolerance control to insure strict adherence to specifications and provide maximum winding space. PRECISION PAPER TUBES possess 15 to 20% greater strength, yet are light in weight.

Made from the finest dielectric kraft or fish paper, phenol impregnated, acetate or combinations, PRECISION PAPER TUBES afford high insulation, heat dissipation and moisture resistance. Available in any size, shape, I.D., O.D.—any quantity.

Write today for Arbor List of over 2000 sizes . . . Send specifications for free sample.

PRECISION PAPER TUBE CO.

2041 W. CHARLESTON ST.

CHICAGO 47, ILL.

Plant No. 2: 79 Chapel St., Hartford Conn. Also Mfrs. of PRECISION Coil Bobbins

Technical University of Denmark in Copenhagen.—JOHN D. KRAUS, *Ohio State University, Columbus, Ohio.*

Complex Analysis

By LARS V. AHLFORS. *McGraw-Hill Book Co., New York, 1953, 247 pages, \$5.00.*

THIS BOOK was written for use as a text in the first year graduate course in complex variables which is given at most universities. It is the reviewer's opinion that the author has in fact largely succeeded in creating a text which is concise, rigorous, teachable and authoritative, and inasmuch as a real need exists for a text at this level, this one appears certain to enjoy wide use.

Although the author writes for the mathematician, geometric visualization is stressed in the hope that the reader's intuitive grasp of the matter is developed even though he might not follow the proofs in detail. The author's approach may be a bit abstract for the tastes of most engineers working in applied mathematics. Moreover, most of the results which are of importance in applied mathematics may be found stated elsewhere without rigorous proofs.

In the first chapter, the arithmetic operations satisfied by the complex numbers are introduced and an outline of the justification of the process is presented (i.e., a proof of the existence of the complex-number field). This is followed by the geometric representation of complex numbers. The author is careful to point out that while a geometric argument cannot replace an analytic proof, still geometry is a useful tool for guiding the intuition. This tool is then applied to lead the discussion through the spherical representation (Reimann sphere) and the linear transformations.

The second chapter is devoted to the concept of a complex function as a mapping from one complex plane to another. After a tentative definition of analytic functions, the elementary functions are discussed. Only those topological concepts necessary for function theory are then introduced. Based on those concepts arbitrary analytic func-

tions are presented, concluding with a discussion of elementary Reimann surfaces.

The third chapter covers complex integration. The author considers his delay in introducing integration (until the student has mastered the mappings of the previous chapter) an essential feature of the book. Cauchy's theorem is proved in great generality. The notions of removable singularities, Taylor expansions, zeros and poles, and exact differentials are also introduced. The chapter ends with a discussion of the calculus of residues including an excellent section on the evaluation of real integrals.

The fourth chapter deals with infinite sequences and associated ideas including topics such as uniform convergence, power series, partial fractions, and infinite products. The Reimann mapping theorem ends the chapter.

The fifth chapter is devoted to harmonic functions. These are defined and some of their properties (e.g. maximum principle, Poisson's formula, Harnack's principle, Jensen's formula, the symmetry principle) are proved. The Dirichlet problem is solved by the use of subharmonic functions (Perron's method). Finally, by use of the notion of harmonic measure, mappings of multiple-valued functions are discussed.

The last chapter covers the theory of multiple-valued functions. By the notion of analytic continuation, the general analytic function is defined. From this follows a definition of a Reimann surface and the monodromy theorem. The algebraic functions are studied. The book ends with a discussion of linear differential equations.—S. G. KNEALE and G. W. PRESTON, *Philco Corporation, Philadelphia, Pa.*

Applied Electricity

By H. COTTON. *The Industrial Press, New York*, 480 p, 1953, \$4.50.

THE FIRST edition of this book, introduced in England in 1951, is now revised and somewhat increased in scope, and made available for American use. It is a primary book, aimed at technical schools or as a first course in colleges, and deals with the elements and machinery of direct and alter-

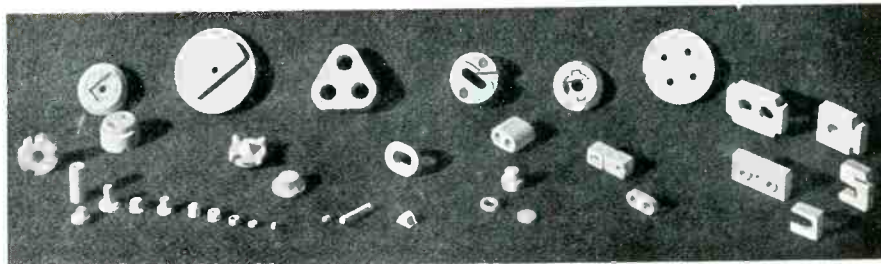

**For Low Power Factor
Low Dielectric Loss Specify**

STAR STEATITE

STAR STEATITE has the ideal characteristics for its effective use in high frequency electronic applications. It reduces the possibility of power loss, deformation and excessive heating of insulators that prevent proper functioning of the assembled product. It is molded into exact shapes to close tolerances; resists great mechanical shock and extreme conditions of heat and humidity. And STAR has the facilities to meet your volume requirements. Why not investigate . . . NOW?

Star PORCELAIN COMPANY
49 Muirhead Avenue • Trenton 9, N. J.

ELECTRAN

- ★ Transformers
- ★ Saturable Reactors
- ★ Electronic Devices

Transformers

Dependable Components

Dependable delivery schedules

Designers and Custom Builders—small and medium quantities—from milliwatts to 50 KVA, single or polyphase.

May We Bid On Your Requirements?

ELECTRAN MFG. CO.
1901 CLYBOURN AVENUE • CHICAGO 14, ILLINOIS

IF IT'S NEW . . . IF IT'S NEWS . . . IT'S FROM **ELCO**

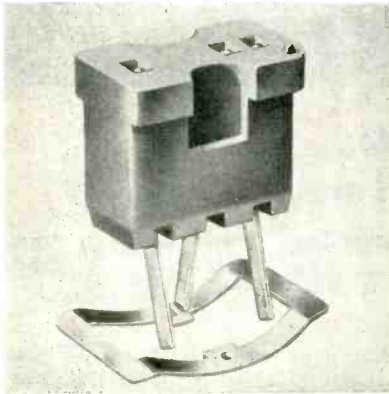

News indeed, is Elco Corporation's new transistor socket, point contact and junction type. The transistor is now emerging as a tremendous new tool for practical everyday electronics; and Elco, with a deep background of experience in transistor socket development for laboratory use, now offers these same highly-refined sockets in mass production for commercial applications. And, as with all Elco products, the use of Elco transistor sockets offers many advantages previously unavailable.

New contact design automatically centers the transistor pins in position, eliminating strain on the transistor body. Positive contact resistance assures excellent circuit performance. Insulator construction affords adaption for printed circuitry, a decided extra advantage; and creates a longer creepage path between contacts. Mounting retainer securely locks body of socket to chassis and is self-adjusting to any variation in chassis thickness from .015" to .062". The retainer is of heat-treated steel cadmium plated; the insulator of low-loss mica filled phenolic. Elco also offers many other new sub-miniature, miniature and printed circuit types. Complete details are yours upon request, as is full information about Elco's quality line of sockets, shields, and sensational new Varicon connectors.

For Catalog Sheets, Call GARfield 6-6620 or Write ELCO Corp., 190 W. Glenwood, Phila. 40, Pa.

nating currents. Since some of the concepts introduced are not explained (integrals and differentials for example) a teacher or previous knowledge of these tools would be required.

The fundamentals are composed of chapters on the electric circuit, magnetism, electrostatics, conduction in electrolytes and thermoelectricity. Then follow chapters on d-c machines, a-c currents and circuits, resonance, polyphase circuits, transformers, alternators, synchronous and induction motors, electronics (32 pages), illumination, measuring instruments and a final section on units and dimensions.

The text is easy to read; there are numerous examples worked out in detail and a great many problems with answers. By the chapter headings it is seen that it deals mostly with fundamentals and with power equipment rather than with electronics. While the slant is definitely English, it would be useful in an American technical school.

—K. H.

Design of Machine Elements

By M. F. SPOTTS. *Prentice-Hall, Inc., New York, 1953, 496 pages, \$9.65.*

IN THE PREFACE, the author states that this book was designed to provide an introduction to the design of machine elements in a comprehensible manner. These aims have, in general, been carried out with admirable results.

When first published in 1948, this book was enthusiastically received. Now the author has gone over his entire book to make it even more comprehensible, more approachable, more flexible than before. He has done this by introducing many additional topics and by going into greater detail than previously. Sufficient definition has been incorporated to acquaint all interested readers with a perspective of each major step.

"Design of Machine Elements", as the title indicates, does not deal with the broader aspects of the design of complete machines, but explains the fundamental principles required for the correct design of the separate elements which compose the machine. If a complete



Silicone RUBBER

Your Part Requires our **INJECTION MOLDING** Process if . . .

- ★ High or low temperature requirements must be met.
- ★ Constant dielectric properties is a "must".
- ★ Resistance to chemicals is required.
- ★ Uniformity and low cost are factors.

Send sample or print for a prompt quotation.

MINNESOTA SILICONE RUBBER CO.

5724 West 36th St. • Minneapolis 16, Minnesota

Affiliated with *Minnesota Rubber & Gasket Co.*
OFFICES IN PRINCIPAL CITIES

"INDUSTRIAL"

for ELECTRONIC COMPONENTS

Precision engineered electronic components and connecting devices for all your needs.

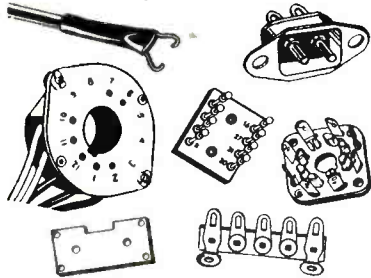

- ANODE CONNECTORS
- INTERLOCK PLUGS
- LAMINATED TUBE SOCKETS
- TERMINAL STRIPS
- WIRED ASSEMBLIES
- METAL or BAKELITE STAMPINGS
- TERMINAL BOARD ASSEMBLIES
- SCREW MACHINE PARTS

— NEW ITEMS —

- TUNER STRIPS, SOCKETS and BRACKETS for UHF



Our extensive design and production facilities are available for developing your special requirements and applications. Representatives in principal cities throughout U.S.A. Call or write for samples and information. ORegon 7-1881.

INDUSTRIAL HARDWARE Mfg. Co., Inc.
109 P. INCL STREET • NEW YORK 12, N. Y.

IF ITS
WILMAD

ITS **PRECISIONIZED**
Glass Components for

- BEARINGS
- RESISTORS
- DASHPOTS
- CAPACITORS
- U.H.F. TUNERS
- VOLTAGE REGULATORS

★ WILMAD PRECISION BORE TUBING

... is available in uniformity and accuracy never before known possible for America's electronics industry



WILMAD GLASS CO. INC.

LANDISVILLE, NEW JERSEY

Specialists to Research and Industry

Our engineers will gladly collaborate on any of your glass requirements.

For **HEAVY DUTY**
WORK! Severest Electrical Services!



P-506-CE
Plug with Cap



S-506-DB
Socket with
deep Bracket

JONES PLUGS & SOCKETS

500 SERIES

*Proven
Quality*

For 5,000 Volts,
25 Amperes per
Contact Alter-
able by circuit
Characteristics.

Socket contacts phosphor bronze, knife-switch type, cadmium plated. Plug contacts hard brass, cadmium plated. 2, 4, 6, 8, 10, and 12 contacts. Plugs and sockets polarized. Long leakage path from terminal, and terminal to ground. Caps and brackets, steel parkerized (rust-proofed). Plug and socket blocks interchangeable in caps and brackets. Terminal connections most accessible. Cap insulated with canvas bakelite.

Write for Jones BULLETIN 19 for full details on line.

Jones

HOWARD B. JONES DIVISION
CINCINNATI MANUFACTURING CORPORATION
CHICAGO 24, ILLINOIS
SUBSIDIARY OF UNITED-CARR FASTENER CORP.

versatile

Multi-channel --
telegraph A1 or
telephone A3.



FROM GROUND TO AIR OR POINT TO POINT

STABLE

High stability (.003%) under
normal operating
conditions.

RUGGED

Components
conservatively
rated. Completely
tropicalized.

Model 446 transmitter operates on 4 crystal-controlled frequencies (plus 2 closely spaced frequencies) in the band 2.5-24.0 Mcs (1.6-2.5 Mcs available). Operates on one frequency at a time; channeling time 2 seconds. Carrier power 350 watts. A1 or A3 AM. Stability .003% using CR-7 (or HC-6U) crystals. Operates in ambient 0° to +45° C using mercury rectifiers; -35° to +45° C using gas-filled rectifiers. Power supply, 200-250 volts, 50/60 cycles, single phase. Conservatively rated, sturdily constructed. Complete technical data on request.

Here's the ideal general-purpose high-frequency transmitter! Model 446... 4-channel, 6-frequency, medium power, high stability. Suitable for point-to-point or ground-to-air communication. Can be remotely located from operating position. Co-axial fitting to accept frequency shift signals.

Consultants, designers and manufacturers of standard or special electronic, meteorological and communications equipment.

AER - O - COM

3000 DOUGLAS ROAD

MIAMI 33, FLA.

Reg. U.S.

Pat. Off.

N.L. Instr't

UHF TV MEASURING INSTRUMENTS

by New London

Write for Complete Catalog of our Measuring Equipment

Designed for laboratory and production test use, the Model 130 has proven itself an ideal low cost instrument.

Frequency range: 450 to 900 mc
Output voltages: 0.01 to 1.0 volts into 75 ohm load
Sweep: 60 cycles, sine wave
Sweep width: 0 to at least 30 mc, continuously variable

Output: Unmodulated, AM or swept

Markers and balun for 300 ohm load are available.

The only UHF Grid Dip Oscillator in the field, the versatile Model 200 is an extremely useful instrument for those who do UHF TV work. Featuring single range tuning and direct reading, the Model 200 has a remarkably smooth meter indication.

Frequency range: 400 to 900 mc, single range
Output: CW
Size: 8½" high x 3" wide x 4" deep

New London Instrument

NEW LONDON 2, CONN.

Company



UHF TV SWEEP GENERATOR MODEL 130 - \$265-



UHF GRID DIP OSCILLATOR MODEL 200 - \$140-

now... RESINITE brings you the HIGHEST RESISTIVITY of any RESINATED PRODUCT

Resinite Coil Forms are laboratory tested and field proven. Their operating characteristics—volume resistivity . . . power factor . . . thermal properties . . . low moisture absorption . . . and resistance to voltage breakdown—represent a new achievement in basic components for electronic application.

Resinite Coil Forms are available with inside or outside threads, slotted, punched or embossed. Axial pressure in excess of 25 lbs. is accomplished through a special three row threaded design. Torque can be controlled to + or -1 in. oz.

RESINITE CORPORATION
DIVISION OF PRECISION PAPER TUBE

2035E W. Charleston St., Chicago 47, Ill.
79 Chapel St., Hartford, Conn.

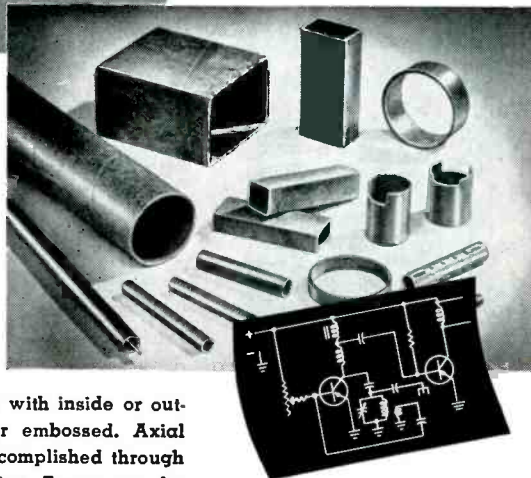

RESINITE 8104: for coil forms requiring very high dielectric properties under extreme humidity.

RESINITE "AC": for applications requiring very high dielectric strength. ELECTROLYTIC CORROSION IS IMPOSSIBLE.

RESINITE 104: for stapling, severe forming, fabricating.

Send today for full details and technical information.

machine is to be designed, the text will serve as a reference work or source book for information on the various elements.

The chapter headings are as follows: 1. Fundamental Principles; 2. Working Stresses; 3. Theory of Torsion; 4. Springs; 5. Screws; 6. Belts, Clutches, Brakes; 7. Welded and Riveted Connections; 8. Lubrication; 9. Ball and Roller Bearings; 10. Spur Gears; 11. Bevel, Worm and Helical Gears; 12. Miscellaneous Machine Elements; 13. Dimensioning and Details; and 14. Engineering Materials.

The well-known basic theories of design are clearly presented, as now being employed. Mathematical derivations are given in full, but have been simplified wherever possible. Tables are included giving the properties of engineering materials as determined by laboratory tests; however, design data usually obtained from catalogs and handbooks have been omitted. The text contains many illustrative examples, problems and solutions. Each chapter is concluded with a brief bibliography for those who may wish to pursue the study of the various machine elements more extensively. Engineers and designers in industry will find this book to be of value as a reference.

Professor Spotts has had many years of experience in teaching machine design, and he has also spent years as a practising engineer in industry. Author of numerous articles on this subject, he is Professor of Mechanical Engineering, The Technological Institute, Northwestern University, Evanston, Illinois.—EUGENE J. MARTIN, *Physics Laboratories, Sylvania Electric Products Inc., Bayside, New York*

THUMBNAIL REVIEWS

ASTM Standards on Electrical Insulating Materials. ASTM, 1916 Race St., Philadelphia 3, Pa., 590 pages, 1953, \$5.25. The 1953 edition containing standards, test methods, specifications and appendices. Printed on Bible paper and with heavy paper cover.

Measurement of Linear and Non-linear Distortion in Electrodynamical Speakers, by Fritz Ingerslev, I Kommission Hos Teknisk Forlag, Copenhagen, 1953 266 pages. In Danish but with a 13-page summary in English.



*where precision
matters...*

THERMADOR



*Transformers for Television
... Radar ... Aircraft ...
Geophysics ... Radio*

You will find Thermador ready, willing and fully qualified to handle your transformer requirements. Engineering experience and manufacturing know-how, developed over a period of 35 years, form the hard core that makes Thermador today's largest West Coast manufacturer of electrical appliances and transformers. We would like to work with you on your next project involving the design and production of transformers for specific requirements...including joint Army-Navy specifications.

transformers:

- Audio Auto Geophysical
- Driver Filament High-Fidelity Audio
- Input-Output Midget Plug-In
- Plate Power Television
- Tube to Line

... also Chokes and Reactors



**THERMADOR ELECTRICAL
MANUFACTURING CO.**

3-320

5110 District Boulevard • Los Angeles 22, Calif.

Want more information? Use post card on last page.

ELECTRONICS — October, 1953

BACKTALK

QRA

DEAR SIRs:

IN YOUR July issue you carried a story (p10) on the first share-time authorization for television operation, that of Stations KMBY-TV and KSBW-TV in Monterey and Salinas, California. As consulting engineer for these two stations, I would like to compliment you on the article. It is regretted, however, that the call letters for the Monterey station were erroneously shown as WMBY-TV.

Construction of these stations is now proceeding and they are expected to be in operation at an early date.

ROBERT L. HAMMETT
Consulting Radio Engineer
San Francisco, California

Loaded

DEAR SIRs:

I HAVE read the article in the July, 1953, issue of ELECTRONICS, "How to Design Small Boat Antennas" by Elbert Robberson, and found it very interesting.

We are in agreement with Robberson's comments and conclusions. However we feel that enough emphasis was not placed on the conclusions relative to the gains to be made by locating the loading coil near the base of the antenna.

From our work in the field of high-Q loading coils for the 75-meter (and 40, 20, 11, etc.) mobile radio amateurs we have come to the conclusion that the amateurs, and some others, have been taking the term center-loading a bit too literally. It becomes obvious that with amateur mobile antennas in the range of 100 to 130 inches in total length, with a loading coil placed at the exact center, the top section will have too little capacitance to tune the coil properly. Also the coil will have more turns, reducing the gain made in resistance loss by moving the coil half way up the whip.

Physically, an efficient loading coil is much more easily mounted at or near the bottom of the antenna where it will ride much better and probably result in the antenna being in tune a higher percentage

ELECTRONIC LENSES?

Pennsylvania Optical, one of the oldest optical houses in the nation, is now successfully applying spectacle making mass production methods to the lens problems of the Electronics Industry.

We're proud of the lenses we are now making for some of the largest manufacturers of electronic equipment. Picture tube face plate lenses. Lenses for Magnetrons, Iconoscopes. Atomic Radiation Windows. Filter Lenses of all kinds. A host of allied "problem children." We take a lot of pride in our control of flat surfaces, of prism tolerances, and diameters.

We are inviting additional specialized lens work in the electronics field, leading to volume orders. We're equipped for everything from basic research to making our own tools to meet its demands.

Will you let us know your lens problems?

**PENNSYLVANIA
OPTICAL
COMPANY**

234 So. Eighth St., Reading, Pa.

Telephone: Reading 4-8397

MICROWAVE ATTENUATORS

**For Precision Measurements
2,600 MCS To 26,500 MCS**

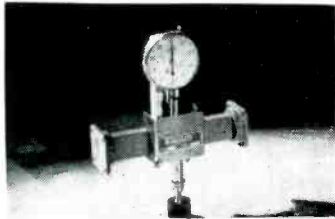

Type 612 — 8.20 to 12.4 Kmc./sec. Waveguide size: 1" x 1/2" O.D. Range: 40 db. Calibrated to an accuracy of ± 0.3 db.

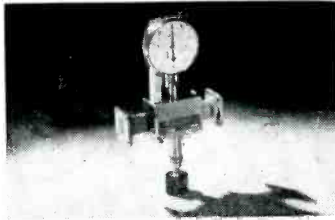

Type 712 — 12.4 to 18.0 Kmc./sec. Waveguide size: .702" x .391" O.D. Range: 40 db. Calibrated to an accuracy of ± 0.3 db.

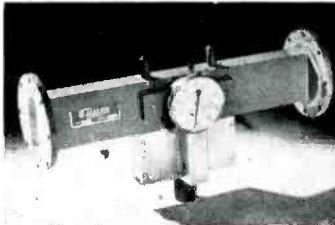

Type 312 — 3.95 to 5.85 Kmc./sec. Waveguide size: 2" x 1" O.D. Range: 50 db. Calibrated to an accuracy of ± 0.3 db.

Latest brochure with detailed specifications and prices on complete line of attenuators available on request.

WAVELINE INC., CALDWELL, N. J.
Formerly: MICROWAVE EQUIPMENT CO.

of the time while the vehicle is in motion. Practically, it also looks better at the base.

All of the above observations are confirmed by our results with a high-Q loading coil we manufacture. On average amateur mobile antennas we recommend the placing of the loading coil not over 24 inches above the spring mount.

If we insist on the principle of center loading, we should also consider that in the base-loaded whip, with the coil replacing a section of the whip, the ball joint, the spring mount and the bottom of the coil itself are active radiators.

H. CHARLES KAETEL
K-W Engineering Works
3145-A North 48th Street
Milwaukee, Wisconsin

Hidden Treasure

DEAR SIR:

YOU HAVE been recommended to us as the best source from which to obtain the names of firms in the U. S. that manufacture electronic equipments for the detection of minerals and metals. Our chief interest is to locate hidden treasures buried in Paraguay after the 1865-1870 war against the Triple Alliance, in which at least 800,000 people died. Most of the private and public money, jewels etc. were buried.

We have already contacted some manufacturers in the U. S. We have their literature and some of their instruments. However, each instrument has advantages and disadvantages for our purpose. We are still looking for something better and more modern, regardless of cost.

Under these circumstances, we have no doubt that you can investigate this matter and put us in direct communication with firms or persons whom you think may be able to submit to us an instrument we could use for our investigations. No doubt that after the various experiences of the late war, mine detectors have been improved and new methods are now available. One commercial instrument seems different from other equipments. It uses a galvanometer instead of a milliammeter and earphones and works with a high-frequency oscillator. However, the manufacturers

ELECTRONIC GLASS WORKING EQUIPMENT

For Radio, Television Tubes, Incandescent Lamps, Glass Lathes for Television Tubes

EISLER B HEAD AUTO INDEXING STEM MACHINE
FRONT VIEW

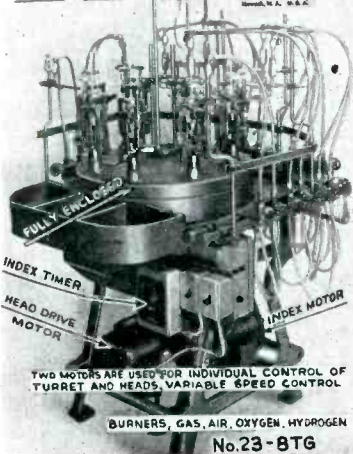

TURNABLES ▶

We make over 100 types of turntables; tilting models and positioners.

More Eisler Stem and Sealing Machines are in use in the Electronics Industry than all other makes combined. There is a reason; they are simple, well-built, compact, last long, have good production, and are constantly being improved to give more production.

TURN TABLE TILTING TYPE
EISLER SIZE No. 3



EISLER B POSITION AUTO INDEX SEALING MACH. GENEVA DRIVE
FRONT VIEW

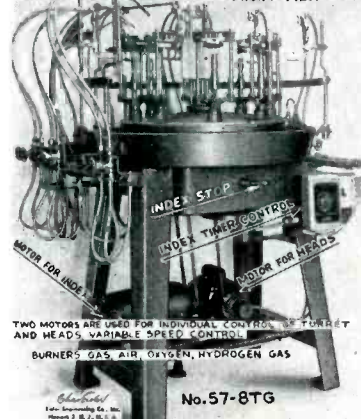

We make Transformers, Spot and Wire Butt Welders, Wire Cutting Machines and 500 other items, indispensable in your production. Eisler Engineers are constantly developing New Equipment. If you prefer your own designs, let us build them for you. Write to Charles Eisler who has served The Industry over 33 years.

Dr. Charles Eisler, President

EISLER ENGINEERING CO., INC.

751 South 13th St., Newark 3, N. J.
Near Avon Avenue

WANT THE BEST IN CAPACITORS?

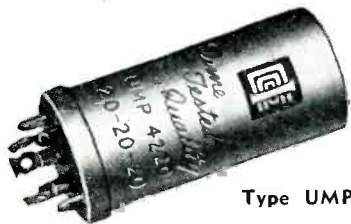

Type UMP

Many, many notable advances in the art of capacitor design and manufacture have been made by the ILLINOIS CONDENSER COMPANY. As an example, ILLINOIS CONDENSER COMPANY has recently been awarded a patent on their unique and exclusive molded capacitor construction as featured in the UMP types.

For almost two decades, ILLINOIS CONDENSER COMPANY has been building quality capacitors and regular users include most all of the largest manufacturers of TV and radio sets. Their names literally compose the "blue book" of electronics.

To meet the ever increasing demand for ILLINOIS electrolytic capacitors, ILLINOIS CONDENSER COMPANY has built new plants and greatly increased production. Why don't you, too, discover why ILLINOIS capacitors are "first choice" of so many!

Write for Catalog!



ILLINOIS CONDENSER CO.
1616 NORTH THROOP STREET • CHICAGO 22, ILL.

DOUBLE BARREL ADVERTISING

Advertising men agree—to do a complete advertising job you need the double effect of both Display Advertising and Direct Mail.

Display Advertising keeps your name before the public and builds prestige.

Direct Mail supplements your Display Advertising. It pin-points your message right to the executive you want to reach—the person who buys or influences the purchases.

In view of present day difficulties in maintaining your own mailing lists, our efficient personalized service is particularly important in securing the comprehensive market coverage you need and want.

Ask for more detailed information today. You'll be surprised at the low overall cost and the tested effectiveness of these hand-picked selections.

for Results



Mc GRAW-HILL
DIRECT MAIL LIST SERVICE

McGraw-Hill Publishing Co., Inc.
130 West 42nd St., New York 36, N. Y.

selective insulation

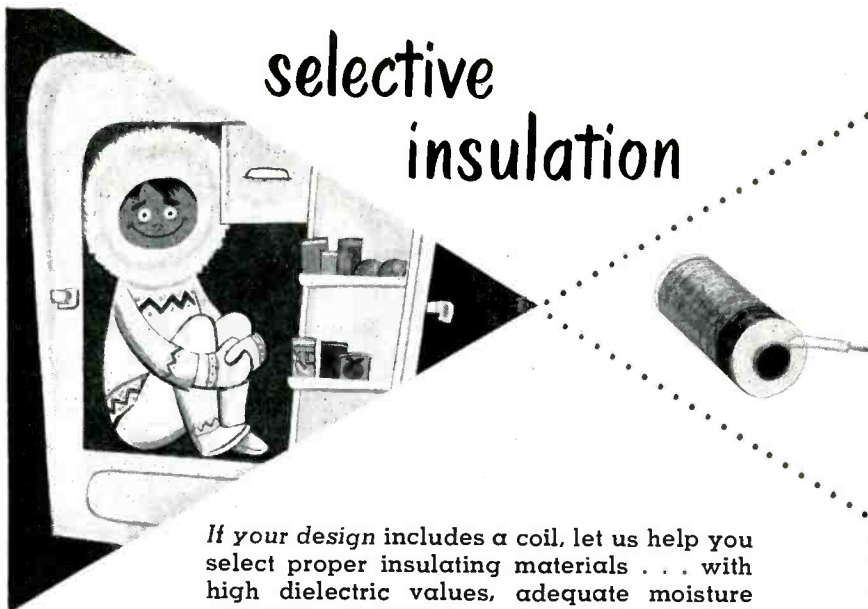

If your design includes a coil, let us help you select proper insulating materials . . . with high dielectric values, adequate moisture resistance, rugged and serviceable physical properties. Make the coil a strong point in your product, instead of a danger spot. Coto-Coil Company, 65 Pavilion Avenue, Providence 5, R. I. New York office: 10 E. 43rd Street, New York 17.

Coto PRECISION WOUND **Coils**



* VAW METERS

MODEL 101
SUPERSONIC FREQUENCY
RANGE 20 cps to 200,000 cps

MODEL 102
LOW POWER FACTOR
RANGE 20 cps to 20,000 cps

FOR MEASUREMENT of VOLTS • AMPS • WATTS

MODEL 101

- POWER RANGE: 100 μ W to 9 Kw.
- INPUT IMPEDANCE: 1 MEGOHM.
- VOLTAGE RANGE: FULL SCALE 0.1V to 300V.
- CURRENT RANGE: FULL SCALE .001 to 30A.

MODEL 102

- READS WATTS AT FULL SCALE AT BOTH 10% AND UNITY POWER FACTORS.
- INPUT IMPEDANCE: 1 MEGOHM.
- POWER RANGE: FULL SCALE, 225 μ W to 18 KW.
- VOLTAGE RANGE: FULL SCALE, 1.5V to 600V.
- CURRENT RANGE: FULL SCALE, .0015A to 30A.

WRITE
WIRE
PHONE

FOR POWER and LOSS MEASUREMENTS — in Cables • in Iron Cores • in Transformers — Copper, Core and Impedances • in Classes A, B, C Amplifier Inputs and Outputs • at Aircraft Upper Power Frequencies • in Underwater Sound Equipment • in Loud Speakers • in Synchro, Motor, and General Servo Circuitry • in Carrier Current Equipment • in Complex Waveforms • in Circuit Analysis, both Linear and Non-linear • in Sound and Noise Analysis • These are but a few of the nearly unlimited applications of the VAW meters.

Our Engineers will be happy to discuss the application of the VAW Meter to solve your particular problem. Write Dept. E-10. Literature available on request.



JOHN FLUKE ENGINEERING COMPANY

1111 WEST NICKERSON STREET, SEATTLE 99, WASHINGTON

Represented by . . . YEWELL ASSOCIATES, Bridgeport & Boston; HORMAN ASSOCIATES, Wash-

*Registered Trademark
ington, D. C.; GERALD B. MILLER CO., Hollywood, San Francisco, Albuquerque, Seattle; M. P. O'DELL CO., Cleveland, Dayton; HUGH MARSLAND & CO., Chicago; EARL LIPSCOMB ASSOCIATES, Dallas, Houston; RMC ASSOCIATES, New York, N. Y.; Bogota, N. J.; THE I. E. ROBINSON CO., Upper Darby, Pa.; Ashbury Park, N. J.; J. D. RYERSON, Syracuse, N. Y.; H. M. RICKARDSON, Minneapolis, Minn.

SILVER GRAPHALLOY

BRUSHES

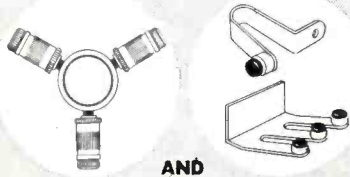

AND

CONTACTS



... for applications requiring low electrical noise, low and constant contact drop, high current density and minimum wear.



EXTENSIVELY USED IN

SELSYNS
ROTATING THERMOCOUPLE and
STRAIN-GAGE CIRCUITS
ROTATING JOINTS
GUN-FIRE CONTROLS
DYNAMOTORS etc.

Wide range of grades available for standard and special applications.

Brush holders and coin silver slip rings available for use with Silver Graphalloy Brushes.

OTHER GRAPHALLOY PRODUCTS:

Oil-free self-lubricating Bushings and Bearings, Oil-free Piston Rings, Seal Rings, Thrust and Friction Washers, Pump Vanes.



Write us for Data Sheets and further information.

GRAPHITE METALLIZING CORPORATION

1055 NEPPERHAN AVENUE • YONKERS, NEW YORK

- Please send data on Graphalloy BRUSHES and CONTACTS.
 Send data on BUSHINGS.

NAME & TITLE _____

COMPANY _____

STREET _____

CITY _____ ZONE _____ STATE _____

Want more information? Use post card on last page.

BACKTALK

(continued)

mention that their latest model has many improvements, but have published no new literature since 1934.

If you are in a position to obtain any information as to the firm manufacturing or selling this equipment, we will appreciate your information. We are sure that you must know about several new inventions that could be used in the field in which we are interested. Having explained to you our requirements we trust you will be of help to us.

JOHN H. G. BALDWIN
General Manager
Promocion
Asuncion, Paraguay

More Treasure

DEAR SIRs:

I HAVE HAD the pleasure of reading your magazine ELECTRONICS in the American Section of the Melbourne Public Library, and I was interested in the wide field of your activities, regarding electronics.

The nature of my inquiry is one regarding an electrical or magnetic appliance that will locate buried treasure (gold, silver, etc., approximately 300 tons) buried about 8 feet under the earth in a chamber built of stone, containing boxes, which were placed therein about 155 years ago.

I would not like a heavy instrument, because the country to be surveyed is very rough and steep in places; therefore the lighter the instrument the better. I would be glad to hear from you or any of your readers who might be able to help me.

N. DALTON
Victoria, Australia

(Editor's Note: The above are typical of the many letters received at this office enlisting our help in finding a good treasure finder. Almost without exception the writers appear to have definite treasures in mind, and cost seems to be of little importance, since a successful instrument would pay for itself many times over.

We have asked Curt Schafer who has had wide experience in the field of detecting buried objects, to explain briefly the situation in this country as he sees it, in the hope that his observations will be of



PRECISION ELECTRONIC SYSTEMS

- RADIO**
 - Direction Finders Electronic Goniometer
 - Signal Generators Crystal Control 1 kc to 150 mc.
 - Spectrum Generator Marker Pulses .5 to 50mc.
- CONTROLS**
 - Servoscope
 - Servoboard
 - System Synthesis
 - Reluctance Amplifiers
 - 60 ✓ Servo Amplifier
 - Plug-in Component Assemblies
- RADIATION**
 - Servotherm Bolometers
 - Bolometer Preamplifiers
 - Thermistor Power Supply
 - Servotherm Pyrometers

Write today for complete information

SERVO

CORPORATION OF AMERICA
NEW HYDE PARK, N. Y.

Want more information? Use post card on last page.

October, 1953 — ELECTRONICS



PRECISION RF STEP * ATTENUATOR

Model AT-120 0 to 1000 MC

Small, rugged ladder attenuator achieves attenuation accuracy and low vswr from dc to uhf. Suitable for all signal and sweep generators in this frequency range.

Care in design assures maximum flexibility in mounting, drive, and types of input and output connections.

Easily adaptable for inclusion in different types of test equipment and in laboratory and production test applications.

SPECIFICATIONS

MAXIMUM STEPS

Ten (eleven contact positions)

ATTENUATION RANGE

Up to 120 db total
Attenuation per step optional

OUTPUT IMPEDANCE

50 or 75 ohms nominal

INPUT IMPEDANCE

100 or 150 ohms nominal
50 or 75 ohms optional

INPUT AND OUTPUT VSWR

1.1 to 1000 mc at 50 ohms

ACCURACY

± .3 db per 20 db step from its dc value up to 1000 mc.

*PAT. PENDING

TRAD

TELEVISION
CORPORATION

Dept. E10
1001 FIRST AVENUE
ASBURY PARK, N. J.

Want more information? Use post card on last page.

ELECTRONICS — October, 1953

BACKTALK

(continued)

value to other readers in their quest for hidden riches.)

Expert Advice

DEAR SIRS:

IT IS certainly a privilege to have the opportunity to comment on such fascinating letters as the above. At the same time, it is difficult to relinquish the luxury of daydreaming about buried gold long enough to gather some pertinent observations on the subject.

There are two primary requirements for treasure locators: sensitivity and stability. The equipment must have good sensitivity or it is useless; but sensitivity without stability is an abomination. There are secondary requirements, such as portability, ease of maintenance, overall weight, and the ability to discriminate between ferrous and nonferrous metals. The last feature is important, for it will save digging up tons and tons of scrap iron.

The writer has personally tested several treasure and pipe locators during the past few months. In each case the instrument was compared directly to the SCR-625 land mine detector which was purchased (new) from a surplus outlet store. The SCR-625 located a buried U. S. silver dollar at a distance of 22 inches; a 6x6x $\frac{1}{8}$ -in. copper plate at a distance of 38 inches; and a standard 11x17x2-in. steel radio chassis at a distance of 5 feet. No commercial treasure or pipe locator tested was able to even approach this sensitivity in the case of the dollar or the copper plate; only one model did better in the case of the steel chassis, detecting it at a distance of 73 inches.

The SCR-625 was originally designed to give the maximum possible sensitivity that its use over the slightly magnetic soil of Long Island would permit. It is highly recommended as a treasure locator (although commercial models are lighter in weight).

If the magnetic permeability of the soil in Paraguay is low, a more sensitive device than the SCR-625 would be useful. The mine detector written up in *ELECTRONICS* for January 1946 ("Vehicular-Mounted Mine Detector", by Dall, Lebourg and Miller) was supplied to the

for high permeability applications

now — the first time
available . . .

PERFORMANCE
GUARANTEED

TAPE WOUND CORES

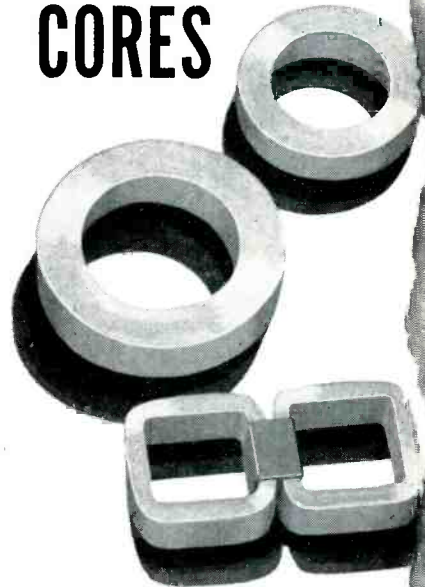

ONLY MAGNETICS, INC.

offers Performance-Guaranteed Tape Wound Cores. Guaranteed performance to specifications means truly economical production of high permeability magnetic devices in your plant . . . and controlled buying by your purchasing department. If you haven't investigated Performance-Guaranteed Tape Wound Cores, why not let us send you the complete story?

FACTORY CORE MATCHING

For applications in which closely matched characteristics are required, save time and money by using the Magnetics, Inc. factory core matching service.

free engineering design
service for high permeability
magnetic applications

Magnetics, Inc. engineering is second to none in the field of high permeability magnetics. Services are free to customers.

Write for full information

MAGNETICS, inc.

Specializing in High Permeability Magnetics

Dept. E-2 BUTLER, PA.

Want more information? Use post card on last page.

interested in **H-E* ?.....**



***HIGH EFFICIENCY**

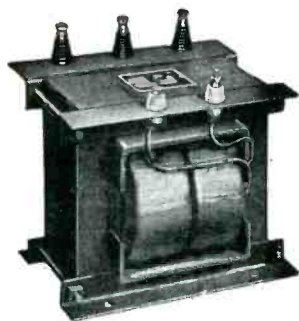

Investigate
NOTHELFER
"NWL" SPECIAL
TRANSFORMERS
 For **ELECTRONICS, RESEARCH and**
SPECIAL INDUSTRIAL FIELDS

Over 28 years' experience in the manufacture of special transformers to meet individual requirements. Built in quality proved by years of actual use.

From 10 VA to 300 KVA Dry-Type only. Both Open and Encased. 1, 2, and 3 Phase. 15 to 400 cycles.

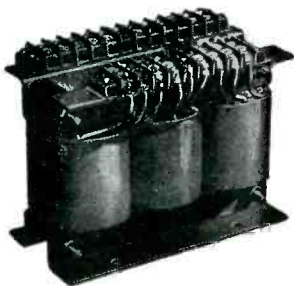

NOTHELFER
 WINDING
 LABORATORIES



9 ALBEMARLE AVE., TRENTON 3, N. J.

U.S. War Department as mine detector set AN/VRS-1, and it is described in War Department Technical Manual TM-11-1138. Increased sensitivity was obtained by increased oscillator output, made practical by the fact that the batteries could be carried in a jeep instead of on a soldier's back. Two other very important features were the automatic drift stabilizing system which saves rebalancing every fifteen minutes or so, and a phase selective circuit which permits the detector to be made responsive to either ferrous or nonferrous metals, but not to both.

The sensitivity of any metal detector is inversely proportional to the sixth power of the distance between the radiating and the detector coils when this distance is measured via the object to be detected. Hence it is readily seen that the sensitivity falls off very rapidly as the distance is increased. The sensitivity could be regained, for objects at a greater depth, by increasing both the oscillator power and the amplifier gain, if the magnetic permeability and resistivity of the soil permitted. This is not always practical, however, for the point is sometimes reached at which the detector gives a continuous indication due to the presence of the ground itself, for almost all soil, sand, and rock show some magnetic susceptibility.

For those seeking custom-designed equipment, Electro-Mechanical Research, Inc., in Ridgefield, Connecticut, has done some fine work in the design of metal and ore locators. We believe that an excellent treasure locator could be built by combining the best features of the SCR-625 and the AN/VRS-1; it could be carried by two persons, one handling the search coil and the other carrying the electronic gear and batteries. We feel that it would be wise to get a good engineering firm to design and build a treasure locator, taking into account the magnetic permeability and resistivity of the soil and rocks in the area where the instrument will be used.

CURTISS R. SCHAFER
 Chief Engineer.
 Electronics Division.
 The Aerotec Corporation,
 Greenwich, Connecticut

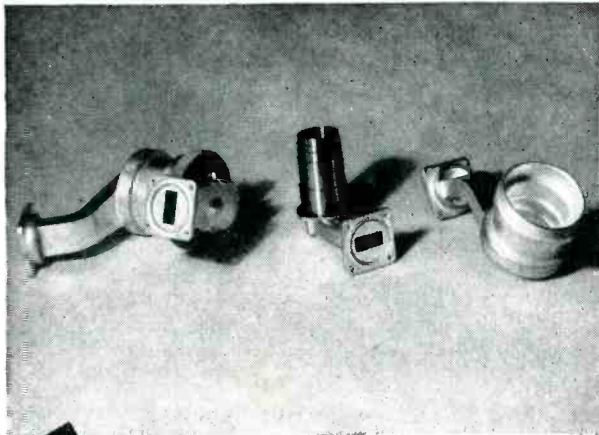

N.R.K. MFG. & ENGINEERING CO.
 4601 WEST ADDISON STREET • CHICAGO 41, ILL.
 Spring 7-2970

Microvane
 Assemblies,
 Radar Components,
 and Precision
 Instruments . . .
 manufactured to
 your Blueprints
 and Specifications.



PROFESSIONAL SERVICES

ANNIS ELECTRIC RESEARCH LABORATORY, INC.

CONSULTING — RESEARCH — DEVELOPMENT AND DESIGN OF RADIO AND ELECTRONIC EQUIPMENT
Antennas, Wave Propagation, Information Storage, Computers, Impedance Matching, and Variable Speed A-C Motors.
P. O. Box 581 1401½ S. Neil St.
Champaign, Ill. Tel. 6-1780

READERS MAY CONTACT

the consultants whose cards appear on this page with the confidence justified by the offering of these special services **NATIONALLY.**

MAURICE I. PARISIER & CO.

Communications Expert
International Engineering Consulting
RADIO BROADCASTING & COMMUNICATIONS
Planning & Installation Supervision
Communication Equipment for Armed Forces
1475 Broadway New York 36, N. Y. LONgacre 4-5434
Offices: Paris-Buenos Aires — Sao Paulo-Bombay

CROSBY LABORATORIES, INC.

Murray G. Crosby & Staff
Radio - Electronic
Research Development & Manufacturing
Communications, FM & TV
Robbins Lane, Hicksville, N. Y.
Hicksville 3-3191

HOGAN LABORATORIES, INC.

John V. L. Hogan, Pres.
Applied Research, Development, Engineering
Est. 1929. Electronics, Optics, Mechanisms, Facsimile Communication, Digital Computers (Circle). Electro-sensitive recording media, Instrumentation.
155 Perry Street, New York 14. CHelsea 2-7855

PICKARD AND BURNS, INC.

Consulting Electronics Engineer
Analysis and Evaluation
of Radio Systems
Research, Development and Production
of Special Electronic Equipment
240 Highland Ave. Needham 94, Mass.

EDGERTON, GERMESHAUSEN & GRIER, INC.

Consulting Engineers
Research, Development and Manufacture
of Electronic and Stroboscopic Equipment
Specialists in High-Speed Photography
160 Brookline Avenue Boston 15, Mass.

INTERFERENCE MEASUREMENT LABORATORY

Interference Study per Government Specifications
Shielded Space for Interference Investigation
Field Surveys for F.C.C. Certification of Induction and Dielectric Heating Equipment
748 McDonald Avenue Brooklyn 18, New York
Gedney 5-3488

ALBERT PREISMAN

Consulting Engineer
Television, Pulse Techniques, Video
Amplifiers, Phasing Networks,
Industrial Appliances
Affiliated with
MANAGEMENT-TRAINING ASSOCIATES
3308-14th St., N. W. Washington 10, D. C.

Eldico of New York, Inc.

Pioneers of Television Interference Elimination from Transmitters, Induction Heaters, Diathermy and etc.
Donald J. S. Merten & Engineering Staff
44-31 Douglaston Pkwy Douglaston, N. Y.
Bayside 9-8686

THE KULJIAN CORPORATION

Consultants • Engineers • Constructors
Electronic Control
Specialists
Utility • Industrial • Chemical
1200 N. Broad St., Phila 21, Pa.

JOSEPH RACKER COMPANY

Radar Consultants & Editors
Technical Manuals
Research and Development
140 Nassau Street, New York 38, N. Y.
Worth 4-1463

ERCO RADIO LABORATORIES, INC.

Radio Communications Equipment
Engineering - Design - Development - Production
Pioneers in Frequency Shift Telegraph
Garden City • Long Island • New York

MAGNETIC INDUSTRIES, INC.

Development & Manufacture
Servo Magnetic Amplifiers and
Special Relays
2640 Huldy Houston 6, Texas

ROTRON RESEARCH CORPORATION

Research and Development
Fluid Dynamics and Heat Transfer.
Exclusively Electronic Applications
Cooling Problems, Heat Exchangers, Fans,
Turbines and Pump Designs
Woodstock, N. Y. Phone 2468

HARRIS GALLAY

Consultant
Electronic Project Development for Industry
Day, Week and Duration of Project Services
Our Laboratory Facilities Optional
Plymouth 9-4237 60 Perry St., Belleville 9, N. J.

Measurements Corporation

Research & Manufacturing Engineers
Harry W. Houck Jerry B. Minter
John M. van Beuren
Specialists in the Design and
Development of Electronic Test Instruments
Boonton, New Jersey

SKINNER, HARLAN AND IRELAND, INC.

Consulting Engineer
Specializing in Magnetic Materials and
Their Application
1122 E. 23rd St. Indianapolis 7, Indiana

GORDON ASSOCIATES, INC.

Government Contract Liaison and Consulting
Specializing in Signal Corps Electronic Requirements, Technical Manuals, Tabular List of Parts, Drawings.
L. Gordon, Pres. P. Preston, Ch. Engr.
157 Broad Street Telephone
Red Bank, New Jersey Red Bank 6-2743

Eugene Mittelman, E.E. Ph. D.

Consulting Engineers & Physicist
High Frequency Heating—Industrial Electronics
Applied Physics and Mathematics
549 W. Washington Blvd. Chicago 6, Ill.
State 2-8021

THE TECHNICAL MATERIEL CORPORATION

Communications Consultants
Systems Engineering
General Offices and Laboratory
121 Spencer Place, Mamaroneck, N. Y.

HANSON-GORRILL-BRIAN INC.

Products & Mfg. Development
ELECTRICAL - ELECTRONIC
HYDRAULIC - MECHANICAL
One Continental Hill Glen Cove, N. Y.
Glen Cove 4-7300

NEW ROCHELLE TOOL CORP.

FOR CERTIFICATION OF INDUCTION AND DIELECTRIC HEATING EQUIPMENT IN ACCORDANCE WITH F.C.C. RULES
320 Main St., New Rochelle, New York
Phone NE 2-5555
Mobile Test Unit Available Entire U. S.

WHEELER LABORATORIES, INC.

Radio and Electronics
Consulting—Research—Development
R-F Circuits—Lines—Antennas
Microwave Components—Test Equipment
Harold A. Wheeler and Engineering Staff
Great Neck, N. Y. Great Neck 2-7806

HIGHLAND ENGINEERING CO.

William R. Spittal & Staff
DESIGN, DEVELOPMENT AND MANUFACTURE
OF TRANSFORMERS, CHOKES, ETC.
FOR THE
ELECTRONIC, INDUSTRIAL & ALLIED FIELDS
Main & Urban, Westbury, L.I., N.Y.
WE-7-2983

NIAGARA ELECTRON LABORATORIES

CONSULTATION - DESIGN - CONSTRUCTION
MFG. THE THERMOCAP RELAY
Specializing in solution of problems of electronic and electro-physical instrumentation for the research of analytical laboratory. Industrial plant problems also invited.
Andover, New York Cable Address: NIATRONLAB

YARDNEY LABORATORIES, INC.

Research - Design - Development
Electro-Chemical Generators of Energy
105 Chambers Street Worth 2-3534, 35, 36
New York 7, N. Y.

CRYSTALS FOR ALL PURPOSES

LOW FREQ.—FT 241A for 55B, lattice filter. 1/4" spc. 54th or 72nd harm channels listed by fund. Fractions omitted.

SCR.		9C 610	
1/4" sp	1/2" sp	2 banana plus	1/4" spc.
370 396 422 487 512	400 459	5620	2030 2390
372 397 423 488 513	440 461	5810	2039 2415
374 398 424 490 514	441 462	6370	2045 2435
375 401 425 491 515	442 463	6450	2052 2442 S
376 402 426 492 516	444 464	6470	2065 2532 S
377 403 427 493 518	445 465	6490	2105 2545
379 404 429 494 519	446 466	6522 9	2125 2557 S
380 405 430 495 520	447 468	6547 9	2131 3202 S
381 406 431 496 522	448 469	6817 9	2145 3215 S
383 407 433 497 523	450 470	7380	2155 3237 S
384 408 434 498 525	451 472	7390	2220 3250
385 409 435 501 526	452 473	7480	2258 3322 S
386 411 436 502 527	453 475	7580	2260 3510
387 412 437 503 529	454 476	7810	2280 3520
388 413 438 504 530	455 477	7930	2292 2 3550
390 414 481 505 531	456 479	51 29	2290 3570
391 415 483 506 533	457 480	EA	2300 3580
392 416 484 507 534	458	10 FT	2305 3945
393 418 485 508 536		200 or	2320 3955
394 419 486 509 537	99c each	500 KC	2360 3995
395 420 511 538	10 for \$9.00	241 A	
49c EA—10 for \$4.50		HOLDER	\$1.29 EA
		1/4" SPC.	\$1.95 EA

FT 243 — 1/4" P IN SPC.

4190 6175 7806	1015 5740 5840	6273 6450 6600	7440 7650
5030 6206 7840	3735 5760 5850	6306 6473 6606	7506 7673
5185 6773 7873	5305 5773 5873	6336 6506 6606	7540 7706
6040 6873 7906	5677 5800 5906	6340 6540 6673	7573 7973
6072 7740 7940	5706 5806 5940	6373 6573 6706	7606 8240
6140 7773	5725 5825 5973	6406 6575 6740	7640 8273

49c EA—10 for \$4.50
99c EA—10 for \$9.00

• Add 20c for each 10 xtals or less for postage and handling

Sun

PARTS DISTRIBUTORS, LTD.

520 TENTH ST., N.W. - WASHINGTON, D.C.



FLUXES

SOLDERING
BRAZING & WELDING

L. B. ALLEN CO. INC. Chicago 31, Ill.

6751 Bryn Mawr Ave.

SUB-CONTRACTING

MILITARY and COMMERCIAL

receivers—test equipment
transmitters—controls
sub-assemblies

TELETRONICS LABORATORY, INC.
Westbury, L. I., N. Y. Westbury 7-1028



HIGH VOLTAGE POWER SUPPLIES

Available in ranges from 2,500 to 25,000 volts D.C. with or without built-in meters. Regulated or unregulated types available. Delivery good on all standard models.

Send for catalogue E

PRECISE MEASUREMENTS CO.
942 KINGS HIGHWAY, BROOKLYN 23, N. Y.
Phone ES 5-9435

A PRIVATE TECHNICAL PLATING SERVICE

offering PALLADIUM
RHODIUM in flash, intermediate and heavy electrodeposits. Information regarding electroplated thicknesses upon request.

DANIEL D. ZIELIK
Brown's Lane Fairfield, Connecticut

MILITARY-SUB-CONTRACTING-COMM.



Electronic—Mechanical Devices
Full Metal, Machine Shop Facilities
From Raw Metal to Finished Device

No Order Too Small

UNIVERSAL MANUFACTURING CO.
196 Bowery
Rector 2-1997 New York 12, N. Y.

CONTACTS

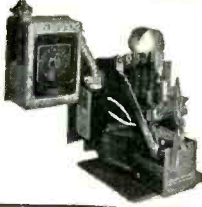
FOR THE FIELD OF ELECTRONICS

EISLER MANUFACTURES COMPLETE EQUIPMENT

WELDERS FOR SPOT & WIRE BUTT
RADIO, TV TUBE EQUIPMENT & REPAIR UNITS
INCANDESCENT, FLUORESCENT MFG EQUIPMENT
NEON SIGN MAKERS EQUIPMENT, GLASS LATHES
ELECTRONIC EQUIPMENT, VACUUM PUMPS, Etc.
Wet Glass SLICING & CUTTING MACHINES for Lab Use
TRANSFORMERS, SPECIAL & STANDARD TYPES

EISLER ENGINEERING CO., INC.
751 So. 13th St. Newark 3, N. J.

Have you problems in

Metal to Glass Seals?

NAME IT . . . WE'LL MAKE IT!

TERMINALS
HEADERS
END SEALS . . . SPECIAL ITEMS

QUALITY PRODUCTS CO.
387 Charles St., Providence, R. I.

Shorted Turn Indicator

Sensitive, rugged, non-shocking
for unmounted coils; \$150. f.o.b.
HUNTINGTON BEACH, CALIF.

KARTRON

WALKIE-RECORDALL 5 lb. miniature BATTERY RECORDER-PLAYBACK

Continuous, permanent, indexed recording, up to 4 hrs., only 3¢ hr. Instantaneous, permanent playback. Picks up sound up to 60 ft. Records conferences, lectures, dictation, 2-way phone & sales talks; while walking, riding or flying. Records in close briefcase with "hidden mike" Write for Detailed Literature.

MILLS REPRODUCER CO., INC.
812 BROADWAY Dept. E-10 NEW YORK 3, N. Y.

SEARCHLIGHT SECTION

(Continued on the opposite page)

ENGINEER . . . WAITING . . .

THE OPPORTUNITY OF A LIFETIME FOR QUALIFIED MAN WITH A GOOD SOUND PRODUCT

We are AAA-1 manufacturers of electro-mechanical components, located in NYC.; interested in expanding our operations into diversified branches of the electro-mechanical and electronic components field.

IF YOU ARE ABLE TO ORGANIZE AND SETUP AN OPERATION IN YOUR OWN SPECIALTY

we will give you control of a separate division of our company, created and staffed to fill your own specifications.

- . . . **YOU** will have complete backing and cooperation
- . . . **YOU** will earn and enjoy the highest remuneration possible, receiving the prevailing salary scale plus an attractive profit-sharing arrangement.

If you have a product you think we can use—if you want a chance to make your skill and "know-how" pay off—please write us giving a complete outline of your experience and the product you have in mind. Your reply will be held in strictest confidence. Box E 1094, 221 W. 41 St., N. Y. 36.

GENERAL MAGNETICS INC.

has openings for

ELECTRICAL ENGINEERS

With at least three years experience in design and development of MAGNETIC SERVO AMPLIFIERS and Voltage Regulators.

A chance to grow with a young and progressive company. Salary and advancement commensurate with ability. State education, experience and salary requirements.

Address all inquiries to:

GENERAL MAGNETICS INC.

135 Bloomfield Ave. Bloomfield, N. J.

ENGINEERS: TV COLOR TUBE OPPORTUNITIES

Leading Tube Manufacturer has several engineering positions opening in the West in design and development on color picture tubes. Write giving full resume to

P-9080, Electronics
68 Post St., San Francisco 4, Calif.

REPLIES (Box No.): Address to office nearest you
NEW YORK: 330 W. 42nd St. (36)
CHICAGO: 520 N. Michigan Ave. (11)
SAN FRANCISCO: 68 Post St. (4)

POSITION VACANT

ELECTRONICS ENGINEERS and Physicists interested in Research and Development on trigger circuits and high speed sweeps. Opportunity to do original work on transducer applications to specialized problems in shocks and detonations. P-8766, Electronics.

SELLING OPPORTUNITY OFFERED

ESTABLISHED TRANSFORMER company seeks additional representation for line of commercial and military power and electronic transformers. Especially interested in Eastern U. S. RW-9070, Electronics.

SELLING OPPORTUNITIES WANTED

SALES ENGINEERING—College training, with 15 years varied experience in communications—electronics. Presently employed as chief engineer regional broadcast station. Desire to represent reputable company in Southern territory, preferably Ky.-Tenn. area. RA-8933, Electronics.

THE REDUCED Government Budget will require intensive representation in Washington to retain your position or gain new business. I can represent one additional electronic account. RA-9184, Electronics.

BUSINESS OPPORTUNITIES

Patent Newest Development in Rotary Generators direct current (Modulus). No brushes no collector slip-ring. Owner will sell, apply Carnus 6033 Hutchinson Montreal, Canada.

Manufacturing facility. Tools & equipment of Electronic Mfg. shop available for cash, or interest in established enterprise. List on request. West Coast only. BO-9034, Electronics, 68 Post St., San Francisco 4, Calif.

CONTRACT WORK

ELECTRONICS TECHNICIAN would like to manufacture small items or parts. Willing to buy special shop equipment. CW-9187, Electronics.

ADD'L LINES WANTED
by
MFR'S. REPRESENTATIVE
actively covering
CALIFORNIA, ARIZONA, NEV.

Specialize in electronic
components & instruments

EXCELLENT ESTABLISHED
SALES CONTACTS

Write
RA-9164, Electronics
68 Post St., San Francisco 4, Calif.

ENGINEERS, PHYSICISTS, and APPLIED MATHEMATICIANS NEEDED

for Research and Development Programs

Design of electronic instrumentation for underwater ordnance, including high gain amplifiers, conventional filters, power amplifiers, oscillators and detectors in the ultra sonic range.

Transducer design, fundamental problems in underwater acoustics involving transmission, attenuation, reflection, etc. Problems in sound control and noise reduction.

Mathematical treatment of original scientific research problems in the fields of hydrodynamics, acoustics, electronics, mechanics, network theory, servomechanisms, communication and information theory, and operations research.

Excellent Opportunities for Graduate Study

Liberal Vacation Policies

Excellent Working Conditions

Write Personnel Director

ORDNANCE RESEARCH LABORATORY THE PENNSYLVANIA STATE COLLEGE

P. O. Box 30

State College, Pennsylvania

ELECTRONIC DEVELOPMENT IS MOVING WEST*

ENGINEERS—Take this opportunity to join the staff of a Western electronics pioneer & leader.

Creative ability finds expression with us!

- RESEARCH
- DEVELOPMENT
- PRODUCTION

Broad project variety in special receivers, transmitters & other devices. Advanced design techniques.

* Figures show 20% U. S. activity in So. California

Relocation expenses—excellent working conditions—Central location. Scheduled reviews & advances. Fine insurance plan. Move should not disturb urgent military projects.

Send complete resume with income history & requirements to engineering employment mgr.

Hoffman LABORATORIES, Inc.

3761 SO. HILL ST.

LOS ANGELES 7, CALIF.

(A Subsidiary of Hoffman Radio Corp.)

SALES ENGINEER Powdered Metals

Contact and sell electronics, metallurgical, and allied industries. B.S. in E.E. Knowledge of electronic design, and sales experience preferred. Salary \$5,200 and up according to experience.

P-9192, Electronics
330 W. 42 St., New York 36, N. Y.

ELECTRICAL SALES & ENGINEERING REPRESENTATIVE

Nationally known California Corporation desires sales engineering representative for Eastern U. S. with sound background in general electrical insulation field, to promote sale of new line of yarns and textile materials for high temperature application. Must have car and be free to travel. Salary and expenses. RW-8960, Electronics
1111 Wilshire Blvd., Los Angeles 17, Calif.

FIELD ENGINEERS

Pacific Division, Bendix Aviation Corporation, needs electronic field engineers to form a new Field Engineering Group offering excellent opportunities for growth. The job requires supervision of installation and maintenance, and instruction in the operation of Bendix airborne radar at aircraft plants and Air Force Bases within U. S. limits.

Positions are open at several levels, and inquiries are also invited from recent graduates. Salaries based on ability, experience, and education. Travel allowance in addition to salary.

Address inquiries to W. S. Leitch, Chief Electronics Engineer, 11600 Sherman Way, North Hollywood, California.

Additional Employment Advertising on pages 458, 460 thru 467 & 494



HAVE YOU EVER THOUGHT OF A GENERAL MOTORS' CAREER?

ENGINEERS DESIGNERS
Electronic Servo Electro-Mechanical

RIGHT now we have unusually attractive project assignments at our Milwaukee plant for high caliber engineers. Some of the necessary qualifications are—experience in research, analysis, and/or design and development . . . in any of these fields:

AIRBORNE INSTRUMENTATION COMPUTERS
SERVO-MECHANISMS AVIONICS

These will be permanent positions inasmuch as our operations consist of extensive manufacturing as well as development programs. At AC SPARK PLUG you will be part of a steadily expanding division of G.M.C.—a division with over 20 years' experience in the instrument field. With us you profit from "small-company" advancement opportunities plus "large-company" employee benefits. **ADVANCEMENT FROM WITHIN** is a fact, not a phrase. Let your next step be a letter to

SUPERVISOR OF EMPLOYMENT

FIELD ENGINEERS

Assignment—you will assist in the installation, operation, and maintenance of our equipment at aircraft plants and Air Force bases. The work will include liaison between AC and the customer, training of customer personnel, analysis of problems, and recommendations for improvements. Many of these outstanding openings are one-year overseas assignments.

Your Background—your educational background can be in any of the fields of AE, EE, ME, Physics, or equivalent. To be successful in these positions you should have a definite interest in people as individuals and be willing to relocate to field assignments. Single men given preference.

Training—our theoretical and applied in-plant training (here in Milwaukee) will prepare you for these assignments. In addition to your salary, you will receive a field allowance—and a substantial bonus if selected for overseas assignment . . . if you're looking for an opportunity with a "present" and a future write us for further facts.

AC Spark Plug Division • **GENERAL MOTORS CORPORATION**
1925 E. KENILWORTH PL. MILWAUKEE 2, WIS.

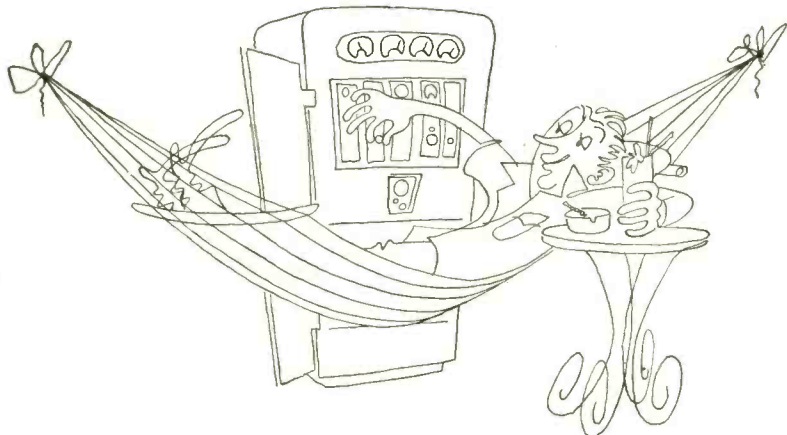

Pleasant Working Conditions

So we're exaggerating a little! If you want to get technical about it (and you probably do) your life at our company won't be quite this cushy. We can promise this though—even the sky's not the limit for future opportunity. You work with a congenial group of engineers. People will listen to your ideas. The boss's door is always open.

Who you are—You're an Electronic or Mechanical Engineer. You're experienced in air communication and navigation circuitry and development. You have worked with low or high frequency circuits, instrumentation, component utilization or associated problems.

What you do now—Simple! Just contact:

Arthur E. Harrison, Vice President, Engineering
wilcox Electric Company, Inc.
Fourteenth & Chestnut, Kansas City 27, Mo.

ENGINEERS SYSTEMS RADAR SERVO COMPUTER

BACKGROUND:
Responsible positions open for top level development and project engineers with practical and research experience in:

- Advanced Electronic Circuits and Systems
- Microwave Radar
- Microwave Receivers and Transmitters
- Also Engineering Design and Analysis relating to fields such as:—
- Analogue and Digital Computers
- Servomechanisms
- Communications
- Navigation
- Fire Control



Requirements emphasize advanced analytical and/or management experience on highly complex electronic and electro-mechanical systems.

Kindly send resume and salary requirements to

The W.L. MAXSON Corp.
460 W. 34th ST., NEW YORK 1, N.Y.

What means most to an Engineer?



**PROFESSIONAL
RECOGNITION**

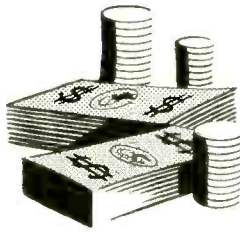

**GOOD
SALARY**

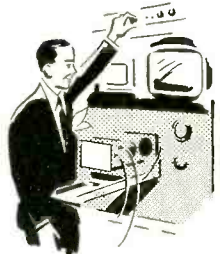

**UNEXCELLED
FACILITIES**



**SUBURBAN
LIVING**

A Career at RCA offers all Four!

RCA offers opportunities now—real career opportunities—for qualified **ELECTRONIC, COMPUTER, ELECTRICAL, MECHANICAL** and **COMMUNICATIONS ENGINEERS . . . PHYSICISTS . . . METALLURGISTS . . . PHYSICAL CHEMISTS . . . CERAMISTS . . . GLASS TECHNOLOGISTS.**

Positions are open in research, development, design and application. Long range work in many fields is being carried on both for commercial developments and military projects for war and peace.

At RCA you'll work in an exciting professional atmosphere, with technical and laboratory facilities unsurpassed anywhere in the radio-electronic industry. You are in close and constant

association with leading scientists and engineers. Individual accomplishment is not only recognized, it is sought out. Delightful suburban living is easily available for your family. And there's ample opportunity for income and position advancement.

Plus, Company-paid hospitalization for you and your family . . . accident and life insurance . . . progressive retirement plan . . . fine recreational program . . . modern tuition-refund plan at recognized universities for advanced study.

Join the team at RCA, world leader in electronic development, first in radio, first in recorded music, first in television. Rest easy in the knowledge that your future is secure, the rewards many and varied.

Personal interviews arranged in your city.
Please send a complete resume of your education and experience to:

MR. ROBERT E. McQUISTON, Manager
Specialized Employment Division, Dept. 200J
Radio Corporation of America
30 Rockefeller Plaza, New York 20, N.Y.

Positions Open In: RESEARCH— DEVELOPMENT—DESIGN—APPLICATION in any of the following fields:

RADAR—Circuitry—Antenna Design—Servo Systems—Information Display Systems—Gear Trains—Stable Elements—Intricate Mechanisms

COMPUTERS—Digital and Analog—Systems Planning—Storage Technique—Circuitry—Servo Mechanisms—Assembly Design—High Speed Intricate Mechanisms

COMMUNICATIONS—Microwave—Aviation—Mobile—Specialized Military Systems

MISSILE GUIDANCE—Systems Planning and Design—Radar and Fire Control—Servo Mechanisms—Vibration and Shock Problems

NAVIGATIONAL AIDS—Loran—Shoran—Altimeters—Airborne Radar

TELEVISION DEVELOPMENT—Receivers—Transmitters and Studio Equipment

COMPONENT PARTS—Transformer—Coil—Relay—Capacitor—Switch—Motor—Resistor

ELECTRONIC TUBE DEVELOPMENT—Receiving—Transmitting—Cathode-Ray—Phototubes and Magnetrons

ELECTRONIC EQUIPMENT FIELD ENGINEERS—Specialists for domestic and overseas assignment on military electronic communications and detection gear.



RADIO CORPORATION of AMERICA

ENGINEERS...

*Tie in your future
with*
ADMIRAL

... at the steadily expanding electronics engineering activity of our Chicago, Illinois, plant.

Can your professional experience be more fully recognized? Think of your future ... investigate these opportunities at Admiral.

Openings exist in all classifications for Junior, Intermediate and Senior Project Engineers.

They are for Research, Development, and Product Development in the following fields:

MONOCHROME AND COLOR TV RECEIVERS
COLOR GENERATING TEST EQUIPMENT
UHF SYSTEMS
RADIO RECEIVERS
RADAR SYSTEMS
LABORATORY TEST EQUIPMENT

All with the security and possibilities for advancement inherent in this type of work.

Chicago is foremost among cities in supplying unsurpassed educational and recreational facilities. Individuals with a technical educational background will have the opportunity of furthering their experience and education by working with qualified engineering personnel. Excellent opportunities exist in the Chicago area for further study and education including post-graduate work.

We suggest you write Mr. Walter Wecker, Personnel Division, giving educational qualifications and related experience. Interviews will be arranged at your convenience.

Admiral Corporation

3800 W. Cortland St.
Chicago 47, Illinois

ELECTRONIC ENGINEERS

EE or ME degree, minimum 3 years' experience in research and development work involving microwave circuits and antennas, circuit development, servo-mechanisms, analogue computers or related equipment.

FIELD REPRESENTATIVES

A few openings for graduate engineers only with backgrounds similar to above. Continental U.S.A.

3 good reasons for choosing GENERAL PRECISION LABORATORY

- 1. OPPORTUNITY** Because we are a comparatively small company with a close working relationship between management and staff, recognition and advancement are more rapid—as evidenced by the number of young men in top positions today.
- 2. STABILITY** GPL provides interesting work with a great measure of stability due to our association with a large, diversified parent organization.
- 3. GOOD LIVING** Consider the opportunity to live in a fine suburban community in Westchester County, N. Y., known throughout the country for its high standard of living.

Expenses will be paid for qualified applicants who come for interviews. Please submit complete resume to:

Mr. H. F. Ware

GENERAL PRECISION LABORATORY, Inc.

A subsidiary of General Precision Equipment Corp.
63 Bedford Road, Pleasantville, New York

Electrical Engineers and Physicists

- Radar Simulation
- Advanced Circuitry
- Analog Computers
- Ballistics
- Mapping
- Telemetering

Senior and Junior Engineers

A Job with Good "Contacts"

We offer you the opportunity to come in contact with an entire project, not with just a segment of the overall job. Here is your chance to join a firm with a future ... to grow with us ... to gain individual recognition by working closely with technical management. You will live and work in a delightful suburban community ... associate with other top-notch engineers. If you are looking for a job with *good contacts*, write:

Industrial Research Laboratories
Hilltop and Frederick Roads
Baltimore 28, Maryland

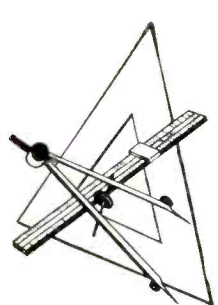

Help Build Tomorrow's World TODAY!

GOODYEAR AIRCRAFT CORPORATION, pioneer and leader in lighter-than-air craft, offers you a new employment opportunity with a well-established and fast-growing company where "careers are planned."

DESIGN AND DEVELOPMENT engineering opportunities are available for capable and imaginative men and women in the field of airships, aircraft and aircraft components.

RESEARCH AND DEVELOPMENT projects — missiles, electric and electronics systems, servomechanisms, new special devices, fiber resin laminates — all present an urgent need for engineers with fresh talent, aptitude and ambition.

POSITIONS ARE OPEN at several levels in various fields with salaries based on education, ability and experience.

Physicists	Civil engineers
Mechanical engineers	Electrical engineers
Aeronautical engineers	Technical editors
Welding engineers	Technical illustrators

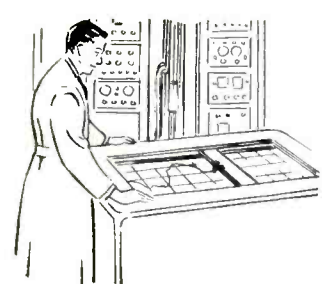

AKRON, THE HOME OF GOODYEAR AIRCRAFT, is located in the lake region of northeastern Ohio. Cosmopolitan living, year-round sports and recreation, cultural and educational advantages make this thriving city an ideal spot for a pleasant home.

YES, BUILD YOUR FUTURE — TODAY! Write, giving your qualifications, or requesting an application form.

C. G. Jones, Salary Personnel Department

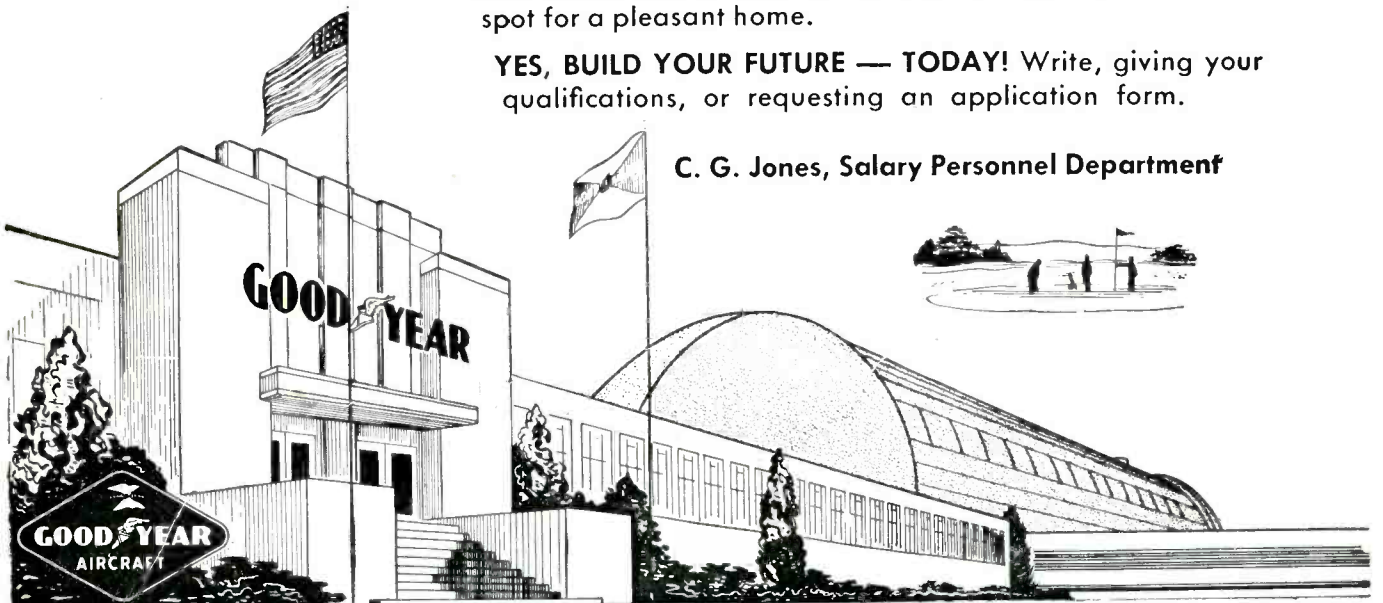

GOODYEAR AIRCRAFT CORPORATION, 1210 MASSILLON RD., AKRON 15, OHIO

to
men
who
want
the
best

ENGINEERS, EE

1. Development of radio and radar components and systems.
2. Design of components for the magnetic deflection of Cathode Ray Tubes.
3. For component and system development work in airborne navigational equipment.

DESIGNERS

1. For work in the design of electro-mechanical navigational computers.

Kollsman provides excellent facilities for the design and development of America's finest aircraft instruments. In our modern laboratories you'll find a congenial atmosphere in which you can do your best work. You'll be encouraged to advance as our progressive organization continues to grow.

At Kollsman you'll receive liberal benefits including paid life, hospitalization, surgical, accident and health insurance. Not to be overlooked is the convenient location in a quiet residential section only 20 minutes from the heart of New York City. Why not find out what Kollsman has to offer you?

KOLLSMAN INSTRUMENT CORP.

80-08 45th Ave., Elmhurst, L. I., New York



HOUSTON, TEXAS

Precision equipment manufacturer needs qualified experienced engineer for audio and sub-audio transformer design and development. Experience with high permeability alloys desirable. Knowledge of magnetic circuitry must be sufficient for development work on magnetic amplifiers. Salary commensurate with ability.

SOUTHWESTERN INDUSTRIAL ELECTRONICS CO.

P. O. BOX 13058, HOUSTON 19, TEXAS

ELECTRONICS ENGINEERS

This established electronics manufacturer located in the heart of western New York requires men with design experience. Permanent positions available for senior and junior men with EE degree or equivalent experience. Fine cultural community in which to live with good schools, homes, and progressive associates. Please write to:

CHIEF ELECTRONICS ENGINEER
STROMBERG-CARLSON COMPANY
ROCHESTER 3, NEW YORK

SENIOR ENGINEERS

MECHANICAL—ELECTRICAL

For Responsible Positions in

DESIGN • DEVELOPMENT • RESEARCH

3 to 5 years experience in one or more of the following fields required:

Radar—Sonar—Fire Control Systems—Micro-Wave Techniques—
Pulse Circuits—Servo Mechanisms—Electro-Mechanical Design—
Speech Compression—Small Mechanisms—Heat Transfer—
Thermo-dynamics—Packaging—Compressors
Turbines—Internal Combustion Engines.

melpar, inc.

The Research Laboratory
of Westinghouse Air Brake Co. and its subsidiaries

- Offers to Qualified Men
- DIVERSIFICATION OF ASSIGNMENT
 - INDIVIDUAL RECOGNITION
 - RAPID ADVANCEMENT
 - SECURITY & STABILITY

Write to Personnel Director,

MELPAR, INC. Dept. E-4

452 Swann Avenue

Alexandria, Virginia

or 10 Potter St., Cambridge, Mass.



CHIEF ELECTRONIC ENGINEER

For design and development of electronic measuring and test equipment. Unusual opportunity for man qualified by experience and ability to assume the responsibilities of a chief engineer. Company moderate sized, long established with top reputation in the industry. Located in Metropolitan New York area. Send complete resume including education, experience, income history and requirements.

P-9149, Electronics
330 W. 42 St., New York 36, N. Y.

ENGINEERS

Responsible, permanent positions open in ELECTRICAL and ELECTRONIC engineering for development and research in circuitry and instrumentation design utilizing semi-conductors. Established electronic manufacturer with modern, well-equipped, air conditioned plant located in Northern New Jersey.

P-9129, Electronics
330 W. 42nd St., New York 36, N. Y.



Hydrobuoyant Spheremotor

A chain of flexibly coupled, hollow rubber spheres loop over drive pulley and through air-filled "J" chamber. Underwater end of "J" chamber forms water seal as spheres go through aperture. Neglecting friction: Will this machine operate? If so, which way does it go?*

**Design,
development engineers...**

*Like to solve
interesting problems?*

Most engineers do—of the off-beat variety like the one above as well as the more practical ones you're always running into at Honeywell.

Right now we need a

**FLIGHT
CONTROL ENGINEER,**

a systems, analysis or component design man, with experience in calibrators, recorders, amplifiers, computing receivers or circuits.

Honeywell offers this man professional engineering assignments, creative opportunities, a fine place to work and many benefits.

Write J. A. Johnson, Engineering Placement Director, Dept. EL-10-189, Honeywell, Minneapolis 8, Minnesota. Learn in detail about the interesting opportunities at Honeywell. Ask for our book, "Emphasis on Research."

*Mathematical solution to above problem on request.

Honeywell



First in Controls

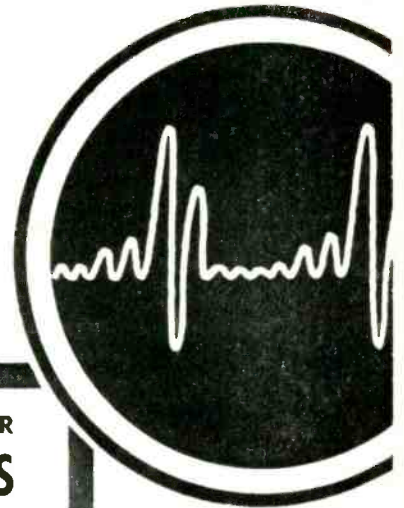
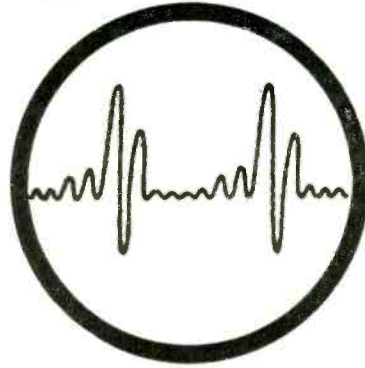

SPECIAL OPPORTUNITIES FOR SENIOR ENGINEERS

Convair in beautiful, sunny San Diego invites you to join an "engineers" engineering department. Interesting, challenging, essential long-range projects in commercial aircraft, military aircraft, missiles, engineering research and electronics development. Positions open in these specialized fields:

Electrical Design	Servo-mechanisms
Mechanical Design	Aerodynamics
Structural Design	Thermodynamics
Structures	Operation Analysis
Weights	System Analysis

Generous travel allowances to those accepted.
For free brochure, write Mr. H. T. Brooks,
Engineering Dept. 900

CONVAIR

IN BEAUTIFUL
SAN DIEGO

3302 PACIFIC HIWAY
SAN DIEGO 12, CALIFORNIA

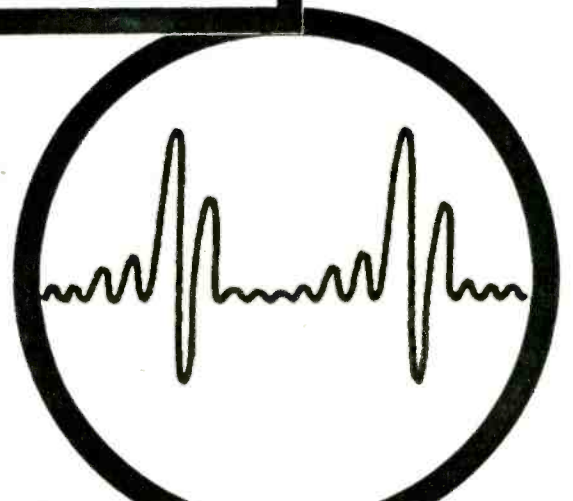

Capehart 

announces, with pride, new facilities which provide truly unexcelled opportunities for professional growth in Electronics.

Research, Development, and Production Engineers are needed to staff our growing operations in Radar and Pulse Systems, Microwaves, Guided Missile Guidance Systems, Antennas, Radio, Television, Computers, Vacuum Tubes, Servomechanisms, Solid State Physics, etc.

These positions are enhanced by an easy, relaxed, continuous welcome in one of America's most pleasant Communities.

R. S. V. P.

TO

EMPLOYMENT DIRECTOR

CAPEHART-FARNSWORTH

FT. WAYNE 1, INDIANA

ELECTRONIC ENGINEERS & TELEVISION ENGINEERS

The Standard Coil Products Co., Inc., a leading electronics manufacturer, has started operations at their new plant located in North Dighton. Applications are now being accepted for experienced personnel in the above mentioned classifications, preferably with experience in UHF—VHF tuners, I. F. strips, high voltage and fly-back coils and test equipment design. Excellent opportunity with our fast growing organization which is not dependent upon defense contracts. Plant pleasantly located in small New England town near Providence and Boston. Good housing and schools. In resume state salary requirements and send to Personnel Manager.

STANDARD COIL PRODUCTS CO., INC.

SPRING STREET,

NORTH DIGHTON, MASS.

WANTED
ENGINEER WITH
EXPERIENCE IN
VHF OR UHF

Interesting creative work with the most resourceful and progressive firm in the field of television equipment.

This position is permanent. It will offer every opportunity for unlimited advancement and for developing a successful career. The plant is now housed in a newly-acquired larger building, only 22 miles from downtown New York City. The surroundings and atmosphere are stimulating and congenial.

Attractive Salary

Write stating qualifications.

BLONDER-TONGUE LABORATORIES

526-536 NORTH AVENUE
WESTFIELD, NEW JERSEY

LOS ALAMOS requires

ELECTRONICS ENGINEERS

for design and development work. B.S.E.E. or Physics with progressive and independent experience in the field. Write John A. Stevenson

Los Alamos Scientific Laboratory
of the
University of California

Los Alamos

New Mexico

ELECTRONIC ENGINEERS

FOR DESIGN & DEVELOPMENT WORK IN
RADAR

COMPUTERS

DIGITAL TECHNIQUES

with a young progressive company,
send resumé of experience and
education, with salary requirements,

to

 Electronic Engineering Company

of California

180 SOUTH ALVARADO STREET LOS ANGELES 4, CALIFORNIA
DUNKIRK 2-7353

Exceptional Opportunities for...

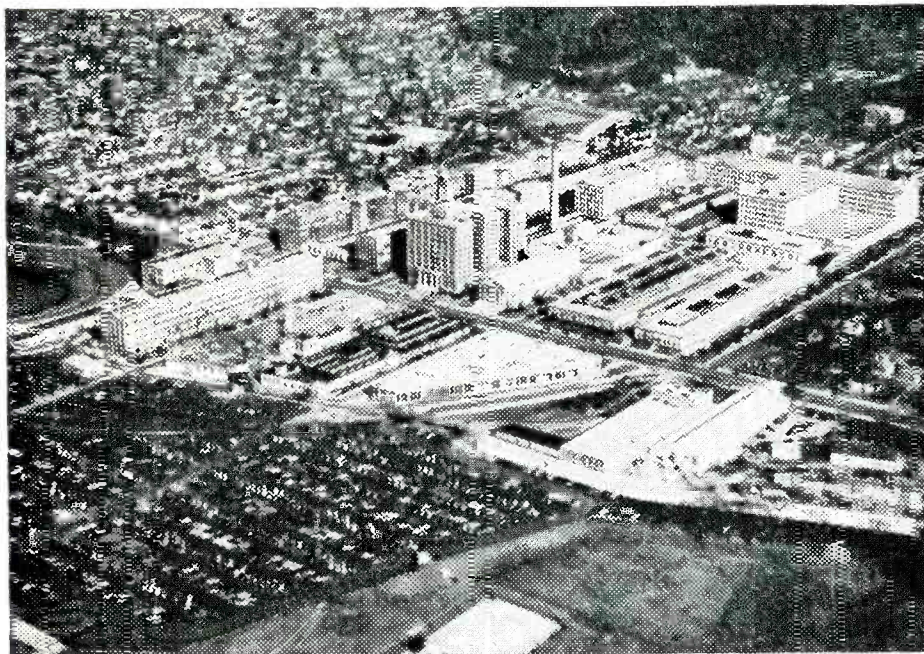

THE NATIONAL CASH REGISTER COMPANY, Dayton 9, Ohio

electrical engineers
mechanical engineers
mechanical designers

in the field of electronic computers and associated equipment for use in business machines.

Write, giving education and experience to Employment Manager.

Reply to Department A.

ENGINEERS AND PHYSICISTS BS-MS-Ph.D:

Responsible positions in mechanical, electrical or electronic engineering, physics or engineering physics for advanced development and design of special equipment and instruments. Prefer men with minimum of two years' experience in experimental research design and development of equipment, instruments, intricate mechanisms, electronic apparatus, optical equipment, servomechanisms, control devices and allied subjects. Positions are of immediate and permanent importance to our operations. Southwestern location in medium sized community. Excellent employee benefits. Reply by letter giving age, experience and other qualifications. All applications carefully considered and kept strictly confidential.

Ind. Rel. Manager
Research & Development Dept.

**PHILLIPS
PETROLEUM COMPANY**
Bartlesville • Oklahoma

Bell Telephone Laboratories

has career openings for experienced

*electrical engineers
mechanical engineers
physicists*

For work on Guided Missiles, Radar, Fire Control and Underwater Systems in New Jersey (20 miles from New York City).

The company that has pioneered many of the major developments in the fields of communications and electronics now offers you an opportunity to join its staff. Here you will gain invaluable experience and great satisfaction through the challenging diversified nature of the work. To qualify, you must be a college graduate (preferably not over 40 years of age) with related experience of the following types:

Systems Engineering

Analysis
Coordination
Evaluation
Planning
Studies

Systems Development

Fundamental Development
Circuit Design
Mechanical Design
Equipment Development
Field Testing



Write, giving full details of education and experience to:

BELL TELEPHONE LABORATORIES Inc.

Employment Director, Box 2, New York 14, N. Y.

Additional Position Vacant Advertising on page 494

Want more information? Use post card on last page

THE BIGGEST AND THE BEST

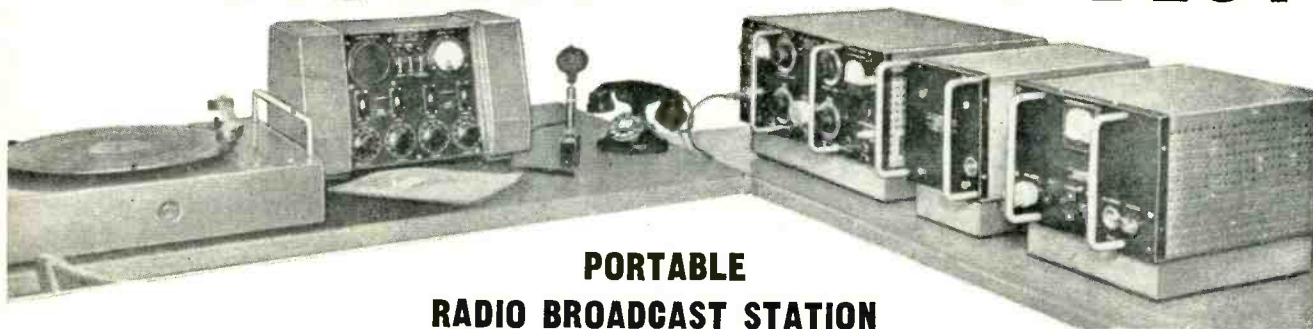

PORTABLE RADIO BROADCAST STATION 50 WATTS OUTPUT, COMPLETE WITH ALL ACCESSORIES

NEW, UNUSED equipment, designed for Psychological Warfare (Propaganda) and Armed Forces Radio—Troop entertainment, this equipment will meet FCC specs for carrier stability (crystal-controlled) and fidelity. *Freq. Range* is 1,100 to 1,500 KC, and design provides either crystal control or VFO. *Modulation* is 100% using a special hi-efficiency circuit. *Operation* is from 90 to 240 Volts, 50/60 cycles AC, and total drain at full modulation—725 watts. *Audio Response* is within 1 db from 100. to 5,000 cps, and distortion less than

5% rms at 100% modulation. Design provides for use with quarter-wave antenna against ground, with loading coil of sufficient inductance included within transmitter to permit use of smaller antenna where conditions do not allow proper size. **THE EQUIPMENT SUPPLIED FORMS A COMPLETE MOBILE OR PORTABLE BROADCAST STATION, except for AC Power.** The following are the various units supplied, with net weights and dimensions:

TRANSMITTERS—RECEIVERS ETC.

- TDQ** VHF 100-156 MC. 50W. AM X-mtr for 110 V. 50/60 C. AC.
- BC-797** VHF 110-126 MC. 50W. AM Output for 110 V. 50/60 C. AC.
- SCR-510/610.** FM Trans-Receiver, 20 to 28 and 28 to 37 mc respectively. With PE-117 or 120 Vibrator Power Supply and other accessories.
- SCR-619.** FM Trans-Receiver, 27 to 38.9 mc, complete with all accessories. NEW units.
- SCR-522** VHF, 4-Channel, 100-156 MC Trans-Recv. Eqt. for Plane or Ground Communications.
- SCR-511.** Walky-Talky, 3-6 MC, Crystal Controlled Trans-Recv. with Plug-In Units for Freq. Changing.
- BC-611** and **MAB HANDY** and **WALKIE-TALKIES.**
- SCR-284** Field Radio Equipment, A1, A3 emission. Complete with all Accessories.
- BC-221** Frequency Meters, Excellent condition. Complete with crystal and matching Calibration Book.
- BC-312/342** Receivers. Like New Units.
- BEACHMASTER 250 & 500 WATT SOUND SYSTEMS** for Airports, Shipyards, Amusement Parks, Civilian Defense, Etc. Write for Prices and Literature.
- TCS** X-mtr-Receiver for Ship or Shore.
- TBK** HF 500W, 2-20 Mc. Transmitter with MG, Starter, and Spares.
- TAJ** 500 W. Output, 175-550 Kc. with M.G. for AC or DC operation.
- TAQ,** Same as TAJ above but 1,000/1,500 W. output, with MG.
- TBL** 350 W. Output, A1, A3, I.F. & H.F. for AC or DC operation.
- APN-4** Loran Eqt. R-9A/APN-4 Receivers and 1D-6A & 6B Indicators, with tubes, crystal, etc. Reconditioned to like-new.
- WRITE FOR PRICES.**
- GO-9** 100/125 W. HF, HF Ship or Aircraft Transmitter, A1 and A2 Emission. All New with Spares.
- ATD** Aircraft Transmitters, 50 W. A1 & A3. 1.5 to 9.05 MC. NEW.
- GP-7** Aircraft Transmitters.
- ZB-3** ILAS Eqt.
- SCR-283** Rcvg. & X-mtng Eqt. Complete.
- RT-3/ARN-1** Altimeter.
- RADIOSONDES** AN/AMQ-1A to D. New.
- PE-75U** Gas Engine Generators. NEW. w/Spares.
- T-21/GR-3-C** Sound Ranging Microphones for locating Artillery Fire.
- NA** Underwater Beacon Equipment.
- BD-57-B** Switchboards, telephone.
- HS-23,** 33 Headphones.
- AN-CRT-1A** Sonobuoys.
- DZ-2** DIRECTION-FINDERS, Aircraft or Marine, 15 to 1750 KC in 6 bands, for 24/23 V.D.C. operation. With 34" or 55" Loop Extension Shaft. Complete. NEW eqpt. with Dynamotor, Loop Extension Shaft and Control, Cables, Instruction Manual, etc., all export packed in 2 cases per set.

WRITE FOR PRICES

EXTRA

PE-104 POWER SUPPLIES for Receiver of SCR-284, NEW, with Spare Vibrator. Export-Packed. Large Quantity Available. **WRITE FOR PRICES.**

LIST OF MATERIAL PER SET

Qty.	Item	H.	W.	D.	Wt. (lb.)
1	Radio Broadcast Transmitter TWT PB-50A	11¼	18¾	177/8	49½
1	Transmitter Power Supply, Type PB-50	10½	12½	16	89¼
1	Pressure Cooling and Voltage Selector Unit, Type B2.	117/8	9	177/8	54¼
1	Control Console Mixer, Type 2C4	11	18	93/8	35
1	Phonograph Turntable, Type T2, two-speed 33½ & 78 RPM	6¾	20¼	18	20
2	Dynamic microphones, cables, connectors				
1	Set of operating tubes for all units				
9	Connecting cables for all units				
1	Auxiliary Antenna Kit, Type 10B	12	12	3	20
1	Set of spare operating tubes for all units				
1	Set of spare parts				
1	Kit of small tools for maintenance				
1	Technical manual, TM 11-825, Portable Radio Broadcast Transmitter TWT PB-50A				
5	Armored Trunks for Transporting	20	28¾	12½	32½

The five armored trunks are supplied as part of the equipment. They serve as carrying cases, with the various units packed.

PRICE, PER COMPLETE SET AS LISTED ABOVE, NEW—UNUSED . . .

\$1,100.00

600 WATT W. E. AUDIO OR SUPERSONIC POWER AMP.

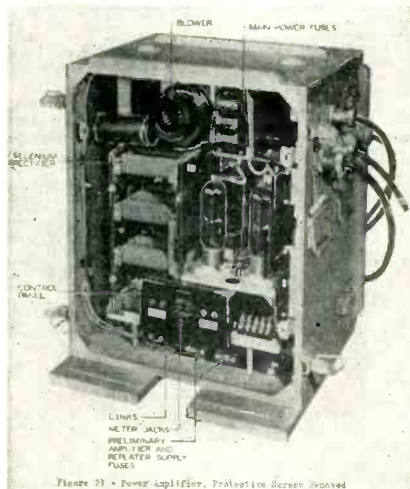

NEW, Western Electric Audio Power Amplifiers in wooden transportable case, 600 watts max. output, for use as PA amplifier, modulators, or use as 400 to 1200 cycle power source to test servos, radar, test eqpt., etc., requiring 110 V., 400 to 1200 cycles AC up to 600 watts. Requires 40 watts max. to drive to full output. Less than 10% total harmonics in output. Input imped. 250/500 ohms; Output imped. 15 to 18 ohms. Uses 4- 805's (supplied) in push-pull parallel. H.V. Power Supply uses selenium rectifiers (no tubes) and motor blower for forced-air cooling. Operates from 115, 3-Phase, 60 cycles, or 208V., 4-wire (3-phase) 60 cycles AC. Rugged design and construction. Freq. response 200-6000 cycles (amplifier only) substantially linear. Easily converted to Supersonic Driver & Amplifier for testing, operating magnetostriction units, by changing input & output transformers (20 to 25 KC available, AC additional cost). Dim: 21" x 24" x 28" overall. NEW, UN-USED eqpt

PRICE, EACH \$385.00
Driver Amplifier, WE, for above, with tubes \$175.00
Speaker 12 units, PM horn type, in 2 sections, shock and blast proof, with 6 lb. #5 alnico slugs \$215.00
20-25KC (Tunable) Input & Output Transformers, for conversion of above, for 600W. Output. PAIR \$120.00

TELEMARINE
 3040 W. 21st
 B'KLYN 24,

Cable: Telemarine, N. Y.
 Tel. ESplanade 2-4300

IN SURPLUS COMMUNICATIONS EQPT!

WESTERN ELECTRIC 250/350 WATTS RADIOTELEPHONE EQPT.

- ★ Provides Complete 2-Way Long or Short Distance Radiotelephone Communication
- ★ Frequency Range—2 to 20 MC
- ★ 30 Channels Transmit & Receive. All Crystal Controlled
- ★ Monitors 3 Separate Channels Simultaneously
- ★ Voice-Operated Carrier Control or Push-To-Talk, as Desired
- ★ Motor-Driven Channel Switching Controlled by Channel Selector
- ★ Highest Degree of Construction, Salt Air Corrosion Resistant, Hermetically Sealed Transformers, Etc.

The Model 248A Radiotelephone Equipment was developed at Bell Telephone Laboratories to furnish powerful, dependable radiotelephone communication, especially on the high seas. It is ideal for ship installation, and fixed-radio installation, since its design and construction are of the highest possible degree.

Each 248A Equipment consist of: 1-48A Radiotelephone Transmitter; 1-48A Radio Receiver (cabinet has provision for a total of 3 receivers, the 48A Receiver provides 10 channels in the 2-6 MC range; a 48B Receiver provides 10 channels in the 4 to 20 MC range, available at additional cost. The 2nd and 3rd receiver may be either a 48A or 48B, available at extra cost); 1-43A Control Unit (may be installed remotely); and, 1-104A Antenna Tuning Unit (medium frequency). A 104B Antenna Unit with whip antenna for the higher frequency, is available at additional cost.

The 48A Radiotelephone Transmitter provides 30 channels of transmission, all crystal controlled, and is rated at 250 watts output. However, a Western Electric Modification Kit is supplied with each, which will increase the power to 300/350 watts. Features of this transmitter include automatic variable-gain audio amplifier; sidetone (hearing of one's own voice in the telephone receiver); interlock safety relays; provision for Selective Ringer installation within cabinet (up to

3 units, 1 for each receiver) for automatic selective calling; motor driven switches for channel selection, controlled by the 43A Remote Control Unit which incorporates a telephone handset, monitoring loud-speaker; ventilating fan for cooling and providing filtered air within cabinet; hinged transmitter and individual receivers for easy access to parts, etc.

Operation of this equipment is from 115 V., 50/60 cycles AC.

This equipment is NOT GOVERNMENT SURPLUS, and is NEW—UNUSED. Additional accessories and full spares also available. Priced far below original selling price!!

WRITE FOR DESCRIPTIVE LITERATURE AND PRICES.

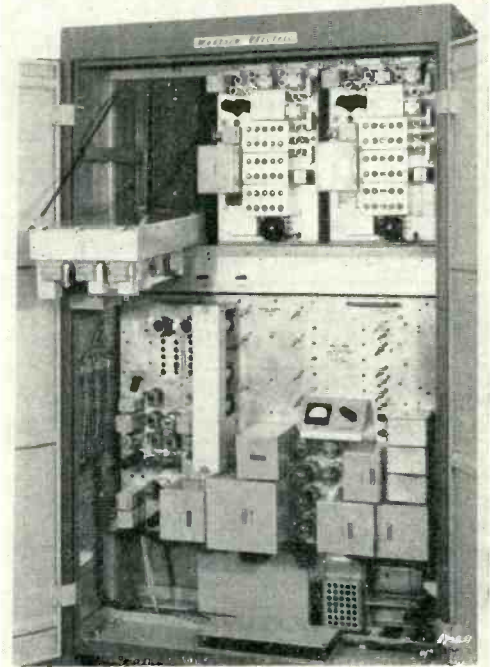

W. E. MODEL 107A SELECTIVE RINGER

Latest design W.E. Selective Ringer, for use with any size Ship-to-Shore Radiotelephone. Operates from radiotelephone's receiver to ring bell when shore telephone operator has call for you. Compact, easily installed. Dim. 15 7/8" L. x 8 1/2" H. x 5 1/2" W. Nt. Wt. 18 lbs. NEW EQPT., with instruction book.

PRICE, EACH \$135.00

SCR-296-A SHORE RADAR

Designed to determine accurately range and azimuth of surface craft and to furnish this information for fire (shore battery) control purposes. It is a fixed radar installation with following Specs: Range — 100,000 yards max., Min. 500 yards.

Accuracy — plus or minus 20 yards (max. range).

Azimuth — 360 degrees. Peak Power 40 KW.

Indicators—5" Class A scope for Range; 3" for Azimuth.

Frequency—700 MC (43 centimeters).

Operation—120 V. 60 cycles A.C.

Excellent, like new material, complete with all amplifiers, servos, synchros, concentric transmission line and plumbing, tubes, spare parts, etc., in 29 cases per set. WRITE FOR PRICES, or further details.

GE 10 KW FM POWER AMPLIFIERS and RECTIFIERS

BRAND NEW, not war surplus, 10 KW FM Power Amplifiers with associated separate Power Rectifiers, designed for boosting low power FM broadcasting stations. Can be used for increasing power of television stations (sound portion), or by changing L and C can be converted to power amplifier on other frequencies. Present range 88-108 MC. Rectifier Power Supply delivers approximately 5,000 V. at 18.4 KVA. Operates from 220 V., 50/60 Cycles, 3 phase AC. Power Amplifier uses 2 GL5518 (not supplied) forced-air cooled GE high efficiency tubes. Includes internal blower system, reflectometer amplifier (with tubes) and GL-8008 rectifier tubes. Beautifully constructed, new equipment at terrific price savings!

PRICE, Type BF-3-A 10 KW RF FM Amplifier and Separate Rectifier, less RF Final Tubes \$4,000.00

RECTIFIER ONLY, if desired. WRITE FOR PRICE.

SPECIAL!!

PE-218D Inverters, 25-28 V. DC Input; 115 V., 380-500 cycles output at 1500 VA. NEW UNITS. OUR PRICE, EACH \$19.95

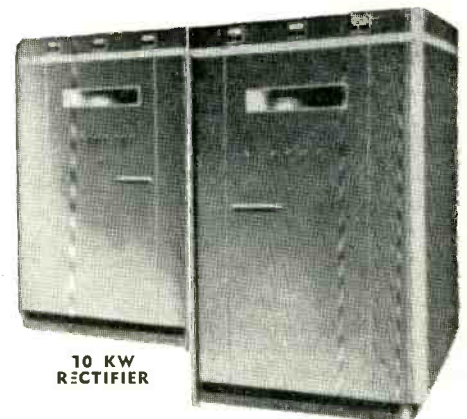

10 KW RECTIFIER

10 KW POWER AMP.

EXPORTERS, GOVERNMENT AGENCIES, INDUSTRIALS!

We have a large stock of Transmitters, Receivers, Walkie-Talkies, VHF Equipment, Ship & Shore Communications, FM Broadcast Stations, Radar, Accessories, etc. Write and tell us of your requirements. Descriptive literature and prices available upon request.

COMMUNICATIONS CO.

STREET
NEW YORK,

All Prices F.O.B. N.Y.C.

All Material Offered Subject to Prior Sale

Reliance Specials

SOUND POWERED HANDSET



TS-10 Type—includes 5 ft. cord. USES NO BATTERIES OR EXTERNAL POWER SOURCE. PAIR—\$18.95

SOUND POWERED HEAD & CHEST SET

Navy Type M Head and Chest Set. Brand New For Work Requiring Free Use of Hands. Heavy Duty—Consists of Headset with 2 Phones and Chest Mike. Includes 20 Ft. Rubber Cord. EACH \$14.88

TELEPHONE FIELD WIRE

W-110-B
1/2 MILE COIL... \$7.95
1 MILE REEL... \$14.95



HAYDON TIMING MOTOR
1 R.P.M. 115 V., 60 Cycle. \$1.95

TIMING MOTOR

8 RPM 115 V 60 cyc
E. Ingraham Co. **\$1.79**

Timer—Industrial Timer Corp. 15 min. on 15 min. off continuous 115 V. A.C. Fully cased Plugs into octal socket. \$5.50

TIME DELAY RELAY

Raytheon CPX 24166
1 Min. Delay. 115 V., 60 Cycle
2 1/2 second recycling time spring return • Microswitch contact, 10A • Holds ON as long as power is supplied • Fully Cased • ONLY \$6.50

JONES BARRIERS STRIPS

2-140V	\$0.17	3-141W	\$0.27	8-141 1/2 W	\$0.64
3-140 3/4 W	.21	4-141	.24	9-141	.48
6-140	.28	5-141	.29	9-141Y	.71
10-140W	.59	5-141 1/2 W	.41	3-142	.24
10-140 3/4 W	.59	7-141 1/2 W	.56	2-150	.43
13-141 3/4 W	.27	8-141	.44	3-150	.60

Brand New Meters—Guaranteed

0-10 ma. D.C. 3 1/2" \$3.95
0-1 Ma D.C. 3 1/2" Dejur (Scale Reads 0.4 KV) \$5.75

SELENIUM RECTIFIERS

Full Wave 200 Ma 115V \$1.70
Half Wave 100 Ma 115V .91

3 AG FUSES

Amp.	Per 100	Per 1000	Amp.	Per 100
1/8	54.00	54.00	8	53.00
1/4	4.00	3.00	10	3.00
3/8	4.00	3.00	15	3.00
1/2	4.00	3.00		

3 AG FUSE HOLDERS (Finger) 25¢

RESISTORS

Type EB 1/2 W 10%	6¢ ea.	54.00 per C
EB 1/2 W 5%	12¢ ea.	8.00 per C
GB 1W 10%	9¢ ea.	7.00 per C
GB 1W 5%	18¢ ea.	14.00 per C
Type HB 2W 10%	12¢ ea.	9.00 per C
HB 2W 5%	24¢ ea.	18.00 per C

AVAILABLE IN ALL STANDARD RMA VALUES

POSTAGE STAMP MICAS

AVAILABLE IN ALL STANDARD RMA VALUES
PRICE SCHEDULE

5 mmf to 910 mmf.	5¢
.001 to .0013 mfd.	8¢
.0015 to .0056 mfd.	15¢
.0062 to .0091 mfd.	20¢
.01 mfd.	25¢

SILVER MICA—POSTAGE STAMP

AVAILABLE IN ALL STANDARD RMA VALUES
PRICE SCHEDULE

10 mmf to 910 mmf.	10¢
.001 mfd to .002 mfd.	20¢
.0022 mfd to .0091 mfd.	50¢
.01 mfd.	95¢

ASSORTMENTS

GEARS—100 SMALL GEARS, BUSHINGS & SHAFTS. \$6.50
RESISTORS—200 1/2 WATT ALL INSULATED AMET-ICAN MADE \$2.50
HARDWARE—5 lbs. BOLTS—NUTS—LUGS—WASHERS ETC \$2.00

PULSE TRANSFORMERS

UTAH—9262 9278 9289 9318 9340 9350
WESTERN ELECTRIC—D166173 D161310
K58696 K59800 K59862 K51361
GENERAL ELECTRIC—80-G-5
JEFFERSON ELECTRIC—C-12A-1318
DINION COIL—TR1048 TR1049
also 352-7250-2A 352-7251-2A T-1229621-60

AN CONNECTORS

See Our Ad February, 1953 Electronics
PHONE! WIRE! WRITE! YOUR NEEDS

TERMS—Cash with Order or 25% Deposit—Balance C.O.D. Net 10 Days to Rated Accounts. All Prices are Net F.O.B. Our Warehouse.

UNIVERSAL JOINTS ALUMINUM

1/4" hole, 1/2" O.D. 1-1/2" long with two 6/32 tapped set-screw holes EACH 85¢
3/8" O.D. 1-1/2" long with two 6/32 tapped set-screw holes EACH 80¢

OIL FILLED CONDENSERS

MFD	V.D.C.	Price	MFD	V.D.C.	Price
5.2	50	\$0.89	0.5	3,000	\$2.40
6	400	.85	2	3,000	4.50
3 x 3	400	1.00	2	4,000	7.95
4	500	.85	0.01	5,000	.95
1	600	.55	1	5,000	4.88
0.5-0.5	600	.40	0.03-0.03	6,000	1.50
2	600	.75	1	6,000	9.95
4	600	1.75	0.02-0.02	7,000	1.55
8	600	1.85	0.1	7,000	1.79
10	600	3.25	0.1-0.1	7,000	5.95
4 x 3	600	2.50	0.1	7,500	2.25
8-8	600	1.95	0.075-0.075	8,000	6.50
1	800	.60	0.15-0.15	8,000	6.95
1	1,000	.69	0.25	20,000	19.95
2	1,000	.95			
3	1,000	1.70			
4 x 3	1,500	1.85			
0.02	2,000	.65			
0.1-0.1	2,000	1.30			
0.1-0.5	2,000	.95			
0.5	2,000	1.65			
8	2,000	3.75			
8	2,000	7.95			
0.25	3,000	2.25			

OIL FILLED AC CONDENSERS

MFD	V.A.C.	Price	MFD	V.A.C.	Price
7.5	220	\$2.00	15	440	\$6.25
20	220	4.95	15	660	2.95
1	236	.49	2.9	660	4.35
4	236	1.60	3	660	4.45
8	236	1.95	4	660	4.95
3	330	1.45	5	660	5.45
4	330	2.75	6	660	5.95
20	330	6.75	8	660	7.50
25	330	7.50	0.2	750	.69
4.4	375	2.15			

COAXIAL CABLE CONNECTORS

A full line of Jan approved connectors in stock

83-1AC	\$0.42	PL-274	\$1.10	UG-88/U	\$ 90
83-1AP	.30	PL-275	2.10	UG-89/U	1.10
83-1HC	.35	SO-239	.40	UG-102/U	.80
83-1F	1.10	UG-13/U	1.70	UG-103/U	.68
83-1H	.12	UG-18B/U	1.05	UG-104/U	1.40
83-1HP	.22	UG-20B/U	1.60	UG-105/U	1.50
83-1J	.73	UG-21/U	1.85	UG-106/U	.15
83-1K	.10	UG-21B/U	1.00	UG-107B/U	2.75
83-1HTY	.65	UG-21C/U	1.05	UG-146/U	2.00
83-1SP	.45	UG-21D/U	1.45	UG-167/U	3.75
83-1SPN	.50	UG-22/U	1.30	UG-175/U	.12
83-1T	1.30	UG-22A/U	1.60	UG-176/U	.12
83-2AP	1.95	UG-23B/U	1.20	UG-185/U	.95
83-2J	2.10	UG-23/U	1.20	UG-196/U	1.65
83-2R	1.65	UG-23B/U	1.50	UG-203/U	.65
83-2ZAP	1.40	UG-23C/U	1.10	UG-221/U	1.15
83-2ZF	2.10	UG-24/U	1.30	UG-255/U	1.95
83-2ZJ	1.40	UG-27/U	1.25	UG-260/U	.85
83-2ZB	.68	UG-27A/U	2.25	UG-261/U	1.10
83-2ZSP	.80	UG-27B/U	2.95	UG-262/U	1.10
83-2ZT	1.95	UG-28A/U	2.95	UG-273/U	1.45
83-168	.12	UG-29B/U	1.75	UG-274/U	2.30
83-185	.12	UG-30/U	2.30	UG-290/U	.90
CW-123A/U	.45	UG-57B/U	1.85	UG-291/U	.95
M-358	1.30	UG-58/U	.70	UG-306/U	2.65
M-359	.30	UG-58A/U	.90	UG-414/U	1.95
M-359A	.65	UG-59A/U	1.90	UG-499/U	1.25
PL-258	.75	UG-88/U	1.75	UG-625/U	1.35
PL-259	.45	UG-85/U	1.65		
PL-259A	.50	UG-87/U	1.40		

NEW COAXIAL CABLES Jan approved

	Price per 1000 ft.		Price per 1000 ft.
RG5/U*	\$140.00	RG 22/U*	\$150.00
RG6/U	180.00	RG 22A/U	285.00
RG7/U*	85.00	RG 24/U	675.00
RG8/U*	100.00	RG 26/U	475.00
RG9/U	250.00	RG 29/U*	50.00
RG9A/U	275.00	RG 34/U*	300.00
RG10/U	240.00	RG 35/U	900.00
RG11/U*	100.00	RG 41/U*	295.00
RG11A/U*	350.00	RG 54A/U	97.00
RG 12/U	240.00	RG 55/U*	110.00
RG 13/U*	216.00	RG 57/U*	325.00
RG 17/U	650.00	RG 58/U*	60.00
RG 18/U	900.00	RG 58A/U*	70.00
RG 19/U	1250.00	RG 59/U*	55.00
RG 20/U*	1450.00	RG 62/U*	150.00
RG 21/U*	220.00	RG 77/U*	100.00

Add 25% for orders less than 500 feet.
* No minimum order—other 250 minimum.

NEW RG-8/U Unmarked 100 Ft. Coil. Special \$5.95

SELSYN MOTORS

Army Ordnance Type C-78248 115V. 60 Cy. Transmitter. Approx. 3-3/8" dia. x 5-3/8" L. Like new. EACH \$27.50

SELSYN MOTORS

50 V. 50 Cy. High Torque. Connect in Series For Use On 110 V. 60 Cy. Approx. 3-3/8" dia. x 5-3/8" L. Like New. ONLY \$12.95 PAIR

DIFFERENTIAL Used \$4.95

115 V, 60 Cycle New \$9.95 #C78249

3 3/8" dia. x 5 3/8" long
Used between two C78248's as a dampener. Can be converted to 3600 RPM Motor in 10 minutes. Conversion sheet supplied. (Converted) \$5.50
Mounting Brackets—Bakelite for selsyns, and differentials shown above. 35¢ pair

PRECISION RESISTORS (WIRE WOUND SPOOL TYPE)

1/2 watt one percent tolerance WW3 or Equal	35¢ ea
.250 7 4 16 37 105 8 400	4451 25K
.334 9 1 20 123 8 411 3	5000 30K
.502 10 48 25 705	6500 32.89K
.557 10 84 30 130	723 7000 33K
.627 11 1 46 147.5	750 7500 33.3K
.760 11 25 50 180	855 8000 35.89K
1 11 74 52 210	2193 8500 36K
1 01 12 32 55 1 230 4	2200 8800 37K
1 53 13 62.5 235	2250 14.82K 47K
2 13 02 75 260	2500 15K 50K
2 04 13 15 79 81 270	2850 15.7K 59K
2 5 13 52 87 298.3	3427 16.7K 59.15K
3 5 13 89 97 8 301 8	4000 17K 79.01K
5 26 14 98 100 366.6	4300 20K 125K

1 watt one percent tolerance WW4 or Equal 45¢ ea

.861 3 39 20 270	2000 7000 50K
1.01 5 1 28 425	2200 8000 55K
2 55 5 21 38 1250	3300 9000 80K
2 58 12 50 1750	6000 20K

1 watt one percent tolerance WW5 or Equal 60¢ ea.

100K 128K 150K 240K 320K 500K 600K	
120K 130K	

1 watt WW5 or Equal 65¢ ea.

84K-2% 522K-1% 645K-1% 700K-1% 1 meg-5%	
-----------------------------------------	--

1 MEGOHM 1 WATT 1% \$1.50

TYPE "J" POTENTIOMETERS

Ohms	Shaft	Ohms	Shaft	Ohms	Shaft
100	SS*	2.5K	SS	100K	7/16
150	SS*	3.0K	3/8	200K	SS
150	SS*	4.0K	3/8	250K	5/8
500	1/4	15K	3/8	250K	SS
1.0K	9/16	25K	SS	1.0 Meg.	1/4
1.5K	5/16	75K	SS		
2.0K	1/4	100K	3/8		

SS: Screw-driver slot. * Split locking bushing. \$1.25 EACH

TYPE "JJ" POTENTIOMETERS

Ohms	Shaft	Ohms	Shaft	Ohms	Shaft
10K-10K	SS	30K-10K	3/8†	90K-3K	1/4
15K-15K	SS		† With switch.		

PRICE—\$2.50 EACH

High Current Filament Transformer

Amertran type W Pri. 105-125 V. 60 cy. 1 Phase—Sec. 5V. 190 amps.—.97 KVA 35 KV. RMS Insul. Test 7x10x12; Wt. 80 lbs. Ideal For Use As Arc Welder. SPECIAL \$29.50 ea.
Kenyon S-14940 S.C. #2Z9943-1073 Pri. 105-125 V. 60 Cy. Sec. 5V. 115 Amps. \$19.50 ea.
Kenyon S-13377 S.C. #2Z9943-7 Pri. 115 V. 60 Cy. Sec. 5V. 60 Amps. \$15.25 ea.

RAYTHEON PLATE TRANSFORMER

TYPE UB355A
PRI. 110V/220V/440V/60 cy
SEC #1 300V @ 4 AMPS. SEC. #2 300V @ 4 AMPS.
1750 RMS TEST. 9 3/4" x 9 1/2" x 8 1/2" HIGH... \$19.95

Choke 10 hy 400 MA 90 OHMS HERMETICALLY SEALED \$4.88

2J1G1 SELSYNS \$8.50 400 CYCLE BRAND NEW

400 CYCLE INVERTERS Leland Electric Co.

#10800 in; 20-28 V.D.C., 32 A. 8000 R.P.M. Out: 115V. 400 Cyc. 1 phase, 1500 V.A. 90 PF... \$29.50
Minimum Orders \$3 Get on our Mailing List

AIRCRAFT SOLENOID CONTACTORS

18 to 29 VDC Double Make Contacts



25-Amp Contacts Continuous; 50-Amp Surge; SPST: Spec. #94-32185D; 160 ohm; 6.5 oz approx
Guardian 34420 (B2) #R375

Guardian 33557 (B2A) #H376
E. CR2791A102A10 (B2A) #R377
Struthers Dunn 61HXX100 (B2A) #R378
Cutler Hammer 6041H60A (B2A) #R379
Square "D" Class 9350 (B2A) #R380
RBM B2A #R381
Ward Leonard B2 #382
RBM B2 #383
Allen Bradley B2A #R384
Leach 1227-24 (B2A) #R385

200-Amp Contacts, Continuous, 800-Amp Surge, SPST: SPEC. 94-32324C; AN-R-20A; 70 ohms
Square "D" B4 #R386
Autolite B4 #R174
Autolite B4A #R387
Cutler Hammer 6041H17C; B4 #R388

50-Amp Contacts; Continuous; 100-Amp Surge; SPST: Spec. #94-32351-B; 100 ohm
Allen Bradley X91419 (B5A) #R105
Hart 692R4 (B5A) #R389

Square "D" B5A #R25
Cutler Hammer 6041H2A (B5A) #R24
Cutler Hammer 6041H79A (1204-1 or B5B) #R294
Leach 7064-278 (1204-1 or B5B) #R301

100-Amp Contacts; Continuous; Spec. 94-32352; SPST
Allen Bradley X95345; 65 ohm; Identical to NAF 1204-2 (A-BX95395) except coil connection screws inverted; #R606

200-Amp Contacts; Continuous; 800-Amp Surge
Arrow, H & H 39169; Spec. 94-32353; SPST; B7A; 10/110 ohm; #R320
Guardian 1204-3; 10/110 ohm; #R321
Allen Bradley X95396; NAF 1204-3; 60 ohms; #R322

200-Amp Contacts, 1000-Amp Surge; 10 ohm 8-28VDC; Intermittent Duty; Spec. 32424; SPST
Autolite B8; #R128
Guardian 34056 #R129
Hart 694R15A #R601
Cutler Hammer 6041H139A #R130
Leach 7210-24 #R602

15-Amp Inductive; SPDT; Time Delay 0.050 sec (slow make); Spec. #32429; 180 ohms 7/2 oz approx
Leach 2069-147 #R323
Guardian 34464 #R324

200-Amp Contacts; 18-29 V; Spec. 94-32183; SPST
Eclipse C1-73110-521-1; 60 ohm; #R325

200-Amp Contacts; 8-28V DC Intermittent Duty
Spec. #94-32181; SPST; Eclipse D1-66198-518-2; 6 ohms; #R126
Cutler Hammer 6041H61A; 50 ohms; #R292

1204-1 (B5B) 50-Amp Contacts; Spec. 569A; SPST
Cutler Hammer 6041H79A; 150 ohms; #R291
Leach 7064-278; 150 ohms; #R326

1204-2 (B6B) 100-Amp Contacts; Spec. 560A; SPST
Allen Bradley X95395; 65 ohms; Identical to B6B (A-B X95345) except coil connecting screws inverted; #R327
1204-3 (B7B) 200-Amp Contacts; Spec. M569A; SPST
Allen Bradley X95396; 60 ohms; #R329
Cutler Hammer 6041H81A; 65 ohms; #R295
1181-1; 25-Amp Contacts; Spec. S85D; SPST
Struthers Dunn CX1535; 24VDC; 240 ohms; #R604



CUTLER-HAMMER AIRCRAFT & COMMERCIAL D-C CONTACTORS

C-H No.	AAF or NAF	COIL Volts D.C. Ohms	CONTACTS Cir-cuit Amps	Stock No.	Price Ea.
6041H2A	B5	24 100	SPST 50	R298	2.50
6041H2B	B5A	24 100	SPST 50	R24	2.75
6041H6A	—	24 100	SPST 50	R288	2.75
6041H12A	—	24 65	SPST 100	R421	3.50
6041H17C	B4	24 65	SPST 200	R289	4.95
6041H36A	A3	12 17	SPST 200	R121	4.5
6041H50A	—	12 17	DPST 50	R290	3.50
6041H54A	—	24 100	SPDT 50	R299	3.95
6041H60A	B2	24 160	SPST 25	R291	1.95
6041H61A	D1	24 50	SPST 200	R292	4.95
6041H63B	—	24 50	SPST 100	R293	3.95
6041H79A	B5B	1201-1	18-29 150 SPST 50	R294	3.50
6041H81A	B7B	1201-3	18-29 65 SPST 200	R295	4.95
6041H84A	—	12 25	No Contacts	R296	1.75
6041H39A	B8	10-24	10 SPST 200	R130	4.95
6041H58A	—	12 25	SPST 50	R128	2.75
6041H69A	3350-2	24 100	SPST 50	R297	3.95
9565H2B	—	24 25	SPST 50	R300	6.95



MAGNECON CONTACTORS

200 Amp Contacts SPST, Double Make Holding Current Automatically Cut by 90%

305381-2, 36VDC, 14 ohm Start, 140 ohm Hold. #R589	\$4.95
305381-3, 72 VDC, 60 ohm Start, 600 ohm Hold. #R590	\$5.50
305281-4, 120VDC, 200 ohm Start, 2000 ohm Hold. #R591	\$5.95

LEACH CONTACTORS

Leach No.	AAF or NAF	COIL Volts D.C. Ohms	CONTACTS Cir-cuit Amps	Stock No.	Price Ea.
1227-24	B2A	18-29 160	SPST 25	R385	2.25
2069-147	B9	18-29 180	SPDT 15	R323	2.25
5023CG17	—	24 100	SPDT 60	R282	5.00
5030	—	12 7	SPST 60	R700	3.95
5030CSP	—	12 25	SPST 50	R125	2.95
5031LA	—	12 25	SPST 100	R707	3.50
5035	—	12 7	SPST 60	R713	3.50
5035CS	—	12 25	SPST 60	R714	3.50
5035-3	—	12 7	SPST 60	R703	3.50
5037	—	12 25	SPST 50	R705	3.50
5050	—	24 25	SPST 40	R701	3.50
5051GM	—	24 40	SPST 65	R708	3.50
5053SM	—	24 10	SPDT 100	R712	4.50
5055	—	24 25	SPST 40	R704	3.50
5057	—	24 105	SPST 30	R706	3.50
5058	—	24 10	SPST 200	R709	7.95
5058CDWG17	—	24 140	SPST 200	R710	7.95
5058-1G17	—	24 10	SPST 200	R711	7.95
7064-12C	—	12 40	SPST 75	R702	3.50
7064-278 (NAF1204-1)	B5B	18-29 100	SPST 50	R391	3.50
7210-24	B8	18-29 66	SPST 200	R602	3.95



ARC 3 & ARC 5 RELAYS



23025 RBM 48VDC; SPDT; 8000 ohm; 6 ma; #R128 \$2.50
55251 (K403, K405) Telechron; 24VDC; SPST; n.o. (1A); 300 ohm; #R174 \$1.25
55340 (K203) Price; 24VDC; SPST n.o., (1A); 300 ohm; #R170 \$1.25
55342 (K206, K213) Telechron; 24VDC; (2A's); (1C); 300 ohm; Anti-Capacity Arms; Low Loss Bakelite Insulation; #R171 \$1.75
55476 (K101) Clare; 12-24VDC; Co-Axial Antenna Relay; SPDT (1C); 275 ohms; #R421 \$9.95
55526 (K109, K116) Cook; 24VDC; (1A, 1C); 300 ohm; Ceramic Insulation; #R107 \$1.75
55528 (K170) G. E.; 12VDC; SPST n.o., (6A's); 150 ohm; #R426 \$2.00
55531 (K106) Cook; 12-24VDC; (2A's, 2C's); 150 ohm; #R405 \$1.95
55585 (K103) G. E.; 12-24VDC; Sealed Plug-In-Relay; SPDT (1C); 2500 ohm; #R419 \$4.95
55589 (K102) G. E.; 12-24VDC; DPST n.o. (2A); 280 ohm; #R245 \$1.75
55836 (K406) G. E.; 24VDC; SPDT; 250 ohm; #R402 \$1.50
55837 (K401, K402) G. E.; 24VDC; Double Make (2A); 300 ohm; #R108G \$1.25
55837 (K401, K402) RBM; Same as #R108G; #R108R \$1.50
55837 (K401, K402) Allied; Same as #R108G; #R108 \$1.75
23012-0 RBM; 24VDC; SPST; 250 ohms; #R172 \$1.50
6385 ARC; 12-24VDC; SPST n.o. (1A), 10 Amp Contacts; 200 ohm; #R213 \$2.00
7251 ARC; 24VDC; SPDT; (1C); 300 ohm; #R406 \$1.50
7252 ARC; 24VDC; DPST n.o. (2A); 300 ohm; #R354 \$1.50
7735 ARC; 24VDC; Antenna Relay; SPDT (1C); 200 ohm; #R799 \$3.95

OTHER CONTACTORS

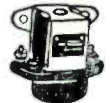

Mfrg. & No.	Volts D.C. Ohms	CONTACTS Circuit Amps	Stock No.	Price Ea.
RBM 118083	24 153	SPST 60	R715	2.50
RBM 117083	24 10	SPST 60	R716	2.50
RBM 120083	32 178	SPST 60	R717	2.50
RBM 119083	32 272	SPST 60	R718	2.50
RBM BNS	24 200	SPST 50	R224	2.50
Guardian 79733	24 65	SPDT 60	R131	3.00
Guardian 34585	24 ea 2x24	2xSPDT 2x75	R223	9.95

Dual Electrical Latching



G.E. CR2792B118A3	24 150	SPST 50	R23	2.95
G.E. CR2792D116W2	12 30	SPST 100	R719	5.50
G.E. CR2800-384A3	24 50	SPST 200	R720	5.95
G.E. CR9533K100A2	24 240 2B; 1A	15	R132	9.95
2 Switchettes; extra long throw				
G.E.M29J682-1	10-12 30	No Contacts	R167	1.25
EPCO S47D	12 35	SPST 50	R122	2.50
A-B X86382	24 40	SPST 100	R722	3.50
Autolite	12 17	SPST 50	R74	2.50
Allied AN1332	24 175	SPST 75	R486	3.95
Allied AN1328	6 14.2	SPST 75	R721	4.50

ACCESSORIES FOR TELEPHONE TYPE RELAYS

Clare CR1 Molded Bakelite Cover #R1	.90
Clare BR2 Long Relay Bracket #BR2	.20
Clare BR4 Short Relay Bracket #BR4	.15

CARBON MONOXIDE DETECTOR SIGNAL ASSEMBLY

MINE SAFETY APPLIANCES CO. Type K-1 and K1-N—Manufacturer's Part No. SK 1557 and SK 1557-1—Spec. No. 27493

NEW! REG. PRICE \$300

8900 each 3 for \$250.00
10 for \$825.00



TERMS:—All prices F.O.B. Our Plant. Rated Firms Net 10 Days; All Others Remittance with Order.

Orders Under \$10 Remittance With Order, Plus A approximate Shipping Charges (overage will be returned.)

324 CANAL ST., N.Y.C., 13, N.Y. Walker 5-9642



BENDIX AIRCRAFT TYPE GENERATOR

Bendix-Eclipse Aviation; Type 1235 Counter-clockwise rotation Speed 2600-4500 RPM; 28.5 VDC @ 15 A. A Two-Brush ball bearing generator suitable for any application where 28 volt output is required. Field and armature taps for adjustment of voltage from 12 to 28 volts. **NEW \$15.00**



G. E. GENERATORS

General Electric Type 5-ASB-31J3; 400 cycles out at 115 volts; 7.2 amps; 8,000 rpm.; size 6" long x 6" dia. **\$99.50 ea.**

SINE-COSINE GENERATORS

(Resolvers)

Diehl Type FJE43-9 (Single Phase Rotor). Two stator windings 90° apart, provides two outputs equal to the sine and cosine of the angular rotor displacement. Input voltage 115 volts, 400 cycle. **\$30.00 ea.**

Diehl Type FFE-43-1 same as FJE-43-9 except it supplies maximum stator voltage of 220 volts with 115 volts applied to rotor. **\$25.00 ea.**

Arma Resolver Type 213014; equal in size to size 5 synchro; 55-60 cycle; single phase primary, 2 phase secondary. **\$79.50**

VOLTAGE GENERATORS (RATE)

ALNICO MIDGET D.C. VOLTAGE GENERATOR Type B-35-D. **\$17.50**

ALNICO MIDGET D.C. VOLTAGE GENERATOR Type B-44-D. **\$17.50**

A.C. GENERATOR; 67 V. 20 Cyc. 2-Phase, .015 Amps. Type PM-1, 1200 R.P.M. **\$15.00**

SYNCHRONOUS SELSYNS

110 volt, 60 cycle, brass cased, approx. 4" dia. x 3" long. Mfg. by Diehl and Bendix.

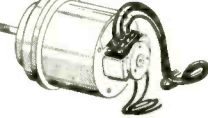

Quantities Available.

REPEATERS **\$20.00 ea.**

TRANSMITTERS **\$20.00 ea.**

AUTOSYN MOTOR TYPE 1

115 VAC; 60 cycle; 1-phase; DR. # CB 4279 Foot Mounted; Mfg. Bendix Aviation Corp. **\$22.50 ea.**

SELSYN GENERATOR

General Electric MOD. 2J15M1; 115-57.5 Volts 400 Cycle. **\$22.50 ea.**

SYNCHROS

AUTOSYN MTR. KOLLSMAN Type #403; 32 VAC; 60 cycle; single phase. **\$22.50**

AUTOSYN MTR. BENDIX Type #851; 32 VAC; 60 cycle; single phase. **\$22.50**

SYNCHRO TRANSMITTER. KEARFOTT Type R-212-1A-A Rotor; 26 Volts; single phase; Stator; 11.8 Volts; 3-phase; 400 cycle. **\$25.00**

MICROSYN UNIT, Type 1C-006-A. **\$35.00**

IF Special Repeater (115V-400 Cy.) **\$15.00 ea.**

2J1F 3 Generator (115-400 cyc.) **\$10.00 ea.**

5CT Control Transformer; 90-50 Volt; 60 Cy. **\$50.00 ea.**

5F Motor (115/90 Volt—60 cyc.) **\$50.00**

5G Generator (115/90 v.—60 cy.) **\$50.00 ea.**

5/DG Differential Generator (90-94 volts—400 cyc.) **\$30.00 ea.**

TRANSMITTER, BENDIX C-78248; 115 Volt, 60 Cycle **\$25.00 ea.**

Differential C-78249; 115 V., 60 Cy. **\$5.00**

5N MOTOR (115 Volts/60 Cycle) **\$22.50**

REPEATER, BENDIX C-78410; 115 Volt, 60 Cycle **\$37.50 ea.**

REPEATER, AC synchronous 115 V., 60 cycle, C-78563 **\$15.00 ea.**

REPEATER, DIEHL MFG. No. FJE 22-2; 115 Volt; 400 Cy.; Secondary 90 V. **\$27.50**

7G Synchro Generator (115/90 volt; 60 cycle) **\$75.00**

6G Synchro Generator (115/90 volt; 60 cycle) **\$60.00**

6DG Synchro Differential Generator (90/90 volt; 60 cycle) **\$60.00**

2-JF5-J Selsyn Control Transformer; 105-55 Volts; 60 Cycle **\$50.00**

5JD5HA1 Selsyn Generator; 115-105 Volts; 60 cycle **\$50.00**

2J1F1 GENERATOR; 115—57.5 Volt; 400 cycle **\$12.50 ea.**

2J1H1 DIFFERENTIAL GENERATOR; 57.5—57.5 Volt; 400 cycle **\$12.50 ea.**

2J1G1 CONTROL TRANSFORMER; 57.5—57.5 Volt; 400 cycle **\$7.50 ea.**

PIONEER TORQUE UNITS

TYPE 12606-1-A; Contain CK5 Motor coupled to output shaft through 125:1 gear reduction train. Output shaft coupled to autosyn, follow-up (AY43). Ratio of output shaft to follow-up Autosyn is 15:1. **\$70.00 ea.**

TYPE 12604-3-A; Same as 12606-1-A except it has a 30:1 ratio between output shaft and follow-up Autosyn **\$70.00 ea.**

TYPE 12602-1-A; Same as 12606-1-A except it has base mounting type cover for motor and gear train. **\$70.00 ea.**

Immediate Delivery

ALL EQUIPMENT FULLY GUARANTEED

All prices net FOB Pasadena, Calif.

INVERTERS

10563 LELAND ELECTRIC

Output: 115 VAC; 400 cycle; 3-phase; 115 VA; 75 PF. Input: 28.5 VDC; 12 amp. **\$69.50 ea.**

PIONEER 12126

OUTPUT: 10 VAC; 10V AMP; FREQ 400 cycle; 3-phase .60 P.F. INPUT: 28 VDC; 1.25 AMPS. **\$29.95 ea.**

PIONEER 12117

OUTPUT: 26 volts; 400 cycles; 6 volt amperes, 1-Phase INPUT: 24 VDC; 1 amp. **\$25.00 ea.**

ALTERNATOR, CARTER

Mfg. Carter Motor Co.; OUTPUT: 7 VAC; 9.7 amp.; 650 cycles, and 295 VDC. 200 amps. INPUT: 26.5 VDC; 10.5 amps; 6500 rpm. **\$49.50 ea.**

PE 218 LELAND ELECTRIC

Output: 115 VAC; Single Phase; PF 90; 380/500 cycle 1500 VA. INPUT: 25-28 VDC; 92 amps; 8000 RPM; Exc. Volts 27.5. **BRAND NEW** **\$39.95 ea.**

PE 109 LELAND ELECTRIC

Output: 115 VAC, 400 cyc.; single phase; 1.53 amp.; 8000 RPM; Input: 13.5 VDC; 29 amp. **\$69.50**

MG-0-7S ONAN

Navy Type PU/11 Output: 115 VAC; 480 cyc.; single phase; 5.3 amp and 26 VDC @ 3.8 amp. Input: 115/230 VAC; 60 cyc.; single phase **\$225.60**

MG 153 HOLTZER-CABOT

Input: 24 V, DC, 52 amps; Output: 115 volts—400 cycles, 3-phase, 750 VA. and 26 Volt—400 cycle, 250 VA. Voltage and frequency regulated **\$95.00 ea.**

PIONEER 12130-3-B

Output: 125.5 VAC; 1.15 amps. 400 cycle single phase, 141 VA. Input: 20-30 VDC, 18-12 amps. Voltage and frequency regulated **\$89.50 ea.**

12116-2-A PIONEER

Output: 115 VAC; 400 cyc.; single phase; 45 amp. Input: 24 VDC 5 amp. **\$90.00 ea.**

10285 LELAND ELECTRIC

Output: 115 Volts AC, 750 V.A., 3 phase, 400 cycle, .90 PF, and 26 volts, 50 amps, single phase, 400 cycle, 40 PF. Input: 27.5 VDC, 60 amps. cont. duty, 6000 RPM. Voltage and Frequency regulated. **\$195.00**

10486 LELAND ELECTRIC

Output: 115 VAC; 400 Cycle; 3-phase; 175 VA; .80 PF. Input: 27.5 DC; 12.5 amp; Cont. Duty **\$90.00 ea.**

PIONEER 10042-1-A

DC INPUT 14 Volts; OUTPUT: 110 Volts; 400 Cycle 1-Phase; 50 Watt. **\$90.00**

94-32270-A LELAND ELECTRIC

Output: 115 Volts; 190 VA; Single Phase; 400 Cycle; .90 PF. and 26 Volts; 60 VA; 400 Cycle; 40 PF. Input: 27.5 Volts DC; 18 amps; cont. duty, voltage and freq. regulated **\$95.00**

PIONEER AUTOSYNS

AY-1 26 Volt—400 Cycle. **\$6.95**

AY-5 26 Volt—400 Cycle. **\$7.95**

AY27D 26 Volt—400 Cycle. **\$12.50**

AY6—26 Volt—400 cyc. **\$4.95 ea.**

AY30D—26 Volt—400 cyc. **\$25.00 ea.**

AY14D **\$10.00**

AY34 **\$20.00**

AY20—26 Volt—400 cyc. **\$12.50 ea.**

PORTABLE GAMMA SURVEY METER

Model 247B: For detecting and measuring higher intensities of Gamma radiations while obtaining discrimination against other radiations. Range switch permits selection on scales of zero to 50, zero to 500, zero to 5000, and zero to 50,000 milliroentgens/hour (MR/HR). Entirely self-contained, the unit consists of a watertight aluminum case with sealed detector assembly, hermetically sealed meter, vacuum tubes and circuit components with power supply of 1-45V dry battery and 1-300V dry battery. Dimensions are 10-3/4" wide; 12-59/64" high; weight 12-3/4" lbs. incl. batteries. Mfg. Victoreen Instrument Co. Original A.E.C. cost over \$300. Buy it at a tremendous savings. **Brand New** **\$89.50**



ALNICO FIELD MOTORS

(Approx. size overall 3 1/2" x 1 1/4" diameter)

DELCO TYPE #5069600; 27.5 volts DC; 250 RPM **\$19.95**

PM Motors Delco Type #5069371; 27.5 volts; DC Alnico Field; 10,000 r.p.m.; dimensions 1" x 1" x 2" long; shaft extension 1/2" diameter 0.125" **\$15.00**

PIONEER GYRO FLUX GATE AMPLIFIER Type 12076-1-A, complete with tubes **\$27.50 ea.**

AC CONTROL MOTOR

A. C. SYNCHRONOUS MOTOR Type RBC 2505; Volts 115; Cycles 60; RPM 2; Mfg. HOLTZER CABOT ELECT. Approx. size: 2 1/2" x 2 1/2" x 2 1/2" **\$15.00 ea.**

400 CYCLE MOTORS

PIONEER: TYPE CK5 2 Phase; 400 cycles **\$25.00 ea.**

EASTERN AIR DEVICES TYPE J49A; 115 V; 0.1A; 7000 r.p.m. Single phase 400 cycle **\$17.50 ea.**

AIRESEARCH; 115V; 400 CPS; Single phase 6500 RPM; 1.4 amp; Torque 4.6 in. oz.; HP .03 **\$10.00 ea.**

EASTERN AIR DEVICES TYPE JM6B; 200 VAC; 1 amp; 3 phase; 400 cycles, 6000 RPM **\$12.50 ea.**

EASTERN AIR DEVICES, TYPE J31B; 115 V. 400-1200 Cycle. Single Phase **\$12.50 ea.**

AIRESEARCH: AC induction, 200 V; 3 Phase, 400 Cycle, 2 H.P.; 11,000 RPM; 8 amps. \$79.50 ea.

AIREARCH: AC Induction, 200 V; 3 Phase, 400 Cycle, 12 H.P. 6500 RPM; 1.5 amps. \$25.00

Electric Motor: PNT-1400-A1-1A Serial No. 207, 208 V., 400 Cycles, 3 phase Kearfott Co., Inc. **\$17.50 ea.**

SERVO MOTOR 10047-2-A; 2 Phase; 400 Cycle, with 40-1 Reduction Gear

SMALL DC MOTORS

DELCO #5072000; 27.5 VDC; 11.75 rpm **\$15.00**

DELCO #5068750; constant speed; 27 VDC; 160 RPM; built-in reduction gears and governor **\$17.50 ea.**

J. OSTER; series reversible motor; 1/50th H.P.; 10,000 RPM; 27 1/2 VDC; 2 amps; **SPERRY #806069**; approx. size 1 1/2" x 3 1/2" **\$7.50 ea.**

(Approx. size 4" long x 1 1/2" dial.)

General Electric Type 5BA10AJ37; 27 volts, DC; 5 amps. 8 oz. inches torque; 250 RPM. shunt wound; 4 leads; reversible. **\$15.00 ea.**

General Electric, Mod. 5BA10F33; 12 oz. inches torque, 12 DC, 50 RPM, 1.02 amp. **\$15.00 ea.**

General Electric Type 5BA10AJ52C; 27 volts, DC; 5 amps. 8 oz. inches torque; 145 RPM; shunt wound; 4 leads; reversible. **\$15.00 ea.**

GENERAL ELECTRIC DC MOTOR Mod. 5BA10AJ64, 160 r.p.m.; 65 amp; 12 oz.-in. torque; 27V DC **\$19.95 ea.**

2 1/2 H.P. MOTOR—Mfg. LEECE-NEVILLE Co; Type 1454-MO; 24VDC; 4000 RPM; 100 amp. **\$85.00**

115 VOLT GENERATORS

Brand new Eclipse generators: 115 VAC; 9.4 amp; 1000 watts; single phase; 800 cycles, 2400-4200 rpm. DC output is 30 volts at 25 amp. Unit has spline drive shaft and is self-excited **\$29.95**



MICROPOSITIONER

Barber Colman AYLZ 2133-1 Polarized D.C. Relay; Double Coil Differential sensitive, Alnico P. M. Polarized field. 24V contacts; .5 amps; 28 V. Used for remote positioning, synchronizing, control, etc. **\$12.50 ea.**

Eastern Air Devices, Type J31B; 115 volt; 400-1200 Cycle; single phase; variable frequency; continuous duty; L & R #2 blower; approx. 22 cu. ft./min. **\$15.00**

BLOWER

BLOWER ASSEMBLY

115 Volt, 400 Cycle, Westinghouse Type FL, 17CFM, complete with capacitor. **New** **\$12.50 ea.**

SENSITIVE ALTIMETERS

Pioneer Sensitive altimeters, 0-35,000 ft. range calibrated in 100's of feet. Barometric setting adjustment. No hook-up required **\$12.95 ea.**



C and H Sales Company

BOX 356-X EAST PASADENA STATION

PASADENA 8, CALIFORNIA

A LEADING SUPPLIER OF ELECTRONIC & AIRCRAFT EQUIPMENT

IMMEDIATE DELIVERY -- FULLY GUARANTEED

A. C. SYNCHRONOUS MOTORS

110 Vt. 60 Cycle

HAYDON TYPE 1600, 1/240 RPM
 HAYDON TYPE 1600, 1/60 RPM
 HAYDON TYPE 1600, 4/5 RPM
 HAYDON TYPE 1600, 1 RPM
 HAYDON TYPE 1600, 1 1/5 RPM
 TELECHRON TYPE B3, 2 RPM
 TELECHRON TYPE BC, 60 RPM
 HOLTZER CABOT, TYPE RBC 2505, 2 RPM, 60 oz. 1 in. torque.

SERVO MOTORS

PIONEER TYPE CK1, 2 ϕ 400 CYCLE
 PIONEER TYPE 10047-2-A, 2 ϕ , 400 CYCLE, with 40:1 reduction gear.

D. C. MOTORS

BODINE NFHG-12, 27 VTS., governor controlled, constant speed 3600 RPM, 1/30 HP.
 DELCO TYPE 5068750, 27 VTS., 160 RPM, built in brake.
 DUMORE, TYPE EIY2PB, 24 VTS., 5 AMP., .05 HP., 200 RPM.
 GENERAL ELECTRIC, TYPE 5BA10AJ18D, 27 VTS., 110 RPM, 1 oz. 1 ft. torque.
 GENERAL ELECTRIC, TYPE 5BA10AJ37C, 27 VTS., 250 RPM, 8 oz. 1 in. torque
 BARBER COLMAN ACTUATOR TYPE AYLC 5091, 27 VTS., .7 amp., 1 RPM, 500 in. lbs. torque.
 WHITE ROGER ACTUATOR TYPE 6905, 12 VT., 1.3 amp., 1 1/2 RPM, 75 in. lbs. torque.

AMPLIDYNE AND MOTOR

AMPLIDYNE, GEN. ELEC. 5AM31NJ18A input 27 vts., at 44 amp. output 60 vts. at 8.8 amp., 530 watts.
 MOTOR, GEN. ELEC. 5BA50LJ22, armature 60 vts. at 8.3 amp., field 27 vts. at 2.9 amp. 1/2 HP., 4000 RPM.

PIONEER AUTOSYNS 400 CYCLE

TYPE AY1, AY5, AY14G, AY14D, AY20, AY27D, AY38D, AY54D.
 PIONEER AUTOSYN POSITION INDICATORS & TRANSMITTERS.
 TYPE 5907-17, single, ind. dial graduated 0 to 360°, 26 vts., 400 cycle.
 TYPE 6007-39, dual ind., dial graduated 0 to 360°, 26 vts., 400 cycle.
 TYPE 4550-2-A, Transmitter, 2:1 gear ratio 26 vts., 400 cycle.

INVERTERS

WINCHARGER CORP. PU 16/AP, MG750, input 24 vts. 60 amps. outputs 115 vts., 400 cycle, 6.5 amp., 1 phase.

HOLTZER CABOT, TYPE 149F, input 24 vts. at 36 amps., output 26 vts. at 250 V.A. and 115 vts. at 500 V.A., both 400 cycle, 1 phase.

PIONEER TYPE 12117, input 12 vts., output 26 vts. at 6 V.A., 400 cycle.

PIONEER TYPE 12117, input 24 vts., output 26 vts. at 6 V.A., 400 cycle.

WINCHARGER CORP., PU/7, MG2500 input 24 vts. at 160 amp., output 115 vts. at 21.6 amp., 400 cycle, 1 phase.

GENERAL ELECTRIC, TYPE 5D21NJ3A, input 24 vts. at 35 amps., output 115 vts. at 485 V.A., 400 cycle, 1 phase.

LELAND, PE 218, input 24 vts. at 90 amps. output 115 vts. at 1.5 K.V.A., 400 cycle, 1 phase.

LELAND, TYPE D.A. input 28 vts., at 12 amp. output 115 vts. at 115 V.A., 400 cycle, 3 phase.

ENGINE HOUR METER

JOHN W. HOBBS, MODEL MI-277 records time up to 1000 hours, and repeats, operates from 20 to 30 volts.

VOLTAGE REGULATOR

LELAND ELEC. CO. TYPE B, CARBON PILE. Input 21 to 30 volts D.C. regulated output 18.25 vts. at 5 amp.

WESTERN ELEC. TYPE BC937B, input 110 to 120 volts, 400 cycle. Output variation 0 to 7.2 ohms at 5 to 2.75 amps.

WESTERN ELEC. TRANSTAT, input 115 vts., 400 cycle output adjustable from 92 to 115 vts., rating .5 K.V.A.

AMERICAN TRANS. CO., Transtat input 115 vts., 400 cycle output 75 to 120 vts. or 0 to 45 volts, rating .72 K.V.A.

SYNCHROS

1 F SPECIAL REPEATER 115 vts. 400 cycle.
 2J1F1 GENERATOR, 115 vts. 400 cycle.
 2J1F3 GENERATOR, 115 vts. 400 cycle.
 2J1G1 CONTROL TRANSFORMER 57.5 vts. 400 cycle.
 2J1H1 DIFFERENTIAL GEN. 57.5/57.5 vts. 400 cycle.
 5G GENERATOR, 115 vts. 60 cycle.
 5DG DIFFERENTIAL GEN. 90/90 vts. 60 cycle.
 5HCT CONTROL TRAN. 90/55 vts. 60 cycle.
 5CT CONTROL TRAN. 90/55 vts. 60 cycle.
 5SDG DIFFERENTIAL GEN. 90/90 vts. 400 cycle.

ALL PRICES F. O. B. GREAT NECK N. Y.

TACHOMETER GENERATOR & INDICATOR

GENERAL ELECTRIC, GEN, TYPE AN5531-1, Pad mounting 3 phase variable frequency output.

GENERAL ELECTRIC, GEN. TYPE AN5531-2, Screw mounting 3 phase variable frequency output.

GENERAL ELECTRIC, IND. 8DJ13AAA, works in conjunction with above generators, range 0 to 3500 RPM.

D. C. ALNICO FIELD MOTOR

DIEHL TYPE FD6-23, 27 vts. 10,000 RPM.

GENERAL ELECTRIC D. C. SELSYNS

8TJ9-PAB TRANSMITTER 24 VTS.
 8TJ11- INDICATOR, dial 0 to 360°, 24 vts.

RECTIFIER POWER SUPPLY

HAMMETT ELECTRIC MFG. CO. MODEL SPS-130. Input voltage 208 or 230 volts, 60 cycle, 3 phase, 21 amps. Output 28 volts at 130 amps. continuous duty, 8 point tap switch, voltmeter ammeter, thermo reset all on front panel.

MISCELLANEOUS

PIONEER MAGNETIC AMPLIFIER ASSEMBLY Saturable reactor type, designed to supply variable voltage to a servo motor such as CK1, CK2, CK5 or 10047.
 SPERRY A5 CONTROL UNIT, part No. 644836.
 SPERRY A5 AZIMUTH FOLLOW-UP AMPLIFIER, part No. 656030.
 SPERRY A5 DIRECTIONAL GYRO, part No. 656029, 115 vt. 400 cycle, 3 phase.
 SPERRY A5 PILOT DIRECTION INDICATOR, part No. 645262 contains AY 20.
 ALLEN CALCULATOR, TYPE C1, TURN & BANK IND., part No. 21500, 28 vts. D. C.
 TYPE C1, AUTO-PILOT FORMATION STICK, part No. G1080A3.
 PIONEER GYRO FLUX GATE AMPLIFIER, Type 12076-1-A, 115 vt. 400 cycle.

INSTRUMENT ASSOCIATES

Write for Catalog NE100

351 GREAT NECK ROAD, GREAT NECK, N. Y.
 Telephone GReat Neck 4-1147

U. S. Export License-2140

Western Union address:
 WUX Great Neck, N. Y.

Buy TOP Radio-Electronic Values!

HEAVY DUTY SWITCHES



H&H 4-P.D.T. Toggle Switch. 5 AMP. @ 250 Volt. 10 Amp. @ 125 Volt. Single 3/4" hole mount. Ball handle.
 Stock No. 6203A Price Each **\$1.95**

CUTLER HAMMER TYPE 8905K628 4 Pole D.T. Neutral Center Toggle Switch. Luminous Tip—Bat Handle. 2 Hole Mtg.
 Stock No. 6291A Price Each **\$1.95**

TOGGLE SWITCH

CUTLER HAMMER =8803K5 SPST BAT HANDLE, SINGLE HOLE MTG.
 STOCK No. 6423A Price Each **\$0.35**

SWEEP CAPACITOR

5-10 MMFD. Sweep Generator Capacitor. Has cylindrical silver plated rotor, concentric to silver plated stator plates. Rotor has high speed ball bearings. Completely enclosed in moulded bakelite housing. Ideal for motor driven sweep generators.
 Stock No. 6276A Price Each **\$2.00**

HIGH VOLTAGE TRANSFORMER

21,000 volt 100MA. Half Wave oil filled. Maloney Electric Co.
 Stock No. 5728A Price Each **\$300.00**

PLATE TRANSFORMER

Thordarson Tru-Fidelity Plate Transformer. Primary 208-210-220-230-240 Volts 60 Cycle. Secondary 3310 V.C.T. @ .86 Amps. 10,000 Volt insulation. Brand new—limited quantity.
 Stock No. 6399 Price Each **\$60.00**

FILTER REACTORS

4 Henry @ 1.75 Amps. Thordarson Tru-Fidelity. 15,000 Volt Test. 10 Ohms D.C.
 Stock No. 6400A Price Each **\$35.00**

Swinging Choke. Thordarson Tru-Fidelity. 10-20 Henry @ 500 to 50 M.A. 7500 Volt Test. 55 Ohms D.C.
 Stock No. 6401A Price Each **\$20.00**

SCOPE TRANSFORMERS

2500 Volt @ 1.6 M.A. Secondary. 115 Volt 60 Cycle Primary. Insulated for 7500 Volts. Open strap mounting 3/8" centers. Mfg. by Thordarson.
 Stock No. 6387A Price Each **\$15.00**

FILAMENT TRANSFORMER

20 VOLTS TAPPED AT 14 VOLTS @ 20 AMPS. PRIMARY TAPPED IN 5 VOLT STEPS FROM 210 TO 240 VOLTS 50-60 CYCLE STANCOR SS10696. 4" x 5" x 5" HIGH.
 Stock No. 6292A Price Each **\$4.95**

MIL-T-27

FILAMENT TRANSFORMER

PRIMARY: 107.5; 112.5; 117.5; 122.5; 127.5; 225; 235 and 245 Volts 50/60 cycle
 SECONDARY: 6.3 Volts @ 5.3 AMPS and 6.3 Volts @ 3 AMPS. Ceramic bushings with solder lug terminals. Rated for continuous duty under Mil-T-27. Class "A" Grade 1 specs. Hermetically sealed case, 2 3/4" x 3 1/2" x 3 1/8" high.
 Stock No. 6284A Price Each **\$35.00**

6.3 VOLT FILAMENT TRANSFORMERS

Primary 115 Volt 60 Cycle 1600 Insulation Three 6.4 Volt Secondaries

6.3 Volts @ 4.9 Amps.
 6.3 Volts @ 4.5 Amps.
 6.3 Volts @ 1.1 Amps.

Horizontal Half Shell Mounting. 2 1/2" x 2 13/16" Mounting Centers. 2 13/16" x 3 3/8" Core Size. 2 1/2" above Chassis. Soder Lug Terminals—All Terminals Marked.

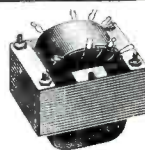

Stock No. 5254A

Price Each **\$2.65**

RESISTORS PRODUCTION QUANTITIES

in stock of late carbon and wire wound resistors. 1/2—10 watt sizes, savings 10—25%.

Large Quantities such as

Pieces	Resistance	Wattage	Percentage	Material
150,000	220 ohm	1/2 Watt	20%	IRC
500,000	100 ohm	1 Watt	10%	IRC
1,000,000	220 ohm	1 Watt	10%	IRC
100,000	390 ohm	1 Watt	10%	IRC
150,000	1000 ohm	1 Watt	10%	IRC
75,000	6.8 megohm	1 Watt	10%	IRC
100,000	100 ohm	2 Watt	10%	St'CPole
100,000	4700 ohm	2 Watt	10%	St'CPole
50,000	2200 ohm	2 Watt	20%	St'CPole
60,000	470 ohm	4 Watt W/W	10%	Cl'Rstat
90,000	13000 ohm	10 Watt W/W	15%	Cl'Rstat

Send us your requirements.

STANDARD BRAND RESISTORS

10 ohm	1 Watt	10%
100 ohm	1 Watt	10%
6.8 megohm	1 Watt	20%
820 ohm	1 Watt	5%
4300 ohm	1 Watt	5%
30,000 ohm	1 Watt	5%
62,000 ohm	1 Watt	5%
300,000 ohm	1 Watt	10%
12 megohm	2 Watt	10%
18 megohm	2 Watt	10%
22 ohm	2 Watt	20%
22 ohm	2 Watt	20%
6800 ohm	2 Watt	20%
15,000 ohm	2 Watt	20%

HI-VOLTAGE RESISTORS

10 meg	MXV-1	1 Watt	15%	IRC
12 meg	MXV-1	1 Watt	15%	IRC
15 meg	BBF	1 Watt	15%	RPC
25 meg	MXV-2	2 Watt	15%	IRC
200 meg	BBR	3 Watt	15%	RPC

TYPE "J" POTENTIOMETERS

500 Ohm—2 Watt Type J Pot. 3/8" Long Shaft. 1/4" long Bushing. Complete with Knob.

Stock No. A6123 Price Each **49¢**

100 ohm Type J with 3/8" bushing and locking nut. Screw-driver slot.

Stock No. 6270A Price Each **\$0.49**

LAB. POTENTIOMETERS

MODEL 260. 6 Watt 20,000 OHM Laboratory. Potentiometer. Resistance tolerance plus or minus 5%. Five finger bronze wiper. Bakelite shaft 3/8" Diam. x 1 1/4" Long.

Stock No. 6277A Price Each **\$1.50**

MALLORY M200R

200 ohm 4 watt Rheostat
 Stock \$25.00 Price
 No. 6137A per 100 Each **30¢**

SIGNAL CORPS & NAVY TRANSFORMERS

Over 200,000 transformers, chokes etc. For Signal Corps and Navy Equipment. Send us your requirements, or ask for our catalog listing by Signal Corps Numbers. DON'T DELAY!

THORDARSON AUDIO PASS FILTERS



Band pass 800 to 1200 cycles Input 10000 ohms — Output 25000 Ohms Level 10DB

Stock No. T48500 Price 5.50 ea.

THORDARSON BAND PASS FILTERS

600 ohms to 600 ohms 1700 cycles to 3300 cycles Attenuation 25 DB at 1450 cycles or 50 DC at 4880 cycles. Size: 6" x 6 1/2" x 5"

Stock No. 5897A Price Each **\$8.00**

LOW PASS FILTER

500 Ohm to 500 Ohm. 200 to 2000 Cycles. Sig. Corps No. 3Z1891-1.2. P/O R/19A—TRC-1.
 Stock No. 6413A Price Each **\$3.00**

SENSITIVE RELAYS

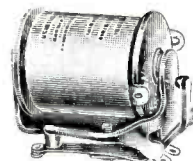

MIDGET TYPE RELAYS

Automatic Electric Type R-45. 600 ohm Coils Normally open contacts except as noted.

Stock No.	Contents	M. A.	Price Each
102152	5 P.S.T.	2.0	\$1.25
102249	2 P.S.T.*	4.5	1.50
102264	3 P.S.T.	6.0	2.00

 * 1 Norm. open-1 Norm. closed.

Same type and style as above, but has 24 V.A.C. coil. Intermittent duty. Will operate on 6 V.D.C. Continuous duty. Contacts: S.P.S.T.-N.O. and S.P.D.T.

Stock No. 102248A Price Each **\$1.25**

304TL's EIMAC JAN 304TL's INDIVIDUALLY BOXED \$10.95

RADAR ANTENNA

NAVY TYPE CBM 66AFT-1 Antenna Assembly. Part of SF-1 Radar Equipment, has two sets of 115V 60 cycle—MK1 MOD. 4 type 5G MFG. by Bendix and 2-115VDC fractional motors, complete assembly with cover.

\$150.00 each

TINNED WIRE

1/4 lb. spools of No. 20 solid tinned wire. Individually boxed.

Stock No. 6391A Case of 100 at \$20.00 Price Each **25¢**

TERMS:

Open Accounts to rated or Acceptable reference accounts. Others pre-payment of 25% deposit with order, balance C.O.D. Price F.O.B. Chicago and subject to change without notice. Merchandise subject to prior sale.

ORDER TODAY!

Radio Surplus Corp.

732 South Sherman Street
 Chicago 5, Illinois
 Phone: HA rrisson 7-5923

Micro-Wave Lavoie Freq. Meter 375 to 725 MCS



Model TS-127/U is a compact, self-contained, battery powered, precision (± 1 Mc) frequency meter which provides quick, accurate readings. Requires a standard .5V "A" and 45V "B" battery. Has 0.5 MIN. time switch. Contains sturdily constructed "H-Q" resonator with average "Q" of 3000 working directly into detector tube. Uses 957, LS6 and 3S4 Tubes. Complete, new with inst. book, probe and spare kit of tubes. Less batteries.

Full data on request
\$79.50

HIGH VOLTAGE OIL CAPACITORS



.001 MFD 50,000V DC	\$37.50
.01 MFD 5,000V DC	\$2.95
.02 MFD 8,000V DC	\$9.50
.025 MFD 50,000V DC	\$45.00
.025/.025 MFD 50,000V DC	\$59.50
.1 MFD 500V DC	\$.95
.1 MFD 3,000V DC	\$2.95
.135 MFD 7,500V DC	\$6.95
.15 MFD 12,000V DC	\$7.50
.2 MFD 50,000V DC	\$67.50
.25 MFD 15,000V DC	\$19.50
.25 MFD 20,000V DC	\$26.50
.25 MFD 50,000V DC	\$72.50
1 MFD 7,500V DC	\$12.50
1 MFD 15,000V DC	\$49.95
2 MFD 6,000V DC	\$14.50



FLUXMETER

Used to calibrate field strength of magnets from 500 to 4000 gauss and indicate polarity. Probe has gap of 1 3/4". Beautifully built in hardwood case with hinged cover. Instructions for operation on under side of cover. Size 12 3/4 x 9 x 6 in. Ideal for lab and school use. New. An exceptional value at... **\$29.50**

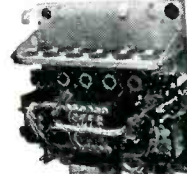

G.E. Servo Amplifier

Used in B29 planes for Central Station Fire Control Systems K2, B3 and B4. Used to drive Amplidyne 5AM31N19A and Control Motor 5BA50LJ2A. New less tubes. **\$29.50**

RADAR EQUIPMENT

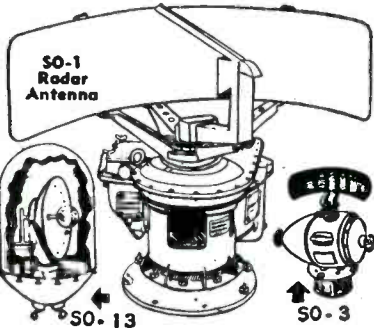

SO-1 Radar Antenna

SO-13

SO-3

RADAR ANTENNAS

Type SO-1 (10CM) assembly with reflector, waveguide nozzle, drive motor. New... **\$279.50**
 Type SO-3 (3 CM.) Surface Search type with reflector, drive motor, etc., but less plumbing. New in original cases... **\$189.50**
 Type SO-13 (10CM.) Assembly with 24" dish, dipole, drive motor, gearing. New... **\$149.50**
 Also in stock — spare reflectors, nozzles, probes, right angle bends for SO-1 antennas.

CRYSTAL DIODE

Sylvania 1N211. Individually boxed and packed in leaded foil... **\$3.00**

HIGH POT TRANSFORMER

High Voltage Trans. Westinghouse Pri: 115, 60 cy., Sec: 15,000 C.T., 60 MA. Good for Hi-Pot test set up. C. T. ungrounded... **\$29.50**



Telrad Frequency Standard

Complete self contained, dual 100/1000 kc crystal, multivibrator and harmonic amplifier. Calibrates with WWV and provides 1000, 100, and 10 kc check points from 100 to 45,000 kc. 115V. 60 cycle. New with instructions. **\$29.50**

INVERTERS

Onan M-G-215H. Navy type PU/13. Input 115/230, 60 cy., 1 Ph. Output: 115, 480 cy., 1 Ph., 1.2KV and 26V DC at 4 amps. New... **\$295.00**
 Onan M-G-075. Navy type PU/11 Input: 115/230, 60 cy., 1 Ph. Output: 115, 480 cy., 1 Ph., 5.3 amps. and 26 VDC @ 3.8 Amps. New... **\$225.00**
 Leland Elec. Co. PE206A. Input: 28DC at 38 Amps. Output: 30V, 300 cy., 1 Ph., 0.183VA. New... **\$22.50**
 G.E. J8169/12. Input: 28DC. Output: 115, 400 cy., 1 Ph., 1.5KVA. New... **\$32.50**
 G.E. 5AS1315511A. Model 218J. Input: 28 DC. Output: 115, 400 cy., 1 Ph., 1.5 KVA. Regulated. New... **\$89.50**
 Holtzer-Cabot M.G. 164. Input: 440, 3 Ph., 60 cy., Output: 70V, 146 cy., 3 Ph., 0.140KVA. New... **\$67.50**
 Eloor. 7ADC to 110AC, 60 cy., 1 Ph. at 2.4 Amps. New... **\$39.50**



TS-47/APR Test Oscillator

Provides calibrated CW, mod. or pulse signal source from 40 to 500 mc. Operates on 80, 115 or 230 V. from 50 to 2600 cy. or battery supply. New with tech. manual. **\$265.00**

DYNAMOTORS

Navy type CA10-211-44. Input: 105 to 130DC. Output: either 26DC at 20 amps, or 13DC at 40 amps. Radio filtered and complete with line switch. New... **\$89.50**
 Type PE94CM. For SCR-522. Brand new in overseas cases. Has wide band input and output filters. **\$19.50**

REPAIR PARTS FOR BC-348 RECEIVERS (H, K, L, R, Only)

Also BC 224 Models F, K. Coils for ant., r.f., det., osc., I.F., c.w. osc., xtal filters, 4 gang cond., front panels, dial assemblies, vol. conts., etc. Write for complete list and free diagram.

MODEL AN/APA-10 PANORAMIC ADAPTER

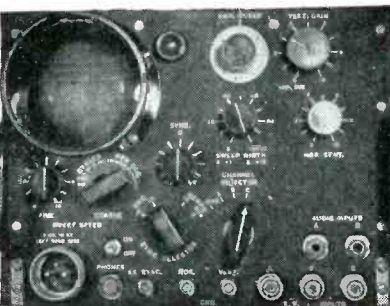

Provides 4 Types of Presentation:
 (1) Panoramic (2) Aural
 (3) Oscillographic (4) Oscilloscopic

Designed for use with receiving equipment AN/APR-7, AN/APR-5, AN/APR-4, SCR-587 or any receiver with I.F. of 455 kc, 5.2mc or 30mc. With 21 tubes including 3" scope tube. Converted for operation on 115 V. 60 cycle source.

Price... **\$245.00**
 Gov't Cost \$1800.00.
 AN/APA-10 80 Page Tech Manual... **\$2.75**

AMPLIDYNES

G.E. 5AM21J7. Input: 27VDC. Output: 60VDC. 150 Watts. 4600 RPM. Type MG-27-B. New... **\$34.50**
 Edison 5AM31N18A. Input: 27VDC. 44 Amps. 8300RPM. Output: 60VDC at 8.8 Amps. 530 Watts. New... **\$12.50**
 G.E. 5AM31N9A. 530 Watts. 7600 RPM. Input: 27VDC. Output: 60VDC. Weight 3 1/2 lbs... **\$29.50**

SCR-522 EQUIPMENT

Complete BC-624C receivers and BC-625AM Transmitters including mounting racks, plugs, connectors, P.E. 94CM dynamotor. Brand new equipment with instruction manuals.

SMALL D.C. MOTORS

G.E. 5BA50LJ2A. Armature 27VDC at 8.3 Amps. Field 60VDC at 2.3A RPM 4000. H.P. 0.5. New... **\$27.50**
 Oster E-7.5. 27.5DC. 1/20HP, 3600RPM. Shunt Wound. New... **\$9.50**
 Dumore Co. type ELBG. 24VDC. 40-1 gear ratio. For type H-1 Intervalometer. New... **\$6.75**
 G.E. 5BBY47AB12. 1/4 H.P. Perm. Mag.—1 amp. 250V. 1725 RPM. New... **\$22.50**

MULTI-CONDUCTOR CABLE

CO-215. Stock 3E2215. Bulk 9 conductor No. 20 A.W.G. Stranded tinned copper plastic insulated, color coded, tinned copper braided shield. Plamenol jacketed. Made by G.E. Available 1000, 1500, 2000 ft. reels. Price... **\$.15 Ft.**

400 CY. BLOWERS

Westinghouse. Type FL. 115V. 400 cy., 6700 RPM. Airflow T.C.F.M. New... **\$6.75**

TRANSMITTING MICA CAPACITORS



LARGE QUANTITIES IN STOCK
WRITE FOR LIST

SYNCHROS

Ford Inst. Co. Synchro Differential Generator. Mod. 3 Type 551DG. 90/90V. 400 cy., Ord. Dr. 173020. New... **\$22.50**
 Armor. Synchro Differential Generator. Type 6DG. New... **\$60.00**
 Hobart Mfg. Co. Synchro Differential Synchro Type XIX 115V. 60 cy. New... **\$9.50**

STEP BY STEP MOTOR

Bendix—Type CAL 14810 (MFK Mod 0). 70 Volts DC input... **\$16.50**

SWEEP GENERATOR CAPACITOR



High speed ball bearings. Split stator silver plated coaxial type 5/10 mmfd. Brand new.

Price **\$2.25**

RAYTHEON VOLTAGE REGULATORS

Adj. input taps 95-130V. 60 cy. 1 Ph. Output: 115V. 60 Watts. 1/2 of 1% Reg. Wt. 20 lbs. 6 1/2" H x 8 3/4" L x 4 3/4" W. Overload protected. Sturdily constructed. Tropicalized.

ELECTRONICRAFT

INC.

27 MILBURN ST. BRONXVILLE 8, N. Y.
 PHONE: BRONXVILLE 2-0044



PRICE—NEW **\$16.75**

Weston HIGH QUALITY TEST EQUIPMENT



WL-117 WAVEMETER

A precision wavemeter having a range from 2400 mc to 3400 mc with an accuracy of better than 0.1% over the entire range. The resonant cavity has a Q of not less than 1000 and normally from 1000 to 2000. The unit, supplied with a pickup dipole interconnecting cable and adapters, may also be used for relative field strength measurements.

PRICE: \$390.00



WL-62 ECHO BOX

A portable ringlip cavity for microwave research; the unit has a frequency range from 9320 to 9420 mc, with a Q of 50,000 to 80,000. The echo box is used for relative power measurements, spectrum analysis, frequency checks, tests for unstable operation and a host of other applications in the laboratory.

PRICE: \$550.00

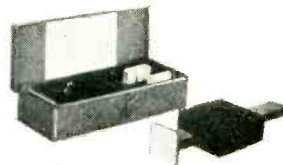

WL-108 TERMINATION

This 1" x 1/2" waveguide hi-power load is capable of dissipating a peak power of 200 kilowatts and an average power of 150 watts. The VSWR is less than 1.10 over the entire frequency range of 9300 to 9450 mc. All accessories including carrying case and coupling adapters are supplied with the unit.

PRICE: \$90.00

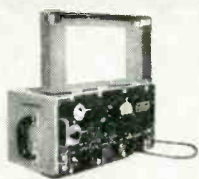

WL-13 SIGNAL GENERATOR

A versatile x-band signal generator providing a source of pulsed or CW power and having provisions for square-wave and sawtooth modulation. Accurate monitoring of the RF output is accomplished with a thermistor bridge and a calibrated attenuator. The power supply is electronically regulated to insure stable operation of the 723A/B Klystron oscillator.

PRICE: \$1275.00



WL-89 VOLTAGE DIVIDER

An indispensable aid in high power radar and transmitter measurements this unit has provisions for 100:1 and 10:1 voltage division. It can be used with an oscilloscope to measure video pulses between 200 and 20,000 volts in high-impedance circuits. The ratio accuracy is within $\pm 15\%$ and transmission is within 2 db from 150 cycles to 5 megacycles.

PRICE: \$45.00



WL-102 PULSE GENERATOR

Equivalent to the TS-102/AP Range Calibrator, this crystal controlled pulse generator produces a square-topped, 50 volt synchronizing pulse of 8 microseconds at a prf of 400, 800, 1600 or 2000 cps, and a triangular marker pulse of 0.4 microseconds duration at a prf corresponding to a pulse-echo distance of 1500 ft. The phase between the marker and sync. pulses is continuously variable from -180 to $+180$ degrees.

PRICE: \$550.00



WL-125 POWER METER

This instrument is a compact, battery operated thermistor bridge designed to measure power in the range of 2400 to 3335 mc., and having a full-scale sensitivity of 2 milliwatts. Among other applications, it can be used to measure antenna patterns, check standing wave ratio and determine average or peak powers. A complete set of accessories, including a 10 db and 16 db attenuator pad for measuring higher power levels, are supplied with the unit.

PRICE: \$390.00



SG-8/U NOISE GENERATOR

This popular model, employing a 5722 temperature limited diode as the R.F. noise source, can be used as an absolute means of receiver noise measurements as well as for fundamental studies. The normal input impedance is 270 ohms but a 50 ohm adaptor is supplied with the unit as a standard accessory.

PRICE: \$290.00



WL-90 DUMMY LOAD

Provides a 50 ohm termination in the form of a 50 to 1 ratio voltage divider for making over-all performance tests on radar units such as the AN/APQ-7, 13, 13A, 23 and a host of other equipments in this frequency and power range. The 49 and 1 ohm resistor elements are carbon coated ceramic rods in helium filled glass tubes and are capable of dissipating up to 500 watts at a peak voltage of 5000 volts.

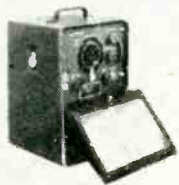

BC-221 FREQUENCY METER

This universally used and time-tested instrument is a precision meter designed to measure or radiate R.F. impulses between 125 and 20,000 KC. The overall accuracy of the unit is 0.034% over the entire operating range. It is portable and completely self contained or, if desired, it can be obtained with a power supply for 115 volt operation.

PRICE:
Without Modulation \$125.00
With Modulation 165.00
115v Power Supply 35.00

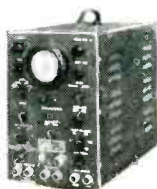

TS-100 OSCILLOSCOPE

This instrument can be used with a linear sweep as a general purpose test oscilloscope or it can be used with a circular sweep as a precision range calibrator. It has a PRF rate of 300 to 1500 per second. Trigger input—15 volts at 100 volts per microsecond rise. Trigger output—120 volts (+ 20 volts). It can be used for detecting "jitter" in trigger divider circuits and modulator trigger pulse, and also for determining and adjusting division rate.

PRICE: \$550.00



WL-2688/U CRYSTAL RECTIFIER TEST SET

A combination ohmmeter-ammeter designed to measure the electrical characteristics of microwave crystal rectifiers such as the LN21 and LN23 series. The instrument is completely self contained and requires only a single 1 1/2 or 2-volt cell for operating power.

PRICE: \$53.75

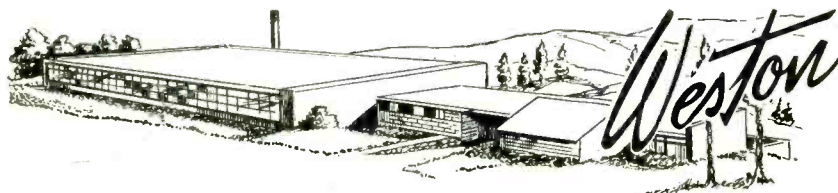

WESTON LABORATORIES, INC.
HARVARD, MASS.
Tel: HARVARD 250—AYER 300—TWX HARV 193
Cable: WESLAB

DIRECTRON SELENIUM RECTIFIERS Buy Direct From M'facturer

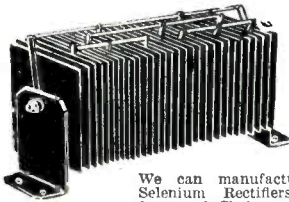

We can manufacture other Selenium Rectifiers, Transformers & Chokes

NEW SELENIUM RECTIFIER TRANSFORMERS
 PRI: 115 V., 60 cycles in. 4 Amps..... \$8.75
 SEC: 9, 12, 18, 24, and 36 12 Amps..... 16.75
 volts 24 Amps..... 35.75
Continuous Ratings 30 Amps..... 45.00
 50 Amps..... 59.75

NEW SELENIUM RECTIFIER CHOKES
 2 Amps—.06 Hy.—4 ohms..... \$3.95
 4 Amps—.07 Hy.—6 ohm..... \$7.95
 12 Amps—.01 Hy.—1 ohm..... \$14.95
 24 Amps—.004 Hy.—.025 ohm..... \$29.95

• Vacuum Capacitors 50 MMF.—20 KV... \$9.50

PANORAMIC ADAPTOR Only \$69.50

Full-Wave Bridge Types				
Current (Continuous)	18/14 Volts	36/28 Volts	54/42 Volts	130/100 Volts
1 Amp.	\$1.35	\$2.15	\$3.70	\$8.50
2 Amps.	2.20	3.60	5.40	10.50
2 1/2 Amps.	3.15	5.10	7.65	13.00
4 Amps.	4.25	7.95	12.95	25.25
6 Amps.	4.75	9.00	13.50	33.00
10 Amps.	6.75	12.75	20.00	44.95
12 Amps.	8.50	16.25	25.50	49.00
20 Amps.	13.25	25.50	38.00	79.50
24 Amps.	16.25	32.50	45.00	90.00
30 Amps.	20.00	38.50
36 Amps.	25.00	48.50

FILTER CAPACITORS		
Capacity	W. Voltage	Ea.
500 MFD.	50 V.	.98
1000 MFD.	12 V.	.40

• 5" Scope, In Good, Used Condition
 • 115 Volts—60 Cycle Input
 • Sweeps 100-0-100 KCS



Official Distributor
 Westinghouse Relitron*
 Power Tubes (*Trademark)

• New Erco 4 Channel Shlp-to-Shore Marine Transmitter — Receiver — F.C.C. Approved—Write for Full Details—

• W.E. Chokes—New Herm. Sealed.—KS-9476 —8 hy. @ 300 MA. 75 ohms \$5.00
 KS-13063—4 to 7 hys.—200 to 700 MA. 42 ohms average \$7.75

• Vibrapacks—12 Volts Input—Mallory-350 V. @ 125 MA. Out—New \$9.95

FULLY GUARANTEED

TUBE SPECIALS

STANDARD BRANDS ONLY

0A2 .90 2C52	4.25 354	.75 6B 36GT	1.13 7F7	.85 83-V	1.00 700A	19.00 866-A (JAN) 1.25	WL-5554/	130.00
0A3/VR75 1.05 2D21	1.20 3X2500-A3135.00	6B Y5-G	2.50 7H7	.70 84-6Z4	6.50 700-B	25.00 866-A	679	
0B2 .80 2E22	2.50 4B22	7.50 6B Z7	1.20 7J4	17.50 98R	9.50 700-D	44.00 (Hytron)	1.75 WL-5557/17	8.50
0B3/VR90 .95 2E24	3.35 4B24	4.50 6C1	.52 10 (Special)	.95 HF-100	5.50 703-A	4.95 869-B	65.00 WL-5558/	
0C3/VR105 .95 2E30	2.05 4B25	8.00 6C3	.65 10T1	.75 C-100E	2.00 704-A	.85 872-A	3.75 32	15.50
0D3/VR150 .95 2J21, 2J21A	7.95 4B28/CE225	2.95 6C5	.65 12A7T	.80 100-TH	5.95 705-A	1.90 884	1.55 WL-5559/	
0Z4/OZ4A .55 2J22	6.50 4C27	21.50 6CB6	.59 12AU7	.65 10-F (WE)	2.50 707-A	7.50 885	1.65 57	22.00
1A4 1.20 2J26	14.00 4C35	19.95 6CD6-G	2.10 12AW6	.88 FG-105	18.50 707-B	14.00 WL-889-	5.645	7.75
1A4E1 .90 2J27	10.95 WL4D21	6CS6 5915	1.10 12AX7	.75 VU-11E	.88 708-A	4.50 RA	295.00 5546	7.75
1A3 .70 2J31	25.00 4-125A	30.25 6C16/6BQ6	2.10 12AX7	1.90 HY-114B	.40 709-A	3.50 WL-891	223.00 WL-5683	9.43
1A7GT .77 2J32	25.00 4D22	18.50 6D6	.75 12BA6	.60 C-120	.55 CK710	.95 892-R	150.00 WL-5685	31.90
1AX2 1.05 2J34	24.00 4E27A	25.00 6F4	3.50 12BE6	.90 CK-24	10.00 713A	1.20 902	5.00 5693	6.25
1B3GT/8016 .90 2J37	12.00 4J32	225.00		121-A	8.00 714AY	10.00 902P1	9.00 5726	1.85
1B22 1.85 2J39	7.95 4J36	140.00		F-123A	5.00 715A	5.00 SD917A	3.00 5732	3.95
1B23 6.50 2J40	27.50 4J37	225.00		WL-172	51.00 715B	7.95 918	2.20 WL-5735	130.00
1B24 9.00 2J50	36.75 4-65A	write		211/VT4C	.88 717-A	.80 921	2.00 5744	2.00
1B26 2.25 2J54	62.95 4-125A	write		RX215	8.00 719A	25.00 922	1.60 5749	1.75
1B27 11.50 2J54B	125.00 4X150A	write		227	3.95 721A	4.50 924	2.50 5751	2.90
1B32 2.50 2J55	60.00 4-400A	45.00		RX233A	3.50 723A	7.00 927	1.75 5800	6.50
1B42 9.50 2J61	37.50 4X500A	75.00		250-TH	16.95 723A/B	17.00 931A	4.75 5814	2.20
1G6GT .90 2J62	33.00 4X1000A	110.00		FG-271/	725A	4.70 SN949	3.50 5829	1.75
1L4 .65 2K22	23.50 5A6	2.75		5551	57.50 726B	60.00 954	.35 5837	
1L6 .95 2K23	11.50 5A4	1.35		274A&B	2.75 726C	62.50 955	.42 SD1104	110.00
1N21 .85 2K25	23.95 5BP1	5.00		275A (WE)	7.95 728-EY	250.00 956	.45 5838	3.00
1N21B 1.95 2K26	65.00 5BP2	5.00		300B (WE)	7.95 730A	22.00 957	.43 5840	8.00
1N23A 2.05 2K28	27.75 5C22	39.00		HF-300	17.50 801-A	40 958	.68 5844	3.00
1N23B 2.25 2K29	23.00 5D21	15.00		304-TH	7.75 802	3.25 958A	.68 WL-5846	130.00
1N31 7.25 2K30	WL5D22/			304-TL	8.75 803	3.35 959	1.95 5886	3.00
1N34A .75 410R	325.00 4-250A	41.25 6J4 (RCA)	7.10 12S17	.63 307-A	4.00 805	3.35 980	1.50 5991	3.95
1N38 1.20 2K33	250.00 5FP7	1.75 6J5 (RCA)	5.00 12S17A	.55 310-A (WE)	3.95 807	1.55 SN980B	.30 5910	.75
1N38A .83 2K34	150.00 5GP1	5.00	43.00 159A4A	.55 311-A (WE)	6.50 808	4.20 991/NE16	.50 WL-5934	15.00
1N39 4.05 2K2	.40 5J29	15.00 6J6W	4.22 5J29	.95 316-A	.75 WL-810	16.25 FM1000	.25 WL-5956	25.00
1N44/400B 1.20 3A4	.59 5J30	45.00 6K4	2.25 25AV5	1.20 323-A	5.00 811	2.95 CK-1005	.65 5995	write
1N45/400C 1.30 3A5	.85 5J2P	25.00 6K4A	2.25 25BQ5GT	1.15 CK359A	7.00 811-A	3.55 CK-1027	2.75 6013	write
1N49 .50 3AP1	8.50 5LP5	17.00 6K4GT	.55 25L6GT	FG-271 (WE)	4.00 812	2.95 1201/1201A	.65 6095	write
1N54 .79 3B7/1291	.39 5R4GY	1.20 6K7	.60 25Z6GT	.52 371-B	.812-A	3.60 1203A	.45 6096	write
1N54A 1.05 3B22	2.49 5TP4 (RCA)	38.50 6L5C	1.10 28D7	.55 VT-166	.90 WL-813	18.00 1209A	.57 6097	write
1N54 75 3B24	4.75 5U4G	.58 6L6-G	1.10 35B5	.55 373A (WE)	4.00 814	3.75 1612	2.00 6099	write
1N69 .60 3B25	3.95 5V4G	.95 6L5-GA	1.10 35C5	.55 374A (WE)	3.50 816	1.20 1613	.85 6101	110.00
1N70 1.20 3B26	3.50 5W4	.80 6L6-M	1.50 35L6GT	.60 387A (WE)	2.50 822	19.50 1616	.88 6151	
1N72 1.10 3B28	5.95 5X4G	.75 6L7	.70 35Z3	.75 394-A	4.00 827-R	53.00 1622 (6L6M)	1.95 (Hytron)	3.20
1N81 1.00 3B29	8.50 5Y4G	.55 6N7	.75 35-T	2.75 403-B (WE)	7.50 828	10.50 1625	.26 7193	.75
C1 B 3C31 2.95 3BP1	4.75 6CJ	14.50 6P7G	.85 35Z5GT	.55 404-A/5847	829	7.95 1629	.29 WL-8000	14.50
C6 .50 3BP11	9.00 6-4	.35 6Q7GT	.80 41	.75 404-B	.829-A	7.40 1632	.30 8003	
H4G .60 3C21	5.00 6-4B	.45 6S7M	.95 42	407-A (WE)	4.50 829-B	12.50 1636	2.70 8005	4.95
1J6GT .50 3C23	8.50 6AB7	.95 6SD7GT	.80 45 (Special)	.40 408-A (WE)	2.50 WL-829-B	16.25 1638	4.90 8008	6.20
1P23 3.75 3C24/24G	1.15 6A7	.80 6SG7	.66 47	6.00 417-A (WE)	7.95 830-B	2.75 1655	1.79 8011	.75
1P28 11.50 3C27	7.50 6AF4	1.39 6SH7	.70 RK-47	.35 GL-434A	17.95 832	7.75 1665	1.85 8012	2.50
1P40 1.75 3C33	9.50 6AG5	.70 6SJ7	.65 NE-48	5.15 WL-446A	1.95 832A	9.95 38022	write 8013A	3.95
1P42 5.00 3C45	10.00 6AG7	1.20 6SK7GT	.59 WL-SR50	.77 WL-450TH	77.00 WL-833A	49.50 38222 (3B23)	4.90 9025	5.25
1U4 .55 3D6/1299	.35 6AH6	.88 6SL7GT	.65 50A5	.55 450TL	42.00 SD-834	4.00 CK-33233	.75 9001	1.15
1O6 .75 3D21	2.75 6AJ5	1.30 6SN7GT	.69 50B5	.60 GL-471A	2.50 836	5.00 5514	4.75 9002	.85
1R4/1294 .59 3D21A	5.50 6AJ6	1.95 6S7	.59 50C6G	.85 WL-491A	4.50 837	1.25 5516	7.75 9003	1.15
1X2/1X2A .90 3DP1	3.95 6AJ7	1.50 6T8	.66 50L6GT	.55 CK5011X	1.25 838	3.35 WL-5550/	.65 9004	.25
1Z2 3.25 3DP1-S2	3.95 6AK5	.70 6V6GT	1.40 53A	4.95 WL-592A	1.85 838	3.50 681	50.00 9005	1.90
2AP1 8.50 3E29/829-B	9.95 6AK5-W	1.50 6V6M	.57 RK59	1.95 527	15.00 843	13.75 WL-5552/	90.00 9005	.25
2B22 2.95 3FP7	1.75 6AK5 (WE)	1.25 6W4GT	.75 WL-SK60	5.15 559	1.95 849	75.00 651	121.00 9025	write
2C22 .55 3CP1	3.00 6AK6	.95 6W6GT	.88 QK-60	90.00 GL-552	60.99 860	3.50 WL-5553/	265.00	
2C39A 13.75 3I30	95.00 6AL5	.53 6Y6-G	.50 QK-51	1.50 WL-579B	15.00	2.50 665		
2C40 6.75 3Q4	.60 6AN4 (Syl)	1.50 6X5GT	.70 VR-85	295.00 WL-KU610	22.00			
2C43 14.75 3Q5GT	.99 6AQ5	.48 "A4	.75 QK-72	1.10 WL-KU627	22.00			
2C44 1.10 3RP1	8.75 6AR6	2.70 "A7	.69 RKR-72	1.10 WL-629	13.00			
2C51 3.90 3L4	.90 6AS6	2.25 "A8	.76 RKR-73	.65 WL-632B	29.00			
	6A76	.55 7B7	4.25 75	.50 635	11.00			
	6A8	.55 7B8	.78 76	.70 651	70.00			
	6AV6	.55 7C4	.29 77	.80 ZP-653	220.00			
	6AX4GT	.60 7C5	.69 78	.65 WL-672A	35.00			
	6B8	.70 7C6	.69 80	.95 WL-KU676	55.00			
	6BE6	.59 7C30	85.00 81	.85 WL-677	55.00			
	6BH6	.80 7E5	.39 82	1.15 WL-678	47.00			
	6BG6-G	1.89 7E6	.55 83					

TELEPHONE REctor 2-2562

Terms: F O B-N Y C—25% Deposit with order —or send full remittance to save C O D charges —Rated Firms (D.&B.) Net 10 days—All merchandise guaranteed. CABLE: BARRYLECT, N. Y.

BARRY ELECTRONICS CORP.

136-C LIBERTY ST. N. Y. 6, N. Y.

COMMUNICATIONS EQUIPMENT CO.

MICROWAVE PLUMBING

"S Band," RG48/U Waveguide

- POWER SPLITTER** for use with type 726 or any 10 CM Shepherd Klystron. Energy is fed from Klystron antenna through dual pick-up system to 2 type "N" connectors. **\$22.50 EACH**
- DIRECTIONAL COUPLER**, Broadband type "N" Coupling, 20 db. with std. flanges, Navy #CABV 47AAN-2. **\$37.50**
- LHTR, LIGHTHOUSE ASSEMBLY**, Part of RP39 APG 5 & APG 15. Receiver and Trans. Cavities w/assoc Tr. Cavity and Type N CPLG. To Recvr. Uses 2C40, 2C43, 1B27, Tunable APX 2400-2700 MGS, Silver Plated. **\$49.50**
- BEACON LIGHTHOUSE** cavity 10 cm. Mg. Bernard Rice, each. **\$47.50**
- MAGNETRON TO WAVEGUIDE Coupler** with 721-A Duplexer Cavity, gold plated. **\$45.00**
- RT-39 APG-5** 10 cm. lighthouse RF head c/o Xmitr.-Recvr.-TR, cavity compl. recvr. & 30 MC IF strip using 60K5 (2C40, 2C43, 1B27 lineup) w/Tubes. **721A TR BOX** complete with tube and tuning plungers. **\$2.50**
- MCCALL KLYSTRON CAVITIES** for 707B or 2K28 **\$4.00**
- WAVEGUIDE TO 3/4" RIGID COAX "DOORKNOR" ADAPTER CHOKE FLANGE, SILVER PLATED BROAD BAND** **\$32.50**
- AS14A AP-10** CM Pick up Dipole with "N" Cables **\$4.50**
- DAJ ECHO BOX, 10 CM TUNABLE**. **\$22.50**
- HOLMDELL-TO-TYPE "N" Male Adapters, W.E. #D167284**. **\$2.75**
- I.F. AMP. STRIP; 30 MC. 30 db. gain, 4 MC Bandwidth, uses 6AC7's—with video detector. A.F.C. less tubes**. **\$24.50**
- POLY ROD ANTENNA, AS31/APN-7** in Lucite Ball, Type "N" feed. **\$14.00**
- ANTENNA, AT49A/APR; Broadband Conical, 300-3300 MC Type "N" Feed**. **\$12.50**
- "E" or "H" PLANE BENDS, 90 deg. less flanges**. **\$7.50**

7/8" RIGID COAX—3/8" I. C.

- ROTARY JOINT**, Stub-supported, UG 46/UG 45 fittings. **\$27.50**
- 10 CM STABILIZER** Cavity, tunable, standard UG46 UG 45 fittings. **\$45.00**
- RG 44/U RIGID COAX**, stub support, 5 ft. sections, with UG46/UG45 connectors. **\$12.50**
- RT ANGLES**, 45° bend. **\$2.50**
- RIGHT ANGLE BEND**, with flexible coax output pick-up loop. **\$8.00**
- SHORT RIGHT ANGLE BEND**, with pressurizing nipple. **\$3.00**
- RT. ANGLE BEND 15" L. OA**. **\$3.50**
- FLEXIBLE SECTION, 15 L. Male to female**. **\$4.25**
- 3/4" RIGID COAX, BULKHEAD FEED-THRU**. **\$14.00**
- MIXER ASSY, "Pencil" Type for "SO" Radars**. Complete with crystal and 2-type "N" output connectors. **\$12.50**



MICROWAVE MIXER

CV-12/APR-6; Waveguide/mixer unit, 4000-6000 mc. Designed for use with microwave receiver. Has pick up loop for coupling to lighthouse cavity local oscillator. RF input is to 1" x 2" waveguide (contact flange). Output (thru in21 x1) is from standard 50-ohm coax connector. Brand new, complete with crystal. As shown. **\$35.00**

APS-2 SPARE PLUMBING

- Z-601C**: Elevation Joint. **\$9.50**
- Z-601B**: Transmission Line from El. Jt. to antenna feed. **\$4.50**
- Z-601A**: Antenna and Dipole feed assy. **\$12.50**
- Z-601E**: Azimuth Rotating Joint. **\$15.00**
- Z-911**: Long Rt. Angle Bend, 90 Deg. **\$4.50**
- Z-910**: Short Rt. Angle Bend with pressure fittings. **\$3.50**

MICROWAVE ANTENNA EQUIPMENT

- AT49/APR**—Broadband Conical, 300-3300 MC. Type N Feed. **\$12.50**
- AS-31/APN-7**: 10 cm Polyrod in Lucite Ball, Type N Fitting Coax Feed. **\$4.25**
- Relay System Parabolic reflectors** approx. range 2000 to 6000 Mc. Dimensions 4 1/2" x 3 1/2". New. **\$100.00**
- Dipole for above**. **\$12.00**
- TDY "JAM" Radar** rotating antenna, 10 cm. 30 deg. beam, 115 V AC drive, New. **\$150.00**
- Parabolic Peel**, Radiation pattern approx. 25 deg. in horizontal, 33 deg. in vertical planes. **\$35.00**
- Cone Antenna, AS 125 APL, 1000-3200 Mc**, Stub supported with type "N" connector. **\$14.50**
- AS14A/AP, 10 CM** pick up dipole assy, complete w/length of coax and "N" connectors. **\$3.50**
- AS-16A/PG-4** Yagi Antenna, 5 element array. **\$22.50**
- 30" Parabolic Reflector Spain Aluminum dish**. **\$4.85**
- APS-34** Pillbox Antenna, waveguide input: 24,000-27,000 MC. **\$22.50**

RADAR ANTENNAS

- | | |
|-------------|--------------|
| AS-12/APS-3 | AS-125/APR |
| AS-17/APS-2 | AS-217/PG-15 |
| AS-13/PG-2 | AT49/APR |
| AS69/APT | AS14/AP |

MAIL ORDERS PROMPTLY FILLED. ALL PRICES F.O.B. NEW YORK CITY. SEND M.O. OR CHECK. ONLY SHIPPING SENT C.O.D. RATED CONCERNS SEND P. O. ALL MDSE SUBJECT TO PRIOR SALE AND PRICES SUBJECT TO CHANGE WITHOUT NOTICE. PARCELS IN EXCESS OF 20 POUNDS WILL BE SHIPPED VIA CHEAPEST TRUCK OR RAILEX.

X Band—RG 52/U WAVEGUIDE

- VSWR Measuring Section**, Consisting of 6" straight section, with 2 pick-up, Type "N" Output Jacks. Mounted 1/2 Wave apart. **\$8.50**
- UG 40A/U Broadband Choke Planges**. **\$1.65**
- UG10 cover**. **\$7.50**
- Rotating-joints** supplied either with or without deck mounting. With UG40 flanges. **each, \$17.50**
- Bulkhead Feed-thru Assembly**. **\$15.00**
- Pressure Gauge Section** 15 lb. gauge and press nipple **\$10.00**
- Pressure Gauge, 15 lb.** **\$2.50**
- Directional Coupler, UG-40/U Take off 20 db.** **\$17.50**
- TR-ATR Duplexer section** for above. **\$12.50**
- Waveguide Section 12" long** choke to cover 45 deg. twist & 2 1/2" radius, 90 deg. bend. **\$4.50**
- Waveguide Section 2 1/2" ft. long** silver plated with choke flange. **\$5.75**
- Rotary joint** choke to choke with deck mounting **\$17.50**
- 90 degree elbows, "E" or "H" plane 2 1/2" radius** **\$12.50**
- 15 degree twist**. **\$8.00**
- Microwave Receiver, 3 CM. Sensitivity: 10-12u Watts**. Complete with L.O. and AFC Mixer and Waveguide Input Circuits. 6 I.F. Stages give approximately 120 dB gain at a bandwidth of 1.7 MC. Video Bandwidth: 2 MC. Uses latest type APC circuit. Complete with all tubes, including 723A/B Local Oscillator. **\$175.00**
- ADAPTER, waveguide to type "N", UG 81/U, p/o TS 12, TS-13, Etc.** **\$27.50**
- ADAPTER, UG-103/U round cover to special btl. Flange for TS-45, etc.** **\$2.50 ea.**

APS-15 SPARE WAVEGUIDE PARTS

- CU-73/APS-15A, SCS #223265-73** right angle bend, E plane, 6 1/2" x 10", with directional coupler on 6 1/2" arm, type "N" takeoff 20 db coupling. **\$12.50 each**
- Z-607 Dwg. Symbol**, Approx. 150 degree bend with 90 deg. twist. One end pick-up loop with press. fitting. **\$6.50**
- Z-614: Philco 756-1142, CG124/APS-15A**, Wave-selector: approx. 10" L. with 15 deg. bend at center (E-plane) 20 db coupling. **\$12.50**
- Philco 348-1425**, 180 deg. bend, with pressure fitting. **\$4.50**
- Z-609, Philco 348-1629**, 13 1/2" run, with bend & 90 deg. twist (on 9 1/2" section). **\$6.75**
- Z-606: 8" run with 30 deg. bend (E-plane) one end**. **\$4.50**
- Philco 348-1427** E plane bend 11" x 6 1/2". **\$6.50**
- CG1/APS-3** Philco 358-5212, S-curve 16" L with round contact flanges. **\$5.75**

WAVEGUIDE FLANGES

UG 39/U	\$1.10	UG 51/U	\$1.65
UG 40/U	\$1.25	UG 52/U	\$3.40
UG 40A/U	\$1.65	UG 52A/U	\$3.40

K Band RG 53/U WAVEGUIDE

- APS-31** Rotating joint. **\$49.50**
- Right Angle Bend E or H Plane**, specify combination of couplings desired. **\$12.00**
- 45° Bend E or H Plane**, choke to cover. **\$12.00**
- Mitered Elbow**, cover to cover. **\$4.00**
- TR-ATR-Section** Choke to cover. **\$4.00**
- Flexible Section 1"** choke to choke. **\$5.00**
- S-curve** Choke to cover. **\$4.50**
- APS-34** K-Band Pillbox Antenna. **\$22.50**
- Slotted Section**, with Carriage & Probs. **\$45.00**

MAGNETRONS

Type	Price	Type	Price
2121	\$ 8.75	2139	\$24.50
2122	7.50	2149	59.50
2127	19.95	2161	34.50
2131	24.50	2162	34.50
2132	28.50	2131	85.00
2137	12.50	725-A	Write
2138	16.50	730-A	24.50



QK 60, 61, 62—\$85 ea.

KLYSTRONS

723A	\$12.50	2K25/723A/B	\$27.50
723A/B	19.50	417-A (Sperry)	17.50

SELSYNS

- 115 VAC 60 CYCLES 1 PHASE**
- 1—Transmitter #C-78248 } Per Set
- 1—Differential #C-78249 } **\$24.50**
- Transmitter Units Only. **\$17.50 ea.**

PULSE EQUIPMENT

- MIT. MOD. 3 HARD TUBE PULSER**: Output Pulse Power 144 W (12 KV at 12 Amp). Duty Ratio: .001 max. Pulse duration: 0.5, 1.0, 2.0 microsec. Input voltage: 115 v. 400 to 2400 cps. Uses: 1-71B, 4-89-1, 3-72's, 1-778, New. **Less Cover—\$135**
- APQ-13 PULSE MODULATOR**, Pulse Width .5 to 1.1 Micro Sec. Rep. rate 624 to 348 Pps. Pk pwr. out 35 KW Energy 0.018 Joules. **\$49.00**
- TPS-3 PULSE MODULATOR**, Pk. power 50 amp. 24 KW (1200 KW DR); pulse rate 200 PPS. 1.5 microsec. pulse line impedance 50 ohms. Circuit series charging version of DC Resonance type. Uses two 705-A's as rectifiers, 115 v. 400 cycle input. New with all tubes. **\$49.50**

PULSE TRANSFORMERS

- GE #K-2494A**
Primary: 9.33 KV, 50 ohms Imp.
Secondary: 28 KV, 450 ohms
Pulse length: 1.0/5 usec @ 635/120 PPS.
Pk. Power Out: 1.740 KW
Bifilar: 1.5 amps (as shown) **\$62.50**
- GE #K-2748-A**, 0.5 usec @ 2000 Pps. Pk. Pwr. out is 32 KW impedance 40:100 ohm. Pri. volts 2.3 KV Pk. Sec. volts 11.5 KV Pk. Bifilar rated at 1.3 Amp. Fitted with magnetron well. **\$39.50**
- K-2745**, Primary: 3.1/2.8 KV, 50 ohms Z. Secondary: 14/12.6 KV 1025 ohms Z. Pulse Length: 0.25/1.0 usec @ 600/600 PPS. Pk. Power 200/150 KW. Bifilar: 1.3 Amp. Has "built-in" magnetron well. **\$42.50**
- K-2461A**, Primary: 3.1/2.6 KV—50 ohms (line). Secondary 14/11.5 KV—1000 ohms Z. Pulse Length: 1 usec @ 600 PPS. Pk. Power Out: 200/130 KW. Bifilar: 1.3 Amp. Fitted with magnetron well. **\$39.75**
- UTAH X-151T-1**: Dual Transformer, 2 Wdgs. per section 1:1 Ratio per sec 13 MH inductance 80 ohms DCR. **\$7.50**
- UTAH X-150T-1**: Two sections, 3 Wdgs. per section. 1:1 Ratio, 3 MH, 8 ohms DCR per Wdg. **\$7.50**
- 68G711**: Ratio: 4:1 6.7 Ohms, Pri: 0.23 Ohms sec. **\$4.50**
- TR1049**: Ratio: 2:1 Pri, 220 MH, 5 Ohms sec. **75.50**
- DCR 100 Ohms**. **\$6.75**
- K-901695-501**: Ratio 1:1, Pri. Imp. 40 Ohm. Sec. Imp. 40 Ohms. Passes pulse 0.6 usec with 0.05 usec rise time. **\$9.95**
- Ray UX 7896**—Pulse Output Pri. 5v. sec. 41v. **\$7.50**
- Ray UX 8442**—Pulse inversion—40v + 40v. **\$7.50**
- PHILCO 352-7250, 352-7251, 352-7287**
- RAYTHEON: UX8693, UX5986**. **\$5 ea.**
- W.E.: D-166310, D-166638, KS 9800, KS9948.**
- UTAH #9262**, with Cracked Beads, but will operate at full rated capacity. **\$5.00**
- UX 8093 (SCS #228627-54)**, 3 Wdgs, 32 turns #18 wire. DCR is: 362/372/4 ohms. Total voltage 2500 vdc. **\$5.00**
- D-166173**: Input: 50 ohms Z. Output: 900 ohms Z. Wdgs. Freq. range 10 kc-2Mc. P/O AN/APQ-13 **\$12.50**

PULSE NETWORKS

- 15A—1,400-50**: 15 KV, "A" CKT, 1 microsec. 400 PPS. 50 ohms Imp. **\$37.50**
- G.E. #33 (3-84-810)**: 8-2.24-4051 50PPT: 3KV "E" CKT Dual Unit: Unit 1, 3 sections, 0.84 Microsec. 810 PPS, 50 ohms Imp: Unit 2, 8 Sections, 2.24 microsec. 405 PPS 50 ohms Imp. **\$6.50**
- 7-5E3-1-200-67P**, 7.5 KV "E" Circuit, 1 microsec. 200 PPS, 67 ohms impedance 3 sections. **\$7.50**
- 7-5E4-16-60**, 67P, 7.5 KV "E" Circuit, 4 sections, 16 microsec. 60 PPS, 67 ohms impedance. **\$15.00**
- 7-5E3-3-200-67P**, 7.5 KV, "E" Circuit, 3 microsec. 200 PPS, ohms Imp, 3 sections. **\$12.50**
- KS8865 CHARGING CHOKE**: 115-150 II @ .02A, 32-40II @ .08A, 30,700V Corona Test, 21KV Test **\$37.50**
- G.E. 25E5-1-350-50 P2T**, "E" CKT, 1 Microsec. Pulse @ 350 PPS, 50 OHMS Impedance. **\$69.50**
- KS8623 CHARGING CHOKE**: 16II @ 75 MA, 580 Ohms DCR, 9000 Vac test. **\$14.95**
- G.E. 6E3-5-2000 50 P2T**: 6 KV, "E" Circuit 0.5 usec /2000 PPS/50 ohms/2 sections. **\$7.50**

THERMISTORS

- D-164699** Bead Type DCR: 1525-2550 Ohms @ 75 Deg. F. Coefficient: 2% Per Deg. Fahr. Max. Current 25 MA AC/DC. **\$2.50**
- D-167332** Bead Type, DCR is 1525-2550 Ohms. Rated 25 MA at 825-1175 VDC. **1.50**
- D-167613** Disk Type DCR: 355 Ohms @ 75 Deg. F. P.M. 2.5%, 1 Watt. **1.50**
- D-166228** Disk Type 7120 Ohms @ 60°F. 4220 Ohms @ 80°F 2590 Ohms @ 100°F, 1640 Ohms @ 120°F. **1.50**

10 CM R.F. HEAD

Complete R.F. Head and Modulator delivers 50 KW Peak R.F. at 3000 MC. Pulsar delivers 12KV pulse at 12 Amp. to magnetron of .5, 1, or 2 microsec. duration at duty cycle of .001. Unit requires 115V, 400-2400 Cycles, 1 phase @ 3.5A. Also 24-28 VDC @ 2A. External sync. Pulse of 20V Req'd. Brand New, Complete with schematic and all tubes. **\$375.00**

COMMUNICATIONS EQUIPMENT CO.

MOBILES! C. D. MEN! CAPI!

IDEAL DYNAMOTOR—CONVERTS EASILY TO SUPPLY UNIT DELIVERING

12 Volt Input— 6 Volt Input
 610 V @ 150 MA OR 300 V @ 90 MA
 325 V @ 125 MA 160 V @ 110 MA

Brand New with Conversion Data. **\$3.75**

SELENIUM RECTIFIERS

Full-Wave Bridge Types

Current (Continuous)	18/14 Volts	36/28 Volts	54/42 Volts	130/100 Volts
1 Amp.	\$1.35	\$2.15	\$3.70	\$8.50
2 Amps.	2.20	4.20	5.40	10.50
2 1/2 Amps.			6.00	13.00
4 Amps.	4.25	7.95	12.95	25.25
6 Amps.	4.75	9.00	13.50	33.00
10 Amps.	6.75	12.75	20.00	44.95
12 Amps.	8.50	16.25	20.50	49.00
20 Amps.	13.25	25.50	38.00	79.50
24 Amps.	16.25	32.50	45.00	90.00
30 Amps.	20.00	38.50		
36 Amps.	25.00	48.50		

UNDERWATER MICROPHONES

Originally designed for use in harbor defense equipment, these amazing hydrophones may be coupled to any hi-gain audio amplifier. For listening to undersea sounds such as schools of fish, shrimp, lobster, etc. Ideal for fishermen, explorers, students. Available in two models described below:

JR HYDROPHONE: Consists of a mosaic of 7 crystals encased in a rubber sheath approx. 4" diam and 1" long. Directivity is essentially horizontal. A matching transformer is "built-in", permitting use of long cable runs without loss. **\$24.50**

M-1 HYDROPHONE: A lattice of 3 crystals encased in a rubber disk approx. 1 inch thick and 6 inches diameter. Directivity is essentially vertical (downward). Complete with amphenol fitting. **\$27.50**

SUPERSONIC OSCILLATOR

For experimenters, teachers, technicians. Delivers 30 watts of R.F. Tunable from 17-27KCS. Originally designed as driver unit for 500 watt Sonar set. Operates from 115 V, 60 cycles. Brand New. Rack Panel Size. Complete with all tubes. **\$119.25**

APN-3 SPARE PARTS

K-901684-501: SCS #229632-306, Trans.	\$2.49
K-901689-501: SCS #229631-238, Trans.	2.45
K-901692-503: SCS #229617-70, Xfmr. Fil.	2.49
K-901699-501: SCS #229617-68, Fil. Xfmr.	3.45
K-901698-501: SCS #229618-38, Plate Xfmr.	4.29
K-901695-501: SCS #229627-19, Pulse Xfmr.	3.50

DYNAMOTORS

ALL BRAND NEW—ORIGINAL PACKING

TYPE	INPUT VOLTS		AMPS		PRICE
BD 69††	14	2.8	220	.08	\$12.95
O-402†	13.5	12.2A	300	.20	
SP 175	18	3.2	450	.06	4.49
PE 86	28	1.25	250	.050	4.25
DM 415	14	6.2	330	.170	6.75
DM 33A	28	7	540	.250	3.95
BD AR 93	28	3.25	375	.150	7.50
23350	27	1.75	285	.075	3.95
B-19 PACK	12	9.4	275	.110	8.95
			500	.050	
OA-3A*	28	10	300	.260	6.95
			150	.010	
5053	28	14	250	.060	3.95
PE 73 CM**	28	19	1000	.350	**

* Replacement for PE 94.
 ** Price sent on request.
 † Less Filter.
 †† Used, Excellent.

INVERTERS

PE-218-H: Input: 25/28 vdc, 92 amp. Output: 115 v. 350/500 cy 1500 volt-amperes. New. **\$44.50**
 PE-206: Input: 28 vdc, 38 amps. Output: 80 v. 800 cy. 500 volt-amps. Dim: (13x5 1/2 x 10 1/2). New. **\$22.50**
 NAVY CR-211095: Input: 22-30 VDC 75-60A. Output: 115/100 CY. 1 KVA/8.7A. RPM: 4800. With coupling provision for motor. Brand New. Original packing. **\$150.00**

POWER TRANSFORMERS

Comb. Transformers—115V/50-60 cps Input

CT-766	300-0-300V/120MA, 2 x 5V/3A, 2.5V/5A	\$3.95
CT-129	550-0-550V @ 150 MA, 6.3V/4A, 2.5VCT/5A	5.79
CT-013	450-0-450V @ 200 MA, 10V/1.5A, 2.5V/3.5A 5V/3A	6.95
CT-15A	550VCT .085A 6.3V/6A, 6.3V/1.8A	2.85
CT-364	4200V .002A/12KV Test, 5VCT/3A/12KV	12.95
CT-341	1050 10MA, .625V @ 5 MA, 26V @ 4.5A 2x2.5V/3A, 6.3V @ 3A	9.95
CR 825	360VCT .340A 6.3VCT/3.6 6.3VCT/3A	3.95
CT-626	1500V .160A 2.5/12, 30/100	9.95
CT-071	110V .200A 2.5/10, 5V/10, 2.5/10	4.95
CT-367	580VCT .050 A 5VCT/3A	2.25
CT-403	350VCT .025 A 5V/3A	2.75
CT-331	585VCT .086 A 5V/3A, 6.3V/6A	4.25
CT-456	390VCT .80 MA 6.3V/1.3A, 5V/3A	3.45
CT-531	585VCT .85 MA 5V/3A, 6.3V/5A	4.95
CT-442	525VCT 75 MA 5V/2A, 1 CT/2A, 50V/200 MA	3.85
CT-720	550-0-550V/250 MA, 6.3V 1.8A	8.95
CT-43A	600-0-600V/.08A, 2.5VCT/6A, 6.3VCT/1A	6.49
CT-7-501	650VCT/200MA, 6.3V/8A, 6.3V/5A	6.49
CT-444	230-0-230V/.085A, 5V/3A, 6V/2.5A	3.49

Filament Transformers—115V50-60 cps Input

Item	Rating	Each
FT-140	5VCT @ 10A 25KV Test	\$22.50
FT-157	4V/16A, 2.5V/2.75A	2.95
FT-101	6V/.25A	.79
FT-924	5.25A/21A, 2x7.75V/6.5A	14.95
FT-824	2x26V/2.5A, 16V/1A, 7.2V/7A, 6.4V/10A, 6.4V/2A	8.95
FT-463	6.3VCT/4A, 5VCT/3A, 5VCT/3A	5.49
FT-56-2	7.2V/21.3A, 6.5V/6.85A, 5V/6A, 5V/3A	8.95
FT-38A	6.3/2.5A, 2x2.5V/7A	2.79
FT-A27	2.5V/2.5A, 7V/7A, TAP 2.5V/2.5A, 16 KV TEST	18.95
FT-608	6.3V/3A/750V Test	1.79
FT-873	4.5A/V, 5A, 7V/7A	2.19
FT-889	2x5V A 5A, 29KV Test	24.50

Special Fil. Transformers—60 cps

Item	Pri. Volts	Secondaries	Price
STF-370	220/440	3x2.5V/5A, 3KV Test 2.5V/15A	6.95
STF-11A	220V	2x40V/2.5V/6A	4.49
STF-608	220V	24V/0.6A, 5V/3A, 6.3V/1A, 6.3V/1A	3.45

TRANSFORMER SPECIAL

#766: Primary: 115 V, 60 cy, 1.6 Sec. Secondary: 200-0-300 V @ 120 MA, D.C., 2-5V WDGs @ 3 A ea, Also 2.5 VCT @ 5 A. Ruggedized, Herm. Sealed. Size: 4 3/4" H x 3 3/8" x 4 1/2". 11 Solder TmIs. M.F.D. W.E. **\$3.95**

400 CYCLE TRANSFORMERS

(All Primaries 115V, 400 Cycles)

Stock	Rating	Price
352-7102	6.3V/2.5A	1.45
M-7472426	1450V/0.0MA, 2.5V/.75A, 6.4V/3.9A, 5V/2A, 6.5V/3A, P/O ID-39/APG-13	4.95
352-7039	640VCT @ 380MA, 6.3V/.9A, 6.3V6A 5V/6A	5.49
702724	9800/8600 @ 32MA	8.95
KS9584	5000V/290MA, 5V/10A	22.50
KS9607	734VCT/177A, 1710VCT/177A	6.79
352-7273	700VCT/350MA, 6.3V0.9A, 6.3V 25 A, 6.3V/.06A 5V/3A	6.95
352-7070	2x2.5V/2.5A (2KV TEST) 6.3V/2.25A, 1200/100/750V @ .005A	7.45
352-7196	1140/1.25MA, 2.5V/1.75A, 2.5V/1.75A —5KV Test	3.95
352-7176	320VCT/50MA, 4.5V/3A, 6.3VCT/20A, 2x6.3VCT/6A	4.75
901682	2.5V/1.75A, 6.3V/2A —5KV Test	2.39
901689-501	13V 9A @ 4.25A	2.49
901688-501	2.77V @ 4.25A	3.45
UX8855C	900V75MA, 100V/.04A	4.29
RA6405-1	900VCT/.067A, 5V/3A	3.79
T-4852	800VCT/55MA, 5VCT/3A	3.59
352-7098	800VCT/806MASV/3A, 6V/1.75A	4.25
KS 9336	2500V/1MA, 300, VCT, 135MA	5.95
M-7474319	1100V 50MA TAPPED 625V 2.5V/5A 6.3V/2.7A, 6.3V/.66A, 6.3VCT/21A	3.95
KS8884	27V/4.3A, 6.3/2.9A, 1.25V/.02A	2.95
52C080	650VCT/50MA, 6.3VCT/2A, 5VCT/2A	3.75
32332	400VCT/35MA, 6.4V/2.5A, 6.4V/.15A	3.85
68G631	1150-0-1150V	2.75
80G198	6VCT/.00006 KVA	1.75
302433A	6.3V 9.1A, 6.3VCT/6.5A, 2.5V/3.5A, 2.5V/3.5A	4.85
KS 8445	592VCT/138MA, 6.3V/8.1A, 5V/2A	5.39
KS 9685	6.4/7.5A, 6.4V/3.8A, 6.4/2.5A, ALL CT	4.79
70G30G1	600VCT/36MA	2.65
M-7474318	2100V/.027A	4.95
352-7069	2-2.5V Wdgts. at 2.5A, Each Lo-Cap., 22KV Test	5.95
352-7096	2.5V/1.75A, 5V/3A, 6.5V/6A, 6.5V/1.2A, P/O BC800	
352-7099	360VCT/20MA, 1500V/1MA, 2.5V/1.75A, 6.3V/2.5A, 6.3V/.6A, P/O BC-925	6.45
0163253	5200V/.002A, 2.5V/5A	5.35
M-7471957	2.5V/20A, 12KV Test	4.85
352-7179	250V/100MA, 6.5V/12ACT 5V/2A	3.45

"SEA-DOG" CONVERTER

Designed for Buships, this rugged, compact dynamotor is rated as follows:
INPUT: 115 VDC—6 AMPS
OUTPUT: 13 VDC at 40 AMPS
 —OR—26 VDC at 20 AMPS
 Brand, Spanking, New; Original **\$89.50**
 Packing

VOLTAGE REGULATORS

CARBON—PILE TYPES

LELAND TYPE "A": Coil: 245 ohms. Current 108-110 MA. Reg. Resistance: 1.5-2.5 ohms with 1.2-3.3 Amps. for 80 V.
LELAND TYPE "B": Volts In: 21-30 V. Volts Out: 18-25 V DC. at 5 A.
LELAND TYPE "C": Spec: Vlt 9000—2 C. Input: 22-30 VDC. Coil: 300 MA. Output: 19 V @ 5.7 A.
WEBSTER: 35x025: Philco 451-1035 Input: 21-30 V. D.C. Output: 18 VDC/4.75 A.
Price, Any Model. \$2.25 ea.



GN 35 HAND GENERATORS

BRAND NEW. IN ORIGINAL CARTONS. WILL DELIVER 8 V @ 2.5A AND 325-365 V @ 100 MA OR 10 V 1.25A AND 380-420 V @ 70 MA. LESS HAND CRANKS. A GREAT VALUE **\$17.50**

CIRCUIT BREAKERS

HEINEMANN: .01A, 2340 V—Insulated for 5000 V. Separate TmIs. for coil and contact. **\$1.95**
 #1510 M-7: 7 A, 24 VDC SCS #3H900-7-3. **\$1.65**
 #AM 1614-100: 100 Amps, 24 VDC. **\$1.65**
 #AM 1614-80: 80 Amps, 24 VDC. **\$1.45**
 #AM 1610-5: 500 MA, 1000 VDC. Curve 3. SCS #3H900A-50 **\$2.25**
 SCS #3H900-10-3: 40 VDC, 10 Amps. **\$1.65**

TEST OSCILLATOR TS-47/APR

A. Function: The oscillator provides a calibrated high-frequency source for testing receivers. Unit can be operated from either an a-c or a d-c power source.
B. Electrical Characteristics:
 Frequency Range: Two bands, 40 to 115 mc and 115 to 500 mc.
 Signal Output: Sine wave of 1,000 cps modulated 50 percent, or a 70-microsecond pulse with prf of 500 cps.
C. Specifications:
 A-c Operation: 80, 115, or 230 volts at 50 to 2,000 cycles.
 D-c Operation: 6.3 volts at 0.30 ampere (dial light off) and 202.5 volts at 0.016 ampere. Dial light draws 0.25 ampere. Four 1-1/2-volt and three 67.5-volt dry batteries are required.
 Tube Complement
 2 tubes 9002
 1 tube 6X5GT
D. Signal Corps Stock No. 3F3910-47
Price, New \$265

HIGH-POWER GEAR

TRANSTAT:

Type TH45BG: Input 130/260V, 50-60 cy. 1 ph. Output Range: 0-260V, 45A. Max. 11.7 KVA two-unit bank, parallel connected. Completely enclosed in cabinet with handwheel atop. Brand New. **\$235.00**



CIRCUIT BREAKER:

ITE Model KJ. Will handle 600 VAC at 115A. Break time adjustable from instant to 10 minutes. Break amperes adjustable from 115A to 1000% overload. Brand New. **\$15.00**

ALTERNATOR:

Louis-Allis Co. Type "AL". 198-C. Output 110/220V —1 ph, 60 cy, 9 P.F. 1200 RPM, completely self-regulating with built-in exciter. Brand new, original crates. **\$795.00**

MAIL ORDERS PROMPTLY FILLED. ALL PRICES F.O.B. NEW YORK CITY. SEND M.O. OR CHECK. ONLY SHIPPING SENT C.O.D. RATED CONCERNS SEND P. O. ALL MDSE. SUBJECT TO PRIOR SALE AND PRICES SUBJECT TO CHANGE WITHOUT NOTICE. PARCELS IN EXCESS OF 200 POUNDS WILL BE SHIPPED VIA CHEAPEST TRUCK OR RAILCAR.

131 Liberty St., New York 7, N. Y. Dept. E-10 Chas. Rosen Phone: Digby 9-4124

WANTED
ARC-1, 3, ART-13, BC-342, 348,
APS-10, 15, TS-13, 35, 146, 147,
148, 174, 175, 263 ETC. All SCR,
BC, AN, TS. ALL TUBES.

RADALAB
 1964 Webster Ave., Bronx 57, N. Y.
 TEL: WE 3-3232-3

TERMS—Minimum order \$25.00 all
prices FOB New York City. 25% de-
posit with order, balance COD. Rated
firms open account. Prices subject to
change without notice.

ALL TUBES STANDARD BRAND, NEW, GUARANTEED

OA2..... \$.89	3DP1/S2..... 5.95	304TL..... 7.90	814..... 2.95	931A..... 5.25	5676..... 3.30	9001..... 1.40	OA3/VR75..... .97
OB2..... .95	3E29..... 11.75	307A..... 5.25	815..... 3.75	958A..... .75	5687..... 3.95	9003..... 1.50	OB3/VR90..... .89
1B24..... 8.25	3J21..... WRITE	703A..... 3.95	829B..... 11.75	959..... 2.95	5691..... 7.65	FG17..... 3.50	OC3/VR105..... .95
1P21..... 29.75	5LP1..... 14.75	705A..... 1.85	832..... 7.25	1603..... 5.15	5692..... 7.65	FG32..... 11.75	OD3/VR150..... .98
2C40..... 9.25		707A..... 7.95	832A..... 8.25	1624..... 1.40	5693..... 6.50		WL676..... 49.50
2C42..... 8.50		707B..... 15.95	833A..... 39.50	5516..... 5.25	5702..... 2.95		WL677..... 45.00
2C43..... 12.95	2 J 41 RCA	715B..... 9.25	845..... 5.40	5643..... 7.25	5703..... 1.89		IN21..... 1.40
2C51..... 5.90	Write For Price	715C..... 19.75	866A..... 1.40	5651..... 2.65	5704..... 2.40		IN21B..... 2.75
2D21..... 1.25		723A/B..... 7.40	869B..... 69.75	5654..... 1.95	5718..... 6.50		IN21C..... 20.00
2D21W..... 1.25		723A..... 14.50	872A..... 3.25	5670..... 4.00	5719..... 8.65		IN23..... 1.10
2K25..... 30.00	6C21..... 19.75	725A..... 4.25	884..... 1.80	5672..... 1.40	5726..... 1.69		IN23B..... 3.25
2K28..... 31.50	6J4..... 5.90	726A..... 3.75			5726..... 2.75		IN26..... 7.45
2K50..... WRITE	100TH..... 8.95	803..... 4.25			5814..... 5876		IN34..... .62
3C45..... 14.95	211..... .96	805..... 1.69			6005..... 16.50		IN34A..... .85
3B24..... 4.90	250TH..... 16.50	807..... 1.69			8005..... 6.40		IN38..... 1.25
3D21A..... 4.69	250TL..... 16.50	811..... 2.95			8020..... 1.10		IN38A..... 1.10
3DP1..... 3.50	304TH..... 7.90	813..... 10.50			8025..... 4.75		FG172..... 35.00

Complete stock of receiving tubes available. Send us your requirements.

7C 22 TUBES
 Brand New W.E.
 Tuneable 400-600
 MC, 450KW output,
 15KV plate, AV filament
 P.O.R.

FG57..... 17.50	IN34..... 1.25
FG97..... 22.50	IN38..... 1.10
FG105..... 17.50	
FG172..... 35.00	

TEST EQUIPMENT

- TSK1/SE K Band Spectrum Analyzer
- TS3A/AP Frequency and power meter S Band 225.00
- RF4A/AP Phantom Target S Band
- TS10/APN Altimeter Test Set 35.00
- TS12/AP VSWR Test Set for X Band
- TS/13-AP X Band Signal Generator 1000.00
- TS14/AP Signal Generator
- TS15/AP Flux Meter
- TS19/APQ 5 Calibrator
- TS-23/APN Altimeter Test Set
- TS33/AP X Band Power and Frequency Meter
- TS/34AP Western El. Synchroscope 240.00
- TS35/AP X Band Signal Generator
- TS36/AP X Band Power Meter
- TS-45/APM-3 X Band Signal Generator 300.00
- TS/47/APR 40-400MC Signal Generator
- TS-56/AP L Band Slotted Line
- TS-59/APN Altimeter Test Set
- TS-61/AP S Band Echo Box
- TS-62/AP X Band Echo Box
- TS69/AP Frequency Meter 400-1000MC
- TS-76/APM-3 Wave Guide Kit for TS-45
- TS-89/AP Voltage Divider
- TS100 Scope
- TS102A/AP Range Calibrator
- TS108 Power Load
- TS110/AP S Band Echo Box
- TS125/AP S Band Power Meter
- TS126/AP Synchroscope
- TS146/UP X-Band Test Set
- TS147 X Band Signal Generator
- TS-148 X Band Spectrum Analyzer
- TS-173/UP Frequency Meter 550.00
- TS174/AP Freq. Meter
- TS175 Freq. Meter
- TS-250/APN Test Set for Altimeter
- TS251 Range Calibrator APN9
- TS270 S-Band Echo Box
- 256B&R Synchroscope—Mfg DuMont
- TSX-45E 3 CM Spectrum Analyzer

AN/APN-3 SHORAN
 A high precision navigation and bombing equipment for use in aircraft or ships. Used with AN/CPN-2 ground beacons. Complete sets available: indicator, computer, comparator etc. Mfg: RCA. Write

MILITARY ELECTRONICS

- SCR-284 Portable Field Radio, Frequency Range 3-5 Mc. 6 or 12v D.C. \$280.00
- SCR-522 Transceiver 10 156 Mc. 4 CH. xtal control 24v. \$129.00
- SCR-536 HANDIE TALKIE. \$200.00 pr.
- SCR-555 Direction Finder 18-35 mc. Complete installations. 12v D.C. Input. POR
- SCR-619 ARMY FIELD RADIO 27-38.9 mc. Xtal Control 6-12v D.C. Input. POR
- SCR-718A, B, C, High Alt. Altimeter 0-50,000 ft. 2 ranges 110v 400-2600 cyc. \$575.00
- AN/ARC-1 Transceiver 100-156 mc xtal controlled 10CH. 24v 20 and 50 CH. available \$750.00
- AN/ARC-3 Transceiver 100-156 mc. xtal controlled 8 CH. 24v. \$1350.00
- AN/ARC-4 Transceiver 140-144 Mc. Xtal control 4 CH. 12-24v. \$65.00
- APT-4 RADAR JAMMER TRANSMITTER 165-780 mc. 110v. 400cyc. P.O.R.
- APT-5 RADAR JAMMER TRANSMITTER 30 watt output, uses 3C22 tube. \$159.50
- AN/APR-1 Receiver 38-1000 mc. in 3 Tuning units. 110v 60-2600 cyc. \$895.00

AN/TPQ-2 K-BAND GROUND RADAR
 Very late model set. Used to plot trajectory of artillery and mortar shells and to enable counter battery fire with extreme accuracy. This Radar is so accurate and sensitive it will pick up movements of personnel on the battlefield. It can also be used to measure height of cloud cover for weather forecasting. Mfg: WESTERN ELECTRIC. Write

- AN/APR-4 Receiver 38-4000 mc. 5 Tuning units. 110v 60 cyc. POR
- AN/APR-5 Receiver 1000-3100 mc. 10 mc. IF. bandwidth. 30MC IF 110v 60 cyc Input \$475.00
- AN/APR-6 Receiver 6000-10,000 Mc. uses 30 mc. IF 110v 40 cyc. Input. \$475.00
- AN/APA-11 Pulse Analyzer used to measure pulse char. of any signal fed to it. POR
- BC-639 100-156 MC VHF Receiver with PWR Supply 110v 60 cyc. P.O.R.
- AN/APN-9 LORAN RECEIVER Airborne Navigation Equipment P.O.R.
- BC-348 Receiver 28v Freq. Range. 1.7-18 mc \$150.00
- BC-348R or Q Receiver 28v late model. \$190.00

RADAR

TS-250 ALTIMETER TEST SET
 Can be used with APN-1, SCR-718 or most any airborne altimeter. Operates 24 v. D.C. Brand new Mfg'r. P.O.R.

- BC-312 Receiver 1-7-18 mc. 12v D.C. \$159.50
- BC-342 Receiver 1.7-18 mc. 110v A.C. \$159.50
- AN/APS-2 S Band Radar Airborne Range 5-100 miles 5" P.P.I. 3" A Scope
- AN/APS-3 X Band Radar-Search and Homing 5" Screen. Provides Class B indication \$950.00
- AN/APS-4 X Band Search Homing Radar. Presentation 3" B Scope. \$950.00
- AN/APS-6 X Band Search and Gun Firing RADAR. Range 3-100 miles. \$2500.00

Micro Wave Radio Telephone & Relay Equipment 6400-7200 MC. Complete Equipment in 6 ft. rack cabinets. Manufactured Sperry-Gyroscope. POR

10 CM STANDARD FREQUENCY BEACON CAVITIES
 Mfg. Bernard Rice. Price \$18.50 each

- AN/APS-10 LIGHTWEIGHT SEARCH AND NAVIGATION RADAR. Freq. 9375 mc. Range approx. 90 miles. 110v 400 cyc. 5" P.P.I. POR
- AN/APS-15A and B High Resolution X BAND Navigation and Blind Bombing Radar. Presentation on 5" PPI and 3" A" Scope. Output 40 KW. 115v 400 cyc. POR
- AN/APN-2 Complete Sets available checked out, also SCR-729 available. POR
- UPN-2 S Band Radar Beacon. Has range 35 miles, used to send coded signals to Radars. 110v 60 cyc Input. \$350.00
- UPN-4 Portable 3 cm Radar Beacon. Used to send coded signals to Radar 12v D.C. Input. POR
- SO-8 MARINE RADAR S-BAND. \$2000
- SO-13 MARINE RADAR S-BAND \$2250

SCR 291A
 Long range automatic direction finder. Used to take bearings on aircraft, ships, etc. Freq. range 1.5-30MC. input 110v 60 cycle. Complete sets available including receiver, indicator, antennae, cables, etc. Write

ALL EQUIPMENT RECONDITIONED CHECKED OUT AND GUARANTEED

PLUGS WITH PIN CONTACTS



Type AN 3108
ANGLE
PLUG



Type AN 3106
STRAIGHT
PLUG

**TAKE
YOUR
PICK!**

**50 cents
each.**

PLUGS WITH SOCKET CONTACTS



Type AN 3108
ANGLE
PLUG



Type AN 3106
STRAIGHT
PLUG

TALLEN Co., Inc.

ARC - PLUGS

PL	Plugs
PLP	Plugs
PLQ	Plugs

- PL 59
- 63
- 64
- 65
- 74
- 75
- 81
- 83
- 108
- 112
- 117
- 123
- 147
- 148
- 150
- 151
- 152
- 153
- 154
- 156
- 164
- 167
- 169
- 171
- 172
- 179
- 181
- 182
- 183
- 184
- 188
- 216
- 219
- 259
- 265
- PLQ 63
- 64
- 77
- SO 92
- 126
- 131
- 132
- 180

RECEPTACLES WITH SOCKET CONTACTS



Type AN 3102
BOX MOUNTING
RECEPTACLE



Type AN 3101
CABLE
RECEPTACLE



Type AN 3100
SHIELDED
RECEPTACLE

**2,000
TYPES OF . . .**

Connectors

Plugs

Sockets

Receptacles

TYPE . . .

AN

PL

UG

SO

ARC

CLT

NK

GK

DPD

FK

etc.

RECEPTACLES WITH PIN CONTACTS



Type AN 3102
BOX MOUNTING
RECEPTACLE



Type AN 3101
CABLE
RECEPTACLE



Type AN 3100
SHIELDED
RECEPTACLE

TALLEN CO. Inc.

58 Carlton Ave.
Brooklyn 5, N. Y.

WRITE FOR OUR FREE BULLETIN MORE GOOD ITEMS

GUARANTEED BRAND NEW

ELECTRONIC RESEARCH TUBE SPECIALS

STANDARD BRANDS ONLY

WRITE FOR OUR FREE BULLETIN MORE GOOD ITEMS

Table listing various vacuum tubes with columns for Type No., Price, and Receiving Tubes. Includes sub-sections for Transmitters and special Purposes Tubes.

COAXIAL CONNECTORS

Table listing coaxial connectors with columns for Type, Price, and M.F.T. Includes various types like 83-1AC, 83-1B, etc.

COAXIAL CABLE

Table listing coaxial cables with columns for Type, Price Per M Ft., and M.F.T. Includes types like RG-58, RG-59, etc.

PULSE TRANSFORMERS

Table listing pulse transformers with columns for Type, Price, and M.F.T. Includes types like UT-1, UT-2, etc.

OIL FILLED CONDENSERS

Table listing oil filled condensers with columns for MFD, VDC, Price, and M.F.T. Includes types like 2, 5, 10, 20, etc.

ELECTRONIC RESEARCH LABORATORIES 715-19 ARCH ST. PHILA. 6, PA. Telephone - MARKET 7-6771, 2-0-3

Prompt ANSWERS to business problems

MISCELLANEOUS business problems are daily being solved quickly and easily by the use of the Searchlight (classified advertising) Sections of this and other McGraw-Hill publications.

When you want additional employees, want to buy or sell used or surplus new equipment, want additional products to manufacture, seek additional capital, or have other business wants—advertise them in the Searchlight Section for quick, profitable results.

- American Machinist
- Aviation Week
- Business Week
- Bus Transportation
- Chemical Engineering
- Chemical Week
- Coal Age
- Construction Methods & Equipment
- Electrical Construction & Maintenance
- Electrical Merchandising
- Electrical World
- Electronics
- Eng. & Mining Journal
- E. & M. J. Markets
- Engineering News-Record
- Factory Mgt. & Maintenance
- Fleet Owner
- Food Engineering
- Nucleonics
- Power
- Product Engineering
- Textile World
- Welding Engineer

Classified Advertising Division

McGraw-Hill PUBLISHING CO.
330 W. 42nd St.,
New York City 36, N. Y.

A.C. INDUCTION MOTOR

115 VOLTS 60 CYCLE 1.9 RPM; Torque Oz. In. 75; Watts—0, with variable Multiple Disc Coder Wheel and Micro Switch mounted on Bracket Assy. Holtzer Cabot Motor Type RWC 2565—Price.....\$24.95

BLOWERS

115 Volt 60 cycle BLOWER (pictured) - approx. 100 CFM Dis. 2 1/4" intake; 2" outlet. Quiet running Motor size: 2 1/2" x 1 1/4". NEW — not Gov't surplus. **\$8.95**



DUAL BLOWER — Same as RN-520 above, except has blower assembly in each side of motor. Order No. 1C880.....\$13.95
COMPACT TYPE — 108 CFM, motor built inside squirrel case, 4-1/2" Intake; 3-3/4" x 3" Dis. Complete size: 4-1/4" W. x 9-3/8" H. x 3-1/8" D. Order No. 2C067.....\$14.50
FLANGE TYPE — 140 CFM, 3-1/2" Intake; 2-1/2" Dis. Complete size: 8-1/2" W. x 7-1/4" H. x 6-3/4" D. Order No. 1C807.....\$13.95
FLANGE TWIN — 275 CFM, 4-1/2" Intake; 3-1/4" x 3" Dis. Complete size: 11-1/4" W. x 9-3/8" H. x 8-1/16" D. No. 2C069.....\$21.95

COAXIAL CABLES:

RG-8/U (SPECIAL) 51.5 ohms. Same size as RG-8/U. Prices: 1 to 100 ft. @ 8¢ per ft.—100 to 500 ft. @ 7 1/2¢ per ft.—500 to 1000 ft. @ 7¢ per ft.—1000 ft. rolls @ 6 1/2¢ per ft.
RG-31/U—71 ohms, 145 ft. length.....\$15.00

PE-103 DYNAMOTOR

With Filter Base and Cables, 6 or 12 VDC input; output 500 VDC 160 MA.....NEW: \$39.95—USED: \$29.95

TRANSFORMERS—100V. 60 Cycle Pri.

5 VOLT CT-25A—10,000 V. Ins. OPEN FRAME—6" x 5" x 1 1/2".....\$7.95
 Sec. Two 12 V. 4 A. Windings—gives 12 V. 8 A. or 24 V. 4 A.....\$5.95
 Sec. 24 V. 1/2 A.....\$1.50 Sec. 24 V. 1 A.....\$1.95
 Sec. 24 Volt 6 Amps.....\$5.95
 Sec. 6-24 or 30 Volts, 8 Amps.....\$5.95

MOTORS: 24 VOLT DC 1/10 HP.

2800 RPM Reversible Motor—Size: 5-1/4" x 3-1/2". Shaft Size: 1" x 1/4". Emerson No. 186-0412—Price.....\$5.95
GEAR HEAD for above motor. Ball Bearing Gear. Shaft, 10 to 1 reduction. Price.....\$5.95
COMBINATION Motor & Reduction Gear.....\$10.00
24 VAC OPEN FRAME—20 RPM Double Shaft Back Gear Motor with Disengage Clutch. Shaft size: 1-1/2" x 3/16". Price: \$6.95
24 VAC OPEN FRAME—3 RPM Back Gear Motor. Shaft size: 3/4" x 3/16". Price: \$5.95
24 VDC REVERSIBLE—5000 RPM with Magmaite Brake. Flange Mount Spline Shaft—size: 5/8" x 3/16". Motor: 4" L. x 2-1/2" Dia. GE Motor only #51A25A32A.....Price: \$8.95
24 VDC AIRWAY MOTOR — Model #Z-350. Approx. 5000 RPM. Motor size: 2-1/2" x 1-3/8". Shaft size: 1/2" x 1/4". Price: \$4.95
26 VOLT 60 CYCLE—40 RPM Synchronous Cramer Motor #1117. Shaft size: 1" x 1/8". Price: \$1.95
110 VDC 1/70 HP. 1550 RPM. Motor size: 4" x 2-1/2". Shaft size: 1" x 3/16". Redmond #157. Price: \$4.95
6 VDC 1/20 HP. 4000 RPM. Motor size: 5" x 3". Shaft size: 3/8" x 1/4". Redmond #E-56. Price: \$4.95
12 VDC 1/30 HP. 4500 RPM. Motor size: 3" x 2-1/4". Shaft size: 1" x 3/16". Deleo #5017520.....\$4.95

24 VDC REVERSIBLE MOTOR

— 3.7 RPM, 40 lb. Torque Motor. Size: 5-1/2" x 4-1/32" x 3-5/16". Shaft size: 2 1/32" x 5/16". Also operates 24 VAC. Philco No. 441-1008.....\$5.95
27.5 VDC—6000 RPM, 1.5 oz. in. Shaft Size: 1-1/8" x 1/4". Motor Size: 2-1/2" x 1-1/2". No. 5063-267.....\$6.95
27 VDC—1-10 HP—3500 RPM. Shaft Size: 5/8" x 1/4". Motor Size: 4" x 3-1/2". Air Assoc. No. EE-763.....\$6.95
80 VDC—1/50 HP—3000 RPM. Shaft Size: 3/8" x 1/4". Motor Size: 5" x 3". G.E. No. 5 PN:8HA10.....\$8.95
28.5 VDC 1/35 HP—2200 RPM. Shaft Size: 1-1/4" x 1/4". Motor Size: 4-1/2" x 3-3/8". Electroflux No. 16876.....\$5.95



FREE SURPLUS LISTING SHEET
Brand new release—just off the press! Send for your FREE copy today. Mailed promptly on request!

LOOK AT THESE ITEMS WE HAVE IN STOCK! MANY, MANY MORE NOT LISTED! WRITE US YOUR NEEDS—IMMEDIATE REPLY!

ANTENNAS:	DYNAMOTORS:	RADAR* RECEIVERS* TRANSMITTERS:	MISCELLANEOUS:
AN-104B	DM-21	APS-3	RL-42B
A-104A	DM-25	RT-5/APS-4	MC-235
AN-109	DM-32	T-28/APT	HS-30
AN-117	DM-36	T-39/APO-9	M-396
AN-130	DM-40	AM-14/APT	M-359
AN-131	DM-41	AM-18/APT	BC-434A
AN-157	DM-42	AM-33/APT	BC-1366
AN-547	DM-43	BC-645	BC-450
MS-49 to 56	DM-45	BC-966	MC-476
AB-38-GR	PE-86	BC-454	FT-470
RC-173	PE-94	BC-455	WT-7A
AT1/APN-2	PE-103	BC-456	F-10A
AT2/APN-2	BD-77	BC-456	ME-57
AT3/APT	BD-87	RA-10A	BC-347
AT38/APT	BD-93	RT-7/APN-1	BC-709
AT42/APT	DY-22	AN, CRW-2	BD-72
AT49/APR-4	DA1-A	T-2/CRN-1	BD-116
AS27/ARN-5	MP-28BA	MARK II	EE-65
AS61/ARN-5	MP-10G	SCR-284	K-13
AS62/APR-2	MP-206		N-6A

ADDRESS DEPT E • All Prices Are F.O.B., Lima, Ohio • 25 Deposit on C.O.D. Orders

FAIR RADIO SALES • 132 SOUTH MAIN ST. LIMA, OHIO

PULSE TRANSFORMER

Tube base plug in type

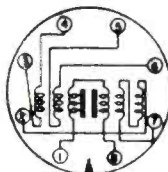

TYPE UX 7350
Each Coil—50-T#36E
Max. DC Res. Ohms
1 & 8=4.02Ω
2 & 7=4.542Ω
3 & 4=2.357Ω
5 & 6=2.185Ω

Here are precision made, high quality compact pulse transformers wound on hypersil cores. They are built in octal bakelite tube bases and can be adapted to many uses. They are completely impregnated and sealed.

SUGGESTED USES

- ★ Blocking Oscillator, Multivibrator and Scope Circuits.
- ★ Wherever Accurate Timing and Triggering are necessary.
- ★ Unexcelled in circuit applications for generating low power and low voltage pulses.
- ★ Can be used in circuits utilizing repetition rates from 0 to well over 1 MC and pulse widths ranging from .05 Microsecond up.

Price \$4.50 each Immediate Delivery

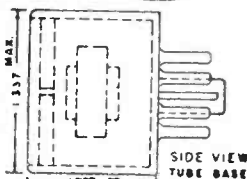
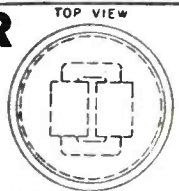

HATRY and YOUNG
THE Elect IN ELECTRONICS

811 Boylston St., Boston 16, Mass. CO 7-4700

SAVE ON TUBES BRAND NEW TUBES GUARANTEED TUBES

0A2	50.95	2J49	85.00	4J30	199.50	C6L/5528	2.50	VT-127A	2.75	KU627	17.50	801A	.39	CK1006	1.95
0A3/VR75	1.10	2J56	149.00	4J31	99.50	6AL5W	1.75	FG172	23.50	KU676	39.50	803	3.75	CK009P7	write
0B2	1.35	2J61	39.50	4J34	149.50	6AN5	2.95	FG177	14.50	WL577	39.50	805	3.25	1613	.98
0B3/VR90	1.09	2J62	35.00	4J41	99.50	6AN6	2.90	204A	49.50	700/B/C/D	16.50	807	1.59	1616	.90
0C3/VR105	1.00	2K22	32.50	4J52	200.00	6AS6	2.30	211/VT4C	.95	702A	2.75	808	2.95	1619	.39
0D3/VR150	.90	2K25	28.50	4-65A	15.00	6AS7G	4.50	217C	4.95	703A	4.75	809	2.95	1625	.39
1B22	2.00	2K26	69.50	4-125A	22.50	6BF7	2.50	221A	1.95	705A	1.50	811A	2.90	1626	.39
1B23	8.95	2M28	32.00	4X150A	22.50	6BL6	69.50	RX233A	3.50	706AY	39.50	813	10.95	1629	.39
1B24	9.50	2M29	23.95									814	2.75	1642	.69
1B26	2.30	2K34	150.00									815	3.95	1644	.89
1B27	12.50	2K41	125.00									826	1.95	2050	1.40
1B32/532A	2.98	2K45	110.00									828	9.95	2051	1.10
1B38	29.50	2K48	99.50									829	8.95	5516	5.50
1B42	17.50	3B23	4.95									829B	9.95	5586	175.00
1B51	9.50	3B24	4.75									832	7.95	5611	115.00
1N21B	2.50	3B25	3.50									832A	9.50	5635	8.95
1N22	2.25	3B28	6.50									709FY	39.50	833A	39.50
1N23B	3.49	3B29	12.50									706GY	39.55	836	3.45
1N34A	.79	3B29	2.50									707A	7.90	837	1.45
1N35	1.50	3C22	72.50									707B	13.55	838	3.98
1N38	1.50	3C23	9.95									708A	3.95	849	24.50
1N47	4.50	3C24/24G	1.50									713A	.95	851	49.50
1N54	.89	3C27	3.75									5021	2.00	307A/RK75	4.25
1N55	2.75	3C33	9.95									12DP7	16.95	310A	4.95
1N58A	1.25	3C45	12.50									12GP7	25.00	310B	12.95
1N60	.60											12HP7	13.50	316A	1.25
1N63/K33	2.39											15R	.69	327A	4.50
1N69	.89											FG 17/5557	3.95	331A	10.95
1N70	2.40											RX 21	8.50	349A	8.50
VS-2	9.50											FG 32	12.95	350B	3.95
2A515	4.25											35TG	5.95	368AS	6.00
2C21/1642	.69											RK47	4.95	371B	.75
2C39	17.50											EF50	.75	374B	4.95
2C39A	22.00											52HAP7	write	388A	1.49
2C40	7.25											FG57/5559	15.00	393A	9.95
2C42	19.95											RK60/1641	2.25	394A	3.95
2C43	14.95											RK65/5D23	29.50	417A	8.50
2C44	1.19											HY69	4.50	434A	15.00
2C46	19.95											RK72	1.20	445A	1.19
2C51	4.50	3D22	10.95	5HP1	4.50							RK73	1.20	446B	7.50
2C52	4.95	3E29	11.95	5HP4	4.50							75T	6.95	450TH	44.50
2D21	1.25	3FP7	1.95	5IP1	22.50							75TL	8.95	450TL	44.50
2D21W	2.49	3GP1	3.95	5JP2	19.95							83V	1.10	451	3.95
2E22	2.75	3HP7	3.95	5JP4	22.50							FG95/5560	22.50	464A	10.95
2E24	3.50	3JP1	12.50	5JP5	27.50							VT98	19.95	469	13.95
2E26	3.25	3K30	250.00	5J23	39.50							98R	5.95	471	2.25
2J21A	7.95	4E24	6.95	5J26	write							100TH	9.50	527	11.50
2J22	12.25	4C27/CV92	17.50	5J29	11.95							FG-104/5561	29.50	W1530	16.95
2J26	14.95	4C28	35.00	5J30	39.60							FG-105	19.00	531	5.75
2J27	14.95	4C35	22.00	5J33	25.00							VU-111	.95	CK536AX	.95
2J31	27.50	4E28	14.50	5NP1	5.95							HF120	9.95	559	1.19
2J32	29.50	4J22	129.50	5R4GY	1.25							F-123A	7.75	575A	13.95
2J33	27.50	4J23	129.50	5T4	1.50										
2J34	25.00	4J26	129.50												
2J36	89.00	4J27	129.50												
2J42	149.50	4J28	129.50												
2J48	24.50	4J29	149.50												

YOUR SURPLUS WANTED
We Pay Highest Prices!



SPECIAL! Vacuum Capacitors

50 mmfd. 15,000 v. . .	\$7.50
1/2 mmfd. 32,000 v. . .	\$10.00
50 mmfd. 32,000 v. . .	\$12.50
100 mmfd. 20,000 v. . .	\$14.50

RECEIVING TUBES?
WE HAVE ALL TYPES
IN STOCK
Standard Brands ONLY!

All Prices F.O.B. Los Angeles, subject to change without notice. Minimum order \$3.00



ELECTRONICS
Dept. E-29
7552 Melrose Ave.
Los Angeles 46,
California

Thousands of other types in stock. Send us your requirements.

QUARTZ CRYSTALS

Standard makes such as crystal Research, Bliley, etc. made to a tolerance of .03% or better and are available in the following frequencies and types: Type FT-243 (Pin Spacing 0.485, Pin dia. 0.093") Price \$1.15 each. In lots of 25 (can be ordered in various frequencies) Price \$23.75
NOTE:—In the frequencies listed below, those shown singly are in quantities of 50 or more, while others showing two frequencies with the word "to" in between indicates a variety of frequencies, between these limits. In small quantities, for example:—"3761 to 2770" indicates availability in 3762, 3763—3770 KC.

FREQUENCY (IN KILOCYCLES)

1930	5500	5900	7525 to 7576	7725 to 7728.75	8000	8550
2125	5630	5955	7560	7733.3	7840	8575
2320	5633.3	6000 to 6075	7580	7740	7850	8580 to 8591.7
2390	5650 to 5667.7	6100 to 6173.3	7608.3	7741.7	7860	8600 to 8691.7
2400	5655.5	6202.6 to 6250	7616	7750	7870	8700 to 8741.7
2430	5677.7	6300 to 6375	7620	7751.25	7875	8716.7
2940	5700	6400 to 6475	7625	7758.3	7880	8786.25
3105	5706.7	6500 to 6575	7641.7	7773.75	7890	8808.75
3110	5722.2	6600 to 6675	7650	7775	7906.6	8876.25
3664 to 3690	5725	6700 to 6725	7660	7783.7	7925	8921.25
3751 to 3799	5740	6825 to 6875	7673.3	7791.7	7930	9135.0
3825	5744.4	6830	7675	7800	7940	9500
4280	5750	6900 to 6975	7691.7	7806.6	7950	9511 to 9500
4375.25	5760	6978.75	7700	7810	7960	9501 to 9583
4644 to 4650	5773.3	7239 to 7240	7708.3	7820	7975	12,650 to 12,996
4840 to 4890	5790	7425 to 7475	7710	7825	7980	13,004 to 13,896
4900 to 4960	5800 to 5893	7458.75	7716.7	7830	7983.3	16,585.55

Type FT241 or CRIA/AR (Pin Spacing 1/2", Pin dia 1/8") Price each .79 25 for \$17.50

4390	5450	5840	6300 to 6370	6730	7270	7725 to 7790	8412 to 8490
4880	5604.1	5910 to 5970	6370	6870	7440	7800 to 7890	8500 to 8567
5030 to 5090	5740	6010 to 6090	6403 to 6490	6890	7460	7900 to 7990	8630
5100 to 5180	5780	6100 to 6180	6520 to 6590	6910	7550 to 7560	8250 to 8298.4	8745
5200 to 5295	5817.5	6203 to 6290	6630 to 6690	7140	7600 to 7675	8300 to 8351	11,677

Type DC 34 & 35 (Pin Spacing 13/16" Pin dia 3/16")

2326	2422	2540	3077.5	3190	3480	4305	4380
2360	2446	2851	3095	3270	3705	4325	4405
2390	2478	2863	3155	3462.5	4300	4345	

Type 241A W.E. (Pin spacing 0.485", Pin dia 0.093") \$23.75 for 25

70.0	72.0	73.2	76.0	78.0	91.2	92.8	93.8	95.4	96.6	98.2
70.6	72.4	73.4	76.4	78.8	91.6	93.0	94.0	96.0	96.8	98.6
70.8	72.8	74.8	76.8	79.6	92.0	93.2	94.2	96.2	97.6	
71.6	73.0	75.4	77.6	90.8	92.4	93.6	94.6	96.4	98.0	

BE1205—We can supply Crystals ground to a tolerance of .01% to a frequency close in value to those crystals itemized in BE1201, BE1202, or BE1203. Price \$1.95 each.

EDLIE ELECTRONICS, INC.

154 Greenwich Street
New York 6, N. Y.
Telephone DIgby 9-3143

TYPE G MICA CONDENSERS

MFD	Voltage	Type	Price
.04	1 KV	G-1	\$12.50
.09	1.5 KV	G-1	16.30
.08	1.5 KV	G-1	16.30
.0008	3 KV	G-1	13.75
.02	3 KV	G-1	19.50
.00095	5 KV	C-D48274	14.50
.0015	5 KV	CRV-48416	15.50
.006	5 KV	CRV-48415	15.50
.00025	6 KV	PL-586-59	15.90
.00024	6 KV	G-1	16.40
.0006	6 KV	G-1	16.25
.0004	6 KV	G-1	16.25
.0002	6 KV	1950-207	15.90
.001	6 KV	G-1	19.50
.0012	7 KV	CRV-48157	17.50
.003	7 KV	UC 3048	17.50
.002	8 KV	UC 2371	27.50
.000375	10 KV	CRV-48418	28.50
.00068	10 KV	MX-61	28.50
.00057	10 KV	CD-38897-2	28.50
.00025	10 KV	CRV-48155	28.50
.00015	10 KV	UC-3123	28.50
.00002	10 KV	UC-3292	25.50
.0008	10 KV	CRV-48417	28.50
.0005	10 KV	UC-2617	28.50
.0002	10 KV	UC-3296	28.50
.001	10 KV	48270-B5	28.50
.02	10 KV	PL-133-52	28.50
.0025	12 KV	XPXW	57.50
.008	12 KV	G-4	62.40
.00532	15 KV	1980-318	60.40
.00002	15 KV	MX-60	49.50
.002	15 KV	G-3	87.50
.0025	15 KV	1970-218	52.90
.01	15 KV	1940-225	52.90
.00035	20 KV	PL-289-51	52.40
.00025	20 KV	G-3	52.40
.00015	20 KV	1970-404	53.50
.0056	20 KV	PL-1391-97B	59.50
.0005	20 KV	G-3	54.70
.0003	20 KV	UC-3112K	400 K
.0002	20 KV	G-3	52.50
.0001	20 KV	G-3	49.90
.004	20 KV	G-3	99.50
.0025	25 KV	G-4	190.00
.002	30 KV	1940-217	210.00
.0005	35 KV	G-4	210.00
.001	35 KV	1940-214	225.00
.001	75 KV	PL-49-728	360.00

MICA CONDENSERS

MFD	VDC	Price
.00005	1200	5.69
.00022	1200	5.69
.025	600	1.89
.022	600	1.25
.004	1200	.78
.001	600	.49
.01	500	.89
.01	1100	.69
.01	1200	1.35
.01	2500	2.25

TYPE 9

MFD	VDC	Price
.0005	1200	5.69
.024	1500	2.50
.005	2500	1.50
.003	2500	1.90
.01	2500	2.05

TYPE F MICA

MFD	VDC	Price
.00055	5000	\$6.90
.00051	5000	6.90
.0009	3000	5.10
.0001	3000	5.25
.056	1000	3.90
.025	2500	2.10
.02	2000	4.90

TYPE E

MFD	VDC	Price
.00005	3000	57.25
.001	8000	10.25

RESISTORS STANDARD BRANDS

Ohms	Adj.	Price
22	Adj.	5.63
50	Fixed	.81
75	Fixed	.81
100	Fixed	.81
125	Fixed	.81
500	Fixed	1.15
500	Adj.	.81
750	Fixed	.81
5 K	Fixed	.87
20 K	Fixed	1.34
50 K	Fixed	1.12

HIGH VOLTAGE CAPACITORS

MFD	VDC	Price
522.50	25	25
27.50	25	25
29.50	33	33
Y-3605	35	35
1.25	49	49
10.25	51	51
19.75	5.5	5.5
7.50	5.1	5.1
10.25	1	1
14.63	10	10
9.75	1	1
7.25	1	1
7.50	1	1
8020	1	1
14772	92.50	1
5K/8K	Vitamin-Q	37.50
26F359	27.50	2
20 K	TK 200002-2	42.50

100 WATTS

Ohms	Adj.	Price
15	Adj.	1.19
25	Adj.	1.19
50	Fixed	.81
75	Fixed	.81
100	Fixed	.81
125	Fixed	.81
500	Fixed	1.15
500	Adj.	.81
750	Fixed	.81
5 K	Fixed	.87
20 K	Fixed	1.34
50 K	Fixed	1.12

VACUUM CONDENSERS

MFD	VDC	Type	Price
50MMFD	5 K	8047	\$5.50
12 MFD	20 K	VC-12	7.50
50 MFD	20 K	VC-50	32.50
100 MFD	20 K	W-50	11.50
100 MFD	7.5 K	1L33	14.50

PULSE TRANSFORMERS

UTAH:	Price
9280	9286
9281	9287
9282	9287-D
9283	9288
9284	9289
9285	9318
9340	9350
X 124 T2	X 124 T3
X 143 T3	X 146 T1

RAYTHEON:

UX 7307	UX 7361 A	UX 10066
UX 7350	UX 8092	U 12920

WESTINGHOUSE:

IP1	132 AW	145 EW2
IP2	132 BW	145 EWP
IP4	132 BW2	166 AW
IP8	132 DW	176 AW
IP13	133 AW	407 CW2
IP26	134 EW	
IP29	145 EW	

GENERAL ELECTRIC:

68G627	68G894	80G59
68G666	68G979	80G625
68G709	80G13	
68G813	80G58	

FREED:

#22647	K 2478	K 353564-D2
K 2449	K 2721A	BX 17-17
K 2460	K 2746 A	7472407

SPECIAL PRECISION RESISTOR

Wire Wound
IRC TYPE WWS
1 Meg. 1 W 1%
Quantities Available 4.00 ea.

SPECIAL VALUES

TV. Alignment Signal Generator channels 1-13 Sound & Video crystal controlled. Hazeltine Model 1314. 1317 Complete EXC. \$ 850.00
LR-1 Frequency Meter 160KC.-30MC EXC. 1200.00
TS-33/AP Frequency Meter 8700-9500MC. EXC. 225.00
BC-221 & LM Freq. Meters. EXC. 99.50
Signal Generator Ferris 14C 75-30, 000KC. EXC. 350.00
TS-12/AP X Band Test Sets Complete EXC. 300.00
TS-13/AP X Band Signal Generator EXC. 900.00
Model 80 Signal Generator—Measurements Corp. EXC. 590.00
804C Signal Generator 8-330MC. EXC. 400.00
TS-146/UP X Band Signal Generator EXC. 600.00
ME11/U RF Wattmeter. LIKE NEW 125.00
AN/SGC-1 Teletype Terminal Set LIKE NEW 225.00
Capacitance Bridge—General Radio 716B 275.00
Impedance Bridge—General Radio 160A EXC. 225.00
A LARGE STOCK OF ARC-1, ARC-3, ART-13, APN4A, APN4B, APR4, ARB, BC-312, BC-342, BC-348, BC-433G, BC-611, BC-1306, CRT-3, 196A, I222, IE-19A, IE-35A, IE-36A, SCR-284, SCR-522, SCR-578, SCR-625, TCS, T19/APQ5, TS-34/AP, TS-100/AP, TS-184/AP, 14C. Plugs and Selsyns. PUR
* PUR—Price up request.

WANTED

All types of radio and electronic surplus. We especially need: APA10, APN9, APR4, APN4, ARC1, ARC3, ART13, ATC, BC221, BC342, BC348, BC611, BC721, DVI2, DVI7, I10, LM10 to LM18, MG149F, MG149H, PUI4, R5/ARN7, R5A/ARN7, SCR718C, TCS, TN16, TN17, TN19, TN54, TS3, TS13/AP, TS33, TS35, TS45, TS75, TS76, TS102, TS147/UP, TS148/UP, TS173, TS174, T175, TS250, TS251, TS323, (ICT, IF, IG, 5CT, 5DG, 5F, 5G, 6DG, 6G, I15V, 60 c.p.s. Selsyns), and all types of Hewlett Packard, General Radio Co., Measurements Corp., Bonton Radio, Ferris, Leeds & Northrup, and other test equipment.

Please state accurate description, condition, and your lowest price. Explain modification, if any. We pay freight charges.

NEW CATALOG NOW AVAILABLE

PHOTOCOON SALES

417 N. Foothill Blvd. SYcamore 2-4131
Pasadena 8, Calif. RYan 1-6751
CABLE: Photocoon, Pasadena.

LOOKING FOR HARD-TO-FIND PARTS & EQUIPMENT?

Just a partial list of our present stock:

- BC-348 • BC-342 • ART-13
- ARC-3 • APN-9 • LM
- BC-221 • BC-611
- VARIOUS TEST EQUIPMENT

NEW EXPORT DIVISION FOR ALL FOREIGN ORDERS

Prompt attention to all inquiries—all languages

Atten: Schools, Labs, Hams!
WE PAY MORE
FOR RADIO PARTS & EQUIPMENT
Cash in on your surplus equipment—or we'll trade for something you really need. Write today!

Write for FREE Surplus Catalog.

HARJO SALES CO

4109 BURBANK BLVD.
P. O. Box 1187
Magnolia Park Station
BURBANK, CALIFORNIA
Cable: HARJO

WESTERN ELECTRIC TUBES

Available From Stock

2C51	4.25	373A	4.75
101D	1.39	374A	4.25
101F	1.39	393A	5.75
101L	.75	394A	3.75
102F	1.39	396A/2C51	4.25
102L	1.39	403A	3.25
104D	1.39	403B	3.50
244A	5.50	404A	14.95
310A	4.75	406A	P.U.R.
310B	6.75	407A	4.75
311A	4.75	408A	2.75
311B	5.75	412A	3.50
336A	4.25	416A	P.U.R.
337A	4.50	417A	10.95
349A	6.75	418A	9.75
350B	6.75	421A	8.50
351A	7.75	422A	6.50

Calvert Electronics

INCORPORATED
59 FOURTH AVE. NEW YORK 3, N. Y.
OREGON 4-3027

SPECIAL PURPOSE TUBES

C1A	6.25	3B24W	6.75	6BM6	52.50	276A	6.50	700D	12.50	815	4.50
1B22	1.75	3B25	3.50	6C21	16.75	282A	10.25	701A	4.50	829A	6.75
1B23	6.00	3B26	2.75	6CF	12.75	283A	3.25	702A	2.00	829B	9.00
1B24	7.75	3B28	4.50	7BP7	3.75	304TH	6.75	705A	1.00	830B	2.00
1B32	1.50	3C23	6.75	9LP7	3.50	304TL	5.00	706AY	22.50	832	6.00
1B35	8.00	3C24	1.00	12DP7	12.50	307A	2.75	706FY	30.00	832A	7.50
1C21	2.00	3C31	2.50	12GP7	15.50	310A	3.50	706GY	30.00	833A	30.00
2AP1	6.75	3DP1	3.00	FG-17	3.00	311A	3.25	707A	4.00	836	3.00
2C39A	12.50	3EP1	3.50	RX-21	7.50	313C	2.25	707B	9.50	837	1.00
2C40	6.25	3GP1	3.00	RK-23	2.25	323A	11.25	708A	2.75	838	3.00
2C43	10.50	3JP12	15.00	RK-62	2.00	323B	9.75	709A	2.75	846	85.00
2C44	1.00	3KP1	9.75	RK-73	1.00	328A	4.25	715A	3.00	849	18.50
2D21	1.00	4C22	7.50	75T	5.00	329A	6.00	715B	4.50	860	2.25
2E22	1.75	4C27	12.75	FG-95	16.50	348A	6.50	715C	15.75	861	10.00
2J22	5.25	4J34	112.50	F-128A	38.50	350A	4.25	719A	18.25	866A	1.00
2J26	13.50	4J35	150.00	F-129B	90.00	352A	7.50	721A	1.50	878	1.25
2J27	9.75	5BP1	3.50	VT-158	38.75	353A	3.25	723A B	13.50	884	1.00
2J31	20.25	5BP4	3.50	FG-172	18.75	354A	15.00	724A	1.75	869B	55.00
2J32	22.50	5C30	3.00	FG-190	7.75	355A	15.00	724B	2.25	892R	257.25
2J33	20.25	5CP1	4.25	204A	28.75	375A	10.50	725A	4.25	902-P1	4.25
2J34	18.75	5D21	13.75	F-207	180.00	394A	2.50	726A	8.75	923	1.00
2J38	9.00	5FP7	1.25	212E	25.50	417A	6.00	726B	40.00	927	1.00
2J50	15.75	5FP14	12.25	WL-218	28.75	434A	12.00	726C	60.00	931A	3.75
2J55	50.00	5JP1	16.75	F-232CH	180.00	446A	1.00	728CY	25.00	CK-1006	1.50
2J56	112.50	5JP4	16.75	250R	6.00	446B	3.00	728DY	25.00	1624	1.00
2J61	30.00	5JP11	16.75	250TH	13.50	450TL	40.00	728EY	25.00	2050	1.25
2K25	20.50	5J23	30.00	250TL	8.50	GL-451	3.00	728GY	25.00	ZB-3200	150.00
2K41	93.75	5J30	29.50	253A	11.75	464A	6.00	803	2.50	8012	1.50
2X2A	1.25	5LP1	13.00	264C	3.00	527	8.75	807	1.25	8013	2.00
3AP1	5.00	5R4GY	1.00	267B	7.00	631-P1	3.75	808	1.50	8020	1.00
3BP1	3.75	C6A	4.50	271A	6.50	WL-530	12.75	811	2.25	8025	3.50
3B24	4.25	6BL6	52.50	274B	2.25	700A	12.50	814	2.50	PD-8365	50.00

- Receiving tube listings—upon request
- Usual terms apply

western engineers

ELK GROVE, CALIFORNIA
GEORGE WHITING, OWNER

- Unconditional guarantee extended
- Subject to prior disposition

CARRIER EQUIPMENT

Western Electric CF-1A 4-channel carrier telephone terminals.
EE-101-A 2-channel 1000/20 cycle carrier ringers.
CF-D-B 4-channel carrier pilot regulated telephone terminals complete with four channels 1000/20 cycle ringing.
CF-D-B 4-channel pilot regulated telephone repeaters.
C-42-A V. F. telegraph in from 2- to 12-channel terminals.
FMC-1 or 2 channels carrier telephone terminals, automatic regulation, duplex signaling each channel. Carrier frequencies above 35 KC. Ideal for adding channels above type "C".
Complete engineering and installation services offered.

RAILWAY COMMUNICATIONS, INC.
Raytown, Missouri
Telephone: FLeming 2121

IN STOCK FOR IMMEDIATE DELIVERY SIGMA 4F 8000 OHM RELAYS

All New, Contract Termination Material—Production Quantities Available

Special Low Price—3 for \$10.25—10 for \$32.50—100 for \$300.00
Super-Sensitive BK-35 Type Relays, 10,000 ohm at 1/2 ma, 5PDT \$4.95

HERE IS ANOTHER GOOD NUMBER

Type DYR-6011, Dual .1 mfd 600 VDC, 3 Side Terminals Bathtub Capacitor
100,000 Clean New Units Available—Priced at 17 1/2¢ for Quick Sale
Note: at this price you can use them as is, tie both sections together for approx. .25 mfd capacity or use as single .1 mfd unit.

FOR FAST, INTELLIGENT, FRIENDLY SERVICE ON ELECTRONIC ITEMS "CALL ON ESSCO"

ELECTRONIC SPECIALTY SUPPLY CO.

58 WALKER STREET NEW YORK CITY 13, N. Y. TEL. WALKER 5-8187

RADIO TUBES at New Low Prices

Type	Our Price	Type	Our Price	Type	Our Price	Type	Our Price	Type	Our Price
OZ4A	\$.59	6AG5	.62	6K6GT	.54	12SR7	.69	805	3.00
1R5	.57	6AL5	.49	6K8G	.80	12SQ7	.56	808	1.75
1S4	.69	6AQ5	.50	6SG7	.60	35Z4GT	.59	830B	2.40
1T4	.61	6AX4GT	.90	6SK7 Met.	.58	35Z5GT	.40	864	.20
1A5GT	.62	6B8G	.70	6SH7	.60	50L6GT	.50	866A	1.10
1B3GT	.93	6B8	.75	6SK7GT	.55	6SN7GT	.60	9002	.80
1U5	.60	6BE6	.52	6SS7	.80	6S57	.50	9004	.38
2X2	.56	6BQ6GT	1.00	6X5GT	.50	7Q7	.60	9006	.35
5T4	1.59	6C6	.59	12AU7	.65	12SK7 Met.	.50	2050	1.50
5U4G	.50	6H6 Met.	.54						
6AB7	.80	6J5 Met.	.50						
6AC7	.80	6J5GT	.40						

Purchasing Agents: NOTE: all tubes are New, Standard Brands, Packed in original cartons. Immediate delivery. Terms 25% with order, balance C.O.D. Minimum order: Transmitting tubes—50 per type, or multiples of 50. Discounts on large orders. State quantity. Call or write today for detailed price list.

We are world-wide suppliers to Air lines, Government Agencies and the Radio industries

METROPOLITAN OVERSEAS SUPPLY CORPORATION
1133 Broadway New York 10, N. Y. Chelsea 3-1105



FOLLOW ARROW FOR MILITARY ELECTRONICS

VHF CONTROL TOWER

COMPLETE TRANSMITTER-RECEIVER, FREQUENCY METER, POWER SUPPLY, ALL MOUNTED ON STANDARD RACKS, 6 FT. HIGH. FREQUENCY RANGE: 100-156 MC. 110/220 V. 60 CPS. LIKE NEW. GUARANTEED. WRITE FOR COMPLETE LITERATURE.....P.U.R.

TRANSMITTER TA-2J-24



High powered crystal controlled, long-range transmitter. Frequency range: 300-600 Kc. and 2.9-15 MC. Eight separate channels are provided. New. Send for complete literature P.U.R.

Radar

- APR-4 New, APT-3 RC-224 Complete APT-4 RC-266
- APR-5 Mark 16 RT34/AP513
- APS-4 New, MD4/AP2 T-85/APT-5
- Complete MD5/AP53 PB-104/APT-5
- APS-6 New, MD22/UPN2 MD38/APQ13
- Complete RC-1841FF
- APT-1 APT-2 RC-214

FOLLOW ARROW TO GET HIGHEST PRICES FOR YOUR NEW AND USED RADIO GEAR! What have you to sell? WRITE TODAY!



TS-159/TPX

Can be used as frequency meter. 150-200 MC. Separate 30 MC. output. Unit is crystal controlled. 2" meter has two scales: 0-50 and 0-500 VDC. Operates from 110 V. 400 cyc. Easily converted to 110 V. 60 cyc. Complete, new, with schematic. **\$69.50** Only

Test Equipment

Complete Line

- DuMont 224-A Oscilloscope, TS127/U
- 1-77 Hickok Tube Checker TS131
- 1-208 FM Signal Generator TS-148/UP
- RPC Model 644 Multimeter TS-173/UR
- Hewlett Packard 200-C TS-174/UR
- 1-198 TS-23/APN TS175/UR
- BC-638 TS-24A TS182/UP
- BC-1255 TS-25/UPN TS184A/AP
- CWI-60ABJ TS27/TSM TS204/AP
- 1E-36 TS-33 TS-218
- 1-95 TS34/AP TS251
- 1-96-A TS-35/AP TS323/UP
- 1-122 TS36/AP 1-146
- 1-130A TS-45A TS-268/U
- 1-139 APM-3 Boonton Mod.
- 1-145 TS-59/APN 78B Sig. Gen.
- 1-212 TS61/AP Boonton Type
- 1-222 TS89 102FSig.Gen.
- TS-3A/AP TS92 LAD Sig. Gen.
- TS10A/APN TS100/AP LAD
- TS12/AP TS-102 LAVOIE Freq
- TS-12 Spare TS111/CP Meter: 300-
- Parts Kit TS-118/AP 600 MC.
- TS16/APN TS126 TS-56A/AP
- TS19/APQ I-100 ADF Test
- HEWLETT-PACKARD #205 Set

RECEIVERS—TRANSMITTERS

- ARC-1 IPE-125AX RTA/1B
- ARC-3 4 R-9/APN-4 SCR-422
- R-4/ARR-2 BC-733-D TA21-24
- ID-6/APN-4 R-57/ARN R-28/ARC-5
- MP-10G BC-788-A-AM-C T-23/ARC-5
- BC-639 BC-639 R-89/ARN
- RM-26 I SCR-284 R-1/ARR-1
- SCR-540 MN-26 Complete RM-25
- SCR-561 Equip. Installation SCR-536
- Motorola Model Fstr-250

EE 89 phone amplifier

GOVERNMENTS, AIRLINES AND INDUSTRIALS! Send for FREE Catalogue No. 112 for complete list of Military, Industrial, and Aviation Electronics. WE HAVE THE LARGEST INVENTORY OF SUCH EQUIPMENT IN THE UNITED STATES.

ARROW SALES INC.

Mailing Address: P. O. BOX 3878-E, N. HOLLYWOOD, CALIF.
Office-Warehouse: 7460 VARNA AVENUE, N. HOLLYWOOD, CALIF.
Poplar 5-1810 • Stanley 7-6005 • Cable Address: ARROWSALES



CHECK AND COMPARE OUR COMPLETE STOCKS

The following is just a partial list of the current electronic and aircraft equipment now in our warehouse. Write for complete information. Prompt replies to all inquiries.

RC-103 & AN/ARN-5 ILS

New in original cartons. Complete. Consists of all accessories, plus AS-27A, R89B/ARN-5 and BC-733D. Modified to flag alarm.

TBS 4 & 5, NEW, COMPLETE

- IE-17 TEST SET
- AN/ARN-7 COMPLETE
- SCR-269 COMPLETE
- AN/ARC-1 BHF EQUIPMENT

BC-611 & BC-721 HANDIE TALKIES, Plus SPARE PARTS. Quantity available.

AN/ART-13 EQUIPMENT

- ATC XMTR T-47A/ART-13 XMTR
- T-47/ART-13 XMTR CU-24 ANT. LOAD
- CU-25 ANT. LOAD DY-11 & 12 Dynam't'r
- MT-283 MOUNT 0-16 LFO
- MT-284 MOUNT ATC DYNAM'T'R
- SA-22 ANT. LOAD C-87 CONTROL BOX

AN/APG-13A RADAR

Absolutely complete, brand new

- AN/APN-2 MG-153
- SCR-729 New APS-2, 3, & 15
- TA2J-24 Components
- RTA-1B AN/ARC-5 VHF
- BC-1016 SCR-274 & ARC-5,
- APA-6 INDICATOR Command Equipm't
- APA-11 INDICATOR R-4/ARR-2 Receivers
- APA-17 RADAR BC-640 VHF XMTR
- HS-33 HEAD SETS, SCR-510
- NEW SCR-522
- MG-149F & H MG-153

SPARE PARTS

- SCR-720 SCR-522
- SO-7 AN/ART-13
- AN/ARN-7 AN/ARC-1
- SCR-269 BC-611

SCR-718 A, AM, B & C

Altimeter equipment—complete

To insure the finest of service and quality of merchandise, we have just recently put into operation our own reconditioning and function-testing plant, complete with all facilities.

WANTED

- CFI UNITS ART-13 BC-788
- 1-152 BC-348 Q & R
- TOP DOLLAR PAID

EXPORT INQUIRIES INVITED

We carry an unusually large stock of Airline Equipment, Test Equipment, Radar Sets, etc. Write for our low prices and complete information. We furnish immediate answers to all inquiries. Write today!

V & H ELECTRONIC INDUSTRIES INC.

2033 West Venice Blvd.—Dept. E-23
Los Angeles 6, California
Phone: REpublic 3-1127

SELENIUM RECTIFIERS



FULL WAVE BRIDGE TYPES

D.C. AMPS.	0-26 VAC 0-20 VDC	0-52 VAC 0-40 VDC	0-130 VAC 0-100 VDC	0-156 VAC 0-120 VDC
.5	\$2.75	\$5.10	\$9.85	\$11.40
1.0	3.65	6.85	15.50	18.15
1.5	3.90	7.35	16.20	18.90
2.5	5.55	10.10	20.50	23.95
4.0	7.45	13.95	29.65	36.00
6.0	8.00	14.65	30.40	37.00
8.0	9.65	18.20	42.00	49.60
12.0	10.25	19.05	43.85	51.80
15.0	17.40	32.80		
22.5	18.20	34.30		

RECTIFIER TRANSFORMERS

All Primaries Tapped
110-125 Vac 60 Cycles



SEC. VOLTS	AMPS	PRICE
18 VAC	10	\$9.95
tapped at 9V.	35	35.00
	70	60.00
36 VAC	5	\$5.95
	15	7.80
	20	28.50
	35	45.00

HI-AMP CHOKES

5 AMPS	.03 HY	.2 OHM	\$7.95
10 AMPS	.015 HY	.06 OHM	13.95
20 AMPS	.007 HY	.03 OHM	28.50

FILTER CAPACITORS



W.V. D.C.	Cap. Mfd	Price	W.V. D.C.	Cap. Mfd	Price
12	3000	\$1.50	50	500	.95
15	1000	.75	50	1000	1.95
15	2000	1.25	50	2000	3.50
15	4000	2.50	150	200	1.75
18	1000	.90	200	500	3.25
18	2000	1.45	200	1200	6.50
25	1000	1.50			
35	2000	2.00			
35	3000	2.25			

MOTOR SPECIAL



Diehl Cat #FB2101-6 115 Va 60 Cycles 0.4 Amps, 1500 RPM 4-Pole Shaded Pole Type. Shaft 1/4" x 1" Long. Ball Bearing. Cast Frame. Shpg. Wt. 6 Lbs. Brand New.....\$4.50



OIL CAPACITOR

2 x .15 MFD 8000 V.D.C. Us both section in parallel for .3 MFD or in series for .075 MFD. Ca 26F381.....99
Lots of six in orig. carton.....\$5.00

MISCELLANEOUS

- Grain-O-Wheat bulbs, type 319A, 3volts Dos. \$1.00
- Selenium Rect., Bridge, 36VAC-28VDC 2 Amp..... 4.95
- Circuit Brkr, 10 Amp, thermal, pus b-to-reset..... .40
- Guardian Relay, 250 Amp. Type B8..... 2.50
- Thordarson Choke 10 Hys. 55 Ma. Fully Casod..... .65
- Fuse, 1/40 Amp. 84G..... .50
- Oil Capacitor, 8 MFD 660VAC KGM..... 3.00
- Phase Inverter, FTR MC-413-A w/tubes..... 3.00
- Oil Capacitor, .5 MFD 400 VDC, Rect. Case..... .10
- Shaft Coupling, ceramic, 1/4" to 1/2"..... .15



FILTER CHOKE

50 Hys. 40 ma. 1780v. RMS Test. Raytheon Type U7402. Dimen. 3 1/2" x 3 1/2" x 3 1/4". Shpg. weight 6 lbs.....\$1.5

Minimum order \$5.00. All prices are FOB shipping point. Send check or M.O. We will ship transportation charges collect. Rated concern send P.O., Terms Net 10 days.

GATES ELECTRIC

63 WEST BROADWAY
New York, N. Y. Phone WO 2-7587

MARINE TRANSMITTERS

TCS radiotelephone 1.5 to 12 Mc for marine or mobile use. Operates from 12VDC. Complete with all accessories. Excellent condition\$450.00
 TBA 1 KW Professionally converted for 110/220 60 cy operation and modulated. Write for complete description.\$3500.00
 SO-1 & SO-2 Radar fully reconditioned, like new overseas packed.\$2750.00

HIGH VOLTAGE CONDENSERS

Cat. No.	MFD	WVDC	Price
G.E. 26F444	8	2 KV	[9.95
G.E. 23F47	2	4 KV	9.95
G.E. 25F509G2	.1	6 KV	[7.50
G.E. 25F774	.1 X .1	7 KV	8.00
G.E. 25F450	.1	7.5 KV	7.50
G.E. 25F360	.1	12 KV	9.50
C.D.	.65	12.5 KV	17.50
Intereon	.25	15 KV	19.95
G.E. 14F91	1.0	15 KV	39.50
Intereon	.5	25 KV	49.50
Intereon	1.0	25 KV	69.50
East A8734	1.0	25 KV	89.50
G.E. 14F71	.25	32.5 KV	60.00

HIGH CURRENT MICA CONDENSERS

Ceramic cased, Sangamo type G1 or similar

Mfd	WVDC	Amp @ 1 mc	Price
.04	1 KV	25	7.50
.08	1.5 KV	35	12.50
.09	1.5 KV	40	15.00
.02	3 KV	21 (600 Kc)	15.00
.00035	6 KV	5	12.50
.00075	6 KV	7	14.50
.0005	6 KV	5	14.00

Type G-2 or Similar

.0012	5 KV	8	17.50
.003	7 KV	15	19.00
.0002	10 KV	10	19.50
.00025	10 KV	3	19.50
.0003	10 KV	5	19.50
.0005	10 KV	6	19.50
.00057	10 KV	8	19.50
.00065	10 KV	6	19.50

Type G-3 or Similar

.05	3 KV	50	45.00
.005	5.5 KV	25	45.00
.00015	20 KV	5	36.00
.0012	20 KV	15	36.00

400 V TRANSFORMERS

All primaries 115V 400cy

UX8486A 5V/5A/13.500VRMS	\$3.50
UX8306A 6V/3.7A/1780VRMS	2.50
UX8302C 6.3V/4.7A; 5V/3A; 6.3V/6A 1780VRMS	3.95
UX8485A 6500V/.055A	11.50
UX8301C 600V/.175A	5.50
UX7812B 1000V/.0025A/3KVRMS; 6V/.45A/1780 VRMS	6.95
UX7779E 800V/.085A/390V/.100A; 5V/3A; 5V/.3A/1780VRMS	4.50
UX8352A 65V/.01A; 110V/.01A; 6.3V/1.0A 2.5V/7.0A/1275VRMS	5.50
UX7732A 4580V/.002A; 2.5V/5A/11000 VRMS	9.50

WX4298E Pulse transformer, pri 4KV 1Mu sec Sec 16KV @ 16A 17.50
 WX4298D Pulse Transformer 9.50
 UX8442 Trigger Transformer +40V -40V (pulse inversion) 7.50
 UX7307 Blocking Transformer 10.00

PULSE NETWORKS

15A-1-400-50; 15KV "A" Circuit 1 Mu Sec, 400 PPS, 50 ohms Impedance\$27.50
 25A-1-850-50; 25KV "A" Circuit; 1 Mu Sec 850 PPS, 50 ohms Impedance 60.00

PIONEER TORQUE UNITS

12604-3-A Contains CK5 motor & AY43D autosyn gear ratio motor to shaft 125:1, Gear ratio shaft to follow-up Autosyn 15-1\$70.00
 12606-1-A Same as above except Gear ratio shaft to follow-up autosyn 30:1 / 70.00
 12602-1-A Same as 12606-1-A except has base mounting cover for motor & gears 70.00
 12077-1-A Pioneer Amplifier 35.00

PIONEER AUTOSYNS

AY-1	26V 400cy	\$6.95
AY-5	26V 400cy	8.95
AY-6	26V 400cy	3.95
AY-30D	26V 400cy Generates signal to amplifier 12077-1-A	25.00
AY-43D	or DW cancels signal from amplifier #12077-1-A	25.00

DYNAMOTORS

TYPE	INPUT	OUTPUT	Mils	Price
DM-34	12V	220V	80	\$12.50
DM-35	12V	625V	225	24.50
DM-36	24V	220V	80	12.50
DM-37	24V	625V	225	17.50
DM-64	12V	275V	150	11.50
BD-65	12V	400V	440	22.50
BD-77	12V	1000V	350	25.00
TCS Rcvr	12V	225V	100	12.50
TCS Xmtr.	12V	440V	200	22.50

All prices FOB Oakland, Calif., subject to change without notice. Terms 25% cash with order. Balance COD.

EMMONS RADIO SUPPLY CO.
 405 10th St., Oakland, Calif.
 Phone TWinoaks 3-7411



GRAIN OF WHEAT LAMPS

#322 3 V. .19 amp.
 #328 6 V. .2 amp.
 100 for \$25.00 10 for \$3.00



MARKTIME 5 HOUR SWITCH

A 10 amp. timing device. Pointer moves back to zero after time elapses. Ideal for shutting off radios and TV sets when you go to bed. Limited supply at this special PRICE \$4.90

Also available in 15 min., 30 min., 1 hr. at \$5.90

10 Seconds to 24 Minutes Timer

A hand wound electric TIMING SWITCH. Pointer moves back to ZERO and shuts off RADIO-TV-Electric Mixer-Photographic Devices-Time Delay etc. Furnished with Calibration Chart and Pointer Knob. Biggest bargain we ever had..... \$125



3" Round Elapsed Time Meter \$125
 General Electric \$15.50
 Westinghouse Square \$16.00

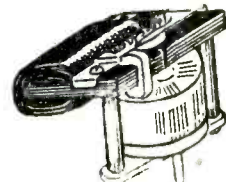

Genuine TELECHRON Motors

2 RPM \$2.90
 3 RPM 3.90
 4 RPM 3.90
 3.6 RPM 3.15
 1 RPM 3.95
 60 RPM 4.30

1800 RPM SYNCHRONOUS Motor; 115 \$450

volts AC, 18 watts 1 1/4 lbs.; 2"x3"x2"
 New Sound Powered HAND SET TELEPHONES, 50' Flex. Rubber covered cable FREE. \$19.00 Pair



REDMOND Powerful 5" Blower or Ventilator 115 volts AC 60 cycles 18 watts. For Kitchen - Laboratory. Heat or Cold or Chemicals.\$7.50

Hand Cranked A.C. Generators { 2 bar. \$4.50
 Removed from Ancient Telephones { 3 bar. \$5.50
 Polarized Bell or Buzzer { 5 bar. \$6.50
 Works on Magneto or 115 volt A.C. \$150
 Complete 2 Station Magneto Hinger \$1750
 Telephones. Incl. Batteries-wire.....

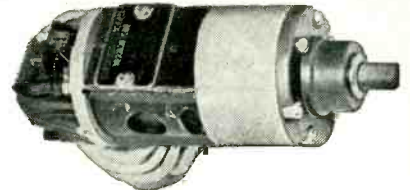

Perhaps the smallest reversible GEARED-MOTOR in the world

Deleo-PM-Permanent Magnet Alnico Field Motor 250 RPM, 27 volts, 110 m.a. Speed depending on the voltage. Designed to be used in bombsights, automatic pilots, etc. Cost at the factory \$26.10. Delivery 4 months.
 #5067127 1/4" shaft. \$1750
 #5071895 1/2" shaft.
 and some with 11/16" gear.
 O.U.T. PRICE. Immediate Delivery!!
 Clamps to hold motor: \$1.50 ea.

#5069600 \$1850

NE-2	1/25 Watt NEON lamp 10 for \$1.00, 100 for \$7.50
NE-16	1/4 Watt NEON lamp D.C. \$3.00 Bayonet Base. 10 for.....
NE-21	1/4 Watt NEON lamp S.C. \$2.50 Bayonet Base. 10 for.....
NE-48	1/4 Watt NEON lamp D.C. \$2.00 Bayonet Base. 10 for.....
NE-30	1 Watt NEON lamp Med. \$2.50 Screw Base. 10 for.....
NE-29	1/4 Watt NEON lamp D.C. \$3.50 Bayonet Base. 10 for.....
NE-30	1 Watt NEON lamp D.C. \$3.50 Bayonet Base. 10 for.....
AR-1	2 Watt ARGON lamp Med. \$3.00 Screw Base. 10 for.....
NE-40	3 Watt NEON lamp Med. \$3.50 Screw Base. 10 for.....



HAYDON SYNCHRONOUS TIMING MOTOR

110 v. 60 cycle 30 RPM \$2.60
 110 v. 60 cycle 1/10 RPM \$2.35
 110 v. 60 cycle 1 RPM \$2.85
 220 v. 60 cycle 2 RPM \$1.65

ZENITH Motorized Remote control made for T.V. but ideal for opening doors-windows-Turntables-Gadgets-Tuning Radios. Complete with Transformer 16 ft. cable and reversing button. \$8.95
 A few more left

ALL PRICES F.O.B. N. Y.

EST. 1923 **BLAN** EST. 1923
 64-0 Dey St. New York 7, N. Y.

AN/APR-4 LABORATORY RECEIVERS

Complete with all five Tuning Units, covering the range 38 to 4,000 Mc.; wideband discone and other antennas, wavetraps, mobile accessories, 100 page technical manual, etc. Versatile, accurate, compact—the aristocrat of lab receivers in this range. Write for data sheet and quotations.

We have a large variety of other hard-to-get equipment, including microwave, aircraft, communications, radar; and laboratory electronics of all kinds. Quality standards maintained. Get our quotations!

We will buy any Electronic Material at top prices. SCHOOLS—unload your dusty surplus for cash or credit.

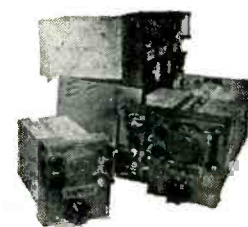

ENGINEERING ASSOCIATES

434 PATTERSON ROAD

DAYTON 9, OHIO

WE BUY AND SELL GOVERNMENT SURPLUS

electronic components, units, wire, etc.

Your Inquiries Invited

LAPIROW BROS.

1649 Hoffner St. Cincinlnatt 23, Ohio
 Kirby 1285

T47A/ART-13 TRANSMITTERS
 BC-610-E TRANSMITTERS
 BC-312, BC-342, BC-348 RECVRs.
 BC-221 & LM FREQUENCY METERS

ALLTRONICS

BOX 19, BOSTON 1, MASSACHUSETTS
 Richmond 2-0916, LYnn 8-3100

VARIACS

50-A	0-115 V 45 A	88.50
100-Q	0-115 V 18 A	34.50
200-CU	0-115 V 7.5 A	13.50
200-CUH	0-230 V 2.5 A	17.50

western engineers

ELK GROVE, CALIFORNIA

24 HOUR DELIVERY FROM STOCK!

RELAYS

Our stock of more than a million relays — in over a thousand different types — is the world's largest. Don't delay your production for want of large or small quantities of relays of any type.

Telephone, wire or write for quotations.

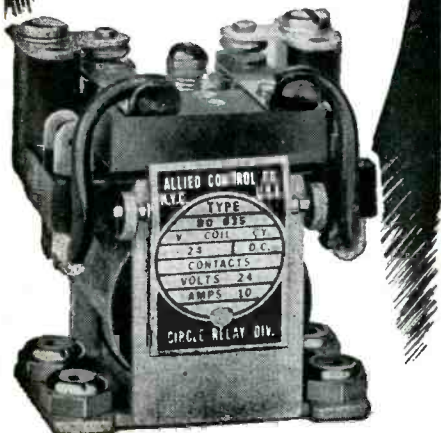

NEW AND MORE COMPREHENSIVE

1953 RELAY SALES CATALOG

NOW READY

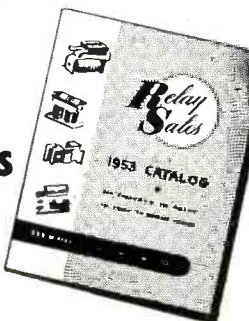

Be sure to send for your copy



Telephone SEley 8-4146

833 W. CHICAGO AVE.
DEPT. 4, CHICAGO 22, ILL.

POWER RHEOSTATS



ohms W	Ea.	ohms W	Ea.	ohms W	Ea.
.1 150	4.89	50 50	2.10	500 100	3.60
.5 25	1.98	60 25	1.86	500 150	4.63
.5 50	2.34	75 25	1.86	500 300	6.93
.5 150	4.89	75 50	2.10	750 25	1.86
1 50	2.34	75 75	3.25	750 150	4.90
2 50	2.34	80 50	2.10	1000 25	2.10
2 100	3.86	100 25	1.86	1000 50	2.22
2 300	6.93	100 75	2.10	1200 225	6.41
3 100	3.86	100 100	3.60	1200 300	25.93
3 225	6.41	125 25	1.86	1250 50	2.22
5 25	1.86	150 50	2.10	1250 150	4.90
5 50	2.10	175 25	1.86	1500 25	2.10
5 100	3.86	185 25	1.86	1500 50	2.22
5 150	4.63	200 75	1.86	1600 50	2.22
6 25	1.86	200 100	3.60	1800 150	5.15
6 50	2.10	200 150	4.63	2000 25	2.10
6 75	3.25	225 50	2.10	2000 50	2.22
7 25	1.86	250 25	1.86	2250 150	5.15
7.5 75	3.25	250 50	2.10	2500 50	2.22
7.5 225	6.41	300 50	2.10	2500 100	3.71
8 50	2.10	300 75	3.25	2500 150	5.15
10 25	1.86	300 100	3.60	3000 25	2.22
10 50	2.10	350 25	1.86	3000 100	3.71
10 100	3.60	350 100	3.60	5000 25	2.22
12 25	1.86	350 150	4.63	5000 50	2.34
12 50	2.10	370 25	1.86	7500 50	2.34
15 25	1.86	378 150	4.63	7500 100	4.40
15 75	3.25	400 25	1.86	10000 25	2.50
15 100	3.60	450 75	3.25	10000 100	4.75
20 50	2.10	500 25	1.86	15000 25	2.75
22 50	2.10	500 50	2.10	20000 150	6.98
25 25	1.86	500 50	2.10		
50 25	1.86	500 75	3.25		

Specify Type Shaft Required—1/4" S5 or Knob Type (Special Prices to Quantity Users)

HIGH POWER TR. MICA

G-1 TYP				G-2 TYP				G-3 TYP				G-4 TYP			
mfd.	kv	type	ea.	mfd.	kv	type	ea.	mfd.	kv	type	ea.	mfd.	kv	type	ea.
.0001	6KV	.0005	10KV	.006	10KV	.0015	7KV	.00025	30KV	.0025	25KV	.00025	30KV	.0025	25KV
.00015	6KV	.001	10KV	.015	7KV	.0025	25KV	.00025	30KV	.0025	25KV	.00025	30KV	.0025	25KV
.0002	6KV	.002	10KV	.025	1.6KV	.0025	25KV	.00025	30KV	.0025	25KV	.00025	30KV	.0025	25KV
.0004	6KV	.03	2KV	.0025	30KV	.0025	25KV	.00025	30KV	.0025	25KV	.00025	30KV	.0025	25KV
.0008	6KV	.045	2KV	.0025	25KV	.0025	25KV	.00025	30KV	.0025	25KV	.00025	30KV	.0025	25KV
.01	4KV	.0001	20KV	.0039	20KV	.00025	20KV	.00025	20KV	.00025	20KV	.00025	20KV	.00025	20KV
.032	2KV	.00015	20KV	.0075	15KV	.00025	20KV	.00025	20KV	.00025	20KV	.00025	20KV	.00025	20KV
.04	1KV	.00025	20KV	.01	15KV	.00025	20KV	.00025	20KV	.00025	20KV	.00025	20KV	.00025	20KV
.051	1.5KV	.0004	20KV	.01083	12KV	.00025	20KV	.00025	20KV	.00025	20KV	.00025	20KV	.00025	20KV
.08	1.5KV	.00045	15KV	.03	8KV	.00025	20KV	.00025	20KV	.00025	20KV	.00025	20KV	.00025	20KV
.09	1.5KV	.00047	20KV	.056	5KV	.00025	20KV	.00025	20KV	.00025	20KV	.00025	20KV	.00025	20KV
.0001	10KV	.00095	5KV	.000155	30KV	.00025	20KV	.00025	20KV	.00025	20KV	.00025	20KV	.00025	20KV
.00015	10KV	.001	20KV	.0004	30KV	.00025	20KV	.00025	20KV	.00025	20KV	.00025	20KV	.00025	20KV
.0002	10KV	.0012	20KV	.000533	30KV	.00025	20KV	.00025	20KV	.00025	20KV	.00025	20KV	.00025	20KV
.0003	10KV	.00124	15KV	.001	30KV	.00025	20KV	.00025	20KV	.00025	20KV	.00025	20KV	.00025	20KV
.000375	10KV	.0015	20KV	.001	15KV	.00025	20KV	.00025	20KV	.00025	20KV	.00025	20KV	.00025	20KV
.004	5KV	.0051	10KV	(Many Others)		.00025	20KV	.00025	20KV	.00025	20KV	.00025	20KV	.00025	20KV

TRANSMITTING MICAS TYPE "4" and "9"

mfd.	kv	type	ea.	mfd.	kv	type	ea.
.0001	600	4	.36	.0015	600	4	.36
.003	600	4	.36	.0032	600	4	.42
.00005	600	4	.29	.002	600	4	.39
.00005	2500	9	.57	.002	1200	4	.72
.0001	600	4	.29	.0025	600	4	.39
.0001	2500	9	.57	.003	600	4	.43
.00015	600	4	.36	.004	600	4	.45
.0002	600	4	.29	.005	1200	9	.99
.00025	600	4	.29	.0047	600	4	.47
.0005	600	4	.29	.005	2500	9	1.86
.0005	2500	4	.75	.006	600	4	.54
.0005	2500	9	.77	.01	600	4	.65
.0006	2500	9	.85	.01	1200	9	1.41
.0007	600	4	.36	.02	600	4	.92
.00075	600	4	.36	.02	1250	9	2.12
.0008	600	4	.36	.025	600	4	1.08
.0009	600	4	.36	.03	300	4	.99
.001	600	4	.36	.03	600	4	1.34
.001	1200	4	.54	.043	600	4	1.75
.001	1200	9	.57	.05	300	4	1.19

Many other sizes in stock



TYPE "J" POTENTIOMETERS

TYPE "J"	TYPE "JL"	TYPE "JJ"
\$1.25	\$1.50	\$2.95
ohms 150*	ohms 4000†	ohms 80K†
200†	5000†	100K†
200*	6500†	125K†
300†	9000†	150K†
400†	10K†	165K†
500†	12K†	250K*
600†	15K†	300K*
650†	20K†	400K*
750†	25K†	1meg*
1000*	30K†	1meg*
1400†	50K†	2meg*
1500†	60K*	3meg*
2000†	75K*	

Type "JJJ" \$4.95

20K-200K†	75K-250K†	750K-750K†
45K-27K-2.5K 1/2 sh	80K-400K†	150K-150K†
700K-700K†	1meg-1meg†	250K-350K*
(*) 1/2" screwdriver slotted shaft. (†) Knob type shaft. (‡) Both types.	500K-35K†	2meg-2meg†
	25K-10K†	25K-25K†
	2000-20K†	10K-10K†
	25K-10K†	1meg-1meg†
	7K-1meg†	5K-5K†
	300K-400K†	400K-400K†
	25K-400K†	500K-500K†
	1meg-500K†	50K-50K†

Many other Hard-To-Get items available for immediate delivery from our large inventory. Send us your requirements and let us quote. New MICA listing now ready.

A. MOGULL CO.

17 Warren St., N. Y. 7, N. Y.
Phone: WORTH 4-0865-6431



B-7 PULL OUT LIGHT
(Cockpit Lamp)
\$2.25 each

For Aircraft, Boats, Cars and Workshops. Gives White or Red Light. Unit pulls out 6 feet from self-rewind reel. Any Voltage. Mounts Anywhere. Small Bakelite case 3 x 3 1/4 x 4 1/4.

SPECIAL OFFER

RHEOSTAT — 50 Watts 125 ohm W/Knob 1.15 ea.

CAPACITOR SPECIALS

Cat. #22F-391 1 MFD. 600 V DC. .75 ea.
Bathtubs ST CP-53 Case
Cat. #23F-154 1 MFD. 500 V DC. .45 ea.
Channels Oil Filled
Cat. #TJU-10010 1 MFD. 1,000 V DC Ceramic-Screw Term. .60 ea.
Cat. #21F-442 5 MFD. 330 V AC or 600 V DC .125 ea.
Cat. #26F-382 10 MFD. 600 V DC. 2.85 ea.
W/Brackets—Ceramic-Screw Term.

Full Line of Capacitors in Stock.

MOTOR SPECIALS

DIHLL PILOT MOTOR #802077 24 V DC 10,000 RPM\$2.95 ea.
BODINE #NSHG-12 27 V DC Governor Controlled Constant Speed 3600 RPM 1/30th HP 6.95 ea.
HUGHES — BOOSTER MOTOR 24 V DC Reversible 3.50 ea.
SELSYNS 2TJG1 7.50 ea.
2TJF3 7.50 ea.

RELAYS — SWITCHES — SWITCHETTES — BLOWERS — ALL TYPES — IN STOCK

All Merchandise Guaranteed New. Check With Us On Your Present and Future Requirements

Excess Inventories Purchased

NEW YORK ELECTRONICS

218 FULTON STREET NEW YORK 7, N. Y.
RECTOR 2-4137

BRAND NEW • FULLY GUARANTEED SENSITIVE MICROAMMETER

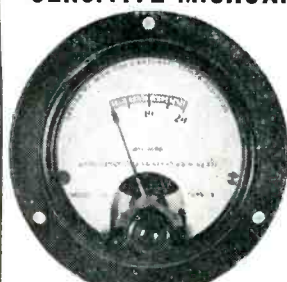

WESTON 301 Original Weston Boxes 0-20 Microamps DC

3 1/2" Round Flush Mount Bakelite Mfd. for Test Set TS402—No. 85400 \$9.95 FOB NY EACH Rates, Accounts 10 Days. Others 25% with Order. Balance COD

GREENWICH Sales Company Digby 9-3813

RELAY SPECIALISTS AUTHORIZED FACTORY DISTRIBUTORS

STRUTHERS-DUNN POTTER & BRUMFIELD

100,000 RELAYS

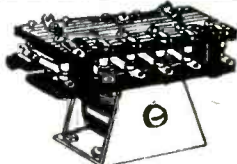

ALL TYPES

Six Pole DT Allied Relay\$6.95
4 Pole DT 24 VDC 3.95
3 Pole DT 24 VDC 2.95
Sigma 4F 8000 Ohm Coil 6.81
Sigma 5R Dual 100 Ohm Coil 4.95

RADIO DEVELOPMENT & SALES CO.
323 ATLANTIC AVE.—ULSTER 5-0488—BKLYN, 1, N. Y.

SPECIAL
6F5 METAL \$5.55

EMELTONE ELECTRONICS CO.
71 W. Broadway - N. Y. 7, N. Y. Phone REctor 2-1696

SPECIAL
VT 98 ENGLISH \$15.00
TYPE

Crystal Diodes

Standard Brands Only

SPECIAL PURPOSE TUBES

Receiving Tubes

Klystrons, Magnetrons

CRYSTAL DIODES	1B22	2.50	2J51	250.00	6AK5	1.00	371A	.85	730A	35.00	956	7.55	5702	4.45	
1N21A	1B23	7.00	2J55	80.00	6AN5	2.50	371B	.85	731A	4.50	957	.95	5704	1.90	
1N21B	1B24	12.00	2K22	30.00	6AN6	3.25	388A	3.00	801	2.10	958	2.50	5706	2.75	
1N21C	1B25	3.50	2M23	20.00	6AR6	2.75	393A	12.00	802	4.00	958A	1.00	5718	8.50	
1N22	1B27	13.00	2M25	28.00	6AS6	2.25	394A	4.00	803	4.00	1812	2.00	5719	11.00	
1N23	1B29	2.75	2K26	100.00	6AS7G	4.00	407A	5.50	804	16.00	1813	1.50	5720	6.25	
1N23A	1B32	3.25	2K28	33.00	CGJ	9.00	408A	3.00	805	3.00	1816	1.50	5722	3.90	
1N23B	1B35	9.00	2M29	28.00	6C21	22.00	417A	12.00	807	1.65	1819	6.00	5726	2.00	
1N25	1B42	9.00	2K39	100.00	6C24	55.00	434A	20.00	807W	11.50	1820	1.50	5734	16.00	
1N26	1B43A	60.00	2M41	150.00	10Y	.80	446A	2.50	808	2.25	1822	2.25	5734	3.25	
1N27	8.00	2M45	125.00	12A6	.65	450TH	50.00	809	3.50	1824	1.50	5735	1.50		
1N28	1P21	28.00	2X2	60.00	15E	2.00	450TL	50.00	810	11.50	1825	.30	5763	2.50	
1N31	1P28	10.00	3A5	1.10	15R	1.25	451	10.00	811	3.95	1826	.25	5814	3.80	
1N34	71	3B22	3.50	3B22	3.50	FC-17	8.00	468	26.00	1831	2.75	1830	1.50	5840	9.00
1N34A	71	2C26A	6.00	3B24	5.50	FX21	8.00	474A	3.00	812	3.00	1831	1.50	5863	14.00
1N35	2.20	3B24W	8.50	35T	6.00	502	6.00	502	73.00	813	11.50	1832	1.50	5878	1.65
1N38	1.10	2C39	20.00	3B25	6.50	RM60	2.50	527	15.00	814	3.75	1833	1.50	5881	3.00
1N40	11.50	2C39A	21.00	3B26	6.00	RM65	32.00	530	16.00	815	4.50	1841	1.50	6005	3.00
1N41	12.00	2C40	10.00	3B27	4.50	75TH	13.00	532A	3.50	816	1.50	1865	1.50	7193	6.75
1N43	1.75	2C43	17.50	3B28	4.50	100TH	11.50	375A	21.00	826	1.50	2050	1.50	8005	6.75
1N44	1.50	2C44	1.50	3C21	5.00	FC-172	25.00	600	7.00	828	12.00	2051	1.50	8008	7.10
1N45	6.00	2C46	30.00	3C24	1.50	211 Sp	1.25	602	9.00	829B	12.75	5516	7.20	8008	2.00
1N51	.50	2C50	9.00	3C31	6.00	GL-218	30.00	604	7.75	830B	4.50	5527	46.00	8013A	5.00
1N52	1.37	2C51	5.00	3C33	21.00	249B	7.00	614	3.50	832	7.00	5545	18.50	8014A	70.00
1N53	.90	2C53	13.00	3E29	18.00	249C	6.50	700A	24.00	832A	9.50	5559	27.00	8019	4.00
1N58	1.25	2D21	1.50	3E29	12.00	249R	4.00	700C	24.00	833A	13.00	5560	80.20	8020	2.25
1N60	.61	2E22	2.50	4X100A	40.00	249S	20.00	700D	26.00	834	3.00	5563	4.50	8025	4.50
2AP1	10.00	2E24	3.00	4-125A	25.50	250TH	20.00	701A	5.80	836	3.50	5581	2.25	8025	1.20
3AP1	10.00	2E26	3.40	4-150A	30.00	250TL	20.00	703A	5.50	837	1.45	5582	7.65	9002	1.90
3AP1A	12.00	2E27	3.50	4-250A	38.00	252A	28.00	705A	1.90	838	3.95	5585	150.00	9003	1.30
3BP1	6.00	2E36	3.50	4-500A	100.00	253A	20.00	707B	16.00	843	1.25	5633	11.00	9004	4.50
3CP1-5A	2.00	2J22	10.50	4B24	140.00	255B	130.00	708A	15.50	845	7.00	5634	11.50	9005	2.10
3CP1	5.50	2J26	15.00	4B25	5.75	258B	10.00	714A	15.00	851	55.00	5635	12.75	9006	.40
5BP1	5.00	2J27	20.00	4B26	8.50	304TH	9.00	715A	6.00	852	19.00	5636	8.00		
5CP1	6.00	2J31	30.00	4B28	10.00	304TL	9.50	715B	9.00	860	3.25	5638	10.50		
5FP7	2.90	2J32	30.00	4C27	6.00	307A	4.00	715C	28.00	861	26.00	5645	44.85		
5GP1	5.20	2J33	25.00	4C35	38.00	316A	2.50	717A	1.20	864	4.00	5651	2.50		
5LP1	20.00	2J34	25.20	4E27	26.00	319A	21.00	719A	28.00	866A	1.65	5654	2.00		
7BP7	8.00	2J36	113.00	4D32	31.00	323B	11.00	721A	4.00	869B	60.00	5657	200.00		
OA2	1.00	2J38	15.00	4J52	300.00	327A	4.00	721B	6.00	872A	3.50	5672	1.40		
OB2-VR75	1.10	2J39	14.00	5C22	47.50	328A	8.00	723A/B	20.00	876	1.35	5675	17.00		
OB2	.90	2J40	38.00	5D21	16.50	332A	45.00	724B	2.00	884	1.75	5676	1.25		
OB3-VR90	.95	2J42	125.00	5J26	150.00	350A	8.00	725A	10.00	885	1.75	5678	1.25		
OC3-VR150	.90	2J48	45.00	5R4G	1.50	358B	8.00	726A	14.00	931A	5.00	5683	9.80		
1B21A	2.50	2J49	63.00	6AK5W	2.00	355A	21.00	726B	49.00	954	.45	5686	4.50		
						357A	19.00	726C	69.00	955	.67	5687	4.00		

PRICES SUBJECT TO CHANGE

ALL ITEMS SUBJECT TO PRIOR SALE

WRITE, WIRE OR PHONE

Above listing is only partial. Inquire if your items are not listed.

ATT. EXPORTERS & FOREIGN AGENCIES

Special prices for quantities. Cash paid for your SURPLUS TUBES. Send list and prices.

K-RK-ARC-UG-PL-AN

CONNECTORS

In Stock for Immediate Delivery

Connector Corporation

OF AMERICA

137 Hamilton St., New Haven 11, Conn. Phone: Spruce 7-2513

New York Phone: LExington 2-6254

MARITIME INTERNATIONAL COMPANY

11 STATE STREET NEW YORK 4, N. Y.
Cable Address: Foxcroft Telephone: Digby 4-3192

Your Reliable Source of Supply For

SPECIAL PURPOSE & TRANSMITTING TUBES

This Month's Special:

Westinghouse 8013A @ 3.95 ea.

CONDENSERS (Match Stick)

.01, .001, .002 & .004 MFD.

Large Quantity

\$8 per M. Quantity discounts.

SAMUEL KASS, INC.

46 Cooper Sq. NY 3

GR 7-9881

FOR SALE

Teletype Terminal Equip. AN/FGC-1

Gen. Radio Type 1105A Freq. Measuring Equip.
Measurements #78E Signal Generator
Hewlett-Packard #610 RF Generator

FS-9179, Electronics

330 W. 42 St. New York 36, N. Y.

TELEPHONE RELAYS



Large Stock of

CLARE, TYPES C D & E
COOKE, AUTOMATIC-ELECTRIC

ALL TYPES OF COILS and PILE-UPS

Send Us Your Specs. for Our Quote

CLARE TYPE C STANDARD SIZE SENSITIVE TELEPHONE RELAYS

Coil	Contacts	Will Close at	Price
1) 6500 ohms 1A	4	4 MA	\$2.25 ea.
2) 6500 ohms 1C	3	4 MA	3.00 ea.
3) 6500 ohms 1B-1C	3.5	4 MA	2.75 ea.
4) 6500 ohms 2A	4	4 MA	3.00 ea.
5) 6500 ohms 4A	4	4 MA	3.00 ea.
6) 6500 ohms 3A-1B	4	4 MA	3.00 ea.
7) 6500 ohms 5A	5	4 MA	3.25 ea.

CLARE TYPE G HALF SIZE SENSITIVE TELEPHONE RELAYS

Coil	Contacts	Will Close at	Price
1) 6500 ohms 2A	5	5 MA	\$2.50 ea.
2) 5800 ohms 3A	4	4 MA	2.50 ea.
3) 5800 ohms 2B-1C	5	5 MA	2.50 ea.
4) 4850 ohms 1C	4	4 MA	2.50 ea.
5) 3600 ohms 1C	6	6 MA	2.00 ea.
6) 4350 ohms 1A	5	5 MA	2.00 ea.
7) 1300 ohms (None)		ACTUATOR	1.50 ea.

All above Relays may be used for continuous duty operation on 110V. D.C.

OTHER TYPE G TELEPHONE RELAYS

1) 1300 ohms 1A-1C	24 or 48V.	\$2.50 ea.
2) 400 ohms 1A	12 or 24V.	1.65 ea.

CONTACT SYMBOLS

A=Norm. Open B=Norm. Closed C=S.P.D.T.

G.E. Relays #CR2791-B109P36 Coil-10,000 ohms
Contacts 1A, 1B Operates on 8 MA... Price \$1.65
Signal Wheelock Relays #KS9665 Coil-2,000 ohms
Contacts-1A, 1B, 1C Oper. at 9 MA Price-\$2.75 ea.
Leach Relays Type 1025-SN-BF. Coil-24V. 425
ohms. Contacts-D.P.S.T. Norm. closed. Rated
at 10 Amps... Price-\$1.50 ea.
FIVE Prong CR-2791 G.E. Plug In Relays.
1) C-103C25 2200 ohms SPDT 4.5 MA... \$4.00 ea.
2) C-104B28 700 ohms SPDT 6 MA... \$3.00 ea.

CLARE TYPE A Tel. Relay. Coil-55 Volts AC
60 cy. Contacts-3PDT (3 form C) Price-\$3.50 ea.

Clare SK-5032 (Hermetically Sealed) Plug-In
Relays. Coil-30 ohms 6 volts Contacts-DPDT.
Price-\$4.00 ea.

SIGMA TYPE 5F SENSITIVE RELAYS. Has two
70 ohm coils. Contacts-SPDT... Price-\$3.00 ea.

TYPE H TRANSMITTING MICA CONDENSERS

1) .003 MFD	2500v.	DCW	\$4.45 ea.
2) .01 MFD	1200v.	DCW	.45 ea.
3) .001 MFD	1200v.	DCW	.35 ea.

Chase

Electronic Supply Co.
222 Fulton St.
New York 7, N. Y.
Digby 4-3088
Hollis 4-5033

A S S O C I A T E D R A D I O E N G I N E E R S



C-79331 - TRANSMITTER - 115V
60 Cy. Delco, New, Limited Quantity
Order Now. Wt. 11 lbs **\$11.95**

5B Motor - 115/90V - 60 Cy.....	\$25.00
5CT Cont. Tr. - 90/55V - 60 Cy.....	45.00
5DG Dif. Gen. - 90/90V - 60 Cy.....	40.00
5F Motor - 115/90V - 60 Cy.....	45.00
5G Gen. - 115/90V - 60 Cy.....	45.00
5N Mtr. - 115/90V - 60 Cy.....	25.00
6CT Cont. Tr. - 90/55V - 60 Cy.....	60.00
6G Gen. - 115/90V - 60 Cy.....	55.00
6SG Gen. - 115/90V - 60 Cy.....	55.00
7DG Dif. Gen. - 90/90V - 60 Cy.....	65.00
7G Gen. - 115/90V - 60 Cy.....	75.00
C-56701 Repeater - 115V 60 Cy.....	22.50
C-69406 Repeater - 115V 60 Cy.....	22.50
C-78248 Trans. - 115V - 60 Cy.....	25.00
C-78249 Dif. Gen. - 115V - 60 Cy.....	7.50
C-78386 Trans. - 115V - 60 Cy.....	22.50
81E - 113-2 G.E. Mtr. 115V 60 Cy.....	22.50
81E - 123-2 G.E. Mtr. 115V 60 Cy.....	22.50
Type A Bendix - 115V 60 Cy.....	22.50
Type AA Henschel 115V-60 Cy.....	22.50
Type M Bendix Mtr. 115V-60 Cy.....	22.50
Type MS Henschel 115V 60 Cy.....	22.50
1CT Cont. Trans. 90/55V 60 Cy.....	65.00
1N Mtr. - 115/90V - 60 Cy.....	45.00
2J1F1 Gen. 115/57.5V - 400 Cy.....	10.00
2J1G1 Gen. 57.5/57.5V - 400 Cy.....	5.75
2J1H1 Dif. Gen. 57.5 - 400 Cy.....	12.50
2JDSJ1 Mtr. - 220V - 60 Cy.....	50.00
2J5A-2 Gen. - 115/105V - 60 Cy.....	25.00
2J-5F1 Cont. Tr. 105/55V-60 Cy.....	45.00
2J5L1 Cont. Tr. 105/55V-60 Cy.....	45.00
2J5LA1 Gen. 115/105V - 60 Cy.....	25.00

2J-151 Selsyn Generator G. E.
57.5/57.5V - 400 Cy. \$9.95 per Pair



MG-149F Holtzer Cabot
In: 28V DC 36A
Out: 26V 400 Cy. 500 VA SP.
115V 400 Cy. 750VA SP...\$ 65.00

MG-149H Holtzer Cabot
In: 28V DC 44A
Out: 26V 400 Cy. 250 VA SP
115V 400 Cy. 500VA SP...\$125.00

MG-153F Holtzer Cabot
In: 28V DC 52A
Out: 26V 400 Cy. 250VA SP
115V 400 Cy. 750 VA Thp...\$125.00

10285 - Leland
In: 27V DC 60A
Out: 26V 400 Cy. 50VA SP
115V 400 Cy. 750VA Thp...\$ 90.00

104685 - Leland
In: 27.5DC 12.5A Cont. Duty
Out: 115V AC 400 Cy. 175VA
80PF Thp\$ 90.00

11702 or 10563 - Leland
In: 28 1/2V DC 12A
Out: 115V 400 Cy. 115VA Thp...\$ 75.00

PE - 109 - In: 12V DC 29A
Out: 115V AC 200VA
400 Cy SP\$ 65.00

PE - Leland - In: 28V DC 38A
Out: 500V 800 Cy. 500VA SP
80V 800 Cy. 500VA SP...\$ 40.00

PU-7 Wincharger - In: 28V DC 160A
Out: 115V 400 Cy. 2500VA SP...\$ 90.00

PU-16 Wincharger - In: 28V DC 60A
Out: 115V 400 Cy. 6.5A SP...\$90.00

PE-218 - Leland - Wincharger - G.E.
In: 28V DC 92A. Out: 115V
380/500 Cy. 1500VA SP...\$40.00

778-B Bendix - In: 24V DC 250VA
Out: 26V 400 Cy. 60VA SP
115V 400 Cy. 190VA SP...\$ 65.00

800-1 Bendix - In: 24V DC 75A
Out: 115V AC 800 Cy.
10.5A SP\$ 40.00

12116-2A Pioneer - In: 24V DC 5A
Out: 115V 400 Cy. 45W SP...\$ 65.00

12117-2A Pioneer - In: 24V DC 1A
Out: 26V 400 Cy. 6VA SP...\$ 27.50

12117-6B Pioneer - In: 28V DC 0.8A DC
Out: 26V AC 6VA 400 Cy. SP...\$ 27.50

12126-2A Pioneer - In: 27.5V DC 1.25A
Out: 26V 400 Cy. 10VA Thp...\$ 35.00

12130-4B Pioneer - In: 28V DC 12.18A
Out: 125V 400 Cy 141VA S Ph...\$ 75.00

We maintain an extensive stock of RADAR, ELECTRONIC, and PRECISION TEST EQUIPMENT. Your inquiries given immediate attention. All equipment is unconditionally guaranteed.

A DIVISION OF
Arnold A. Semler, Inc.
6855 TUNJUNGA AVENUE
NORTH HOLLYWOOD, CALIF.

HERE'S YOUR GUIDE TO SATISFACTION

TRIPOLI from new Headquarters gives you Immediate delivery on all stock items



Push Button Switches. Oak #32P055. 4 Button type, spaced 3/4" 3-7/8" Mounting centers\$1.25
Button

#1 DPST #2 DPST
#3 (2) SPST (2) SPDT w/followup shorting shoe SPST
#4 (3) SPDT w/SPST ON when button is in out position



Miniature I.F. COILS F.W. Sickles & K-Tron 10.7 MC Ratio Detectors Size 3/4" x 3/4" x 2", \$3.40 each (\$250.00/M)

CAPACITORS. Ceramic: 120 MMFD. 1500V, Durez Coated N750 Temp. Cof. 5% tol.\$18.00/M

CAPACITORS. Ceramic: 100 MMFD, CC30. 500V, N750 Temp. Cof. 10% tol.\$31.00/M

CAPACITORS. Ceramic: 20 MMFD, CC20. 500V, NPO Temp. Cof. 10% tol.\$35.00/M

CAPACITORS: 2.2 MMFD, Discap, general purpose (G.M.C.), 500V, 25 MMFD tol.\$28.00/M

PADDERS. High Capacity, Compression type: 1000-3000 MMFD.....\$32.00/M

PADDERS. High Capacity. Compression type: 1500-4500 MMFD\$36.00/M

SOCKETS. Howard B. Jones: #S-406-FHE. \$.25 ea. **SOCKETS.** Howard B. Jones: #S-2412\$.25 ea.

TRANSFORMERS: (Power) 115V. 400cy. Pri. 27V. 4.3 amp; Sec. 6.3V. 2.9 amp; Sec. 1.25V. 20 amp. Sec. Sig. Corp. #2Z9613-112 WE #KS-8984.\$1.25

TRIMMERS: 2-7 MMFD. Tubular, Ceramic, Centralab type #829.\$38.00/M

TRIMMERS: 1-4 MMFD. Tubular, Ceramic, Centralab type #829.\$28.00/M

"FORMERLY THE TRIMAR CO."

4x150A Eimac Tubes \$28.00 ea.

TRIPOLI ELECTRONICS COMPANY

3415 W. MADISON ST. CHICAGO 24, ILLINOIS
Telephone - VAn Buren 6-0232

WE BUY all new surplus at a fair price to you. Send us your inventory of surplus equipment. HUNDREDS of other items not on this list are available—let us know your requirements, we may have just the items you need.

Your Best Source of Supply in Jan Type Special Purpose & Receiving TUBES

OC3/VR10595	9GP7	7.50
OD3/VR15085	RK60/1641	1.75
1B22	1.75	211/VT4C49
1B24	7.95	304TL	7.75
1B25	2.50	310A	3.50
1B32/532A	2.25	321A	3.00
1P23	4.00	715B	7.50
2C39A	12.50	715C	15.00
2C42	7.50	801A/VT6229
2C46	7.50	84350
2J54	47.50	860	2.75
2K22	35.00	872A	3.15
2K23	27.50	921	1.75
2K54	99.50	931A	4.25
2K55	99.50	95435
2x2/87945	95535
3DP1	3.50	95735
3E29	9.50	1624	1.25
3CP1	3.50	162539
6C21	18.00	164449
7BP7	5.00	900425

CRYSTAL DIODES

1N23A	2.50
1N23B	2.75
1N26	7.50

ATTENTION: Purchasing Agents. Send us your inquiries on any type tubes, quotations and availabilities IMMEDIATELY upon request. Above is only PARTIAL LISTING ONE MILLION TUBES FOR SALE RECEIVING AND TRANSMITTING TYPES. F.O.B. N.Y.C.

ALLIED ELECTRONIC SALES
74 Cortlandt Street New York 7, N. Y.
Phone—Barclay 7-5839—5840

FOR SALE

RCA RADIO FREQUENCY GENERATOR

Model 15 BH with or without aluminum heating oven. Good as new. Immediate delivery.

FS-9012, Electronics
520 N. Michigan Ave., Chicago 11, Ill.

CONNECTORS

AN-UG

LARGE INVENTORY

ROSE ELECTRONICS, INC.

76 VESEY ST.
New York 7, N. Y. * CO 7-6195

FOR SALE—VERICON

Industrial television system. Almost new, used only 230 hours. Camera, monitor, and power back. Original cost \$8500.00 but will sell at sacrifice.

AUDICON TELEVISION CORPORATION
7 Whitney Avenue New Haven, Conn.
Phone: LOcust 2-3836

"SEARCHLIGHT"

IS

Opportunity Advertising

—to help you get what you want.
—to help you sell what you no longer need.

Take Advantage Of It

For Every Business Want

"Think SEARCHLIGHT FIRST"



WESTON 433

**High Frequency A.C. Voltmeter
Portable Laboratory Standard**

Frequency Range from 25 to 2400 Cycles, for 0-150 Volts. Manufactured by Weston to an accuracy of 1/4% of 1% from 25 to 1000 cycles, and within 1 1/4% up to 2400 cycles.

The most commonly used ranges are 60 and 400 cycles and we have tested each one against Primary Standards and guarantee that these ranges are accurate within 1/4% of 1%.

Knife edge pointer; hand calibrated mirror scale; shielded iron vane movement; Resistance approx. 2800 ohms; scale length 4.04" in case 5" x 6" x 3 1/2". (Sim. to illust.)

BRAND NEW—SURPLUS—GUARANTEED
Only 59 in Stock

List Price Approx. **\$70.00**
YOUR NET COST FOB NYC **\$45.00**

MARITIME SWITCHBOARD
Instrument & Accessories

336 CANAL STREET, NEW YORK 13, N. Y.
WOrth 4-8216 (7)

IMMEDIATE DELIVERY

NEW — AN/APR4 — USED

RECEIVERS

With following TUNING UNITS
in stock—TN16-17-18-54

Write for prices

- | | |
|-----------------|-----------------|
| APS3 components | TS184/APS13 |
| BC1306 | TS251 |
| PE237 | EE8 Telephones |
| BC433G | BC314 |
| MG153 | BC342 |
| BC1033 | SCR714 (BC1137) |
| APS13 | Dynamotor DM28 |
| SCR269F & G | DY9 |
| APR2 | BC376 |
| SCR625 | RA52 |
| SCR 508 crystal | CRT3 |
| 350 ft. RG 54U | MP10 |
| cable | LP21LM |
| TS10 | BC1277 |
| TS16 | BC1287 |
| TS59 | IE19A |
| TS69 | MN26C-LB-Y |
| TS 100/AP | RA10DA-DB |
| TS127 | MR9B |
| TS159/TPX | AN/CPN3 |

We buy any electronic material at top prices!

Write for our new 1953 Catalog!

Shipments FOB warehouse. 20% Deposit on orders. Minimum order \$5.00. Illinois residents, add regular sales tax to remittance. Prices subject to change without notice.

R W ELECTRONICS

Dept. EL, 1712-14 S. Michigan Ave.
Chicago 16, Ill.
PHONE: HArrison 7-9374

COILS

RF-IF Sub-assemblies
Production & Special Test Equipment
AN/APR-4 Receivers & Parts
JERRELL ELECTRONIC, INC.
1970 Neva Dr. Dayton 4, Ohio
ORegon 1351

X-RAY

All types for industrial and experimental application. Tubes, cables and components.
MEDICAL SALVAGE CO., INC.
217 E. 23rd St., New York 10, N. Y.
Murray Hill 4-4267

POWER TUBES REBUILT

UNIVERSAL VACUUM TUBE CORP.
137 Alexander Ave., Yonkers 2, N. Y.

**WHEN YOU ORDER
WELLS
COMPONENTS...**



HERE'S WHAT YOU GET

- 1 IMMEDIATE DELIVERY FROM STOCK (in any quantity)
- 2 FINEST QUALITY OF FAMOUS BRANDS
- 3 GENERALLY LOWER PRICES
- 4 RETURN PRIVILEGE FOR FULL CREDIT IF NOT SUITED TO YOUR REQUIREMENTS

The valuable service Wells provides to the industry is being used by many of our greatest manufacturers as a matter of course.

Our vast stock (the world's largest) may contain just the components you need to fill urgent orders — at a substantial savings in time and cost.

ADEL CLAMPS • ANTENNAS Insulators, Mast Sections • BINDING POSTS • BLOWERS • CABLE ASSEMBLIES • CHOKES • COILS • CONDENSERS Oil Filled, Bathub, Hearing Aid, Transmitting Miccas, Silver Miccas, Ceramic, Variable, Trimmer • CRYSTALS • FILTERS • FUSES & MOUNTINGS • GENERATORS • GROUND RODS • HEADSETS • I.F. COILS • JACKS • JACK BOXES • KEYS, Telegraph KNOBS • LAMPS • LORD MOUNTS • LUGS MOTORS & BRUSHES • PLUGS • RECTIFIERS Selenium, Copper Oxide, Meter, Diode • RESISTORS—All Types • SELSYNS • SOCKETS • SWITCHES Aircraft, Micro, Switchettes, Toggle • TIMERS • TUBING—Flexible • TUNING SHAFTS • TRANSFORMERS All Types • VIBRATORS • WALKIE TALKIES

DYNAMOTORS

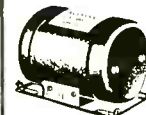

OVER 100,000
NEW DYNAMOTORS
IN STOCK!

DM 32A — DM 53A — PE 86 — PE 101C
DM 33A — D 101 — PE 94, etc.
Large quantities of brushes for all types of dynamotors and motors.

Write us for quotations. Advise us your requirements.

A complete Signal Corps stock number listing of items in our stock. Write for listing No. SG-200. (For government agencies and contractors only.)

Manufacturers and distributors—write for new Condenser Catalog C-10 now available.

Write, Wire, Phone Your Requirements
all phones: **SEeley 8-4143**

WELLS SALES, INC.

833 W. CHICAGO AVE., DEPT. 5L, CHICAGO 22, ILL.

IN STOCK
FOR IMMEDIATE DELIVERY

BRAND NEW JAN-C-25 CAPACITORS

CP53—CP54—CP55
CP61—CP63—CP65
CP67—CP69

Every "E" & "F" Characteristics
Item Listed In Jan-C-25

ALSO

CP70 CAPACITORS
"E" & "F" Characteristics
600 and 1000 Volts
"B" and "E" Terminals

O'DEL ELECTRONICS CORPORATION

293 WEST BROADWAY
NEW YORK 13, N. Y.
CANAL 6-4700

EXCELLENT OPPORTUNITIES FOR GRADUATE ENGINEERS

Electronic & Mechanical

Experience in Design and Development of Radar and Sonar necessary.

Senior Engineers with Degree or equivalent and at least 5 years experience in any one of following fields: Microwave, circuit design, filter network design, precision components (capacitors - resistors), and communications.

Broad knowledge of Search and Fire Control Systems; Servo Mechanisms, Special Weapons, Microwave, Antennas and Antenna Mounts, etc. Mechanical Engineer should also have experience in packaging of Electronic Equipment to Gov't. specifications including design of complex cabinets, shock mounts and sway brace structures.

Field Engineers

Qualified to instruct in the operation and supervise installation, maintenance and repair of Radar, Sonar and allied electronic equipments in the Field.

Senior engineers with degree or equivalent of at least 5 years experience in flight simulators, radar and sonar trainers.

A chance to grow with a young and progressive company; salary and advancement commensurate with ability; liberal vacation, sick leave, 9 paid holidays, group life, sickness and accident insurance plans, and a worthwhile pension system.

STAVID ENGINEERING, INC.

PERSONNEL: 312 PARK AVENUE

PLAINFIELD, N. J. - PL. 6-4806

ELECTRONIC ENGINEER OR PHYSICIST

MS in electrical engineering or physics with wide general electronic experience and particular skill in digital computation for responsible position in Research and Development Department.

Duties will involve the research and development of special electronic apparatus, servomechanism, control devices and other special instrumentation necessary for the conduct of chemical and engineering operations. In addition, will exercise general operating and maintenance supervision over a digital computer of advanced design and other major electronic equipment.

Permanent position with good promotional possibilities. Salary commensurate with experience and demonstrated ability.

Please give details of education, experience, and salary desired.

The ATLANTIC REFINING COMPANY
Salaried and Technical Section
Plant Personnel Division
3144 Passyunk Avenue
Philadelphia 1, Pennsylvania

STAFF EDITOR

Must be graduate engineer (electronics). Industry experience essential. Aptitude for technical reporting desirable. Mail resume, requirements to

W. W. MacDonald, Editor
ELECTRONICS
330 W. 42nd St.,
New York 36, N. Y.

WANTED

1. Commercial receiver, Hammerlund SP-600 LX or similar
2. Power amplifier, General Radio 1233A
3. Coax Kit, General Radio 874-EX
4. Precision audio oscillator, Hewlett Packard
5. Vacuum tube voltmeter, RCA Voltomyst
6. Regulated power supply, Packard D type 710A

Items may be used but must be in excellent condition. Other makes and similar equipment acceptable.

In reply, state exact model, serial numbers and age.

W-8880, Electronics
1111 Wilshire Blvd., Los Angeles 17, Calif.

ELECTRONIC TUBES URGENTLY NEEDED

CASH PAID FOR:

Radio, TV, Special Purpose, all types, small and large quantities. State types, quantities, prices.

WRITE NOW to

W-9166, Electronics
330 W. 42 St., New York 36, N. Y.

WILL BUY

All ART-18/type T-47A \$200.00; ART-18/type T-47, \$150.00; BC-348 unmodified \$65.00, BC-348 modified \$50.00; APN-9 \$200.00; ARC-3 complete \$600.00; R77 Receivers \$300.00; ARC-1 \$300.00; BC-312 \$60.00; BC-342 \$60.00.

Ship via Express C.O.D., subject to inspection to:
H. FINNEGAN
49 Washington Ave. Little Ferry, N. J.

HIGH VACUUM EQUIPT.

FORE PUMPS—DIFFUSION PUMPS
VACUUM COATERS—MISC. EQUIPT.

Some new REASONABLE. Write for list
ZENITH OPTICAL LABORATORY
1940 Great Neck Rd. Copiague, L. I., N. Y.

PEAK FOR VALUE

SORENSEN VOLTAGE REGULATED POWER SUPPLY

Model 500-S. 95 to 125 Volts Input, 50 to 70 cy. Output Regulated to 115 Volt at .5 KVA. Complete With Tubes... 69.97

CERAMIC CASED MICA

.0025 MFD, 25,000 VDC, 22 Amps at 3000 KC. Type G4... 27.57

BLOWER MOTOR

Squirrel Cage, Redmond, 115 V 60 Cycle Motor, 140 CFM. Silent Operation. Brand New... 6.97

HEINEMANN CIRCUIT BREAKER

115 V 60 Cycle Coil, Trips at 5 Amps. S. P. Brand New... 97 ea., 10 for 8.97

PANEL METERS

NEW GOV'T SURPLUS STANDARD BRANDS 2" METERS

DB meter—10 to +20... 53.49
0-500 mg DC... 3.49
0-200 Microamps... 6.95
0-400 Microamps... 5.95
0-600 Microamps... 5.95
0-150 Milliamps... 4.50
0-200 Milliamps... 4.50
0-1000 Milliamps... 4.50
0-150 V. DC (1 MA)... 4.95
0-1.5 Volts AC... 4.95
0-3 Volts AC... 4.95
0-200 Microamps... 58.95

OIL CONDENSER BARGAINS

4 MFD 600 VDC... 5.97
10 MFD 600 VDC... 1.77
2 MFD 1500 VDC... .97
4 MFD 1500 VDC... 2.57
6 MFD 1500 VDC... 2.97
8 MFD 1500 VDC... 3.57
4 MFD 2500 VDC... 5.97
2 MFD 4000 VDC... 5.27
3 MFD 4000 VDC... 5.97
100 MFD 4000 VDC... 47.57
1 MFD 5000 VDC... 2.97
2 MFD 5000 VDC... 5.97
2 MFD 12,500 VDC... 29.97
25 MFD 25,000 VDC... 17.97
5 MFD 25,000 VDC... 26.97

1 Megohm, 1% W. W. Precision RESISTORS. SHALLCROSS. ONLY... 97c ea., 10 for \$8.95

NON-INDUCTIVE RESISTORS 59c
Ohmite, 250 Ohm, 100 Watt. Special, 5 for \$2.50

Min. Order \$3.00—25% with Order

PEAK ELECTRONICS CO.

66 West Broadway, New York 7, N. Y.
Phone WOrth 2-5439

5 J 33

MAGNETRON TUBES

Mfr. FTR. Cond. New
Large Quantity
Price \$22.50 ea.

TYPE 207

CLASS "B" MODULATOR

Mfr. RCA Cond. New
Price \$150.00

att; Pur. Agnts
Stock Control Mgrs.
Materiel Coordinators

We are specialists in terminated government inventory purchasing. No Hemming . . . No Hawing . . . We give you immediate market price or better for all electronic surplus.

Call . . . wire . . . write . . .

CADISCO

1005 W. North Ave.
Baltimore 17, Md. Phone LA 3-4045

\$2.95 EACH or 2 for \$5.00



Upright Telephone complete with cord in Tested and Guaranteed condition. For inter-communication or extension. Complete list of telephone parts, inter-communication sets, switchboards, handsets, magneto and dial telephones, etc. Write for list. F.O.B. Simpson, Pa. C.O.D. Shipments accepted.

TELEPHONE ENGINEERING CO.
Dept. 18 Simpson, Pa.

WE HAVE THE LARGEST STOCK OF MILITARY EQUIPMENT IN THE WORLD. ALL EQUIPMENT RECONDITIONED AND CHECKED OUT TO ORIGINAL SPECIFICATIONS IN OUR OWN COMPLETELY EQUIPPED SHOP

RADAR-COMMUNICATIONS-TEST EQUIPMENT

- | | | |
|-----------------------------------------------------------------------------------------------------------------------------------------------------------------------------------------------------------------------------------------------------------------------------------------------------------------------------------------------------------------------------------------------------------------------------------------------------------------------------------------------------------------------------------------------------------------------------------------------------------------------------------------------------------------------------------------------------------------------------------------------------------------------------------------------------------------------------------------------------------------------------------------------------------------------------------------------------------------------------------------------------------------------------------------------------------------------------------------------------------------------------------------------------------------------------------------------------------------------------------------------------------------------------------------------------------------------------------------------------------------------------------------------------------------------------------------------------------------------------------------------------------------------------------------------------------------------------------------------------------------------------------------------------------------------------------------------------------------------------------------------------------------------------------------------------------------------------------------------------------------------------------------------------------------|---------------------------------------------------------------------------------------------------------------------------------------------------------------------------------------------------------------------------------------------------------------------------------------------------------------------------------------------------------------------------------------------------------------------------------------------------------------------------------------------------------------------------------------------------------------------------------------------------------------------------------------------------------------------------------------------------------------------------------------------------------------------------------------------------------------------------------------------------------------------------------------------------------------------------------------------------------------------------------------------------------------------------------------------------------------------------------------------------------------------------------------------------------------------------------------------------------------------------------------------------------------------------------------------------------------------------------------------------------------------------------------------------------------------------------------------------------------------------------------------------------------------------------------------------------------------------------------------------------------------------------------------------------------------------------------------------------------------------------------------------------------|-----------------------------------------------------------------------------------------------------------------------------------------------------------------------------------------------------------------------------------------------------------------------------------------------------------------------------------------------------------------------------------------------------------------------------------------------------------------------------------------------------------------------------------------------------------------------------------------------------------------------------------------------------------------------------------------------------------------------------------------------------------------------------------------------------------------------------------------------------------------------------------------------------------------------------------------------------------------------------------------------------------------------------------------------------------------------------------------------------------------------------------------------------------------------------------------------------------------------------------------------------------------------------------------------------------------------------------------------------------------------------------------------------------------------------------------------------------------------------------------------------------------------------------------------------------------------------------------------------------------------------------------------------------------------------------------------------------------------------------------------------------------------------------------------------------------------------------------------------------------------------------------------------------------------------------------------------------------------------------------------------------------------------------------------------------------|
| <p>APS-2 8-band search radar
 APS-3 X-band search & homing radar
 APS-4 X-band search & homing radar
 APS-6 X-band search & gunlaying radar
 APS-10 X-band search & navigation radar
 APS-15 X-band navigation & blind bombing radar
 SO-13 8-band marine radar
 SO-10 CM portable radar
 TFS-1 portable search radar
 TFS-3 long range early warning ground radar
 VC-VE-VF-VG remote PPI radar indicator
 UPN-1&2 8-band paratroop radar beacon
 SCR-602 early warning portable radar
 APN-19 airborne 8-band radar beacon
 APQ-5 low alt. bombing attachment
 APA-10 Panoramic adaptor
 APA-11 pulse analyzer used with APR equip.
 APA-17 automatic bearing indicator used with A.P.I. equip.
 APA-23 automatic sig. strength & time recorder
 APA-38 panoramic adapter 30 MC input used with APR equip.
 APR-1 radar search rec. 28-1000 MC
 APR-2 radar search rec. 85-1000 MC
 APR-4 radar search rec. 38 4000 MC
 APR-6 radar search rec. 1000-3100 MC
 APR-6 radar search rec. 6000-10000 MC
 APT-4 radar jammer 165-780 MC
 APT-5 radar jammer uses 3C22 osc.
 APN-9 airborne loran
 APN-8 10 CM high pwr. ground radar beacon
 APN-1 altimeter
 CRT-3 dual freq. victory girl
 PPN-1 Rebecca transponder used with APS's</p> | <p>ARQ-5 automatic panoramic rec. 18-80 MC
 ARN-7 automatic radio direction finder
 SCR-555 direction finder 18-65 MGS
 SCR-284 portable field radio station
 AN/TRC-2 remote control equipment
 SCR-619 freq. mod. field radio 120 channel
 AN/ARC-1 radio tele. trans./rec.
 SCR-522 V.H.F. trans./rec. 100-156 MCS
 SCR-269G automatic R.D.F.
 AN/ARN-7 automatic R.D.F.
 SCR-291 radio direction finder
 AN/TRC-1 V.H.F. radio tele. relay station
 RC-261 radio remote control with RM-63 52
 BC-639 rec. 100-156 MC with RA42 power supply
 BC-902 port. marker beacon xmitter 75 MGS
 RC-103 instru. landing system
 SCR-718C high altitude radio altimeter
 SCR-536 handi-talkies 3-6 MC batt.
 AN/CRC-7 V.H.F. handi-talkies 112 MC
 BC-191 transmitter
 BC-325 airport high pwr. xmitter
 BC-640 xmitter 100-156 MC 50 watt
 DAK automatic direction finder marine
 RAK-7 rec. w/p. a. 15-500 KC 110 v. 60 cyc.
 TCS marine equipment 1.5-12 MGS
 BC-348 rec. 1700 KC-18 MC & 200-400 KC
 BC-342 rec. 1700 KC-18 MC 115 v. 60 cyc.
 TS- 3/AP 8-band pwr. & freq. mtr.
 TS- 10/AP altimeter test set
 TS- 12/AP X-band VSWR test set</p> | <p>TS- 13/AP X-band sig. gen. pwr. & freq. mtr.
 TS- 14/AP 8-band sig. gen. & pwr. mtr.
 TS- 15/AP busmeter
 TS- 16/AP altimeter test set
 TS- 23/AP SCR-718 test set
 TS- 24/ARR2 test set
 TRC-1 test oscillator
 TS- 33/AP power test meter
 TS- 34/AP portable synchroscope
 TS- 35/AP X-band sig. gen. pwr. & freq. mtr.
 TS- 36/AP X-band pwr. mtr. batt. oper.
 TS- 45/AP X-band sig. gen. pwr. freq. mtr.
 TS- 56/AP L-band slotted line
 TS- 59/AP altimeter test set
 TS- 61/AP 8-band echo box
 TS- 62/AP X-band echo box
 TS- 67/AP R.F. L.S. test set
 TS- 69/AP cavity type freq. mtr. 400-1000 MC.
 TS- 89/AP pulse voltage divider
 TS- 98/AP precision range calibrator
 TS- 102/AP 8-band wave meter
 TS- 111/AP APB radar test set
 TS- 112/AP APB radar test set
 TS- 125/AP 8-band precision pwr. mtr.
 TS- 127-U freq. meter 300-750 MC
 TS- 148/UP 3 CM spectrum analyzer
 TS- 155/UP 8-band sig. gen. pwr. freq. mtr.
 TS- 170/ARNS L.L.S. field test set
 TS- 184/AP echo box & attenuator
 TS- 226/AP pwr. mtr. 300-1000 MC to 1 KW peak
 TS- 268/UP crystal diode test set
 I-100 radio compass test set
 I-208 tank radio test set
 CW-60/ABM 8-band freq. meter
 BC-221 Freq. mtr. mod. & unmod.
 IE-19 ARC-1/SCR-7 comp. test set
 IE-36 SCR-622 test set</p> |
|-----------------------------------------------------------------------------------------------------------------------------------------------------------------------------------------------------------------------------------------------------------------------------------------------------------------------------------------------------------------------------------------------------------------------------------------------------------------------------------------------------------------------------------------------------------------------------------------------------------------------------------------------------------------------------------------------------------------------------------------------------------------------------------------------------------------------------------------------------------------------------------------------------------------------------------------------------------------------------------------------------------------------------------------------------------------------------------------------------------------------------------------------------------------------------------------------------------------------------------------------------------------------------------------------------------------------------------------------------------------------------------------------------------------------------------------------------------------------------------------------------------------------------------------------------------------------------------------------------------------------------------------------------------------------------------------------------------------------------------------------------------------------------------------------------------------------------------------------------------------------------------------------------------------|---------------------------------------------------------------------------------------------------------------------------------------------------------------------------------------------------------------------------------------------------------------------------------------------------------------------------------------------------------------------------------------------------------------------------------------------------------------------------------------------------------------------------------------------------------------------------------------------------------------------------------------------------------------------------------------------------------------------------------------------------------------------------------------------------------------------------------------------------------------------------------------------------------------------------------------------------------------------------------------------------------------------------------------------------------------------------------------------------------------------------------------------------------------------------------------------------------------------------------------------------------------------------------------------------------------------------------------------------------------------------------------------------------------------------------------------------------------------------------------------------------------------------------------------------------------------------------------------------------------------------------------------------------------------------------------------------------------------------------------------------------------|-----------------------------------------------------------------------------------------------------------------------------------------------------------------------------------------------------------------------------------------------------------------------------------------------------------------------------------------------------------------------------------------------------------------------------------------------------------------------------------------------------------------------------------------------------------------------------------------------------------------------------------------------------------------------------------------------------------------------------------------------------------------------------------------------------------------------------------------------------------------------------------------------------------------------------------------------------------------------------------------------------------------------------------------------------------------------------------------------------------------------------------------------------------------------------------------------------------------------------------------------------------------------------------------------------------------------------------------------------------------------------------------------------------------------------------------------------------------------------------------------------------------------------------------------------------------------------------------------------------------------------------------------------------------------------------------------------------------------------------------------------------------------------------------------------------------------------------------------------------------------------------------------------------------------------------------------------------------------------------------------------------------------------------------------------------------|

FAMOUS MAKE PANEL METERS
 2" sq., any range millimeter d.c. voltmeter r.f. ammeter. Large selection available.
\$295 EA.
WHILE THEY LAST!!

SPECIAL GIVE AWAY OFFER
EIMAC TYPE 100TH TUBES
3 for \$15.50
NEW . . . GUARANTEED

ONE MILLION TUBES TUBES
 In Stock At Low Prices
 Receiving, Transmitting, Special Purpose, Cathode Ray, Klystrons, Magnetrons, Crystal Diodes, New, Standard Brands, Guaranteed

EXPORTERS • GOVERNMENT AGENCIES • LABORATORIES • SCHOOLS!!
 Consult us. Come to the source. Warehouses of our own stock. We will buy, sell or swap in any quantity. Space limits complete listings. Write for our catalog.

RADIO HAM SHACK, INC.

Cable: "Hamshack N. Y."
 370 Greenwich St. New York 13, N. Y. CANAL 6-8446-7-8-9

TUBES:

Industrial Receiving Transmitting

Specialists in JAN Tube Types

Standard Brands Only

OA2.....	5.90	3B25.....	3.95	304TH.....	7.75
OA3.....	1.20	3B26.....	3.50	304TL.....	7.75
OA4G.....	1.00	3B28.....	5.95	316A.....	3.80
OB2.....	1.00	3B29.....	8.50	339A.....	7.00
OB2.....	1.00	3BP1.....	4.55	388A.....	2.75
OC3.....	1.00	3C21.....	5.00	394A.....	4.00
OD3.....	.95	3C24.....	1.15	GL14A.....	120.00
1B22.....	1.85	3C45.....	10.00	GL434A.....	17.95
1B23.....	6.50	3DP1.....	3.95	GL46A.....	1.95
1B24.....	9.00	3E29.....	9.95	704A.....	.85
1B26.....	2.25	3FP7.....	1.95	705A.....	1.90
1B27.....	12.00	3GP1.....	3.00	707A.....	7.75
1B32.....	2.50	4B22.....	7.75		
1B42.....	9.50	4B25.....	8.00		
1P21.....	49.50	4J32.....	225.00		
1P23.....	3.75	4J36.....	140.00		
1P28.....	11.50	5BP1.....	5.00		
1P40.....	1.75	5BP4.....	5.00		
1P41.....	5.00	5D21.....	15.00		
1P42.....	5.00	5FP7.....	1.75		
2B22.....	2.95	5J29.....	15.00		
2C40.....	7.95	5LP5.....	17.00		
2C43.....	17.50	5R4GY.....	1.20		
2C44.....	1.85	5R4WG.....	4.00		
2C51.....	3.75	6AC7W.....	3.25		
2D21.....	1.20	6AK5(WE).....	1.25		
2D21W.....	2.35	6AR6.....	1.90		
2J26.....	20.00	6A56.....	1.90		
2J31.....	25.00	6A57G.....	3.50		
2J37.....	12.00	6C3.....	14.50		
2J40.....	22.50	6C7A.....	40.00		
2J50.....	36.75	6F4.....	3.50		
2J54.....	62.95	6J3.....	5.75		
2J54B.....	125.00	6J5W.....	1.50		
2J61.....	39.95	6K4.....	2.25		
2K22.....	23.00	6K4A.....	3.50		
2K23.....	11.50	6LWGA.....	8.45		
2K25.....	24.00	7AK7.....	7.00		
2K28.....	27.75	7C30.....	85.00		
2K30.....	25.00	7C30.....	300.00		
2K33.....	250.00	15R.....	1.90		
2K33A.....	250.00	FG32.....	14.00		
3B24.....	175.00	FG37.....	23.00		
3B24W.....	9.00	15R.....	1.90		
		28D7.....	1.40		
		35T.....	3.00		
		6F105.....	18.50		
		FG172.....	29.95		
		250TH.....	16.50		
		250TL.....	16.50		
		274B.....	2.75		
		707B.....	14.00		
		708A.....	4.50		
		709A.....	3.50		
		713A.....	1.20		
		714A.....	53.00		
		715B.....	7.95		
		721A.....	3.75		
		829B.....	12.50		
		832.....	7.75		
		830B.....	2.75		
		832A.....	3.95		
		837.....	1.20		
		838.....	3.25		

Fully Guaranteed

872A.....	3.75	5725.....	4.25
921.....	2.00	5726.....	1.50
922.....	1.85	5727.....	2.25
955.....	.35	5749.....	2.15
956.....	.35	5750.....	2.50
958.....	2.00	5751.....	1.50
959.....	1.50	5763.....	1.30
1012.....	2.70	5783.....	6.00
1014.....	1.95	5811.....	2.75
1016.....	.90	5814.....	2.25
1017.....	.90	5825.....	12.75
1018.....	6.30	5826.....	2.00
1020.....	.30	5837.....	110.00
1021.....	2.70	5840.....	7.75
1041.....	18.44	5841.....	11.00
1044.....	20.00	5901.....	6.50
1045.....	33.50	5902.....	11.00
1046.....	60.00	5903.....	7.75
1047.....	14.00	5915.....	1.20
1048.....	22.00	5932.....	8.50
1049.....	28.00	5937.....	24.00
1050.....	12.15	5963.....	1.30
1051.....	4.50	5964.....	1.45
1052.....	3.00	5985.....	6.00
1053.....	12.0	6005.....	3.75
1054.....	12.50	6072.....	5.50
1055.....	.75	6080.....	8.00
1056.....	.75	6082.....	5.25
1057.....	12.0	6083.....	5.25
1058.....	12.50	6095.....	write
1059.....	8.00	6096.....	write
1060.....	8.00	6097.....	write
1061.....	12.00	6098.....	write
1062.....	7.75	6111.....	11.50
1063.....	7.75	6112.....	11.50
1064.....	5.25	6113.....	11.50
1065.....	5.25	6114.....	11.50
1066.....	5.25	6115.....	11.50
1067.....	5.25	6116.....	11.50
1068.....	5.25	6117.....	11.50
1069.....	5.25	6118.....	11.50
1070.....	5.25	6119.....	11.50
1071.....	5.25	6120.....	11.50
1072.....	5.25	6121.....	11.50
1073.....	5.25	6122.....	11.50
1074.....	5.25	6123.....	11.50
1075.....	5.25	6124.....	11.50
1076.....	5.25	6125.....	11.50
1077.....	5.25	6126.....	11.50
1078.....	5.25	6127.....	11.50
1079.....	5.25	6128.....	11.50
1080.....	5.25	6129.....	11.50
1081.....	5.25	6130.....	11.50
1082.....	5.25	6131.....	11.50
1083.....	5.25	6132.....	11.50
1084.....	5.25	6133.....	11.50
1085.....	5.25	6134.....	11.50
1086.....	5.25	6135.....	11.50
1087.....	5.25	6136.....	11.50
1088.....	5.25	6137.....	11.50
1089.....	5.25	6138.....	11.50
1090.....	5.25	6139.....	11.50
1091.....	5.25	6140.....	11.50
1092.....	5.25	6141.....	11.50
1093.....	5.25	6142.....	11.50
1094.....	5.25	6143.....	11.50
1095.....	5.25	6144.....	11.50
1096.....	5.25	6145.....	11.50
1097.....	5.25	6146.....	11.50
1098.....	5.25	6147.....	11.50
1099.....	5.25	6148.....	11.50
1100.....	5.25	6149.....	11.50

Receiving Tubes

6AQ5..... \$.48
 6SN7GT..... .69
 6V6GT..... .50
 12AT7..... .73
 12AU7..... .60
 12SL7..... .60
 12SN7..... .69
 25L6GT..... .60

All Other Types in Stock. Write for Quotes

ELECTRIC TRADING CO.

Offers a Well-Rounded Selection of Continuous Duty—110 V.—A.C.—60 Cycles

BLOWERS

Brand New-Top Quality-Fully Guaranteed

80 C.F.M.—3" DIAMETER ROTOR
 General Electric Capacitor Motor—Sheet Steel Housing—3" Inlet, 2" Outlet. Base Mounted
\$12.50
 No. BL 80.....

100 C.F.M.—3" DIAMETER ROTOR
 Powered by choice of Fasco or Heinze shaded pole, two pole, enclosed motors. 3" inlet, 2" outlet. Sheet steel housing. No. BL100..... **\$8.95**

200 C.F.M.—4 1/2" DIAMETER ROTOR
 Powered by Bodine split phase. 1725 rpm 40°C. Ball bearing motor. 4 1/2" inlet and 5 1/2" x 3" outlet
 No. BL200B..... **\$22.50**

230 C.F.M.—4 1/2" DIAMETER ROTOR
 Powered by Fasco shaded pole two pole motor. 4" inlet, 2 1/2" x 2 1/2" outlet. No. BL230F..... **\$12.95**

600 C.F.M.—6" DIAMETER ROTOR
 Powered by General Electric 1/4 H.P. 1725 rpm motor. 5 1/2" inlet and 7" x 3 1/2" outlet. Base mounted.
 No. BL600..... **\$32.50**

900 C.F.M. 7 1/2" DIAMETER ROTOR
 American Blower Co. powered by General Electric 1/3 H.P. 1725 rpm motor. 7 1/2" inlet and 8" x 6" outlet. Base mounted.
 No. BL900ABC..... **\$55.00**

TWIN BLOWER—200 C.F.M.—3" DIA. ROTORS
 Delco (General Motors Corp). Shaded pole two pole enclosed motor. 3" inlets and 2" outlets. No. BL200D..... **\$16.75**

TWIN BLOWER—400 C.F.M.—4 1/2" DIA. ROTORS
 Redmond shaded pole two pole motor. 4" inlets and 2 1/2" by 2 1/2" out-lets. No. BL400R..... **\$17.50**

HIGH PRESSURE—STURTEVANT—WESTINGHOUSE
 Range: 310 cfm @ 1/2" S.P. to 120 cfm @ 3" S.P. Powered by G.E. ball bearing 1/6 H.P. 3450 rpm motor. 3 1/2" inlet x 3 1/2" outlet. No. BL310..... **\$65.00**

HIGH PRESSURE—SPENCER, TURBO-COMPRESSORS
 Multi-stage, direct connected. 2 3/4" in. x 2 1/2" out. 30 cfm @ 64 ounces. 2 H.P. AC/DC. 115/230 volts/60 cyc. No. BL305P..... **\$100.00**
 12 cfm @ 35 ounces. 3/4 H.P. AC/DC. 115 volts/25 to 60 cycles. No. BL12SP..... **\$75.00**
 Powered by Black & Decker AC/DC. ball bearing, continuous duty, internal fan cooled, high speed, single phase motors.











ORDERS PROMPTLY FILLED WHILE QUANTITIES LAST.
 Additional Information Will Be Furnished on Request

ELECTRIC TRADING CO.

313-315 Canal St., New York 13, N. Y.
 Air Equipment Experience Since 1906

THE *Electro* INDEX

INDEX

SEARCHLIGHT OCTOBER, 1953

This index is published as a convenience to the readers. Care is taken to make it accurate but ELECTRONICS assumes no responsibility for errors or omissions.

Electro INDEX to Electronic Component VALUES

PULSE NETWORKS & TRANSFORMERS

GE #6E3-5-2000-P2T	514.50
Sprague #7.5E3-3-200-67P	12.50
Sprague #7.5E4-16-60-67P	14.50
Sprague #8E5-1-1000-50P	22.50
Sprague #10E3-0.5-2050-50P	34.50
Sprague #15A1-400-50P	27.50
Sprague #15E4-0.91-400-50P	24.50
Fast #15E5-1.33-700-50P2T	29.00
Sprague #25E5-1.0-500-50P3T	65.00
GE #M7467813P1, 2.5 Microsec, 2000PPS, 2.7KV	9.50
Raytheon WX5782A, 1.2 Microsec, 3.5 KV	14.50
WE #D163329 Network Ass	29.50
Raytheon U12920 Pulse Trans	14.50
GE #80G13 Pulse Trans	8.50

HIGH VOLTAGE CAPACITORS

Cap. No.	Mfd.	WVDC	Price
2LXP30	120	3KV	599.50
22F985	2	4KV	14.50
22F221	4	4KV	22.50
PFD4D244	7	4KV	34.50
22F225	1	5KV	14.50
14F1	7	5KV	72.50
14F2	1	5KV	45.50
19F210	0.1	6KV	32.50
A7548	2x.25	6KV	17.50
T#00020	2	6KV	27.50
26F513	2x.68	7.5KV	27.50
7520	2x1.0	7.5KV	27.50
14F338	4.5	7.5KV	79.50
CC21B	2x0.5	9KV	32.50
3DA20-136	.02	10KV	7.50
10020	0.1	10KV	9.95
Inerteen	1.0	10KV	25.00
14F13	0.1	10KV	124.50
26F68	0.1	10KV	9.95
T#K120065	.65	12.5KV	19.95
15020	.25	15KV	19.50
14F17	1	15KV	49.95
14F63	1	15KV	49.95
14F18	1.5	15KV	62.50
20020	.25	20KV	27.50
14F64	.25	20KV	27.50
37485	.25	20KV	27.50
26F585	.06	25KV	17.50
XSW200	.25	20KV	27.50
20005	.65	20KV	45.00
14F22	1.0	20KV	62.50
14F139	.01	22KV	15.50
Inerteen	.5	25KV	57.50
25020	.5	25KV	57.50
14F24	.5	25KV	57.50
14F83	.75	25KV	72.50
Inerteen	1.0	25KV	85.00
A6734	1.0	25KV	85.00
S1258441	1.5	25KV	124.50
14F112	.001	50KV	24.50
14F98	2.025	50KV	37.50
14F127	.025	50KV	37.50
14F126	.2	50KV	70.00
14F97	.25	50KV	70.00

VARIABLE TRANSFORMERS

Line	Volts	Output V.-Amps	KVA	Price
115	0-135	3.0	0.4	\$11.25
115	0-135	7.5	0.86	16.50
115	0-135	7.5	0.86	20.50
*115	0-135	15.0	2.0	41.50
*115	0-135	15.0	2.0	51.00
115	0-135	30.0	4.0	51.00
115	0-135	45.0	5.0	110.00
115	0-135	45.0	6.1	110.00
115	0-57.5	45.0	5.2	76.00
*115/230	0-230	25.0	5.7	55.00
*115/230	0-270	31.0	7.0	90.00

* w/case, line cord plug, Input receptacle
used, reconditioned like new units

ELECTRONIC TUBES

0A2	.95	1B36	16.75	1N35	1.75
0A3	1.04	1B38	39.95	1N36	4.25
0A4G	1.05	1B41	45.00	1N47	5.25
0B1	1.25	1B42	17.50	1N58A	1.15
0B3	1.10	1B50	32.50	1N60	.60
0C3	1.10	1B51	12.00	1P21	29.50
0D3	.95	1B54	37.50	2AP1A	6.50
0Z3	.95	1D21	3.95	2AP1A	10.50
VG1A	8.75	1N21	1.25	2B22	3.25
ELC1B	6.75	1N21A	1.55	2C21	.95
1B21A	2.95	1N21B	2.50	2C22	.49
1B22	3.10	1N22	1.85	2C26A	.59
1B23	8.75	1N23	1.35	2C33	3.65
1B24	9.00	1N23A	2.35	2C36	27.50
1B26	3.75	1N23B	2.95	2C39	26.00
1B27	19.00	1N23	5.25	2C39A	26.00
1B29	2.75	1N26	8.25	2C40	5.50
1B32	2.25	1N34	.60	2C43	18.00
1B35	11.50	1N34A	.90	2C44	1.45

ELECTRONIC TUBES

2C50	4.50	RK65	1.75	813	13.50
2C51	6.25	FG67	22.50	814	3.25
2C52	6.75	CE07Z	.95	815	4.95
2C53	11.50	RKR73	.75	816	1.50
2D21	1.60	RK75	4.25	826	1.25
2E22	2.50	FG81A	9.25	828	12.50
2E30	2.00	2E97	2.95	828	9.00
2E31	2.10	FG95	27.50	829A	11.00
2E32	1.60	FG97	25.00	829B	13.00
2E36	2.75	FG98A	2.00	830B	3.25
2E41	3.35	HF100	15.00	832	8.50
2E42	2.65	ML100	59.95	832A	9.55
2G21	2.20	400T	7.95	834	37.50
2G22	2.20	FG104	24.95	834	13.50
2J21A	7.50	FG105	24.95	836	4.65
KJ22	3.00	VU11B	2.95	837	1.25
2J26	25.00	144B	2.35	838	4.65
2J27	23.00	RX120A	14.50	841	.65
2F30	62.50	F123A	26.50	845	1.26
2J31	37.50	F124A	1.95	849	59.95
2J32	37.00	VT127	2.75	852	75.00
2J33	32.00	FG128	45.00	852	27.50
2J37A	37.50	FG172	29.95	857B	203.00
2J39	21.50	GL203A	13.00	860	4.95
2K22	45.00	203D	69.95	864	3.35
2K23	45.00	204A	230.00	865	2.35
2K25	27.50	CE213	2.50	868	2.50
2K28	29.95	RX235A	72.50	885	2.00
2K29	29.95	FG235A	72.50	885	2.00
2K39	195.00	250TH	7.95	886	1.70
2K41	150.00	250TL	19.00	913	15.50
2K45	135.00	267B	3.45	923	1.85
2RA3	1.95	270A	99.50	927	1.95
2V38	2.75	FG271	57.50	929	1.40
2X2A	1.85	FG280	59.50	931A	4.75
3AP1	12.25	282A	14.50	932	4.25
3B24	4.75	304TH	13.50	937	3.50
3B24W	9.50	304TL	11.95	955	.69
3B26	6.75	307A	4.95	956	.69
3B29	6.50	307A	55.00	959	3.25
3B29	14.95	CE309	5.25	959	3.25
3B3C	7.50	310A	6.50	991	.39
3B3P	4.75	310C	4.20	CM1017	1.75
3C24	1.95	313C	3.00	CM1089	1.25
3C31	6.50	316A	3.00	CM1090	1.75
3C35	12.50	316A	3.00	R1111	3.50
3C37	18.50	323B	12.50	R1131C	7.50
3DP1	9.50	320A	4.75	R128	.95
3DP2	2.50	320A	3.50	1201	1.25
3E29	11.00	331A	1.35	1203A	.95
3FP7	3.95	331A	8.00	1274	2.15
3FP7A	14.00	368A	7.95	1274	2.15
3G21	6.95	371B	1.39	1614	2.10
4-65A	19.50	381A	1.75	1616	1.25
KC4	50.00	381A	1.75	1616	1.25
KC4-3	39.95	381A	1.75	1622	2.25
4B24	8.50	394A	4.50	1622	2.25
4B26	11.00	394A	4.50	1620	6.50
4B28	6.25	417A	17.50	1622	2.25
4B32	11.00	417A	17.50	1622	2.25
4C35	32.50	446B	16.75	1625	.49
4C37	22.50	446B	16.75	1626	.49
4E27A	35.50	450TH	55.00	1630	.85
4J31	135.00	450TL	55.00	1630	.85
4J33	195.00	464A	8.95	1632	.85
4J35	195.00	471B	12.50	1632	.85
4J52	225.00	GL502A	1.80	1634	.85
5B1	4.25	532A	16.95	1841	2.65
5BP1	5.25	549	34.50	1663	3.10
5CP1	4.50	549	34.50	1846	3.10
5D21	17.50	525	1.75	1851	1.95
5FP7	2.50	525	1.75	1851	1.95
5FP7A	12.50	WL616	45.00	1960/5336	3.75
5P1A	27.50	500	20.50	1.85	
5J1	27.50	KAU628	32.00	1.15	
5L1	27.50	F631	65.00	4120	.95
5L2	35.00	F632A	60.00	UX5501	3.25
5LP5	14.50	649	6.95	R4410	15.00
5RP1A	27.50	651/656	69.50	5528	10.00
5RP2A	37.50	656	9.95	CEL	10.00
5R4GY	1.75	653	34.50	5557	7.25
5R4WGY	3.25	672A	34.50	5559	18.50
5RP11	22.50	GL675	2.35	5651	3.35
6A15	2.50	705A	59.50	5654	4.00
6AK5	1.30	706AV	58.50	5659	4.35
6AR6	3.35	706GV	18.25	5661	3.75
6B56	2.95	707A	18.25	5661	3.75
6B57	4.50	707B	19.25	5663	2.00
6B57	1.30	707A	1.95	5670	4.25
6B57	1.30	707A	1.95	5691	8.45
6B57	1.30	707A	1.95	5691	8.45
6C21	29.50	714AV	12.50	5837	8.45
6J1	6.95	715	5.00	5693	6.95
6K4	4.50	715A	5.75	5732	3.95
7BP7	8.95	714B	19.50	5749	3.95
9LP7	37.50	715C	24.50	5751	3.75
12MP7	65	717A	1.75	5783	1.65
12DP7	17.50	718V	79.50	5837	8.45
12CP7	17.50	719A	42.50	VX-34	5.25
12MP7	17.50	720CV	65.00	5814	3.95
12AP7	17.50	721A	4.50	5838	4.75
15E	1.85	723AB	22.50	5871	3.35
FG17	1.05	724A	2.75	5917	4.95
FG17	5.25	724B	3.15	5U4WG	4.95
RK20A	9.95	725A	9.50	X6089	1.75
24C	1.85	726A	14.50	UX6653	1.25
30T	9.00	726C	75.00	7937	3.00
FG-27A	23.00	5N729	3.25	2C22	.49
2ZB7	2.35	730A	28.95	8002R	105.00
FG32	15.00	W1762	45.00	8011	3.00
FG33	23.00	801A	.85	8012	3.00
FK34	85.00	802	4.20	8013	3.35
35T	9.00	803	5.00	8013A	5.50
35T	9.00	804	16.50	8020	2.15
35T	9.00	805	4.95	8025	5.45
CE36C	1.75	806	17.95	9038	4.85
RK39	14.50	807	1.65	9002	.95
ES50	1.30	808	6.95	9003	1.55
3A	5.95	809	3.50	9005	2.25
FG57	14.95	810	11.00	9005	2.25
5B	1.35	811	2.95	9006	.45
OK55	65.00	812	4.75	AX5903	

EMPLOYMENT

Positions Vacant	458-467, 494
Selling Opportunities Offered	459
Positions Wanted	459
Selling Opportunities Wanted	459

BUSINESS OPPORTUNITIES

Offered	459
---------	-----

TO THE ADVERTISERS

OCTOBER, 1953

SEARCHLIGHT SECTION
(Classified Advertising)
H. E. Hilty, Mgr.

Industrial Research Laboratories.....	462
Industrial Test Equipment Co.....	492
Instrument Associates.....	473
Jerrell Electronics Inc.....	493
JSH Sales Co.....	484
Kass Inc., Samuel.....	491
Kollsman Instrument Corp.....	464
Lapirow Bros.....	489
Lectronic Research Laboratories.....	482, 483
Los Alamos Scientific Laboratory.....	466
Maritime International Co.....	491
Maritime Switchboard Co.....	493
Maxxon Corp., W. L.....	460
McDonald, W. W.....	492
Medical Salvage Co., Inc.....	493
Melpar, Inc.....	464
Metropolitan Overseas Supply Corp.....	487
Milgray Electronics, Inc.....	495
Minneapolis Honeywell.....	465
Mogull Co., Inc., Alexander.....	490
Monmouth Radio Laboratories.....	485
National Cash Register Co., The.....	467
New York Electronics.....	490
O'Del Electronics Corp.....	493
Peak Electronics.....	494
Pennsylvania State College, The.....	459
Phillips Petroleum Co.....	467
Photocon Sales.....	486
Radalab.....	480
Radio Corporation of America.....	461
Radio Development & Sales Co.....	490
Radio & Electronic Surplus.....	485
Radio Ham Shack, Inc.....	495
Radio Surplus Corp.....	474
Railway Communications Inc.....	487
Relay Sales.....	490
Reliance Merchandising Co.....	470
R. W. Electronics.....	493
Rose Electronics, Inc.....	492
Southwestern Industrial Electronics Co.....	464
Standard Coil Products Co., Inc.....	466
Stavid Engineering Inc.....	494
Stromberg-Carlson Co.....	464
"TAB".....	498
Tallen Co., Inc.....	481
Telemarine Communications Co.....	468, 469
Telephone Engineering Co.....	494
Tripoli Electronics Co.....	492
Universal General Corp.....	471
Universal Vacuum Tube Corp.....	493
V. & H. Electronic Industries.....	488
Wells Sales Inc.....	493
Western Engineers.....	489
Weston Laboratories Inc.....	476
Wilcox Electric Inc.....	460
Zenith Optical Lab.....	494

THE Electro INDEX

SELSYNS—SYNCHROS

Immediate Delivery—Fully
Guaranteed

1CT Control Transformer, 90/55V 60~	\$64.50
1G Generator, 115/90V 60~	64.50
1F Motor, 115/90V 60~	64.50
1HCT Control Transformer, 90/55V 60~	84.50
1DG Differential Generator 90/90V 60~	64.50
1HG Generator, 115/90V 60~	84.50
1HDG Differential Generator, 90/ 90V 60~	84.50
21M1 Control Transformer, 105/ 63V 60~	59.50
1H Motor, 115/90V 60~	49.50
15F Motor, 115/90V 400~	17.50
1F Special Motor, 115/90V 400~	15.00
21D1 Generator, 115/90V 400~	12.50
21F1 Generator, 115/57.5V 400~	9.50
21F3 Generator, 57.5/57.5V 400~	9.50
21G1 Control Transformer 57.5/ 57.5V 400~	9.50
21H1 Differential Generator 57.5/ 57.5V 400~	12.50
21H2 Generator, 115V 400~	17.50
21DL1 Motor, 115/90V 400~	15.00
3F Motor, 115/90V 60~	84.50
3HCT Control Transformer, 90/55V 60~	84.50
21D5R1 Motor, 115/90V 400~	27.50
55F Motor, 115/90V 400~	32.50
55G Generator, 115/90V 400~	32.50
55DG Differential Generator 90/90V 400~	32.50
K55950 Generator, 115/90V 400~	15.00
K55950L2 Generator, 115/90V 400~	15.00
21A39BB2 Motor, G.E., 110/55V 60~	55.00
215FB1 Control Transformer 105/ 63V 60~	60.00
21D5C2 Motor, 115/105V 60~	60.00
215H1 Generator, 115/105V 60~	50.00
215HA1 Generator, 115/105V 60~	60.00
215A4 Generator, 115/105V 60~	60.00
215S1 Differential Generator 90/90V 60~	60.00
21D5J2 Motor 115/90V 60~	60.00
215LA1 Generator 115/105V 60~	60.00
2165F1 Generator 110/55V 60~ (used)	35.00
21D123A16 Motor, 110/40V, 60~	55.00
5A Generator, 115 Volts 60 Cycles.	55.50
5B Generator, 115 Volts 60 Cycles.	22.50
5CT Control Transformer 90/55V 60~	50.00
5HCT Control Transformer 90/55V 60~	69.95
5D Differential Motor, 115/90V 60~	50.00
5DG Differential Generator, 90/90V 60~	50.00
5F Motor, 115/90V 60~	50.00
5G Generator, 115/90V 60~	50.00
5M Motor, 115 Volts 60 Cycles	22.50
5N Motor, 115 Volts 60 Cycles.	22.50
216F1 Generator, 115/90V 60~	64.50
216F2 Generator, 115/90 Volts 60~	64.50
65G Generator, 105/90 Volts 60~	60.00
6CT Control Transformer, 90/55V 60~	60.00
6DG Differential Generator 90/90V 60~	60.00
6G Generator, 115/90V 60~	57.00
7G Generator, 115/90V 60~	69.95
C44968-6 Type II-1, Repeater, 115V 60~	22.50
C56701 Type II-4 Repeater, 115V 60~	22.50
C56776-1 Repeater AC Syn. 115V 50~	22.50
C69406 Diehl FJ84-8 Transmitter 115V 60~	22.50
C69406-1 Type II-2 Repeater, 115V 60~	22.50
C77610 Type III Repeater, 115V 60~	22.50
C78248 Transmitter AC Syn. 115V 60~	22.50
C78249 Differential AC Syn. 115V 60~	9.50
C78254 Type XII Differential, 115V 60~	22.50
C78411 Transmitter AC Syn. 50V 50~	14.50
C78414 Transmitter AC Syn. 115V 60~	49.50
C78359 Diehl 84-4, Receiver 115V 60~	22.50
C78360 Diehl 84-5, Transmitter 115V 60~	22.50
C78386 Type XV Transformer 115V 60~	22.50
C78791 Transmitter AC Syn. 115V 60~	22.50
C79331 Type I-4 Transmitter 115V 60~	22.50
C81369 Type II-8 Repeater, 115V 60~	22.50
PATT-6547 Admiralty Transmitter 115V 60~	17.50
PATT-6548 Admiralty Transmitter 115V 60~	17.50

DIEHL AC CONTROL MOTORS

FP25-2, 22V 2ph 60~.85A 1600RPM	\$22.50
FP25-3, 20V 2ph 60~.5A 3200RPM	22.50
FPE25-8, 75/75V 60~.11/.11A 2ph 2 watts, 2 pole	24.50
FPE25-9, 100/100V 400~.44/.44A 2ph 4 watts, 2 pole	27.50
FPE25-11, 75/75V 60~.11/.11A 2ph 4 watts, 2 pole	29.50
FPE25-12, 115/115V 60~.16/.16A 2ph 5 watts, 2 pole, 3200 RPM	34.50
FPE25-14, 20/20V 60~.5/.5A 2 ph 2 pole	22.50
FPE25-16, 20/20V 60~.85/.85A 2 ph 2 pole, 1600 RPM	24.50

SINE-COSINE GENERATORS

(Resolvers)

Diehl Type FJE43-9 (Single Phase Rotor)
Two stator windings 90° apart, provides
two outputs equal to the sine and cosine
of the angular rotor displacement. In-
put voltage 115 volts, 400 cycle, \$30.00 ea.
Diehl Type FJE-43-1 same as FJE-43-9
except it supplies maximum stator vol-
tage of 220 volts with 115 volts applied to
rotor \$25.00 ea.
Diehl Type FJE43-10 \$30.00

PM MINIATURE MOTORS

DELCO 5068571, 27VDC, 10000RPM	\$18.50
DELCO 5068750, 27VDC, 160RPM (used)	12.50
DELCO 5069230, 27VDC, 145RPM (used)	12.50
DELCO 5069600, 27VDC, 250RPM (used)	12.50
GE #5BA10AJ37B, 27VDC, 250RPM 8oz/in torque (used)	12.50
GE #5BA10AJ40, 24VDC, 140RPM 10oz/in torque	16.00
HOLTZER-CABOT #B3-RBD0808, 24VDC, 5000RPM	15.00
Diehl P. M. Motor #FD6-21, Part #K515098L01, 27.5VDC 10,000RPM (large quan. available)	14.50

FRACTIONAL HP MOTORS

EAD J31, 115VAC 400cy 1/50 HP 5000RPM	\$9.95
EAD J31, 115VAC 400cy 1/100 HP .25A 7200RPM	9.95
DELCO A7155, 27VDC 2.4A 1/30HP 3600RPM	9.95
OSTER #D-4-2 24VDC 1/60HP 1800 RPM	9.95
1/4HP 3800RPM	22.50
ELEC SPEC. TYPE 1A1, 24VDC 15A 1/4HP 3800RPM	22.50
DELCO A7156, 27.5VDC 1/50HP 3000 RPM	8.95
OSTER #E-6-1, 115VDC .39A 1/50HP 1725RPM	9.95
ELEC. IND. #203, 115VAC 60cy 0.45A 1/75HP 1800RPM	12.50
JAY ELEC. #145, 230VDC Armature- 30V Fields 1/4HP 3450RPM	23.75
DIEHL DELCO C78291/C7889, 115V 60cy 3ph 1/40HP 2850RPM	4.95
OSTER #E2-1 SERVO, split dif- ferential fields, stalled torque, 11 oz/in w/.5A arm. cur. & 70MA one field 5000RPM	9.95
OSTER VRS-1B, 6VDC, 1.8A 5000 RPM	8.95
PACKARD, 6VDC, 1/100HP 5000 RPM	6.95
REDMOND, 6VDC, 1/50HP 5000 RPM	8.95
PIONEER K55603, 24-28VDC, 0.6A, 1/100HP 5000RPM	5.50
ALLIANCE #2207, 27.5VDC, 1/100HP 7500RPM	8.95
LEAR #C004, 24VDC, 1.5A 8W 7500 RPM	6.95
EICOR ML2310-52, 24VDC 0.32A 1800RPM	5.00
UNIVERSAL #523, 115VDC 12A 5000 RPM	5.95
WESTINGHOUSE #171391B, 27VDC 6.5A 1/8HP 5800RPM	14.95
HOLTZER-CABOT RBD-220 2 VDC 18A 1/3HP 6000RPM	22.50

BLOWERS

W.E. K515098L01, PM Mtr w/2" Impeller, 27.5VDC 10,000RPM	\$14.50
ALLIANCE 28VDC 35CFM	8.95
FASCO MOD 69C, 115VAC 60cy 50 CFM	9.95
REDMOND 24VDC 1.35A 4750RPM 100CFM	12.50
REDMOND 115VAC 60cy 85CFM	12.95
WESTINGHOUSE TYPE FL 115V 400cy 6700RPM 50CFM	8.95
EAD, 115V 400cy 110CFM	14.95
WESTINGHOUSE 115VDC 1/75HP 250CFM	20.50
AMERICAN 230V 60cy 1/3HP 2000 CFM	49.50

Electro INDEX to Electronic Component VALUES

ELECTRO Sales Company Inc.

50 EASTERN AVE., BOSTON 13, MASS. CAPITOL 7-3456



SEARCHLIGHT SECTION

FEDERAL "ITT" SELENIUM BATTERY CHARGER RECTIFIER
10-0-100 Volts (CT) 100 Amp (Fast Cooled).
Replace Your Old Inefficient Sulphid Rectifier
with the New Selenium Type. SPECIAL \$11.98

SELENIUM RECTIFIERS
1/2 WAVE FOR RADIO & TV

CURRENT (Cont.)	LIST PRICE	"TAB" PRICE	QTY 12 FOR
55MA @ 130V	1.50	59	56.48
75MA @ 130V	1.85	69	7.58
100MA @ 130V	2.05	79	8.58
150MA @ 130V	2.25	89	10.78
200MA @ 130V	3.15	1.39	14.98
300MA @ 130V	3.30	1.49	15.98
400MA @ 130V	3.45	1.59	16.98
500MA @ 130V	4.40	1.98	21.23
230MA @ 18V	1.40	.59	5.98
230MA @ 36V	2.25	.89	8.98
230MA @ 300V	6.95	1.39	14.98

SELENIUM RECTIFIERS
We specialize in Rectifiers and Power supplies to your specifications. Immediate delivery.

Current	18V	36V	54V	130/100
Volts	18V	36V	54V	130/100
1 Amp	\$1.35	\$2.15	\$3.70	\$7.50
2 Amp	2.20	3.60	5.40	10.50
3 Amp	4.25	6.95	10.40	21.23
6 Amp	4.75	9.00	13.50	33.00
10 Amp	6.75	12.75	21.00	40.00
12 Amp	16.25	25.50	45.00	90.00
20 Amp	13.25	25.50	45.00	90.00
21 Amp	16.25	25.50	45.00	90.00

Full Wave Rectifier Trans. 115V/60cy inputs up to 14V DC at 12 amps. \$21.98
up to 28V DC at 12 amps. \$1.98
up to 28V DC at 48 amps. \$12.00

C "TAB" fast delivery SPECIALS

RECTIFIER XFMRs
PRIMARY 115V 60 cyc
SECONDARY 0-9-12-18-21-36V

CONT. CURRENT	4 amp	5 amp	6 amp	8 amp	10 amp
30-32-34-36V 48 A	58.75	58.75	58.75	58.75	58.75
18 Volt 2 amp.	1.98				

RECTIFIER CHOKES

Amp	Ohm	Ohm	Ohm	Ohm
4 Amp	.07	.6	1.0	1.5
2 Amp	.07	.6	1.0	1.5
1 Amp	.04	.4	.75	1.1

TUBES

0A2	50.95	2021	1.26	3B28	
0A3 VR75	1.37	7636	1.44	3C21	
0B2	1.37	7636	1.44	3C31	
0C3 VR90	1.99	2643	1.44	3C31 CIB	
0E3 VR105	1.15	7636	1.44	3C31	
0K3 VR150	.90	2431	2.00	3C45	
1B3/0016	.81	2431A	79.95	30E/1259	
1B21/471A	1.82	2431	37.00	3D21A	
1B22	2.20	2432	37.00	3Z2	
1B23	3.90	2434	27.00	3Z23	
1B24	1.45	2435	25.50	4A5	
1B26	2.45	2437	12.70	4A5	
1B27	12.75	2438	11.75	FLB/HD	
1B32/532A	1.82	2439	17.00	5A2	
1B35	9.15	2442	187.00	5C22	
1B37	16.98	2448	24.25	5C20 CSB	
1B38	78.25	2451	44.45	5U4G	
1B41	49.95	2450	21.25	5Z23 RK65	
1B42	18.00	2452	24.50	5Z24	
1B46	1.50	2453	19.00	5R9Y	
1B53	49.95	2456	119.00	5R1GYW	
1B56	38.50	2461	49.95	5T4	
1B58	175.00	2462	78.25	5U4G	
1B60	69.75	2422	39.45	5V4G	
1B63	50.90	2423	39.45	6AQ5	
1B63A	75.00	2424	68.45	6AR5	
1L4	.69	2425/723A	24.90	6AN6	
1L6	38.25	2428	29.00	6AM8	
1L7	33.00	2429	29.00	6AL5	
1V2	70.25	2435	39.95	6AK5	
1X2A	1.29	2441	126.00	6AK5W	
2C36	27.36	2442	1.45	6AL7GY	
2C39	21.00	2448	120.00	6AM6	
2C39A	29.50	2422	49.95	6L6	
2C42	39.29	2422	2.70	6AL7GY	
2C43	17.75	3823/RK22	4.95	6AN5	
2C43/461A	9.49	3824	8.95	6AN5	
2C44	1.20	3825	1.20	6AQ5	
2C51	5.49	3826	8.25	6AQ5W	

"TAB" THAT'S A BUY

RHEOSTAT SALE
15 ohm 25W w/knob \$1.49; 2 for \$2.49
60 ohm 50W w/knob 2.20; 2 for 3.98
100 ohm 50W Model K 1.98; 2 for 3.50
200 ohm 25 Model P 1.49; 2 for 2.49
300 ohm 25 Model P 2.98; 2 for 5.00
350, 500, 5000 ohm Slotted
slant, 25 watt 79c; 3 for 2.00

SPECIALS
Powerstats & Test Equipment

Type 20/0-135V/3Amp (N) \$10.98
Type 116/0-135V/7.5 Amp (N) 16.98
Type 116/0-135V/15 Amp (LN) 20.49
Type 1226/0-270V/30 Amp (LN) 41.98
Type 1226/0-270V/45 Amp (LN) 43.98
3000 BU/0-135V/30 Amp (LN) 38.00
3020 BU/0-270V/18 Amp (LN) 48.00
GR 50A/0-135V/45 Amp/5KV (LN) 100.00
GR 50B/0-270V/31 Amp/7KV (LN) 100.00
GE ST4A Sump Generator (N) 300.00
GE ST5A Sump Generator (N) 325.00
GE ST2A Oscilloscope (N) 275.00
(N) NEW & (LN) LIKE NEW

CONDENSER SPECIALS
2 MFD 330 VAC
1000 VDC STD MFRG 25¢
LOTS OF 10
Smaller Quantities Each 49c; 3 for \$1.25
2MFD 600VDC W/MTG Clamp 3 for \$1.50

DC POWER SUPPLY
0 to 135VDC AMP
Variable DC supply input
115V/60 cyc. Usable Lab
supply. filament D.C. plating,
battery charging, model
railroad includes voltage or
speed control, and center off reversing sw. Ideal
for two "HO" looms. \$10.95; 2 for \$20.00

"TAB" Tested & Guaranteed

PRICES SUBJECT TO CHANGE
WRITE FOR COMPLETE TUBE LISTING

7.90 6AQ5	81C6J/5C21	9.89	42B7	1.49	FG104	37.98	CM532DX	1.89	805	3.90	CM5703	1.29
8.90 6A07GT	1.29 6A4A	6.66	42B7	1.49	FG104	37.98	CM532DX	1.89	805	3.90	CM5703	1.29
9.90 6AR5	1.29 6A4A	6.66	42B7	1.49	FG104	37.98	CM532DX	1.89	805	3.90	CM5703	1.29
3.45 6AR6	2.98 6A4A	6.66	42B7	1.49	FG104	37.98	CM532DX	1.89	805	3.90	CM5703	1.29
1.45 6AS5	1.45 6A4A	6.66	42B7	1.49	FG104	37.98	CM532DX	1.89	805	3.90	CM5703	1.29
14.95 6AS6	2.43 6L6	2.09	42B7	1.49	FG104	37.98	CM532DX	1.89	805	3.90	CM5703	1.29
.69 6AS7G	4.65 6L6G	1.35	42B7	1.49	FG104	37.98	CM532DX	1.89	805	3.90	CM5703	1.29
8.95 6AT6	5.16 6A4A	1.35	42B7	1.49	FG104	37.98	CM532DX	1.89	805	3.90	CM5703	1.29
13.95 6AUGT	1.61 6L6G	1.35	42B7	1.49	FG104	37.98	CM532DX	1.89	805	3.90	CM5703	1.29
4.90 6AUGT	1.59 6A7GT	1.35	42B7	1.49	FG104	37.98	CM532DX	1.89	805	3.90	CM5703	1.29
1.59 6AV5GT	1.59 6A7GT	1.35	42B7	1.49	FG104	37.98	CM532DX	1.89	805	3.90	CM5703	1.29
19.95 6AV6	4.65 6D7GT	1.35	42B7	1.49	FG104	37.98	CM532DX	1.89	805	3.90	CM5703	1.29
16.98 6AW6	1.89 6F5	.77	42B7	1.49	FG104	37.98	CM532DX	1.89	805	3.90	CM5703	1.29
3.89 6B4C	1.29 6G4	1.35	42B7	1.49	FG104	37.98	CM532DX	1.89	805	3.90	CM5703	1.29
39.85 6B6C	1.63 6G7	.63	42B7	1.49	FG104	37.98	CM532DX	1.89	805	3.90	CM5703	1.29
3.95 6B7	1.27 6H7	.61	42B7	1.49	FG104	37.98	CM532DX	1.89	805	3.90	CM5703	1.29
78.25 6B7	1.29 6H7	.61	42B7	1.49	FG104	37.98	CM532DX	1.89	805	3.90	CM5703	1.29
36.50 6B8GT	1.23 6K7GT	.70	42B7	1.49	FG104	37.98	CM532DX	1.89	805	3.90	CM5703	1.29
1.65 6B8GT	1.65 6L7GT	.69	42B7	1.49	FG104	37.98	CM532DX	1.89	805	3.90	CM5703	1.29
1.29 6B9	1.29 6L7GT	.69	42B7	1.49	FG104	37.98	CM532DX	1.89	805	3.90	CM5703	1.29
1.75 6B8E	1.95 6D7GT	.65	42B7	1.49	FG104	37.98	CM532DX	1.89	805	3.90	CM5703	1.29
2.49 6B8F5	.98 6F7	.65	42B7	1.49	FG104	37.98	CM532DX	1.89	805	3.90	CM5703	1.29
1.29 6B8G	1.29 6G7	.65	42B7	1.49	FG104	37.98	CM532DX	1.89	805	3.90	CM5703	1.29
1.10 6B7	2.55 6G7	.98	42B7	1.49	FG104	37.98	CM532DX	1.89	805	3.90	CM5703	1.29
1.39 6B8CG	1.39 6V6	1.39	42B7	1.49	FG104	37.98	CM532DX	1.89	805	3.90	CM5703	1.29
1.40 6B8E	1.40 6V6	1.39	42B7	1.49	FG104	37.98	CM532DX	1.89	805	3.90	CM5703	1.29
1.49 6B8E	.83 6W4GT	.57	42B7	1.49	FG104	37.98	CM532DX	1.89	805	3.90	CM5703	1.29
1.22 6B16	.69 12AK5	1.58	42B7	1.49	FG104	37.98	CM532DX	1.89	805	3.90	CM5703	1.29
1.40 6B16	1.21 12A7	1.08	42B7	1.49	FG104	37.98	CM532DX	1.89	805	3.90	CM5703	1.29
1.45 12A7E	1.45 12A7E	.75	42B7	1.49	FG104	37.98	CM532DX	1.89	805	3.90	CM5703	1.29
.78 6B16T	1.79 12A7E	.81	42B7	1.49	FG104	37.98	CM532DX	1.89	805	3.90	CM5703	1.29
1.05 6B8GT	1.20 12A7	.69	42B7	1.49	FG104	37.98	CM532DX	1.89	805	3.90	CM5703	1.29
.54 6BQ7	1.65 12A7E	.49	42B7	1.49	FG104	37.98	CM532DX	1.89	805	3.90	CM5703	1.29
1.29 6B22	1.29 6L7GT	1.98	42B7	1.49	FG104	37.98	CM532DX	1.89	805	3.90	CM5703	1.29
2.90 6C21	29.45 12AW6	1.60	42B7	1.49	FG104	37.98	CM532DX	1.89	805	3.90	CM5703	1.29
.55 6CB6	69 12A4GT	1.10	42B7	1.49	FG104	37.98	CM532DX	1.89	805	3.90	CM5703	1.29
1.20 6C1G	1.20 12A7	2.79	42B7	1.49	FG104	37.98	CM532DX	1.89	805	3.90	CM5703	1.29
3.98 6D4	2.70 12A7	2.79	42B7	1.49	FG104	37.98	CM532DX	1.89	805	3.90	CM5703	1.29

TACHOMETER GENERATOR
GENERAL ELECTRIC
PART #2CMM5-AAK-20
SILVER & MICA CONDENSERS
NEW \$3.98; 2 for \$7

KITS AND COMPONENTS
Oil Condensers Assorted 5 for \$1.25
Electrolytic Assorted 5 for 1.25
Silver & Mica Condensers 5 for 1.25
Controls, Popular Values 5 for 1.25
Resistors, 1/2 & 1W 100 for 1.25
Vitrectus, 1/2 & 1W 100 for 1.25
Sockets, Ass'd. B, T, 5, 4P 12 for 1.25
Iron Core Sling & Screw 50 for 1.25
Knobs, Ass'd. w/Inserts 50 for 1.25

"TAB" PICK 'EM \$1.00
Special Lots of 5

866A KIT AND XFMR
2 Tubes, Bekin, xfmr 115v 60cy Inp. outpt.
2.5vct. 10A/Hr insul. SPECIAL \$4.98

DIODE PROBE TUBE
Unveiled for No-Loss VHF testing. Ultra
compact, subminiature-envelope. w/data
V92... \$2.50; 5 for \$11.98

OIL CONDENSER SPECIAL
DUAL 8MFD 600 VDC \$2.25
FITS STD 4 PRONG SOCKET
4 HOLE FLANGE MTG

"LAST MINUTE SPECIALS"
Helipot 50K ohm 10 Turn 0.5% 50KAJZ... \$8.95
Attenuator 7470 & 1003 ohm 12 amp... 3.49
Hand Attenuator T3232 dual 600 ohm...
20 step 1 1/2 DB per step... 10.98
Eveready 500 Ohm 1/2 Watt Battery... 3.98
Vector Turret Socket 8N9T & Base...
Shield... 2 for 98
Lacing cord #6 Waxed for cabling... 1.38
Lacing cord #12 Waxed, linen... 1.89
K. Miller stripper #100 & cutter... 89
Clock radio 5 tube 100% make... 16.95
Carb. drifts (1000 ohm) 5%... 3 for 3.89
Hytron adapter SH17, 28 29V... 3 for 5.00
Line filter P/S AR for AN/ARC5...
Installation, used, 80%... 1.98

12A27	1.49	FG104	37.98	CM532DX	1.89	805	3.90	CM5703	1.29
12BA6	.59	FG104	37.98	CM532DX	1.89	805	3.90	CM5703	1.29
12BA7	1.17	MG7	17.60	CM533AX	1.49	805	3.90	CM5703	1.29
12BD6	1.23	11N70GT	2.49	CM534AX	1.49	805	3.90	CM5703	1.29
12BE6	.59	11Z26GT	1.19	CM536AX	1.49	805	3.90	CM5703	1.29
12BF6	.59	11Z27GT	1.19	CM537AX	1.49	805	3.90	CM5703	1.29
12C7	1.29	F123A	7.90	CM538DX	1.49	805	3.90	CM5703	1.29
12C7B	1.35	VT12A	3.90	CM539DX	1.49	805	3.90	CM5703	1.29
12C7C	1.85	VX130	4.50	CM541DX	1.49	805	3.90	CM5703	1.29
12C7D	.69	CV148	4.98	CM543DX	1.49	805	3.90	CM5703	1.29
12C7E	.80	FG165	1.49	CM544DX	1.49	805	3.90	CM5703	1.29
12C7F	.72	FG172	2.90						

INDEX TO ADVERTISERS

AGA Div. of Elastic Stop Nut Corp. of America	439
Ace Electric Corp.	401
Ace Electronics Inc., Div. of Aerovox Corp.	369
Ace Wire Co.	266
Adams & Westlake Company	251
Aeronautical Communications Equipment, Inc.	449
Airborne Instruments Laboratory, Inc.	45
Aircraft Radio Corporation	425
Aircraft-Marine Products, Inc.	30, 31
Airdesign, Inc.	389
Air-Mite	387
Airpax Products Co.	336
Alden Products Company	123
Allen-Bradley Co.	253
Allen Co., Inc., L. B.	458
Allied Control Co., Inc.	56, 57
Allied Industries, Inc.	405
Alpha Metals, Inc.	499
American Electrical Heater Co.	236
American Electric Motors	290
America Lava Corporation	53
American Phenolic Corporation	210, 211
American Television & Radio Co.	322
American Time Products, Inc.	309
Ampex Corp.	325
Andrew Corporation	74
Antara Chemicals, Div. of General Dye-stuff Corporation	104, 105
Anti-Corrosive Metal Products Co., Inc.	378
Arco Electronics, Inc.	353
Arkwright Finishing Co.	366
Arnold Engineering Co.	42
Assembly Products, Inc.	399
Astron Corporation	77
Atlas Engineering Co., Inc.	433
Augat Bros., Inc.	431
Automatic Electric Mfg. Co.	328
Ballantine Laboratories, Inc.	218
Barco Chemical Products Co.	437
Barker & Williamson, Inc.	216
Barstead Still & Sterilizer Co.	411
Barry Corporation	15
Belden Manufacturing Company	34
Bell Aircraft Corporation	391
Bell Telephone Laboratories	257
Bendix Aviation Corporation, Eclipse-Pioneer Division	350
Pacific Division	286
Red Bank Division	400
Bentley, Harris Mfg. Co.	25
Berkeley Div., Beckman Instruments, Inc.	282
Beryllium Corporation	337
Bird Electronic Corporation	443
Birmingham Sound Reproducers Ltd.	383
Birnback Radio Co., Inc.	445
Bircher Corporation	389
Boesch Manufacturing Co., Inc.	435
Boonton Radio Corporation	199
Bowser, Inc.	364
Bradley Industries	441
Bradley Laboratories, Inc.	87
Bridgeport Brass Co.	279
Bristol Brass Corporation	118
Bristol Motor Division, Vocaline Company of America, Inc.	415
Browning Laboratories, Inc.	298

Brush Electronics Co.	262
Buggie and Company, H. H.	408
Burgess Battery Company	409
Burnell & Co.	291
Burroughs Research Center, Electronic Instruments Div.	213
Bussmann Mfg. Co.	207
Calidyne Company	272
Cambridge Thermionic Corp.	76
Canadian Aviation Electronics, Ltd.	305
Cannon Electric Co.	276
Carboloy Dept. of General Electric Co.	108, 109
Carborundum Company	297
Caribe Aircraft Radio Corp.	430
Carter Motor Co.	211
Centralab Division of Globe-Union, Inc.	11, 12, 13
Chase Brass & Copper Co.	303
Chester Cable Corp.	58
Chicago Telephone Supply Corporation	120, 121
Chicago Transformer, Div. of Essex Wire Corp.	340
Cinch Manufacturing Corp.	195
Clare & Co., Inc., C. P.	110, 111
Cleveland Container Co.	217
Clifford Manufacturing Co.	267
Cohn Corp., Sigmund	415
Collectron Corporation	401
Collins Radio Company	62, 63
Communication Accessories Co.	75
Conrad & Moser	407
Consolidated Engineering Corp.	23
Consolidated Vacuum Corp.	205
Constantine & Co., L. L.	69
Constantine Engineering Laboratories Co.	503
Continental Connectors Electronic Sales Div., DeJur Anisco Corp.	390
Continental-Diamond Fibre Co.	29
Cornell-Dubilier Electric Corp.	315
Corning Glass Works	271
Coto-Coil Company	453
Cramer Co., Inc., R. W.	215
Crescent Co., Inc., The	326
Cross Co., H.	435
Dano Electric Co.	437
Davelle Laboratories, Inc.	223
Daven Co., The	Third Cover
DeJur Anisco Corporation	388, 390
Detroit Diesel Engine Div. General Motors Corp.	406
Dialight Corporation	96B
Doclean Corporation	235
Dow Corning Corporation	80A, 80B
Driver-Harris Company	219
Dupont de Nemours & Co., (Inc.), E. I.	241
Durant Manufacturing Co.	417
Dynamic Air Engineering Inc.	326
Eastern Air Devices, Inc.	277
Eastern Precision Resistor Corp.	409
Edison, Incorporated, Thomas A.	332
Eicor, Inc.	404

ARE YOU IN THE KNOW TOO ?

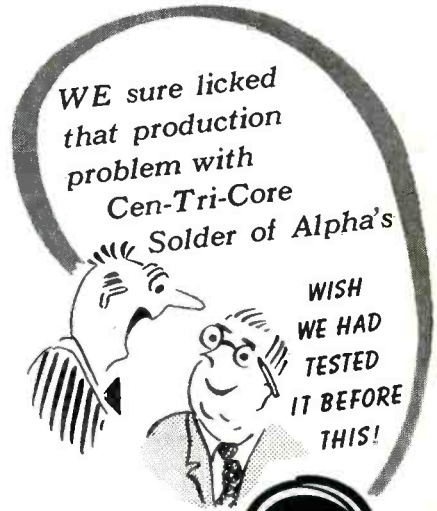

ALPHA

CEN-TRI-CORE

"ENERGIZED"

ROSIN-FILLED

SOLDER

MORE JOINTS PER POUND WITH CEN-TRI-CORE

Exclusive Features

- guarantees against rosin voids or skips
- eliminates cold joints and rejects
- available in eight core sizes
- solders to plated or oxidized parts
- simultaneous "wetting flow" and take
- surpasses federal specifications for non corrosiveness and purity

for further information write ...



ALPHA METALS, INC.
59 Water St., Jersey City 4, N. J.

Specialists IN SOLDER For Over 50 Years
Want more information? Use post card on last page.

MILO is a bridge!



Circuit bridges are indispensable in electronic development. Structural bridges are vital to modern civilization. Both are short-cuts. Detours can be interesting but, when you're in a hurry, head for the nearest bridge!

MILO is *your* bridge. With hundreds of ramps reaching back to the factories where electronic components and test instruments are made. With thousands of ramps leading to your plants where they are used.

MILO anticipates your needs. When you must have many different components to produce electronic devices quickly, there no time to meander about the *headwaters*—no need to go way back to the *source*. The material is already "on the bridge" at MILO. A phone call will start it down the ramp to you.

Check List (D-O) of LEADING BRANDS IN STOCK

Dale Products (Dalohm)	Guardian Electric	Kester
Dialco	Gudeman Company	Kings Electronics
Dumont	Haldorson	Krauter
Eby	Hallicrafters	Lectrohm
Eitel-McCullough	Hammarlund	Littelfuse
Elmenco	Hardwick Hindle	Mallory
Erie Resistor	Hickok	James Millen
Esico	Hytron (C B S)	Minnesota Mining & Mfg.
F T R (Federal)	I C A (Insuline)	Mueller
General Cement	I R C	Multicore
General Control	Industrial Instruments	National Company
General Electric	J B T	Ohmite
Greenlee	Jay Specialities	
Grayhill	E. F. Johnson	



MIL-SPEC COMPONENTS AVAILABLE

FREE CATALOG! *Chief Engineers, Qualified Executives!* Write now on your company letterhead for MILO'S edition of the 1954 Master. Please address Dept. E-10.

MILO RADIO & ELECTRONICS CORP.

ELECTRONICS FOR INDUSTRY

700 GREENWICH STREET, NEW YORK 7, N. Y. • Phone BEekman 3-2980

Teletype NY1-1839 • Wire MILO-WUX-N.Y. • Cable MILOELECTRO-N.Y.

Elsler Engineering Co., Inc.	452, 458
Eitel-McCullough, Inc.	65
Elco Corp.	448
Electran Mfg. Co.	447
Electric Regulator Corp.	283
Electrical Industries Div. of Amperex Electronic Corp.	319
Electro Motive Mfg. Co., Inc.	255
Electro Tec Corporation	299
Electro-Technical Products, Div. of Sun Chemical Corporation	252
Electronic Associates, Inc.	238
Electronic Computer, Div. of Underwood Corp.	502
Electronic Instrument Co., Inc.	401
Electronic Transformer Co.	126
Engineering Research Associates, Div. of Remington Rand, Inc.	254
Epeco Products, Inc.	445
Erie Resistor Corp.	84

Fairchild Camera & Instrument Corp.	316
Fairchild Engine & Airplane Corp.	342
Fansteel Metallurgical Corp.	426
Federal Telephone & Radio Corp.	307
Ferroxcube Corporation of America	61
Finn & Company, Inc., T. R.	280
Fluke Engineering Co., John	453
Ford Instrument Company	102
Freed Transformer Co., Inc.	261
Frequency Standards	413
Fusite Corporation	284

Gamewell Company	410
Garlock Packing Co.	246
Gates Radio Company	237
General Chemical Div., Allied Chemical & Dye Corporation	289
General Electric Company	
Apparatus Dept.	88, 89, 112, 275, 317
Electronics Dept.	19, 40, 41, 59
General Industries Co.	212
General Radio Company	17
Good-all Electric Mfg. Co.	402
Goodmans Industries Ltd.	124
Gramer Transformer Corp.	287
Grant Pulley & Hardware Co.	412
Graphite Metallizing Corp.	454
Grayhill	445
Green Instrument Co., Inc.	433
Gries Reproducer Corp.	425
Gudebrod Bros. Silk Co., Inc.	421
Gyromechanisms, Inc.	399

Hallett Manufacturing Company	321
Hallicrafters	90
Hammarlund Manufacturing Co., Inc.	414
Hanovia Chemical & Mfg. Co.	405
Hardwick, Hindle, Inc.	125
Hart Manufacturing Co.	264
Haydon Company, A. W.	409
Haydon Mfg. Co., Inc.	228
Heath Company	393
Heiland Research Corp.	222
Heldor Manufacturing Corp.	263

Helipot Corporation, a Div. of Beckman Instruments, Inc.	201
Hermetic Seal Products Co.	83
Hewlett-Packard Company	72, 73
Hickok Electrical Instrument Co.	445
Hinde & Dauch.	226
Hi-Q Division, Aerovox Corp.	368
Hopkins Engineering Co.	266, 431
Hudson Radio & Television Corp.	224
Hughes Aircraft Company.	233
Hughes Research & Development Labs	232, 415
Hycor Company, Inc.	413
Illinois Condenser Co.	453
Indiana Steel Products Company.	46, 47
Induction Motors Corp.	432
Industrial Hardware Mfg. Co., Inc.	449
Industrial Test Equipment Co.	431
Industrial Timer Corporation.	86
INFRA Electronic Corp.	403
Institute of Radio Engineers, The.	234
Instrument Electronics Corp.	395
Instrument Resistors Co.	391
Insulation & Wires Inc.	122
Intermetall.	419
International Rectifier Corp.	238
International Resistance Co.	28, 29
Ippolito & Co., Inc., James.	407
Iron Fireman, Electronics Div.	67
Irvington Varnish & Insulator Co.	127

James Vibrapowr.	381
JAN Hardware Manufacturing Co., Inc.	444
Jelliff Mfg. Corp., C. O.	427
Johns-Manville.	295
Johnson Co., E. F.	344
Jones Div., Howard B., Cinch Mfg. Corp.	449
Jones Electronics Co., M. C.	421

Kable Engineering Co.	227
Kalbfell Laboratories, Inc.	320
Karp Metal Products Co.	81
Kartron.	458
Kaupp and Sons, C. B.	245
Kearfott Company, Inc.	418
Kelthley Instruments.	334
Kellogg Company, M. W.	64A, 64B
Kellogg Switchboard & Supply Co.	411
Kenyon Transformer Co., Inc.	294
Kepeo Laboratories, Inc.	68
Kester Solder Company.	259
Keystone Electronics Company.	442
Kings Electronics Co., Inc.	343
Kinney Manufacturing Co.	265
Knights Company, James.	302
Kolleman Instrument Corp.	214

Laboratory for Electronics, Inc.	225
Lambda Electronics Corp.	395
Lampkin Laboratories Inc.	427
Lamson & Sessions Co.	92
Lapp Insulator Co., Inc.	242
Lavoie Laboratories, Inc.	313
Leach Relay Co.	204

Quality? PLUS ✓
Prices? COMPETITIVE ✓

**Specify Chemelec
Electronic Components**

**MADE OF
TEFLON**
duPont Trademark

Chemelec High Performance Electronic Components include a complete line of Teflon-insulated 7 and 9-pin Miniature Tube Sockets, 9-pin Connectors, Crystal Sockets, Stand-off Insulators, Feed Through Insulators and Terminals.

All provide the same high performance which this superior insulating material assures. Surface resistivity 3.5×10^{13} ohms. Loss factor less than 0.0005. Dielectric constant 2.0 (60 cycles to 30,000 megacycles). Serviceable at -110° F. to 500° F. Won't carbonize under arcing. Zero water absorption by ASTM Test. Unaffected by extreme humidity. Won't DC plate. Chemically inert, non-gassing, immune to corrosive atmospheres, fungus, oil, solvents. Non-flammable, tough, resilient, withstands and absorbs mechanical shock and vibration.

Write for Catalogs: Miniature Tube Sockets, No. SO-428; 9-pin Connectors, No. CN-409-M; Crystal Sockets, No. CS-441; Stand-off Insulators, No. TE-401; Feed Through Insulators and Terminals, No. CF-400.

**UNITED
STATES
GASKET
COMPANY**



**FLUOROCARBON
PRODUCTS DIVISION**
CAMDEN 1, NEW JERSEY

Representatives in Principal
Cities Throughout the World

THESE ELECTRONIC COMPONENTS

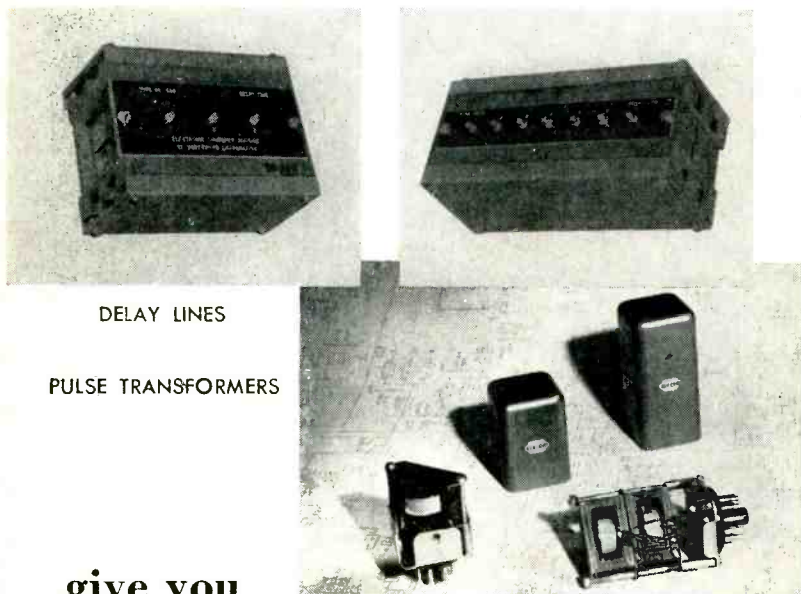

DELAY LINES

PULSE TRANSFORMERS

give you
PREDICTABLE PERFORMANCE AT LOWER COST:

The Electronic Computer Division of UNDERWOOD has overcome one of your major cost items . . . the expense of producing components for electronic equipment.

With ELECOM's facilities for producing custom-made components in large quantities, one of your development and production headaches is eliminated . . . and at significant money savings!

DELAY LINES with a delay-to-rise-time ratio as high as 45 to 1, with delay of 400 microseconds or more, as well as PULSE TRANSFORMERS offering reliable and predictable performance . . . these are some of the important electronic components available to you at costs usually *much lower* than if you design and manufacture in your own plant. Write today and let us know your requirements, or phone us in New York at EX 2-3400.



ELECTRONIC COMPUTER DIVISION
UNDERWOOD CORPORATION

35-10 36th Avenue Long Island City 6, New York

Originator's of ELECOM, Underwood's low-cost, high-speed electronic computers for practical research, engineering, and business applications.

Leeds & Northrup Company.....	60
Leland, Inc., G. H.....	330
Lenkurt Electric Sales Co.....	372, 373
Lewis & Kaufman, Ltd.....	203
Lindgren & Assoc. (Mfrs.) Erik A.....	405
Link Aviation, Inc.....	208
Lord Mfg. Co.....	268
Magnatran Incorporated.....	395
Magnecord, Inc.....	331
Magnetics Inc.....	455
Mallory & Co., Inc., P. R.....	128, 197
Mansol Ceramics.....	436
Marconi Instruments.....	324
Marion Electrical Instrument Company.....	243
Markem Machine Company.....	300
McLaughlin Corp., J. L. A.....	353
Measurements Corporation.....	444
Mepeco, Inc.....	91
Metal Textile Corporation.....	356
Metals & Controls Corp., General Plate Div.....	50
Methode Manufacturing Corp.....	424
Mica Insulator Co.....	44
Micro, A Division of Minneapolis-Honeywell Regulator Co.....	374
Microlab.....	439
Midland Mfg. Co., Inc.....	43
Miles Reproducer Co., Inc.....	158
Milford Rivet & Machine Co.....	306
Millen Mfg. Co., Inc., James.....	436
Millivac Instrument Corp.....	244
Milo Radio & Electronics Corp.....	500
Minneapolis-Honeywell Regulator Co. Aero Division.....	274
Industrial Division.....	98, 99
Minnesota Silicone Rubber Co.....	448
Mitchell-Rand Insulation Co., Inc.....	78
Moloney Electric Company.....	281
Motordyne Inc.....	391
Muirhead & Co., Limited.....	3
Multi-Metal Company.....	397
N. R. K. Mfg. & Engineering Co.....	456
National City Bank of New York.....	96A
National Moldite Co.....	96
National Research Corp.....	347
National Union Radio Corp.....	339
National Vulcanized Fibre Co.....	95
New Hermes, Inc.....	423
New London Instrument Co.....	345, 450
New York Transformer Co., Inc.....	420
Nielsen Hardware Corp.....	439
Northeastern Engineering Inc.....	327
Northern Radio Company, Inc.....	85
Nothelfer Winding Laboratories.....	156
Onan & Sons Inc., D. W.....	318
O'Neil-Irwin Mfg. Co.....	429
Oster Mfg. Co., John.....	437
PM Industries Inc.....	38
Pacific Scientific Co.....	338
Pallard Products Inc.....	273

Panoramic Radio Products, Inc.	410
Paramount Paper Tube Corp.	427
Patton-MacGuyver Company	399
Penn Engineering & Mfg. Corp.	220
Pennsylvania Optical Company	451
Phalo Plastics Corporation	392
Phelps Dodge Copper Products Corp.	
Inca Manufacturing Div.	54, 55
Pheoll Manufacturing Co.	338
PhotoCircuits Corporation	296
Pix Manufacturing Co., Inc.	441
Plaskon Division, Libbey-Owens-Ford Glass Co.	219
Plastoid Corporation	27
Polarad Electronics Corp.	439
Potter Instrument Company, Inc.	434
Precise Measurements Co.	458
Precision Apparatus Co., Inc.	504
Precision Paper Tube Co.	416
Premier Instrument Corp.	387
Presto Recording Corp.	79
Price Electric Corp.	119
Progressive Manufacturing Co.	348
Pye Limited	82
Pyroferrie Co.	371

Quaker City Gear Works	250
Quality Products Co.	458

R-B-M Div., Essex Wire Corp.	206
RFI Shielded Enclosures Corp.	301
Radio City Products Co., Inc.	385
Radio Cores, Inc.	358
Radio Corp. of America	247, 4th Cover
Radio Materials Corporation	285
Radio Receptor Co., Inc.	52, 349
Railway Communications, Inc.	370
Railway Express Agency, Air Express Div.	209
Rapid Electric Co.	389
Raytheon Manufacturing Co.	21, 230
Remler Company Ltd.	442
Reon Resistor Corp.	377
Resinite Corporation, Div. of Precision Paper Tube	450
Resistoflex Corporation	428
Rex Corporation	114
Rhode Island Insulated Wire Company, Inc.	71
Robinson Incorporated, Edward E.	393
Royal Metal Mfg. Co.	421

Saugamo Electric Company	256
Saratoga Industries, Inc.	320, 443
Sarkes Tarzian, Inc., Rectifier Div.	270
Scientific Electric, Div. "S" Corrugated Quenched Gap Co.	417
Scientific Electronic Labs, Inc.	429
Sealtron Corporation	329
Secon Metals Corporation	431
Servo Corporation of America	454
Servomechanisms, Inc.	396
Shakeproof Div. of Illinois Tool Works	97
Shallcross Manufacturing Co.	117

OUR EXPERIENCE PRODUCES ANOTHER HIGH PRECISION PRODUCT!

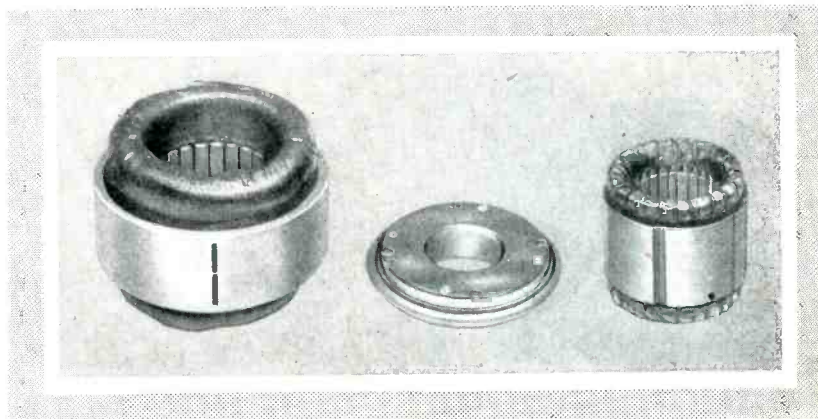

New

Celco

radar
deflection yokes



Celco

Celco is at present supplying the country's leading manufacturers of radar equipment with the latest type deflection yokes made to precise specifications. Units are now being manufactured using high nickel alloy steels punched to close tolerances with complex winding distributions and high voltage insulations.

Send drawings of your designs for quotation and take advantage of the Celco production experience in this specialized field.

OTHER CELCO SPECIALTIES

TRANSFORMERS
MAGNETIC AMPLIFIERS
STATOR WINDINGS
VARIABLE REACTORS
ROTOR CASTINGS

Constantine Engineering Laboratories Co.

70 ISLAND AVENUE,

MAHWAH, NEW JERSEY

PRECISION

SERIES ES-500A
HIGH SENSITIVITY—WIDE RANGE
5" OSCILLOSCOPE

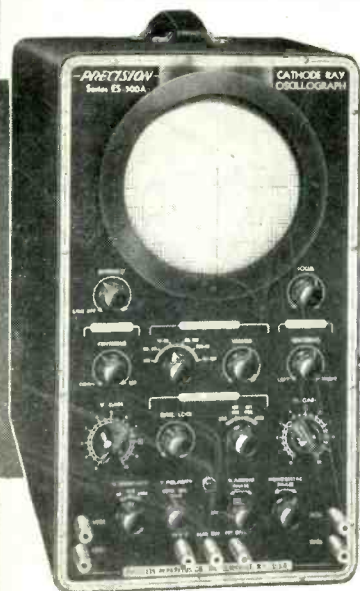

**PUSH-PULL
'V' and 'H' AMPLIFIERS**
20mv. per inch 'V' Sensitivity
1 Volt P-P Internal Calibrator

- ★ Regulated, Push-Pull Vertical Amplifier: .02v. per inch sensitivity. 10 cycles to 1 MC response. 2 Megs. and 22 mmf. input.
- ★ 1 Volt Peak to Peak, Regulated, Built-In Voltage Calibrator.
- ★ Compensated Vert. Input Step Attenuator.
- ★ 'V' Phase-Reversing Switch.
- ★ Push-Pull Horizontal Amplifier: .15v. per inch deflection sensitivity. 10 cycles to 1 MC response at full gain. 1/2 Meg. and 20 mmf. input.
- ★ Internal Linear Sweep: 10 cyc. to 30 KC.
- ★ Controlled, 4-Way Synch. Selection: Internal Pos., Internal Neg., External and Line.
- ★ 'Z' Axis Modulation Input.
- ★ Internal, Phasable 60 Cyc. Beam Blanking.
- ★ Sinusoidal Sweep Phasing Control.
- ★ All 4 Horizontal and Vertical Plate Connections Directly Accessible at Rear.
- ★ Four-Way Lab-Type Input Terminals.
- ★ Light Shield and Mask, removable and rotatable.
- ★ Fully Licensed under W.E. Co. patents.

SERIES ES-500A: In louvered, black ripple, heavy gauge steel case. 8 1/4" x 14 1/2" x 18".
Net Price \$173.70

SERIES SP-5 Oscilloscope Test Probe Set

for
WAVEFORM ANALYSIS, TROUBLE-SHOOTING,
SIGNAL TRACING AND ALIGNMENT
(with Series ES-500 and ES-500A)

Set includes shielded Master Cable and four different, detachable probe heads:

1. High Impedance—Low Capacity Probe
2. Signal-Tracing—Crystal Probe
3. Resistive—Isolating Probe
4. Shielded—Direct Probe

★ In vinyl-plastic carrying case.
Net Price \$23.50

PRECISION APPARATUS COMPANY, INC.

42-27 HORACE HARDING BLVD., ELMHURST 13, N. Y.
Export Division: 458 Broadway, New York 13, U.S.A. • Cables—Morhanex
In Canada: Atlas Radio Corp., Ltd., 560 King Street, W., Toronto 2B

Shaw Insulator Co.	413	Universal Winding Co.	32A, 32B, 32C, 32D
Shure Brothers, Inc.	334	Vector Electronic Co.	433
Sickles, F. W. Div. of General Instrument Corp.	231	Vectron, Inc.	422
Sigma Instruments, Inc.	311	Veeder-Root Incorporated	106
Signal Engineering & Mfg. Co.	429	Vickers Electric Div., Vickers Inc.	278
Simmons Fastener Corp.	339	Victoreen Instrument Co.	375
Simpson Electric Company.	357, 361	Victory Engineering Corp.	248
Sola Electric Co.	351	Vulcan Electric Company.	435
Sorensen & Company.	2		
South Chester Corp.	32		
Southern Electronics Company.	441		
Spencer-Kennedy Laboratories, Inc.	435		
Sperry Gyroscope Company.	293		
Sprague Electric Co.	9, 107, 379		
Stackpole Carbon Company.	33		
Standard Cabinet Company.	403		
Standard Piezo Company.	423		
Star Porcelain Company.	447		
Sterling Transformer Corp.	425		
Stevens-Arnold Inc.	308		
Steward Manufacturing Co., D. M.	376		
Stoddart Aircraft Radio Co.	394		
Stone Paper Tube Co.	93		
Stupakoff Ceramic & Manufacturing Co.	221		
Sun Parts Distributors Ltd.	458		
Superior Electric Company.	35		
Superior Tube Company.	66		
Switchcraft, Inc.	411		
Sylvania Electric Products, Inc.	7, 311, 397		
Synthane Corporation.	115		

Taylor Fibre Co.	103
Technitrol Engineering Co.	407, 433
Technology Instrument Corp.	362, 363
Tektronix, Inc.	36
Telechron Dept. of General Electric Co.	333
Telechrome, Inc.	419
Teletronics Laboratory, Inc.	116, 458
Tenney Engineering Inc.	380
Tensolite Insulated Wire Co., Inc.	387
Texas Instruments, Inc.	113
Thermador Electrical Mfg. Co.	451
Thomas & Skinner Steel Products Co., Inc.	416
Titeflex, Inc.	341
Tobe Deutschmann Corporation.	386
Trad Television Corp.	455
Transicoll Corporation.	367
Transistor Products Inc.	423
Transradio, Ltd.	365
Triad Transformer Corp.	346
Triplett Electrical Instrument Co.	301
Tru-Ohm Products Div. of Model Engi- neering & Mfg. Inc.	269
Tung-Sol Electric, Inc.	229

Ucinite Company, Div. of United Carr Fastener Corp.	70
Union Switch & Signal, Div. of Westinghouse Air Brake Co.	48, 49
United Electronics.	51
United Manufacturing & Service Co.	346
U. S. Components, Inc.	419
United States Gasket Co.	501
United States Motor Corp.	91
United Transformer Co.	2nd Cover
Universal Manufacturing Co.	403, 458

Waldes Kohlnoor, Inc.	37
Ward Leonard Electric Company.	100, 101
Waterman Products Co., Inc.	359
Waters Manufacturing, Inc.	240
Wavelline, Inc.	452
Webber Manufacturing Co., Inc.	437
Weckesser Co.	429
Westfield Metal Products Co., Inc.	411
Westinghouse Electric Corp.	64, 323, 403, 446
Weston Electrical Instrument Corp.	80
Wheeler Insulated Wire Co., Inc.	292
White Dental Mfg. Co., S. S.	260, 417
Whitney Blake Co.	354
Williams & Co., C. K.	365
Wilmad Glass Co., Inc.	449
Winchester Electronics Inc.	398

Zielik, Daniel D.	458
Zophar Mills, Inc.	397

PROFESSIONAL SERVICES. 457

SEARCHLIGHT SECTION (Classified Advertising)

H. E. HILTY, Mgr.

SEARCHLIGHT ADVERTISERS INDEX 496, 497

This index is published as a convenience to the readers. Every care is taken to make it accurate, but ELECTRONICS assumes no responsibility for errors or omissions.

Shocking News About Super Davohm Resistors



Since Daven originated the first pie-type wire wound resistor more than a generation ago, it has pioneered many innovations in the production of resistors.

Today, *only Daven* uses a stranded lead wire to connect the resistance wire to the solder terminal of the Super Davohm Precision Wire Wound Resistor.

As a result, no matter how much strain, stress, heat or pressure is applied to the solder terminal, no accompanying shock is put upon the fine resistance wire itself, but is absorbed by the heavy lead wire without adversely affecting the resistor in any way.

Therefore, Super Davohm Resistors are substantially more rugged than conventional resistors and are able to withstand unusual vibration, rough treatment and abnormal shocks.

This exclusive Daven feature, plus the many other quality aspects of Super Davohm Precision Wire Wound Resistors, makes Daven the leader in the resistor field.

The Super Davohm line includes resistors made in accordance with MIL-R-93A specifications, as well as sub-miniature units to give you the most complete selection of resistors available anywhere. Deliveries can be made to meet your requirements.

Write for assistance with your problems, and ask for a copy of Daven's complete, new brochure on Super Davohm Precision Wire Wound Resistors.

THE **DAVEN** CO.

191 CENTRAL AVENUE, NEWARK 4, N. J.



Why you can count on RCA Transistors for your designs

RCA is engaged in a program to provide the industry with transistors to meet equipment designers' needs now, and equipment manufacturing requirements in the future.

To achieve this goal, RCA is gearing transistor production to the progress being made in developing new manufacturing techniques and improved methods of production control.

As production volume grows with increasing demands, you can count on RCA to provide transistors of the highest quality consistent

with the best engineering practice known.

For technical data, or help on specific design problems using RCA transistors, write RCA, Commercial Engineering, Section 42-JR, Harrison, New Jersey. Or call your nearest RCA Field Office:

(EAST) Humboldt 5-3900, 415 S. 5th St., Harrison, N. J.

(MIDWEST) Whitehall 4-2900
589 E. Illinois St., Chicago, Ill.

(WEST) Madison 9-3671
420 S. San Pedro St.,
Los Angeles, Cal.



FREE technical bulletin on RCA Transistors; includes circuits, characteristics, typical operating conditions, curves, connections. Write: RCA, Commercial Engineering, Section 42-JR, Harrison, N. J.

APPLICATION GUIDE FOR RCA TRANSISTORS

RCA Type	Max. Ratings—Absolute Values		Characteristics at Ambient Temp. of 25°C			
	Collector Dissipation (mw)	Ambient Temperature (°C)	Power Gain (db)	Frequency for Alpha Cutoff (Mc)	Approx. Useful Power Output at 50 Mc (mw)	Current Amp. Factor (approx.)
RCA-2N32 Point-contact type—for pulse or switching applications	50	40	21*	2.7#	—	2.2†
RCA-2N33 Point-contact type—for oscillator applications up to 50 Mc	30	40	—	—	1.0	—
RCA-2N34 Junction p-n-p type—for low power, of amplifier applications	50	50	40**	—	—	40††
RCA-2N35 Junction n-p-n type—for low power, of amplifier applications	50	50	40**	—	—	40††

* With collector load resistance of 10000 ohms, signal-source impedance of 500 ohms, and signal frequency of 5000 cps.

†† Between Base Connection and Collector.

Measured at a point 3db down from its low-frequency value (100KC). Cutoff frequency is defined as the frequency at which the current amplification factor has dropped to 0.7 of its low-frequency value.

** With collector load resistance of 30000 ohms, signal-source impedance of 500 ohms, and signal frequency of 5000 cps.

† Between Emitter and Collector.



RADIO CORPORATION of AMERICA
TUBE DEPARTMENT
HARRISON, N. J.

Tmks.®